

BYTE

the small systems journal

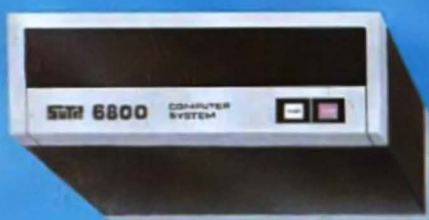

SWTPC announces first dual minifloppy kit under \$1,000

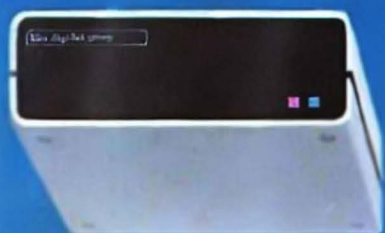

Now SWTPC offers complete best-buy computer system with \$995 dual minifloppy, \$500 video terminal/monitor, \$395 4K computer.



\$995 MF-68 Dual Minifloppy

You need dual drives to get full benefits from a minifloppy. So we waited to offer a floppy until we could give you a dependable dual system at the right price.

The MF-68 is a complete top-quality minifloppy for your SWTPC Computer. The kit has controller, chassis, cover, power supply, cables, assembly instructions, two highly reliable Shugart drives, and a diskette with the Floppy Disk Operating System (FDOS) and disk BASIC. (A floppy is no better than its operating system, and the MF-68 has one of the best available.) An optional \$850 MF-6X kit expands the system to four drives.



\$500 Terminal/Monitor

The CT-64 terminal kit offers these premium features: 64-character lines, upper/lower case letters, switchable control character printing, word highlighting, full cursor control, 110-1200 Baud serial interface, and many others. Separately the CT-64 is \$325, the 12 MHz CT-VM monitor \$175.



\$395 4K 6800 Computer

The SWTPC 6800 comes complete with 4K memory, serial interface, power supply, chassis, famous Motorola MIKBUG® mini-operating system in read-only memory (ROM), and the most complete documentation with any computer kit. Our growing software library includes 4K and 8K BASIC (cassettes \$4.95 and \$9.95; paper tape \$10.00 and \$20.00). Extra memory, \$100/4K or \$250/8K.

Other SWTPC peripherals include \$250 PR-40 Alphanumeric Line Printer (40 characters/line, 5 x 7 dot matrix, 75 line/minute speed, compatible with our 6800 computer and MITS/IMSAI); \$79.50 AC-30 Cassette Interface System (writes/reads Kansas City standard tapes, controls two recorders, usable with other computers); and other peripherals now and to come.

Circle 200 on inquiry card.

Enclosed is:

- _____ \$1,990 for the full system shown above (MF-68 Minifloppy, CT-64 Terminal with CT-VM Monitor).
- _____ \$995 for the Dual Minifloppy
- _____ \$325 for the CT-64 Terminal
- _____ \$175 for the CT-VM Monitor
- _____ \$395 for the 4K 6800 Computer

- _____ \$250 for the PR-40 Line Printer
- _____ \$79.50 for AC-30 Cassette Interface
- _____ Additional 4K memory boards at \$100
- _____ Additional 8K memory boards at \$250
- _____ Or BAC # _____ Exp. Date _____
- _____ Or MC # _____ Exp. Date _____
- Name _____ Address _____
- City _____ State _____ Zip _____



Southwest Technical Products Corp.

219 W. Rhapsody, San Antonio, Texas 78216
London: Southwest Technical Products Co., Ltd.
Tokyo: Southwest Technical Products Corp./Japan

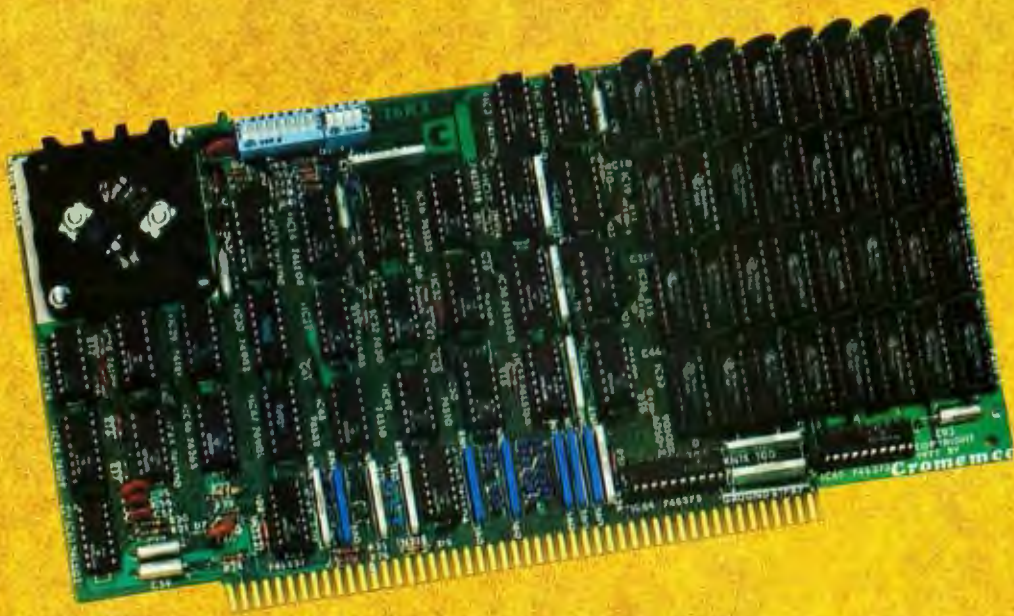

The new 16K RAM card that turns your computer into a working giant

Available now —
store/factory

Here's the industry's leading 16K RAM card.

It has two outstanding features that make it important to you:

(1) It's fast: It operates up to 4 MHz with no wait states. That's important because it lets you run programs on your Cromemco Z-1 and Z-2 computers in about half the time required by other systems. Even if your present computer is not 4 MHz fast, this new Model 16KZ RAM equips you for the time when you'll need and want higher computer speed.

(2) It has Cromemco's Bank-Select feature. Bank-Select lets you expand memory far beyond 64K bytes. Not just beyond 64K but far beyond — up to 512K bytes if you wish. Again, with Cromemco you get present outstanding performance plus obsolescence protection.

Bank-Select lets you organize memory into 8 banks of 64K each. The active bank is software-selected.

A useful giant

Whatever your S-100 bus computer — Cromemco, Altair 8800 or IMSAI 8080 — you can have enormous memory with the new Model

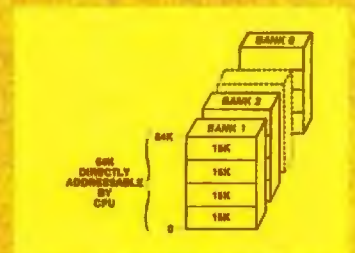
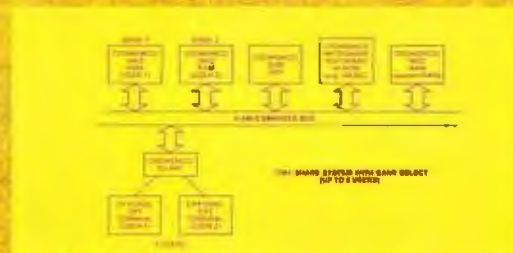

16KZ. You can run the large programs and files that make computers truly valuable — that take them out of the toy class and make them useful, producing units.

With Bank-Select you can even operate an S-100 bus computer as a time-share computer with up to 8 stations. A given memory bank can be accessed only by one station, so there is full confidentiality.

Advanced Cromemco engineering

Designing a 16K RAM card to operate at 4 MHz is a significant engineering accomplishment. That's why

Cromemco with our strong engineering staff is the only manufacturer to offer such a card.

And notice that this advanced card is available and ready for delivery — at your store or from the factory.

16K RAM memory kit (Model 16KZ-K) \$495.

16K RAM memory assembled, tested, and burned in for 160 hours (Model 16KZ-W) \$795.

Mastercharge and BankAmericard accepted with signed order. Show complete card number and expiration date. California users add 6% or 8% sales tax, as applicable.



Cromemco

incorporated

Specialists in computers and peripherals

2400 CHARLESTON RD., MOUNTAIN VIEW, CA 94043 • (415) 964-7400

Meet the most powerful μ C system available for dedicated work. Yet it's only \$595.*

Here's the muscle you've been telling us you wanted: a powerful Cromemco microcomputer in a style and price range ideal for your dedicated computer jobs—ideal for industrial, business, instrumentation and similar applications.

It's the new Cromemco Z-2 Computer System. Here's some of what you get in the Z-2 for only \$595:

- The industry's fastest μ P board (Cromemco's highly regarded 4 MHz, 250-nanosecond cycle time board).
- The power and convenience of the well-known Z-80 μ P.
- A power supply you won't believe (+8V @ 30A, +18V and -18V @ 15A — ample power for additional peripherals such as floppy disk drives).
- A full-length *shielded* motherboard with 21 card slots.
- Power-on-jump circuitry to begin automatic program execution when power is turned on.
- S-100 bus.
- Standard rack-mount style construction.
- All-metal chassis and dust case.
- 110- or 220-volt operation.

DEDICATED APPLICATIONS

The new Z-2 is specifically designed as a powerful but economical dedicated computer for systems work. Notice that the front panel is entirely free of controls or switches of any kind. That makes the Z-2 virtually tamper-proof. No accidental program changes or surprise memory erasures.

FASTEST, MOST POWERFUL μ C

Cromemco's microcomputers are the fastest and most powerful available. They use the Z-80 microprocessor which is

widely regarded as the standard of the future. So you're in the technical fore with the Z-2.

BROAD SOFTWARE/PERIPHERALS SUPPORT

Since the Z-2 uses the Z-80, your present 8080 software can be used with the Z-2. Also, Cromemco offers broad software support including a monitor, assembler, and a BASIC interpreter.

The Z-2 uses the S-100 bus which is supported by the peripherals of dozens of manufacturers. Naturally, all Cromemco peripherals such as our 7-channel A/D and D/A converter, our well-known BYTESAVER with its built-in PROM programmer, our color graphics interface, etc., will also plug into the S-100 bus.

LOW, LOW PRICE

You'll be impressed with the Z-2's low price, technical excellence and quality. So see it right away at your computer store—or order directly from the factory.

Z-2 COMPUTER SYSTEM KIT (MODEL Z-2K) (includes 4 MHz μ P card, full-length 21-card-slot motherboard, power supply, one card socket and card-guide set, and front panel; for rack mounting) \$595.

Z-2 COMPUTER SYSTEM ASSEMBLED (MODEL Z-2W) (includes the above as well as all 21 sockets and card guides and a cooling fan; for rack mounting) . . . \$995.



Shown with optional rack cabinet

*kit price



Cromemco

INCORPORATED

Specialists in computers and peripherals

2422 CHARLETON RD. MOUNTAIN VIEW, CA 94035 • (415) 964-7600

In the Queue

Foreground

- 12 SCORTOS: IMPLEMENTATION OF A MUSIC LANGUAGE
Software, Music—Taylor
- 30 CONTROL THE WORLD! (OR AT LEAST A FEW ANALOG POINTS)
Peripheral Interfaces—Ciarcia
- 62 TECHNIQUES FOR COMPUTER PERFORMANCES OF MUSIC
Computer Music—Chamberlin
- 84 TUNE IN WITH SOME CHIPS
Applications—Sierad
- 126 AN APL INTERPRETER FOR MICROCOMPUTERS, Part 2
Interpreter Design—Wimble

Background

- 26 A NEW DRESS FOR KIM
Design—Atkins
- 44 EXPANDING THE TINY ASSEMBLER
Software Design—Emmerichs
- 54 ONE-SIDED VIEW OF WIRE WRAP SOCKETS
Hardware—Rampil
- 102 THE NOVAL 760
System Description—Hauck-Nash
- 112 NOTES ON INTERFACING PLAYER PIANOS
Music Peripherals—Helmrs
- 122 NOTES ON ANATOMY: THE PIANO'S REPRODUCTIVE SYSTEM
Software History—Morgan
- 190 WALSH FUNCTIONS: A DIGITAL FOURIER SERIES
Interface Technology—Jacoby

Nucleus

- 4 In this BYTE
- 6 Reflections on Entry into Our Third Year
- 8 Letters
- 25 Alphanumeric Music
- 50 Review: Heuristics SpeechLab
- 59 Technical Forum: Personal Computer Network
Adding New Transcendentals to Limited BASiCs
On Finite State Machines and Their Uses
Comments on Floating Point Representation
- 97 Ask BYTE
- 110, 210, 216 What's New?
- 166, 200 BYTE's Bits
- 172 BYTE's Bugs
- 186 Clubs, Newsletters
- 202 Book Reviews
- 222 Classified Ads
- 224 BOMB
- 224 Reader Service

PUBLISHERS
Virginia Peschke
Manfred Peschke
EDITOR IN CHIEF
Carl T. Helmers Jr
PRODUCTION MANAGER
Judith Havey
CIRCULATION MANAGER
Gregory Spitzladen
ASSISTANT PUBLISHER
Debra Boudrieau
EDITOR
Christopher P. Morgan
CO-OP EDITOR
Scott Morrow
PRODUCTION EDITORS
Karen Gregory
Nancy Salmon
ADVERTISING
Debra Boudrieau, Director
Norcen Bardsley
Virginia Peschke
EDITORIAL ASSISTANT
Ingrid Nyland
PRODUCTION ASSISTANT
Cheryl Hurd
NEW PRODUCTS EDITOR
Elizabeth Albaugh
DEALER SALES
Ginnie F. Boudrieau
CLUBS, PAPERBYTES
Peter Travisano
TRAFFIC MANAGER
Edmond C. Kelly Jr
ART
Wai Chiu Li
Ellen Shamonksy
SPECIAL PRODUCTS
Floyd W. Rehling
Medellin Stephens
David Wozmak
EXECUTIVE SECRETARY
Patricia Clark
RECEPTIONIST
Jacqueline Earnshaw
DRAFTING
Douglas Glen
Stephen Kruse
Lynn Malo
Bill Morello
Dorothy Shamonksy
TYPOGRAPHY
Custom Marketing Resources Inc
Goodyway Graphics
PHOTOGRAPHY
Ed Crabtree
EDITORIAL CONSULTANT
Daniel Fylstra
ASSOCIATES
Walter Banks
Steve Ciarcia
David Fylstra
Portia Isaacson
FOREIGN DISTRIBUTOR
Pan Atlantic Computer Systems GmbH
Frankfurter Str 78
D61 Darmstadt West Germany
(0 61 51) 29 29 23

ADVERTISING SALES REPRESENTATIVES

National:
Parker & Short
1 Lakeside Office Park
Wakefield MA 01880
(617) 246-2293
Southern California:
Buckley/Boris Associates Inc
912 South Barrington
Suite 202
Los Angeles CA 90049
(213) 826-4621
Northern California:
Jules E. Thompson Inc
Hearst Building
Suite 1111
San Francisco CA 94103
(415) 362-8547

BYTE is published monthly by BYTE Publications Inc, 70 Main St, Peterborough NH 03458. Address all mail except subscriptions to above address; phone (603) 924-7217. Address all editorial correspondence to the editor at the above address. Unacceptable manuscripts will be returned if accompanied by sufficient first class postage. Not responsible for lost manuscripts or photos. Opinions expressed by the authors are not necessarily those of BYTE. Address all subscriptions, change of address, Form 3579, and fulfillment complaints to BYTE Subscriptions, PO Box 361, Arlington MA 02174; phone (617) 646-4329. Second class postage paid at Peterborough NH 03458 and at additional mailing offices—USPS Publication No. 102410. Subscriptions are \$12 for one year, \$22 for two years, and \$32 for three years in the USA and its possessions. Add \$5.50 per year for subscriptions to Canada and Mexico. \$25 for a one year subscription by surface mail worldwide. Air delivery to selected areas at additional rates available upon request. \$25 for a one year subscription by air delivery to Europe, or DM 60,— for a one year subscription through our European distributor in Darmstadt, West Germany. Single copy price is \$2.00 in the USA and its possessions, \$2.40 in Canada and Mexico, and \$3.50 in Europe or DM 8,— through our European distributor in Darmstadt, West Germany, and \$4.00 elsewhere. Foreign subscriptions and sales should be remitted in United States funds. Printed in United States of America. Entire contents copyright © 1977 by BYTE Publications Inc. All rights reserved.

About the Cover

The conceptual target of the cover painting for September was a theme of music and sound. Taking this theme, Robert Tinney implemented this cover, entitled "Breaking the Sound Barrier." It was inspired by the legend of opera star Enrico Caruso breaking a wine glass through sympathetic resonances with his voice. The sound barrier we're referring to, of course, is the physical barrier between a program and the real world, which is crossed by one of a number of musical and audio output devices and software presently on the market or about to come to the marketplace.

In This BYTE

Experimenting with music on your computer can be very rewarding. If you're looking for a streamlined way to input musical material into your system, look no further. Hal Taylor shows you how in **SCORTOS: Implementation of a Music Language**. Who knows, with SCORTOS you could have your synthesized concerto for alpenhorn and orchestra up, running and debugged by next week.

A naked microcomputer board is unprotected from a harsh environment. In his article this month, R Travis Atkins turns couturier as he fashions external garb in the form of **A New Dress for KIM**.

Steve Garcia returns this month with a combination of tutorial ideas and practical details so characteristic of his style. Read Steve's **Control the World! (Or at Least a Few Analog Points)** to review digital to analog conversion, and learn how BASIC can be used to compute and represent waveforms through a converter using a scope as a display.

2 Flutes

P02 K2- T3/4 O3 F4 G4 A6. F16 / O4 C8. C8 B16 O2 F4 B4 / D8. E16 F4. G8 / F E D C O3 B O2 C /
P03 K2- T3/4 O3 F2.^ / F4 F2.^ / F2 4 / F2.^ / F2 4 /

page 12

A Tiny Assembler need not have tiny features, as Jack Emmerichs explains in his article on **Expanding the Tiny Assembler**. Jack adds structured programming features and incremental improvements to the Tiny Assembler design he described in April and May issues of BYTE this year. By reorganizing the symbol table to add the "begin" pseudo operation, "Tiny" takes on a number of "big" features while preserving practical operation as Version 3.1 in under 4 K bytes of memory.

Looking for a very simple way to build a wire wrap board? Ira Rampil has an idea in **A One-Sided View of Wire Wrap Sockets**.

Are you interested in making music with your computer? Hal Chamberlin's **A Sampling of Techniques for Computer Performance of Music** is one of the best ways to get acquainted with this fascinating field. The article will give you complete directions for creating 4 part harmony on your microprocessor for a very modest investment. Get out those 4 voice fugues that have been languishing in your music drawer and bring them to life!

Did you ever want your computer to sing you a lullaby? Well, as Ted Sierad points out, it's not too hard to do so if you **Tune In With Some Chips**, using the circuit and software he describes.

The roster of "complete" computer systems for the amateur computing person expanded considerably with the introduction of the Noval 760. Turn to an account by designers Lane T Hauck and James D Nash, **System Description: the Noval 760**, for details of the philosophy and overall design behind this product.

A double feature written by Carl Helmers and Chris Morgan of BYTE covers key details of an interesting musically oriented peripheral which can be added to the personal computer: acoustic pianos with pneumatic player actions. **Notes on Anatomy: The Piano's Reproductive System** gives global morphology of a Duo-Art upright reproducing piano. **Notes on Interfacing Pneumatic Player Pianos** covers some details of how to engineer a computer interface for the pneumatic control lines using valve elements manufactured for the pipe organ industry.

With this issue, readers will note the continued progression of information on APL, and several articles introducing the theme of music representation and performance with computers. Readers can look forward to further information on these themes in future issues.

APL is one of the most interesting high level languages around these days. If you want to continue learning what goes on in an APL interpreter, read part 2 of Mike Wimble's **An APL Interpreter for Microcomputers**. Here Mike covers the expression evaluation sections of the interpreter.

Many people are familiar with use of orthogonal basis functions such as sines and cosines to compute arbitrary waveforms. But how many readers have heard of **Walsh Functions: A Digital Fourier Series** which forms arbitrary repetitive waveforms as weighted sums of digital waveforms? Read Benjamin F Jacoby's tutorial to find out a bit about these functions and their generation.

Announcing the West Coast's largest Personal Computing Show. April 28, 29, and 30, 1978 at California's brand new Long Beach Convention Center. This is a selling show with 180 booths (each draped, carpeted and with 500 watts of electricity). Three full days of conference sessions. There will be home brew exhibits, exhibitors lounge, inquiry badge system, computerized registration, a newsroom, and a full blown advertising and promotional campaign to bring you thousands of qualified buyers.



PERCOMP '78[®]

**I wouldn't miss it
for anything.**

Send me the show kit:

Name: _____ Title: _____

Company: _____

Address: _____ State: _____

Zip Code: _____ Phone: _____

Call: (714) 973-0880 Or mail this coupon: PERCOMP 78,
1833 E. 17 St., Suite 108, Santa Ana, CA 92701.

Sign early, corner booths are limited.

Editorial

BYTE's 0.02 Centennial

Reflections on Entry into Our Third Year

By Carl Helmers

The September 1977 BYTE marks the end of the second year of our publication's existence in the public eye, although actual work on the magazine began at the end of May 1975. Since that time, the phenomenon of personal computing has expanded considerably as more people become aware of it through mass media publications, radio and television shows, trade fairs such as the First West Coast Computer Faire and the National Computer Conference. Good sense says a peak must be reached in any new and expanding marketplace, but to date we have seen no signs of the traditional "shakeout" (intense competition such as that which occurred recently in the calculator and watch marketplaces). For whatever reasons, a few firms have fallen by the wayside, but the general trend still remains one of expansion and exploration, to the ultimate benefit of the user of personal computing products who is presented with new options and lower prices for older options.

The "appliance" computer, a complete system presented in an assembled and tested package is on the threshold of its ultimate dominance in the general purpose personal computer field: from the high end, moving down in price, we find products like the Apple-II and the Commodore PET 2001 machines; from the low end, moving up in function at the same price, we find the increasing versatility and capability of programmable calculators such as the newly announced Texas Instruments SR-59 with its optional ROM software modules and expanded printing and magnetic card peripheral capabilities. And for the discrimi-

Continued on page 95

Rated **G** Great Locations

Now Open:

22634 Foothill Blvd.
Hayward, CA 94542
(415) 538-8080

6840 La Cienega Blvd.
Inglewood, CA 90302
(213) 776-8080

24001 Via Fabricante
Mission Viejo, CA 92675
(714) 770-0131

4233 Convoy Street
San Diego, CA 92111
(714) 560-9912

104 W. First Street
Tustin, CA 92680
(714) 544-0542

50 East Rand Road
Arlington Heights, IL 60004
(312) 255-6488

9511 No. Milwaukee Ave.
Niles, IL 60648
(312) 967-1714

813-B Lyndon Lane
Louisville, KY 40222
(502) 425-8308

16065 Frederick Road
Rockville, MD 20855
(301) 948-7676

2 De Hart Street
Morristown, NJ 07960
(201) 539-4077

1612 Niagara Falls Blvd.
Buffalo, NY 14150
(716) 836-6511

225 Elmira Road
Ithaca, NY 14850
(607) 277-4888

6439 Westheimer Road
Houston, TX 77057
(713) 977-0909

Opening Soon:

Huntsville, AL
San Francisco, CA
San Jose, CA
Thousand Oaks, CA
Detroit, MI
Nashua, NH
Austin, TX

Franchise Opportunities Available—Contact:

**E. E. Faber, President
ComputerLand Corp.**

1922 Republic Ave.
San Leandro, CA 94577
(415) 895-9363

Articles Policy

BYTE is continually seeking quality manuscripts written by individuals who are applying personal systems, or who have knowledge which will prove useful to our readers. Manuscripts should have double spaced typewritten texts with wide margins. Numbering sequences should be maintained separately for figures, tables, photos and listings. Figures and tables should be provided on separate sheets of paper. Photos of technical subjects should be taken with uniform lighting, sharp focus and should be supplied in the form of clear glossy black and white or color prints (if you do not have access to quality photography, items to be photographed can be shipped to us in many cases). Computer listings should be supplied using the darkest ribbons possible on new (not recycled) blank white computer forms or bond paper. Where possible, we would like authors to supply a short statement about their background and experience.

Articles which are accepted are typically acknowledged with a binder check 4 to 8 weeks after receipt. Honorariums for articles are based upon the technical quality and suitability for BYTE's readership and are typically \$25 to \$50 per typeset magazine page. We recommend that authors record their name and address information redundantly on materials submitted, and that a return envelope with postage be supplied in the event the article is not accepted. ■

Rated **G**

The Best Game in Town.

Welcome to ComputerLand. An incredible adventure into the world of personal computers. A one-of-a-kind shopping experience.

Each ComputerLand store presents everything you ever wanted to know about computers. And then some.

Take our Game Room, for starters. You'll find excitement for the whole family in our endless variety of challenging computer games. You can battle the Klingons in an out-of-this-world game of Star Trek. Create an electronic work of art with a computer controlled TV. Test your skill in a game of computerized hangman.

You can even plot your biorhythm.

But we're more than just fun and games. Each ComputerLand store offers a knowledgeable and personable staff of professionals



And if your system breaks down, our in-store service department will get you back up and running.

Right now!

Great Selection.

Your first stop at ComputerLand may well be your last stop.

ComputerLand offers the finest quality and



Largest selection of all the major brand names. Like Apple Computer, Cromemco, DEC, Diablo, Hazeltine, ICOM, IMSAI, Lear Siegler, National Semiconductor, North Star, Texas Instruments, Vector Graphics and more.

to serve you.

Plus the greatest avail-

able selection of micro components. Whether it's a data processing system for your business or a computer controlled sprinkler system for your home, you'll find whatever you need at ComputerLand.

Plus a complete inventory of tools, books and accessories.

What's more, at ComputerLand, we deal in product. Not promises. Our inventory is on our own shelves. Rather than the manufacturer's. So you can take delivery on tomorrow's components today.



Read on.

Genuine Service.

We want to supply you with the one system that's right. Rather than a complete system that isn't. Or a limited system that is.

That's why, at ComputerLand, you deal with real professionals who are also real people. People who speak your language

... in addition to BASIC, COBOL or FORTRAN.

People, in short, who can offer both the novice and the old hand the same expert guidance in selecting the optimum system he or she needs.

Yet, assisting in the purchase is only the beginning of ComputerLand's service. If the kit you bought requires a little more do-it-yourself than you yourself can do, we provide assembly assistance.

If that complex program proves to be just that, we provide programming assistance.

Which means, simply put, that at ComputerLand, you get exactly what you want.

Exactly when you want it.

Be Our Guest.

Begin with the grand tour of our exhibit areas. "Test-drive" any of our individual systems.

Then tell us your needs. We'll sit down and talk about the system that's right for you. It's as easy as that at ComputerLand.



The great computer store. RATED G.

Call or write for the address of the ComputerLand store nearest you. Franchise opportunities available.

ComputerLand™

1922 Republic Avenue, San Leandro, CA 94577 (415) 895-9363

Letters

REGARDING INTERFACING THE IBM SELECTRIC KEYBOARD PRINTER

My congratulations to Mr Fylstra on a job well done in his June article in BYTE. I spent half a year, back in 1970, on designing the interface for the 735 Selectric to the Microdata 800 Mini-computer, and in the process went through many of the discoveries revealed in the article. As the man who serviced our IBM IO printers (an ex-IBM'er) said to me, that machine is a triumph of development over engineering!

One fruit of my work was a 2048 bit ROM which we custom programmed to do the ASCII to "bail code" conversion and back, without recourse to a software lookup table. It is still available as the MM5230KP from National Semiconductor. But note that it handles only the "correspondence" version of the Selectric: our machine needed full upper and lower case graphics.

Dan's comments on using the "a" and "b" contacts for figuring ready/busy of the printer are quite valid. One thing we learned was that allowing the clutch to stop between characters does lead to shortened life between adjustments. Back in 1970 we used a TTL voting circuit to read the contacts, because they bounced so much, and accurate timing is essential for "wide open" running.

One last point: The contacts are open reed, and *must* be "wetted" by using a current several times higher than the 5 mA shown, else they get dirty very quickly.

Good luck to all ye who pass this way again!

Richard Percival
National Semiconductor GmbH
Industriestrasse 10
808 Furstenfeldbruck GERMANY

IS BUS COMPATIBILITY NEEDED?

I have recently noticed that many people ascribe a certain importance to a product if it is "Altair (S-100) compatible." This should not be unusual; many people own Altair bus based systems and wish to buy only what is useful to them. But I am angered by people who automatically downgrade a product that is not S-100, even if they do not own a system themselves. They seem to think that compatibility and board interchangeability rank high on the list of priorities for a "good" computer system. This is typical of most of the hobby market.

I feel that the next few years will bring a change in that viewpoint. As computers become more and more

common, processor power and built-in features will take precedence over bus compatibility. This is especially true in the consumer market. Who, in the early days of radio, would buy a separate tuner, amplifier and speaker assemblies if they could buy a complete, assembled unit? Consumers would never consider buying and inserting full size printed circuit boards into a system; they will rarely care whether they have a separate video board of a video section or a single board computer if it works.

This is not to say that the Altair (S-100) design will vanish. The large number of systems and boards available makes it a great system for *someone who knows what he or she is doing*. For all others, a system that is self-enclosed and requires no expansion for basic IO devices (tape recorder, TV set) will be more popular.

If we are to go anywhere with home computers, as designers we must understand what consumers expect them to do; we must not force them to adapt to our insufficiencies; we must learn to provide a useful and well-integrated product.

C David Espinosa
21191 Gardens Dr
Cupertino CA 95014

The first automobiles were not truly consumer oriented, either, but as the public became educated in the uses of the product and as manufacturers learned more about the product and its design, the personal transporter became today's ubiquitous mechanism. In the continuing evolution of the personal computer, a similar user orientation is in the works and presently unfolding as innovative technological entrepreneurs gain experience and refine the product concepts.

IBM 360/370 EMULATIONS

Concerning Tom Koon's letter in the May 1977 BYTE about 360/370 emulation: this has already been done in at least one instance that I know of. Roger Appel of Interdata recently mentioned that his company took on this project a few years back. Interdata's Boston area phone is (617) 890-0557, and as to the price, don't count on it being cheap.

J Howell Mitchell Jr
Dynamics Research Corp
60 Concord St
Wilmington MA 01887

A PUZZLE: DELETING THE DELIMITER

I have comments to make regarding Dave Chapman's problems with delimiting the delimiter (May 1977 BYTE). There is a similar but even more annoying problem if you're working with an editor program which has a delete character.

The question is, how do you change

There's an iCOM for Everyone at these Computer Stores...

ARIZONA

Byte Shop
Tempe
(602) 894-1129

CALIFORNIA

Orange Computer Ctr
Costa Mesa
(714) 646-0221

Byte Shop
Lawndale
(213) 371-2421

Byte Shop
Mt. View
(415) 969-5464

Computer Mart
Orange
(714) 633-1222

Byte Shop
Pasadena
(213) 684-3311

Byte Shop
Santa Barbara
(805) 966-2638

Byte Shop
Santa Clara
(408) 249-4221

Byte Shop
San Diego
(714) 565-8008

Byte Shop
San Rafael
(415) 457-9311

Computer Room
San Jose
(408) 226-8384

Byte Shop
Tarzana
(213) 343-3919

Tech-Mart
Tarzana
(213) 344-0153

Byte Shop
Thousand Oaks
(805) 497-9595

Byte Shop
Walnut
(415) 933-6252

Byte Shop
Westminster
(714) 894-9131

COLORADO

Prime Radix
Denver
(303) 573-5942

FLORIDA

Byte Shop
Miami
(305) 264-2983

The Computer Store
Jacksonville
(904) 725-8158

ILLINOIS

Itty Bitty Machine
Evanston
(312) 328-6800

Numbers Racket
Champaign
(217) 352-5435

Champaign Computer
Champaign
(217) 359-5883

INDIANA

Data Group
Indianapolis
(317) 849-5280

KENTUCKY

Cybertronics
Louisville
(502) 499-1551

MASSACHUSETTS

American Used
Computer
Boston
(617) 261-1100

MINNESOTA

Microprogramming
Burnsville
(612) 894-3510

NEW HAMPSHIRE

Computer Mart
Nashua
(603) 883-2386

NEW JERSEY

Computer Mart
Iselin
(201) 283-0600

NEW YORK

Synchro Sound
Hollis
(212) 468-7067

Computer Mart
NYC
(212) 686-7923

NORTH CAROLINA

Digital Dynamics
Charlotte
(704) 374-1527

PENNSYLVANIA

Byte Shop
Brymar
(215) 525-7712

SOUTH CAROLINA

Carolina Computers
Columbia
(803) 798-6524

TEXAS

Micro Store
Richardson
(214) 231-1096

Microtex
Houston
(713) 780-7477

Computer Terminal
El Paso
(915) 542-1638

WISCONSIN

Madison Computer
Madison
(608) 255-5552

CANADA

Computer Mart
Toronto
(416) 484-9708

Computer Place
Toronto
(416) 598-0262

iCOM MICROPERIPHERALS®
6741 Variel Ave., Canoga Park, CA 91303 U.S.A.
Tel. (213) 348-1391 a division of Perlec Computer Corporation

Rich Man, Poor Man, Merchant, Physician, Teacher, Lawyer, Student, Musician....



There's an iCOM Floppy Disk System for Everyone!

More Uses

People from every walk of life are adding iCOM® Floppy Disks to their microcomputers for such diverse tasks as payroll, inventory control, mailing lists, game playing, record keeping, parts ordering . . .

We've uncovered some innovative applications, too: The sailboat architect who puts equations and algorithms on an iCOM disk to test his nautical theories; the student who has automated a bowling alley; the iCOM dealer who designed an environmental control system for a university.

More Speed

These users have found iCOM floppies to be much faster and more versatile than cassette or paper tape.

With iCOM, programs can be loaded in seconds; files updated in minutes; hundreds of programs can be stored on a single disk.



More Models

iCOM has Frugal Floppies™, Dual Floppies, Microfloppies™ (using the new 5 1/4" diskette), and other new approaches to floppy disk systems. Each is hardware and software compatible with Altair™, IMSAI, Poly 88, Sol-20 and other microcomputers using the Altair S-100 bus format.



More Software

Then there's iCOM's famous software: Powerful field-proven FDOS-II with macro-assembler, string-oriented text editor, and file manager. Plus easy-to-use compatible 8K Disk BASIC. Each with super features such as: named variable length files, auto-file create, open and close, multiple merge and delete . . . and more.

More Backup

We've been building floppies for microcomputers for more than 3 years. Long before the rest. Thousands of systems are operating perfectly in the field. And we're part of Perlec Computer Corporation, one of the largest manufacturers of peripherals, microsystems, data entry products and data processing systems. We'll be around whenever you need us.

More Dealers

Maybe not in quantity, but in quality. We've chosen our dealer network carefully to assure you of assistance every step of the way. Our prices are right. Our delivery is fast. Our dealers are experienced and knowledgeable.

Must Reading

Our free booklet, "What a Floppy Disk Can Do for You" is must reading. Send for yours today or visit your dealer.

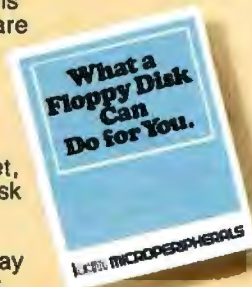

©1977, Perlec Computer Corporation

iCOM® MICROPERIPHERALS®

a division of Perlec Computer Corporation

6741 Variel Ave., Canoga Park, CA 91303 U.S.A.
Tel. (213) 348-1391 TWX 910-494-2788

a delete character, when typing the character deletes the previous character? A variation of this exercise is obtained when you suppose that somehow the character for "change" has been set to be the character for "delete."

These are amusing puzzles, and it can be left to the reader to figure out how to get into and out of these situations.

E G Johnston
Computer Sciences Corporation
Silver Spring MD 20910

MORE ON SR-52/SR-51 INTERNALS

I am interested in interfacing the SR-52 with some other equipment and

have gathered a little (very little) information which might help William D Lewis (letters of June 1977 BYTE) with his SR-52. First, the SR-52 and SR-51 terminal strips appear to be similar. The SR-52 has a TMC0501NL which they call U1 and a TMC0524NL which appears to be a version of the TMC-0523NS-5, but it is called U2.

The terminal strip connectors in the order shown in the June BYTE are: NC, D12, 02, Ext, IDLE, IRG, D15, DO, 01, KN, KP, KR. The pinouts of the TMC-0501NL are: 1(DPT), 2(SB), 3(SA), 4(SF), 5(SC), 6(SD), 7(SE), 8(KT), 9(KS), 10(KR), 11(KQ), 12(KP),

Continued on page 174

OUR DEALERS

NORTHEASTERN STATES

Computer Workshop, Rockville, MD; Computer Mart, Waltham, MA; Iselin, NJ; Hoboken Computer Works, Hoboken, NJ; Audio Design Electronics, New York, NY; Byte Shop East, Levittown, NY; Computer Corner, White Plains, NY; Computer Enterprises, DeWitt, NY; Fayetteville, NY; Computer Mart of New York, New York, NY; Computer Shoppe, Middle Island, NY; Ithaca Audio, Ithaca, NY; Byte Shop, Bryn Mawr, PA; Personal Computer Corp., Frazer, PA

SOUTHEASTERN STATES

Computer Hut, Hialeah, FL; Delta Electronics, Leesburg, FL; Douglas Computer Systems, Jacksonville, FL; Economy Computing Systems, Orlando, FL; Electronic Shop Inc., Melbourne, FL; Microcomputer Systems Inc., Tampa, FL; Computer Systems Center, Atlanta, GA; Computer Electronics, Baton Rouge, LA; Byte Shop, Columbia, SC

MIDWESTERN STATES

American Microprocessors, Prairie View, IL; Bite and Bytes, Posen, IL; Itty bitly machine company, Evanston, IL; Lillipute Computer Mart, Skokie, IL; Numbers Racket, Champaign, IL; Data Domain, Bloomington, IN; Home Computer Center, Indianapolis, IN; Micro Bus Inc., Cedar Rapids, IA; Data Domain, Louisville, KY; Computer Mart, Royal Oak, MI; Computer Systems, St. Clair Shores, MI; General Computer, Troy, MI; Computer Depot, Minneapolis, MN; Computer Room Inc., Eagan, MN; High Technology, Oklahoma City, OK; Milwaukee Computer Store, Milwaukee, WI

WESTERN STATES

Bits & Bytes Computer Shop, Phoenix, AZ; Personal Computer Place, Mesa, AZ; Affordable Computer Store, Santa Clara, CA; A-VIDD Electronics, Long Beach, CA; Bits n Bytes, Fullerton, CA; Byte Shop, Burbank, CA; Fresno, CA; Lawndale, CA; Long Beach, CA; Palo Alto, CA; Pasadena, CA; Placentia, CA; San Diego, CA; San Jose, CA; San Rafael, CA; Santa Clara, CA; Tarzana, CA; Thousand Oaks, CA; Walnut Creek, CA; Westminster, CA; Computer Center, Costa Mesa, CA; Computer Center, San Diego, CA; Computer Components, Van Nuys, CA; Computer Electronics, Santa Barbara, CA; Computer Emporium, Newport Beach, CA; Computerland, San Leandro, CA; Computer Mart, Orange, CA; Computer Playground, Westminster, CA; Computer Power and Light, Studio City, CA; Computer Store of San Francisco, San Francisco, CA; Dunston Enterprises, Redding, CA; Executive Office Equipment, Pasadena, CA; Micro Computers, Fountain Valley, CA; Microsystems Engineering, San Francisco, CA; Sunny Sounds, San Gabriel, CA; Sunshine Computer, Carson, CA; Upland Computer Labs, Upland, CA; Ximedia, San Francisco, CA; Byte Shop, Boulder, CO; Englewood, CO; Mighty Mini Company, Denver, CO; Microcomputer Systems of Hawaii, Honolulu, HI; Small Computer Systems, Honolulu, HI; Computer Mart of West Texas, Lubbock, TX; Computer Shop, San Antonio, TX; Computer Terminal, El Paso, TX; Electronic Specialty, Houston, TX; Houston Computer Mart, Houston, TX; KA Electronic Sales, Dallas, TX; Micro Store, Richardson, TX; Vanguard Systems, San Antonio, TX

FOREIGN

Microtech Computers, Winnipeg, Manitoba, Canada; Haywood Electronic Associates Ltd., Northwood, Middlesex, England; Instrumatic, Geneva, Switzerland.



VECTOR GRAPHIC INC.

790 HAMPSHIRE ROAD • A + B
WESTLAKE VILLAGE, CA 91361

Not Affiliated With Vector General

AN IMPORTANT WARNING ABOUT THE ELEMENT MERCURY AND ITS COMPOUNDS

The June 1977 issue of BYTE arrived recently and Mr Pasken's letter on obtaining mercury caught my eye, causing me to go back and read Mr Firth's article on weather prediction in the December 1976 issue, page 62, which I had not read the first time around. I fear that Mr Firth, and perhaps Mr Pasken, are under a misapprehension as to the nature of the hazards of contact with metallic mercury. As an industrial hygienist, I feel impelled to set the record straight and to comment on Mr Pasken's method of obtaining mercury.

A note in Mr Firth's article states that "mercury can be harmful if you breath the vapors, swallow it or otherwise get it in your body. But there is little danger from . . . putting your hands in it." It is true that mercury vapors are harmful; however, the rest of the statement I have quoted is, by and large, *not true* for metallic mercury, which is what one would use in a barometer. Metallic mercury is readily absorbed through the skin. On the other hand, if swallowed it passes virtually without absorption through the gastrointestinal tract and presents very little hazard to the individual. (One should, of course, try to avoid swallowing it anyway.)

Mr Pasken does not address the hazards of mercury, but his method of obtaining it is one which, in view of those hazards, I would not recommend. In breaking open mercury switches and cleaning the mercury by passing it through a hole in a filter paper, one's tendency would be to work with the material rather close to the face. This could result in considerable breathing of mercury vapors. (Remember, most readers will not be doing this in a chemistry lab equipped with adequately performing fume hoods.) In addition, the potential for skin contact is obviously quite great.

Mercury, if spilled on a floor, can be quite difficult to clean up. Sweeping will only break it into smaller and smaller drops which will lodge in cracks and in-

crease the cleaning problem. Vacuuming is a preferred method. But most people don't keep laboratory aspirators in their homes, and contaminating the family vacuum cleaner with mercury is hardly an ideal solution. There are also commercial materials which when sprinkled onto a mercury spill create mercury compounds which can be swept up, but I doubt that many people have such things available to them at home. And frankly, should mercury be spilled on a rug, I can't imagine how it could be cleaned up completely.

There are a few other points to consider. If mercury is spilled on your floor, it is a greater hazard to your small children and pets than to you. They are down there where the vapors are stronger and are in more intimate contact with the floor, and potentially with the spill. Also, mercury is fun to play with. Children, and adults too, like to coat coins with it or watch a droplet roll around the palm of a hand. Such recreation leads to skin contact, *which should be avoided*. Finally, should you be working with mercury in your home in winter, and your home is not heated with forced air, the room in which you work will not have much ventilation and the mercury vapor concentration will be higher than otherwise.

I should mention that the above statements on the hazards of mercury are made with respect to metallic, or elemental, mercury. Mercury compounds can also be hazardous in other modes of exposure.

In summary, metallic mercury is a hazardous material, both by breathing the vapors and by skin contact. If you must work with it, avoid skin contact, and, if you don't have access to a chemistry laboratory, work with it outside or in a well-ventilated room. Store mercury, and your open dish mercury barometer, where children, pets and other curious people cannot get at it, again, preferably in a well-ventilated room.

Peter L Zavon
57-01 Fox Run
Plainboro NJ 08536

You Asked For It!

You asked for the Intel 8080A CPU We gave you the **VECTOR 1**
You asked for a real-time clock We gave you the **VECTOR 1**
You asked for eight level
vectored priority interrupts We gave you the **VECTOR 1**
You asked for a jump-on-reset
and resident monitor We gave you the **VECTOR 1**
You asked for the S-100 bus We gave you the **VECTOR 1**
You asked for an 18 slot
fully shielded motherboard We gave you the **VECTOR 1**
You asked for a
rugged, reliable chassis We gave you the **VECTOR 1**

*Then . . . You asked for the compactness and
convenience of installing your mini-floppy
disk directly in the front panel. NOW . . . We give you the **VECTOR 1+***



VECTOR GRAPHIC INC. Not affiliated with Vector General, Inc.
790 Hampshire Rd., A + B, Westlake Village, CA 91361 Telephone: (805) 497-0733



Photo 1: The author's computer music system, which consists of an Altair 8800 computer with 32 K bytes of programmable and read only memory, and an ADM-III video terminal. Also pictured is a Mini-Moog electronic music synthesizer (top left) and a Farfisa VIP 400 electronic organ (bottom left).

SCORTOS:

Implementation of a Music Language

Hal Taylor
Interactive Music
Box 11
Arlington VA 22210

Perhaps nowhere can technology better serve the creative end of the music arts than through the computer. The computer has a natural affinity for the application to music since it is capable of carrying out processes which create and perform music. It can be programmed to learn any language the composer wishes to use to describe his musical ideas. It can manipulate the symbols of that language to produce transformations of the composer's original ideas. It can enlarge and improve the quality of the composer's creative output by allowing him to work in an interactive mode where he can hear his musical works performed within minutes of their conception.

The computer owes this affinity to its unerring accuracy and high bandwidth, qualities which its human inventors do not possess. The human mind is slow and noisy and requires years of exercise to achieve the coordination necessary to perform complex

musical passages. Although the computer may never be able to match the expressive subtleties of a concert soloist, it is in some cases more suitable for the performance of music than a human being.

If a program can be devised to convert musical symbols to the sounds they represent, then the computer can be of value to the composer as a means of developing composition prototypes, that is, preliminary designs of musical works that he could hear performed before he copied the parts and gave them to the orchestra. An editing capability would also be available to him to alter the music until it produced the desired results. When the computer performed the work to his satisfaction, the original score and the instrumental parts could be published on a computer controlled plotter. With such a system the composer could avoid the drudgery of hand copying parts, and would be encouraged to experiment

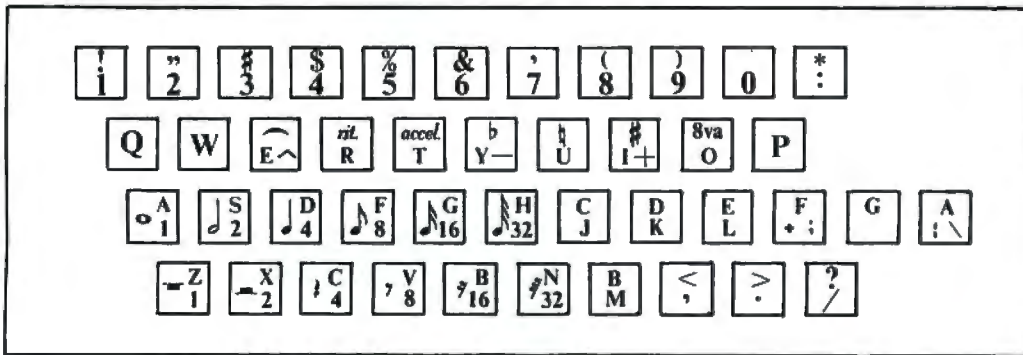

Figure 1: A standard alphanumeric keyboard modified for the SCORTOS language. SCORTOS is a language dedicated solely to the processing of musical information. The keyboard is a standard ASCII unit which has been relabeled with music symbols. The user enters a musical composition by striking the keys which correspond to the symbols in the music score of the composition (see also photo 2).

with new forms that he might otherwise hesitate to give to an orchestra.

The computer can also be useful to the composer as an originator of musical ideas since it can simulate the process by which the human mind creates music. A music composition consists of a series of musical events chosen from a minimum of about 200 different possibilities (consider, just 12 tones and 18 types of notes). Only certain of these combinations are pleasing to the human ear. The composer's job is to discover those combinations which produce aesthetic results. The manner in which he or she does this is personal, intuitive, and cannot by itself form the basis for a workable algorithm. It is possible, however, to infer some of the underlying rules of music by analyzing it. Whether we are composing with our minds or with a computer, we follow a set of rules that determine which pitches will be chosen, in what order they will be arranged, and how long each will last in time.

The set of rules describes the style and structure of the music and can be represented in a computer by a statistical model. A process can be programmed into the computer that uses the model to decide which musical events are suitable for use in the composition. The process is one in which random choices are discarded according to a stochastic model. [According to Webster's, *stochastic processes are processes based on the behavior of random variables. Random variables, in turn, are functions which are the result of statistical experiments in which each outcome has a fixed probability. For example, the number of spots showing if two dice are thrown is a random variable. . . CM*] In order to produce a musical event, the program generates a random number



Photo 2: The modified ADM-III video terminal. The keytops on the ASCII keyboard have been modified to enable the user to easily encode musical compositions. See figure 1.

which it associates with a variable such as pitch or time. The number is then subjected to the constraints of the model. The model is constructed by feeding specimens to an analysis program which are representative of the desired compositional style. The specimens are analyzed according to pitch, time and chord structure, and a probability matrix of n dimensions is generated, where n is the degree of order desired and represents the extent to which the analysis was carried out. As n increases, progressively more order is imposed upon the process, since more information is available to describe the

Introducing Apple II.™



You've just run out of excuses for not owning a personal computer.

Clear the kitchen table. Bring in the color TV. Plug in your new Apple II*, and connect any standard cassette recorder/player. Now you're ready for an evening of discovery in the new world of personal computers.

Only Apple II makes it that easy. It's a



complete, ready to use computer, not a kit. At \$1298, it includes video graphics in 15 colors. It includes 8K bytes ROM and 4K bytes RAM—easily expandable to 48K bytes using 16K RAMs (see box). But you don't even need to know a RAM from a ROM to use and enjoy Apple II. For example, it's the first personal computer with a fast version of BASIC permanently stored in ROM. That means you can begin writing your own programs the first evening, even if you've had no previous computer experience.

The familiar typewriter-style keyboard makes it easy to enter your instructions. And your programs can be stored on—and retrieved from—audio cassettes, using the built-in

cassette interface, so you can swap with other Apple II users.

You can create dazzling color displays using the unique color graphics commands in Apple BASIC. Write simple programs to display beautiful kaleidoscopic designs. Or invent your own games. Games like PONG—using the game paddles supplied. You can even add the dimension of sound through Apple II's built-in speaker.

But Apple II is more than an advanced, infinitely flexible game machine. Use it to teach your children arithmetic, or spelling for instance. Apple II makes learning fun.

Apple II can also manage household finances, chart the stock market or index recipes, record collections, even control your home environment.

Right now, we're finalizing a peripheral board that will slide into one of the eight available motherboard slots and enable you to compose music electronically. And there will be other peripherals announced soon to allow your Apple II to

talk with another Apple II, or to interface to a printer or teletype.

Apple II is designed to grow with you as your skill and experience with computers grows. It is the state of the art in personal computing today, and compatible upgrades and peripherals will keep Apple II in the forefront for years to come.

Write us today for our detailed brochure and order form. Or call us for the name and address of the Apple II dealer nearest you. (408) 996-1010. Apple Computer Inc., 20863 Stevens Creek Boulevard, Bldg. B3-C, Cupertino, California 95014.

Apple II™ is a completely self-contained computer system with BASIC in ROM, color graphics, ASCII keyboard, lightweight, efficient switching power supply and molded case. It is supplied with BASIC in ROM, up to 48K bytes of RAM, and with cassette tape, video and game I/O interfaces built-in. Also included are two game paddles and a demonstration cassette.

SPECIFICATIONS

- **Microprocessor:** 6502 (1 MHz).
- **Video Display:** Memory mapped, 5 modes—all Software-selectable:
 - Text—40 characters/line, 24 lines upper case.
 - Color graphics—40h x 48v, 15 colors
 - High-resolution graphics—280h x 192v; black, white, violet, green (12K RAM minimum required)
 - Both graphics modes can be selected to include 4 lines of text at the bottom of the display area.
 - Completely transparent memory access. All color generation done digitally.
- **Memory:** up to 48K bytes on-board RAM (4K supplied)
 - Uses either 4K or new 16K dynamic memory chips
 - Up to 12K ROM (8K supplied)
- **Software**
 - Fast extended integer BASIC in ROM with color graphics commands
 - Extensive monitor in ROM
- **I/O**
 - 1500 bps cassette interface
 - 8-slot motherboard
 - Apple game I/O connector
 - ASCII keyboard port
 - Speaker
 - Composite video output

Apple II is also available in board-only form for the do-it-yourself hobbyist. Has all of the features of the Apple II system, but does not include case, keyboard, power supply or game paddles. \$598.

PONG is a trademark of Atari Inc.

*Apple II plugs into any standard TV using an inexpensive modulator (not supplied).



apple computer inc.™

Circle 208 on inquiry card.

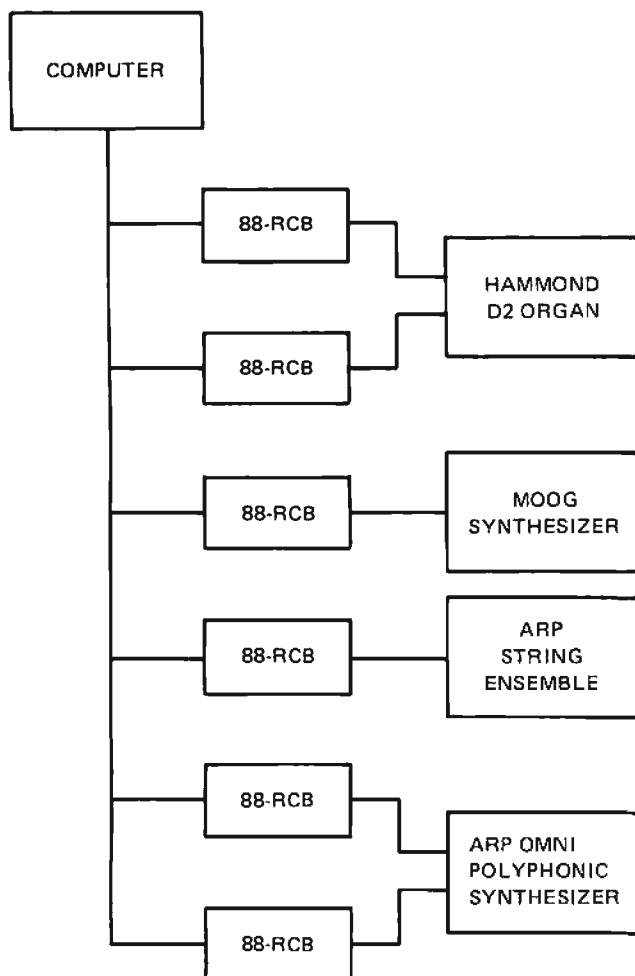

Figure 2: A medium scale SCORTOS configuration. The 88-RCB units are relay boards which can be driven by the computer to operate organs, synthesizers or other similar instruments. Each board consists of two 8 bit data registers which can be loaded from the central processing unit. Each of these bits in turn drives a transistor which energizes a relay. One 88-RCB board control 16 keys, or 1 1/4 octaves of a musical keyboard. The system can address (and therefore control) up to 256 keys.

desired composition and less is left up to chance.

Zeroth order stochastic control is no control at all. Random choices are used to build the composition without testing them against the model producing unlistenable music in most cases. In *first* order control, the transitions between pitches and rhythms are governed by the probability distribution of those transitions as they occurred in all the analyzed samples. Music produced in this manner still sounds amorphous, but will have fewer pitches that sound alien.

It is not until we impose higher order control that a melody as we know it will take shape with its symmetrical phrases and regular intervals. In *second* order control, the selection of an event depends upon the

event that preceded it; in *third* order control the previous two notes, and so on. For example, if the previous note chosen was a B-flat and the random number generator has just produced a C, the program refers to that location in the probability matrix which gives the probability of a C following a B-flat. If there is no probability of this happening, the C is rejected. If the probability is 1.00 then a C always follows a B-flat in this style of music, and the program will reject all random numbers that are not Cs.

Of course the source of the information within the model need not be music specimens, as in this example, but may originate from mathematical functions, poetry or any one of a hundred other sources. It is this capability which makes the computer so intriguing as a composer's tool.

The Score to Sound System

The Score to Sound System (SCORTOS) was developed to provide the composer with an inexpensive means of conducting computer implemented music research and composition prototype development. The system has the capability to perform conventional music scores by allowing music symbols to be entered through a terminal keyboard by an operator. Music of computer generated specifications can be performed through user program calls to a set of subroutines that interface the user program to the SCORTOS system software.

Music is produced by the computer driving relays that are wired in parallel to the keyboard switches of electronic music instruments — organs, synthesizers, etc. This allows a simple and inexpensive interface between the composer's studio instruments and the computer. The limitation of this approach is in its inability to provide the computer with access to the timbre controls of the synthesizer, an encumbrance which may be tolerable to experimenters primarily interested in the musical variables of tonality and syntax. Also, there is a rich assortment of preset timbres available in commercial keyboard instruments, among them, the Orchestron which generates actual orchestral and choral sounds from a prerecorded optical disk.

The system consists of an Altair 8800 computer with 32 K bytes of memory, an ADM-III video terminal, a mass storage device (either cassette or floppy disk), one or more International Data Systems 88-RCB relay control boards and any electronic keyboard instruments the user wishes to connect to the 88-RCBs.

The ADM-III has a standard ASCII key-

Verbatim™

The
whole
message
is quality.

You want to record your message verbatim—word for word—whether it's bits, bytes or "Dear Folks" translated into word processor language.

Our objective in manufacturing recording media for the electronics industry—digital tape cassettes, floppy disks, mag cards, computer cartridges—is to give you the finest, the best, the most dependable, the most cost-effective.

That means rugged, long-lived, abrasion-resistant recording media with superior magnetic qualities. If we made tires, they'd be steel-belted radials.

We delivered our first digital grade certified tape cassettes back in the beginning, 1969. We made the first commercial 3740-compatible floppy disks that didn't bear IBM's name. And the first Flippy® reversible flexible disks with *anyone's* name on them. The first mini data cassette is ours. And we've got the newest miniature flexible disk, the MD 525.

Now, Verbatim media. It's a new formulation of ferric oxides, an advanced macromolecular binder system to adhere it to the tough polyester film, and a process control system that demands over 200 separate quality checks before the material is cut, packaged, and certified to be 100% error-free.

The final quality check? "Make it pretty!" Our production people tell us that magnetic recording media is one of the rare instances in manufacturing where aesthetic appearance translates directly into final product quality. It has to look beautiful to work beautifully.

We have the formulas, the machines, the technology to make high quality recording media. But it takes the best people in the industry to deliver Verbatim disks, cards, cartridges and cassettes. You'll find them at your favorite retail computer store.



Circle 206 on inquiry card.

Information Terminals Corp. 
Sunnyvale, California

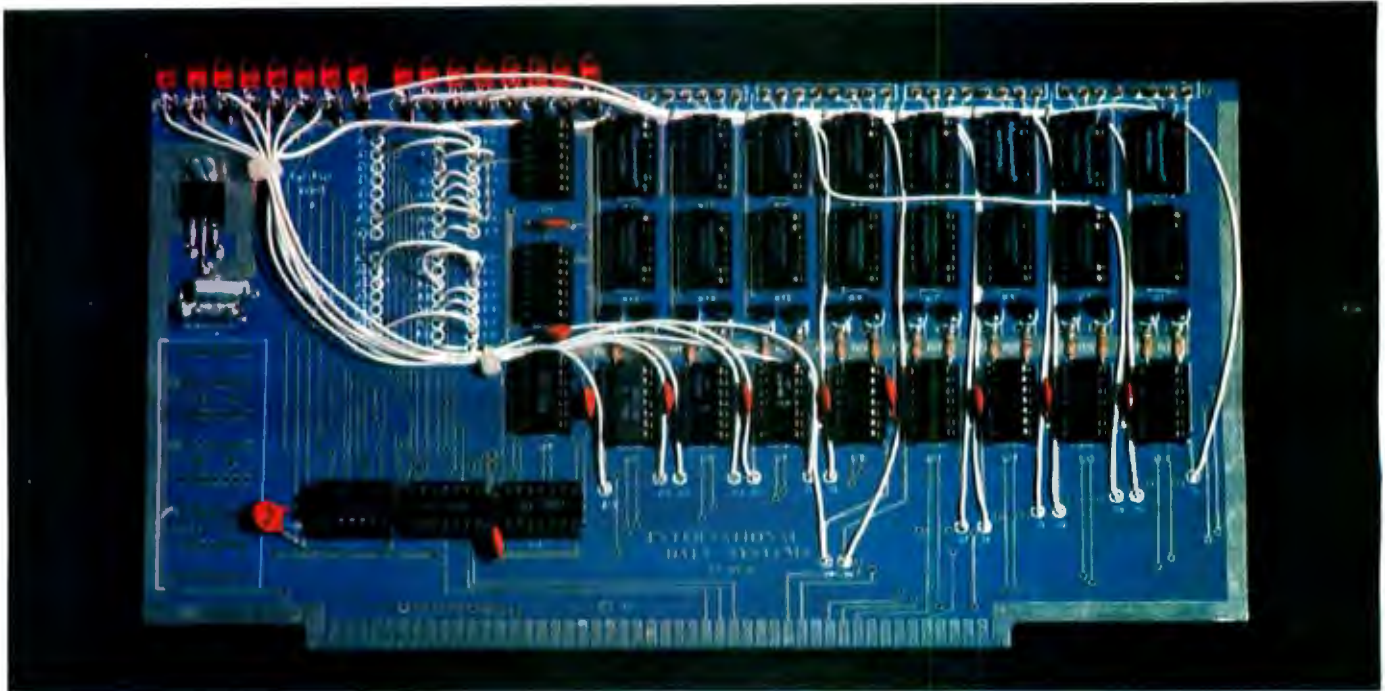

Photo 3: A close-up view of the component side of the 88-RCB 16 channel relay interface board which can drive a musical keyboard with signals from the computer.

board whose keytops have been relabeled with music symbols (see figure 1 and photo 2). The composer enters the composition into the computer by striking the key corresponding to each musical symbol as it appears in the score. This creates a music text file. The source text is passed to a language processor which maps each musical event represented in the source text into a physical IO address plus a timing value, and writes this to a binary output file. The result is a list of records each of which defines which key of which instrument will be turned on and for how long. The binary output of the language processor is read by a driver program which uses the IO addresses and timing values in each record to determine what data is to be loaded into the data registers of the 88-RCBs, and at what time it is to be loaded. The keyboard instrument responds by playing the piece just as if someone were playing on its keyboard. In fact, the system can be thought of as an organist with 16 very flexible fingers, because it is capable of performing 16 separate parts simultaneously.

Keyboard Instrument to Computer Interface

The 88-RCB is the interface between the computer and the electronic keyboard instruments. It was designed expressly for the SCORTOS system project, but is also useful for other low current switching applications. The board has two 8 bit data registers which are "write only" accessible to the central processing unit (CPU) through

two output ports which are individually strappable to any address in the 8080 IO channel. The data register latches the contents of the CPU's A register when an OUT instruction has been executed to that register's output port address. The outputs of each bit of the data registers drive a transistor which in turn drives a board mounted DIP relay.

The complement outputs of the data register latches are used to drive light emitting diodes (LEDs) which can be mounted on the board or on a front panel to monitor the status of each relay. The relays are wired in parallel to the keyboard switches of the electronic music instruments which electrically isolate the peripherals from the computer and ensure plug-to-plug compatibility among most keyboard instruments. Each 88-RCB controls 16 keys, or 1 1/4 octaves of keyboard. To ensure an adequate tonal range, two 88-RCBs may be configured on any instrument (see figure 2).

The maximum number of keys the system can address is 256. In arriving at a figure of maximum connectivity, it was necessary to balance programming considerations against what was thought to be an adequate number of system-controllable sound producing peripherals. 256 keys are equal to about 20 octaves of keyboard (three full piano keyboards) which may be distributed among ten sound-producing peripherals, giving each instrument a 2 octave range. This maximum configuration seems adequate to provide for the largest studio application.

Introducing Our Disk System.



It's like adding a room to your brain!

The System 8813 from PolyMorphic Systems is a complete, powerful problem solver in a single walnut cabinet. This machine allows you to perform complex financial, engineering, and scientific models in the comfort of your office or den.

The high speed video display presents your results in text, tables and graphics. The detachable typewriter-like keyboard permits relaxed program entry and operation. Convenient mini-discs store programs and data for compact filing, secure storage, and fast access. Our disc BASIC programming language is simple enough for the computer newcomer, yet powerful enough to amaze the most advanced users.

The whole family can immediately use and enjoy pre-programmed applications and educational packages. Let the System 8813 become your trusted business, profession, and

personal tool. The PolyMorphic Disc System is a completely assembled and tested unit with brushed aluminum front panel, walnut cover, detachable keyboard, video monitor, 16K RAM. Includes system software and fully extended BASIC on disc.

















System with 1 disc drive — \$3250
System with 2 disc drives — 3840
System with 3 disc drives — 4430

Delivery 60 days ARO. Upgrade packages for POLY 88 owners will also be available. Prices and specifications subject to change without notice.

**PolyMorphic
Systems**

(805) 967-0468

460 Ward Drive, Santa Barbara, CA 93111

Music Symbol	Description	SCORTOS Code	Music Symbol	Description	SCORTOS Code
	whole note	X1		quarter rest	4
	half note	X2		eighth rest	8
	quarter note	X4		sixteenth rest	16
	eighth note	X8		thirty-second rest	32
	sixteenth note	X16		left hand repeat	[
	thirty-second note	X32		right hand repeat]
	whole rest	1		bar	/
	half rest	2		triplets	3(XnXnXn)





Music Symbol	Description	SCORTOS Code
C	Pitch representations	C
D		D
E		E
F		F
G		G
A		A
B		B
	sharp	+
	natural	N
	flat	-
	slur	^
.	dot	.

Table 1: The alphanumeric music coding convention used by the SCORTOS system. The X symbol preceding each numeric SCORTOS code symbol indicates that the numeric symbol must be preceded by a pitch representation before it can be recognized as a note. For example, C2 would be a half note with pitch C.

A simple method of representing keyboard address was chosen to minimize the execution time of the DRIVER program. One byte is used to represent the keyboard address (pitch), and one byte contains the length of time the event will last (rhythm). Since a music piece consists of so many events, the size of the data record is critical. It affects the total performance of the system by limiting the length of any performance to the number of event records that will fit in available memory. For this reason, it is not practical to increase the size of the event data record to accommodate a connectivity greater than 256.

The Alphanumeric Representation of Music

The conventional music score format is not the most perfect method for entering music into computers. The music symbols must be somehow transformed into a code the computer understands. In the conventional method, the operator enters data from

a music score into an alphanumeric keyboard. This method has two disadvantages: it often requires multiple alphanumeric symbols to define one musical event (one character for pitch, one character for rhythm, one character for dynamics). The second disadvantage is that the choice of alphanumeric symbols must relate in some way to the quality of the musical symbols they represent, which in the past has meant that the symbols were scattered about the keyboard with no regard to their qualitative value. As a result, the data entry process was a hunt and peck procedure which may have been too discouraging for all but the most enthusiastic.

The human to computer interface should provide maximum ease in data entry and data editing. There are four ways to accomplish this:

- Choose a set of alphanumeric symbols to represent the set of musical symbols that will enable music passages to be

Oboe

P01 K2- T3/4 (2.)03 "The dotted half rest is to be repeated three times"

2 Flutes

P02 K2- T3/4 O3 F4 G4 A8. F16 / O4 C8. C8 B16 O2 F4 B4 / D8. E16 F4. G8 / F E D C O3 B O2 C /
P03 K2- T3/4 O3 F2. ^ / F4 F2 ^ / F2 4 / F2. ^ / F2 4 /

Violin

P04 K2- T3/4 2. / 2. / 4 4 F4 ^ / F2. /

Cello

P05 K2- T3/4 2. / 2. / 4 8. O2 E~16 F ^ / F2. /

Figure 3: A fragment of an orchestral score annotated in SCORTOS code (see listing 1).

best recognized in alphanumeric form.

- Eliminate all redundancies in the music score.
- Position the alphanumeric symbols on the keyboard logically in the order of their musical value and group them by type.
- Generate bar markings and bar numbers automatically during data entry.

Table 1 shows the alphanumeric symbols used to represent conventional music notation in the Score to Sound System. Note that each alphanumeric symbol alludes to the quality of the music symbol it represents. A musical event can be defined by one or two symbols, depending upon whether the event is a rest or a note. A numeric symbol which is not preceded by a letter character is recognized as a rest. Notes always occur as a pair of symbols, that is, a letter character followed by a numeric symbol. Figure 3 illustrates a portion of an actual orchestral score along with its corresponding SCORTOS code.

Since the characters generated by the SCORTOS keyboard hardware do not correspond to those desired to represent the music symbols, the data entry software echoes back the desired character with the terminal in full duplex mode.

System Software

The SCORTOS System Software consists of a group of programs written in 8080 assembler language which carry out the four major functions of the system:

- entry and manipulation of the symbolic music text.
- conversion of the text to binary data.
- conversion of events initiated by user programs to binary data.
- conversion of the binary data to music.

The interaction of these programs with each other is shown in figure 4.

The monitor allows the user to control the system's major functions. It recognizes three command verbs with one or more arguments per verb. Each verb calls a system module, and its arguments specify the data file which is to be operated upon by that module. Table 3 is a list of command verbs recognized by the monitor.

The editor allows the user to enter music text through the terminal keyboard and provides a means by which it may be easily manipulated.

As text is entered through the keyboard, the editor's data entry processor keeps a running count of the bar number and auto-

Continued on page 206



One Sol-20 equals three computers.

To do real work with any computer, big or small, it takes a complete system. That's one of the nice things about the Sol-20. It was built from the ground-up as the heart of three fixed price computer systems with all the peripheral gear and software included to get you up and on the air.

Sol System I costs just \$1649 in kit form or \$2129 fully burned in and tested. Here's what you get: a Sol-20 with the SOLOS personality module for stand alone computer power, an 8192 word memory, a 12" TV/video monitor, a cassette recorder with BASIC software tape and all necessary cables.

Sol System II has the same equipment plus a larger



capacity 16,384 word memory. It sells for \$1883 in kit form; \$2283 fully assembled.

For even more demanding tasks, Sol System III features Sol-20/SOLOS, a 32,768 word memory, the video monitor, Helios II Disk Memory System and DISK BASIC Diskette. Price, \$4750 in kit form, \$5450 fully assembled and tested.

And remember, though we call these small or personal computer systems, they have more power per dollar than anything ever offered. They provide performance comparable with mini-computer systems priced thousands of dollars more.

**The Small Computer
Catalog for the rest of the real
computer system story.**

Visit your local computer store for a copy of our fully illustrated 22 page catalog. Or you may write or call us if more convenient. Please address Processor Technology, Box B, 6200 Hollis Street, Emeryville, CA 94608. (415) 652-8080.



The functional beauty of Sol Computer Systems is more than skin deep. A look inside reveals a simple elegance of design and sturdy construction.

**Processor
Technology**
Corporation

See Sol here...

ALABAMA

ICP, Computerland
1550 Montgomery Hwy.
Birmingham, AL 35226
(205) 979-0707

ARIZONA

Byte Shop Tempe
813 N. Scottsdale Rd.
Tempe, AZ 85281
(602) 894-1129

Byte Shop Phoenix
12654 N. 28th Dr.
Phoenix, AZ 85029
(602) 942-7300

Byte Shop Tucson
2612 E. Broadway
Tucson, AZ 85716
(602) 327-4579

CALIFORNIA

The Byte Shop
1514 University Ave.
Berkeley, CA 94703
(415) 845-6366

Byte Shop of Burbank
1812 W. Burbank Blvd.
Burbank, CA 91506
(213) 843-3633

Byte Shop Computer Store
6041 Greenback Lane
Citrus Heights, CA 95610
(916) 961-2983

Computer Center
1913 Harbor Blvd.
Costa Mesa, CA 92627
(714) 646-0221

Data Consultants, Inc.
2350 W. Shaw, Suite 114
Fresno, CA 93711
(209) 431-6461

Bits 'N Bytes
679 S. State College Blvd.
Fullerton, CA 92631
(714) 879-8386

The Byte Shop
16508 Hawthorne Blvd.
Lawndale, CA 90260
(213) 371-2421

Opamp/Computer
1033 N. Sycamore Ave.
Los Angeles, CA 90038
(213) 934-3566

Digital Deli
80 W. El Camino Real
Mountain View, CA 94040
(415) 961-2828

The Computer Mart
624 West Katella #10
Orange, CA 92667
(714) 633-1222

Byte Shop
496 South Lake Ave.
Pasadena, CA 91101
(213) 684-3311

The Computer Store
of San Francisco
1093 Mission Street
San Francisco, CA 94103
(415) 431-0640

Byte Shop

321 Pacific Ave.
San Francisco, CA 94111
(415) 421-8686

The Computer Room
124H Blossom Hill Rd.
San Jose, CA 95123
(408) 226-8383

The Byte Shop
509 Francisco Blvd.
San Rafael, CA 94901
(415) 457-9311

The Byte Shop
3400 El Camino Real
Santa Clara, CA 95051
(408) 249-4221

Recreational Computer
Centers
1324 South Mary Ave.
Sunnyvale, CA 94087
(408) 735-7480

Byte Shop of Tarzana
18424 Ventura Blvd.
Tarzana, CA 91356
(213) 343-3919

Computer Components
5848 Sepulveda Blvd.
Van Nuys, CA 91411
(213) 786-7411

The Byte Shop
2989 North Main St.
Walnut Creek, CA 94596
(415) 933-6252

Byte Shop
14300 Beach Blvd.
Westminster, CA 92683
(714) 894-9131

COLORADO

Byte Shop
2040 30th St.
Boulder, CO 80301
(303) 449-6233

Byte Shop
3464 S. Acoma St.
Englewood, CO 80110
(303) 761-6232

FLORIDA

Sunny Computer Stores
University Shopping Center
1238A S. Dixie Hwy.
Coral Gables, FL 33146
(305) 661-6042

Delta Electronics
2000 U.S. Hwy. 441 East
Leesburg, FL 32748
(904) 357-4244

Byte Shop of Miami
7825 Bird Road
Miami, FL 33155
(305) 264-2983

Microcomputer
Systems Inc.
144 So. Dale Mabry Hwy.
Tampa, FL 33609
(813) 879-4301

GEORGIA

Atlanta Computer Mart
5091-B Buford Hwy.
Atlanta, GA 30340
(404) 455-0647

ILLINOIS

itty bitty machine co.
1316 Chicago Ave.
Evanston, IL 60201
(312) 328-6800

Reeves Communications
1550 W. Court St.
Kankakee, IL 60901
(815) 937-4516

itty bitty machine co.
42 West Roosevelt
Lombard, IL 60148
(312) 620-5808

INDIANA

The Data Domain
406 So. College Ave.
Bloomington, IN 47401
(812) 334-3607

The Byte Shop
5947 East 82nd St.
Indianapolis, IN 46250
(317) 842-2983

The Data Domain
7027 N. Michigan Rd.
Indianapolis, IN 46268
(317) 251-3139

KENTUCKY

The Data Domain
3028 Hunsinger Lane
Louisville, KY 40220
(502) 456-5242

MICHIGAN

The Computer Store
of Ann Arbor
310 East Washington
Ann Arbor, MI 48104
(313) 995-7616

Computer Mart
of Royal Oak
1800 W. 14 Mile Rd.
Royal Oak, MI 48073
(313) 576-0900

General Computer Store
2011 Livernois
Troy, MI 48064
(313) 362-0022

MINNESOTA

Computer Depot, Inc.
3515 W. 70th St.
Minneapolis, MN 55435
(612) 927-5601

NEW JERSEY

Hoboken Computer Works
No. 20 Hudson Place
Hoboken, NJ 07030
(201) 420-1644

The Computer Mart
of New Jersey
501 Route 27
Iselin, NJ 08830
(201) 283-0600

NEW YORK

The Computer Mart
of Long Island
2072 Front Street
East Meadow, L.I. NY 11554
(516) 794-0510

The Computer Shoppe
444 Middle Country Rd.
Middle Island, NY 11953
(516) 732-4446

The Computer Mart
of New York
118 Madison Ave.
New York, NY 10001
(212) 686-7923

The Computer Corner
200 Hamilton Ave.
White Plains, NY 10601
(914) 949-3282

OHIO

Cybershop
1451 S. Hamilton Rd.
Columbus, OH 43227
(614) 239-8081

Computer Mart of Dayton
2665 S. Dixie Ave.
Dayton, OH 45409
(513) 296-1248

OREGON

Byte Shop Computer Store
3482 SW Cedar Hills Blvd.
Beaverton, OR 97005
(503) 644-2686

The Real Oregon
Computer Co.
205 West 10th Ave.
Eugene, OR 97401
(503) 484-1040

Byte Shop Computer Store
2033 SW 4th Ave.
Portland, OR 97201
(503) 223-3496

RHODE ISLAND

Computer Power, Inc.
M24 Airport Mall
1800 Post Rd.
Warwick, RI 02886
(401) 738-4477

SOUTH CAROLINA

Byte Shop
2018 Green Street
Columbia, SC 29205
(803) 771-7824

TENNESSEE

Microproducts & Systems
2307 E. Center St.
Kingsport, TN 37664
(615) 245-8081

TEXAS

Byte Shop
3211 Fondren
Houston, TX 77063
(713) 977-0664

Interactive Computers
7646½ Dashwood Rd.
Houston, TX 77036
(713) 772-5257

The Micro Store
634 So. Central
Expressway
Richardson, TX 75080
(214) 231-1096

VIRGINIA

The Computer Systems
Store
1984 Chain Bridge Rd.
McLean, VA 22101
(703) 821-8333

Media Reactions Inc.
11303 South Shore Dr.
Reston, VA 22090
(703) 471-9330

WASHINGTON

Byte Shop Computer Store
14701 N.E. 20th Ave.
Bellevue, WA 98007
(206) 746-0651

The Retail Computer Store
410 N.E. 72nd
Seattle, WA 98115
(206) 524-4101

WISCONSIN

Madison Computer Store
1910 Monroe St.
Madison, WI 53711
(608) 255-5552

The Milwaukee
Computer Store
6916 W. North Ave.
Milwaukee, WI 53213
(414) 259-9140

CANADA

Trintronics
160 Elgin St.
Place Bell Canada
Ottawa, Ontario K2P 2C4
(613) 236-7767

First Canadian
Computer Store Ltd.
44 Eglinton Ave. West
Toronto, Ontario M4R 1A1
(416) 482-8080

The Computer Place
186 Queen St. West
Toronto, Ontario M5V 1Z1
(416) 598-0262

Pacific Computer Store
4509-11 Rupert St.
Vancouver, B.C. V5R 2J4
(604) 438-3282



Melanie Jubb's oil painting celebrates the idea of computers and music, emphasizing this issue's artistic themes. ■



Photo 1: The author's new dress for KIM is shown in this shot taken with the briefcase opened. The unused area of the power supply cover is used to advantage as a place to mount prototyping boards for use in IO contexts with KIM.

R Travis Atkins
67 Greenend Av
Middletown RI 02840

At first I was reluctant to take KIM out in public because she was so small and homely compared to other systems her age. No one actually ever laughed at her in my presence, but I could sense the pity that they had for me. I wondered, would my KIM forever be overshadowed by those bristling brutish Altairs and IMSAIs at every social gathering? I knew KIM's strengths and her weaknesses, and I wondered if there was anything that I could do to help her find acceptance in the world. Then, one evening, while talking to a friend whose IMSAI was drawing considerable attention, as usual, it occurred to me that it wasn't his central processing unit's IQ that set it apart from my humble KIM. No, it was the way that it was dressed that did so much toward creat-

ing the image of great sophistication and power.

I resolved that very evening to give my KIM the same advantages that her peers had; after all, who wants to be accused of neglecting loved ones? If she was to be ooo'd and aaah'd over, then she'd have to be dressed up before I took her out again. Although I must say honestly that I doubted that her 8.5 by 11 by 5/16ths dimensions would ever win her a spot on the centerfold of BYTE.

I suspect that there are many other KIM owners around who have also wondered how to dress up their bare-bones KIM board to take them out to club meetings and such, so here's the way that I did it. I hope it gives you some good ideas for your own KIM-1.

First of all, I had two major constraints to deal with: namely, my budget and my own skill, or rather lack of skill in the field of beautifully sculptured fiberglass and metal enclosures and the like. So I knew that I would have to settle for a simple and cheap approach to this thing. One thing that the KIM had going for it was its small size, because that meant that it could be placed inside a reasonably sized package. But, what was a reasonably sized package? And, where could I get one cheap?

A shoe box? . . .no, that's too big. Hey, how about that old briefcase in the back of my closet? . . .not a bad idea!

Much to my surprise and pleasure I discovered that those sneaky designers at MOS Technology must have been anticipating my train of thought, because when I opened that old briefcase and dropped the KIM in, it was a perfect fit! Great, now I knew what my enclosure was going to be, so the next question was how to support it inside the briefcase. Again, two constraints: first of all, protection for the

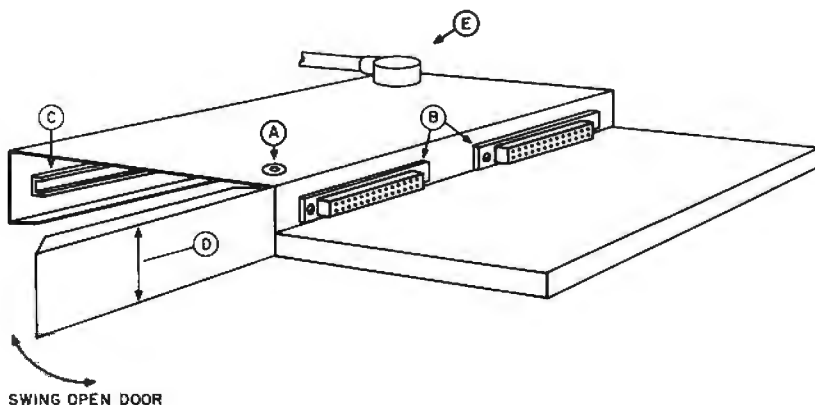

Figure 1: The assembly which was inserted into the briefcase has two sections at different levels as shown in this view. The section at the left covers a built-in power supply for the system. The lower section on the right faces two edge connectors (B) for the KIM-1 card. A single pop rivet hinge (A) allows a door to the power supply section to open. This allows the power supply card to slide out on the appropriate card guides (C). The power cord and other externals plug into the top of the chassis (E), which has enough area to accommodate prototyping cards as seen in photo 1. The height of the power supply section (D) is chosen based on the size of the briefcase.

A New Dress for KIM

(A Brief Case History)

printed circuit board itself, and secondly, reasonable looks.

The briefcase's exterior would provide some rough handling protection for the KIM, but it would also need some solid support from the bottom; therefore, since the bottom of my briefcase was not flat, I would have to construct a flat platform for the KIM. As for the basic appearance, I really wasn't too crazy about an open frame power supply, nor would that be an awfully safe setup. So, I decided that the power supply would have to be placed inside a special enclosure, away from stray fingers. The chassis design, shown in figure 1, was the result of considerable study.

Some of the more notable yet less obvious features of this design are:

- A swing open door to provide access to the power supply compartment (pop rivet hinge).
- The 44 pin edge connectors (one of which is provided with the KIM-1) penetrate the chassis wall to give solid support and to protect the loose wires.
- PC board edge guides to hold the power supply and other auxiliary components on a removable card.
- An overall height selected to suit the briefcase depth (mine filled the lower half).
- Placement of the power cord, switches, and other auxiliary parts on the top surface of the power supply compartment to facilitate easy removal of the entire assembly for bench work or to change to a new briefcase.
- A large surface to place connectors, etc.
- A Plexiglas cover sheet to further protect the KIM-1 board and filter the LED displays may also be added.
- Use of the upper half of the briefcase to carry documentation, etc.

The KIM-1 board is recessed in this design, but it is not hard to get to the keyboard for programming it, although this was one thing that I thought might give me trouble at first. Being recessed does give the KIM an added amount of protection, and I have found that the recess over the board is a great place to carry my KIM-1 owner's manual. That spares me from having to explain what in the world I have in my briefcase every time I open it in public.

The auxiliary area on top of the power supply compartment is the place where you can customize your chassis to suit your own particular needs. On my chassis I put a surplus 50 pin connector which is wired to most

of the pins of the A connector, and selected pins of the E connector of my KIM board. I use this to patch into a small prototype board which I also placed on that surface, and I must say this has proven to be a most useful setup. Of course, you will probably want to provide jacks for your audio cassette unit, and maybe one for a Teletype if you're fortunate enough to have access to one.

At any rate, my little KIM is no longer the club wallflower, and as I look into her future I see a handsome genuine calfskin briefcase waiting. ■

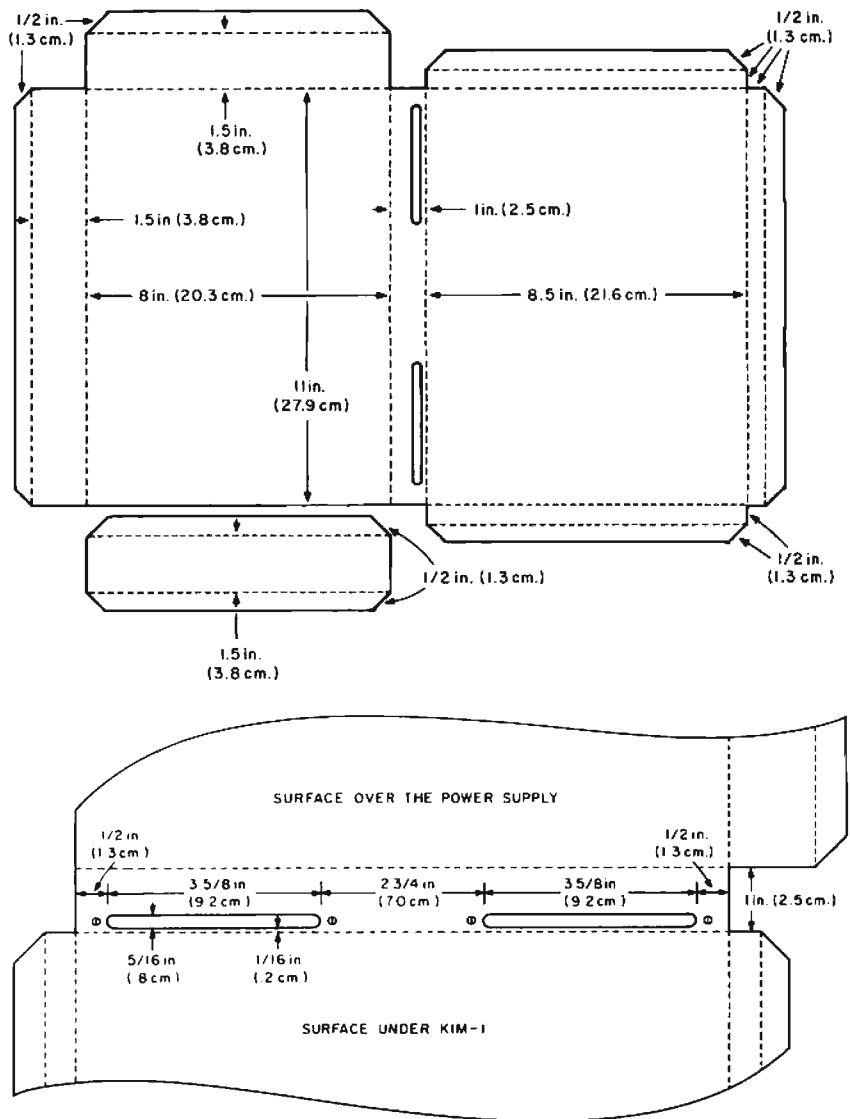
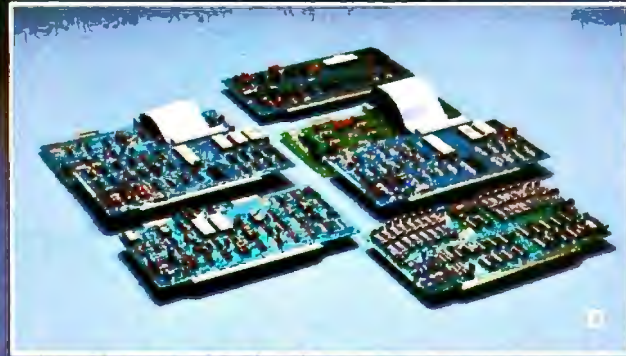

Figure 2: The mechanical design of the chassis box is shown in this illustration. The depths of the two sections are dimensioned to fit the author's briefcase. This can be fabricated out of a piece of aluminum stock 1/16 of an inch thick and measuring 20.5 by 15.5 inches (or, in integral metric dimensions, 2 mm thick measuring 52 by 39 cm). The drawings show dimensions for the actual KIM-1 connector holes with metric dimensions in parentheses. The housing was cut, milled (the pin edge connector holes) and constructed at a local machine shop for under \$15.



- A. VDP-80 Computer with 300 lpm printer.
- B. PCS-80 with CRT, dual floppy disk & Intelligent Keyboard options.
- C. Peripherals—(clockwise from left) 45 cps daisy-wheel printer / terminal; 24x80 CRT terminal; 45 cps daisy-wheel printer; Intelligent Breadboard; 44 col. alphanumeric line printer.
- D. Processor, Memory & Interface boards—shown MPU-A, 65K RAM, and floppy disk, line printer and serial I/O's.
- E. PCS-80 System—sample component configurations.

Microcomputers: Just Ask IMSAI.

If you wonder who leads the way in technology, look into IMSAI's list of industry firsts—IMSAI 8048, first complete control computer on a board; IMSAI 65K RAM Board, first to offer four times the memory capacity previously available on one board; IMSAI printers, first with high-speed direct memory access.

If you wonder why IMSAI products have gained the reputation for the standard of excellence in microcomputer systems, check with any one of the more than 10,000 IMSAI owners.

If you wonder who offers the broadest line of hardware, software, and peripherals, visit any one of the more than 275 IMSAI dealers around the world.

If you wonder how microcomputing can fit your specific needs, ask IMSAI. Because when it comes to microcomputers, we have the answers.

An IMSAI Product to Answer Every Microcomputing Need:

Let's start with our product line. In all, IMSAI offers more than 120 high quality, completely integrated systems, components, peripherals and software. Here's just a sampling:

Single Board Central Processors:

- MPU-A (8080 based)—Industry standard.
- MPU-B (8085 based)—50% faster 8080.
- 8048—Programmable control computer.

Interfaces:

- Video I/O—24x80 CRT, Edit & data entry.
- Serial I/O—2 port I/O, all std. protocols.
- Parallel I/O—4 & 6 port TTL level I/O.
- Multiple I/O—2 cassette, 2 parallel, 1 serial & 1 control I/O.
- DMA—For floppies & line printers.

Peripherals:

- Printers—40/80/132 col. 30 cps-300 lpm.
- Video displays—Large assortment.
- Tape Drive—9 track, 800 bpi, 25 ips.
- Floppy Disks—Single/double density.

Memory Expansion Boards:

- 4K RAM—Programmable memory protect.
- 16/32/65K RAM-16K paging option for virtual memory addressing.
- Intelligent Memory Mngr.—Handles up to 1 megabyte.

Self-Contained Systems:

- VDP-80—Computer/terminal/mass storage unit. Assembled & tested.
- PCS-80—Integrated component system.

Software:

- DOS—Enhanced CP/M.
- BASIC—Interactive or compiler with scientific and/or commercial features.

- FORTRAN IV—Level 2 ANSI compiler.
- Self-contained Systems:
 - SCS 1 & 2/TCOS—Assembler/line editor/debugger.
 - 4 & 8K BASIC—Optional cassette support.

Compare IMSAI. You'll realize that ours is the most complete product line available. Whatever your needs, you can get them from one source, IMSAI.

A wide selection of components is only the beginning. IMSAI offers much more. Just ask.

Answers For Businessmen:

Announcing IMSAI's VDP-80. This totally self-contained unit includes a megabyte of disk memory via floppy disk, 32K computer memory (expandable to 256K), 12" CRT and 62 pad main keyboard with 10 pad numeric keyboard. Several printer options available.

If you want speed and accuracy in high volume work such as word processing, or business data collection and analysis, the VDP-80 is your cost effective answer.

Answers For The Personal User & Educators:

Introducing IMSAI's new PCS-80 System, the fully integrated microcomputer component system, configurable to your exact needs. The basic system consists of our Intelligent Keyboard and the PCS-80 which houses an 8085 based CPU, 16K of RAM, intelligent ROM monitor, serial I/O port, 24x80 CRT, with an extra 7 slots in the chassis for expansion.

System component options include single or dual mini and standard floppy disks. The choice is yours, configure the system as you like.

IMSAI has answers for the educator, too. Take the basic PCS-80, add 8K of PROM, 4K of RAM and our self-contained 8K BASIC software, and you have a complete operating system your entire department can use to teach anything from elementary programming to advanced computer science.

Require a bit less sophistication? Use our Intelligent Breadboard system for learning, designing and building microcomputer assemblies.

Rather do it from scratch? Start with our single board MPU-B central processor, the heart of the PCS-80 System. It has a 1K ROM monitor, 256 bytes of RAM and serial and parallel I/O.

Since the MPU-B is 8085 based, you can run all programs previously developed for the 8080, 50% faster. Without requiring faster memory.

Answers For Industry:

IMSAI products provide the expandability and flexibility manufacturers demand for microcomputing applications.

We offer rack mountable components for the standard 19" RETMA racks, powerful MPU boards, I/O and memory boards for easy system expansion and configuration, and a broad line of peripherals and subsystems fully integrated and ready to go to work.

IMSAI has what you need to make tomorrow's design today's reality.

Answers For Current IMSAI Users:

There are over 10,000 of you. And, we haven't forgotten. You might say that we thought of you before you even thought of us.

That's why every new product is designed to accommodate expansion, rather than outdate equipment.

For example, our new PCS-80 retrofit kit comes complete with MPU-B, replacement front panel photomask and additional hardware bracketing. So you can enjoy a single cabinet PCS-80 computer, with your choice of integrated component configurations.

The Answer For Everyone:

Dial (415) 483-2093, Ext. ACT. That's IMSAI's action hotline. Designed to answer the thousands of questions we didn't have a chance to answer in the space of this ad.

Call us. We'll assist you in putting together a system, direct you to your nearest IMSAI dealer, and send you our new catalog with all the details.

In short, if you have any questions at all regarding microcomputers, put us to the test.

Just ask IMSAI.

IMSAI®

**The Standard of Excellence in
Microcomputer Systems.**

IMSAI Manufacturing Corporation
14860 Wicks Blvd., Dept. B-9
San Leandro, CA 94577
(415) 483-2093 TWX 910-366-7287

Features and specifications subject to change without notice.

Circle 205 on inquiry card.

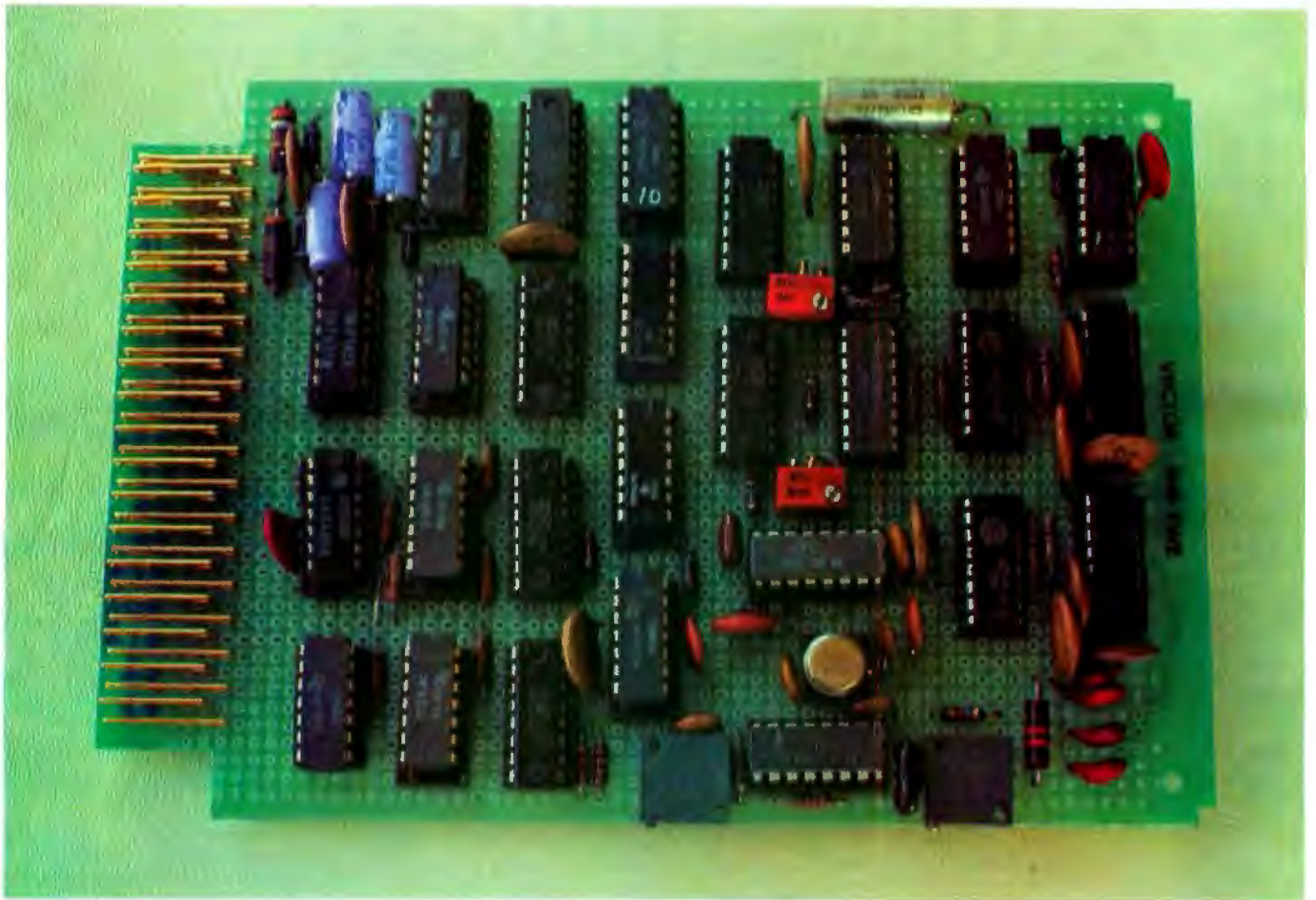

Photo 1: The author's prototype for the 4 channel self-refreshing digital to analog converter shown in figure 9. Also contained on the board is a prototype 4 channel analog to digital converter circuit.

Control the World!

Steve Ciarcia
POB 582
Glastonbury CT 06033

(Or at Least a Few Analog Points)

"Ka-chunk! OK, get the reading quick! Ka-chunk! Pop! Pop! Bang!! The darn thing crapped out again! We'll never get one of these detectors to pass a life test."

The burly mechanic puffed his fat cigar and with a disgusted sigh continued, "The dime store engineers who design these kludges should be the ones who have to test them! That's if you could ever get them out of that puzzle factory upstairs!"

That was my cue. I was indeed an engineer descended from the puzzle factory and my mission was to discover why we were

having so much trouble life test qualifying one of the pressure detectors we intended for future manufacture. Hearing the preceding commentary as I approached the testing lab, I decided that an authoritative professional type would not be very popular at the moment, so I went into my innocent nonmanagerial mode and entered the lab.

This lab was not unlike any other small production qualification and testing lab. It had the usual machinery and instrumentation and many artifacts of former test programs lying about. The most prominent

XITAN

TECHNICAL
DESIGN
LABS

IS YOUR DOLLAR BUYING AS MUCH POWER & FLEXIBILITY AS TDL'S XITAN SYSTEMS PROVIDE?

OUR CUSTOMERS SAY
THINGS LIKE THIS
ABOUT TDL PRODUCTS:

"... the best CPU board I've put together... excellent parts...
worked right off without trouble shooting." JRC
Cambridge, Mass.

"Great product." KMM
Bella Vista, Ark.

"... high quality components, good engineering & complete
documentation... up and running without any problems." WP
Seattle, Wash.

"Excellent." Col. DWW
Santa Maria, Calif.

"Very impressed with superb quality." SK-I
Boston, Mass.

XITAN alpha 1

When we combined our highly praised ZPU board and our System Monitor Board, we defined the standard for the industry; we integrated more power and flexibility in two slots of our motherboard than most other systems can muster using five or more boards. When we put this setup into our rugged aluminum case we created the first XITAN system, the *alpha 1*. By adding a CRT terminal and/or teleprinter you will have a complete computer system.

KIT: \$769 ASSEMBLED & TESTED: \$1039

XITAN alpha 2

By adding a Z16 memory module and our PACKAGE A software to the *alpha 1* we created a second XITAN system, the *alpha 2*. Thus, a complete and extremely powerful micro-computer system emerges well worthy of you who are operating at the most sophisticated levels. The XITAN *alpha 2* provides you with 18K of RAM, 2K of ROM, 2 serial I/O ports, 1 parallel I/O port, our 1200 baud audio cassette interface as well as our extraordinarily powerful software package which includes 8K Basic, the Text Output Processor, the Zapple Text Editor and the Relocating Macro-Assembler. Add your own I/O device and GO... with the most powerful and flexible micro-computer package ever offered.

KIT: \$1369 ASSEMBLED & TESTED: \$1749

IF YOU ARE A BEGINNER, YOU WON'T EASILY OUTGROW THE XITAN SYSTEM.
IF YOU ARE AN ADVANCED USER, YOU WILL DISCOVER XITAN IS EXACTLY WHAT YOU NEED.

Circle 209 on inquiry card.

Write for descriptive brochure on the XITAN *alpha* series
and system software. When you ask at your dealer, say "ZY-TAN."

ORDERING INFORMATION: Send check, money order or BankAmericard, Master Charge
current number and expiration date. Shipping is usually made via UPS or UPS Blue Label.
Specify other arrangements if you wish. Prepaid orders are shipped postpaid.

TECHNICAL
DESIGN
LABS

RESEARCH PARK BLDG. H 1101 STATE ROAD
PRINCETON, NEW JERSEY 08540 (609) 921-0321

artifact was the leader of the instrumentation group, Ned. Ned's large frame amply filled the white lab coat though it was barely discernable in the dense cloud of cigar smoke. The combined scent of hydraulic oil, burned resistors, and cigar smoke convinced me that today was not going to be my day.

"Hi, Ned. What's the problem with the new detector?," I asked.

"It's about time one of you guys came down and asked. This has got to be the most fragile pressure detector I have ever tested.

So far, we have wiped out four engineering prototypes and haven't gotten to 20,000 pressure cycles, let alone the 50,000 life test," he bellowed.

My eyes rolled slightly as he mentioned the failed units. These pressure detectors were not in the least bit fragile; they were ruggedized units with a prospective sale price of \$4700 each. The four engineering prototypes were handmade and far more costly. Before it became too apparent that I was coming to a slow burn, I asked the obvious question. "Ned, are you following the engineering test specification?"

"You guys are really something! I've been in this business for 30 years. I was testing . . ."

"OK, OK, Ned! Just tell me what your test procedure is. Pretend I'm a novice and tell me by the numbers." I was sure that he felt that was the way he had to work with any engineer, so I humored him and just listened.

"All right. The pressure detector is rated at 7500 PSIG and we are life testing it," he said with a cigar chomping smile. "The pressure is cycled between 0 pounds per square inch gauge (PSIG) and 10,000 PSIG every ten seconds and remains at 5,000 PSIG between cycles. [PSIG, or gauge pressure, is a differential pressure measurement using the ambient pressure as a reference. Usually, standard sea level pressure (14.7 pounds per square inch) is used as the reference . . .CM] At the conclusion of each cycle, the detector reading is compared to an out-of-tolerance spec. Oven temp and other control parameters are constantly monitored. Every 10,000 cycles, a calibration run is taken and compared to the accuracy specification quoted. We just haven't been able to get one of the bloody things to hang together long enough to finish the test. The pressure diaphragm keeps breaking."

So far, what he was relaying was exactly the procedure I had outlined. Nothing sounded wrong, so the next obvious question was a description of the test apparatus.

"I decided to automate the testing procedure," he gleamed like a kid describing a new toy. "I made a sequencing circuit with relays to cycle the pressure automatically. All the operator does is record the data and run the calibrations. Here, let me draw you a diagram."

It was unbelievable! True, Ned was following the spec, but what a way to do it! Pressure transducers are expected to withstand a certain amount of overpressuring, which was the reason for the test. But overpressure in combination with a 10,000 PSIG

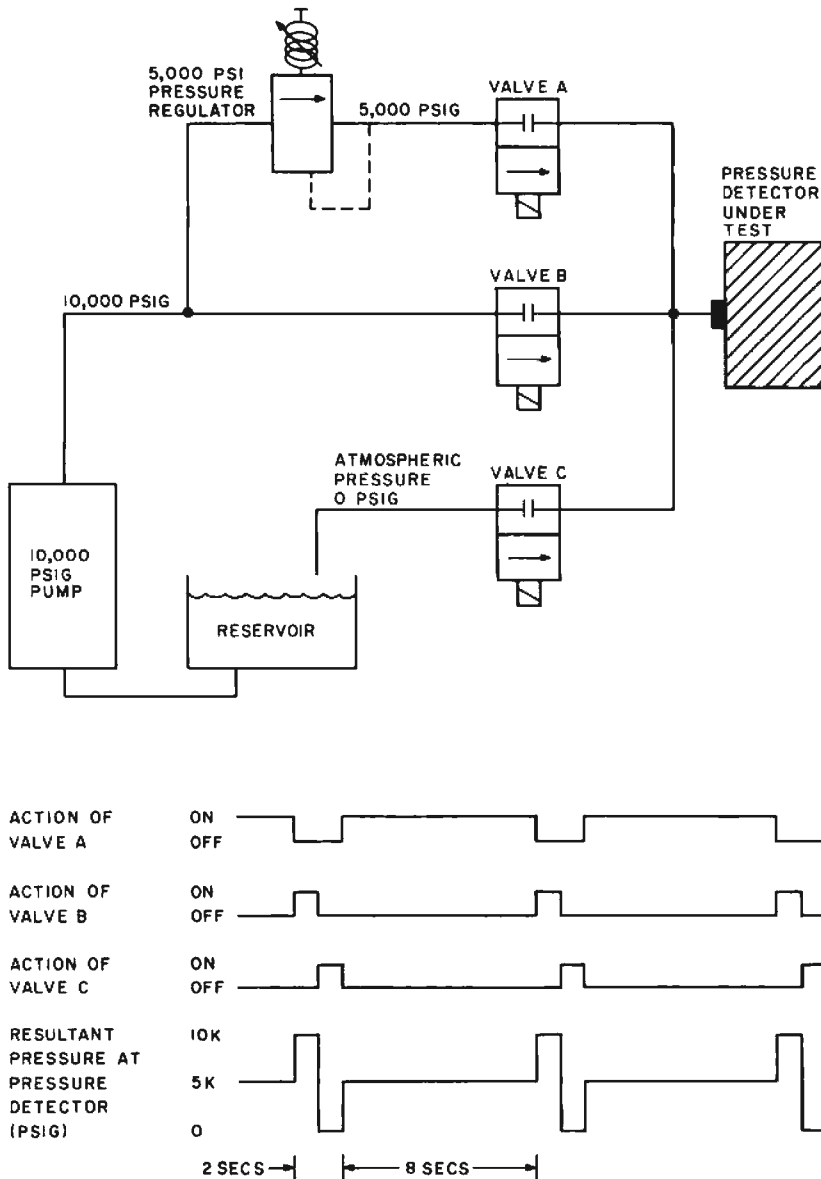

Figure 1: Configuration of a conventional impulse pressure calibration test setup. Note that the pressure detector under test receives what amounts to a square wave input. This type of violent pressure change can shorten the life of the detector and give a false indication of its long term life expectancy. PSIG, or "gauge pressure," is explained in the text.

EXTENSYS corporation

64K for \$1495

The most cost effective products for your microcomputer.

RM64
64K bytes

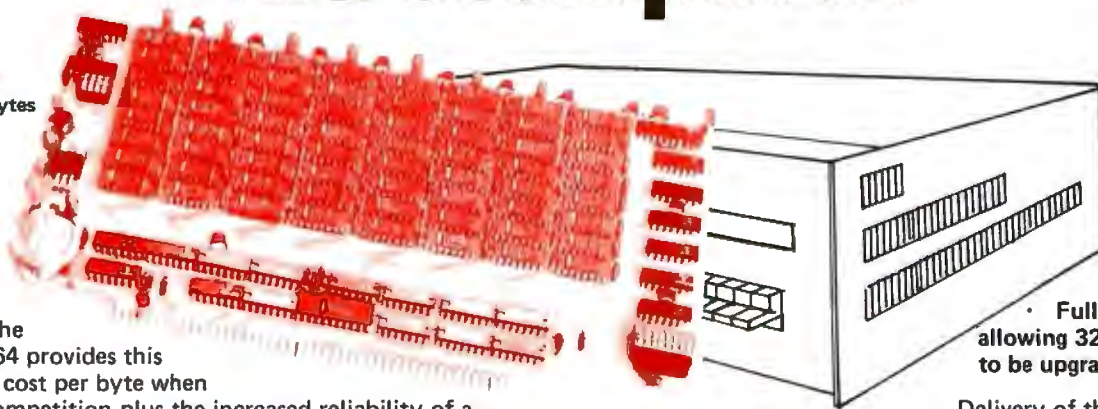

THE EXTENSYS RM64 MEMORY BOARD provides the most cost effective system memory found in the industry. The RM64 provides this because of our low cost per byte when compared to our competition plus the increased reliability of a single board over multiple boards containing less memory. The board is S-100 bus compatible making it usable in over a dozen different microcomputer systems including ALTAIR and IMSA1. The RM64 is available in three configurations: 32K, 48K or 64K bytes of memory all on ONE board. The board is completely assembled, checked out and burned in for at least 50 hours prior to shipment. This complete testing procedure allows Extensys to provide a one year warranty on parts, labor and materials (assuming no misuse of the board occurs).

- On board hardware is provided for:
 - Individual memory bank address selection in 8K byte increments;
 - Complete dynamic refresh logic without loss of processing efficiency while programs are running;
 - Board select logic which allows more than one 64K byte board per system;
 - S-100 bus compatibility including on-board voltage regulator;
 - Memory overlap which allows memory sharing the same address space to coexist in the same system;

Write protection in 16K blocks; and

Fully socketed for 64K, allowing 32K and 48K versions to be upgraded at a later date.

Delivery of the RM64 is 15 to 30 DAYS upon receipt of order. Prices for the RM64 include shipping and handling prepaid in the continental United States.

EXTENSYS Corporation is also announcing several other new highly cost effective products. These include a total floppy disk system based around File I/O board and a multiprocessor operating system. The other product, which interfaces with the RM64 memory board to create a megabyte or more of memory and adds full DMA capability to the File I/O board, is a Board Select/DMA board. Both of these products are S-100 compatible.

Contact your local computer store or order directly from EXTENSYS

Circle 210 on inquiry card.

extensys corporation
B-3

592 Weddell Drive
Sunnyvale, California 94086
(408) 734-1525

QTY	DESCRIPTION	AMOUNT
_____	RM64-32K byte board @ \$ 895 ea.	_____
_____	RM64-48K byte board @ \$1195 ea.	_____
_____	RM64-64K byte board @ \$1495 ea.	_____
Subtotal		_____
California residents add 6% tax		_____
TOTAL		_____
Shipping and handling prepaid in continental United States		
NAME _____		
ADDRESS _____		
CITY _____ STATE _____ ZIP _____ SIGNATURE: _____		
PHONE (INCLUDE AREA CODE) _____		

Please check method of payment:

- Check Enclosed
- BankAmericard No. _____ expiration date _____
- Master Charge No. _____ expiration date _____

impulse was like a jackhammer. The engineering group upstairs would be amazed that the test made it though 20,000 cycles. I wiped my brow, leaned against the concrete wall and asked with a pathetic whimper, "I suppose the failed detectors make good boat anchors."

"What?", he asked, not having heard what I had said.

"Ned, while I think your intention is fine, your method may be a little too rough on the unit. Why don't we change the square wave pressure being applied to the detector to a sinusoidal waveform." This was the method I had assumed he was going to use initially.

"I can't have a guy sitting there cranking a pressure controller knob ten hours a day. It's going to take two weeks to run this test as it is. That's why I automated it!" He seemed to get mad as I challenged his inventiveness.

"You don't have to compromise anything. Get a DC proportional control valve from the stock room and modulate the pressure sinusoidally. In fact, you can use the minicomputer which you ordinarily use for mathematical calculations over there

in the corner to drive it directly, collect the data, and run the calibration automatically."

"You guys upstairs must be suffering from thin air. I know about computers; ones and zeros and all that stuff. We're talking about a DC voltage controlled valve. That isn't consistent with computer binary voltage levels. You would have exactly the same on and off situation as my relay controller," he stated.

It was going to be an uphill fight, but I knew I was going to have to introduce Ned to the world of analog to digital and digital to analog conversion. I first mapped out the life test circuit and diagrammed the waveforms.

Ned was no neophyte. He felt that he knew a lot about computers and in fact was quite familiar with the uses of BASIC and FORTRAN on the lab minicomputer. But Ned had never considered that this number crunching machine has the same logical abilities to control analog devices if properly interfaced.

General Considerations

While this may have been a lengthy introduction to computer analog interfacing, it often takes a real life situation to make one realize the added potential of the computer when it is combined with analog capabilities.

Since natural parameters such as displacement, temperature, volume and magnetic field strength are analog, and most practical methods of data acquisition, manipulation and visual presentation are digital, conversion between analog and digital qualities is a fundamental operation in computing and control systems. The basic building blocks are the digital to analog converter (DAC), and the analog to digital converter (ADC).

Because these converters are essentially interface devices, the basic conversion circuitry must be adapted to properly mate the application to the computer. Such variables include the possible necessity for buffers, registers, clock circuitry and reference voltages, all of which are external supports for the actual conversion device. The exact design requirements can be lengthy and are handled separately by necessity. Digital to analog conversion is the first topic to be discussed.

Digital to Analog Conversion

The digital to analog converter can be thought of as a digitally controlled programmable potentiometer which produces an analog output. This output value (V_O) is the product of a digital signal (D) and an

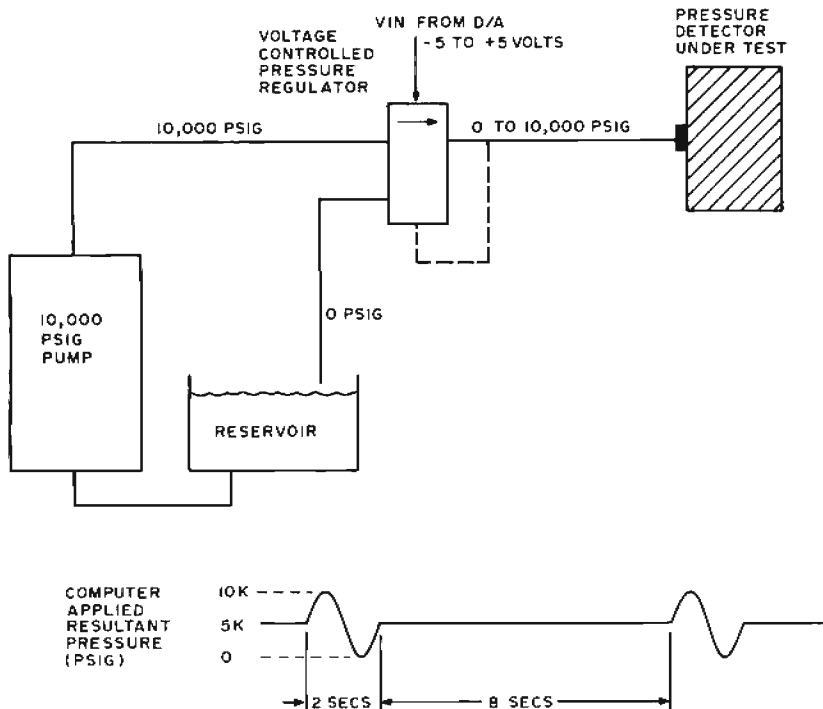

Figure 2: The same pressure detector as in figure 1 being tested here with a computer controlled system which applies the test pressure sinusoidally. This approach gives a much better indication of the unit's true life expectancy, and incidentally shows one practical application of digital to analog conversion.

Why you should buy a digital multimeter from the leader in digital multimeters.

If you're shopping for your first multimeter, or moving up to digital from analog, there are a few things you should know.

First, look at more than price. You'll find, for instance, that the new Fluke 8020A DMM offers features you won't find on other DMMs at *any* price. And it's only \$169.*

Second, quality pays. Fluke is recognized as the leading maker of multimeters (among other things) with a 30-year heritage of quality, excellence and value that pays off for you in the 8020A.

Third, don't under-buy. You may think that a precision 3½-digit digital multimeter is too much instrument for you right now. But considering our rapidly changing technology, you're going to need digital *yesterday*.

If you're just beginning, go digital.

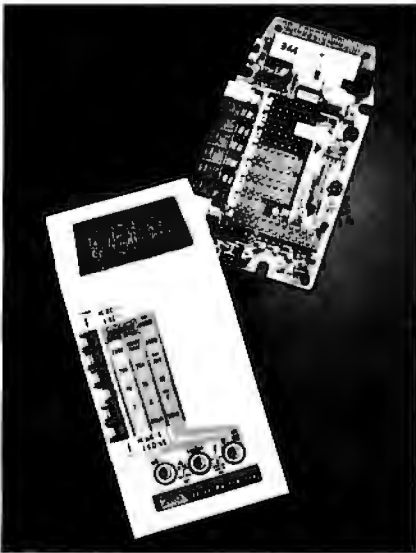

Why not analog? Because the 8020A has 0.25% dc accuracy, and that's *ten*

times better than most analog meters.

Also, the 8020A's digital performance means things like 26 ranges and seven functions. And the tougher your home projects get, the more you need the 8020A's full-range versatility and accuracy. The 8020A has it; analog meters don't.

If you're a pro.

You already know Fluke. And you probably own a benchtop-model multimeter.

Now consider the 8020A: smaller in size, but just as big in capability. Like 2000-count resolution and high-low power ohms. Autozero and autopolarity. And the 8020A is MOV-protected to 6000V against hidden transients, and has overload protection to 300V ac.

Nanosiemens?

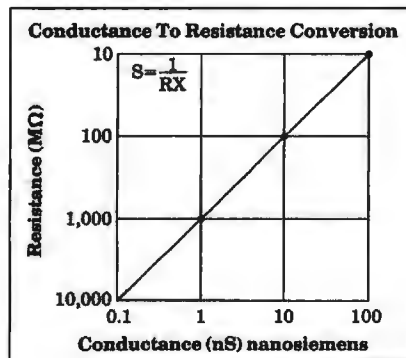

Beginner or pro, you'll find the meter you now have can't measure nanosiemens. So what? With the 8020A *conductance* function, you can measure the equivalent of 10,000 megohms in nanosiemens. Like capacitor, circuit board and insulation leakage. And, you can check transistor gain with a simple, homemade adapter. Only with the 8020A, a 13-oz. heavyweight that goes where you go, with confidence.

What price to pay.



\$169.*

Of course, you can pay more. Or less. In fact, you could pay almost as much for equally compact but more simplistic meters, and get far less versatility. And, the 8020A gives you the 'plus' of custom CMOS LSI chip design, and a minimum number of parts (47 in all). All parts and service available at more than 100 Fluke service centers, worldwide. Guaranteed, for a full year.

Rugged. Reliable. Inexpensive to own and to operate; a simple 9V battery assures continuous use for up to 200 hours.

Where to buy.

Call (800) 426-0361 toll free. Give us your chargecard number and we'll ship one to you the same day. Or, we'll tell you the location of the closest Fluke office or distributor for a personal hands-on feel for the best DMM value going.

*U.S. price only

Fluke 8020A DMM for Home Electronics Experts: \$169



Circle 211 on inquiry card.

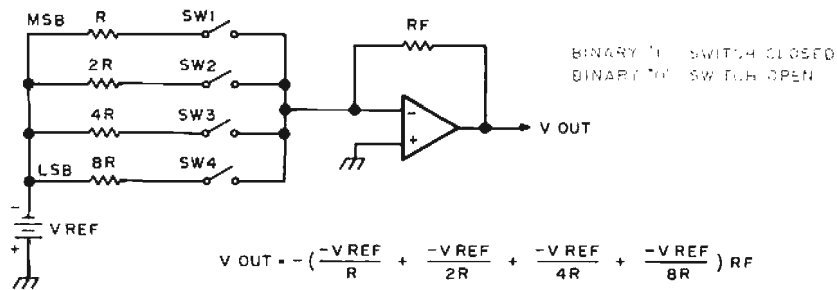

Figure 3: A 4 bit weighted resistor digital to analog converter. A 4 bit word is used to control four single-pole single-throw switches. Each of these switches is in series with a resistor. The resistor values are related as powers of 2, as shown. The other sides of the switches are connected together at the summing point of an operational amplifier. Currents with magnitudes inversely proportional to the resistors are generated when the switches are closed. They are summed by the op amp and converted to a corresponding voltage.

analog reference (V_{REF}) and is related by the following equation:

$$V_o = (D) (V_{ref})$$

To a large extent, no digital to analog or analog to digital converter can be of much practical use to anyone without specifying the type of code utilized to represent digital magnitude.

Converters work with either unipolar or bipolar digital codes. Unipolar includes straight binary and binary coded decimal (BCD). Even floating point converters have been used on occasion: witness the auto ranging digital voltmeter. Offset binary, one's and two's complement and Gray code are usually reserved for bipolar operation. Since the obvious sphere of this article is home computer applications, straight and

offset binary will be the only digital methods addressed.

It is important to remember that the binary quantity presented by the computer is a representation of a fractional value to be multiplied by a reference voltage. In binary fractions, the most significant bit has a value of $1/2$ or 2^{-1} , the next most significant bit is $1/4$ or 2^{-2} , and the least significant bit is $1/2^N$ or 2^{-N} . It can be seen that adding up all the bits approaches a value of 1. (The more bits, the closer the value is to 1). The discrepancy between the binary value approaching 1 and the actual value 1 is the quantization error of the digital system. I'll discuss this later.

Offset binary is nothing more than straight binary except that the binary number zero is set to represent the maximum negative analog quantity. In the easiest terms, the most significant bit is a zero for negative analog values, and a one for positive analog values.

The conversion of digital values to proportional analog values is done by either of two basic conversion techniques: the weighted resistor digital to analog converter and the R-2R digital to analog converter. The weighted resistor digital to analog converter is by far the simplest and most straightforward. This parallel decoder requires only one resistor per bit. In the weighted resistor digital to analog converter, switches are driven directly from the signals that represent the digital number D. Currents with magnitudes of $1/2, 1/4, 1/8, \dots, 1/2^N$ are generated by connecting resistors with magnitudes of $R, 2R, 4R, \dots, 2^N R$ between a reference voltage, $-V_{ref}$, and the summing point of an operational amplifier by means of a set of switches. The various currents are summed and converted to a voltage by the operational amplifier (see figure 3).

While this may appear to be a simple answer to an otherwise complex problem, this method has some potentially hazardous ramifications. The accuracy of this converter is a function of the combined accuracies of the resistors, switches (since all switches have some resistance) and the op amp. In conversion systems of greater than ten bits resolution, the magnitudes of the resistors become exceptionally large and the resultant current flow is reduced to such a low value as to be lost in circuit noise.

A reasonable alternative to the weighted resistor digital to analog converter is the R-2R converter. This is often referred to as a resistor ladder digital to analog converter. The R-2R digital to analog converter is the most widely used type of digital to analog

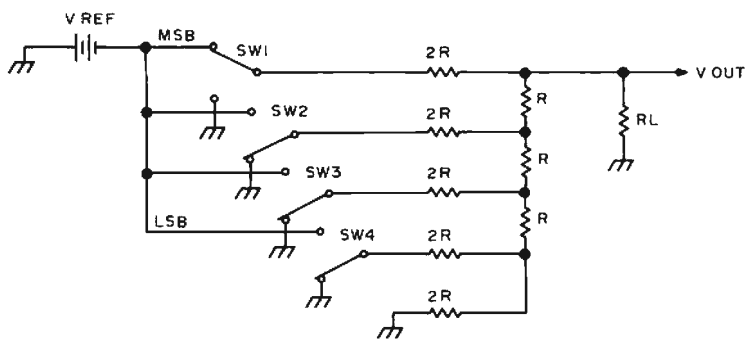
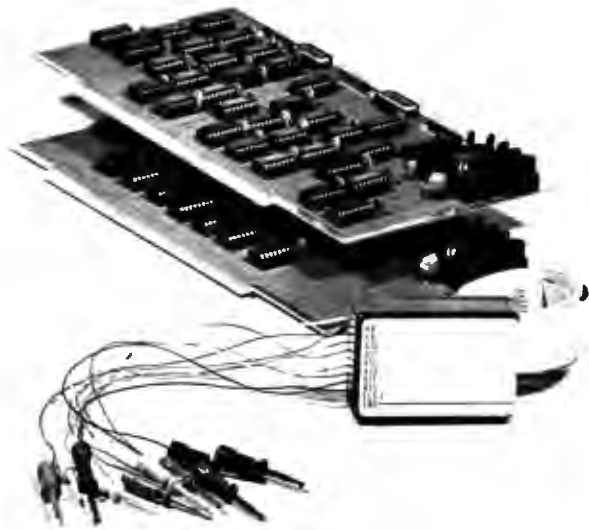

Figure 4: A 4 bit "R - 2R" ladder network digital to analog converter. This type of digital to analog converter makes use of a resistor ladder network constructed with resistors of values R and 2R. The topology of this network is such that current flowing into any branch of a 3 branch node will divide itself equally through the two remaining branches. Because of this, the current will divide itself in half as it passes through each node on its way to the end of the ladder. The four switches are again related as powers of 2. The position of each switch with respect to its distance from the end of the ladder determines its binary significance.



24 channel Logic Analyzer plugs into your S-100 Bus

The DATALYZER

The Databyte Logic Analyzer (DATALYZER) is a convenient, flexible, high quality device. Efficient engineering has allowed a combination of features previously available in only the most expensive units.

Designed to plug easily into your S-100 Bus, the DATALYZER is a complete system — for only \$495. Display of disassembled program flow is a standard feature, not an extra. And the low price includes 30 logic probes, so you can hook up immediately, without additional expense.

The DATALYZER is available in kit form (\$495), and as a fully assembled device on two PCB's (\$595). Four-week delivery, a substantial warranty, and the Databyte, Inc. commitment to service make the DATALYZER a worthwhile investment. Begin debugging by sending the coupon now.

24 Channel LOGIC ANALYZER, complete with 2 cards and 3 sets of probes (only one set shown).

Features

- 24 channels with 256 samples each.
- Display of disassembled program flow.
- Dual mode operation — external mode analyses any external logic system. Internal mode monitors users data and address bus.
- Selectable trigger point anywhere in the 256 samples.
- 0-16 bit trigger word format or external qualifier.
- 10MHz sample rate (50ns min. pulse width)
- Synchronous clock sample with coincident or delayed clock mode.
- User defined reference memory.
- Displays and system control through keyboard entry.
- TTL Logic level compatible (15 pf and 15 μ a typical input loading).
- Includes annotated source listing.

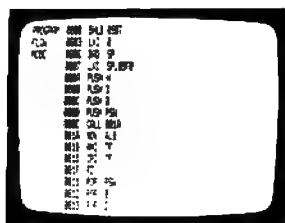

Display of disassembled program flow.

Circle 212 on inquiry card.

Databyte, Inc.

P.O. Box 14B
7433 Hubbard Avenue
Middleton, Wisconsin 53562
Tel: (608) 831-7666

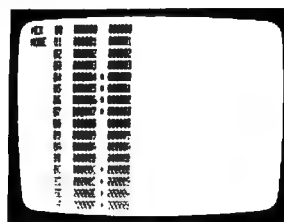

Displays in Hex

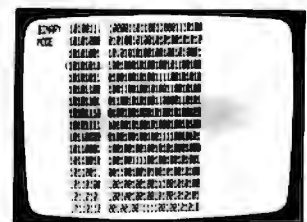

Displays in Binary

Please send me the 24 Channel LOGIC ANALYZER	
<input type="checkbox"/>	Kit — (manual included) \$495.00 (Wis. res. add 4%)
<input type="checkbox"/>	Assembled and Tested (manual included) \$595.00
<input type="checkbox"/>	Operators' manual only \$7.50
Delivery of all items in four weeks to:	
Name _____	
Address _____	
City _____ State _____ Zip _____	
Telephone _____	
Payment Enclosed: <input type="checkbox"/> Check <input type="checkbox"/> Money Order	
<input type="checkbox"/> BankAmericard <input type="checkbox"/> Master Charge Exp. Date _____	
Number _____	
Signature _____	

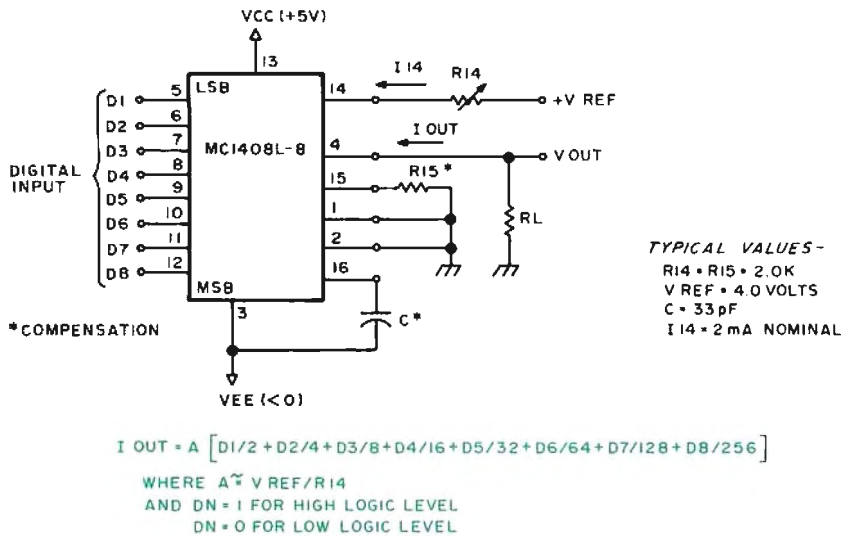

Figure 5: A typical current output monolithic multiplying digital to analog converter. This Motorola integrated circuit contains an R-2R network like the one in figure 4 plus additional current switching logic. The relative accuracy of this 8 bit unit is ± 1 least significant bit, or 0.19% of full scale.

converter, even though it uses more components. This circuit is illustrated in figure 4 and also contains a reference voltage, a set of binary switches and an op amp, but the basis of this converter is a ladder network constructed with two resistor values, R and 2R.

One resistor (2R) is in series with the bit switch, while the other (R) is in the summing line, so that the combination forms what electrical engineers call a "pi" network. This suggests that the impedances of the three branches of any node are equal, and that a current, I, flowing into a node through one branch flows out as I/2 through the other two branches. In other words, a current produced by closing a bit switch is cut by half as it passes through each node on

the way to the end of the ladder. Simply speaking, the position of a switch, with respect to the point where the current is measured, determines the binary significance of the particular switch closure.

This type of converter is easy to manufacture because only two resistor types are needed and can be reduced to one value, R, if three components are used for each bit. Keeping matched resistor values with the same temperature coefficients contributes to a very stable design. Certain tradeoffs are required between ladder resistance values and current flow to balance accuracy and noise.

One form of the R-2R ladder digital to analog converter is the multiplying digital to analog converter. Digital to analog converters are available with either a fixed reference or with an external variable reference. Multiplying digital to analog converters, which utilize external variable analog references, produce outputs which are directly proportional to the product of the digital input multiplied by this variable reference. Functionally, these converters are available as current or voltage output types. The current output devices are necessarily faster because they do not include output amplifiers which limit the bandwidth. Because this output amplifier is not included, current digital to analog converters tend to be a little less expensive than voltage types.

Probably one of the most useful and cost effective multiplying digital to analog

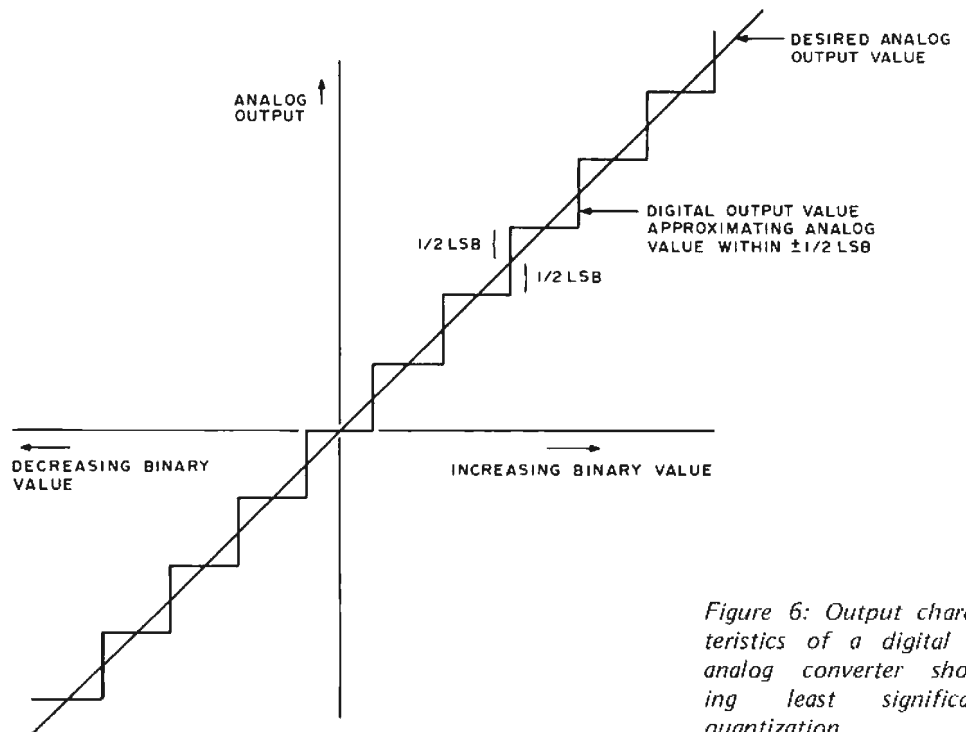
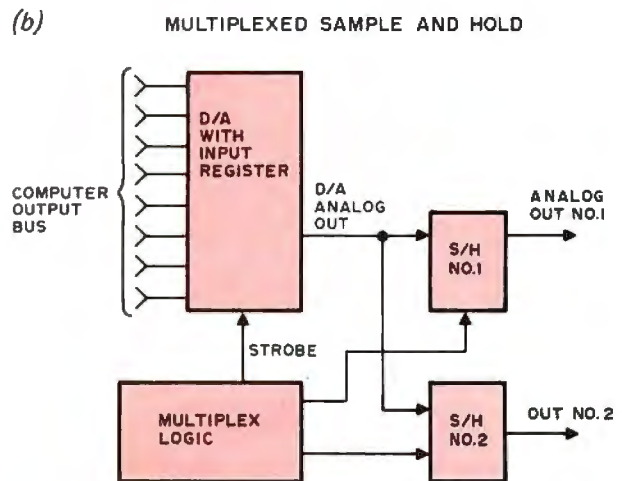
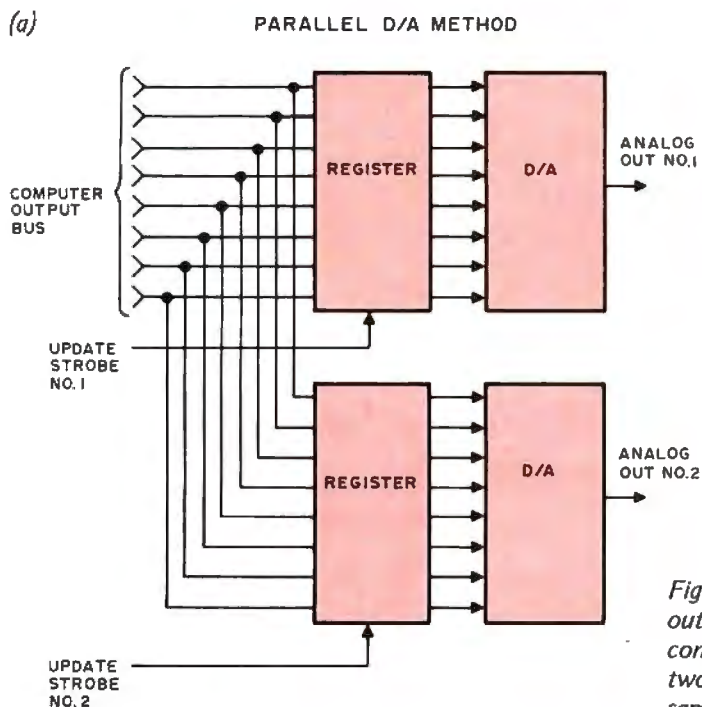

Figure 6: Output characteristics of a digital to analog converter showing least significant quantization.



Figures 7a and 7b: Two methods for providing multiple channel output capability. Figure 7a shows a parallel digital to analog converter method in which the computer routes information to two different digital to analog converters. In figure 7b, two sample and hold circuits are fed by the same digital to analog converter. Multiplex logic switches the output of the converter between the two sample and hold circuits. The latter do just what their name implies: when strobed, they store the value of the incoming voltage and stay very close to that value until strobed again, at which time they change to the new value. The sample and hold technique of figure 7b is economically more attractive than the multiple digital to analog converter approach.

converters available on the hobby market today is the Motorola MC1408L-8 8 bit digital to analog converter (see figures 5 and 6).

As previously mentioned, this monolithic converter contains an R-2R ladder network and current switching logic. Each binary bit controls a switch which regulates the current flowing through the ladder. If an 8 bit digital input of 11000000 (192₁₀) is applied to the control lines of the illustrated converter, the output current would be equal to $(192/256)$ (2 mA) or 1.50 mA. Note that when binary 11 111 111 (or 255 decimal) is applied, there is always a remainder current which is equal to the least significant bit. This current is shunted to ground, and the maximum output current is 255/256 of the reference amplifier current, or 1.992 mA for a 2.0 mA reference current. The relative accuracy for the MC1408-L8 version is $\pm 1/2$ least significant bit, or 0.19% of full scale, and is more than adequate for most home computer analog control applications.

A Design with the User in Mind

I could actually stop right now and be satisfied that the reader has at least some idea of what a digital to analog converter is, but no mention has been made as to its uses. BYTE has published previous articles on digital to analog converters, but few actually using them in detail designs.

When we last left Ned in the testing lab, he was hooking up a voltage controlled pressure regulator and attaching it to the com-

puter through a digital to analog interface. Though only the voltage requirement of the value was mentioned, the pressure detector is situated in an environmental control chamber with the temperature maintained by a setpoint controller.

At various times during the testing phase, the temperature is elevated. To adequately automate this test procedure, therefore, two analog output values are required: one for temperature setpoint and the other for pressure setpoint. It takes one digital to analog converter for the first voltage and we could add another separate digital to analog converter for the second voltage, but this is overly expensive and not necessary. The preferred method is to use multiplexed digital to analog conversion. This technique uses a single converter and switches it back and forth between the two channels doing the respective digital to analog conversion 50% of the time on each channel. To insure that each channel does not go on and off as the converter switches back and forth between them, a circuit called a sample and hold is employed on each channel to maintain the output at a constant level until the next refresh by the digital to analog converter. Figures 7a and 7b illustrate the

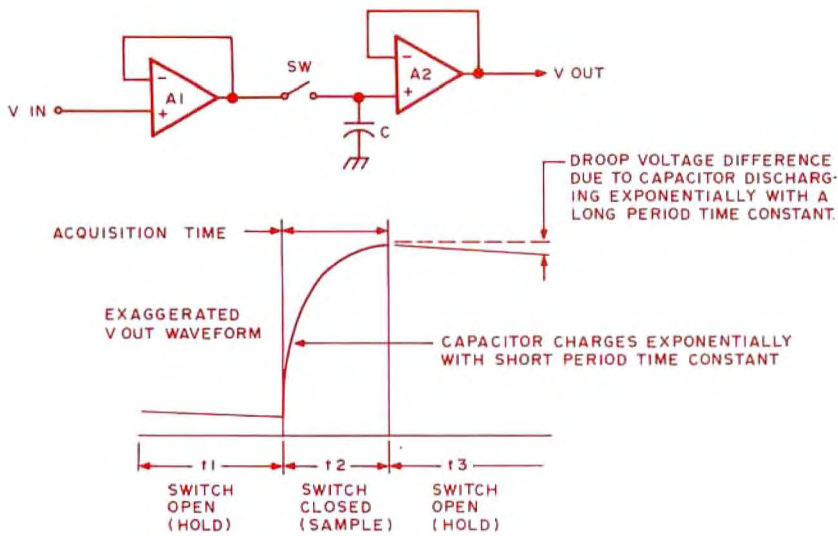

Figure 8: A basic sample and hold circuit. When the switch is closed, the capacitor begins to charge up exponentially to the value of the input voltage. Theoretically, the capacitor will maintain this value indefinitely after the switch is opened, but in reality a certain amount of voltage "droop" (exponential decay) will occur over time as the capacitor slowly discharges.

separator versus multiplexed digital to analog approach, and figure 8 illustrates a basic sample and hold circuit.

A sample and hold circuit is simply a charged capacitor analog storage device. Amplifier A1 is an impedance isolating buffer connected to the digital to analog converter or other voltage supply and connected to the capacitor through a switch. This switch is normally open in the "hold" state. When the output is to be updated, the switch is closed, the circuit enters the "sample" or acquisition mode, causing the capacitor to charge exponentially toward the new value present at the output of A1. When the switch is reopened and again in the "hold" state, the output of A2 will be equal to the capacitor voltage level.

The secret of good sample and hold is to use good high input impedance buffers to minimize the leakage from the capacitor and hold the output for long periods of time. No sample and hold can be designed without some droop during the holding period. The best that the designer can do to minimize this feature is to use precision components (usually more expensive) and refresh the sample and hold frequently enough to overcome decay problems.

Is There a Way to Overcome the Necessity to Refresh Sample and Hold Outputs?

For the home computer experimenter, sample and hold outputs, which require periodic refreshing, can become a bother.

This is especially true during step-by-step checkout of system software.

Refreshing a multiplexed digital to analog interface usually requires a separate digital to analog refresh subroutine which must be called at regular intervals while executing the program. Simple, inexpensive sample and holds may require updating tens of times per second, while the better designed circuits available to the hobbyist can do satisfactorily with a once per second update. The fact remains, though, that the refresh is a requirement. This can limit digital to analog interface applications.

Drive the Digital to Analog Converter with BASIC?

Many extended BASIC programs such as the Digital Group MaxiBASIC can directly interface with computer input and output ports. This means that analog devices can be driven with a digital to analog converter, analog data processed through an analog to digital converter, and the acquired data mathematically manipulated using BASIC. The implication is a pseudoreal time analog control scheme utilizing BASIC. This is a realistic capability in slow process control applications where control feedback does not have to be activated within microseconds of an initiating event. Solar heating, low duty cycle repetitive machine functions, building environmental control systems, and supervisory control of setpoint controllers are examples of slow processes where slow computer response is of no major consequence.

The Final Configuration

Utilization of BASIC as a real time operating system does imply some constraints. If analog control is involved, the time between updates to an analog output interface can be on the order of tens of seconds, especially if the computer is required to do extensive calculations and record outputs to a printer. Of course, a special interrupt driver could be added to the BASIC and the processor interrupted frequently to service the external devices; but why make life difficult? The idea of using BASIC in the first place was to provide a control capability without adding special machine language drivers, a capability which would enable anyone to try his or her hand at closed loop control programming. This approach, though, tends to eliminate the classical sample and hold multichannel digital to analog method from consideration. It would also seem that the only approach left is the separate storage register and

Meet the First Family in floppies.

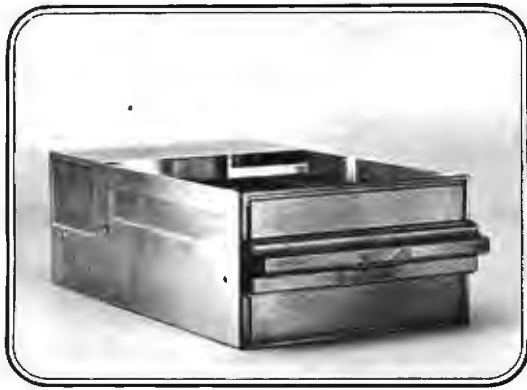

The roots of our floppy family

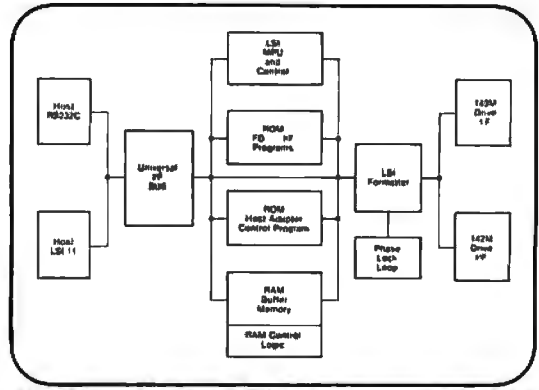

1143M controller • LSI technology • 1K buffer



Dual head

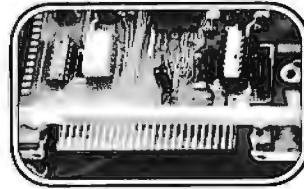

50 pin LSI interface

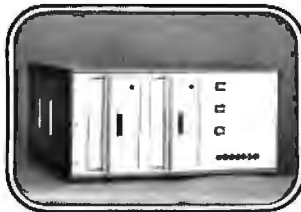

1149M Multipurpose Cabinet assembly.
Rack or table mounted.

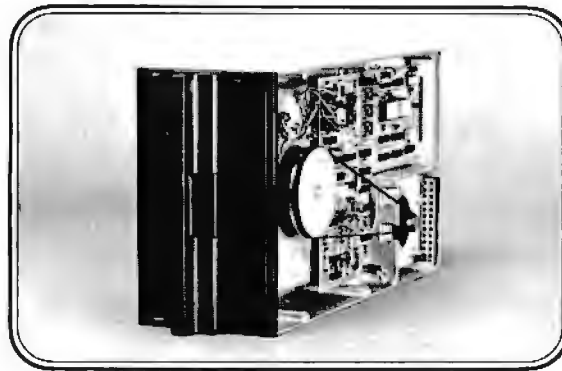

New 143M disk drive. Two-sided recording.
Single/double density. LSI Multifunction.



Our host adaptors

CalComp's got it all together for you. A total floppy family. Any way you want it...single products or the total package. In every case you get *true* multifunction, LSI technology, high MTBF and low MTTR reliability, compatibility and multiple interfaces.

And that's not all. *Field-proven* double density — now one or two-sided. And our new 1143M controller along with three host adaptors.

With CalComp it's all there. Choice. Flexibility. Everything you need for all or part of a total memory subsystem. *Plus* CalComp's worldwide service to support our family. We've delivered 50,000 drives — why not add your application requirements to our growing family.

Just call us or use the coupon. We'd like to tell you more about our family.

California Computer Products, Inc.
2411 West La Palma Avenue
Anaheim, California 92801
(714) 821-2011

FREE

Please send me your free Floppy Family information kit.

I am interested My needs are immediate

Name

Company Title

Address Phone

City State Zip

CALCOMP

Circle 213 on inquiry card.

Power Wiring Table					
Number	Type	+5 V Pin	GND Pin	+6.8 V Pin	-8.2 V Pin
IC1	74LS04	14	7	-	-
IC2	74LS04	14	7	-	-
IC3	74LS30	14	7	-	-
IC4	74170	16	8	-	-
IC5	74170	16	8	-	-
IC6	7400	14	7	-	-
IC7	MC1408-LB	13	2	7	3
IC8	7493	5	10	16	4
IC9	LM301A	-	-	8	4
IC10	CD4051AE	-	-	8	4
IC11	MC1458G	-	-	8	4
IC12	MC1458G	-	-	8	4

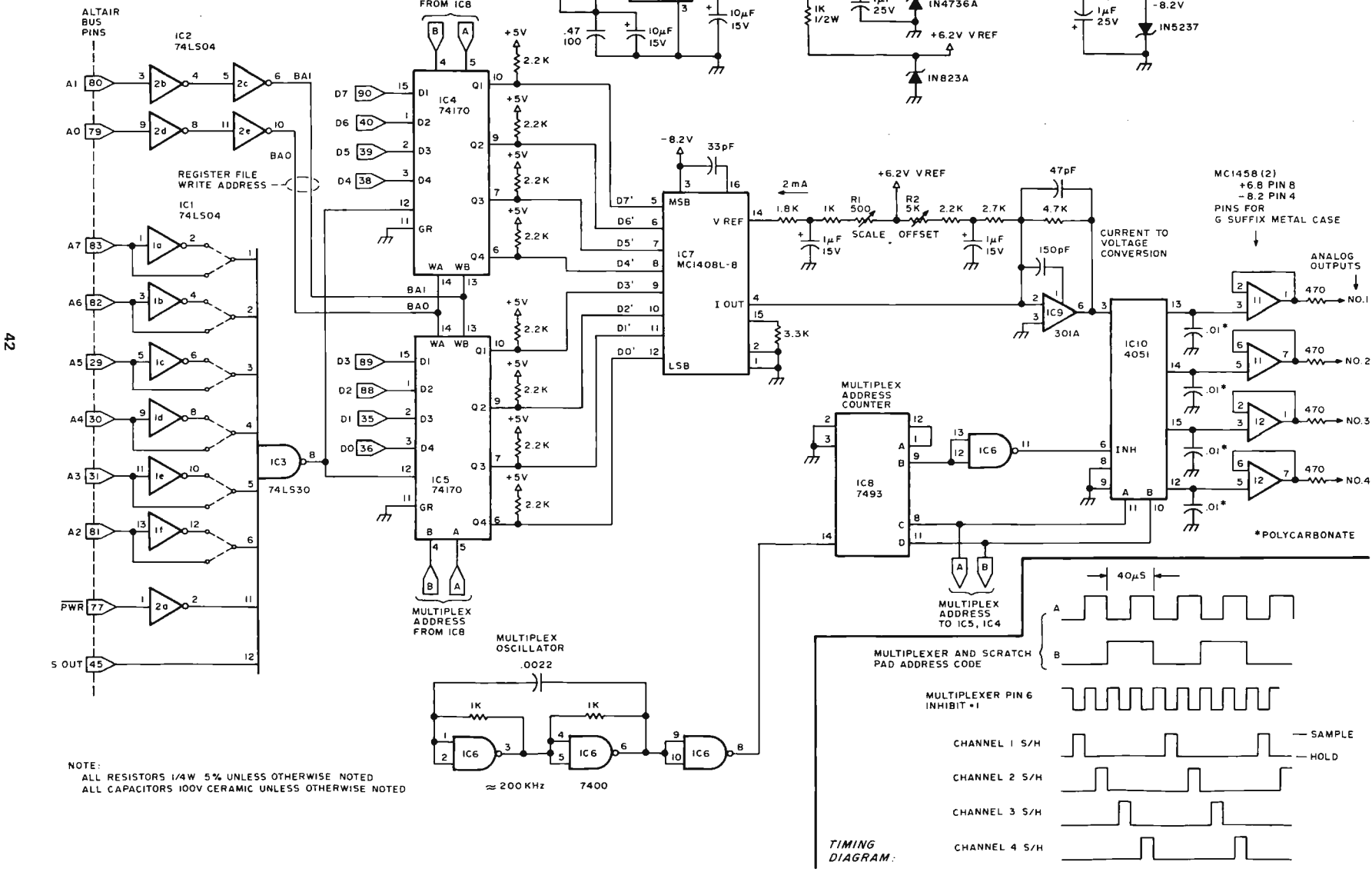

NOTE:
 ALL RESISTORS 1/4W 5% UNLESS OTHERWISE NOTED
 ALL CAPACITORS 100V CERAMIC UNLESS OTHERWISE NOTED

Figure 9: A "smart" 4 channel self-refreshing digital to analog converter. The circuit is self-refreshing and asynchronous in the sense that it maintains its analog outputs independent of computer timing. IC1, IC2 and IC3 form an address decoding network which decodes the 8080 or Z-80 processor's output port address and strobos the computer data bus contents into IC4 and IC5,

which form an 8 bit random access scratch pad. IC7 performs the actual analog to digital conversion. The remaining portion of the circuit consists of timing generation and an analog multiplexer with sample and hold circuitry.

digital to analog converter combination previously illustrated. A more intelligent alternative is a combination of the two methods.

The necessary interface is essentially a smart multiplexed digital to analog converter which maintains its analog setpoints independent of the computer timing. The design of this interface is illustrated in figure 9. It is a hybrid system composed of separate digital storage sample and hold circuits for each of four output channels. Internal timing generators sequentially read the storage registers, initiate the digital to analog conversion, and refresh the sample and holds. Photo 1 shows how this card looks when built using a Vector board with 44 pin edge connector.

The key feature of this unit is the input storage buffer. Two 74170 4 by 4 bit registers are configured to form a 4 word by 8 bit random access scratch pad. An address decoding network composed of IC1, IC2, and IC3 decodes the processor's output port address and strobes the computer data bus contents into the appropriate scratch pad location. These four jumper selectable port addresses can be set to be any four consecutively numbered output ports. The exact selection and jumpering details are outlined in the check out procedure. This particular scratch pad can be written into and read from simultaneously. The interface is completely asynchronous and does not have to be synchronized with the computer in any way.

There are four basic sections to the interface: the scratch pad and port decoding, digital to analog converter, timing generator and analog multiplexer, and sample and holds. A basic timing diagram of the interface is illustrated as part of figure 9.

The timing section consists of a 200 kHz clock generator IC6 and address counter IC8. The 7493 counts down the 200 kHz clock and drives the address lines of the scratch pad and multiplexer at a 50 kHz conversion rate. Each channel is accessed, converted and sampled in a similar manner. When the address lines have settled on a particular channel, the output lines of the scratch pad (IC4 and IC5) present the respective stored digital word to the digital to analog converter IC7. The converter immediately starts moving towards the new value.

Since its settling time is dependent upon the magnitude of change from one channel

to the next, the worst case being minus full scale to plus full scale, the 20 μ s conversion period incorporates a 10 μ s settling time. For the first 10 μ s, the analog multiplexer IC10 is inhibited from conducting the signal to the sample and hold. After this settling time has concluded, the inhibit signal is dropped, and for the next 10 μ s the sample and hold for that particular channel is in the sample mode. The circuit automatically sequences itself to the next scratch pad address and repeats the process over and over.

Anyone capable of a little quick math can realize that if the digital to analog conversion is proceeding at 50,000 conversions a second, each sample and hold is being updated at the fantastic rate of 12,500 times a second. This seems to be in direct disagreement with a "tens of times a second" statement made earlier. It is important to remember that this is an asynchronous analog interface. When new data is written into the scratch pad, the new value is not available at the sample and hold output until the next regular sampling period, controlled by the timing generator. The high sampling rate is more to increase the response of the interface than refresh the outputs.

At a 50 kHz conversion frequency, there is a worst case delay of 80 μ s between a scratch pad update and an appropriate analog output response. This is of no consequence as far as this article is concerned. However, to maintain the ability to use BASIC as a real time operating system and yet not lose the capability to do high speed applications such as voice synthesis, a few simple modifications can be made. The interface clock rate can be increased from 200 kHz to 400 kHz. This has been successfully accomplished on the prototype and will increase the sampling rate on each channel to 25,000 samples per second. Unfortunately, it is far more demanding of the current to voltage converter IC9. Only one out of three LM301As may work successfully over the full range of 10 V. Another quick method is to remove the 7493 (IC8). This causes the interface to stay addressed on channel 4, doing 50,000 uninhibited conversions per second.

The converter itself is an 8 bit MC1408L-8 multiplying digital to analog converter. As previously outlined, "multiplying" means that it uses an external variable reference voltage. In this case, a 6.8 V zener diode regulated voltage is passed

Continued on page 156

Expanding the Tiny Assembler

(Increasing Function without Building More Memory)

Jack Emmerichs
8465 N 51
Brown Deer WI 53223

```

LOCN P1 B2 P3
0000
0000 >>
0000 >> EXAMPLE OF AN INLINE BGN BLOCK
0000 >>
0000 >>
0100 > ORG $100
0100 >ROUTINEA RMP 2 SUPROUTINES AVAILABLE
0102 >ROUTINEB RMB 2 IN EXISTING CODE
0104 >ROUTINEC RMR 2
0106 >ROUTINED RMP 2
0108 >ROUTINEE RMB 2
010A >ROUTINEF RMP 2
010C >FLAG1 RMP 1 TEST CONDITIONS
010F >FLAG2 RMP 1 AVAILABLE IN
010E >FLAG3 RMP 1 EXISTING CODE
0200 > ORG $200
0200 >>
0200 >> INLINE CODE
0200 >>
0200 >
0200 >NEWBLOCK BGN START OF INLINE BLOCK
0200 7F 01 0C > TST FLAG1
0203 21 00 > RLT CON11 JUMP TO SUBROUTINE
0205 22 00 > RHI CON12 DEPENDING ON TEST
0207 71 01 0E > TST FLAG2 CONDITIONS
020A 23 00 > RLS CON13
020C BE 01 00 > JSR ROUTINEA
020F 20 00 > BFA CO FIRST USE OF SYMBOL 'GO'
0211 2F 01 0E >CON11 JSR ROUTINEB
0214 0C >
0214 20 00 > BFA CO
0216 2D 01 0A >CON12 JSR ROUTINEC
0219 0E >
0219 20 00 > BFA CO
021B 2E 01 06 >CON13 JSR ROUTINED
021D 0F >
021F 2F 01 0A >GO JSR ROUTINEE SYMBOL 'GO' RESOLVED
0215 0A >
021A 03 >
021D 0E >
0221 > END END OF INLINE BLOCK
*** UNRESOLVED:
*** SYMBOLS?
Y
CON1 CON11 CON2 CON14 CON3 CON1F GO CON1F
0221
0221 71 01 0E >CONTINUE TST FLAG3
0224 22 00 > RHI GO REUSE OF SYMBOL 'GO'
0226 2D 01 0A > JSE ROUTINEF
0229 01 >GO NOP 'GO' RESOLVED AGAIN
0225 03 >
022A >>
022A >> INLINE CODE CONTINUES
022A >>
022A >>
022A >
022A > END END OF ASSEMBLY
*** UNRESOLVED:
*** SYMBOLS?
Y
CONE 0221 FLA1 010C FLA2 010E FLA3 010F CO 0229
NEWK 0200 FOUA 0100 FOUB 0102 FOUC 0104 EOU 010E
FOUE 0108 FOUF 010A

```

Listing 1: This simple in line BGN block shows the format of the BGN and END pseudooperations of the Version 3.1 Tiny Assembler. Any symbols defined within the block are deleted by the END statement for the block and can be reused without conflict by subsequent code. Thus the symbol GO at location 021E defined within block NEWBLOCK is not the same location as the later use of GO in the outer level of the hierarchy at location 0229. Note that the new version of Tiny Assembler still condenses symbols into 4 character names in the symbol table by using the first three and the last characters of the symbol as typed. Thus the NEWBLOCK name at location 200 condenses to NEWK in the symbol table.

It is worth noting that the group of people who have been using the Tiny Assembler since the end of 1976 as listed on page 133 of the March 1977 BYTE excludes the author: ME! Well, I have finally gotten my own computer system up and running and have been able to get some use out of the assembler myself. I soon found that there were a few things here and a few things there that could be changed or added that would make the whole assembly process more convenient. I guess there is just no pleasing some people.

The problem is that, as predicted, I have a minimal configuration system. It is a SwTPC 6800 with (at the moment) no extras. The assembler just fits, so there is no place to put patches or additions except at the top of the symbol table. This of course reduces the capacity of the program. It became obvious that the proper approach to further modifications would be to increase the efficiency of the assembler so that additions could be made while maintaining or increasing the symbol table capacity. The first modification, therefore, would have to be the ability to delete symbols when no longer needed so that the symbol table space could be reused. This would allow a smaller table to handle a larger number of symbols.

As suggested in the article "Implementing the Tiny Assembler" (May 1977 BYTE, page 84), this has been accomplished by developing a "begin" statement (the assembler mnemonic is BGN). This statement causes the next available location in the symbol table to be pushed into a table stack and a structural level counter (which starts at 1 and keeps track of the nesting level of the BGN statements) to be incremented. Symbols entered beyond this point in the table belong to this BGN block. A label on the BGN statement itself will not belong to the block being defined, but to the group of

This general arrangement is significantly modified, however, by the 1 pass nature of the Tiny Assembler. In this case, a symbol "belongs to" the first block that references it rather than the block that defines it as a label. Therefore, a symbol that is defined and used at a low level is inaccessible to higher levels as usual, but symbols that are first referenced in a low level block of code and then defined as a label in a later higher level block of code cannot be handled by the assembler. This is because the symbol belongs to the low level block, and both the forward reference table and the symbol table will be cleared of all references to such a symbol at the end of the low level block.

This problem of what level the symbol belongs to can be avoided by requiring such symbols to be first entered into the symbol table by a high level block of code (as a forward reference if need be). In this way the symbol and all references to it will belong to the high level block and will stay in the tables while low level blocks are created and ended. When the symbol is finally used as a label, all unresolved references to it will be resolved, even those which were made in blocks which have been terminated and no longer exist. In general, a symbol must be entered into the symbol table at a level equal to or higher than every reference that is made to it. It is therefore a good idea to define common subroutines early in the program or to make reference to their entry point names in the highest levels of the structure.

To illustrate how these rules are applied, consider what symbols are "known to," or can be referenced by code within block G in the example in figure 1. Any items in A and E that have already been used can be referenced because they are ancestors. Any items within G itself can of course be referenced. This was the scope of the original versions of the Tiny Assembler. The entry points of H and I can be referenced because they are direct descendants. The entry point of B can be referenced because it is an ancestor's sibling that has already been defined. The entry point of F can be referenced because it is a sibling that has already been defined. Any items first used within H, I, J or K cannot be referenced by G because they belong to a lower level. Any information about C and D that was not originally referenced in A is unavailable because they are cousins. The entry point of L (if not yet used) and any items in A and E that have not yet been used cannot be made a forward reference because they will not be defined until after references to them from G have been removed.

When a program is structured as a network instead of a simple hierarchy, things become a bit more complex because of relationships that cross between branches of the structural tree. The same rules apply when determining what can be referenced from what, however, so a program's block structure should be planned so that multiple paths within the network can be contained within a single block to reduce or eliminate forward reference problems.

For programs with a moderate number of symbols or extremely complex forward references, the whole assembly may be considered a single block. In this case, no BGN statement need be used at all. The first END statement that is encountered ends the program much as it does in the original versions of the Tiny Assembler.

It should be pointed out that the entire table of currently active symbols is searched during symbol processing. Therefore, a block may not redefine a symbol used by an earlier but still active block. If this is tried, a duplicate symbol error will occur. This restriction is based on the fact that a 1 pass assembler allowing redefinition of symbols at a local level could not tell the difference between a forward reference to a redefined local symbol and a backward reference to an existing global symbol. Therefore, symbols may only be reused after they have been deleted from the symbol table by an END statement. As it turns out, the hierarchical structuring scheme of the Tiny Assembler is similar to other structural languages such as PL/I, but the restrictions on redefining symbols and the rules determining what level of the structure a symbol belongs to make the structuring of source programs for this assembler unique.

While developing the methods used to handle BGN and END statements it became evident that the deletion and possible reuse of symbols would make it very difficult to produce a complete symbol table dump at the end of the program. In fact, there may never be a complete symbol table during an entire assembly (a situation which requires a 1 pass design by the way). Therefore, each END statement terminates a structural block as if it were a complete program. All unresolved forward references to symbols first used in the current block are listed and the user is given a chance to abort the END statement. If it is aborted, the user will reenter the block, and may continue with corrections and additions as if the END had not been entered. If the user does not elect to abort the END statement, a sorted symbol table listing is provided for the completed block. In this way, every

GET THE BEST FROM... SEALS

ORDER FORM

[Write in each box the quantity of each part required]

KIT	ASSEMBLED	KIT	ASSEMBLED	KIT	ASSEMBLED
<input type="checkbox"/>	<input type="checkbox"/>	<input type="checkbox"/>	<input type="checkbox"/>	<input type="checkbox"/>	<input type="checkbox"/>
<input type="checkbox"/>	<input type="checkbox"/>	<input type="checkbox"/>	<input type="checkbox"/>	<input type="checkbox"/>	<input type="checkbox"/>
<input type="checkbox"/>	<input type="checkbox"/>	<input type="checkbox"/>	<input type="checkbox"/>	<input type="checkbox"/>	<input type="checkbox"/>
<input type="checkbox"/>	<input type="checkbox"/>	<input type="checkbox"/>	<input type="checkbox"/>	<input type="checkbox"/>	<input type="checkbox"/>
<input type="checkbox"/>	<input type="checkbox"/>	<input type="checkbox"/>	<input type="checkbox"/>	<input type="checkbox"/>	<input type="checkbox"/>
ASSEMBLY AND OPERATING MANUAL \$4.00					

NAME _____ PLEASE PRINT OR TYPE

ADDRESS _____

CITY _____ STATE _____ ZIP _____

SEND CHECK • MONEY ORDER • COD'S ACCEPTED • CREDIT CARDS

SEALS ELECTRONICS, INC
P.O. BOX 11661
KNOXVILLE, TN 37919

	COPY ACCOUNT NUMBER FROM YOUR BANK AMERICARD
<input type="checkbox"/>	<input type="checkbox"/>
<input type="checkbox"/>	AT CARD
<input type="checkbox"/>	EXPENSE
<input type="checkbox"/>	COPY ACCOUNT NUMBER FROM YOUR MASTER CHARGE
<input type="checkbox"/>	<input type="checkbox"/>
	Copy number Make your name or MasterCharge
<input type="checkbox"/>	AT CARD
<input type="checkbox"/>	EXPENSE

MOST ORDERS SHIPPED WITHIN 10 WORKING DAYS

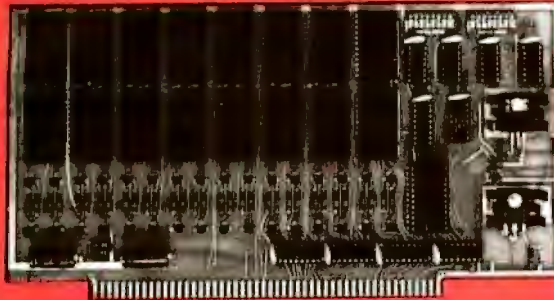

4KROM [READ ONLY MEMORY]

- Will accept up to 16 ea. 1702-A or 5203 EProm Providing up to 4096 words of non-volatile memory for Boot Loads to Complete Programs.
- Programming Available at Factory for \$3.00 per EProm when accompanied by binary formatted tape.
- Each 1702-A has its own V_{gg} clocked for Low Power Consumption.
- Will work with the weakest power supply based S-100 buss computer.
- Switched Selected Address in 4K Blocks.
- Switch selected wait states so that even the slowest 1702-A can work in your system. 0-8 wait states.
- Solder Masked on both sides of PC Board.
- Component Screened on Component Side of PC Board.

Kit Price: . . \$119.00

Assembled Price: . . \$179.00

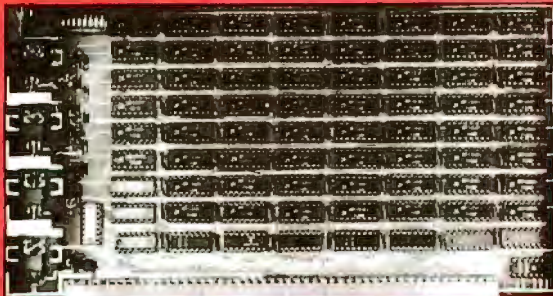

68KSC [STATIC MEMORY CARD FOR SWTPC 6800]

- 8192 Words of Static Memory
- Access Time: 600 nsec. (250 nsec on request)
- Memory Chip 91L02 APC or 2102AL-4
- Battery Standby
- Address Selected 8 Ea. SPST Dip Switch
- Low Power
- All Lines Buffered.
- All IC's with sockets
- Solder Masked on both sides of PC Board.

Kit Price: . . \$269.00

Assembled Price: . . \$369.00

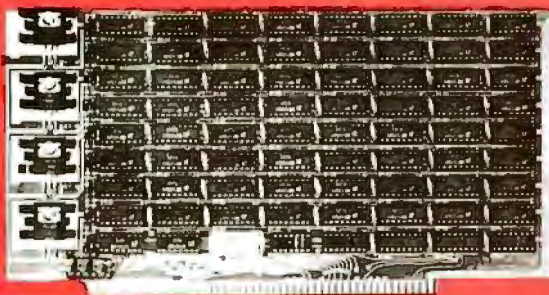

8KSC-Z [STATIC MEMORY CARD]

- ALTAIR[®], IMSAI[®] and S-100 buss compatible.
- Access Time: 250 nsec max.
- Zilog Speed Compatible up to 4 mhz.
- Memory Chip: 2102LHPC or 2102AL-2
- Battery Standby: >1.5 to 4 volts <
- Address Select: 8 ea. Spst. Dip Switch.
- Wait States: None
- Current Reg.: Less than 200 ma per 1K
- All Address, Control, and Data out lines fully buffered.
- All IC's supplied with IC Sockets
- Solder Masked on Both Front and Back of P.C. Board.

Kit Price: . . \$295.00

Assembled Price: . . \$395.00

Circle 214 on inquiry card.

OTHER SEALS ELECTRONIC PARTS AVAILABLE

Item No.	Description	Kit Price	Assembled Price
8KSC	8K Static Memory Card 500 nsec	\$269.00	\$369.00
WWC	Wire Wrap Card	\$37.50	\$47.50
88 EXT	88 Extender Card	\$29.00	\$38.00
68 Ext-S	Extender Card (Small) SWTPC 6800 Compatible Products	\$19.00	\$25.00
68 Ext-L	Extender Card (Large) SWTPC 6800 Compatible Products	\$29.00	\$39.00
68 WWC	Wire Wrap Card SWTPC 6800 Compatible Products	\$35.00	\$45.00
BBUC	Battery Back-Up Card	\$55.00	\$68.00

SEALS 
ELECTRONICS, INC.

ORDER DELIVERY: FROM STOCK TO 10 DAYS

TELEX NO. 55-7444 TELEPHONE NO. 615/693-8655

occurrence of every symbol and unresolved reference in an assembly is listed without requiring that they ever really exist at the same time.

Does this "virtual symbol table" mean that we have an assembler of unlimited capacity that will run in 4 K? Well, no, not really. While this may be theoretically true, there are some practical limits which are

likely to be reached. All programs have a root segment and a list of global symbols which exist throughout the entire assembly. As the program increases in size, the root segment usually grows along with it, but at a slower rate. At some point it becomes impractical to try to fit ever larger programs into the Tiny Assembler. The current design provides for 150 symbols when running in a 4 K machine. This is large enough to assemble simple programs with ease, significant programs through moderate use of structural blocking, and large complex programs if need be. I don't really know what its practical limit would be now, because as noted earlier, I haven't really used the Tiny Assembler enough.

As an additional improvement, the Version 3.1 Tiny Assembler can now expand or contract to the user's requirements. If an 8 K machine were used, the symbol table could be increased to hold over 830 symbols. This could be effectively expanded into the thousands through the use of structural blocking. However, the sequential search times required to find symbols in such a table would no doubt start to become noticeable. Remember, this is supposed to be a TINY assembler, not competition for a full-scale standard assembler.

Having addressed the capacity problem, I then returned to the minor changes that started this whole modification project in the first place. Several items which did not work as one might expect in the previous version have been changed to process in a more normal manner, and a larger subset of the Motorola 6800 assembly language definition is now supported. The following is a list of some of the major changes which have been made. They are illustrated (where possible) in listing 3.

- The FCC pseudooperation will allow the use of character string delimiters as well as the previous string length operand.
- The FCB statement will allow the use of literals following an apostrophe, and the FCB and FDB statements may now make forward references.
- Delimiters such as the comma (,), space (), plus (+) and minus () may be used as literals after an apostrophe. The apostrophe itself may be used as such a literal.
- If a label is used with an ORG statement, its value (as well as the program counter) is set to the value of the operand.
- Execution of the assembler after an assembly has been completed invokes the cold start rather than the warm

```

G
LOCN B1 B2 B3
0000 >.....
0000 >>
0000 >>   EXAMPLES OF THE EXTENFIF TINY ASSEMBLER FUNCTIONS
0000 >>
0000 >.....
0000 >
0000 41 42 43 >   FCC 5,ABCDEF   STEFNF LENGTH = 5
0003 44 45
0005 41 42 43 >   FCC /ABCDEF/   STEFNF DELIMITERS CAN BE ANY
0008 44 45
000A 41 42 43 >   FCC !ABCDEF:   NON NUMERIC VALID CHARACTER
0001 44 45
000F >
000F 31 32 00 >   FCB '1,2,3,4'   USE OF APOSTROPHE IN FCB AND
0012 00 00 >   FCB XX           FORWARD REFERENCE IN FCB & FCB
0014 >
0003 >%%         FCB 3           RESOLVE FORWARD REFERENCES IN
0011 03
1FFF >XX        FCB $1FFF       PREVIOUS FCB & FCB
0012 1F FF
0014 >
0014 2C 27 20 >   FCB '.,,','.,,','.,,'
0017 2E
0018 >>
0018 >>           NOTE USE OF COMMA AS A LITERAL
0018 >>           AND AS A DELIMITER ABOVE
001A >
0100 >CONTINUE ORG $100     FULL FUNCTION ORG STATEMENT
0100 01 00 >   FCB CONTINUE
0102 >>PAGE

```

```

LOCN B1 B2 B3
0102 >.....
0102 >>
0102 >>   EXAMPLE OF FORWARD REFERENCE HANDLING
0102 >>
0102 >.....
0102 >
0102 >F$1FFF      FCB          START NEW STRUCTURAL BLOCK
0102 B6 00 00 >   LFAA AAAA     ESTABLISH FORWARD REFERENCES
0105 B6 00 00 >   LFAA BFFF
0108 >
0108 >
0108 >NX1L$VFI, FCB          START ANOTHER STRUCTURAL BLOCK
0108 B6 00 00 >   LFAA AAAA     REFERENCE ALREADY ESTABLISHED
0108 B6 00 00 >   LFAA BFFF     REFERENCE ALSO ESTABLISHED
0108 B6 00 00 >   LFAA CCCC     REFERENCE TO NEW ITEM
0111 >
0111 >END          END OF NX1LEVEL, CCCC IS UNDEFINITE
*** UNRESOLVED:
CCCC 010F
*** SYMBOLS?
Y
CCCC 0000

0111
00FF >AAAA      FCB $$$      RESOLVE SYMBOL, AAAA
0103 00 FF
0109 00 FF
0111 >
0111 >END          END FWDREF
*** UNRESOLVED:
BFFF 0106
BFFF 010C
*** SYMBOLS?
Y

0111
0001 >BBBB      FCB 1        ADDIT END AND DEFINE BFFF
0106 00 01
010C 00 01
0111 >
0111 >END          END FWDREF AGAIN
*** UNRESOLVED:
*** SYMBOLS?
Y
AAAA 00FF BFFF 0001 NX1L 0108

0111
0111 >
0111 >END          END OF ASSEMBLY
*** UNRESOLVED:
*** SYMBOLS?
Y
CODE 0100 FFFF 0102 %% 0003 XX 1FFF

```

Listing 3: In addition to the reorganization of symbol table management and introduction of the BGN pseudooperation, a number of minor incremental improvements were added to Version 3.1 of the assembler. These are illustrated here, and are described in more detail in the text of the article.

Recognition for Heuristics SpeechLab

A new star is born. The Heuristics voice input board for the Altair (S-100) bus is an interesting new option for personal computing enthusiasts. Now, for \$250 one can add voice input to the computer.

The first thing I noticed about the Heuristics SpeechLab was the price, \$250 in kit form, compared to huge sums for commercial equipment. After seeing a live demonstration at the Homebrew Computer Club in Palo Alto CA, I was convinced that the board worked. Horace Enea and John Reykjalin, the principle designers, demonstrated the recognition of three words after a single training. Horace would type in a word and then pronounce it. The computer then used about 64 bytes to store a template for the word, "Apple, banana, mango. . ." The crowd at Homebrew stood in amazement as the computer typed out the spoken words.

Three weeks later I had my own SpeechLab kit. Surprise number two. The two documentation manuals are an order of magnitude better than anything else I've seen produced by the personal computer industry.

Hardware Manual

The hardware manual contains the standard sections: introduction, assembly, and theory of operation; but, the pages are numbered, paragraphs are tied together and the manual is actually readable. Several useful appendices are also included: troubleshooting, test program, warranty, schematics, etc.

Laboratory Manual

"Now what are you going to do with it?" is a question frequently asked by friends of personal computer owners. With this kit the question is the answer. The Heuristics people seem to be trying to create a Renaissance environment for scientific inquiry. The laboratory manual is a successful attempt to tie the diverse field of computer speech analysis together in a coherent fashion. The manual is bound to become popular among re-

searchers in the field of speech recognition. The work is probably the best text material presently available on the subject.

The manual consists of 270 pages. The main body of the text presents 35 exploratory experiments to thoroughly acquaint the user with the problems and techniques of speech recognition. A sampling of experiments are: confusion matrix, compression amplifier, fricative consonants, and area averaging. A complete listing and explanation of Li Chen Wang's Palo Alto Tiny BASIC is included. The BASIC has been modified with a "Speech" command to access the speech input board through a high level interface. Most of the experiments are centered around Tiny BASIC, a wise design decision that makes experimentation easy and interesting. The experiments are clearly presented and should be easy to perform for anybody who can program in BASIC.

Assembly

The printed circuit board is silk-screened. Components are sequentially numbered as they appear on the board, from left top to bottom right. The layout appears to be flawless; no jumper patches are needed. I completed the assembly in two 2 hour sessions. Everything went smoothly except for two missing resistors which were supplied in four working days by mail. Like most small companies headed for success, Heuristics is bending over backwards to please customers. The hardware worked perfectly, so I didn't need the excellent troubleshooting section that is included.

One word of warning. The Heuristics board is intended for use with an Altair (S-100) bus 8080 computer, enough memory to run Tiny BASIC, and some application programs. A hardcopy terminal is not a must, but is useful for obtaining plots of waveforms.

**Rick Parfitt
1 Johnstone Dr
San Francisco CA 94131**

Why buy a micro, when you can buy a mini for less!



MOST OF TODAY'S PERSONAL COMPUTERS are microcomputers. Compared to our minicomputer they are slow and expensive.

Our mini "the MINI 12™" has been around for three years. We've been steadily selling it to industrial customers who have proven its reliability. Only recently have we paid much attention to the personal computing market. We've discovered that our computer is simply better, and most interestingly, **LESS EXPENSIVE.**

NONE OF THE MICROCOMPUTERS can offer you the range of software available to the MINI 12. Compatibility with the most popular minicomputer, DEC's PDP-8E, gives you a vast library of programs. You will also be pleasantly surprised when you experience the speed and sophistication of our **EXTENDED BASIC** compiler, or **FORTRAN**, **ALGOL** and **FOCAL.**

Unlike today's microcomputers, our Mini 12 is fully software supported by an advanced operating system, including...file handling text editor, symbolic assembler,

loaders, ODT (octal debugging technique), batch processor, and system utilities.

The MINI 12 comes with 8K of memory and is easily expandable to 32K. Because the MINI 12 processes 12 bit words (instead of 8 bit bytes) you need far less memory. For most applications... using our optional MINI STORE digital cassette system with the BASIC compiler, you will never need add another single byte!

Because we want you to have the pleasure of using your minicomputer right away, our MINI 12 comes fully assembled, debugged and ready to plug in. It includes a full front panel, controller for eight digital tape drives, and built-in serial interface plus other technical niceties like a binary loader and monitor bootstrap in ROM memory.

Frankly, when compared with microcomputers, we're surprised at how good a deal we are. Write... or better yet, give us a call @303-794-1634 and let us help you get it all together!

TLF Post Office Box 2298, Littleton, Colorado 80161, Telephone 303-794-1634

Announcing a Computer that thinks in BASIC for only \$298.



Ohio Scientific's new Model 500 computer has full mini-computer BASIC in ROM and a minimum of 4K RAM for user programs. BASIC is always there when the computer is turned on.

Make your terminal intelligent!

If your company or school has remote computer terminals, consider the Model 500-1. It fits in the communications line between the terminal and modem or system. When the 500-1 is off, the terminal talks to the modem. When it is on, the terminal talks to the Model 500. Use the Model 500 for short and medium sized programs in BASIC. Use its *immediate* mode as an ultra-powerful scientific calculator!

Computers for Students

Couple a Model 500 to a low cost purchased or leased terminal such as the popular ASR-33 teletype for student instruction. The Model 500's BASIC is a perfect instructional language for students. Since the computer's machine code is also accessible, the Model 500 can challenge the advanced student with other optional software such as our interactive Assembler/Editor.

Personal Computing

The Model 500 has eliminated all of the grief of the first generation personal computers. This computer comes fully assembled, tested, and guaranteed. Most importantly, it is *easy to use* since the BASIC is always there.

Flexibility and Expandability

The Model 500 uses Ohio Scientific's standard 48 line bus so that it is fully compatible with our Model 400 kits and Challenger™ product lines. Any of thirteen accessory boards including RAM, PROM, parallel, serial, A/D, D/A, cassette, and video graphics can be added as well as peripherals including floppy disks, line printers, color graphics, and more.

The Model 500 is offered here in three forms to meet every application and pocket book.

Specifications

Model 500 Board \$298.00

8" x 10" fully assembled board including 6502 microprocessor running at 1MHz, 512 bytes of PROM, 8192 bytes of ROM containing 8K BASIC and 4096 bytes of RAM for user programs. The board contains an ACIA based serial interface which is jumper selectable for RS-232C or 20ma loop at 110, 300, 1200, 2400, or 4800 baud.

The 8K BASIC features: full floating point math including transcendental functions, N dimension arrays, multiple letter

variables, full string functions, logical operators, PEEK, POKE, USR, and lots more!

The Model 500 board requires +5 volts at 2 amps, -9 volts at 500ma, an external reset switch, and an ASCII serial terminal for operation.

Model 500-1 \$429.00

Fully enclosed 500 board with power supply, reset switch, and two 25 pin EIA standard terminal connectors for loop through operation. The 500-1 is 12" x 15" x 4".

Model 500-8 \$629.00

This unit is a 500 board in an eight slot Challenger™ case allowing seven slots for expansion. The unit has a heavy-duty UL recognized power supply and is 15" x 17" x 10".

ORDER FORM

Order directly from:
Ohio Scientific, Hiram, Ohio 44234

This introductory offer expires August 31, 1977. Please allow up to 60 days for delivery.

PRINT OR TYPE CLEARLY.

Name _____

Shipping Address _____

City _____ State _____ Zip _____

Payment by: BAC (VISA) _____ MC _____ Money Order _____

Credit Card Account # _____ Expires _____

Interbank # (Master Charge) _____

_____ Model 500 Boards @ \$298.00 _____

_____ Model 500-1 Computer @ \$429.00 _____

_____ Model 500-8 Computer @ \$629.00 _____

_____ Additional 4K RAM Memories
for 500-8 @ \$149.00 _____

4% Sales Tax (Applies to
Ohio Residents only) _____

TOTAL CHARGED OR ENCLOSED _____

All orders shipped insured UPS unless otherwise requested.

OHIO SCIENTIFIC

Hiram, Ohio 44234

The Complete Challenger System



Imagine a system complete with terminal, CPU, memory, floppy disk, software, and all the little necessities to make it work together immediately. Now imagine this complete system available not only fully assembled, but priced much lower than anyone else's kit. What you are dreaming of is OSi's "new" Challenger System!

In the configuration shown above, the Challenger includes everything an end user needs for a complete small computer system. All you add is 110 VAC power and a desk to put it on. This fully-assembled system includes:

HARDWARE:

OSi Challenger 65 with 16K RAM, serial interface, system monitor PROM, and floppy disk bootstrap PROM.

OSi Challenger single drive floppy disk formatted for 250K bytes storage per diskette surface.

Stand-alone terminal and Sanyo monitor for 16 lines of 64 characters at 2400 baud (other terminal options are available). And all interconnecting cables!

SOFTWARE:

2 diskettes containing over 100,000 bytes of software including OSi's powerful Disk Operating System with variable length sectors. **6502 DISK BASED RESIDENT ASSEMBLER/EDITOR!** A totally interactive Assembler/Editor which assembles up to 600 lines a minute and is completely compatible with MOS Technology's Cross Assembler format. This program also contains a powerful disk-based line editor with commands for general text editing. **OSI'S EXTENDED MONITOR:** A powerful machine language debugging and utilities package including a Disassembler which is format compatible with the Assembler! **OSI 6502 8K BASIC FOR DISK BY MICROSOFT:** This powerful BASIC has all the features of Altair® 8K BASIC for the 8080 plus higher speed and disk storage. And it comes complete with a BASIC program library.

DOCUMENTATION AND SUPPORT:

We include over 600 pages of hardware, software, programming, and operation manuals. The Challenger is based on the well-proven OSi 400 system. The over 2,000 OSi 400s and Challengers now in use assure continuing hardware and software support for this system for years to come!

EXPANDABILITY:

The Challenger System can now be expanded to 192K of RAM and 16K of I/O and ROM. There are over 13 accessory boards including A/D, D/A, parallel and serial I/O, cassette interfaces, a dual drive floppy, a video graphics display, several RAM and PROM boards, and multiple-processor configurations.

APPLICATIONS:

The Challenger system is complete, fully assembled and configured so that the Disk Operating System can be booted in immediately on system power-up. Even a relatively inexperienced operator can have a complex BASIC program on-line just seconds after the system is turned on. The ease of use, high reliability, and large library of standard BASIC applications programs make the OSi Challenger System the first practical and affordable small computer system for small business, educational institutions, labs, and the personal computerist.

PRICES:

Challenger System, complete as stated above with terminal and monitor

\$2599⁰⁰

As above without terminal. Specify RS-232 or 20ma loop and baud rate

\$2099⁰⁰

IMPORTANT NOTE:

One of the most important features of the Challenger System is that it is not really "new". OSi has been delivering the basic circuitry of the Challenger since November 1975 and the floppy disk since June 1976. The only thing new is the total integration of the components as a complete, simple to use, fully-assembled, small computer system.

For more free information and the address of the OSi Computer Dealer or representative in your area, write to: OSi; Dept. S; Hiram, Ohio 44234 or enclose \$1.00 for the full OSi catalog which contains kits from \$134 and fully assembled computers from \$439.

OHIO SCIENTIFIC

Dept. S, Hiram, Ohio 44234

Circle 216 on inquiry card.

One-Sided View of Wire Wrap Sockets

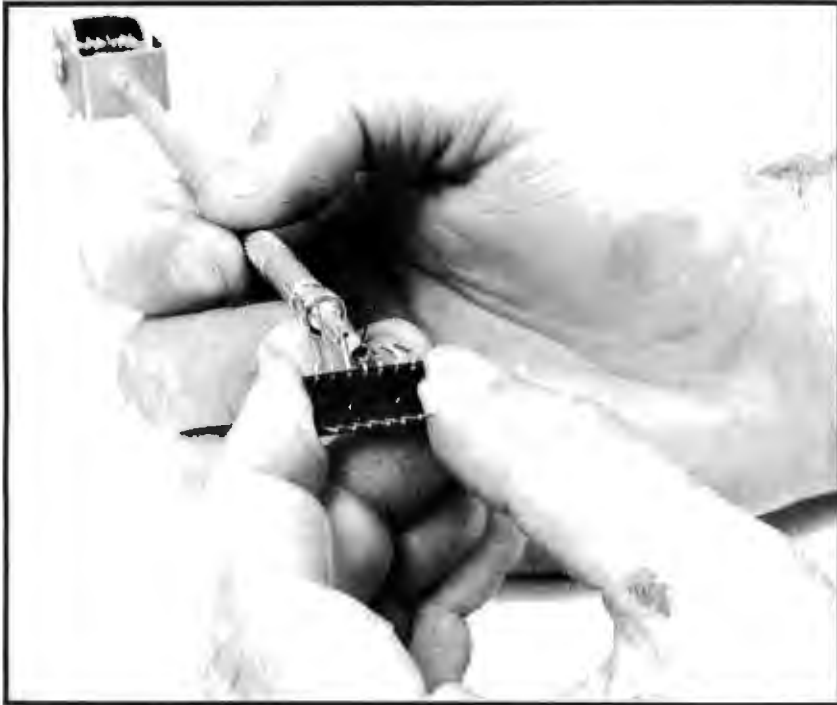

Photo 1: Bending a socket pin with a Slit-N-Wrap tool. The Slit-N-Wrap is positioned approximately 0.1 inch (0.254 cm) from the bottom of the socket, and the pin is bent up so it lines up vertically with the holes on the top of the socket. Three pins on this socket have already been bent showing what the result looks like.

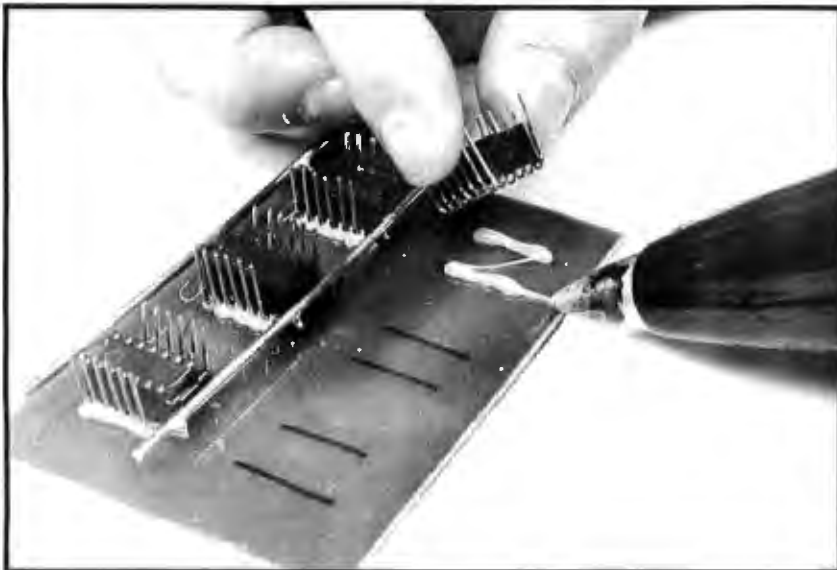

Photo 2: A mounting procedure for sockets. First determine where the sockets will be placed and make a mark where the pins contact the board (the black marks on the board). Using a hot glue gun, put a generous amount of glue on the board at the spot where the pins contact. Put the socket down on the glue and hold for a few seconds until the glue cools.

Ira Rampil
Dept of Electrical and Computer Engineering
University of Wisconsin—Madison
Madison WI 53706

Recently, while laying out the components for a new PDP-11 device controller, a devilishly simple construction technique revealed itself to me. Digital Equipment Corporation specifies that their printed circuit modules be restricted to component heights of 0.38 inch (0.97 cm), and on the solder side only 0.06 inch (0.15 cm) are allowed for the height of soldered and clipped off leads. These specifications enable boards to be mounted on half inch centers on a backplane. A problem arises, however, if wire wrap or Vector Slit-N-Wrap is the desired interconnection technique. DEC's solution to this problem is to provide a circuit board with soldered sockets for the integrated circuits. Each socket pin is connected by a foil trace to a wire wrap post staked and soldered to the component side of the board. Aside from meeting the DEC dimensional specifications, there is another important benefit. Since the wire wrapping is now done on the same side as the components, it's harder to get lost and make erroneous connections. The only caveat is to route the wires so they do not cross directly over any chip, otherwise you will have difficulties replacing defective components.

There are two difficulties in using DEC manufactured boards in my, or any other, microprocessor application. The first problem is flexibility; the layouts are prearranged and there is no provision for 40 pin chips. The second problem is cost; a so called quad board which measures about 10.5 by 8.5 inches (26.7 by 21.6 cm) costs approximately \$160.

The new technique which is described here retains all of the DEC board advantages with ultimate flexibility of layout, and very low cost. The best advantage is simplicity. The entire technique consists of bending the leads of a conventional wire wrap socket around so that they point upwards, and then gluing the socket down on a blank, unperforated board. The photos demonstrate the technique using a new Slit-N-Wrap pencil, by Vector Electronic Company.

For best result:

- Use quality sockets that have their posts solidly embedded in plastic, so they

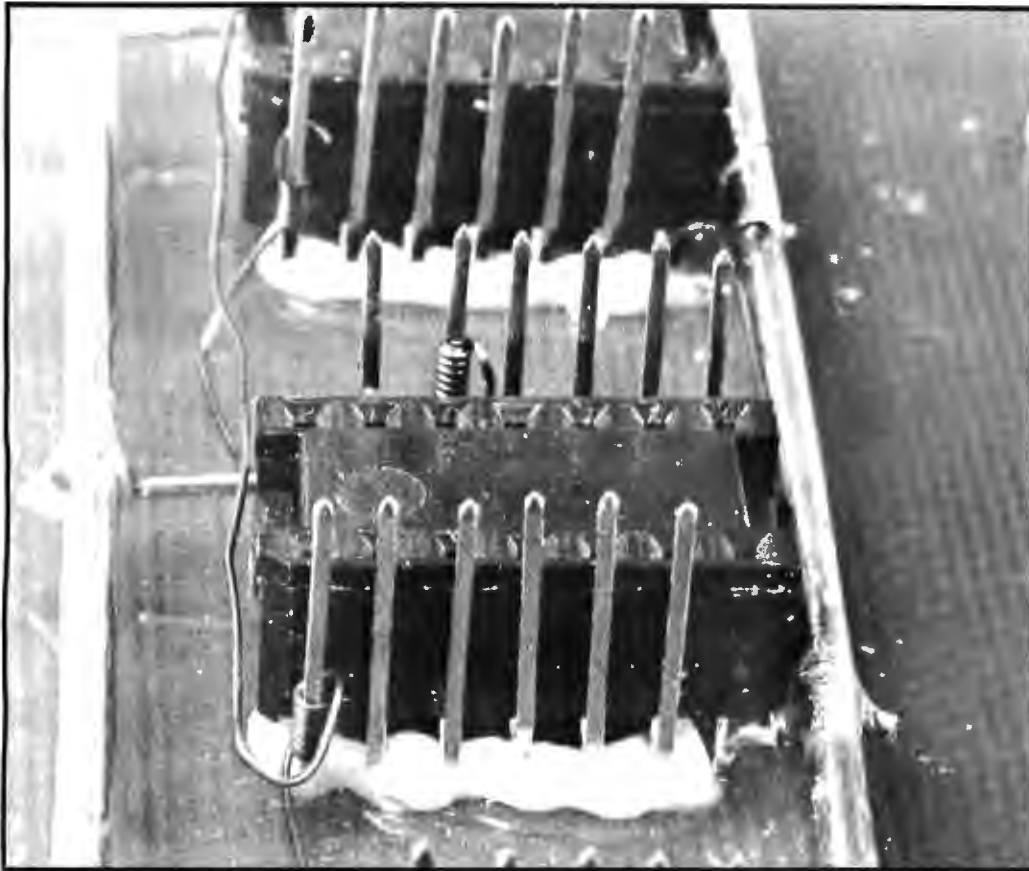

Photo 3: Closeup view of several mounted sockets. Notice how the glue is sitting at the bends in the pins, assuring a good mechanical connection and secure mounting. One very important item should be noticed: none of the wires cross other sockets. This is to prevent difficulties with changing circuits, should one fail. The heavy copper bars running on either side of the sockets are power connections. Notice that pins 7 and 14 are connected to these bars for ground and +5 V.

will not be pulled out during the bending operation.

- Use a metal wire wrap pencil to do the bending. It is exactly the right size for the job. Slide the pencil down each post to a point about 0.1 inch (0.254 cm) from the socket base. Slowly bend the post out straight, away from the socket, and then up along the body. Remove the pencil and press the bent post flat against the socket to remove some of the remaining angle. The bent posts should be vertically aligned with each respective pin contact in the socket. Use of the wire wrap pencil leaves just enough room between the post and the socket for the wrapping operation.

- One method of gluing the sockets down is to mix a small solution of epoxy glue and briefly press each socket into the glue so that all of the bends in the posts receive a small dab of glue. After all of the sockets are in place, bake the board in an oven at approximately 140°F for an hour or until the glue hardens. A faster method is to use a hot glue gun as shown in photo 2. It will prove useful to roughen a smooth circuit board with a file or sandpaper prior to gluing to achieve a stronger board. If mechanical shocks are anticipated this is an essential consideration.

- Route all of the wires into the spaces

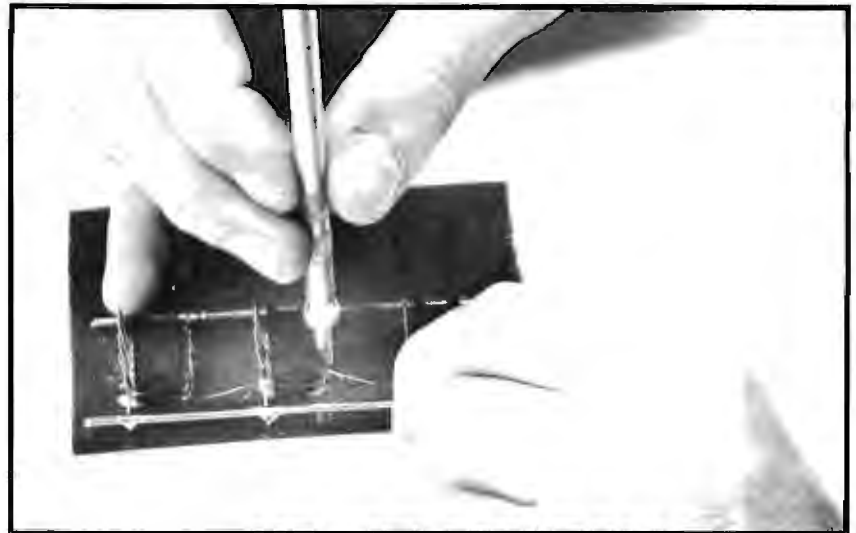

between sockets. Never cross a socket. This will allow you to easily replace the individual integrated circuits.

- The Slit-N-Wrap tool is a very easy and inexpensive way to wire wrap. It is convenient for doing daisy chaining with. My only complaint with the system is the means of cutting the wire. I think a surgeon's iris scissor or other small cutting tool would be much better than the tiny chisel provided by Vector. ■

Photo 4: View of the Slit-N-Wrap in action on the one-sided prototyping board. Notice how the tip of the tool fits snugly on the pin with very little room between it and the socket.



THE DUMB TERMINAL
THE DUMB TERMINAL

THE DUMB TERMINAL

THE DUMB TERMINAL

THE DUMB TERMINAL

If you like the Dumb Terminal, join the club.

The Dumb Terminal Fan Club, that is. Because in just two short years, the Lear Siegler Dumb Terminal has made thousands of friends. Throughout the world.

And there's a good chance you're one.

You might be a distributor, an OEM—even an end user. Or maybe just an admirer of good, practical design.

You might work with terminals for a living. Or assemble them for a hobby.

But it really doesn't matter. Because the Dumb Terminal Fan Club is strictly for fun. For everyone.

Be the first on your block.

Here's your chance to become a Dumb Terminal *charter* member.

And it's so easy. No goldfish to gulp down. No blood oath to take.

All we need is your completed membership application form and a measly \$6.00. (Cash, check, or money order, please.)

In return, you'll receive a nifty Dumb Terminal Fan Club Kit containing:

One official Dumb Terminal T-shirt. A good, practical design. (Just like the Dumb Terminal.) Fashioned in durable blue cotton/polyester. With a likeness of our Club Leader on the chest.

One 8" x 10" color photo of The Dumb

Terminal, Himself. Autographed and suitable for framing.

One official Dumb Terminal Fan Club Membership Certificate. To proudly display on your office, den, or garage wall. A real conversation starter.

One official Dumb Terminal Fan Club Membership Card. Entitling you to all the rights, privileges, and fun of a *charter* member. Positive identification, should someone ask, that you're definitely one of us.

One Dumb thing after another.

In weeks to come, there'll be more Dumb fun.

Like an official Dumb Terminal Fan Club newsletter to help keep members informed of product updates and Club activities.

Plus posters, paraphernalia, and surprises, too.

So don't wait until you need another clean T-shirt—join the Dumb Terminal Fan Club today.

Chances are, it won't be the only thing you share with some of the smartest folks around.



Dumb Terminal. Fun Club.
Lear Siegler

Circle 217 on inquiry card.

What! No decoder ring? Well, count me in as a Charter Member of the Dumb Terminal Fan Club anyway. Please make all checks and money orders payable to LeAnce & Reiser, OK?

Name _____ Title (?) _____

Company _____

Street _____

City _____ State _____ Zip _____

Enclosed is \$_____ for _____ Fan Club Kit(s).

Quantity and size(s) of shirt(s) required.

_____ S _____ M _____ L _____ XL

Rush this application to: Dumb Terminal Fan Club Headquarters c/o
LeAnce & Reiser, P.O. Box 17123, Irvine, CA 92714



The book you've waited for is here!

UNDERSTANDING MICRO COMPUTERS AND SMALL COMPUTER SYSTEMS

PROGRAM COUNTER
BOOLEAN LOGIC REGISTER
INDEX REGISTER
ADDRESSING MODE
EPROMs
PROMs
OPERATIONS
MNEMONICS
ROMs
HEXADECIMAL
MEMORY WORDS
BITS

What's an accumulator? How do you use relative addressing? Indexed addressing? Boolean logic operations? Does a program counter count programs? What's an I/O port? What are EPROMs? What is paging? A stack? The difference between a dot and vector CRT display? How do you copy programs using an ordinary tape recorder? What can a microcomputer really do? What kind of personal computer system should I buy?

These and hundreds of other questions about microcomputers are answered in this profusely illustrated, easy-reading "must" book. Here are the fundamental concepts behind the operation of virtually all microcomputers... written in simple English so that anyone can gain the extra knowledge that will let him or her read and understand computer magazines and manufacturers' literature and feel "at home" around computers. Here are just some of the items discussed...

- How a CPU is organized and how it follows sequences of directives to solve problems.
- Illustrates basic instructions from almost every class of microprocessor.
- Discusses common memory addressing modes — illustrates typical uses.
- What you must know to tell a computer what to do when using machine language programming methods.
- Explains use of flow charts; program worksheets; hand assembly of source codes into object codes; memory maps; purpose of an Editor, Assembler, Monitor.
- Benefits of using a high level language — introduction to BASIC.
- How a computer communicates. Types of commonly used input/output devices and their operational concepts.
- Practical aspects of selecting a small computer system.
- Plus, hundreds of other practical facts and information.

If you're at all curious about small computers, you must own this 300 page no-nonsense text that reads like a simple book, and includes an easy-to-use glossary of key microcomputer oriented words. **UNDERSTANDING MICRO-COMPUTERS**. The name says it all. And, it all costs only \$9.95. Order your copy today!

**SCELBI COMPUTER
CONSULTING INC.**
PO Box 133 — PP STN
Milford, CT 06460

Price shown for North American customers. Master Charge, Postal and Bank Money Orders preferred. Personal checks delay shipping up to 4 weeks. Pricing, specifications, availability subject to change without notice. SCELBI Books are available in many fine Computer Stores.

Circle 218 on inquiry card.

Personal Computer Network



The PCNET (Personal Computer Network) Committee has been functioning in the Palo Alto area since the April 1977 West Coast Computer Faire. The committee's goal is the creation of regional (followed by national) personal computer networks for the computer to computer transfer of messages and files. A set of network protocols (sets of conventions defining all levels of intercomputer communication) is almost completely designed. These protocols should be operable in 8 K bytes of machine copy, and are designed to be implemented in string BASIC.

The committee believes this should be attractive to personal computer users. Participation will be voluntary; you can decide to participate (or not) on any given day of network operation. Network functioning will be relatively insensitive to the absence of an appreciable fraction of member computers.

Our current thinking indicates the following tentative equipment required for participation in the network:

- A personal computer with 12 to 16 K of user memory and string BASIC.
- An originate/answer MODEM capable of 300 bps.

A message service: the ability to send a message (generally English text, although almost any file can be sent) is quite valuable. It doesn't sound very dramatic, but it is surprising how powerful and efficiency improving such a message exchange facility is. What keeps ordinary message services (telephone, telegraph, mail) from working well seems to be a combination of factors: too slow (mail); often hard to catch someone (phone); difficult or time consuming to use (mail, telegrams); expensive in terms

TESTED!

ASSEMBLED!

**THE SAME 8K STATIC MEMORY KITS
YOU'VE PURCHASED IN THE PAST, NOW ASSEMBLED AND TESTED
.... FOR THE SAME PRICE**

"FAST 8" \$275 "8K BABY" \$265



SPECIFICATIONS:

Access Time:	"Fast 8" 250 ns, Fairchild 2102LHPC "8K BABY" 450 ns, Fairchild 2102L1PC No Wait States
Power Consumption:	"Fast 8", 1.6A at +5V "8K BABY", 1.3A at +5V
Address Lines:	Schmitt triggers for buffering
Memory Protect:	Hardware 8K
Power Regulators:	4 ea. 7805
Address Select:	Dip switch accessible from top of board. No need to remove board to re-locate.
Output Disable:	Permits use with transparent loader
Board:	Quality G-10 material with solder mask both sides

VECTOR GRAPHIC INC.
790 HAMPSHIRE RD., A+B
WESTLAKE VILLAGE, CA 91361
TEL: (805) 497-0733

Not affiliated with Vector General, Inc.

ORDER FROM YOUR LOCAL DEALER TODAY!

THE LATEST IN TAPE SYSTEMS

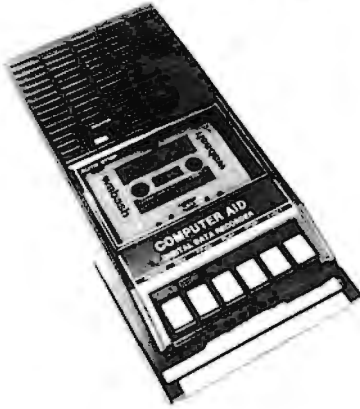

MODEL CC-8 - \$175.00

4800 BAUD CASSETTE RECORDER

An ASYNCHRONOUS NRZ type Recorder with remote motor start/stop. Error rate 10^8 at 4800 BAUD. Can be used from 110 to 4800 BAUD into a UART or "Bit Banger PIA" — no clocking required. This is not an audio recorder. It takes RS232 or TTL signals from the terminal or computer and gives back the same signals. No audio interface is used. Motor start/stop is manual or through TTL or RS232 signals.

Tape speed is 3.2"/second nominal; 1.6"/sec. optional. 110 volt, 60 Hz, 5 watts. (220 Volts on special order). Can use high quality audio cassettes (Philips Type) or certified data cassettes. Can be used in remote locations from a 12 Volt battery.

Recommended for DATA LOGGING, WORD PROCESSING, COMPUTER PROGRAM RELOADING and DATA STORAGE. Especially recommended for 6800 systems, 6502 systems, 1800 systems and beginners with the 8080 systems. Manual control except for motor start/stop. 6800 or 8080 software for file or record searching available on request with order. Used by major computer manufacturers, Bell Telephone and U.S. Government for program reloading and field servicing. AVAILABILITY — Off the shelf.



MODEL 3M3A - \$220.00

50 KILOBAUD CARTRIDGE RECORDER

This is a self clocking (1/1) high speed recorder. Loads BASIC in under 2.0 seconds. Recording is done at 19.2 Kilobaud. Playback at 30 Kilobaud. File or Record searching is done at 50 Kilobaud and loading is automatic. Worst case access time about 2 minutes for up to 2 megabytes on the 3M Data Cartridge.

Tape speed 10"/sec. on record, up to 30"/sec. on playback. Records one clock track and one data track on each pass (2 passes). Recording is NRZ unencoded from RS232 or TTL signals.

This recorder requires one Parallel port for motor control, and one serial port for data and clock. (Cannot be used with UART's or UART boards such as the 3P+S). Used with USART's, ACIA's or other 1/1 clocking I/O devices under software control only. No manual controls. Software for 8080 and 6800 available. Power supply is built in, 110V, 60 Hz. 220 V, 50 Hz for export.

AVAILABILITY — 90 Days

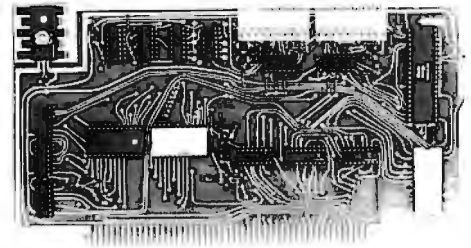

2SIO (R) CONTROLLER

\$190.00 (\$160.00 Kit)

PROVIDES MONITOR AND TAPE SOFTWARE in ROM TERMINAL and TAPE PORTS on SAME BOARD CONTROLS ONE or TWO TAPE UNITS (CC-8 or 3M3A)

This is a complete 8080, 8085, or Z80 system controller. It provides the terminal I/O (RS232, 20 mA, or TTL) and the data cartridge I/O, plus the motor controlling parallel I/O latches. Two kilobytes of on board ROM provide turn on and go control of your Altair or Imsai. NO MORE BOOTSTRAPPING. Loads and Dumps memory in hex on the terminal, formats tape cartridge files, has word processing and paper tape routines. Best of all, it has the search routines to locate files and records by means of six, five, and four letter strings. Just type in the file name and the recorder and software do the rest. Can be used in the BiSync (IBM), BiPhase (Phase encoded) or NRZ modes with suitable recorders and interfaces.

This is Revision 7 of this controller. This version features 2708 type EPROM's so that you can write your own software or relocate it as desired. One 2708 preprogrammed is supplied with the board. A socket is available for the second ROM allowing up to a full 2K of monitor programs.

Fits all S100 bus computers using 8080 or Z80 MPU's. Requires 2 MHz clock from bus. Cannot be use; with audio cassettes without an interface. Cassette or cartridge inputs are RS232 level.

AVAILABILITY — Off the shelf.

OVERSEAS: Export Version 220 volt 50 hz. Write factory or: Megatron-Datameg, 8011 Putzbrunn, Munchen, Germany; Nippon Automation 5-16-7 Shiba, Minato-Ku, Tokyo, Japan; Hobbydata, FACK 20012, Malmo, Sweden; G. Ashbee, 172 Ifield Road, London SW 10-9ag; Trintronics, Ltd., 186 Queen Street W., Toronto, Ontario, Canada; EBASA, Enrique Barges 17, Barcelona 14, Spain; ARIES, 7, rue Saint Phillippe du Roule, 75008 Paris; Microlem 20131, Milano, Italy; Eagle Electric, Capetown, S. Africa.

For U.P.S. delivery, add \$3.00 Overseas and air shipments charges collect. N.J. Residents add 5% Sales Tax. WRITE or CALL for further information. Phone Orders on Master Charge and BankAmericard accepted.

Canadian Distributor:
Trintronics Limited
186 Queen Street West
Toronto, Canada M5V 1Z1
Tel: (416) 598-0262

NATIONAL MULTIPLEX CORPORATION

3474 Rand Avenue, South Plainfield NJ 07080 Box 288 Phone (201) 561-3600 TWX 710-997-9530

Circle 219 on inquiry card.

of characters per dollar (phone, telegrams) etc. A computer based message system overcomes most of these difficulties.

People regularly using such a system rapidly develop a whole new communication style. Most messages are brief, 500 characters or less. Content tends to be much more informal and direct than conventional media such as business letters. Message system users move rapidly toward a computer based personally oriented file system containing messages, distribution lists, text files, etc. The difference is one of kind, not just of degree.

The PCNET Committee is about to start a series of experiments. We would welcome people with personal computer systems who would like to participate. We're especially interested in people in the Palo Alto dialing area. We would also be most interested in similar network efforts in other places. We'd like to avoid West Coast chauvinism and want to work closely with people in other parts of the country.

For further information write or call:

Dave Caulkins
 (415) 328-2411 (work)
 (415) 948-5753 (home)
 437 Mundel Way
 Los Altos CA 94022

This text was supplied by Dave Fylstra. ■

Adding New Transcendentals to Limited BASICs

Vince A Sempronio
 PSC #2 Box 1451
 BAFB DC 20332

As an avid reader of your periodical, and a devoted BASIC user, I discover that even the best of the many "tiny" BASICs that have hit the market still lack a few functions which I, as well as others, find useful. What do you do when you need some of the more complex math functions, more specifically the trigonometric functions? Well, if your BASIC has only the TAN (tangent), ATN (arc-tangent), and SQR (square root), most of the trigonometric functions are available

Continued on page 184

Put exceptional versatility and control into your S-100 bus system with the 'blue boards'...and save money in the bargain!



XB1 Extender Board
 Board Only \$9.00
 With Connector \$13.50



MT1 15 slot Mother Board
 Board Only \$45.00
 With Connectors \$105.00



MB4 4K Static RAM (low power)
 Kit \$129.95
 Assembled \$179.95

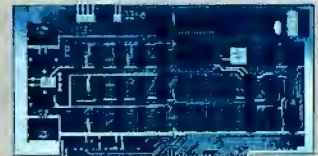

VB1A Video Board
 Kit \$189.95
 Assembled \$264.95



MB6A 8K Static RAM (low power)
 Kit \$265.00
 Assembled \$325.00

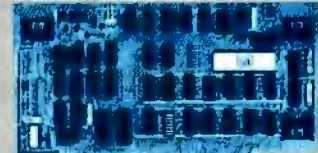

SB1 Synthesizer Kit
 Kit \$250.00
 Assembled \$325.00



MB3 2K/4K EPROM (1702A)
 Kit less PROM's \$65.00
 2K—\$105.00/4K—\$145.00
 Assembled board available



I/O2 Interface Board
 Kit \$55.00
 Assembled \$79.95



MB7 16K Static RAM (low power)
 Kit \$525.00
 Assembled \$599.95

We're the blue boards!

Compare the Cybercom blue boards with any others on the market today. You'll find exceptional quality plus prompt delivery and significant cost savings. All Cybercom kits are guaranteed 90 days for parts and labor.

Contact your local computer hobbyist store or write for details.



Solid State Music

2102A Walsh Avenue, Santa Clara, CA 95050
 Telephone (408) 246-2707

Circle 220 on inquiry card.

A Sampling of Techniques for Computer Performance of Music

Hal Chamberlin
29 Mead St
Manchester NH 03104

Computer music is probably one of the most talked about serious applications for home computers. By serious I mean an application that has a degree of complexity and open-endedness which can totally preoccupy experimenters and funded institutions for years. Computer performance of music is a discipline so vast that the final, "best" technique for its implementation or even a good definition of such a technique may never be discovered.

At the same time, computer music is an easy field to break into. With only minimal effort and expenditure a very impressive (to the uninitiated) music performance demonstration may be put together. With a little more work a system may be assembled which is of great value to other family members, particularly children just starting to learn music theory. Such a system could, for example, eliminate manual dexterity as a factor in a child's musical development. Finally, on the highest level, it is no longer very difficult to break into truly original research in serious performance of music by computer. The advances in digital and linear integrated circuits have made putting together the hardware system for supporting such research largely a matter of clever system design rather than brute financial strength. Programming, tempered with musical knowledge, is the real key to obtaining significant results. Thus, in the future, hobbyists working with their own systems will be making important contributions toward advancement of the computer music art.

While the scope of one article cannot

fully cover such an extensive topic, it should serve to acquaint the reader with the more popular techniques, their implementation, strengths, weaknesses, and ultimate potential.

Generally, all computer music performance techniques can be classified into two generic groups. The first includes schemes in which the computer generates the sound directly. The second covers systems where the computer acts as a controller for external sound generation apparatus such as an electronic organ or sound synthesizer.

Early Techniques

Just as soon as standard commercial computers such as the IBM 709 and, later, the 1401 made their appearance, programmers started to do frivolous things with them after hours, such as playing games and music. Since elementary monotonic (one note at a time) music is just a series of tones with different frequencies and durations, and since a computer can be a very precise timing device, it did not take long for these early tinkerers to figure out how to get the machine to play such music. The fundamental concept used was that of a *timed loop*.

A timed loop is a series of machine language instructions which are carefully chosen for their execution time as well as function, and which are organized into a loop. Some of the instructions implement a counter that controls the number of passes through the loop before exiting.

Let's examine some fundamental

timed loop relationships. If the sum total execution time of the instructions in the loop is M microseconds then we have a loop frequency of

$$\left(\frac{10^6}{M}\right) \text{ Hertz (cycles per second).}$$

If the initial value of the decrementing counter that controls the number of loop passes is N, then the total execution time before exit from the loop is (MxN) microseconds. Thus what we really have is a "tone" with a frequency of

$$\left(\frac{10^6}{M}\right) \text{ Hertz}$$

and a duration of

$$\frac{M \times N}{10^6} \text{ seconds.}$$

Using different loops with more or fewer instructions will give us different Ms and thus different notes. Using different Ns when entering these loops gives different durations for the notes, and so we have satisfied the definition of elementary monotonic music.

Of course at this point the computer is merely humming to itself. Several techniques, some of them quite strange, have evolved to make the humming audible to mortals.

One such method that doesn't even require a connection to the computer is to use an AM portable radio tuned to a quiet spot on the broadcast band and held close to the computer. Viola! /Sic/ The humming rings forth in loud, relatively clear notes. As a matter of fact, music programs using this form of output were very popular in the "early days" when most small system computers had only 256 bytes of memory and no IO peripherals except the front panel.

What is actually happening is that the internal logic circuitry with its fast rise time pulses is spewing harmonics that extend up into the broadcast band region of the radio spectrum. Since some logic gates will undoubtedly switch only once per loop iteration, the harmonics of the switching will be separated in frequency by the switching or loop frequency. Those high frequency harmonics that fall within the passband of the radio are treated as a "carrier" and a bunch of equally spaced nearly equal amplitude sidebands. The radio's detector generates an output frequency equal to the common differences of all these sidebands, which is the loop frequency and its harmonics. The timbre of the resulting tones is altered somewhat by the

choice of instructions in the loop, but basically has a flat audio spectrum like that of a narrow pulse waveform. Noise and distortion arise from other logic circuitry in the computer which switches erratically with respect to the timed loops. One practical difficulty with this method is there is no clearly identifiable way to get the computer to "shut up" for rests or space between identical notes.

The Hammer-Klavier

Other early methods used some kind of output peripheral to make sound. In a demonstration of an IBM 1401 over a decade ago this was literally true: the computer played a line printer! It seems that the hookup between a 1401 central processing unit and the 1403 printer was such that software had control of the printer hammer timing. Each time a hammer was fired a pulse of sound was emitted upon impact with the paper. Using a timed loop program with a print hammer fire instruction imbedded in the loop gave a raspy but accurately pitched buzz. [It also tended to cause IBM customer engineers great trepidation . . .CH/ This same scheme should also be possible on some of the small, completely software controlled dot matrix printers that are now coming on the market.

A sane approach, however, is to connect a speaker to an output port bit through an amplifier. Instructions would then be placed inside the timed loops to toggle the bit and thus produce a clean, noise-free rectangular wave.

Timed Loop Example

Let's look at an example of a timed loop music playing program, not so much for its musical value (which is negligible), but for some insight into what is involved, and also to introduce some terms. The MOS Technology 6502 microprocessor will be used for these examples. These programs are designed to run on a KIM-1 system, and should run on most other 6502-based systems with very minor modifications. Motorola 6800 users should be able to easily convert the programs into 6800 machine language. 8080 users will benefit most because successful conversion indicates a thorough understanding of the concepts involved.

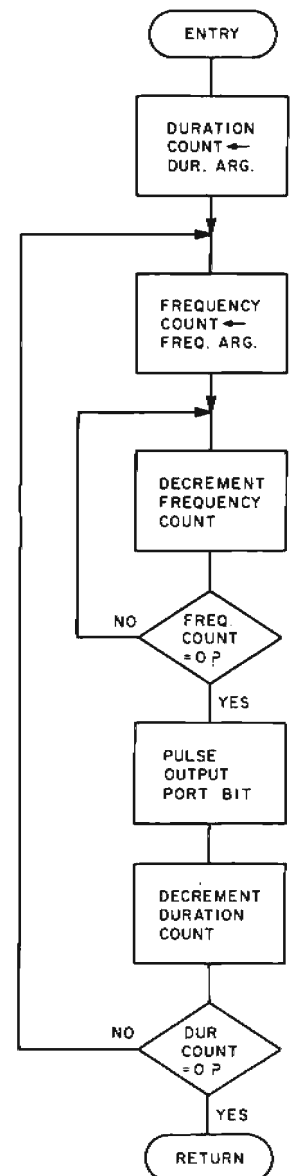

Figure 1: A basic tone generation subroutine. There are two nested loops in this routine: the first, or inner loop controls the frequency (or pitch) of the note to be generated, while the second, outer loop controls the duration of the note. A train of square waves is generated at the output port bit which is used to drive the circuit in figure 2 to produce an audible tone.

Note	Frequency (Hz)
Middle C	261.62
C#	277.18
D	293.66
D#	311.13
E	329.63
F	349.23
F#	369.99
G	391.99
G#	415.30
A	440.00
A#	466.16
B	493.88

Table 1: Equally tempered scale note frequencies in Hertz. In order to determine frequencies of notes in the higher octaves, multiply by 2 for each octave above this one. For lower octaves, divide by 2 for each lower octave.

The heart of the program is the tone generation subroutine which will be named TONE. Ideally, such a routine would accept as input two arguments: one related to the pitch of the note and the other controlling the duration. With such a subroutine available, playing a piece of music amounts to simply fetching the arguments from a "song" table in memory and calling the routine for each note to be played.

As mentioned previously, we could have a separate, carefully timed loop for each different tone frequency needed. TONE would then call the proper one based on the pitch parameter. Indeed this approach is very accurate (to within 1 μ s on the 6502) but a great deal of memory is consumed for the 30 or so notes typically required. It also lacks flexibility. (This will be discussed later.) A better approach is to embed a second, *waiting* loop to control the execution time of one pass through the outer loop, and thus the tone's frequency. Figure 1 is a flowchart illustrating this. When using this scheme, the frequency argument directly determines the number of times through the inner, waiting loop and the duration parameter directly determines the number of times through the outer, tone generation loop.

Now, how are the argument values determined to get the frequencies and durations desired? First the execution time of the nested loops must be determined. In the KIM-1 with a 1 MHz clock and a 6502 the tightest inner waiting

loop that can be written is 5 μ s, assuming that the inner loop count (frequency argument) is 256 or less and that it is held in a register. The total time spent in the loop is $[(5 \times M) - 1]$ microseconds, where M is the frequency argument and the -1 is due to the shorter execution time of an unsuccessful branch. (The observant reader will note that the execution time of some 6502 instructions is altered if they cross a memory "page boundary"; thus, an assumption of no page crossing is made.) But there is still the time required for a pass through the outer loop to output a pulse and decrement the duration counter. This is termed "loop overhead." For an example, let's say that the loop overhead is 25 μ s. As a result, the total outer loop time is $[(5 \times M) - 1 + 25]$, or $[(5 \times M) + 24]$ microseconds which is the period of the audio waveform output. In order to determine the M required for a particular note, a table of note frequencies (see table 1) is consulted. Then the equation,

$$M = \frac{\left(\frac{10^6}{F} - 24\right)}{5}$$

where F is the desired frequency, is solved for the nearest integer value of M. Lower frequency notes are preferred so that the percentage error incurred due to rounding M is minimized. The duration argument is actually a count of the number of audio tone cycles which are to be generated for the note, and thus its value is dependent on the tone frequency as well as the duration. Its value can be determined from the relation $N = D \times F$, where N is the duration argument, D is the duration in seconds, and F is the note frequency in Hertz.

As a complete example, let's assume that an eighth note G# an octave above middle C is to be played, and that the piece is in 4/4 time with a metronome marking of 80 beats per minute. Since an eighth note in this case is one half of a beat, the duration will be

$$\frac{0.5 \times 60}{80}$$

or 0.375 seconds. The note table shows that the frequency of G# an octave above middle C is 830.6 Hz, which yields a frequency argument of 236. The duration argument is 311. So if TONE is called with these parameters, a nice G# eighth note will be produced.

Now let's go a step further and look at a practical "music peripheral" and TONE subroutine. Figure 2 shows a circuit for driving a speaker from any kind of TTL compatible

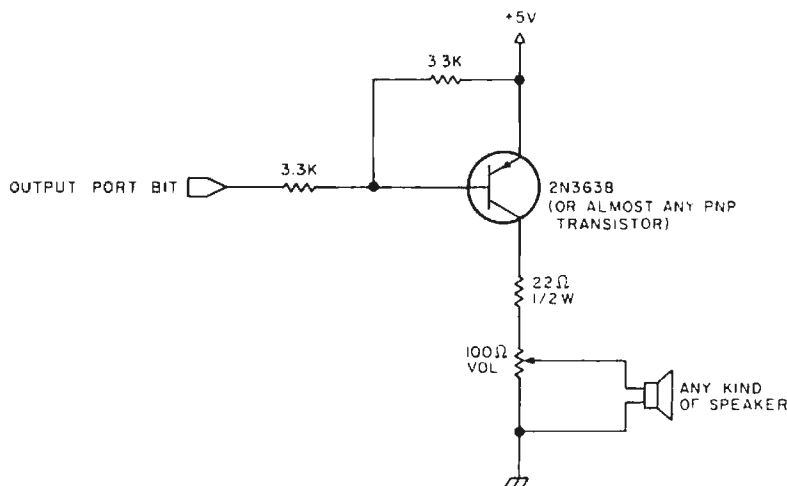

Figure 2: A speaker driver circuit designed to accept square or rectangular waves and produce audible tones through a loudspeaker. In this particular application the circuit is driven from an output port bit of a KIM-1 micro-computer, although the circuit can accept any TTL compatible output port bit. When the input to the circuit is a logical 0 level, the transistor turns on and drives the speaker. When the input is a logical 1, the transistor turns off and current to the speaker is interrupted.

Wave Duty Cycle	Harmonics									
	Fund	2	3	4	5	6	7	8	9	10
1/2	1.00	0	0.333	0	0.200	0	0.143	0	0.111	0
1/3	1.00	0.500	0	0.250	0.200	0	0.143	0.125	0	0.100
1/4	1.00	0.707	0.333	0	0.162	0.236	0.143	0	0.111	0.141
1/5	1.00	0.841	0.561	0.259	0	0.173	0.240	0.210	0.116	0
1/6	1.00	0.867	0.667	0.433	0.200	0	0.143	0.217	0.222	0.173

Table 2: Harmonic amplitudes of rectangular waves. Note that, unlike square waves, asymmetrical rectangular waves contain even numbered harmonics. This simple technique of varying the duty cycle of such waves can have an appreciable effect on the timbre of the resulting sound.

output port bit, including those found in the 6530 "combo chips" used in the KIM-1. When the output port bit is a logic 0 level, the transistor turns on and drives a current determined by the volume control setting through the speaker. When the bit is a logic 1, the current is interrupted. Larger speakers or even a high fidelity speaker system will give a richer timbre to the lower pitched tones. The AUX input to a sound system may also be used instead of the transistor circuit. Using a patch cord, connect the shield to the common terminal of the power supply and the center conductor to the output port bit through a 10 K to 100 K isolation resistor.

Listing 1 shows an assembled listing of a practical timed loop tone generation subroutine for the 6502 microprocessor. Several refinements beyond the flowcharted example have been made to improve tone quality and flexibility. The inner waiting loop has been split into two loops. The first loop determines the length of time that the output rectangular waveform is to be a logic 1 and the second loop determines the 0 time. If both loops receive the same frequency argument (which they do as written) and the loop time of both loops is the same, then a symmetrical square wave output is produced. However, if one or more "do nothing" instructions is inserted into one of the two loops, the output waveform will become nonsymmetrical. The significance of this is that the rectangular waveform's duty cycle affects its harmonic spectrum, and thus its timbre. In particular, there is a large audible difference between a 50%-50% duty cycle (square wave) and a 25%-75% duty cycle. Table 2 lists the harmonic structure of some possible rectangular waves. As a result, some control over the timbre can be exercised if a separate TONE subroutine is written for each "voice" desired. Unfortunately, if this is done the frequency arguments will have to be recom-

puted since the outer loop time will then be altered.

Real music also possesses *dynamics*, which are the changes in overall volume during a performance. Furthermore, the *amplitude envelope* of a tone is an important contributor to its overall subjective timbre. The latter term refers to rapid changes in volume during a single note. This is the case with a piano note, which builds up rapidly at the beginning and slowly trails off thereafter. Of course the setup described thus far has no control over either of these parameters: the volume level is constant, and the envelope of each note is rectangular with sudden onset and termination.

```

; TONE SUBROUTINE FOR 6502
; ENTER WITH FREQUENCY PARAMETER IN ACCUMULATOR
; DURATION PARAMETER STORED AT LOCATION DUR (LOW PART) AND
; DUR+1 (HIGH PART) WHICH IS ASSUMED TO BE IN PAGE ZERO
; ROUTINE USES A, X, AND DESTROYS DUR
; LOOP TIME = 10*(FREQ PARAMETER)+44 MICROSECONDS

1700 MPORT = X'1700 ; ADDRESS OF OUTPUT PORT WITH SPEAKER
00E0 DUR = X'E0 ; ARBITRARY PAGE 0 ADDRESS OF DURATION PARAM

0100 A2FF TONE: LDX #X'FF ; SEND ALL 1'S TO THE OUTPUT PORT
0102 B80017 STX MPORT
0105 AA TAX ; TRANSFER FREQ PARAMETER TO INDEX X
0106 CA WHIGH: DEX ; WAIT LOOP FOR WAVEFORM HIGH TIME
0107 D0FD BNE WHIGH ; TIME IN THIS LOOP = 5*FREQ PARAMETER
0109 F000 BEQ .+2 ; WAIT 15 STATES TO MATCH TIME USED TO
010B F000 BEQ .+2 ; DECREMENT AND CHECK DURATION COUNT AFTER
010D F000 BEQ .+2 ; WAVEFORM LOW TIME
010F F000 BEQ .+2
0111 F000 BEQ .+2
0113 A200 LDX #0 ; SEND ALL 0'S TO THE OUTPUT PORT
0115 B80017 STX MPORT
0118 AA TAX ; TRANSFER FREQ PARAMETER TO INDEX X
0119 CA WLOW: DEX ; WAIT LOOP FOR WAVEFORM LOW TIME
011A D0FD BNE WLOW ; TIME IN THIS LOOP = 5*FREQ PARAMETER
011C C6E0 DEC DUR ; DECREMENT LOW PART OF DURATION COUNT
011E D005 BNE TIMWAS ; BRANCH IF NOT RUN OUT
0120 C6E1 DEC DUR+1 ; DECREMENT HIGH PART OF DURATION COUNT
0122 D0DC BNE TONE ; GO DO ANOTHER CYCLE OF THE TONE IF NOT 0
0124 60 RTS ; RETURN WHEN DURATION COUNT RUNS OUT
0125 F000 TIMWAS: BEQ .+2 ; WASTE 7 CYCLES TO EQUAL TIME THAT WOULD
0127 F000 BEQ .+2 ; HAVE BEEN SPENT IF HIGH PART OF DUR WAS
0129 D0D5 BNE TONE ; DECREMENTED AND GO DO ANOTHER CYCLE

```

Listing 1: An assembled listing of a practical timed loop tone generation subroutine for the 6502 microprocessor. This routine is an elaboration of the flowchart shown in figure 1 which allows the user to generate nonsymmetrical rectangular waves. Experimenting with the wave's duty cycle affects the harmonic content of the resulting tone and creates many interesting aural effects.

By graduating to a more sophisticated music peripheral, control of dynamics and amplitude envelopes can be achieved with a timed loop music program. The secret is to use a *digital to analog* converter connected to all eight bits of the output port. A digital to analog converter (DAC) does just what its name implies: it accepts a binary number from the output port as input and generates a corresponding DC voltage as its output.

The circuit in figure 3, which can be used with any TTL compatible output port, gives an output voltage

$$V = \left(\frac{I}{255} \right) \times 5$$

where I is the binary number input between 0 and 255. When working with this kind of DAC, it is convenient to regard the binary number, I, as a fraction between 0 and 1 rather than an integer. The benefit of this will become apparent later when calculations will be performed to arrive at the value of I. The output of the DAC must be used with a sound system or the amplifier circuit in figure 8, not the simple transistor speaker driver circuit in figure 2.

As written, the TONE subroutine (see listing 1) alternately sends 0 and 255 to the output port with the music peripheral. With a DAC connected to that port, voltages of 0 and 5 V will be produced for the low and high portions of the rectangular wave. If instead 0 and 127 were output, the DAC would produce only 0 and 2.5 V giving a rectangular wave with about half the amplitude. This in turn produces a less loud tone, and so control over dynamics is possible by altering the byte stored at hexadecimal 101.

Arbitrary amplitude envelopes are also made possible by continuously exercising control over the amplitude during a note. Simple envelope shapes such as a linear attack and decay can be computed in line while the note is being sounded. A more general method is to build a table in memory describing the shape. Such a table can be quickly referenced during note playing. Great care must be taken, however, to insure that loop timing is kept stable when the additional instructions necessary to implement amplitude envelopes are added.

More Complex Techniques

Even if all of the improvements mentioned above were fully implemented, the elementary timed loop approach falls far short of significant musical potential. The primary limitations are a narrow range of tone colors and restriction to monotonic performance. The latter difficulty may be alleviated through the use of a multitrack tape recorder to combine separate parts, but this requires an investment in noncomputer hardware and is certainly not automatic. Also, unpitched percussive sounds such as drum beats are generally not possible. Musicians, too, will probably notice a host of other limitations such as lack of vibrato and

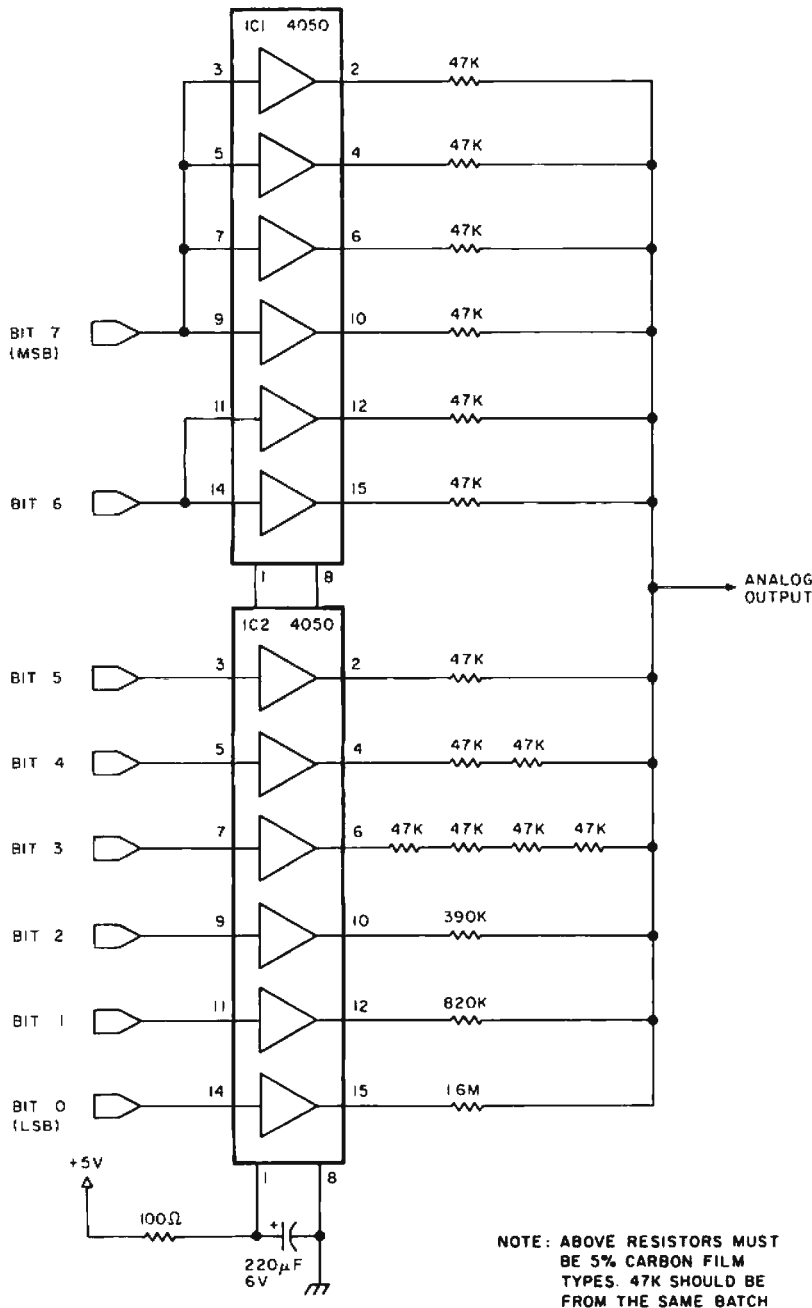

Figure 3: An 8 bit digital to analog converter (DAC). This circuit accepts an 8 bit binary number from the output port and generates a corresponding DC voltage as its output. The output voltage from this circuit is equal to $\left(\frac{I}{255} \right) \times 5$ V, where I is the decimal equivalent of the 8 bit input which can take on any value from 0 to 255.

The complete \$655 line printer.

It's ready to plug in, has an 80-column format, a remarkable MTBF and is 14 times faster than a teletype!



Breaking the hardcopy barrier

It's finally happened! The Axiom EX-800 provides full performance hardcopy at a price compatible with today's low cost micros. This little 80-column machine zips along at 160 characters per second (14 times faster than a teletype) — at a breakthrough single quantity price of \$655 for a complete printer.

When we say complete we mean it

The EX-800 is a stand-alone unit with case, power supply, 96 character ASCII generator and interface, paper roll holder, infra-red low paper detector, bell, and multi-line asynchronous input buffer. You won't find these standard features on any other printer, regardless of price!

Our only option

Our printer is so complete, that we offer only one option. A serial interface (RS 232C or current loop) good for 16 baud rates from 50 to 19,200 and thoughtfully provided with a switch for either Centronics or Tally compatibility. Might we call it a Tally-whacker? At \$85.00 it certainly should be!

Built-in LSI microprocessor

The heart of the EX-800 is a printed circuit card, containing a custom LSI chip made by Intel to Axiom specifications, which controls all printer functions. Microprocessor power means flexibility. Such as the built-in self test routine and variable

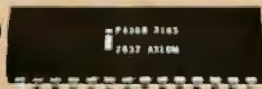

character size. It also means reliability. Several industry surveys have shown LSI to be many times more reliable than equivalent conventional circuitry.

THIS LIFE-SIZE SAMPLE SHOWS THE 80-COLUMN PRINTOUT FROM AXIOM'S EX-800 PRINTER
There are 3 character sizes (upper and lower case) which can be MIXED.
This can have the same effect as UNDERLINING or changing COLOR.

The advantages of electrosensitive printing

The EX-800 can print 80, 40, or 20 characters across the five inch wide electrosensitive paper. Under software control, single characters or words may be printed larger for emphasis. The permanence of the hardcopy is archival, because once the aluminum coating has been removed, there is no way to put it back. It's unaffected by sunlight, moisture or heat. Although the printer doesn't provide multiple copies, excellent quality photocopies can be made from the high contrast printout. Also,

the paper is inexpensive and readily available, costing about 1¢ for an 8½ x 11" equivalent.

Light, small, quiet, reliable, and versatile

Our EX-800 weighs in at 12 pounds, is just 9½ inches wide, 4 inches high, and 11 inches deep, and is delightfully quiet which makes it ideal for office and other low noise environments. The simple print mechanism is virtually maintenance free. In fact, tests show an incredible MTBF, many times greater than impact printers. This versatile printer is the ideal mate for micros, minis, CRTs, instruments and systems.

Just unbox and plug it in

That's all you have to do to the Axiom EX-800 — apart from pay for it, and at \$655 that's almost a pleasure.

Circle 221 on inquiry card.

Send to: **AXIOM**
5932 San Fernando Rd.,
Glendale, CA 91202

- Urgent. Please phone me at ext _____
- Have rep contact me
- I'd like to have a demonstration
- Send lit including sample of printout

Name _____

Company _____

Dept. _____

Address _____

City _____ State _____

Zip _____ Telephone _____

AXIOM

AXIOM CORPORATION

5932 San Fernando Rd., Glendale, CA 91202 • (213) 245-9244 • TWX 910-497-2283

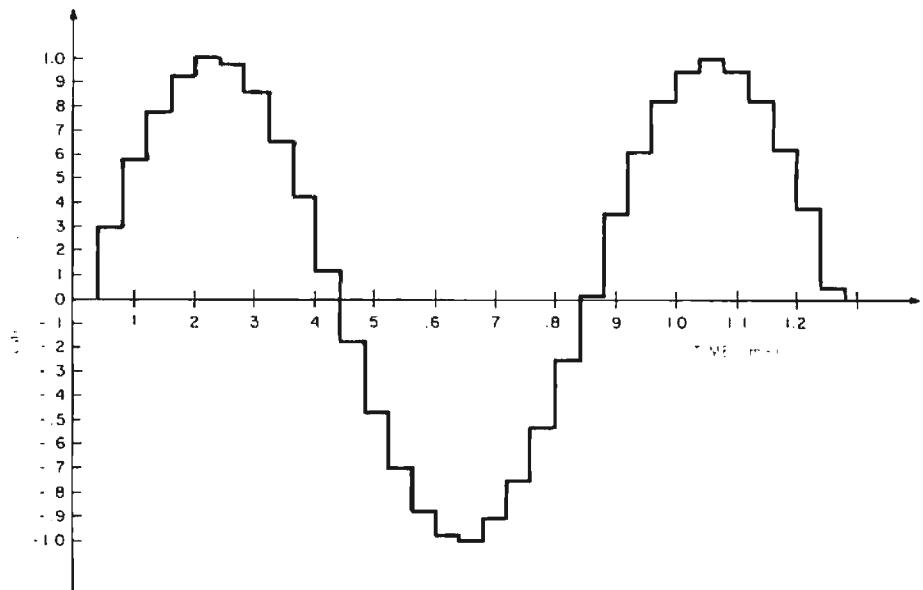

Figure 4: A sine wave as it would appear at the output from the digital to analog converter shown in figure 3. Each step in the approximation of this wave is called a sample. This particular illustration shows a 1.2 kHz sine wave sampled at a rate of 25,000 samples per second. The resulting waveform is only a very rough approximation of the original, but low pass filtering can improve accuracy (see figure 5 and text).

other subtle variations. All of these shortcomings may be overcome by allowing the computer to compute the entire sound waveform in detail at its own speed.

The one fundamental concept that makes direct waveform computation possible is the *sampling theorem*. Any waveform, no matter how simple or complex, can be reconstructed from a rapid series of discrete voltage values by means of a digital to analog converter such as the one used earlier. As an example, let's try to generate an accurate sine wave using a DAC. If this can be done, it follows from the Fourier (harmonic) theorem that any other waveform may also be synthesized.

Figure 4 shows a sine wave as it would appear at the DAC output. Each step on the approximation to the sine wave is termed a *sample*, and the frequency with which these samples emerge from the DAC is the *sample rate*. An attempt is being made in the example to generate a 1.2 kHz sine wave at a sample rate of 25 kHz, or one sample every 40 μ s. Obviously this is a very poor sine wave, a fact that can be easily demonstrated with a distortion analyzer.

Before giving up, let's look at the frequency spectrum of this staircase-like wave on a spectrum analyzer. The spectral plot in figure 5 shows a strong frequency component at 1.2 kHz which is the sine wave we are trying to synthesize. Also present are the distortion component frequencies due

to the sampling process. Since all of the distortion components are much higher in frequency than the desired signal, they may be easily removed with a sharp low pass filter. After filtering, the distortion analyzer will confirm that a smooth, pure sine wave is all that remains.

What will happen if the sine wave frequency is increased but the sampling frequency remains constant? With even fewer samples on each sine wave cycle the waveform from the DAC will appear even more distorted. The lowest frequency distortion product is the one of concern since it is the most difficult to filter out. Its frequency is $FD = (FS - f)$ Hertz, where FD is the lowest distortion component frequency, FS is the sampling frequency, and f is the sine wave signal frequency. Thus as f increases, FD decreases until they merge at $f = FS/2$. This frequency is termed the *Nyquist frequency* and is the highest theoretical frequency that may be synthesized. Any attempt to synthesize a higher frequency will result in the desired signal being filtered out and the distortion frequency emerging instead. This situation is termed *aliasing* because the desired signal frequency has been replaced by a distortion component alias frequency. Operating close to the Nyquist frequency requires a very sharp filter to separate the signal from the distortion. With practical filters, signal frequencies up to 1/4 to 1/3 of the sampling frequency are realizable.

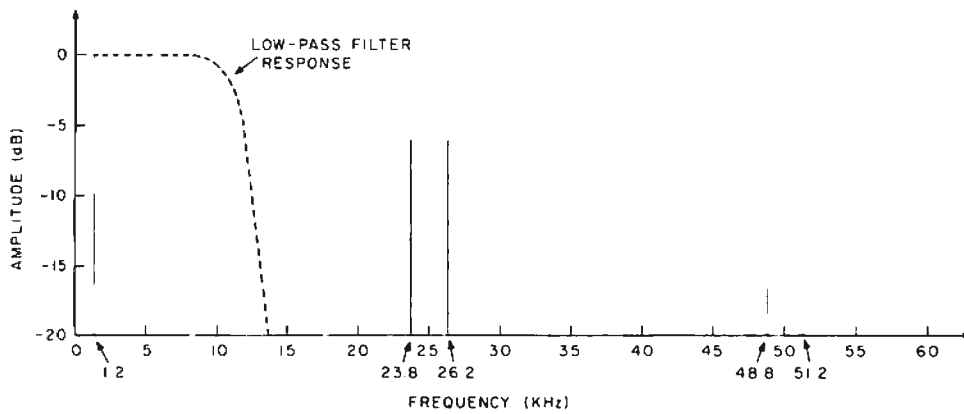

Figure 5: The spectral plot of the staircase-like sine wave approximation shown in figure 4. This frequency versus amplitude graph indicates a strong frequency component at 1.2 kHz, the frequency of the sine wave. Normally, this would be the only frequency component to appear on a plot like this, but the presence of steeply rising steps in this waveform approximation introduces distortion components at higher frequencies, as shown.

Since any sound, whether it is a pitched tone or unpitched sound, is actually a combination of sine waves, it follows that any possible sound may be produced by a DAC. The only limitation is the upper frequency response, which may be made as high as desired by increasing the sample rate. The low frequency response has no limit, and extends down to DC.

There is another form of distortion in DAC generated sounds which cannot be filtered out, since it is spread throughout the frequency spectrum. *Quantization noise* is due to the fact that a DAC cannot generate voltages that are exact samples on the desired waveform. An 8 bit converter, for example, has only 256 possible output voltage values. When a particular voltage is needed, the nearest available value will have to be used. The theoretical signal to noise ratio when using a perfect DAC is related to the number of bits by the equation $S/N = (6 \times M) + 4$ decibels where M is the number of bits. A practical DAC may be as much as 6 db worse, but a cheap 8 bit unit can yield nearly 50 db, which is as good as many tape recorders. When using 12 bits or more, the DAC will outperform even the best professional recorders. Thus it is apparent that computed waveforms can, in theory, be used to generate very high quality music; so high, in fact, that conventional audio equipment is hard pressed to reproduce it.

Now that we have the tools, let's see how the limitations of computer music mentioned earlier can be overcome. For tones of definite pitch, the timbre is determined by the waveshape and the amplitude envelope. Concentrating on the waveshape, it should be apparent that a waveform table in memory repeatedly dumped into the DAC

will produce an equivalent sound waveform. Each table entry becomes a sample, and the entire table represents one cycle of the waveform. The frequency of the resulting tone will be FS/N where FS is the sampling frequency (rate at which table entries are sent to the DAC) and N is the number of entries in the table. To get other frequencies, either the sample rate or the number of table entries must be changed.

There are a number of reasons why the sample rate should remain constant, so the answer is to change the effective table length. If the table dump routine were modified to skip every other entry, the result would be an effective halving of table size and thus doubling of the tone frequency. If the table is fairly long, such as 256 entries, a number of frequencies are possible by skipping an integer number of entries.

To get musically accurate frequencies, it is necessary to be able to skip a fractional number of table entries. At this point the concept of a *table increment* is helpful in dealing with programming such an operation. First, the table is visualized as a circle with the first entry conceptually following the last as in figure 6. A pointer locates a point along the circular table which represents the sample last sent to the DAC. To find what should be sent to the DAC next, the table pointer is moved clockwise a distance equal to the table increment. The frequency of the resulting tone is now

$$\frac{FS \times I}{N}$$

where FS and N are as before and I is the increment.

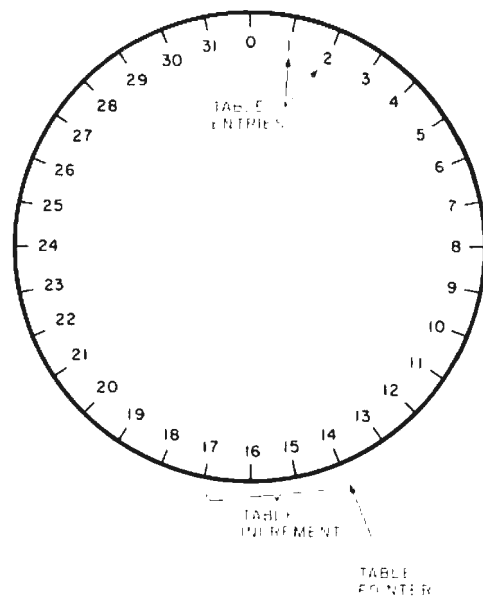

Figure 6: Diagrammatic representation of the circular table used for storing the waveform "template." The technique illustrated here is that of storing a large number of samples of one cycle of a musical waveform in memory as a table which wraps around itself in circular fashion. A pointer is used to point to the next sample to be extracted. In order to create a waveform with a given frequency, the program is designed to skip a fractional number of table entries to get the next sample value. This fractional number is called the table increment value. The process is continued around the table for one revolution to create a complete waveform. The cycle around the table is repeated until the duration counter decrements to zero.

With integer increments, the pointer always points squarely to an entry. With mixed number increments, the pointer also will take on a fractional part. The sensible thing to do is to interpolate between the table entries on either side of the pointer to arrive at an accurate value to give to the DAC. This is indeed necessary to assure high quality; but simply choosing the nearest entry may be acceptable in some cases, particularly if the table is very large.

There is one elusive pitfall in this technique. The table may contain the tabulation of any waveform desired, subject to one limitation: a nonzero harmonic component of the waveform must not exceed the Nyquist frequency, $FS/2$. This can easily happen with the larger table increments (higher frequency tones), the result being aliasing of the upper harmonics. Theoretically this is a severe limitation. Often a small amount of aliasing is not objectionable, but

a large amount sounds like gross intermodulation distortion. High sample rates reduce the possibility or magnitude of aliasing, but of course require more computation. For the moment, we will ignore this problem and restrict ourselves to relatively smooth waveforms without a lot of high frequency harmonics.

Now that the DAC is used for generating the actual waveshape, how is amplitude control accomplished? If an amplitude parameter is defined that ranges between 0 and 1.0 (corresponding to amplitudes between zero and maximum), the desired result is obtained by simply multiplying each sample from the table by this amplitude parameter and sending the product to the DAC. Things are nice and consistent if the table entries are also considered as fractions between -1 and +1 because then the product has a range between -1 and +1 which is directly compatible with the DAC. (Note that the DAC in figure 3 is unipolar. It can be considered bipolar if +2.5 V output is the zero reference and the sign bit is inverted.)

The last major hurdle is the generation of simultaneous tones. Obviously, two simultaneous tones may be generated by going through two tables, outputting to two separate DACs, and mixing the results with an audio mixer. This is relatively simple to do if the sample rates of the two tones are the same. Actually, all the audio mixer does is to *add* the two input voltages together to produce its output, but a very important realization is that the addition can also be done in the computer before the output conversion by the DAC! The two samples are simply added together with an ADD instruction, the sum is divided by two (to constrain it to the range of -1 to +1), and the result sent to a single DAC. This holds true for any number of simultaneous tones! The only requirement is that the composite samples not overflow the -1 to +1 range that the DAC can accept. Rather than dividing the sum, it is best to adjust the amplitude factors of the individual "voices" to prevent overflow. So now we have the tools necessary to generate an ensemble of tones, each one possibly having its own waveform, amplitude envelope, and loudness relative to the others. Indeed, this is all that is necessary to simulate a typical organ.

Up to this point the timbre (waveform) of a tone has been determined by the contents of a fixed waveform table. Truly interesting musical notes change their timbre during the duration of the note. A reasonable alternative to switching between similar tables for implementing this is to build the tone from harmonic components. Each harmonic component of the tone is simply



yours

*mem·o·ry/ˈmem-(ə)rē/n.
 a: the power or process of reproducing or recalling what has been learned and retained esp. through associative mechanisms
 b: the store of things learned and retained from an organism's activity or experience as evidenced by modification of structure or behavior or by recall and recognition.

There are only 2 types of memory. yours and ours.

Ours is the **16K SPACE BYTE**
 A fully static, state of the art RAM

\$599. Fully assembled, burned in and tested

*definition according to Webster's New World Dictionary

Single +8 volt power requirement
 4 independent 7805 voltage regulators, one for each 4K block.
 Typical worst case power dissipation is less than 2 amps

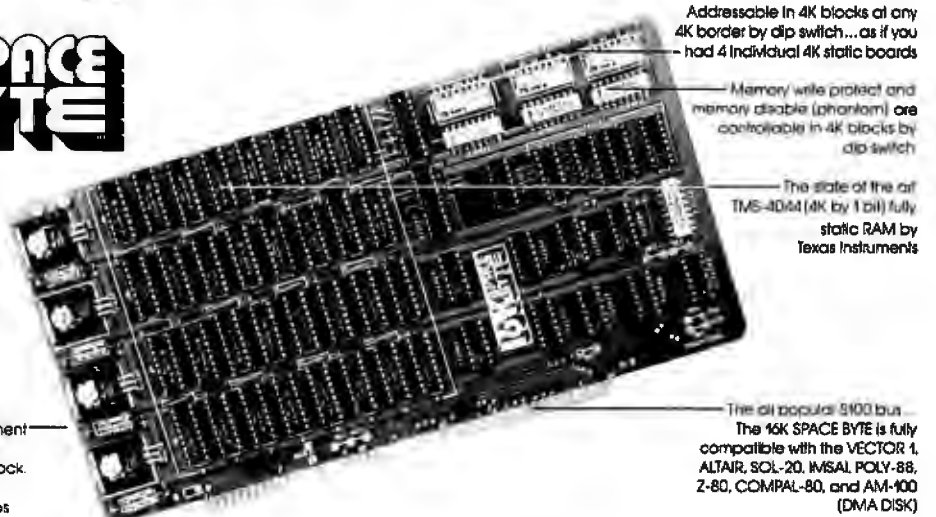

Addressable in 4K blocks at any 4K border by dip switch...as if you had 4 individual 4K static boards

Memory/write protect and memory disable (phantom) are controllable in 4K blocks by dip switch

The state of the art TMS-4044 (4K by 1 bit) fully static RAM by Texas Instruments

The all popular 8100 bus...
 The 16K SPACE BYTE is fully compatible with the VECTOR 1, ALTAIR, SOL-20, IMSAI, POLY-88, Z-80, COMPAL-80, and AM-100 (DMA DISK)

Circle 222 on inquiry card.

THE SPACE BYTE CORPORATION 1720 Pontius Ave. Suite 201 Los Angeles, CA 90025 (213) 468-8080

Listing 2: A program which, in conjunction with tables 3, 4 and 5, generates four simultaneous musical voices, each with a different waveform and volume level. The program is designed for use with the 6502 processor coupled to an 8 bit unsigned digital to analog converter (DAC) like the one shown in figure 3.

```

; THIS PROGRAM PLAYS MUSIC IN 4-PART HARMONY ON THE KIM-1 OR
; OTHER 6502 BASED SYSTEM USING AN 8-BIT UNSIGNED
; DIGITAL-TO-ANALOG CONVERTER CONNECTED TO AN OUTPUT PORT. TUNED
; FOR SYSTEMS WITH A 1 MHZ CRYSTAL CLOCK. DOES NOT USE THE ROR
; INSTRUCTION.
; SONG TABLE IS AT "SONG"
; ENTRY POINT IS AT "MUSIC"

0000      . =      0          ; ORG AT PAGE 0 LOCATION 0

1700      DAC      =      X'1700      ; OUTPUT PORT ADDRESS WITH DAC
1701      DACDIR   =      X'1701      ; DATA DIRECTION REGISTER FOR DAC PORT
1780      AUXRAM   =      X'1780      ; ADDRESS OF EXTRA 128 BYTES OF RAM IN 6530
1C22      KIMMON   =      X'1C22      ; ENTRY POINT TO KIM KEYBOARD MONITOR

0000 00      V1PT:  .BYTE  0          ; VOICE 1 WAVE POINTER, FRACTIONAL PART
0001 0000      .WORD  WAV1TB        ; INTEGER PART AND WAVE TABLE BASE
0003 00      V2PT:  .BYTE  0          ; VOICE 2
0004 0000      .WORD  WAV2TB
0006 00      V3PT:  .BYTE  0          ; VOICE 3
0007 0000      .WORD  WAV3TB
0009 00      V4PT:  .BYTE  0          ; VOICE 4
000A 0000      .WORD  WAV4TB

000C 0000      V1IN:  .WORD  0          ; VOICE 1 INCREMENT (FREQUENCY PARAMETER)
000E 0000      V2IN:  .WORD  0          ; VOICE 2
0010 0000      V3IN:  .WORD  0          ; VOICE 3
0012 0000      V4IN:  .WORD  0          ; VOICE 4

0014 00      DUR:   .BYTE  0          ; DURATION COUNTER
0015 0000      NOTES: .WORD  0          ; NOTES POINTER
0017 0002      SONGA: .WORD  SONG      ; ADDRESS OF SONG
0019 0000      INCPT: .WORD  0          ; POINTER FOR LOADING UP V1IN - V4IN
001B 0C00      INCA:  .WORD  V1IN      ; INITIAL VALUE OF INCPT
001D 5200      TEMPO: .WORD  82        ; TEMPO CONTROL VALUE, TYPICAL VALUE FOR
; 3:4 TIME, 100 BEATS PER MINUTE, DUR=64
; DESIGNATES A QUARTER NOTE

0100      . =      X'100          ; START PROGRAM CODE AT LOCATION 0100

; MAIN MUSIC PLAYING PROGRAM

0100 A9FF      MUSIC: LDA  #X'FF      ; SET PERIPHERAL A DATA DIRECTION
0102 8D0117      STA  DACDIR        ; REGISTER TO OUTPUT
0105 D8         CLD                ; INSURE BINARY ARITHMETIC
0106 A517      LDA  SONGA          ; INITIALIZE NOTES POINTER
0108 8515      STA  NOTES          ; TO BEGINNING OF SONG
010A A518      LDA  SONGA+1
010C 8516      STA  NOTES+1

010E A000      MUSIC1: LDY  #0        ; SET UP TO TRANSLATE 4 NOTE ID NUMBERS
0110 A51B      LDA  INCA           ; INTO FREQUENCY DETERMINING WAVEFORM TABLE
0112 8519      STA  INCPT         ; INCREMENTS AND STORE IN V1IN - V4IN
0114 B115      LDA  (NOTES),Y      ; GET DURATION FIRST
0116 F03C      BEQ  ENDSNG        ; BRANCH IF END OF SONG
0118 C901      CMP  #1            ; TEST IF END OF SONG TABLE SEGMENT
011A F029      BEQ  NXTSEG        ; BRANCH IF SO
011C 8514      STA  DUR           ; OTHERWISE SAVE DURATION IN DUR
011E E615      MUSIC2: INC  NOTES   ; DOUBLE INCREMENT NOTES TO POINT TO THE
0120 D002      BNE  MUSIC3        ; NOTE ID OF THE FIRST VOICE
0122 E616      INC  NOTES+1
0124 B115      MUSIC3: LDA  (NOTES),Y ; GET A NOTE ID NUMBER
0126 AA         TAX                ; INTO INDEX X
0127 B520      LDA  FRQTAB+1,X     ; GET LOW BYTE OF CORRESPONDING FREQUENCY
0129 9119      STA  (INCPT),Y     ; STORE INTO LOW BYTE OF VOICE INCREMENT
012B E619      INC  INCPT         ; INDEX TO HIGH BYTE
012D B51F      LDA  FRQTAB,X      ; GET HIGH BYTE OF FREQUENCY
012F 9119      STA  (INCPT),Y     ; STORE INTO HIGH BYTE OF VOICE INCREMENT
0131 E615      INC  NOTES        ; DOUBLE INCREMENT NOTES TO POINT TO THE
0133 D002      BNE  MUSIC4        ; NOTE ID OF THE NEXT VOICE
0135 E616      INC  NOTES+1
0137 E619      MUSIC4: INC  INCPT   ; INDEX TO NEXT VOICE INCREMENT
0139 A519      LDA  INCPT         ; TEST IF 4 VOICE INCREMENTS DONE
013B C914      CMP  #V4IN+2
013D D0E5      BNE  MUSIC3        ; LOOP IF NOT
013F 205701      JSR  PLAY        ; PLAY THIS GROUP OF NOTES
0142 4C0E01      JMP  MUSIC1      ; GO LOAD UP NEXT SET OF NOTES

0145 C8         NXTSEG: INY        ; END OF SEGMENT, NEXT TWO BYTES POINT TO
0146 B115      LDA  (NOTES),Y     ; BEGINNING OF THE NEXT SEGMENT
0148 48         PHA                ;
0149 C8         INY                ; GET BOTH SEGMENT ADDRESS BYTES
014A B115      LDA  (NOTES),Y     ;
014C 8516      STA  NOTES+1      ; THEN STORE IN NOTES POINTER
014E 68         PLA                ;
014F 8515      STA  NOTES        ;
0151 4C0E01      JMP  MUSIC1      ; GO START INTERPRETING NEW SEGMENTT

0154 4C221C      ENDSNG: JMP  KIMMON ; END OF SONG, RETURN TO MONITOR
; 4 VOICE PLAY SUBROUTINE

```

a sine wave with an amplitude dependent on the waveform of the resulting tone. Giving a different amplitude envelope to each harmonic is equivalent to smoothly changing the timbre during the note. The aliasing problem mentioned earlier can also be solved by simply omitting any harmonics that become too high in frequency.

Dynamic timbre variation can also be accomplished by a *digital filter* which does the same thing to a sampled waveform that a real inductance-capacitance filter does to a normal waveform. A digital filter is simply a subroutine which accepts a sample value as an argument and gives back a sample value which represents the filtered output. The equations used in the subroutine determine the filter type, and other arguments determine the cutoff frequency, Q, etc. This is a fascinating subject which deserves its own article.

What about other, unpitched sounds? They too can be handled with a few simple techniques. Most sounds in this category are based in part on random noise. In sampled form, random white noise with a uniform frequency spectrum is simply a stream of random numbers. For example, a fairly realistic snare drum sound may be generated by simply giving the proper amplitude envelope to pure white noise. Other types of drum sounds may be generated by using a digital filter to shape the frequency spectrum of the noise. A resonant type of digital filter would be used for tomtoms and similar semipitched drums, for example. A high pass filter is useful for simulating brush and cymbal sounds. An infinite number of variations are possible. This is one area where direct computation of sound waveforms really shines.

The sampling theorem works both ways also. Any waveform may be converted into digital samples with an analog to digital converter (ADC) with no loss of information. The only requirement is that the signal being sampled have no frequency components higher than half of the sampling frequency. This may be accomplished by passing the signal to be digitized through a sharp low pass filter prior to presenting it to the ADC. Once sound is in digitized form, literally anything may be done to it. A simple (in concept) application is intricate editing of the sound with a graphic display, light pen and large capacity disk. The sound may be analyzed into harmonic components and the result or a transformation of it applied to a synthesized sound. Again, this is an area that deserves its own article.

Application Software!



You can
buy software
from anybody -
but ours works
in your system.

We only sell one product, Quality.

We have been in business for over nine years building a reputation for providing a quality product at nominal prices — NOT what the traffic will bear. Our software is:

- **Versatile** — as most programs allow for multiple modes of operation.
- **Tutorial** — as each program is self prompting and leads you through the program (most have very detailed instructions contained right in their source code).
- **Comprehensive** — as an example our PSD program not only computes Power Spectral Densities but also includes FFT's, Inverse-transforms, Windowing, Sliding Windows, simultaneous FFT's variable data sizes, etc. and as a last word our software is:
- **Readable** — as all of our programs are reproduced full size for ease in reading.
- **Virtually Machine Independent** — these programs are written in a subset of Dartmouth Basic but are not oriented for any one particular system. Just in case your Basic might not use one of our functions we have included an appendix in Volume V which gives conversion algorithms for 19 differ-

ent Basic's; that's right, just look it up and make the substitution for your particular version. If you would like to convert your favorite program in to Fortran or APL or any other language, the appendix in Volume II will define the statements and their parameters as used in our programs.

Over 85% of our programs in the first five volumes will execute in most 8K Basic's with 16K of free user RAM. If you only have 4K Basic, because of its' lack of string functions only about 60% of our programs in Volumes I thru V would be useable, however they should execute in only 8K of user RAM.

Future additions:

Soon to be released! A "fantastic" word processing package set up for lawyers, publishers and writers; and a Medical Billing system which will also allow a patients record to be individually scanned. AND there are rumors that a 12K chess game, in Basic, will also be released.

Volumes VI and VII available on our Firmware System.

Vol. I — \$24.95
Bookkeeping
Games
Pictures

Vol. II — \$24.95
Math/Engineering
Plotting/Statistics
Basic Statement
Def.

Vol. III — \$39.95
Advanced Business
Billing, Inventory
Investments
Payroll

Vol. IV — \$9.95
General Purpose

Vol. V — \$9.95
Experimenter's
Program



SCIENTIFIC RESEARCH

1712-B Farmington Court, Crofton, MD 21114

Phone orders call (800) 638-9194

Information and Maryland residents call (301)721-1148

Add \$1.50 per volume handling, all domestic shipments sent U.P.S. except APO and P.O. Box which go parcel post. Foreign orders add \$8.00/volume for air shipment and make payable in U.S. dollars only.

AVAILABLE AT MOST COMPUTER STORES

Master Charge and Bank Americard accepted.

Our Software is copyrighted and may not be reproduced or sold.

Listing 2, continued:

```

0157 A000      PLAY:  LDY  #0          ; SET Y TO ZERO FOR STRAIGHT INDIRECT
0159 A61D      LDX   TEMPO        ; SET X TO TEMPO COUNT
                                ; COMPUTE AND OUTPUT A COMPOSITE SAMPLE

015B 18       PLAY1: CLC          ; CLEAR CARRY
015C B101     LDA   (V1PT+1),Y    ; ADD UP 4 VOICE SAMPLES
015E 7104     ADC   (V2PT+1),Y    ; USING INDIRECT ADDRESSING THROUGH VOICE
0160 7107     ADC   (V3PT+1),Y    ; POINTERS INTO WAVEFORM TABLES
0162 710A     ADC   (V4PT+1),Y    ; STRAIGHT INDIRECT WHEN 1 INDEX = 0
0164 8D0017   STA   X'1700       ; SEND SUM TO DIGITAL-TO-ANALOG CONVERTER
0167 A500     LDA   V1PT         ; ADD INCREMENT TO POINTERS FOR
0169 650C     ADC   V1IN         ; THE 4 VOICES
016B 8500     STA   V1PT         ; FIRST FRACTIONAL PART
016D A501     LDA   V1PT+1       ;
016F 650D     ADC   V1IN+1       ;
0171 8501     STA   V1PT+1       ; THEN INTEGER PART
0173 A503     LDA   V2PT         ; VOICE 2
0175 650E     ADC   V2IN         ;
0177 8503     STA   V2PT         ;
0179 A504     LDA   V2PT+1       ;
017B 650F     ADC   V2IN+1       ;
017D 8504     STA   V2PT+1       ;
017F A506     LDA   V3PT         ; VOICE 3
0181 6510     ADC   V3IN         ;
0183 8506     STA   V3PT         ;
0185 A507     LDA   V3PT+1       ;
0187 6511     ADC   V3IN+1       ;
0189 8507     STA   V3PT+1       ;
018B A509     LDA   V4PT         ; VOICE 4
018D 6512     ADC   V4IN         ;
018F 8509     STA   V4PT         ;
0191 A50A     LDA   V4PT+1       ;
0193 6513     ADC   V4IN+1       ;
0195 850A     STA   V4PT+1       ;
0197 CA       DEX              ; DECREMENT & CHECK TEMPO COUNT
0198 D008     BNE   TIMMAS       ; BRANCH TO TIME WASTE IF NOT RUN OUT
019A C614     DEC   DUR          ; DECREMENT & CHECK DURATION COUNTER
019C F00C     BEQ   ENDNOT      ; JUMP OUT IF END OF NOTE
019E A61D     LDX   TEMPO       ; RESTORE TEMPO COUNT
01A0 D0B9     BNE   PLAY1       ; CONTINUE PLAYING
01A2 D000     TIMMAS: BNE   .+2   ; 3 WASTE 12 STATES
01A4 D000     BNE   .+2         ; 3
01A6 D000     BNE   .+2         ; 3
01A8 D0B1     BNE   PLAY1       ; 3 CONTINUE PLAYING
01AA 60      ENDNOT: RTS        ; RETURN
                                ; TOTAL LOOP TIME = 124 STATES = 8170 HZ

01AB      P1END =              ; DEFINE BEGINNING ADDRESS FOR THIRD PART
                                ; OF SONG TABLE

```

Sampled Waveform Example

It should be obvious by now that while these sampled waveform techniques are completely general and capable of high quality, there can be a great deal of computation required. Even the most powerful computers in existence would be hard pressed to compute samples for a significant piece of music with many voices and all subtleties implemented at a rate fast enough for direct output to a DAC and speaker. Typically the samples are computed at whatever rate the program runs and are saved on a mass storage device. After the piece has been "computed," a playback program retrieves the samples and sends them to the DAC at a uniform high rate.

Most microprocessors are fast enough to do a limited amount of sampled waveform computation in real time. The 6502 is one of the best 8 bit machines in this capacity due to its indexed and indirect addressing modes and its overall high speed. The example program shown in listing 2 has the inherent capability to generate four simul-

taneous voices, each with a different waveform and volume level. In order to make the whole thing fit in a basic KIM-1, however, only one waveform table is actually used.

This program could probably be considered as a variation of the timed loop technique, since the sample rate is determined by the execution time of a particular loop. The major differences are that all of the instructions in the loop perform an essential function and that the loop time is constant regardless of the notes being played. Using the program as shown on a full speed (1.0 MHz) 6502 gives a sample rate of 8.77 kHz, which results in a useful upper frequency limit of 3 kHz. The low pass filter in figure 7 coupled with the DAC in figure 3 and audio system or amplifier in figure 8 are all the specialized hardware necessary to run the program with full 4 part harmony.

The program consists of two major routines: MUSIC and PLAY. MUSIC steps through the list of notes in the song table and sets up DUR and V1IN thru V4IN for the PLAY routine. PLAY simultaneously plays the four notes specified by V1IN thru V4IN for the time period specified by DUR. Another variable, TEMPO, in page zero controls the overall tempo of the music independently of the durations specified in the song table. The waveform tables for the four voices are located at WAV1TB thru WAV4TB and require 256 bytes (one memory page) each. The actual waveform samples stored in the table have already been scaled so that when four of them are added up there is no possibility of overflow.

The song table has an entry for each musical "event" in the piece. An entry requires five bytes, the first of which is a duration parameter. By suitable choice of the TEMPO parameter in page 0, "round" (in the binary sense) numbers may be used for duration parameters of common note durations. A duration parameter of 0 signals the end of the song, in which case the program returns to the monitor. A duration parameter of 1 is used to specify a break in the sequential flow of the song table. In this case the next two bytes point to the continuation of the table elsewhere in memory. This feature was necessary to deal with the fragmented memory of the KIM-1, but has other uses as well. All other possible duration values are taken literally and are followed by four bytes which identify the notes to be played by each voice. Each note ID points to a location in the note frequency table which in turn contains a 2 byte frequency parameter for that note which is placed in V1IN thru V4IN.

The PLAY routine is optimized for speed,

Bet on Quay microcomputers, components, and software. They're winners.

See Quay products. Booths 341 &
342. Personal Computing
'77 Show. August 27, 28
Atlantic
City, N.J.

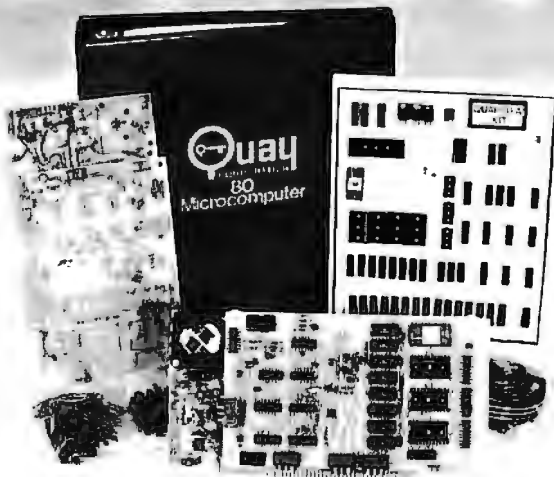

Ber 1. Quay 80AI.-CPU, monitor I/O.

For beginners, Quay 80AI is a sure thing. It's a stand alone microcomputer in a kit. Assemble it. Plug it into your power supply. Hook on a terminal. And go. Quay 80AI uses the powerful Z80 microprocessor with a 2.5 Mhz clock, it's also S100 bus compatible and fast, efficient, expandable and economical. You can't lose.

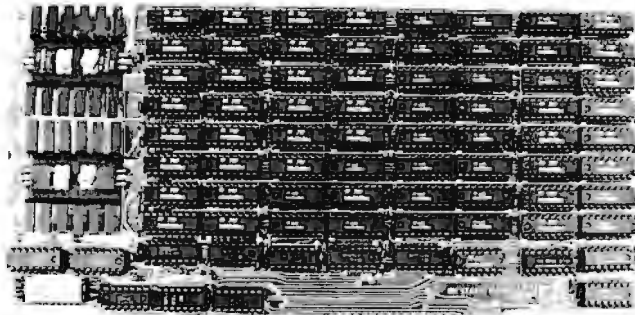

Ber 2. Quay 80SMB. 8K memory.

Here's 8K of static RAM memory in a kit. You'll never find a more economical way to add memory. Great for expanding the capacity of Quay 80AI or any other S100 microcomputer.

Ber 3. Quay 80MBPS. Motherboard/power supply.

When you're expanding, looking at bigger games, the Quay 80 MBPS 12-slot motherboard with or without a power supply is best for you. Gives you plenty of room. And when the time comes, you can put it into a dynamite Quay chassis (Ber 4).

Ber 4. Quay 80C. Chassis.

If you've grown with Quay, component by component, you'll reach the point where you'll want this fine chassis. It turns a jumble of hardware into a compact, good-looking, functionally-efficient system. It gives your high-quality components the look of class.

Ber 5. Quay 8000. System.

The Quay 8000 is a complete microcomputer system consisting of the Quay 80AI (Ber 1), the Quay 80SMB (Ber 2), Quay 80MBPS (Ber 3), Quay 80C (Ber 4), and Quay 80 4K Basic (Ber 7). If you want a complete package with plenty of power and Basic, this is it. It's the best system you can buy for the dollars (under 1K bucks). You're in operation with a complete top-quality system. (It's less expensive to buy the complete system than to buy the individual components.)

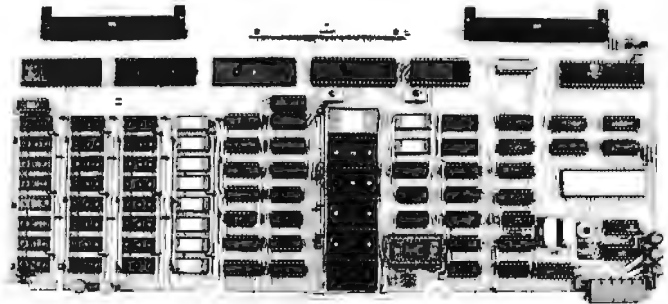

Ber 6. Quay 90MPS. OEM microcomputer.

The Quay 90MPS is a complete OEM microcomputer system on a single board. It's designed for OEM use or for the highly sophisticated hobbyist. Quay 90MPS comes completely assembled and tested. It uses the Z80 microprocessor, has 6K of memory (expandable to 65K), a 2.5 Mhz clock with a 4Mhz clock option. This is the big time.

Ber 7. Quay 80AI and Quay 90MPS software.

Quay has available for its systems the following software in Basic: ■ 2KB on UV Prom for 80AI or 90MPS ■ 4KB on UV Prom for 90 MPS ■ 4 KB on cassette tape for 80AI or 90MPS ■ 10KB on cassette tape for 90MPS.

Ber 8. Quay coming events.

Available soon: an Assembler Editor package and Business Applications for 10K Basic. Get on the Quay mailing list so when they're ready you'll be among the first to know.

Send for detailed information on all Quay products. Get in on a good thing. Or for fast action call 201-681-8700.

Dealer inquiries invited.

Circle 223 on inquiry card.



P.O. Box 386 □ Freehold, N.J. 07728 □ Phone: 201-681-8700.

Figure 7: A sharp low pass filter with 3 kHz cutoff. This circuit is used to filter out the high frequency distortion illustrated in figure 5.

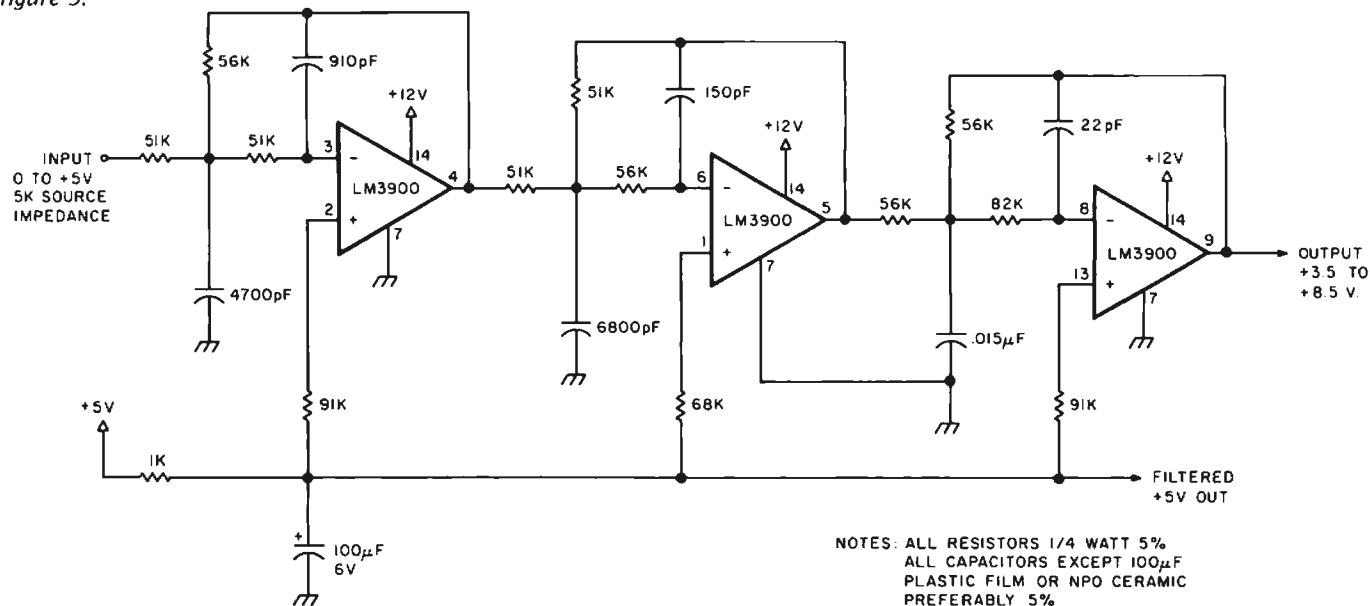

NOTES: ALL RESISTORS 1/4 WATT 5%
ALL CAPACITORS EXCEPT 100µF
PLASTIC FILM OR NPO CERAMIC
PREFERABLY 5%

NOTE FREQUENCY TABLE FOR 8.772 KHZ SAMPLE RATE
RANGE FROM C2 (65.41 HZ) TO C6 (1046.5 HZ)

ID	NOTE	FREQ.	INCR.
001F	0000	0	SILENCE
0021	01E9	2	C2# 65.405 1.9089
0023	0206	4	C2# 69.295 2.0224
0025	0225	6	D2 73.415 2.1427
0027	0245	8	D2# 77.783 2.2701
0029	0268	10	E2 82.408 2.4051
002B	028C	12	F2 87.308 2.5481
002D	02B3	14	F2# 92.498 2.6996
002F	02DC	16	G2 97.998 2.8601
0031	0308	18	G2# 103.83 3.0302
0033	0336	20	A2 110.00 3.2104
0035	0367	22	A2# 116.54 3.4013
0037	039A	24	B2 123.47 3.6035
0039	03D1	26	C3 130.81 3.8178
003B	040B	28	C3# 138.59 4.0448
003D	0449	30	D3 146.83 4.2854
003F	048A	32	D3# 155.57 4.5402
0041	04CF	34	E3 164.82 4.8102
0043	0519	36	F3 174.62 5.0962
0045	0566	38	F3# 185.00 5.3992
0047	05B8	40	G3 196.00 5.7203
0049	060F	42	G3# 207.65 6.0604
004B	066C	44	A3 220.00 6.4208
004D	06CD	46	A3# 233.08 6.8026
004F	0735	48	B3 246.94 7.2071
0051	07A3	50	C4 261.62 7.6356
0053	0817	52	C4# 277.18 8.0897
0055	0892	54	D4 293.66 8.5707
0057	0915	56	D4# 311.13 9.0804
0059	099F	58	E4 329.63 9.6203
005B	0A31	60	F4 349.23 10.1924
005D	0ACC	62	F4# 369.99 10.7984
005F	0B71	64	G4 391.99 11.4405
0061	0C1F	66	G4# 415.30 12.1208
0063	0CD7	68	A4 440.00 12.8416
0065	0D9B	70	A4# 466.16 13.6052
0067	0E6A	72	B4 493.88 14.4142
0069	0F45	74	C5 523.24 15.2713
006B	102E	76	C5# 554.36 16.1794
006D	1124	78	D5 587.32 17.1414
006F	1229	80	D5# 622.26 18.1607
0071	133E	82	E5 659.26 19.2406
0073	1462	84	F5 698.46 20.3847
0075	1599	86	F5# 739.98 21.5969
0077	16E2	88	G5 783.98 22.8811
0079	183E	90	G5# 830.60 24.2417
007B	19AF	92	A5 880.00 25.6831
007D	1B36	94	A5# 932.32 27.2103
007F	1CD4	96	B5 987.76 28.8283
0081	1EBB	98	C6 1046.5 30.5426
0083	POEND		DEFINE BEGINNING ADDRESS FOR SECOND PART OF SONG TABLE

Table 3: Note frequency table used in conjunction with listing 2. This table is for a sample rate of 8.772 kHz. The range of the notes used is from 65.41 Hz (for C2) to 1046.5 Hz (for C6).

because its loop time determines the sample rate. Essentially, the routine maintains four pointers (V1PT thru V4PT) to the four waveform tables. Each pointer consists of three bytes in order of increasing significance. The first byte is the "fractional part" of the pointer, and the second byte is the integer part which is also the lower half of an address in the waveform table. The third byte is the upper address which normally remains constant. Waveform table lookup is considerably simplified by using the indirect addressing mode of the 6502 with these pointers. Note that the fractional part of the pointer is ignored when the table lookup takes place, since interpolation is much too slow for a real time routine.

During each sample, waveform table entries for each voice are fetched, added up, and sent to the digital to analog converter output port. Then the increment (VxIN) is added (double precision) to each pointer (VxPT). Wraparound from the end of a waveform table to the beginning is automatically taken care of due to the fact that the table occupies a full memory page. Finally, the tempo counter is decremented and checked. If the tempo counter is zero, it is restored and the duration counter is decremented and checked. If it is also zero the note is finished and PLAY returns. The net result is that TxD samples are computed and sent out for the event, where T is the tempo parameter and D is the duration parameter. Note that, unlike the earlier timed loop example, there is no interaction between the duration parameter and the note frequencies being played.

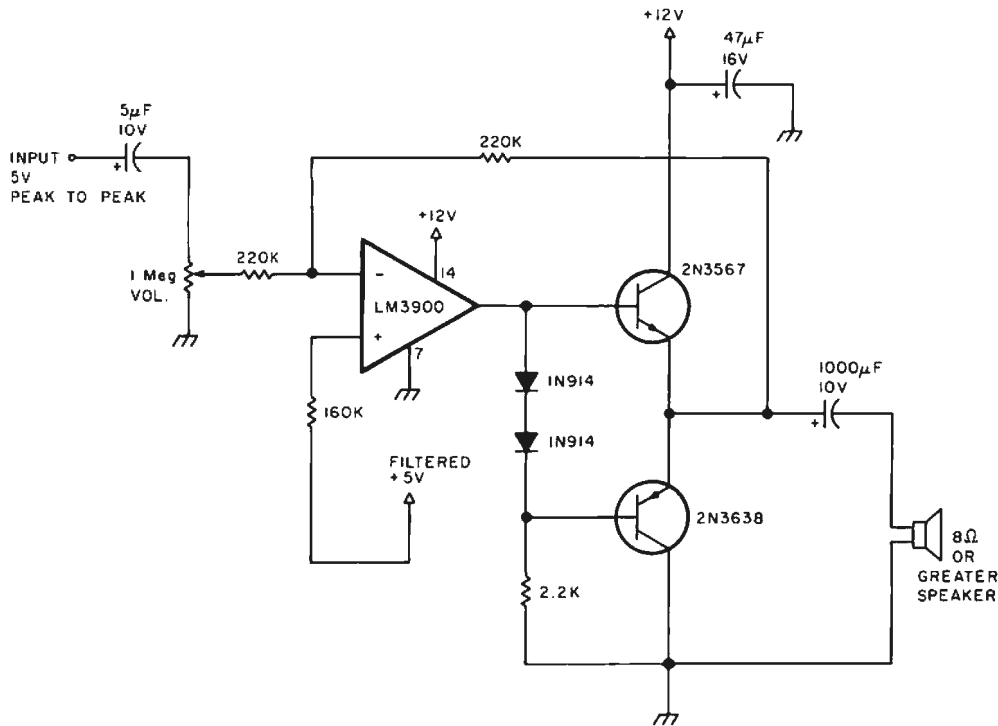

Figure 8. An inexpensive, wide band low power audio amplifier. This circuit, when coupled with the circuits in figures 3 and 7, is all the experimenter needs to create music with his or her microprocessor.

How does it sound? With the waveform table shown and a reasonably good speaker system, the result sounds very much like an electronic organ, such as a Hammond. There is a noticeable background noise level due to compromises such as prescaled waveforms and lack of interpolation in the tables, but it is not objectionable. The pitches are very accurate, but there is some beating on chords due to compromises inherent in the standard equally tempered musical scale. Also there are noticeable clicks between notes due to the time taken by the MUSIC routine to set up the next set of notes. All in all the program makes a good and certainly inexpensive basis for the "family music application" mentioned earlier.

Synthesizer Control Techniques

So far we have discussed techniques in which the computer itself generates the sound. It is also possible to interface a computer to specialized sound generation hardware and have it act as a control element.

The most obvious kind of equipment to control is the standard, modular, voltage controlled sound synthesizer. Since the interface characteristics of nearly all synthesizers and modules are standardized, a computer interface to such equipment could be used with nearly any synthesizer in common use.

Generally speaking, the function of a voltage controlled module is influenced by one or more DC control voltages. These are usually assumed to be in the range of 0 to +10 volts, although some modules will

```

;
; SONG TABLE
; EACH MUSICAL EVENT CONSISTS OF 5 BYTES
; THE FIRST IS THE DURATION OF THE EVENT IN UNITS ACCORDING TO
; THE VALUE OF "TEMPO", ZERO DENOTES THE END OF THE SONG.
; THE NEXT 4 BYTES CONTAIN THE NOTE ID OF THE 4 VOICES, 1 THROUGH
; 4. 0 INDICATES SILENCE FOR THE VOICE.
;
0200 . = X'200 ; START SONG AT 0200
;
; SONG TABLE FOR THE STAR SPANGLED BANNER BY FRANCIS SCOTT KEY
; AND J. STAFFORD SMITH
; DURATION COUNT = 64 FOR QUARTER NOTE
;
0200 604A000032 SONG: .BYTE 96,74,0,0,50 ; 3/8 C5 C4 1
0205 104400002C .BYTE 16,68,0,0,44 ; 1/16 A4 A3
020A 4040000024 .BYTE 64,64,0,0,36 ; 1/4 G4 F3 2
020F 4044000024 .BYTE 64,68,0,0,36 ; 1/4 A4 F3
0214 404A000022 .BYTE 64,74,0,0,34 ; 1/4 C5 E3
0219 80544E441E .BYTE 128,84,78,68,30 ; 1/2 F5 D5 A4 D3 3
021E 305C52441C .BYTE 48,92,82,68,28 ; 3/16 A5 E5 A4 C#3
0223 105800401C .BYTE 16,88,0,64,28 ; 1/16 G5 G4 C#3
0228 4054003C1E .BYTE 64,84,0,60,30 ; 1/4 F5 F4 D3 4
022D 4044003C1E .BYTE 64,68,0,60,30 ; 1/4 A4 F4 D3
0232 4048403C28 .BYTE 64,72,64,60,40 ; 1/4 B4 G4 F4 G3
0237 804A403A32 .BYTE 128,74,64,58,50 ; 1/2 C5 G4 E4 C4 5
023C 204A000032 .BYTE 32,74,0,0,50 ; 1/8 C5 C4
0241 204A000032 .BYTE 32,74,0,0,50 ; 1/8 C5 C4
0246 605C544424 .BYTE 96,92,84,68,36 ; 3/8 A5 F5 A4 F3 6
024B 2058004028 .BYTE 32,88,0,64,40 ; 1/8 G5 G4 G3
0250 4054003C2C .BYTE 64,84,0,60,44 ; 1/4 F5 F4 A3
0255 80524A4032 .BYTE 128,82,74,64,50 ; 1/2 E5 C5 G4 C4 7
025A 304E46002E .BYTE 48,78,70,0,46 ; 3/16 D5 B#4 B#3
025F 10524A402E .BYTE 16,82,74,64,46 ; 1/16 E5 C5 G4 B#3
0264 40544A442C .BYTE 64,84,74,68,44 ; 1/4 F5 C5 A4 A3 8
0269 405400003C .BYTE 64,84,0,0,60 ; 1/4 F5 F4 F4
026E 404A000032 .BYTE 64,74,0,0,50 ; 1/4 C5 C4
0273 404400002C .BYTE 64,68,0,0,44 ; 1/4 A4 A3 9
0278 403C000024 .BYTE 64,60,0,0,36 ; 1/4 F4 F3
027D 304A000032 .BYTE 48,74,0,0,50 ; 3/16 C5 C4
0282 104400002C .BYTE 16,68,0,0,44 ; 1/16 A4 A3
0287 403C000024 .BYTE 64,60,0,0,36 ; 1/4 F4 F3 10
028C 4044000024 .BYTE 64,68,0,0,36 ; 1/4 A4 F3
0291 404A000022 .BYTE 64,74,0,0,34 ; 1/4 C5 E3
0296 80544E441E .BYTE 128,84,78,68,30 ; 1/2 F5 D5 A4 D3 11
029B 305C52441C .BYTE 48,92,82,68,28 ; 3/16 A5 E5 A4 C#3

```

Table 4: This song table is an encoding of "The Star Spangled Banner" in 4 part harmony which is used by the program in listing 2. Each musical event in the table consists of five bytes. The first byte represents the duration of the event in units, according to the value of the "tempo" (0 denotes the end of the song). The next four bytes contain the note identifications of the four voices (0 indicates silence for the voice).

have a predictable response to negative voltages as well. In a voltage controlled oscillator, for example, the output frequency is determined by a control voltage. For typical tuning, 0 V would correspond to 16 Hz (a very low C), and the frequency would increase one volt per octave for higher voltages. Thus, +4 V would produce middle C, and the maximum input of +10 V

would produce a nearly inaudible 16.4 kHz. A typical oscillator module has two or three control inputs and a number of outputs. The voltages at the inputs are internally summed to form the effective control value (useful for injecting vibrato), and the outputs provide several different waveforms simultaneously.

A voltage controlled amplifier has as a minimum a signal input, a control input, and a signal output. The voltage at the control input determines the gain from the signal input to the signal output. In a typical setting, +8 V would correspond to unity (0 db) gain, with lower voltages decreasing the gain by 10 db per volt.

Many other voltage controlled devices have been developed during the approximately 12 year history of this field. In order to play music, the modules are first "patched" together with patch cords (like old style telephone switchboards) according to the desired sound characteristics. Manually operated control voltage sources such as potentiometers, joysticks and specialized organ-like keyboards are then manipulated by the player. The music is generally monotonic due to difficulties in the control elements (now being largely overcome). Multitrack tape recorders are universally utilized to produce the results heard on recordings such as Walter Carlos's *Switched on Bach*.

A useful computer interface to a synthesizer can be accomplished with nothing more than a handful of digital to analog and optionally analog to digital converters. The DACs would be used to generate control voltages under program control and the ADCs would allow operator input from the keyboard, for example, to be stored. Since control voltages vary slowly compared to the actual sound waveforms, real time control of a number of synthesizer modules is possible with the average microprocessor. Due to the large number of DACs required and the relatively slow speeds necessary, a multiplexing scheme using one DAC and a number of sample and hold amplifiers is appropriate. The home builder should be able to achieve costs as low as \$2 per channel for a 32 channel, 12 bit unit capable of controlling a fairly large synthesizer.

The routing of patch cords can also be computerized. A matrix of reed relays or possibly CMOS bilateral switches interfaced to the computer might be used for this task. The patches used for some contemporary synthesizer sounds resemble the program patch boards of early computers and thus are difficult and time consuming to set up and verify. With computer controlled patching, a particular setup may be recalled

Table 4, continued:

02A0	105800401C	.BYTE	16,88,0,64,28	; 1/16	G5	G4	C#3		
02A5	4054003C1E	.BYTE	64,84,0,60,30	; 1/4	F5	F4	D3	12	
02AA	4044003C1E	.BYTE	64,68,0,60,30	; 1/4	A4	F4	D3		
02AF	4048403C28	.BYTE	64,72,64,60,40	; 1/4	B4	G4	G3		
02B4	8044003A32	.BYTE	128,74,64,58,50	; 1/2	C5	G4	E4	C4	13
02B9	204A000032	.BYTE	32,74,0,0,50	; 1/8	C5		C4		
02BE	204A000032	.BYTE	32,74,0,0,50	; 1/8	C5		C4		
02C3	605C544424	.BYTE	96,92,84,68,36	; 3/8	A5	F5	A4	F3	14
02C8	2058004028	.BYTE	32,88,0,64,40	; 1/8	G5	G4	G3		
02CD	2054003C2C	.BYTE	32,84,0,60,44	; 1/8	F5	F4	A3		
02D2	80524A4032	.BYTE	128,82,74,64,50	; 1/2	E5	C5	G4	C4	15
02D7	304E46002E	.BYTE	48,78,70,0,46	; 3/16	D5	B#4		B#3	
02DC	10524A402E	.BYTE	16,82,74,64,46	; 1/16	E5	C5	G4	B#3	
02E1	40544A442C	.BYTE	64,84,74,68,44	; 1/4	F5	C5	A4	A3	16
02E6	405400003C	.BYTE	64,84,0,0,60	; 1/4	F5		F4	C4	
02EB	404A000032	.BYTE	64,74,0,0,50	; 1/4	C5		F4	C4	
02F0	404A00002C	.BYTE	64,68,0,0,44	; 1/4	A4		F4	A3	17
02F5	403C000024	.BYTE	64,60,0,0,36	; 1/4	F4		F3		
02FA	01	.BYTE	1		DEFINE END OF THIS SEGMENT				
02FB	8300	.WORD	POEND		ADDRESS OF BEGINNING OF NEXT SEGMENT				
0083		. =	POEND		ORG AT END OF PAGE 0 CODE				
0083	305C544428	.BYTE	48,92,84,68,40	; 3/16	A5	F5	A4	G3	
0088	105C544428	.BYTE	16,92,84,68,40	; 1/16	A5	F5	A4	G3	
008D	405C544424	.BYTE	64,92,84,68,36	; 1/4	A5	F5	A4	F3	18
0092	405E544628	.BYTE	64,94,84,70,40	; 1/4	B#5	F5	B#4	G3	
0097	4062544A2C	.BYTE	64,98,84,74,44	; 1/4	C6	F5	C5	A3	
009C	8062544A2C	.BYTE	128,98,84,74,44	; 1/2	C6	F5	C5	A3	19
00A1	205E544628	.BYTE	32,94,84,70,40	; 1/8	B#5	F5	B#4	G3	
00A6	205C54442C	.BYTE	32,92,84,68,44	; 1/8	A5	F5	A4	A3	
00AB	405E524032	.BYTE	64,88,82,64,50	; 1/4	C5	E5	G4	C4	20
00B0	405C54443C	.BYTE	64,92,84,68,60	; 1/4	A5	F5	A4	F4	
00B5	405E524640	.BYTE	64,94,82,70,64	; 1/4	B#5	E5	B#4	G4	
00BA	805E58461A	.BYTE	128,94,88,70,26	; 1/2	B#5	G5	B#4	C3	21
00BF	405E52461A	.BYTE	64,94,82,70,26	; 1/4	B#5	E5	B#4	C3	
00C4	605C4A4424	.BYTE	96,92,74,68,36	; 3/8	A5	C5	A4	F3	22
00C9	20584A4028	.BYTE	32,88,74,64,40	; 1/8	G5	C5	G4	G3	
00CE	40544A3C2C	.BYTE	64,84,74,60,44	; 1/4	F5	C5	F4	A3	
00D3	80524A4032	.BYTE	128,82,74,64,50	; 1/2	E5	C5	G4	C4	23
00D8	204E00362E	.BYTE	32,78,0,54,46	; 1/8	D5		D4	B#3	
00DD	20524A3A2E	.BYTE	32,82,74,58,46	; 1/8	E5	C5	E4	B#3	
00E2	40544A3C2C	.BYTE	64,84,74,60,44	; 1/4	F5	C5	F4	A3	24
00E7	40443C0036	.BYTE	64,68,60,0,54	; 1/4	A4	F4		D4	
00EC	01	.BYTE	1		DEFINE END OF THIS SEGMENT				
00ED	AB01	.WORD	P1END		ADDRESS OF BEGINNING OF NEXT SEGMENT				
01AB		. =	P1END		ORG AT END OF PAGE 1 CODE				
01AB	4048403C28	.BYTE	64,72,64,60,40	; 1/4	B4	G4	F4	G3	
01B0	804A003A1A	.BYTE	128,74,64,58,26	; 1/2	C5	G4	E4	C3	25
01B5	404A000032	.BYTE	64,74,0,0,50	; 1/4	C5		F4	C4	
01BA	40544A4424	.BYTE	64,84,74,68,36	; 1/4	F5	C5	A4	F3	26
01BF	40544A4028	.BYTE	64,84,70,64,40	; 1/4	F5	B#4	G4	G3	
01C4	20544A442C	.BYTE	32,84,74,68,44	; 1/8	F5	C5	A4	A3	
01C9	20524A442C	.BYTE	32,82,74,68,44	; 1/8	E5	"	"	"	
01CE	404E463C2E	.BYTE	64,78,70,60,46	; 1/4	D5	B#4	F4	B#3	27
01D3	404E463C2E	.BYTE	64,78,70,60,46	; 1/4	D5	B#4	F4	B#3	
01D8	404E4A3E2C	.BYTE	64,78,74,62,44	; 1/4	D5	C5	F#4	A3	
01DD	4058464028	.BYTE	64,88,70,64,40	; 1/4	G5	B#4	G4	C3	28
01E2	205E460028	.BYTE	32,94,70,0,40	; 1/8	B#5	B#4		G3	
01E7	205C4A002C	.BYTE	32,92,68,0,44	; 1/8	A5	A4		A3	
01EC	205B40002E	.BYTE	32,88,64,0,46	; 1/8	G5	G4		B#3	
01F1	01	.BYTE	1		DEFINE END OF THIS SEGMENT				
01F2	8017	.WORD	AUXRAM		ADDRESS OF BEGINNING OF NEXT SEGMENT (IN 6530 RAM)				
1780		. =	AUXRAM		ORG AT BEGINNING OF 6530 RAM				
1780	20543C0030	.BYTE	32,84,60,0,48	; 1/8	F5	F4		B3	
1785	40544A4432	.BYTE	64,84,74,68,50	; 1/4	F5	C5	A4	C3	29
178A	40524A401A	.BYTE	64,82,74,64,26	; 1/4	E5	C5	G4	C4	
178F	204A000032	.BYTE	32,74,0,0,50	; 1/8	C5		C4		
1794	204A00002E	.BYTE	32,74,0,0,50	; 1/8	C5		C4		
1799	60544A442C	.BYTE	96,84,74,68,44	; 3/8	F5	C5	A4	A3	30
179E	2058004032	.BYTE	32,88,0,64,50	; 1/8	G5	G4	C4		
17A3	205C004440	.BYTE	32,92,0,68,64	; 1/8	A5		A4	G4	
17A8	205E004640	.BYTE	32,94,0,70,64	; 1/8	B#5		B#4	G4	
17AD	80625C5444	.BYTE	128,98,92,84,68	; 1/2	C6	A5	F5	A4	31
17B2	20544E4436	.BYTE	32,84,78,68,54	; 1/8	F5	D5	A4	D4	
17B7	2058484034	.BYTE	32,88,72,64,52	; 1/8	G5	B4	G4	D#4	
17BC	605C544432	.BYTE	96,92,84,74,50	; 3/8	A5	F5	C5	C4	32
17C1	205E544E32	.BYTE	32,94,84,78,50	; 1/8	B#5	F5	D5	C4	
17C6	4058524632	.BYTE	64,88,82,70,50	; 1/4	G5	E5	B#4	C4	
17CB	80544A443C	.BYTE	128,84,74,68,60	; 1/2	F5	C5	A4	F4	33
17D0	00	.BYTE	0		END OF PIECE				

and set up in milliseconds, thus enhancing real time performance as well as reducing the need for a large number of different modules.

Other musical instruments may be interfaced as well. One well-published feat is an interface between a PDP-8 computer and a fair sized pipe organ. There are doubtless several interfaces to electronic organs in existence also. Even piano mechanisms can be activated, as noted elsewhere in this issue.

Recently, specialized music peripherals have appeared, usually oriented toward the S-100 (Altair) bus. In some cases these are digital equivalents of analog modules of similar function. For example, a variable frequency oscillator may be implemented using a divide-by-N counter driven by a crystal clock. The output frequency is determined by the value of N loaded into a register in the device, much as a control voltage affects a voltage controlled oscillator. Such an approach bypasses the frequency drift problems and interfacing expense of analog modules. The biggest advantage, however, is availability of advanced functions not feasible with analog modules.

One of these is a programmable waveform. A small memory in the peripheral holds the waveform (either as individual sample values or Fourier coefficients), which can be changed by writing in a new waveform under program control. Another advantage is that *time multiplexing* of the logic is usually possible. This means that one set of logic may simulate the function of several digital oscillators simultaneously, thus reducing the per oscillator cost substantially. Actually, such a digital oscillator may be nothing more than a hardware implementation of the PLAY routine mentioned earlier.

Digital/analog hybrids are also possible. The speech synthesizer module produced by Computalker Consultants, for example, combines a programmable oscillator, several programmable amplifiers and filters, white noise generator, and programmable switching on one board. Although designed for producing speech, its completely programmable nature gives it significant musical potential, particularly in vocals.

How do these various control techniques compare with the direct waveform computation techniques discussed earlier? A definite advantage of course is real time playing of the music. Another advantage is simpler programming, since sound generation has already been taken care of. However, the number of voices and complexity of subtle variations is directly related to the quantity of synthesizer modules available.

```

;
; WAVEFORM TABLE
; EXACTLY ONE PAGE LONG ON A PAGE BOUNDARY
; MAXIMUM VALUE OF AN ENTRY IS 63 DECIMAL OR 3F HEX TO AVOID
; OVERFLOW WHEN 4 VOICES ARE ADDED UP
;
0300      . =      X'300      ; START WAVEFORM TABLE AT 0300
;
0300      WAV1TB =      .      ; VOICE 1 WAVEFORM TABLE
0300      WAV2TB =      .      ; VOICE 2 WAVEFORM TABLE
0300      WAV3TB =      .      ; VOICE 3 WAVEFORM TABLE
0300      WAV4TB =      .      ; VOICE 4 WAVEFORM TABLE
; NOTE THAT ALL 4 VOICES USE THIS TABLE DUE
; TO LACK OF RAM IN BASIC KIM-1
;
; FUNDAMENTAL AMPLITUDE 1.0 (REFERENCE)
; SECOND HARMONIC .5, IN PHASE WITH FUNDAMENTAL
; THIRD HARMONIC .5, 90 DEGREES LEADING PHASE
;
0300 3334353636 .BYTE X'33,X'34,X'35,X'36,X'36,X'37,X'38,X'39
0305 373839
0308 393A3A3B3B .BYTE X'39,X'3A,X'3A,X'3B,X'3B,X'3B,X'3C,X'3C
030D 3B3C3D
0310 3C3C3C3C3C .BYTE X'3C,X'3C,X'3C,X'3C,X'3C,X'3C,X'3C,X'3C
0315 3C3C3C
0318 3C3C3C3B3B .BYTE X'3C,X'3C,X'3C,X'3B,X'3B,X'3B,X'3B,X'3B
031D 3B3B3B
0320 3A3A3A3A3A .BYTE X'3A,X'3A,X'3A,X'3A,X'3A,X'3A,X'39,X'39
0325 3A3939
0328 3939393939 .BYTE X'39,X'39,X'39,X'39,X'39,X'39,X'39,X'39
032D 393939
0330 3A3A3A3A3A .BYTE X'3A,X'3A,X'3A,X'3A,X'3A,X'3B,X'3B,X'3B
0335 3B3B3B
0338 3B3C3C3C3D .BYTE X'3B,X'3C,X'3C,X'3C,X'3D,X'3D,X'3D,X'3D
033D 3D3D3D
0340 3E3E3E3E3F .BYTE X'3E,X'3E,X'3E,X'3E,X'3F,X'3F,X'3F,X'3F
0345 3F3F3F
0348 3F3F3F3F3F .BYTE X'3F,X'3F,X'3F,X'3F,X'3F,X'3F,X'3F,X'3F
034D 3F3F3F
0350 3E3E3E3D3D .BYTE X'3E,X'3E,X'3E,X'3D,X'3D,X'3C,X'3C,X'3B
0355 3C3C3B
0358 3B3A393838 .BYTE X'3B,X'3A,X'39,X'38,X'38,X'37,X'36,X'35
035D 373635
0360 3433323130 .BYTE X'34,X'33,X'32,X'31,X'30,X'2F,X'2E,X'2D
0365 2F2E2D
0368 2C2B2A2928 .BYTE X'2C,X'2B,X'2A,X'29,X'28,X'27,X'26,X'25
036D 272625
0370 2423222121 .BYTE X'24,X'23,X'22,X'21,X'21,X'20,X'1F,X'1F
0375 201F1F
0378 1E1E1D1D1D .BYTE X'1E,X'1E,X'1D,X'1D,X'1D,X'1D,X'1C,X'1C
037D 1D1C1C
0380 1C1C1D1D1D .BYTE X'1C,X'1C,X'1D,X'1D,X'1D,X'1D,X'1D,X'1E
0385 1D1D1E
0388 1E1F1F2020 .BYTE X'1E,X'1F,X'1F,X'20,X'20,X'21,X'21,X'22
038D 212122
0390 2323242425 .BYTE X'23,X'23,X'24,X'24,X'25,X'26,X'26,X'27
0395 262627
0398 2828292929 .BYTE X'28,X'28,X'29,X'29,X'29,X'2A,X'2A,X'2B
039D 2A2A2B
03A0 2B2B2B2B2B .BYTE X'2B,X'2B,X'2B,X'2B,X'2B,X'2B,X'2B,X'2A
03A5 2B2B2A
03A8 2A2A292928 .BYTE X'2A,X'2A,X'29,X'29,X'28,X'27,X'27,X'26
03AD 272726
03B0 2524232221 .BYTE X'25,X'24,X'23,X'22,X'21,X'20,X'1F,X'1D
03B5 201F1D
03B8 1C1B191817 .BYTE X'1C,X'1B,X'19,X'18,X'17,X'15,X'14,X'13
03BD 151413
03C0 11100F0D0C .BYTE X'11,X'10,X'0F,X'0D,X'0C,X'0B,X'09,X'08
03C5 0B0908
03C8 0706050403 .BYTE X'07,X'06,X'05,X'04,X'03,X'03,X'02,X'01
03CD 030201
03D0 0100000000 .BYTE X'01,X'00,X'00,X'00,X'00,X'00,X'00,X'00
03D5 000000
03D8 0000010101 .BYTE X'00,X'00,X'01,X'01,X'01,X'01,X'02,X'03,X'04
03DD 020304
03E0 0506070809 .BYTE X'05,X'06,X'07,X'08,X'09,X'0B,X'0C,X'0D
03E5 0B0C0D
03E8 0F10121315 .BYTE X'0F,X'10,X'12,X'13,X'15,X'16,X'18,X'1A
03ED 16181A
03F0 1B1D1F2022 .BYTE X'1B,X'1D,X'1F,X'20,X'22,X'23,X'25,X'27
03F5 232527
03F8 282A2B2C2E .BYTE X'28,X'2A,X'2B,X'2C,X'2E,X'2F,X'30,X'31
03FD 2F3031
;
; .END

```

Table 5: This table is an encoding of the samples of the waveform used by the program in listing 2. The table is exactly one memory page long on a page boundary. The maximum value of any entry is decimal 63 or hexadecimal 3F to avoid overflow when all four voices are summed.

For example, if more voices are needed, either more modules must be purchased or a multitrack tape recording must be made, which then takes us out of the strict real time domain. On the other hand, a new voice in a direct synthesis system is nothing more than a few bytes added to some tables and a slightly lengthened execution time. Additionally, there may be effects that are simply not possible with currently available analog modules. With a direct synthesis system, one merely codes a new subroutine, assuming that an algorithm to produce the effect is known.

A separate problem for the experimenter is that a "critical mass" exists for serious work with a direct synthesis system. To achieve complexity significantly beyond the

4 voice example program described earlier, a high speed, large capacity mass storage system is needed. This means an IBM type digital tape drive or large hard surface disk drive; usually at least \$3000 for a new drive less interface. Used 7 track tapes and 2311 type disks (7.5 megabytes) are often available for \$500 and certainly provide a good start if the user can design his own interface. Synthesizer modules or peripheral boards, on the other hand, can be purchased one at a time as needed.

Music Languages

Ultimately, software for controlling the sound generation process, whether it be direct or real time control, is the real frontier. The very generality of computer music synthesis means that many parameters and other information must be specified in order to produce meaningful music. One function of the software package is to convert "musical units of measure" into physical sound parameters such as conversion of tempo into time durations. Another part is a language for describing music in sufficient detail to realize the control power available from music synthesis without burdening the user with too much irrelevant or repetitious detail. With a good language, a good editor for the language, and real time (or nearly so) execution of the language, the music system becomes a powerful composition tool much as a text editing system aids writers in preparing manuscripts.

Music languages can take on two forms. One is a descriptive form. Music written in a descriptive language is analogous to a conventional score except that it has been coded in machine readable form. All information in the score necessary for proper performance of the piece is transcribed onto the computer score in a form that is meaningful to the user yet acceptable to the computer. Additional information is interspersed for control of tone color, tempo, subtle variations, and other parameters available to the computer synthesist.

A simple example of such a language is NOTRAN (NOte TRANslation) which was developed by the author several years ago for transcribing organ music. Listing 3 shows a portion of Bach's "Toccatina and Fugue in D Minor" coded in NOTRAN. The basic thrust of the language was simplicity of instruction (to both the user and the interpreter program), rather than minimization of typing effort.

Briefly, the language consists of statements of one line each which are executed in straight line sequence as the music plays. If the statement starts with a keyword, it is

```
* TOCCATA AND FUGUE IN D-MINOR      BACH
*
VOICE1 40,0,0,0,0,30,0,0,0,0,0,0,60,0      10      30,30
VOICE2 37,0,0,0,0,0,0,0,50,0,0,0,50,0      10      60,60
VOICE3 0,0,9,0,38,0,0,0,38,19,0,0,0,28,0    15      100,250
TEMPO 1/4=1200

    /-/

002 1A3,1/64; 2A2,1/64
    1A03,1/64; 2A02,1/64
    1A3,1/8; 2A2,1/8
    R,1/32
    1G3,1/64; 2G2,1/64.
    1F3,1/64; 2F2,1/64
    1E3,1/64; 2E2,1/64
    1D3,1/64; 2D3,1/64
    1C#3,1/32; 2C#2,1/32
    1D3,1/16; 2D2,1/16
    R,1/4
    3D2,1/1; R,1/4
    2C#3,1F2; R,1/16
    1E3,7/16; R,1/16
    1G3,7/16; R,1/16
    1B03,5/16; R,1/16
    1C#4,4/16; R,1/16
    1E4,3/16

    /-/

140 1B04,1/8; 1G4,1/8; 1E4,1/8; 2E3,1/8; 3C#3,1/8
    1E3,1/32
    1G3,1/32
    1B03,1/32
    1C#4,1/32
    1B04,1/8
    1B04,1/8; 1G4,1/8; 1E4,1/8; 1C#4,1/8; 2E3,1/8; 3C#3,1/8
    1A4,1/8; 1F#4,1/8; 1D4,1/8; 2F#3,1/8; 3C3,1/8
TEMPO 1/4=950
    1D3,1/32
TEMPO 1/4=1050
    1A3,1/32
TEMPO 1/4=1150
    1D4,1/32
TEMPO 1/4=1200
    1F#4,1/32
    1A4,1/8
    1A4,3/8; 1F#4,1/8; 1D4,1/8; 2F#3,1/8; 3C3,1/8
141 1D4,1/2; 1B03,1/2; 2G3,1/2; 3G2,1/4
    1G4,1/2; 3B02,1/4
    1E4,1/4; 1C#4,1/4; 2B03,1/4; 3E2,1/4
    1F4,1/4; 1D4,2/4; 2A3,1/4; 3F2,1/4
142 1E4,1/2; 2A3,1/2; 3A2,1/2; R,1/4
    1C4,2/4; R,1/4
    1D4,4/2; 2F3,1/4; 3B02,1/4
    2B03,1/4; 2G3,1/4; 3G2,1/4
143 2A3,3/2; 2F3,3/2; 3D3,3/2; 3D2,3/2
END
```

Listing 3: Bach's "Toccatina and Fugue in D Minor" as encoded in NOTRAN, a music language developed by the author (NOTRAN stands for NOte TRANslation). The main function of the language is to transcribe organ music, but it will work equally well with other types of music. Program statements are used to encode duration, pitch, attack and decay rates, and loudness of each note.

Business Firmware UNVEILED!

What is a Firmware System ?

A Firmware System is the entire package — Software and Hardware that work.



Our Firmware includes a miniature micro 8080 and Z/80 computer; S-100 Buss, with over 65K of user RAM. No switches to set, Power-on operation, multiple I/O interfaces, line printer, Video Terminal, over 600K Byte Disk, Disk Extended Basic and **applications** Software diskettes complete with full documentation (includes **General Ledger, Payroll, Word Processing, Medical A/R, A/P, Engineering, Statistics, more**) includes "Help" and Tutorial Software.

Our "General Ledger Program" is a complete comprehensive business system designed to keep *all* of your company's records without the need for updating from other programs and there is *no* need to keep monthly tear sheets to be added together for end of the year reports as our system will provide you with year end account totals for cash, accural, hybrid and chart of accounts systems. This program generates over 30 major reports. Including: 941's, P/L's, Balance Sheets, and year end account totals for filing Federal Income tax Schedule C's and/or 1120's plus a lease purchase plan and 24-hour field service in most areas. Hard to believe! For less than \$250/month you can lease your very own, nothing else to purchase. Foreign packages available last of '77.

Business Software Too!

Includes over \$25,000.00 of business programs free and that's only part of what we're giving away. We built our reputation providing quality software at affordable prices. Now we are going to do the same with Firmware.



Firmware System (fully assembled) \$8999.00*

Additional 600K disks optional.

Compare at \$30,000 for other micros or \$70,000 for mini's

*Add \$60 for UPS shipping and handling • No Purchase Orders — include 50% deposit with all COD orders.



SCIENTIFIC RESEARCH

1712-B Farmington Court Crofton, MD 21114
(301) 721-1148

Dealer Inquiries Invited

a specification statement; otherwise, it is a note statement. Specification statements simply set up parameters that influence the execution of succeeding note statements and take no time themselves.

A VOICE statement assigns the timbre described by its parameters to a voice number which is used in the note statements. In the example score, the first group of parameters describe the waveform in terms that are implementation dependent, such as harmonic amplitudes. The next, isolated parameter specifies the overall loudness of the voice in relation to other voices. The last pair of parameters specifies the attack and decay times respectively for notes using this voice. Depending on the particular implementation, other parameters may be added without limit. For example, vibrato might be described by a set of three additional parameters such as vibrato frequency, amplitude, and a delay from the beginning of a note to the start of vibrato.

A TEMPO statement relates note durations in standard fractional terms to real time in milliseconds. The effect of a tempo statement lasts until another is encountered. Although the implementation for which the example was written required a sequence of tempo statements to obtain a retard, there is no reason why an acceleration or a retard set of parameters could not be added.

Note statements consist of one or more note specifications and are indented four spaces (the measure numbers are treated as comments). Each note specification begins with a voice number followed by a note name consisting of a letter, optional sharp (#) or flat (@) sign, and an octave number. Thus C#4 is one half step above middle C. Following the comma separator is a duration fraction. Any fraction is acceptable, but conventional musical fractions are normally used. Following the duration are two optional modifiers. A period (.) indicates a "dotted" note which by convention extends the note's duration by 50%. An "S" specifies a staccato note which is played as just an attack and decay (as specified by the corresponding voice statement) without any steady state. The presence of a semicolon (;) after a note indicates that additional notes which are intended to be part of the same statement are present, possibly extending to succeeding lines.

The execution sequence of note statements can become a little tricky due to the fact that note durations in the statement may not all be equal. The rule is that all notes in the statement start simultaneously. When the shortest one has ended, the notes in the next statement are initiated, even though some in the previous statement may

be still sounding. This could continue to any depth such as the case of a whole note in the bass against a series of sixteenth notes in the melody. The actual implementation, of course, limits the maximum number of simultaneous tones that may be built up.

Also available is a rest specification which can be used like a note specification. Its primary function is to provide silent space between note statements, but it may also be used to alter the "shortest note" decision when a note statement is scanned. If the rest is the shortest then the notes in the next statement are started when the rest elapses even though none of the current notes have ended. A use of this property may be seen in the last part of measure 2 where an arpeggio is simulated.

As can be seen, NOTRAN is best suited for describing conventional organ music, although it could be extended to cover a wider area as well. One such extension which has been experimented with but not fully implemented is percussion instruments. First a set of implementation dependent parameters was chosen to define a percussive sound, and then a PRCUS statement similar to the VOICE statement was added to the language. To initiate percussive sounds, specifications such as "P3,1/4" would be interspersed with the note specifications in note statements. The "3" would refer to percussive sound number 3 and the 1/4 would be a "duration" which would be optional. All percussive sounds in the same statement would start simultaneously with the regular notes.

A much more general music language is the well-known MUSIC V. It was designed to make maximum use of the flexibility afforded by direct waveform computation without overburdening the user. It is a massive program written in FORTRAN and clearly oriented toward large computers. Much significant computer music work has been done with MUSIC V, and it is indeed powerful. An excellent book is available which describes the language in detail and includes some background material on digital sound generation (see entry 1 in the list of references at the end of this article).

A different approach to music languages is a "generative" language which describes the *structure* of the music rather than the note by note details. In use, the structure is described by "loops," "subroutines," and "conditional branches" much as an algorithm is described by a computer language. The structure is "executed" to produce detailed statements in a conventional music language which is then played to produce sound. The intermediate step need not necessarily be visible to the user. One well

thought out system is described in reference 2. It was actually developed as a musicological analysis tool and so has no provisions for dynamics, timbre, etc. It could, however, be extended to include these factors. One easy way to implement such a language is to write a set of macros using a good mini-computer macroassembler.

Conclusion

By now it should be apparent that computer generated music is a broad, multidisciplinary field. People with a variety of talents can make significant contributions, even on a personal basis. In particular, clever system designers and language designers or implementers have wide open opportunities in this field. Finally, imaginative musicians are needed to realize the potential of the technique.

A Short Cut to a Singing KIM...

As his article was being finished by our production department, Hal Chamberlin notified us that he has completed the design of a board which accomplishes the digital to analog conversion and filtering functions

described in this article. The board contains printed circuitry for an 8 bit digital to analog converter, low pass filter and power amplifier. Without components, the board may be purchased for \$6; completely assembled and tested the price is \$35. Orders should be mailed prepaid to Micro Technology Unlimited, 29 Mead St, Manchester NH 03104. In addition, a software package for the KIM-1 computer is available on cassette tape (KIM format) for \$13 added to the price of the output board. A 7 Inch 16 ohm speaker can be ordered for \$5 prepaid, completing the required parts of a KIM's music system. ■

REFERENCES

1. Mathews, Max, *The Technology of Computer Music*, MIT Press, Cambridge MA, 1969. Contains a detailed description of MUSIC V, the high level music language.
2. Smoliar, Stephen, "A Parallel Processing Model of Musical Structures," PhD dissertation, Massachusetts Institute of Technology, September 1971.
3. Oppenheim, A and Schafer, R, *Digital Signal Processing*, Prentice-Hall, NJ, 1975.



wire wrapping center



<p>NEW HOBBY WRAP MODEL BW 630</p>  <p>Battery wire wrapping tool</p> <p>\$34.95 <small>ONLY \$29.95 COMPLETE WITH BIT AND SLEEVE</small></p>	<p>STRIP/WRAP/UNWRAP MODEL WSI-30</p>  <p>\$5.95*</p>	<p>RIBBON CABLE ASSEMBLY</p> 	<p>DIP SOCKETS</p> 
<p>DIP IC INSERTION TOOL WITH PIN STRAIGHTENER MODEL INS-1416</p>  <p>\$3.49*</p>	<p>WIRE DISPENSER MODEL WD-30-B</p>  <p>\$3.45*</p>	<p>PRE-CUT PRE-STRIPPED WIRE</p> 	<p>WIRE WRAPPING KIT</p>  <p>\$15.45*</p>

*MINIMUM ORDER \$25.00, SHIPPING CHARGE \$1.00, N.Y. CITY AND STATE RESIDENTS ADD TAX

OK MACHINE AND TOOL CORPORATION

3455 CONNER STREET, BRONX, NEW YORK, N.Y. 10475 U.S.A.
PHONE (212) 994-6600 TELEX NO. 125091

Tune in with Some Chips

Ted B Sierad
146 Sunset Rd
Mamaroneck NY 10543

Are you fascinated with the idea of computerized music, but find the mechanics of producing such effects too complex? I've come up with a simple technique which is the subject of this article, and which is well within the capabilities of the novice computer experimenter. With less than a dozen inexpensive integrated circuits, a few resistors, capacitors and a small prototyping board you can be well on the way to creating interesting music with your Altair, IMSAI or similar computer. My design creates a programmable music tone generator peripheral which has outputs that sound somewhat reminiscent of a clarinet when it is programmed by simple or complex software used to sequence notes in time. The first attempts I made at music generation required complicated programs and many integrated circuits. But as I gained more familiarity with the problem, the project reduced into a relatively simple solution as illustrated here.

The Hardware

The diagram of the melody box hardware is illustrated in figure 1. This hardware is the key to generation of tones from the computer. Software to be described later is responsible for sequencing the notes in time, thus creating a melody. The basic principle of operation of this melody box peripheral is

use of a latched binary code in eight bits to select one of several adjustable resistors which will be switched into an oscillator circuit as the timing resistor. In the particular circuit shown in figure 1, I used a pair of 7475 latch circuits to hold the code sent from an 8080's IO instruction; then I decoded the 8 bit pattern with a pair of 7441 circuits which I happened to have on hand in my workshop. The 7441s separately decode two 4 bit codes into selection of one of ten open collector output lines. These output lines are low if the line is selected, and effectively disconnected if not selected. The software used to drive the IO port should be set up to select only one active line by giving out a "null code" such as binary 1111 in one half of the 8 bit word, while selecting a given tone in the other half of the 8 bit word. This guarantees that only one line is in the low state out of a possible 20 lines. The line which is in the low logical state will then affect the frequency of the oscillator implemented by the 555 timer integrated circuit, IC7 of figure 1. The pitch of the note selected is determined by the tuning of the potentiometer associated with a given binary code by the decoders.

The low logic level output of the decoder is similar to a ground or zero voltage. Since all the other lines are effectively floating as open collector outputs, a definite low state on the one line inserts the resistor selected

Figure 1: Schematic of the melody box. This circuit works by changing the timing elements of a 555 oscillator integrated circuit to set the pitch. One resistor sets the pitch of each note of the scale. To turn off the oscillator, the circuit detects a special case which turns off the power to the oscillator by raising its ground pin to the high logic level.

Integrated Circuit Power Wiring

Number	Type	+5 V	GND
IC1	7475	5	12
IC2	7475	5	12
IC3	7441	5	12
IC4	7441	5	12
IC5	7404	14	7
IC6	7402	14	7
IC7	555	8	5

Resistor Number	Potentiometer Value	Approximate Setting
R3	100 k	40 k
R4	100 k	48 k
R5	100 k	56 k
R6	100 k	64 k
R7	100 k	68 k
R8	100 k	76 k
R9	100 k	80 k
R10	100 k	86 k
R11	200 k	90 k
R12	100 k	43 k
R13	100 k	56 k
R14	100 k	67 k
R15	100 k	76 k
R16	100 k	86 k
R17	200 k	95 k
R18	200 k	108 k
R19	200 k	135 k
R20	200 k	152 k

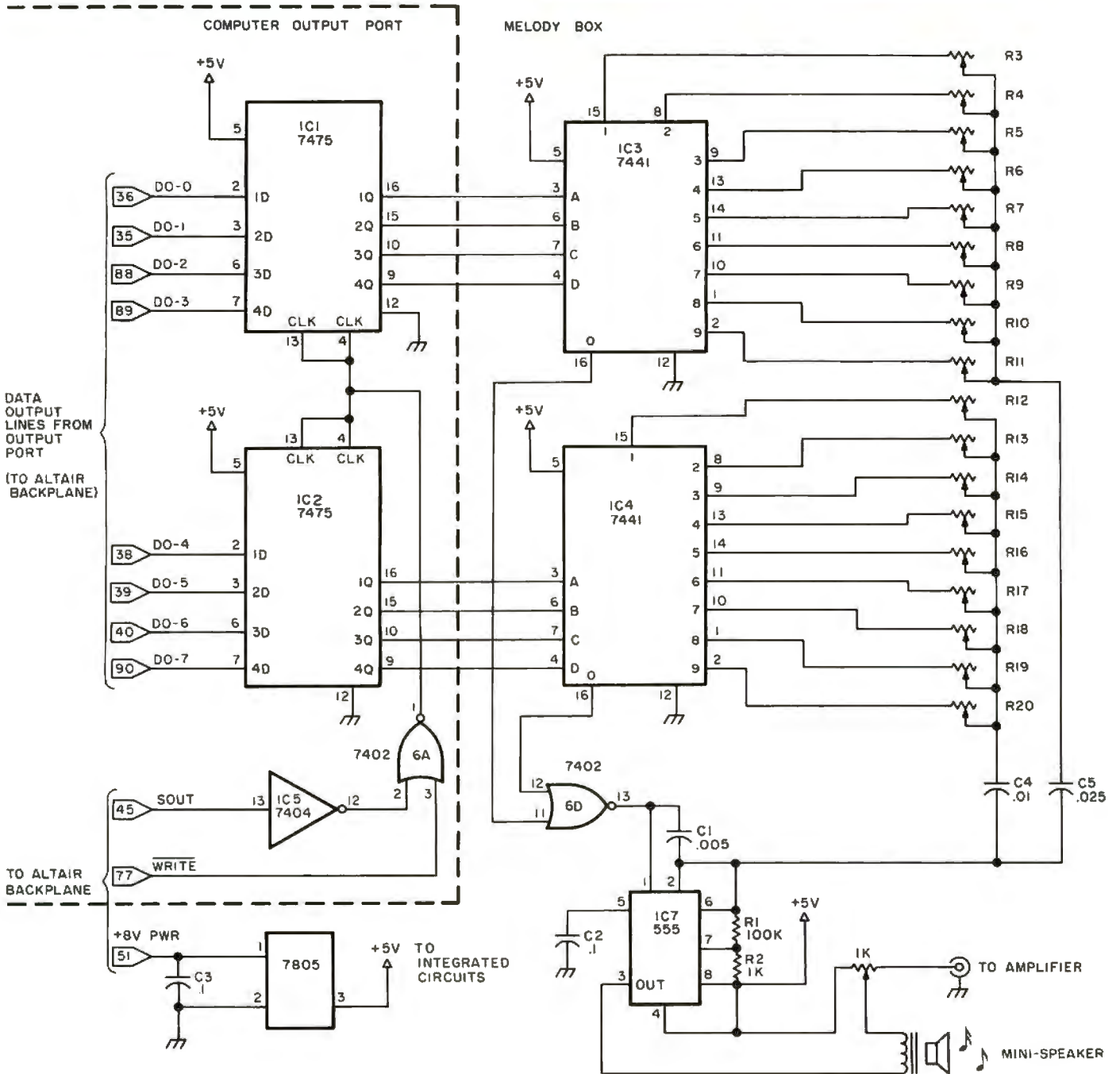

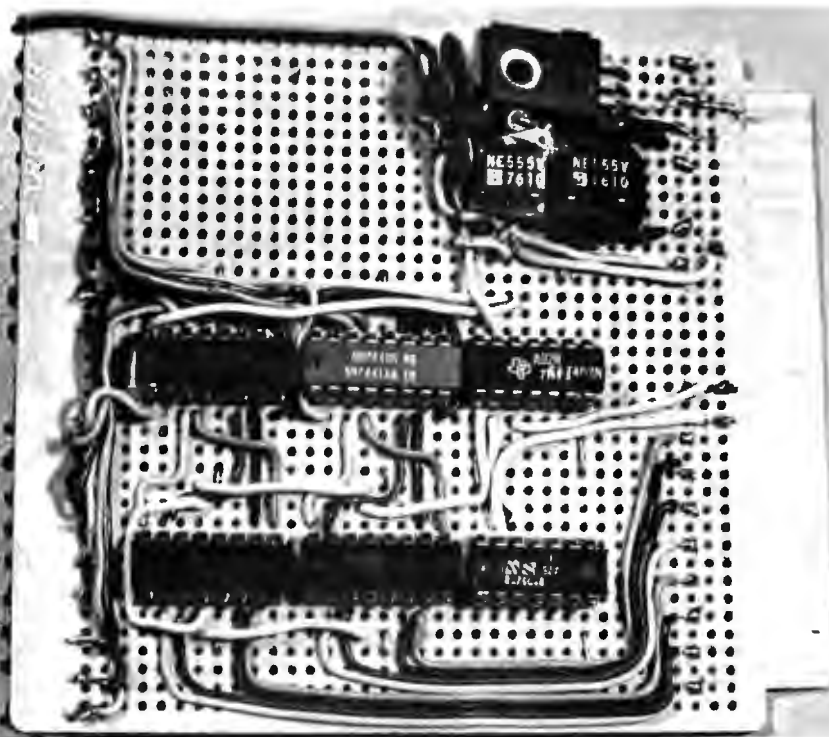

Photo 1: The melody box as constructed, using a Radio Shack prototyping board.

into the 555's timing circuit. The circuit is tuned by running a scale and adjusting the pitches by ear, or even by using a frequency meter.

But what about having no sound at all? Rests are important to music, and there must be some way to turn off the sound. Simply selecting none of the resistors is the first thought which comes to mind, but this does not work very well at all, as you'll find out if you try it. What I did was to put in the NOR gate logic of IC6d to detect when both halves of the 8 bit output word are 0, as indicated by selection of the 0 output line of each decoder. When this happens, the output of the NOR gate is high. Since I use this NOR gate as the power and signal ground of the 555 oscillator, I have effectively removed power from the 555 and turned it off when the double 0 state is output to the port. This may not be optimal engineering, but it certainly works.

My hardware stopped at the point of generating the tones, but for a full range of musical effects, you would certainly want to add some digital controlled filters and amplifiers to this basic pitch generation facility. Some filtration can be accomplished, of course, by manipulation of the tone controls of your high fidelity amplifier.

Further Simplifications of Hardware

The circuit of figure 1 is how I built the melody box; but after building it, it occurred to me that several further simplifications could be made. For example, the

latches and IO port decoding logic outlined by the dotted lines could easily be replaced by an existing IO port on a computer, such as those provided by the peripheral interface adapters (PIA) of typical IO port boards. The 7441 is not the only open collector decoder chip available, and if you want to make 32 or 64 notes, use of two or four 74159 circuits with a 5 or 6 bit binary code would be possible. The only major disadvantage I find with this circuit is that it has to be tuned individual note by individual note.

Construction

The melody box was built on a Radio Shack IC experimental breadboard, #276-154 (Archer), which plugs into their #276-1551 card connector socket. This type of board has a foil pattern on one side. The integrated circuits or sockets are inserted from the nonfoil side and pins are then soldered to pads designed to take the DIP package pins as well as several connecting wires or components. See photo 1 for a look at my version. I used Molex pins to fabricate sockets for the integrated circuits, although solder tail sockets or no sockets at all could be used depending on your preferences and sources of supply. Wiring is done from the nonfoil side, with stripped ends of the wires going through the board to the appropriate pads. I used multiple colors for the wires in order to make tracing of the circuit easy. The space between the solder

Continued on page 91

4 USERS ON 1 MICRO?!

That's right! The TSC Multi-User System brings you the capability you've been asking for! Four simultaneous users, all running BASIC, all independent, and all on the same Micro!

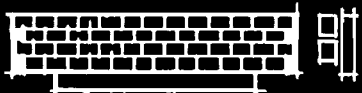

Presently, the system is available only for the SWTPC 6800. It includes a 4-user version of TSC's Micro BASIC Plus. Also available are 8K tape and disc-based BASICs.

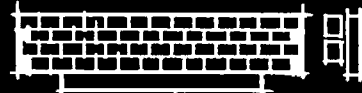

SWTPC 6800

You thought it couldn't be done, but TSC has done it! The basic system sells for less than \$130 and is available now. Write for complete details or visit your dealer.



*Also be sure to check out the complete line of TSC software, including Text Editors, Word Processing Systems, Assemblers, Utilities, Diagnostics, Interpreters, Games, and more!



Technical Systems Consultants, Inc., P.O. Box 2574, West Lafayette IN 47906

Circle 225 on inquiry card.

COME TO PC '77 ...

Atlantic City, New Jersey

August 27 and 28, 1977

PC '77 offers you the most complete show of its kind ever held. Proven in '76 and acclaimed in '77 by all the major professional publications as the coming event of the year, this show is a 'must'. Make plans now to attend. Here are some of the scheduled events:

PRE-CONVENTION PROFESSIONAL SEMINARS

August 22-26 Technical Design Labs and Trenton State College Z80 Seminars at nearby Trenton State College.

Five software and four hardware seminars.

August 25, 26, 28 SYBEX Seminars at the Shelburne Hotel. Three intensive seminars: Introduction to Microprocessors, Programming Microprocessors, Microprocessors Applications.

August 24, 25, 26 TYCHON INC. Microcomputer Interfacing Workshop at the Shelburne Hotel.

August 26, 27 Osborne & Associates Microprocessors — Where they came from and where they are going, an analysis of all products on the market today. At the Shelburne Hotel.

MORE NEW PRODUCTS THAN EVER!

All the products you've been reading about in the ads will be on display at PC '77. Many companies will be showing exciting new products. HEATH COMPANY will display exclusively, for the first time, their complete computer line. SOLID STATE MUSIC, POLYMORPHIC SYSTEMS, THE DIGITAL GROUP, THOMAS INSTRUMENTATION, MOS TECHNOLOGY, TECHNICAL DESIGN LABS, SOUTHWEST TECHNICAL PRODUCTS, CROMEMCO, E & L INSTRUMENTS, THE INTERPRING GROUP, KENT-MOORE INSTRUMENTS, PERSCI INC., GEORGE RISK INDUSTRIES, MID WEST SCIENTIFIC, OSBORNE AND ASSOCIATES, EXPANDOR, QUAY CORP, MATRIX PUBLISHERS, CAMELOT PUBLISHING CO, HAYDEN BOOK CO, GAW ELECTRONICS, ENCLOSURE DYNAMICS AND SOROC TERMINALS will all be showing new products. Plan to attend!

OUTSTANDING COMPUTER HOBBYIST OF THE YEAR AWARD

This is an annual award presented to a person who has given outstanding service to others in the personal computing field with no commercial motives. Nominations are currently being accepted from individuals and clubs.

For an interesting evening of family entertainment, plan to attend the Ice Capades which are in town the week of PC '77.

LET'S KEEP THE PERSONAL IN PERSONAL COMPUTING!



Deal yourself in™
on the biggest personal
computing show
of the year!

FREE! SEMINARS, FORUMS, TECHNICAL TALKS

**SATURDAY
NIGHT BANQUET
WITH
OUTSTANDING
SPEAKERS.**

Tickets are limited, first
come, first served.

**DOOR
PRIZES**

Thousands
of dollars
worth. You
may be a
lucky winner!

Session of the Pro-
posed National Organ-
ization of Computer
Clubs chaired by Sol
Libes of the Amateur
Computer Group of
New Jersey and Rich-
ard Kuzmack of Ches-
apeake Microcompu-
ter Club.

ENIAC by Dr. John Mauchly, the co-inventor of ENIAC
PROGRAMMING ENIAC by Mrs. John Mauchly
SAM 76 by Claude Kagan of Western Electric Co., an interactive symbol system manipulations system which grows with the user.
TELECOMMUNICATIONS FROM THE TERMINAL USER'S VIEWPOINT by David L. Peters of Vadic Corp.
INTRODUCING THE HEATHKIT COMPUTER PRODUCTS by Lou Frenzel of Heath Company
HOW MICROPROCESSORS ARE DESIGNED by Will Mathys of MOS Technology
THE FUTURE OF MICROS IN MEDICINE by Dick Moberg, Dept. of Neurosurgery, Jefferson Medical College, Philadelphia
THE HUMAN FACTOR by Andrew Singer of ROM Magazine
SHOULD MICROS BE USED FOR BUSINESS APPLICATIONS? by Frank J. Ponzio, Jr., of Mini Computer Suppliers, Inc.
ROBOTS by Tod Loofbourrow, author for Interface Age Magazine
GETTING INTO THE MICRO COMPUTER BUSINESS by Robert S. Jones, publisher of Interface Age Magazine
MUSIC FOR THE HOBBYIST, HARDWARE AND SOFTWARE by Malcolm Wright of Solid State Music
HAM RADIO APPLICATIONS by Dr. Robert Suding of the Digital Group
HANDICAPPED SYMPOSIUM by Dr. Robert Suding of the Digital Group
HOME MANAGEMENT SYSTEMS by Dr. Robert Suding of the Digital Group
FLOPPY DISK by Herbert G. Waite of PerSci Inc.
INTERFACING A HOME SELECTRIC by Charles Yates of Amateur Computer Group of New Jersey
MOVING UP TO AMATEUR RADIO by Chod Harris of the American Radio Relay League
OPERATING THROUGH AMATEUR SATELLITES OSCAR 6 AND 7 by Gary Tater W3HUC of AMSAT
THE PHASE III MICROPROCESSOR CONTROLLED AMATEUR SATELLITE by Tom Clarke WA3LND and Jan King W3GEY of AMSAT
MICROPROCESSOR APPLICATIONS FOR RADIO AMATEURS by Kasser G3ZCZ of AMSAT
WHAT PEOPLE ARE NOT GOING TO DO WITH HOBBY COMPUTERS by Stephen Gray of Creative Computing
APPLICATIONS OF MICROCOMPUTERS: THE MYTH AND THE REALITY by David Ahl of Creative Computing
INTRODUCTION TO COMPUTERS THROUGH THE BASIC LANGUAGE by Eri Golembo of Computer Mart of New Jersey
DYNAMIC DEBUGGING SYSTEM FOR THE 8080 CODE by Larry Stein and David Beney of Computer Mart of New Jersey
MICROPROCESSORS FOR THE HOBBY MARKET TODAY AND TOMORROW by Dr. Adam Osborne of Osborne and Associates
GETTING STARTED WITH MICROCOMPUTER SOFTWARE by Dr. Christopher A. Titus, author of the Bugbooks
COMPUTERS AND MUSIC by Carl Helmers of BYTE Magazine

PRE-REGISTER! FILL OUT AND MAIL THE COUPON ON BACK PAGE!



DOOR PRIZES
 ★★★★★★★★★★

COME SEE
 ★★★★★★★

MORE

MORE

MORE

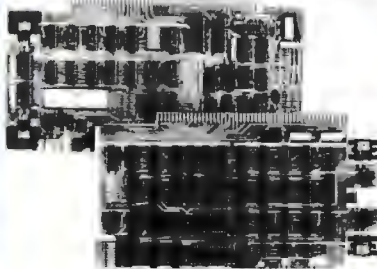

Solid State Music

Plug in any one of a number of Solid State Music modules and enhance the power of an Altair (S-100) bus system. In particular enjoy the new SB-1 music synthesizer and the VB1A video board to be given out as door prizes at PC77.

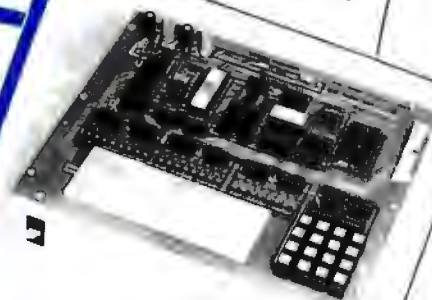

E & L MMD-1

Complete 8080 based microcomputer with keyboard, 500 word RAM memory, 24 LED read out, power supply and case. Includes Bug Books V & VI, programmed self-training course in digital electronics and microcomputer technology.

**MSI 6800
 COMPUTER SYSTEM**

Midwestern Scientific Instruments

The newest and most advanced 6800 Computer System available. At PC '77, MSI will demonstrate the new MSI 6800 and the MSI FD-8 Floppy Disk Memory System running Multi-User BASIC with full program and Data File handling capability.



Scientific Research Vol I - V

Where does one get software? The lucky winners of the Scientific Research BASIC software library will have a good start at answering this question.

Interface Age

Life Time Subscription

Interface Age is an exciting window on this burgeoning new technology. Find out about microcomputing for the home and the small businessman using this monthly compendium.



Technical Design Labs

The Xitan Alpha 1 is the beginning of a general purpose Z-80 microcomputer system. Add your own serial terminal and interfaces to the Altair (S-100) bus to create a state of the art personal computer system.



Heathkit

This new Heathkit H9 video terminal features data rates ranging from 110 to 9600 bps, EIA RS-232 and 20 ma current loop interfaces, a full ASCII keyboard and 12 lines of 80 characters per line.

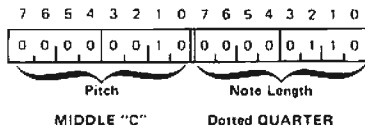

NOTE LENGTH (Odd Bytes)

Hexadecimal Length Code	Octal Length Code	Relative Decimal Length	Musical Symbology
01	001	1	Sixteenth note
02	002	2	Eighth note
03	003	3	Dotted eighth note
04	004	4	Quarter note
06	006	6	Dotted quarter note
08	010	8	Half note
0C	014	12	Dotted half note
10	020	16	Whole Note
20	040	32	Two whole notes
40	100	64	Four whole notes

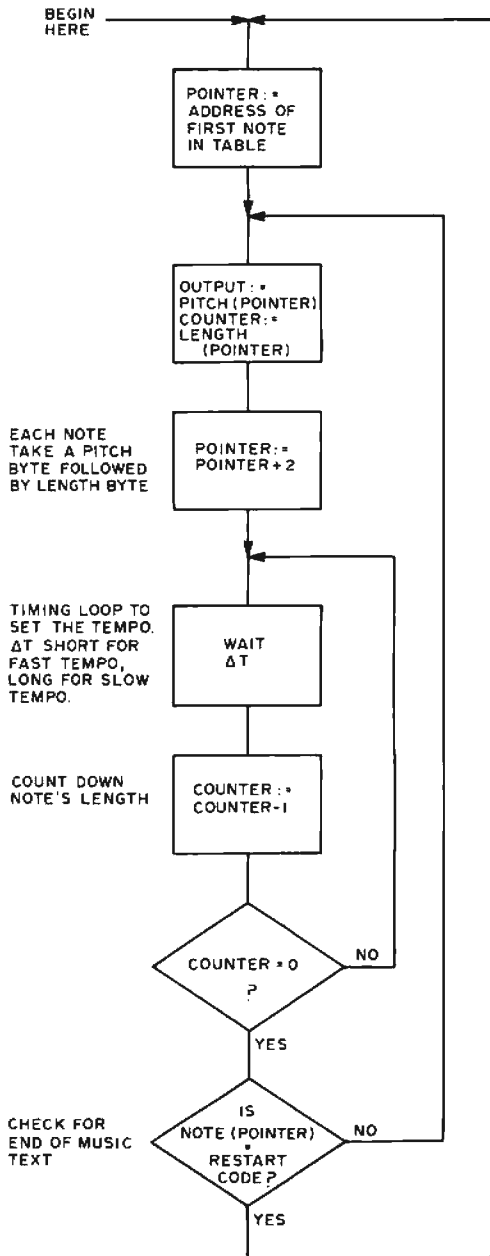

PITCH (Even Bytes)

Hexadecimal Note Code	Octal Note Code	Musical Note	Music Symbology
00	000	Z Silent	
01	001	Optional*	
02	002	C	
03	003	C# or Db	
04	004	D	
05	005	D# or Eb	
06	006	E	
07	007	F	
08	010	F# or Gb	
09	011	G	
10	020	G# or Ab	
20	040	A	
30	060	A# or Bb	
40	100	B	
50	120	C	
60	140	C# or Db	
70	160	D	
80	200	E	
90	220	F	
FF	377	Restart code	

Figure 2: Programming model for the melody box. The note pitch and length codes listed are interpreted by the program shown as a flowchart here. Each note is completely specified by a pitch code and a length code contained in two bytes of memory as shown by the example.



Figure 3: The melody box notes are tuned by running this chromatic scale text through the program of figure 2. While listening to the scale, adjust each note's potentiometer until the sound is a correct musical interval.

A Set of Chromatic Scale Data for Tuning the Melody Box

Octal		Hexadecimal	
Relative Address	Note and Length Code	Relative Address	Note and Length Code
000	001 002	00	01 02
002	002 002	02	02 02
004	003 002	04	03 02
006	004 002	06	04 02
010	005 002	08	05 02
012	006 002	0A	06 02
014	007 002	0C	07 02
016	010 002	0E	08 02
020	011 002	10	09 02
022	020 002	12	10 02
024	040 002	14	20 02
026	060 002	16	30 02
030	100 002	18	40 02
032	120 002	1A	50 02
034	140 002	1C	60 02
036	160 002	1E	70 02
040	200 002	20	80 02
042	220 002	22	90 02
044	000 040	24	00 40
046	377 xxx	26	FF xx

repeat code

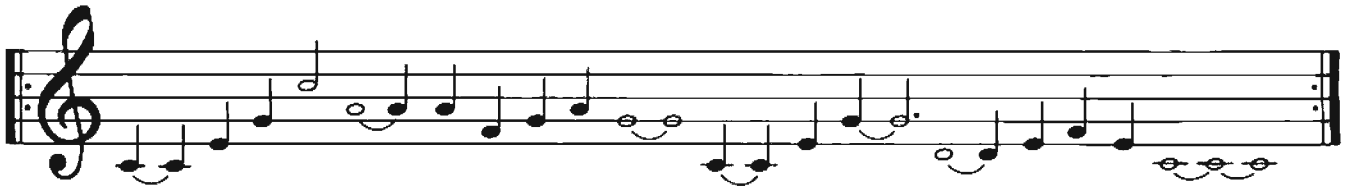

TABLE LOCATIONS →

OCTAL	000	002	004	006	010	012	014	016	020	022	024	026	030	032	034	036	040	042	044	046	050
HEXADECIMAL	00	02	04	06	08	0A	0C	0E	10	12	14	16	18	1A	1C	1E	20	22	24	26	30

Figure 4: A test string, shown in machine code form and in traditional musical representation, sans time signature, using note lengths as defined in figure 2.

A Familiar Tune

Octal		Hexadecimal	
Relative Address	Note and Length Code	Relative Address	Note and Length Code
000	002 004	00	02 04
002	002 004	02	02 04
004	006 004	04	06 04
006	011 004	06	09 04
010	120 014	08	50 0C
012	040 024	0A	20 14
014	040 004	0C	20 04
016	007 004	0E	07 04
020	011 004	10	09 04
022	040 004	12	20 04
024	011 040	14	09 20
026	002 004	16	02 04
030	002 004	18	02 04
032	006 004	1A	06 04
034	011 004	1C	09 04
036	011 014	1E	09 0C
040	004 024	20	04 14
042	006 004	22	06 04
044	007 004	24	07 04
046	006 004	26	06 04
050	004 004	28	04 04
052	002 030	2A	02 18
054	000 001	2C	00 01
056	377 xxx	2E	FF xx

stop

PUT A MACRO IN YOUR MICRO!



TIMESHARING FOR A MICRO™

Imagine playing Startrek to kill time while you wait for your computer to print out a complicated listing—but using the same computer.

Hardware limitations of the 8080 have made micro-computer timesharing impractical for the personal computer enthusiast. The AM-100™ 16-bit microprocessor set puts at your command a system which easily accepts multi-tasking from a multiple user structure. In addition the AM-100™ system lets you control priorities and allocate memory requirements for each job activated. There is even a security system to prevent unauthorized access to the data files (a Macro Computer?).

- Teachers—have each student at a terminal at the same time running a learning program. Monitor the progress on your master terminal.
- Computer Stores/Amusement Parks—set up a game bank with one computer and eight terminals. Have different games on each screen.
- Businessmen—put a terminal on the desk of your bookkeeper, stock clerk and design engineer. Perform the daily accounting, inventory control and design problems at the same time. Hook a terminal in the shop and audit production schedules with the processor's real-time clock.

WESTERN DIGITAL MICROPROCESSOR

The AM-100 is based on Western Digital's advanced WD-16 microprocessor chip set. It has been re-microprogrammed to give a more flexible macro instruction set while still maintaining the general architecture and source code format on the popular PDP-11 series.

S-100 BUS COMPATIBILITY

The 16-bit processor system interfaces to the 8-bit S-100 bus by multiplexing through 70-plus TTL logic chips. This multiplexing is totally transparent to the programmer.

See unit on display at our **BYTE SHOP** retail stores:

**813 N. Scottsdale Rd.
Tempe, Arizona 85281
(602) 894-1129**

**12654 N. 28th Dr.
Phoenix, Arizona 85029
(602) 942-7300**

**2612 E. Broadway
Tucson, Arizona 85716
(602) 327-4579**

ALPHA BASIC COMPILER

The BASIC language processor implemented is a compiler as opposed to the more popular interpreters. It reads the source code statements and generates a compacted and fully resolved object code program. The object code program is then executed by a special runtime package which is reentrant and may be shared by several users at once. The source code need not be present during this execution thereby reducing memory requirements.

FOR THE SYSTEM USER

- Conversion starts as low as \$1495 including full software
- MicroAge will provide you with the best support hardware in memories, terminals and I/O systems
- Complete multi-user/multi-tasking systems available configured to your specification and needs
- Look to MicroAge to provide you with a full consulting service for small business, scientific and educational computer systems
- User implementation is provided anywhere in the United States along with maintenance and service programs

Circle 226 on inquiry card.

Write or call us for further information and details:

MICROAGE™

**803 N. Scottsdale Rd.
Tempe, Arizona 85281
Phone: (602) 894-1193**

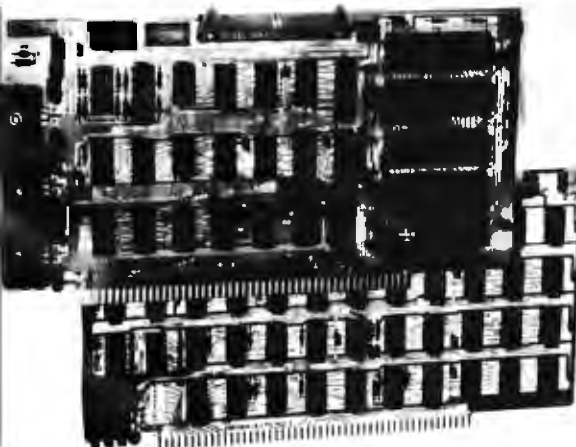

Introducing the AM-100™ by Alpha Microsystems: A 16-bit microprocessor CPU (2-card set) that replaces the 8080 microprocessor in your S-100 bus type computer.

- Eight 16-bit registers
- Multi-level DMA and vectored interrupt system
- Real-time clock on the CPU board
- Hardware supported totally relocatable object code
- Multi-user multi-tasking timeshared operating system
- Multi-user structured file system with passwords
- Multiple pass macro level assembler and linking loader
- Floppy disk file management system and utilities
- Up to 10 times the throughput of an 8080 system
- Fully supports most S-100 peripherals without modification
- ALPHA BASIC™ extended compiler and run system (not an interpreter)
- Free-form text editor and letter-writing text formatter
- System generation program to create custom operating system monitors
- Completely device independent with logical file I/O calls

Photo 2: Installation of the melody box inside an Altair 8800 is accomplished by wiring various wires from the backplane of the computer. The power switch and volume control were mounted on the back panel of the computer, so that the melody box could be turned off.

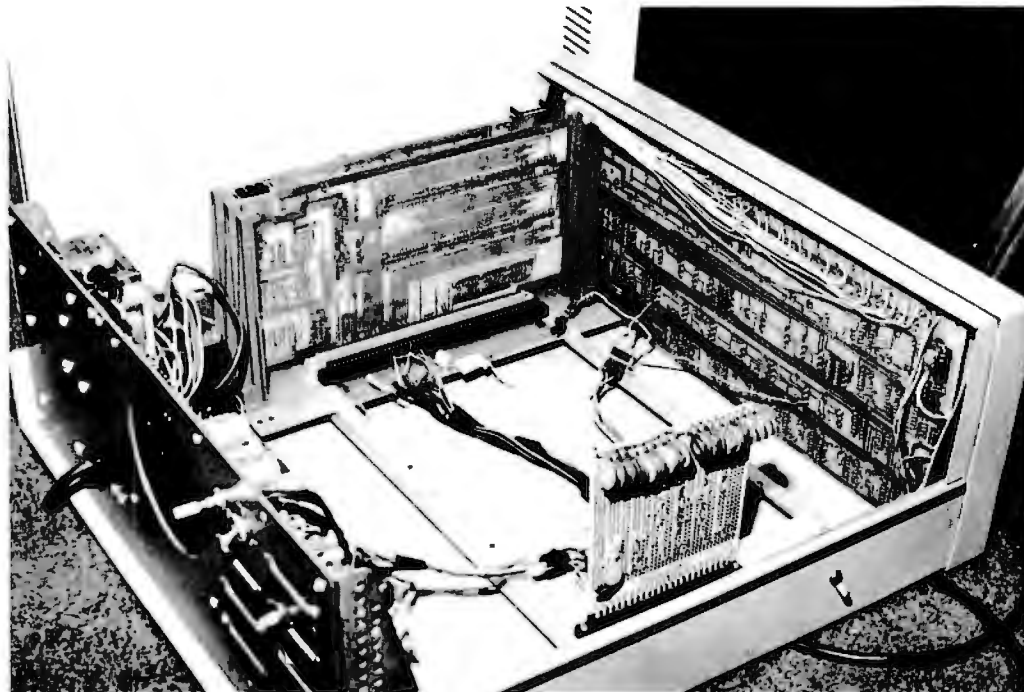

pads and bus lines of the card is relatively small, so care must be used to prevent solder bridges from forming. I recommend a low wattage iron with a pencil tip. 25 to 30 W will work well.

The 20 variable resistors used can typically be found at prices from \$.20 to \$.49 depending on how good you are at shopping around. I mounted the actual melody box inside my Altair 8800, as shown in photo 2. The circuit connections to the Altair bus were made as shown in figure 1. When mounting the circuit inside the computer cabinet, care should be taken to prevent damage to existing boards of the computer. I found that covering the boards with a layer of paper was a good precautionary measure to prevent any splatter of solder. In order to make the Altair connections, you must remove the mainframe backplane board (the one with all the edge connectors) so that you can solder to the underside.

Software for the Melody Box

The melody box requires instructions to tell it what to do. In an organ, piano or other instrument, a special purpose keyboard gives instructions about what note to play and for how long. Making the melody box play a tune consists of writing a program to generate a time sequence of instructions.

A programming model for the melody box is summarized in figure 2. The data required for each note is the pitch of the note, and the length of the note. In the program I wrote for my Altair, I used one 8

bit byte to represent the pitch, followed by a second 8 bit byte with an integer count giving the length. A table of the pitch codes, referenced to a music staff, and a table of length codes with equivalent note symbols are shown as part of figure 2. The flowchart in figure 2 shows an algorithm which is easy to implement on any small computer. In my own system, I enter these codes with the front panel toggle switches and the "deposit" function.

Once you have coded up the details of a program which will execute the flowchart of figure 2, the first step is to tune the melody box. In figure 3 I've shown the musical representation of an ascending chromatic scale, as well as the corresponding table of byte values (in octal and hexadecimal) for the 2 byte note pitch and length codes required to play this scale. An arbitrarily long rest follows the end of data before the repeat. Tuning is accomplished by ear (assuming you know what a scale sounds like) while playing this chromatic scale with the program. The potentiometers of the circuit in figure 1 should be adjusted until the scale sounds "right."

As a second example, figure 4 shows a familiar tune, both in music notation and as a table of values for the music program to utilize. In the music notation, the table locations are written below in hexadecimal and octal to show how the two representations correspond. The limits on what tunes you can play are only dependent upon how much imagination you have and how big your Altair's memory is. ■

Continued from page 6

nating or experienced user, the wealth of options available in the many varieties and permutations of 8080, Z-80, 6502, 6800 and 9900 systems at reasonable prices make it less and less likely that our readers will continue to be frustrated and annoyed by such devices of torture as job control, account numbers, contention for the use of a system, and the host of limitations encountered when commercial and industrial systems are twisted to personal purposes in "off" hours.

During the coming year, our third as a magazine born out of and devoted entirely to personal computing, we expect to see continued evolution in the field. The last half of 1977 represents the entry of several relatively large concerns into the marketplace, in the form of Heathkit this summer and Commodore soon to follow. Rumors have it that companies ranging from Atari and Bally Manufacturing (arcade games) to Radio Shack and Texas Instruments are in the process of developing general purpose systems appropriate for personal computing uses. This sort of "confirmation" of the marketplace's existence is bound to keep all firms on their competitive toes and ultimately benefit the user who is presented with more options and ways of achieving the personal computing function. (We even see the same phenomenon in our own sub-branch of the industry, the publications devoted to personal computing.) Like all industries, we can expect to see ups and downs in the trend, but for the moment we certainly relish and enjoy the heady expansion and growth evident all around us. Once again, technology in its application to human affairs is having its effect, and our lives as individuals are being improved as a result, despite the pessimists, gainsayers and prophets of doom chattering on about their usual maudlin spectres. We have yet to see large and useful personal data banks, practical automatons and similar challenges which have been projected by the writers of "hard" science fiction. But even if such are seen in our lifetimes, one thing is certain: the challenge of technology and invention which so marks the human race will continue with new horizons, just as today's computer technology could scarcely have been envisioned 20 years ago. ■



COMPLETE FLOPPY DISK SYSTEM FOR YOUR ALTAIR/IMSAI \$699

That's right, complete.

The North Star MICRO-DISK SYSTEM™ uses the Shugart minifloppy™ disk drive. The controller is an S-100 compatible PC board with on-board PROM for bootstrap load. It can control up to three drives, either with or without interrupts. No DMA is required.

No system is complete without software: we provide the PROM bootstrap, a file-oriented disk operating system (2k bytes), and our powerful extended BASIC with sequential and random disk file accessing (10k bytes).

Each 5" diameter diskette has 90k data byte capacity. BASIC loads in less than 2 seconds. The drive itself can be mounted inside your computer, and use your existing power supply (.9 amp at 5V and 1.6 amp at 12V max). Or, if you prefer, we offer a power supply (\$39) and enclosure (\$39).

Sound unbelievable? See the North Star MICRO-DISK SYSTEM at your local computer store. For a high-performance BASIC computing system, all you need is an 8080 or Z80 computer, 16k of memory, a terminal, and the North Star MICRO-DISK SYSTEM. For additional performance, obtain up to a factor of ten increase in BASIC execution speed by also ordering the North Star hardware Floating Point Board (FPB-A). Use of the FPB-A also saves about 1k of memory by eliminating software arithmetic routines.

Included: North Star controller kit (highest quality PC board and components, sockets for all IC's, and power regulation for one drive), SA-400 drive (assembled and tested), cabling and connectors, 2 diskettes (one containing file DOS and BASIC), complete hardware and software documentation, and U.S. shipping.

MICRO-DISK SYSTEM . . . \$699
(ASSEMBLED) \$799
ADDITIONAL DRIVES. . . \$425 ea.
DISKETTES. \$4.50 ea.
FPB-A \$359
(ASSEMBLED) \$499

To place order, send check, money order or BA or MC card # with exp. date and signature. Uncertified checks require 6 weeks processing. Calif. residents add sales tax.

NORTH STAR COMPUTERS, INC.
2465 Fourth Street
Berkeley, CA 94710

---**Problems for Computer Solution** by Steve Rogowski, Teacher Edition. A collection of mathematical problems designed to stimulate thought and encourage research by students towards the goal of a final solution. The subjects range from arithmetic through calculus and on to problems that have yet to be resolved. An analysis of each problem provides ideas on logical approaches to a solution, and a sample program demonstrates one possible final solution. \$9.95.



---**Chemistry with a Computer** by Paul A. Cauchon. People are always looking for details of applications for the computer. It is one thing to say "gee whiz wouldn't it be nice if. . ." but such thoughts are but the stimulus to action. One result of a "gee whiz" idea is a series of educational and tutorial BASIC programs for use by teachers of chemistry, invented by Paul A. Cauchon and published by Educomp Corporation. This book contains a collection of tutorial, simulation and problem generation programs which can be employed to advantage by teachers in high schools or colleges wherever a BASIC facility is available. If you're a chemistry professor or teacher by trade, or just a hobbyist interested in chemistry, this book will prove to be an invaluable tutorial aid. \$9.95.

Take a Byte of APL



---**APL—An Interactive Approach** Second Edition, Revised, by Gilman and Rose. Here's an excellent way to introduce yourself to the APL language. APL is rapidly becoming one of the most popular high level languages in the computer field because of its clarity and conciseness. Gilman and Rose have extensively updated their popular book to include the latest information about the language and the various forms of it which are now in use. Since the examples are all carefully spelled out, **APL—An Interactive Approach** is particularly recommended for those who do not have access to an APL terminal. Answers to all problems are included. \$11.95.

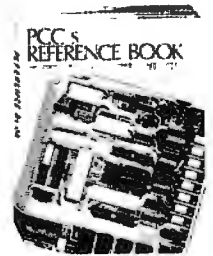
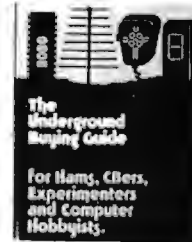

---**The Underground Buying Guide**, by Dennis A. King. Here at last is a source book for all those hard to find suppliers! It's designed especially for computer hobbyists, experimenters, hams and CB'ers, and can tell you where to buy items like connectors, discrete components, electronic music supplies, instrumentation, analog to digital and digital to analog converters, and synthesizers. The list goes on to include Teletypes, speakers, microcomputer software, cassette units, floppy disks and many other items. It will be an invaluable addition to your reference library. \$5.95.



---**PCC'S Reference Book of Personal and Home Computing**. Ever try to find the addresses of some manufacturers of, say, tape cassette or floppy disk interfaces for micros? Frustrating, isn't it? Well PCC has done something about it. This book lists hundreds of companies and stores selling hardware, software, and services. Survey articles on software, hardware, kits, applications and the future for the experienced and the not-so-experienced user of micros. Also included in this edition are bibliographies for further reference, book reviews, and an index of the articles from the major hobbyist magazines. \$4.95.

Send to: Bits, Inc. 70 Main Street Peterborough NH 03458	 	Check Payment method: <input type="checkbox"/> My check is enclosed <input type="checkbox"/> Bill my MC No. _____ Exp. date _____ <input type="checkbox"/> Bill my BAC No. _____ Exp. date _____
Name _____	Total for all books checked \$ _____	
Address _____	Postage, 50 cents per book for _____ books \$ _____	
City _____ State _____ Zip Code _____	Grand Total \$ _____	
Signature _____	Prices shown are subject to change without notice. All orders must be prepaid. In unusual cases, processing may exceed 30 days.	
You may photocopy this page if you wish to leave your BYTE intact.		

**A NEW CHESS SPECIAL
INTEREST GROUP**

Recently three computer chess programs have become available to the computer hobbyist, and two dedicated chess playing machines have been announced. The newspapers carry news of the US and international computer chess tournaments.

With this growing interest, one would expect that there'd be some medium of communication among devotees of computer chess. But the only articles appear in obscure professional publications which the average reader never heard of. So, having tried to get someone else to do it, I decided to try to start a *Computer Chess Newsletter*, with the contents furnished by the readers, based upon a model provided by Hal Singer's pioneering *Micro-8 Newsletter* for computer users. Now the problem is to get contributions. Anyone with any interest in computer chess playing or programming, please write. So far no price, size, or frequency of publication has been determined.

We need letters and articles about experiences with specific programs, either on hobby machines or the larger programs available on some campus computers and some timesharing systems. In fact, we need a list of known programs. How do they compare, for strength, for speed of response, for the way the moves

are reported, the way the board is displayed?

Lots of hobbyists would like to try their hand at writing a chess program but don't know how to get started. Any advice or experience in this would be most appreciated. Also, descriptions of chess programs and their philosophies would be most welcome. There is not exactly a surplus of material to read on things like this.

Anyone interested in receiving the first issue should send a letter enclosing a couple of 13¢ stamps to defray costs for the first try. I hope that a great deal of interest shows up in the form of contributions of material for the newsletter.

Doug Penrod
1445 La Cima Rd
Santa Barbara CA 93101

For an interesting news item on the subject of computer chess, readers should consult the June 1977 Scientific American, the "Science and the Citizen" column, page 56. This report covers the first computer program to answer chess master David Levy's 1968 challenge (which is up in 1978). The program was Chess 4.5, a product of Lawrence R Atkin and David J Slate of the computation center at Northwestern University. In ordinary tournament play, the chess program lost; in "blitz" high speed play, the program won handily. The

Ask BYTE

details and play-by-play account of the game are in the Scientific American piece. ■

**INTERACTIVE COMMENTARY — APL
ROMs CONTINUED**

I have thoroughly enjoyed your magazine for some time now; even though I can't really be termed a "home hacker" (I run on a PDP-11/45 under RSTS or UNIX), it is still interesting and very informative. Keep up the good work!

I would like to comment on a few letters from recent issues. First, on the APL character set ROMs: I would love to see this developed, and made available soon and relatively inexpensively. APL is a wonderful language, but is not widely enough available to be well known. I have worked on an APL interpreter for our 11, which is compatible with APL/360; however, we don't have enough APL terminals, so I thought of getting some ROMs burned for DEC-writers, but it turned out to be too



WE PAY POSTAGE!

ELECTRONICS

P. O. Box 401247, Garland, Texas 75040 (214) 271-2461

TERMS: ORDERS UNDER \$15 ADD \$.75. NO C.O.D. WE ACCEPT VISA AND MASTER CHARGE CARDS. MONEY BACK GUARANTEE ON ALL ITEMS. TEXAS RESIDENTS ADD 5% SALES TAX.

16K E-PROM CARD

S-100 (1MSA1/ALTAIR) BUSS COMPATIBLE

IMAGINE HAVING 16K

\$69.95 (KIT)

OF SOFTWARE ON LINE AT ALL TIME!

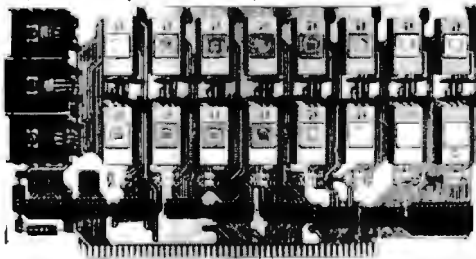

DEALER INQUIRES INVITED

KIT FEATURES:

1. Double sided PC Board with solder mask and silk screen and Gold plated contact fingers.
2. Selectable wait states.
3. All address lines and data lines buffered!
4. All sockets included.
5. On card regulators.

USES
2708's!

KIT INCLUDES ALL PARTS AND SOCKETS! (EXCEPT 2708's)

SPECIAL OFFER: Our 2708's (650 NS) are \$12.95 when purchased with above kit.

**2708 1KX8 2708
EPROMS**

Prime new units from a major U.S. mfg. 650 N. S. access time. Equivalent to four 1702A's in one package!

GOING INTO
BUSINESS
SALE! **\$15.75 each**

8K LOW POWER RAM KIT

(S-100 BUSS COMPATIBLE)

\$149.00

(Kit of All
Parts and
Sockets)

The last word in RAM Kits. Uses 21L02-1 RAM's. All address and data lines fully buffered. PC Board is solder masked and silk screened and has gold plated contacts. Four regulators with heatsinks included.

expensive. If some other people want to get together and get them done, count me in! Also, if anyone out there is working on a "tiny APL" for an 8080 or another microprocessor, contact me; I'd like to hear what you're doing. I've given it some thought myself, but don't have a microprocessor handy to play with.

Second, to P M Lashley in February 1977 BYTE, I must say that while FORTRAN may be a "virtual pterodactyl," it does have its merits, the biggest one being portability. I program in "C" mainly, a beautiful language, impeccably cleanly structured; but how many of you out there have heard of it, much less know where you could run it? This is the one point in which FORTRAN outweighs its competitors; however, much better they may be. If this is of no concern, be my guest and scrap FORTRAN! (I'll help!!)

Thanks for a fine mag. I'm sure I won't be disappointed in the years to come.

Christopher A Kent
935 Burney Ln
Cincinnati OH 45230

Having recently conversed with a representative of a firm planning an APL "black box" computer, we found that according to the gentleman in question a full APL interpreter does not have to be an emulation of a 360 with several

hundred thousands bytes (as is the case in IBM's 5100 APL). This caller claimed it was possible to implement APL for an 8080 or Z-80 in under 12 K bytes with clever programming. See Mike Wimble's articles for the algorithms. ■

MORE BASIC QUESTIONS

In your March 1977 BYTE, you listed a Space War game in BASIC written by David Price (page 106). In his game he uses the instruction MAT. I have just purchased an SwTPC 6800 12 K byte computer with SwTPC's 8 K BASIC. SwTPC's BASIC does not have a MAT instruction. My question is: What can I use to substitute in place of the MAT instruction?

Steve Wright
13900 SE Highway 212, SP#74
Clackamas OR 97015

The MAT refers to "matrix" operations. In David Price's program, the concept of a matrix (often a two-dimensional one) is used to represent a two-dimensional array of values. For example, line 520:

MAT K=ZER(3,3)

The "MAT" at the beginning of a line is your cue that an array or "matrix" is involved. In the statement above, this would be equivalent to writing:

*DIM K(3,3)
FOR I=1 TO 3
FOR J=1 TO 3
K(I,J)=0
NEXT J
NEXT I*

(The DIM is only needed once in a program, at or near its beginning.) In David's program, the MAT statements are essentially used only to allocate storage for matrix data type arrays, followed by initialization similar to the example shown. There are other operations applicable to matrix data, but most uses of the matrices in David's programs refer to components, once values have been initialized. If you do not have a two-dimensional array facility, a much more difficult simulation of two-dimensions is also possible. ■

SOME BASIC VARIATIONS

I put the March 1977 BYTE "Star Trek" program (page 106) on disk in an IBM VM 370 operating system with a timeshared terminal. I encountered several problems due to the differences between VM 370 BASIC and the version used by David Price in his program. Most were solvable with the help of a guide at the end of the article, but a few still have me stumped.

Continued on page 209

No bells or whistles...just performance, a warranty and a low price.

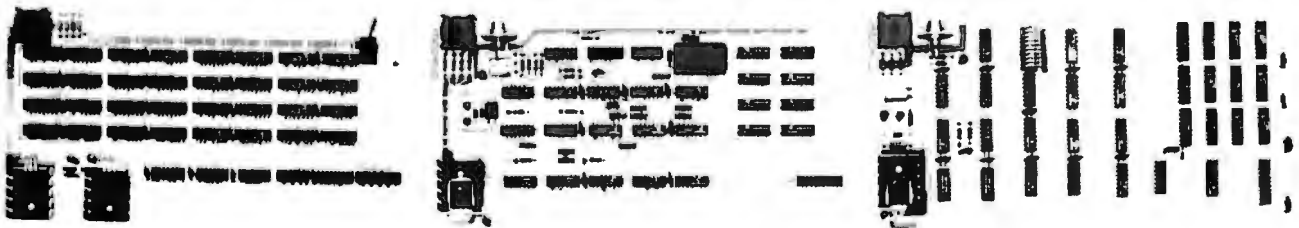

For \$107.00 take your choice; the 4K RAM board or the alpha video board. For \$137.00 the video graphic board can't be matched. (8K RAM and much more on the way.)

These are *not* kits, but completely assembled, burned-in, tested boards with a 1 year warranty. No soldering, no messing, no chance of mis-connections . . . just plug 'em in and you're ready to go.

The 4K RAM has the same features and speed as what you're used to (500 nsec, no wait states) but with a couple of extras you might not expect. Like a mechanical write protect switch that gives you positive memory protection. And Visaddress*, an easily accessible switch on top of the board for easy to read address selection.

The alpha video board offers Visaddress address selection and displays 128 ASCII characters; both upper and lower case. A standard 16 line by 32 character format with character selectable video reverse and socketed ROM are standard features. (Character generator ROM available with standard graphics characters. Optional Greek or ASCII control characters available.)

And our video graphic board gives you an exceptionally easy approach to computer animated dynamic displays.

Our matrix approach allows direct addressing of each dot in an 128 by 96 array, simplifying dynamic movement. And unlike DMA displays, our on-board RAM allows your CPU card to do other work during display time and with no dynamic RAM problems. And like our other boards, it has Visaddress address selection.

Quality, assembled boards at less than kit prices. But what else would you expect from a company whose prime product is electronic test instrumentation and microprocessing components?

Order direct, by check, BankAmericard or Master Charge (Add \$1.50 shipping, credit customers give us all the card numbers, please and Ohio residents add 4½% sales tax) or contact us for more information. Kent-Moore Instrument Company, P.O. Box 507, Industrial Ave., Pioneer, Ohio 43554. (419) 737-2352.



Kent-Moore
INSTRUMENT COMPANY

DO IT WITH 16 BITS

DO IT BETTER

With the language that is best suited for your application: Business programming in **COBOL**, Scientific and Engineering in **FORTRAN IV**, Educational in **BASIC**, and Systems Implementation in our **MACRO ASSEMBLER**.

With hardware that will grow with your application, and protect your software investment.

DO IT FASTER

With extensive support and utility programs to speed development of your applications software. These include a Diskette Operating System, Relocatable Linking Loader, Load Module Library Editor, Symbolic Debugger, and Text Editors.

With a 16 bit processor that includes hardware multiply and divide, real-time clock, and peripherals like single or dual diskette subsystems with integral DMA controller.

DO IT WITH A MicroNOVA®

BPI

If you are serious about computing, call or write today. BPI Inc., 2205 East Broadway, Suite 6, Tucson, Arizona 85719 (602) 326-6975

SYNCHRO-SOUND Enterprises

Your Small Computer Department Store

One-stop shopping for
Hardware and Software

Compare our PRICES, PRODUCTS, QUALITY, DELIVERY, SERVICE . . . we carry everything you need in small computers, terminals, printers, monitors, keyboards, accessories. We'll meet or beat competitive prices on everything we sell!

NEW LEAR SIEGLER ADM-3A TERMINAL



- Full addressable cursor.
- Character Generation— 5 x 7 dot matrix.
- Display Format— Standard: 1920 characters, displayed in 24 lines of 80 characters per line.
- Character Set— Standard: 64 ASCII characters, displayed as upper case, plus punctuation and control.
- Communications Rates— 75 to 19,200 baud (switch selectable).
- Computer Interfaces— EIA standard RS232C and 20mA current-loop (switch selectable).
- Data Entry— New data enters on bottom line of screen; line feed causes upward scrolling of entire display with top-of-page overflow. Automatic new line switch selectable, end-of-line audible tone.

ADM-3A Kit 795.00
ADM-3A Assembled . . 895.00
Lower Case Option . . . 89.00

IMSAI 8080 MICROCOMPUTER



Powerful • Easy to use • Low cost

With 22 Slot Mother Board . . . \$619.95
With Z-80 CPU 849.95

OKIDATA Model 110 Line Printer



• 110 CPS
dot matrix

Friction Feed \$1099.00
Tractor Feed 1229.00
RS 232C Serial Interface . . . 250.00

SPECIAL BUYS

HAZELTINE Modular One Video
Terminal \$1639.00
SORAC IQ120 Video Terminal Kit 959.00
DEC LA180 Printer 2769.00
COMPUCOLOR 8001 Color Graphics
Computer 2595.00
ICOM Microfloppy Disc & Controller 989.00
NORTH STAR Microfloppy Disc &
Controller 599.00
OKIDATA Model 22 Printer 2095.00
OMNITEC 401C 300 Baud Modem 300.00
2708 EPROMS 29.95
OAE Papertape Reader 69.95

SOL 20 In Stock For Immediate Delivery

NEW

COMMERCIAL QUALITY KEYBOARD

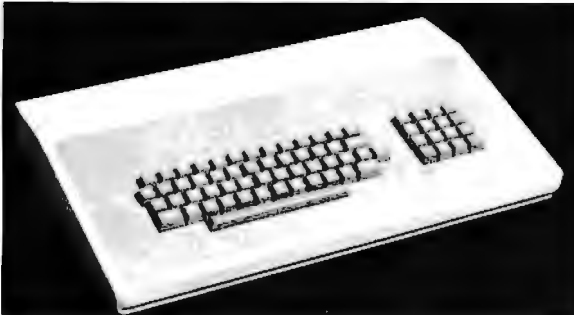

The Model SS-1 Communications Terminal is a non-contact capacitive keyboard with a guaranteed life of over 100,000,000 operations.

- MOS/LSI Encoder with high reliability low power consumption.
- Key Roll Over which eliminates operator error and increases thruput.
- Hysteresis for tease proof operation.
- Solid State performance at mechanical switch prices.
- Tactile Feedback at the operate point.
- ASR-33 Array with four mode encoding.

Keyboard Kit \$99.95
Enclosure (with numeric
cutout) 49.95
Numeric Pad 34.95
Complete Kit (with pad) 179.95
Assembled Unit
(with pad) 229.95

DECwriter II



- 132 column printing • 30 CPS
 - Full keyboard • Tractor Feed
- \$1769.95**

SOFTWARE

Attention ALTAIR DISK Owners

Now available—an Accounts Receivable System for the small user. This system is expressly designed to be run on an 8080 based microcomputer using an Altair floppy disk with Altair Basic, Video Terminal and Printer. Many features normally found only on large scale computers are included. Provided are such functions as: Adding New Customer Accounts, Deleting Dormant Accounts, Transaction Processing, and Report Generation. The Monthly Statements include both current and aged balances. Other reports generated are the Aged-Accounts Receivable and Delinquency Notices.

This easily usable system requires very little operator training. All communication is in an interactive mode with the program constantly prompting the appropriate responses. Operator errors are easily corrected and accidental data base deletions are prevented by requiring additional confirmation.

This Accounts Receivable System, although supplied ready for use, may readily be modified to include special installation-dependent functions. All major programs are written in high level language making program additions and alterations a simple task. This program module is designed to serve as the basis for a complete accounting package. Provisions are included for linking Billing Inventory Control and General Ledger modules which will be available in the near future.

We carry a full line of the following: TDL, OAE, Processor Tech., Hayden, Tarbell, IMSAI, Cromemco, Compucolor, Icom, Lear Siegler, Okidata, DEC, Javelin, Teletype, North Star, Heuristics, Peripheral Vision, TRW. Same day delivery and shipping on most items. Full, modern repair facilities on premises for complete servicing of everything we sell.



Circle 231 on inquiry card.

SYNCHRO-SOUND Enterprises

The Computer People

193-25 Jamaica Avenue, Jamaica,
New York 11423 • 212/468-7067

Hours 9-4 daily
and Saturday

Visit our new showroom . . .
working units on display

Dept. B BankAmericard • Master Charge

Please send me further information on: (list items)

_____ Price List

Name _____

Address _____

City _____ State _____ Zip _____

System Description: The Noval 760

Here is the designer's eye view of a new product which represents one of the most complete ready to run computer packages seen to date. Introduced with a 4 page advertisement in June 1977 BYTE, this manufacturer's product description provides some more detailed information for readers' inspection and evaluation.

Lane T Hauck, Director of Research and Development
James D Nash, Senior Systems Programmer
Noval Inc
8401 Aero Dr
San Diego CA 92123

The first wave of personal computing hysteria seems to have subsided. A casual stroll through the West Coast Computer Faire last spring served as a pretty clear indication that the small computer user has grown up in a big hurry. We now hear these alleged "kids" rapping about relocatability, graphics generation and memory design, a far cry from the "dumb" user concept.

The Noval 760 computer was designed to fill the needs of the advanced hobbyist, who has a serious interest in learning about writing and using software. The system emphasis at Noval has been placed on provision of a unified hardware and software package which facilitates program development. The Noval 760 system does *not* allow the user to pick up a 4 year degree in computer science within two weeks by following the manual, but it does simplify some of the "dog" work required to design, write and debug programs written for amusement or more serious business.

The most startling aspect of the 760 is its package. The computer system is housed in an attractive desk, which in its "folded"

position is a piece of contemporary furniture. It is, in fact, fully functional as a desk, complete with drawer space. However, lifting the rear half of the desk top (photo 1) reveals a computer console with video display and cassette mass storage. The center drawer pulls out to reveal a full alphanumeric keyboard.

The design philosophy of the 760 system is to provide a fully assembled and tested computer, with everything needed to develop and run programs. This philosophy is carried through all aspects of the hardware and software, and especially in the way the hardware and software work together.

Hardware

The Noval 760 computer is based on an 8080A microprocessor. The standard hardware includes:

- 16 K bytes of user program memory.
- 3 K bytes of PROM systems software.
- 12 inch (30 cm) solid state monitor.
- Full alphanumeric keyboard.
- 32 column printer.
- Digital cassette tape unit with full electronic control.
- Eight built-in IO ports (three user available).
- Heavy-duty power supply.
- Graphics system, including 1 K bytes of user programmable refresh memory, 2 K bytes of user programmable char-



acter generator memory, and 1 K bytes of scratch pad memory.

Dynamic memories with invisible refresh are used for all programmable memory. No memory wait states are generated, and full refresh is maintained when the system is halted. An optional second memory board expands the system to 32 K, and PROM expansion to 16 K is optional.

The standard software PROM occupies 3 K bytes, with sockets for an additional 1 K bytes of user supplied PROM. The system uses a direct video monitor for a clear, crisp display. The wide bandwidth attained using the direct drive approach is especially important in the high resolution graphics mode.

The drawer mounted keyboard has all the standard ASCII keys, plus special control keys for video games, such as up and down arrows. The keyboard is scanned and encoded using software, so that key codes may

be arbitrarily assigned, if desired.

The printer is a dot matrix impact printer, manufactured by LRC Products Inc. Rather than employing a standard ROM for character generation, the software creates the images to be printed. This allows user defined symbols to be created along with standard ASCII characters, a graphics mode which enhances the usefulness of the printer as a plotting device.

The tape mass storage unit is a PhiDeck, with Noval designed electronics, capable of reading and writing at 2500 bits per second. This allows a 4 K byte program to be loaded or saved in about 20 seconds.

The IO system is implemented using a distributed logic technique. One corner of the main printed circuit board is devoted to eight parallel connected Molex connectors of 20 pins each. All signals from the processor which are necessary to implement the first eight ports (ports 0 to 7) are bussed to these

Photo 1: The Noval 760 is shown in this picture as it appears in its natural setting for use: unfolded in a living room, office or den. The console with display and cassette drive folds into the desk and the drawer with its keyboard closes, so that when not in use the Noval 760 blends into the decor as a desk-like woodtone piece of furniture.

connectors. The cable for any peripheral is terminated by a small printed circuit board which contains four integrated circuits which actually implement the IO port.

The graphics system is one of the nicest aspects of the Noval hardware. The display system contains its own 4 K byte volatile memory which is dedicated to image generation and display. Control of the screen is done using a memory mapped approach, so that every screen location has a unique memory address. This allows fast access to any screen location using any of the 8080A memory referencing instructions.

The graphics system is character oriented with user defined character graphics. 1 K bytes of the video memory are devoted to holding the character codes for the screen which are accessed every time the beam scans the CRT. The screen is organized as 28 rows of 32 characters each. The character codes span a full 8 bit range which gives the capability for defining 256 different characters. The characters are formatted as an 8 by 8 array of "dots." The definition of these dot patterns is contained in a second 2 K byte image memory, also user programmable. (A little figuring shows that to represent 256 different images of 64 dots each requires 2 K bytes of memory.) Since, like the refresh memory, the image memory is treated like any other 8080A system memory, it can be directly accessed using conventional memory reference instructions. "Loading" the character generator is simply a matter of writing bit patterns (which will be displayed as dot pattern on the CRT) into consecutive memory locations.

What about color? This feature is built into the system, but an external color monitor is required to use it. The system allows the user to define four different color "schemes" for use with such a monitor, where each scheme consists of eight pairs of image and background colors. Although the color schemes themselves require burning a 32 by 8 PROM, selection of one of the four is done in software.

1 K bytes of memory physically located in the video system are available for general purpose use. In all Noval system software, the 8080A "overhead" variables such as the stack data and system flags are stored here, so that the user has maximum use of the 16 K byte (or 32 K with expansion) memory elsewhere in the system.

The development of hardware for the Noval system was closely paralleled by intensive software development. It is the "cooperation" between these two disciplines which we feel has produced a successful integrated package.

Software

Noval software is organized around a number of utility and supervisory routines which are collectively referred to as the system "monitor." In the minimum system configuration, a 3 K byte PROM resident segment of the monitor contains a command processor, a few utility routines and the software required to communicate with the front panel, keyboard, CRT and cassette tape. The primary function of this 3 K program is to load other monitor and system routines from cassette (unless a PROM option has preloaded this data).

Standard software includes an editor, assembler, debugger, and a graphics character generation package. As an option, all of the above software can also be installed in PROM. A BASIC interpreter is also available.

Editor, Assembler and Debugger

The Noval editor, assembler and debugger for 8080A code have many unique features. Before examining this system, however, let's quickly outline what these development tools are traditionally designed to do.

An editor allows you to enter, format and modify ASCII text. Input to the editor is either old text which is to be modified or new lines of text which are typed in. Text output from the editor is used as input to the assembler. The assembler input is called a source program. The assembler translates the "source" into binary codes which are intelligible to your processor. Traditionally on large machines and many minicomputers editors and assemblers are independent programs; text created by the editor must be saved somewhere while the assembler is being loaded. When the assembler has been loaded, the edited source program can be reloaded and assembled.

When assembly is complete, the assembler produces a listing of the source program and the associated binary codes. The binary codes are called the object program. The assembler output also includes a list of errors found in the source program. Perhaps you typed MOB A,B instead of MOV A,B, or maybe you forgot to define label "LOOP." So back you go to the editor. Load, reedit, save, load, reassemble, . . .

The Noval system uses an interactive approach to editor and assembler design. The Noval editor can be used in a mode which checks each line of proposed assembly language code for syntax errors as it is entered. Thus when you type "MOB A,B" and attempt to insert it into the text, the editor does not allow the line to be inserted. Instead, an error message is issued and the

Visibly increase your computing power.



Want results you can see?

Take a close look at the Soroc IQ 120 CRT terminal. It can augment the computing power of your system and provide you with more flexibility than before.

Yet, it's priced low.

If you think the SMART TERMINAL is going to cost you an arm and a leg, for a few more features — THINK AGAIN!

For a suggested retail price of \$995.00 only, the IQ 120 gives you upline, tab, home, and absolute

cursor addressing in addition to the usual forespace, backspace, downline, new line, and return.

And, besides full or half duplex conversation mode, the IQ 120 provides block mode so you can transmit a line or a page at a time.

What's more, it offers field protection, auto repeat, and a numeric pad. Plus 15 switch-selectable baud rates, 80 x 24 standard format, and a standard RS-232 interface.

Contact us for more information

today. We think you'll like seeing things our way.

SOROC Technology, Inc.,
165 Freedom Avenue, Anaheim,
California 92801. Call (714)
922-2860. For those calling outside
of California, call toll free (800)
854-0147, or one of our authorized
distributors.

Circle 232 on inquiry card.

**SOROC**
TECHNOLOGY, INC.

See us at '77 Consumer Trade Fair, Booth #306 in Computermania, Booth #519.

line must be retyped. The method used involves the editor and assembler working together; the assembler is called by the editor to check the syntax of each proposed instruction. The editor cannot check for every possible assembly error condition, but errors that are caught constitute a large percentage of typical assembly errors. The editor's interactive assembly mechanisms can, of course, be disabled to allow input of arbitrary text as well.

The mechanics of using the editor and assembler have been kept as simple as possible. A 2 letter keyboard command (ED) calls the editor from the monitor's command processor. The first 24 lines of text (if any) are displayed immediately. Each line of text has been automatically assigned a line number. One letter keyboard commands allow you to insert (I), erase (E) or change (C) lines. Up arrow (↑) and down arrow (↓) allow viewing of previous or upcoming pages of text. Any specific section of text can be displayed by simply typing the line number. A search command (S) allows capability to search for any ASCII string. All editor commands immediately display the results of command execution. An inserted line, for example, is immediately displayed along with its neighboring lines.

The "ESC" key causes exit from the editor and returns control to the monitor command processor. All assembler commands work directly on prescanned text created by the editor, with no need to save intermediate results. Assembler options include capabilities to assemble and list errors, assemble and print assembly listing on the printer, assemble and display a listing on the CRT, and execute the object program after assembly. When assembly errors are noted (most are undefined labels since syntax is checked during editing), the editor can be immediately recalled and the source program modified. The Noval editor and assembler interaction helps minimize the time spent in the program development cycle, a concern which is just as important to the amateur as it is to the professional programmer.

The monitor save text command allows saving any number of lines on the cassette tape. Special assembly commands allow segments of the large source program to be read into memory, assembled and linked to previously assembled segments. Very large programs can be assembled in this manner. The ultimate size limitation essentially depends only on the amount of available memory.

When the source program has assembled properly, typing OD transfers control to the Noval ODT (On-line Debug Technique) com-

mand processor. From here insertion of software breakpoints and use of the ODT jump command allow the user to execute any segment of object program. Before the jump all 8080A registers can be preset. Upon hitting a breakpoint (a dedicated restart instruction, "RST 2"), the breakpoint address is displayed along with all register values, the stack pointer address and previous elements on the stack. When the entire development procedure is complete, the debugged source and object programs can easily be saved on cassette tape.

Leave the Driving to Us

Communication between the central processor and peripheral equipment in this (or any) system is accomplished with software "drivers." Drivers deal with the detailed workings of system input or output, and, at best, are organized to make such communication an easy task. Drivers for all peripherals in the Noval system are included in the standard PROM monitor. Also included is extensive documentation on how to use each of them. Furthermore, the monitor includes a large number of utility routines which can be used for special purpose programming applications. Examples include a routine to print ASCII text on the screen; routines to create and display graphics characters; a routine to find a keyboard key "push" and return the ASCII code for the key. In total, the user of the Noval system has access to over 75 systems routines which can be used in a variety of applications.

An Eye Toward Revision

One problem with accessing drivers using subroutine calls is that absolute address of the subroutine must be known. As subroutine revisions are made, absolute addresses change and all references to subroutines must be modified. Typically, a reassembly of a large amount of user applications software is required each time system subroutines are modified. *[Perish the thought.]* Noval monitor utility routines can be called without knowing the absolute address of the routine. To call one of these routines, the programmer inserts an "RST 7" instruction followed by a 1 byte constant which identifies the desired routine. As an example,

```
RST 7 (Restart 007)
DB 17 (Define Byte 017)
```

calls utility routine number 17, which erases the display screen. The restart 7 data (the "DB 17" above) is used by the monitor to



Talk to your computer for \$299 with SpeechLab™

Use SpeechLab to directly control any S-100 Bus Computer such as Sol, IMSAI, Altair and so on. SpeechLab can teach you almost as much as the Bell Laboratories know about voice recognition, voice control and computer input.

SpeechLab digitizes and extracts data from speech wave form and applies pattern matching techniques to recognize the vocal input. Response is real time. The system features 64 bytes of storage per spoken word and can handle up to a 64 word vocabulary. And recognition after very little practice is 95 percent or better.

\$299* assembled and tested

When we talk price everybody's skeptical. And why not? We give you a complete hardware/software system, a 275 page laboratory manual, 95 page hardware manual and high fidelity microphone.

The lab manual includes 35 graded experiments with over 100 tables and graphs. In fact, it's the only introductory volume on speech recognition currently available.

Software includes SpeechBasic Basic programming language in source and

paper tape, assembly language speech recognition program in source and paper tape, hardware self-test program in source and paper tape. SpeechBasic plot, correlation, recognition and advanced recognition programs are offered in source.

Hard to believe, you bet. True? A Los Angeles customer says, "I love your kit!!! I have 40 boards and 2 IMSAI's and your kit was the best documented of them all. I love the way you integrated the software and hardware together. I love your lab manual!"

We loved those comments. They tell the story better than we ever could. The LA customer did ask who the founders of the firm were so he could relate better. They're a couple of

gifted young engineers who got tired of the big firm, big technology trip and decided to take a chance with a better idea.

You can't get better quality You can't get more performance

Sure, more complex, higher price equipment is available for about 50 times more money. It won't do much more than you can do with SpeechLab. And the quality and state-of-the-art engineering can't be any better. We use CMOS design for low power and ultimate reliability.

See SpeechLab at your nearby computer store

Selected computer stores have SpeechLab on display. Visit your nearest. If he doesn't have it, ask him to contact us or simply write us directly.

Heuristics, Inc., Box B, 900 N. San Antonio Road
Los Altos, CA 94022, Phone (415) 948-2542

- Send me SpeechLab. I enclose \$299.
California residents add sales tax.
- Send me more information.

Name _____

Street _____

City _____ State _____ Zip _____

Heuristics

INC.

*Available in kit form for slightly less.

index into a "call" or "jump" table. Entries in the table contain the absolute addresses of the utility routines, thereby freeing the programmer from having to deal with absolute addresses. This technique assures that programs which call the monitor system routines will execute properly with all (including future) versions of monitor software. RST 6 has been reserved for the user to construct a similar call table for his or her own use. Two dedicated locations in scratch pad memory are used to specify the starting address of the call table.

And an Eye to Graphics

Another 2 letter monitor command (GR) transfers control to the graphics character generator command processor. Simple keyboard commands allow the user to place any of 256 current character definitions at any screen line and column; create or modify character graphics by defining individual dots within an 8 by 8 matrix; erase the screen; select a graphics color scheme; or save a created set of characters on cassette tape. The characters created in this manner can be used by routines created by the editor and assembler.

Noval BASIC

Noval BASIC is available as a minimal cost option. However, a prerequisite for running this version of BASIC is that the entire system monitor (including the editor, assembler, etc) be installed on PROM. The reason for this requirement is that some of

the extended features of Noval BASIC require use of editor and assembler subroutines. Noval BASIC itself occupies 6 K bytes of memory, and is available in both volatile memory and PROM versions. If the PROM version of BASIC is installed, a total of 16 K bytes of systems software resides in a Noval 760.

Consistent with the overall Noval design philosophy, BASIC has been enhanced to take full advantage of system flexibility. Some of the features are graphics character generation and display capabilities; color selection capability; saving and loading programs from cassette tape; listing programs on the printer; fast BCD floating point package; full control of display screen presentations, including cursor positioning; single and double dimensioned arrays; and the ability to call monitor and user assembly language subroutines.

Although the Noval BASIC interpreter is designed to be consistent with the 1974 ANSI standard (which presents a "standard BASIC"), the extra features of this system require some differences. Some of the most useful "extras" of this version concern the use of monitor subroutines and the development of user assembly language subroutines. Noval BASIC allows the user to preset all 8080A registers before a call to an assembly language routine whether it is in the monitor, or user created. Similarly, all registers can be read after the call has been completed. The statement SYS (n) calls system routine number "n." The USER statement provides a similar facility for user defined routines.

About the Manufacturer

Noval was formed about a year ago as a sister company to Gremlin Industries, an established manufacturer of electronic arcade games. The goal of Noval is to provide the personal computing user with the microprocessor technology which Gremlin has developed in-house and refined over a 3 year period. This explains the heavy emphasis in the Noval system on assembly language, graphics and game-oriented features. Additionally, Noval is involved in a continuing research project with the San Diego school system, called Telemath, in which tutorial games are designed around mathematical learning objectives for grade levels 2 thru 6. Out of this effort has evolved a mathematical game library of over 50 programs to date. All Telemath programs are available to Noval system users, as are selected Gremlin Industries arcade games, which until now were rarely seen in homes and offices.■

Interpreting Specs

The effective resolution in each 8 by 8 spot character cell is equivalent to 256 spots horizontally, 224 spots vertically. Keeping one character definition for the "null" (all spots off) condition, and using 255 character definitions for active (nonnull) graphic information, any picture which requires use of less than about 28% of the full screen area for active video information (restricted to the 28 by 32 character cell grid) can be represented. If the picture has repeating subelements which can be programmed into the matrix of character cells, then more of the screen can be covered with meaningful information. Animation graphics can be smoothly represented on this grid by devoting small groups of programmable character cell definitions to picture elements which evolve with time . . . CH

XIMEDIA PRESENTS

The SOROC IQ120

CURSOR CONTROL. Forespace, backspace, up, down, new line, return, home, tab, PLUS ABSOLUTE CURSOR ADDRESSING.

TRANSMISSION MODES. Conversation (half and full Duplex) PLUS BLOCK MODE — transmit a page at a time.

FIELD PROTECTION. Any part of the display can be "protected" to prevent overtyping. Protected fields are displayed at reduced intensity.

EDITING. Clear screen, typeover, absolute cursor addressing, erase to end of page, erase to end of line, erase to end of field.

DISPLAY FORMAT. 24 lines by 80 characters (1,920 characters).

CHARACTER SET. 96 characters total. Upper and lower case ASCII.

KEYBOARD. 73 keys including numeric key pad.

REPEAT KEY. 15 cps repeat action.

DATA RATES. Thumbwheel selectable from 75 to 19,200 baud.

SCREEN. 12 inch rectangular CRT — P4 phosphor.



SPECIAL INTRODUCTORY PRICING

Kit \$ 995.00 Assembled \$ 1,295.00

(Price includes block mode, lower case and 24 line options.)

Specials of the Month

North Star Micro Disk
with power supply and cabinet Kit — \$699
Assembled — \$799

IMSAI I-8080 with TDL ZPU Kit — \$825
Assembled — \$975

Digital Systems FDS Disk Drive with
CP/M Software (assembled only) . Single — \$1,750
Dual — \$2,350

Mountain Hardware PROROM Kit — \$145
Assembled — \$210

Vector Graphic 8K RAM Kit — \$235
Assembled — \$285

**NOW WE'RE
TOLL FREE
800-227-4440**

**(in California, Hawaii, and Alaska, call collect:
415/566-7472)**

Circle 228 on inquiry card.

XIMEDIA OFFERS A FULL RANGE OF PRODUCTS FOR THE PERSONAL COMPUTER ENTHUSIAST AND THE SMALL SYSTEM DESIGNER. LET US QUOTE ON ALL YOUR HARDWARE AND SOFTWARE NEEDS.

OUR RETAIL STORE — THE COMPUTERIST™ — IS NOW OPEN IN SAN FRANCISCO. CALL US FOR DIRECTIONS.

XIMEDIA

1290 24th Avenue, San Francisco, CA 94122
(415) 566-7472

COD orders freight collect. Orders with payment shipped prepaid. California residents add 6% sales tax. Please allow 3 weeks for delivery.

What's New?

Microsoft Announces 8080 FORTRAN IV Compiler

Microsoft has announced a FORTRAN IV compiler for the 8080 micro-computer. Called FORTRAN-80, the compiler is a full implementation of ANSI Standard FORTRAN with the exception of the double precision and complex data types.

FORTRAN-80 provides three data types including: logical (1 byte), integer (2 byte), and real (4 byte floating point). An extended version of FORTRAN-80 with double precision and complex data types is forthcoming.

The compiler generates pure, relocatable code which may be placed in ROM. The run time package may also be placed in ROM. This 1 pass compiler requires less than 12 K bytes of memory,

the run time system less than 6 K bytes.

A relocating linking loader is included with the FORTRAN package so that subprograms may be compiled separately and linked at load time. This also means that only the specific subprograms required are loaded (including system subprograms).

Another part of the package is a relocating assembler and an assembly language debugging program. The assembler may be used to produce FORTRAN compatible subprograms. The debugging system may be used with the load map produced by the loader to debug FORTRAN and/or assembly language programs.

Additional features of Microsoft FORTRAN-80 include:

- Multistatement code optimization.
- Mixed mode expressions.
- All standard FORTRAN library functions for reals and integers.

Individual copies of FORTRAN-80 may be purchased for \$500 including documentation. The manual is \$15; OEM (original equipment manufacturing) licenses are available. Contact Microsoft, 819 Two Park Central Tower, Albuquerque NM 87108.■

Circle 644 on inquiry card.

A New Catalog from E & L Instruments

The Complete Bugworks Catalog is the name of E & L Instruments' new publication describing such items as solderless breadboards, op amp designer modules and socket boards. The Bugbooks series, which teaches electronics and microcomputer theory, is also offered. Copies of the catalog may be obtained by writing to E & L Instruments Inc, 61 First St, Derby CT 06418.■

Circle 651 on inquiry card.

How to Sell Your Product

The Handbook on Marketing for Electrical Engineers is a 127 page soft-cover manual available from Schoonmaker Associates, PO Drawer, Coram NY 11727, for \$25.50. The book discusses the marketing of technical products and covers such topics as product planning, pricing, sales forecasting, publicity and tactics for the small company. Additional titles on related subjects are also available.■

Circle 652 on inquiry card.

Prototype Cards for SWTPC 6800 Bus

Two prototyping boards for either wire wrap or solder-tail and wiring pencil are now available from Personal Computing Company, Dallas TX. These boards are either IO size or memory size. Since they use Molex connectors at the bus interface, they are compatible with the SWTPC bus structure and mother board. In addition, other connectors are provided to allow off board and IO functions.

The cards are arranged in rows of holes with the holes on 0.1 inch (0.25 cm) centers and the rows on 0.3 inch (0.76 cm) centers; no pads are dedicated to either power or ground; however, power and ground buses are provided throughout the card. Bypass capacitor locations are provided to eliminate power line noise. Two regulators can be installed in special locations on the memory size card. The IO size card has provision for one regulator. The memory size card is \$19.95, and the IO size card is \$9.95. Contact Personal Computing Company at 3321 Towerwood, Dallas TX 75234.■

Circle 650 on inquiry card.

Computer Warehouse Store Catalog

The Computer Warehouse Store, 584 Commonwealth Av, Boston MA 02215, is perhaps the largest new and used computer equipment store in the world. Their new catalog (of similar proportions) lists a wide range of brand name kit and assembled computer products. In addition, there is much tutorial information along with microprocessor comparison charts and a multitude of onetime bargains. This is a true computer hacker's "wishbook" of useful equipment and accessories. The catalog is available free from the above address.■

Circle 656 on inquiry card.



**New...
a breadboard
for your
Altair/Imsai.**

HTC 88P kit \$138
write today for specs
Homestead Technologies Corp.
891 Briarcliff Rd. NE Suite B-11
Atlanta, Georgia 30306
dealers please inquire

Circle 234 on inquiry card.

COMPUTER

Telefile makes computers work better and faster. Our company, a leader in the unlimited world of computer enhancement, has the rare opportunity for

- Diagnostic programmer with a minimum of 2 years experience in communications and assembly level programming.
- Technician hardware checkout, P. C. Board and documentation experience required.
- Draftsperson at least 3 years P. C. Board, layout/tape-up, logic diagram or assembly background necessary.

Telefile is the right company at the right time and the right place for the exceptional applicant.

If the challenge of success is your goal, send your resume in complete confidence to:

D. E. White V P of Engineering
Telefile Computer Corp
17131 Daimler Street,
Irvine, CA 92714

We are an equal opportunity employer.

Circle 235 on inquiry card.

**CONVERT ANY TV
TO A HIGH QUALITY MONITOR**



- Hot Chassis or Transformer sets
- 64-80 characters per line
- By-passes tuner & I.F.
- Normal viewing unaffected
- Safe—Easy Installation

ACVM Hi-Resolution \$24.95 ppd
RFVM Ch2-6 Modulator \$9.95 ppd

VAMP INC. Box 29315
Los Angeles, Calif. 90029
Calif. Residents add 6% Sales Tax

Circle 236 on inquiry card.

FLIP OVER OUR FLOPPY



Only \$750 from Peripheral Vision.

Peripheral Vision is a brand-new company that's dedicated to selling reasonably priced peripherals for various manufacturers' CPU's.

We think you'll flip over our first product.

It's a full-size floppy disk for the Altair-Imsai plug-in compatible S-100 BUS. And it's available for as low as \$750.

Here are the features:

- 1 interface card supports 4 drives
- Stores over 300,000 bytes per floppy
- Bootstrap EPROM included—no more toggling or paper tape
- Completely S-100 plug-in compatible
- Interface cabling included
- Drive is from Innovex (the originator of the floppy concept)—assembled and tested
- Interface card design is licensed from Dr. Kenneth Welles and the Digital Group
- Disk operating system with file management system included on floppy
- Cabinet and power supply optional

Prices:	Kit	Assm.
Interface card kit and assembled and tested drive	\$750	\$850
Power supply— +24V at 2A	45	65
Cabinet—Optima, blue	—	85

Now, a little more about our company.

Peripheral Vision may be brand-new, but we have some old-fashioned ideas about how to run our business.

We know there are serious incompatibilities among the different manufacturers' peripherals and CPU's. We want to get them together. And, we want to bring significant new products to market—products consisting of everything from adaptation instructions/kits for hardware and software to major new products.

It's a tall order, but we feel we're up to the task. Peripheral Vision has already obtained a license from The Digital Group to adapt versions of some of their products to the S-100 BUS. And we're working on getting more from other companies.

Most important to our customers, Peripheral Vision is committed to helping you get along with your computer. We'll do all we can to make it easy.

Write us now for all the information on our company, our philosophy and our exciting line of products. And be prepared to flip over all of it.

**PERIPHERAL
VISION INC.**

P.O. Box 6267 / Denver, Colorado 80206 / (303) 733-1678

Send me the works, and I just might flip over it!

Name _____

Address _____

City/State/Zip _____

Circle 237 on inquiry card.



Photo 1: The object of the design exercise documented in this article is an interface between the computer in the basement and the Steinway baby grand player piano shown at the left in this picture. Using the interface of figure 1, and the solenoid valves of photo 2, electronic control of the restored piano will be completed by adding a motor driven bellows unit of later vintage than this 1910 piano. In the picture, various subassemblies have been placed at skewed angles atop the keyboard (spool box and 3 phase wind motor) and underneath (foot operated bellows and pedals). In the restoration of this piano, all the original mechanisms will be preserved, with the electronics interface consisting of an addition to the basic design.

Notes on **Interfacing Pneumatic Player Pianos**

Carl Helmers
Editor

Everyone is familiar with the concept of the player piano, a complex mechanical monstrosity which had its heyday in the early part of this century as the prime home entertainment device before the invention of electronic media which now dominate the home entertainment scene. But player pianos are far from dead. Just as there is an active subculture of computer aficionados, there is a whole cult of player piano and mechanical music freaks. Thanks largely to these people a working player piano is not an uncommon sight in the parlors, dens and

living rooms of contemporary suburbia.

Many of the owners of player pianos may not recognize that these instruments can be a most interesting output device for a personal computer, an output device whose interface can be achieved with very little woodworking and mechanical skill as well as the usual hardware and software skills of the experienced computer hacker.

I have long had an interest in electronic music as generated and controlled by computers. It is this interest which started me on the road to learning electronics hard-



- ANY NUMBER OF FILES MAY BE OPEN (IN USE) AT ONE TIME
- THE NUMBER OF FILES AND SIZE OF FILES IS LIMITED ONLY BY THE SIZE OF THE DISC
- MERGING FILES REQUIRES NO EXTRA DISC SPACE
- NO WAITING FOR THE DISC TO RE-PACK
- LONGER DISC LIFE — MORE EVEN DISC WEAR

Our Basic Floppy Disc System (BFD-68) must, in all modesty be called superb. It comes completely assembled with a disc controller that is plug compatible with the SWTPC 6800. In fact all our products use the 6800 standard SS-50 (Smoke Signal 50) bus used by SWTPC. The cabinet and power supply are capable of handling up to 3 Shugart Mini-Floppy Drives. One drive is included in the price of the BFD-68 and others may be added easily at any time. Or you may save money by ordering the dual-drive BFD-68-2 or triple drive BFD-68-3 (pictured). Price: BFD-68 \$795, BFD-68-2 \$1139, BFD-68-3 \$1479, SA-400 Drive \$360.

The BFD-68 includes our Disc Operating System Software. Our software provides for a soft-sectored disc format consisting of 128 bytes per sector, 18 sectors per track and 35 tracks per disc. The software provides direct commands to name and rename files, transfer memory to disc and disc to memory and to automatically jump to the starting location of any program loaded from disc to memory. The direct command names are: RUN, GET, GETHEX, CLOSE, SAVE, DELETE, APPEND, RE-NAME, COPY, LIST, FIND, LINK and PRINT. In addition, the Disc File Management subroutines are available to create files under your program control.

A bootstrap PROM is included on the controller board to initiate the Disc Operating System which loads into a 4K memory board located at 7000 or optionally at D000. Thus, you can be up and running from a cold start in just a few seconds.

SUPER SOFTWARE

Free patches are provided for SWTPC BASIC version 2.0 and Co-Resident Editor/Assembler. These patches allow the SAVE and LOAD commands to work with the disc or the cassette at your option.

SUPER EDITOR: Smoke Signal Broadcasting now has its own editor. It is a content oriented editor with string search and block move capability. Changes may be made by referring either to line number or string content or a combination of references. Naturally, it is designed for file transfers to and from the BFD-68. Price: SE-1 \$29 on diskette or cassette.

ALL OUR PRODUCTS EXCEPT THE PS-1 ARE COMPLETELY ASSEMBLED.

SUPER ASSEMBLER: Inputs source code from file on the BFD-68 disc system and outputs object code to disc file. Assembly listings include alphabetized and tabulated symbol table. Price: SA-1 \$29 on diskette or cassette.

Complete source listing included for both editor and assembler. Order both for \$53 and save \$5.

SMARTBUG — A CURE FOR MIKBUGITIS: A super smart Motorola-Mikbug replacement that preserves almost all Mikbug entry locations so your present programs will run without modification. Uses ACIA instead of PIA and includes many additional features including a software single-step trace command. A SMARTBUG listing is included and object code is provided on a 2708 free with each P-38 series board purchased. Source listing available separately for \$19.50.

NEED A FULL SIZE FLOPPY? Our P-38-FF is a plug-in interface card to the ICOM Frugal Floppy™. It includes all the features of the P-38-I plus one 2708 EPROM containing the ICOM bootstrap software. Just plug the P-38-FF into your SWTPC 6800 and your ICOM into the P-38-FF and you're ready to use the Frugal Floppy and ICOM's 6800 software package. Price \$299.

Our P-38 is an 8K EPROM board containing room for 8 2708's. Or, you may use it to hold up to 7 2708's plus your Motorola Mikbug or Minibug II ROM. The P-38 addressing is switch selectable to any 8K location. Price \$179.

The P-38-I contains all the features of the P-38 plus an interface to the Oliver Paper Tape Reader and our EPROM Programmer. Price \$229.

The PS-1 Power Supply Kit provides plus and minus 16 volts required for the P-38 series boards. Also, it allows a wiring modification to be made to the 8 volt supply that will increase its output by one volt. Price \$24.95.

Our M-16-A is a 16K single power supply STATIC RAM memory system. The M-16-A is fully buffered and requires only half the power of a similar size system using low-power 2102's. With the M-16-A, you can expand your system to 48K and still have room left for one of our EPROM boards. The M-16-A is switch selectable to any 4K starting address and hardware write protect is included. Quick delivery. Price \$529.

BANKAMERICARD, VISA AND MASTER CHARGE WELCOME.



SMOKE SIGNAL BROADCASTING

P.O. Box 2017, Hollywood, CA 90028 • (213) 462-5652

Circle 238 on inquiry card.

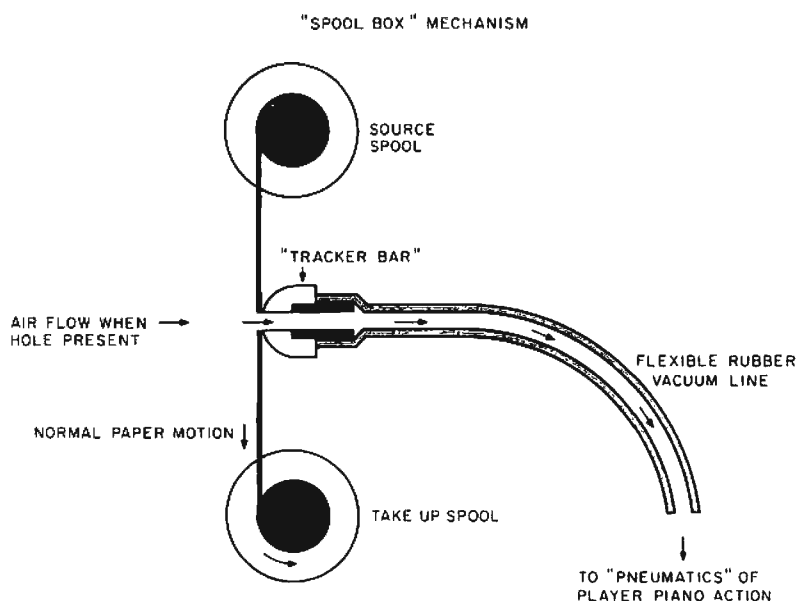

Figure 1: The normal arrangement of a player piano's vacuum control system is illustrated here. A player piano roll moving past a "tracker bar," analogous to a magnetic tape recorder's read head, turns on and turns off a flow of air into the evacuated control line which goes to one of the pneumatic controls of the piano. For the key mechanisms, the leading edge of loss of vacuum cues the striking of a key, which is held down until vacuum is restored. This occurs when the roll passes to a point which closes off the particular line. For control of a full 88 notes, there are 88 separate "channels" in the tracker bars of the more sophisticated players, not counting additional channels to control dynamics, pedals and other special effects.

ware skills needed to build computers for music control.

I also knew that player pianos existed, and would eventually make an interesting experiment for use with electronic music in programmed performances of concerto style works with orchestral background for the solo instrument provided by electronics. But I had never turned my attention to the details of the piano interface problem until one day in October of 1976 when I went to an estate auction in nearby Milford NH at which a 1910 Steinway-DuoArt baby grand player piano (in unplayable condition) was put on the block. After outbidding a mechanical music box museum owner from Maine, I had the potential for the ultimate piano. When the piano is eventually restored, it will provide my personal and computer music systems with a piano output device which, incidentally, can be used for normal piano rolls, normal practice under direct manual control of the keys, and under computer control using an interface to be described in this article.

The piano, which is shown in photo 1, gave me the impetus needed to examine in more detail the problem of controlling a

pneumatic vacuum line with the output of a computer. Figure 1 shows a schematic illustration of the essence of the typical player piano's control mechanism. The player piano roll passes over what is called the "tracker bar" in the jargon of that technology. This tracker bar has one hole for each active key of the piano as well as auxiliary holes for various other types of information which may be encoded on the rolls. When a hole in the roll passes the hole in the tracker bar, the vacuum line associated with the hole is opened to outside air. This release of the vacuum in the line triggers one of the "pneumatics" in a bank under the piano, which is basically a vacuum operated buffer amplifier with enough output power to toggle a key or actuate some other mechanism. The operation of the "pneumatic" is of no great concern at this point, since all we need to know is that if the vacuum line is opened, the key will be struck, and that if the vacuum line is closed, the key will be released and the device will charge up with vacuum, waiting for the next time that key is to be actuated. The conversion to electronic control is simplest if we just adapt the existing mechanism by plugging up the tracker bar holes (temporarily during electronic performance) and adding a "T" junction to each control line so that an electronic control valve can simulate the opening of the vacuum line. Figure 2 shows this adaptation of the usual vacuum line arrangement for electronic control.

Figure 2 also shows schematically the physical arrangement of a flap valve. As I began looking into the problem of controlling air flow, I quickly learned about the existence of electrically controlled pneumatic devices used in pipe organ and piano technology. It turns out that there is a company called Reisner Inc, which among other items makes a specialty of manufacturing and selling control valves for player pianos and pipe organs. Photo 2 shows the model for the schematic rendition in figure 2, a Reisner No 601-90 magnet with 5/8 inch valve mounted for the purpose of testing on a scrap of pine board, with a metal standoff used as the junction fitting to connect to the vacuum line. The Reisner subassembly consists of everything you see attached to the metal frame which is screwed to the top of the wood block: the magnet, the upper valve seal with cushions for sound dampening, and the return spring. In adapting this unit to a player piano's purposes, a bank of these valves is required, with a number depending upon the details of the particular piano. (For more complete

CP/M

LOW-COST MICROCOMPUTER SOFTWARE

CP/M is a low-cost control program for microcomputers which brings together recent advances in computer and peripheral technology. CP/M is an advanced disk operating system designed for use with IBM-compatible diskette-based computer systems which employ the Intel 8080 microcomputer. Previously available only to OEM's, CP/M has been in existence for over three years in various manufacturers' products, and has undergone extensive field testing. The functions of this software package include named dynamic files, program editing, assembly, debugging, batch processing, and instantaneous program loading, resulting in facilities similar to popular timesharing services. CP/M is an "unbundled" software package which can be easily adapted to any 8080 or Z-80 computer system with at least 16K of main memory and one or two IBM-compatible disk drives. The field-modification manual provided with CP/M has been used successfully by many CP/M users in customizing CP/M for their own hardware configurations.

DIGITAL RESEARCH

Please send me the following:

- CP/M Documentation (Complete set of 6 manuals) for \$25.00.
- CP/M Documentation and CP/M System Diskette for \$70.00.
- Free CP/M brochure and price list.
- Information concerning high level languages and optional packages.

NOTE: IMS Associates and Digital Systems distribute CP/M with their hardware systems.

- Bank Americard No. _____ Exp. date _____ Master Charge No. _____
Exp. date _____ Check or M.O. enclosed.

California residents add 6% sales tax. Amount enclosed _____

Name _____ Address _____

City _____ State _____ Zip _____

DIGITAL RESEARCH Post Office Box 579 • Pacific Grove, California 93950



Photo 2: A test jig used to try out the magnetic control valve concept. The Reisner No. 601-90 magnet with 5/8 inch valve is mounted on a wood block using wood screws. In a final installation as part of a multiple valve attachment to a player piano's penumatics, one such valve would be assigned to each control tube of the piano.

information on these valves, contact Reisner Inc, 240 N Prospect St, POB 71, Hagerstown MD 21740.) The physical mounting of the valve magnets, tubing, etc, depends upon the particular piano being converted. In the case of my baby grand player, an equipment chest will probably be attached under the sounding board in back of the presently installed pneumatics chest. Some woodworking ability and some mechanical handiwork are required in the fabrication of a bank of valves and in making the interconnections to the vacuum lines.

Electrical Drive and Interface

The era of integrated circuits simplifies the basic problem of controlling the sole-

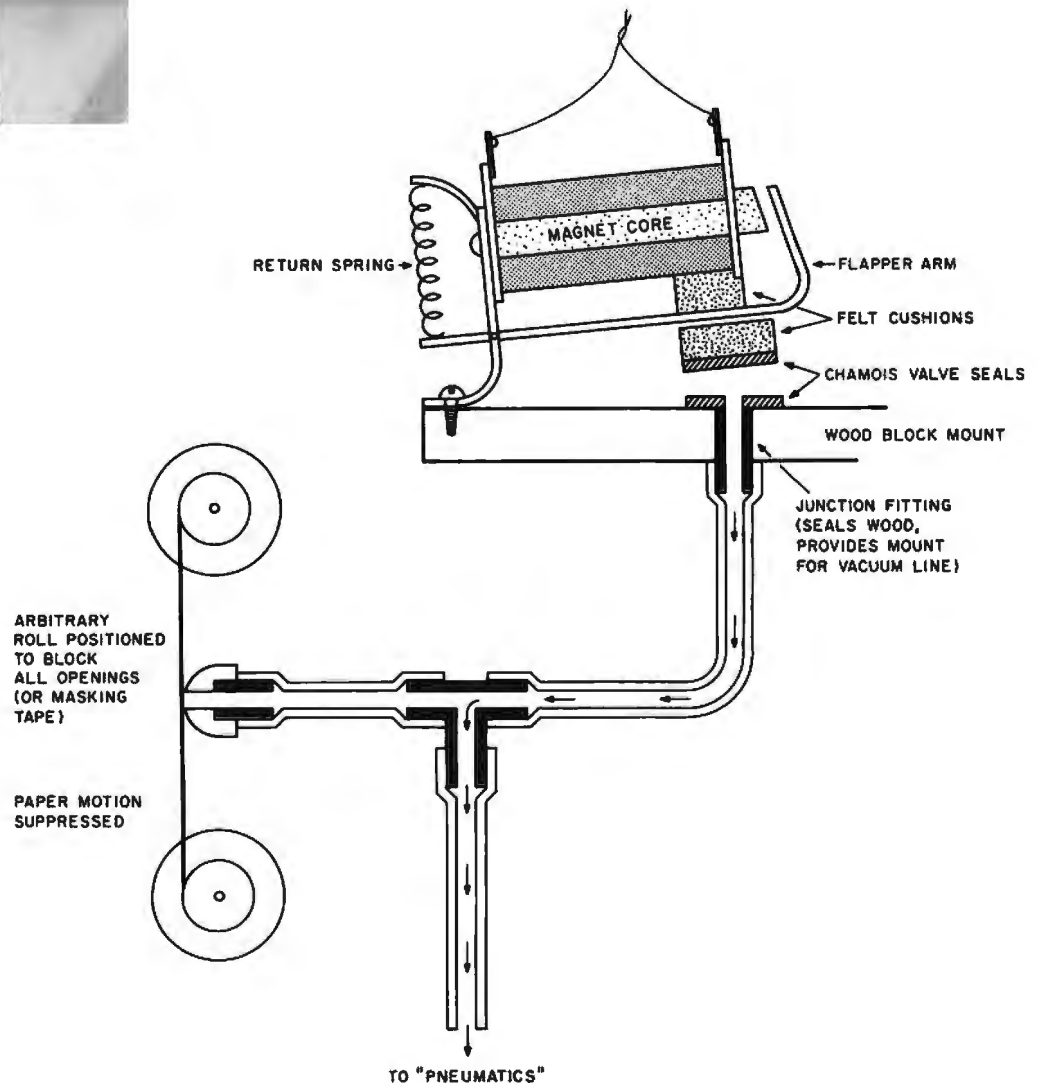

Figure 2: Adapting the player piano mechanisms for computer control is accomplished using Reisner magnets and flapper valves. Each tube from the tracker bar is modified with a "T" junction which allows an alternate control point on the vacuum line. When the piano is run in computer control mode, all the holes in the tracker bar are sealed and the solenoid controlled valves simulate the effects of the roll's passage over the bar. The sealing of the bar can be accomplished by pasting a run of masking tape over the bar or by disabling the spool box's drive motor and positioning a roll's leader over the tracker bar to close all the holes. For details of the valve, see photo 2. A basic interface drive circuit for the solenoid is shown in figure 3.

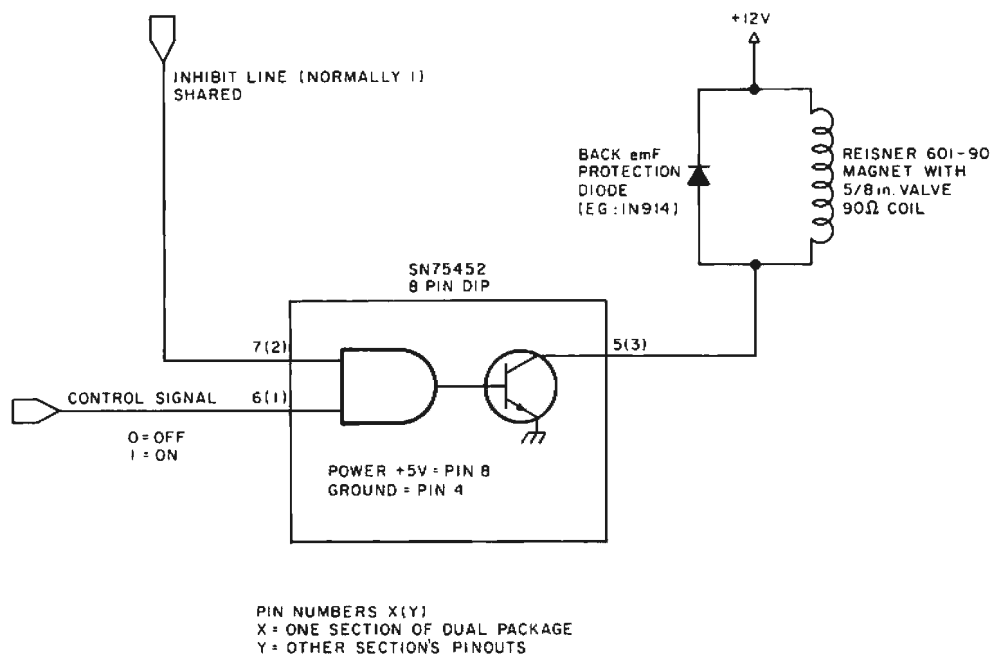

Figure 3: The basic magnet drive circuit used for the pneumatic player piano interface. The driver circuit shown here is a Texas Instruments SN75452, a dual peripheral driver which comes in a miniature 8 pin dual in line package. Each driver has a maximum capability of sinking 300 mA in the low level output state (logical 1 input which "turns on" the magnet). With the nominal 90 ohm coil and a low level output of 0.25 V the coil will have 11.75 V across it. The current through the coil is thus 130 mA, more than enough to actuate the valve based on experiments with the unit shown in photo 1 which was tested against a vacuum applied to valve through the rubber hose.

noids of the Reisner magnet valves. The solenoid coil has a resistance of nominally 90 ohms, and from the specification sheet (confirmed by tests in my laboratory) the valves can be actuated under load with a current higher than about 100 mA (about 9 V across the magnet). Using the *Texas Instruments Linear and Interface Circuits Data Book* as the source of information, it soon became apparent that the 75452 peripheral driver circuit (or its cousin, the 75451) would prove quite adequate for the job since it can sink 300 mA and has a maximum voltage rating well above the voltage required for the actuation of the magnets. The basic circuit for driving a solenoid with the 75452 integrated circuit is shown in figure 3. In this illustration, I have shown one of the two gate inputs as an inhibit signal (normally at logic level 1) and the other input pin as the control signal defined so that if it is low (logic 0) the magnet is off (valve closed) and if it is high (logic 1) the magnet is on (valve open). The diode mounted on the solenoid coil is an absolute requirement. These magnets have a considerable inductance, and as a result when the current is removed will generate a

substantial back EMF which can damage the 75452 output transistor if it is not shorted out by the diode. (The inductance is sufficient to cause an impulse which can be felt by the observer if fingers are held across the coil while the voltage is removed. This suggests a minimum of 50 to 100 V of inductive "kick.")

Logic of a Practical Interface

The brute force technique of interfacing the piano would be to simply put one wire from a latched output bit to each driver of the piano magnets, resulting in roughly 80 to 100 twisted pair interface data paths in a monstrously thick cable. This is an unwieldy mess. The problem is shared by pipe organ aficionados, as I found out from Jeff Raskin's lecture at the First West Coast Computer Faire's session on computers and music in April of this year. At that time he suggested the use of a serial technique to define the state of a bank of control valves. Basically, the technique consists of using serial synchronous transmission from the computer to cut down on the immense number of lines which would otherwise be required. Figure 4 shows a detailed sketch of

QUAN-TRONICS

COMPUTER PRODUCTS
READY FOR IMMEDIATE DELIVERY

IMSAI COMPUTER

MODEL 8080 MICROPROCESSOR SYSTEM

\$875

ASSEMBLED
AND TESTED

INCLUDES CPU, MAINFRAME WITH 22 CARD SLOTS, FRONT PANEL,
AND POWER SUPPLY. COMES ASSEMBLED AND READY TO PLUG IN AND ENJOY!

8K RAM BOARD

\$225

250 nS
ACCESS

LOW
POWER

NOT A
KIT

ASSEMBLED
AND TESTED

- S100 BUS: PLUGS RIGHT INTO ALTAIR/IMSAI, OR ANY COMPUTER USING THE "ALTAIR" BUS.
- CONVENIENT DIP SWITCH SELECTION OF ADDRESS ASSIGNMENT AND WAIT CYCLES
- MEMORY PROTECTION DIP SWITCH SELECTABLE IN INCREMENTS OF 256, 512, 1K, 2K, 4K, or 8K BYTES
- FULLY BUFFERED ADDRESS LINES ALLOW USE IN LARGE COMPUTER SYSTEMS

16K 2708 EPROM BOARD

\$99

INCLUDES ALL SUPPORT CIRCUITRY AND SOCKETS READY TO PLUG-IN 16 2708 IC'S

2708'S NOT INCLUDED

- ALLOWS CONVENIENT STORAGE AND ALTERATION OF YOUR OWN CUSTOMIZED COMPUTER PROGRAMS
- S100 BUS: PLUGS RIGHT INTO ALTAIR/IMSAI, OR ANY COMPUTER USING THE "ALTAIR" BUS
- DIP SWITCH SELECTION OF MEMORY ADDRESS ASSIGNMENT
- DIP SWITCH SELECTION OF MEMORY WAIT CYCLES
- ASSEMBLED AND TESTED, NOT A KIT

8K 2708 EPROM PROGRAMMER BOARD

\$145

COMPLETE SYSTEM FOR "BURNING IN" PROGRAMS INTO THE
ELECTRICALLY ALTERABLE 2708 MEMORY

2708'S
NOT INCLUDED

- S100 BUS ALTAIR/IMSAI COMPATIBLE
- COMPLETE 2708 PROGRAMMING SYSTEM
- DOUBLES AS 8K NON VOLATILE PROGRAM STORAGE
- ASSEMBLED AND TESTED, NOT A KIT

2708 EPROMS \$19⁹⁵ 21L02 250 nS \$1⁹⁵

TOP QUALITY PARTS — NOT SECONDS

**74 SERIES IC's
74LS SERIES IC's
LINEARS**

**COMPLETE LISTINGS
IN OUR CATALOG**

ORDER BY PHONE: (213) 888-5079

OR BY MAIL

QUAN TRONICS

P.O. BOX 264
CHATSWORTH, CA 91311

Many other parts available — Just call or write for free catalog

IN THE L.A. AREA PRODUCTS AVAILABLE AT:

TECH MART

19590 VENTURA BOULEVARD
TARZANA, CALIFORNIA 91356
(213) 344-0153

NEW PRODUCTS COMING — WATCH FOR OUR ADS — INFORMATION AVAILABLE

WE WELCOME INQUIRIES

Circle 241 on inquiry card.



Print Your Heart Out.

With help from the Digital Group, naturally.

Now, that small computer system you own or have been considering for personal or business use suddenly becomes a lot more usable—with the addition of a full-size impact printer from the Digital Group. A printer designed for small computers that need big output (like yours).

With the Digital Group printer, you can print your heart out...and it won't cost an arm and a leg. The Digital Group printer is available for less than \$500. That's right—\$500.

There are lots of capabilities and outstanding features of the Digital Group printer...and (as always) the best news is our price. Kit prices start as low as \$495 for the printer and interface card. It simply can't be beat.

Find out all the facts about the Digital Group printer now. Just fill in the coupon below or give us a call for the details. We think you'll find a place for our printer in your system ...and in your heart.

Circle 242 on inquiry card.

Just look at these specifications:

- **Fast**—120 characters per second
- 96 characters per line
- 12 characters per inch horizontal
- 6 lines per inch
- Makes up to 4 copies simultaneously
- Character set and pitch variable under software control—double width characters, etc.
- 5 x 7 character matrix
- Ribbon has built-in re-inkers for a life of 10,000,000 characters
- Paper can be either a standard 8½-inch roll, fanfold or cut page
- Interfaces to 8-bit parallel ports

the digital group

P.O. Box 6528
Denver, Colorado 80206
(303) 777-7133

Quick. I want to print my heart out.
Send me all the details on your full-size impact printer.

Name _____

Address _____

City/State/Zip _____

Please print.

Notes on Anatomy:

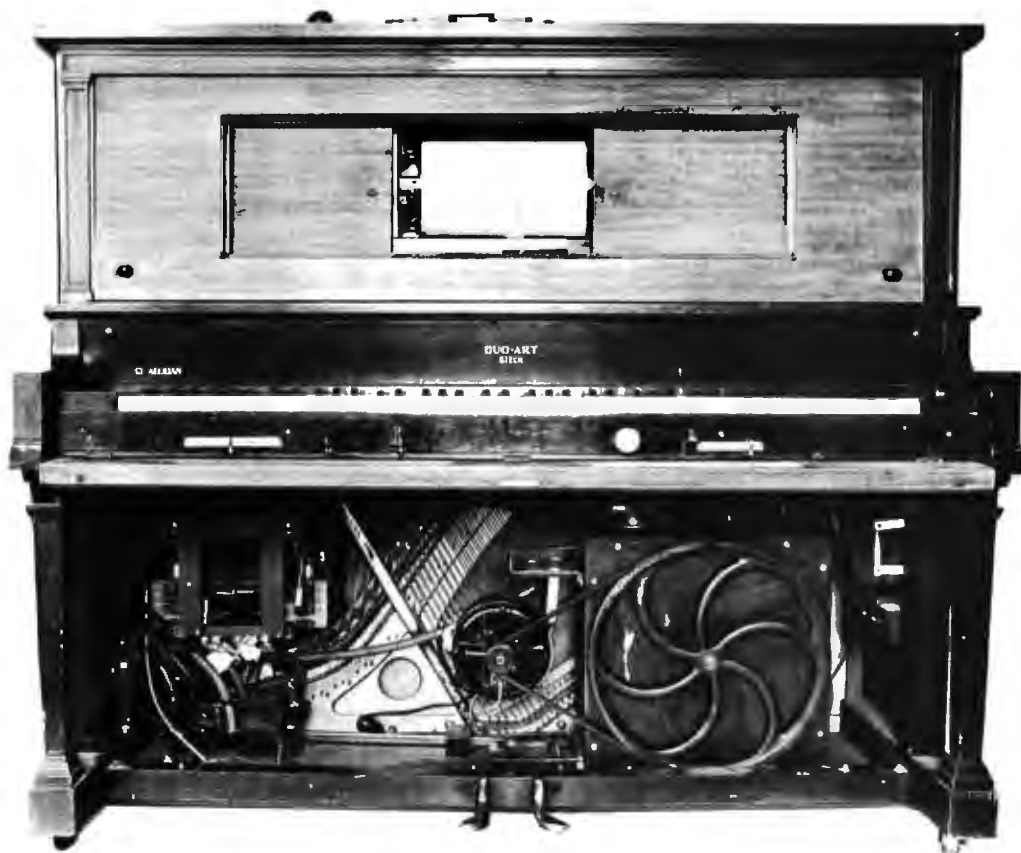

Photo 1: The Duo-Art reproducing player piano as it is currently displayed in my home. Notice the electric motor at bottom center. It is original equipment. The vacuum pump is at the right; it is connected to the motor by a 1968 V8 Buick fan belt, which just happens to be a perfect fit. The piano was built in 1925 and required extensive renovations. The binary dynamics control system is located at bottom left (see photos 3a and 3b).

The Piano's Reproductive System

By Chris Morgan, Editor

When was the binary number system first used for control purposes in a mass produced machine? The early nineteenth century Jacquard punch card controlled loom comes immediately to mind; but, surprisingly enough, a more widespread application occurred in the first quarter of this century: the reproducing player piano!

The reproducer was so-called because it went one step beyond the player piano in its ability to "reproduce" the dynamics and subtle shadings of the pianist who recorded the roll.

I have owned a Duo-Art upright reproducing piano for five years now (see photo 1), during which time I have restored it so that it can now play the specially encoded Duo-Art rolls which were made for it. The Duo-Art roll catalog was remarkably extensive, featuring such items as Chopin etudes and Beethoven sonatas

in addition to a large selection of popular titles. (The *pièce de résistance* was a complete set of themes from Wagner's Ring cycle comprising some 30 odd rolls!).

Reproducers were a luxury item during the 1920s, and for good reason: they were built like fine watches and contained some fairly sophisticated features (for the time) to control dynamics, operate the pedals, and so on.

Photo 1 shows the Duo-Art with the bottom cover removed for clarity. The spool box (photos 2a and 2b) is located at the top and is the place where the piano roll is inserted. Immediately below the keyboard are the levers which are used to control the speed of the roll as it plays, as well as volume and roll rewind. At the bottom center is the original electric motor (built in 1925) which drives the vacuum pump at the right. No pedalling is required on this

model, a boon for the lazy experimenter. Like most player pianos, the Duo-Art works on a vacuum actuated system which opens and closes cloth covered "pneumatics," or bellows. These in turn do all the mechanical work inside the piano, such as playing keys and operating pedals.

But what makes the Duo-Art so interesting is its binary-based volume control system located in the lower left section of the piano (see photos 3a and 3b for a close-up). There are two independent volume control systems built into the Duo-Art. They are controlled by two sets of four holes per set, located above the main row of holes near each end of the tracker bar. Photo 4 shows the right-hand set of holes in enlargement. Notice that they are vertically in line with the four highest note sensing holes on the tracker bar. When a Duo-Art roll is played, therefore, a special pneumatic 8 pole double throw switch must be thrown to disable the lower two sets of four holes and allow the upper two sets of four holes to control piano dynamics (the volume of sound heard).

Each set of holes is connected to a set of "accordion" pneumatics, so-called because they open and close like vertical accordion bellows. A rod at the top of each pneumatic is connected to an air governor. As the pneumatics close, the governor admits more and more air to the system and the volume of the notes played on the controlled side of the keyboard goes up.

The spacings of the four sections of the pneumatics are $1/2$, $1/4$, $1/8$ and $1/16$ inch, so that 16 different volume levels can be achieved. This bellows is in fact a form of mechanical digital to analog converter. So we have two nybbles (or one byte) of information to control volume in a Duo-Art reproducer piano. Photo 3b shows a level corresponding to $1/2 + 1/8$, or $10/16$ ths of maximum volume, and photo 3a shows a zero level for comparison. Photo 5 shows the roll positioned to produce the level of photo 3b; the most significant bit is to the left. Since an opening (hole) corresponds to a binary 1 level, the binary number here is 1010.

Counting from the right in photo 4, the first 3 holes are mute pedal control, automatic reroll and the "theme" hole. The theme hole is an ingenious feature. There are often cases when the piano must suddenly change volume levels for isolated notes or chords and then return to the previous level. It takes a finite time for this sort of change, so the rolls are designed to allow the



Photo 2a: The spool box, showing the brass tracker bar. There are 88 holes across the bar, corresponding to the notes of the piano. There are additional holes at each end to input two 4 bit "nybbles" of information to the dynamics (volume) control system from the paper roll.

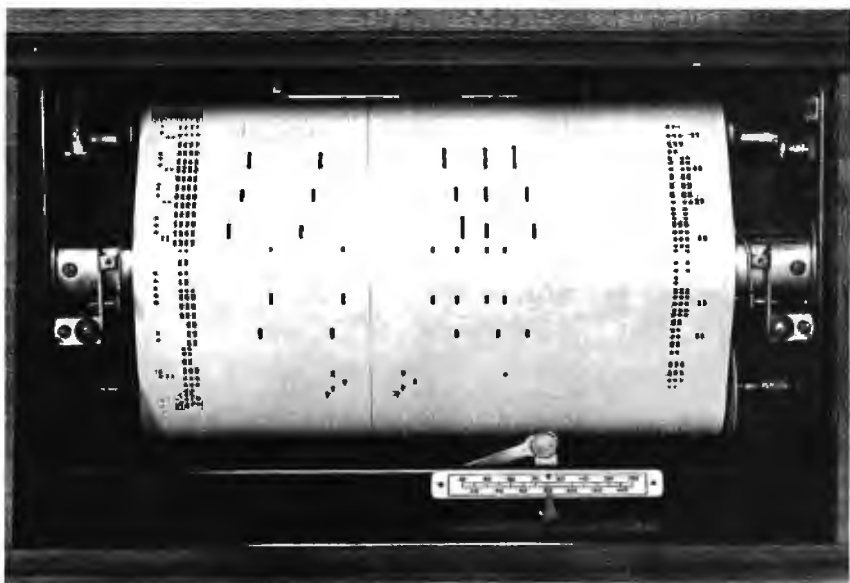

Photo 2b: A view of the spool box with a Duo-Art roll installed. Note the dense groups of holes at each side of the roll; these contain binary encoded information about the volume of the notes which are being played. All four dynamics holes are about to be uncovered on the left side as the roll paper moves downward across the tracker bar. (Thus maximum volume is about to be set up.) The dynamics holes appear as groups of holes rather than long slots so that the paper will not fall apart. The tracker bar holes underneath are long enough so that the small paper bridges left for mechanical strength do not close up the holes as they pass over them.

left-hand accompaniment dynamics control system to control the entire keyboard range, while the right-hand theme system "charges" itself with vacuum for the up-



Photo 3a: One of the two Duo-Art accordion pneumatics used to control the volume of one half of the piano keyboard. Each of the four chambers can be individually exhausted under control of the piano roll. The pneumatic is connected by a rod on top to an air governor. The four chambers close by 1/2, 1/4, 1/8 and 1/16 inches, so that the air governor can be set to any of 16 different vacuum levels to power the keyboard pneumatics. The roll's 4 bit binary "word" is thus translated into a vacuum level: in effect, this is a digital (vacuum lines from tracker bar) to analog (mechanical position of governor) converter.



Photo 3b: The accordion pneumatic shown converting the integer value 10 into one of 16 possible mechanical positions. This corresponds to the binary number 1010 on the roll. See photo 5.



Photo 4: A closeup illustrating the four right hand dynamics control holes, located slightly above the center line of the rest of the holes.

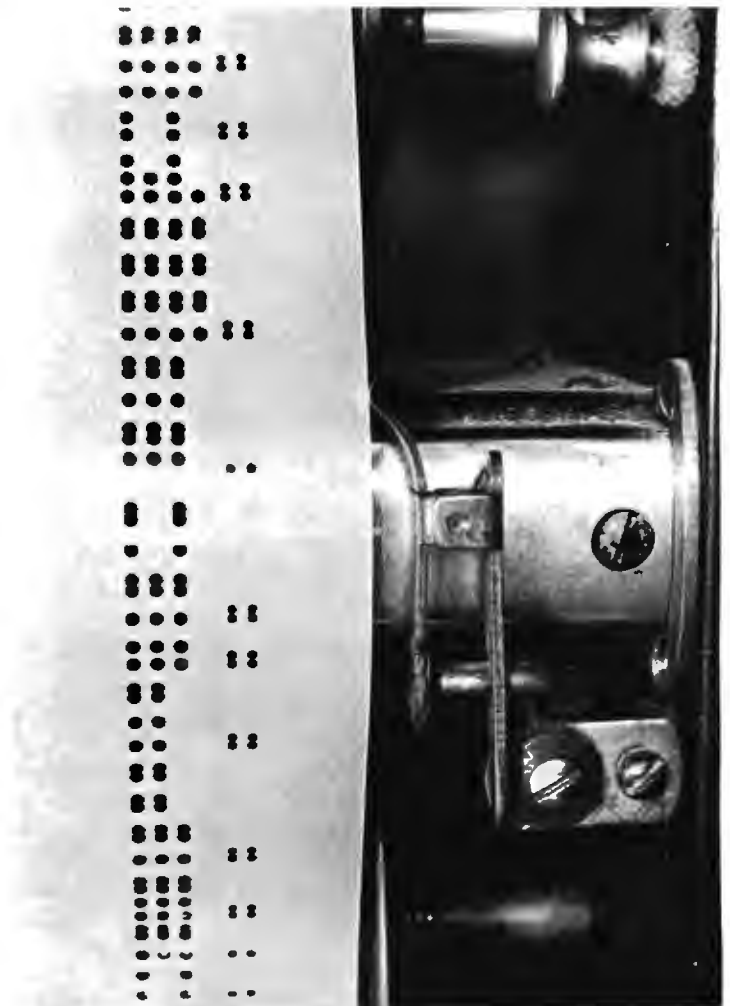

Photo 5: The roll in this case is outputting level ten to the accordion pneumatics. Photo 3b indicates the resulting mechanical position output of the pneumatics.

coming volume change. When the roll triggers either or both of these holes, control of the respective sides of the keyboard is transferred for that instant to the theme control. Details of this theme control system are essential to the design of software drivers for Duo-Art players converted to computer control.

Numerous other fascinating features abound on this instrument. Take for example the automatic roll-centering negative feedback system. The curved vertical "finger" shown in photo 5 is one of two which are positioned to just touch the edges of the roll. If the roll wanders off to the right or left, the fingers tilt back, uncovering air tubes which are under vacuum. This sends a signal to a set of opposing bellows with a high damping ratio, which push the roll spool back until the air tube is covered again. The design is simple, yet effective. Long before Norbert Wiener made it explicit, servomechanisms as control systems were in practical daily use.

Just how good does the Duo-Art sound? Well, it has some obvious limitations (limited dynamic range, for one), but on the whole it sounds remarkably good. The sound

quality is several orders of magnitude better than the "new fangled" phonograph which eventually supplanted it commercially.

In its heyday, the Duo-Art Company could afford to hire some of the most famous pianists of the age to record for them: Paderewski (see photo 6), Wanda Landowska, Vladimir Horowitz (when he was in his twenties), Igor Stravinsky (!), George Gershwin (playing his own four-hand arrangement of "Rhapsody in Blue" by overdubbing), and on and on. The rolls were beautifully decorated, too (see photo 6).

Readers wishing to find out more about the fascinating hobby of reproducing pianos should write to the Vestal Press, POB 97, Vestal NY 13850, and ask for their catalog. The Vestal Press specializes in books about player pianos and other musical automata. The Player Piano Company in Wichita KS is an excellent source of supplies for the do-it-yourself restorer. The current bible in the field is *Rebuilding the Player Piano*, by Larry Givens, published by Vestal. In it you'll find valuable material about the Duo-Art and about the other brands of competing reproducers like the Ampico and Wurlitzer models. But that's another story. ■

Photo 6: A Duo-Art roll of Chopin's "Polonaise, Opus 40, Number 1," as played by Paderewski, in position over the tracker bar. Note the extensive ornamentation, both visually and verbally, in the form of the performer's authorization of the work. This roll is approximately 55 years old. Paderewski was a link in a list of salon pianists which began in America with Louis Moreau Gottschalk, and which continues to this day with certain candleabra wielding virtuosos.



A note on the organization of this article: Because of the large number of figures in this article, the procedure used in part 1 last month is continued this month, ie: the text has been incorporated into the figure and table captions. We hope this will eliminate unnecessary page turning. The figure and table numbering sequence used in this installment continues the sequence begun in the first part. The final part of this 3 part article will appear next month.

Mike Wimble
6026 Underwood Av SW
Cedar Rapids IA 52404

An APL Interpreter for Microcomputers

The Great APL Interpreter Contest

As an incentive to those experimenters who would like to try writing their own APL interpreters based on this series of articles, BYTE announces the Great APL Interpreter Contest. We will award prizes for APL interpreters (suitable for publication with royalties to authors) based on Mike's flowcharts (or independent of them if you prefer).

Contestants are free to write their interpreters for any microprocessor they choose. Entries will, however, be judged on their suitability for use on small systems with a minimum of 16 K bytes of memory, as well as on programming elegance and efficient use of space. All of these factors should therefore be kept in mind.

Entries should be addressed to BYTE, attn: The Great APL Interpreter Contest, 70 Main St, Peterborough NH 03458 and must be postmarked no later than midnight, February 28 1978. Entries must be in the form of a publication quality manuscript which describes the implementation of the interpreter and which includes a listing of source code and object code. Contestants should also submit machine readable source and object code in the form of paper tape or cassette.

The winners (if any) will receive \$1000 plus normal author payments, should the entry be chosen for publication in book form or as an article in BYTE. We reserve the right to choose more than one winner under the same terms.

Judging will be done by the editors of this magazine. Those seriously interested in entering this contest should call Carl Helmers or Chris Morgan at BYTE, 603-924-7217. May the midnight oil burn prosperously for all.

Part 2: Evaluation Expression

Backus-Naur Form (BNF)

BNF is a notation used quite often in the description of computer language grammar and semantic information. Many of the figures in this series of articles contain a short BNF description of the formal elements of APL treated by the flowchart in question. A BNF statement looks like:

$$\langle A \rangle ::= \langle B \rangle | \langle C \rangle | \langle A \rangle \langle B \rangle$$

In BNF, brackets (" < " and " > ") are used to enclose tokens or "terminal elements," and the symbol " :=" means "may be composed of." The symbol " | " is the notation of a logical "or." This notation was first developed for the description of the ALGOL language, and has since been used widely in numerous books and papers on language design and compiler writing. The example statement above can be translated into words as follows:

"An A token is composed of either a single B token, or a single C token, or an A token followed by ("concatenated with") a B token."

There is no restriction against possible recursion in BNF syntax descriptions, a feature which allows very simple language constructs to form very complicated statements which can be correctly parsed by the interpreter or compiler.

Figure 11: The logic of the statement interpreter. At this level the interpreter recognizes the two valid forms of a statement: either an expression, or a right arrow followed by an expression. When interpretation begins, variable I points to the rightmost byte in table SP of the immediate statement to be executed. Subroutine E is invoked to recognize and interpret an expression, setting B to true if a valid expression is found, and setting B false otherwise. If an expression is found, a test is made for a right arrow occurring at the beginning of the statement. If found, subroutine BRANCH is invoked to interpret the program branch. Otherwise, subroutine SUCCESSOR is invoked to interpret an advance to the next statement.

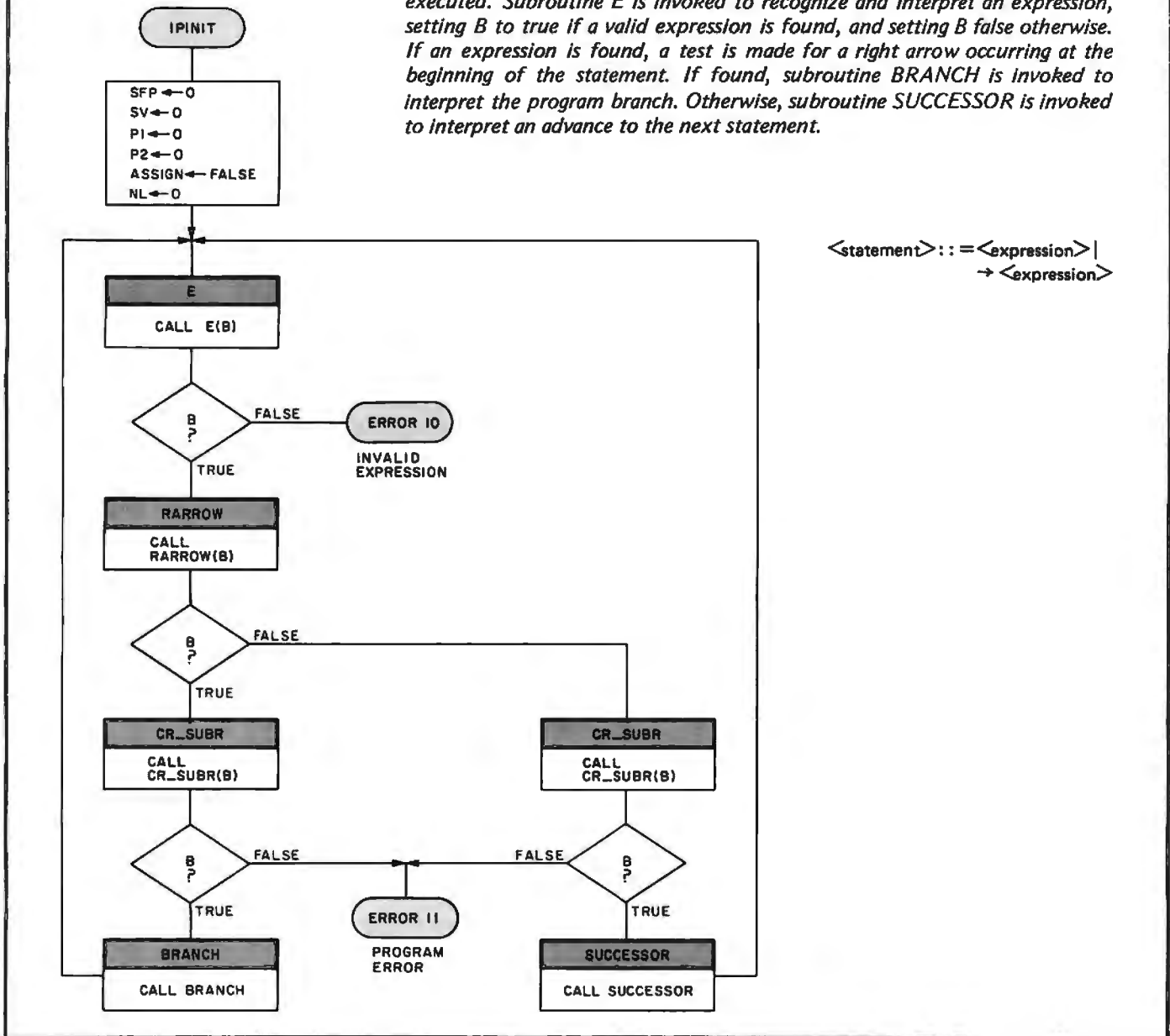

$\langle \text{statement} \rangle ::= \langle \text{expression} \rangle | \rightarrow \langle \text{expression} \rangle$

Table 8: A table of tables built and used by the statement interpreter. Whenever a subroutine is invoked, SFP is incremented by 1 and table SF is modified. SFP then indicates the current level of nesting or of recursion. If SFP is 0, the interpreter is presently executing a syllable in the immediate mode statement. Pointers to the value of operands for the various operators are stacked in table SVAL much as in any stack-oriented expression evaluator. Tables SD1 and SD2 are used to hold pointers to the right and left arguments of a function call.

Table	Indexed By	Element	Description
SF	SFP		Holds information for subroutine calls.
		S1	Points to FTAB entry of subroutine invoked.
		S2	Value of I (last interpreted syllable pointer) for calling subroutine.
		S3	Statement number of calling subroutine at time of subroutine call.
SVAL	SV		Holds stacked pointers to value of operands.
SD1	P1		Holds stacked pointer of left actual parameter.
SD2	P2		Holds stacked pointer of right actual parameter.

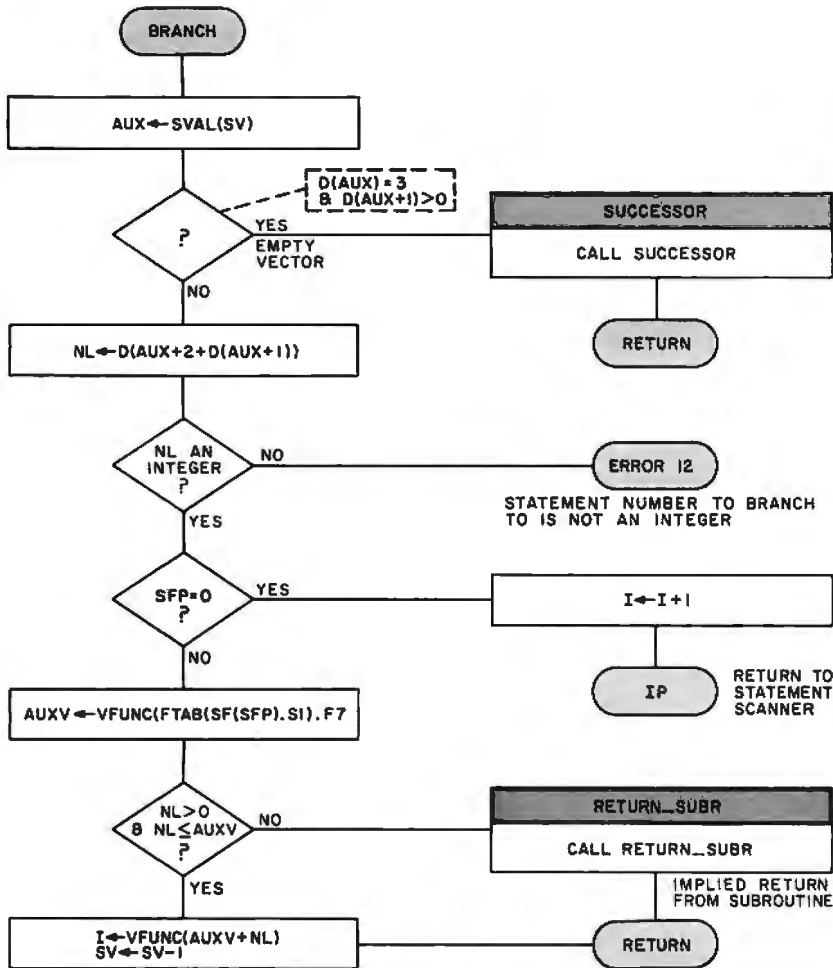

Figure 12: The logic for interpretation of a program branch, ie: a right arrow followed by an expression. A pointer to the result of that expression is in the top of stack SVAL. The result must be an integer equal to the statement number of the desired statement to be executed in the current subroutine. If the result is an empty vector, then the branch is simply to the next statement. A noninteger result is an error. An attempt to branch while not in a subroutine is ignored and control is returned to the statement scanner. Finally, a branch to a statement number not in the current subroutine results in a return from the subroutine.

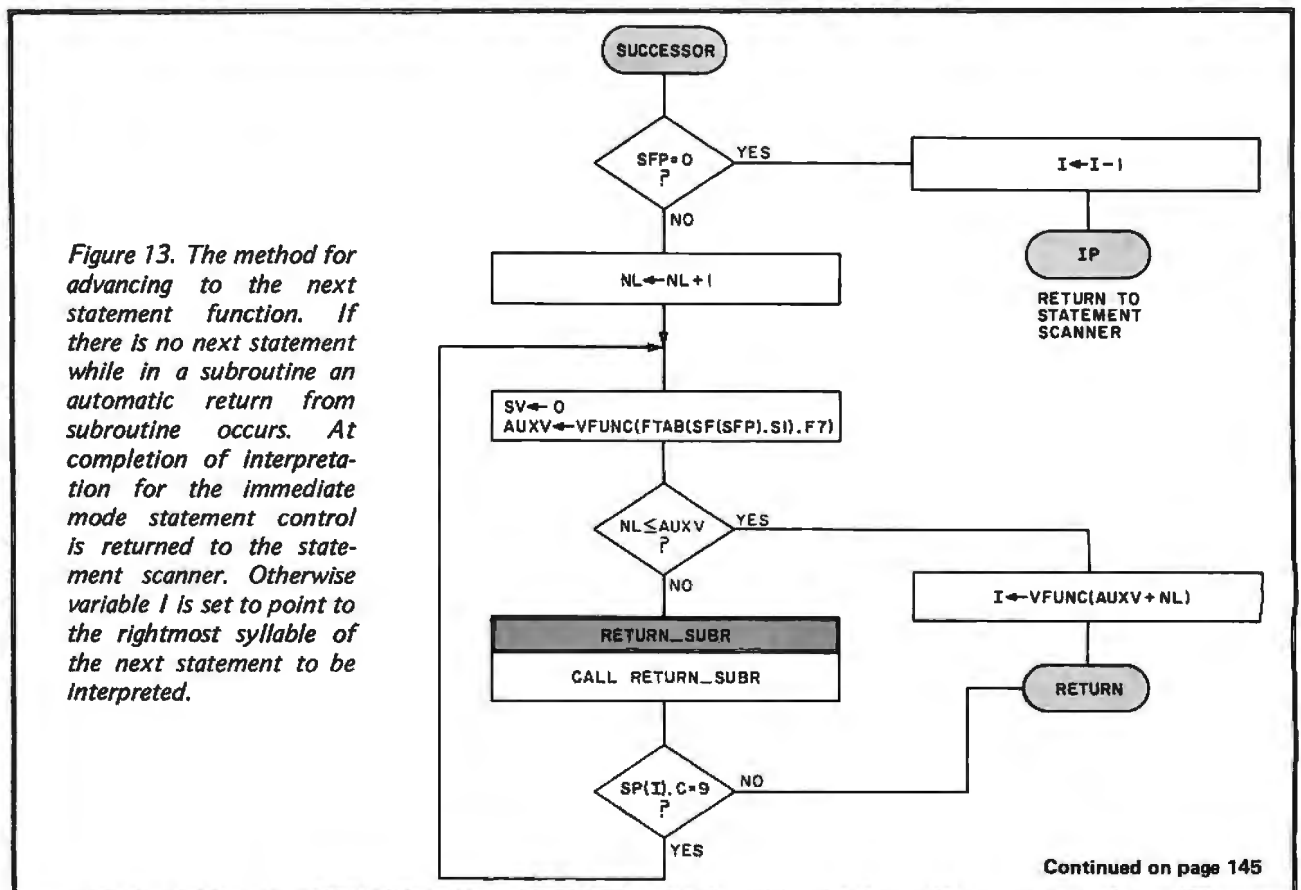

Figure 13. The method for advancing to the next statement function. If there is no next statement while in a subroutine an automatic return from subroutine occurs. At completion of interpretation for the immediate mode statement control is returned to the statement scanner. Otherwise variable I is set to point to the rightmost syllable of the next statement to be interpreted.

Continued on page 145

Introducing HEATHKIT® COMPUTERS

A new value standard in personal computing systems featuring two powerful computers with better software, full documentation and service support from the Heath Company.

Heath Company has been interested and involved with personal computing since we first marketed an analog computer system all the way back in 1957. This continuing interest, along with the recent technological advances that have brought personal computing to the forefront of the electronics marketplace, has given us the opportunity to think through the recent developments, and develop two "total design" computer systems that give the computer hobbyist, whether beginner or advanced, everything needed for REAL power, performance and reliability — at prices that give you MORE value and performance for your computer dollar!

Total system design. The Heathkit computer line, both hardware and software, has been designed from the ground up to be a total computing system that meets all the needs of the computer hobbyist. The two mainframes are based on performance-proven well-documented MP modules, the 8080A and LSI-11. Using these CPU's was a conscious design decision, because of their proven performance, reliability and efficiency, and the tremendous amount of existing applications programs, documentation and source materials that are available. The Heath-designed CRT terminal, paper tape reader/punch, serial and parallel interfaces make total system setup easy and fast, and the Heath-designed software provided assures immediate usefulness and versatility.

Superior documentation. Heath Company is world-famous for the accuracy and clarity of its instruction manuals. The Heath computer line continues this well-deserved reputation. Assembly and operations manuals are written with easy-to-understand step-by-step instructions that leave nothing to chance. Simply follow the easy-to-understand instructions in the manual and you'll be up and running fast. As in all Heathkit products, easy self-service and troubleshooting is a definite benefit that can result in substantial cost-savings over the life of a product. These considerations, along with nationwide service and technical assistance at Heathkit Electronic Centers or the Heathkit factory, mean that you

have the most reliable protection for your computer investment available anywhere.

System versatility. Both Heathkit computers offer full expansion potential to provide outstanding flexibility and adaptability to meet any application. Mass storage capability is available in both audio cassette and paper tape format on the H8 and in paper tape format on the H11 for added convenience. Additional memory expansion boards can be added to either unit, along with an expanding number of I/O devices.

Continuing Development. Heath will continue to design and develop new compatible products for their computer systems. Coming in the future will be — floppy disk storage, line printer, additional applications programs, and self-instructional courses in programming and assembly languages. All Heathkit computer users are eligible to join HUG (the Heath User's Group) and H11 customers are eligible to join DECUS, the Digital Equipment Computer User's Society.

We're confident you'll find the Heathkit computer line one of the most intelligent, sensibly developed and complete product lines available today. It offers you total versatility and expansion capability to go wherever your imagination and computing prowess take you. And, in the Heathkit tradition, it offers the best price/performance and reliability combination you'll find anywhere.

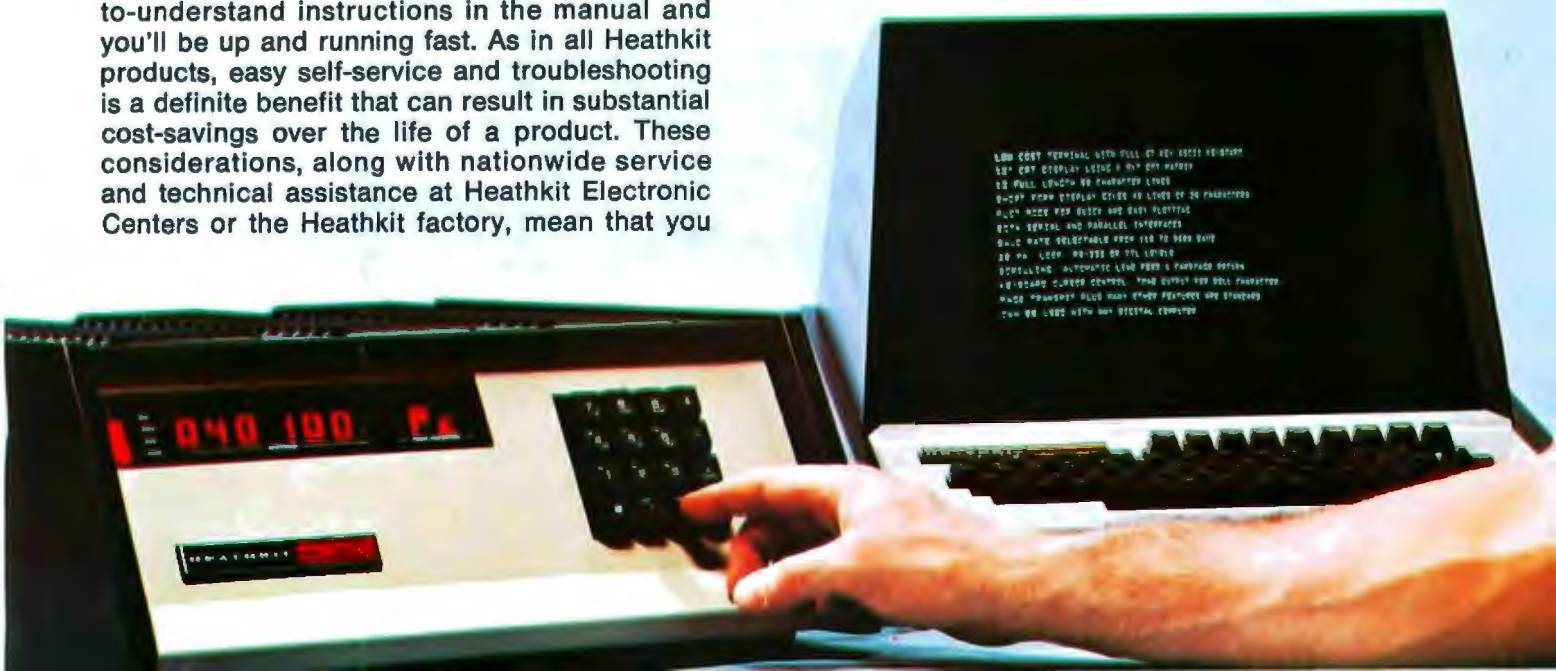

THE HEATHKIT H8 COMPUTER



A unique, value-packed computer featuring an "intelligent" front panel with built-in extended ROM monitor, octal entry keypad and digital readout, exclusive Heath bus, a pre-wired and tested 8080A-based CPU, and complete systems software at no extra cost!

\$375⁰⁰



HEATHKIT 8-BIT DIGITAL COMPUTER

A low-cost digital computer that's easier to build and to use! Features an intelligent front panel with keyboard entry and 9-digit display, a heavy-duty power supply with enough extra capacity for memory and I/O expansion and

a 50-line fully buffered bus capable of addressing 65K bytes and a mother board with positions for up to 10 plug-in circuit boards. Includes BASIC, assembler, editor and debug software at no extra cost!

The Heathkit H8 computer is an 8-bit machine based on the popular 8080A chip. It is one of the lowest-cost general-purpose computers on the market, and thanks to Heath's exclusive design, one of the most versatile.

The interrupt controlled "intelligent" front panel gives you far more power and control than is found on conventional units with bit switches and indicators. The 16-digit keyboard allows octal data entry and control that's far faster and less error prone than binary switches. The 9-digit octal readout provides you with more information than conventional models too.

The octal keyboard and display emulate a true hardware front panel with complete access to memory, all registers and functions. The 9-digit seven-segment octal display has three readout modes: 6 digits of address and 3 digits data; 6 digits register data and 2 digits register identification; and three digits data with three digits port address. The front panel functions are defined by a panel monitor control program (PAM-8) stored in a 1K x 8 ROM on the CPU board. The complete access to 8080 internal circuits and functions makes the H8 an ideal trainer and learning tool.

Complete front panel functions include: display and alter of memory locations; display and alter of registers; dynamic monitoring of registers or memory during program execution; program execution control including break-point capability and single instruction step; automatic tape load and store through a built-in routine that allows programs to be loaded with a single button; and write or read any I/O port. The front panel of the H8 is so versatile it's like having a mini I/O terminal built right in!

Other features of the H8 front panel include status lights for power-on, run, monitor and interrupt enable; a built-in speaker for audible feedback on keyboard entry. The speaker also can be programmed for variable tones, permitting a variety of special effects to be generated.

The CPU board is fully wired and tested. It features the 8080A, clock, systems controller, ROM monitor and full bus buffering. Seven vectored interrupts are available on the bus for quick response to your I/O requests. A built-in clock lets you design and run in real time.

The H8 uses an exclusive, Heath-designed bus which incorporates many practical improvements over existing busses. The bus is fully buffered to reduce noise and crosstalk and is "glitch" free to eliminate timing problems. Three-state line drivers and receivers are used on all bus lines to eliminate loading problems. The 50 lines include address, data, control, clock and interrupt lines, plus all signals needed to support the 8080 MPU and virtually any I/O or memory accessory. The bus is implemented on a heavy-duty printed circuit mother board with wide, heavy copper foils for greater physical strength plus reduced crosstalk and noise. The board has 10 positions for installing

connectors that accept the front panel, CPU, memory, I/O and accessory cards. All I/O bus connectors are included with the mother board for fast and easy expansion when you want it.

The H8's built-in power supply is convection cooled for adequate ventilation without the use of noisy fans. Separate IC regulators provide distributed regulation with a heat sink on each circuit board for excellent heat dissipation. Power supplies of +8, -18 and +18 volts are provided to handle up to 32K memory plus three I/O interfaces. Switch-selectable 120 V, 60 Hz or 240 V, 50 Hz AC increases versatility.

The H8 includes all system software in 1200 baud audio cassette form at no extra charge. The Benton Harbor BASIC™ is an enhanced version of standard Dartmouth BASIC with unique statements and commands to extend usefulness. The efficient compression techniques of the Benton Harbor BASIC permit you to put more program in less space.



All H8 systems software is supplied in audio cassette form. Also available in paper tape (H8-15, page 5) at extra cost.

HASL-8 The Heathkit Assembly language is a 2-pass absolute assembler that lets you program with easily understood mnemonics and generates efficient machine language code. A minimum of 8K memory is required.

The TED-8 software is a line-oriented text editor used for generating source programs for the assembler or general word processing. Requires a minimum of 8K memory.

The BUG-8 a powerful terminal console debug program, is an enhanced and extended version of the front panel monitor program to allow entry and debugging of user machine language programs via an external terminal. Requires 3K memory plus user program.

The H8 is housed in a rugged, heavy-duty cabinet, 16¼" W x 6½" H x 17" D. Requires at least one H8-1 Memory.

Kit H8, Shpg. wt. 30 lbs. 375.00

Suggested applications for the H8 computer: As a trainer—learn microprocessor operation, interfacing and programming. The powerful front panel lets you get at and use all parts of the unit. As an entertainment center—use game and other applications programs for entertainment the whole family can enjoy.

As a hobby computer—the H8 can be used to process any information you program into it—it's perfect for hobby experimentation and design. A variety of peripherals and interfaces let you use it with other equipment—run your Ham radio station, control your model railroad systems, etc.

As an educational system—the H8 is ideal for schools, community colleges, libraries, etc. Full H8 software permits teaching BASIC plus machine and assembly language programming.

As a home management center—use the H8 to keep telephone numbers, monitor your budget, keep your checkbook balanced, do your income taxes, inventory your personal belongings. There are hundreds of ways the H8 can make your life more convenient.



Comprehensive Heathkit assembly and operations manuals give you the superior documentation you NEED for a thorough understanding of your H8.

Systems software is supplied in audio cassette format.

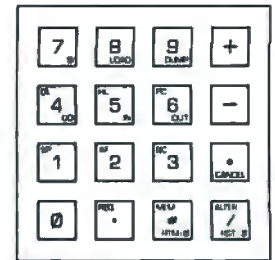

Its unique front panel keyboard makes the H8 the most powerful and sophisticated low-cost general-purpose computer available. Just take a look at these features!

- Direct-access to registers and memory even while program is running
- One button load and dump for fast, uncomplicated system startup
- Single instruction key lets you "step" through programs for easy debugging, program evaluation and learning
- Input/output keys let you communicate directly with any port

The unique Heath-designed 50-pin bus is implemented on a heavy-duty printed circuit board with heavy copper-foil bus lines. The 10-position mother board is complete with all connectors. The bus lines are fully buffered to eliminate noise and crosstalk, and "glitch-free" to prevent timing problems.

Modular circuit boards slide into the H8 mainframe for easy memory and I/O expansion, easy access for servicing. The boards are in a semi-vertical position with unconfined heat sinks to enhance convection cooling and improve heat dissipation.

Heavy-duty power supply, rugged steel chassis and securely mounted and braced circuit boards make the H8 a truly reliable and long-life machine.

Unique Heathkit Software.

The Heathkit software supplied with the H8 computer has a number of features that make it easier to use and more practical than conventional systems. Automatic "command completion" simplifies typing; dynamic syntax checking instantly alerts you to errors and a special user configuration lets you really personalize your system. H8 software pushes the state-of-the-art a generation ahead — it's memory efficient to give you more computing power for your memory dollar, modular design for easy expansion, and thoroughly documented for easy programming and maximum effectiveness.

Memory Display



High Order Address Location Low Order Address Location Data at Location 040 100

Register Display



High Order Contents Low Order Contents Register Identification

I/O Port Display



Data Port Number

H8 "Intelligent" Front Panel

The H8 front panel digital readout is the most informative display available on any personal computer to date. All displays are continuously updated even while your program is executing, giving you instant access to registers and memory for direct monitoring of program activity.

MEMORY DISPLAY — Shows memory location and contents using 6 digits for address and 3 digits for data.

REGISTER DISPLAY — Shows CPU-register contents using 6 digits for data and 2 digits for register identification.

I/O PORT DISPLAY — Shows I/O port data and location using 3 digits for data and 3 digits for port address.

H8 ACCESSORIES, SOFTWARE AND MANUAL SET

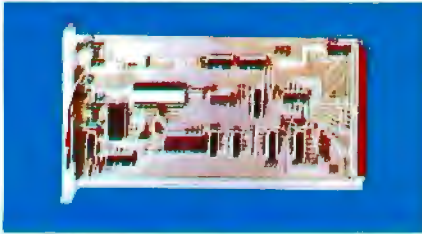

The H8 CPU is fully wired and tested to insure quick and trouble-free system startup. It contains the performance proven 8080A microprocessor chip, a 1Kx8 ROM with monitor program for controlling the front panel and input-output (load-dump) routines. Other features of the CPU include: 7 vectored interrupts, DMA capability, crystal-controlled clock and fully buffered bus with three state drivers. Use of the 8080A, which has the largest software library of any microprocessor, along with Heath software and documentation, makes the H8 one of the most practical and immediately useful computers you can own.

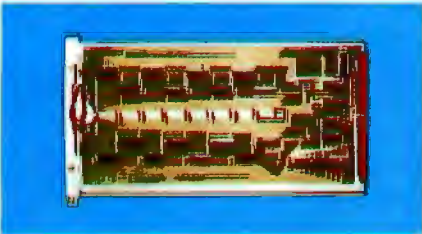

H8-1 Memory Board. 8Kx8 memory card supplied with 4K memory, plugs directly into H8 bus. Features maximum storage capacity of 8192 8-bit words. Uses modern 4Kx1 static memory IC chips for easy assembly and service. Access time, less than 450 nS. With on-board regulators, heat sinks and full buffering. Expandable to 8K memory with H8-3 chip set below.
Kit H8-1, Shpg. wt. 2 lbs. **140.00**

H8-3 Chip Set. Kit of eight 4K static memory IC's. Expands H8-1 to full 8K storage. With sockets.
Kit H8-3, Shpg. wt. 1 lb. **95.00**



H8-2 Parallel Interface. Connects H8 to any parallel device such as a paper tape reader/punch (required for H10) or line printer. Has three independent parallel ports, each with 8 bits input and 8 bits output and universal handshaking capability. Compatible with all Heath software. 390 μ S maximum transfer time. With diode-clamped inputs, buffered outputs and full interrupt capability.
Kit H8-2, Shpg. wt. 3 lbs. **150.00**

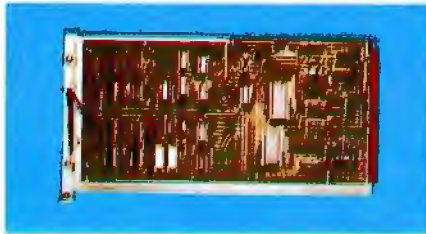

H8-5 Serial I/O and Cassette Interface. Connects the H8 to serial devices such as the H9 video terminal (page 10) or the H36 DEC Writer II (page 12). Features jumper selectable data rate from 110 to 9600 baud, plus common input/output interfaces including 20 mA current loop and EIA RS-232C compatible levels. The cassette recorder interface permits the use of standard cassette recorders (Heathkit ECP-3801, page 12). Uses the popular Byte/Manchester or "Kansas City" standard recording format with a 300 or 1200 baud read/record rate. Control lines for remote start and stop of two cassette units allow separate record and playback for easy program or file editing. Also has full interrupt capability. LED test circuit for easy board setup and overall system servicing. Fully compatible with all Heath software.
Kit H8-5, Shpg. wt. 3 lbs. **110.00**

NOTE: Proper operation of the H8-5 is assured only if you use the Heath ECP-3801 cassette player/recorder and Heath-recommended recording tape (ECP-3802, page 12). Heath is not responsible for improper operation associated with other cassette units.

Extended Benton Harbor BASIC

Extended Benton Harbor BASIC is an enhanced and more powerful version of the BASIC supplied with the H8. It provides even faster operation and includes character strings, additional convenience commands and math functions, dynamic storage allocation, access to real time clock, keyboard interrupt processing, expanded error messages and recovery ability, LED display control and key pad support. A minimum of 12K memory is required to run this BASIC, 16K is preferred if full use is to be made of its capabilities.

H8-13 (1200 baud audio cassette)
Shpg. wt. 1 lb. **10.00**

H8-14 (fan fold paper tape)
Shpg. wt. 1 lb. **10.00**

Paper Tape Systems Software

A paper tape version of the systems software supplied with the H8 computer. It consists of four fan fold paper tapes, one each for Benton Harbor BASIC, HASL-8 assembler, TED-8 editor, and BUG-8 debug. For use with the H10 paper tape reader/punch or other paper tape I/O equipment.

H8-15, Shpg. wt. 1 lb. **20.00**

H8 Manual Set

Find out about the H8 before you buy! This manual set includes the complete assembly and operations manuals for the H8 Digital Computer, H8-1 memory card, H8-2 parallel interface, H8-3 4K memory expansion chip set, H8-5 serial and I/O cassette interface, H9 video terminal and H10 paper tape reader/punch. H8 software documentation covering monitor, editor, assembler, debug and BASIC is also included. In handsome 3-ring binder.

HM-800 Manual Set.
Shpg. wt. 11 lbs. **25.00**

The purchase price of the HM-800 manual set will be refunded when you buy the H8. Simply include HM-800 saleslip with your order.



You can get even more excitement and practical use from your H8 by joining HUG, the Heathkit User's Group. It will put you in contact with other Heathkit computer users, provide a program library and an informative newsletter to keep you up to date. A HUG application is enclosed with each Heathkit computer product. See page 12 for further details.

THE HEATHKIT H11 DIGITAL COMPUTER

Two of the finest names in modern electronics, Heath and Digital Equipment Corporation (DEC) combine to bring you the world's first 16-bit computer priced within reach of the general public!

\$1295⁰⁰



The H11 and all its accessories
will be available November 10th, 1977.

HEATHKIT®/DIGITAL EQUIPMENT CORPORATION® H11 DIGITAL COMPUTER

Heath and DEC join forces to bring you mini-computer performance at a microcomputer price! The H11 features a fully wired and tested DEC KD11F board that contains the 16-bit LSI-11 CPU, 4096 x 16 read/write MOS semi-

conductor memory, DMA operation; and includes the powerful PDP-11/40 instruction set, PLUS Heath/DEC PDP-11 software. Equivalent commercial versions of the H11 would cost \$1,000's of dollars more!

The new Heath/DEC H11 personal computer is one of the most powerful and sophisticated units available today! It combines the advanced, performance-proven hardware and software of the LSI-11 with Heath's expertise in kit design and documentation to bring you a personal computer of almost incredible power and flexibility. Equivalent commercial versions of the H11 would cost over twice as much, and you still wouldn't get the superior documentation and support of the H11!

The LSI-11 bus is a mechanically and electrically superior bus with 38 high-speed lines containing data, address, control and synchronization lines. Sixteen lines are used for time multiplexing of data and addresses. All data and control lines are bidirectional, asynchronous, open-collector lines capable of providing a maximum parallel data transfer rate of 833K words per second under direct memory access operation.

The 16-bit CPU functions are contained on four MOS LSI integrated circuit chips. These chips provide all instructions, decoding, bus control, and ALU functions of the processor. The CPU has eight general registers which serve as accumulators, index, autoincrement/autodecrement registers or stack pointer.

The KD11F memory is a 4096-by-16 MOS semiconductor memory composed of LSI 4K dynamic RAM chips. These chips require little power, provide fast access time, and are refreshed automatically by the processor's microcode. Additional memory cards can be added to expand memory capacity up to 20K in the H11 cabinet (32K words total).

The backplane/card guide assembly holds the microcomputer and up to six I/O and memory modules. All LSI-11 bus data, control, and power connections are routed on the printed circuit backplane to each module location. The backplane/card guides are fully compatible with all standard DEC LSI-11 accessories.

An efficient, well-designed switching power supply provides the required DC voltage for the LSI-11 as well as all accessory modules. The supply features overvoltage and overcurrent/short-circuit protection, power fail/automatic restart and a built-in fan for quiet cooling. The dual primary power configuration can be connected for 115 V, 60 Hz or 230 V, 50 Hz input power.

Has single-level, vectored, automatic priority interrupt, real-time clock input signal line, ODT/ASCII console routine/bootstrap resident in microcode for automatic entry into debugging mode, replacement of panel lights and switches with any terminal device generating standard ASCII code, and the ability to automatically commence operation through resident bootstrap routines.

The H11 is supplied with versatile PDP-11 software including editor, relocatable assembler, linker, absolute loader, debug program, I/O executive program, dump routines, BASIC and FOCAL (See details below). The software requires a minimum of 8K memory, with 12K to 16K total memory recommended for maximum capability. Rugged metal cabinet measures 6½" H x 19" W x 17" D. For 110/220 VAC, 50/60 Hz.

Kit H11, Shpg. wt. 34 lbs. 1295.00
NOTE: See DEC software license form on page 15.

POWERFUL HEATH/DEC PDP-11 SOFTWARE AT NO EXTRA COST!

The H11 includes a sophisticated software system that lets you get your computer up and running with practical programming capabilities. This paper tape based software would cost over \$1200 if purchased separately. A minimum of 8K memory is required to run the software. The programs include:

ED-11. Assists you in the creation and modification of ASCII source tapes, also used to write assembly language programs and for general text editing or word processing functions.

PAL-11S. Relocatable assembler converts ASCII source tapes into relocatable binary modules. This lets you create programs in small, modular segments for easier coding and debugging. These binary modules serve as inputs to LINK-11S.

LINK-11S. Link editor which links the modules created by the PAL-11S into a load module ready for execution on the H-11. The module is loaded into the H-11 via the Absolute Loader.



The H11 is complete with superior Heathkit documentation and versatile system software.

Absolute Loader. Loads absolute binary tapes into the H11 memory for execution.

ODT-11X. Lets you debug the programs which you have created. Permits modifying and controlling program execution "on the fly" for quick, efficient debugging.

IOX. I/O executive program permits I/O programming without developing device-driving programs. Links to your programs using the LINK-11S. For use with high speed paper tape reader/punch and line printer.

DUMP-AB and DUMP-R. Lets you dump absolute binary contents of memory into the paper tape punch.

BASIC. DEC's powerful version of standard Dartmouth BASIC interpreter uses english-type statements and mathematical symbols to perform operations. Immediately translates, stores and executes the program. Includes string capability.

FOCAL™. DEC's own Interpretive computer language which combines simplicity with computing power. Ideal for most scientific, engineering and math applications. FOCAL™ programs can be written and executed easily. Both 4K and 8K versions are included.

NOTE: H11 owners are eligible for membership in the Digital Equipment Computer User's Society (DECUS). This organization provides useful symposia, newsletters, program library and other useful information to help you get the most from your LSI-11 computer.

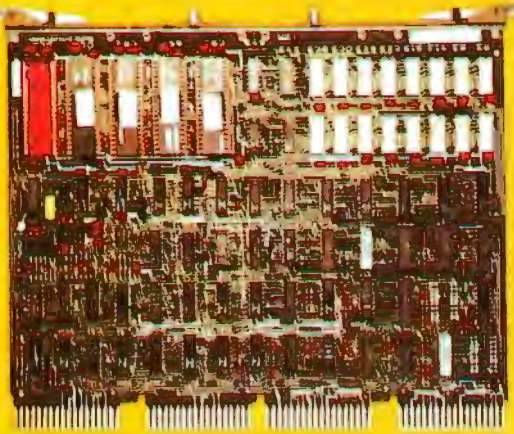

FULLY WIRED AND TESTED K011F BOARD

The "heart" of the H11 computer is the standard DEC LSI-11 microcomputer board. The 16-bit CPU functions are contained in four silicon gate N-channel MOS LSI integrated circuit chips for high reliability and superior performance. The 4096-by-16 read/write MOS semiconductor memory is composed of LSI 4K dynamic RAM chips that provide fast access time and require little operating power. The CPU executes the powerful PDP-11/40 instruction set with over 400 instructions. There are no separate memory I/O or accumulator instructions, so you can manipulate data in peripheral device registers as easily and flexibly as in memory registers. The LSI-11 board is supplied fully wired and tested to facilitate kit assembly and provide greater reliability and less chance of error.

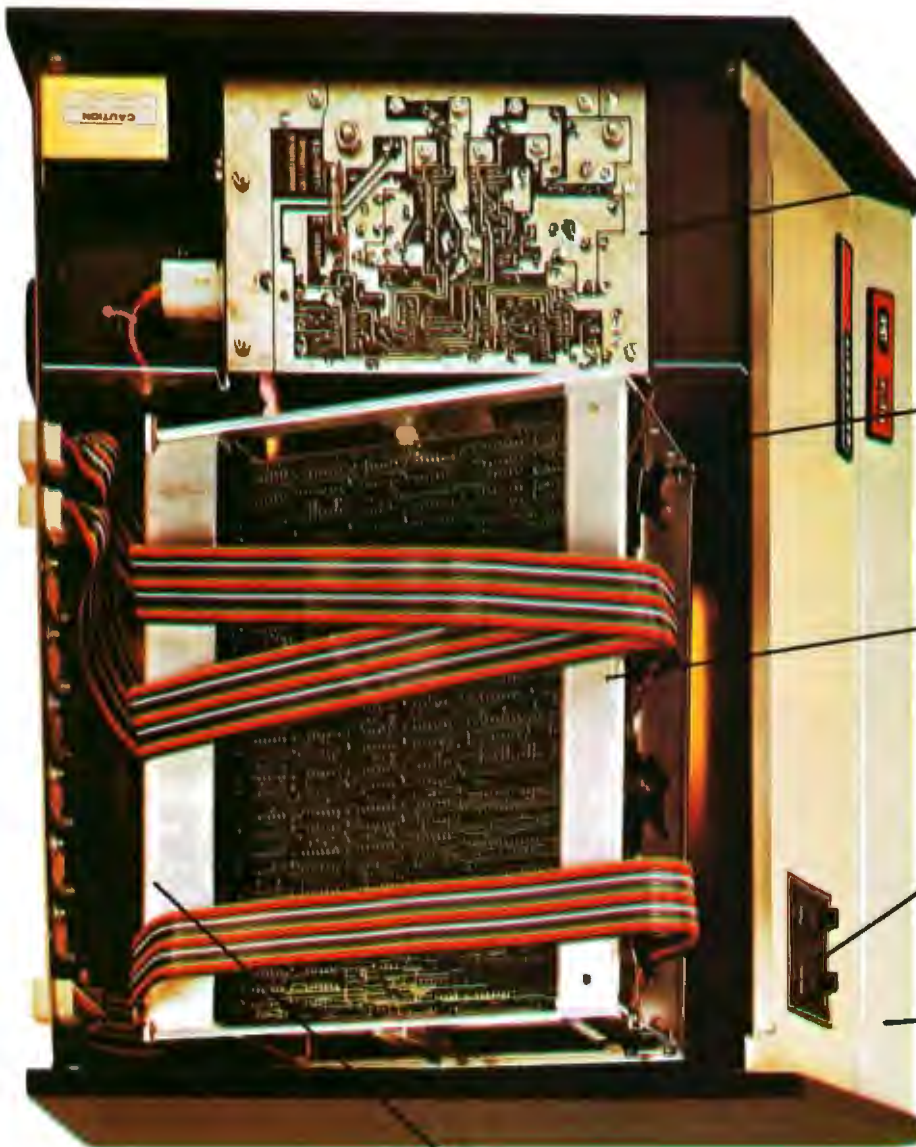

Compact, efficient switching power supply uses less power to operate and generates less heat than conventional supplies. Overvoltage and overcurrent/short circuit protection, along with automatic power-up and power-down sequencing, provide high reliability and long life operation.

Built-in quiet-running fan provides efficient cooling and prevents heat buildup.

Card cage with backplane accommodates up to six accessory cards in addition to LSI-11. The card cage swings up for easy access and service even while the H11 is operating. Accessory boards slide directly into card guides with all connectors supplied.

Front panel controls include DC power switch and run/halt switch. Status lights indicate processor activity.

Styled and sized to match Heathkit peripherals for total system continuity.

Rugged steel chassis and extra-thick backplane with heavy, solid connectors for added strength and years of superior performance.

The H11 and all its accessories will be available November 10th, 1977.

H11 ACCESSORIES, SOFTWARE AND MANUAL SET

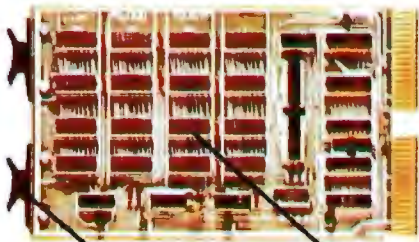

Card handles provide easy removal and insertion in card cage

1

Sixteen state-of-the-art 4K static memory chips for high density storage

All IC's are socketed for easy kit assembly, easy access for service or troubleshooting

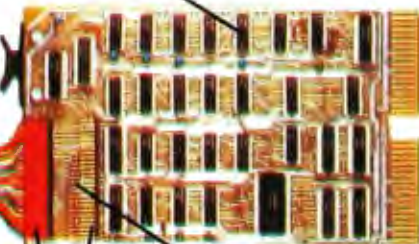

2

All inputs are diode-clamped for worry-free interfacing and system protection

Separate cables and rear panel connectors for high-byte and low-byte increase system flexibility

Gold-plated edge connectors maintain superior electrical contact for high reliability and long life

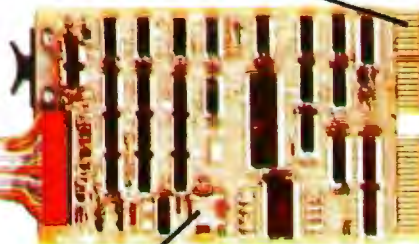

3

Quartz crystal and integrated baud rate generator has superior accuracy for reliable system interfacing

1 H11-1 4K Memory Expansion Module

Plugs into H11 backplane, adds 4K x 16-bit word capacity to H11 memory. Uses high-reliability 1Kx4 static MOS RAM chips. Access time is less than 500 nS. Has decode circuitry for operation on 4K address boundaries. Handle for easy removal and insertion. Compatible with PDP 11/03 and other LSI-11 backplane machines.

Kit H11-1, Shpg. wt. 2 lbs. 275.00

2 H11-2 Parallel Interface

General-purpose parallel interface featuring 16 diode-clamped latched data input lines, 16 latched output lines, 16-bit word or 8-bit byte data transfers. Has LSI-11 bus interface and control logic for interrupt processing and vectored addressing; control status registers compatible with PDP-11 software routines. Four control lines for output data ready, output data accepted, input data ready and input data accepted logic operations. Maximum data transfer rate, 90K words per second under program control. Maximum drive capability, 25-ft. cable. Plugs into H11 backplane, can be used with DEC PDP-11/03 and other LSI-11 backplane machines. Also compatible with TTL or DTL logic devices. The H11-2 is required for interfacing the H11 to the H10 Paper Tape Reader/Punch.

Kit H11-2, Shpg. wt. 2 lbs. 95.00

3 H11-5 Serial Interface

Universal asynchronous receiver/transmitter serial interface module for use between LSI-11 bus and serial devices such as the Heathkit H9 video terminal (page 10) or LA36 teleprinter (page 12). Has optically isolated 20 mA current loop and EIA interfaces; selectable baud rates of 50, 75, 110, 134.5, 150, 200, 300, 600, 1200, 1800, 2400, 4800 and 9600. Plugs into H11 backplane, fully compatible with PDP 11/03 and other LSI-11 backplane machines. With all mating connectors.

Kit H11-5, Shpg. wt. 2 lbs. 95.00

H11-6 Extended Arithmetic Chip

Adds powerful arithmetic instructions to the LSI-11, including fixed point multiply, divide and extended shifts plus full floating point add, subtract, multiply and divide. Helps minimize or eliminate arithmetic sub-routines, speeds up program execution and eases program development. Saves memory space too. 40-pin dual-inline package IC plugs into socket on KD11F board.

H11-6, Shpg. wt. 1 lb. 159.00

Manual Set for H11 Computer

Includes complete assembly and operation manuals for the H11 Digital Computer, H11-1 4K memory board, H11-2 parallel interface, H11-5 serial interface, H9 CRT terminal, and H10 paper tape reader/punch. Also includes complete soft-



ware documentation — monitor, editor, assembler, linker, BASIC, FOCAL and related software. In handsome 3-ring binder.

HM-1100 Manual Set, Shpg. wt. 12 lbs. 25.00

NOTE: The price of the manual set can be deducted when you order an H11.

NOTE: DEC, DIGITAL, FOCAL and PDP are registered trademarks of Digital Equipment Corporation.

Special DEC Software License Requirement

H11 purchasers are required to fill out and sign the DEC license agreement on page 15. Please do so and include with your H11 order. Heath cannot ship merchandise without this license agreement.

THE HEATHKIT H9 VIDEO TERMINAL

One of the lowest-cost full ASCII terminals available anywhere — features a bright 12" CRT display with twelve 80-character lines, 67-key keyboard, all standard serial interfaces, plus a fully wired and tested control board and a wiring harness for simplified assembly.

\$530⁰⁰



H9 LONG AND SHORT-FORM VIDEO DISPLAY TERMINAL

The H9 video terminal is a general-purpose computer peripheral designed for use with the Heathkit H8 or H11 computers. It provides keyboard input and a CRT for the convenient entry and display of computer programs and data. The H9 can be used with any digital computer in dedicated stand-alone applications or in time-sharing systems.

Character format is standard upper case 5 x 7 dot matrix. The long form display is twelve 80-character lines. The short form display is forty-eight 20-character lines in four 12-line columns. The automatic line carryover feature executes line feed and return when line exceeds character count on both long and short form displays. A built-in oscillator/speaker generates a 4800 Hz tone and serves as audible end-of-line warning.

Auto-scrolling is featured in both long and short form. In the long form, as the line enters at bottom, the top line scrolls off-screen; in the short form, as new column enters from right, the left column scrolls off-screen. Auto-scrolling can be

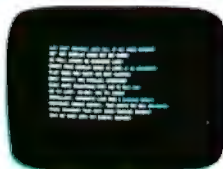

Long form — twelve 80-character lines



Short form — forty-eight 20-character lines



Plot mode — graphs, curves, simple figures

Three separate modes give the H9 real display versatility

defeated with a front panel switch. The cursor mark indicates the next character to be typed for accurate positioning. Cursor control keys include up, down, left, right and home. Serial data baud rates are selectable from 110-9600. Baud rate clock output and reader control are available on the rear panel connector. The erase mode permits automatic full page erase or erase to end of line starting at cursor position. A transmit page function allows a full page to be formatted, edited and modified, then transmitted as a block of continuous data.

The plot mode permits graphs, curves and simple figures to be displayed. Plot-



Control PC board is fully assembled and tested for added reliability and simplified kit assembly. A wiring harness with connectors helps reduce time-consuming point-to-point wiring.

ting can be accomplished via the keyboard or from external inputs.

The H9 serial interface provides EIA RS-232C levels, a 20 mA current loop or standard TTL levels. Parallel interfacing includes standard TTL levels, 8 bits input and 8 bits output and 4 handshaking lines.

Ultra-compact size, only 12½" H x 15½" W x 20¾" D, makes the H9 ideal for desktop or console applications. For 110 VAC, 60 Hz or 230 VAC, 50 Hz.

Kit H9, Shpg. wt. 50 lbs. 530.00

Full ASCII 67-key Keyboard

Function keys are positioned away from characters to prevent miskeying and error.

Standard typewriter keyboard for easy, more accurate input.

Wide, easy-to-use space bar aids accurate typing.

THE HEATHKIT H10 PAPER TAPE READER/ PUNCH

A general-purpose mass storage peripheral designed for use with the H8 and H11 computers plus any other computer. Features a heavy-duty built-in power supply, totally independent punch and reader and a copy mode for fast, easy tape duplication.

\$350⁰⁰



H10 DELUXE PAPER TAPE READER/PUNCH



Heavy-duty solenoids for reliable, long-life operation

Precision machined punch block for accurate, consistent punched holes

Advanced reader design with stepper motor and solid-state sensors for accurate reading

The H10 is a complete paper tape reader/punch mass storage peripheral using reliable low-cost paper tape. It's fully compatible and styled to match with the H8 and H11 computers. It also works reliably with any other computer through a parallel interface. The H10 uses standard 1" wide roll or fan-fold 8-level paper tape. Standard punched paper tape gives you the reliability, durability and trouble-free handling you need for effective mass storage of programs and data.

The reader reads tape at a maximum rate of 50 characters per second. A full sensitivity adjustment on each channel permits any color, thickness, quality (oiled

or unoiled) paper tape to be used. Sensitive photo Darlington transistors and an incandescent lamp reader head provide reliable reading. The powerful stepper motor drive insures accurate tape positioning and movement.

The punch operates at a maximum speed of 10 characters per second. Precise ratchet/solenoid drive and reliable solenoid control of punches provide high-accuracy punching. The precision die-block punch head gives you positive and consistent punching.

Controls include power on-off, read and punch start. A feed control feeds blank paper tape through the punch to produce leader tape. A copy control on the rear panel permits tape being read to be duplicated by the punch for efficient and accurate tape copying.

Interface has parallel 8-bit input bus for punch, parallel 8-bit output bus for reader, standard TTL logic levels and handshaking lines for both reader and punch. A rear panel 24-pin interface connector and mating cable are supplied. The H10 is fully compatible with Heathkit H8 and H11 computers when the appropriate parallel interface accessories are used. It can also be interfaced with other computers with parallel interface facility.

Accessories include holder for roll paper tape, chad collector tray, and collector box for fan-fold tape. With 8" roll (900 ft.) blank paper tape.



Styled to match the Heathkit H8 and H11 computers. Cabinet with metal top and rugged steel chassis, 12 1/2" H x 9 3/4" W x 19 1/2" D. For 110-130 VAC, 60 Hz, or 220-240 VAC, 50 Hz.

Kit H10, Shpg. wt. 29 lbs. 350.00

H10-2, Three Blank Rolls Paper Tape, each 8" diameter, 900 ft. min.

H10-2, Shpg. wt. 5 lbs. 10.00

H 10-3, Three Boxes Blank Fan-fold Tape. Approx. 1000 ft. each.

H10-3, Shpg. wt. 5 lbs. 10.00



ECP-3801 Cassette Recorder Storage Device

Has volume and tone controls, pushbuttons for record, play, rewind, fast forward, stop and eject, built-in 3-digit counter with reset button. Factory wired, not a kit.

ECP-3801, Shpg. wt. 6 lbs. **\$55.00***

Heath recommended high output, low noise, premium grade audio recording tape. Pack of three 30-minute blank cassettes.

ECP-3802, Shpg. wt. 1 lb. **per pack 5.00**

*NOTE: Proper operation of the H8-5 and H8 software is assured only when the ECP-3801 cassette recorder and ECP-3802 tape is used. Heath does not assume responsibility for improper operation resulting from the use of any other cassette units.

HUG® - the Heathkit User's Group

Our new user's group brings you in contact with other Heathkit computer owners and users, provides a newsletter, a program library, new product information and hardware/software ideas. Membership in HUG is a useful, practical way to get the maximum enjoyment and benefit from your Heathkit computer system. Here's what you get:

- 1 year subscription to the quarterly newsletter
- Software library allowing you to submit programs and obtain programs submitted by others. A modest fee will be charged for software duplication.
- An attractive 3-ring binder to hold newsletters, software documentation and other materials.
- Program submission forms
- Software library catalog
- HUG membership list
- Credit toward purchase of software

Dues are \$14.00 for one year. Complete details of HUG membership are included with every Heathkit computer product. H11 owners are also eligible for membership in DECUS, see page 7 for details.

Heathkit 12

LA36 DEC Writer II Keyboard Printer Terminal

The famous LA36 DEC Writer II with true 30-cps throughput, variable-width forms handling, 128-character upper/lower case set, and extra-quiet operation. Fully assembled, factory tested and ready to use!

The LA36 is an advanced technology teleprinter offering fast, reliable operation at one of the best price/performance ratios in the industry. It features a 7x7 dot matrix print head for crisp, clear character formation; switch-selectable 10, 15 and 30 cps printing speeds; variable width forms handling from 3 to 14 7/8" wide; adjustable right and left hand tractors for precise margin positioning; half or full duplex operation; ANSI-standard multi-key rollover and a typewriter-like keyboard.

The precision-designed stepper motor paper feed has fine vertical adjustment for accurate forms placement. LA36 will handle up to 6-part forms with a .020" maximum pack thickness. Print format is 132-column, with 10 characters per inch horizontal spacing and 6 lines per inch vertical spacing. Uses the entire 128 character ASCII upper/lower case set with 95 printable characters. A CAPS-lock key simplifies data entry. A parity check on output prints a replacement character, strappable to odd, even, or none with mark or space. A last-character visibility feature moves the head four columns to the right when printing stops, returns to proper position when printing is resumed.

The integral 20 mA current loop interface makes the LA36 compatible with both the H8 and H11 computers, as well as all other hobby and personal computers. Operates on 90-132 VAC or 180-264 VAC for reliable performance even under brown-out conditions. With connecting cable and integral stand for easy setup. Overall size, 27 1/2" W x 33 1/4" H x 24" D.

H36 (LA36 DEC Writer II) Shipped Motor Freight, prepaid to your nearest terminal within the Continental U.S. Include your phone number on order for notification of arrival. Arrangements for home delivery at extra charge at your option. **NO C.O.D. ORDERS ACCEPTED.** **\$1495.00**

H36-1 Fan-fold paper for H36. Standard 14 7/8" x 11" white and green, single part, lined paper. 3450 sheets per carton.

H36-1, Shpg. wt. 50 lbs. **30.00**

H36-2 EIA Interface. Provides EIA RS232-C or CCITT-V24 interface for LA36. Includes auto answer, timed disconnect and half/full duplex logic. Straps are available to send timed break (230 mS), 3000 mS long space, forced disconnect or do nothing (stops printing, discards data) on a paper-out condition. Modem controls and a 9-ft. cable with 25-pin data-set type connector are also supplied. Factory wired, not a kit.

H36-2, Shpg. wt. 1 lb. **65.00**

APPLICATIONS SOFTWARE - COMING SOON!

Both the H8 and H11 Digital Computers are supplied with complete systems software that provide you with everything you need to develop your own specific applications programs. However, you can make your computer immediately useful by using the programs below. These programs represent the beginning of a complete series of application software packages that will allow you to get immediate value from your computer system without a time consuming software development effort on your part. Described below are a series of game packages that make your computer an excellent source of entertainment and leisure time activities.

BLACKJACK. An interactive program game that allows four players to play the card game blackjack on the computer. The computer performs all of the functions of the dealer and keeps track of player progress, winnings and losses. The program is written in and runs under extended BASIC and requires a minimum of 16K of RAM in the H8 and 8K in the H11. Standard Las Vegas casino blackjack rules apply.

BIORHYTHM. This popular applications program computes standard biorhythm information and plots sinusoidal curves of your physical, emotional, and intellectual characteristics over a given time period. The biorhythm program will show you your ups and downs and will tell you your good and bad days. It will help you plan your activities. While this program is not a game, it is an entertaining activity that you and your friends and family will enjoy. The program runs under extended BASIC and requires 16K of RAM in the H8 and 12K RAM in the H11.

STARTREK. Startrek is perhaps the most popular computer game available. It allows you to guide, control and command the Starship Enterprise in its travels through the galaxy, fighting Klingons and solving a variety of problems. A truly challenging, sophisticated and entertaining computer game. Runs on the H8 or H11 computers with 8K of RAM or more.

GAME SET #1. This software package lets you play 8 popular computer games. These games include Craps, Orbit, Tic Tac Toe, Nim, Hexapawn, Hangman, Hmrabi, and Derby. 8K RAM or more is required on either the H8 or H11. These games will provide hours of entertainment for you and your family.

GAME SET #2. Another popular game package for the H8 and H11 computers. Contains 8 popular computer games including bagles, slot machine, gomoku, yachtze, apollo, gunner, wumpus, and cube.

AVAILABILITY. Blackjack, Biorhythm and Startrek will be available after October, 1977. Game Set #1 will be available November, 1977 and Game Set #2 available, February, 1978.

Order a complete Heathkit computer system and SAVE!

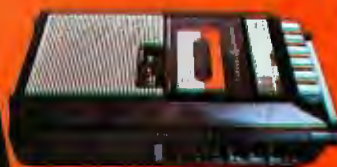

The ECP-3801 is the Heath-recommended cassette recorder/player for use with the H8 computer software. See opposite page for complete description.

SYSTEM ONE

The minimum recommended H8 system

H8 Computer	\$375
H8-1 4K Memory	140
H8-3 4K Chip Set	95
H8-5 Serial I/O and Cassette Interface	110
H9 Video Terminal	530
ECP-3801 Cassette Recorder/Player	55

If purchased separately, \$1305.00

Heath System price is **\$1239⁷⁵***

Choose any of the Heath-recommended systems shown here, the specially-priced HS-11 system below, or "roll your own" with a selection of products you choose. Any way you do it, you'll get a top-value, high-performance system, and you'll SAVE 5%! Here's how to qualify for the 5% computer systems discount:

1. Select either the H8 or H11 and one major peripheral (H9, H10 or LA36).
2. Choose the I/O Interface, memory and software accessories you need.
3. Specify each in the spaces provided on the order blank.
4. Deduct 5% from the total price of the products (excluding shipping and handling charges).

*Systems illustrated already have discount prices calculated for you.

From time to time, Heath will offer specially priced total systems such as the HS-11 below. These systems will be discounted even deeper than 5% to provide you with even MORE value for your computer dollar!

SYSTEM TWO

H8 Computer	\$375
Two H8-1 4K Memories	280
Two H8-3 4K Chip Sets	190
H8-5 Serial I/O and Cassette Interface	110
H8-13 Extended BASIC in Cassette Format	10
H9 Video Terminal	530
ECP-3801 Cassette Recorder/Player	55

If purchased separately, \$1550.00

Heath System price is **\$1472⁵⁰***

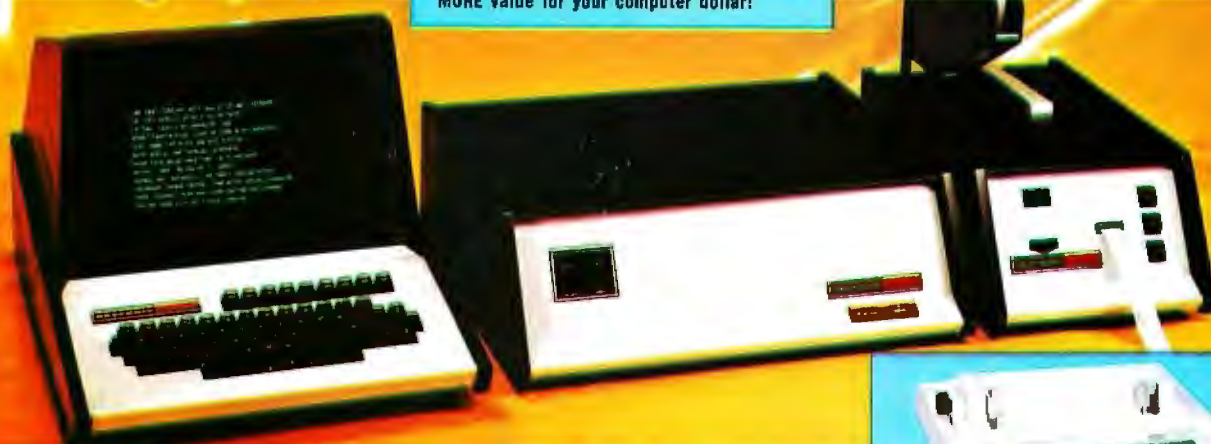

SYSTEM THREE

The minimum recommended H11 system

H11 Computer	\$1295
H11-1 4K Memory	275
H11-2 Parallel Interface ..	95
H11-5 Serial Interface	95
H9 Video Terminal	530
H10 Paper Tape Reader/Punch	350

If purchased separately, \$2640.00

Heath System price is **\$2508⁰⁰***

SYSTEM FOUR

SAVE EVEN MORE on this specially-priced Heath HS-11 complete computer system!

H11 Computer	\$1295
H11-1 4K Memory	275
H11-2 Parallel Interface ..	95
H11-5 Serial Interface	95
H10 Paper Tape Reader/Punch	350
H36 LA36 DEC Writer II ...	1495

If purchased separately, \$3605.00



\$3350⁰⁰*

YOU SAVE \$255!

NEW HEATHKIT SELF-INSTRUCTIONAL COMPUTER COURSES



These Heathkit self-instructional courses are designed to help you get the most from your computer investment, whether you buy your computer hardware from Heath or anywhere else. While many pre-developed software programs are available, the only way to realize the full value of your personal computer is to learn programming yourself. These courses use the PROVEN Heathkit individual learning techniques to give you a thorough understanding of programming, even if you have no prior knowledge or experience. They'll show you exactly how to make your personal computer system really personal!

BASIC PROGRAMMING SELF-INSTRUCTIONAL COURSE

This course teaches you how to program your computer using the popular BASIC language. BASIC (Beginner's All-Purpose Symbolic Instruction Code) is essential for hobby and personal computing; it is also widely used in education and business. The course covers all formats, commands, statements and procedures plus the creative aspects of computer programming, so you can make practical use of it in solving problems and creating your own unique programs. Like other Heathkit self-instructional courses, it uses programmed instructions backed by practical hands-on computer experiments and demonstrations to reinforce and personalize the text material. An optional final exam (passing grade 70%) brings you a Certificate of Achievement and 3.0 Continuing Education Units*. While the BASIC course is keyed to Heathkit computers, it is also equally applicable to any computer system using BASIC. Available after Oct. 20th, 1977.

EC-1100, Shpg. wt. 6 lbs. 29.95

*Continuing Education Units (CEU's) are nationally recognized means of acknowledging participation in non-credit adult education.

COMING SOON!

8080 Programming: Teaches you the machine and assembly language used with 8080-based computers. Shows you how to use the editor, assembler and debug software to create efficient programs. Ideal for the H8 and other 8080A based machines. Coming soon.

LSI-11 Programming: Shows you how to use editor, assembler, linker, debug and executive I/O software to create efficient programs. Applicable to H11 and most other Digital Equipment Corporation PDP-11 series computers. Coming soon.

COMING IN OCTOBER!

MICROPROCESSOR SELF-INSTRUCTIONAL COURSE

Learn how microprocessors operate and how to design with them. Covers applications, machine language programming, hardware I/O interfacing and much more. The course includes all IC's needed to perform exciting experiments. The microprocessor trainer used with the course features the popu-

lar 6800 microprocessor plus 256 bytes of RAM, a 1K ROM monitor, 6-digit hexadecimal display and hexadecimal keyboard. The Heathkit microprocessor course/trainer combo is the fast, easy low-cost way to learn about these important devices. Watch for it in our next catalog!



GENERAL COMPUTER BOOKS

Microcomputer Dictionary and Guide (Matrix). Comprehensive source of definitions and basic information on computers and related topics. A super reference source. A must for your library. EDP-218 17.95

Introduction to Microcomputers Vol. I (Osborne). Excellent introduction to microcomputers and fundamental computer concepts. EDP-224 7.50

Introduction to Microcomputers Vol. II (Osborne). Complete descriptions of all popular microprocessors, 8080, 6800, 6502, SC/MP, Z80, F8, 2650, etc. Good reference. EDP-225 12.50

How to Buy and Use Minicomputers and Microcomputers (Sams). A fundamental text on mini/micro operation and application. EDP-227 9.95

TV Typewriter Cookbook (Sams). Good text explaining I/O terminals, interfacing, etc. EDP-226 9.95

8080 BOOKS

Build a library to support your H8 computer or any 8080 based machine.

Bugbook III (E & L). Superior reference source on 8080 interfacing and programming. Includes experiments. EDP-231 15.00

Bugbook IIA (E & L). Serial I/O concepts and terminal interfacing. EDP-232 5.00

8080 Programming for Logic Design (Osborne). Programming and Using the 8080 microprocessor. EDP-229 7.50

Heathkit 14

8080 Software Gourmet Guide and Cookbook (Scelbi). Excellent source for 8080 programs and subroutines. EDP-228 9.95

Practical Microcomputer Programming: 8080 (Northern Technology). Machine/Assembly programming concepts for the 8080. EDP-235 21.95

6800 BOOKS

Great reference sources for your 6800 based computers.

6800 Programming for Logic Design (Osborne). Programming and using the 6800 microprocessor. EDP-230 7.50

8080 Software Gourmet Guide and Cookbook (Scelbi). Excellent source of commonly used 6800 programs. EDP-233 9.95

6800 Microprocessor Applications Manual (Motorola). Comprehensive review of typical 6800 applications, design solutions, etc. EDP-244 25.00

6800 Microprocessor Programming Manual (Motorola). Programming principles and examples for the 6800. EDP-245 10.00

H11/LSI-11/PDP-11 BOOKS

Here are several important reference sources to help you get the most value from your H11 Computer.

Minicomputer Systems: Organization and Programming (Prentice-Hall). Good basic text. Emphasis on the PDP-11. EDP-238 17.95

PDP-11 Programming (Algonquin). A programmed instruction text teaching the concepts of PDP-11 operation and programming. EDP-239 5.00

The Minicomputer in the Laboratory (Wiley). Operation, programming and applications of PDP-11 computers. EDP-246 19.50

GENERAL PROGRAMMING AND APPLICATIONS BOOKS

Assembly Level Programming (Lexington). Good basic book on assembly language programming of small computers. EDP-236 14.95

101 BASIC Computer Games (DEC). A classic. Have fun with your computer. EDP-237 7.50

BASIC Software Library, Vol. I. Complete lists of BASIC applications programs book-keeping, games, pictures (graphics). EDP-240 24.95

BASIC Software Library, Vol. II. Math, engineering, plotting and statistical programs in BASIC. EDP-241 24.95

BASIC Software Library, Vol. III. Advanced business applications programs in BASIC. EDP-242 39.95

BASIC Software Library, Vol. IV. Games and business applications programs in BASIC. EDP-243 9.95

BASIC Software Library, Vol. V. Games, graphics, and useful math programs in BASIC. EDP-251 9.95

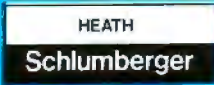

Heath Company, Dept. 334-336
Benton Harbor, Michigan 49022

ORDER FORM Agreement

Gentlemen: Please send me the Heathkit Computer Products I have checked below. I understand that if I order products designated for future delivery Heath will do their best to ship within 30 days of those availability dates.

- H8 Computer at \$375.00 each plus \$5.40 shipping and handling.
- Qty. _____ H8-1 4K Memory(s) at \$140.00 each plus \$1.15 shipping and handling.
- Qty. _____ H8-3 4K Chip Set(s) at \$95.00 each plus \$1.15 shipping and handling.
- H8-2 Parallel Interface at \$150.00 each plus \$1.30 shipping and handling.
- H8-5 Serial I/O Cassette Interface at \$110.00 plus \$1.15 shipping and handling.
- H8-13 Extended BASIC Cassette at \$10.00 each plus \$1.15 shipping and handling.
- H8-14 Extended BASIC on paper tape at \$10.00 each plus \$1.15 shipping and handling.
- H8-15 Paper Tape Systems Software for H8 at \$20.00 each plus \$1.15 shipping and handling.
- HM-800 Manual Set at \$25.00 each plus \$2.37 shipping and handling.
- H11 Computer at \$1295.00 each plus \$5.52 shipping and handling.
- Qty. _____ H11-1 4K Memory(s) at \$275.00 each plus \$1.15 shipping and handling.
- H11-2 Parallel Interface at \$95.00 each plus \$1.15 shipping and handling.
- H11-5 Serial Interface at \$95.00 each plus \$1.15 shipping and handling.
- Please send the following Computer Books (order must total \$10.00 minimum) postpaid (Print numbers plainly.)

- H11-6 Extended Arithmetic Chip at \$159 each plus \$1.15 shipping and handling.
- HM-1100 Manual Set at \$25.00 each plus \$2.50 shipping and handling.
- H9 Video Terminal at \$530 each plus \$7.64 shipping and handling.
- H10 Paper Tape Reader/Punch at \$350 each plus \$4.96 shipping and handling.
- H10-2 Three Rolls Paper Tape at \$10.00 plus \$1.15 shipping and handling.
- H10-3 Three boxes Fan-fold Paper Tape at \$10.00 plus \$1.15 shipping and handling.
- H36 DEC Writer II at \$1495 (No COD's, see page 12 for shipping information.)
- H36-1 Fan-fold Paper at \$30.00 plus \$7.76 shipping and handling.
- H36-2 E1A Interface at \$65.00 each plus \$1.15 shipping and handling.
- ECP-3801 Cassette Recorder/Player at \$55.00 each plus \$1.69 shipping and handling.
- ECP-3802 Cassette Recording Tape, Pkg. of three at \$5.00 plus \$1.15 shipping and handling per pkg.
- EC-1100 BASIC Programming Course at \$29.95 plus \$1.69 shipping and handling. Available after October.
- HS-11 Special Priced Complete System at \$3350 each plus \$14.00 shipping and handling.

Note: The H11 and all its accessories will be available November 10th, 1977.

To remove order form cut out entire page along dotted line.

HEATH REVOLVING CHARGE PLAN



You may purchase Heathkit products on our convenient Revolving Charge Plan. No money down and up to two years to pay. Up to \$1500 maximum account balance.

- I would like to open a Heath Revolving Charge Account. Please rush me the necessary application forms when you receive this order.

I enclose my check money order for \$ _____ (Michigan residents add 4% sales tax.)

Or charge to my Visa/BankAmericard Master Charge

Acc't No. _____ Exp. Date _____

If Master Charge, include Code No. _____

Add on to or reopen my existing Heathkit Charge Account. No. _____ (\$1500 maximum account balance.)

Signature _____ (necessary to ship merchandise)

Name _____ Please print plainly

Address _____

City _____ State _____ Zip _____

BR-119 All prices net F.O.B. Benton Harbor, Mi. Prices and specifications subject to change without notice.

HEATH/DEC Software License Agreement:

This form **MUST** accompany your H11 computer order.

CUSTOMER SUBLICENSE GRANT

HEATH COMPANY (hereinafter referred to as HEATH) pursuant to a license agreement with Digital Equipment Corporation (hereinafter referred to as DIGITAL) does hereby grant to CUSTOMER a non-transferable and non-exclusive sublicense to use the Binary Software Program(s) PTSP-11 Paper Tape System, FOCAL/PTS Language Processor, BASIC/PTS Language Processor (hereinafter singularly and/or collectively referred to as "Software") on the following terms and conditions.

DESCRIPTION OF SOFTWARE:

Software is furnished to CUSTOMER for use on a single CPU only and may be modified, or copied (with the inclusion of DIGITAL'S copyright notice) only for use on such CPU. The CUSTOMER shall not provide or otherwise make available the Software or any portion thereof in any form to any third party without the prior approval of DIGITAL. Title to the ownership of the Software shall at all times remain with DIGITAL.

DIGITAL AND HEATH JOINTLY AND SEVERALLY DISCLAIM ALL IMPLIED WARRANTIES WITH REGARD TO THE SOFTWARE LICENSED HEREUNDER, INCLUDING ALL WARRANTIES

OF MERCHANTABILITY AND FITNESS; and any stated express warranties are in lieu of all obligations or liability on the part of either DIGITAL or HEATH for damages, including but not limited to special, indirect or consequential damages arising out of or in connection with the use or performance of the Software licensed hereunder.

This Sublicense Grant, the licenses granted hereunder and the Software may not be assigned by the CUSTOMER without prior written consent from DIGITAL. No right to reprint or copy the Software, in whole or in part, is granted hereby except as otherwise provided herein.

HEATH COMPANY
By William E. Johnson

CUSTOMER
By _____
Customer's Signature

Heathkit is the name to look for in quality electronic kits



Heath Company, located on the shores of Lake Michigan near Benton Harbor, is the world's largest manufacturer of electronic kits. Heathkit products are marketed primarily through the Heathkit Mail Order Catalog, published 5 times a year, and a nationwide chain of Heathkit Electronic Centers (Units of Schlumberger Products Corporation).



In addition to this new line of personal computing products, Heath Company offers nearly 400 other electronic kits of virtually every description. Product categories include Amateur Radio, Automotive Accessories, Stereo Hi-fi Components, Test Instruments, Color TV, Boating and Marine Accessories, Leisure and Home Improvement Products, and our award-winning self-instruction programs. Every Heathkit product is supplied with a comprehensive step-by-step instruction manual that tells you all you need to know, from unpacking the kit to plugging it in. These manuals are world-famous for their clarity, accuracy and precision. Let Heath show you how easily you can put together superior quality electronic products. Send for your FREE copy of our latest catalog!

Heathkit Computer Systems are also sold and serviced through 47 Heathkit Electronic Centers nationally (Units of Schlumberger Products Corporation) at slightly higher prices. Check the white pages of your telephone directory for the Heathkit Electronic Center nearest you.

Canadian Customers: Contact the Heathkit Electronic Center in most major cities or write for Canadian Prices to:

Heath Company, A Division of Schlumberger Canada, Ltd.
1480 Dundas Street E.
Mississauga, Ontario L4X 2R7

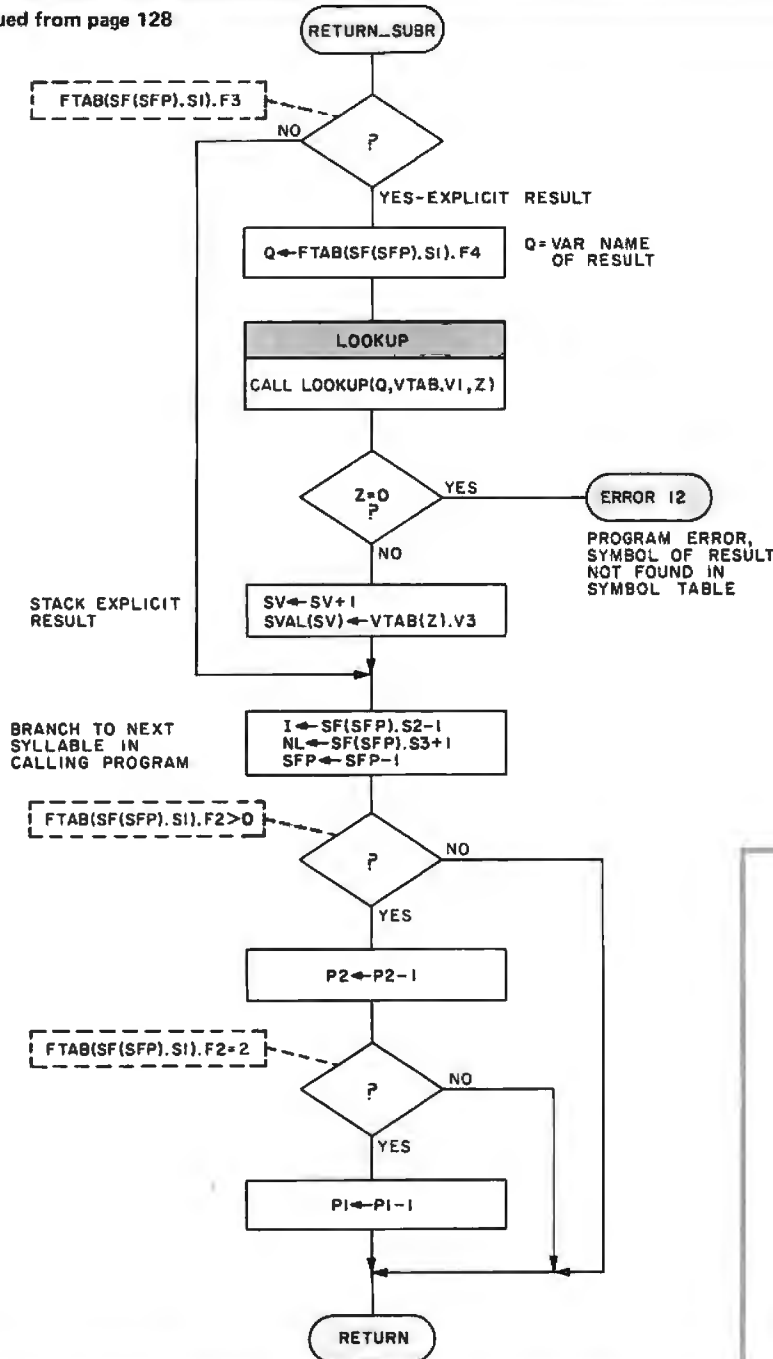

Figure 14: The procedure used to return from a subroutine. If the subroutine had an explicit result, an indirect pointer to the result must be stacked in table SVAL. Information stacked in table SF by the call to the subroutine must be unstacked. Finally, before continuing the interpretation at the proper syllable, any actual parameter pointers stacked in tables SD1 and SD2 must be unstacked.

Statement branching and subroutine linkage is a relatively simple process compared with expression evaluation. The next few figures return us to our discussion of the interpreter itself by detailing the expression evaluation process.

THE PAIA 8700 COMPUTER/CONTROLLER

An exceptional price on an applications oriented 6503 based micro-processor system featuring:

- ▶ 1K bytes RAM locations (512 bytes supplied)
- ▶ 1K bytes ROM (256 byte monitor included)
- ▶ 2 - 8 bit input ports
- ▶ 2 - 8 bit output ports (1 latched, 1 buffered)
- ▶ 24 key touch operated keypad (used by monitor to allow entry & execution of user programs also user definable.)
- ▶ 2 - latched seven segment displays (used by monitor to display memory location & contents easily user programmed)
- ▶ Optional cassette interface (\$22.50) fits entirely on the processor board.

THE IDEAL, LOW COST SOLUTION TO IMPLEMENTING ALL THOSE WILD COMPUTER BASED CONTROL SYSTEMS YOU'VE BEEN DREAMING OF!

PAIA software currently available or under development includes: Music synthesizer interface; Home applications package including: multi-zone fire/burglar alarm, real time clock, energy saving heat/air conditioning control, computer generated "door-bell"; Model railroad controller and more.

8700 COMPUTER CONTROLLER KIT \$149.95
(requires 5v. @ 1.2A.; 12v. @ 150 ma.)
Shipped direct from PAIA (add \$3.00 postage)

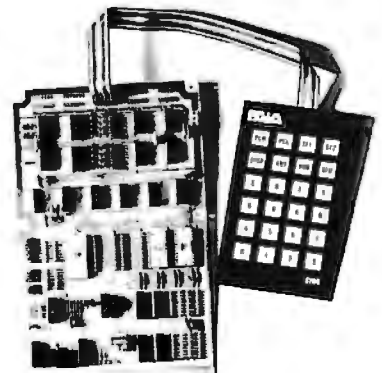

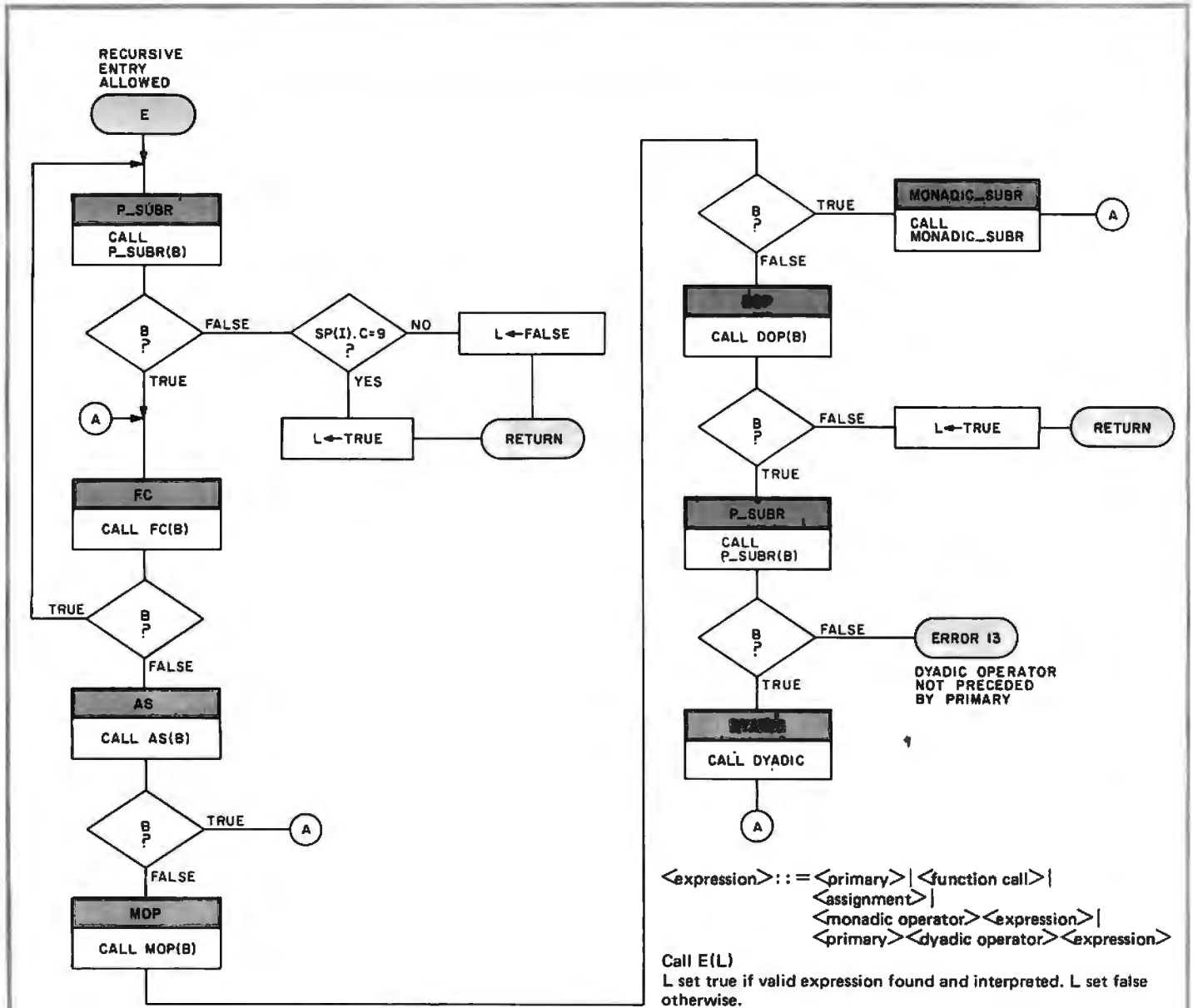
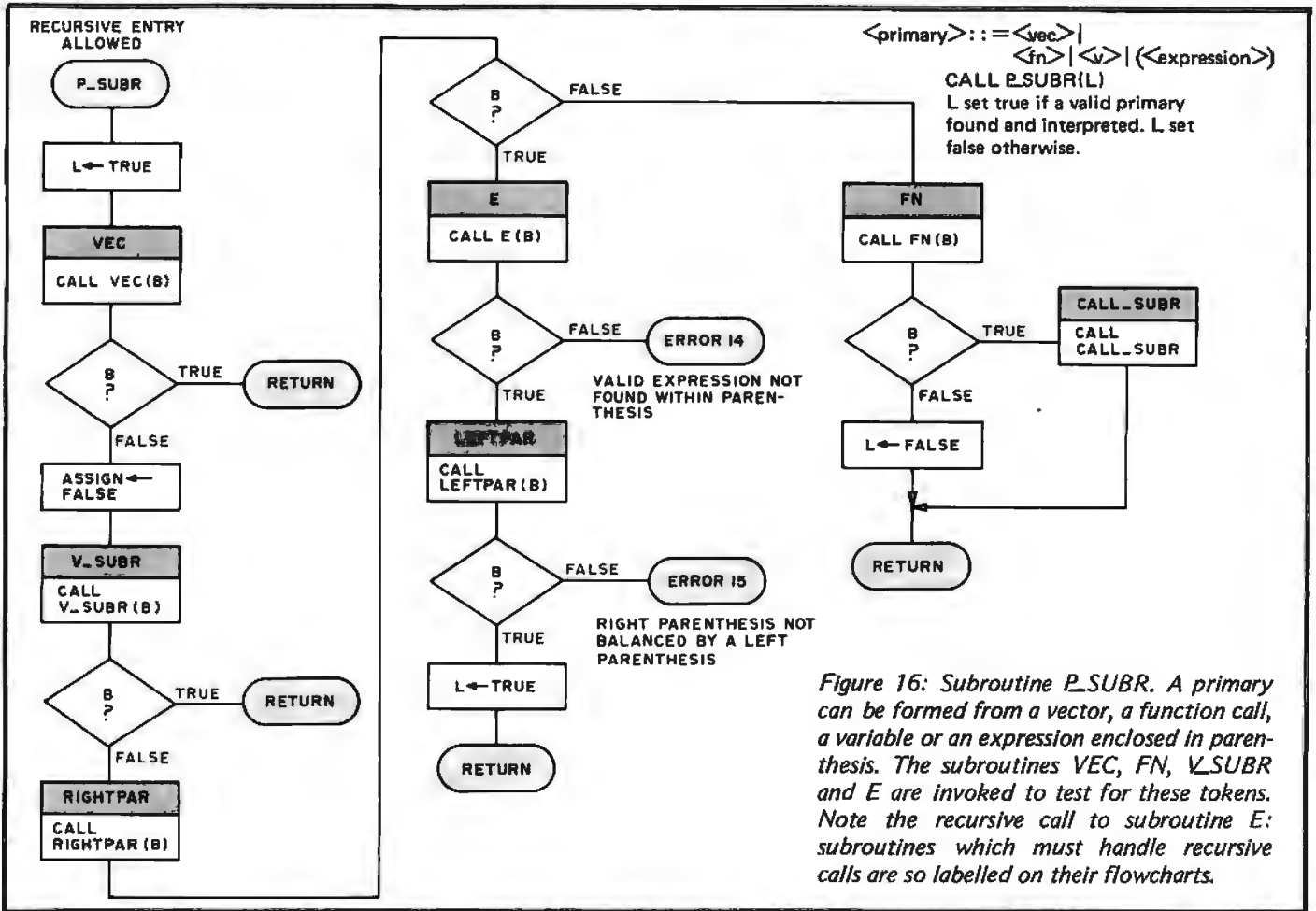

Figure 15: Subroutine E. This routine is called in figure 11 to recognize and interpret an expression. Five primary subroutines are invoked by E to interpret a valid expression. First P_SUBR is called to test for a valid primary which must be the rightmost token in any valid expression. After a primary is found, subroutine FC is called to test for and interpret a valid function call. If found, subroutine E starts again; otherwise, AS is called to look for a valid assignment. Subroutines MOP and DOP may also be called to look for monadic and dyadic operators, respectively (see figure 17). The total result is that a valid expression will be interpreted and argument L will be set true. In the case of an invalid or a nonexistent expression, argument L will be set false.



ACT-IV



Standard features: Full screen display of 24 lines by 80 characters. Professional, highly reliable keyboard with 2 key rollover. Auto repeating cursor keys, 'space' and 'period.'

Full ASCII display of upper and true lower case characters plus a unique set for the display of control characters.

Console selectable 'Page' mode with true editing: Insertion and deletion of characters or lines with automatic display rearrangement. Data rates to 19200 baud.

Absolute cursor positioning, report of cursor position, fixed tabs, home up, bell, erase to end of line and erase to end of file are all standard. A 'smart' page transmit ignores trailing spaces and blank lines.

The ACT-IV comes in two configurations: In a compact cabinet without monitor for \$550 (ACT-IVA) or complete with 12" data monitor and numeric keypad for \$800 (ACT-IVB). All units are fully assembled and tested. More detailed information concerning the ACT-IV can be obtained from any discriminating computer store.

Micro-Term Inc.

P.O. Box 9387 St. Louis, MO 63117 (314) 645-3656

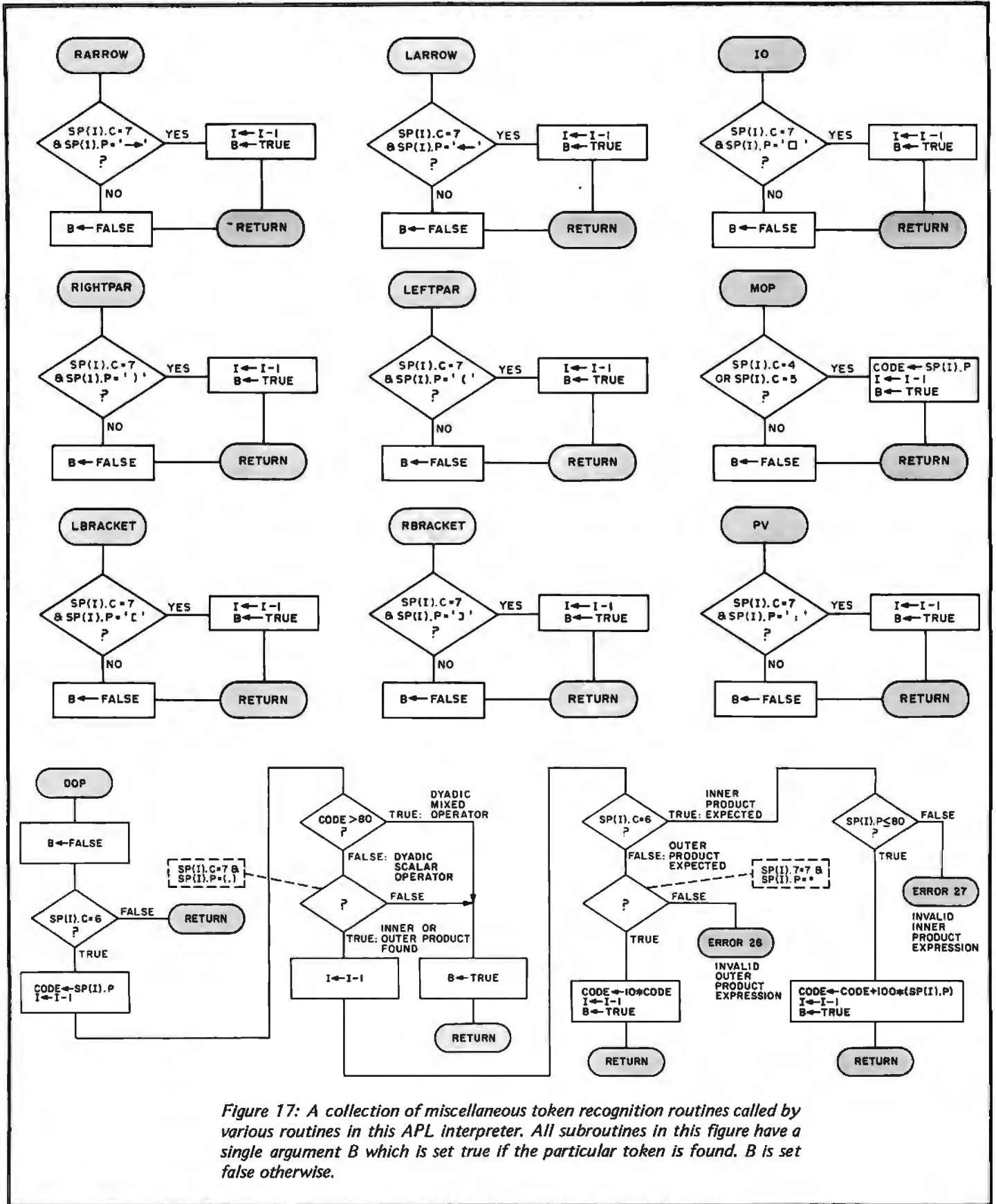
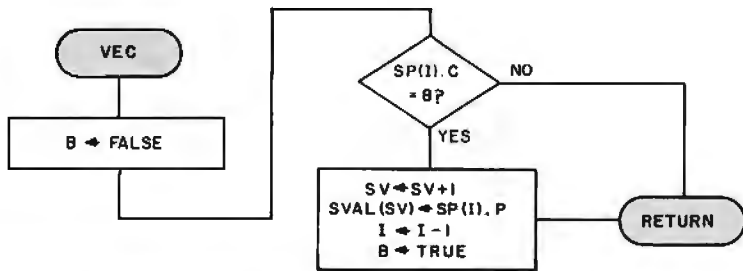

Figure 17: A collection of miscellaneous token recognition routines called by various routines in this APL interpreter. All subroutines in this figure have a single argument B which is set true if the particular token is found. B is set false otherwise.



CALL VEC(B)
 B is set true if a constant or vector is recognized; the recognized constant/vector being stacked. B is set false otherwise.

Figure 18: Interpretation of a vector or constant. If the current syllable indicates a constant or a vector, the pointer to the associated value is stored in table SVAL.

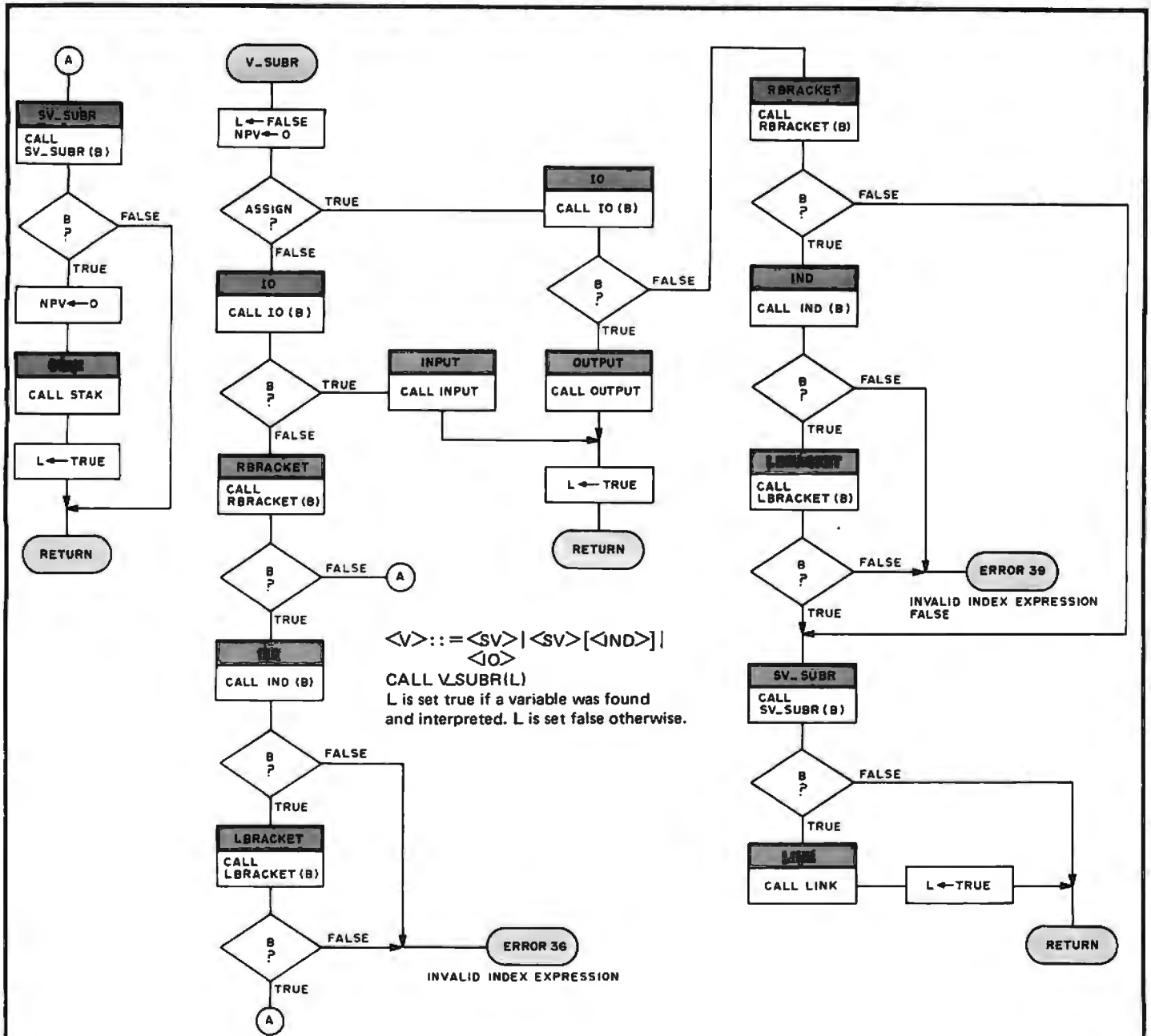
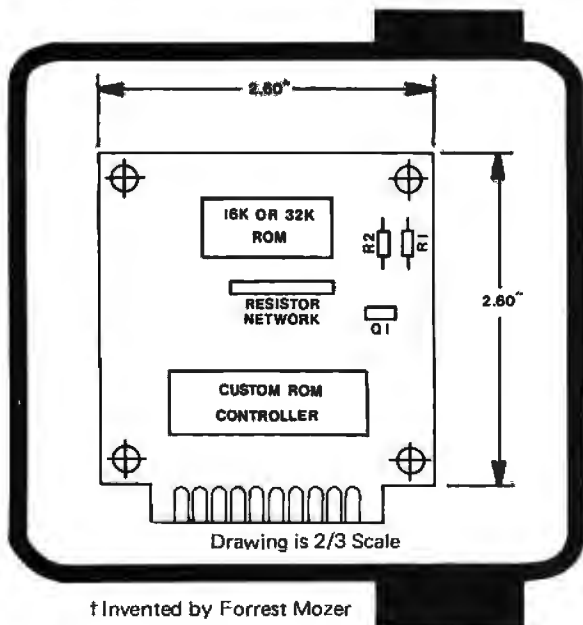
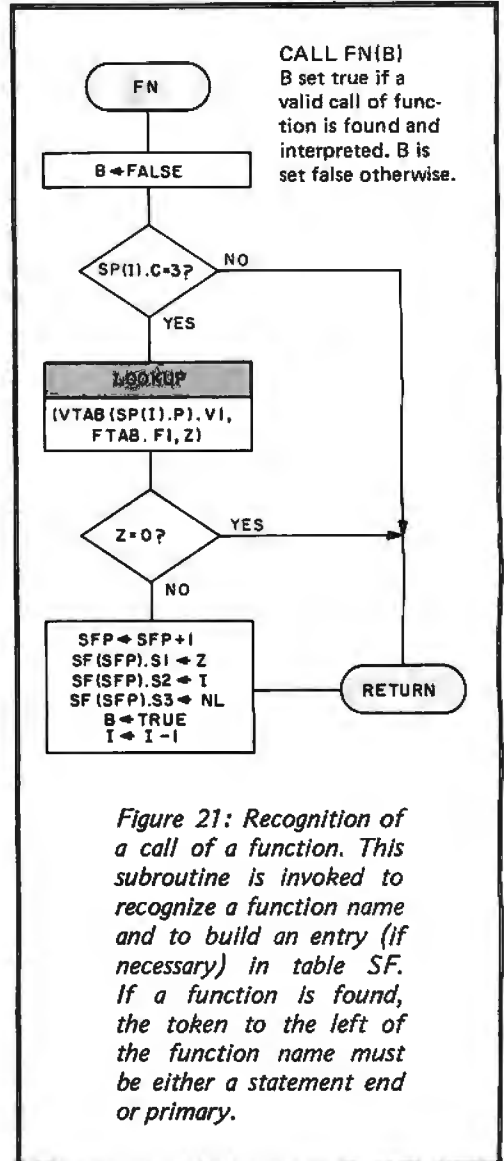
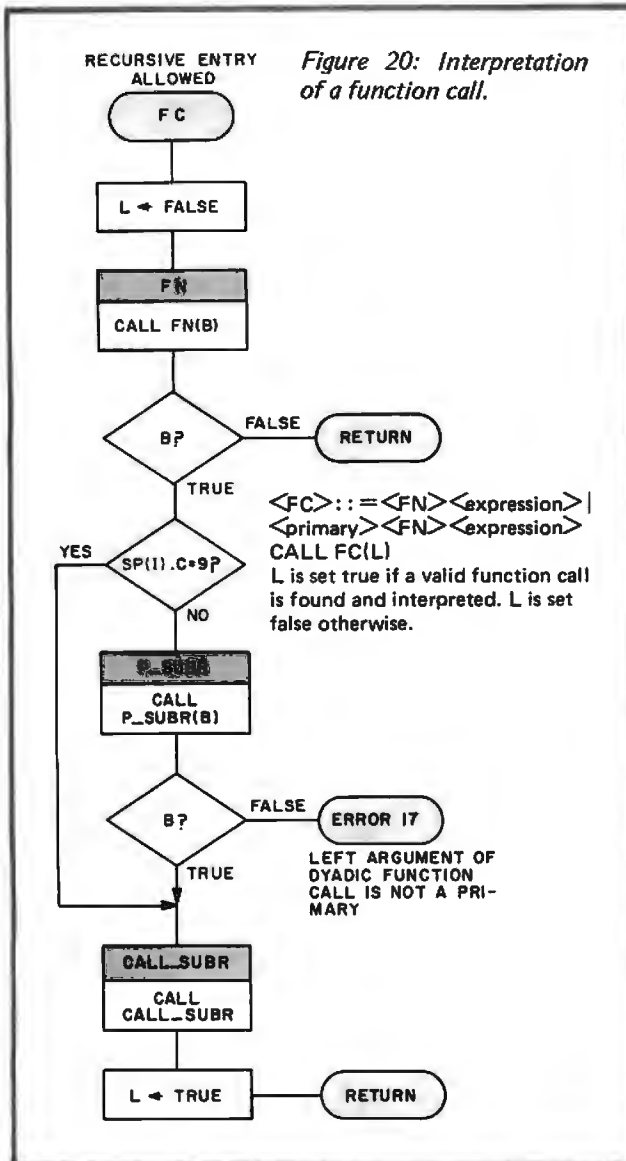

Figure 19: Interpretation of a variable. This process is more complicated than the interpretation of a constant. A variable can be formed from a variable, a simple variable followed by an index expression, or a quad operator. Further, variables occurring to the left of an assignment operator are handled differently from those on the right. Subroutines STAK and LINK (figures 25 and 26) handle the stacking of operand pointers and the linking of results to a symbol table entry.



Introducing—New, Low-cost, Fixed Vocabulary Speech Synthesizers[†]

for Computer Hobbyists or OEM use

FEATURES

- Two 64-word vocabularies available:
 - Full spoken numerics plus a variety of measurement words
 - ASCII characters: numerics, alphabet, special symbols
- Clear, highly intelligible male voice
- All MOS-LSI circuitry
- 6-bit parallel strobed input
- No external clocks required
- Inputs are TTL compatible
- Analog Speech output signal

\$179⁰⁰*

*Plus state sales taxes where applicable



TELESENSORY SYSTEMS, INC.

3408 Hillview Avenue, Palo Alto, California 94304
Telephone (415) 493-2626, Attention: Paul Obester

Figure 22: Call of function semantics. This routine is invoked to perform the linkages and table updates required in interpreting a function call. The last step is to set I to point to the rightmost syllable of the first statement in the called function.

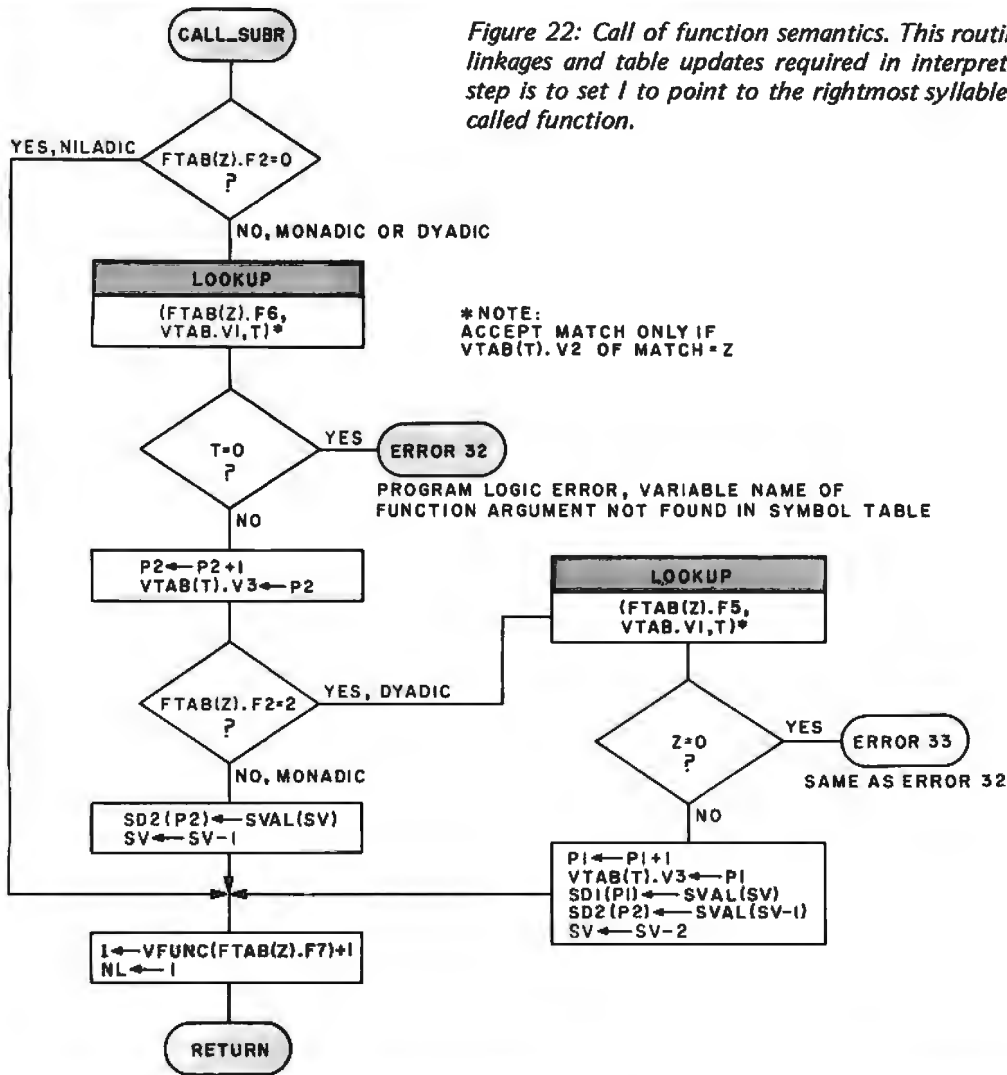

MULTIPLE DATA RATE INTERFACING FOR YOUR CASSETTE AND RS-232 TERMINAL

the CI-812

The Only S-100 Interface You May Ever Need

On one card, you get dependable "KC-standard"/biphase encoded cassette interfacing at 30, 60, 120, or 240 bytes per second, and full-duplex RS-232 data exchange at 300- to 9600-baud. Kit, including instruction manual, only \$89.95*.

PERCOM

PERCOM DATA COMPANY, INC.
4021 WINDSOR • GARLAND, TEXAS 75042
(214) 276-1968

*Assembled and tested,
\$119.95. Add 5% for
shipping. Texas resi-
dents add 5% sales tax.
BAC/MC available.



PerCom 'peripherals for personal computing'

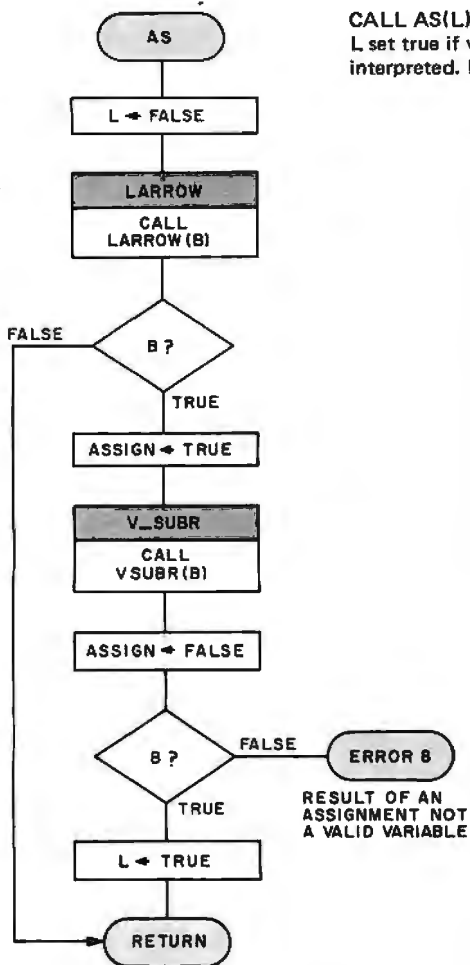

Figure 23: Interpretation of an assignment. This routine searches for a valid assignment which must be of the form "variable ← expression." Again, subroutines LARROW and V_SUBR are called to interpret the appropriate tokens. V_SUBR is also called by P_SUBR (see figure 19), but it functions differently for the two calls, since one is looking for a variable to the right of an assignment symbol, and the other is looking for a variable to the left of an assignment symbol. Variable ASSIGN is used to signify which mode to use.

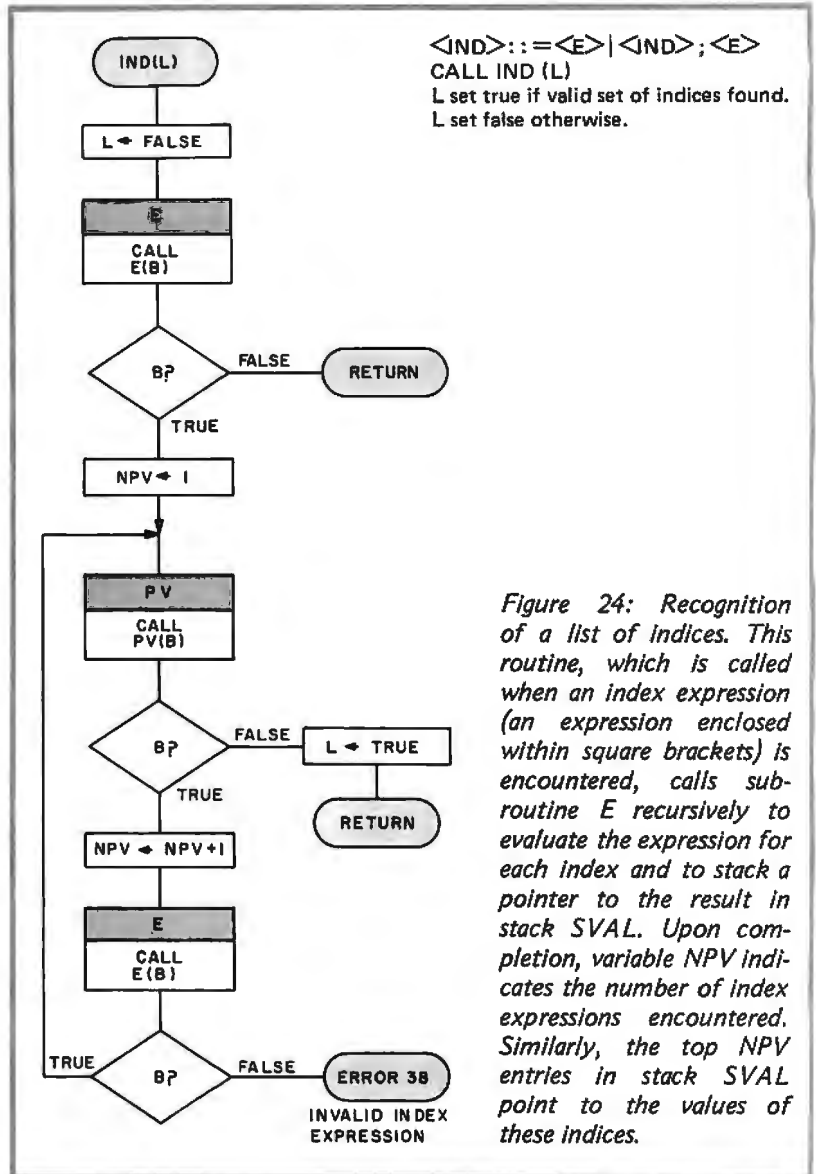



Figure 24: Recognition of a list of indices. This routine, which is called when an index expression (an expression enclosed within square brackets) is encountered, calls sub-routine E recursively to evaluate the expression for each index and to stack a pointer to the result in stack SVAL. Upon completion, variable NPV indicates the number of index expressions encountered. Similarly, the top NPV entries in stack SVAL point to the values of these indices.



DAJEN Electronics
7214 Springleaf Ct.
Citrus Heights, Ca. 95610
(916) 723-1050

HIGH-SPEED CASSETTE INTERFACES (The Stringy Disk)

CRI-B



600 to 12,000 baud status controls, 1K monitor with cassette routines provided on tape.

All I Need!!!
Universal I/O Interface

High-speed cassette, two relays for control of two recorders; space for three 2708's, one provided, with monitor software, 2708 programmer; reset-jump; ram for stack; RS-232, 20 ma, 60 ma, serial; 3 parallel ports; speeds from 20 to 19,200 baud.

Kit \$285. Assembled, tested \$345.
Mastercharge, BankAmericard, Visa

UCRI

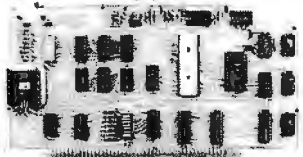

Relay control of two recorders, latched input port for keyboard, tape reader, etc. File-search capabilities.

Biphase, Kansas-City, Altair, IMSAI, Poly, Tarbell compatible

Kit \$120, Assembled \$165
Manual \$3.50

Kit \$135, Assembled \$175
Manual \$4.50

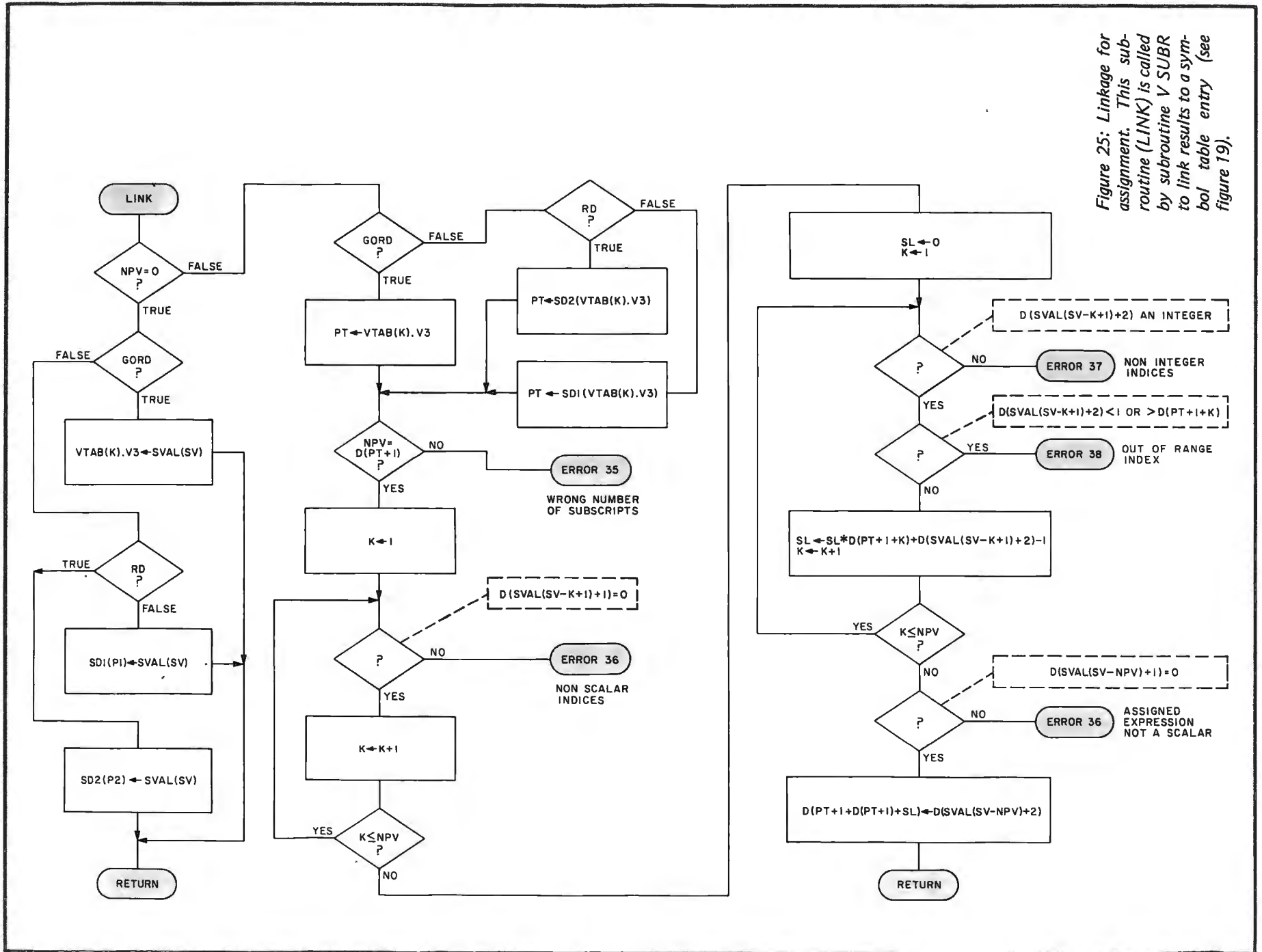
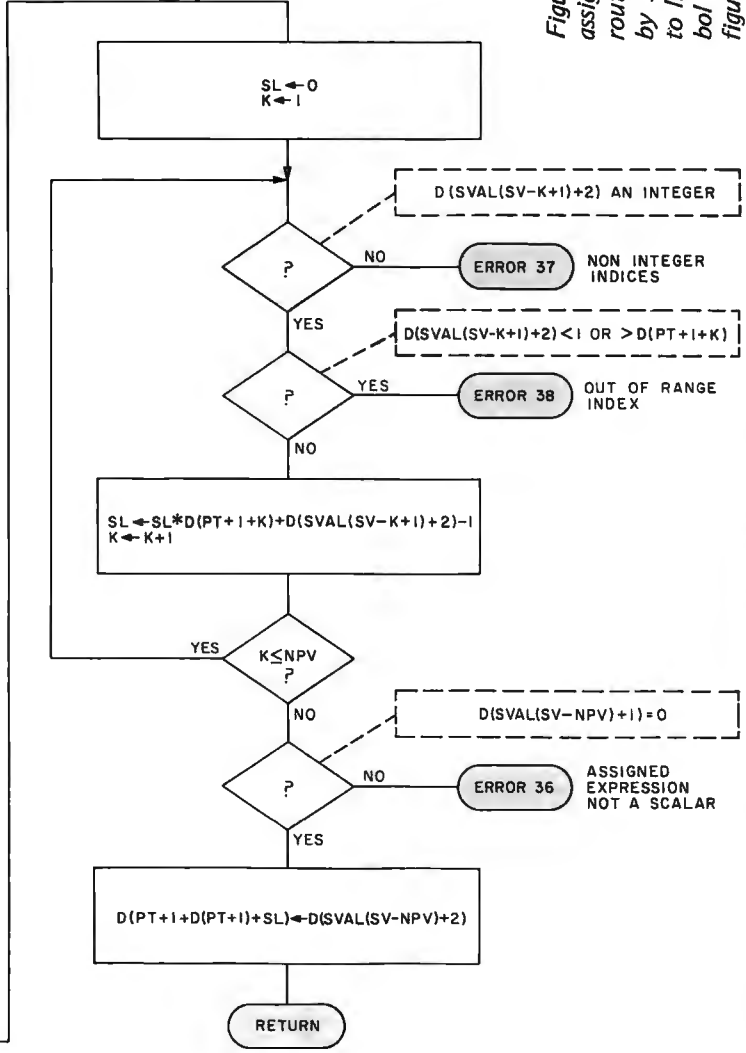

Figure 25: Linkage for assignment. This subroutine (LINK) is called by subroutine V SUBR to link results to a symbol table entry (see figure 19).



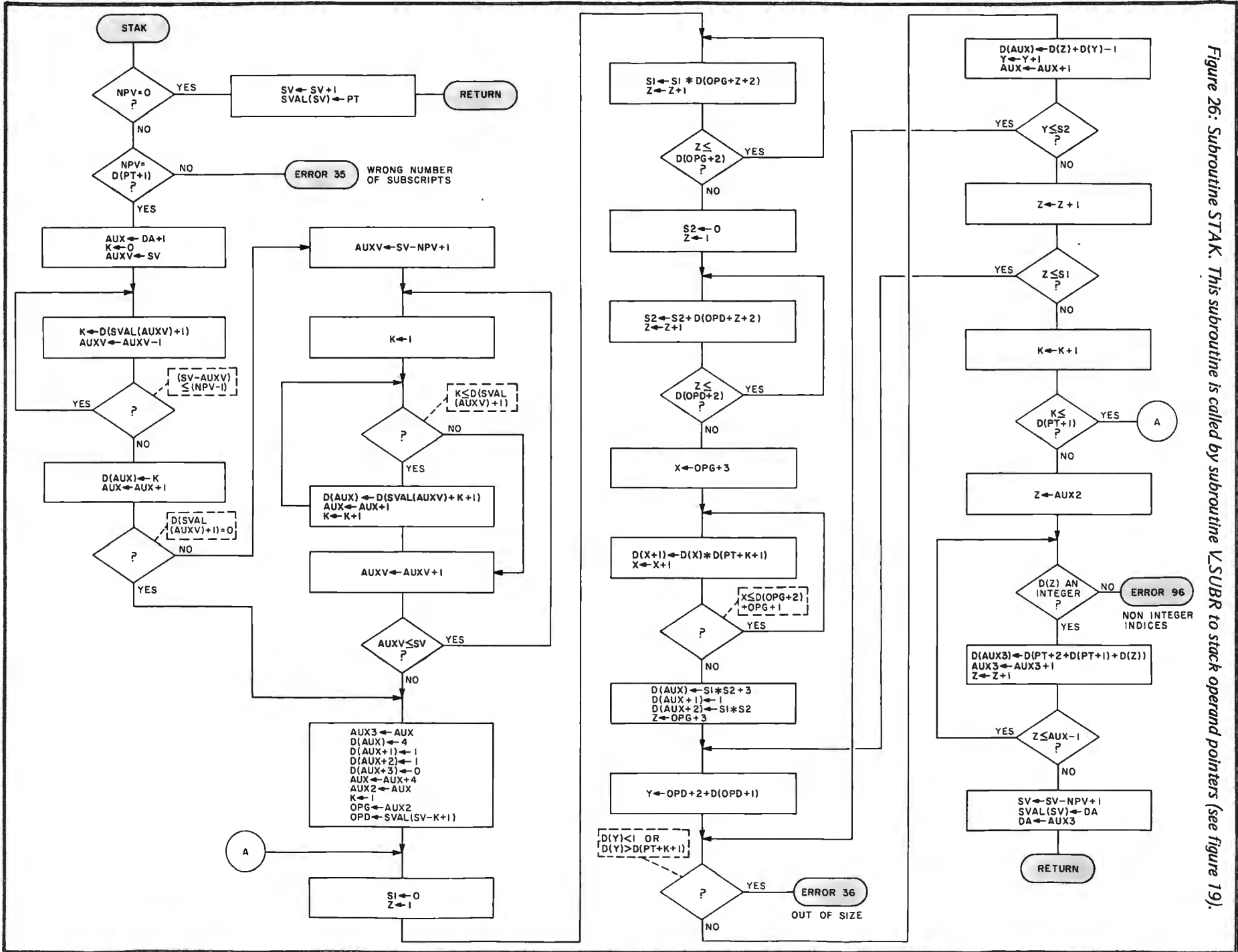

Figure 26: Subroutine STAK. This subroutine is called by subroutine VSUBR to stack operand pointers (see figure 19).

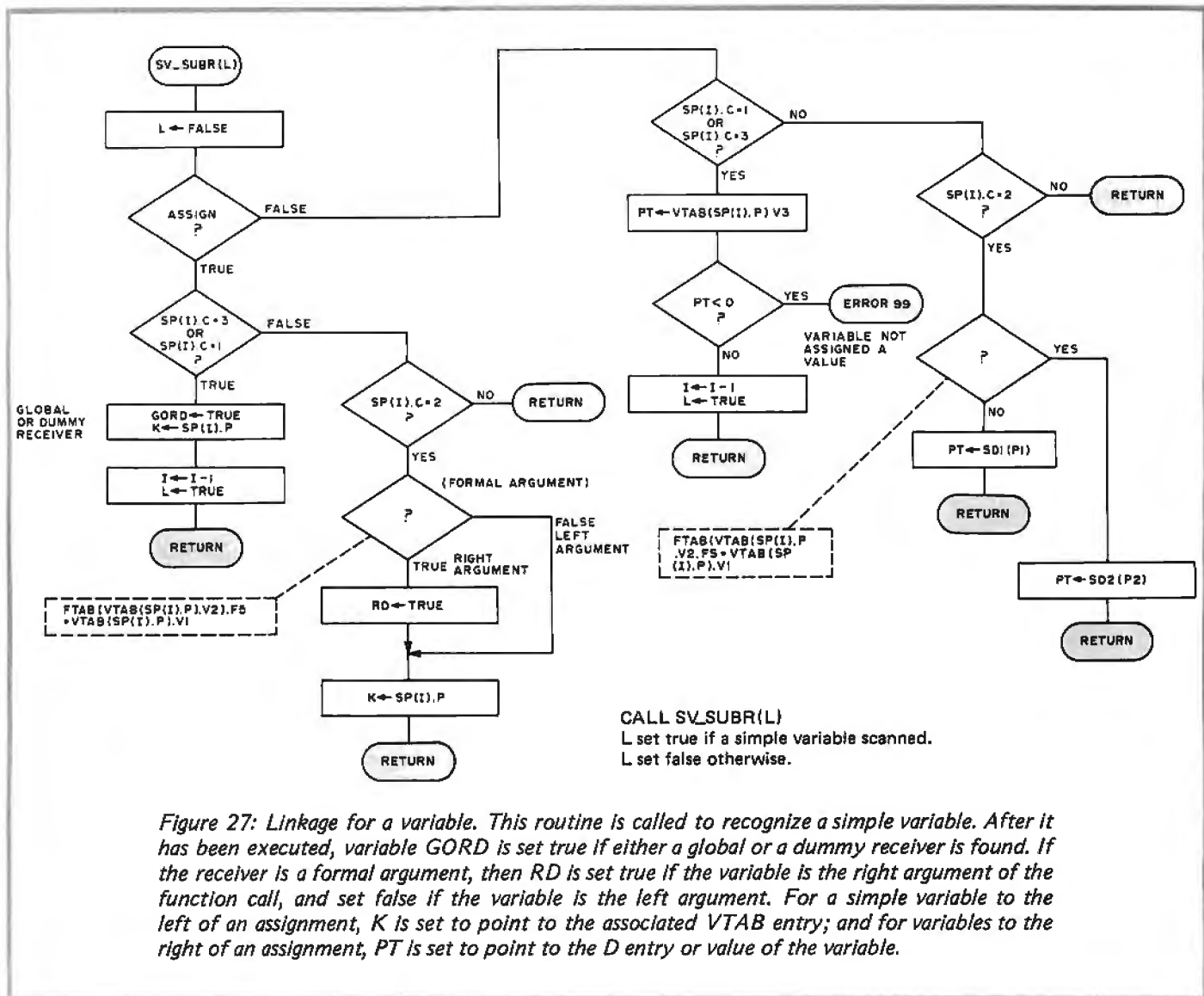

Figure 27: Linkage for a variable. This routine is called to recognize a simple variable. After it has been executed, variable GORD is set true if either a global or a dummy receiver is found. If the receiver is a formal argument, then RD is set true if the variable is the right argument of the function call, and set false if the variable is the left argument. For a simple variable to the left of an assignment, K is set to point to the associated VTAB entry; and for variables to the right of an assignment, PT is set to point to the D entry or value of the variable.

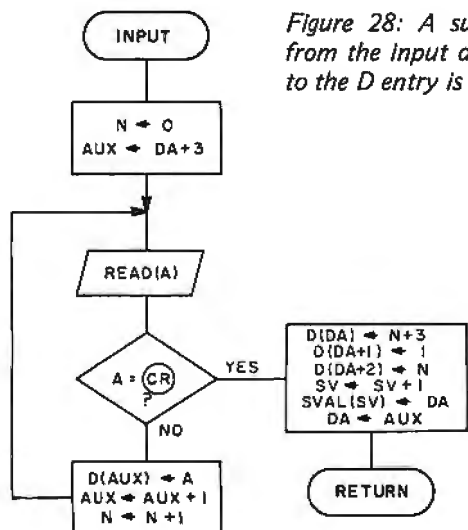

Figure 28: A subroutine used to input a constant vector. A value is read from the input device, an appropriate entry is made in table D, and a pointer to the D entry is stacked in table SVAL.

Note: No flowchart is shown for a quad denoting output, since the process is more or less implementation dependent (although simple). The element in the top of stack SVAL points to the table D entry to be listed.

That concludes part 2 of this 3 part series of articles describing an APL interpreter. Although the flowcharts may look awesome, the actual amount of code to be written is not overly great. My PL/I version of this interpreter is less than 1600 statements long.

Next month's concluding article describes the mathematical processing section of the statement interpreter, and describes the four arithmetic processing subroutines MOP, MONADIC, DOP and DYADIC. Since they define the number and use of the primitive operators, most of the tailoring of the interpreter will be done in these subroutines. ■

through a resistor that sets the current flowing into pin 14 to approximately 2 mA.

An additional resistor, R_1 (also in this current leg), allows the current to be varied by a small percentage and provides the ability to adjust the full scale range of the digital to analog converter. The output of the converter is a current which is equivalent to the product of this reference current and the binary data on the control lines. The current is converted to a voltage through IC9 and can be zero offset through the use of the offset adjustment pot, R2.

The digital code stored in the scratch pad and presented to the digital to analog converter is in offset binary. A binary value of 00 000 000 produces an output of -5 V

from the converter while 11 111 111 is equivalent to $+5$ V. In offset binary, if the most significant bit is a zero, the output is negative and if the most significant bit is a one, the output is positive. Since the converter has a range of 10 V, and is an 8 bit device, the resolution of the converter is $1/256$ of 10 V, or approximately 40 mV. This means that the smallest output increments will be in 40 mV steps. To change this to finer increments requires that the range be shorter, such as $+2.56$ V to -2.56 V. By adjusting the span and zero pots, any reasonable range may be chosen, but the resolution will always be equal to the least significant bit or $1/256$ of the range, and accuracy is estimated to be $\pm 1/2$ least significant bit.

INTERFACE ASSEMBLY AND CALIBRATION

1. Be sure to build the circuit with good quality sockets for all integrated circuits. With all components except integrated circuits wired in place, and presuming that there are no shorts, apply power to the interface. It should be noted that while the interface is shown with Altair (S-100) bus notation, there is no requirement that it be an S-100 configuration. The digital to analog conversion will work with any computer capable of providing an 8 bit data bus, 8 bit IO address bus, and an output enable strobe. Computer cycle time and architecture are irrelevant. For use with a Digital Group 8080 system, the address and data buses are connected to the equivalent DGS pin numbers, S-100 pin 77 on the interface board is grounded, and the DGS pin 17 IO write signal is used on pin 45 of the interface board in place of Sout.

2. Using a meter, check to see that the right supply voltages are on the appropriate integrated circuit pins and that V_{ref} on the digital to analog converter is approximately 6.2 V. If substituting parts, take care not to exceed 15 V between V_{cc} and V_{ee} on the CMOS 4051.

3. Disconnect the power and attach the port decoding jumpers for the desired port addresses. Each of the six address lines, A7 thru A2, can be, by the appropriate placement of the jumpers, decoded as an inverted or non-inverted signal. In building the circuit from scratch, an appropriate technique is to use a DIP socket with each pin, used as a jumper terminal. Selective wiring between the pins can then be done with wire wrap or Vector Slit-N-Wrap. The inverted choice is designated as a zero code, and the noninverted as a one. If all jumpers were set to the one position, channel 1's port address would be decoded as binary 11 111 100₂, or octal 374. Channel 4 would be 377 octal. If all jumpers were set to zeros, channel 1 would start at port address 0 and channel 4 would be port address 3 octal. Pick the binary code for whatever port assignment desired and wire the jumpers.

4. Insert integrated circuits IC1, 2, 3, 4, 5, 7 and 9. Apply the power, and with a short program which just outputs a value from the accumulator to an output port, output a binary 10 000 000 to the port address corresponding to channel 4 on the interface board. Using a meter to monitor the output of the LM301A, adjust the zero pot R2 until the output is 0 V. With the same programming technique, load a binary 11 111 111 (octal 377) to channel 4 port address and adjust the span pot R1 for a meter reading of $+5.12$ V. A binary setting of 00 000 000 should output -5.12 V. If you are unsuccessful at this point, with power off, remove the MC1408L-8 and the LM301A, and verify that the binary output of the scratch pad is correct. With the integrated circuits presently installed, the scratch pad is latched at an address of channel 4. Nine times of ten, problems like this can be attributed to choosing an incorrect port code. Turn off the power.

5. Insert the clock generator IC6, reapply power, and using a scope or frequency counter, verify an approximate 200 kHz clock rate. Turn off the power.

6. Next, insert IC8, the CMOS multiplexer IC10, and the sample and hold op amps IC11 and 12. Be very careful in handling the CMOS integrated circuit. It is very easily damaged by static charges. Turn on the power and then using the same simple program, output a binary value to one of the channel addresses and note with a meter that it is in fact the correct voltage. Using the program, vary the output of each channel separately across the range and note that no other channel outputs should change. Sympathetic tracking usually indicates a bad multiplexer integrated circuit.

A few cautions: Don't use op amps with a frequency response less than the LM301A and use only the L8 version of the MC1408-L8 (not MC1408-L7 or MC1408-L6) if you want a guaranteed eight bits of precision.

```

80 REM THIS PROGRAM CALCULATES THE VALUES FOR A SINE WAVE AND
82 REM PUTS THEM IN PAGE 100 (OCTAL) OF MEMORY
90 PRINT "SINE WAVE POINT CALCULATOR"
100 LET A=3.14/180*360/256
110 FOR B=0 TO 255
120 LET W=INT(127.5+(127.5*SIN(A*B)))
130 FILL 16384+B,W
160 NEXT B

```

Listing 1: An extended BASIC program to compute and load a table in memory with 256 sample points of a sinusoidal waveform. Digital Group MaxiBASIC interpreter.

Now How Do I Use It?

Once you have conquered the hardware and constructed an interface (see notes in the box) you should be ready to exercise it under program control. There are some interesting applications using the digital to analog interface alone, none the least of which is Ned's problem.

You will remember that my solution to the impulse response problem in Ned's test setup was to vary the pressure sinusoidally using a computer generated voltage to control a pressure regulator. Adding a computer sounds a bit unnecessary, but remember that an analog to digital interface will be attached for data acquisition.

With this particular digital to analog interface, programming an analog control voltage utilizing an extended BASIC such as the Digital Group's MaxiBASIC, is quite easy. To operate a real time sine wave that varies the pressure between 0 and 10,000 PSIG requires a control regulator with a control voltage range of -5 V to +5 V and the following very simple BASIC program:

```

90 REM THIS PROGRAM CALCULATES
  AND OUTPUTS A SINE WAVE.
100 LET A = 3.14/180*360/256
110 FOR B = 0 TO 255
120 LET W = INT(127.5+127.5*SIN(A*B))
130 OUT 252,W
140 NEXT B
150 END

```

This program calculates 256 values of a sine wave with an amplitude of -5 to +5 V. When run in real time, the period of the waveform is about two seconds. The period is basically set by the time it takes to compute the expression on line 120 some 256 times. An alternative method is to calculate the points once, load the values in memory and call a subroutine which scans the table when directed to do so by the program.

The first time that the points are computed, it will take two seconds as before. Then they are available in a look up table. A program which constructs such a memory resident table is illustrated in listing 1. Photo 2 shows an oscilloscope trace of the synthesized sine wave created by the digital to analog converter in figure 9 using the table created by listing 1.

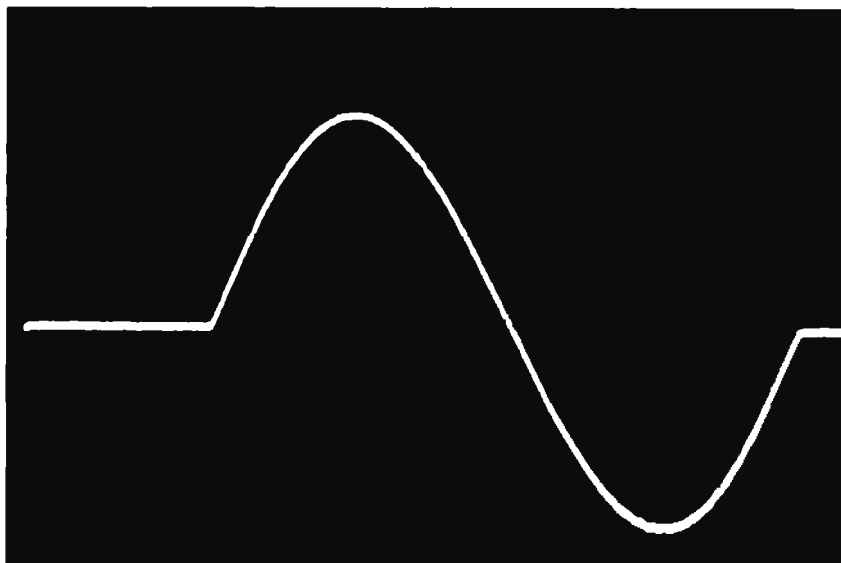

Photo 2: An oscilloscope display of a sinusoidal waveform synthesized by using the BASIC program in listing 1 in conjunction with the digital to analog converter shown in figure 9.

Split Octal Address	Octal Code	Operation	Commentary
012/000	041 000 100	LXI H&L	Set the program counter to page 100;
012/003	176	MOV A	Move addressed memory to accumulator;
012/004	323 375	OUT	Output accumulator to port 375;
012/006	054	INR L	Increment L register;
012/007	302 003 012	JMP COND.	Jump to 012/003 if L ≠ 0;
012/012	311	RET	Return to BASIC program;

Listing 2: A machine language program which is used to drive the digital to analog converter in figure 9. This program is called by the extended BASIC program in listing 3.

```

300 PRINT "THIS PROGRAM WHICH DRIVES AN 8 BIT D/A PRODUCES "
310 PRINT "ANY WAVEFORM FROM A BINARY TABLE"
400 REM THIS PROGRAM CALLS A SUBROUTINE AT 012/000 (OCTAL)
410 REM WHICH OUTPUTS THE 256 WAVEFORM VALUES TO
420 REM D/A ON OUTPUT PORT 375(OCTAL)
430 REM OCTAL AT 012/000
440 REM 041 000 100 176 323 375 054 302 003 012 311
450 REM MAX SPEED FOR ADSR IS 4 MSEC.
470 REM BINARY TABLE IS ON PAGE 100 (OCTAL)
502 PRINT "GENERATE THE WAVEFORM HOW MANY TIMES ?":INPUT E
505 FOR X=1 TO E
510 LET A=CALL(2560,0)
515 NEXT X
1000 END

```

Listing 3: An extended BASIC program which calculates 256 points of a given waveform which is to be synthesized and then calls the machine language routine in listing 2 to actually drive the digital to analog converter in figure 9. The call to the subroutine in listing 2 occurs at line 510 of this program. Digital Group MaxiBASIC interpreter.

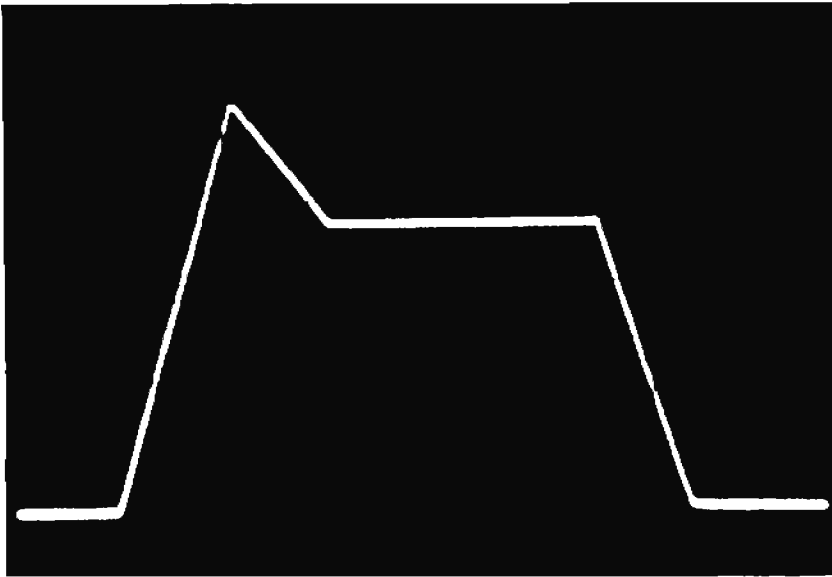

Photo 3: An oscilloscope display of a musical envelope waveform called an ADSR waveform. "ADSR" stands for Attack, Decay, Sustain and Release, a popular way of characterizing an amplitude envelope which is typical for many musical instrument waveforms. This waveform was synthesized by means of the program in listing 4 which was used to drive the digital to analog converter in figure 9. Also see figure 10.

```

80 PRINT "ADSR MEMORY LOADER"
90 REM THIS PROGRAM COMPUTES DECIMAL VALUES FOR A PIECE-WISE
91 REM LINEAR ADSR WAVEFORM AND ILLUSTRATES THE METHOD
92 REM THE VALUES ARE THEN LOADED INTO PAGE 100(OCTAL) OF MEMORY
93 REM THEY ARE THEN AVAILABLE FOR MACHINE SUBROUTINES
100 FOR X=0 TO 60
105 REM THIS IS THE "A" SECTION
110 LET Y=INT((255/60)*X)
120 FILL 16384+X,Y
125 NEXT X
130 LET W=61
135 FOR Z=0 TO 39
137 REM THIS IS THE "D" SECTION
140 LET Y=INT((-75/40)*Z+255)
150 FILL 16384+W,Y
152 LET W=W+1
155 NEXT Z
160 FOR X=101 TO 220
170 LET Y=180
172 REM THIS IS THE "S" SECTION
175 FILL 16384+X,Y
180 NEXT X
185 LET N=221
190 FOR X=0 TO 34
192 REM THIS IS THE "R" SECTION
200 LET Y=INT((-180/35)*X+180)
210 FILL 16384+N,Y
212 LET N=N+1
220 NEXT X
1000 END

```

Listing 4: An extended BASIC program which generates a table of sample points of the ADSR waveform whose graph appears in figure 10. Digital Group MaxiBASIC interpreter.

LINE EQUATIONS

A FROM 0 TO 60
 $Y = 255/60X$
D FROM 61 TO 100
 $Y = 75/40X + 255$
S FROM 101 TO 220
 $Y = 180$
R FROM 221 TO 255
 $Y = 180/35X + 180$

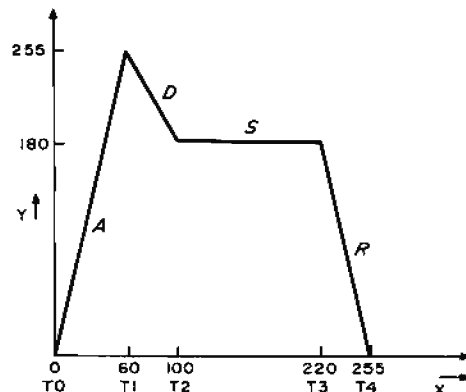

Figure 10: A simple ADSR (Attack, Sustain, Decay and Release) envelope waveform along with the line equations necessary for digital to analog waveform synthesis (see photo 3 and listing 4).

A simple program which scans the table and drives the digital to analog converter is assembled into the memory of my particular system at split octal address 012/000 (hexadecimal 0A00) as shown in listing 2. This program can be called at any time with the BASIC command CALL (2560,0), and when driven at faster than 100 ms periods can be easily displayed on an oscilloscope. [Note that 2560 is decimal for split octal address value 012/000 or hexadecimal 0A00.] The program in listing 3 incorporates the routine in listing 2 as a called subroutine and can be used to display any waveform defined by the table located at address 100/000 in split octal notation (hexadecimal 4000).

On to Bigger and Better Applications

An obvious application of this programming technique is to mathematically compute and generate complex waveforms which would otherwise require extensive dedicated hardware to duplicate. Music application is an area which is being heavily infiltrated with computer technology. A composer interested in electronic music effects can design discrete waveforms, display and review them before committing them to a performance design.

An alternative approach is to use BASIC to generate all the tables defining envelope or waveform aspects of desired instruments and then let BASIC sit idle while a machine language program selects and calls the tables to produce a musical score.

It's often easier to illustrate one example rather than discuss volumes of theory. One of the least complicated musical envelope waveforms is the ADSR envelope. ADSR stands for Attack, Decay, Sustain and Release. Various combinations of these four variables produce unique sounds similar to such instruments as the piano or trumpet. In an electronic music application the composer would combine the necessary fundamentals and harmonics characteristic of a particular instrument and control the output amplitude with an ADSR waveform feeding a voltage controlled amplifier, or VCA. Both the envelope and harmonic content are separate elements of musical compo-

16384 BYTES for \$485.00

assembled (with sockets) : tested - burned-in - guaranteed

A new high in S100 bus memory cost effectiveness. Fully assembled (with sockets), tested, burned-in and guaranteed. 4Kx1 dynamic memory chips (the same ones used by the ton in IBM compatible memory systems) combined with self contained control logic, yield a memory system with these features:

- Low power consumption, total board 5 watts.
- Transparent refresh, which means the memory looks static to the outside world.
- No waiting. In fact, XRDY is not even connected to the memory.
- Full DMA capability.
- Reliable, low level clock and control signals.
- Three full days testing at 70° C (185° F).

SPECIFICATIONS

Capacity:	16384 bytes
Addressing:	16K boundaries
Bus structure:	S100 - Plug compatible with IMSAI 8080, POLY 88, ALTAIR 8800, BYTE-8, SOL
Address and Data Buffering:	<200 uA, special high impedance buffers - less than one low power Schottky load
Access time:	350 nSec
Memory chips:	MM 5271 (National Semiconductor and others) 4K dynamic

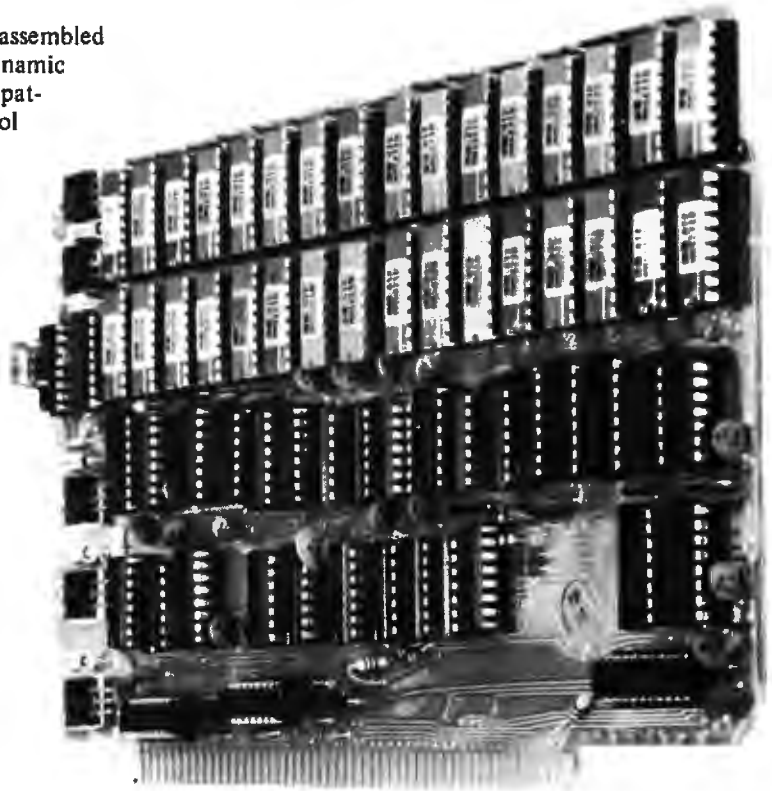

Dynabyte Inc.

4020 Fabian Way, Palo Alto Ca. 94303

for more information call or write to:

R.H.S. MARKETING
2233 El Camino Real
Palo Alto, California 94306
(415) 321-6639

DEALER INQUIRES INVITED
B of A & Mastercharge accepted

Dynabyte®

brings to the S100 Bus a state of the art, industrial quality memory system.
16K on a single board for \$485.00, Guaranteed for 1 year.

Circle 248 on inquiry card.

```

90 PRINT "WAVEFORM BEING CALCULATED"
92 REM THIS PROGRAM CALCULATES THE COORDINATES OF A COMPLEX WAVEFORM
93 REM THE POINTS ARE IN PAGE 100 (OCTAL)
100 LET B=3.14/180*360/256
110 FOR A=0 TO 255
120 LET E=-((255/3.14)*SIN(A*B))
125 LET F=-((255/(2*3.14))*SIN(2*A*B))
130 LET G=-((255/(3*3.14))*SIN(3*A*B))
150 LET Y=INT(127.5+E+F+G)
160 PRINT A,Y
170 FILL 16384+A,Y
180 NEXT A
500 END

```

Listing 5: An extended BASIC program which calculates sample points of the Fourier series illustrated in figure 11 and stores them in a table. Digital Group MaxiBASIC interpreter.

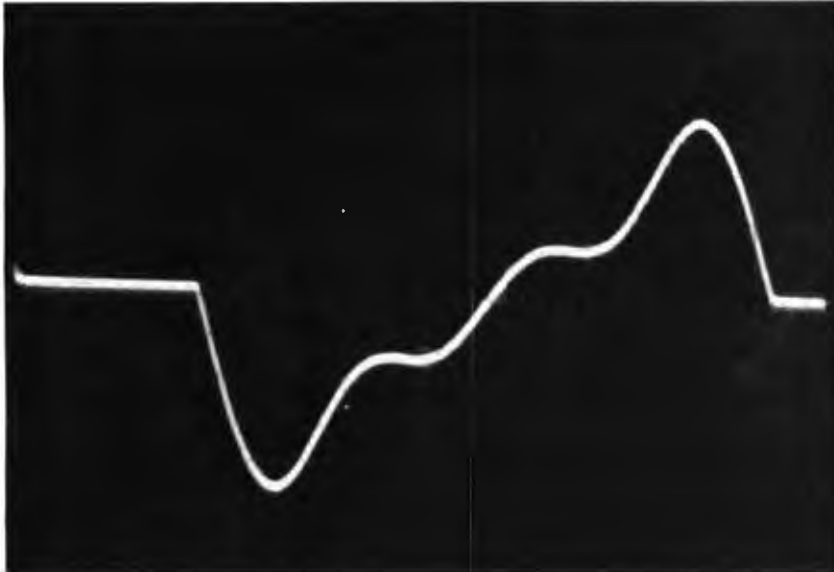

Photo 4: An oscilloscope display of the waveform resulting from the synthesis of a typical complex waveform using the program in listing 5 and the digital to analog converter in figure 9. The waveform is the result of summing three terms of a Fourier series (see figure 11).

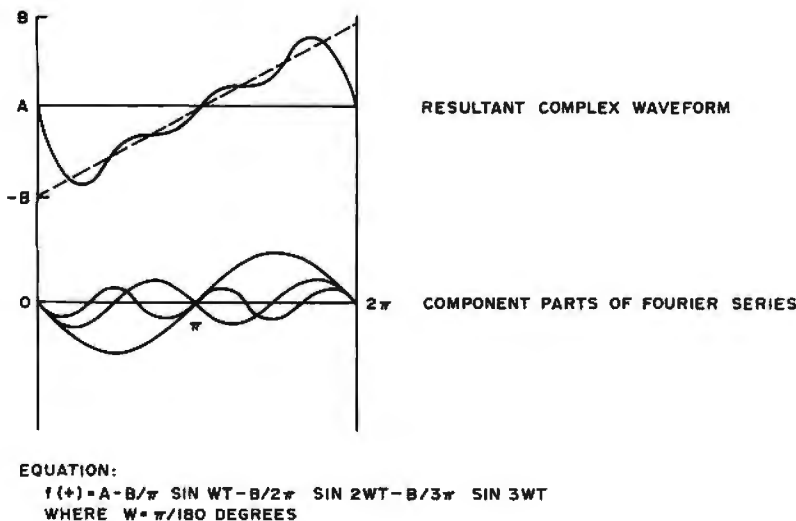

Figure 11: A typical complex waveform which is the sum of three terms of a Fourier series. These equations were used by the program in listing 5 to generate the oscilloscope trace of photo 4.

sition. Here they are synthesized separately to illustrate the technique, but mathematically they could be combined into one table. This would impose a far greater limitation on usage than would separate waveforms, but it is not the purpose of this article to investigate electronic music.

The simplest ADSR waveform is composed of four separate linear time dependent functions. Time $T = 0$ to T_1 is the attack, T_1 to T_2 is the decay, T_2 to T_3 is the sustain, and T_3 to T_4 is the release. Each section is defined by a separate equation and is illustrated by the graph in figure 10. Any waveform which is to be synthesized can be graphed in a similar way.

The four lines in the graph are defined by four equations. These equations, and the beginning and end point limits, can be combined into a BASIC program which creates a table of points. The table is stored in page 100 octal and the display routine is the same as was illustrated in listing 3 (see listing 4 and photo 3).

Real satisfaction comes from mathematically recreating complex waveforms. Synthesis is the combining of parts to form a whole. In Fourier analysis it is the recombination of the terms of the trigonometric series, usually the first four or five, to produce the original wave.

Often it is only after synthesizing a wave that the student is convinced that the Fourier series does in fact express the periodic wave for which it was obtained. This technique of mathematically solving the line equations, loading a point table, and either outputting directly to a plotter or calling a subroutine for an oscilloscope display can prove to be an invaluable education tool to a student involved in advanced math or music courses. Using the digital to analog interface as a Fourier waveform syn-

Note From the Author

This article is an attempt to introduce the computer experimenter to more thought-provoking applications for his or her computer so that the question of its usefulness in the non-industrial environment will seldom if ever be questioned. I'm shortly to begin a regular feature in BYTE on applications systems (hardware and software), and invite correspondence from you, the reader, on possible topics, ideas you would like to see implemented. My address is given at the beginning of this article.

thesizer involves the same point plotting methods as previously outlined, with the exception that the equations become more involved.

Consider the trigonometric series for the complex waveform with a peak amplitude of $B=127.5$ as illustrated in figure 11.

The Fourier series approximating a triangular waveform can be plugged into an extended BASIC program which calculates the points, while the program in listing 3 can be used to display the tabulation. Photo 4 shows the resulting oscilloscope display.

Conclusions

What started out to be just a simple interface for an analog output can be incorporated into control, music and educational applications. The extent and direction of an experimenter's system expansion is of necessity governed by price performance. This is an inexpensive interface which connects an otherwise isolated digital computer to the analog world. When coupled with a high level language such as extended BASIC, its potential is limited only by the programmer. To think that the home computer is an expensive toy useful only to bide time between monopoly games is equivalent to thinking that a building is only used to hold the sidewalk down. ■

REFERENCES

1. *Digital to Analog Converter Handbook*, Hybrid Systems Corporation, Crosby Dr, Bedford MA.
2. Graeme, Jerald G, *Applications of Operational Amplifiers - Third Generation Techniques*, McGraw Hill Book Company, NY, 1973.
3. Sheingold, Daniel H (ed), *Analog-Digital Conversion Handbook*, Analog Devices Inc, Norwood MA.
4. Stout, David F, and Kaufman, Milton, *Handbook of Operational Amplifier Circuit Design*, McGraw Hill Book Company, NY, 1976.
5. Tobey, et al, *Operational Amplifiers - Designs and Applications*, McGraw Hill Book Company, NY, 1971.
6. Wylie Jr, C R, *Advanced Engineering Mathematics*, McGraw Hill Book Company, NY.

The 4 channel self-refreshing digital to analog converter pictured in figure 9 is available in the following forms from Pinnacle Products, POB 3155, Talcottville CT 06066:

Blank PC board	\$34
Postpaid in the Continental US	
Complete kit	\$69
Assembled and Tested	\$99

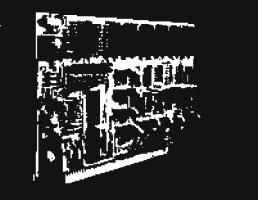

PRAMMER

by XYBEK

**An extraordinary 2k memory board
for your Altair-bussed computer**

- ★ On-board 1702A PROM programmer
- ★ 256 bytes of RAM plus space for 1792 bytes of read-only memory (seven 1702A EPROMs)
- ★ Supplied with one 1702A, pre-programmed with stand-alone programming software no sense switches are used
- ★ Supplied with programming power supply
- ★ PRAMMER's own on-board clock makes it compatible with almost any Altair bussed system.
- ★ All read and write sequences are generated via an board micro-programmed state machine, thus eliminating all one-shots.
- ★ Complete 1702A programming in 18 seconds
- ★ Includes complete listings for PRAMSYS, an eleven-function development system.

COMPLETE KIT: \$209
Assembled and tested: \$289
Immediate (off the shelf) delivery
 California residents please add sales tax.
 COD, Master Charge, BankAmericard and Visa accepted.

XYBEK • P.O. Box 4925 • Stanford, CA 94305
 Telephone: (408) 296-8188

THE BETTER BUG TRAP

DEBUG AND CONQUER

Altair/IMSAI compatible board catches program bugs and provides timing for real-time applications.

Four hardware breakpoint addresses. Software breakpoints only possible at instructions in RAM. Better Bug Trap breakpoints can be in ROM or RAM, and at data or instructions in memory, input/output channels, or stack locations.

Board can stop CPU or interrupt CPU at a breakpoint.

Real-time functions: watchdog timer, real-time clock (for time of day clock), interval timer.

Sophisticated timesharing made possible!

Unique interrupt structure: generates a CALL instruction to your subroutine anywhere in memory, not a RST!

Addressed as memory. All parameters set easily by software.

All this and more for about the price of a real-time clock board, but nothing else does the job of the Better Bug Trap.

\$160, assembled and tested. 2 manuals plus software. 90 day warranty. Shipped UPS. Delivery from stock.

Micronics inc.

BOX 3514, 123 WEST 3RD ST., SUITE 8
 GREENVILLE, NC 27834 • (919) 758-7757

Personal Computing Expo will come to New York!

PCE PERSONAL COMPUTING EXPO NEW YORK COLISEUM, OCTOBER 28, 29, 30, 1977

It's a brand new show (in the world's biggest economic center) specifically for manufacturers, buyers and those providing services to the personal computing enthusiast. For the first time, this booming field will have a New York Coliseum showcase. It is planned as the largest public show of its type and will attract attendance from the huge population areas of Boston, Washington, Philadelphia and Baltimore. New York's is the world's communications focal point, the one place that will put personal computing in a significant spotlight. New York is surrounded in depth

by people who work in the computer field, by computer learning centers, universities, personal computing clubs and thousands of others whose lives are affected by computers.

More than 100,000 paid subscribers of BYTE magazine will be urged to view the exciting exhibits and to attend the BYTE-sponsored lectures. Circle the dates: October 28, 29, 30 — and make your plans now to be there when Personal Computing Expo comes to New York!

"Personal Computing: An idea whose time has come!"*

Tutorials by the IEEE Computer Society, Mid-Eastern Area

Personal Computing Expo is also joined by the Institute of Electrical and Electronics Engineers Computer Society, Mid-Eastern Area Committee, whose experienced staff is presenting six day-long tutorials at a modest charge. If inconvenient for you to attend a tutorial during the show, simply sign up for follow-up tutorials on weekends after the show.

Whereas the lectures will provide you with information, the tutorials will teach important skills enabling you to use your own computer at home or at work.

TUITION:

The tuition fee for the tutorial program includes a one-day admission to the Personal Computing Expo.

	One Tutorial	Two Tutorials	Three Tutorials
Students (with ID)	\$30	\$50	\$75
IEEE Members	\$40	\$70	\$100
Non-Members	\$50	\$90	\$125

Tuition includes hand-out material, including text and/or hand-out materials. Participants will also receive a certificate of participation.

REGISTRATION:

In order to provide an interactive, learning environment between the participants and the lecturers, the number of registrants is limited. Registration is accepted on a first-come, first served basis. Early registration is therefore suggested. Cancellations received before September 15, 1977 will receive a full refund.

To register, make your check payable to the IEEE COMPUTER SOCIETY, and mail to:

Daniel R. McGlynn, Ph.D.
Tutorial Program Chairman
IEEE Computer Society
329 - 84th Street
Brooklyn, N.Y. 11209

FOR FURTHER INFORMATION:

on the technical content of the tutorials, technical background suggested to derive maximum benefit from the program, or information on the IEEE Computer Society, call

Cary Ringel
Chapter Chairman
IEEE Computer Society (212) 460-4600

TIME AND LOCATION:

The tutorials will be held from 9 AM to 4 PM each day in the New York Coliseum, at a location to be announced and posted. Participation in the tutorials also includes a one-day admission to the exhibition area and other lecture programs.

EXPO TICKETS:

Will be sent to tutorial registrants about three or four weeks prior to the show.

BYTE DAILY TUTORIALS AND
SPONSORED LECTURES

The Small Systems Journal



**Exciting lectures
sponsored by**

BYTE

The Small Systems Journal

Personal Computing Expo is endorsed by BYTE magazine, whose staff has contacted prominent speakers for an exciting series of lectures.

Visitors will be able to attend these meetings **free of charge**. The lectures will not conflict with each other eliminating the worrisome choice among several equally important topics. In addition, they will be repeated on the next day to give you a second chance if you missed a topic.

Lectures are typically 30 minutes, often with demonstrations and an additional 15 minutes for questions.

Portia Isaacson Ph.D. . . . Saturday 11 AM and Sunday 12 Noon

Co-owner of the Micro Store, a personal computer store, in Richardson Texas actively engaged for 12 years in the computing field in industry and at universities.

Member of the ACM and IEEE, and chairman of the 1977 National Computer Conference.

Author of many articles in professional journals and magazines.

Received a Ph.D. in Computer Science from the Southern Methodist University.

Personal Computing: An Idea Whose Time Has Come

A review of what has happened so far in the personal computing field, and an outlook into future developments, including those in the computer assisted home. Slide demonstration.

Sol Libes . . . Friday 6 PM and Saturday 10 AM

President of the Amateur Computer Group of New Jersey

Teacher of electronics and computer programming at a community college

Author of 10 books (working on the 11th) and several hundred magazine articles in electronics and computing

Received an award for "The Outstanding Amateur Computer Hobbyist of 1976" in Atlantic City by Personal Computing 1976 show, and BYTE.

How to Get Started

A discussion of typical home computer systems and their essential hardware and software components.

John H. Dilks III . . . Saturday 1 PM and Sunday 2 PM

President of Personal Computing Inc. and trade fair director of the Personal Computing shows in Atlantic City in 1976 and 1977.

Experience with various computer systems since 1962.

Employed by Western Electric Co. Inc., division of the Bell System.

Member of the Amateur Computer Group of New Jersey and of the Philadelphia Area Computer Society.

Teaches microcomputer courses in an adult evening program at a vocational school.

Innovative and Unusual Computer Applications for the Home.

Discussion of "far-out" applications of microcomputers and electronic technology for home use, such as a child locator and warning device, a home security system, etc. Slide demonstration.

Robert S. Jones . . . Friday 7 PM and Saturday 2 PM

Publisher of Interface Age Magazine

Prior experience in sales and marketing for the semiconductor industry, including Intel, National Semiconductor and Analog Devices Inc.

Personal Computing for the Business Man

Evaluating business applications for micro computers, including slides showing selected applications.

Louis E. Frenz . . . Saturday 3 PM and Sunday 3 PM

Director of Computer Products at Heath Company, involved in the planning of new computer products.

Prior to Heath, with McGraw Hill in product planning and design of educational electronic kits.

Prior experience including computer engineering for eight years

Author of several books, home study courses and numerous magazine articles in electronics and computers.

Received a BS in electronics from the University of Houston and a MEd from the University of Maryland

How to Build Personal Computer Kits

Tips for successful kit construction. Benefits of kit products for the personal computer user. Including slides showing selected computer kits.

Carl Helmers . . . Saturday 4 PM and Sunday 4 PM

Editor-in-Chief and co-founder of BYTE magazine.

Obtained computing experience as a personal way to accomplish artistic and technological goals in music.

Graduated in 1970 with a BS in Physics from the University of Rochester, NY.

Worked for several years at Intermetrics, Inc. in Cambridge, Massachusetts on the NASA Space Shuttle Project.

Prior to working with BYTE, publication of a small computer newsletter on a part-time basis.

Computers and Music

How to create music with computers. Problems of performing electronic music, music under computer program control and computer music in conjunction with traditional instruments. Illustrations and examples from personal experience.

Jack L. Davies . . . Friday 8 PM and Saturday 5 PM

President of Pan Atlantic Computer Systems GmbH, a distributor of various micro computer systems in Europe.

Extensive experience in using minicomputers and microcomputers in the US

Military Schools in Europe. Designed and developed numerous games and educational programs for students in these schools.

Microcomputers in Education

Discussion of the many possibilities of using microcomputer systems in schools. Effect of personal computers on students.

David Fylstra . . . Saturday 6 PM and Sunday 5 PM

Member of the research staff of the Telecommunications Sciences Center at Stanford Research Institute for more than two years. Specialized in microcomputer software and computer simulation of speech processing systems.

Graduated in 1974 with a BA in English and Psychology, Stanford University, Phi Beta Kappa.

Active in the research on communication systems and devices for the deaf.

Speech Analysis and Synthesis for the Amateur

Using the personal computer as a device to analyze the acoustical foundations of speech and to formulate rules for the control of the speech synthesizer.

Max Mathews Ph.D. . . . Friday 9 PM and Saturday 7 PM

Director of Acoustical and Behavioral Research, Bell Labs

Author of *The Technology of Computer Music*, and numerous articles.

Scientific Advisor to the Institute for Research and Coordination of Acoustics and Music (IRCAM)

Dr. Mathews is often regarded as the "Father of Computer Music"

Pure Digital and Real Time Music Synthesis

The use of the digital computer as a musical instrument with which composers and performers create and play music. Slide and tape demonstration.

Carl L. Holder . . . Saturday 8 AM and Sunday 6 PM

Director of Product Management, Planning and Communications at Information Terminals Corp. for five years.

Prior experience, including Memorex Corp., in the area of magnetic media development and testing.

Present and Future Storage Devices

Survey and discussion of current devices and media, including latest technological developments like the charge coupled devices and magnetic bubble memories. Costs, advantages and disadvantages of these devices for the personal computer user. Accompanied by slides.

DAILY TUTORIALS

There will be two tutorials offered each day, one aimed at those participants who have little or no experience with microprocessors, and the other for those already experienced with microprocessor systems.

BASIC COURSES

1. Development of Microcomputer Systems for Business Use

Sy Ratner, Citibank, N.A.

- system design concepts
- economic efficacy of microcomputers versus large centralized computer systems
- distributed processing definitions
- advantages and problem areas
- network design and architecture
- data communications aspects
- case study: design of a stand-alone workstation for data entry and retrieval

2. Development of Microcomputer Systems for Home Use

Cary Ringel, Con Edison

- survey of simple microcomputer control systems for home use
- selection of hardware: IC's, boards, kits, development systems
- programming and software aids
- interfacing: A/D and D/A conversion
- examples: design of a home control system; microcomputers for a music synthesizer; computer TV games.
- case study: use of the Motorola 6800 in design of a microcomputer system

3. Survey and Comparison of Microprocessors

Donald Lewis, Standard Microsystems Inc and other speakers

- definitions and distinctions between ALU-chips, controllers, microprocessors, microcomputers
- current applications
- microprocessor architectures (bit-slice, 4-bit, 8-bit, 16-bit, minicomputer-type)
- vendor survey
- performance evaluation and criteria for selection

INTERMEDIATE/ADVANCED COURSES

4. Microprocessor Interfacing

Donald Lewis, Standard Microsystems Inc.

- interface components (peripheral interface chips, UARTS, etc.)
- interface standards (IEEE 488, RE 232C, S-100, etc.)
- interfacing to keyboards
- interfacing to cassette and floppy disk drives
- interfacing to display devices
- case study: how to design a CRT terminal

5. Microprocessor Programming and Software

Donald Lewis, Standard Microsystems Inc.

- software design: flow-charting, setting breakpoints, documentation, etc.
- assembly language for the Intel 8080, 8085, Z-80, Motorola 6800
- instruction types and addressing techniques
- use of the stack
- interrupt handling and direct memory access (DMA)
- software development aids
- high level languages for microcomputers

6. Technology Analysis and Forecast of Future Microprocessor Structures

Daniel R. McGlynn, U.S. Philips Corp.

and Will Mathys, MOS Technology Inc

- emergence of specialized computational elements (SCE) - architectural evolution (stack processors, reconfigurable architectures, multi-level logic) resource management techniques
- software evolution (nano-programming, extensible instruction sets, structured programming modules, very-high-level languages)
- evolution of semiconductor technology of microprocessors microprocessor architecture at the chip level
- case studies: design of MOS Technology's new 8-bit and 16-bit processors

Personal Computing Expo to be produced by H.A. Bruno & Associates

H.A. Bruno & Associates, Inc., has been prominent in the exposition and promotion fields since 1923. Highly skilled in the production and promotion of consumer and trade shows, the company currently promotes the American Energy Expo, the National Boat Show, Auto Expo/New York. Promotion assistance also is currently rendered to the National Computer Conference and the Triennial IFIPS Congress in Toronto.

The show producer has promoted successful shows in the New York Coliseum every year since the building opened in 1957. Staff personnel are thoroughly familiar with the building, its services, management and labor.

Interesting, educational exhibits of Personal Micro Computers

The lectures and tutorials are not just theory! You will be able to see a multitude of micro computers. Try out various demonstrations: fascinating games, even in color; small business applications; computer produced speech; music; color graphics; and many more. Micro computers are not only small and portable, also you will need only a "micro budget" to be able to take them home.

Show Hours and Admission

Personal Computing Expo hours are as follows:

Friday, Oct. 28 — Noon to 10 p.m.

Sat. Oct. 29 — 10 a.m. to 10 p.m.

Sunday, Oct. 30 — Noon to 7 p.m.

General Admission: \$5.00 (includes free BYTE lectures) per day.

Two-day Tickets: \$9.00 (advance sale only)

Three-day tickets: \$13.00 (advance sale only)

General Information

You may find it advantageous to purchase two or three-day admission tickets in advance. These are available by mail only, no later than October 10, 1977. Use coupon below.

Group rates (10 or more persons) qualify for \$1.00 off regular prices. Arrangements must be made by mail prior to October 10, 1977.

Special arrangements have been made if you desire to stay overnight. Our headquarters hotel, the Barbizon-Plaza, is located on Central Park South, two blocks from Columbus Circle. Single rooms available at \$34.00 per night; \$40.00 double, plus tax. There's a weekend plan: \$22.95 daily, plus tax per person, double occupancy . . . includes breakfast (brunch on Sunday) and meal gratuities. Children under 14 in same room with parents, free.

For hotel reservations and information, call toll free (800) 223-5493. From New York State call (800) 223-5963.

For those traveling to New York by air, American Airlines offers a convenient service through arrangement with Personal Computing Expo. For information, call toll free (800) 433-1790. In Texas the number is (800) 792-1150. From the West Coast, round trip fare via American is only \$227.00.

20,000 persons are expected to attend and view the more than 200 exhibits by personal computer manufacturers and retailers.

Personal Computing Expo will occupy the 4th floor of the New York Coliseum. It is located on 59th Street and Columbus Circle — the geographical center of New York City. Garage parking in the building is available.

For answers to any questions pertaining to your attendance at Personal Computing Expo, contact the Show Manager, Ralph Ianuzzi, at Area Code 212/753-4920.

**Advance sale of tickets available . . . Three days '13
Two days '9 . . . General Admission '5
MAIL THIS CONVENIENT ORDER FORM NOW!**

Personal Computing Expo admission is \$5.00 per day. Advance reservation eliminates waiting in line. Order advance tickets with this coupon. Admission ticket includes access to exhibits, lectures and tutorials.

Please send me _____ advance registration tickets for three days, October 28-29-30. Total cost \$13.00 per person.

Please send me _____ advance tickets for two days, October _____ and October _____. Cost is \$9.00 per person.

Please send me _____ advance tickets for one day, October _____. Cost is \$5.00 per person.

**Make all checks payable to PERSONAL COMPUTING EXPO, and mail to:
Personal Computing Expo, 78 East 56th Street, New York, N.Y. 10022.**

Name _____ Amount enclosed \$ _____

Address _____

City _____ State _____ Zip _____

BYTE's Bits

International Symposium on Minicomputers, Personal and Home Computers

MIMI-77 is the title of a symposium sponsored by the ICORD, IEEE Region 7, and the International Society for Mini and Microcomputers. The dates are November 16, 17 and 18 1977, and the location is Montreal CANADA. The program is divided into two sections. One section covers mini and micro-computer technology and its application; the second section covers personal and home computers. The document we received describing this event was a "call for papers." Persons interested in submission of an abstract for a paper at the

Dr Iverson's "Thought Experiment" Answered

Last month we published an article by Dr Kenneth Iverson entitled "Understanding APL" (August 1977, page 36), in which readers were challenged to solve the following APL expressions:

$$(2=+/Q0=(1N)0. | 1N)/1N$$

The answer, which only becomes apparent for $N = 7$ or greater, is the set of prime numbers from 1 through $N!$ To show how this unexpected result comes

conference, or in being placed upon its mailing list, should contact:

Prof J L Houle, MIMI-77
École Polytechnique, Case postale
6079, Succursale A
Montreal, Quebec CANADA
H3C 3A7
Phone: (514) 344-4753

about, let us evaluate the expression for $N = 7$. Since expressions are evaluated from right to left in APL, the first step is to evaluate $1N$:

$$1N = 1 \ 2 \ 3 \ 4 \ 5 \ 6 \ 7$$

Next we evaluate everything to the left of the compression operator ($/$). Expressions in parentheses are evaluated first, so we start with $(1N)0. | 1N$, which becomes

$$1 \ 2 \ 3 \ 4 \ 5 \ 6 \ 7 \ 0. | 1 \ 2 \ 3 \ 4 \ 5 \ 6 \ 7$$

for $N = 7$. Performing the residue operation ($|$), we get:

```
0 0 0 0 0 0 0
1 0 1 0 1 0 1
1 2 0 1 2 0 1
1 2 3 0 1 2 3
1 2 3 4 0 1 2
1 2 3 4 5 0 1
1 2 3 4 5 6 0
```

Before we can transpose this array, we must first perform the "0=" operation:

```
0 0 0 0 0 0 0
1 0 1 0 1 0 1
1 2 0 1 2 0 1
0= 1 2 3 0 1 2 3
1 2 3 4 0 1 2
1 2 3 4 5 0 1
1 2 3 4 5 6 0
```

This gives:

```
1 1 1 1 1 1 1
0 1 0 1 0 1 0
0 0 1 0 0 1 0
0 0 0 1 0 0 0
0 0 0 0 1 0 0
0 0 0 0 0 1 0
0 0 0 0 0 0 1
```

Next, we transpose this array using the transpose operator (Ω). The result is:

```
1 0 0 0 0 0 0
1 1 0 0 0 0 0
1 0 1 0 0 0 0
1 1 0 1 0 0 0
1 0 0 0 1 0 0
1 1 1 0 0 1 0
1 0 0 0 0 0 1
```

Performing the $+/$ operation on this array gives:

$$1 \ 2 \ 2 \ 3 \ 2 \ 4 \ 2$$

The expression has thus been reduced to $(2=1 \ 2 \ 2 \ 3 \ 2 \ 4 \ 2)/1 \ 2 \ 3 \ 4 \ 5 \ 6 \ 7$ and this reduces to

$$2 \ 3 \ 5 \ 7$$

This vector is indeed the set of prime numbers between 1 and 7, inclusive. The algorithm works for all integer values of N . (Note that the algorithm excludes 1. If you happen to take the position that 1 is a prime number, try writing an APL statement which includes it!)

For readers totally unfamiliar with APL, any of Dr Iverson's many writings on the subject should help. See the references listed in last month's BYTE. ■

\$699. Now or never.



Price increases \$100 on Oct. 15, 1977.

Equinox 100™ is The Frontrunner in S-100 personal computers... because it gives you full front panel access to all CPU registers and register pairs, I/Os and memory locations via octal 12-key keyboard and digital LED readout... single-step and programmable Slow-Step™... no-crash 26-amp constant voltage power supply... 20-slot shielded and actively terminated busboard... and more!

Order your Equinox 100™ kit at your local personal

computer store, by direct mail or by phone. But you must order before Oct. 15, 1977 to save \$100.

For \$699, it's now or never.

ORDER: At your computer store

WRITE: P.O. Box 6314,
Albany, CA 94706

CALL: BAC/MC orders to
800-648-5311

EQUINOX 100

The Frontrunner from
Parasitic Engineering

See us at the Atlantic City show!

TSC's Software Catalog...

We've received a 1977 catalog from Technical Systems Consultants, Box 2574, W Lafayette IN 47906. While a lot of people have been just talking about

Personal Computing Expo Sets Inaugural NY Show for October 28 thru 30

A major trade and public show, featuring the latest developments and equipment in the last growing field of personal computing, is scheduled to be held at the New York Coliseum, October 28 thru 30 1977.

The show is called Personal Computing Expo. It will feature an expected 250 exhibitors who will be showcasing their products for the first time in New York City.

There will be speeches arranged by BYTE magazine and the IEEE to fill the seminar agenda, which includes topics for everyone interested in personal computers, from novice to advanced levels. Leading manufacturers have been invited to display and explain their microcomputer systems along with other experts who will conduct forums on algorithms, software, language compilers and assemblers.

Personal design of computers for the more experienced, kit building for the novice, microcomputer applications for business, industry and homes as well as computerized games, vocal output and music are among other topics to be included in the forum.

Persons interested in exhibiting at Personal Computing Expo should contact Ralph Ianuzzi, show manager, H A Bruno & Associates, Inc, 78 E 56th St, NY 10022, (212) 753-4920. ■

Computer Shack is Reborn (as "Computerland")

We received the following information from Computer Shack:

Computer Shack Inc, 1922 Republic Av, San Leandro CA 94577, has announced that it plans to change its name to Computerland Corporation. Computer Shack president E E Faber said this action will "strengthen the impact and recognition of the trade name among the consumer public." According to management, franchisees and staff have expressed a strong preference for the "Computerland" name claiming that it better communicates the special nature of this retail computer business. "It avoids the long-range dilution of image that could result from associating high technology quality products and modern store designs with the public's perception of the name Computer Shack," Faber adds.

Computerland Corporation is now operating franchised retail stores in three regional markets: Northern and Southern California and the Atlantic Seaboard. ■

the concept, the people at TSC have gone out and done what a growing number of entrepreneurs are doing: publishing and selling software at reasonable prices. The *TSC Software Catalog*, which has a nominal price of 25 cents to cover postage, is available from the company. Most items are sold as completely commented, assembled machine code source listings for the 6800, 8080 or 6502 processor of your system. The prices for typical items from the catalog?

- A BCD floating point package for the 6800 processor is \$6.50 for the documentation, plus \$3 for a MIKBUG format paper tape.
- A scientific functions extension of the above package runs \$10 plus \$4 for a paper tape. This gets you transcendentals, and other goodies.
- And of course, the firm will give you a high level language for the 6800 in the form of "Micro Basic Plus" which runs \$15.95 for the documentation, plus a paper tape at \$6 or cassette tape at \$6.95.

The catalog is packed full of numerous items, with most programs written for the 6800 so far (but don't ignore the

availability of several 6502 and 8080 packages).

The following quotation from the catalog regarding copyrights and pricing is well worth considering as a philosophy for personal use software marketing:

TSC software is among the lowest priced software available to the hobbyist. All prices essentially reflect the cost of documentation and packaging. Why does TSC sell software for so little? The answer is simple: All TSC software is copyrighted, which means it is illegal to make copies of any form. The low pricing is to encourage the hobbyist to buy from us instead of paying close to the same amount for a copy at the local copying machine.

We heartily agree with this approach, since the world of the personal use computer cannot support the concept of unit sales of custom written hand crafted programming of extremely expensive software. The automobile was a success because of mass production and distribution. Marketing software to lots of people with personal computers requires high volume production at low margin as with any mass market, an enterprise which TSC is proving quite realistic. ■

The Midwest's Most Complete Computer Store

THE GENERAL COMPUTER STORE

Now Serving Lansing

WE STOCK

- CompuColor
- Continental specialties
- D.E.C.
- Hitachi
- Iasis
- Imsai
- Intelligent systems
- Lear Siegler
- Microterm
- National Multiplex
- North Star
- Polymorphics
- Processor Tech.
- Sanyo
- SWTP
- Tarbell
- TDL
- Texas Instruments
- Vector Graphics
- Vector Electronics
- Ven-Tel
- Xybak
- Books and Magazines
- Sams - Haydens - Osborne Tab - etc. and many others.

ASK FOR OUR Z-80 SPECIAL
SEND \$2 FOR OUR COMPLETE CATALOG OF PRODUCTS & PRICES.
* Refundable with purchase of \$25 or more.

The General Computer Company

A computer company of professionals.

2011 LIVERNOIS • TROY, MICHIGAN 48084 • PHONE (313) 362 0072
1310 MICHIGAN AVENUE • EAST LANSING, MICHIGAN 48823 • PHONE (517) 351 3260

FIRE SALE!

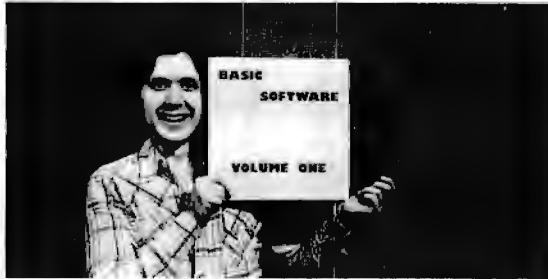

That's right, if we don't sell a bunch of our BASIC SOFTWARE VOLUME 1 albums quick, we'll get fired! Included are lots 'n' lots of your favorite Basic programs such as LUNAR LANDER and BLASTOFF!, plus new ones like MAILING LIST, FOURIER FIT and AMPLE ANNIE. Plays through your *Tarbell, Kansas City* or *Altair* cassette interface (we coded all three ways). Or make cassette copies. Only 6 bucks. Don't be a dummy, order today! Satisfaction guaranteed or money back.

\$6 to: SOFTWARE RECORDS

PO BOX 8401-B
UNIVERSAL CITY, CA 91508

(CALIFORNIA RESIDENTS: PLEASE ADD 6% SALES TAX)

NEW . . . 1977

MICROCOMPUTER CATALOG!



Hundreds of microcomputer products and accessories from many manufacturers.

Our new MICRO 77 Catalog provides you with a single, easy to use source for comparing and selecting microcomputers — from simple low cost trainers, to advanced systems designed for business, scientific, and engineering applications.

Whether you choose a kit or fully assembled unit, this easy to use catalog can help take the mystery out of selecting the computer system that is best for your application.

Included in this catalog is a convenient glossary of terms for reference, and sections covering:

- MICROCOMPUTER SYSTEMS
- PERIPHERALS
- DEVELOPMENT AND TEST EQUIPMENT
- SOFTWARE
- BOOKS AND PROGRAMMED COURSES

Send \$1.00 (refundable with first order) for your copy today!

microcom systems

865 3rd Street South, St. Petersburg, FL 33701

Continued from page 120

values with the data line and shift clock line, after which the now valid outputs of the n bit shift register can be transferred into the n bit latch to set the state of the valves.

As conceived here, the unit can be directly plugged into an existing parallel output port which has 3 available lines. The timing diagram shown in figure 4 is implemented in software by programming the states of the bits when transferring the current data for the piano, which might be derived from a music interpreter program, or from a real time keyboard source. When programming the low level transfer routine, each bit in turn is shifted and is used to control how the "serial data" line will be set at the output port. After the bit is defined, the "shift clock" bit is turned off, then turned back on, to clock the data into the shift register. After all the control bits have been transferred by " n " operations, the output bit which controls the "transfer clock" line is toggled off, then on, accomplishing the transfer of the shift register's contents to the latches and thus defining the state of the various solenoids.

System Reset and Inhibit

The state of the solenoid drivers must be set in software in the control computer; however, if the system is first turned on, or if garbage is left over from previous use, the result could be a crashing dissonance on the piano output device. To account for bad initial values, the circuit incorporates IC3, which drives the inhibit lines as a set-reset flip flop. When system reset occurs (low level on that line) all the solenoid drivers are disabled by a low level on the "inhibit" input (see figure 3). When the first transfer of data under program control defines a valid solenoid drive state, the inhibit condition is removed by the transfer clock pulse, and does not recur until another system reset.

Summary

In these notes, I have outlined the essentials of the low level details needed to interface a pneumatic player piano with a typical computer system's parallel output lines. This can lead to some very interesting personal use applications of computers, as new piano music is programmed and played using the mass storage facilities of a personal computer instead of the traditional piano roll. These notes are by no means complete, and I leave the software of control of the piano system to the tastes and judgement of the individual user. ■

Musical Micros, and More

—Fingertip Math from Texas Instruments. The subtitle of *Fingertip Math* reads: "How to use an electronic calculator to put speed, accuracy and confidence into everyday mathematics." It includes chapters on how to use a calculator, reciprocals, powers and roots, number systems, geometric applications, interest and mortgage calculations, and more. *Fingertip Math* is dedicated entirely to applications of the conventional 4 function calculator. Beginners and professionals alike will find it to be a useful, self-contained tutorial manual. Only \$2.95.

No duplicate material
allowed for 1982 (1981 reissues)



FINGERTIP
MATH



TEXAS INSTRUMENTS INC.
DAVIDSON, TEXAS

—*Bipolar Microcomputer Components Data Book* from Texas Instruments. If you like to build computers from scratch, or are just interested in finding out what is available to the enterprising hacker, Texas Instrument's *Bipolar Microcomputer Components Data Book* is for you. Included are detailed data sheets covering Schottky and Integration Injection Logic (I²L) 4 bit slice processor elements, plus the SBP9900 16 bit microprocessor. A wide range of bipolar memory components is also covered, as well as bipolar microcomputer support function circuits such as latched bus transceivers, shift registers, programmable logic arrays (PLAs), and so on. With the aid of this handbook, the enterprising experimenter can create a variety of high-powered designs. Only \$2.95.



—*Microcomputer Handbook* by Charles J Sippl. We often hear people say, "I'd like to find out more about microcomputers. I'm not a technical type, but I feel I can handle a fairly rigorous approach as long as it's well-written. What's available?" Charles J Sippl's *Microcomputer Handbook* is one answer to this question. The book covers the present state of computer technology very well, concentrating on both hardware and software. Lucid and complete glossaries are combined with a variety of illustrations. Topics covered include: microcomputers: where they are, what they are doing, and what is next; kits; distributed intelligence; and why the new systems are easier to use. The book was written by a computer industry lecturer and consultant and is highly recommended for the intelligent layman as well as for professionals and experimenters. The glossaries alone are worth the price of the book—don't miss this one! This hardcover reference is only \$19.95.

—*The Technology of Computer Music* by Max Mathews, published by the MIT Press. If you're interested in creating music on your microcomputer, here is an excellent source book on the subject written by Max Mathews, often called the "Father of Computer Music." The book includes sections covering the fundamentals of digital sound generation, including the sampling theorem, digital to analog converters, analog to digital converters, filtering, and storage of musical data. A significant portion of the book is devoted to a description of MUSIC V, the well-known high level music language. The sections of the book have been graded so that readers new to the field can approach the material systematically. \$16 hardcover.



—*On the Sensations of Tone* by Herman Helmholtz and published by Dover Publications. This remarkable book is a reprint of the original 1885 edition, reprinted with Dover's usual attention to detail. Despite its age, *On the Sensations of Tone* is still a standard text for the study of the physics and physiology of music. Part 1 explains the sensations of sound in general, vibrations, sympathetic resonances, etc. Part 2 covers combinations of tones and beats. Part 3 concludes the book with Helmholtz's theory of the aesthetic relationships of musical tones. This book will make a valuable addition to the library of anyone interested in the production of music on microcomputers. \$6.95.

Send to:
Bits, Inc.
70 Main Street
Peterborough NH 03458

Check Payment method:



My check is enclosed

Bill my MC No. _____ Exp. date _____

Bill my BAC No. _____ Exp. date _____

Name _____

Total for all books checked \$ _____

Address _____

Postage, 50 cents per book for _____ books \$ _____

City _____ State _____ Zip Code _____

Grand Total \$ _____

Signature _____

Prices shown are subject to change without notice.
All orders must be prepaid.
In unusual cases, processing may exceed 30 days.

You may photocopy this page if you wish to leave your BYTE intact.

A Bit of the BASIC

—**Computer Resource Book—Algebra** by Thomas A Dwyer and Margot Critchfield is an exciting new way to learn about algebra and the interesting things you can do with it using a computer. The book uses the BASIC language, and flowcharts are used throughout to show the structure of programs. There are 60 applications programs including straight line graphs, polynomial equations, a space probe navigator, temperature profiles, computer generated animation, the ultramatic root finder, random number generation and many more. Although it is particularly suitable for students, just about everyone will find some intriguing and easy to use applications in this entertaining book. \$4.80.

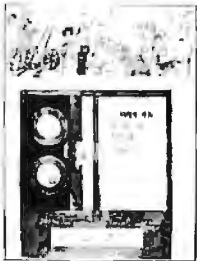

—**Introduction to Computer Programming** by Rudd A Crawford Jr and David H Copp. Here is an excellent way to learn about the general aspects of computer programming. **Introduction to Computer Programming** makes use of a hypothetical computer model and set of assembly language instructions designed to help the beginner see what goes on in computer programs. The emphasis throughout is on general principles; such concepts as loops, decisions, flowcharts and IO routines are covered in detail. The book also provides many example problems and prompts the reader by posing several quiz questions. Anyone who masters its contents will have a solid foundation for the study of practical assembly and high level languages. It is especially recommended for students, but just about everyone new to the subject should profit from it. \$4.35.

—**Basic BASIC** by James S Coan. If you're not already familiar with BASIC, James Coan's **Basic BASIC** is one of the best ways to learn about this popular computer language. BASIC (which stands for Beginner's All-purpose Symbolic Instruction Code) is easy to learn and easy to apply to many problems. **Basic BASIC** gives you step-by-step instructions for using a terminal, writing programs, using loops and lists, solving mathematical problems, understanding matrices and more. The book contains a wealth of illustrations and example programs, and is suitable for beginners at many different levels. It makes a fine reference for the experienced programmer, too. \$7.95.



—**Advanced BASIC** by James S Coan. **Advanced BASIC** is the companion volume to James Coan's **Basic BASIC**. In this book you'll learn about some of the more advanced techniques for programming in BASIC, including string manipulation, the use of files, plotting on a terminal, simulation and games, advanced mathematical applications and more. Many useful algorithms are covered, including some clever sorting techniques designed to reduce program execution time. As with **Basic BASIC**, there are many illustrative example programs included. **BASIC** doesn't have to be basic with **Advanced BASIC!** \$6.95.

—**A Guided Tour of Computer Programming in BASIC** by Thomas A Dwyer and Michael S Kaufman. Colorful graphics abound in this lively introduction to the BASIC language. The authors have tried to present a rigorous, yet entertaining approach to the subject. Written for the novice, **A Guided Tour** begins with a section on how to recognize a computer, followed by some tips on working at a terminal. By the end of the book readers are writing their own programs and solving elementary problems in finance and business. The emphasis throughout is on learning by doing. Anyone interested in computer programming should benefit from **A Guided Tour of Computer Programming in BASIC**. \$4.80.

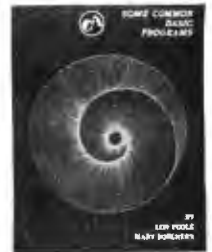

—**Some Common BASIC Programs** by Lon Poole and Mary Borchers, published by Adam Osborne and Associates. At last, a single source for all those hard to find mathematics programs! **Some Common BASIC Programs** combines a diversity of practical algorithms in one book: matrix multiplication, regression analysis, principal on a loan, integration by Simpson's rule, roots of equations, operations on two vectors, chi-square test, check writer, geometric mean and variation, coordinate conversion and a function plotting algorithm. These are just some of the many programs included. For only \$7.50 you can buy the kind of programs previously available only as part of software math package systems for large scale computers. All the programs are written in a restricted BASIC suitable for most microcomputer BASIC packages, and have been tested and debugged by the authors. \$7.50.

Send to:
Bits, Inc.
70 Main Street
Peterborough NH 03458

Name _____

Address _____

City _____ State _____ Zip Code _____

Signature _____

You may photocopy this page if you wish to leave your BYTE intact.

Check Payment method:

My check is enclosed

Bill my MC No. _____ Exp. date _____

Bill my BAC No. _____ Exp. date _____



Total for all books checked \$ _____

Postage, 50 cents per book for _____ books \$ _____

Grand Total \$ _____

Prices shown are subject to change without notice.
All orders must be prepaid.
In unusual cases, processing may exceed 30 days.

The Best of BYTE, Volume 1



Send now to:

BYTE Interface Technical Services, Inc.
70 Main St
Peterborough NH 03458

The volume we have all been waiting for! The answer to those unavailable early issues of BYTE. Best of BYTE, edited by Carl Helmers Jr and David Ahl. This 384 page book is packed with a majority of material from the first 12 issues. Included are 146 pages devoted to "Hardware" and how-to articles ranging from TV displays to joysticks to cassette interfaces, along with a section devoted to kit building which describes seven major kits. "Software and Applications" is the other side of the coin: on-line debuggers to games to a complete small business accounting system is included in this 125 page section. A section on "Theory" examines the how and why behind the circuits and programs. "Opinion" closes the book with a look ahead, as to where this new hobby is heading. It is now available through BITS Inc for only \$11.95 and 50 cents postage.

Name _____

Address _____

City _____ State _____ Zip _____

The Best of BYTE, Volume 1

Price of Book \$ _____

Postage, 50 cents \$ _____

Total \$ _____

Check enclosed



Bill MC # _____ Exp. Date _____



Bill BA # _____ Exp. Date _____

Signature _____

In unusual cases, processing may exceed 30 days. All orders must be prepaid.

You may photocopy this page if you wish to leave your BYTE intact.

PAPERBYTES

Tiny Assembler 6800 – Microprocessor Self Assembler

No. 700 \$7

PAPERBYTES

Tiny Assembler 6800

Design and Implementation
of a Microprocessor Self Assembler
by Jack Emmerichs

Originally described in the April and May 1977 BYTE, PAPERBYTES is now offering Jack Emmerichs' Tiny Assembler 6800. This book contains the complete Tiny Assembler source listing plus object code in cross assembly format (space restrictions prevented printing of this material in BYTE). A bar code version of Tiny Assembler is included for convenience, as well as reprints of Jack's two articles and additional user manual materials. Tiny Assembler will run on any machine with MIKBUG and 4K of memory starting at address 0000, and is an excellent tool for the interactive development of functional blocks for a large structured program. Add it to your 6800 system and you'll have a valuable programming aid which can free you from the drudgery of machine language. The best part is the price: only \$7. Order yours today!

Name _____

Address _____

City _____ State _____ Zip _____

PAPERBYTES
Tiny Assembler 6800

Price of Book \$ _____

Postage, 35 cents \$ _____

Total \$ _____

Check enclosed



Bill MC # _____ Exp. Date _____



Bill BA # _____ Exp. Date _____

Signature _____

In unusual cases, processing may exceed 30 days. No. 700
You may photocopy this page if you wish to leave your BYTE intact.

Send today to:

BYTE Interface Technical Services, Inc.
70 Main St
Peterborough NH 03458

Dealer inquiries invited

All orders must be prepaid.

SUPER DENSE GRAPHICS

320 Horizontal by 200 Vertical

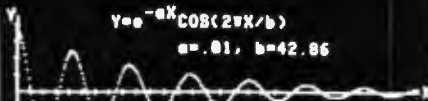

IF YOUR COMPUTER CAN'T SMILE (OR PLOT) IT PROBABLY HAS MERLIN DEFICIENCY ANEMIA.



(EQUATION PLOTTED WITH BASIC)

The MERLIN Super Dense add-on kit provides maximum resolution at a minimum cost. In fact, MERLIN with Super Dense has more capabilities than any other S-100 bus video interface at any price!

Once you've seen 'Super Dense' graphic resolution you'll know there is nothing to compare it to . . . short of spending over \$600 . . . and even then you'll not have all of the capabilities of MERLIN with 'Super Dense'.

Super Dense provides true bit-mapping. Each and every point on the screen is controlled directly by a bit in memory. (Requires 8K of system memory.)

ROM character-graphics looked good for a while; then came MERLIN's 160 by 100 bit mapping graphics; and now . . .

320 by 200 bit-mapping graphics!!!
If you're looking for a graphic display, MERLIN with Super Dense is the best there is. And if you hadn't considered graphics or thought it was out of your price range, consider what you could do with 320 H by 200V graphics and for only \$39 extra.

The Super Dense add-on kit to the popular MERLIN video interface is now available with off-the-shelf delivery.

M320-K, Super Dense Kit . . . \$39
M320-A, Super Dense Asm. . . \$54
See MERLIN ad on previous page.

For information fast, write direct, or see 'Super Dense' at your nearest computer store.

MC and BAC accepted.



BYTE's Bugs

Super Bug #1

Thanks to inputs from Allen Evans (2 Munsell St, Binghamton NY 13901), Adrian Cammelot (Bell & Howell, Dept 8540, 7100 McCormack Rd, Chicago IL 60645), and several other readers, it became obvious to us that the July 1977 issue of BYTE had a rather important defect in our presentation of "Jeu de NIM, Peut Etre?" by Alain Chancé on page 90. The listing of the TI SR-52 program printed on page 91 included only one half of the total information which came with the article. Presented here then is the complete listing of the program as received with the article. Note that the listing has only two sheets and that these are numbered "2" and "4" in the images printed here, which are photo copies of photo copies of the originals. ■

SR-52 CODING FORM ~ KODEFORM ~ FEUILLE DE PROGRAMMATION

TITLE / TITEL / TITRE **JEU DE NIM** PAGE / SEITE / PAGE **3** OF / VON / DE

PROGRAMMER / PROGRAMMIERER / PROGRAMMEUR **Alain CHANCE** DATE / DATUM / DATE **fin août 1976**

Loc. Adr.	Code	Key Taste	Comments	Loc. Adr.	Code	Key Taste	Comments	Loc. Adr.	Code	Key Taste	Comments	Labels
Adr.	Kods	Touche	Bemerkungen	Adr.	Kods	Touche	Commentaires	Adr.	Kods	Touche	Commentaires	Label
	Code		Commentaires		Code				Code			Labels
000	46	*LBL		00	0			00	0			A nombre de
11	A	A	A	52	*dex			42	STO			B nombre de B
42	STO			87	*1			06	6			C jeu
06	6			56	*rtn			07	7			D non affecté
05	5			46	*LBL			56	*rtn			E E(=) >=0
98	*prt			12	B	B		46	*LBL			A' 10 STO 00
33	*PAP			42	STO			19	*D'	*D'		B2 (act=1)
36	*IND			09	9			01	1			C=100 no47
42	STO			08	8			00	0			D'
09	9			38	*prt			55	+			E=0 54 part
09	9			35	+			42	STO			E=0 54 part
16	*A'			46	*LBL			45	Y^=			F=0 54 part
00	0			16	*A'	A'		43	RCL			G=0 54 part
46	*LBL			01	1			06	6			H=0 54 part
37	*1	*1		00	0			07	7			I=0 54 part
36	*IND			42	STO			65	X			J=0 54 part
49	*PROD			00	0			36	*IND			K=0 54 part
09	9			00	0			43	RCL			L=0 54 part
08	8			95	=			00	0			M=0 54 part
43	RCL			42	STO			00	0			N=0 54 part
06	6			09	9			95	=			O=0 54 part
09	9			09	9			56	*rtn			P=0 54 part
75	-			56	*rtn			46	*LBL			Q=0 54 part
17	*B'			46	*LBL			10	*E'	*E'		R=0 54 part
22	INV			17	*B'	B'		85	+			S=0 54 part
80	*if pos			02	2			02	2			T=0 54 part
00	0			45	Y^=			95	=			U=0 54 part
03	3			43	RCL			15	E			V=0 54 part
07	7			00	0			55	+			W=0 54 part
42	STO			00	0			02	2			X=0 54 part
06	6			55	+			75	-			Y=0 54 part
09	9			02	2			46	*LBL			Z=0 54 part
01	1			95	=			15	E	E		
36	*IND			56	*rtn			22	INV			
46	SUM			46	*LBL			52	EE			
09	9			18	*C'	*C'		53	(
08	8			43	RCL							
01	1			00	0							

TEXAS INSTRUMENTS

MERLIN

THE INTELLIGENT VIDEO INTERFACE

MERLIN is the best ASCII/Graphics board now available for the S-100 bus . . . and at an unbelievable price!

Compare these features to any other video interface:

- ☆ 160H x 100V resolution bit mapping graphics
- ☆ On-board ROM (Monitor/Editor) option
- ☆ 40 characters by 20 lines, character ROM generated (hardware)
- ☆ Keyboard interface (with power)
- ☆ Programmable modes and display format
- ☆ Serial I/O port
- ☆ Low power . . . only 600ma at +5V
- ☆ Extremely fast (uses DMA)
- ☆ Comprehensive User Manual . . . 200ps
- ☆ American 60HZ or European 50 HZ operation.

Designed-in expandability means maximum versatility at minimum cost. Add-on options now available (in kit form) include:

- ☆ Super Dense Graphics (M320-K) \$39
- ☆ Lower case characters (LC) \$25
- ☆ Serial-to-parallel expansion KIT (MSEK-K) \$45
- ☆ 1500 Baud (software) cassette interface kit (MCAS-K) \$29
- ☆ 2K x 8 Mask ROM; graphics, cassette, & extended editing software (MEI) \$35
- ☆ 2K x 8 Mask ROM/256 RAM; Monitor Editor Software (MBI) . . \$39

The MBI ROM software is designed to allow turnkey operation and sophisticated editing and scrolling.

Ask to see a demonstration of MERLIN at your nearest computer store. Many dealers now stock MERLIN and there is nothing like a hands-on demo for really evaluating a product. We know you'll be sold.

- MERLIN Kit with Manual \$269
- MERLIN, assm'd & tested \$349
- MERLIN User Manual \$ 10

For fast information, write us direct! MC and BAC accepted.



Blackjack Bug

Master Steve Viterwyk of 4402 Meadow Wood Way, Tampa FL 33624, told us at the National Computer Conference show in Dallas TX about his discovery of a small bug on page 150, "SR-52 Card BLACKJACK," line 036, of the June 1977 BYTE. The present sign should be a division sign. Thanks, Steve. ■

While working with the information presented in "Sweet Auto Line," I believe I have discovered a slight bug. At the tags ONOFF: AND UNAUTO: reference is made to NEXT-1; I had to use NEXT-2 instead of NEXT-1. NEXT-1 plopped me back in mainline in the middle of an instruction.

If no one else has discovered this bug maybe you can advise everyone in general through an editorial comment.

Walter R Norwood, manager
Computer Hobbies Unlimited
9601 Kendrick Rd
Richmond VA 23235

We've had several other verbal comments by readers, but yours was the first written comment. ■

A Sour Note in "Sweet Auto Line"

I loved that "Sweet Auto Line" article in your February 1977 BYTE, page 12. Mr Nico is to be congratulated on a job well done. I am anxiously looking forward to future "goodies" comparable to this article.

SR-52

CODING FORM ~ KODEFORM ~ FEUILLE DE PROGRAMMATION

TITLE / TITEL / TITRE **JEU DE NIM** PAGE / SEITE / PADE **4** OF / VON / DE
PROGRAMMER / PROGRAMMIERER / PROGRAMMEUR **Alain CHANCE** DATE / DATUM / DATE **fin août 1976**

Loc. Adr. Code	Key Kode	Comments	Loc. Adr. Code	Key Kode	Comments	Loc. Adr. Code	Key Kode	Comments	Labels Label Labels
000	42	STO		50	*st fix		06	6	A Labels
180	75	-		02	2		09	9	B Utilisateur
	93	.	040	18	*c'		01	1	C
	05	5	152	16	*A'		00	0	D non affecté
	54)		46	*LBL	000	69	*PROD	E à
040	52	EE		77	*4	*4	06	6	A' usage
117	95	=		22	INV		08	8	B' de la
	56	*rn	040	58	*dsz		58	*dsz	C calculatrice
	46	*LBL	152	77	*4		89	*3	D'
	13	C C		19	*d'	000	43	RCL	E
127	11	A		10	*E'		06	6	Registers Registers / Allocations
	25	CLR		30	*if zro		09	9	00 dsz
	16	*A'	040	77	*4		60	*if flg	01 rangée 1
	18	*C'	162	19	*d'		02	2	02 rangée 2
	46	*LBL		22	INV	000	02	2	03 etc.
040	88	*2	*2	44	SUM	202	02	2	04
127	19	*d'		06	6		01	1	05 ↓
	44	SUM	040	08	8		01	1	06 (en base
	06	6		01	1		42	STO	07 deux)
	08	8		00	0	000	06	6	08
040	58	*dsz		45	y*	202	07	7	09 rangée 3
127	88	*2		53	(16	*A'	10 0
	16	*A'	040	42	STO	172	46	*LBL	11 rangée 1
	46	*LBL		75	-		79	*5	*5
	89	*3	*3	43	RCL	000	22	INV	12 rangée 2
040	43	RCL		06	6	212	58	*dsz	13 etc
127	06	6		07	7		78	*5	14 ↓
	08	8	040	35	=	172	19	*d'	15
	10	*E'		22	INV		30	*if zro	16 (en base
040	90	*if zro		69	*PROD	000	78	*5	17 dix)
127	01	1		06	6	217	18	*c'	18
	09	9		08	8		12	B	19 rangée 3
	00	0	040	18	*c'	182	00	0	20 SUPPLÉMENTS
	60	*if flg		12	B		22	INV	21 SUPPLÉMENTS
	02	2		41	GTO	000	52	EE	57-68-69
040	01	1		89	*3	202	86	*rset	2 98
127	08	8		17	*B'				3 et 99
	06	6	040	44	SUM	182			4

TEXAS INSTRUMENTS

13(KO), 14(KN), 15(SH), 16(VSS), 17(O1), 18(O2), 19(EXT), 20(IDLE), 21(IRG), 22(I/O8), 23(I/O4), 24(I/O2), 25(I/O1), 26(VDD), 27(VGG), 28(SG), and the pinouts on the TMC0524 which are probably the same as the TMC0523 are: 1(D15), 2(VGG), 3(VDD), 4(I/O1), 5(I/O2), 6(I/O4), 7(I/O8), 8(IRG), 9(IDLE), 10(EXT), 11(O2), 12(O1), 13(VSS), 14(DO), 15(D1), 16(D2), 17(D3), 18(D4), 19(D5), 20(D6), 21(D7), 22(D8), 23(D9), 24(D10), 25(D11), 26(D12), 27(D13), 28(D14).

I know nothing more about the internal structure of the two chips than the pinout names convey except that the TMC0501 is called an "Arithmetic Logic Chip" and the TMC0534 is 13 K word ROM called a "SCOM." I believe it also generates the digit scan pulses and the two phase clock.

I don't think it will help Mr Lewis to write Texas Instruments as I have written and telephoned them and the only information I can get is that the information is confidential. However, that was over a year ago and they may have changed by now.

A company called Bootstrap Enterprises, POB 614, Richardson TX 75080 sells "service manuals" on the SR-50 and SR-52 and they may have one on the SR-51. Their price is \$4.50. The data is skimpy but helps and they are prompt.

I am interested in any information which anyone may have on the internal workings of the SR-52.

Incidentally, does anyone know of a MOS or CMOS decade counter with three state BCD output. If so, I'd like its number and manufacturer.

Jack Lambert
5 Graham Rd
Lexington MA 02173

In his article "All This Just to Print a Quotation Mark?" in May 1977 BYTE, page 132, the author offers us a mind bending cure that is worse than the disease. Since the BASIC language he was using did not allow the user to represent a quote within a string delimited by quotes, he created an entire scratch file for the sole purpose of storing a quote which he subsequently read up as a variable and used.

The language I use, PASCAL, features a simple and straightforward solution: a quote mark within a string is represented by a pair of quote marks. Thus, in PASCAL you might say that the problem of quotes is "THE LANGUAGE" "S PROBLEM".

George Cohn
Indiana University
Wrubel Computing Center
Memorial Hall West, Room 013
Bloomington IN 47401

Right you are. But no one has any small computer PASCAL compilers (or interpreters) yet, and when a user has to put up with what he's got, some mind bending contortions may result out of sheer necessity.

COMMENTS ON PASCAL AND STACK MACHINES

The rumor of a Z-200 from ZILOG (April 1977 BYTE, page 140) seems to have triggered a groundswell in the small computer industry (and among personal computer enthusiasts) that cannot be ignored.

The concurrent article (page 128) by Donald J Slavely in your Technical Forum pages adds weight to the concept of using PASCAL (or a PASCAL subset)

as a high level language for micro-processor users. The problem, of course, has been core. For example, PASCAL on a PDP 11/45 typically resides in 16 K of 16 bit words and takes seven passes to produce code for an abstract machine. There is an additional overhead of 21 K words for an operating environment.

The ZILOG product, if it exists, would go a long way to bringing the small computer industry to a mature basis by providing it with a structured language. If the Z-200 does not exist the clamour of interest in such a product which your publication has generated must surely bring about its existence.

Keep up the good work, BYTE.

John S Perry
Hartley Compter Applications Pty Ltd
39 Sherwood Rd
POB 366
Toowong Qld 4066 AUSTRALIA

It turns out that Z-200 (later Z-800) rumor was untrue as of the spring of this year, but Zilog (and other companies) are not resting on past laurels. One design idea we heard at the West Coast Computer Faire from an LSI designer employed by a semiconductor laboratory was the idea of a fairly conventional processor design (at the machine language level) with built-in hooks to higher level functions implemented by fast machine language routines built into a ROM located in the processor. The suggestion was made that such routines could be made to run faster than if they were in external ROM segments due to the lack of any need to go through the external interfaces of the chip, and also due to short-cuts in the addressing of operands. In essence, the concept is one of some "vertical" microprogramming extensions of the instruction set built into the

SWTP 6800 OWNERS—WE HAVE A CASSETTE I/O FOR YOU!

The CIS-30+ allows you to record and playback data using an ordinary cassette recorder at 30, 60 or 120 Bytes/Sec.! No Hassle! Your terminal connects to the CIS-30+ which plugs into either the Control (MP-C) or Serial (MP-S) Interface of your SWTP 6800 Computer. The CIS-30+ uses the self clocking 'Kansas City'/Biphase Standard. The CIS-30+ is the FASTEST, MOST RELIABLE CASSETTE I/O you can buy for your SWTP 6800 Computer.

PerCom has a Cassette I/O for your computer!

Call or Write for complete specifications

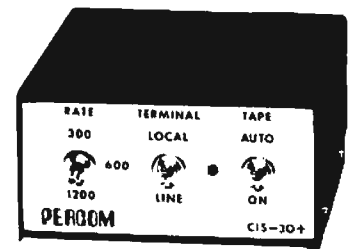

Kit — \$69.95*
Assembled — \$89.95*
(manual included)
* plus 5% f/shipping

PERCOM

PerCom Data Co.

P.O. Box 40598 • Garland, Texas 75042 • (214) 276-1968

PerCom — 'peripherals for personal computing'



TEXAS RESIDENTS ADD 5% SALES TAX

design, using the basic instruction set of the processor to implement the functions. As for Zilog, it was the faster Z-80A which was announced this past spring, although representatives of the firm do not deny work upon a machine appropriate for high level language representations of programs. One comment, though, was that it would most likely be a machine which made it easy to generate high level language object code, rather than a design which in any sense could be said to directly execute high level language code.

COMPLAINTS ABOUT BYTE IN THE NUDE.

Now that BYTE is arriving with labels pasted on the cover, I (and probably others) would like to know a simple chemical method of removing the labels.

H W Neff
American Microsystems Inc
3800 Homestead Rd
Santa Clara CA 95051

My May issue of BYTE was really messed up in the mail. By coincidence or not, May also happened to be the first issue I got without a wrapper. Is there any way you could put my copy in a wrapper and (hopefully) keep it from being shredded?

J A Beuckman
11889 Creste Verde
St Louis MO 63141

The labels on the cover (May and June 1977) of BYTE were a temporary deviation from standard practice due to the disruptions of a strike at our printer. We like wrappers on magazines as much as you do, and will restore them as soon as possible.

OVERLY PRODUCT ORIENTED?

The LED display as suggested by Mr James Hogenson in his article "Multiplex Your Digital LED Displays" [March 1977 BYTE, page 122] seems unnecessarily complicated and expensive, at least for use as a digital readout for a microcomputer. A good alternative would be the use of two (hexadecimal) or three (octal) Hewlett-Packard alphanumeric displays 5082-7300 series. As noted by the attached data sheet, these displays have their own decoder drivers with memory and are DTL and TTL compatible. they can easily be inserted into a small breadboarding socket and hand wired to the bi-directional data bus as follows:

The latch enable should be set to **OUT** in order to monitor read in and instruction results, and set to ground when single stepping.

Data sheets for the displays may be obtained directly from Hewlett-Packard. J A Titus of Tychon Inc should be credited with researching this product. The displays may be obtained from Schweber Electronics and cost \$15.60 per unit.

I would like to take the opportunity to say that your magazine has been a disappointment. Your publication is overly product oriented. In fact, many of your articles are simply reprints of product fliers. How about more emphasis placed on inexpensive computer projects, eg: simple interfacing involving different low priced memories, parallel to serial interfacing, etc?

Also a section devoted to simple software implementation and not necessarily involving BASIC or a high level language would be of interest. An educational series devoted to interested beginners would be helpful. Many of your articles are so difficult to understand that the novice is simply confused.

Considering the rapid advances being made in computer technology, it would behoove the hobbyist with restricted funds to stay with a low cost modular approach with software replacing hardware wherever possible. I think that much of what we see today as being the latest thing in microcomputer products will be obsolete within five years.

Don Woods
12012 Pebblebrook Ln
Carmel IN 46032

You make some good points. But as

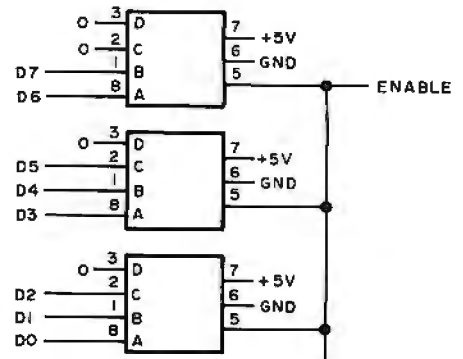

to "Your publication is overly product oriented. In fact, many of your articles are simply reprints of product fliers," you are out on a proverbial limb sawing rapidly at the nearest node in the root direction. Our articles convey information about the theory and operation of computers, how to build same, designing software, etc. Surely we put in new product releases as well, but that's all part of balancing the complicated equation of customers that is involved in any commercial magazine such as ours. . .CH

FAST & AFFORDABLE

The OAE Model OP-80A quality engineered paper tape reader will read punched tape as fast as you can pull it through (0-5,000 cps). Each unit includes a custom optical sensor array, high speed data buffers, and all required handshake logic to interface with any microprocessor parallel I/O port. Check our specs. AT OAE WE MAKE QUALITY AFFORDABLE!

\$74.50 KIL
\$95.00 A&T

OAE

Oliver Audio Engineering, Inc.
7330 Laurel Canyon Blvd.
North Hollywood, CA. 91605
(213) 765-8080

Available at quality computer stores everywhere. (Or, add \$2.50 for domestic shipping and handling — CA res. add 6%.)

**MORE HIDDEN GOLD:
PC-100 OPERATES WITH SR-51**

This letter is in response to that from William D Lewis in June 1977 BYTE. Perhaps I am not the typical BYTE reader because I have acquired over the last several months the Texas Instruments Models SR-51, SR-56, SR-52 and PC-100A. The last is a printer for the

SR-56 and SR-52. If one removes the batteries from these calculators, the appearances of the battery compartments are similar (but quite different from that for the SR-50). For all, in addition to the battery terminals, there is a 12 pad connector strip as pictured by Lewis.

I have been tempted for months to put the SR-51 onto the PC-100A just to see what would happen. I was inhibited from this by two facts: The first is that the compartment on the SR-51 is shallow as compared with the others, and second the PC-100A has a 3 position switch marked SR-52, SR-56, "other." After Lewis' letter I said, "I'll do it," and jammed the SR-51 onto the printer. I say "jammed" because it did not go on quite as smoothly as either the SR-56 or SR-52. Naturally I chose the "other" position for the PC-100A selector switch.

The SR-51 is not an "other" device and a next test showed it was not an SR-56. A third trial shows the SR-51 to be an SR-52 as far as the printer is concerned. And, talk about hidden gold, the results were fantastic (see reproduction of a printout). Before I discuss them let me point out that the inner workings of the SR-56 and SR-52 are very different as viewed by the PC-100A and things go to hell if the PC-100A selector switch does not match the calculator.

Texas Instruments is very inconsistent in its various machine features and their modes of operations as compared with those from Hewlett-Packard, thus the SR-51 has many functions not offered on the SR-52 and a few not offered on the SR-56. But, surprise, the PC-100A knows about them (unless it is the SR-51 which has more goodies than have been announced). In any case, when the PC-100A is adjusted for the SR-52 but actually gets the SR-51, the printer works as one would hope it would. Actually it works better than one

would reasonably expect. One can press the PC-100A PRINT button to print the displayed value at any time, but the operation is most interesting when the PC-100A is in the TRACE mode; here one gets a complete audit trail of all operations and results from operations. The operations printed out include SINH, COSH, SLOPE, INTCP and other functions which *do not even exist* on either the SR-56 or SR-52. Where does this information come from? Will some Texas Instruments engineer please tell us?

The many owners of the SR-51 know that it has the most preprogrammed functions and built-in conversions of all the pocket calculations built by Texas Instruments to the present time. Now that the price for the PC-100A printer is dropping, many of these owners might wish to make a spiffy equipment upgrade by buying one for their SR-51. And, of course, the printer will be usable for a subsequent SR-56 or SR-52. Note: SR-51A might be different from the SR-51.

Webb Simmons
1559 Alcala Pl
San Diego CA 92111

To carry this research further, we need a reader with an SR-51A to try the trick described here. Chances are that the trick will still work, since Texas Instruments probably was consistent in one respect: the design programmers most likely used a common coding scheme for all the arithmetic and transcendental functions of the calculator just to minimize the probability of software error.

POPULAR COMPUTING REPLUGGED

We do appreciate the plug for *Popular Computing* in Peter Trivisanov's Clubs and Newsletters column in your

COMPUTING e			
STMS 1	1. CLF ALL		
	1. STI	0.5	SINH
	1. -	.5210958055	
	1. -	.5210958055	ASINH
SUM 1	1. SM1	0.5	
	2. -	0.5	COSH
	0.5 SM1	1.127625965	
	1. -	1.127625965	ACOSH
	1. SM1	0.5	
	4. -	0.5	TANH
	1.041666667	1.462117157	
	5. -	1.462117157	ATANH
	1.009321333	79.	
	6. -	79.	CLF
	1.001333333	0.5	TANH
	1. -	1.462117157	
	1.000198411	1.462117157	ATANH
	8. -	0.5	
	1.000024801	1.	E+
	9. -	1.	
	1.000018757	4.	E-
	10. -	4.	
	1.000002756	5.	E+
	11. -	5.	
	1.0000010251	6.	
	12. -	6.	
	1.000000021	1.166666667	
	13. -	1.166666667	SDV
	1.000100391	1.77612706	
	14. -	1.77612706	MAF
	1.1470745e-11	3.5790330e	
	15. -	3.5790330e	CLF
	1.647162732e-12	1.	
	16. -	1.	
	1.71131828	1.	
	17. -	1.	
	1.71131828	1.	
	18. -	1.	
	1.71131828	1.	
	19. -	1.	
	1.71131828	1.	
	20. -	1.	
	1.71131828	1.	
	21. -	1.	
	1.71131828	1.	
	22. -	1.	
	1.71131828	1.	
	23. -	1.	
	1.71131828	1.	
	24. -	1.	
	1.71131828	1.	
	25. -	1.	
	1.71131828	1.	
	26. -	1.	
	1.71131828	1.	
	27. -	1.	
	1.71131828	1.	
	28. -	1.	
	1.71131828	1.	
	29. -	1.	
	1.71131828	1.	
	30. -	1.	
	1.71131828	1.	
	31. -	1.	
	1.71131828	1.	
	32. -	1.	
	1.71131828	1.	
	33. -	1.	
	1.71131828	1.	
	34. -	1.	
	1.71131828	1.	
	35. -	1.	
	1.71131828	1.	
	36. -	1.	
	1.71131828	1.	
	37. -	1.	
	1.71131828	1.	
	38. -	1.	
	1.71131828	1.	
	39. -	1.	
	1.71131828	1.	
	40. -	1.	
	1.71131828	1.	
	41. -	1.	
	1.71131828	1.	
	42. -	1.	
	1.71131828	1.	
	43. -	1.	
	1.71131828	1.	
	44. -	1.	
	1.71131828	1.	
	45. -	1.	
	1.71131828	1.	
	46. -	1.	
	1.71131828	1.	
	47. -	1.	
	1.71131828	1.	
	48. -	1.	
	1.71131828	1.	
	49. -	1.	
	1.71131828	1.	
	50. -	1.	
	1.71131828	1.	
	51. -	1.	
	1.71131828	1.	
	52. -	1.	
	1.71131828	1.	
	53. -	1.	
	1.71131828	1.	
	54. -	1.	
	1.71131828	1.	
	55. -	1.	
	1.71131828	1.	
	56. -	1.	
	1.71131828	1.	
	57. -	1.	
	1.71131828	1.	
	58. -	1.	
	1.71131828	1.	
	59. -	1.	
	1.71131828	1.	
	60. -	1.	
	1.71131828	1.	
	61. -	1.	
	1.71131828	1.	
	62. -	1.	
	1.71131828	1.	
	63. -	1.	
	1.71131828	1.	
	64. -	1.	
	1.71131828	1.	
	65. -	1.	
	1.71131828	1.	
	66. -	1.	
	1.71131828	1.	
	67. -	1.	
	1.71131828	1.	
	68. -	1.	
	1.71131828	1.	
	69. -	1.	
	1.71131828	1.	
	70. -	1.	
	1.71131828	1.	
	71. -	1.	
	1.71131828	1.	
	72. -	1.	
	1.71131828	1.	
	73. -	1.	
	1.71131828	1.	
	74. -	1.	
	1.71131828	1.	
	75. -	1.	
	1.71131828	1.	
	76. -	1.	
	1.71131828	1.	
	77. -	1.	
	1.71131828	1.	
	78. -	1.	
	1.71131828	1.	
	79. -	1.	
	1.71131828	1.	
	80. -	1.	
	1.71131828	1.	
	81. -	1.	
	1.71131828	1.	
	82. -	1.	
	1.71131828	1.	
	83. -	1.	
	1.71131828	1.	
	84. -	1.	
	1.71131828	1.	
	85. -	1.	
	1.71131828	1.	
	86. -	1.	
	1.71131828	1.	
	87. -	1.	
	1.71131828	1.	
	88. -	1.	
	1.71131828	1.	
	89. -	1.	
	1.71131828	1.	
	90. -	1.	
	1.71131828	1.	
	91. -	1.	
	1.71131828	1.	
	92. -	1.	
	1.71131828	1.	
	93. -	1.	
	1.71131828	1.	
	94. -	1.	
	1.71131828	1.	
	95. -	1.	
	1.71131828	1.	
	96. -	1.	
	1.71131828	1.	
	97. -	1.	
	1.71131828	1.	
	98. -	1.	
	1.71131828	1.	
	99. -	1.	
	1.71131828	1.	
	100. -	1.	
	1.71131828	1.	
	101. -	1.	
	1.71131828	1.	
	102. -	1.	
	1.71131828	1.	
	103. -	1.	
	1.71131828	1.	
	104. -	1.	
	1.71131828	1.	
	105. -	1.	
	1.71131828	1.	
	106. -	1.	
	1.71131828	1.	
	107. -	1.	
	1.71131828	1.	
	108. -	1.	
	1.71131828	1.	
	109. -	1.	
	1.71131828	1.	
	110. -	1.	
	1.71131828	1.	
	111. -	1.	
	1.71131828	1.	
	112. -	1.	
	1.71131828	1.	
	113. -	1.	
	1.71131828	1.	
	114. -	1.	
	1.71131828	1.	
	115. -	1.	
	1.71131828	1.	
	116. -	1.	
	1.71131828	1.	
	117. -	1.	
	1.71131828	1.	
	118. -	1.	
	1.71131828	1.	
	119. -	1.	
	1.71131828	1.	
	120. -	1.	
	1.71131828	1.	
	121. -	1.	
	1.71131828	1.	
	122. -	1.	
	1.71131828	1.	
	123. -	1.	
	1.71131828	1.	
	124. -	1.	
	1.71131828	1.	
	125. -	1.	
	1.71131828	1.	
	126. -	1.	
	1.71131828	1.	
	127. -	1.	
	1.71131828	1.	
	128. -	1.	
	1.71131828	1.	
	129. -	1.	
	1.71131828	1.	
	130. -	1.	
	1.71131828	1.	
	131. -	1.	
	1.71131828	1.	
	132. -	1.	
	1.71131828	1.	
	133. -	1.	
	1.71131828	1.	
	134. -	1.	
	1.71131828	1.	
	135. -	1.	
	1.71131828	1.	
	136. -	1.	
	1.71131828	1.	
	137. -	1.	
	1.71131828	1.	
	138. -	1.	
	1.71131828	1.	
	139. -	1.	
	1.71131828	1.	
	140. -	1.	
	1.71131828	1.	
	141. -	1.	
	1.71131828	1.	
	142. -	1.	
	1.71131828	1.	
	143. -	1.	
	1.71131828	1.	
	144. -		

June 1977 issue, and no doubt it will trigger a flood of inquiries. All the subscription information was meticulously correct.

But where did the other material come from? We have produced 52 issues to date, with exactly two games all told. "Schwartz on Calculators" was one article; hardly a monthly feature. And except for one issue devoted to the Altair, there has never been any information about the micro field. In fact, we rather avoid printing any news at all, with the objective of making our issues sort of timeless. Gee, other than that, everything was correct.

Popular Computing is for people who want to compute, and it contains lots of computing problems, articles on how to compute and a series on the Art of Computing.

We'll explain all this to those who write, since we don't want anyone subscribing under a misconception.

Just think of the fun I could have describing BYTE in the same way!

But we do like being mentioned, very much.

Fred Gruenberger
Popular Computing
POB 272
Calabasas CA 91302

Oops! Your letter should correct things a bit.

COPSE OUT

About computers there is no question that the coming of the chip computer heralds a new age. Science fiction writers have long foretold of the personal and personable computer. It is becoming fact. Yet, we who are about to enter the copse must needs reflect upon our passage first, and not as an afterthought.

Your rebuke of Mr Garner's argument, (Ask BYTE, May 1977) was thoughtless and without point. Mr Garner correctly points a finger in the direction of the dike that leaks: our technology. He questions the moral quality of a course of action that is new and untold. And you, obviously lacking an equitable pen, denounce his unspoken ethics only to replace them with your own equally unspoken ethics. Pray tell, from where do you draw your reason, for surely that well is dry?

It can be argued that by any truly human standard of value, computers and robots are not highly desirable technology. I do not argue that human beings are the measure of morality; but I must contend that automation of mental and physical drudgery is not necessarily ethical. If I may, I shall submit an analogy. A man who thinks to build a box might employ a computer to design it, and a robot to build it. The box once complete, though, is not his box. The man never affected the box except to ask for its construction. Effectively he does not understand the box because he did not apply himself to it.

I think (if I may be so bold) that Mr Garner poses this question to each of us. We strive, I no less than others, to produce artificial intelligence. Is it right that this intelligence supplant human intelligence? And is the definition of drudgery to be equated with that of effort? The man who built (euphemistically speaking) the box did not have to reason to build it. His mind was not exercised, nor were his hands. He needed only a rudimentary education and rudimentary expectations to build a box. If he worked in a factory he probably didn't even fully know how to use that wonderful tool which supplanted his own intelligence, and most likely his pride in himself.

In closing I shall ask a question posed once before. Is the definition of drudgery to be equated with that of effort? Take care in your answer, if any, for there are no easy solutions which you might glily offer.

Nelson E Ingersoll
1620 Carlisle NE Apt C
Albuquerque NM 87110

We'd have a boring world indeed if everything remained constant (and incidentally, regimented) by superstitious fears of the unknown. Progress in technology, good with the bad, is a living manifestation of a viable sentient species, the human race. Attempting to build the dike around technology in the first place is probably one root cause of your metaphorical leak.

I claim it is no less a mark of craftsmanship to give the robot system specifications of one box or many boxes to build than it is to design and build the box by hand; the more versatile person might use either method of construction depending upon mood and ends other than physical creation of a particular box.

COMMENTS ON CERTIFICATION OF TAPES

Judging from David Allen's article on saturation recording, personal computing is about to discover some of the benefits of professional digital recording techniques, of which high storage capacity and faster access time are but a few. Mr Allen may be optimistic, though, in stating the cassette used need not be certified. Of course, an uncertified tape will work if there happen to be no dropouts in a critical area, but are you prepared to trust a laboriously debugged program or critical data to an uncertified cassette? If you can afford to gamble the recovery time and effort against the small additional cost for a certified product it may not matter; but most people, especially those using their systems in a commercial environment, would find the certified cassette well worth the investment. Some of the newer cassette subsystem suppliers, such as Microdesigns, have also discovered the desirability of using a certified cassette. Incidentally, most certified cassettes are usually more

FINALLY.

A State-of-the-Art Tool For Learning Software Design.

And at an affordable price. The Modu-Learn™ home study course from Logical Services.

Now you can learn microcomputer programming in ten comprehensible lessons. At home. In your own time. At your own pace.

You learn to solve complex problems by breaking them down into easily programmed modules. Prepared by professional design engineers, the Modu-Learn™ course presents systematic software design techniques, structured program design, and practical examples from real 8080A micro-computer applications. All in a modular sequence of 10 lessons . . . more than 500 pages, bound into one practical notebook for easy reference.

You get diverse examples, problems, and solutions. With thorough background material on micro-computer architecture, hardware/software trade-offs, and useful reference tables. All for only \$49.95.

For \$49.95 you learn design techniques that make software work for you. Modu-Learn™ starts with the basics. Our problem-solution approach enables you to "graduate" as a programmer.

See Modu-Learn™ at your local computer store or order now using the coupon below.

Please send the Modu-Learn™ course for me to examine. Enclosed is \$49.95 (plus \$2.00 postage and handling) or my Mastercharge/BankAmericard authorization.

Name: _____

Address: _____

City: _____ State: _____

Card # _____

Expiration date: _____

Signature: _____



711 Stierlin Road
Mountain View, CA 94043
(415) 965-8365

LOGICAL

SERVICES INCORPORATED

reliable and less likely to jam, and can be operated at high speeds and accelerations without damage.

Robert H Katzive,
Product Manager — Marketing
Information Terminals Corp
323 Soquel Way
POB 9077
Sunnyvale CA 94086

MODES OF EXPRESSION IN ENGLISH IDIOM

Please don't be intimidated by the likes of Lawyer Welborn, "Windmill Jousting Department" in your June Letters. He's obviously too intelligent to claim that BYTE has no female readers, since that argument could be knocked down by one counterexample, and law school has taught him the fallacy of strict majority rule ("Let's vote on what everybody's favorite color is"), so he resorts to ridicule and appeals to his own definition of reason. But it's easy enough to tell where his heart is when he categorizes your readers as "gals" and "men." Why not "women" and "guys?"

I'll admit that there are places where a simpler construction could be used. For example, in BYTE's Bits, the

phrase "the user plays the record on his or her phonograph" could have been tightened up by substituting "a phonograph." But it never struck me that you folks were on any kind of "crusade" (unless that's how you define good manners). All that I've noticed is that yours is just about the only technical publication I can read without wincing every so often.

Carol J Pruitt
1621 18th St NW
Cedar Rapids IA 52405

PATCHING INFO NEEDED

In your write-up of SwTPC 4 K and 8 K BASIC in the What's New? column on page 72 of January 1977 BYTE, the following sentence appeared: "These packages should work on any 6800 computer system with MIKBUG." I have discovered that the key word in that sentence is "should."

My system is based on a Motorola MEK6800D1 Evaluation Kit with MIKBUG, and neither 4 K nor 8 K BASIC will "play" on it. I have discovered one problem with 8 K BASIC: by changing the instruction at hexadecimal address 0B0D to 7E 0B41, the program jumps around some unwanted

PIA initialization routines. Now I can execute the commands and some simple programs, but the IF...THEN and FOR...NEXT statements, along with most of the functions, don't work.

If anyone has successfully modified SwTPC 8 K BASIC for a Motorola Evaluation Kit I would appreciate hearing from him or her.

Paul E Pennington
1503 Park Av
El Dorado KS 67042

The "should" evaluation was made based on the design of the SwTPC computer system, which has a fairly straightforward adaptation of the Motorola design information. However, as we have found from assembly of an MEK-6800D1, the ROM which comes with that system is for "JBUG," a new monitor which differs from MIKBUG in several key areas.

SR-52 INFORMATION SOURCE

The BYTE readership may be interested to know that there is now an SR-52 Troubleshooting Guide available for \$12 plus local tax plus \$1 shipping from Texas Instruments, POB 53, Lubbock TX 79408.

The artificial intelligence and robotics articles in the past couple of issues were great!

David B Lamkins
DBL Electronics
502-12 Sherman St
Canton MA 02021

ATTENTION AUTHORS: PRESCRIPTION NEEDED

Please get some of your contributors to write a few articles on troubleshooting a nonfunctioning microcomputer. These articles should be pitched to the level of the poor fellow with limited electronic troubleshooting experience who bravely assembled a microcomputer kit only to have it quit working on him. Don't let them say check to see if the assembly was done correctly. The kit documentation already says that. Have them start with the assumption that the assembly has been checked or that the computer was operating and then failed.

Some sample questions that the articles should answer:

- What instruments are necessary and what additional ones are nice to have?
- How does one use the schematics to determine what signals and voltages will be found at various points in the circuits?
- How can one narrow the malfunction down to a particular part of the computer?
- Does one need a stock of replacement parts to use in substitution tests and, if so, how does one determine which ones?

—As featured in March 1976 Popular Electronics—

The Incredible "Pennywhistle 103"

Think Of It As The Ultimate!



4' Interconnect cable
\$15.95

\$129⁹⁵

(plus \$3.50 for postage and handling).
California residents add 8 1/4% sales tax.
Allow approximately four weeks for delivery.

The Pennywhistle 103 Acoustic Coupler is the first professional quality modem available in kit form. The Pennywhistle may be used either as an acoustic coupler (with the telephone handset) or it may be wired directly into the telephone. In either case, The Pennywhistle will operate in both the half-duplex (unidirectional) or the full-duplex (bidirectional) modes.

The Pennywhistle 103 is capable of recording data to and from audio tape without critical speed requirements for the recorder and it is able to communicate directly with another modem and terminal for telephone "hamming" and communications for the deaf. In addition, it is free of critical adjustments and is built with non-precision, readily available parts.

The Pennywhistle is the only Acoustic Coupler Modem Kit in the world with these features. The Pennywhistle represents many things in terms of operation, construction and concept. It is, in effect, a new generation of Acoustic Coupler Modems.

—SPECIFICATIONS—

Data Transmission Method	Frequency-Shift Keying, full-duplex (half-duplex selectable).
Maximum Data Rate	300 Baud.
Data Format	Asynchronous Serial (return to mark level required between each character).
Receive Channel Frequencies	2025 Hz for space; 2225 Hz for mark.
Transmit Channel Frequencies	Switch selectable: Low (normal) = 1070 space, 1270 mark; High = 2025 space, 2225 mark.
Receive Sensitivity	-48 dbm acoustically coupled.
Transmit Level	-15 dbm nominal. Adjustable from -8 dbm to -20 dbm.
Receive Frequency Tolerance	Frequency reference automatically adjusts to allow for operation between 1800 Hz and 2400 Hz.
Digital Data Interface	EIA RS-232C or 20 mA current loop (receiver is optoisolated and non-polar).
Indicators	Red LED indicates power without carrier. Amber LED lights and red LED goes out upon acquisition of carrier. Data received causes both LEDs to flicker.
Power Requirements	120 VAC, single phase, 10 Watts.
Physical	All components mount on a single 5" by 9" printed circuit board. All components included.

Requires a VOM, Audio Oscillator,
Frequency Counter and/or Oscilloscope to align.

M&R ENTERPRISES
P.O. Box 61011, Sunnyvale, California 94088

● Is there a burn in time during which one should expect a fairly high incidence of part failure? If so, can one expect the kit manufacturer to replace the parts that failed?

● Where can one go for assistance and advice other than computer club members and the local computer store? Are there any books on the subject?

Buren R Shields
900 Idlewilde Ln SE
Albuquerque NM 87108

A BIT OF A PUZZLE

Does anyone happen to know how it came to be that a "billion" means 10^9 to Americans and 10^{12} to the British, or why Americans and Europeans use "." and "," in opposite fashion when writing numbers?

Jan Kok
126 S Lincoln Av
Loveland CO 80537

INTELLECTUAL AWE

On an intellectual level I am in awe of the creator of the mess pictured on your April 1977 issue. However, if I want to look at junk, I have my own workshop as a source of enjoyment. Your covers could be a lot better.

Mark H Spohr MD
POB 439
Tahoe City CA 95730

PS: I really enjoy the content of your magazine.

But not everyone has your wide experience, and after all, it was the April cover, was it not?

MORE ON QUOTE KLUDGES

David Chapman's complaint (May 1977 BYTE) about the ugly circumlocution (Is it a kludge if your language processor makes you do it?) required to print a quotation mark is certainly valid. There are, however, better solutions than his suggestion of allowing either single or double quotes as delimiters.

Slightly better is the two for one idea of PL/I. This allows both single ('') and double (""') quotes in the same string.

Better yet is the technique used to solve a similar problem in some text editors (see *Software Tools* by Kernighan and Plauger, Addison-Wesley Publishing, Reading MA 01867, 1976). A single character (for example %) is used as an escape throughout the system. Whenever this character occurs, the character immediately following it loses any special meaning. "Therefore, a string can include '%',%% and even % (carriage-return)." With some cooperation from the keyboard input routines "% (delete-line)" and "% (delete-previous-character)" may be used as data.

This solves many problems which

occur when a program produces as its output another program which produces...

Moral: People who write software should provide simple yet powerful tools for people who write programs.

Corollary: People who write programs should provide simple yet powerful tools for people who use programs.

Dale Wilson
231 Couch Av
St Louis MO 63122

Ah, but your solution assumes control over the systems software; David's article concerned ways around short-sighted but already implemented systems software which he had access to.

ATTENTION AUTHORS: 2311 DRIVE DATA NEEDED

There have been many articles written about attaching floppy disks to microprocessors and the advantages to be gained from having direct access storage on a microsystem. However from the user's standpoint, floppy disks have possibly two disadvantages: the high cost compared to the cost of the micro-computer, and a relatively small storage capacity.

In the used computer equipment market there are a large quantity of IBM 2311 equivalent disk drives available at bargain prices. These units could offer as much as seven million bytes of direct access storage per spindle depending upon the sectoring approach used. Has anyone investigated the problem of interfacing such a unit to a micro-processor? Perhaps someone has already built such an interface unit.

Any articles on this subject would be greatly appreciated.

Fred W Newton
Manager Data Processing
The Fenton Art Glass Company
Williamstown WV 26187

The 2311 drive has been around for some time due to the widespread use of the IBM System 360 and its cousins. An earlier version with similar media, the 1311 disk drive, should also prove useful to homebrewers.

ARTICLES WANTED

Would appreciate article on use of small computer (Altair 8800b) for routine office tasks such as bookkeeping, payroll, taxes, and also on engineering calculations (lighting, heat loss, heat



Manufacturer of
Computer Systems

BEEHIVE'S B100



B100 features

- Cursor Control
- Erase Mode
- Addressable Cursor
- Switch Selectable Transmission Rates:
75 to 19,200 bps
- Communication Mode:
HDX/IDX/BLOCK
- RS232C and a Current Loop Interface
- Non-Glare Screen

Low Cost/Expanded Features

Beehive's B100 terminal is a self-contained, operator/computer accessible, remote video display terminal. Beehive's B100 has switch selectable transmission rates from 75 to 19,200 bps and features cursor control, RS232C or current loop interface, addressable cursor, and erase mode. Expansion options, such as formatting, editing, blink, block send, 16 function keys, and hard copy capability with printer interface are available.

Beehive's B100 terminal employs a 12-inch monitor which is formatted to display 24 lines with 80 characters on each line. Upper and lower case characters are optional. The terminal has a total page memory of 1920 characters.

BEEHIVE INTERNATIONAL

USA: 4310 Armetia Eastman Drive • Box 25668 • Salt Lake City, Utah 84125 • Phone (801) 355-6000 • TWX 910-925-5271
EUROPE: Schephol Airport • Building 70 Schephol East • Amsterdam, The Netherlands • Phone 020-451522 • Telex 15261

The
fabulous **Phi-Deck**® family
of 5 cassette transports
under \$100 in quantities of 10

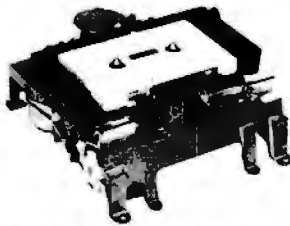

- Featuring:
- Die-cast frames
 - Remote controllable
 - Precise, fast head engage/disengage
 - Quick braking
 - Search FF/rewind 120 ips
 - Speed ranges from .4 to 20 ips

Electronic packages and mag heads for most applications

For application in:

- | | |
|-----------------------------------|---------------------------------------|
| 1. Micro processing | 7. Security/automatic warning systems |
| 2. Data recording/logging/storage | 8. Test applications |
| 3. Programming | 9. Audio visual/education |
| 4. Instrumentation | 10. Telephone interconnect |
| 5. Industrial Control | 11. Hi-Fi |
| 6. RS-232 Data storage | 12. Point of sale |



Title I Incorporated
4605 N. Stiles P.O. Box 18209
Oklahoma City, Oklahoma 73118 (405) 521-9000

- I am interested in application no. _____
- Have Representative call Send application notes

Name _____ Title _____
Company Name _____
Address _____
City _____ State _____ Zip _____
Phone Number _____

"We may have the surplus electronics you need!"

Terminal/Keyboard
With Schematics
\$250.00



- CRT Terminals
- Assemblies
- Peripherals
- Components

Tape Drives \$800.00 Keyboards \$40.00 to \$60.00
(ASCII Encoded)

Equipment Cabinets \$45.00 to \$60.00
(19" With Fan)

Send for a free catalog or call
Bill Blaney, toll free 800 258-1036
in NH 603-885-3705

Come to our showroom

WORLDWIDE ELECTRONICS, INC.
10 Flagstone Drive, Hudson, New Hampshire 03051

gain, etc), and especially annual hour-by-hour energy calculations using weather data as input to optimize heating and air conditioning design of buildings. Thanks.

Fred McDavid

**ONE POINT DOES NOT
A TREND MAKE**

I strongly object to your filling issues with articles of a comic or trivial nature. A certain amount of levity is acceptable, but when serious information is ultimately excluded, you cease to be a significant journal and degenerate to the status of trade rag.

Take, for example, your April issue. I immediately object to "Chu Dynasty," "Plexitus," "Arcturus," and "Private Affair." Proceeding to the rest, I see only three articles of interest: "1200 bps Tape," "Baudot," "8008." It may appear that hardware preoccupies my thoughts, and to a degree it does, since your magazine is one of the few sources of beer budget hardware information; of course, good software is not restricted by capital, so anyone can profit from the journals in that regard.

Trevor Hanson
H & D Enterprises
101 Decatur Av
Guilford CT 06437

PIED IN THE SKY?

I have a better origin for the name of the robot in your June 1977 issue "Newt: A Mobile, Cognitive Robot" (by Ralph Hollis, page 30). The lines go:

*And I chiefly use my charm
On creatures that do people harm.
The mole and toad and newt and viper;
And people call me the Pied Piper.*

The author is Robert Browning.

You are the Pied Piper and you do harm by bringing "pied in the sky" articles such as this. I would be happy if I could get a robot to move, much less recognize patterns and play with blocks. As editor of BYTE I would say that your decision to run this article is equivalent to piping Home Computer Town free of hobbyists. Slow-Syn™ bifilar stepping motors indeed!

Mike Rivers
78 Leyfred Ter
Springfield MA 01108

Pied Piper, indeed? What better real world application than mechanisms that move and interact with the environment?

RALPH HOLLIS = TOM PAXTON?

Ralph Hollis obviously had as much fun writing his article, "Newt: A Mobile, Cognitive Robot," [June 1977 BYTE, page 30] as I did reading it.

It's a comprehensive technical piece with some excellent ideas on robotic

design. It's also the story of a labor of love. His pictures and descriptions lend the little fellow personality. I chuckled as I read the article, thinking of Tom Paxton's song, "The Marvelous Toy."

The words of this fanciful song, written well over a decade ago, seem to describe Newt. Here is the song; perhaps you'll agree:

*When I was just a wee little lad
Full of health and joy,
My father homeward came one night
And gave to me a toy.
A wonder to behold it was
With many colors bright.
And the moment I laid eyes on it
It became my heart's delight.*

*The first time that I picked it up
I had a big surprise,
For right on its bottom were two big buttons
That looked like big green eyes.
I first pushed one—then the other
Then I twisted its lid,
And when I sat it down again
Here is what it did . . .*

*It went zip when it moved,
Bop when it stopped,
Whirrrr when it stood still.
I never knew just what it was
And I guess I never will.*

*It first marched left, then marched right
Then marched under a chair.
And when I looked where it had gone
It wasn't even there.
I started to cry and my daddy laughed
For he knew that I would find,
When I turned around, my marvelous toy
Achuggin' from behind.*

*Now the years have gone by, too quickly it seems,
I have my own little boy.
And yesterday I gave to him
My marvelous little toy.
His eyes nearly popped right out of his head,
He gave a squeal of glee.
Neither one of us knows just what it is,
But he loves it just like me.*

*It still goes zip when it moves,
Bop when it stops,
Whirrrr when it stands still,
I never knew just what it was,
And I guess I never will.*

Is Ralph Hollis a pseudonym for Tom Paxton, or is Tom Paxton a pseudonym for Ralph Hollis?

J Tom Badgett
1917 Washington St
Bluefield WV 24701

"The Marvelous Toy" by Tom Paxton. © Copyright 1961, Cherry Lane Music Company. Used with permission. All rights reserved. (For interested readers, this song is available on an Elektra recording, The Complete Tom Paxton, 7E-2003.)

MONITOR?

I recently received my first issue of

**BUILD YOUR OWN
VIDEO TERMINAL FOR
\$85 "PLUS"**

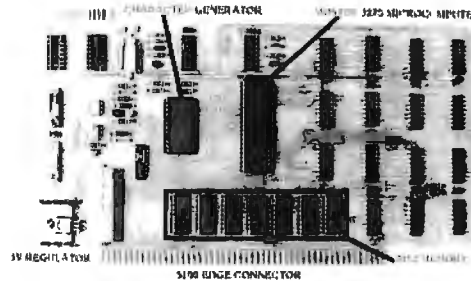

- Serial ASCII or BAUDOT
- Full X-Y Cursor control
- 128 Characters, including upper and lower case
- 16 lines X 64 characters
- 5100 Compatability
- Operates on 7VDC unregulated, 6.3 VAC @ 0.75 A

The SCT-100 Single Card Terminal interfaces directly to any computer or modem having serial ASCII or BAUDOT capability. It requires only the addition of a standard ASCII keyboard, and a TV monitor. It is available as a partial kit for \$85.00 including the PC board, character generator ROM, and the 3870 micro-computer. The complete SCT-100 kit is \$155.00 (\$185.00 prewired & tested).

To order, call or write today. MC, BAC Accepted.

VECTRON P.O.Box #20887, Dallas, Texas, 75220
Phone (214) 350-5291

M6800

HARDWARE/SOFTWARE

• **REAL TIME OPERATING SYSTEM**

RT/68⁰ is mask-programmed on a 6830 ROM that replaces the Mikbug[®] ROM in your SWTPC 6800, Motorola D1 or D2 Evaluation Kit, etc. It is a powerful real time, multiprogramming operating system with many versatile system functions. RT/68⁰ can support up to 16 concurrent programs at 8 priority levels.

MICROWARE has improved the Mikbug[®] functions, added four more (Dump, Exec, Sys, Bkpt) and made tape load and punch program-usable. RT/68⁰ is software and hardware compatible with Mikbug[®] and supports ACIA or PIA type interfaces. The comprehensive manual includes a complete source listing.

RT/68MX \$5.00

• **ANALOG INTERFACE SUBSYSTEM**

Consists of a PIA connected to a high speed, high accuracy 8 bit digital-to-analog converter. Also included is a buffer and precision comparator to implement an analog-to-digital converter using one of several software techniques listed in the manual. Applications include sensor input/output, audio synthesis, vector graphic displays, etc. Circuit board is plug-compatible with the SWTPC 6800 I/O buss.

AS1-K (COMPLETE KIT) 87.50
AS1 (ASSEMBLED and TESTED) 115.00

• **SERIAL I/O INTERFACE**

An RS-232 type serial interface card with full modem control capabilities (RTS, CTS, DCD). May also be used for interface with audio cassette systems. Plug compatible with SWTPC 6800 I/O buss.

SC1-K (COMPLETE KIT) 30.00
SC1 (ASSEMBLED and TESTED) 40.00

THE MICROWARE CORPORATION

P.O. BOX 954 Des Moines, Iowa 50304

Write or use reader service card for free brochure.
Phone Orders (515) 279-9856 U.S. Orders Postpaid.
BankAmericard and Mastercharge give all info on card.
Mikbug[®] is a trademark of Motorola, Inc.

S-100
COMPATIBLE
BLANK
BOARDS

Z-80 CPU	\$35.00
2708/16 EPROM	\$25.00
PROTOBOARD	\$25.00
8k STATIC	\$25.00
16/64 DYNAMIC RAM	\$35.00

PLEASE ADD \$2.00 SHIPPING PER ORDER.



(607)
273-3271

PO BOX 91 ITHACA, N.Y. 14850
WE'D LIKE TO MEET YOU AT PC '77, BOOTH 206

**SAVE 5% To 15% On The
World's Finest
Hardware & Software.
Call (315) 637-6208 NOW.**

	List Price	Our Price
IMSAI 808 Kit with 22 slots	\$751	\$645
IMSAI 4K 500ns RAM Kit	\$139	\$117
North Star Micro-Disco System Kit	\$699	\$599
Gromemco Bytesaver Kit	\$195	\$185
Vector Graphic 8K 500ns RAM (Assembled)	\$265	\$225
Edge Connectors & Guides for IMSAI (In lots of 10-each)	\$ 7	\$ 4
Our own Extender Board w/connector	\$ 30	\$ 15

Shipping charges \$10 per CPU or larger units, \$1.50 per kit, \$2.00 minimum per order.

Provided stock is available, we will ship immediately for payment by cashier's check, money order or charge cards. Allow 3 weeks for personal checks to clear.

N.Y. State residents add appropriate sales tax. Prices may change without notice.

computer
enterprises™

P.O. Box 71 • Fayetteville, New York 13066

BYTE. Congratulations! This is one of the finest computer hobbyist oriented magazines I have read to date.

I will come right to the point of this letter. I am looking for a TV monitor that has a 9 inch diagonal screen, perhaps in kit form. I would also be interested in just the CRT and associated electronics so I could design my own terminal cabinet.

All of the monitors (assembled) that I have seen have been over \$100. My question is: why buy a \$125 monitor and watch nothing but your computer readout, when you could buy a 9 inch TV and get the networks also?

Is there anything that BYTE is aware of that might fill my needs?

Rick Downs
205 Shelton Beach Rd
Apt 53
Saraland AL 36571

Look on page 1-4 of The Best of BYTE Volume 1 (see the BITS advertisement in this issue) for a reprint of Kenneth Barbier's article "The Ignorance is Bliss Television Drive Circuit."

**A LETTER OF THANKS
TO RALPH BURHANS AND
ASSOCIATES**

Many thanks for the series on Omega navigation. I have been experimenting with analog Omega devices for years; now, thanks to your series, I have embarked on a digital version.

I have coded the phase lock loop program for the 6800 already. Currently I am developing a simulator to drive it for test and evaluation. Let's have more on digital radio receivers and coherent CW.

Roy Murphy
System Development Corporation
REM 500
Macara CA 94086

**APL CHARACTER GENERATION
INTEREST**

In reading February 1977 BYTE, I noticed a letter of interest dealing with character ROMs for APL. At the end of the letter, you said something about creating a demand. I'd like to say that I would be willing to purchase two or three such generators, but not five.

Thomas Curley
POB 69
Morrisville NY 13408

A note of interest regarding visual representations: systems with re-definable programmable memory buffer areas for character generation will prove quite useful to APL hackers. Two examples are currently on the market: the Novul computer first seen in BYTE in the June 1977 issue, and the ECD Micromind computer which has been advertised since January of this year. With such redefinable graphics sets, there

is no need to have a ROM at all; one simply creates a table in software with the needed definitions, and changes the definitions "on the fly" if the total number of symbols exceeds the re-definable character generation buffer memory capacity.

**ATTENTION AUTHORS:
16 BIT PROCESSOR INFORMATION
NEEDED**

I have every issue of BYTE and I feel that it's the best magazine going in the field. I'm presently stationed in Korea, and I repair computers for the Army. I have a delay of a month in receiving my issues, since I have the family send them to me from home. This keeps them from disappearing before I get them, and it gives them an excuse to write. But, to the point.

I find that there is a definite lack of information in the 16 bit processor area. Although there has been a 16 bit chip or two described, the information is very general and, with the exception of the PACE chip, they are hard to find. I prefer to use the PACE chip and associated family of circuits, but any 16 bit chip will suffice.

Examples of information for those wanting a 16 bit system might be:

1. Are there any kits using the 16 bit chips available? [*Yes: A system with the Texas Instruments 9900 has been seen in two forms to date.*]
2. Since the majority of the peripherals are set up for use with 8 bit processors, can they easily be interfaced with the 16 bit ones? (A logical approach would be to divide the 16 bit word into two 8 bit words, putting the upper half to the device first, then the lower.) [*Yes: by emulating the 8 bit bus, as you suggest.*]
3. With all the readily available memory for 8 bit processors, can they be used? (Again, with each board using half a 16 bit word?)
4. What software is available? [*It varies.*]
5. More articles on 16 bit systems are needed, especially those pertaining to the problems of constructing a system.

SP/5 Bernard J Steeves
047-46-6241
169th Sig Co
APO SF 96218

RCA 1802 BASIC WANTED

I am running a homebrew CDP 1802 for which I have not seen an edition of BASIC. If there is such an edition, please let me know.

David Fansler
710 Ward St
Graham NC 27253 ■

Ample Juice



Constant voltage power supplies by Parasitic Engineering.

Give your Altair, IMSAI or custom system the power it needs to keep your programs up and running through brown-outs and power fluctuations. The famous Parasitic Engineering Constant Voltage Power Supplies deliver full output with line voltages as

low as 90 volts or as high as 140 volts. 12-amp kit designed for Altair 8800-(A), \$90 postpaid. Universal 20-amp kit, \$200 postpaid. (Cal. res. add tax).

Thinker Toys™

1210 10th St., Berkeley, CA 94710
See it at your local computer shop.
Or place BAC/MC orders to 800-648-5311.

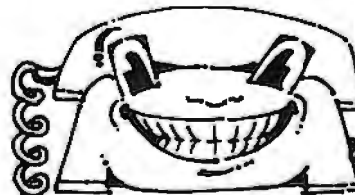

FINALLY, A TELEPHONE WITH BYTE!

6800 AUTOMATIC TELEPHONE DIALER PROGRAM \$9.95 postpaid

Have your 6800 system dial your phone • Uses only 5 external components • Stores 650 variable length phone numbers • Operates in less than 1K bytes of memory

Includes: Paper tape in Mikbug® format and object code • Circuit diagram and instructions • Instructions for adapting to other 6800 systems

6800 TELEPHONE ANSWERING DEVICE PROGRAM \$4.95 postpaid

Have your 6800 system answer your phone and record messages automatically. Compatible with any 6800 system.

Includes: Assembly listing and object code • Circuit diagram and instructions

Write to: SOFTWARE EXCHANGE
2681 PETERBORO
W. BLOOMFIELD, MICH. 48033

Mikbug® is a registered trademark of Motorola Inc.

COMPUTALKER

S-100 BUS

↑

CSR 1
SYNTHESIS-BY-RULE
SOFTWARE

↑

SPEAK "KAAMPYUTAOLKER"

MODEL CT-1 SYNTHESIZER	395.00
CSR1 SOFTWARE SYSTEM	35.00
DEMONSTRATION CASSETTE	2.95

CALIF. RESIDENTS ADD 6% SALES TAX

WRITE FOR INFORMATIVE LITERATURE

COMPUTALKER CONSULTANTS

P.O. BOX 1951, DEPT. B, SANTA MONICA, CA 90406

21 START-AT-HOME COMPUTER BUSINESSES

*in the shoestring, start-at-home
computer business handbook*

CONSULTING ● PROGRAMMING ● SOFTWARE PACKAGES ● COM
FREELANCE WRITING ● SEMINARS ● TAPE/DISC CLEANING
FIELD SERVICE ● SYSTEMS HOUSES ● LEASING ● SUPPLIES
PUBLISHING ● TIME BROKERS ● HARDWARE DISTRIBUTORS
SALES AGENCIES ● HEADHUNTING ● TEMPORARY SERVICES
USED COMPUTERS ● FINDER'S FEES ● SCRAP COMPONENTS
COMPUTER PRODUCTS AND SERVICES FOR THE HOME

Plus - - hundreds of ideas on moonlighting, going full-time, image building, revenue building, bidding, contracts, marketing, professionalism, and much more. No career planning tool like it ever published. Order now and if you're not completely satisfied, send it back within 30 days for a full and immediate refund.

● 8½ X 11 ringbound ● 113 pp. ● \$12.00

DATASEARCH

730 WAUKEGAN ROAD • SUITE 108
DEERFIELD, ILLINOIS 60015

Rush ___ copies of "The Shoestring Start-At-Home
Computer Business Handbook to me right away -

NAME/COMPANY _____

ADDRESS _____

CITY/STATE/ZIP _____

CHECK ENCLOSED BANKAMERICARD MASTERCARD

Continued from page 61

to you. The formulas below will implement their respective functions.

By using the TAN and SQR functions, the sine, cosine, secant and cosecant may be found. The formulas are as follows, with x in radians.

$$\begin{aligned} \text{SIN}(x) &= \text{TAN}(x) / \text{SQR}(1 + \{\text{TAN}(x)**2\}) \\ \text{COS}(x) &= 1 / \text{SQR}(1 + \{\text{TAN}(x)**2\}) \\ \text{SEC}(x) &= \text{SQR}(1 + \{\text{TAN}(x)**2\}) \\ \text{CSC}(x) &= \text{SQR}(1 + \{\text{TAN}(x)**2\}) / \text{TAN}(x) \end{aligned}$$

Note: could cause a division error when x approaches 0.

From the ATN and SQR function, the Arc-sine and Arc-cosine may be calculated.

$$\begin{aligned} \text{ASN}(x) &= \text{ATN}(x / \text{SQR}(1 - x*x)) \\ \text{ACS}(x) &= \text{ATN}(\text{SQR}(1 - x*x) / x) \end{aligned}$$

For values of x <= 0, normalize by adding 2π to x.

For still other formulas, try looking in any engineering and math handbook. TAN and SQR can often be found in such books expressed as series approximations which can be expressed even in limited 16 bit integer BASICS. ■

On Finite State Machines and Their Uses

Gerald Owens
POB 9038
Tucson AZ 85720

The two articles by M Wimble in the May and June 1977 BYTES entitled "Artificial Intelligence, An Evolutionary Idea" provided much food for thought for me, as well as many others I'm sure. If I had a personal computer, I'd try a crack at the earthquake prediction model.

However so much that I hate to dampen anyone's spirits, I must point out a basic limitation to what the system that Wimble outlines has. The implementation is based on what is called a deterministic finite state automation. It's finite, since there are only so many states, and it's deterministic, since when one goes from one state to the next there is no ambiguity or uncertainty as to which state to go to next. Certain properties can be proved about what a finite state automation can do and what it can't do.

First, what it can do. Recurrent patterns are its forte. Given a recurrent pattern, the

method Wimble outlines will construct a finite state automaton that will predict what will happen next.

Now, what it can't do. The deterministic finite state automaton cannot recognize, or act upon, all computer languages. You cannot use the method to teach your computer BASIC and expect it to digest your Star Trek program. The language level is of a higher sort than what a finite state

automaton can recognize. You should have somebody write up an article on the four levels of grammar, as outlined by Noam Chomsky, and the machines used to recognize sentences in those grammars. I may suggest that there are more fruitful lines of endeavor (like perpetual motion machines or faster than light travel) than teaching a deterministic finite state machine a language. ■

Comments on Floating Point Representation

Sheldon Linker's article on "What's in a Floating Point Package?" [page 62, May 1977 BYTE] needs a refinement that might make a difference.

He states that the base of the exponent controls the dynamic range of the arithmetic. What he did not state is that the base also effectively controls the precision. The bigger the base, the greater the dynamic range and the poorer the precision. And this has nothing to do with stealing bits from the mantissa. Choosing the base is not an arbitrary matter of picking a hefty dynamic range.

The problem is illustrated when you attempt to add a single lowest order bit to a mantissa that has all the bits turned on. You can either up the exponent by 1 and renormalize (which is the procedure I read into Linker's article) or you can just not perform the addition. If the exponent is based on 2, then increasing the exponent causes a change in magnitude equal to the change that would be found if a bit were added to any other number. If the base is 16, the change is much greater. The net result is that the precision is much closer to six digits rather than seven.

Another way to look at it is to acknowledge first that all integer arithmetic takes place in finite steps; there are gaps between the numbers. Next, observe that the machine doesn't, through processes unknown, convert over to a continuous number machine when floating point is implemented. With floating point we just get the option of choosing the gap size as well as scaling the numbers.

The difference between base 2 and base 16 may seem trivial to the novice, and indeed must have seemed trivial to enough of the right people at IBM when they went hexadecimal. With base 2 you get seven digits throughout the dynamic range. With base 16 you *seem* to get seven digits most of the time, but are bound to get six now and then. In fact, with 2 and 16 as bases you get four and three digits of precision if your computations have any sophisti-

cation (like multiplication and summing) at all. The exact results, of course, depend on the numbers involved, but if you're interested in floating point and want precision, then base 2 cannot be beat. But remember that if you go double precision, then the range will probably be extended and you will have to extend the exponent field.

As an historical note, I heard somewhere that IBM put the exponent up front just to be different from Burroughs or Univac who had the exponent on the right. ■

R A Baker
2227 N Belmont
Richmond TX 77469

get your hands on...

Hands on microprocessor short course with FREE take home microcomputer included in the \$499 tuition. (New interfacing workshop \$299.)*

Sept 14, 15, 16	Dallas, TX
Sept 19, 20, 21, (22, 23)*	Houston, TX
Sept 26, 27, 28, (29, 30)*	Washington, DC
Oct 11, 12, 13	Melbourne, FL
Oct 18, 19, 20	Denver, CO
Oct 26, 27, 28	Palo Alto, CA
Oct 31, Nov 1, 2, (3, 4)*	San Diego, CA
Nov 14, 15, 16, (17, 18)*	Indianapolis, IN
Nov 28, 29, 30, (Dec 1, 2)*	Boston, MA
Dec 6, 7, 8	Detroit, MI
Dec 12, 13, 14, (15, 16)*	Chicago, IL
Jan 3, 4, 5	Mayaguez, Puerto Rico

(Special course for management)

Learn microprocessors first hand from the original hands on people.

For more information call Jerilyn Williams, (317) 742-6802 or write Wintek Corp., 902 North 9th Street, Lafayette, IN 47904



- 6800 Hardware/Software
- Custom Hardware/Software
- In-house short courses

IBM SELECTRIC TYPEWRITER INPUT OUTPUT CONVERSION KIT

Easy to install on any
IBM Selectric I and II,
providing quality hard
copy output for all
microprocessor devices.

PRICE \$395

EDITYPER SYSTEMS CORPORATION
A SUBSIDIARY OF TYCOM CORPORATION
26 Just Road, Fairfield, New Jersey 07006 (201)227-4141

Clubs and Newsletters

Conducted by
Peter Trivisano

Space Coast Microcomputer Club

The second edition of the *Space Coast Microcomputer Club Newsletter* is out, with an interesting feature by Paul Rainosek, a tabulated comparison of some of the different microprocessor chips available. The various advantages and disadvantages are clearly listed. The comparison includes Intel 8080, Motorola M6800, MOS Technology 6502, Fairchild F8, Signetics 2650, and Cosmac 1801. To find out more about the Space Coast Microcomputer Club contact Ray Lockwood, 1825 Canal Ct, Merritt Island FL 32952.

West Virginia Computer Society

We hadn't heard anything from the West Virginia Computer Society in quite some time. Their newsletter *Oscillations* came in a few days ago to inform us that they are alive and very well at 167 Iroquois Trail, Ona WV 25545.

Indian River Computer Society, Melbourne FL

The Indian River Computer Society meets every Thursday at 7 PM in room 621 of the Science Tower on the campus of FIT, Melbourne FL.

Membership is open to the general public.

For more information call Bill Carter at (305) 773-7837, or Frank Canova at (305) 724-4751, or write: Indian River Computer Society, FIT Electrical Engineering Dept, Country Club Rd, Melbourne FL 32901.

Montreal Area Computer Society

Over the past year the Montreal Computer Society has grown from 12 members to over 90. The club meets once a month, usually on the second Tuesday evening of the month, at Vanier College, 5160 Decarie Blvd. For further information contact John Erikson, the club president at (514) 932-2344 or write: Montreal Area Computer Society, POB 613, Stock Exchange Tower, Montreal, Quebec, CANADA.

canada Boards DO Something



CL2400
Real Time Clock

\$98—Kit \$135—Assembled

If your system needs to know what time it is, our CL2400 is the board for you. The present time in hours, minutes, and seconds is always available for input, and is continuously updated by the highly accurate 60 Hz power line frequency. Need periodic interrupts? The CL2400 can do that, too, at any of 6 rates. Reference manual with BASIC and assembly language software examples included.



PC3200
Power Control System

PC3232 \$299—Kit \$360—Assm.
PC3216 \$189—Kit \$240—Assm.
PC3202 \$39.50—Kit \$52—Assm.

If your system needs on/off control of lights, motors, appliances, etc., our PC3200 System components are for you. Control boards allow one I/O port to control 32 (PC3232) or 16 (PC3216) external Power Control Units, such as the PC3202 which controls 120 VAC loads to 400 Watts. Optically isolated, low voltage, current-limited control lines are standard in this growing product line.

canada
systems, inc.
(formerly comptek)

P.O. Box 516
La Canada, CA 91011
(213) 790-7957

Indianapolis Small Systems Group

The Indianapolis Small Systems Group meets on the second Tuesday of each month at the Union Building, Medical Center, IUPUI. Recording secretary T O Whitaker has voiced a strong desire to apply small computers systems to practical business and technical applications. Among such applications is a computerized "newspaper" now under development which would allow the user to receive news over the telephone via a modem. If you have experience with this type of application or would like to find out more about the organization, contact the Indianapolis Small Systems Group at 4719 Squire Dr, Indianapolis IN 46241, or call (317) 241-7396.

IEEE Computer Society

The IEEE Computer Society is one of the most vigorous wings of the Institute of Electrical and Electronics Engineers, the world's largest professional engineering society. *Computer* magazine is published by the computer society; editor and publisher True Seaborn and staff produce this high quality technical magazine every month and cover the microcomputer scene in some detail.

Useful features of the magazine include a monthly column listing all of the new integrated circuits which appear each month from the various manufacturers, and the Repository, a listing of new technical papers about computers. The serious experimenter would do well to consider joining this important organization.

We received the following from Merlin Smith, president of the IEEE Computer Society:

The IEEE Computer Society is really a subset of a much larger organization—the Institute of Electrical and Electronics Engineers, whose antecedents reach back into the 19th century and whose history is closely connected with the evolution of electrotechnology in the US. The IEEE, with 180,000 members worldwide, is organized geographically into regions and sections. It is organized by technical interest areas into groups and societies, the largest of which is the Computer Society, with 26,000 members.

Like the IEEE, the Computer Society is mainly in the business of dissemination of technical information through conferences, tutorials, workshops, periodicals, and other publications. Its major conferences are COMPCON Spring, held annually in

Why Wait?



The Tarbell Cassette Interface

- Plugs directly into your IMSAI or ALTAIR*
- Fastest transfer rate: 187 (standard) to 540 bytes/second
- Extremely Reliable — Phase encoded (self-clocking)
- 4 Extra Status Lines, 4 Extra Control Lines
- 37-page manual included
- Device Code Selectable by DIP-switch
- Capable of Generating Kansas City tapes also
- No modification required on audio cassette recorder
- Complete kit \$120, Assembled \$175, Manual \$4

TARBELL ELECTRONICS

20620 S. Leapwood Ave., Suite P, Carson, Ca. 90746
(213) 538-4251

California residents please add 6% sales tax

*ALTAIR is a trademark/tradename of MITS, INC.

CONTROL the WORLD OUTSIDE YOUR COMPUTER...

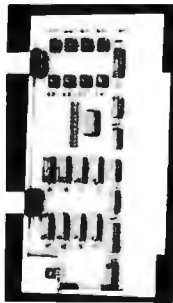

The OPTO-ISOLATOR/RELAY BOARD (\$117) is a natural for controlling audio systems, model trains, robot devices ... more uses are discovered daily, as described in our applications notes. 8 reed relays respond to an 8 bit word from your computer; 8 opto-isolators accept an 8 bit word from the outside world and send it back to your machine for handshaking or further control purposes.

All kits are S-100 buss Altair/IMSAI compatible. Available by mail (shipped postpaid in the USA from stock) or at many fine computer stores. California mail orders add tax.

...OR THE WORLD INSIDE IT!



Whether for troubleshooting or analysis, at some point you will need our EX-TENDER BOARD W/ LOGIC PROBE (\$35). Ours offers a built-in logic probe (hi, lo, and pulse), special edge connector that allows clip lead probing, jumper links in all supply lines, a non-skid needlepoint probe ... plus quality parts and a realistic price.

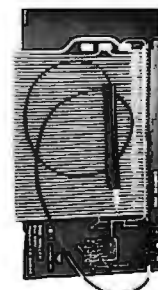

MULLEN COMPUTER BOARDS

BOX 6214, HAYWARD, CA 94545

Need Hard Copy?



TRY OUR SOFT PRICES

SSP-40	\$575
<small>Contains its own micro processor for easy connection to your RS232 serial port or TTY current loop.</small>	
MP-40	\$425
<small>Interfaces to your micro computer parallel output port for ASCII data transfer.</small>	
KP-40 KIT	\$179
<small>Contains mechanism, PC board, all components, transformer and complete assembly instructions for parallel data transfer.</small>	

All of our 40 series printers use the same reliable 547 impact dot matrix mechanism with up to 40 columns per line on ordinary paper with a print speed of 75 lines/minute.

SEND FOR FREE LITERATURE



Box 22101
Salt Lake City, Utah 84122
(801) 566-0201

ASSEMBLER/EDITOR

ADDITION TO SOFTWARE PACKAGE 1 SYSTEM 8080 OR Z-80

NOW YOU CAN HAVE AUTOMATIC INSERTION OF LINE NUMBERS DURING PROGRAM ENTRY AND EDITING. AN EXTENSIBLE COMMAND TABLE, REORDERING OF LINE NUMBERS, AN ASC PSEUDO OP FOR PLACING ASCII MESSAGES IN PROGRAM, A GLOBAL SYMBOL TABLE, OCTAL NUMBERS RECOGNIZED BY THE ASSEMBLER, AN EXTENSIBLE LIST OF PSEUDO OPS, AN EFFICIENT TAPE DRIVER FOR TARBELL, DAJEN, AND OTHER INTERFACES, AND MORE. DO MULTIPLE SECTION ASSEMBLIES BY BUILDING PROGRAM SOURCE CODE ON SEVERAL TAPE FILES AND READING IN FILES IN SEQUENCE. SYSTEM IS PROMMABLE WITH 6K IN HIGH MEMORY.

SOFTWARE PACKAGE 0.5

SOURCE ONLY	OBJ. CODE-PAPER TAPE	OBJ. CODE-TARBELL
\$14.95	\$19.95	\$24.95

IMMEDIATE DELIVERY

OBJECTIVE DESIGN, INC.
P.O. BOX 20325
TALLAHASSEE, FL 32304
(904) 224-5545

FLORIDA RESIDENTS ADD 4% STATE SALES TAX

San Francisco, COMPCON Fall, held annually in Washington DC, and COMPSAC, held annually in Chicago.

The major periodicals of the Computer Society are the scholarly Transactions on Computers, Transactions on Software Engineering, and Computer, which appeals to a broader readership. Of specific interest to computer hobbyists and personal computing enthusiasts, Computer has recently inaugurated a new section, "Microsystems," which carries papers and articles on the whole field of small scale computing.

The Computer Society has chartered some 18 technical committees corresponding to the various technical specialties within the field of computer engineering. Included among them is the Technical Committee on Minis and Micros, which is of special interest to the personal computing community. The Mini/Micro TC has inaugurated a series of micro-computer workshops (see May Computer); these likewise may be of interest to your readers.

The traditional orientation of the IEEE Computer Society has been to the computer designer or the sophisticated computer user, and our membership qualifications entail fairly specific academic and/or professional requirements. However, computers are becoming increasingly "friendly to the uninitiated," and the lines separating the professional from the non-professional are tending to blur, at least in some areas. One way for a BYTE reader to find out whether the Computer Society has anything to offer is to pick up a copy of Computer at one of our conferences or tutorials, at one of our local chapter meetings, or even at the local computer store.

Another way is to write our Publications Office at 5855 Naples Plz, Long Beach CA 90803, and request a membership application.

Micro-8 Computer Club, Lompoc CA

Micro-8 is a loosely organized, nonhierarchical, extremely enthusiastic group. Originally, it was known as the Central Coast Computer Users Group but recently the name has been changed to perpetuate the memory of the pioneering, now defunct Micro-8 Newsletter. The membership includes Hal Singer, former editor of that publication.

Drop in sometime. Visitors are welcome. The club usually has a number of systems on display and lectures by club members are not infrequent.

You can contact Micro-8 at 2497 Lompoc-Casmalia Rd, Lompoc CA 93436, (805) 735-1023. Meetings are held on the third Wednesday of each month at the Cabrillo Computer Center, 4350 Constellation Rd, Lompoc CA, at 7:30 PM.

BAMUG: Bay Area Microprocessor Users Group

The Bay Area Microprocessor Users Group meets on the first Thursday of each month at the Hayward Regional Occupational Center, Hayward CA, at 7 PM.

Like many hobbyist clubs, BAMUG is looking for microcomputer oriented lecturers willing to share their knowledge for little or no fee. Literature from microprocessor manufacturers is especially welcome. Contact BAMUG, 1211 Santa Clara Av, Alameda CA 94501, (415) 523-7396.

Amateur Computer Society of Columbus OH

ACSC meets the first Wednesday of every month at the Center of Science and Industry beginning at 7:30 PM. Dues are \$5 per year and include a monthly newsletter I/O.

To get in touch with the Amateur Computer Society of Columbus, write: Fred Hatfield K8VUDU, Computer Data Systems, 1372 Grandview Av, Columbus OH 43212, (614) 486-3347.

New England Computer Club

New England hobbyists who haven't done so already should investigate the advantages of membership in a first class computer club, the New England Computer Society, or either of its two affiliates, the Southern New England Computer Society and the New Hampshire Computer Society. Contact Robert M Tripp, POB 3, S Chelmsford MA 01824. A newsletter, *The Computerist*, is available at the same address by subscription at \$6 per year or 60 cents for a single copy.

Crescent City Computer Club

Crescent City is an active club, sponsoring monthly lectures, classes in BASIC, Assembly Language, and PL/M. The club also includes homebrew and calculator groups. Meetings are held at 8:00 PM at the Science Building, University of New Orleans, second floor, on the second Friday of each month. Write POB 1097, New Orleans LA 70122 or call (504) 722-6321. ■

MICROCOMPUTERS

19" RACK S-100 BUS CARD CAGE

RUGGED
20 SLOTS
EXTRUDED
CHANNELS

BUS TERMINATION
GROUND PLANE
SOLDER MASK
12.25"H x 8"D

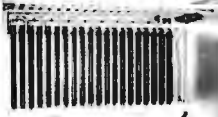

ECT-100 CARD CAGE & MOTHER BOARD KIT \$100
ECT-100-F with 20 CONNECTORS & GUIDES . . KIT \$200
ECT-100-8080 CARD CAGE MICROCOMPUTER . KIT \$320
ECT-100-Z80 CARD CAGE MICROCOMPUTER . KIT \$420
PS HEAVY DUTY 30A POWER SUPPLY KIT \$100

10 SLOT TABLE TOP SYSTEMS

8080 or Z80 10 SLOT TABLE TOP MICROCOMPUTERS
WRITE FOR SYSTEMS VARIATIONS & LOW PRICES



CPU's
8080 or Z80
NEED NO FRONT PANEL
JUMP ON RESET CIRCUIT

MOTHER BOARDS 10 SLOTS, 20 SLOTS or 21 SLOTS
PROTOTYPING BOARD . \$28 8K RAM KIT \$295
EXTENDER CARD \$24 16K RAM KIT \$555

ELECTRONIC CONTROL TECHNOLOGY

P.O. BOX 6, UNION, NEW JERSEY 07083
(201) 686-8080

DIGITAL MICRO SYSTEMS

PRESENTS:

A 16K STATIC RAM \$525 16K KIT

FOR THE S-100 BUS

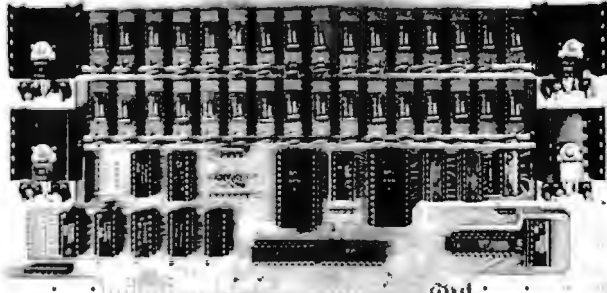

Uses the new intel 2114 4K Static RAM (which will also be built by Motorola, Signetics, Fairchild, National, T.I., Synertek, NEC, Intersil, and Fujitsu, etc.). Features complete static operation (No refresh or clocked chip select), software protect, paging, individually addressable 4K blocks, completely buffered address and data lines, fully socketed. Available with 8K or 16K of memory.
Prices: 8K kit - \$295; 16K kit - \$325; 8K expansion kit - \$250 16K assembled and tested - \$595

S-100 BUS TERMINATING CARD \$25 KIT
Absorbs noise, overshoot, ringing, reflection. Plated thru holes, gold plated fingers.

EXTENDER CARD FOR EASY TROUBLESHOOTING \$16 KIT
With jumpers in power supply lines for current measurement. Low profile so card can remain in the machine with the cover on. With edge connector, gold fingers.

PLASTIC KEYBOARD ENCLOSURE
Blank molded ABS plastic enclosure for use with keyboard, controls, modem, etc. Size - 13 1/4 x 11 1/2 x 2 1/2. PRICES: Blank enclosure - \$20. With cutout for keyboard available from Radio Shack, etc. - \$27.

Prices shown include U.S. shipping. Cashiers check or M.O. preferred. Personal check may delay shipping 3 weeks. Add \$3 for C.O.D. Purchase Orders add 4% - net 30. Utah residents add 4.75%.

DIGITAL MICRO SYSTEMS BOX 1212, OREM, UTAH 84057
Toll free 24 hour Order Desk (800) 453-1444; in Utah call (801) 224-2102

Walsh Functions:

A Digital Fourier Series

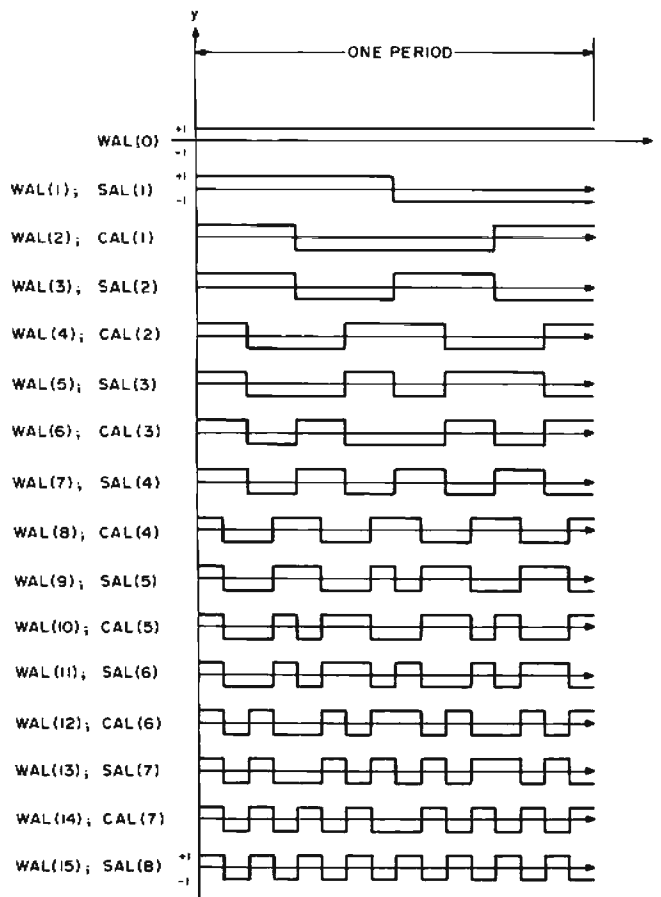

Benjamin Franklin Jacoby, PhD
Information Conversion Devices Co
88 W Frankfort St
Columbus OH 43206

Using a mathematical technique called Fourier analysis, it is possible to build arbitrary wave forms by adding together various "components."

While a full appreciation of the inner workings of the Fourier series requires a knowledge of advanced mathematics far beyond the capacity of many persons interested in electronics, that in no way deters them from using the concepts or even simplified portions of the math in practical applications. Even beginners are aware that wave forms can be broken into a set of harmonics and that a set of sinewaves of integer multiple frequencies can be summed to build up a complex wave form. In a like manner, Walsh function concepts can be put to work once a few fundamental ideas are mastered. A key to generating complicated sounds in computerized music and voice outputs is the ability to generate arbitrary wave forms from digital codes.

In these days of digital computers, a person familiar with Fourier concepts might ask the question: Is it possible to build up any wave form out of a sum of square waves of some type? Such a system would be ideal for use with digital logic. This question has been answered in the affirmative by the German mathematician H Rademacher, not in 1972 or 1962, but in 1922. His set of square waves, called "Rademacher functions," consists of a fundamental square wave of 50% duty cycle at some frequency

Figure 1: The Walsh Functions WAL(0) Through WAL(15). The fact that Walsh functions lend themselves to digital generation is evident in the nature of the basic wave forms. The notations SAL and CAL emphasize the resemblance of Walsh functions to the Fourier series trigonometric functions SIN and COS.

Fourier series are used to create wave forms as the sum of pure sine and cosine waves at selected frequencies; this leads to the obvious question: Is it possible to use a similar mechanism which builds a complex wave form out of digital wave forms with sharp edges?

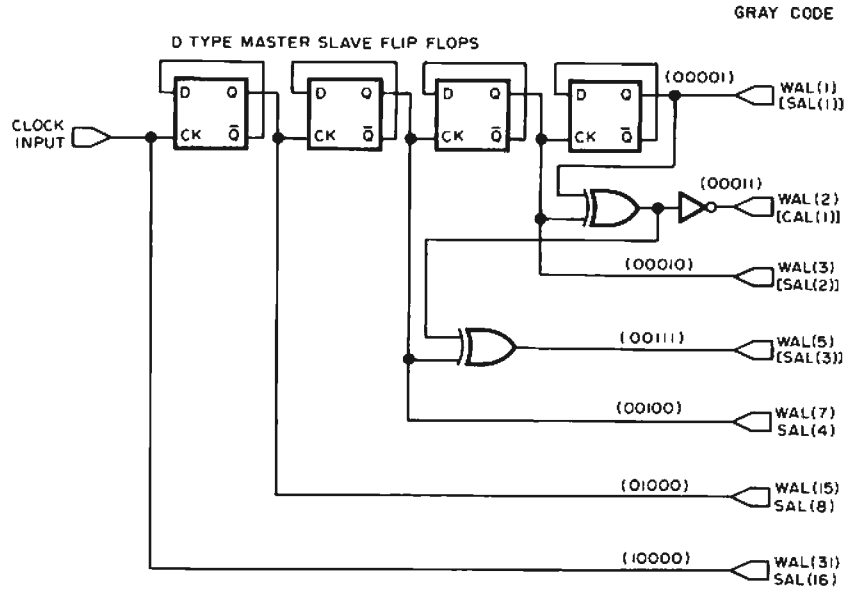

Figure 2: The logic of a digital circuit which generates a set of Walsh functions using a string of flip flops and some external gating. The flip flops are connected as toggles (division by 2 at each stage). The exclusive OR gates combine terms to produce the more complicated Walsh wave forms indicated.

plus harmonics of square waves of 2,4,8,16,32 and higher powers of two times the fundamental frequency. A deficiency of this system, however, is that it is not possible to generate any arbitrary wave shape from only a simple sum of these square wave harmonics.

Also in 1922, J L Walsh presented his independently developed system to the American Mathematical Society. His system was later shown by the Polish mathematician Kaczmarz in 1929 to include the Rademacher system as a subset of the Walsh complete set of orthonormal functions, which, in plain English, says that some of the Walsh functions are square waves and that if all Walsh functions are allowed (you may not need to use them all, however) then any arbitrary periodic wave form can be built up by adding them together in a manner totally analogous to sinewave summation in Fourier series.

Interest in the engineering applications of Walsh functions was sparked by an article in the IEEE Spectrum by Dr H F Harmuth of the University of Maryland in 1968 and is continuing because of the suitability of Walsh functions to generation by digital systems.

The fastest way to understand what Walsh functions are is simply to look at a picture of some wave forms. Figure 1 shows the Walsh functions WAL(0) through WAL(15). It is seen that WAL(0) is merely a DC level which we will usually ignore in practical applications since offsets are easily handled by other means and that WAL(1), WAL(3), WAL(7), and WAL(15) are really the square wave Rademacher functions. You will note that in addition to the WAL(n)

designation, the functions are also labeled with CAL or SAL. These labels are also commonly used and are acronyms for the terms Cosine WALsh and Sine WALsh by analogy to Fourier analysis. In short all WAL (even n) are called CAL and all WAL (odd n) are called SAL. CAL and SAL are also numbered but the numbers do not correspond to the WAL designation though they are easy to figure out. Also by analogy to Fourier analysis, a Walsh spectrum is called a sequency spectrum as opposed to a Fourier frequency spectrum.

Enter Mr Gray and His Code

However, knowing what Walsh functions look like and knowing how to generate them digitally are two different things. It is clear that the generation of WAL(1), WAL(3), WAL(7), WAL(15), etc, is a snap since they are simple square waves. A string of flip flops does the job, as shown in figure 2. The generation of the remaining functions, while a little more difficult, is not impossibly complex once the mathematics is shaken down into a few simple rules:

1. To generate WAL(n), first write the number n in Gray code. Gray code is a modified binary code having only one bit changing at a time when going to the next higher or next lower number. A table of Gray code numbers is shown in table 1; and with a little

In translating a mathematical summation into a physical circuit, the operational amplifier provides the summing element and the resistors from inputs to the summing node form the coefficients of the component signals.

Walsh functions are the digital answer to sines and cosines used in Fourier analysis.

WALSH FUNCTION	DIGIT	WAL(31)	WAL(15)	WAL(7)	WAL(3)	WAL(1)	WALSH FUNCTION
WAL(0)	0	0	0	0	0	0	
WAL(1)	1	0	0	0	0	1	SAL(1)
WAL(2)	2	0	0	0	1	0	CAL(1)
WAL(3)	3	0	0	0	1	0	SAL(2)
WAL(4)	4	0	0	1	1	0	CAL(2)
WAL(5)	5	0	0	1	1	1	SAL(3)
WAL(6)	6	0	0	1	0	1	CAL(3)
WAL(7)	7	0	0	1	0	0	SAL(4)
WAL(8)	8	0	1	1	0	0	CAL(4)
WAL(9)	9	0	1	1	0	1	SAL(5)
WAL(10)	10	0	1	1	1	1	CAL(5)
WAL(11)	11	0	1	1	1	0	SAL(6)
WAL(12)	12	0	1	0	1	0	CAL(6)
WAL(13)	13	0	1	0	1	1	SAL(7)
WAL(14)	14	0	1	0	0	1	CAL(7)
WAL(15)	15	0	1	0	0	0	SAL(8)
WAL(16)	16	1	1	0	0	0	CAL(8)
WAL(17)	17	1	1	0	0	1	SAL(9)
WAL(18)	18	1	1	0	1	1	CAL(9)
WAL(19)	19	1	1	0	1	0	SAL(10)
WAL(20)	20	1	1	1	1	0	CAL(10)
WAL(21)	21	1	1	1	1	1	SAL(11)
WAL(22)	22	1	1	1	0	1	CAL(11)
WAL(23)	23	1	1	1	0	0	SAL(12)
WAL(24)	24	1	0	1	0	0	CAL(12)
WAL(25)	25	1	0	1	0	1	SAL(13)
WAL(26)	26	1	0	1	1	1	CAL(13)
WAL(27)	27	1	0	1	1	0	SAL(14)
WAL(28)	28	1	0	0	1	0	CAL(14)
WAL(29)	29	1	0	0	1	1	SAL(15)
WAL(30)	30	1	0	0	0	1	CAL(15)
WAL(31)	31	1	0	0	0	0	SAL(16)

GRAY
CODE

Table 1: Gray Code Bit Patterns for the Walsh Functions WAL(0) Through WAL(31). The corresponding SAL and CAL notation of each WAL function is shown down the right hand column of the table.

So you want to produce a sine wave? Calculate the values at 16 evenly spaced locations in the period, then use these values to calculate the Walsh coefficients using a tabulator method. Then wire in resistors of values derived from the Walsh coefficients and the output of the circuit will be a step function approximation of the desired sine wave.

- study, the pattern can easily be extended to any value.
- Starting with the least significant bit, assign a square wave Rademacher function to each bit. Assign WAL(1) to the LSB, WAL(3) to the next, WAL(7) to the next, etc.
 - Any Rademacher function whose bit is 0 is not used. Those whose bits are 1 are combined by modulo 2 addition, which is to say by exclusive OR gates to give the Walsh output of that order.
 - All Walsh functions must begin positive so that the composite Walsh output may need to be inverted depending upon how many exclusive OR gates were used to produce it.

A couple of examples are shown in figure 2 and a complete generator producing all Walsh functions from WAL(1) through WAL(15) is shown in figure 3.

It should be noted that although a Walsh function is mathematically defined as going from +1 to -1, and it is possible to obtain

positive and negative swings with CMOS logic with positive and negative supplies, in practice little is gained by going this route since all that is involved is a DC offset which is easily handled by the summing amplifier. Thus, 0-5 volt TTL logic outputs are fine.

Now that a set of Walsh functions has been generated, it only remains to add them in a summing amplifier with appropriate magnitudes and signs to simulate any wave form with a stair step approximation. The general expression of a Walsh function representation is a summation analogous to that found in Fourier analysis:

$$\text{Arbitrary wave form} \equiv X(t) = A_0 + \sum_{i=1}^{\infty} (A_i \cdot \text{SAL}(i) + B_i \cdot \text{CAL}(i))$$

where A_i and B_i are weighting constants which correspond to the resistors used in the summing amplifier inputs. The size of the steps and the number present will be determined by how many harmonics are combined. The more you use, the smaller and more numerous the steps, hence the better will be your approximation to your original wave form. The determination of these combining coefficients from the wave form desired requires a bit more detailed consideration.

Wave Form Synthesis

Before proceeding any further into the theoretical aspects of Walsh applications, a review of what we are attempting to do and how we intend to do it will help get our feet on solid ground. The device we wish to build using Walsh functions could be called "a square wave to arbitrary wave form converter." It will be a circuit into which you put a square wave of some frequency and out of which comes a periodic analog signal with a frequency related to that of the input wave (perhaps some submultiple) and a wave form that can be made to take any shape desired by adjusting a set of controls, switches or internal resistors. With such a device, digital logic could be used to synthesize a frequency and the converter could then be set to produce a sinewave for use in standard applications, or given sufficient accuracy of conversion, a computer could be made to talk or even sing. Both have been done by engineers working in this area.

The converter consists of two parts: The first is the digital expander which expands the input square wave into a variety of

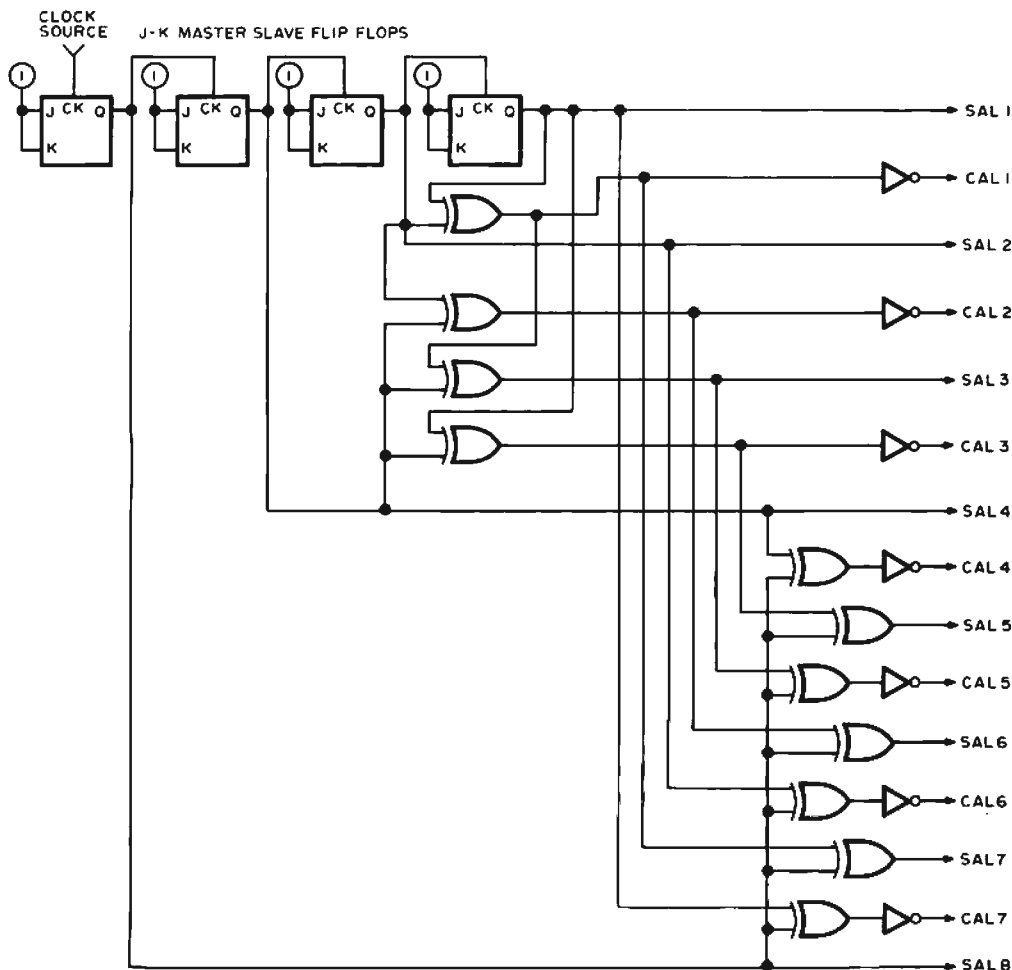

Figure 3: Extending the logic of figure 2, this circuit generates all the Walsh functions WAL(1) through WAL(15) as illustrated in figure 1. This circuit uses an alternate kind of flip flop, the JK master slave flip flop connected as a toggle. This circuit could be built with two 7473 ICs, three 7486 ICs and one 7404 circuit. (One of the 12 exclusive OR sections is used as an inverter.)

digital wave forms, and the second is the analog combiner which adds up these wave forms to produce the periodic analog output. The expander is, of course, the Walsh generator shown earlier and the combiner will be discussed below.

All of the Walsh outputs will be fed into the summing junction of an operational amplifier, but they will not have the same strength or sign. It is the strength and sign of each component which will determine the net analog output so that once we have chosen the analog output we desire, the relative strength and sign of each Walsh harmonic must be calculated from that desired wave form. Once these values are known, a negative sign can be handled with a digital inverter and the magnitude by the choice of the resistor value into the summing junction. The net output will then be a stair step approximation to the desired output which can then be made more perfect by low pass filtering to smooth the wave shape.

Theoretically, the calculation of the coefficients from the analog wave form desired involves complex operations with the integral calculus; but it turns out that it is

possible to shortcut the high powered math by starting, not with the analog signal, but rather with the stair step approximating function itself. This function can be easily determined by eyeball or by just taking the height of each step to be the value of the analog output at the center of each time interval. Figure 4 shows two examples: a linear ramp and a sinewave with 16 step approximations. The height of each step is shown.

Before proceeding to an actual calculation we will give some time and work saving rules, which are illustrated in figure 5.

1. The waveform to be synthesized must be repetitive (as in Fourier synthesis), although it is easy to start and stop at any point by control of the digital input.
2. It is especially advantageous to use 2^n steps in one period as this gives an automatic cutoff to the number of Walsh harmonics required

Thus: With a 4 step output no functions beyond WAL(3) are required
 " 8 " " WAL(7) "
 " 16 " " WAL(15) " ...etc.

3. If the coefficients for a higher order

When Walsh function analysis is applied to a linear ramp, what's the result? A set of resistor values which form an ordinary DA converter operating upon the binary value in the counter used for the Walsh function generator.

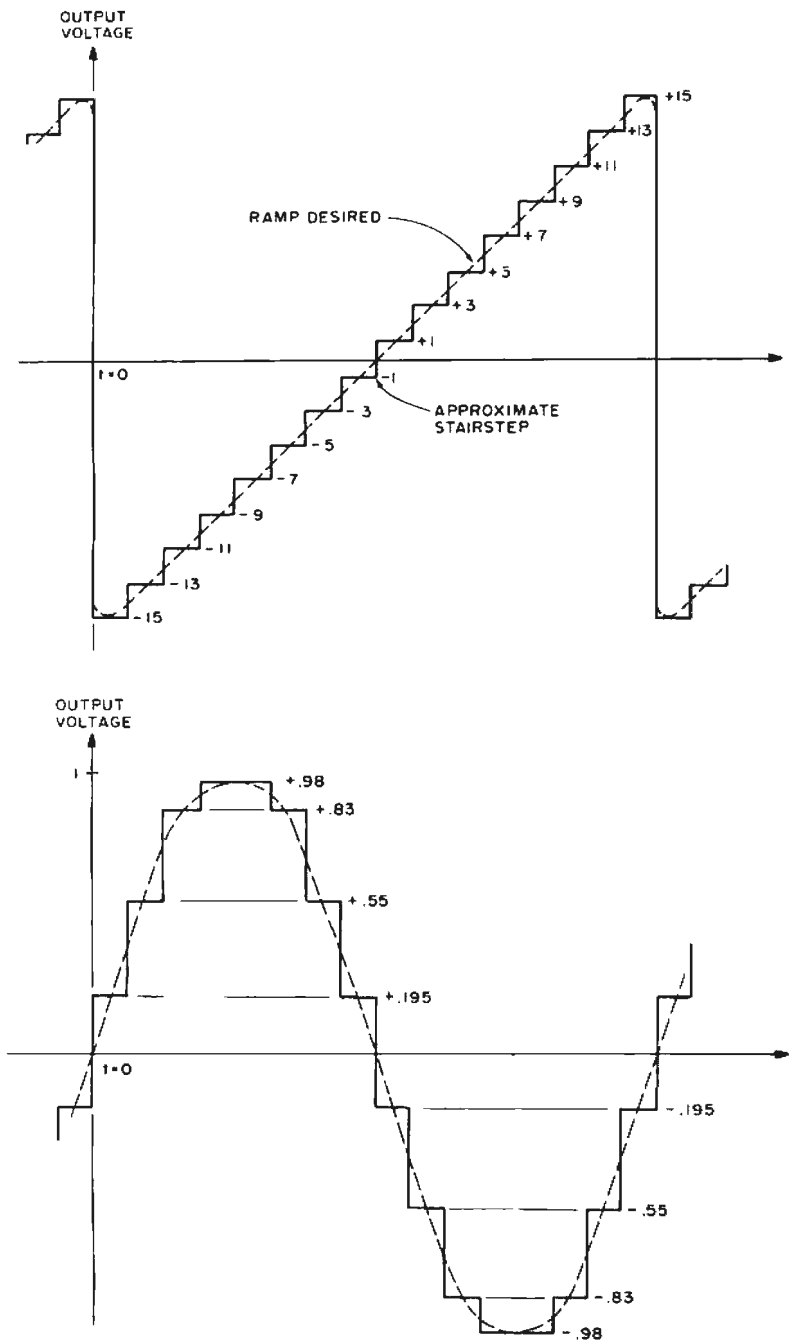

Figure 4: By picking a series of weighting constants for each Walsh function term, the outputs of figure 3 can be summed by an operational amplifier to produce arbitrary wave forms. Here are examples of the ramp and sine wave approximations generated by the Walsh function method. The smooth curve is the desired one in each case, obtained by filtering the output of the summing amplifier.

approximation are calculated (say 16 steps), and a less accurate approximation can be used (say 8 steps) then one only need disconnect WAL(8) through WAL(15) since the lower order coefficients will have the same value in either case (or nearly so). This effect is demonstrated in the sine generator circuit.

If your wave form to be synthesized possesses certain symmetries or can be made to do so by a DC baseline shift, many Walsh component coefficients will be zero which will not

only simplify the calculations, but the circuitry as well.

4. If the wave form to be synthesized is even, which is to say that any value that the function takes to the left of center is the same as the value an equal distance to the right of center, then only CAL functions will be used and all SAL coefficients will be zero.
5. If the wave form is odd, or can be made so by a baseline shift, then only SAL functions will be used and all CAL coefficients will be zero. Here any value to the left of center equals minus the value to the right of center.
- 6A. If the wave form is even as in point 4 above and in addition it is even about the 1/4 point, then only CAL(k) where k is an even number will be present and all CAL(k) where k is an odd number will be zero.
- 6B. If the wave form is even as in point 4 above and in addition is odd about the 1/4 point, then only CAL(k) where k is an odd number will be present and all CAL(k) with k an even number will be zero.
- 7A. If the wave form is odd as in point 5 above and in addition is even about the 1/4 point, then only SAL(k) where k is an odd number will be present and all SAL(k) where k is an even number will be zero.
- 7B. If the wave form is odd as in point 5, and in addition is odd about the 1/4 point, then only SAL(k) with k an even number will be present and all SAL(k) where k is an odd number will be zero.

In the calculations that follow it will also be observed that if a wave form is even or odd, the signed sums of the step values need only be calculated for the first half of the wave form since that value will be exactly half the sum of all steps. This is probably best understood by examining some practical examples.

Two Examples

The first example will be the linear ramp. This function can be made odd by adjusting the baseline, so by rule 5 it is seen that only SAL coefficients need be calculated and no CAL functions need be generated.

The best way to get your mind right in calculating coefficients is to make a table as shown in table 2. The value desired for each step comprising the output function is written in order along the top of the table. Since we are attempting to produce a linear ramp, our output will be a rising staircase with a fixed increase with each step (we used two

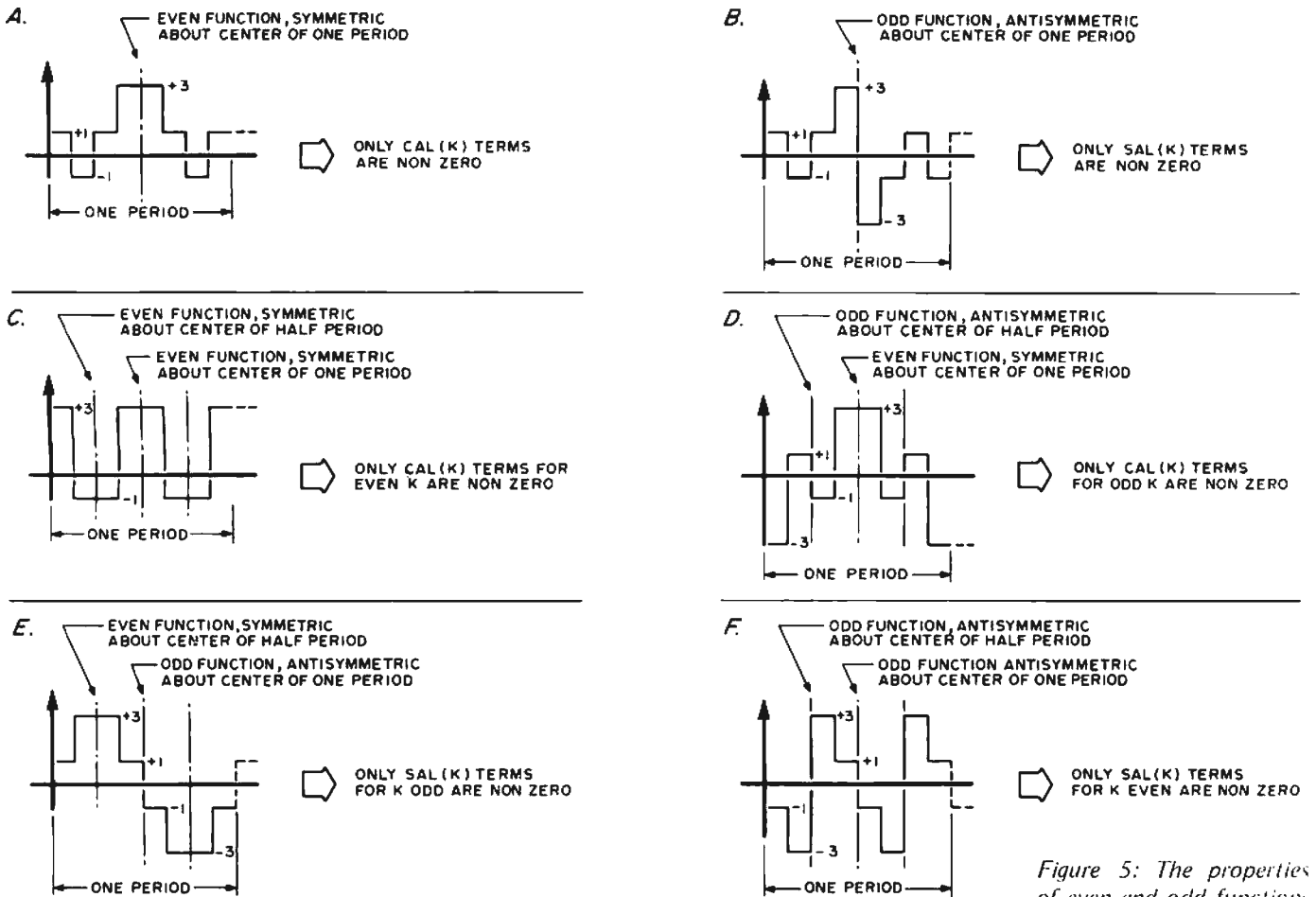

Figure 5: The properties of even and odd functions give constraints on the weighting constants needed for a given wave form. Here are illustrations of six different special cases of symmetry which give zero terms in the Walsh function sum.

SIGN OF WALSH FUNCTIONS

P = positive N = negative

Normalized Ratio

- SAL(1) = -1 = -1
- SAL(2) = -0.5 = -1/2
- SAL(4) = -0.25 = -1/4
- SAL(8) = -0.125 = -1/8

Desired Function Values	ONE PERIOD															Signed Sum	
	-15	-13	-11	-9	-7	-5	-3	-1	+1	+3	+5	+7	+9	+11	+13		+15
SAL(1)	P	P	P	P	P	P	P	P	N	N	N	N	N	N	N	N	-128
SAL(2)	P	P	P	P	N	N	N	N	P	P	P	P	N	N	N	N	- 64
SAL(3)	P	P	N	N	N	N	P	P	N	N	P	P	P	P	N	N	0
SAL(4)	P	P	N	N	P	P	N	N	P	P	N	N	P	P	N	N	- 32
SAL(5)	P	N	N	P	P	N	N	P	N	P	P	N	P	P	P	N	0
SAL(6)	P	N	N	P	N	P	P	N	P	N	N	P	N	P	P	N	0
SAL(7)	P	N	P	N	N	P	N	P	N	P	N	P	P	N	P	N	0
SAL(8)	P	N	P	N	P	N	P	N	P	N	P	N	P	N	P	N	- 16

Table 2: A computational table used to help determine the Walsh function coefficients for the linear ramp. The relative strength of the SAL or CAL term in question is obtained by summing horizontally the +1(P) or -1(N) Walsh function value multiplied by the actual wave form value desired for that element of time. After figuring out the value of the signed sum for each term, the values should be normalized so that the largest magnitude is 1 (regardless of sign). Thus the normalized ratios shown below this picture were computed assuming -128 corresponded to -1.

units per step). This staircase will eventually be filtered to remove the jogs and give a linear ramp.

The body of the table shows the sign (positive or negative) each particular Walsh function takes in each of the 16 time intervals into which one period of the output wave form has been divided. As indicated earlier, we need not go past WAL(15) in this case. The Walsh sign values can be taken from the wave forms of figure 1 or from table 3 which is good for up to 32 segment approximations.

The numbers to the far right are the sums of the upper values when all signs are taken into account. Thus, for WAL(1) we see that it is positive in the first half period, but the step values are negative, so we get:

$$(-15) + (-13) + (-11) + (-9) + (-7) + (-5) + (-3) + (-1) = -64$$

and in the second half period where WAL(1) is negative and the values positive we get:

$$-(+1) - (+3) - (+5) - (+7) - (+9) - (+11) - (+13) - (+15) = -64$$

or a total of -128. This number gives the relative strength of WAL(1) in the output summa-

The Sign of CAL and SAL in Each 1/32 Interval of Their Period

WAL(0)	PPPP	PPPP	PPPP	PPPP	PPPP	PPPP	PPPP	PPPP
SAL(1)	PPPP	PPPP	PPPP	PPPP	NNNN	NNNN	NNNN	NNNN
CAL(1)	PPPP	PPPP	NNNN	NNNN	NNNN	NNNN	PPPP	PPPP
SAL(2)	PPPP	PPPP	NNNN	NNNN	PPPP	PPPP	NNNN	NNNN
CAL(2)	PPPP	NNNN	NNNN	PPPP	PPPP	NNNN	NNNN	PPPP
SAL(3)	PPPP	NNNN	NNNN	PPPP	NNNN	PPPP	PPPP	NNNN
CAL(3)	PPPP	NNNN	PPPP	NNNN	NNNN	PPPP	NNNN	PPPP
SAL(4)	PPPP	NNNN	PPPP	NNNN	PPPP	NNNN	PPPP	NNNN
CAL(4)	PPNN	NNPP	PPNN	NNPP	PPNN	NNPP	PPNN	NNPP
SAL(5)	PPNN	NNPP	PPNN	NNPP	NNPP	PPNN	NNPP	PPNN
CAL(5)	PPNN	NNPP	NNPP	PPNN	NNPP	PPNN	PPNN	NNPP
SAL(6)	PPNN	NNPP	NNPP	PPNN	PPNN	NNPP	NNPP	PPNN
CAL(6)	PPNN	PPNN	NNPP	NNPP	PPNN	PPNN	NNPP	NNPP
SAL(7)	PPNN	PPNN	NNPP	NNPP	NNPP	NNPP	PPNN	PPNN
CAL(7)	PPNN	PPNN	PPNN	PPNN	NNPP	NNPP	NNPP	NNPP
SAL(8)	PPNN	PPNN	PPNN	PPNN	PPNN	PPNN	PPNN	PPNN
CAL(8)	PNNP	PNNP	PNNP	PNNP	PNNP	PNNP	PNNP	PNNP
SAL(9)	PNNP	PNNP	PNNP	PNNP	NPPN	NPPN	NPPN	NPPN
CAL(9)	PNNP	PNNP	NPPN	NPPN	NPPN	NPPN	PNNP	PNNP
SAL(10)	PNNP	NPPN	NPPN	PNNP	PNNP	NPPN	NPPN	NPPN
CAL(10)	PNNP	NPPN	NPPN	PNNP	PNNP	NPPN	NPPN	PNNP
SAL(11)	PNNP	NPPN	NPPN	PNNP	NPPN	PNNP	NPPN	NPPN
CAL(11)	PNNP	NPPN	PNNP	NPPN	NPPN	PNNP	NPPN	PNNP
SAL(12)	PNNP	NPPN	PNNP	NPPN	PNNP	NPPN	NPPN	PNNP
CAL(12)	PNPN	NPNP	PNPN	NPNP	PNPN	NPNP	PNPN	NPNP
SAL(13)	PNPN	NPNP	PNPN	NPNP	NPNP	PNPN	NPNP	PNPN
CAL(13)	PNPN	NPNP	NPNP	PNPN	NPNP	PNPN	PNPN	NPNP
SAL(14)	PNPN	NPNP	NPNP	PNPN	PNPN	NPNP	NPNP	PNPN
CAL(14)	PNPN	PNPN	NPNP	NPNP	PNPN	PNPN	NPNP	NPNP
SAL(15)	PNPN	PNPN	NPNP	NPNP	NPNP	PNPN	PNPN	PNPN
CAL(15)	PNPN	PNPN	PNPN	PNPN	NPNP	NPNP	NPNP	NPNP
SAL(16)	PNPN	PNPN	PNPN	PNPN	PNPN	PNPN	PNPN	PNPN



 P = Positive N = Negative
 (Columns only for ease of reading.)

Table 3: A larger computational table giving 32 Walsh function components and their signs during a 32 interval period.

	$\sin(11.25^\circ) = 0.19509$ $\sin(33.75^\circ) = 0.55557$ $\sin(56.25^\circ) = 0.83147$ $\sin(78.75^\circ) = 0.98708$ $\sin(101.25^\circ) = 0.98708$ $\sin(123.75^\circ) = 0.83147$ $\sin(146.25^\circ) = 0.55557$ $\sin(168.75^\circ) = 0.19509$								signed sum	Normalized coefficients = A_i
SAL(1)	P	P	P	P	P	P	P	P	-5.1258	-1
SAL(3)	P	P	N	N	N	N	P	P	+2.1232	+0.4142
SAL(5)	P	N	N	P	P	N	N	P	+0.4223	+0.08239
SAL(7)	P	N	P	N	P	N	P	N	+1.0196	+0.1989



Table 4: Using the computational table to calculate the resistor values for a 16 step sine wave approximation. The specialized sine wave generator of figure 6 uses these results, subject to a further approximation shown in table 5.

tion. We repeat the process for each Walsh function.

If we divide all nonzero values by the largest (WAL(1)), it is observed that the weighting is binary and further it is seen that only the square wave Rademacher functions are nonzero. Thus, it is seen that the way to generate a ramp is with a counter feeding a standard digital to analog converter. (So here we have a long, complicated way of arriving at an "obvious" result, but it also should be noted that D to A binary weighting is *only* "matched" to a ramp output.)

If another wave form such as a sinewave is desired, a D to A converter could be used, but a more accurate method would be to switch between 16 voltages of appropriate values. The Walsh system is just as accurate and is simpler for the more general case.

If we divide a sinewave into 16 portions, the value at the center of the first interval will be $\sin(11.25^\circ) = 0.09802$ and the next will be $\sin(33.75^\circ) = 0.55557$ and the next $\sin(56.25^\circ) = 0.83147$, etc. This produces the top row of our table. Since $\sin(x)$ is an odd function, even about the 1/4 point, only SAL(1), SAL(3), SAL(5) and SAL(7) are calculated over the first half period. Our chart with the calculated coefficient values is shown in table 4. Since in a standard operational amplifier summing circuit (we won't go into details here as they can be found in any book on operational amplifiers), the relative summing ratios are related to the inverse of the summing resistor values, we divide each normalized value into 1 and multiply by the feedback resistor value to obtain each summing resistor value in ohms. Table 5 shows the calculated values compared to 1% and 5% EIA resistor standard values.

The total sinewave converter circuit is shown in figure 6. While three of the coefficients were negative, a single inverter was used on the lone positive Walsh output since the op amp inverts the wave form. In addition, a gate has been added by which the phase of the entire output wave form can be

$\frac{1}{A_i} \times 10k$	1%	5% EIA
10.00k	10.0k	10k
24.14k	24.3k	24k
121.4 k	121 k	120k
50.27k	49.9k	51k

Table 5: The EIA resistor equivalents for the calculated values of table 4. The 5% tolerance resistance values shown at the right were used in the circuit of figure 6.

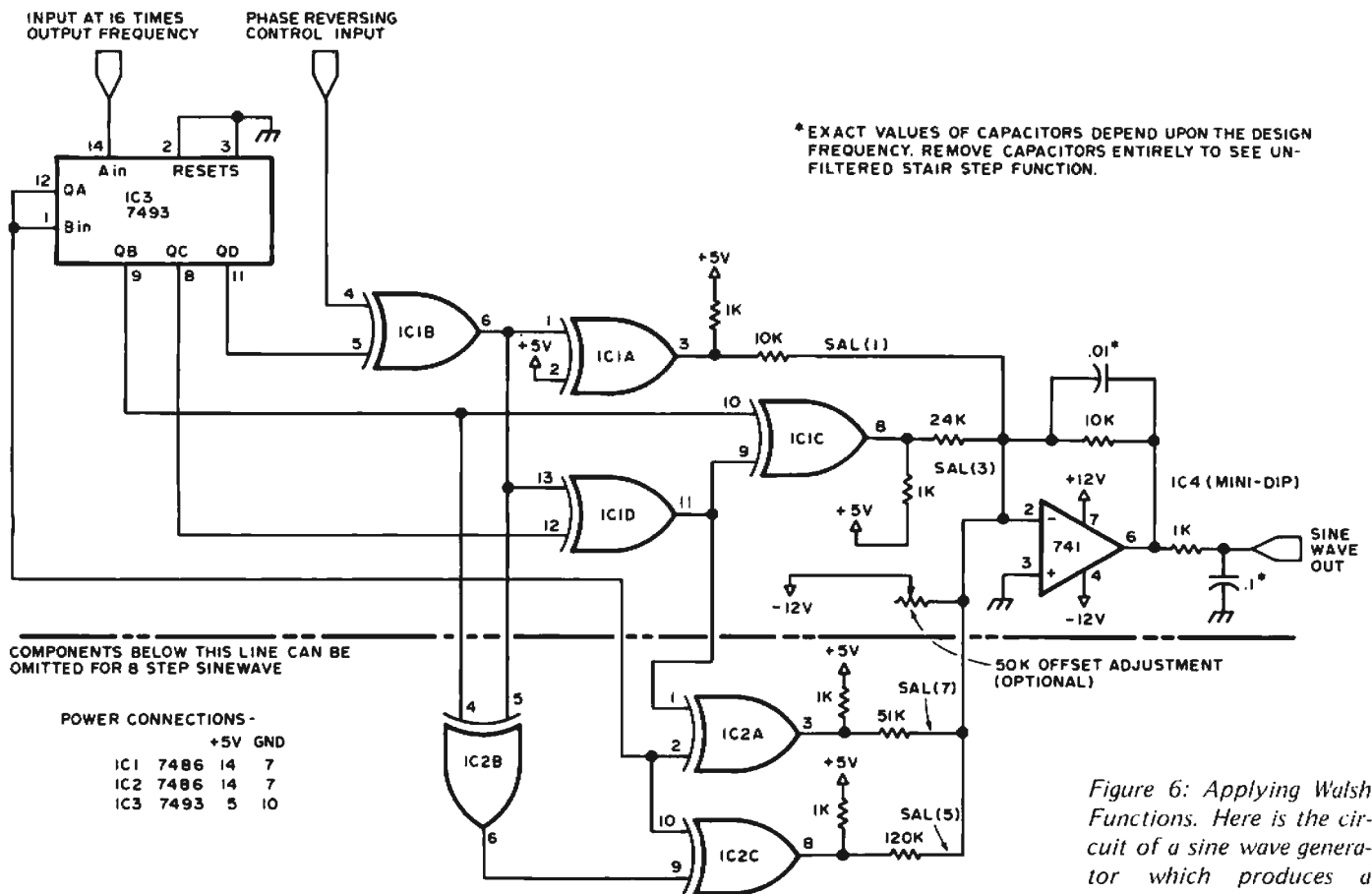

Figure 6: Applying Walsh Functions. Here is the circuit of a sine wave generator which produces a Walsh function approximation of the sine function. The frequency of the sine wave is set by the input to pin 14 of the 7493. Filtering components of the operational amplifier help smooth out the staircase wave form generated by summing the Walsh function components as weighted by resistors.

inverted by simultaneously inverting all Walsh components. It is interesting to also note that if the components below the dotted line are removed, an 8 step sine wave approximation results. The feedback capacitor and output low pass filter can be added to smooth up the wave form to give a nearly perfect sine wave.

The Walsh methods presented here would seem to have wide application for experimentation and engineering. Although these concepts are based on advanced mathematics, nevertheless, as the philosopher Seneca observed so many years ago, "The language of truth is simple."

Walsh Functions for Music Synthesis?

Some background information on the use of orthogonal functions in music wave form synthesis has been generated by Hal Chamberlin, and published in *Electronotes Newsletter*, Volume 4, Number 25, July 20 1973. Hal also sent along a copy of a portion of a report by B A Hutchins, 60 Sheraton Dr, Ithaca NY 14850, on the use of Walsh functions in wave form generation. According to Hal, there was considerable analysis of Walsh functions in electronic music circles

during a period of time approximately centered on 1973, but complexities of controlling the Walsh harmonic amplitudes digitally led to the demise of that interest. Hal's current approach is to employ a real time Fourier series evaluation module which digitally sums terms of the first 32 components of a Fourier series, specified to 8 bit accuracy both in amplitude and phase.

GLOSSARY

The following terms may be unfamiliar to some readers and are highlighted with further explanations.

Baseline: It is possible to add a fixed DC level to an analog signal, which will not affect its wave form. Using the 0 V and +5 V levels obtained with TTL circuits (using pull up resistors) as "Walsh functions" corresponds to a baseline adjustment of +2.5 volts to the ideal case of a symmetric positive or negative voltage value.

CAL: An acronym derived from Cosine WALsh. The CAL functions are the "even" Walsh functions, analogous to the Fourier cosine functions.

Duty cycle: For a digital wave form, the duty cycle is the percentage of time spent in the high state relative to the full period of the wave form.

Even function: An even function (or wave form) is one which is symmetric about the center point of its period. This means that its value a certain distance to the left of center is the same as its value the same distance to the right of center.

Fundamental: The lowest frequency in a Fourier or Walsh function summation.

Gray code: A binary code modified so that only one bit changes when going to the next higher or lower number. It is often used to deglitch position encoders.

Harmonic: A frequency which is a multiple of the fundamental frequency.

Integral calculus: The mathematical formalism used to calculate the area under a curve. The integral calculus is used together with the theory of orthogonal functions to evaluate analytically the coefficients of Fourier and Walsh function expansions. The example of Walsh function coefficient calculation in this article uses properties of Walsh functions to simplify the process of calculating integrals required for the coefficients. There is no such simplification for the Fourier coefficients of a wave form, thus making the application of Fourier analysis a more complicated problem.

Odd function: An odd function (or wave form) is one which is antisymmetric with respect to the center point of its period. This means that if at a fixed interval before the center point its value is X, then at the same interval past the centerpoint the value will be $-X$.

Orthonormal functions: The mathematical theory of orthonormal functions is one of the most powerful tools used by physicists, theoretical chemists and engineers. Among other applications, it provides the tools needed to analyze complex wave forms and synthesize such wave forms using the principle of superposition: That the whole is a linear sum of its parts. Fourier series and Walsh function analysis mentioned here are two particular choices of a set of orthonormal functions which have useful practical applications. (See also spectrum below.)

Periodic wave form: A periodic wave form is one which has a fixed shape which is constantly repeated. A simple example would be the clock oscillator signal of a typical home brew central processor. A more complicated example (subject to imperfections) would be a long steady tone played on a musical instrument.

Rademacher functions: The subset of Walsh components consisting of only the unmodified square waves.

SAL: An acronym derived from Sine wALsh. The SAL functions are the "odd" Walsh functions, analogous to the Fourier sine functions.

Sequency: Walsh function terminology referring to the Walsh components of a wave form in exactly the same way that frequency is used to refer to the Fourier components. Example: Sequency spectrum.

Spectrum: When orthonormal functions are used to analyze a wave form, the result frequently is a set of coefficients which weigh each of the basic functions found in a (theoretically) infinite sum which represents the wave form. Each coefficient corresponds to some parameter of the orthonormal functions, which might be, for example, a number "n." Whatever the parameter is, a spectrum for the analysis is obtained by plotting the coefficient values versus the parameter value for a large number of coefficients. For a Fourier analysis, the result is a plot of coefficient versus frequency (which at the low end corresponds to a small integer value). A Walsh spectrum would plot the coefficient of WAL (n) versus n.

Wave form: For the purposes of this article, a signal's wave form is a value of (for example) voltage as a function of time. ■

BIBLIOGRAPHY

1. J L Walsh: "A Closed Set of Orthonormal Functions," *American Journal of Math*, Vol 45 pp 5-24, 1923.
2. H Rademacher: "Einige-Satze von allgemeinen Orthogonalfunktionen," *Math Annalen*, Vol 87 pp 112-138, 1922.
3. H F Harmuth: "Applications of Walsh Functions in Communications," *IEEE Spectrum*, Nov 1969.
4. M S Corrington: "Solution of Differential and Integral Equations with Walsh Functions," *IEEE Transactions on Circuit Theory*, Vol CT-20 No. 5, Sept 1973.
5. W M Walmsley: "Walsh functions, transforms and their applications," *Electronic Engineering*, June 1974.

LONG ISLAND

THE AFFORDABLE



COMPUTER STORE

COME SEE WHAT A "REAL" COMPUTER STORE LOOKS LIKE

MICROCOMPUTERS PERIPHERALS ACCESSORIES

IMSAI 8080 BYTE-8 SWTP MP68 CROMEMCO PROCESSOR TECH INTERFACES (KITS or ASSEMBLED UNITS)	MEMORY EXPANSION COLOR TV GRAPHICS LEAR SIEGLER ADM 3 PAPER TAPE READER
---	--

PROGRAMS AND SOFTWARE

VARIOUS BASICS — TINY, 4K, 8K and 12K
 FOCAL — DOS — GAMES — BUSINESS APPLICATIONS

ALSO AVAILABLE . APPLE 1 CASSETTES FLOPPIES
 MODEMS TERMINALS DEC WRITERS

BUSINESS APPLICATION INQUIRES INVITED
 SYSTEM DEMONSTRATIONS AND LITERATURE / MAGAZINES



Byte Shop East, Inc.
 27-21 Hempstead Turnpike
 Levittown, Long Island
 (516) 731-8116

Two blocks east of Wantagh Pkwy.

HOURS TUES THRU FRIDAY 12-9
 SATURDAY 10-5

WHAT'S A BOPA?

ADDRESS	ROUTINE	CODE	MNEMONICS	COMMENTS
60	Clear	21	LXI—H	F800 Start Addr of Display
61	Video	00		
62	Display	F8		
63	Screen	38	MVI—M	A0 Load "Space"
64		A0		
65		7C	MOV A,H	Move high Address
66		FE	CPI	For Comparison
67		FC		
68		C8	RZ	Return When End
69				Of Screen Reached
6A		23	INX H	Next Display Addr.
6B		C3	JMP	Go to Load "Space"
6C		S3		
6D		0D		
6E				
6F				
70				

Close-up of Board

ORDER CODE:

- BOPA-1 Single card system \$11.95
- BOPA-4 Four card system with 128 entries, pen, and Solvex-80 cleaning solution \$39.95
- BOPA-8 Complete system with 256 entries, pen, Solvex-80. \$74.95
- PNS Special ink pen. \$ 1.00
- SLX Solvex cleaning Sol'n., 1 1/4 oz. \$ 1.25

MIN. ORDER \$5. - Calif. Residents add 6% Tax.
For orders less than \$15, add \$1 for shipping.
Foreign orders add 50¢ per board (U.S. Funds Only).

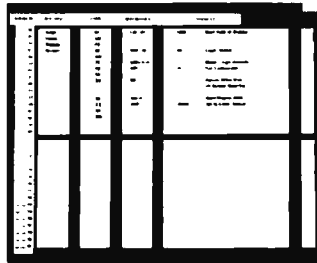

It's a Basic Operating Programming Aid, a new and revolutionary microcomputing aid to help you write machine level programs faster and more accurately.

— FEATURES —

- ★ You write on movable slats.
- ★ 32 memory addresses per board.
- ★ You assign the memory range.
- ★ Automatically reassigns addresses as you edit.
- ★ Compiles and assembles programs quickly.
- ★ 4 columns, ROUTINE, CODE, MNE., COMMENTS.
- ★ Reduces Programming Time.
- ★ Machine level programming is a snap.
- ★ Program anywhere, it's portable.
- ★ Re-usable, unbreakable mechanism.
- ★ Corrections are quick and easy.
- ★ Excellent learning aid.
- ★ Fits 3 ring binder (9" X 11" X 3/16").
- ★ Completed programs can be xeroxed.

See It At Your Local Computer Store.

VAMP INC.
P.O. Box 29315
Los Angeles, CA 90029

MACC COMPUTERFEST '78

EXHIBITS

- ▶ MANUFACTURERS
- ▶ CLUBS & STORES

MOVIES

GAMES

FLEA MARKET

For Information
P.O. Box 9578
North End Station
Detroit, Mich. 48201

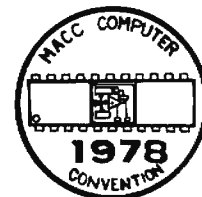
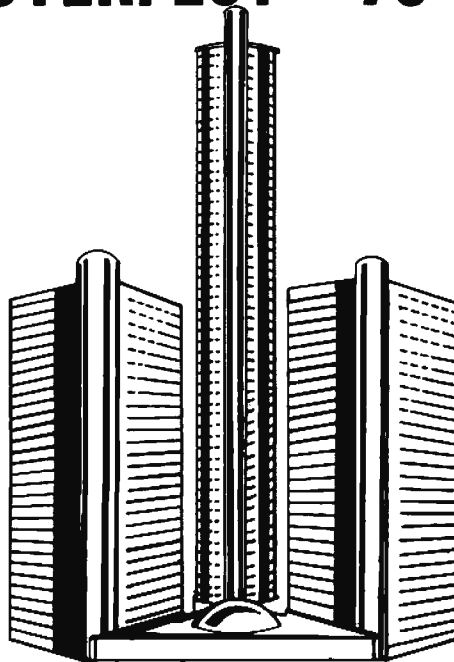

PRESENTATIONS

COMPUTERS IN

- ▶ THE HOME
- ▶ SCHOOL
- ▶ ART & MUSIC
- ▶ YOUR FUTURE
- ▶ SOCIAL IMPACT

DETROIT PLAZA HOTEL
JUNE 23-25, 1978



1978
SPONSOR

SOUTH EASTERN MICHIGAN COMPUTER ORGANIZATION



Photo 1: Perhaps a key element of the Heath line is this H9 video terminal, used with either the H8 or H11 systems. It is a full ASCII terminal (but with upper case only in the display section) and a wide range of data rates.

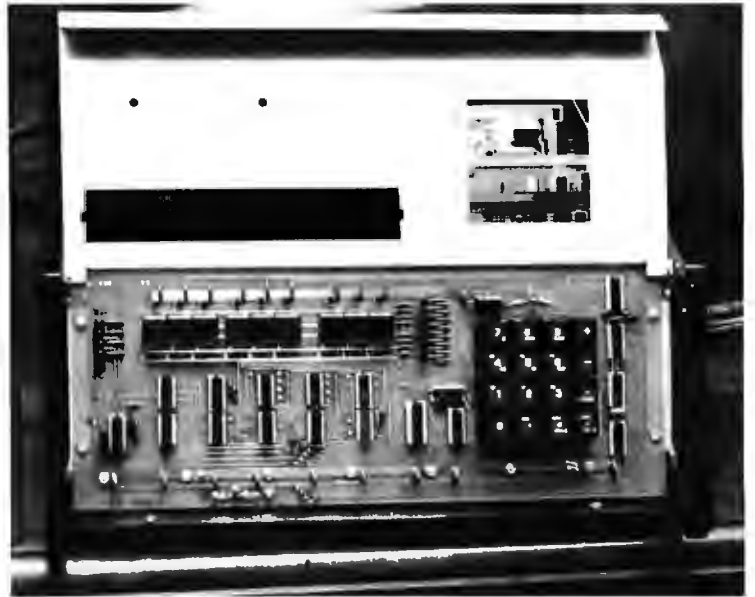

Photo 2: Flipping up the front panel of the demonstrator of the Heathkit H8 computer (an 8080 based product) in the press room revealed this lower level structure.

Some Candid Photos Shot in Benton Harbor

As noted in August 1977 BYTE, the Heathkit product line was introduced to the press June 1, to prime the publicity pumps in time for the August introduction of the line in public at the Personal Computing 77 show in Atlantic City. Here are some candid photos taken in the Heath plant in Benton Harbor MI during the press party. ■



Photo 3: Here is an H8 computer used in a production and test situation at the Heathkit plant, with its memory board mounted on an extender. The boards in the H8 are mounted at an angle with respect to vertical, which keeps the height of the cabinet down while allowing bigger boards to be designed.



Photo 5: One point which many might overlook, but technology freaks can't ignore, is the specialized equipment which gets built when a firm has a large manufacturing operation. Here is a prime example of several very interesting cases of manufacturing automation at Heath: a machine which collates resistors prior to packing. Each reel holds a supply of resistors mounted on tape strips which many readers may have seen occasionally in surplus houses. The reel feeds a mechanism which removes the resistors from the tape on command and drops the resistor into a bin on a conveyor belt moving horizontally in a loop around the machine. The net result is that the human bag packers (not seen in this photograph) simply dump the properly collated resistor assortment from a bin into a bag and seal it, and have no need to physically handle each resistor. Such automation is possible only due to the uniformity of the resistors, and even then a machine tender is required to monitor occasional exception conditions.

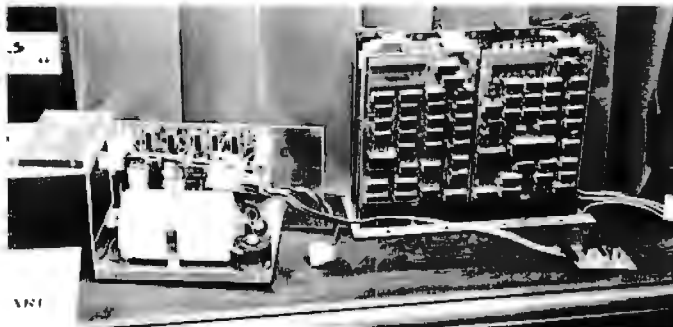

Photo 4: The "guts" of the H11 product by Heathkit are represented by the two boards shown here on the table in the press room. The DEC LSI-11 board and several peripheral and memory cards are mounted in the back plane assembly at right, and the switching regulated power supply for the system is shown at the left.

NYU Conference

A conference on Computing in the Arts and Humanities will be held from Friday evening to Sunday noon, October 21 to 23 1977, at Warren Weaver Hall, New York University. Sponsored by ACM/SIGLASH (Association for Computing Machinery/Special Interest Group on Language Analysis and Studies in the Humanities) and the NYU Departments of Computer Science, Linguistics, Art and Art Education, Music and Music Education, the program will include:

Performances

Friday evening: computing in the visual arts and presentations of video and film works.

Saturday evening: concert of music composed with the aid of computers.

Sessions

Challenge sessions in music, art and language understanding: computing in the arts and humanities — Is it a new medium, a tool or a distraction?

And:

- Music tape and talk sessions
- Computer vs human poetry
- Literary analysis
- Computer fashion show
- Other demonstrations and discussions

Cash Grants Offered for Surveys of Progress in Robotics

Three individual grants of \$100 are offered by the US Robotics Society to students who survey practical activity in research and development on robots in specified areas of the world. The surveys must be performed for academic credit with formal approval of appropriate professors.

With the sudden rise in the use of personal, privately owned computer systems, private research and development in robotics and artificial intelli-

gence has surged. More than 70 members of the US Robotics Society alone report active work on robots. The Society is seeking an estimate of robotics activity worldwide, and these first grants are the beginning of a general search for knowledge of work on robots.

Grants will be made for surveys of: the US West of the Mississippi, the US East of the Mississippi, and Canada. Later grants will be made for surveys of other areas.

The reports will be published as part of the basic robotics literature, establishing their authors and supervisors as important contacts in the field.

Proposals from applicants are due on or before September 30 1977; completed reports are due on or before June 30 1978.

For details, write: Survey Grants, United States Robotics Society, Box 26484, Albuquerque NM 87125. ■

Signs of Maturity?

When computer stores find mass media advertising to be useful, then we have a sure sign that the marketplace for computers is becoming mature. According to a note which passed this way from The Computer Mart of Orange CA, that store is running an advertising campaign in the *Los Angeles Times* and the *Santa Ana Register*. ■

For registration information contact conference chairperson: Dr Naomi Sager, NYU Linguistic String Project, 251 Mercer St, New York NY 10012, (212) 598-2294, ext 5. ■

Houston Personal Computing Faire

We recently received a terse note: Houston TX, September 16 thru 18, Houston Personal Computing Faire. Contact Richard McClendon, POB 36584, Houston TX 77036. ■

NEW 8080 and 8085 REFERENCE GUIDE

A TOTALLY NEW CONCEPT! SAVES TIME AND MONEY! MAKES YOUR JOB EASIER!

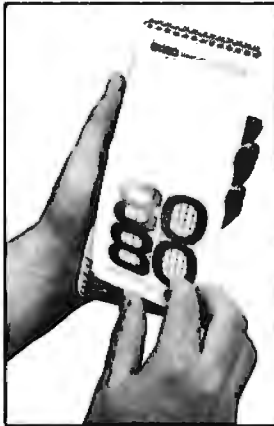

A powerful new tool for every serious 8080 user — professional and novice alike. Priceless timesaver for engineers, technicians, and programmers. Saves time and money in the lab, on the production line, or in the field.

Convenient pocket size — 3 3/8 by 7 3/4 inches — gives quick and easy access to all vital reference data. No more searching here and there for codes, instructions, or definitions. It's all there — at your finger tips — everything you need to successfully use the 8080A and — Intel's new 8085 microprocessor.

Features cross listing, for rapid assembly and disassembly, of MACHINE CODES and MNEMONICS • Concise description of 8080 and 8085 OPERATIONS, SIGNALS, PINOUTS, and INSTRUCTIONS • Convenient cross conversion of OCTAL, HEXIDECIMAL, DECIMAL, ASCII, and EBCDIC codes • Easy-to-read tables of powers of two, eight, and sixteen . . . and much more . . .

Sturdy • Handsome • Easy-to-use • Data Packed
Your timesaver will give many years of professional service.

\$12.95 each (plus postage & California sales tax) — 25% discount for 4 or more.

MoneyBack Guarantee: You must be fully satisfied or simply return the guide within 15 days for full and prompt refund.

URBAN INSTRUMENTS • 4014 CODY ROAD • DEPARTMENT C1 • SHERMAN OAKS • CALIFORNIA 91403



PLEASE SEND _____ 8080 timesavers to: CHECK/M.O. ENCLOSED BANKAMERICARD MASTER CHARGE

NAME CARD NUMBER

STREET GOOD THRU 4 DIGITS ABOVE NAME

CITY SIGNATURE (MASTER CHARGE)

STATE ZIP

Book Reviews

CMOS Cookbook by Don Lancaster, Howard W Sams and Company, Indianapolis IN, 1977. \$9.95.

This book will prove immensely useful to anyone interested in sophisticated logic design. Like the author's earlier *RTL* and *TTL Cookbooks*, it covers everything from basic principles and practical usage tips to relatively complete applications in a style that is informal, understandable, and very easy to read. If you want to learn about CMOS from the ground up, or if you want a handy reference source of CMOS circuit ideas, this book is for you.

The reader who is comfortable with TTL may doubt the book's claim that "CMOS is the first hassle-free digital logic family," but Don makes a good case. He cites its very low cost, low power requirements and wide power supply voltage ranges, open circuit

inputs and wide output voltage swings, very high fanout, and tolerance of system noise. He doesn't neglect the disadvantages of CMOS, though, and warns about its sensitivity to input capacitance and its speed limitations. After reading this book, you will undoubtedly appreciate CMOS as a very practical alternative to TTL.

The following categories are among the subjects covered in the book:

- basic logic elements and transmission gates
- power supplies and the relationship between voltage, current and speed
- CMOS usage rules
- breadboarding techniques
- tools
- testing and monitoring states
- interfacing CMOS to TTL, LEDs and other devices.

Also included is a minicatalog of 100 devices, including such interesting packages as a frequency synthesizer, touch-tone dialer, modem, top octave music generator, TV numeric display, wristwatch and frequency counter.

The next topic is combinational logic.



Spring into Season with a BYTE T-shirt



At last! No more wardrobe crises! BYTE T-shirts are here! Now you have the perfect garb for computer club meetings, Altair Conventions, playing Shooting Stars and computer chess. (A pair of trousers from your own closet is suggested as an addition to the BYTE T-shirt. BITS can't do everything for you.)

BYTE T-shirts are of top quality 100% cotton or cotton-polyester. The original design, by artist Judy Lee Rehling, is silk screened in red on white shirts with blue trim on collars and sleeves, or on blue heather shirts.

The \$5.50 price includes postage and handling.

Send to: **In unusual cases, processing may exceed 30 days.**

BITS, Inc.
70 Main St.
Peterborough NH 03458

Please send me extra large blue heather
 large white with blue trim and red letters
 medium
 small T-shirts @ \$5.50 each (includes postage and handling)

Total enclosed \$ _____

Bill MasterCharge No. _____ Exp. Date _____

Bill BankAmericard No. _____ Exp. Date _____

Name _____

Address _____

City _____ State _____ Zip _____

Signature _____

All orders must be prepaid
Prices shown are subject to change without notice.

NOW HEAR THIS!!

ALPHA DIGITAL SYSTEMS

SELLS IMSAI KITS AND TOTAL INTEGRATED SYSTEMS ASSEMBLED, CHECKED-OUT, AND WARRANTED AT KIT PRICES

ALPHA 1

SPECIAL DOS SYSTEM DEAL (includes)

- IMSAI 8080 Computer
 - 22 Slot Mother Bd with Conn
 - 16 K RAM
 - 90 K Disk (with Controller)
 - Selectric typewriter (with Controller)
 - DOS-BASIC Software
- Assembled System Total \$3995
(Less Selectric) \$2495

Select any kit or system of kits from the IMSAI price list, order from us and receive the assembled unit for the same price. If you don't have a price list, drop us a line and we will send you one. Terms: Cash with Order - Prices include freight (NC Residents Add 4% Sales Tax)

How can ALPHA DIGITAL SYSTEMS do all this? Its simple. ALPHA DIGITAL WANTS TO BE YOUR COMPUTER COMPANY

ADS ALPHA DIGITAL SYSTEMS
RT. 4 BOX 171A
BOONE, N.C. 28607
(704) 264-7946

Circle 283 on inquiry card.

PHOENIX

Bits & Bytes

COMPUTER SHOP

- Lear Siegler ADM-3 Kit \$799
- Vector-1 Z-80 8K \$888
- 9" Sanyo Monitor \$169

North Star - EPA - Tarbell
Act 1 Terminals - Cybercom
Thinker Toys - Equinox 100
Vector Graphics - Per Com

6819-C N. 21st Ave.
Phoenix, Az. 85015
(602) 242-2507

Circle 284 on inquiry card.

BYTE SHOP™

the affordable computer store

7825 BIRD ROAD OF
(305) 264-2983 MIAMI
DIAL 264-BYTE

WE HELP YOU GET YOUR SYSTEM
UP AND RUNNING.

IMSAI 8080 MEMORY EXPANSION
BYTE-8 COLOR TV GRAPHICS
SWTP MP88 LEAR SIEGLER ADM 3
CROMEMCO PAPER TAPE READER
PROCESSOR TECH
INTERFACES (KITS or ASSEMBLED UNITS)

IN FORT LAUDERDALE

1044 E Oakland Pk Blvd
(305) 561-2983

Circle 285 on inquiry card.

Washington D.C.'s
Newest Computer Store

Intelligent Business Machines, Inc.

Cromemco, IMSAI,
TDL, Administrator I,
SEALS, DIP Chips, etc.

Come see us at

938 Ellsworth Dr.
Silver Spring, MD 20910

Circle 286 on inquiry card.



IT'S A GREAT BIG COMPUTER WORLD
But You Only Need
THE COMPUTER CORNER

- SOL - A New Dawn Is Here!
- IMSAI 8080
- POLY - 88
- TDL Z-80
- Memories & I/O Boards

- Computer Book Service
- Magnetic Tapes & Disks
- Full Line of Magazines
- Brain Games & Puzzles
- Workshops & Club Information

Visit THE COMPUTER CORNER for all your computer needs. Stop in and browse - you'll like our personal service.

THE COMPUTER CORNER
White Plains Mall - Upper Level
200 Hamilton Avenue
White Plains, New York 10601
Tel: (914) WHY-DATA

Ample Parking
10-6 Pally & Saturday
10-9 Thursday

Circle 287 on inquiry card.

computer depot inc. T.M.

3515 W. 70th Street
Minneapolis MN 55435
612-338-2695

Upper Midwest
Headquarters
for

PROCESSOR TECHNOLOGY, IMSAI,
POLYMORPHIC SYSTEMS, DIGITAL
GROUP, WAVE MATE, CROMEMCO,
VECTOR GRAPHICS, TDL, SEALS,
TARBELL, MICRO DESIGNS,
NORTH STAR, NATIONAL SEMI-
CONDUCTOR, FAIRCHILD SEMI-
CONDUCTOR, MOSTEK, E & L
INSTRUMENTS, SAMS, TAB,
HAYDEN, WILEY, MC-GRAW HILL

Catalog Free

C40

Circle 288 on inquiry card.

COMPUTER MART OF NEW HAMPSHIRE

DEALERS FOR TDL ICOM IMSAI DIGITAL GROUP

SOFTWARE INCLUDES:

8K BASIC EXT. BASIC
TEXT EDITOR DISK BASIC
WORD PROCESSOR
MACRO-ASSEMBLER

170 MAIN STREET NASHUA
(603) 883-2386

Circle 289 on inquiry card.

**ECONOMY
TERMINALS**

**ET1 CRT
TERMINAL
FEATURES**

\$895



Box 12261
Minneapolis, Minn. 55412
(612) 522-1076

- 24x80 display, with anti-glare screen & filter
- 12" Indus 15 Mhz monitor
- 90 day warranty (parts & labor, F.O.B. factory)
- 86-hour elevated-temperature operating O.C. test*
- RS 232 and 20 ma interface
- L.F. CR, BS, Local, Rubout, Break, Home & Clear, Tab*, Remote Cursor Placement* and Scrolling*
- Micro-Processor based, with 63-key keyboard

*These functions vary with the model selected.

Circle 290 on inquiry card.

SURPLUS

POWER SUPPLY
CONTROL DATA

BARGAIN

- + 5V @ 8.5A
- + 12V @ 2.5A
- + 30V @ 200ma (unregulated)
- 6.2V @ 25ma (no adj. pot)
- 12V @ 2A
- + 180 V @ 150 ma

Brand new, made by CDC for microprocessor terminals. 110 VAC in, regulated and adjustable DC outputs. Overvoltage protected +5, -12. Power status signal. Fan Schematic. Original list \$600. From stock, UPS paid, custom foam box, guaranteed. \$50.00

ELECTRAVALUE INDUSTRIAL
BOX 484
Cedar Knolls, NJ 07927
(201) 267-1117

Circle 291 on inquiry card.

Besides covering basic gates and deMorgan's theorem, Don describes features unique to CMOS, such as transmission gate logic and his own "Mickey Mouse Logic" (M²L). He goes on to discuss advanced logic design techniques using data selectors, read only memories (ROMs) and programmable logic arrays (PLAs). Finally Don gives some approaches to creative logic design, something for which he is famous. Although some of his suggestions, such as "use nonobvious codes or timing sequences," may make the reader shudder, this short section on design philosophy is very valuable.

Following the organization of his earlier books, the focus shifts to multivibrators. Basic astable and monostable multivibrators are covered, of course, but since he starts with more sophisticated CMOS packages, Don is able to present more interesting applications like data rate and touch-tone generators, equally tempered music and voltage controlled oscillators.

Succeeding chapters deal with clocked logic: flip flops, counters and shift registers. Although the basics are still covered, the more interesting examples exploit the special properties or the more sophisticated pack-

ages available with CMOS: touch and proximity sensors, phase detectors, character generator serial video and Teletype transmitters, and digital sine wave generators.

A very special chapter describes CMOS op amps, analog switches, and phase locked loops. The application examples for all three devices should give the reader a good grasp of their capabilities. The section on analog switches is especially interesting.

The final section of the book, "Getting It All Together," presents some larger scale designs, as well as challenges to the reader. Here you will find circuits for a video game, a digital wristwatch, and even a complete basic circuit and key waveforms for Don's TVT-4 television typewriter.

All in all, this book packs a lot of ideas into its 400 pages, and forms a superb introduction to an important new logic family. If you want to keep up-to-date on integrated circuit technology, you should not pass up this book.

Dan Fylstra
Hamilton Hall C-23
Harvard Business School
Boston MA 02163

COMPUTER ENGINEERING

THE MIDNIGHT SPECIAL . . .

. . . a full color limited edition poster for your Casey Jones fantasies.

The poster is 16½ by 21½ inches (41.9 by 54.6 cm) with a white border. The colors are the same as the original by Robert Tinney, which graces our July cover, minus the BYTE logo. The price is \$3.00, plus 50¢ postage. It is shipped unfolded, in a mailing tube.

ORDER NOW. SUPPLIES ARE LIMITED.

BITS Inc

70 Main Street
Peterborough NH 03458

Posters \$3.00 each
plus \$.50 mailing

Bill BankAmericard
 Bill Master Charge



Check Enclosed
\$

No. _____

Exp: Date _____

Name _____

Address _____

City _____ State _____ Zip _____



In unusual cases, processing may exceed 30 days.



VDB-1 VIDEO DISPLAY BOARD, BASED ON A.L. ANDERSON'S ARTICLE IN NOV. 76 BYTE

Also
CPU-1 Central processor board using the MOS Tech. 6502 and TIM monitor chips. Compatible with SWTPC memory and I/O boards. Give your SWTPC TIM capability or build a complete system.

EPB-1 Eprom programmer for 1702A eproms.
EPB-2 Eprom programmer for 2704 & 2706's
VDB-1 & CPU-1 Plug directly onto the SWTPC bus.
EPB-1 & 2 plug into the SWTPC 6800 MP-L board and use software for timing functions. 6800 software provided. All boards adaptable to other systems.

Price each bare board with documentation \$29.00 plus \$2.50 shipping and handling. Documentation only, \$5.00 refundable.

F&D ASSOCIATES
NEW PLYMOUTH, O. 45654

Circle 292 on inquiry card.

Raeco
TPT-1

THE ULTIMATE IN:

OPTICAL TAPE READERS

Precision machined tape guide

Interface directly to a PIA or DART

Tri-state buffer output

All handshake logic TTL compatible

Pull thru tape heads 0 to 5000 cps

Interface thru a 14 pin IC plug

TPT-1 ASSEMBLED & TESTED \$38.00*

MSA-1 PLUG-IN HANDSHAKE ADAPTER \$ 5.50*

*POSTPAID: 10% DISCOUNT AND IN SALES TAX

TO ORDER, SEND CHECK OR M.O. TO:

MICROCOMP P.O. BOX 1221

10800 DU LAC, WI 54903

WE SPECIALIZE IN MICROCOMPUTER SYSTEMS FOR

HOBBY-BUSINESS-EDUCATION

WE ARE EXCLUSIVE OSI DEALERS...

... WE DO A BETTER JOB.

KITS: FULL SYSTEMS-PERIPHERALS-FLOPPY DISKS-ACCESSORIES-
DIGITAL CLOCK-KITS-VIDEO TERMINALS-BOOKS-MAGAZINES-
SEND FOR FREE CATALOG TODAY!!!

Circle 293 on inquiry card.

FREE!
DISKETTE
CASE

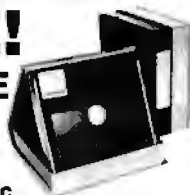

Attractive
Durable Plastic

Easy Handling & Safe Storage
FREE with every 10 Diskettes.

DISKETTES: Shugart 800, Altair,
Helios, OSI, Digital Systems,
IMSAI, Innovex @ \$5.50

MINI-DISKETTES: Northstar, For-
trans IV, Smokey Signal, Metropo-
lis, Shugart SA400 @ \$4.25

Immediate Delivery from Stock
Bank Americard / Master Charge

MANCHESTER EQUIPMENT CO.
120 Bethpage Road
Hicksville, N.Y. 11801
Call Collect: (516) 433-0613

Circle 294 on inquiry card.

ALPHANUMERIC T. V. DISPLAY
16 Lines of 32 or 64 Characters
Upper and Lower Case Dot Matrix 7x9
Software Control of Cursor, Scrolling,
LF, CR, Erase to end of line
Uses less than 256 Bytes

Sockets for all I.C.s

S-100 Standard P. C. Board (1 slot)

Combined Video Output for T.V. Monitor

Use standard T. V. set with mod.
KIT \$140.00 ASSEMBLED \$190.00

THE LITTLE SCOUT

Add a Tune to your Digital Alarm
Clock. 2 1/2 x 4 1/4" circuit plays
REVEILLE, PROM in socket let's
you change tune. Ideal for your
budding Boy Scout.

KIT \$14.95 ASSEMBLED \$19.95

Add Postage, \$1, N.J. add 5% Tax

MULAB, INC.
P.O. Box 215

Basking Ridge, N.J. 07920
201-647-0525

Circle 295 on inquiry card.

IMSAI
POLY 88
TDL
"SEALS"
Vector Graphic
SWTPC
Digital Group



**Personal
Computer
Corporation**

phone:

215-647-8460

Frazer Mall

Rt. 30 & 352

Frazer, PA. 19355

Circle 296 on inquiry card.

BYTE
Article Index

Complete listing of all feature
articles appearing in Volume I
of **BYTE**—September 1975 thru
December 1976. Indexed for easy
reference. Includes all errata.

FREE

To get yours, send a \$24 stamped self-addressed
envelope to:

BYTE Index
70 Main Street
Peterborough NH 03458

CANADIANS!

Eliminate the Customs Hassles.
Save Money and get Canadian
Warranties on IMSAI and S-100
compatible products.

IMSAI 8080 KIT \$ 838.00
ASS. \$1163.00

(Can. Duty & Fed. Tax Included).
AUTHORIZED DEALER

Send \$1.00 for complete IMSAI
Catalog.

We will develop complete applica-
tion systems.

Contact us for further information.

**Rotundra
Cybernetics**



Box 1448, Calgary, Alta. T2P 2H9
Phone (403) 283-8076

Circle 298 on inquiry card.



South Florida

**SUNNY COMPUTER
STORES, INC.**

South Florida's First Computer Store

WE CARRY:

- ALPHA MICRO SYSTEMS,
MICRO FILE, PROCESSOR
TECHNOLOGY, IMSAI
- BOOKS, MAGAZINES, NEWS-
PAPERS
- FULL SERVICE
- SOFTWARE
- WRITE OR PHONE US FOR
PRICES

MORE THAN JUST A TOY

Monday 12 noon - 9 pm

Tues.-Fri. 10-6

UNIVERSITY SHOPPING CENTER
1238A SOUTH DIXIE HIGHWAY
CORAL GABLES, FLA. 33146
(305) 661-6042

Circle 299 on inquiry card.

**THE PROM SETTER
READ/WRITE**

1702A and 2708
ALTAIR/IMSAI COMPATIBLE
NO EXTERNAL POWER SUPPLY

**LET YOUR COMPUTER
DO IT ALL**

SOFTWARE INCLUDED
Doubles as an 8 Bit Parallel I/O

KIT COMPLETE — \$210
ASSEMBLED — \$375

DELIVERY LESS THAN 60 DAYS

SZERLIP ENTERPRISES

1414 W. 259th STREET
HARBOR CITY, CA. 90710
Calif. Res. Add 6% Sales Tax

Circle 300 on inquiry card.

Control Character	Meaning
Pnn	musical part number declaration, where nn=a number from 00 to 16
Knc	key signature declaration, where n is a number and c is a "+" or a "-"
Tn/n	time signature declaration; ie: "T4/4" means 4/4 time
Onn	positions the CDEFGAB scale on the terminal keyboard to octave nn of the external instrument's keyboard
()nn	repeat text within parens nn times
< > = C	equate all text within brackets to symbol C
Q+n	transpose all subsequent text up n steps
Q-n	transpose all subsequent text down n steps
" "	all text within quotes is treated as commentary
CTRL A	marks the end of the MUSIC TEXT FILE

Table 2: Control characters used by the SCORTOS language processor.

matically informs the user when he has come to the end of a bar by displaying a slash and the next bar number on the terminal. This provides a checksum for each bar and a milestone to keep the operator informed of his position in the score. Listing 1 shows a sample of the dialog between the operator and the editor as the operator enters the score fragment in figure 3. The italicized type is supplied by the editor, the bold type by the operator.

Conventional string oriented text editors are inconvenient for use with music text since music is prone to have too many occurrences of any given string. Allowing the user to access the text by part number and bar number is more suitable since he refers to a written score in the same way. Various commands are available within the editor which allow a user to list selected bars and make insertions and deletions in the music text at selected bar boundaries.

The converter is the system's music language processor. It scans the text of the music text file and translates the logical entities of rhythm and pitch to the physical values of time and keyboard address. For each event described in the file the converter outputs a 2 byte record which contains the duration of that event in standard system timing units, and the location of the event on the system controlled music keyboards.

Table 2 is a list of control characters recognized by the converter. In keeping with the design goal of eliminating redundancies in the music score, an equate (=) statement was developed. Using equate, repeated groups of notes need only be typed in once and equated to a symbol. Thereafter they may be brought into the music source text by typing the symbol to which they have been equated.

The driver interface subroutines allow the user to communicate with the DRIVER by providing him access to the binary output file. Through their use, a sequence of musical events may be generated from

within the computer by a user written program. For example, the researcher may have made an analysis of a particular composer's style (following the procedure described earlier in this article) and may wish to write a program in BASIC which creates a composition based upon the properties of that style. The sequence of events that constitute the composition would be produced by calls to the driver interface subroutines.

The EVENT subroutine is the principal interface subroutine. Its calling sequence is:

```
CALL EVENT
DS ARG1
DS ARG2
DS ARG3
DS ARG4
```

where:

ARG1 = part number.
 ARG2 = duration of event.
 ARG3 = address of keyboard switch.
 ARG4 = slur code (0= no slur, 1= slur this event to next event).

The DRIVER is a software representation of the inner workings of a player piano where the binary output file, subroutine CLOCK, and the DRIVER's main code are the respective analogs of the piano roll, sprocket drive and mechanical read head. All of the control features of its mechanical counterpart are available within the program, including start performance, pause, and stop performance, and some which are unique to a software simulation, such as discrete tempo control and part selection.

The DRIVER causes music to be performed by initiating and terminating musical events according to the information contained in the binary output file. The program keeps a timer for each part that is participating in the performance. When an event is initiated, the address data in the event's data record is output to the appropriate 88-RCB data register. This causes sound to emanate from the instrument to which the 88-RCB is connected. The timer is set to zero, then incremented 20 times per second and compared at each incrementation to the event duration field of the event's data record. When these two quantities are equal, the event is terminated by a logical exclusive OR of that event's keyboard address data with the 88-RCB data register. The DRIVER then proceeds to the next event record and repeats the process.

Timing is provided internally by subroutine CLOCK which contains a timing loop and which also interprets control commands from the terminal. When a call is

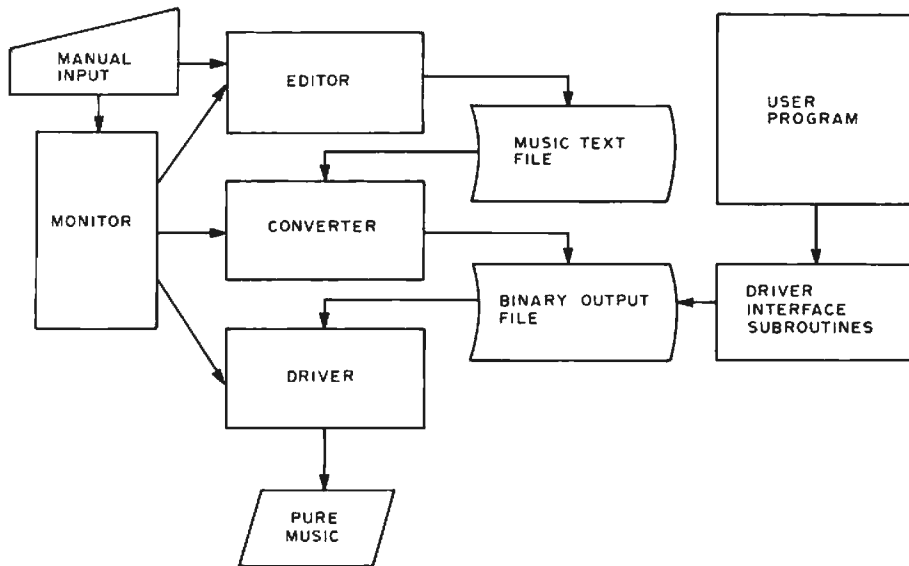

Figure 4: The flow of information through the SCORTOS software. The monitor controls the system's major functions. The editor allows the user to enter music through the computer's keyboard (see figure 1) and to modify it as desired. Listing 1 describes this in more detail. The converter scans the text of the music text file and converts the values for rhythm and pitch into physical values of time and keyboard address. The driver interface subroutines allow the computer to play music that it has composed based on stochastic or random elements contained in the user's programs.

made to CLOCK, the caller will not receive control back until a specified interval of time has passed. In this way it can be used as a time source. The time interval provided by CLOCK is used as the basic unit of time in the system. An interval of 1/20 of a second is sufficient to provide the resolution necessary to perform the most complex musical passages.

The internal generation of timing is less expensive and permits the tempo of the performance to be easily varied on line. By striking the keys labeled "rit" or "accel" on the terminal keyboard, the operator can retard or accelerate the tempo of the performance by 2.5% for each stroke of the key.

The use of processor cycles to generate timing puts a great strain on the DRIVER. It must complete its work so quickly that the listener is not aware of any delay between music parts that are supposed to be occurring simultaneously. Musicians can time a musical event to within 10 ms of its desired occurrence. This imposes on the DRIVER the specification that, for worst case condi-

Command	Meaning
*E ab	Call the EDITOR and load the source text file identified by the characters ab
*C ab,cd	Load the file identified by the two character code ab and use it as input to the CONVERTER. Write the output of the CONVERTER to file cd
*P cd	Load the file identified by the characters cd. Call the DRIVER and perform the music described by the data in file cd

Table 3: A list of command verbs recognized by the system monitor. Each verb calls a system module, and its arguments specify the data file which is to be operated on by that module.

```

EDITOR
COMMAND?      N
FILE CODE?    S5
ENTER PART NO. P01
0001          "SYMPHONY NO 5 (PROKOFIEV)*****OBOE" K2- T3/4 (2.)03
0005          P02
0001          " 1st FLUTE " K2-T3/4 O3 F4 G4 A8. F16 /
0002          O4 C8. O3 B16 O4 F4 B4 /
0003          D8. E16 F4. G8 /
0004          F8 E8 D8 C8 O3 B8 O2 C8 /
0005          P03
0001          " 2ND FLUTE " K2- T3/4 . . . . . etc.
  
```

Listing 1: A sample of the dialog between the operator and the system editor as the operator enters the score fragment in figure 3. The italicized type is supplied by the editor.

ASC II KEYBOARD NEW LOOK IMPROVED DESIGN



\$58.00

This 63 key **ASC II Encoded Keyboard** kit was designed and manufactured by **Electronics Warehouse Inc.** Features: Single 5 volt D.C. supply, utilizing only TTL Logic elements (no MOS devices to blow). TTL drive capability (each of the eight bits of ASC II output will drive the equivalent of ten standard TTL inputs without external buffer drivers), de-bouncing, upper and lower case fully ASC II, 8 bit parallel. In addition to the alpha-numeric and symbol keys available on a regular keyboard, the following keys are utilized: Escape, back-space, tab, line-feed, delete, control, shift-lock, shift (2 keys), return. All 128 ASC II characters are generated.

Kit includes: 63 key keyboard, P.C. board, all required components and assembly manual with ASC II code list.

Optional: Parity bit - add 50¢ • Enclosure - \$25.00
• Serial output - add \$2.00 • 18 Pin edge connector - \$2.00 • Sockets - \$4.00

Note: If you already have this teletype keyboard you can have the kit without it for **\$39.00**. Dealer inquiries invited.

FROM CONCORD

THE FIRST FULL FEATURE



LSI DMM KIT
INTRODUCTORY PRICE:

\$77⁰⁰

Reg. Suggested Retail: \$149.00

- **AUTO RANGING**
- **AUTO POLARITY**
- **AUTO ZERO**
- **3 Large Digits (1/2")**
- **Rechargeable**

MEASUREMENT RANGES:
Voltage (AC & DC) 1 MV - 1000V
Current (AC & DC) 10 μ A - 1A
RESISTANCE 1 Ω - 10 M Ω
Basic D.C. Accuracy better than
0.1% \pm 1 Digit
Power 4 AA batteries (Rechargeable batteries optional)

NI-CAD BATTERIES: \$6.00 • AC CHARGER: \$4.95 • ENCLOSURE: \$12.95 • TEST LEADS: \$1.95 • SHUNT KIT FOR 3 CURRENT RANGES: \$4.75 • SOCKETS \$2.50

ORDERING INFORMATION

SHIPPING AND HANDLING - \$3.00 + 50¢ Insurance
California residents add 6% sales tax

ELECTRONICS WAREHOUSE Inc.

1603 AVIATION BLVD. Dept. B
REDONDO BEACH, CA. 90278
TEL. (213) 376-8005

WRITE FOR FREE CATALOG

You are invited to visit our store at the above address

tions, it must initiate an event for all 16 parts within the same period of time. For this reason great care was taken in the design of the program to ensure that its execution time is held to the minimum.

Conclusion

The functional possibilities addressed by the SCORTOS system are, of course rudimentary. In its present state it provides a foundation on which additional application programs can be built, notably a music language which treats the performer of the music as a computer and not a human. Other possibilities include a set-complex processor to analyze music and statistically model its characteristics, and a plotter interface that will draw musical scores on a plotter. Some of these programs already exist and need only be converted from FORTRAN to BASIC.

I am presently developing a macro capability that allows the user to equate a rhythm sequence to a symbol, and then associate different pitches with each note in the rhythm sequence by means of an argument list in a macro declaration.

The implications of this macro capability go further than just providing a way to eliminate redundancy. The composer often deals in "primitives" which are at a higher level than those allowed by his conventional music language. That is, the composer often thinks in terms of whole musical phrases and note groupings rather than individual notes of which he is compelled to construct those phrases and groupings. In using this higher level language, the composer is able to construct his compositions of larger building blocks and may easily vary the tonal parameters within those building blocks to achieve various aesthetic effects.

The purpose of the SCORTOS system project is to foster computer implemented composition among individuals and institutions whose financial and talent resources have prevented them from undertaking such projects in the past. Over the years various projects of this nature have been conducted at the larger educational centers of the country. The adoption of these projects by individuals and poorer institutions has not been widespread due to the large hardware costs involved, or lack of programming experience within the music departments. I hope that more modestly endowed music institutions will respond to a turnkey installation costing less than \$10,000, and that we may shortly see the computer joining the synthesizer and tape recorder as standard equipment in every electronic music studio. ■

What is the equivalent of the LIN(x) command, the GO TO...OF... command, the PRINT USING, and the IMAGE statements used in the program as listed? Also, when the program is compiled in VM 370 BASIC, lines 1520, 1600, 3370 and 3600 give the error message "NO. OF DIMENS. INVALID"; line 140 gives a "SYNTAX ERROR IN EXPRESSION: message. Can you suggest revisions to eliminate the problems and tell me where to get hold of a VM 370 BASIC manual?

Glenn Bultmann
2218 E Gatehouse Dr
Metairie LA 70001

LIN(x) is a built-in function in the BASIC version used by David Price, a function which is used for formatting control on the terminal. Its semantics are most likely: "advance the terminal by x lines."

PRINT USING and IMAGE are related statements, used to establish a format for output similar to the FORTRAN "FORMAT" statement in the version of BASIC used in David Price's article. The manual for VM 370 would have to be consulted to find the equivalent, or you could dispense with formats entirely (and get a much cruder output) by using PRINT instead of

PRINT USING as a temporary measure.

The GO TO...OF... is the logical equivalent of a computed GO TO in FORTRAN, and probably exists also in the VM 370 BASIC. If you must implement it yourself, the semantics should be satisfied by a series of "IF" statements, as in the following conversion of line 780 of listing 1 of David Price's article, page 107 of the March 1977 BYTE:

New Line 720 code...

```
IF A+1 = 1 THEN GO TO 890
IF A+1 = 2 THEN GO TO 1520
IF A+1 = 3 THEN GO TO 1640
IF A+1 = 4 THEN GO TO 1800
IF A+1 = 5 THEN GO TO 2200
IF A+1 = 6 THEN GO TO 3010
IF A+1 = 7 THEN GO TO 3550
```

Of course, this example could be made more efficient by calculating the expression A+1 first and assigning its value to a variable; to avoid picking another variable name, we show this version of the logic.

The problems with lines 1520, 1600, 3370 and 3600 are due to the fact that the program as written by David Price uses a "substring" feature of the BASIC version he has access to. The notation A\$(x,y) is (from the context of the version of the program we printed) a reference to the characters in string A\$ starting at location x and extending to

location y. Thus if A\$ = "ANYTHING" then A\$(3,5) has the value "YTH" by this interpretation. No simple conversion is possible; however, you can often achieve the same effect by using a FOR...NEXT loop scanning the required range of characters within the string and referencing the characters one at a time using A\$(I) as a form which is most likely allowed in the VM 370 version of BASIC. (Check the manual on this, and possibly use an alternate substring notation if it exists). As for line 140, figuring out why it gives a syntax error would require reference to the manual; however, noting that many times exponentiation is indicated by a double asterisk (**) one likely place to start would be by replacing the up arrow exponentiation symbol by a double asterisk. (This symbol is the upward pointing caret (^) seen in line 140 as printed in March 1977 BYTE).

As for getting hold of the manual for VM 370 BASIC, the most likely place to start is a trip to the computing center which supports your terminal. Most computing centers for timesharing networks have some form of user accessible documentation library. Alternately use the formal channels at your center to order a manual from IBM, or contact IBM yourself. The company is usually only too happy to satisfy such requests for documentation, and the charges are nominal. ■

World's Lowest IC Prices

* SPECIAL PRICES *

MEMORIES

Rams	
74S200	2.95
2102	1.40 *
2102-1	1.80 *
Proms	
82S23/S123	1.95 *
82S129	3.25
Others	
TMS 3409	2.00
MM 5013	1.50
NS 5260	1.50
NS 8619	2.00
MH 0026H	3.25

TTL

7400	.12 *
7402	.14
7403	.14 *
7404	.16 *
7407	.20
7410	.12 *
7416	.25
7420	.12 *
7427	.25
7437	.20
7438	.20 *
7440	.12 *
7441	.65 *
7445	.60

7447	.65 *
7450	.14
7451	.14 *
7473	.28
7474	.28
7475	.40
7480	.35 *
7483	.68
7486	.28
7490	.45
7493	.44 *
7495	.49
74107	.29
74109	.30
74116	1.50
74123	.45 *
74141	.80 *
74145	.65 *
74150	.60 *
74151	.60
74152	.90
74155	.60
74157	.60
74160	.75
74161	.60 *
74163	.75 *
74165	.80

SCHOTTKY

74S01	.25
74S02	.25
74S37	.40
74S38	.60
74S85	2.00
74S113	.80
74S138	1.50
74S139	1.50
74S140	.50
74S151	2.00
74S153	2.50
74S172	4.50
74S174	2.05
74S175	2.05 *
74S181	2.95
74S197	2.20
74S257	1.50

LINEARS

DM8820/30	1.75
NE536T	2.75
NE555V	.43
NE556A	.90
1456V	.75
1458V	.52
566V	1.25
567V	1.35
540L	2.00

HIGH SPEED

74H00	.20
74H01	.20
74H04	.20
74H10	.20
74H11	.20
74H40	.20
74H51	.20
74H52	.20
74H74	.40
74H103	.50
74H106	.50

CMOS

4001	.16
4002	.16
4006	.90
4007	.16
4008	.70
4011	.16 *
4012	.16 *
4013	.30 *
4015	.80
4016	.35 *
4019	.70
4020	.90
4021	.95
4023	.16 *
4025	.20 *
4027	.40
4028	.60
4030	.35
4040	.95
4042	.60
4043	.75
4044	.70
4049	.35 *
4050	.35 *
4066	.65
4068	.35
4071	.16

4073

4073	.16
4075	.16
4516	.85
4528	.75

LOW POWER

SCHOTTKY	
74LS00	.23 *
74LS02	.23 *
74LS08	.23 *
74LS10	.23 *
74LS27	.25 *
74LS73	.45
74LS75	.85
74LS151	.75 *
74LS153	.75 *
74LS157	.75 *
74LS161	1.00 *
74LS163	1.50
74LS164	1.50
74LS174	1.00 *
74LS175	1.50
74LS193	1.50
74LS221	1.25 *
74LS251	1.50
74LS253	1.50
74LS257	1.25 *
74LS258	1.25 *

Order Minimum \$10.00 Add \$1.00 shipping and handling charge per order California residents add 6.5% sales tax All orders shipped First Class within 24 hours

Order the famous lasis 6 volume Programmed Learning Course "Microcomputer Design is a Snap" for \$99.50 and receive a special \$10.00 credit on any group of IC's.

Satisfaction 100% guaranteed.

C.O.D. Orders: Phone (day or night) 408/354-1448

ELTRON

PO BOX 2542B
Sunnyvale, CA 94087

Free catalog—Just send us your name and address

What's New?

A Self Refreshing 4 Channel Digital to Analog Converter

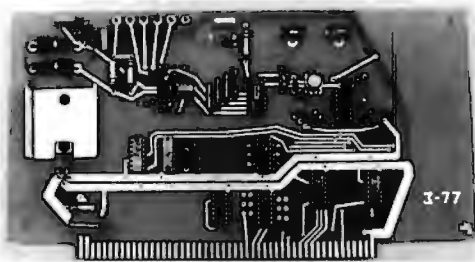

Pinnacle Products has announced a self-refreshing 4 channel digital to analog converter that is Altair bus compatible. Instructions are included for alternate connection to Digital Group Systems. Features include complete output port address decoding and a 3 state bus connection. The converter has eight bits of resolution and can be set to cover any range within -10 to 10 V. It oper-

A New Personal Computing Catalog



A Timely Kit for HP-45 Owners

Egbert Electronics, 1514 S 320 East, Orem UT 84057, has announced a new kit to improve the accuracy of the stopwatch function on the HP-45 calculator. As most owners of the unit know by now, the HP-45 can be turned into a stopwatch by first pressing RCL, and then simultaneously pressing CHS, 7 and 8. The kit provides a quartz crystal to stabilize the internal oscillator, plus associated electronics. Kit price is \$13. Egbert Electronics will do the installation for \$23. ■

The Noval 760 Operating Manual

Noval Inc, 8401 Aero Dr, San Diego CA 92123, (714) 277-8700, has completed the first edition of the *Noval 760 Operating Computer Operating Manual*. This 1 inch (2.5 cm) thick loose-leaf manual is available by itself for \$20. The manual describes hardware characteristics of available modules, as well as the software of the firm's interactive assembly and editing system, BASIC interpreter, and utility routines.

This computer was developed by Gremlin Industries for in-house use as a design system for video arcade game and educational software, and should make an excellent option for many readers interested in graphics and complete systems with "turn key" characteristics. Use the manual alone if you want to investigate what this system package contains. ■

Circle 647 on inquiry card.

ates at a rate of 50,000 conversions a second, updating the four sample and hold outputs from a scratch pad register. Circuit operation as seen from the computer is completely static; no software refresh or wait states are required. A 4 byte computer program is used to set up the unit.

The printed circuit board alone sells for \$34. The complete kit is \$69, and the assembled and tested board is \$99. Contact Pinnacle Products, POB 3155, Talcottville CT 06066. ■

Circle 646 on inquiry card.

A New Wire Dispenser-Stripper for Wire Wrap and Other Applications

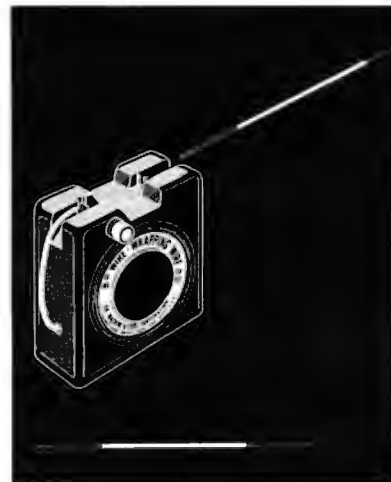

A new wire dispenser from OK Machine and Tool Company, 3455 Conner St, Bronx NY 10475, combines cutting and stripping ability in one unit. Wire is drawn out of the dispenser to the desired length, cut with the built-in plunger, and pulled through the stripping blades. Dispenser includes 50 feet (15 meters) of AWG 30 insulated solid copper wire available in four colors. People who use conventional wire wrap will find this to be an excellent addition to the tool kit. ■

Circle 648 on inquiry card.

Data General Enters the Personal Computing Market

The Computer Store, a chain of retail personal computer outlets in the Northeast, has announced that they will be distributing the entire line of Data General's Micro-NOVA microcomputers, peripherals and software.

Free catalogs are now available from The Computer Store, 120 Cambridge St, Burlington MA 01803, which describe the full line of products, including expansion memories and interfaces; DOS, RTOS, BASIC, FORTRAN and development software; the DASHER matrix printer and the 6000 line of video terminals. ■

Circle 649 on inquiry card.

Digital Equipment's Comments on the Heathkit H11

The following information was received from Digital Equipment Corporation, one party to the synergistic twosome of Heath Company and DEC.

Digital Equipment Corporation announced the signing of a multimillion dollar contract for LSI-11 microcomputers and related products by Heath Company, a subsidiary of Schlumberger, Ltd. The microcomputers, to be delivered over a 3 year period, will be incorporated into Heath's H11 computer



Circle 653 on inquiry card.

NEW!

ELECTRONIC TOUCH ORGAN KIT

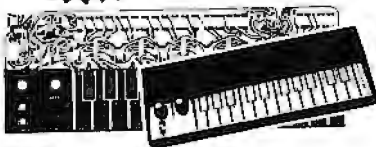

Fantastic new design uses CMOS I.C. and a total of 39 semi-conductors to give a touch control keyboard, all the electronic parts in one PC Board. This organ is easy to build, yet has features like a full two-octave range touch keyboard, variable tremolo; two voices; built-in I.C. amplifier with volume control, complete with speaker and a specially designed plexi-glass case.

BATTERIES NOT INCLUDED *Ideal kit for beginner or gift for children

\$24.50 ea.

SLIM LINE CALCULATOR

6 Functions with % and memory
8 Digits LED display
*One full year guarantee
Special Price Only
\$8.50 Ea.



BATTERIES NOT INCLUDED

CALCULATOR with STOPWATCH

6 Functions with % and memory
8 Digits big green display
*Built-in X'tal controlled stop watch count to 1/10 of a second.
Special Price Only
\$16.50 Ea.



BATTERIES NOT INCLUDED

I.C. TEST CLIPS

Same as the E-Z clips
With 20" Long Leads
In Black and Red Colors
\$1.75 Per Pair



5W AUDIO AMP KIT

2 LM 380 with Volume Control
Power Supply 6-18V DC
only \$5.00 ea.



Multi-Color LED Indicator

Red-Green Colors in one LED
with Plastic Housing
29¢ Ea.
Voltage 2V 20 MA per LED



TIMER KIT

Time Controlled from 1-100sec.
Ideal to be used as time delay unit for burglar alarm, photo service, and other purposes.
Max. leading 110V, 2 AMP.
Supply voltage 12-18V D.C.
\$11.50 each



PT-88 ELECTRONIC IC TIMER

ELECTRONIC ALARM SIREN

COMPLETE UNIT
Ideal for use as an Alarm Unit, or hook-up to your car back-up to make a reverse indicator Light Output up to 130 dB.
Voltage Supply 6-12V
\$7.50



AU-599

19 KEY HEXADECIMAL KEY PAD

• 1-0 • Homekey
• ABCDEF • ←→ Key
SPECIAL \$10.50 ea.



Low Cost Hexadecimal 16 Key Pad

Designed for Calculator
Can be used for Computer Data Entry Pad or Digital Lock
All key tops blank with super good touch feeling. **\$0.95 ea.**



DIGITAL ELECTRONIC LOCK KIT

for auto ignition, entry door, burglar, alarm, etc.
CMOS I.C. 4 Digits Programmable to IN CIRCUIT Any Combination
\$6.50 ea.



400A RELAY AND KEY PAD NOT INCLUDED

POWER SUPPLY KIT

0.35V D.C. REGULATED
Uses UA723 and ZN3055 Power TR output can be adjusted from 0.35V, 2 AMP. Complete with PC board and all electronic parts.
0.35 POWER SUPPLY **\$9.50 each**
Transformer for Power Supply, 2 AMP 24V **\$3.90 ea.**



MA1003, 12V DC CLOCK MODULE

Built in X'TAL controlled time base. Protected against automotive volt transients. Automatic brightness control with 0.3" green color display. Display turnoff with ignition "OFF"



\$23.50 EACH

EDGE CONNECTORS (IMSMA1 Type)

Dual 50 (100 pin)
0.125 spacing wire-wrap
\$4.50 EACH



DB25 Type CONNECTOR

Male **\$3.40 each**
Female **\$3.75 each**
Plastic Housing for Connector **\$1.00 each**

MULTI-COLOR RIBBON CABLES

Type	Conductors	AWG	Price Per Ft.
A	18	20	0.40
B	12	24	0.40
C	18	24	0.45
D	26	26	0.50
E	13	30	0.25
F	22 prs.	26	0.40

red/white twisted prs.
(over 50 ft. per type—less 15%)

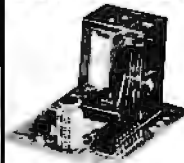

ELECTRONIC SWITCH KIT

CONDENSER TYPE
Touch on Touch Off
use 7473 I.C.
and 12V relay
\$5.50 each



FM WIRELESS MIC KIT

Transmit range up to 100 ft.
Easy to assemble
(Mic Included)
\$4.50 each

Sub-Mini Size
Condenser Microphone
\$2.50 each
FET Transistor Built-in

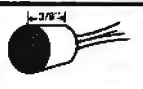

SIGMA 78RE1, 12DC RELAY
400Ω COIL SPDT
\$1.30 ea. or 10 for \$10.00
ALL BRAND NEW UNITS



Computer Grade Capacitors

5600	MFD	6V	\$2.20 ea.
15,500	MFD	75V	\$4.95 ea.
39,000	MFD	12V	\$2.00 ea.
100,000	MFD	6V	\$3.50 ea.



QUARTZ CRYSTALS

1 MHZ **\$4.95**
2 MHZ **\$5.25**
4 MHZ **\$5.25**
10 MHZ **\$5.25**
3.679 MHZ **\$1.25**
Color TV Type



CB MICROPHONE

500 MIC for CB Unit
Talk Switch with Connector and Cord
\$2.50 each
CLOSE OUT SALE



TV GAME MODULATOR UNIT

FCC Approved
For channel 3 and 4
With Osc. Coil



ONLY \$4.50

TI 1985
Alternative AY39500-1
8 Game (28 Pin Dip)
TV Game Chip with Data
Tennis Squash hockey,
practice & 2 shooting.
Special Only **\$11.00**
PC Board for TV same with Data **\$2.50 ea.**
Switch Box between Game & TV **\$1.25 ea.**

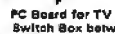

TV Games

Direct Sales Only
\$29.50
FEATURES:
• 4 Games—Tennis, Hockey, Racquet Handball and Single Handball.
• Auto counter display on the screen.



CLOCK KIT MOST POPULAR MM5314 KIT

WITH A NEW CASE !!
Features: 12 24 Hour Display
50 80 HZ Input & Digit Readout
K.I.T. Includes: Grey Color Plastic Case
MM5314 Clock Chip PC Board and Trans
former, 6 Green Color 0.3" Tube Readouts.
All other Transistor Drivers and other Components
Special Only **\$14.95 ea.**



SAE DIP SWITCHES

Part No 100A 692 4XSPST SW
100B 692 8XSPST SW
4 Toggle SPST Switches on a Mini DIP
18 pins Only **\$1.50 ea.**
3 Toggle SPST Switches on a DIP
16 pins Only **\$2.60 ea.**



MINI-MINI TOGGLE SWITCH

Half size of standard toggle switch
rated 3 amp 125V AC contact
1-9 10-99
MS-2432P SPST 0.90 0.90
MS-2432 0.90 0.90
MS-245 DPDT 1.20 1.10
LARGE QUANTITY AVAIL FOR OEM



WIRE WRAPPING TOOL

\$33.50
Wire Wrapping in Bulk
100' **\$2.00**
500' **\$8.50**



Sub Mini Size PANEL METER

500 UA
ONLY \$1.20 ea.



MATCHED PAIR POWER TRANSISTORS

MOTOROLA MJE2955 PNP
MJE3055 NPN
10 AMP 60 VOLT 90 WATTS
\$2.25 PER PAIR



TRANSFORMERS

24V CT (12-0-12V)
800 MA **\$2.25 ea.**
12 or 24V 2 amp Output
\$3.90 each



AC POWER SUPPLY

Adapter Type Transformer
12V AC Output 200 MA
\$2.75 each
8V DC Output 130MA **\$1.80 ea.**
8.7V DC Output 130MA **\$1.80 ea.**
12V DC Output 100MA **\$1.80 ea.**



4 Digits Alarm Clock

LT701E, 60Hz 12 hr display
1.701E, 60Hz, 24 hr display
Power Supply 12V AC
Ideal for panel clock, desk clock,
or auto clock without time base
\$13.50 EACH



50 UA PANEL METER

First choice for metal
Ruler (higher than 0-10)
but can be brass and your
own scale just on the brand
new in box
Only \$3.60 ea.



SUBMINIATURES TOGGLE SWITCHES

SPDT On-Off **\$1.30 ea.**
DPDT On-Off **\$1.90 ea.**
SPDT On-Off **\$1.75 ea.**
Mini-Size Rocker Type
Also Available in the Same Price



JOY STICK

4 100K Volume pot in one
unit, vary resistance
around to the angle of
the stick Perfect for elec-
tronic games or model ra-
dio control



only \$7.50

PUSH-BUTTON SWITCH

N/Open Contact
Color: Red, White, Blue,
Green, Black. **4/\$1.00**
N/Close also
Available **50¢ ea.**
LARGE QTY. AVAILABLE



SOLID STATE ELECTRONIC BUZZER

Mini Size 1" 3" 4" 4"
Supply voltage 1.5V-12V
Ideal for Alarm
or Tone Indicator
\$1.50 each



MINIMUM ORDER \$10.00. California residents add 6% sales tax.
All orders add 10% postage for out of state. Overseas countries add 15% of total order for postage.
SEND CHECK OR MONEY ORDER TO

9/77



FORMULA INTERNATIONAL INC.

12603 CRENSHAW BOULEVARD • HAWTHORNE, CALIFORNIA 90250

For more information please call (213) 679-5152

STORE HOURS 10-7 Monday - Saturday



kits, which will be marketed primarily for hobby, personal and small business applications via Heath's 50 stores and mail order catalog. The contract includes a licensing arrangement providing use of assembly and higher level programming languages such as PAL-11, ED-11, FOCAL and BASIC with the H11 computer.

Digital's microcomputer forms the central element of each H11 computer. Each is a full computer on a board with the operating characteristics of a standard PDP-11 16 bit minicomputer. Currently there are over 10,000 LSI-11s in use in a variety of applications ranging from scoreboard animation to complex medical instrumentation.

The H11 represents the top of Heath's line of computer kits. It is priced at \$1,295 and is scheduled for shipment this fall.

The LSI-11, unlike most other microcomputers, has a central processor with a full 16 bit word length. It comes with built-in memory of 4,096 word (8,192 byte) capacity. Console operations are microcoded so a terminal can be used for program control and debugging.

The instruction set of the LSI-11 is virtually identical to that of other PDP-11 computers, such as the PDP-11/34. Thus, sophisticated program development is achievable with the Heath H11.

Purchasers of the H11 will be eligible to join DECUS (the Digital Equipment Computer Users Society). DECUS functions as a clearing house for more than

28,000 members worldwide who wish to exchange programs and information. "DECUS holds special symposia and publishes a journal. The DECUS library contains over 800 programs designed for the PDP-11 family of computers, many of which were developed for or can run on the LSI-11," he said.

Circle 654 on inquiry card.

A New Bar Code Reader

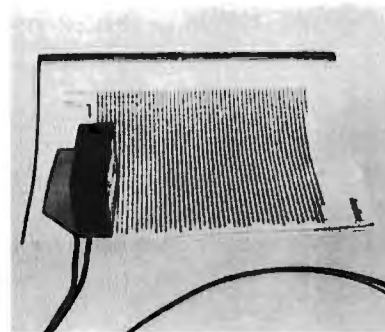

Here is one answer to the question, "Where can I buy a bar code reader to read the bar code listings published in BYTE?". Jeffersonville Engineering Co, 605 E 10th St, Jeffersonville IN 47130, phone (812) 288-8246, has announced its new bar code reader. Priced at \$39.95, the unit outputs +5 V on a bar and 0 V on a space; timing and translation are software dependent. 6502 and 8080 software is said to be currently available for use with the unit.

The company can also print bar code versions of customers' software. Contact them for further details. ■

Circle 655 on inquiry card.

A New Chip on the Block

We received an interesting preliminary product description for a television raster scan display controller recently, sent in by a gentleman at SMC Microsystems Corporation, 35 Marcus Blvd, Hauppauge NY 11787. The product involved is a 40 pin N-channel MOS LSI device called the CRT 5027 Video Timer-Controller.

This device will be of some interest to those homebrewers and designers who are interested in a minimum hassle path to a raster scan display (where minimum is relative to homebrewing the same logic out of SSI and MSI parts).

What this device does is establish all frame formatting, character scanning and sync timing for a video display (with the single exception of the dot address counter which cannot be practically implemented in MOS integrated circuits). The video display functions use seven 8 bit control registers connected to a bi-directional byte oriented data bus with appropriate select lines allowing easy integration in the typical microprocessor system. The boxes entitled "Operation" and "Additional Features" accompanying this note are copied from page 3 of the SMC document, and summarize the salient features of the product.

Persons interested in seriously pursuing homebrew (or commercial) designs with this device are advised to write SMC for a copy of the brochure. Who will be the first reader to homebrew a high resolution graphic display using this chip for timing, about 16 K bytes of memory, and a good black and white monitor? Find out when (sooner or later) the task is accomplished and a construction project is documented as an article. ■

Circle 631 on inquiry card.

Operation

The design philosophy employed was to allow the device to interface effectively with either a microprocessor based or hardware logic system. The device is programmed by the user in one of two ways: via the processor data bus as part of the system initialization routine, or during power up via a PROM tied on the data bus and addressed directly by the Row Select outputs of the chip (See figure 4). Seven 8 bit words are required to fully program the chip. Bit assignments for these words are shown in Table 1. The information contained in these seven words consists of the following:

Horizontal Formatting	
Characters/Data Row	A 3 bit code providing 8 mask programmable character lengths from 20 to 132. The standard device will be masked for the following character lengths, 20, 32, 40, 54, 72, 80, 96, and 132.
Horizontal Sync Delay	3 bits assigned providing up to 8 character times for generation of "front porch"
Horizontal Sync Width	4 bits assigned providing up to 16 character times for generation of horizontal sync width
Horizontal Line Count	8 bits assigned providing up to 256 character times for total horizontal formatting.
Skew Bits	A 2 bit code providing from a 0 to 2 character skew between the horizontal address counter and the horizontal blank and sync signals to allow for realiming of video data prior to generation of composite video signal. The Cursor Video signal is also skewed as a function of this code.
Vertical Formatting	
Interlaced Non-interlaced	This bit provides for data presentation with odd/even field formatting for interlaced systems. It modifies the vertical timing counters as described below.
Scans/Frame	8 bits assigned, defined according to the following equations: Let X = value of 8 assigned bits. 1) in interlaced mode—scans/frame = $2X + 513$. Therefore for 525 scans, program X = 6 (00000110). Vertical sync will occur precisely every 262 1/2 scans, thereby producing two interlaced fields. Range = 513 to 1023 scans/frame, odd counts only. 2) in non-interlaced mode—scans/frame = $2X + 256$. Therefore for 26L scans, program X = 3 (00000011). Range = 256 to 768 scans/frame, even counts only. In either mode, vertical sync width is fixed at three horizontal scans (3H).
Vertical Data Start	8 bits assigned providing scan line resolution in vertical data positioning with respect to vertical sync. The Data Row Counter is reset at vertical sync and will not begin counting until the scan line selected by these eight bits.
Data Rows/Frame	6 bits assigned providing up to 64 data rows per frame
Last Data Row	6 bits to allow up or down scrolling via a preload defining the count of the last displayed data row.
Scans/Data Row	4 bits assigned providing up to 16 scan lines per data row.

Additional Features

Device Initialization

Under microprocessor control—The device can be reset under system or program control by presenting a $\beta 111$ address on A β -3. The device will remain reset at the top of the even field page until a start command is executed by presenting a $\beta 111$ address on A β -3.

Via Self Loading —In a non-processor environment, the self loading sequence is effected by presenting and holding the 1111 address on A β -3, and is initiated by the receipt of the strobe pulse (DS). The 1111 address should be maintained long enough to insure that all seven registers have been loaded (in most applications under one millisecond). The timing sequence will begin one line scan after the 1111 address is removed. In processor based systems, self loading is initiated by presenting the 111 β address to the device. Self loading is terminated by presenting the start command to the device which also initiates the timing chain.

Scrolling—In addition to the Register 6 storage of the last displayed data row a scroll command address 11 β 1 presented to the device will increment the first displayed data row count to facilitate up scrolling in certain applications.

TERMS: Prices good through 9/30/77. Orders under \$10 add 50¢. Please include up to 5% for shipping; excess refunded (may be more with item like power supply). Californians add tax. CODs accepted with street address.

the GODBOUT GAZETTE

Bill Godbout Electronics
PO Box 2355 Oakland CA 94614

CREDIT CARD ORDERS / 24 HOUR ORDER DESK: Place BankAmericard®/Mastercharge®/Visa® charge card orders (\$15 minimum) by calling (415) 562-0636, 24 hours. By the way, do you have our flyer? You probably should.

GODBOUT'S INTRODUCES 24K OF MEMORY FOR \$450; HOBBYISTS REJOICE!

INCLUDES STATIC DESIGN, TRI-STATE OUTPUTS, S100 BUSS COMPATIBILITY

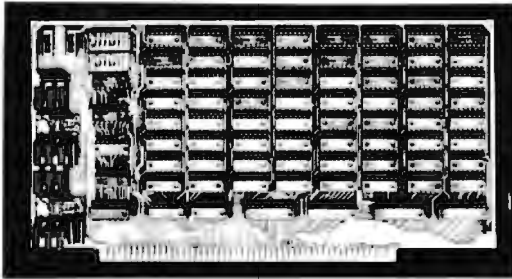

EXCLUSIVE TO THE GAZETTE

It is now possible to purchase three 8K Econoram II™ boards for \$450. A single 8K board, the fastest selling computer kit in Godbout's history, is still available for \$163.84.

"We wanted to make it possible for the computer hobbyists to stuff a lot of memory into their machines at a reasonable price", Bill Godbout is quoted as saying today. Judging from the response, he seems to have succeeded.

However, a representative for the company stressed that price was not the only attractive feature of this board, citing the low current consumption (1.5A guaranteed, 1250 mA typical) and high speed (0 wait states). For users of 2-8u processors driven by a 4 Mc clock, there is even on-board logic for implementing 1 wait state.

He added, "the vector interrupt feature, which lets you know if you are trying to write

into protected memory, is very handy. Also, the board was designed to be configured as two, separately addressable 4K blocks which adds considerably to the versatility."

A poll of users, undertaken by Godbout's, shows that hobbyists are pleased by the all-static design, which eliminates dynamic timing problems. Others find the tri-state outputs, and fully buffered inputs and outputs, to be their favorite features. All agree that the quality is exceptional, from the legendary and solder masked board to the low profile sockets.

Those wishing to take advantage of the special 3/5450 offer should ask for #SPC-24. The standard 8K board (\$163.84) is stock number CK-008; an assembled version, #CK-010, is available for \$188.50. A 4K version of the board costs \$100 in kit form (#CK-007) and \$120 assembled (#CK-009).

Energy Crisis Hits Home

Computer owners from coast to coast have complained of a lack of available energy for their computers. The problem lies not with power generating stations, but rather with the shortage of compact, low priced power supplies capable of providing the many voltages required by micro-processing systems. Experimenters also report being frustrated by the lack of power supplies.

However, the Gazette has confirmed existence of a solution to this energy crisis. Our highly placed source, nicknamed "deep volt", has located the following information about a "CPU Power Supply", also known by its stock number (#CK-014).

"The unit appears to be a well thought out supply, which delivers 5V @ 4A with crowbar over-voltage protection, along with 1/2 Amp of +12V and 1/2 Amp of -12V. A particularly sneaky feature is an adjustable 10 mA bias supply, required by some CPUs, that is often not included in other units. Those who say there are no economical power supplies for small systems are in for a shock as the price is a mere \$50.

"Despite rumors of a power supply energy crisis, with wildly inflated prices forced on a public with no other choice, it seems that the Godbout CPU Power Supply should lay these misconceptions to rest permanently."

MOTHERS SAFE FROM BUSS POLLUTION

Many motherboards have reported flu-like symptoms (coughing, sneezing, dropping bits, scrambling data) when loaded with more than a few peripheral boards. It seemed that these motherboards lacked antibodies capable of rejecting noise, crosstalk, overshoot, etc. This is commonly called "buss pollution".

However, it was discovered that a particular group of motherboards, located in the wilds of the Oakland Airport, had developed an immunity to buss pollution.

It seemed these motherboards had active termination circuitry, and that's what accounted for the difference. Old motherboards may be immunized by simply plugging in an Active Terminator Network (#CK-017, \$29.50).

Or, if you want a new motherboard, Godbout's has two --- both with active terminations, lots of bypass caps, and heavy PC board traces:

#CK-015, a 10/11 Slot Motherboard, comes with 10 edge connectors and is excellent for adding on to small systems. \$90.00
#CK-016, an 18 Slot Motherboard, includes 18 edge connectors and is ideal for starting a stand-alone system. \$124.00

Processor Prices Plummet

The workhorse 8080A, darling of the chip set, has reached a new low in pricing. Prime, new full spec units cost only \$12.95 regardless of quantity purchased when you order part #SPC-22.

In a parallel development memory prices continue to drop. Full speed 2708s are now available for \$25.00; order part #SPC-23.

COMPUTER STRIKE AVERTED

Things looked tough at the negotiating tables located at computer stores throughout the country. The heart of the problem was a common computer grievance: having to shuttle programs in and out of their RAMs, thus hampering their productivity, and tying up work for hours at a time. Computers also complained of abuse at the hands of owners, who became enraged when programs went down the drain if the power went off for even a split second.

When the Godbout team of negotiators arrived on the scene, the computers showed a new spirit of compromise. After all, many of them had Godbout memories inside their cases---and computers are known for their loyalty.

The solution: the computers would go on working, if the owners plugged Godbout Econoram II™ boards into their systems. Then, they wouldn't have to worry about losing their minds if the power went away, because Econorams hold programs and routines in erasable read only memory. So that owners wouldn't face undue hardship due to the extra expense Godbout's introduced several different boards, of various price levels and complexities. All of them feature 1K of static RAM as part of the memory; all of them are compatible with the S-100 buss used by Altair, IMSAI, and many others. They can be programmed by the Godbout Programming Service, or may be shipped unprogrammed.

Many computers, however, specifically suggested the 8080 software board. This 4K Econoram II is programmed with editor and assembler routines for the 8080, very much like the old Econoram; but this newer version has improved listings, which are a natural for getting any 8080 system up and running. For the benefit of any computers who did not receive word of the strike settlement, listed below are the boards offered by Godbout's:

#CK-002 (Smaller) Econoram II™, 2K X 8 of ROM.....\$195.00
#CK-003 (Basic) Econoram II™, 4K X 8.....\$250.00
#CK-004 (Bigger) Econoram II™, 8K X 8, configured as two separate 4K blocks.....\$350.00
#CK-005 8080 Software Board A valuable first step in breaking away from machine language programming.....\$265.00

TANTALUMS PICKED TO CLICK

Tantalum capacitors, long a favorite of industrial contractors where price is no object, are famous for their low series resistance. Now, Godbout's is making them available to the electronics hobbyist at popular prices. The list below shows all tantalum capacitors known to be in existence at the Godbout warehouse.

#CT0.47U	.47 uF 35V	4/\$1.00
#CT2.2U	2.2 uF 20V	4/\$1.00
#CT2.7U	2.7 uF 20V	4/\$1.00
#CT3.3U	3.3 uF 15V	4/\$1.00
#CT4.7U	4.7 uF 10V	4/\$1.00
#CT22U	22 uF 10V	3/\$1.00
#CT33U	33 uF 10V	3/\$1.00
#CT39U	39 uF 10V	3/\$1.00
#CT47U	47 uF 10V	3/\$1.00

(advertisement)



Scientists discover missing link

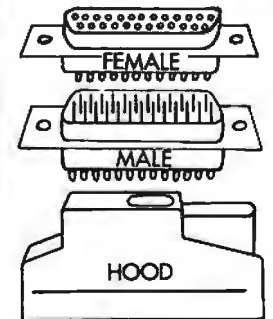

Scientists have long puzzled over the "missing link" between computers and the outside world. Many have searched for this missing link, known in scientific circles as the DB-25 connector.

Extensive diggings at a certain manufacturer have resulted in the finding of this missing link by Godbout's trained researchers. They have isolated this missing link into three actual links, each of which performs a needed function in the crucial computer/outside world interface.

#CK-1004 - DB25P 25 pin RS-232 connector, sub mini D type, male plug with plastic hood. \$3.95
#CK-1005 - DB25S 25 pin RS-232 connector, sub mini D type, female jack. \$3.95
#CK-1006 - DB25H plastic hood, which slips over the male plug to keep dust and glop from gumming up your connector. \$0.90

PARTS FORECAST

A cooling trend is forecast, with the warm TTL front being weakened by cooler, lower power ICs such as CMOS and low power Schottky. As this colder front moves in, we can expect lower prices and decreased emphasis on musky power supplies.

Low Power SCHOTTKY

CMOS

4000	\$0.25	4037	0.50
4001	0.29	4040	1.50
4002	0.34	4041	0.85
4007	0.29	4042	0.85
4008	1.28	4043	0.60
4009	0.53	4044	0.60
4010	0.53	4047	1.63
4011	0.29	4049	0.50
4012	0.29	4050	0.50
4013	0.50	4051	1.03
4014	1.25	4052	1.03
4015	0.90	4053	1.03
4016	0.45	4060	1.48
4017	1.25	4066	0.58
4018	0.55	4069B/	
4020	1.50	74C04	0.33
4021	1.23	4070	0.60
4022	1.20	4071	0.33
4023	0.29	4073	0.33
4024	1.05	4075	0.33
4025	0.29	4076B/	
4027	0.75	74C173	1.63
4028	1.00	4081	0.33
4029	1.73	4116	0.50
4030	0.53	14511	2.00
4033	1.50		

74LS00	\$0.30	74LS151	0.95
74LS01	0.30	74LS155	1.38
74LS02	0.30	74LS157	0.95
74LS04	0.33	74LS164	1.40
74LS08	0.36	74LS161	1.40
74LS10	0.30	74LS162	1.40
74LS11	0.36	74LS163	1.40
74LS12	0.33	74LS168	1.87
74LS14	1.38	74LS169	1.87
74LS15	0.30	74LS173	1.65
74LS20	0.30	74LS174	1.25
74LS21	0.33	74LS175	1.15
74LS22	0.33	74LS195	1.30
74LS26	0.43	74LS240	1.88
74LS27	0.36	74LS257	1.25
74LS30	0.30	74LS258	1.25
74LS32	0.38	74LS266	0.53
74LS37	0.45	74LS283	1.20
74LS38	0.45	74LS365/	
74LS42	0.98	80LS95	0.75
74LS47	1.00	74LS366/	
74LS48	0.98	80LS96	0.75
74LS74	0.50	74LS367/	
74LS75	0.68	80LS97	0.75
74LS76	0.50	74LS368/	
74LS86	0.50	80LS98	0.75
74LS109	0.50	74LS386	0.55
74LS125	0.63	81LS95	1.15
74LS126	0.63	81LS96	1.15
74LS132	1.25	81LS97	1.13
74LS138	1.10	81LS98	1.13
74LS139	1.15		

CRYSTALS

THESE FREQUENCIES ONLY!

Part #	Frequency	Case/Style	Price
CY1A	1.000 MHz	HC33-U	\$5.95
CY2A	2.000 MHz	HC33-U	\$5.95
CY2 (D)	2.010 MHz	HC33-U	\$1.95
CY3A	4.000 MHz	HC18-U	\$4.95
CY7A	5.000 MHz	HC18-U	\$4.95
CY12A	10.000 MHz	HC18-U	\$4.95
CY14A	14.31818 MHz	HC18-U	\$4.95
CY19A	18.000 MHz	HC18-U	\$4.95
CY22A	20.000 MHz	HC18-U	\$4.95
CY30B	32.000 MHz	HC18-U	\$4.95

XR-2206K KII \$29.95 Special XR-2206KA KII \$19.95

EXAR

WAVEFORM GENERATORS

XR-205	\$9.40	XR-555CP	\$ 39
XR-2206CP	4.49	XR-320P	1.55
XR-2207CP	3.85	XR-556CP	1.85

MISCELLANEOUS

XR-2211CP	\$6.70	XR-2240CP	3.25
XR-4138	99	PHASE LOCKED LOOPS	
XR-1310CP	\$3.20	XR-1400	\$3.85
XR-1310EP	3.20	XR-1400	\$4.25
XR-1820P	3.20	XR-1400	3.80
XR-2567	2.99	XR-2206	5.20
		XR-567CT	1.70

CONNECTORS

PRINTED CIRCUIT EDGE-CARD

156 Spacing - Tin-Double Read-Out

Bifurcated Contacts - Fits .054 to .070 P.C. Cards

15/30	PINS (Solder Eyelet)	\$1.95
18/36	PINS (Solder Eyelet)	\$2.49
22/44	PINS (Solder Eyelet)	\$2.95
50/100	PINS (Wire Wrap)	\$6.95
50/100A (1.00 Spacing)	PINS (Wire Wrap)	\$8.95

25 PIN-D SUBMINATURE

DB25P	PLUG	\$3.25
DB25S	SOCKET	\$4.95

IMC 3 1/2 DIGIT DVM KIT

This 0-2 VDC .05 per cent digital voltmeter features the Motorola 3 1/2 digit DVM chip set. It has a 4' LED display and operates from a single -5V power supply. The unit is provided complete with an injection molded black plastic case complete with Bezels. An optional power supply is available which fits into the same case as the 0-2V DVM allowing 117VAC operation.

A. 0-2V DVM with Case \$49.95
B. 5V Power Supply \$14.95

Etching Kits

32 X A-1	P.C. Etch Materials Kit enough for 5 circuit boards	\$29.95 ea.
27 X A-1	Etched Circuit Kit Complete kit - only add water	\$ 9.95 ea.

Plumbboards

3662	6.5 X 4.5 X 1/16 Epoxy glass P-Plumb-44 P.C. Tabs-epoxy .156"	\$ 6.95 ea.
22/44	Mating connector for plumbboard - 22 pin double row	\$ 2.95 ea.

8800V

Universal Microcomputer/Processor plumbboard - Epoxy Glass - complete with heat sink and mounting hardware
 5 3/8 X 10 X 1/16 copper clad

\$19.95 ea.

1/16 VECTOR BOARD

6.1" Hole Spacing

Part No.	L	W	P	Price
PHENOLIC	64P44 05233 XP	4.50	6.50	1.77 1.54
	169P44 05233 XP	4.50	17.00	3.60 3.32
EPDNY GLASS	64P44 062	4.50	6.50	2.07 1.86
	84P44 062	4.50	8.50	2.50 2.31
	169P44 062	4.50	17.00	5.04 4.53
	169P44 062	8.50	17.00	8.23 8.26
EPDNY GLASS COPPER CLAD	169P44 052C1	4.50	17.00	6.90 6.12

SLIT-N-WRAP WIRE WRAP TOOL

Slits and opens insulation exposing bare wire

- No pre-cutting or pre-stripping.
- Comes complete with two - 100 ft spools #28 AWG wire

Model P180 **\$24.50**

HEXADECIMAL ENCODER 19-KEY PAD

- 1 - 0
- ABCDEF
- Return Key
- Optional Key (Parrot)
- Key

\$10.95 each

63 KEY KEYBOARD

This keyboard features 63 unenclosed SST keys, attached to any kind of P.C.B. A very solid molded plastic 13" x 6" base suits most applications.

\$24.95

H0165 16 LINE TO FOUR BIT PARALLEL KEYBOARD ENCODER **\$7.95**

TOOLS

A97MS	Diagonal Cutter - 4" semi-flush cut	\$8.50 ea.
A110MS	Chain Nose Pliers - 4 3/4" long	7.50 ea.
T-8	Wire Stripper - #16 to #20 gauge	3.75 ea.
55B	Wire Stripper - #10 to #20 gauge	2.50 ea.
CS-8	Cutter-Gripper Tool - 3 1/4" long	8.50 ea.

Nipping Tool - Cuts, Trims or Notches Metal up to #18 gauge **6.95 ea.**
 Nibbling Tool Replacement Punch **3.75 ea.**

PERMACEL P-29 PLUS Electrical Tape - All Weather - 3/4" wide x 36 ft. - Black vinyl

1-9 Rolls \$7.99 each 10-up rolls \$6.95/10 roll package

MICROPROCESSOR COMPONENTS

8080A CPU	\$19.95	8228 System Controller - Bus Driver	\$10.95
8212 8 Bit Input/Output	4.95	MC6800L 8 Bit MPU	35.00
8214 Priority Interrupt Control	15.95	MC6820L Periph. Interface Adapter	15.00
8216 Bi-Directional Bus Driver	6.95	MC6810AP1 128 x 8 Static RAM	6.00
8224 Clock Generator/Driver	10.95	MC6830L 1024 x 8 Bit ROM	18.00
CDP1802 - with user manual	39.95	Z80 CPU	49.95

CPU'S

8080 Super 8008	21.95	1101	256 x 1	Static	\$ 1.49
8080A Super 8008	19.95	2101	256 x 4	Static	5.95
2950 8 BIT MPU	26.50	2102	1024 x 1	Static	1.75
		2107 5280	4096 x 1	Dynamic	4.95
		2111	256 x 4	Static	6.95
		2103	16 x 4	Static	2.49
		8171	256 x 4	Static	6.95
		8111	256 x 4	Static	6.95
		8999	16 x 1	Static	3.49
		9110L	1024 x 1	Static	2.25
		73200	256 x 1	Static	6.95
		92421	128 x 1	Static	2.95
		LM5522	2K x 1	Dynamic	2 for 1.00

PROMS

1020A	1024	Firmware	\$ 9.95
5021	2048	Firmware	14.95
AS23	82 x 8	Open-C	5.00
825121	82 x 8	Tristate	5.00
825201	8021	Static	3.95
8021	256 x 2	Fast	3.95
Z100		Erasable	29.95

RAM'S

6301-1	1024	1-Static Bipolar	3.49
6330-1	256	Open Collector Bipolar	2.95
6331-1	256	1-Static Bipolar	2.95

SPECIAL REQUESTED ITEMS

FCM3017	\$ 6.00	8197	2.00
AY-3-6800-1	\$15.95	3341	6.95
MC3001P	3.50	5811	2.95
MC4010P (74418)	7.50	5811	9.95
MC14983	14.50	MC30240	17.50
MC14582	10.50	IC200	18.95
CD4059	8.95	MC16574	17.50
CD4070	.95	MC82574	17.50
MC14489	14.95	MC14419	14.95
MC14410	14.95	ICM7045	24.95
		ICM7207	7.50
		H00165	7.95

PARATRONICS

Featured on February's Front Cover of Popular Electronics

MODEL 100A

Logic Analyzer Kit \$189.00/Kit

Some applications are:

- Troubleshooting microprocessor addressing, instruction, and data flow
- Examine contents of ROMS
- Tracing operation of control logic
- Checking counter and shift register operation
- Monitoring I/O sequences
- Verifying proper system operations during testing

— Analyzes any type of digital system

— Checks data rates in excess of 8 million words per second

— Trouble shoot TTL, CMOS, DTL, RTL, Schottky and MOS families

— Displays 16 logic states up to 8 digits wide

— See ones and zeros displayed on your CRT, octal or hexadecimal format

— Tests circuits under actual operating conditions

— Easy to assemble - comes with step-by-step construction manual which includes 60 pages on logic analyzer operation.

— Troubleshooting microprocessor addressing, instruction, and data flow

— Examine contents of ROMS

— Tracing operation of control logic

— Checking counter and shift register operation

— Monitoring I/O sequences

— Verifying proper system operations during testing

TRIGGER EXPANDER - Model 10 Adds 16 additional bits - Connects direct to Model 100A (Optional brackets permits mounting to 100A for integrated unit) (Baseplate - \$12.00 Model 10 - \$225.00)

BUGBOOK

Continuing Education Series

BUGBOOK I & II - Basic concepts of TTL Logic - over 90 experiments **\$17.00/set**

BUGBOOK IIa - Introduces UART - recommended for RTTY enthusiasts **\$5.00/book**

BUGBOOK III - Explores 8080 chip - introduces Mark 80 Microcomputer **\$15.00/book**

555 TIMER APPLICATIONS SOURCEBOOK WITH EXPERIMENTS - over 100 design techniques **\$6.95/book**

CMOS-IN-DESIGNERS PRIMER AND HANDBOOK a complete CMOS instruction manual **\$6.00**

Introductory Offer - All 6 books (worth \$49.95) **SPECIAL - \$42.95**

CONTINENTAL SPECIALTIES

PROTO BOARD 6 (\$8" long X 4" wide)	\$15.95	PROTO CLIPS	
Other CS Proto Boards		14 PIN	\$4.50
PB100 - 4.5" x 6"	\$ 19.95	16 PIN	4.75
PB101 - 5.8" x 4.5"	29.95	24 PIN	8.50
PB102 - 7" x 4.5"	39.95	DESIGN MATES	
PB103 - 9" x 6"	59.95	DM1 - Circuit Designer	54.95
PB104 - 9.5" x 8"	79.95	DM2 - Function Generator	69.95
PB203 - 9.75 x 6 1/2 x 2 1/4	75.00	DM3 - RC Bridge	59.95
PB203A - 9.75 x 6 1/2 x 2 1/4	120.00 (includes power supply)	Logic Monitor \$84.95 for DTL TTL or CMOS Devices	

QT PROTO STRIPS

QT 595	16 pins	price
QT 596	20 pins	12.50
QT 598	bus strip	2.50
QT 475	470	10.00
QT 478	bus strip	2.25
QT 355	350	6.50
QT 358	bus strip	2.00
QT 185	180	4.75
QT 125	120	3.75
QT 85	80	3.25
QT 75	70	3.00

Experimenter 300 **\$ 9.95**
 Experimenter 600 **\$10.95**

\$5.00 Minimum Order - U.S. Funds Only
 California Residents - Add 6% Sales Tax
 Spec Sheets - 25¢ - Send 35¢ Stamp for 1977A Catalog
 Dealer Information Available

James ELECTRONICS

1021-A HOWARD AVE., SAN CARLOS, CA. 94070
 PHONE ORDERS WELCOME - (415) 592-8097
 All Advertised Prices Good Through September

NOW OPEN SATURDAYS!

Timeband Digital Alarm Clocks

ATTENTION: FACTORY LIMITED QUANTITIES AVAILABLE

- 24-hour alarm
- Door Button
- 100% Solid State
- Large Red Led Display (L.H. right)
- Second's display at touch of button
- Power failure indicator
- One year factory warranty

C-200 - Ivory Case **\$16.95**
 C-200B - Ebony Case **\$19.95**

Timeband LAMP CLOCK

by FAIRCHILD

- 24 hour alarm
- Doze button
- Alarm-on indicator
- 8" high Red LED Display
- AM/PM Indicator
- High Intensity lamp
- Lamp shuts off when collapsed

Model C-598 (Ivory) **\$29.95**

DIGITAL AUTO INSTRUMENT

SEVEN DIFFERENT INSTRUMENTS!
 MEETS OR EXCEEDS ORIGINAL AUTO INSTRUMENT SPEC'S

Please specify which one of the seven models you want when ordering - these do not all come in one unit. Each model must be bought separately.

1 TACHOMETER 0-9900 RPM	4 SPEEDOMETER 0-99 MPH
2 WATER TEMP. 100-250° F	5 OIL PRESSURE 0-80 PSI
3 FUEL LEVEL 3 Percentage Low Fuel Indicator	6 OIL TEMP. 200-350° F
	7 BATTERY MONITOR ±1 Volts From 11-15 VDC

BRIGHT YELLOW ORANGE 3" x 1" LED DISPLAY!

Kit includes case, bracket and all components - complete. Nothing else to buy! 12 Volt NEG GND.

DIMENSIONS 4 1/2" x 4" x 2"

KIT: **\$49.95**
 * Add \$10.00 for required speed transducer. ASSEMBLED: **\$59.95**

DIGITAL STOPWATCH

- Bright 8 Digit LED Display
- Times to 99.999 seconds
- Crystal Controlled Time Base
- Three Stopwatches in One
- Times Single Event - Split & Taylor
- Size 4 1/2" x 1 1/2" x 90" (4th corner)
- Uses 3 Pentac Cells

Kit - **\$39.95**
 Assembled - **\$49.95**
 Heavy Duty Carry Case **\$5.95**

Stop Watch Chip Only (7205) **\$19.95**

QUARTZ DIGITAL AUTO CLOCK OR ELAPSED TIMER!

Elapsed Timer: Hrs, Mins and Secs
 12 or 24 Hr Capacity
 Simple Reset - Start Pushbutton Control

Complete kit includes mounting bracket case and all components nothing else to buy. Features MM5314 chip. Large 2" LED's Accuracy better than +/- mm per mo. internal battery backup. 12 volt non-polar operation.

DIMENSIONS 4 1/2" x 4" x 2"
 12 or 24 HOUR MODE

Kit: **\$29.95**
 Assembled: **\$39.95**

CASE ONLY (includes hardware, mounting bracket and bezel) **\$6.50**

JE700 CLOCK

The JE700 is a low cost clock that is a very high quality unit. The unit features a simulated wood case with dimensions of 6" x 7 1/2" x 1 1/2". It utilizes a MAN12 high brightness readout and the MM5314 clock chip.

115 VAC **\$17.95**

DIGITAL CLOCK KIT - 3 1/2 INCH DIGITS

4 DIGIT KIT \$46.95	4 DIGIT ASSEMBLED \$59.95
6 DIGIT KIT \$69.95	6 DIGIT ASSEMBLED \$79.95

This clock features big 3 1/2" high digits for viewing in offices, auditoriums, etc. Each digit is formed by 31 bright 0.2" LED's. The clock operates from 117 VAC, has either 12 or 24 hr. operation. The 6 digit version is 27" x 3 1/2" x 1 1/2" and the 4 digit is 18" x 3 1/2" x 1 1/2". Kits come complete with all components, case and transformer.

Specify 12 or 24 Hour When Ordering

JE803 PROBE

The Logic Probe is a unit which is for the most part independent of the trouble shooting logic families. TTL, DTL, RTL, CMOS. It derives the power it needs to operate directly off the circuit under test drawing a scant 10 mA max. It uses a MAN12 readout to indicate any of the following states by these symbols: 1 (1.0V), 0 (0V), P (Pulse). The Probe can detect high frequency pulses to 25 MHz. It can't be used at MOS levels or circuit damage will result.

\$9.95 Per Kit
 printed circuit board

TTL 5V 1A Supply
 This is a standard TTL power supply using the well known LM309A regulator. IC provides a steady 5 AMP DC current at 5 volts. We try to make things easy for you by providing everything you need in one package including the hardware for only **\$9.95 Per Kit**

7400N TTL

SN7400N	.16	SN7458A	.26	SN74154N	1.00
SN7401N	.16	SN7460N	.22	SN74155A	.95
SN7402N	.21	SN7470N	.45	SN74156A	.95
SN7403N	.18	SN7474N	.39	SN74157A	.95
SN7404N	.19	SN7475N	.37	SN74157B	.95
SN7405N	.24	SN7476N	.32	SN74158N	1.25
SN7406N	.20	SN7477N	.50	SN74159N	.95
SN7407N	.25	SN7478N	.52	SN74160N	1.10
SN7408N	.25	SN7479N	5.00	SN74161N	1.10
SN7409N	.26	SN7480N	.50	SN74162N	1.10
SN7410N	.18	SN7481N	.98	SN74163N	1.25
SN7411N	.30	SN7482N	.30	SN74164N	1.25
SN7412N	.35	SN7483N	.20	SN74165N	1.25
SN7413N	.45	SN7484N	.39	SN74166N	1.25
SN7414N	.70	SN7485N	3.50	SN74167N	1.25
SN7415N	.35	SN7486N	2.49	SN74168N	1.25
SN7416N	.25	SN7487N	.45	SN74169N	1.25
SN7417N	.21	SN7488N	.75	SN74170N	.80
SN7418N	.33	SN7489N	.48	SN74171N	.80
SN7419N	.49	SN7490N	.49	SN74172N	.80
SN7420N	.37	SN7491N	.79	SN74173N	2.48
SN7421N	.28	SN7492N	.79	SN74174N	2.48
SN7422N	.29	SN7493N	.49	SN74175N	2.48
SN7423N	.29	SN7494N	.88	SN74176N	1.85
SN7424N	.37	SN7495N	4.00	SN74177N	2.20
SN7425N	.42	SN7496N	1.00	SN74178N	18.00
SN7426N	.39	SN7497N	1.00	SN74179N	18.00
SN7427N	.31	SN7498N	1.00	SN74180N	1.25
SN7428N	.29	SN7499N	1.00	SN74181N	1.25
SN7429N	.25	SN7500N	1.00	SN74182N	1.25
SN7430N	.25	SN7501N	1.00	SN74183N	1.25
SN7431N	.25	SN7502N	1.00	SN74184N	1.25
SN7432N	.27	SN7503N	1.00	SN74185N	1.25
SN7433N	.27	SN7504N	1.00	SN74186N	1.25
SN7434N	.25	SN7505N	1.00	SN74187N	1.25
SN7435N	.25	SN7506N	1.00	SN74188N	1.25
SN7436N	.25	SN7507N	1.00	SN74189N	1.25
SN7437N	.25	SN7508N	1.00	SN74190N	1.25
SN7438N	.25	SN7509N	1.00	SN74191N	1.25
SN7439N	.25	SN7510N	1.00	SN74192N	1.25
SN7440N	.25	SN7511N	1.00	SN74193N	1.25
SN7441N	.25	SN7512N	1.00	SN74194N	1.25
SN7442N	.25	SN7513N	1.00	SN74195N	1.25
SN7443N	.25	SN7514N	1.00	SN74196N	1.25
SN7444N	.25	SN7515N	1.00	SN74197N	1.25
SN7445N	.25	SN7516N	1.00	SN74198N	1.25
SN7446N	.25	SN7517N	1.00	SN74199N	1.25
SN7447N	.25	SN7518N	1.00	SN74200N	5.50
SN7448N	.25	SN7519N	1.00	SN74201N	5.50
SN7449N	.25	SN7520N	1.00	SN74202N	5.50
SN7450N	.25	SN7521N	1.00	SN74203N	5.50
SN7451N	.27	SN7522N	1.00	SN74204N	5.50
SN7452N	.27	SN7523N	1.00	SN74205N	5.50
SN7453N	.27	SN7524N	1.00	SN74206N	5.50
SN7454N	.27	SN7525N	1.00	SN74207N	5.50
SN7455N	.27	SN7526N	1.00	SN74208N	5.50
SN7456N	.27	SN7527N	1.00	SN74209N	5.50
SN7457N	.27	SN7528N	1.00	SN74210N	5.50
SN7458N	.27	SN7529N	1.00	SN74211N	5.50
SN7459N	.27	SN7530N	1.00	SN74212N	5.50

MANY OTHERS AVAILABLE ON REQUEST
20% Discount for 100 Combined 7400's

CMOS

CD4000	.25	74C00AN	.75
CD4001	.25	74C01AN	.65
CD4002	.25	74C02AN	.65
CD4003	.25	74C03AN	.65
CD4004	.25	74C04AN	.65
CD4005	.25	74C05AN	.65
CD4006	.25	74C06AN	.65
CD4007	.25	74C07AN	.65
CD4008	.25	74C08AN	.65
CD4009	.25	74C09AN	.65
CD4010	.25	74C10AN	.65
CD4011	.25	74C11AN	.65
CD4012	.25	74C12AN	.65
CD4013	.25	74C13AN	.65
CD4014	.25	74C14AN	.65
CD4015	.25	74C15AN	.65
CD4016	.25	74C16AN	.65
CD4017	.25	74C17AN	.65
CD4018	.25	74C18AN	.65
CD4019	.25	74C19AN	.65
CD4020	.25	74C20AN	.65
CD4021	.25	74C21AN	.65
CD4022	.25	74C22AN	.65
CD4023	.25	74C23AN	.65
CD4024	.25	74C24AN	.65
CD4025	.25	74C25AN	.65
CD4026	.25	74C26AN	.65
CD4027	.25	74C27AN	.65
CD4028	.25	74C28AN	.65
CD4029	.25	74C29AN	.65
CD4030	.25	74C30AN	.65
CD4031	.25	74C31AN	.65
CD4032	.25	74C32AN	.65
CD4033	.25	74C33AN	.65
CD4034	.25	74C34AN	.65
CD4035	.25	74C35AN	.65
CD4036	.25	74C36AN	.65
CD4037	.25	74C37AN	.65
CD4038	.25	74C38AN	.65
CD4039	.25	74C39AN	.65
CD4040	.25	74C40AN	.65
CD4041	.25	74C41AN	.65
CD4042	.25	74C42AN	.65
CD4043	.25	74C43AN	.65
CD4044	.25	74C44AN	.65
CD4045	.25	74C45AN	.65
CD4046	.25	74C46AN	.65
CD4047	.25	74C47AN	.65
CD4048	.25	74C48AN	.65
CD4049	.25	74C49AN	.65
CD4050	.25	74C50AN	.65
CD4051	.25	74C51AN	.65
CD4052	.25	74C52AN	.65
CD4053	.25	74C53AN	.65
CD4054	.25	74C54AN	.65
CD4055	.25	74C55AN	.65
CD4056	.25	74C56AN	.65
CD4057	.25	74C57AN	.65
CD4058	.25	74C58AN	.65
CD4059	.25	74C59AN	.65
CD4060	.25	74C60AN	.65
CD4061	.25	74C61AN	.65
CD4062	.25	74C62AN	.65
CD4063	.25	74C63AN	.65
CD4064	.25	74C64AN	.65
CD4065	.25	74C65AN	.65
CD4066	.25	74C66AN	.65
CD4067	.25	74C67AN	.65
CD4068	.25	74C68AN	.65
CD4069	.25	74C69AN	.65
CD4070	.25	74C70AN	.65
CD4071	.25	74C71AN	.65
CD4072	.25	74C72AN	.65
CD4073	.25	74C73AN	.65
CD4074	.25	74C74AN	.65
CD4075	.25	74C75AN	.65
CD4076	.25	74C76AN	.65
CD4077	.25	74C77AN	.65
CD4078	.25	74C78AN	.65
CD4079	.25	74C79AN	.65
CD4080	.25	74C80AN	.65
CD4081	.25	74C81AN	.65
CD4082	.25	74C82AN	.65
CD4083	.25	74C83AN	.65
CD4084	.25	74C84AN	.65
CD4085	.25	74C85AN	.65
CD4086	.25	74C86AN	.65
CD4087	.25	74C87AN	.65
CD4088	.25	74C88AN	.65
CD4089	.25	74C89AN	.65
CD4090	.25	74C90AN	.65
CD4091	.25	74C91AN	.65
CD4092	.25	74C92AN	.65
CD4093	.25	74C93AN	.65
CD4094	.25	74C94AN	.65
CD4095	.25	74C95AN	.65
CD4096	.25	74C96AN	.65
CD4097	.25	74C97AN	.65
CD4098	.25	74C98AN	.65
CD4099	.25	74C99AN	.65
CD4100	.25	74C00AN	.65

LINEAR

LM350A	.30	LM1351N	1.85
LM350B	.30	LM1414N	1.75
LM350C	.30	LM1486C	.65
LM350D	.30	LM1487C	.65
LM350E	.30	LM1588N	1.85
LM350F	.30	LM1589N	1.85
LM350G	.30	LM1590N	1.85
LM350H	.30	LM1591N	1.85
LM350I	.30	LM1592N	1.85
LM350J	.30	LM1593N	1.85
LM350K	.30	LM1594N	1.85
LM350L	.30	LM1595N	1.85
LM350M	.30	LM1596N	1.85
LM350N	.30	LM1597N	1.85
LM350O	.30	LM1598N	1.85
LM350P	.30	LM1599N	1.85
LM350Q	.30	LM1600N	1.85
LM350R	.30	LM1601N	1.85
LM350S	.30	LM1602N	1.85
LM350T	.30	LM1603N	1.85
LM350U	.30	LM1604N	1.85
LM350V	.30	LM1605N	1.85
LM350W	.30	LM1606N	1.85
LM350X	.30	LM1607N	1.85
LM350Y	.30	LM1608N	1.85
LM350Z	.30	LM1609N	1.85
LM351A	.30	LM1610N	1.85
LM351B	.30	LM1611N	1.85
LM351C	.30	LM1612N	1.85
LM351D	.30	LM1613N	1.85
LM351E	.30	LM1614N	1.85
LM351F	.30	LM1615N	1.85
LM351G	.30	LM1616N	1.85
LM351H	.30	LM1617N	1.85
LM351I	.30	LM1618N	1.85
LM351J	.30	LM1619N	1.85
LM351K	.30	LM1620N	1.85
LM351L	.30	LM1621N	1.85
LM351M	.30	LM1622N	1.85
LM351N	.30	LM1623N	1.85
LM351O	.30	LM1624N	1.85
LM351P	.30	LM1625N	1.85
LM351Q	.30	LM1626N	1.85
LM351R	.30	LM1627N	1.85
LM351S	.30	LM1628N	1.85
LM351T	.30	LM1629N	1.85
LM351U	.30	LM1630N	1.85
LM351V	.30	LM1631N	1.85
LM351W	.30	LM1632N	1.85
LM351X	.30	LM1633N	1.85
LM351Y	.30	LM1634N	1.85
LM351Z	.30	LM1635N	1.85

74LS00 TTL

74LS00	.29	74LS139	1.95
74LS01	.29	74LS151	1.55
74LS02	.29	74LS152	1.89
74LS03	.29	74LS153	1.89
74LS04	.29	74LS154	2.25
74LS05	.29	74LS155	2.25
74LS06	.29	74LS156	2.25
74LS07	.29	74LS157	1.95
74LS08	.29	74LS158	1.95
74LS09	.29	74LS159	1.95
74LS10	.29	74LS160	1.95
74LS11	.29	74LS161	1.95
74LS12	.29	74LS162	1.95
74LS13	.29	74LS163	1.95
74LS14	.29	74LS164	1.95
74LS15	.29	74LS165	1.95
74LS16	.29	74LS166	1.95
74LS17	.29	74LS167	1.95
74LS18	.29	74LS168	1.95
74LS19	.29	74LS169	1.95
74LS20	.29	74LS170	1.95
74LS21	.29	74LS171	1.95
74LS22	.29	74LS172	1.95
74LS23	.29	74LS173	1.95
74LS24	.29	74LS174	1.95
74LS25	.29	74LS175	1.95
74LS26	.29	74LS176	1.95
74LS27	.29	74LS177	1.95
74LS28	.29	74LS178	1.95
74LS29	.29	74LS179	1.95
74LS30	.29	74LS180	1.95
74LS31	.29	74LS181	1.95
74LS32	.29	74LS182	1.95
74LS33	.29	74LS183	1.95
74LS34	.29	74LS184	1.95
74LS35	.29	74LS185	1.95
74LS36	.29	74LS186	1.95
74LS37	.29	74LS187	1.95
74LS38	.29	74LS188	1.95
74LS39	.29	74LS189	1.95
74LS40	.29	74LS190	1.95

BLOCK CHIPS

MM5509	5 Digit, 800 Outputs, Reset Pin	\$9.95
MM5511	5 Digit, 800 Outputs, 12 or 24 Hour	4.95
MM5512	4 Digit, 800 Outputs, 1 PPS Output	4.95
MM5514	5 Digit, 12 or 24 Hour, 50 or 60 Hz	4.95

What's New?

New Printer Features Novel Printing Technique



A new 80 column dot matrix printer from Axiom Corporation, 5932 San Fernando Rd, Glendale CA 91202, has been announced which features an operating speed of 160 characters per second. The EX-800, shown at the NCC show in June, features an unusual electrosensitive printing technique: the nonimpact printing is done by passing a high current through fine wires in the

Bell & Howell Offers New Microprocessor Course

Many people have expressed interest in microprocessor correspondence courses. Now, Bell & Howell offers a new source of such courses. Their new microprocessor correspondence course is available for \$99. The course materials consist of two study units contained in loose-leaf binders.

Topics covered include an introduction to microprocessors, computer languages, system architecture, IO instructions, flowcharts and so on. For more information, contact Bell & Howell Schools, 209 W Jackson Blvd, Chicago IL 60606. ■

Circle 632 on inquiry card.

New Learn-at-Home Electronic Circuits Course from Heath

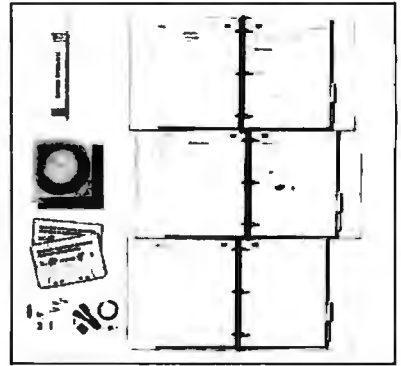

Heath Company, Benton Harbor MI, has introduced a new learn-at-home electronics course covering basic electronic circuits. The course, EE-3104, is one of four basic electronics courses which use programmed instructions plus audio records. The course comes complete with electronic parts for "hands on" experiments. Other courses in the basic electronics series include AC Electronics, DC Electronics, and Semiconductor Devices. An advanced course in Digital Techniques is also available.

Course EE-3104 covers basic and operational amplifiers, power supplies, oscillators, pulse circuits, modulation and demodulation with emphasis on integrated circuits. An optional final exam can be taken for Continuing Education Units (CEUs), a nationally recognized means of acknowledging participation in noncredit adult education.

Courses are mail-order priced at \$39.95. For a free catalog write to Heath Company, Dept 350-18, Benton Harbor MI 49022. ■

Circle 635 on inquiry card.

Cassette Terminal Interface for SwTPC 6800 Operates at 120 bps



PerCom Data Company, 4021 Windsor, Garland TX 75042, has announced a high speed, self-clocking cassette terminal interface for the Southwest Technical Products Corporation 6800 microcomputer.

The CIS-30+, a dual function unit,

interfaces cassette data at user selectable rates of 30, 60 or 120 bytes per second, and provides RS-232 interfacing at 300, 600 or 1200 bps.

Cassette data is Kansas City standard biphasic encoded.

The CIS-30+ user's manual and optional test cassette include PerCom cassette operating software. However, the 6800 resident Motorola MIKBUG is the only software needed for loading at 30 bytes per second. The CIS-30+ will also read unmodified Southwest Technical Products Corporation cassette software.

The CIS-30+ kit is \$69.95. The assembled price is \$89.95. An instruction manual is included. ■

Circle 636 on inquiry card.

Mini-L Loran-C Receiver Announced

A limited number of circuit boards and a user's guide will be available from R W Burhans, 161 Grosvenor St, Athens OH 45701 or PAIA, 1020 W Wilshire Blvd, Oklahoma City OK 73116, for experimental study of the Loran-C, 100 kHz, navigation system with microprocessor data reduction systems. Mini-L is designed to generate 10 μ s interrupt request pulses locked to the Loran-C signals making it a much easier task for microprocessor users to devise their own time measurement software. A 25 page experimenter's manual and two circuit boards (no parts supplied) allow the circuit builder to fabricate an individualized or custom Loran-C antenna preamplifier and radio frequency front-end.

Mini-L contains two user adjustable traps on either side of the Loran-C carrier frequency to help eliminate local area interference, and has a very wide range automatic gain control (AGC) level for hard limiting on signals received. The level control can be arranged to

A New Analog Multiplier Series

Analog Devices, Route 1 Industrial Park, POB 280, Norwood MA 02062, has announced a new series of monolithic

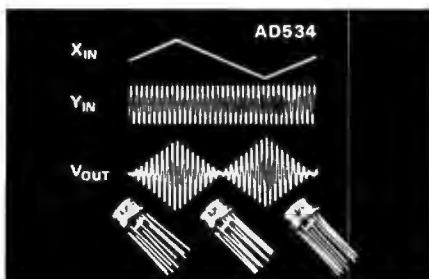

analog multipliers called the AD534 series. The AD534L, in particular, offers a maximum multiplication error of $\pm 0.25\%$, said to be the lowest of any integrated circuit multiplier. Small signal bandwidth of these units is 1 MHz, making them ideal for a variety of applications ranging from music synthesis to modulation and demodulation in communications systems. One real advantage for the experimenter is that these multipliers require no external components: simply feed in two analog signals within the input specs and get out their product. Single quantity price for the AD534 is \$26. ■

Circle 637 on inquiry card.



FIRE-SMOKE-INTRUDER ALARM

12 volt DC operation, large 5 inch bell, one unit, all the works under the bell. Nice for camper, boat, homes. **\$25**

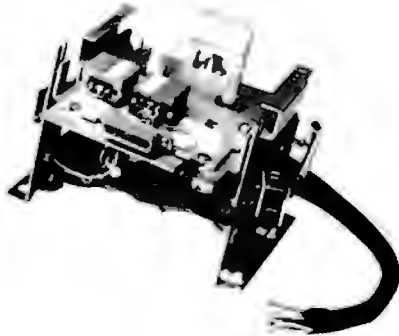

VIATRON CASSETTE DECKS

The computer cassette deck alone \$35 Set of 2 boards read/write amp & serve control boards for this deck **\$40.00**



PORTABLE FIRE ALARM

Operates on 3 internal AA cells (not furnished) On temp rise of approx 150 Sonalert type alarm sounds off. Push to test switch makes nice sounding code practice oscillator **\$6.00**

SPECTRA FLAT TWIST

50 conductor, 28 gauge, 7 strands/ conductor made by Spectra. Two conductors are paired & twisted and the flat ribbon made up of 25 pairs to give total of 50 conductor. May be peeled off in pairs if desired. Made twisted to cut down on "cross talk." Ideal for sandwiching PC boards allowing flexibility and working on both sides of the boards. Cost originally \$13.00/ft

SP-324-A \$1.00/ft. 10 ft/\$9.00

SP-234-A \$1.00 ft 50 cond. 10 ft/\$9.00

SP-234-B .90 ft 32 cond. 10 ft/\$8.00

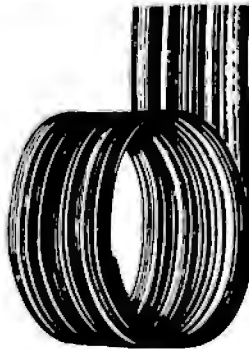

WIRE WRAP WIRE

TEFZEL blue #30 Reg. price \$13.28/100 ft. Our price 100 ft \$2.00; 500 ft \$7.50.

MULTI COLORED SPECTRA WIRE

Footage	10'	50'	100'
8 Cond. #24	\$2.50	9.00	15.00
12 "	22 3.00	11.00	18.00
14 "	22 3.50	13.00	21.00
24 "	#24 5.00	20.00	30.00
29 "	22 7.50	28.00	45.00

Great savings as these are about 1/4 book prices. All fresh & new.

TOUCHTONE ENCODER CHIP

Compatible with Bell system, no crystal required. Ideal for repeaters & w/specs. **\$6.00**

CHARACTER GENERATOR CHIP

Memory is 512x5 produces 64 five by seven ASCII characters. New material w/data **\$6.00**

Meshna

Please add shipping cost on above. Minimum order \$10
FREE CATALOG SP-9 NOW READY
 P.O. Box 62, E. Lynn, Massachusetts 01904

operate either manually or under software control from an external digital to analog converter. The wideband antenna preamplifier may also be used with the Mini-O system as described in March 1977 BYTE. An improved Mini-O circuit board is being developed. ■

Circle 638 on inquiry card.

A New Series of 16 Bit Microprocessors from Texas Instruments

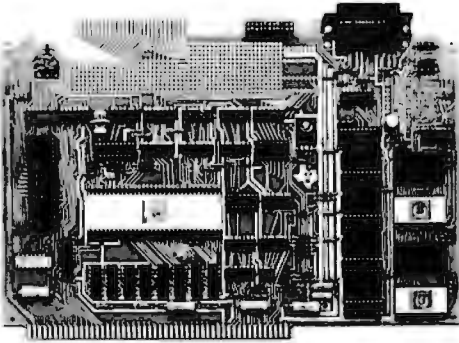

Texas Instruments has announced a new series of 16 bit single board microcomputer modules based on the 9900 chip which feature upward and

downward software compatibility with the rest of the 9900 series. The TM990/100M is the first module to be made available in the new TM990 series. It features 1 K by 16 bits of erasable read only memory expandable to 4 K by 16 bits (the memory will include a self-contained software monitor called TIBUG), plus a 256 x 16 bit volatile user programmable memory expandable to 512 by 16 bits on the board.

Sixteen lines of programmable parallel IO and a selection of either a current loop or RS-232 terminal interface are available. In addition, the TM990/100M offers two programmable interval timers, 15 external hardware interrupts and a blank board area with extra sockets for user prototyping, etc. The TM990/100M sells for \$450, assembled, in single quantities.

This will provide an excellent starting point for the experimenter desiring a 16 bit minicomputer-like processor which features hardware (integer) multiply and divide, real shift instructions and a general register architecture.

For further information, contact Texas Instruments Inc, Inquiry Fulfillment, POB 1443, M/S 653 (Attn: TM990), Houston TX 77001. ■

Circle 639 on inquiry card.

Get Some Pizza Mind

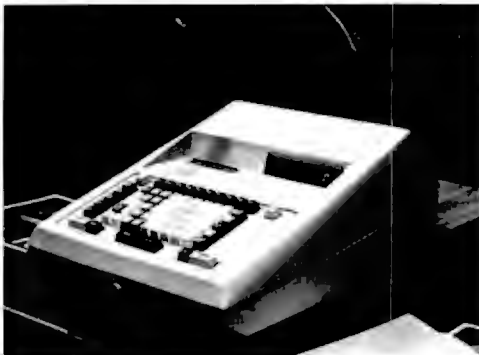

"Big Stan," a new version of the MARK III line of electronic point-of-sale systems by FasFax Corporation, is currently in trial with prospects in the pizza and taco segments of the fast food

industry. The new system automatically prices add-on ingredients to speed counter service and eliminate losses caused by incorrect pricing procedures. It uses its microcomputer intelligence to increase the productivity of food vendors. [Oh! The power of user oriented firmware... CH] Big Stan is programmed to allow for many basic carriers, such as different sizes of pizza shells and a wide variety of ingredients. The ingredients can be assigned to as many as 15 different price classes, thus assuring accuracy regardless of the way clerks enter the order. The unit maintains a complete record of all transactions, labor hours and inventory changes; this information is used to automatically compile management reports. For more information, contact FasFax Corporation at Ledge St, POB H, Nashua NH 03060. ■

Circle 641 on inquiry card.

Small Business Software from Synchro-Sound

Synchro-Sound, 193-25 Jamaica Av, Hollis NY 11423, has announced an accounts receivable system for the small businessman. The system is expressly designed to be run on an 8080 microcomputer using an Altair floppy disk with Altair BASIC, video terminal and printer. Features include: adding new customer accounts, deleting dormant accounts, transaction processing and report generation. The monthly statements include both current and aged balances. Other reports generated are aged accounts receivable and delinquency notices.

The system is said to require little

operator training. All communication is in interactive mode. Operator errors are easily corrected, and accidental data base deletions are prevented by requiring additional confirmation.

This system may be modified to include special installation dependent functions. All major programs are written in high level language to facilitate program additions and alterations. This program module is designed to serve as the basis for a complete accounting package. Provisions are included for linking billing, inventory control and general ledger modules. The latter will be available in the near future. ■

Circle 643 on inquiry card.

A New Smart Terminal from Economy Terminals



Economy Terminals has announced their Model ET1 microprocessor-based video terminal for the experimenter market priced at \$895 each. Hardware features include:

- 24 by 80 display of a 64 character ASCII subset (but a full 96 character set is transmitted)
- 12 inch (30.5 cm) industrial video monitor
- RS-232 and 20 mA current loop interface
- 16 switchable data transfer rates
- Switch selectable odd or even parity with one or two stop bits
- 63 key keyboard with all functions identified on key caps

Software features include:

- Page or scrolling mode of operation
- XY placement of cursor either from keyboard or remotely
- Automatic repeat of any key after a 0.3 second delay

For further information, write Economy Terminals, POB 12261, Minneapolis MN 55412. ■

Circle 640 on inquiry card.

A Most Useful Catalog

Here at last is a source for all those hard-to-get accessories and supplies for mini and microcomputers: Minicomputer Accessories' new 1977 catalog. Small systems enthusiasts will enjoy paging through this compendium which features such things as binders for computer printouts, flowchart design templates, printer paper, cassette storage boxes, cordless paper tape winders, paper tape splicers and trays, myriads of special interconnection cables, extender boards, cable bridge systems for covering floor runs of computer cables, storage cabinets, and so on. The catalog is free for the asking from Minicomputer Accessories, 1015 Corporation Way, POB 10056, Palo Alto CA 94303. ■

Circle 642 on inquiry card.

cybercom BOARDS

MB-1 MK-8 Computer RAM, (not S-100), 4KX8, uses 2102 type RAMs, PCBD only\$22

MB-3 1702A EROM Board, 4KX8, S-100, switchable address and wait cycles, kit less PROMS\$65

MB-4 Basic 4KX8 ram, uses 2102 type rams, may be expanded to 8KX8 with piggybacking, S-100 buss. PC board\$30

MB-6 Basic 8KX8 ram uses 2102 type rams, memory protected in 256 to 8K switchable S-100 buss. PCBD\$35

MB-8 2708 EROM board, S-100, 8KX8 or 16KX8 kit without PROMS\$85

IO-2 S-100, 8 bit parallel I/O port, 1/2 of board is for kludging. Kit\$55 PCBD\$30

VB-1 64X 16 video board, upper lower case Greek, composite and parallel video with software, S-100. Kit\$189.00 PCBD\$35

SP-1 Music synthesizer board, S-100, computer controller wave forms, 9 octaves, 1V rms 1/2% distortion, includes software kit\$250

Altair Compatible Mother Board, 11 x 11 1/2 x 1/4". Board only ...\$45 With 15 connectors\$105

Extender Board full size. Board only\$9

With connector\$13.50

Solid state music Cybercom boards are high quality glass board with gold finger contacts. All boards are check for shorts. Kits only have solder mask. 90 day guarantee on Cybercom kits.

Special 8080A processor & support chip set kit includes one of each; all parts prime 9080A (8080A); 8228; 8212; 8216; 8251; 8214; 8224; 8225. Special\$75.00

Special 2101AL-4 1K x 1 ram 1/3 less power than 21L02 type rams, with power down, prime from NEC. Ea. 2.00; 32 ea. 1.80; 64 ea. 1.70; 128 ea. 1.60; 256 ea. 1.50; 512 ea. 1.45.

9080A AMD 8080A (Prime) 25.00
 8212/74S412 Prime 4.00
 8214 Prime 8.30
 8216 Prime 4.95
 8224 Prime 5.00
 8228 Prime 8.90
 8251 Prime 14.50
 8255 Prime 14.50
 1702A-6 AMD 4702A Prime 8.00
 TMS-6011 UART Prime 6.95
 2513 Char Gen Upper Prime 11.00
 2513 Char Gen Lower Prime 11.00
 1702A Intel Not Prime 8.00

8T10	2.00	8T97	2.00	80L97	1.50
8T13	2.50	8T110	2.00	81L22	1.50
8T16	2.00	5309	8.00	82L23	1.90
8T20	2.00	5312	4.00	85L51	2.50
8T24	2.50	5313	4.00	85L52	2.50
8T26	2.75	5320	5.95	85L63	1.25
8T34	2.50	5554	1.90	86L70	1.50
8T37	2.50	5556	2.50	86L75	1.90
8T38	2.50	5055	1.60	86L99	3.50
8T80	2.50	MC4044	2.25	88L12	.80

74L00	.25	74LS00	.40	1101	1.25
74L01	.25	74LS01	.50	1103	1.25
74L02	.25	74LS02	.40	2101	4.50
74L03	.25	74LS03	.40	2111-1	3.75
74L04	.30	74LS04	.45	2112	4.50
74L05	.40	74LS05	.45	2602	1.60
74L06	.30	74LS08	.40	4002-1	7.50
74L08	.40	74LS10	.40	4002-2	7.50
74L09	.40	74LS12	.55	MM5262	1.00
74L10	.30	74LS20	.40	7489	2.00
74L12	.35	74LS22	.45	74200	4.95
74L26	.40	74LS27	.45	74C89	3.00
74L30	.40	74LS30	.40	82S06	2.00
74L32	.45	74LS37	.60	82S07	2.00
74L42	1.50	74LS38	.60	82S17	2.00
74L51	.35	74LS42	1.50	8223	2.50
74L54	.45	74LS51	.40	82S23	3.00
74L55	.35	74LS54	.45	82S123	3.00
74L71	.30	74LS55	.40	82S126	3.50
74L73	.55	74LS73	.65	82S129	3.50
74L74	.55	74LS74	.65	82S130	3.95
74L75	1.20	74LS76	.65	82S131	3.95
74L78	.90	74LS151	1.55	IM5600	2.50
74L85	1.40	74LS174	2.20	IM5610	2.50
74L86	.75	74LS175	1.95	IM5603	3.00
74L89	3.50	74LS192	2.85	IM5604	3.50
74L90	1.50	2501B	1.25	IM5623	3.00
74L91	1.50	2502B	3.00	IM5624	3.50
74L93	1.70	2507V	1.25	MMI6330	2.50
74L95	1.70	2510A	2.00	DM8573	4.50
74L98	2.80	2517V	1.25	DM8574	5.50
74L123	1.50	2519B	2.80	DM8575	4.50
74L164	2.50	2532B	2.80	DM8576	4.50
74L165	2.50	2533V	2.80	DM8577	3.50
74L192	1.25	DM8131	2.50	DM8578	4.00
74L193	1.20	N8263	3.50	2.4576 MHZ	
MH0026	2.95	MC1489	1.50	XTAL	7.20
MC1488	1.50	DM8837	1.50		

Waneco Boards

MM-1 8KX8 fully buffered, S-100, uses 2102 type rams. PCBD\$30

Mother Board 12 slot, terminated, S-100, board only\$40

MIKOS

419 Portofino Drive
 San Carlos, California 94070
 Please send for IC, Xistor
 and Computer parts list.

Check or money order only. If you are not a regular customer and your order is large please send either a cashier's check or a postal money order, otherwise there will be a delay of two weeks for the check to clear. All items post paid in the U.S. Calif. residents add 6% tax. Money back 30 day guarantee. We cannot accept returned IC's that have been soldered to. Prices subject to change without notice \$10 minimum order.

K-rations for your computer



K-Ration™ 8Kx8 memory with SynchroFresh™.
\$188 assembled and warranted.

Now you can load your Altair, IMSAI, Equinox 100 or other S-100 buss computer with 8K x 8 memory boards for just \$188 apiece... and that's assembled, tested and warranted for repair or replacement for 1 full year. It's possible because Morrow's Micro-Stuff has developed **Synchro-Fresh™**, the first and only memory refreshing system that weaves itself invisibly into the natural timing of the S-100 buss. And that makes the **K-Ration™ 8Kx8** memory refreshingly reliable and helps keep the cost down. Just \$188 assembled with 1 year warranty, kit just \$159 (Cal. res. add tax). Postpaid from ThinkerToys™.

K-Ration™ 4Kx8 MEMORY is now the lowest-cost 4K memory available for S-100 buss personal computers. A complete memory board kit, just \$109 (Cal. Res. add tax). Postpaid from ThinkerToys™. Product of Morrow's Micro-Stuff

Thinker Toys™ 1201 10th St.
 Berkeley, CA 94710

Place BAC/MC orders toll-free to 800-648-5311.
 Or see it at your local computer shop.

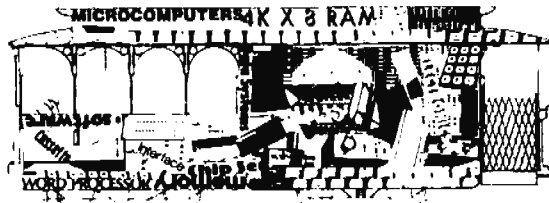

THE FIRST WEST COAST COMPUTER FAIRE

A Conference & Exposition on Personal & Home Computers

Available* for the first time:

CONFERENCE PROCEEDINGS

of the largest convention ever held

Exclusively Devoted to Home & Hobby Computing

over 300 pages of conference papers, including:

(Topic headings with approximate count of 7"x10" pages)

- | | |
|---|--|
| Friday & Saturday Banquet Speeches (16) | Entrepreneurs (6) |
| Tutorials for the Computer Novice (16) | Speech Recognition & Speech Synthesis by Computer (14) |
| People & Computers (13) | Tutorials on Software Systems Design (11) |
| Human Aspects of System Design (9) | Implementation of Software Systems and Modules (10) |
| Computers for Physically Disabled (7) | High-Level Languages for Home Computers (15) |
| Legal Aspects of Personal Computing (6) | Multi-Tasking on Home Computers (10) |
| Heretical Proposals (11) | Homebrew Hardware (8) |
| Computer Art Systems (2) | Bus & Interface Standards (17) |
| Music & Computers (43) | Microprogrammable Microprocessors for Hobbyists (18) |
| Electronic Mail (8) | Amateur Radio & Computers (11) |
| Computer Networking for Everyone (14) | Commercial Hardware (8) |
| Personal Computers for Education (38) | |
| Residential Energy & Computers (2) | |
| Systems for Very Small Businesses (5) | |

---- plus ----

Names & addresses of the 170+ exhibitors at the Computer Faire

Order now from:	Proceedings:	\$12.00	(\$11.95, plus a nickel, if you prefer)
Computer Faire	Shipping & Handling:	.68	(Write for shipping charges outside U.S.A.)
Box 1579	Outside California:	\$12.68	Payment must accompany the order.
Palo Alto CA 94302	Californians Add:	.72	6% Sales Tax
(415) 851-7664	Inside California:	\$13.40	Payment must accompany the order.

*Copies will be shipped before August 30, 1977.

april, 1977 · san francisco

S.D. SALES CO. P.O. BOX 28810 -B DALLAS, TEXAS 75228

★ Imsai - Altair "A" Compatible Kits ★

Z-80 CPU KIT COMPLETE - \$149. kit

Z-80 Chip & Manual \$49.95

Z-80 Manual - \$7.50 Separately

From the same people who brought you the \$89.95 4K RAM KIT. We were not the first to introduce an Imsai/Altair compatible Z-80 Card, but we do feel that ours has the best design and quality for the lowest price!
The advance features of the Z-80 such as an expanded set of 158 instructions, 8080A software compatibility, and operation from a single 5VDC supply, are all well known. What makes our card different is the extra care we took in the hardware design. The CPU card will always stop on an M1 state. We also generate TRUE SYNC on card, to insure that the rest of your system functions properly. Dynamic memory refresh and NMI are brought out for your use. Believe it or not, not all of our competitors have gone to the extra trouble of doing this.
As always this kit includes all parts, all sockets, and complete instructions for ease of assembly. Because of our past experience with our 4K kit we suggest that you order early. All orders will be shipped on a strict first come first served basis. Dealers inquiries welcome on this item. Kit includes Zilog Manual and all parts. Kit shipped with 2 MHz crystals.

THE WHOLE WORKS
\$89.95

4K LOW POWER RAM BOARD KIT

Imsai and Altair 8080 plug in compatible. Uses low power static 21L02-1 500 ns. RAM'S. Fully buffered, drastically reduced power consumption, on board regulated, all sockets and parts included. Premium quality plated through PC Board.
For 250 ns RAM's add \$10.00

NEW! DESIGN CONSOLETTA KIT - \$89.95

S.D. Sales announces the inexpensive way to beat the wire wrap jungle. Our latest kit gives you 124 solderless quick connect terminals, enough for eight 16 pin IC's and provides 50 x 8 common buss matrix. Has regulated +5VDC and +/- 15VDC, all at 1 AMP. Voltage regulation at 100%. Also includes a pulse generator variable from 10hz to 50mhz and .01 sec to 100 nano seconds. Generator output is +5V. In kit form only and includes all parts, sockets; front panel measures 7 1/4"x8 1/2", and hardware. case not available.

CAR/BOAT KIT
\$34.95

Music to your Ears!

New Item!

MUSICAL HORN

Musical Horn Kit for car, boat, or home. Plays any tune from Mozart to Led Zeppelin. Change tunes in seconds; complete solid state electronics. Standard or custom tunes available at \$6.95 each (you supply us with the sheet music - we supply electronics for your favorite tune.) One song supplied with original order. Standard tunes available: DIXIE - EYES OF TEXAS - ON WISCONSIN - YANKEE DOODLE DANDY - NOTRE DAME FIGHT SONG - PINK PANTHER - AGGIE WAR SONG - ANCHORS AWAY - NEVER ON SUNDAY - BRIDGE OVER RIVER QUI - CANDY MAN

HOME KIT
\$26.90

Home kit includes speaker which operates from your door bell. When door bell is pushed your favorite tune is played. Car/boat kit DOES NOT include speaker. Uses standard Bohm PM speaker. Allow 4 weeks delivery on both kits.

Limited Quantity!
\$9.95 kit

6 DIGIT ALARM CLOCK KIT

We made a fantastic kit even better. Redesigned to take advantage of the latest advances in IC technology. Features: Litronix Dual 1/2" displays, Mostek 50250 super clock chip, single I.C. segment driver, SCR digit drivers. Greatly simplified construction. More reliable and easier to build. Kit includes all necessary parts (except case). For P.C. board add \$3.00; AC XFMR add \$1.50. Do not confuse with Non-Alarm kits sold by our competition! Eliminate the hassle - avoid the 5314!
NEW! WITH JUMBO LED READOUTS!

1000 MFD Filter Caps Rated 35 WVDC Upright style with PC leads. Most popular value for hobbyists.

4/\$1.00

SLIDE SWITCH Assortment Our best seller. Includes miniature and standard sizes, single and multi-position units. All new.

12/\$1.00

POWER RESISTOR 15 OHM 25W BY CLAROSTAT

75¢ ea.

RESISTOR ASSORTMENT 1/4W 5% & 10% PC leads. A good mix of values! Special!

200/\$2.

P.C. LEAD DIODES 1N4148/1N914
100/\$2.

40/\$1.

Just received a good mixed lot of National TO-92 plastic transistors. PNP & NPN, even a few FET's. 40-50% yield. Untested Asst.

500/\$3.

DISC CAP ASSORTMENT P.C. Leads. At least 10 different values. Includes .001, .01, .05 plus other standard values.

60/\$1.00

AMD-1702A
Huge Factory Purchase

FACTORY PRIME UNITS! BRAND NEW!
1.5 Micro-Seconds Access Time.
10/\$40. \$4.95 ea.

★ *Special!* ★

3.579545 MHz Time Base Crystal \$1.25

28 PIN SOCKETS 3 for \$1.00

11,000 MFD 50WVDC Computer Grade Cap \$3.00 each

39 MFD 16 V Mallory Electrolytic 15 for \$1.00

FACTORY PRIME!
21L02-1

Not only are our RAM'S faster than a speeding bullet but they are now very low power. We are pleased to offer primo new 21L02-1 Low Power and Super Fast RAM'S. Allows you to STRETCH your power supply farther and at the same time keep the wait light off!

500ns 8/\$12.95
250ns 8/\$15.95

IC'S REMOVED FROM PC BOARDS ALL TESTED; FULL SPEC.

Great Buy!

IC's from XEROX

1402 A Shift Regulator - 50c
MH0025CN - 55c

7400 - 9c
7402 - 9c
7404 - 9c
7406 - 11c
7407 - 11c
7410 - 9c
7416 - 13c
7420 - 9c

7430 - 9c
7440 - 9c
7437 - 10c
7438 - 10c
7451 - 9c
7474 - 16c
7475 - 24c
7486 - 16c

7493 - 26c
74121 - 22c
74123 - 32c
74151 - 9c
74155 - 22c
74193 - 35c
8233 - 35c
Intel - 1302 - 45c

MOS 6 DIGIT UP/DOWN COUNTER

40 PIN DIP. Everything you ever wanted in a counter chip. Features: Direct LED segment drive, single power supply (12 VDC TYPE), six decades up/down, pre-loadable counter, separate loadable compare register with compare out-put. BCD and seven segment outputs, internal scan oscillator, CMOS compatible, leading zero blanking. 1MHz. count input frequency.

\$12.95 Exclusive! \$12.95

CALL IN YOUR BANK-AMERICARD OR MASTER CHARGE ORDER IN ON OUR CONTINENTAL UNITED STATES TOLL FREE WATTS LINE:

1-800-527-3460

Texas Residents Call Collect:
214/271-0022

TERMS:
Money Back Guarantee!

NO COD'S. TEXAS RESIDENTS ADD 5% SALES TAX. ADD 5% OF ORDER FOR POSTAGE & HANDLING. ORDERS UNDER \$10.00 ADD 75c. FOREIGN ORDERS - U.S. FUNDS ONLY!

Orders over \$15. - Choose \$1. FREE MERCHANDISE!

Classified Ads

ASTROLOGY: I am interested in getting in touch with anyone doing astrological chart computation and progression on minicomputer systems. P. Pierce, Bone and Joint Surgery Association, Data Processing Dept, 2704 Marshall Ct, Madison WI 53705.

HELP: I need schematics and electrical specs for a Friden Selectadata paper tape reader, Model STR. Also need schematics and specs and a "Technical Manual" for a Friden Programmatic Flexewriter, Model SPD. I will buy the manuals or pay for copies. John Kane, USS Enterprise, AIMD IM3 WC630, P.O. San Francisco CA 96601.

WANTED: January, February, March, April, May and June 1976 BYTEs. Will pay any reasonable price. Send offers and lists to Reuben Plant, 43 Avista Cir, St Augustine FL 32084.

FOR SALE: One ASR-33 friction feed Teletype complete with reader, punch, and stand, \$700. One ASR-33 sprocket feed Teletype with stand and punch, but no reader, \$400. One ASR-33 sprocket feed Teletype with stand, no reader or punch, \$350. Daniel Skret, 2485 Painted Rock Dr, Santa Clara CA 95051, (408) 296-6783 or (408) 246-8686.

FOR SALE: Video data terminal, RCA Model 70/752, 12 inch screen, 20 lines by 54 Characters. Full editing capability and cursor control, data insert. Output RS232, 1,200 baud, ASCII. Self-contained power supply, timing clock, and two IO boards. ASCII keyboard included, also schematics, specs, etc. \$600 or offer. Dick Blayney, 11241 Laurianne Ln, Garden Grove CA 92641, after 5 PM (714) 539-9175.

FOR SALE: MOD 80-1, fully populated, untested; MOD 8-2, tested; two each MOD 8-4 and MOD 8-5, unpopulated. \$150 for set. RM Terminal as advertised by Micro-Mart, less power supply and printer. S80 Ron Burris, 701 E Pine #143, Lompoc CA 93436.

FOR SALE: MOS Technology, KIM 1, \$175. Perfect condition. Presently running with ASR 33 and cassette tape deck. Complete with all MOS manuals and many programs including Lunar Landing, a text assembler, Hi-Lo and computer roulette games, and a Morse code teaching program. Will sell ASR 33 for \$700. I would like to buy or trade above for a DEC PDP-8. Andy Ring, 49 Main St, Yarmouth ME 04096, (207) 846-5651 or (207) 846-5800 after 5:00.

CIPHERING: Privacy, cryptography, security. Tutorial book, 6603 computer compiled ciphering algorithms, demonstration cipher systems. \$13.25. Clay Pierce, POB 4747, Saticoy CA 93003

FOR SALE: I have several commented listings of SwTPC's MP-E resident assembler for the M6800. Full 132 column paper. \$20 each. George Cruz, 938 Enterprise Av, Inglewood CA 90302

Readers who have equipment, software or other items to buy, sell or swap should send in a clearly typed notice to that effect. To be considered for publication, an advertisement should be clearly noncommercial, typed double spaced on plain white paper, and include complete name and address information. These notices are free of charge and will be printed one time only on a space available basis. Insertions should be limited to 100 words or less. Notices can be accepted from individuals or bona fide computer users clubs only. We can engage in no correspondence on these and your confirmation of placement is appearance in an issue of BYTE.

Please note that it may take three or four months for an ad to appear in the magazine. ■

FOR SALE: NCR data based cassette tapes with clear readers (have been used) but bulk erased, \$4 each or \$3.50 each per dozen. Price includes shipping; supply limited; first come first served. Send cashier's check or money order to Lou Oddo, 2200 Forsyth Rd, Box 28, Orlando FL 32807.

FOR SALE: PolyMorphic, POLY 88 computer, \$480. Seals BKSC-Z, 8 K high speed memory board, \$250. Several IMSAI boards, Tarbell, and PolyMorphic boards. Call (213) 477-8478 for details, or send SASE to Roger Lewis, 1477 Barrington #17, Los Angeles CA 90025.

WANTED: I am a high school student in need of an inexpensive TTY. I wish to use it as an output device for my COSMAC 1802 system and would appreciate any information that would lead to the purchase of such a device. If you can help with this or other devices, please contact Darcy Roberts, 660 Laurier Blvd, Brockville, Ontario, K6V 5X8, CANADA.

WANTED: Economical IBM Selectric or equivalent quality terminal for high quality hard copy. Must have upper and lower case character set, but can be any standard code and keyboard need not be operative. Steve Goldband, 160 Auburn Av, Buffalo NY 14213.

SUMMER 1978: German student (microtechniques, 3rd half-year now) searches opportunity to get some practical experience in small systems and technical English in the USA. Goetz Kluge, Loreleystrasse 93, D6230 Frankfurt 80, W GERMANY

FOR SALE: IMSAI 8080, 22 slot mother board with 9 expms; 8 K Vector Graphics programmable memory, professionally assembled, never been used, guaranteed. \$999. Please call (415) 548-2024, after 7 PM, weekdays only. Gary Melton, 1707B Lincoln St, Berkeley CA 94703.

FOR SALE: 8 K 8080a System, Intel bus 8080a CPU with 6 IO ports, sockets for three more (add one chip), board set up for up to 3 K PROM, 2 to 4 K 450 n static low power programmable memory TVT III with 2 K programmable memory, UART board, cursor control board, HITS cassette interface (space for bootstrap PROM), Hall effect ASCII keyboard, 5 A power supply, case and connectors for 64 K, full documentation, new, not used, backplane unassembled, first \$975. D. Krivosnik, 18 Newcomb Pl, Elizabeth NJ 07202.

FOR SALE: Sphere 320 System (and more!!) Includes CPU board, keyboard, serial interface board (SIM), power supply, 4 K memory board expandable to 16 K (in addition to 4 K of programmable memory on the CPU board), and a video monitor with interface board, all enclosed in an attractive case. Included with this system is a 16 channel 8 bit analog to digital converter for work with analog signal monitoring. Assembly required on the SIM and memory board, but the basic system is up and running on a resident text editor and debugging system in 1 K of PROM. The first check for \$1500 will get this excellent high quality system. Brent Bardsley, 1366 Blaine Av, Salt Lake City UT 84105.

FOR SALE: Three MITS 4 K static programmable memory boards. Assembled, tested and burned in, absolutely new condition. \$185 each, \$360 for two, \$525 for three. I will pay shipping. Chris Pettus, POB 611, Mahbo CA 90265

FOR SALE: Interval Intercept Jr single board computer with programmable memory, ROM monitor, keyboard and LED display, with plug-in serial 20 mA Teletype or RS-232C interface and plug-in 2 channel output interface. New price \$360, will accept highest offer over \$225. Peter Stark, POB 209, Mt Kisco NY 10549, (914) 241-1027

FOR SALE: CT-1024 TV terminal completely assembled in a beautiful wood enclosure. Ready to attach to any TV, includes. Printer, ASCII keyboard, all cursor and erase functions as push-buttons, computer cursor control card, serial interface as RS232C. Plus (unimplemented) scroll mod and 64 character mod board. Only \$325 postpaid. B J Yarkon, 1457 Broadway, Room 305, New York NY 10036.

WANTED: Software. Resident assembler and Tiny BASIC for my Motorola 6800 (20 K) system. I will pay for cost of duplication and mailing. If there is somebody out there who is interested in exchanging programs and hardware information for the Motorola 6800, please write. R Veening, Paul Krugerlaan 113, Den Haag HOLLAND.

FOR SALE: Data Reference Card for RCA 1802 microprocessor. Send \$1 plus self-addressed stamped envelope to R W Moell, 5505 Daywood Ct, Raleigh NC 27609.

FOR SALE: E and L instruments MMD-1 8080a based microcomputer complete with keyboard, 256 bytes programmable memory, 256 bytes of PROM programmed for keyboard entry and execution of programs, power supply, interfacing and breadboarding socket, case, and 40 pin edge connector for expansion. Includes modular, self-taught microprocessor course. Assembled, tested, excellent condition, \$350 Edward D Paradise, 33 Viola Ln, New Britain CT 06053, (203) 223-2883.

IBM 1620: Being modified; additional core, peripherals are to be attached; tape, disk, cassettes, printer are to be attached; any comments, suggestions as to probable problems etc, will be appreciated. Please contact T K Maki, 102 Minott Rd, Westminister MA 01473.

GAMERS: I have compiled a book of BASIC games. Most are new games. If you wish to have a copy, send \$10 in the form of a check or money order to Mike Brothers, 4100 Saratoga Dr, Bloomington IN 47401. Indiana residents add \$.40 for sales tax.

FOR SALE: New 102 switch keyboard printed circuit board double sided, plated through holes, 16 1/4 by 7 inch board. ASCII output or can be changed with 1702A PROM for any 7 bit code. All schematics, parts list, modifications (only five left) \$6. Also Motorola crystal oscillator K1091A (20 MHz \$10 new), (4 MHz \$6 used) 14 pin dip, 4 MHz perfect for OSI video board optional oscillator. Also have miscellaneous parts: bridge rectifiers, filter caps, 6501, 8008, Mark-8 boards, C mod-8 boards, Monitor-8 ROM, 8008 manuals, books, etc. Send SASE for complete list to Ron Angstadt, RD=3, Box 281, Kutztown PA 19530.

FOR SALE: 18 digital cassette tapes and cases by Wang Labs Inc. Like new \$2 each, 30 Shugart full size floppies, most barely used \$4 each. Harry Morrow, 437 Barton Run Blvd, Marlton NJ 08053. Call daytime (215) 586-3600.

FOR SALE: Two GSI 110 floppy disk drives, single or dual density, soft or hard sector drives. The electronics boards are fully optioned, including data separator, a complete set of documentation and all connectors and cables. \$350 each or \$650 for the pair. Jim Baumgardt, 6343 Lincoln Av, Apt F-2, Buena Park CA, (714) 826-7056.

FOR SALE: Selectric IO keyboard printer service manual, clean and barely used, \$20 or early issues of BYTE in trade. Michael Craig, POB 895, West Acton MA 01720.

FOR SALE: Teletype ASR-33 in very good condition, with manuals, \$600. MITS 88-ACR audio cassette interface, assembled and working, \$120. I need more memory and an IO board (RS-232) for S-100 bus and would consider a trade-in on the above items. Donald Bailey, 19 Shaker Rd, Concord NH 03301.

CHESS: BYTE readers interested in exchanging information about computer chess, finding postal opponents for their computer chess programs or organizing a tournament are invited to write me. R M Hord, 3407 N Third St, Arlington VA 22201.

FOR SALE: Complete set of BYTEs, all issues from first thru April 1977. Best offer. Jim McCord, 330 Vereda Leyenda, Goleta CA 93017.

FOR SALE: New Univac 30 cps 132 column 64 character printer with drive electronics board and motor (new), also sturdy Univac case and stand (used), with documentation and interface information, cost \$1800+, sacrifice \$695. D Krivosnik 18 Newcomb Pl, Elizabeth NJ 07202.

NEW COMPUTER INTERFACE BOARD KIT

Our new computer kit allows you to interface serial TTL to RS 232 and RS 232 to TTL. There are four of these supplied with the kit, so you can run up to four devices on one TTL or four separate TTL to RS 232 devices.

Typical use: You can use your computer ports to run an RS 232 printer, video terminal and two other RS 232 devices at once, without

constantly connecting and disconnecting your terminals.

Example: Out store to printer — Voltage requirement + 5V and ± 5V or ± 12 V depending on your RS 232 device.

We supply — board, connectors, documentation and components. Sorry, we do not supply case or power supply.

\$49⁰⁰

GENERAL PURPOSE COMPUTER POWER SUPPLY KIT

This power supply kit features a high frequency torroid transformer with switching transistors in order to save space and weight. 115V 60 cycle primary. The outputs with local regulators are 5V to 10A, in one amp increments, - 5V at 1A, ± 12V at 1A regulators supplied 6 340T-5 supplied.

\$79⁰⁰

UNIVERSAL 4K MEMORY BOARD KIT \$74⁵⁰

This memory board may be used with the F8 and with minor modifications may be used with KIM-1μp.

32-2102-1 static RAM's, 16 address lines, 8 data lines in, 8 data lines out, all buffered. On-board decoding for any 4 of 64 pages, standard 44 pin, .156" buss.

F8 EVALUATION BOARD KIT WITH EXPANSION CAPABILITIES

A fantastic bargain for only with the following features:

\$99⁰⁰

- 20 ma or RS 232 interface
- 64K addressing range
- Program control timers
- 1K of on-board static memory
- Built in clock generator
- 64 Byte register
- Built-in priority interrupts
- Documentation
- Uses Fairbug PSU

FOR FAIRBUG 4K F8 BASIC ON PAPER TAPE \$25⁰⁰

2708 BK EPROM	\$24.95
2523 16 BIT 1 REG	\$ 7.95
2511 CHARACTER GEN	\$ 9.95
2512 HEX 12 BIT SH	\$ 3.50
2102 1 1024 BIT RAM	\$ 1.29
52014 DYNAMIC RAM	\$ 4.75
52024 1K PROM	\$ 6.95
1101A 256 BIT RAM	\$ 8.95
1703A 1K PROM	\$ 4.95
5204 4K PROM	\$10.95
AY 5 1013 UART	\$ 6.95
MINIATURE MULTI TURN TRIM POTS	
100, 500, 1K, 2K, 5K, 10K, 25K, 50K, 100K,	
200K, 500K 1 Meg. \$ 75 each. 3/\$2.00	
CULOT FERRITE TRIGGER POTS Similar to Bourns	
3010 style 3 16" x 5 8" x 1 4" 50, 100,	
1K, 10K, 50K values \$1.50 ea. 2/\$4.00	
TIGHT ACTIVATED SCR'S	
TO 18, 200V 1A \$ 1.10	

TRANSISTOR SPECIALS

2N3648 NPN Si TO 66	\$ 95
2N3172 NPN Si TO 3	\$ 1.60
2N424A PNP Si TO 3	\$ 1.60
2N4918 PNP Si TO 18	\$ 1.00
2N6096 NPN Si TO 3 Darlingtion	\$ 1.70
2N5186 PNP Si TO 92	4/5 \$ 1.00
2N4818 PNP TO 66	\$.60
2N4941 PNP GE TO 5	5 \$ 1.00
2N3919 NPN Si TO 3 HI	\$ 1.50
2N3914 PNP Si TO 92	3 \$ 1.30
2N3767 NPN Si TO 66	\$.70
2N2722 NPN Si TO 18	5/5 \$ 1.35
2N3856 NPN Si TO 3	\$.70
2N3904 NPN Si TO 92	5/5 \$ 1.00
2N3906 PNP Si TO 92	5/5 \$ 1.00
2N5756 NPN Si TO 220	\$.30
2N6109 NPN Si TO 220	\$.55
2N3638 PNP Si TO 5	5/5 \$ 1.00
2N851 7 NPN TO 92 5	3/5 \$ 1.00

WSU 30 HAND WIRE WRAP TOOL USED TO WRAP, UNWRAP AND STRIP #30 WIRE \$5.95

#24 EIGHT CONDUCTOR SPECTRA FLAT CABLE 100/75/30	
#30 WIRE WRAP WIRE SINGLE STRAND 100/75/40	

IN 4148 (1N4148) 1P/\$1.30	
MACA 31 OPTICAL LIGHT SWITCH \$1.50	

LED READOUTS

FND 359 C.C. 4" x 50 HP 7740-3" C.C.	\$1.25
FND 70 C.C. 4" x 55 MAN-7-3" C.A.	\$.95
FND 503 C.C. 5" x 85 NS 33-3 dig. array	\$.75
FND 510 C.A. 5" x 85 DL 747 C.A. 6"	\$1.95

PRINTED CIRCUIT BOARD

4 1/2" x 6 1/2" SINGLE SIDE EPOXY BOARD 1 16" Holes 1/16" thick \$ 60 ea. 5/\$2.60

7 WATT LD-65 LASER DIODE IR \$8.95

2N 3820 P FET	\$ 45
2N 5457 N FET	\$ 45
2N2646	\$ 45
ER 900 TRIGGER DIODES	4 \$1.00
2N 6028 PROG. UJT	\$.65
8 PIN DIP SOCKETS	\$.24
14 PIN DIP SOCKETS	\$.25
16 PIN DIP SOCKETS	\$.28
18 PIN DIP SOCKETS	\$.30
24 PIN DIP SOCKETS	\$.40
28 PIN DIP SOCKETS	\$.50
40 PIN DIP SOCKETS	\$.60

VERIPAX PC BOARD

This board is a 116" single sided paper epoxy board, 4" x 6 1/2" DRILLED and ETCHED which will hold up to 21 single 14 pin IC's or 8, 16, or LSI DIP IC's with buses for power supply connector. \$4.00

MV 5691 YELLOW GREEN BIPOLAR LED	\$.90
EP 100 PHOTO TRANS.	\$.50
RED, YELLOW, GREEN or AMBER LARGE LED'S	6/\$1.00
1L-5 IMCT-2L	\$.75
MOLEX PINS	100/\$1.00
10 WATT ZENERS 3.9, 4.7, 5.6, 8.2, 12.15, 18, 22, 100, 150 or 200V	ea. \$.60
1 WATT ZENERS 4.7, 5.6, 10, 12, 15, 18 or 22V	ea. \$.25
MC6860 MODEM CHIP	\$9.95

Silicon Power Rectifiers

PRV 1A 3A 12A 50A 125A	
100 06 14 30 80 170	
200 07 20 35 115 425	
400 09 25 50 140 650	
600 11 30 70 180 850	
800 15 35 90 230 1050	
1000 20 45 110 275 1250	

SILICON SOLAR CELLS

2 1/2" diameter 4V at 500 ma. \$4.00 / 2V at 200 ma \$2.00

REGULATORS

309K	\$.95	340K-5, 12, 15	
723	\$.50	or 24V \$.85
LM 376	\$.60	340T-5, 6, 8, 12	
320K-5 or 15V	1.40		15, 18 or 24V/10	
320T-5, 12, 15, or 24V	\$.85	78 MG \$1.35
			79 MG \$1.35

RS232 DB 25P male	\$2.95
CONNECTORS DB 25S female	\$3.50

TANTULUM CAPACITORS

22UF 35V 5 \$1.00	6 8UF 35V 3 \$1.00
47UF 35V 5 \$1.00	22UF 35V \$.40
68UF 35V 5 \$1.00	30UF 6V 5/\$1.00
10UF 35V 5 \$1.00	33UF 15V \$.40
22UF 20V 5 \$1.00	47UF 20V \$.35
33UF 35V 4 \$1.00	68UF 15V \$.50
47UF 15V 5 \$1.00	10UF 25V \$.25
M/2001 ALARM CLOCK CHIP	\$5.75

NATIONAL MOS DEVICES

MM1402	1.75	MM6057	2.25
MM1403	1.75	MM6058	2.75
MM1404	1.75	MM5060	2.75
MM5013	2.50	MM5061	2.50
MM5016	2.50	MM5055	4.75
MM5017	2.70	MM5056	4.75
MM5055	2.25	MM6210	1.95
MM5056	2.25	MM6260	1.75

TTL IC SERIES

7400	.14	7445	-.65	74150	-.90
7401	.14	7446	-.65	74151	-.60
7402	.14	7447	-.65	74153	-.60
7403	.14	7448	-.65	74154	-.95
7404	.18	7450	-.15	74155	-.70
7405	.18	7472	-.29	74157	-.58
7406	.25	7473	-.29	74161	-.85
7407	.25	7474	-.29	74163	-.80
7408	.18	7475	-.45	74164	-.95
7409	.17	7476	-.30	74165	-.95
7410	.14	7480	-.35	74173	1.20
7411	.20	7483	-.62	74174	-.95
7412	.20	7485	-.87	74175	-.82
7413	.39	7486	-.30	74176	-.75
7414	.63	7489	1.85	74177	-.75
7416	.25	7490	-.42	74180	-.65
7417	.25	7491	-.58	74181	1.50
7420	.14	7492	-.43	74190	1.00
7425	.25	7493	-.45	74191	1.00
7426	.22	7494	-.70	74192	-.83
7427	.25	7495	-.65	74193	-.83
7430	.14	7496	-.65	74194	-.95
7432	.25	7497	-.28	74195	-.52
7437	-.21	74121	-.33	74257	1.25
7438	-.21	74123	-.65	74279	-.87
7440	.14	74125	-.40	75324	1.75
7441	-.70	74126	-.40	75431	-.65
7442	-.40			75432	-.65

MINIATURE DIP SWITCHES

C15 206-4 Four SPST switches in one miniature package	\$1.75
C15 206-8 Eight SPST switches in a 16 pin DIP package	\$1.95

5 DIV SPST Momentary reset, relay, normally open, J30 Ohmic load resistance 5.75, 3.52 00	
ALCO MINIATURE TOGGLE SWITCHES	
M1A 106 SPDT	\$1.20
M1A 206 DPDT	\$1.70

Full Wave Bridges

PRV	2A	6A	25A
200	75	1.25	2.00
400	95	1.50	3.00
600	120	1.75	4.00

SANKEN AUDIO POWER AMPS

SA 1010 G 10 WATTS	\$ 7.95
SA 1020 G 20 WATTS	\$15.95
SA 1050 G 50 WATTS	\$27.95

WSU-30-Hand wire wrap tool used to wrap, un-wrap & Strip #30 wire \$5.95

CCD 201 180 x 180 CHARGE COUPLED DEVICE \$99.00

Send 25¢ for our catalog featuring Transistors and Rectifiers 145 Hingham St. Cambridge, Mass

74LS SERIES

74LS00	-.23	74LS125	-.65	LM 101	-.75
74LS02	-.23	74LS132	-.65	LM 301/248	-.31
74LS03	-.23	74LS137	-.80	LM 307	-.30
74LS04	-.28	74LS138	-.72	LM 308	-.95
74LS05	-.28	74LS139	-.72	LM 311	-.85
74LS08	-.23	74LS145	1.15	LM 318	1.35
74LS10	-.23	74LS151	-.98	LM 319	-.95
74LS11	-.23	74LS152	-.92	LM 324	1.05
74LS13	-.23	74LS155	1.40	LM 330	1.10
74LS13	-.23	74LS156	-.95	LM 337	2.50
74LS15	-.23	74LS157	-.98	LM 380	-.95
74LS20	-.23	74LS160	1.02	LM 381	1.25
74LS21	-.23	74LS161	1.02	LM 382	1.25
74LS22	-.23	74LS162	1.02	LM 537	2.50
74LS27	-.27	74LS163	1.02	LM 553	2.50
74LS30	-.23	74LS168	1.10	LM 555	-.44
74LS32	-.33	74LS169	1.10	LM 556	-.85
74LS37	-.33	74LS173	1.39		
74LS38	-.37	74LS174	1.05	560	2.00
74LS40	-.27	74LS179	1.22	565	2.10
74LS51	-.23	74LS190	1.50	566	1.50
74LS54	-.23	74LS191	1.50	567	1.50
74LS74	-.48	74LS192	1.75	703	-.90
74LS90	-.95	74LS193	1.75	709	-.25
74LS42	-.88	74LS195	1.25	710	-.35
74LS73	-.40	74LS196	-.99	711	-.35
74LS74	-.40	74LS197	-.89	741 C or V	3.1
74LS76	-.40	74LS257	1.35	747	-.65
74LS90	-.89	74LS258	1.38	748	1.30
74LS92	-.85	74LS266	-.68	1456	-.95
74LS93	-.85	74LS365	-.66	1458	-.60
74LS109	-.90	74LS366	-.65	CA 304B	-.75
74LS112	-.43	74LS367	-.66	CA 3047	-.95
74LS113	-.43	74LS368	-.66	3900	-.49
74LS114	-.43	74LS390	2.20	8038CC	3.90

TRIACS

PRV	1A	1CA	25A	1.5A	6A	35A
100	40	70	1.30	1.30	50	1.20
200	70	110	1.75	1.75	70	2.60
400	110	160	2.60	1.00	120	2.20
600	170	230	3.60	1.50	3.00	

Terms: FOB Cambridge, Mass. Send Check or Money Order. Include Postage, Minimum Order \$5.00, COD'S \$20.00



SOLID STATE SALES

P.O. BOX 74B SOMERVILLE, MASS. 02143 TEL. (617) 547-6005

WE SHIP OVER 95% OF OUR ORDERS THE DAY WE RECEIVE THEM

Reader Service

To get further information on the products advertised in BYTE, fill out the reader service card with your name and address. Then circle the appropriate numbers for the advertisers you select from this list. Add a 9 cent stamp to the card, then drop it in the mail. Not only do you gain information, but our advertisers are encouraged to use the marketplace provided by BYTE. This helps us bring you a bigger BYTE.

*Reader service inquiries not solicited. Correspond directly with company.

Reader Service Number	Page Number	Reader Service Number	Page Number	Reader Service Number	Page Number
283	Alpha Digital 203	233	Heuristics 107	281	PERCOMP 78 5
208	Apple 14, 15	234	Homestead Technology 110	296	Personal Computing Corp 205
221	Axiom 67	203	iCOM 8, 9	*	Personal Computing Expo 162-165
261	Beehive International 179	205	IMSAI 28, 29	237	Peripheral Vision 111
255	BITS 169, 170, 171, 202, 204, 96	286	Intelligent Business Machines 203	*	PolyMorphic 19
284	Bits & Bytes Computer Shop 203	258	International Data Systems 176	207	Processor Technology 22, 23, 24
230	BPI 99	266	Ithaca Audio 182	241	Quantronics 119
*	BYTE Index 205	305	James Electronics 214, 215	223	Quay 75
280	Byte Shop East 198	211	John Fluke Mfg 35	248	RHS Marketing 159
285	Byte Shop of Miami 203	229	Kent-Moore 98	298	Rotundra Cybernetics 205
213	California Computer Products 41	217	Lear Siegler 56, 57	218	Scelbi 58
273	Canada Systems 186	259	Logical Services 177	*	Scientific Research 73, 81
269	Computalk 184	*	MACC 199	309	S D Sales 221
287	Computer Corner 203	260	M & R Enterprises 178	214	Seals 47
288	Computer Depot 203	294	Manchester Equipment 205	238	Smoke Signal Broadcasting 113
267	Computer Enterprises 182	306	Meshna 217	268	Software Exchange 183
313	Computer Faire Proceedings 220	226	Micro AGE 93	253	Software Records 168
202	Computerland 6, 7	254	Microcom 168	220	Solid State Music 61
289	Computer Mart of NH 203	293	Microcomp 205	310	Solid State Sales 223
201	Cromemco 1, 2	250	Micronics Inc 161	232	Soroc 105
247	Dajen Electronics 152	245	Micro Term 147	222	Space Byte 71
212	Databyte 37	265	Microwave 181	200	Southwest Tech CII
270	Data Search 184	307	Mikos 219	299	Sunny Computer Store 205
242	Digital Group 121	256	MiniTerm 172, 173	231	Synchro Sound 100, 101
279	Digital Micro Systems 189	312	MIT'S CIV	300	Szerlip Enterprises 205
239	Digital Research 115	308	Morrow 219	274	Tarbell 187
315	DRC Engineering 97	276	mpi 188	209	Technical Design Labs 31
311	ECD CIII	240	MSI 117	225	Technical Systems Consultants 87
290	Economy Terminal 203	295	Mulab Inc 205	246	Telesensory Inc 150
272	Edityper Systems Corp 186	275	Mullen 187	235	Telefile Computer Corp 110
291	Electravalve 203	219	National Multiplex 60	215	TLF Corp 51
278	Electronic Control Technology 189	227	North Star Computer 95	262	Triple I 180
301	Electronic Warehouse 208	277	Objective Design 188	282	Urban Instruments 201
302	Eltron 209	224	OK Tool 83	236	Vamp 110, 199
210	Extensys 33	257	Oliver Audio Engineering 175	204	Vector Graphic 10, 11, 59
292	F & D Associates 205	216	OSI 52, 53	264	Vectron 181
303	Formula International 211	244	PAIA 145	271	Wintek Corp 185
252	General Computer 167	251	Parasitic 166, 183	263	Worldwide 180
304	Godbout 213	*	PC 77 88, 89, 90	228	Ximedia 109
243	Heath Co 129-144	*	PerCom Data 151, 174	249	Xybek 161

BYTE'S Coping Matter: Etc

BOMB's Double Header...

As noted last month, due to the delay in mailing the May 1977 issue caused by a printing plant strike, the analysis of May's reader reactions to articles was delayed by one month. This month, then, the analysis covers the May and June issues.

On BOMB Card, Article No.

ARTICLE

PAGE

1	Taylor: SCORTOS: Implementation of a Music Language	12
2	Atkins: A New Dress for KIM	26
3	Ciarcia: Control the World! (Or at Least a Few Analog Points)	30
4	Emmerichs: Expanding the Tiny Assembler	44
5	Rampil: One-Sided View of Wire Wrap Sockets	54
6	Chamberlin: Techniques for Computer Performance of Music	62
7	Sierad: Tune in with Some Chips	84
8	Hauck-Nash: The Noval 760	102
9	Helmers: Notes on Interfacing Player Pianos	112
10	Morgan: Notes on Anatomy: The Piano's Reproductive System	122
11	Wimble: An APL Interpreter for Microcomputers: Part 2	126
12	Jacoby: Walsh Functions: A Digital Fourier Series	190

For May, the winner was Sheldon Linker's "What's in a Floating Point Package?" Author Linker thus receives the \$100 first prize bonus, while second place (and a \$50 bonus) went to Jack Emmerichs' article, "Implementing the Tiny Assembler." The May issue statistics found the winner at 1.1 standard deviations away from the mean of all article votes, with the standard deviation coming in at 15% of the mean. May articles had fairly uniform reactions from readers as measured by the relatively small deviation in votes for the various articles.

In contrast, the June voting was characterized by an overwhelming "spike" in the response, with the winning entry Ralph Hollis' "Newt: A Mobile Cognitive Robot." He won the voting (and the \$100 prize) easily with a positive margin of 2.1 standard deviations away from the mean. Second place at 0.6 standard deviations was Dan Fylstra's article on "Interfacing the IBM Selectric Keyboard Printer." Reflecting the "spike" in favor of Newt, the standard deviation of this group of votes was 23% of the mean. ■

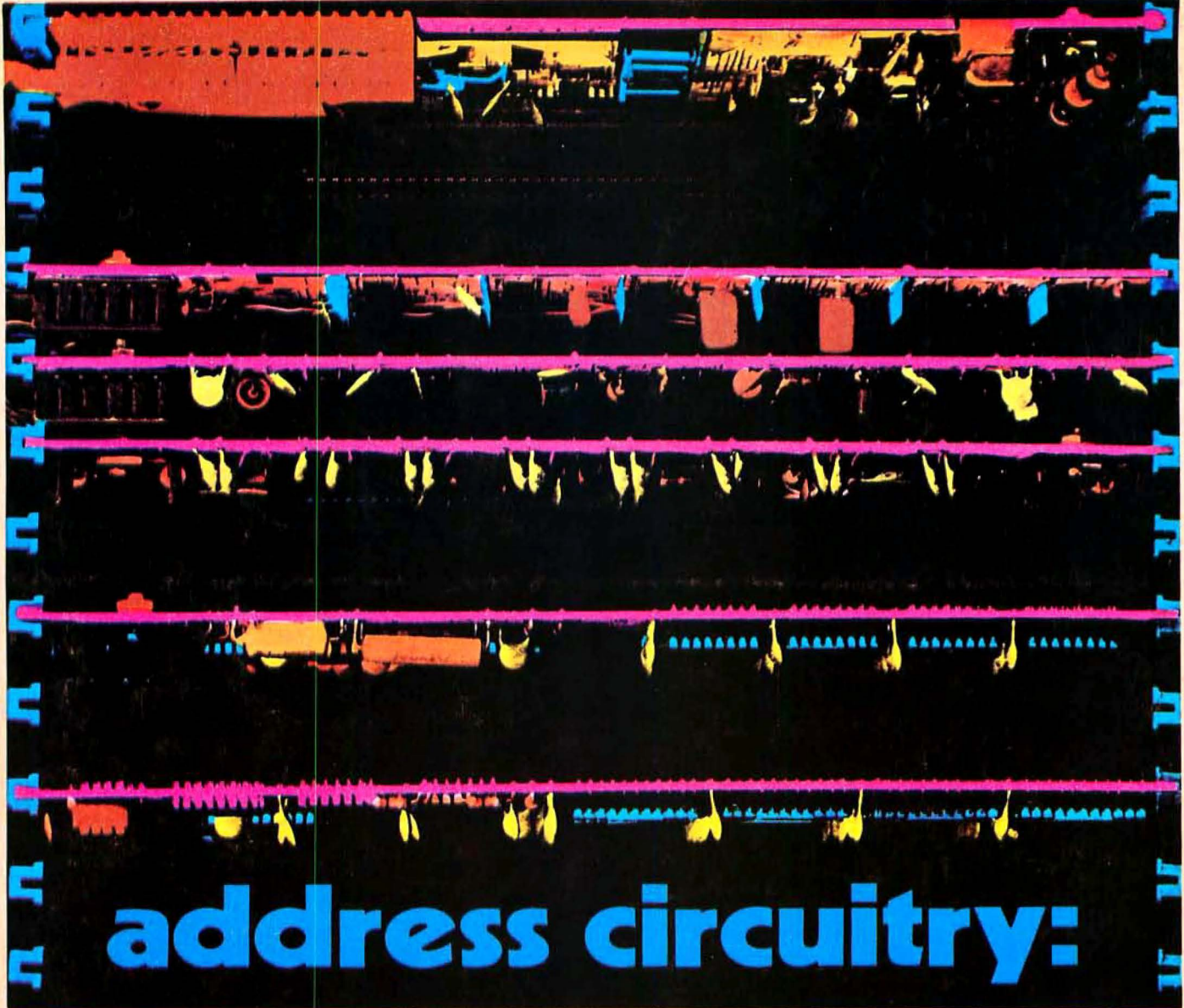

address circuitry:

Altair Computer Centers offer you direct access to the complete line of Altair microcomputer products. For demonstrations, information or service, visit the experts at your local Altair Computer Center today. They're located at these addresses:

ALTAIR COMPUTER CENTER
4941 East 29th St.
TUCSON, AZ 85711
(602)-748-7363

COMPUTER KITS (S.F. area)
1044 University Ave.
BERKELEY, CA 94710
(415)-845-5300

THE COMPUTER STORE
(Arrowhead Computer Co.)
820 Broadway
SANTA MONICA, CA 90401
(213)-451-0713

THE COMPUTER STORE, INC.
(Hartford area)
63 South Main Street
WINDSOR LOCKS, CT 06096
(203)-627-0188

GATEWAY ELECTRONICS, INC.
OF COLORADO
2839 W. 44th Ave.
DENVER, CO 80211
(303)-458-5444

THE COMPUTER SYSTEMCENTER
3330 Piedmont Road
ATLANTA, GA 30305
(404)-231-1691

CHICAGO COMPUTER STORE
517 Talcott Rd.
PARK RIDGE, IL 60068
(312)-823-2388

THE COMPUTER STORE, INC.
120 Cambridge St.
BURLINGTON, MA 01803
(617)-272-8770

THE COMPUTER STORE
OF ANN ARBOR
310 East Washington Street
ANN ARBOR, MI 48104
(313)-995-7616

COMPUTER STORE OF DETROIT
505-507 West 11 Mile St.
MADISON HEIGHTS, MI 48071
(313)-545-2225

THE COMPUTER ROOM
3938 Beau D'Rue Drive
EAGAN, MN 55122
(612)-452-2567

GATEWAY ELECTRONICS, INC.
8123-25 Page Blvd.
ST. LOUIS, MO 63130
(314)-427-6116

ALTAIR COMPUTER CENTER
5252 North Dixie Drive
DAYTON, OH 45414
(513)-274-1149

ALTAIR COMPUTER CENTER
110 The Annex
5345 East Forty First St.
TULSA, OK 74135
(918)-664-4564

ALTAIR COMPUTER CENTER
8105 SW Nimbus Ave.
BEAVERTON, OR 97005
(503)-644-2314

ALTAIR COMPUTER CENTER
611 N. 27th St. Suite 9
LINCOLN, NB 68503
(402)-474-2800

COMPUTER STORES
OF CAROLINA, INC.
1808 E. Independence Blvd.
CHARLOTTE, N.C. 28205
(704)-334-0242

COMPUTER SHACK
3120 San Mateo N.E.
ALBUQUERQUE, NM 87110
(505)-883-8282, 883-8283

THE COMPUTER STORE
269 Osborne Rd.
ALBANY, NY 12211
(518)-459-6140

THE COMPUTER STORE
OF NEW YORK
55 West 39th St.
NEW YORK, NY 10018
(212)-221-1404

ALTAIR COMPUTER CENTER
3208 Beltline Road
Suite 206
DALLAS, TX 75234
(214)-241-4088 Metro-263-7638

ALTAIR COMPUTER CENTER
5750 Bintliff Drive
HOUSTON, TX 77036
(713)-780-8981

COMPUTERS-TO-GO
4503 West Broad St.
RICHMOND, VA 23230
(804)-335-5773

MICROSYSTEMS (Washington, D.C.)
6605A Backlick Rd.
SPRINGFIELD, VA 22150
(703)-569-1110

THE COMPUTER STORE
Suite 5
Municipal Parking Building
CHARLESTON, W.VA. 25301
(304)-345-1360



Circle 312 on inquiry card.