

NOVEMBER 1979 Volume 4, Number 11 \$2.50 in USA/\$2.95 in Canada

# BYTE<sup>®</sup>

the small systems journal  
A MCGRAW-HILL PUBLICATION



ROBERT  
TINNEY

FUN AND GAMES



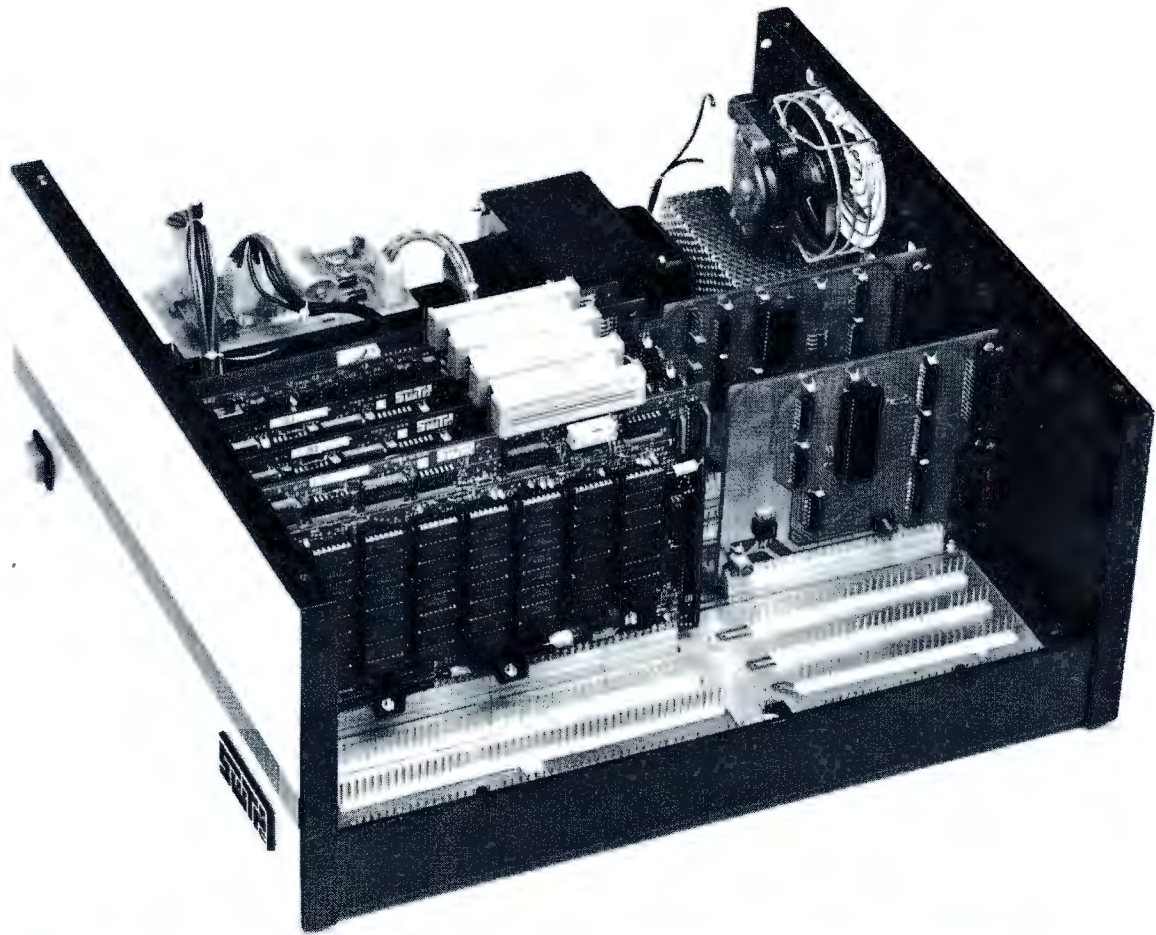

# S/09 THE MIGHTY MICRO

**MC6809 PROCESSOR — 20-BIT ADDRESS BUS  
DIRECTLY ADDRESSES UP TO 768K OF RAM**

Performance and capabilities never before possible are now available to you in the SWTPC S/09. Computer System. The S/09 uses the Motorola MC6809 processor, the most powerful 8-bit general purpose MPU available. It features more addressing modes than other 8-bit MPU's and an optimized consistent instruction set enhanced by powerful 16-bit instructions. This, plus 24 indexing submodes, promote the use of modern programming techniques like position independent code, re-entrancy and recursion.

The 20-bit address bus makes possible direct addressing of up to 768K of memory without any slow or clumsy processes such as bank switching. RAM memory is designed with independent control and array cards for economical expansion of memory. The DMA and the processor boards can access memory independently for different tasks.

Multuser capability is "built-in". No additional hardware is required to operate additional terminals. A dynamic memory management system can allocate available RAM in as small as 4K blocks to the various users or tasks.

The dual-bus motherboard design used in the S/09 makes adding I/O ports to the system quick and economical. I/O address decoding for all I/O slots is supplied with the system. All serial I/O cards may be quickly programmed to run at standard baud rates from 110 to 38,400.

Both multiuser and multitasking/multiuser operating systems are available for the S/09. BASIC, PASCAL and an Assembler are immediately available. Editor and Debug programs are also available for use in system development.

**S/09 complete as shown with 128K bytes of RAM memory, one parallel and two serial I/O ports. . . \$2,995.00**  
**128K memory expansion card . . . . . \$1,995.00**

Circle 356 on inquiry card.



**SOUTHWEST TECHNICAL PRODUCTS CORPORATION**  
**219 W. RHAPSODY**  
**SAN ANTONIO, TEXAS 78216** (512) 344-0241



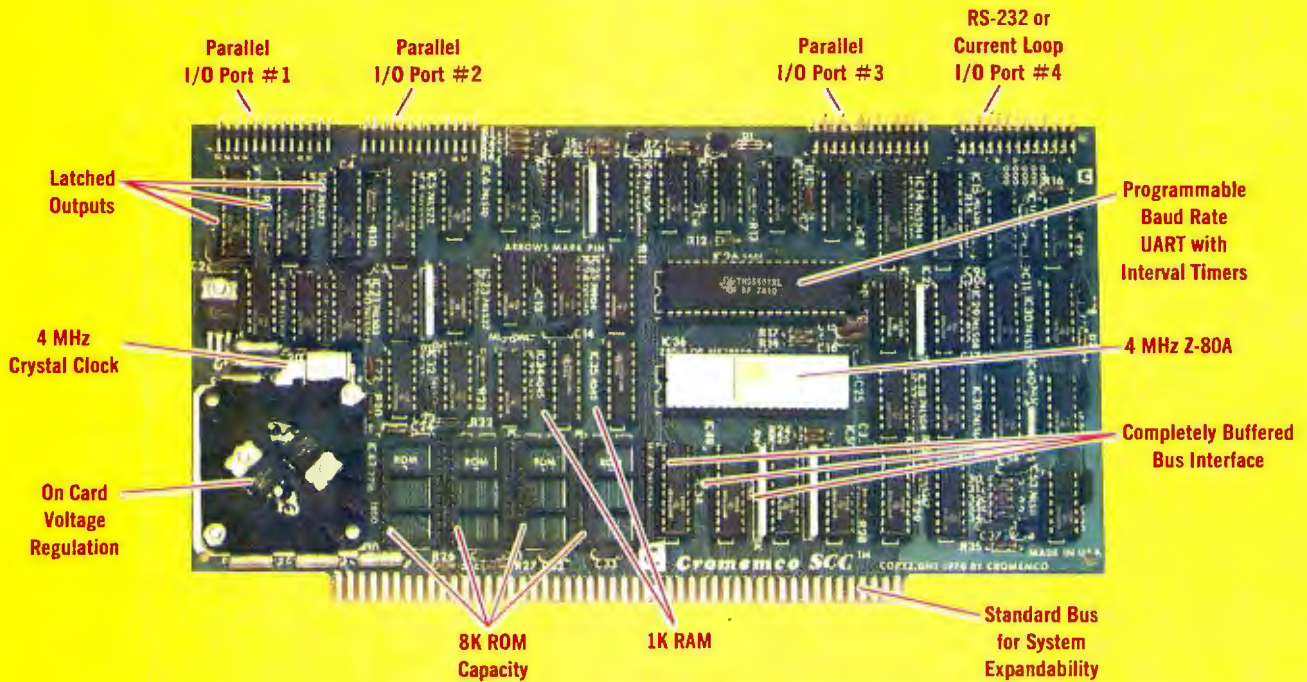

# The single card computer with the features that help you in real life

## COMPLETE COMPUTER

In this advanced card you get a professional quality computer that meets today's engineering needs. And it's one that's complete. It lets you be up and running fast. All you need is a power supply and your ROM software.

The computer itself is super. Fast 4 MHz operation. Capacity for 8K bytes of ROM (uses 2716 PROMs which can be programmed by our new 32K BYTESAVER® PROM card). There's also 1K of on-board static RAM. Further, you get straightforward interfacing through an RS-232 serial interface with ultra-fast speed of up to 76,800 baud — software programmable.

Other features include 24 bits of bi-directional parallel I/O and five on-board programmable timers.

Add to that vectored interrupts.

## ENORMOUS EXPANDABILITY

Besides all these features the Cromemco single card computer gives you enormous expandability if you ever need it. And it's easy to expand. First, you can expand with the new Cromemco 32K BYTESAVER PROM card mentioned above. Then there's Cromemco's broad line of S100-bus-compatible memory and I/O interface cards. Cards with features such as relay interface, analog interface, graphics interface, optoisolator input, and A/D and D/A conversion. RAM and ROM cards, too.



Card Cage

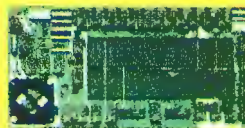

32K BYTESAVER PROM card

## EASY TO USE

Another convenience that makes the Model SCC computer easy to use is our Z-80 monitor and 3K Control BASIC (in two ROMs). With this optional software you're ready to go. The monitor gives you 12 commands. The BASIC, with 36 commands/functions, will directly access I/O ports and memory locations — and call machine language subroutines.

Finally, to simplify things to the ultimate, we even have convenient card cages. Rugged card cages. They hold cards firmly. No jiggling out of sockets.

## AVAILABLE NOW/LOW PRICE

The Model SCC is available now at a low price of only \$450 burned-in and tested (32K BYTESAVER only \$295).

So act today. Get this high-capability computer working for you right away.



**Cromemco**  
i n c o r p o r a t e d

Specialists in computers and peripherals

280 BERNARDO AVE., MOUNTAIN VIEW, CA 94040 • (415) 964-7400





# Low-cost hard disk computers are here

**11 megabytes of hard disk and 64 kilobytes of fast RAM in a Z80A computer for under \$10K. Two floppy drives, too. Naturally, it's from Cromemco.**

It's a reality. In Cromemco's new Model Z-2H you get all of the above and even more. With Cromemco you get it all.

In this new Model Z-2H you get not only a large-storage Winchester hard disk drive but also two floppy disk drives. In the hard disk drive you get unprecedented storage capacity at this price—11 megabytes unformatted.

You get speed—both in the 4 MHz Z80A microprocessor and in the fast 64K RAM which has a chip access time of only 150 nanoseconds. You get speed in the computer minimum instruction execution time of 1 microsecond. You get speed in the hard disk transfer rate of 5.6 megabits/sec.

## EXPANDABILITY

You get expandability, too. The high-speed RAM can be expanded to 512 kilobytes if you wish.

And the computer has a full 12-slot card cage you can use for additional RAM and interface cards.

## BROADEST SOFTWARE SUPPORT

With the Z-2H you also get the broadest software support in the

microcomputer field. Software Cromemco is known for. Software like this:

- Extended BASIC
- FORTRAN IV
- RATFOR (RATional FORtran)
- COBOL
- Z80 Macro Assembler
- Word Processing System
- Data Base Management

with more coming all the time.

## SMALL, RUGGED, RELIABLE

With all its features the new Z-2H, including its hard disk drive, is still housed in just one small cabinet.

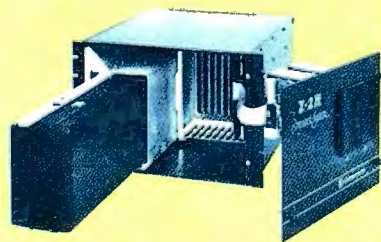

Hard disk drive at lower left can be interchanged just by sliding out and disconnecting plug. Seven free card slots are available. Z-2H includes printer interface card.

Included in that cabinet, too, is Cromemcoruggedness and reliability. Cromemco is time-proved. Our equipment is a survey winner for reliability. Of course, there's Cromemco's all-metal cabinet. Rugged, solid. And, there's the heavy-duty power supply (30A @ 8V, 15A @ +18 V, and 15A @ -18V) for circuitry you'll sooner or later want to plug into those free card slots.

## CALL NOW

With its high performance and low price you KNOW this new Z-2H is going to be a smash. Look into it right now. Contact your Cromemco computer store and get our sales literature. Find out when you can see it. Many dealers will be showing the Z-2H soon—and you'll want to be there when they do.

### PRESENT CROMEMCO USERS

We've kept you in mind, too. Ask about the new Model HDD Disk Drive which can combine with your present Cromemco computer to give you up to 22 megabytes of disk storage.

**Cromemco**  
i n c o r p o r a t e d

280 BERNARDO AVE., MOUNTAIN VIEW, CA 94040 • (415) 964-7400

Tomorrow's computers now



## Foreground

- 26** SOLVING SOMA CUBE AND POLYOMINO PUZZLES *by D Macdonald and Y Gürsel*  
The serious application of computers to game problems
- 66** PROGRAMMING STRATEGIES IN THE GAME OF REVERSI *by Peter B Maggs*  
A tutorial on using the minimax theory in designing a game
- 104** A SPACECRAFT SIMULATOR *by Gary Sivak*  
A space-navigation game
- 113** THE NATIONAL MICROPASTIME *by Joseph J Roehrig*  
Simulating baseball games using actual statistics
- 152** WRITING ANIMATED COMPUTER GAMES *by Tony Estep*  
The essentials of producing animated video games
- 222** BUILD A SIMPLE DIGITAL OSCILLOSCOPE *by Frank DeCaro*  
Display waveforms with light-emitting diodes



page 14



page 26

## Background

- 14** THE INTEL 8086 *by Steve Ciarcia*  
Hands-on experience with a system design kit
- 84** ALPHA-BETA PRUNING *by W D Maurer*  
A programmer's approach to simulating a chess game
- 98** INTERFACING THE PET TO A LINE PRINTER *by P K Govind*  
Connection through the PET user port plus a screen image-printing program
- 140** STACK IT UP *by Charlton H Allen*  
Use your microprocessor's stack to your best advantage
- 172** FIVE USEFUL PROGRAMS FOR THE SC/MP *by Charles A Kapps*  
Utility programs
- 232** THE CHERRY PRO KEYBOARD *by Dan S Parker*  
A professional keyboard for the hobbyist

TEAM FILE # 75-BOSTON

ID	HITTERS	BAIS	HITS
0	YASTREMSKI	1	.232
1	BOYLE	1	.296
2	BURLESON	0	.234
3	PETROCELLI	0	.217
4	EVANS	0	.246
5	LYNN	1	.297
6	RICE	0	.290
7	FSK	0	.300
8	COOPER	1	.293
9	CARBO	1	.204
10	GRIGGIN	0	.226
11	BENIQUEZ	0	.262
12	MILLER	1	.163
13	HEISE	0	.208
14	MONTGOMERY	0	.221
15	BLACKWELL	2	.172
16	CONGLIARO	0	.108

ID	PITCHERS	R-L	HITS
0	WISE	0	.253
1	TIANT	0	.250
2	LEE	1	.259
3	MORET	1	.248
4	CLEVELAND	0	.249
5	WILLDOUGHRI	0	.237

page 113

## Nucleus

Editorial,  
Is Pseudoscience Done by Computers . . . , 6  
Letters, 12  
Programming Quickies, 56, 192  
BYTE News, 81  
Technical Forum, 196  
Book Reviews, 220  
BYTE's Bugs, 221

Event Queue, 228  
Clubs and Newsletters, 236  
Desk Top Wonder, 244  
Languages Forum, 248  
What's New? 249  
Unclassified Ads, 295  
Reader Service, BOMB, 296



Cover Art: The Magic of Computers *by Robert Timney*

BYTE is published monthly by BYTE Publications Inc, 70 Main St, Peterborough NH 03458, a wholly-owned subsidiary of McGraw-Hill, Inc. Address all mail except subscriptions to above address: phone (603) 924-7217. Address subscriptions, change of address, USPS Form 3579, and fulfillment questions to BYTE Subscriptions, PO Box 590, Martinsville NJ 08836. Second class postage paid at Peterborough NH 03458 and at additional mailing offices—USPS Publication No. 102410 (ISSN 0360-5280). Subscriptions are \$18 for one year, \$32 for two years, and \$46 for three years in the USA and its possessions. In Canada and Mexico, \$20 for one year, \$36 for two years, \$52 for three years. \$32 for one year air delivery to Europe. \$32 surface delivery elsewhere. Air delivery to selected areas at additional rates upon request. Single copy price is \$2.50 in the USA and its possessions, \$2.95 in Canada and Mexico, \$4.00 in Europe, and \$4.50 elsewhere. Foreign subscriptions and sales should be remitted in United States funds drawn on a US bank. Printed in United States of America.

Address all editorial correspondence to the editor at the above address. Unacceptable manuscripts will be returned if accompanied by sufficient first class postage. Not responsible for lost manuscripts or photos. Opinions expressed by the authors are not necessarily those of BYTE. Entire contents copyright © 1979 by BYTE Publications Inc. All rights reserved.

BYTE® is available in microform from University Microfilms International, 300 N Zeeb Rd, Dept PR, Ann Arbor MI 48106 USA or 18 Bedford Row, Dept PR, London WC1R 4EJ ENGLAND.

Subscription WATS Line: (800) 258-5485

Office hours: Mon-Thur 8:30 AM - 4:30 PM  
Friday 8:30 AM - Noon



# In This BYTE



## About the Cover

*The theme for this issue is "Fun and Games", using the personal computer to implement dynamic interactive forms of enjoyment not otherwise possible. In the cover by Robert Timney, entitled "The Magic of Computers", we find the essence of an ancient shell game applied with a desk top computer as the missing pea.*

One of the quickest ways to gain experience with a processor is to actually program and interface to it. The Intel 8086 16-bit processor is now available for evaluation as the SDK-86 single board computer. Steve Ciarcia evaluates the SDK-86 board. *Page 14*

The solution of games such as Soma Cubes and polyominoes presents the computer programmer with a nontrivial problem. Although the method of solution may seem quite straightforward, the actual implementation may use up excessive amounts of memory or time. This was one problem facing Douglas Macdonald and Yekta Gursel when they started **Solving Soma Cube and Polyomino Puzzles Using a Microcomputer**. Their final program is capable of solving many problems of this

sort in reasonable lengths of time on an 8 K byte machine.

*Page 26*

Peter B Maggs takes readers behind the scenes to show how a programmer can design a board-game program using minimax theory, a technique used to maximize one's chances of winning a game. Read **Programming Strategies in the Game of Reversi**, a tutorial article with broad applicability in the field of computer games.

*Page 66*

Implementing the data structures needed to simulate a chess game is a task that the average programmer is quite capable of performing. However, developing an effective method of defining the respective priorities for all the possible moves is a

cumbersome task whose solution has eluded many programmers. W D Maurer illustrates the use of the game-tree diagram in a method called **Alpha-Beta Pruning**, a technique that offers a possible solution to this problem.

*Page 84*

Owners of Commodore PETs often wish to have hard-copy printouts of data appearing on their machine's video displays. P K Govind gives advice on how to obtain hard copy in **Interfacing the PET to a Line Printer**.

*Page 98*

Escape all your earthly restrictions and go into orbit with **A Spacecraft Simulator**. Gary Sivak has put together a BASIC program to put your celestial flight skills to the test.

*Page 104*

One type of popular computer-game activity is the simulation of sports events. If you have ever wondered if the best baseball team of today could beat the best team of some long-past season, you may now be able to get at least a theoretical answer. Joseph J Roehrig developed a system that uses real statistical data to simulate the play of baseball games, and he now shares it with us in **The National Micropastime**.

*Page 113*

Using stacks can help to simplify otherwise very complex programming problems. In **Stack It Up**,

Charlton H Allen demonstrates a simple procedure for evaluating mathematical expressions that employ stack control. *Page 140*

Have your recent endeavors with your personal computer been all work and no play? Tony Estep discusses some of the basic principles involved in **Writing Animated Computer Games**. The software was written for the SOL-20, but with minor modifications will run on any VDM-based 8080 computer.

*Page 152*

Even if you own a minimum computer system, you can still do interesting things with it. Charles A Kapps gives **Five Useful Programs for the 5C/MP** which are suitable for minimum systems. The routines can be converted to other systems, such as the COSMAC VIP and KIM.

*Page 172*

Do you need a simple device to show logic signals compared to the system clock? Frank DeCaro can help you to **Build a Simple Digital Oscilloscope**.

*Page 222*

Where most people are particular about the computer they buy, they don't think twice about the most frequently used component of a system: the keyboard. **The Cherry PRO Keyboard** is Dan S Parker's choice and he tells us why.

*Page 232*

**Publishers**  
Virginia Londoner  
Gordon R Williams  
**Associate Publisher**  
John E Hayes  
**Assistant**  
Jill E Callihan  
**Editorial Director**  
Carl T Helmers Jr  
**Executive Editor**  
Christopher P Morgan  
**Editor in Chief**  
Raymond G A Cote  
**Senior Book Editor**  
Blaise W Liffick  
**Editors**  
Richard S Shuford  
Gregg Williams  
**Assistant Editors**  
Bob Braisted  
**Editorial Assistants**  
Gale Britton  
Faith Ferry  
**New Products Editor**  
Clubs, Newsletters  
Charles Freiberg  
**Drafting**  
Jon Swanson

**Production Director**  
Nancy Estle  
**Production Editors**  
David William Hayward  
Ann Graves  
Faith Hanson  
Warren Williamson  
Robin M Moss  
Anthony J Lockwood  
**Art Director**  
Ellen Bingham  
**Production Art**  
Wai Chiu Li  
Christine Dixon  
Holly Carmen LaBossier  
Deborah Porter  
**Typographers**  
Cheryl A Hurd  
Debe L Wheeler  
Sherry McCarthy  
Kathy Becker

**Advertising Director**  
Patricia E Burgess  
**Assistants**  
Ruth M Walsh  
Marion Gagnon  
Eileen Kindl  
**Adv/Prod Coordinator**  
Thomas Harvey  
**Advertising Billing**  
Noreen Bardsley  
Don Bardsley

**Circulation Manager**  
Gregory Splitzfaden  
**Assistants**  
Pamela R Heaslip  
Agnes E Perry  
Melanie Bertoni  
Barbara Ellis  
**Dealer Sales**  
Ginnie F Boudrieau  
Anne M Baldwin  
**Receptionist**  
Jacqueline Earnshaw

**Traffic Department**  
Mark Sandagata  
Thomas Yanni

**Comptroller**  
Kevin Maguire  
**Assistant**  
Mary E Fluhr

**National Advertising Sales Representatives:**  
Hajar Associates Inc  
**East**  
280 Hillside Av  
Needham Heights MA 02194  
(617) 444-3946  
521 Fifth Av  
New York NY 10017  
(212) 682-5844  
**Midwest**  
664 N Michigan Av  
Suite 1010  
Chicago IL 60611  
(312) 337-8008  
**West, Southwest**  
1000 Elwell Ct  
Suite 227  
Palo Alto CA 94303  
(415) 964-0706/(714) 540-3554

**Officers of McGraw-Hill Publications Company:** Gordon L. Jones, President; Group Vice Presidents: Daniel A. McMillan, James E. Boddorf; Senior Vice Presidents: Russell F. Anderson, Ralph R. Schulz, Editorial; Vice Presidents: James E. Hackett, Controller; Thomas H. King, Manufacturing; Robert L. Leyburn, Circulation; John W. Patten, Sales; Edward E. Schirmer, International.  
**Officers of the Corporation:** Harold W. McGraw Jr., President, Chief Executive Officer and Chairman of the Board; Robert F. Landes, Senior Vice President and Secretary; Ralph J. Webb, Treasurer.



# Wordsmith

Defining the New Generation in Word Processing

“

I've seen Lanier, Vydec,  
Xerox, Olivetti, and Wang.  
I've chosen WORDSMITH  
from MICRO DIVERSIONS.

”



Congressman Charlie Rose  
Chairman, Policy Group  
on Information and  
Computers

THE  
**wordsmith**<sup>TM</sup>  
TEXT EDITOR



Yes, I'd like to learn more about Wordsmith.<sup>TM</sup> Send me your information packet.

Name \_\_\_\_\_

Company \_\_\_\_\_

Address \_\_\_\_\_

City \_\_\_\_\_ State \_\_\_\_\_ Zip \_\_\_\_\_

Micro Diversions, Inc.  
8455-D Tyco Road,  
Vienna, Virginia 22180  
(703) 827-0888



**Look for  
Shugart drives  
in personal  
computer systems  
made by these  
companies.**

**Altos Computer Systems**  
2378-B Walsh Avenue  
Santa Clara, CA 95050

**Apple Computer**  
10260 Bandley Dr.  
Cupertino, CA 95014

**Commodore Business Machines, Inc.**  
3330 Scott Boulevard  
Santa Clara, CA 95050

**Digital Microsystems Inc.**  
(Formerly Digital Systems)  
4448 Piedmont Ave.  
Oakland, CA 94611

**Imsai Mfg. Corporation**  
14860 Wicks Blvd.  
San Leandro, CA 94577

**Industrial Micro Systems**  
633 West Katella, Suite L  
Orange, CA 92667

**North Star Computer**  
2547 9th Street  
Berkeley, CA 94710

**Percom Data**  
318 Barnes  
Garland, TX 75042

**Polymorphic Systems**  
460 Ward Dr.  
Santa Barbara, CA 93111

**Problem Solver Systems**  
20834 Lassen Street  
Chatsworth, CA 91311

**Processor Applications Limited**  
2801 E. Valley View Avenue  
West Covina, CA 91792

**SD Sales**  
3401 W. Kingsley  
Garland, TX 75040

**Smoke Signal Broadcasting**  
6304 Yucca  
Hollywood, CA 90028

**Technico Inc.**  
9130 Red Branch Road  
Columbia, MD 21045

**Texas Electronic Instruments**  
5636 Etheridge  
Houston, TX 77087

**Thinker Toys**  
1201 10th Street  
Berkeley, CA 94710

**Vista Computer Company**  
2807 Oregon Court  
Torrance, CA 90503

## Editorial

# Is Pseudoscience Done by Computer Pseudo-Computer- Science?

*by Carl Helmers*

One of my main tasks each month is reading all the manuscripts which are sent to BYTE by authors, who are often our readers. The number of well-prepared manuscripts which come our way is fantastic, and for obvious reasons of space we can only accept so many in a given interval of time. Thus, when an unsolicited article is received, we look for a certain uniqueness of idea and appropriateness for our readers. The article content of BYTE magazine is approximately 90% the result of unsolicited articles. Of course, exceptions occur, for example, the 6809 series by Joel Boney and Terry Ritter (which required a bit of encouragement in advance of its writing), or several of the articles on LISP in our August 1979 issue, which were solicited explicitly by guest editor John Allen.

Thus, a magazine like BYTE has proven to be a self-generating forum, as the readers interact with authors and, as they write about their own particular experiences or pet concepts, even become authors.

This month our featured theme for the issue is loosely entitled "Fun and Games," ie, how computers can be used in various forms to implement mental recreations. We describe how to use computers to simulate mythical worlds and situations and to examine logically defined games and their states. All these topics and more fit under this general category of fun and games.

Readers who examine our table of contents, however, will find that not one of our recent articles has been devoted to the subject of "biorhythms," this in spite of the immense popularity of biorhythm programs at every convention or computer demonstration and a virtual flood of prospective article submissions on this topic. Far be it from me to belittle the concept of having harmless fun with computers by creating fantasy trips and games. Just because one can program a computation does not make that computation a valid representation or model of the real world — witness the fun and humor we get out of fantasy games. Humor is in large measure due to a gentle (or not so gentle) bending of reality in a specific and limited context.

But some biorhythm writers start out by pontificating the veritable truth of a hypothesis and its implications, and fail to make the point that it is all a fantasy simulation. Most people writing about the biorhythm algorithm assume that it corresponds to a proven, well-documented and scientifically valid field of endeavor.

I am reminded of the epistemology of a former associate of mine, who shall remain anonymous. His epistemology essentially boiled down to "if it is printed on paper it must be true . . . ." Much has been printed about the alleged validity of the biorhythm mythology; there is an entire branch of the special-purpose computer industry devoted to cranking out biorhythm calculators. And biorhythm programs do indeed appear in much of the sales promotional literature of personal computing. But that does not make the results a science any more than the prevalence of adventure-style games in tomorrow's computers makes any statement about the real world, other than mankind's characteristic love of fantasy. A corollary of the "if it's printed" epistemology is the statement "if it is represented in a programmed calculation, it must be true . . . ."

 **Shugart**



# "My 8 to 5 minifloppy™ now works nights and weekends."



"I own a fast-growing business and before I bought my computer system I put in a lot of late hours keeping up with my accounting and inventory control. Now the computer does my number crunching quickly, so I have time after hours to have some fun with the system. My son and I started out playing Star Trek on the system, and now we're learning to play chess.

"When I was shopping around for my system, the guys in the computer stores demonstrated all the unique features of the minifloppy. I've got to admit that at first I didn't really understand all the technical details. But now that I use the system every day, I really appreciate the minifloppy's fast random access and data transfer. I like the reliability, too.

"I'm glad I went with Shugart drives. Look, when you lay out your own money for a system, you want dependable performance and good value. Do what I did. Ask for the system with the minifloppy."

## If it isn't Shugart, it isn't minifloppy.

 Shugart Associates

435 Oakmead Parkway, Sunnyvale, California 94086

See opposite page for list of manufacturers featuring Shugart's minifloppy in their systems.

™ minifloppy is a registered trademark of Shugart Associates



As commonly stated, the biorhythm hypothesis has two major assertions. The first is that there exists a fixed point in time, namely the date of birth, when each individual's biological clock starts ticking. The second is that there are three well-defined periods which start in phase at that reference point and have an integer relationship to one another. The particular integers are unimportant. Then, by doing a Fourier summation with unit amplitudes on the three periodic waveforms, we come up with the time domain evaluation of one's state for any given date after birth. Much graphic display programming can be done to make the results of this meaningless calculation look beautiful on a color terminal.

The holes in this hypothesis are obvious. First, why are integer ratios used? After all, nature seems to abhor integers in physical constants, especially so in complicated systematic entities such as biological organisms. At the level of physical constants and ratios of physical constants, there is only one experimental near-integer of any prominence: the reciprocal fine structure constant (137.0360) — and even its "integerness" has become less significant of late as the limits of physical precision of measurement have improved.

Then, in a fallacy shared with astrology, biorhythm calculations assume that the date of birth somehow determines the whole of one's life. In view of even recent knowledge of biological organisms, why not use the date of conception? Replies the "biorhythmicianologist," "Oh, but we don't know that precisely! So let's use something we know instead!" Thus, if there were any validity to a lifelong cycle, the hypothesis would start off by picking a random phase point which is the date of

birth relative to the whole lifetime of the organism. But living systems do not fit ad hoc assumptions. It is true that we observe periodicities in life, even in our own personal lives. But, in order to study such rhythms, the spirit of the natural science investigator must be invoked, obviously aided by the tools of calculation which are now so widely available.

A detailed scientific dissection of biorhythms can be found in William Bainbridge's article "Biorhythms: Evaluating a Pseudoscience," in *The Skeptical Enquirer*, published by the Committee for the Scientific Investigation of Claims of the Paranormal. Editor Kendrick Frazier and the editorial board (which includes such luminaries as Martin Gardner and Philip J Klass) are fighting a valiant fight against the doctrines of pseudoscience in today's world. The magazine is published four times a year. Subscriptions are \$10 a year and are available from the Executive Editor, *The Skeptical Enquirer*, POB 5 Amherst Br, Buffalo NY 14226.

Thus, the dearth of biorhythm calculation articles in BYTE will continue. But, on quite a different plane, there is ample room for appropriate articles on personal information analysis — possibly with some attention to the idea of biological rhythms, which forms the basis for the genuine science of chronobiology. Here we make the hypothesis that there are obvious rhythms of some variables of daily life which go up and down.

To explore this hypothesis, we begin to take data on our daily personal lives using an appropriate measurement. This could be a single bit of information such as "today was a good day" or "today, on the balance, was not so good." Or it could be a series of integer evalua-

## Computer Lab offers the following specials to help us celebrate the opening of our new store:

Integral Data Systems Paper Tiger Printer.....	\$895.00	Commodore Pet with 8K RAM.....	\$715.00
Cromemco TU-ART Digital Interface Board .....	\$265.00	Anadex Printer Model DP-8000 .....	\$895.00
California Computer Systems 12-Slot Mainframe .....	\$359.00	Intersystems DPS-1 Mainframe.....	\$1050.00

*In our new store we are able to carry a wider selection of products and have it in stock when you want it.*

### We carry the following product lines:

Cromemco, California Computer Systems, Integral Data Systems, Commodore, Seattle Computer Products, Godbout Electronics, Thinker Toys, Mountain Hardware, Smoke Signal Broadcasting, Anadex, Soroc, Maxell, Scotch, Intersystems, Electronic Control Technology, and others.

## Computer Lab of New Jersey

538 Route 10  
Ledgeswood, New Jersey 07852  
Phone (201) 584-0556

Hours: Mon, Wed, Fri – 10 to 6 • Tues, Thurs – 10 to 9 • Sat – 10 to 5



# New from SSM.



**80 Character Video**

With 80 characters per line our VB3 is the perfect video interface for  processing. It produces a standard 80x24 display of upper and lower case characters or as much as 80x51 for a full page of text. The matrix for graphic display goes up to 160x204. And with optional EPROM, as many as 256 user programmed characters or symbols can be produced.

VB3 is memory mapped for rapid screen updating. But it occupies memory only when activated. So one or more VB3s can be located at the same address with a full 65K of memory still available to the user.

It generates both U.S. and European TV rates and meets the new IEEE S-100 standard. Other features include keyboard input, black on white or white on black, one level of grey, underline, strike thru, blinking char., blank-out char., and programmable cursor. Software includes a CP/M compatible driver and a powerful terminal simulator.

VB3 is available in several configurations. Retail prices start at \$375 kit, \$440 assembled.



**Z-80 CPU**

We spent over a year designing the CB2 to assure that it will be the most fully S-100 compatible Z-80 CPU on the market.

It operates at 2MHZ or 4MHZ by DIP switch selection and includes two sockets for 2716/2732 EPROMs or TMS 4016 2K RAMs. Memory sockets can be disabled. Separate run/stop and single step switches allow system evaluation without the benefit of a front panel.

CB2 also features an MWRITE signal, firmware vector jump, and an output port to control 8 extended address lines (allowing use of more than 65K of memory). Jumper options generate the new IEEE S-100 signals to insure future S-100 compatibility.

Retail price—\$210 kit, \$275, assembled.

Our line. CPU, Video, I/O, RAM, EPROM, EPROM Programmer, Music, Prototyping, Terminator, Extender, and Mother boards. Available assembled or as kits.



**8080 CPU**

Our new CB1A is identical to our popular CB1 with the exception that the on-board RAM has been increased from 256 bytes to a full 1K.

It also features an optional 2K of 2708 EPROMs, power-on/reset vector jump, MWRITE, parallel input port with status and DIP switch addressing.

Retail price—\$159 kit, \$219 assembled.



2116 Walsh Avenue  
Santa Clara, CA 95050 (408) 246-2707

Send for our free brochure and find out why SSM has become the favorite of discerning Hobbyists and OEMs.





# Why not kill two birds with one stone?

If you have an Apple\* and you want to interface it with parallel and serial devices, we have a board for you that will do both. It's the AIO.™

## Serial Interface.

The RS-232 standard assures maximum compatibility with a variety of serial devices. For example, with the AIO you can connect your Apple\* to a video terminal to get 80 characters per line instead of 40, a modem to use time-sharing services, or a printer for hard copy. The serial interface is software programmable, features three handshaking lines, and includes a rotary switch to select from 7 standard baud rates. On-board firmware provides a powerful driver routine so you won't need to write any software to utilize the interface.

## Parallel Interface.

This interface can be used to connect your Apple\* to a variety of parallel printers. The programmable I/O ports have enough lines to handle two printers simultaneously with handshaking control. The users manual includes a software listing for controlling parallel printers or, if you prefer, a parallel driver routine is available in firmware as an option. And printing is only one application for this general purpose parallel interface.

## Two boards in one.

The AIO is the only board on the market that can interface the Apple to both serial and parallel devices. It can even do both at the same time. That's the kind of innovative design and solid value that's been going into SSM products since the beginning of personal computing. The price, including PROMs and cables, is \$135 in kit form, or \$175 assembled and tested. See the AIO at your local computer store or contact us for more information.



2116 Walsh Avenue  
Santa Clara, California 95050  
(408) 246-2707

\*Apple is a  
TM of Apple  
Computers,  
Inc.

AIO  
Serial & Parallel  
Apple Interface

To explore this hypothesis, we begin to take data on our daily personal lives using an appropriate measurement. This could be a single bit of information such as "today was a good day" or "today, on the balance, was not so good." Or it could be a series of integer evaluations of the form "on a scale of 1 to 10, today rated 8." The important idea here is to begin taking measurements. When a real sequence of data has been built up over several hundred days, we can begin to check the hypothesis for validity by using a Fourier analysis of the data to isolate periodic effects. Due to the sampling time of once per day, no periods could possibly be present shorter than two days, and the longest periodicity component would be half the number of days in the sample. But the result would be a calculated spectrum for this "how I feel" variable. Then, one could check this continuing curve for function for predictability. Besides the Fourier decomposition approach, other methods of analysis are of course possible. Any of the commonly used methods for stock market "prediction" could certainly be applied.

But the result of this "biological rhythm" exercise would be very specific and only applicable to the individual who makes the measurements. There would be no reason to assume that any period found in this data would be the same length as the period for any other person. I do not know what the results would be, but the method of checking the hypothesis is present, and the means of doing such an experiment are within the grasp of every reader who owns a personal computer and who can find access to a Fourier analysis program — such as the Fast Fourier Transform. (See BYTE December 1978 and February 1979 for articles on the Fast Fourier Transform technique.)

So, to answer the question raised by this editorial, I would conclude with several points. First, pseudoscience is pseudoscience. Second, pseudoscience done by computer is still pseudoscience, for the tools of implementation hardly affect the imprecision of thought used in ignoring reality.

Finally, what makes the pseudoscience a pseudoscience is its element of pious fraud, an attempt to ignore contrary data and purport that its premises describe and predict reality. When we remove any intention of purporting that the given hypothesis is anything other than a fantasy, then the pseudoscience classification goes away and we can enjoy it as a game or fantasy.

Thus, pseudoscience done by computer is most definitely not pseudo-computer-science, for even a biorhythm program can be correctly implemented from its premises! And, with the caveat of not purporting a false scientific validity to our fantasies, we can have lots of fun correctly implementing quasi-computer science fantasies and games which make absurd premises. ■

Circle 335 on inquiry card.



Is your "Pencil" getting dull?  
Then you need

# The Pencil Sharpener

from MicroDaSys

"Personalizing Form Letter Package" for your Electric Pencil II™ under CP/M"

You:

- Create your letter or announcement using the EP II
- "Key" insertion items throughout the text
- Set up the insertion data file using EP II, BASIC, or other software
- Or use existing files (Accounts Payable, Mailing list, etc.)
- Identify the particular letter and insertion data file and RUN THE PENCIL SHARPENER

The Pencil Sharpener:

- Uses *your* version of the Electric Pencil II
- Loads in the designated letter
- Inserts all designated data for the appropriate "keys"
- Prints the letter using the EP II "Print Sub-System"
- Personalizes and prints letter after letter, replacing key words

SAVE TIME - FOLLOW UP OLD BUSINESS - CONTACT NEW BUSINESS

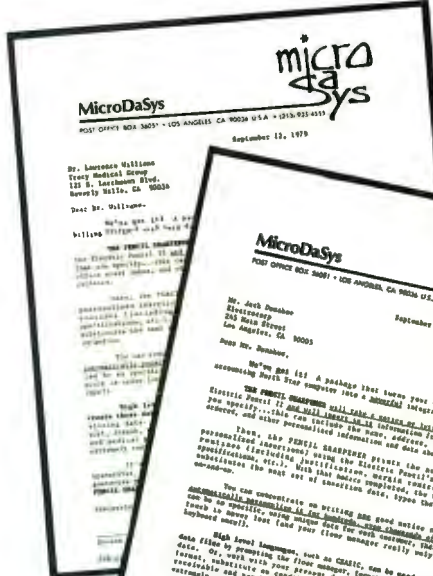
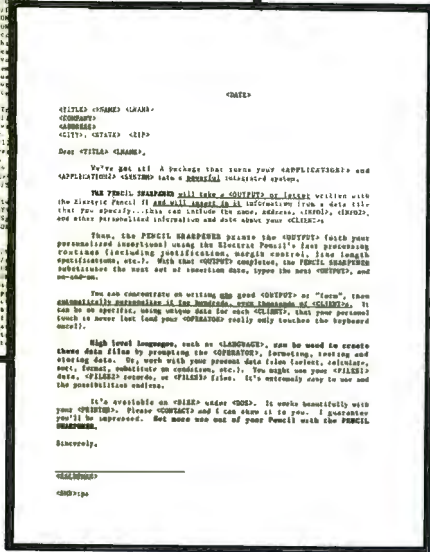
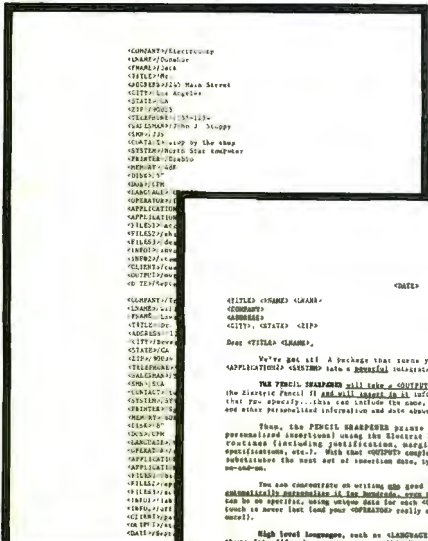

The PENCIL SHARPENER runs on all versions of Electric Pencil II under CP/M.  
Soon available TRS-80 version and "star brightener" for Word Star.

Generous Dealer Discounts!

## GET THE POINT? . . . GET THE PENCIL SHARPENER!

CP/M is a trademark of Digital Research. The Electric Pencil II is a trademark of Michael Shryer Inc.

**MicroDaSys, P.O. Box 36051, Los Angeles, CA 90036**  
**(213) 935-4555 TWX 910 321 2378**

Please send me \_\_\_\_\_ copies of the PENCIL SHARPENER at \$195 each.

Payment terms:

[ ] Check/ M.O. Enclosed [ ] C.O.D. [ ] Charge Card

Card No. \_\_\_\_\_ Exp. \_\_\_\_\_

Name \_\_\_\_\_

Specify disk:

Company \_\_\_\_\_

[ ] 8" [ ] North Star

Address \_\_\_\_\_

[ ] Micropolis

City/State \_\_\_\_\_

[ ] Check here if SOL

Zip \_\_\_\_\_ Telephone ( \_\_\_\_\_ )





# Letters

## Mind Over Matter Expansion

I found your article "Mind Over Matter" (June 1979 BYTE, page 149) very interesting. When all the components arrive, I hope to have an operational muscle monitor. A friend of mine has a great deal of enthusiasm for brain wave monitors, and, although I do not quite see the magic he sees in them, the idea is intriguing.

My difficulty with building the brain wave monitor is that my knowledge of electronics has never gotten past the reading the Heathkit-instructions-stage. You mentioned changing the 100 K ohm

resistor on IC2 to 1 M ohm for brain wave amplification, which is OK; however, then you said that bandpass filters must be added, and you have lost me.

I know it would be a time-consuming project, but I thought that I would try and trouble you for a circuit and parts list at the Heathkit-level for brain wave monitor expansion. I assume that, along with input to an oscilloscope (Heathkit, naturally), the analog output could be used as input to my Cromemco D+7A I/O board?

Frank Gizinski  
2060 St Clair St  
Racine WI 53402

### Author Ciarcia Replies:

*I hope you will have an operational muscle monitor by the time you read this. I regret, however, that I cannot comply with your request. Heathkit and the Muppets both have something in common: because the original is done so well and anything equivalent could only be accomplished with a similar effort, there are no copies. Except through the effort of a complete article on the subject, I hesitate to do only half the job by sketching out a*

*few filter circuits which ultimately demand a great deal of technical ability.*

*In addition to yours, many letters have requested expansion information. In actuality, the required circuitry would constitute a low-frequency spectrum analyzer. I will look into the design, and use it either as an article specifically on expansion of the "Mind over Matter" introduction, or as an additional supplement with one of my regular monthly offerings. I am aware of the obvious interest in expansion, and I do try to present circuits that can be readily constructed.*

*Finally, the biofeedback interface can be readily used with the Cromemco A/D board, if the analog output from the monitor is scaled down to 0 to 2.56 V. This can be done with a 500 K ohm potentiometer serving essentially as a volume control. Analysis of the acquired data is another subject entirely.*

*Perhaps your strength is really software, and you will achieve success better by this method. The ultimate goal is to analyze the low-frequency spectrum. This can be done either through hardware or software.*

## A Rejoycing LISPer

Had James Joyce been a computer scientist, he would have created LISP.

Martin D Sandman  
10720 Cariuto Ct  
San Diego CA 92124

## Move Segmenting

I was gratified to see some evidence ("A Digital Alphanumeric Display," April 1979 BYTE, page 218) that someone is beginning to realize that 7 segments can portray alphanumerics, but noted that Daniel Chester's 7-segment set is confusing in these respects:

A "G" could be a "9,"  
a "Q" could be a "9,"  
an "S" could be a "5,"  
and a "Z" could be a "2."

The following is a set which I devised two years ago:

A B C D E F G H I J K L M N O P Q R S T U  
V W X Y Z and 0 1 2 3 4 5 6 7 8 9

You will note that none of these characters are ambiguous. Furthermore, they do not conflict with Mr Chester's set of special characters.

Alex Funk  
110 E Lynch St  
Durham NC 27701 ■

## Word Processor + Business System

MicroDaSys Makes It Easy.

\$2899



### FEATURES

- S-100 Bus
- Full-Sized Disk Drive (Standard)
- Up To Four Disk Drives
- Z-80\*\* Micro-Processor
- CP/M\*\*\* Disk Operating System
- Printer Interface
- Full Word Processing Capability
- Designed for Business Use

### AVAILABLE SOFTWARE

- Accounts Receivable/Payable
- Payroll
- General Ledger
- Inventory
- Mailing List
- Text Processor
- Plus 500 More!

### AVAILABLE LANGUAGES

- BASIC Compiler (Included)
- FORTRAN
- Pascal
- COBOL
- And Many More!

CALL OR WRITE NOW!

## MicroDaSys

POST OFFICE BOX 36051  
LOS ANGELES, CA 90036

(213) 935-4555

# "Our inventory is our existence. Think we'd trust it to anything less than Scotch® Brand Diskettes?"

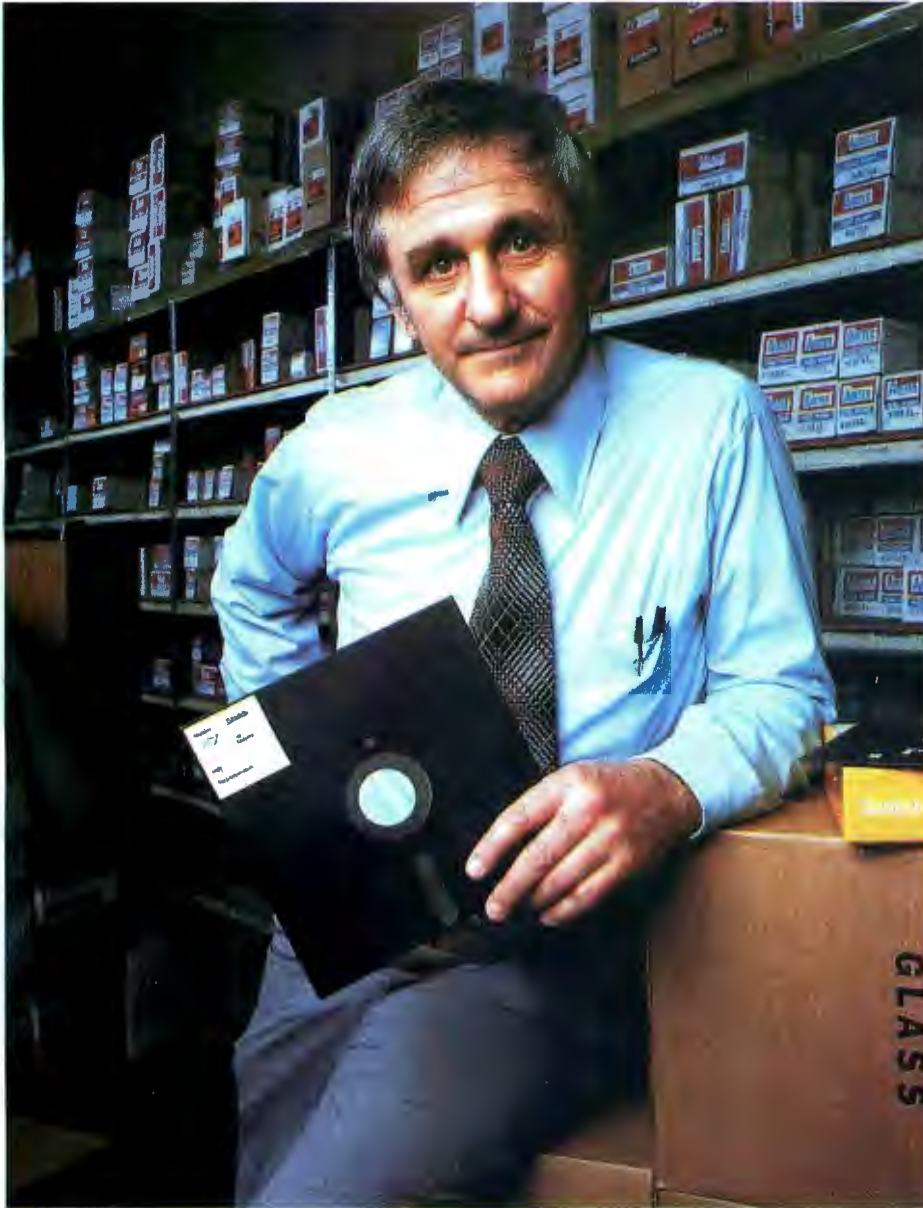

Don Stone, President,  
Mass. Auto Supply Company,  
Inc., Boston, Mass.

Scotch Diskettes are the diskettes you can depend upon with the information *your* business depends upon.

Each one is tested and certified error-free before it leaves our factory. Because we know nothing less than perfection is acceptable for *your* vital business data.

Scotch Diskettes are available in regular or mini sizes, compatible with almost any system.

To find out where you can purchase Scotch Diskettes, call toll free: 800-328-1300. (In Minnesota, call collect: 612-736-9625.) Ask for the Data Recording Products Division. In Canada, write 3M Canada Inc., London, Ontario, N6A 4T1.

If it's worth remembering,  
it's worth Scotch  
Data Recording Products.



# 3M



## The Intel 8086

Steve Ciarcia  
POB 582  
Glastonbury CT 06033

There has been a lot of talk about 16-bit microprocessors lately. You are probably interested in how they work and how they differ from present 8-bit microprocessors. This may seem more important to someone designing systems for a living rather than to the casual computer experimenter; but ultimately personal computing will be affected.

The majority of systems currently available use 8-bit processors primarily because few cost-effective 16-bit processors were available when these systems were designed. As new

personal computers are conceived, the designers will have more 16-bit microprocessors to choose from, and in my opinion, the latter will win out.

Software development is much more expensive than hardware development. It is much cheaper to write one line of code executing a hardware multiply instruction than to write an algorithm to do the same function on a processor devoid of this direct capability. Reduced cost of development should be reflected in lower retail cost. There are always exceptions to the rule, but once amor-

tized and in volume production, the 16-bit microprocessor should prove to be the logical choice for medium to high-level applications.

### The Intel 8086

It isn't necessary to wait any longer if you have a burning desire to learn about 16-bit microprocessors. The latest one available and in volume production is the Intel 8086. The 8086 is a 16-bit microprocessor which is upward-compatible from the 8-bit 8080/8085 series processors. The 8086 contains a set of powerful, new 16-bit instructions. This enables a system designer familiar with 8080 devices to start coding immediately and gradually gain expertise in using the additional 16-bit instructions. It is important to realize that when I refer to compatible instructions I mean functional compatibility. A program written for an 8080 would have different object code than an 8086. This is only a slight inconvenience considering that this former 8080 program should run about ten times faster on an 8086. The evolutionary step between the 8086 and 8080 is far greater than that between the 8080 and 8088.

The apparent goal of Intel designers was to extend existing 8080 features symmetrically and add a wide range of new processing capabilities. The added features include 16-bit multiply and divide, interruptible byte-string operations, 1 M byte direct addressing, and enhanced

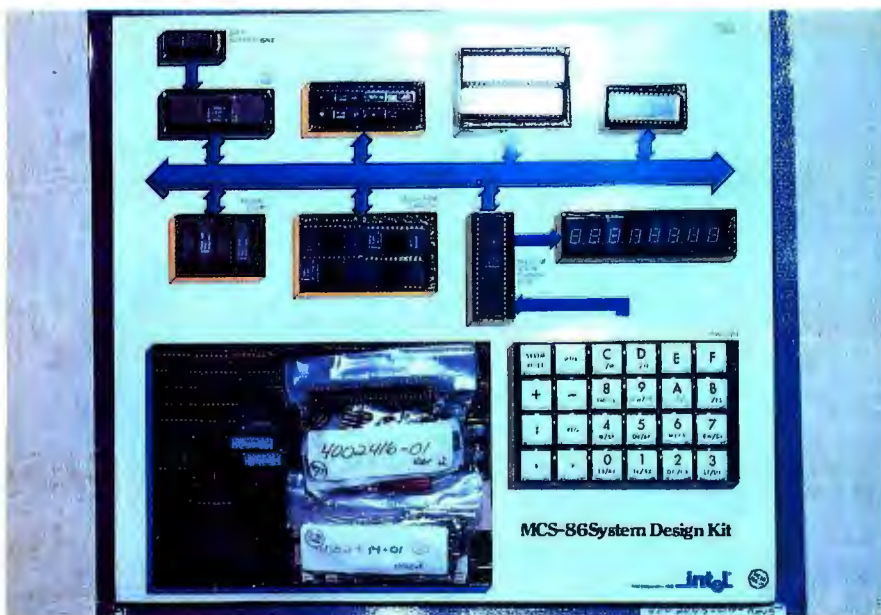
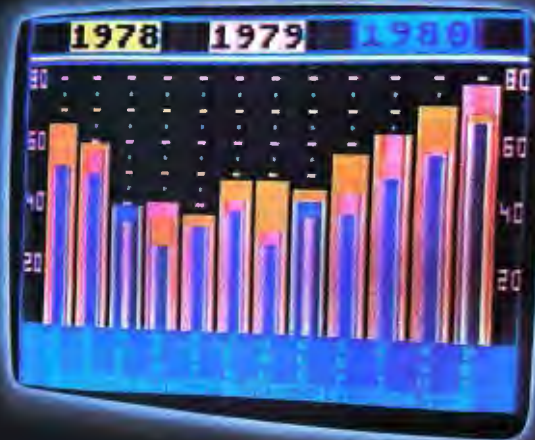

Photo 1: SDK-86 system as delivered from factory.



# MORE COLOR. MORE SOUND. MORE GRAPHICS CAPABILITIES.



ATARI 400



ATARI 800

Compare the built-in features of leading microcomputers with the Atari personal computers. And go ahead, compare apples and oranges. Their most expensive against our least expensive: the ATARI® 400™.

Start with graphics capabilities. The ATARI 400 offers 128 color variations. 16 colors in 8 luminance levels. Plus 29 keystroke graphics symbols and 8 graphics modes. All controlled from a full 57 key ASCII keyboard. With upper and lower case. And the system is FCC approved with a built-in RF modulator. That's just for openers.

Now, compare sound capabilities. Four separate sound channels and a

built-in speaker. With the optional audio/digital recorder, you can add Atari's unique Talk & Teach™ Educational System cassettes.

Here's the clincher: Solid state (ROM) software. For home management, business and entertainment. Or just plug in an Atari 10K BASIC or Assembler language cartridge and the full power of the computer is in your hands.

Memory? 8K expandable to 16K. And that's just for the ATARI 400 at a suggested retail of only \$549.99.

The ATARI® 800™ gives you all that and much more.

User-installable memory to 48K. A full-stroke keyboard.

With a high-speed serial I/O port that allows you to add a whole family of smart peripherals. Including up to four individually accessible disk drives. And a high speed dot-matrix impact printer. And, the Atari Program Recorder is included with the 800 system. Suggested retail price for the ATARI 800 (including recorder) is \$999.99.

Make your own comparison wherever personal computers are sold.

Or, send for a free chart that compares the built-in features of the ATARI 400 and 800 to other leading personal computers.



## PERSONAL COMPUTER SYSTEMS

1265 Borregas Ave. Dept. C, Sunnyvale, California 94086. Call toll-free 800-538-8547 (in Calif. 800-672-1404) for the name of your nearest Atari retailer.



bit manipulation. Arithmetic operations are accomplished in American Standard Code for Information Interchange (ASCII) or binary-coded decimal with a one-instruction hardware conversion.

In addition to the capability of handling data in bits, bytes, words, or blocks, the 8086 incorporates many features formerly found only in minicomputer architecture. It also supports such operations as reentrant

code, position-independent code, and dynamically relocatable programs.

The 8086 is fabricated with a newly developed, high-speed metal-oxide semiconductor (H-MOS) process which is considerably faster than standard MOS. Running up to 8 MHz, the 29,000-transistor 8086 is the fastest single-chip central processor currently available. Unlike the 8080/8085 processor's registers, the 8086's registers can process 16-bit as well as 8-bit data.

Figure 1a shows an internal block diagram of the 8086. The 16-bit arithmetic/logic instructions are handled within the general register files. This section contains four 16-bit general data registers, two 16-bit base pointer registers, and two 16-bit index registers. Figure 1b illustrates an 8086 register model for comparison to the 8080.

The four data registers, addressable also in 8-bit partitions, are primarily from the original 8080. There are twice as many general-purpose registers as there are on 8-bit processors.

The relocation register file is the other unique 8086 enhancement. This group is referred to as the segment register file, and extends direct addressing capability to a full megabyte of memory. This file has four address pointers which contain program relocation values for up to four 64 K byte program segments. In addition, a fifth pointer serves as an I/O (in-

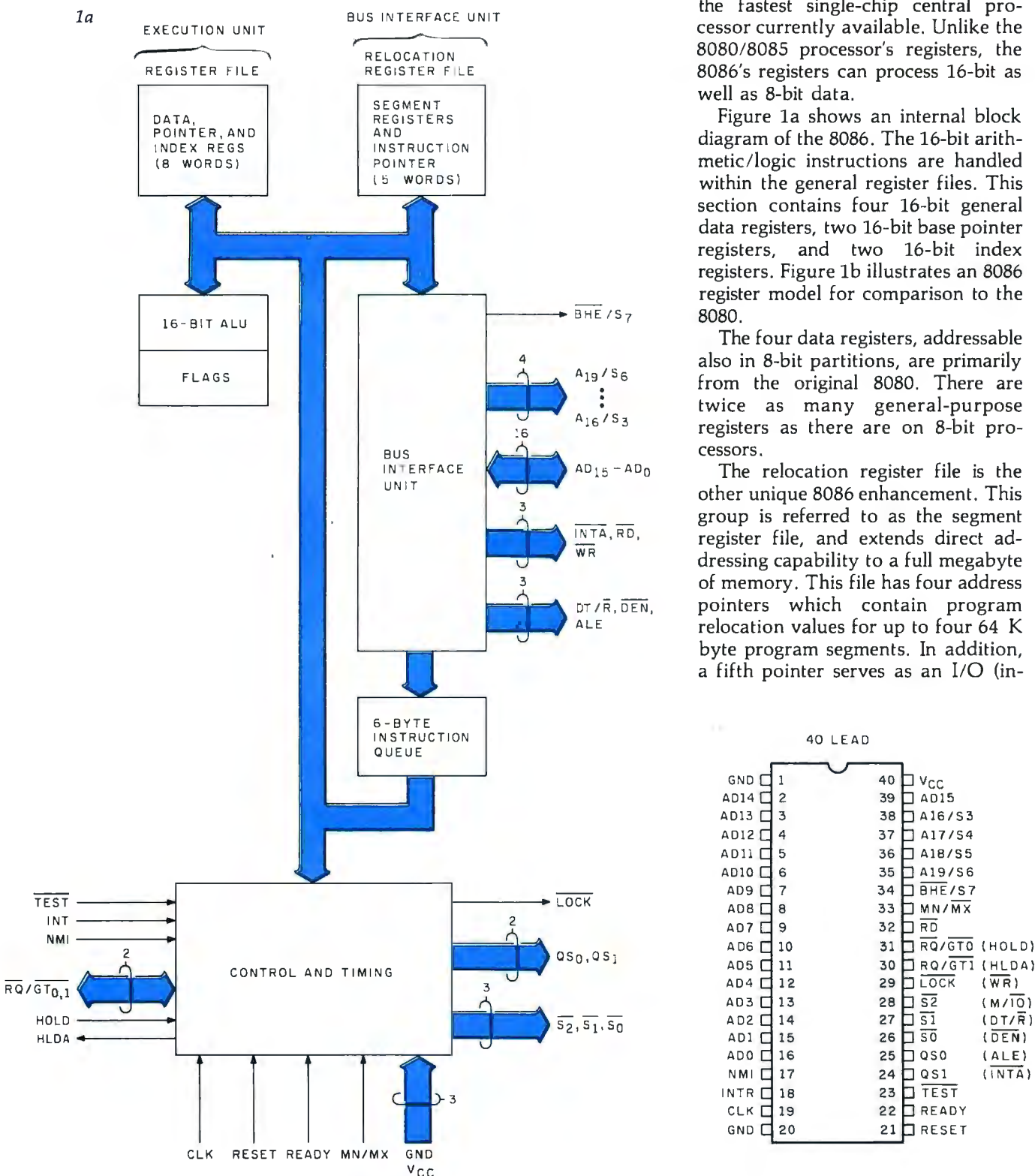

Figure 1: An internal block diagram and pinout specifications of the Intel 8086 (figure 1a). Figure 1b shows the 8086 register model illustrating the differences between the 8086 and the 8080. Figure courtesy Intel Corp.

put/output) control providing address space for a full 65,536 I/O ports.

Logically the 8086 operates more like larger computers than like a classical microprocessor. This is accomplished through independently controlled bus interface and execution units (figure 2). The major contribution is to speed processing by overlapping instruction fetch and execution. Up to six bytes of instruction are placed in a queue before execution. As each instruction is processed, the following instructions move up one position and a new instruction is fetched and placed in the queue. This simultaneous fetch and execute capability induces more efficient use of the memory bus. It is possible for two single-byte 8086 instructions to be executed within the time for one memory cycle. The result is improved performance, given the same bus bandwidth and memory speed as other systems.

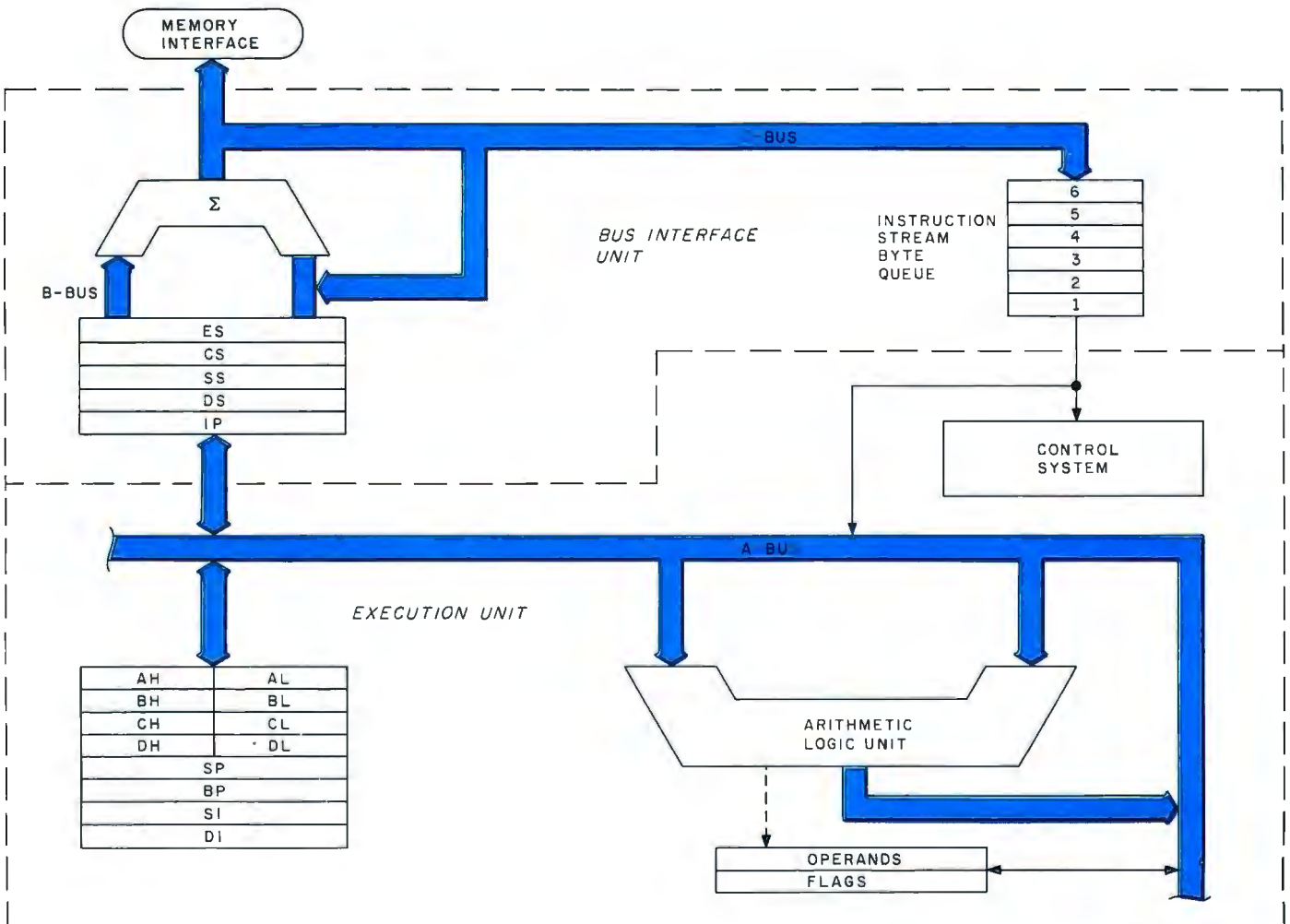
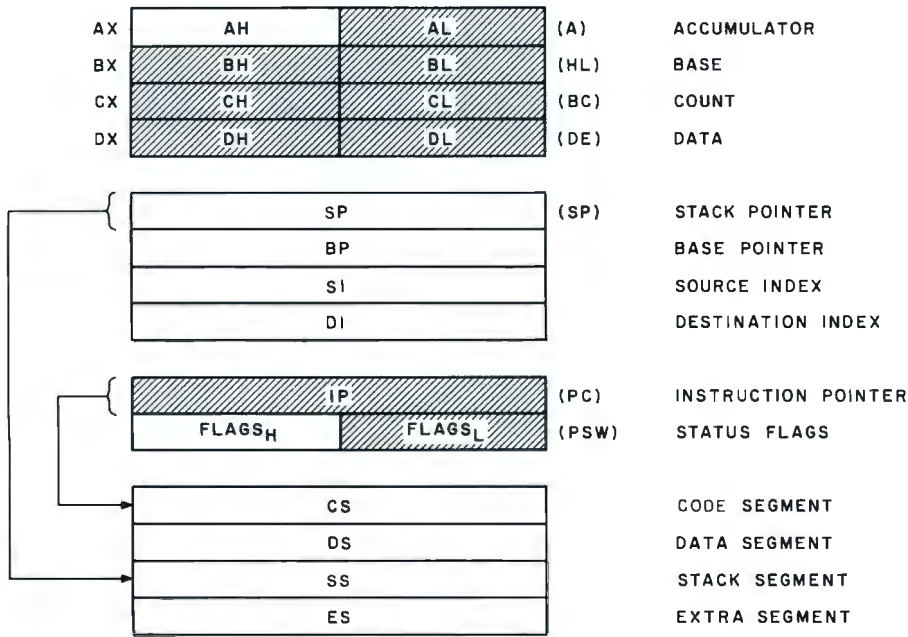

Figure 2: Functional block diagram of internal data paths of the 8086. Figure courtesy Intel Corp.



**Table 1:** Summary of specifications for the SDK-86 board.

**Central Processor**

Processor: 8086  
Clock Frequency: 2.5 MHz or 5 MHz (jumper selectable)  
Instruction Cycle Time: 800 ns (5 MHz)

**Memory Type**

Read-Only Memory: 8 K bytes  
Programmable Memory: 2 K bytes (expandable to 4 K bytes)  
(2 bytes equal one 16-bit word)

**Memory Addressing**

Read-Only Memory: FE000 thru FFFFF  
Programmable Memory: 0 thru 7FF (0-FFF with 4 K bytes)

**Input/Output (I/O)**

Parallel: 48 lines (two 8255As)  
Serial: RS232 or current loop (8251A)  
Data Transfer: Rate selectable from 110 to 4800 bps  
Display: On-board, 8-digit, light-emitting diode (LED) readout

**Interface Signals**

Processor Bus: All signals transistor-transistor logic (TTL) compatible  
Parallel I/O: All signals TTL compatible  
Serial I/O: 20 mA current loop or RS232

**Interrupts**

External: Maskable and nonmaskable; Interrupt vector 2 reserved for nonmaskable interrupt (NMI)  
Internal: Interrupt vectors 1 (single-step) and 3 (breakpoint) reserved by monitor

**Direct Memory Access**

Hold Request: Jumper selectable, TTL compatible input

**Software**

System Monitors: Preprogrammed 2316 or 2716 read-only memories  
Addresses: FE000 thru FFFFF  
Monitor I/O: Keypad and Serial (teletypewriter or video display)

**Power Requirements**

$V_{CC}$ : +5 V ( $\pm 5\%$ ), 3.5 A  
 $V_{TTY}$ : -12 V ( $\pm 10\%$ ), 0.3 A (required if teletypewriter (TTY) or video display terminal connected to serial interface port)

**The Intel SDK-86**

Perhaps this brief introduction has sparked your curiosity and you wish to know more about the 8086. Of course, the best method of learning is to use one. Since at this writing the 8086 is still so new that it is not incorporated into any general-use personal computer, we are left to our own resources and construction abilities. Fortunately Intel realizes that the success of any new product depends on evaluation by as many potential users as possible. For this reason the System Design Kit (SDK) series of products were conceived.

The SDK-86, shown prior to assembly in photo 1, is a single-board, 8086-based computer. Intel's pricing policies make the purchase of the SDK-86 kit far more attractive than a single 8086 chip. It results, in the name of advertising, in one of the better computer offerings on the market. At \$780 the SDK-86 fits within most budgets. It is a complete computer including processor, programmable memory, read-only memory, I/O (input/output), and display. Table 1 is a more explicit listing of specifications and figure 3 is a detailed block diagram.

The SDK-86 is very easy to assemble. As shown in photo 2, it comes packaged so that all components are easily recognizable, even for a novice. Documentation includes an Assembly Manual, User's Manual, User's Guide, and Monitor listings (see photo 3). The assembly procedures are written at such a level that even a person having limited technical knowledge may assemble the kit. The assembly manual progresses from basic solder techniques and component identification to step-by-step assembly and checkout. The only microcomputer assembly literature I have read which was as easily understandable as this comes from the Heathkit people.

All major components are socketed, but to be on the safe side it is a wise idea to purchase additional integrated-circuit sockets. This will allow all integrated circuits to be removed in case troubleshooting is necessary. The fully constructed com-

**Photo 2:** Typical page from the construction manual. Each instruction step is clearly explained and each component is accurately identified.

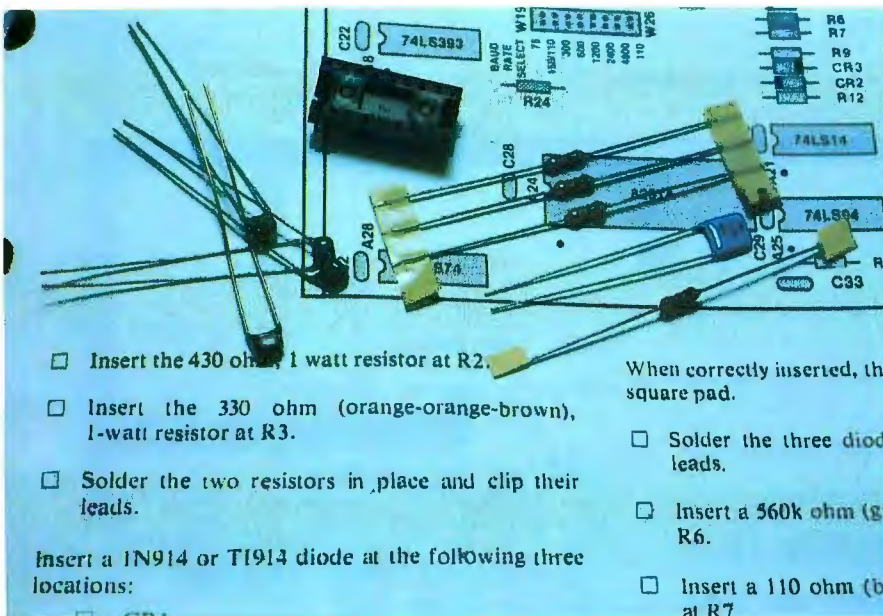

# Both sides now

## North Star Announces — Double Density x 2 Sides = Quad Capacity!

The North Star Horizon now delivers quad capacity by using two-sided recording on our new mini drives! That's 360,000 bytes per diskette! A four drive North Star system accesses over 1.4 megabytes of information on-line! Think of the application flexibility that so much information storage can give you!

North Star has quadrupled the disk capacity of the Horizon computer but prices have increased a modest 15 percent. On a dollar per byte basis, that's a bargain that is hard to beat!

The proven North Star disk controller was originally designed to accommodate the two-sided drives. North Star DOS and BASIC are upgraded to handle the new capacity, yet still run existing programs with little or no change. Of course, single sided diskettes are compatible with the new disk system.

North Star Horizon Computer Prices (includes 32K RAM, one parallel and two serial I/O ports), assembled, burned-in and tested:

Horizon-1-32K-Q	\$2565
Horizon-2-32K-Q	\$3215
Horizon-1-32K-D	\$2315
Horizon-2-32K-D	\$2765

Get both sides now! Quad capacity is available from your North Star dealer.

**NorthStar** 

North Star Computers  
1440 Fourth Street  
Berkeley, CA 94710  
415-527-6950 TWX/Telex 910-366-7001





puter is shown in photo 4. Checkout, after determining that there are no obvious errors, is simply a matter of

applying power and pressing the system reset button.

When the SDK-86 is reset, the 8086

executes the instruction at hexadecimal location FFFF0. The instruction at this location is an intersegment direct jump to the beginning of the monitor program that resides in read-only memory, hexadecimal locations FF000 to FFFFF. The monitor is comprised of two programs resident in programmable read-only memory; one for use with the on-board keypad, and the other a serial monitor that supports a video display or teletypewriter connected to the Electronics Industries Association (EIA) serial interface connector. This latter communication mode is preferable if the SDK-86 is to be used efficiently for software development. Even though the system is constructed to vector to the keyboard monitor on power up, simply interchanging the two sets of programmable read-only memory will allow the unit to start up immediately in the serial mode.

### The SDK-86 Monitor

Both monitors share similar command capability. The keyboard monitor is optimized for the 8-digit, light-emitting-diode (LED) display while the serial monitor is obviously for a video display or teletypewriter. The only dissimilarity is that the latter has the additional ability to read or write to a paper-tape punch, or with the addition of a Frequency-Shift-Keying (FSK) modulator/demodulator, cassette storage. Table 2 lists the serial monitor I/O commands.

Of particular importance are the single-step and go commands. Single step allows a program to be executed one instruction at a time, while the go command allows the user to specify a breakpoint which returns control to the monitor while preserving the machine's status. This allows a program to be run in segments facilitating checkout.

While the monitor does provide some powerful routines, the PL/M listings provided in the documentation do not directly give the addresses of the individual routines. Enough effort is required to extract this information, that rewriting particular routines in user memory is a worthwhile consideration.

*Text continued on page 24*

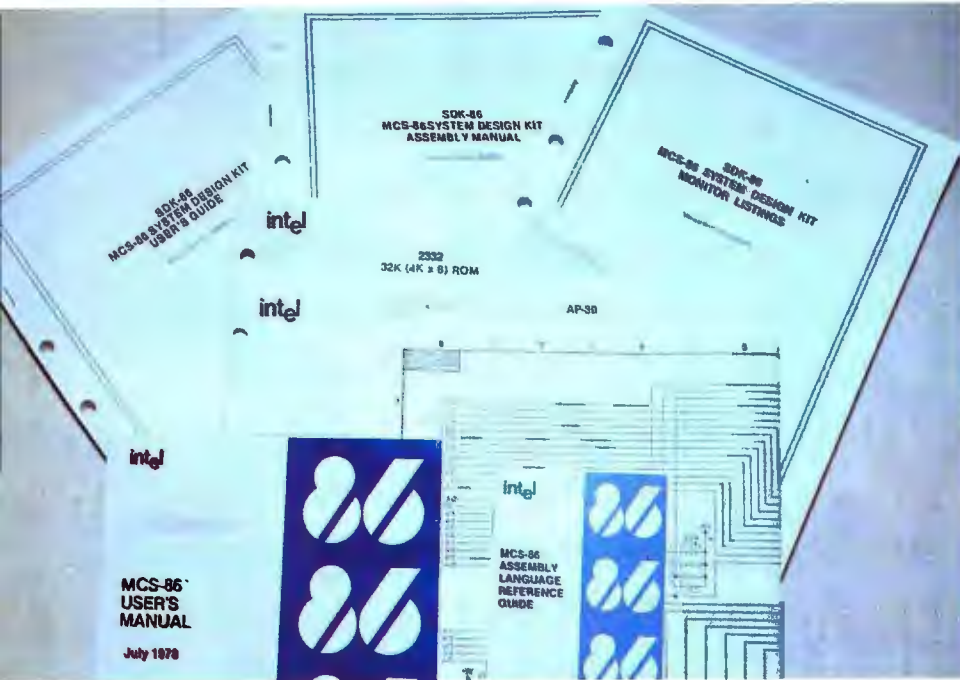

Photo 3: The SDK-86 board comes complete with well-written documentation manuals for assembly and use.

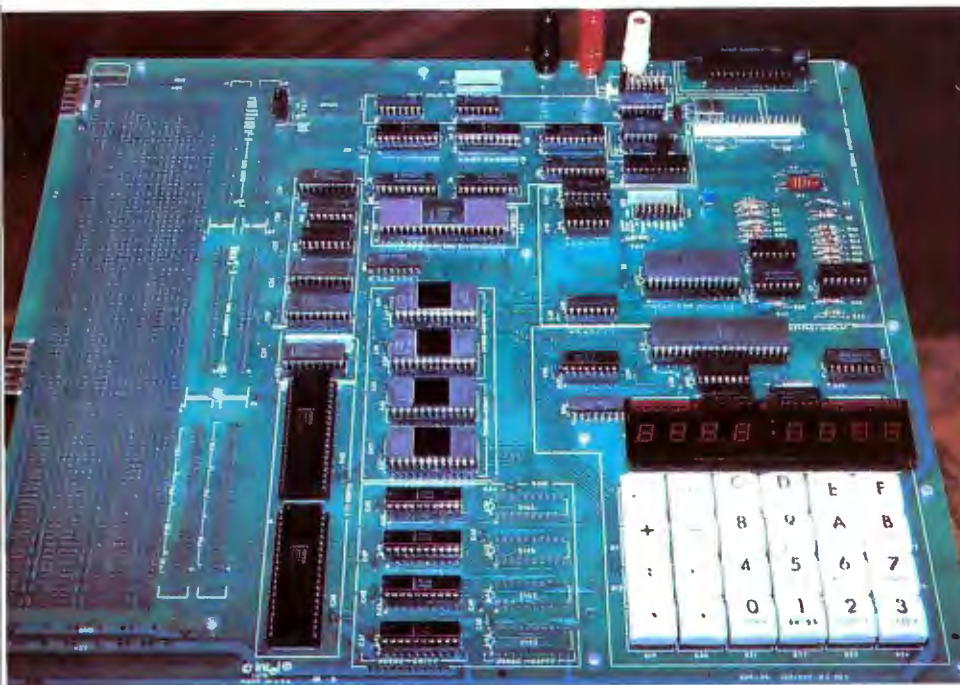

Photo 4: Assembled SDK-86 board. Note the prototyping area on the left-hand side.



ALTOS COMPUTER SYSTEMS PROUDLY ANNOUNCES

**SUN-SERIES**

**ACS8000-6**



## THE VERY FIRST

Double Density Z80 Micro-Computer  
plus Twin 8" Floppies  
plus 14.5Mb Winchester Disk  
for under \$9,500!

And more! 4 user CP/M® for under \$12,000!

®CP/M is a registered trademark of Digital Research, Inc.

ALTOS COMPUTER SYSTEMS, LEADER IN SINGLEBOARD TECHNOLOGY  
DOES IT AGAIN WITH ITS SINGLEBOARD ACS8000-6. TOTAL BUSINESS COMPUTER

### HIGH TECHNOLOGY AGAIN

The new ACS8000-6 single board computer is packed with ultra-high technology: Z80 double-density computer, up to 208Kb of high speed RAM, Floppy-disk and Winchester Hard Disk controllers, DMA, up to 6 serial/2 Parallel I/O, optional 32 bit floating point processor . . . All on One Board, fully socketed, fully documented reliable and maintainable.

### ADVANCED MULTI-USER SOFTWARE

Our new ALTOS Multi-User Executive (AMEX) supports four independent CP/M compatible programs in any of six languages: Basic, Fortran, Cobol, Pascal, APL, C, and a wealth of complete business application packages.

### WINCHESTER MASS STORAGE

We're staying with Shugart for both floppies and Winchester hard disk. Why? Simple, low price, solid reliability and they're our next door neighbor. Our single board computer supports up to 4 Mbytes of floppies and 58 Mbytes of Winchester running under AMEX.

**ALTOS**

**COMPUTER SYSTEMS**

2338-A Walsh Avenue  
Santa Clara, Ca. 95050

### MINI PERFORMANCE FOR 1/2 COST

Prices you will love. Entry level ACS8000-6 Hard Disk System \$9,450  
2 users \$10,670, 4 users \$11,960,  
AMEX separate at \$250.

### AVAILABLE NOW!

Call for your nearest Altos dealer. (408)  
244-5766. Telex 171562 ALTOS SNTA.



Figure 3: A detailed block diagram of the SDK-86 evaluation board. Figure courtesy Intel Corp.

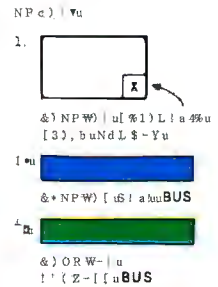
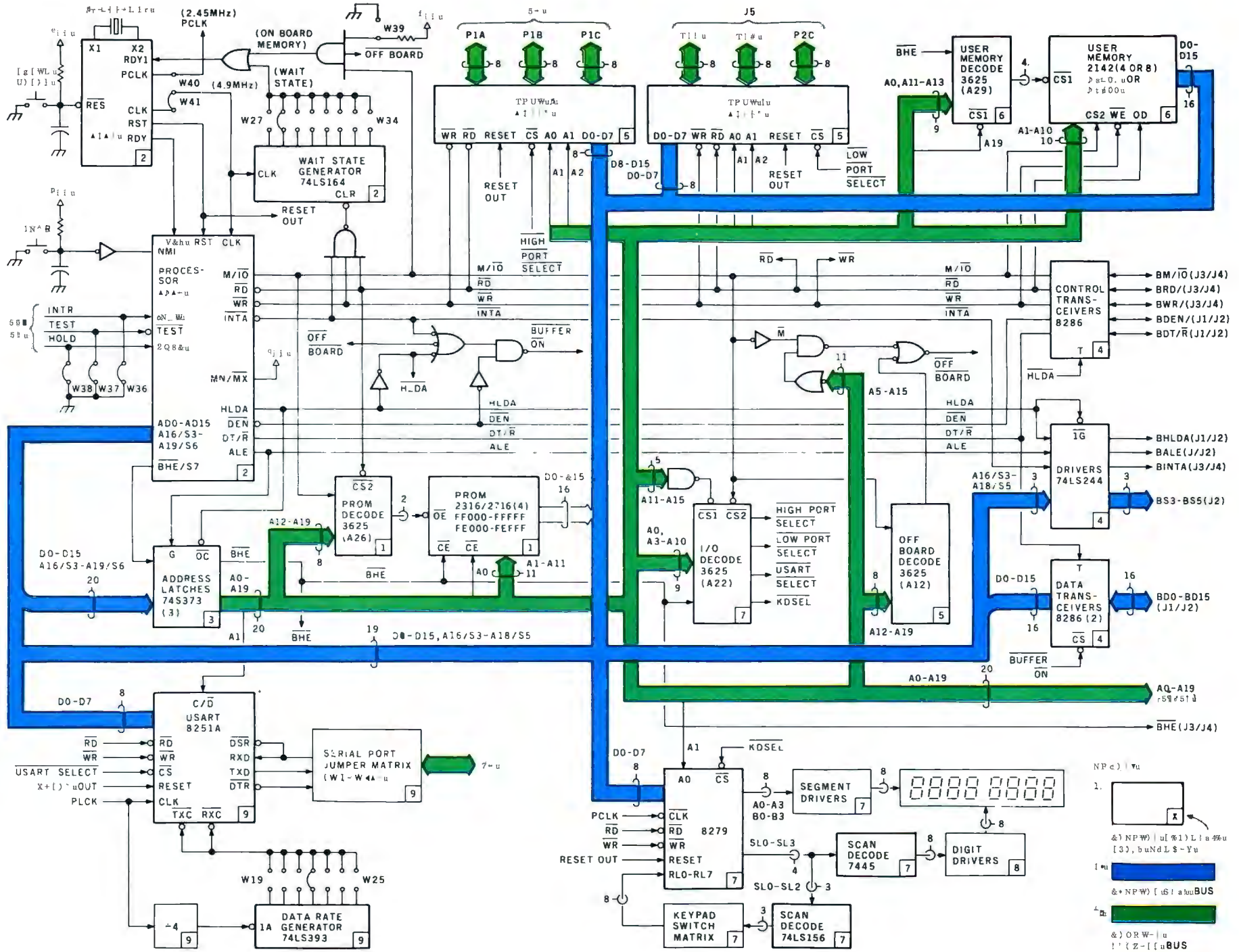



# Super values in high-performance computers



**WH14 Serial Printer**  
\$895 suggested list



**WH19 Smart Video Terminal**  
\$995 suggested list



**WH27 Dual Floppy Disk System**  
\$2595 suggested list



**WH89 All-In-One Computer**  
\$2295 suggested list



**WH11A 16-bit Computer**  
\$1895 suggested list

## Heath Data Systems

You get flexible computer systems designed, built and tested to serve you in many ways — priced to pay for themselves quickly. Choose from 8-bit or 16-bit power, then add the peripherals to configure the system that best fits your needs. You get flexibility, expandability, reliability.

### Hardware

The WH89 All-In-One Computer includes two Z80 microprocessors, 5¼" floppy, high-resolution CRT terminal, professional keyboard and 16K RAM (expandable to 48K) — all in one compact unit. It's a complete, balanced system ideal for word processing or any small business need.

The powerful 16-bit WH11A Computer (DEC® PDP 11/03 compatible) is designed around the DEC KD11-HA CPU and accommodates up to 64K bytes of memory. Add the WH27 Dual 8" Floppy (DEC RX01 compatible) for vast storage capacity and immediate access to programs and data. For video output, add the WH19 Smart Terminal with professional keyboard, direct cursor addressing and eight user programmable keys. The WH19 is compatible with the DEC VT52 and ANSI Escape Mode.

The WH11A System is ideal for the complex problems of business and education.

### Software

The WH11A Computer runs all systems and applications software written for the DEC PDP-11/03 and that includes scores of practical programs for business, technical users and education. It also accepts the powerful DIBEX™ Operating System which is compatible with Dibol, and all Dibol-based software.

The WH27's disk operating system was developed in conjunction with DEC and supports BASIC, FORTRAN and Assembly Languages... all available from Heath Data Systems Dealers.

The disk operating system for the WH89 All-In-One Computer supports MICROSOFT™ BASIC, MICROSOFT™ FORTRAN and Assembly Languages.

### Humanware

The people who build Heath Data Systems hardware stand behind it. Service is available from 55 locations throughout the U.S. and at many more locations in Canada and Europe. There's always someone nearby. Your investment is protected.

### Take a closer look

Heath Data Systems are on display at your nearby Byte Shop, Computerland, Heathkit Electronic Center, Microage Dealer or other qualified computer store.

### OEM discounts

They're available and they're generous. Call (616) 982-3361 for details.



# data systems

Heath Data Systems, Schlumberger Products Corporation  
Hilltop Road, St. Joseph, MI 49085

DEC is a registered trademark of Digital Equipment Corporations.



Text continued:

## In Conclusion

If you have an interest in 16-bit

microprocessors, perhaps the best place to start is with the SDK-86. The 8086 is a quantum leap forward for

microprocessors and the SDK-86 is a cost-effective method of evaluation, complete with all the hardware of a basic computer system. It must be cautioned that a first-time user, unaccustomed even to 8-bit microprocessors, may find the learning process somewhat complicated. The SDK-86, while packaged and assembled in a Heathkit fashion, is an industrial training device and not aimed specifically at the personal computing market. Beyond the minimal checkout procedures and brief description of the monitor commands, there are no sample programs which can be immediately entered and executed. This unit must be thought of as a rather sophisticated trainer. The mechanism is provided in the form of the board, but the actual course of education is completely in the hands of the user. ■

Table 2: The commands which are available for use with the serial monitor.

Command	Monitor Command Summary FUNCTION/SYNTAX
S (Substitute Memory)	Displays/modifies memory locations S[W]<addr>,[[<new contents>],]*<cr>
X (Examine/Modify Register)	Displays/modifies 8086 registers X[<reg>][[<new contents>],]*<cr>
D (Display Memory)	Moves block of memory data D[W]<start addr>[,<end addr>]<cr>
M (Move)	Moves block of memory data M<start addr>,<end addr>,<destination addr><cr>
I (Port Input)	Accepts and displays data at input port I[W]<port addr>,[,]*<cr>
O (Port Output)	Outputs data to output port O[W]<port addr>,<data>[,<data>]*<cr>
G (Go)	Transfers 8086 control from monitor to user program G[<start addr>][,<breakpoint addr>]<cr>
N (Single Step)	Executes single user program instruction N[<start addr>][[<start addr>],]*<cr>
R (Read Hexadecimal File)	Reads hexadecimal object file from tape into memory R[<bias number>]<cr>
W (Write Hexadecimal File)	Outputs block of memory data to paper tape punch W[X]<start addr>,<end addr>[,<exec addr>]<cr>

Next month's "Ciarcia's Circuit Cellar" topic will be electrically alterable read-only memories (EAROMS).

## FINALLY, Apple II® software for the discerning computerist, and the not-so-discerning beginner

### AppleAids™

#### Little Tricks™

A series of carefully explained subroutines containing a potpourri of useful programming techniques in Integer Basic and Applesoft, such as specific key stroke identification, timing loops, disappearing question marks on input, no question marks on input, and many more.

Cassette (16K) ..... 14.95 Disk (32K) ..... 19.95

#### Scroll Control™

Have you ever wondered why you cannot list an Integer Basic or Applesoft program one screen-page at a time? So have we, and we did something about it! Our machine language Scroll Control, hidden in RAM so as not to "bump" into your program, can be engaged or disengaged at a flick of the keyboard. Why be frustrated when instead you can control the scroll? Cassette ..... 9.95 Disk ..... 14.95

### Compulaw™ Series

#### \*Alitax Estimator™

This Applesoft program, prepared under the supervision of an attorney, estimates disposable income after alimony and child support payments and federal taxes. For use by laymen and attorneys. 1980 tables.

Cassette (24K) ..... 9.95 Disk (32K) ..... 14.95

#### \*Pensioner™

A companion to Alitax Estimator in Applesoft designed to calculate the present value of a pension in states in which a pension is subject to division in marital dissolution cases.

Cassette (24K) ..... 9.95 Disk (32K) ..... 14.95

N.J. res. add 5% sales tax  
Apple II and Applesoft are registered trademarks of Apple Computer, Inc.  
Add \$1/item, shipping and handling professional, but not a substitute for legal advice

**SOFTAGON™**  
INCORPORATED

#### Form-It-Out™

A series of routines in Integer Basic and Applesoft containing detailed explanation and examples of programming techniques necessary to professionalize your screen output. Included are right and center justification, windowing, tabbing, cursor positioning among others.

Cassette (16K) ..... 14.95 Disk (32K) ..... 19.95

#### Track & Sector List™

This is the ultimate disk utility. Instead of a catalog, have you ever seen those dreaded words "I/O ERROR"? Is all lost? NO! Now your disk may be saved. Also you can eliminate bad sectors, remove control characters imbedded in file names, change the disk volume number, and more. This machine language program is supplemented by extensive tutorial documentation worth its weight in gold. Disk only (32K) ..... 24.95

### Hex and Decimal Learning Tree™

#### My ABC's™

An early learning Integer Basic program using over one hundred and fifty high resolution graphic letters and pictures in a drill-and-practice format designed to develop identification of capital and small letters, and association of letters with pictures. Scoring capability allows monitoring. Child tested and teacher recognized. Cassette (48K) 14.95 Disk 19.95

#### Now I Can Rhyme™

A companion to My ABC's in Integer Basic. The child selects those high resolution pictures which rhyme. Score-keeping capability allows monitoring. Incorporates progressive levels of difficulty.

Cassette (48K) ..... 14.95 Disk (48K) ..... 19.95

P.O. Box 774M  
Morristown, NJ 07960  
(201) 539-3770





# Concerto in A Flat Mini.

Victor Borge demands the world's finest piano for his concert work. And when he performs at the computer keyboard, he naturally expects the best. The quality mini recording media. That's why he specifies Verbatim.

At Verbatim Corporation the whole message is quality. Our Verbatim brand diskettes, cartridges and cassettes capture your data and play it back bit for bit, byte for byte, verbatim.

Quality mini media is all we make. When you want to be sure *your* data will play, specify Verbatim.

## Verbatim Corporation

323 Soquel Way, Sunnyvale,  
CA 94086

(408) 245-4400. TWX: 910-339-9381

For the name of your nearest  
Verbatim distributor, call toll free:  
(1) 800-538-1793.

In California call: (408) 737-7771  
Call collect.

In Europe:

Verbatim S.A.  
Case Postale 296

1215 Genève 15

Switzerland

Telephone: 41 (22) 34-90-55

Telex: 22647 ITGE CH

Verbatim Ltd.  
Ballysimon Road  
Limerick, Ireland  
Telephone: 061-42755  
Telex: 8206

In the Far East:  
Verbatim Far East Ltd.  
702 Hayama Building  
3-14, 1-Chome  
Hiroo, Shibuya-Ku  
Tokyo 150, Japan  
Tel: (03) 446-2917 Telex: J29587

PEOPLE  
WHO PLAY THE  
COMPUTER  
**Specify  
Verbatim**  
MINI MAGNETIC MEDIA





# Solving Soma Cube and Polyomino Puzzles Using a Microcomputer

---

Douglas A Macdonald  
Yekta Gürsel  
130-33  
Theoretical Astrophysics  
California Institute of Technology  
Pasadena CA 91125

---

The genesis of this article was an inexpensive puzzle consisting of twelve plastic pieces which are supposed to be fitted into a rectangular cardboard box. Despite assurances by experts (see bibliography, Martin Gardner) that there are 2339 separate and distinct ways of solving the puzzle, a year's work by a veritable platoon of people (mainly Yekta) produced only slightly more than 150 solutions.

## Introduction

Polyomino puzzles and Soma Cubes are examples of a class of problems which are particularly suited to solution on a small computer. The amount of data needed in each case is relatively small, but the amount of calculation needed to do an exhaustive search for solutions is staggering.

For a set of Pentominoes, for instance, you need only encode the shapes of the twelve pieces and provide an array of sixty spaces into which you try to fit them. For a Soma Cube there are only seven pieces, which fit into an array of twenty-seven spaces. In both cases, all of the necessary data will easily fit into 2 K bytes of memory. However, the number of individual situations that would have to be considered in an

unoptimized exhaustive search would be  $3.2 \times 10^{16}$  for the Pentomino puzzle and  $4.7 \times 10^{11}$  for the Soma Cube.

In this article, we will present a 6502 assembly language program which will solve a wide variety of puzzles of the sort where a given region, either two or three dimensional, must be filled with a given set of pieces. The program has been written in a general manner so that the shape of the region can be easily changed and certain pieces can be specified as fixed, in order to take advantage of symmetry. The number and shape of the pieces themselves can also be easily changed.

Due to a clever search method, the program given here actually considers many fewer cases than the unoptimized search mentioned above. Using a Commodore PET with a clock frequency of 1 MHz, most of the problems for which we have generated a complete set of solutions have taken from a few minutes to a few hours to run. The longest running problem we have considered, that of Pentominoes in a 10 by 6 rectangle, took slightly less than two days to generate all of the 2339 solutions.

If the program is run in BASIC, which we actually tried, this problem takes more than two months. The large difference in running speeds is due to the fact that BASIC on the PET is an interpreted language, each line of which must be decoded every time it is executed. This should serve as a caveat to anyone intending to write a

BASIC interpreter version of this program.

The search algorithm used in the program is extremely general, as is illustrated by the fact that there are only three places in the assembly code where a check is made to see if the region under consideration is two or three dimensional. Thus the user should find it easy to modify the program to consider more complicated or exotic problems, such as those involving oddly shaped pieces or more than three dimensions.

The program given here is written in the symbolic assembly language of the 6502 microprocessor, but users of other microprocessors should be able to adapt the fundamental algorithm to their own machines without much trouble. The accompanying BASIC routines are written in Commodore's version of BASIC (a Microsoft product), but they should also be easily adaptable to other machines. Since "safe" memory locations vary from machine to machine, users should be aware of the quirks of their own particular computer when they choose the addresses for the variables in the program.

## Polyominoes

Polyominoes are planar objects consisting of a number of squares connected at their edges (see figure 1). The simplest such object is a monomino, which is just a single square. Next is the domino, consisting of two squares joined at a side, which has the shape of the familiar game pieces.

---

## Acknowledgment

*The authors would like to thank Mark Zimmermann for teaching them assembly language, and for allowing generous amounts of computer time to write and debug the program.*

---

Both monominoes and dominoes have only one possible shape. Trominoes consist of three squares and there are two possible shapes, as shown. Similarly, there are five different tetrominoes, twelve different Pentominoes (photo 1), thirty-five different hexominoes, and so on. Interestingly, the formula for the number of n-ominoes as a function of n is not known.

The type of puzzle that we considered was the problem of using a given set of polyominoes to *tile*, or fill in, a region with a given boundary. For instance, the twelve Pentominoes can be used to tile a 20 by 3 rectangle (there are only two different ways of doing this), a 10 by 6 rectangle (2339 ways), a 15 by 4 rectangle (368 ways), or a 12 by 5 rectangle (1010 ways).

We do not even have to be restricted to rectangular shapes: we can give the computer some arbitrary region consisting of sixty squares, and ask it to find all the solutions or a subset of the solutions. One of the more interesting of the Pentomino problems is the case of an 8 by 8 chessboard with the four center squares filled in and not used (65 solutions).

A variety of problems can be developed using the various polyominoes, but the ones to which computer solution is most applicable seem to be those involving Pentominoes. The smaller polyominoes, especially monominoes and dominoes, are so few in number and simple in shape that any puzzle involving them is trivial and can be easily solved without a computer. On the other hand, for hexominoes and higher orders of polyominoes, the number of objects in a complete set is so great that an exhaustive search is impractical, even on a large computer. For this reason, the only examples that we have actually run on the computer have been Pentomino puzzles, although the program is general enough to consider other polyominoes.

In order to make a tractable problem using hexominoes or other higher-order polyominoes, a reasonably sized subset of the complete set of pieces should be chosen. For instance, one could try to tile a sixty square region using ten of the thirty-five hexominoes, or a seventy-two square region using twelve of the hexominoes.

### Soma Cubes

The Soma Cube (trademark of Parker Brothers Inc, Salem MA) is a puzzle invented by Piet Hein, consisting of seven pieces which can be fitted together into a 3 by 3 by 3 cube (and other more exotic shapes). Each of the pieces consists of a number of cubes joined together at their faces. Six of the pieces are composed of four cubes, and the seventh piece is composed of three cubes, as shown in photo 2. Note that piece 2 is just a three-dimensional version of the second tromino in figure 1, and that pieces 5, 6, and 7 are three-dimensional versions of three of the tetrominoes.

There are 240 different ways of constructing a cube out of these pieces. If rotations and reflections of the cube itself and of individual pieces within the cube are treated as different solutions, this number is increased by a factor of 4608 to make a total of 1,105,920 solutions.

As with polyominoes, we can generalize the problem by using more than one set of pieces, or by trying to fill a noncubical region. The program can be easily adapted to consider these situations.

### Encoding

In order to make the problem understandable to the computer, we represent the box into which we are trying to fit the pieces as an array in memory. Each of the pieces is assigned a number. An empty square in the box is represented by a zero in the appropriate array cell, and squares which are filled by piece number K are represented by the actual number K in the corresponding array cells. For convenience, the entire array is surrounded by a boundary of cells into which we put the number -1. This speeds up the search since the machine does not have to make a distinction between cells which are filled and cells which are off the edge of the board.

As an example, consider the Pentomino problem for the 10 by 6 rectangle. The pieces would be assigned numbers between one and twelve, and the array plus boundary would have dimensions of 12 by 8. The number -1 is also put into any square which is off-limits. Thus, an 8 by 8 square with the center four squares off-limits would be represented in memory by a 10 by 10 array

Figure 1: Polyominoes are planar objects consisting of a number of squares connected at their edges.

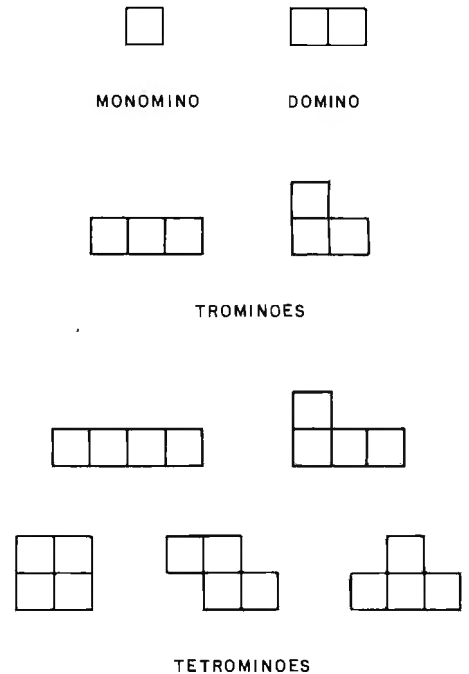

Photo 1: The twelve different Pentominoes, showing their assigned number and letter designations. Pentominoes is a registered trademark of Solomon W Golomb.

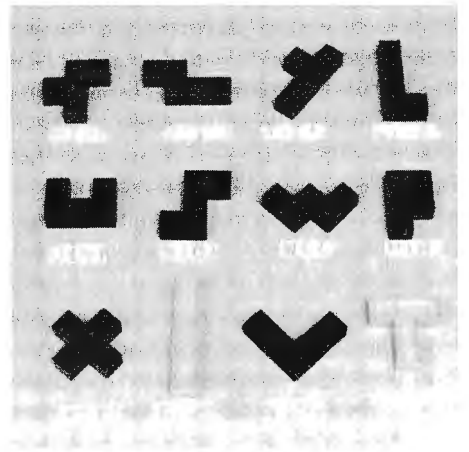
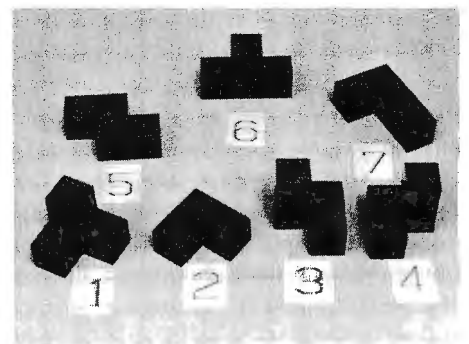

Photo 2: The seven Soma Cube pieces with their assigned numbers.





Solomon W Golomb originally introduced the terminology and many of the problems associated with polyominoes.

with -1s around the boundary and in the four center squares.

Unfortunately, things are not quite this simple, since we cannot specify a two-dimensional array in assembly language, and must therefore store it as a linear array in memory. The mechanics of how we encode and decode the coordinates of a particular square will be explained later.

The numbering of the pieces is somewhat arbitrary, but it is convenient to put the most symmetric pieces first. This makes it easy to have the computer fix one of the pieces on the board in order to take advantage of symmetry. Again using the Pentominoes as an example, the X Pentomino should always be assigned the number 1, since it has the fewest orientations of any of the pieces (ie: only one). If you look at a 10 by 6 board, it is easy to convince yourself that any solution can be rotated or reflected to get the X in the lower left-hand quarter of the board. Thus, a simple way to keep from generating rotations and reflections of already known solutions is to constrain the X to the lower left-hand quarter of the board. Furthermore, it is easy to see that only seven different positions of the X in this corner can possibly lead to solutions; so successive consideration of these seven cases is the quickest way to generate all of the 2339 solutions. For these reasons, the program allows the user to specify any number of pieces as fixed.

The numbering of the Pentominoes and the Soma Cube pieces shown in photos 1 and 2 will be used in the program. Also shown in photo 1 are mnemonic letters assigned to each of the twelve Pentominoes. These letters are used in printing out the solutions to make the output easy to read. For the Soma Cube we used the numbers one thru seven for the printout symbols, but you can easily change these to any symbols you choose.

The option of fixing pieces also

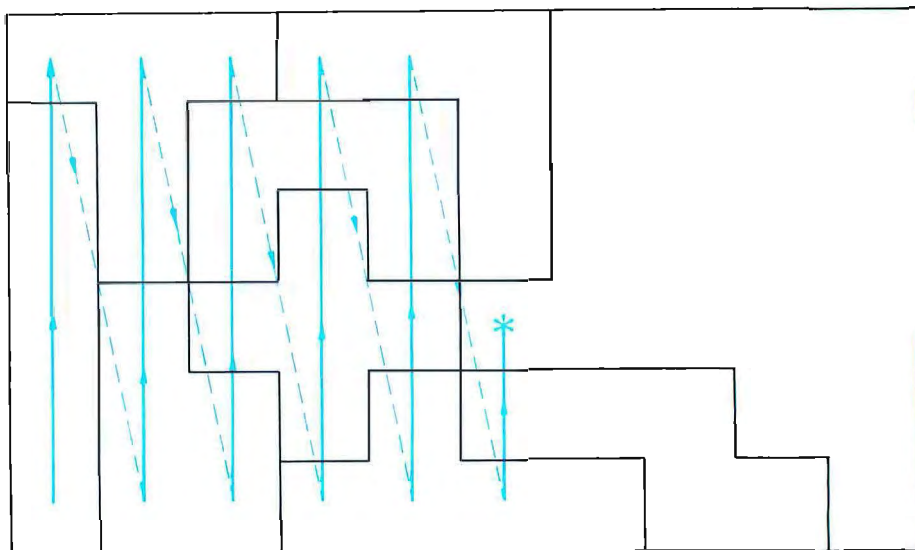

**Figure 2:** The scan procedure starts in the lower left-hand corner of the defined area and proceeds up the first column. When the top of the column is reached, the scan returns to the bottom of the second column, which is scanned from bottom to top. This procedure is repeated until an empty square is encountered. This empty square is then the base square. If no empty squares are found, the problem has been solved.

allows the user to specify part of the solution. For instance, if you want to know whether or not a solution exists when a certain number of the pieces are fixed, enter the positions of these pieces from the keyboard, and the computer will hold them fixed and fiddle around with the remaining pieces. The parts of the program which initialize the positions of the pieces and print out the solutions have been written in BASIC because they are not time-critical. These will be easy for the user to change.

### Algorithm

The program has to order the solutions so that it knows what solutions have already been found and what possibilities are yet to be tried. The program does this by considering the permutations of the piece numbers in ascending order. The meaning of *ascending order* is best illustrated by considering a simple example. If we have three pieces, numbered 1, 2, and 3, then the permutations in ascending order are:

(123), (132), (213),  
(231), (312), (321)

That is, considering the permutations as three-digit numbers, these three-digit numbers are in ascending order. The generalization of this example to higher numbers of pieces is self-evident.

The total number of permutations of N pieces is given by the product of all of the numbers between 1 and N, which is denoted by N! (read N-factorial):

$$N! = N \times (N-1) \times (N-2) \times \dots \times 3 \times 2 \times 1$$

Thus for the twelve Pentominoes, we have  $12! = 479,001,600$  permutations to consider! This is not, however, cause for despair; an efficient search procedure will reduce the possibilities to a small fraction of this number.

In order to make the search procedure clear, we will describe it for the special case of the 10 by 6 Pentomino puzzle. It will be obvious how the method can be generally applied to other cases.

The board is arranged with the long dimension placed horizontally and the short dimension placed vertically. The program applies a scan procedure which starts in the lower left-hand corner and scans up the first column, then goes to the bottom of the second column and scans up this column, and so on, for the third through tenth columns. The first empty square which it runs across in this search is called the *base square* (see figure 2).

The search procedure is summarized in the flowchart in figure 3. Just before the BASIC initialization routine is finished, it performs the search

# The Paper Tiger.™

## At \$995, why settle for less.



The Paper Tiger sets a new standard for low-cost impact printers. More capability. More versatility.

- Eight software-selectable character sizes.
- 80 and 132 column formats.
- Full forms control.
- DotPlot™ graphics option.
- Connects directly to Apple II, TRS-80, and other personal computers.

Plus lots more. For a free brochure, print sample, or the name of the Paper Tiger dealer nearest you, write or call. Integral Data Systems, 14 Tech Circle, Natick, Massachusetts 01760.

**Call toll-free 800-343-6412.**

In Massachusetts, Alaska, and Hawaii call (617) 237-7610.

Circle 176 on inquiry card.



**Integral Data Systems, Inc.**



described above and finds the first base square. If the user has not specified any pieces as fixed, this is just the lower left-hand corner square. If fixed pieces were specified, it need not be this square (figure 2). The computer has in mind a particular permutation of the twelve pieces which was specified by the user. The program chooses the appropriate piece and

looks up its orientations in a table. If the first orientation that it tries does not fit, it goes on to the second, and keeps trying until one of two things happens:

- It finds an orientation which fits, in which case it puts the piece in the box and then scans as described above for the next base square. It then tests this new base square to see whether or not it is isolated (ie: whether or not it is completely surrounded by four filled squares). If the base square is isolated, it cannot serve as the new base square, so the program jumps to the isolated square routine which will be described later. If the new base square is not isolated, the program picks the next piece in the permutation and goes back to the begin-

ning to look up the orientations of this new piece.

- None of the orientations fit, in which case the program takes out the last piece it put in and tests that piece to determine if it has any orientations which have not yet been considered. If there are additional orientations, the program jumps back to the beginning to try these. If all orientations have been considered, the program removes the preceding piece and tests that piece for any more orientations. Pieces are removed in this manner until either a piece is found which has more orientations, in which case the program branches back to the beginning to consider them; or the program reaches the nucleus of pieces which the user specified as fixed. When this happens, the next

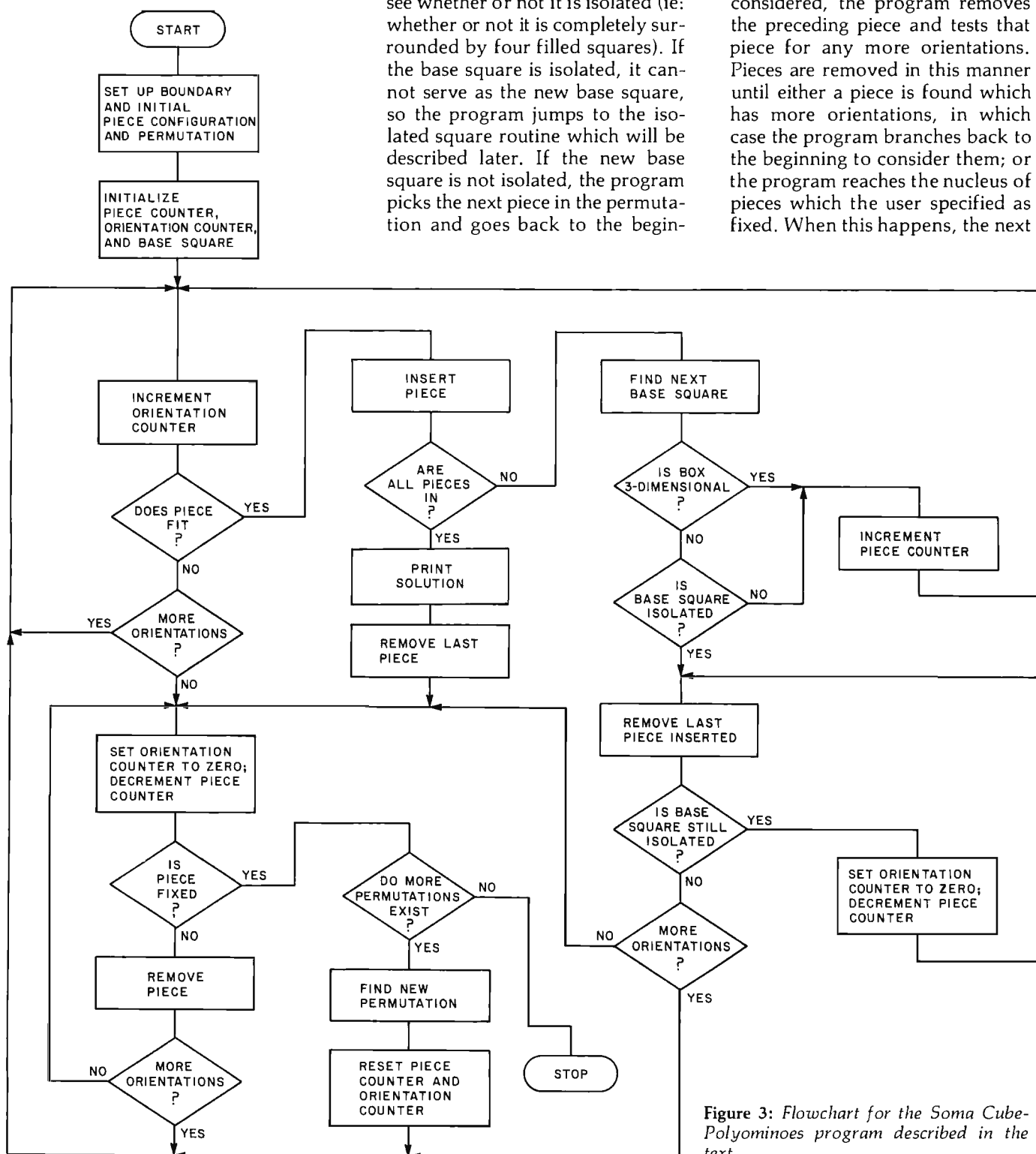

Figure 3: Flowchart for the Soma Cube-Polyominoes program described in the text.

# DIGI-KIT-IZER

## What it means to you.

**dig-i-kit-izer** /dij-e-kit-izer/ *n.* (1): a high-value low-cost computer graphic input device designed to be assembled by the user (2): the most advanced graphics tablet in kit form (3): An instrument that, when assembled, allows the user innumerable methods of design and analysis functions (4): The latest addition to the most extensive, accurate and reliable line of digitizers, by Talos



**\$449.**

No adjustments. No calibration.

### OPTIONS

- **APPLE Interface**
- **TRS-80 Interface**
- **RS 232 Interface**
- **Power Supply**
- **IC Sockets**
- **Unit Enclosure**

Dealer inquiries invited

PLEASE RUSH ADDITIONAL INFORMATION ON THE TALOS DIGI-KIT-IZER

Name \_\_\_\_\_  
Company \_\_\_\_\_  
Title \_\_\_\_\_  
Address \_\_\_\_\_  
City \_\_\_\_\_ State \_\_\_\_\_ Zip \_\_\_\_\_  
Phone \_\_\_\_\_



by **talos**

TALOS SYSTEMS INC.  
7419 E. Helm Drive  
Scottsdale, Arizona 85260  
(602) 948-6540  
TWX (910) 950 1183

**CHECK YOUR LOCAL DEALER NOW**



permutation in the ascending sequence described above is generated and tested. If there are no permutations left, execution stops.

Immediately after any piece is placed, the program checks to see if the board is full. If the board is filled, control is transferred back to BASIC to print out the solution.

Two refinements have been added to the above bare-bones routine, which together result in a considerable savings of time:

The *isolated square* routine mentioned above saves time by immediately recognizing and rejecting isolated base squares. Otherwise, the machine would have to make many tests before rejecting an obviously invalid base square. The routine works by successively removing pieces until the square under consideration is no longer isolated. This routine results in a savings of time only in the two-dimensional case: in three dimen-

sions, it is no more efficient than the basic search described above. This is mainly due to the fact that an isolated square seldom occurs in the three-dimensional case because of the large number of cubes (six) which must be filled to isolate a given cube. For this reason, the isolated square routine is bypassed when the program is used to run the Soma Cube.

The other refinement allows the machine to avoid considering permutations of the pieces which are certain to lead to no solutions. For instance, if the machine never succeeded in fitting more than five pieces into the box in a particular permutation, it will do no good for the permutation routine to interchange the eleventh and twelfth pieces: no progress will be made until the position of the sixth piece is changed. The program takes account of this, and the result is that while the permutations are still done in the ascending order previously described, a large fraction are simply skipped since they cannot lead to solutions.

The method of scanning for the base square in the two-dimensional case is implemented in two loops: the Y-scan loop nested inside the X-scan loop. The scan method for the three-dimensional case is similarly defined by three nested loops: the Z-scan loop is nested inside the Y-scan loop, which is in turn nested inside the X-scan loop.

### Orientation Table

We should explain the meaning of the phrase which was used above when we said that the computer "looks up" the orientations of the pieces. This phrase means exactly what it says: the machine looks up the orientation from a table in memory which has been entered by the user.

But why can't the computer figure the orientations itself? The answer is, of course, that it could. However this would increase the running time of the program by a factor of ten to one hundred. The orientation checker is the most often-used routine in the program, and it is important to have it run as quickly as possible.

The user does not actually have to enter the entire table. Listing 1 is a BASIC program which automatically generates the orientation table in memory. In using this program, the user need enter only one orientation for each piece. The computer automatically generates and encodes the rest of the orientations. This can result in a considerable savings in time and frustration, since a polymino can have as many as eight orientations, and a Soma Cube piece can have as many as twenty-four orientations.

Although this BASIC program makes it possible to use the program without understanding how the orientation table works, it is worthwhile for anyone who intends to use this program to learn how the table is set up, since it is fundamental to the operation for the entire program.

In a BASIC routine, the table would be a four-dimensional array  $B(K, J, M, I)$ . In the assembly language routine, the table is one-dimensional, but we will explain the mechanics of this shortly. At the moment, an explanation of the four-dimensional array will be more helpful.

## FLEX™ SOFTWARE FROM THE U.K.

### EVERYONE'S TALKING ABOUT OUR EXCITING NEW RANGE OF 6800 SOFTWARE FOR FLEX

LABDIS — The only 6800 disassembler you will need, fully labelling, operates disk to disk, inserts operating system equates automatically. Output is in standard mnemonics for input direct to an assembler. Intelligent data block algorithm.

Miniflex \$ 100  
Flex 1.0 \$ 105  
Flex 2.0 \$ 100

MAIL — Mailing package suite. Features fast retrieval, alphabetic sort, complex analysis structure.

Flex 1.0 \$ 255  
Flex 2.0 \$ 250

Phone or write for further details and full catalogue.

# Source

Micro Computer Consultants

12 Vivian Road, Wellingborough, Northamptonshire, England.  
Telephone: +44 933 224040





## We're looking for the most original use of an Apple since Adam.

What in the name of Adam do people do with Apple Computers?

You tell us.

In a thousand words or less.

If your story is original and intriguing enough, you could win a one-week all-expense paid trip for two to Hawaii. Which is the closest we could come to paradise.

### Win fabulous prizes for creative writing.

To enter, drop by your nearest Apple dealer and pick up an entry blank. Fill it out. Then write an article, in 1000 words or less, describing the unusual or interesting use you've found for your Apple.

A jury of independent judges will cast the deciding vote for the grand prize: a week for two, airfare included, in Hawaii.

The judges will also choose 16 additional winners, two each from eight categories:

graphics/music, entertainment, home, business, education, scientific, professional, and industrial. And each winner will choose from a long list of longed-after Apple peripherals—from Apple Disk II's to graphics tablets to Trendcom/printers. Or you can take a \$250 credit towards the purchase of any Apple product.

The contest ends March 31, 1980. All winners will be notified by May 15.

Entry forms are available at your participating Apple dealer. Call 800-538-9696, (800-662-9238 in California), for the one nearest you.

Mail the entry blank, your article and any photos to: Apple Computer, "What in the name of Adam" contest, 10260 Bandley Drive, Cupertino, CA 95014.

And may the juiciest application win.

apple computer



**Listing 1:** BASIC program to generate the orientation tables for polyominoes and Soma Cube. The computer generates all possible orientations after the first orientation has been entered.

```

1 REM COPYRIGHT 1979 ORIENTATION TABLE GENERATOR
10 INPUT"NUMBER OF DIMENSIONS";D:Q=8:IF D=3 THEN Q=24
20 INPUT"NUMBER OF PIECES";P:INPUT"NUMBER OF SQUARES PER
   PIECE";S
30 PRINT"ENTER R0:FIRST ADDRESS OF ARRAY OF LENGTH";P:INPUT R0
40 PRINT"ENTER B0:FIRST ADDRESS OF ARRAY OF LENGTH";(S-1)*Q*P*D
   :INPUT B0
50 DIM X(20),Y(20),Z(20):T=0:M=P*Q*(S-1):FOR I=R0 TO R0+P
   :POKE I,0:NEXT I
60 FOR I=B0 TO B0+(S-1)*P*Q*D:POKE I,0:NEXT I
70 REM ENTER X,Y,Z COORDINATES OF EACH SQUARE OF EACH PIECE
80 FOR K=1 TO P
90 FOR I=1 TO S:X(I)=0:Y(I)=0:Z(I)=0:NEXT I
100 PRINT"PIECE #";K:FOR I=1 TO S:PRINT" SQUARE #";I
   :INPUT" ENTER X";X(I)
110 INPUT" ENTER Y";Y(I):IF D=3 THEN INPUT" ENTER Z";Z(I)
120 NEXT I:PRINT" STANDBY ....."
130 REM TRANSLATE PIECE SO THAT BASE SQUARE IS AT ORIGIN
140 A=0:B=0:C=0:E=0:F=0
150 U=100:FOR I=1 TO S:IF X(I)<U THEN U=X(I)
160 NEXT I:FOR I=1 TO S:X(I)=X(I)-U:NEXT I
170 U=100:FOR I=1 TO S:IF Y(I)<U AND X(I)=0 THEN U=Y(I)
180 NEXT I:FOR I=1 TO S:Y(I)=Y(I)-U:NEXT I:IF D=2 GOTO 220
190 U=100:FOR I=1 TO S:IF Z(I)<U AND X(I)=0 AND Y(I)=0 THEN
   U=Z(I)
200 NEXT I:FOR I=1 TO S:Z(I)=Z(I)-U:NEXT I
210 REM ORDER SQUARES ACCORDING TO THEIR DISTANCE FROM THE BASE
   SQUARE
220 FOR I=1 TO S=1:FOR J=I+1 TO S
   :G=X(I)*X(I)+Y(I)*Y(I)+Z(I)*Z(I)
230 H=X(J)*X(J)+Y(J)*Y(J)+Z(J)*Z(J):IF G<H GOTO 270
240 IF G=H AND (X(I)<X(J) OR (X(I)=X(J) AND Y(I)<Y(J))) GOTO 270
250 IF G=H AND X(I)=X(J) AND Y(I)=Y(J) AND Z(I)<Z(J) GOTO 270
260 W=X(I):X(I)=X(J):X(J)=W:W=Y(I):Y(I)=Y(J):Y(J)=W:W=Z(I)
   :Z(I)=Z(J):Z(J)=W
270 NEXT J:NEXT I:IF A=0 GOTO 380
280 REM COMPARE ORIENTATION TO THOSE ALREADY OBTAINED
290 FOR I=1 TO A:FOR J=1 TO S-1:U=B0+J-1+(S-1)*(Q*(K-1)+I-1)
300 V=Y(J+1):IF V<0 THEN V=V+256
310 IF X(J+1)<>PEEK(U) OR V<>PEEK(U+M) GOTO 360
320 IF D<>3 GOTO 350
330 W=Z(J+1):IF W<0 THEN W=W+256
340 IF W<>PEEK(U+2*M) GOTO 360
350 NEXT J:GOTO 440
360 NEXT I
370 REM PUT ENTRIES IN TABLE
380 J=0:A=A+1:FOR I=2 TO S:J=J+1:U=B0+J-1+(S-1)*(Q*(K-1)+A-1)
390 V=Y(I):IF V<0 THEN V=V+256
400 W=Z(I):IF W<0 THEN W=W+256
410 POKE U,X(I):POKE U+M,V:IF D=3 THEN POKE U+2*M,W
420 NEXT I
430 REM ROTATE TO NEW ORIENTATION
440 B=B+1:IF B=4 THEN B=0:GOTO 460
450 FOR I=1 TO S:W=X(I):X(I)=Y(I):Y(I)=-W:NEXT I:GOTO 150
460 C=C+1:IF C<>2 GOTO 520
470 C=0:IF D=2 GOTO 530
480 E=E+1:IF E>1 GOTO 500
490 FOR I=1 TO S:W=Z(I):Z(I)=X(I):X(I)=-W:NEXT I:GOTO 150
500 F=F+1:IF F>1 GOTO 540
510 FOR I=1 TO S:W=Y(I):Y(I)=Z(I):Z(I)=-W:NEXT I:GOTO 150
520 FOR I=1 TO S:X(I)=-X(I):Z(I)=-Z(I):NEXT I:GOTO 150
530 REM PRINT NUMBER OF ORIENTATIONS AND PUT IT IN ARRAY R
540 PRINT A,"ORIENTATIONS":POKE R0+K,A:IF T=1 GOTO 570
550 NEXT K
560 REM GO BACK AND CORRECT MISTAKES
570 T=1:INPUT"ENTER I.D. NUMBER OF A PIECE YOU NEED TO
   CORRECT(0 IF NONE)";K
580 IF K<>0 GOTO 90
590 PRINT" ***** DONE *****"
600 PRINT"RECORD ARRAYS R AND B ON TAPE TO SAVE":END

```

The first index, K, is the assigned number of the piece whose orientations are being considered. Thus, for the case of Pentominoes, K ranges from one to twelve, and for the Soma Cube pieces it ranges from one to seven.

The second index, J, labels the individual squares or cubes that make up the piece under consideration. The positions of these squares will be defined in the table by their Cartesian coordinates relative to the base square, which is taken at the origin, ie: at (0,0) in the two-dimensional case, and at (0,0,0) in the three-dimensional case. Since the coordinates of the base square are fixed in this way, we need only tabulate the positions of the other squares relative to it. Thus, for Pentominoes, J ranges from one to four (not five), and for the Soma Cube it ranges from one to three (not four).

The ordering of the J values assigned to the various squares is determined by their distance from the base square. It is important that the squares nearest the base square have the lowest values of J because of the method we use to define the boundary of the box (ie: putting -1s around it). Unless the J values are in ascending order with increasing distance from the base square, there is a chance that the program might try to access a memory location which is not a part of the box. The BASIC table-generating program automatically takes care of this ordering.

The third index, M, labels which Cartesian coordinate is referred to by a given table entry. M=1 refers to an X-coordinate, M=2 refers to a Y-coordinate, and M=3 refers to a Z-coordinate. For any polyominoes M can be either one or two, and for the Soma Cube M can be one, two, or three.

The fourth index, I, labels which orientation is being described. The number assigned to a given orientation has no significance except for labelling purposes. The range of I is given by the maximum number of orientations of the pieces under consideration, which is eight for all polyominoes, and twenty-four for the Soma Cube pieces.

To sum up this information with an example, the table element B(1, 2, 3, 4) gives the Z-coordinate of square number 2 in the fourth orientation of

# Compucolor II. The personal computer for the enterprising mind.

You may not have thought of all the reasons for buying a personal computer. There are exciting games, of course, but what about financial management, household records, even income tax? You need a versatile, sophisticated machine that's as limitless as your imagination. You need the Compucolor II.

It costs \$1595\*. That's an exceptional price for a system with an 8-color, 13" display screen, a built-in mini-disk drive, and 8K of user RAM. In fact the Compucolor II has the best cost/performance ratio available in a personal computer. And the price is tax deductible to the extent that you use it in personal tax computation or income-related applications. Consult your tax adviser for full details.

Completely portable, the hardware consists of a full-color screen and detachable keyboard. Simply plug it into the nearest outlet. Programming is easy, with 16K Extended Disk BASIC capabilities stored in ROM. You can also buy low-cost software. Our Sof-Disk™ programs cover a variety of exciting and practical applications. With them, you can beat the Compucolor II at its own games, guide investment decisions, tutor your children, handle financial records, and more.

To find out how much more, visit your nearest computer store. Compare all the systems. You'll choose the Compucolor II.



\*U.S. domestic price  
Unretouched photo of screen

Compucolor Corporation • Intecolor Drive • Technology Park/Atlanta • Norcross, Georgia 30092 • Telephone 404/449-5996



K=9	I \ J					M
		1	2	3	4	
	1	1	1	1	2	1
		0	-1	1	1	2
	2	1	1	2	2	1
		0	1	0	-1	2
	3	1	1	1	2	1
		0	1	2	1	2
	4	0	1	1	2	1
		1	0	-1	0	2
	5	1	1	2	2	1
		0	-1	0	1	2
	6	1	1	1	2	1
		0	-1	1	-1	2
	7	0	1	1	2	1
		1	1	2	1	2
	8	1	1	1	2	1
		0	-1	-2	-1	2

**Table 1:** Orientation table entries for example of Pentomino 9. In the diagrams, the base square is labeled B and the other squares are labeled by their J values. The base square is always the lowest square in the leftmost column of the figure, and the table gives the coordinates of the other squares with respect to it.

piece number 1. Table 1 clarifies this by showing all of the orientations of Pentomino number 9 and the table entries which go with each figure.

The main program looks up values in the orientation table by calling a subroutine called LOOKUP. This subroutine is called many times during each loop of the main program and is therefore the most time-critical portion of the program.

In the program given here, a certain amount of speed has been sacrificed for the sake of generality. If the user is interested only in a particular problem, the subroutine can be speci-

fically rewritten for this problem, and the running time may be cut considerably. For instance, the first program that we wrote considered only the Pentomino problem for a 10 by 6 box, and ran almost twice as fast as the general routine given in this article. Clearly, however, it is most desirable to start with a completely general program like the one given here.

### Definition of Variables

As mentioned before, any arrays of more than one dimension must be stored as linear arrays in memory.

The array A, representing the playing region, is two-dimensional when we are considering polyominoes and three-dimensional when we are considering Soma Cubes. In both cases the linearized array is arranged in memory so that the scan procedure described above goes through the linear array in ascending order. For instance, the Soma Cube array is stored with the Z index varying fastest and the X index varying slowest:

A(1,1,1), A(1,1,2), . . . , A(1,1,5),  
 A(1,2,1), A(1,2,2), . . . ,  
 A(1,2,5) . . . . . , A(5,5,1),  
 A(5,5,2), . . . A(5,5,5)

(Remember that we put a boundary of -1s around the box, so the dimensions of the array are 5 by 5 by 5 rather than 3 by 3 by 3.) The dimensions of array A vary depending on the problem being considered, but a reserved memory space of about 300 bytes is sufficient for most reasonably sized problems. Array A begins at an address denoted by A0 in the BASIC and assembly listings, and is indexed by the value stored in variable L.

In the linearization of the orientation table, the elements B(K, J, M, I) are stored with the index J varying fastest, I varying next fastest, K next, and finally M, varying slowest. More specifically, if we define the following quantities:

- P: number of pieces,
- S: number of squares or cubes per piece,
- Q: maximum number of orientations for any one piece (eight for polyominoes and twenty-four for Soma Cube pieces),
- D: number of dimensions (two for polyominoes, three for Soma Cube),
- B0: beginning address of orientation table,

then the location in memory of the element B(K, J, M, I) is given by  $B0 + J - 1 + (S - 1) \times \{ Q \times [ P \times (M - 1) + K - 1 ] + I - 1 \}$ , and the number of elements in the table is given by  $(S - 1) \times Q \times P \times D$ . In assigning array space, the user should provide enough space for this table. Note that in the symbolic assembly program, the letters P, S, Q, D, I, J, K are used to denote the addresses of these quantities rather than the quantities themselves. Henceforth we will

# A Beautiful Way To Interface



## **IQ 140**

SOROC's first and foremost concern, to design outstanding remote video displays, has resulted in the development of the IQ 140. This unit reflects exquisite appearance and performance capabilities unequaled by others on the market.

With the IQ 140, the operator is given full command over data being processed by means of a wide variety of edit, video, and mode control keys, etc.

The detachable keyboard, with its complement of 117 keys, is logically arranged into 6 sections plus main keyboard to aid in the overall convenience of operation. For example, a group of 8 keys for cursor control / 14 keys accommodate numeric entry / 16 special function keys allow access to 32 pre-programmed commands / 8 keys make up the extensive edit and clear section / 8 keys for video set up and mode control / and 8 keys control message and print.

Two Polling options available: 1) Polling compatible with Lear Siegler's ADM-2. 2) Polling discipline compatible with Burroughs.

## **IQ 120**

The SOROC IQ 120 is the result of an industry-wide demand for a capable remote video display terminal which provides a multiple of features at a low affordable price.

The IQ 120 terminal is a simple self-contained, operator / computer unit.

The IQ 120 offers such features as: 1920 character screen memory, lower case, RS232C extension, switch selectable transmission rates from 75 to 19,200 bps, cursor control, addressable cursor, erase functions and protect mode. Expansion options presently available are: block mode and hard copy capability with printer interface. The IQ 120 terminal incorporates a 12-inch, CRT formatted to display 24 lines with 80 characters per line.

Circle 346 on inquiry card.

**SOROC**  
TECHNOLOGY, INC.

165 FREEDOM AVE., ANAHEIM, CALIF. 92801  
(714) 992-2860 / (800) 854-0147



Listing 2: BASIC driver and printout routine for Soma Cube — Polyominoes program. The "blackout" in line 1070 indicates use of the PET Shift-& graphics character.

```

1 REM POKE 135,20 TO PROTECT MACHINE CODE FROM BASIC INTERPRETER
2 REM B5 HOLDS PRINTOUT SYMBOLS FOR PIECES
3 B5="XIVTUSWPRZYL"
10 REM COPYRIGHT 1979 SOMA-POLYMINO DRIVER PROGRAM
11 INPUT "ENTER NUMBER OF DIMENSIONS";D
12 POKE 31,D
13 INPUT "ENTER THE NUMBER OF PIECES";P
14 POKE 27,P
15 INPUT "NUMBER OF SQUARES PER PIECE";S
16 POKE 25,S
17 PRINT "ENTER DIMENSIONS OF THE BOX":INPUT "WX";WX:INPUT "WY";WY
18 WZ=-1:IF D=J THEN INPUT "WZ";WZ
19 WX=WX+2:WY=WY+2:WZ=WZ+2:POKE 28,WX:POKE 29,WY:POKE 30,WZ
20 REM ASSIGN VALUES TO A0,B0,B0,C1,C2,E0 AGGRFEING WITH
  ASSEMBLY PROGRAM
21 A0=6300:R0=6580:B0=6600:C1=6200:C2=6220:E0=6240
30 REM A5 HOLDS EACH SOLUTION FOR PRINTOUT
40 REM ARRAYS R AND B ARE PRODUCED BY TAB. GEN. PROGRAM AND
  LOADED FROM TAPE
50 POKE 26,S-1:POKE 32,P-1
60 Q=8:IF D=3 THEN Q=24
70 POKE 33,Q:SPACE=Q*P*(S-1):I=INT(SPACE/256):J=SPACE-256*I
  :POKE 36,J:POKE 37,I
80 INDEX=B0-1-(S-1)*(Q+1):I=INT(INDEX/256):J=INDEX-256*I
  :POKE 39,J:POKE 39,I
90 FOR L=A0 TO A0+WX*WY*WZ-1:POKE L,0:NEXT L
100 FOR I=C2 TO C2+P:POKE I,0:NEXT I
110 REM PLACE BOUNDARY OF (-1)'S AROUND BOX
120 J=(WX-1)*WY*WZ:K=(WY-1)*WZ:M=WY*WZ
130 FOR I=A0 TO A0+M-1:POKE I,255:POKE I+J,255:NEXT I
  :FOR L=1 TO WZ
140 FOR I=A0+M+L-1 TO A0+J+L-M-1 STEP M:POKE I,255:POKE I+K,255
  :NEXT I:NEXT L
150 IF D=J THEN FOR I=A0+M+WZ TO A0+J-2*WZ STEP WZ:POKE I,255
160 POKE I+WZ-1,255:NEXT I
170 PRINT "ENTER COORDINATES OF OFF-LIMITS SQUARES."
  :PRINT "WHEN DONE ENTER 999 FOR X"
180 INPUT "X";X:IF X=999 GOTO 210
190 INPUT "Y";Y:Z=0:IF D=3 THEN INPUT "Z";Z
200 POKE A0+WZ*(WY*X+Y)+Z,255:PRINT:GOTO 180
210 PRINT:PRINT "ENTER INITIAL PERMUTATION OF PIECES":PRINT
220 FOR I=1 TO P:INPUT X:POKE C1+I,X:NEXT I
230 INPUT "ENTER NUMBER OF PIECES FIXED";Z
240 POKE 15,Z:POKE 0,Z+1:POKE 14,Z+1:IF Z=0 GOTO 300
250 REM PUT IN FIXED PIECES, IF ANY
260 FOR I=1 TO Z:PRINT "ENTER COORDS. OF EACH SQUARE OF
  PIECE";PEEK(C1+I)
270 FOR J=1 TO S:PRINT "SQUARE";J:INPUT "X";X:INPUT "Y";Y:Z=0
  :IF D=3 THEN INPUT "Z";Z
280 PE=PEEK(C1+I):POKE A0+WZ*(WY*X+Y)+Z,PE:NEXT J:NEXT I
290 REM INITIALIZE BASE SQUARE
300 FOR I=1 TO WX*WY*WZ-1:IF PEEK(A0+I)=0 THEN POKE 11,I
  :GOTO 320
310 NEXT I
320 POKE 18,1
330 SYS(5120)
999 C=0
1000 REM PRINT A SOLUTION
1010 IF PEEK(18)=0 THEN PRINT:PRINT "DONE !!!!!":END
1020 C=C+1:PRINT:PRINT "SOLUTION #";C:PRINT
1030 Z=J:A5="":FOR Y=WY-2 TO 1 STEP -1
  :IF D=3 THEN FOR Z=1 TO WZ-2
1040 FOR X=1 TO WX-2:A=PEEK(A0+WZ*(WY*X+Y)+Z
1050 IF X=1 AND Z<>0 AND Z<>WZ-2 THEN A5=A5+" "
1060 IF A=0 THEN A5=A5+"0":GOTO 1090
1070 IF A=255 THEN A5=A5+"blackout":GOTO 1090
1080 A5=A5+MID$(B5,A,1)
1090 NEXT X:IF D=3 THEN NEXT Z
1100 NEXT Y
1110 U=WX-2:IF D=3 THEN U=(WX-1)*(WZ-2)+1
1120 FOR I=1 TO WY-2:PRINT MID$(A5,U*(I-1)+1,U):NEXT I
1130 REM TYPING "S" WILL CAUSE EXECUTION TO STOP ON NEXT RETURN
  TO BASIC
1140 GET YG$:IF YG$="S" THEN PRINT:PRINT "STOP":END
1150 SYS(5759)
1160 GOTO 1010

```

use (P) with parentheses to denote the contents of memory location P, etc.

Other symbolic addresses appearing in the program include:

N: address containing 1 plus the number of pieces currently in the box,  
 Z: address containing the number of pieces specified as fixed by the user,  
 T: address containing the maximum number of pieces fitted into the box during the current permutation,

WX, WY, WZ: addresses containing the width of the box in the X, Y, and Z directions respectively (including the boundaries of -1s). For two-dimensional problems, WZ is set equal to 1,

C1: first address of an array containing the piece numbers in the order given by the current permutation, (P) is the length of this array,

C2: first address of an array containing the orientation numbers of the pieces in the order corresponding to that in the table beginning at C1, (P) is length,

R0: first address of an array, the N-th element of which is the number of possible orientations of piece number N. This table is automatically generated by the BASIC program which generates the orientation table B, (P) is length,

E0: first address of an array, the N-th element of which gives the position of the base square of piece number N, (P) is length.

The user should choose absolute addresses for the arrays so that they do not overlap; note that the array at B0 is particularly long. Since the arrays at R0 and B0 are both generated by the BASIC orientation-table routine, it simplifies matters if R0 is about 30 bytes in front of B0 so that the two arrays can be recorded on tape as a single file.

Although the assembly language part of the program (listing 3) is completely symbolic and therefore relocatable, the BASIC driver routine in listing 2, which contains the initialization and printout routines, must refer to the *absolute* addresses of some of the variables. Table 2 is a list of the absolute hexadecimal addresses used in running the program on a Commodore Pet with 8 K bytes of memory. In relocating the program, the user should be careful to make the addresses referred to by the two routines consistent. Listing 4 (see

# MOVING DATA AT A SNAIL'S PACE BECAUSE YOU'RE FLOPPY BOUND?

*Let Corvus Systems put you back in the race!*



- For TRS-80†, Apple‡ (including Apple Pascal), S-100 Bus—and now LSI-11.
- Fully compatible hardware/software.
- 10-million byte disk: IMI-7710.
- Proven Winchester technology.
- Z-80 based Corvus disk controller.
- Comprehensive disk diagnostics.
- Up to 4 disks per system.
- System \$5350, add-on disk \$2990.

Corvus offers a complete systems solution to the mass storage problem of micro computers. In a package smaller than a briefcase, we provide an intelligent controller, disk, and personality module. Call or write today for additional information. Get up to speed with Corvus.

**Now! CORVUS SPEAKS APPLE™ PASCAL™!**



†TRS-80 is a registered trademark of Radio Shack, a Tandy Co.  
‡Apple is a registered trademark of APPLE Computers, Inc.

**CORVUS SYSTEMS, Inc.**

900 S. Winchester Boulevard  
San Jose, California 95128  
408/246-0461





# TARBELL VDS-II

## Vertical Disk Subsystem



### SYSTEM INCLUDES:

- 2 Siemens 8" Disk Drives
- 1 Cabinet with Fan and Power Supply.
- 1 Tarbell Floppy Disk Interface, assembled & tested.
- 1 CP/M Disk Operating System.
- 1 Tarbell BASIC.
- All Cables and Connectors.
- Complete User Documentation.
- Fully factory assembled and tested.

VDS-II Single Density . . . \$1888  
 VDS-IID Double Density \$1999

### TARBELL DOUBLE DENSITY INTERFACE FOR 8" FLOPPY DISK

Under Tarbell Double-Density CP/M, single and double density disks may be intermixed. The system automatically determines whether single or double density is in place.

- Software select single or double density.
- Phase-locked-loop and write precompensation for reliable data recovery and storage.
- On-board phantom bootstrap PROM is disabled after bootstrap operation so all 64K memory address space is available to user.
- DMA in single or double density permits multi-user operation.
- Extended addressing provides 8 extra address bits, permitting direct transfers anywhere in a 16 megabyte address range.
- Select up to 4 drives, single or double-sided.
- New BIOS for CP/M included with interface on single-density diskette.

**Double Density Interface only, assembled & tested. . . . . \$425.**

*CP/M is a registered trademark of Digital Research.*

*Tarbell*  
 Electronics

950 DOVLEN PLACE • SUITE B • CARSON, CALIFORNIA 90746  
 (213) 538-4251 • (213) 538-2254



# When you want to improve your image,

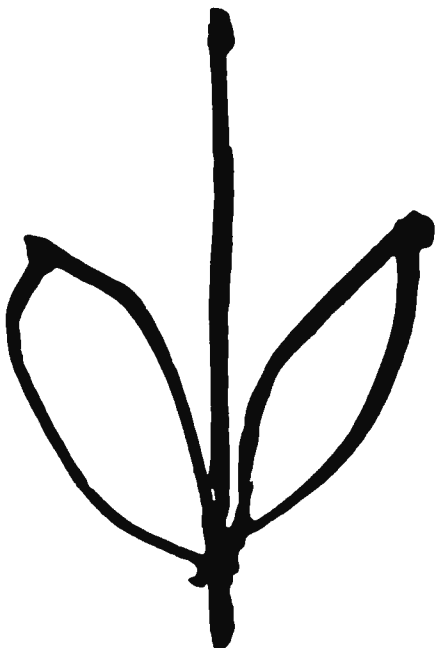
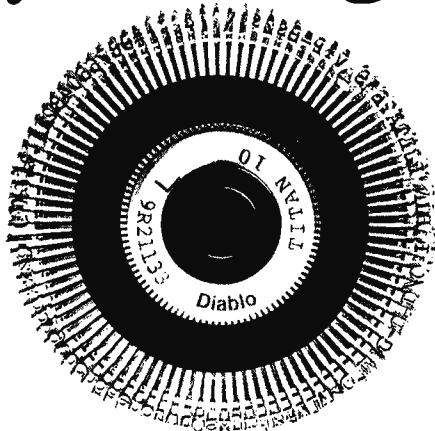

## Pick A Daisy.

Diablo invented the Daisy Wheel. Which is why today, more people pick one of over 100 different Diablo Daisy Wheels when they want print quality at its finest.

So, the next time you want to improve your image, pick our daisy and you're sure to look your best.

### Diablo Systems

### XEROX

Diablo® and Xerox are registered trademarks of XEROX CORPORATION.

Listing 3 continued:

```

LOOP2: JSR LOOKUP ;insert piece (K) by putting the
        LDA K      ;number (K) into the appropriate
        STA A0,X   ;squares of the box
        INC J
        LDA SM1
        CMP J
        BCS LOOP2
        LDX L
        LDA K
        STA A0,X
        TAX
        LDA L
        STA E0,X   ;save base square of piece (K)
        LDA P     ;if all of the pieces are in the box,
        CMP N     ;return to BASIC to print solution
        BNE NXTBASE ;otherwise, find next base square
        RTS
NXTBASE: LDX L    ;scan for next base square
        INCX: INX
        LDA A0,X
        BEQ ISOTEST
        JMP INCX
ISOTEST: STX J    ;put new base square in location J
        LDA D
        CMP #3
        BEQ REPLACE ;if (D)=3, skip isolated square test
        TXA      ;test if new base square is isolated
        CLC
        ADC #1
        TAX
        LDA A0,X
        BEQ REPLACE
        TXA
        CLC
        ADC WY
        TAX
        DEX
        LDA A0,X
        BEQ REPLACE ;if it is not, go to REPLACE
        JMP ISOSQ   ;if it is, go to isolated square routine
REPLACE: LDA J
        STA L      ;set new base square
        INC N      ;increment piece counter
        LDA T      ;(T)=greatest number of pieces
        CMP N      ;successfully fitted into box in
        BCS JSTART ;current permutation
        LDA N
        STA T
JSTART:  JMP START ;return to START
REMOVE:  LDX N     ;remove last piece inserted
        LDA #0
        STA C2,X  ;set orientation number to zero
        DEX      ;decrement piece counter
        STX N
        LDA C1,X
        STA K
        LDA C2,X
        STA I
        LDA Z     ;check if new piece is fixed
        CMP N
        BCC SAVE  ;if no, take it out
        JMP PERMUTE ;if yes, go to next permutation of pieces
SAVE:    LDY K     ;recover base square of the
        LDX E0,Y  ;piece to be taken out
        STX L
        LDA #0
        STA A0,X
        LDY #1
        STY J
LOOP3:   JSR LOOKUP ;take out piece by putting zeroes
        LDA #0    ;in each square it occupies
        STA A0,X
        INC J
        LDA SM1
        CMP J
        BCS LOOP3
        LDX K     ;check if piece has any more orientations
        LDA I
    
```

```

        CMP R0,X
        BCS JUMP1 ;if no, remove a further piece
        JMP START ;if yes, go check them out
JUMP1: JMP REMOVE
ISOSQ: LDY K ;recover base square of piece to be taken
        LDX E0,Y out to cure isolation of new base square
        STX L
        LDA #0
        STA A0,X
        LDA J
        STA SAFE ;store base square in safe place
        LDY #1
        STY J
LOOP4: JSR LOOKUP ;remove last piece inserted
        LDA #0
        STA A0,X
        INC J
        LDA SM1
        CMP J
        BCS LOOP4
        LDA SAFE ;recover base square
        STA J
        CLC ;test if it is still isolated by checking
        ADC #1 if each of the four squares around it is
        TAX filled
        LDA A0,X
        BEQ LEAVE
        DEX
        DEX
        LDA A0,X
        BEQ LEAVE
        TXA
        SEC
        SBC WY
        TAX
        INX
        LDA A0,X
        BEQ LEAVE
        TXA
        CLC
        ADC WY
        ADC WY
        TAX
        LDA A0,X ;if it is not still isolated,
        BEQ LEAVE prepare to return to normal routine
        JMP REPEAT ;if it is, repeat isolated square routine
LEAVE: LDX K ;check if piece (K) has any
        LDA I more orientations
        CMP R0,X
        BCS JUMP2 ;if no, remove previous piece
        JMP START ;if yes, go check them out
JUMP2: JMP REMOVE
REPEAT: LDX N
        LDA #0
        STA C2,X ;set orientation number to zero
        DEX ;decrement piece counter
        STX N
        LDA C1,X ;set new values of (K) and (I)
        STA K
        LDA C2,X
        STA I
        JMP ISOSQ ;repeat isolated square routine
PERMUTE: LDA T ;find new permutation, making sure that
        STA I the repermuation goes at least as far
        CMP P back as the (T)-th piece of the old
        BNE ILOOP permutation
        DEC I
ILOOP: LDA #127 ;the nested I and J loops pick two elements
        STA U of the permutation to be interchanged.
        LDA I These are: the last element of the
        CLC permutation, which has a larger element
        ADC #1 following it, and the smallest element
        STA J following this element which is greater
JLOOP: LDX I than it
        LDY J
        LDA C1,Y
        CMP C1,X
        BCC MAX

```

Listing 3 continued on page 46

# X-RATED

## Revolutionary Computerized Math!

```

Enter: ? SOLVE (X+3 = A+2*X, X):
muMATH Responds:
@ X = -A,
  X = A,
  X = 0
Enter: ? TAN (X) * COS (X) + 1 / CSC (X),
Response:
@ 2 * SIN(X)
Symbolic Integration!
? INT (X * COS(A * X^2), X):
@ SIN(X^2 * A) / (2 * A)
Symbolic Matrix Inversion!
? | 1, X |
@ | 1, X/A |
  | 0, 1/A |
Exact Arithmetic!
? 991 * 94(1/2) / 40 + 35:
@ 296438922463401814427834899493
  2562856695871443300411356128843
  280390406928750451725987785938307
  497936652596433351 / 1250000000000

```

### muMATH™

- These examples illustrate only a few of the many *symbolic* math capabilities of muMATH. Note that it is not limited to *numerical* evaluation as in BASIC or PASCAL.
- Available for 8080, 8085 and Z80 processors using standard CP/M,\* CDOS\*, IMDOS\*, and TRSDOS\* operating systems.
- Engineers and scientists find it ideal for deriving or checking lengthy analytical results.
- Students and teachers agree it is superb for math education from exact arithmetic through calculus.
- Hobbyists have discovered the underlying muSIMP programming system perfect for other artificial intelligence applications.
- Also available from The Software Warehouse is a sophisticated LISP language interpreter for the above processors and operating systems.
- All software with extensive documentation is immediately available.
- Call or write directly for fast response.

\* Manufacturers' registered trademarks.

  
**the**  
**SOFTWARE WAREHOUSE**  
 P.O. Box 11174, Honolulu, Hawaii 96828  
 Telephone (808) 734-5801



# HOW TO MAKE





# YOUR FIRST MILLION

## **New 1.2 megabyte quad-density disk. \$1545.**

Now you can afford to put a million bytes of memory in your S-100 system.

Introducing DISCUS 2+2™ full-size quad-density floppy disk system by Morrow. DISCUS 2+2™ gives you 1.2 megabytes per diskette (600K bytes of double-density data per side). And it's all addressable as easily as main memory with the system's exclusive BASIC-V™ virtual disk BASIC software.

Best of all, DISCUS 2+2™ comes complete, assembled, and ready to run for just \$1545. Included in the system price are an S-100 controller, factory-mounted full-size disk drive, a complete library of pre-interfaced software, even cables and connectors.

But you don't have to get your first million in one big megabyte. Morrow's DISCUS/2D™ single-side double-density floppy disk system gives you 600K per full-size diskette for just \$1149, complete and assembled. And when you want to expand to a full megabyte, just plug in a second drive... both the hardware and software are expandable.

And if economy is a real concern, you can still get started on your million with Morrow's DISCUS I™ 250K single-density disc system. It's delivered complete and assembled for just \$995... and will accept up to 3 more drives.

All three Morrow disk systems meet the Proposed IEEE S-100 standard and are compatible with 2MHz, 4 MHz and 5 MHz S-100 systems. A dual-drive cabinet is available as an option with any density you choose.

Why set your goals low and slow with a mini-floppy system? Get started on your first million with a DISCUS™ full-size system by Morrow. See your local computer shop. Or write Thinker Toys™, 5221 Central, Richmond, California 94804. Or call (415) 524-2101, weekdays 10-5 (Pacific Time).

 Morrow Designs  
**Thinker Toys™**



# A.C. POWER CONTROL for ALL COMPUTERS or COMPLETE TURNKEY SYSTEMS



Interface TO the Real World with GIMIX Relay Driver Boards. Connects to any Computer through a 20 ma. current loop (up to 4 Boards-128 Relays per port).

Interface FROM the Real World with GIMIX

- ★ OPTO BOARDS (up to 34 switch closures with one 8 bit Parallel I/O Port)
- ★ 16 BUTTON KEYPADS
- ★ 35 BUTTON ALPHANUMERIC KEYPADS

**A Broad Range of 6800 Systems and Boards Compatible with the SS50 Bus**

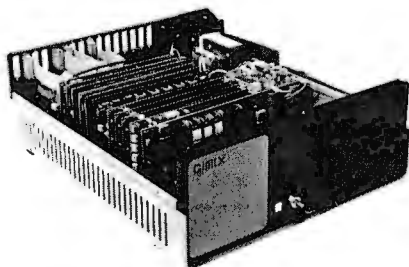

**MAINFRAME:** Includes chassis, power supply, switches, fan and mother board . . . \$ 798.19

**16K SYSTEMS:** Mainframe, plus 6800 CPU, 16K Static Ram and choice of I/O. . . . \$1344.29  
Other packages available.

**16K Static RAM Boards for the SS-50 Bus**

- Gold bus connectors
- 4 separate 4K Blocks
- Individual Addressing, Write Protect, and Enable/Disable for each block



Memories . . .

\$298<sup>13</sup>

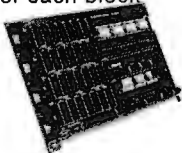

As above with Sockets and Software control features \$368<sup>16</sup>

All GIMIX memory boards are assembled, Burnt-In for 2 weeks, and tested at 2 MHz. Add \$32.00 for 250 ns parts

**TI TMS 4044's — 10% SUPPLY**  
(Not an "equivalent", but the real thing!)

450 ns	\$5.90 each	250 ns	\$6.90 each
8KPROM BOARD	\$ 98.34		
4K PPD PROM BOARD. Burner and Duplicator	198.35		
2708's	each	7.90	
64 or 32 x 16 VIDEO BOARD	198.71		
80 x 24 SUPER VIDEO BOARD with user programmable RAM character generator	458.76		
Serial I/O's	1 Port	\$ 88.41	4 Port 198.43
Parallel I/O's	2 Port	\$ 88.42	8 Port 198.45

Add \$5. handling charge on orders under \$200.

# GIMIX Inc.

1337 WEST 37th PLACE  
CHICAGO, ILLINOIS 60609  
(312) 927-5510 • TWX 910-221-4055

Quality Electronic products since 1975.

Listing 3 continued:

```

LDA U
CMP C1,Y
BCC MAX
STY V
LDA C1,Y
STA U
MAX: INC J
LDA P
CMP J
BCS JLOOP
LDA U
CMP #127
BNE SWITCH
DEC I
LDA Z
CMP I
BCC ILOOP
LDA #0 ;if such elements cannot be found, clear
STA FLAG FLAG and return to BASIC to stop
RTS
SWITCH: INC N ;interchange elements found by
LDA N I and J loops
STA T
LDX I
LDA C1,X
LDY V
STA C1,Y
LDA U
STA C1,X
LDA N
STA J
ZFROC2: LDA #0 ;reinitialize orientation numbers
LDX J
STA C2,X
INC J
LDA P
CMP J
BCS ZEROC2
LDA PM1 ;if repermuation only interchanged last
CMP I two pieces, return to START
BNE ORDER
JMP START
ORDER: LDA I ;otherwise, reorder new permutation
CLC into ascending order
ADC #1
STA J
NEXTJ: LDA J
CLC
ADC #1
STA U
NEXTU: LDX J
LDY U
LDA C1,X
CMP C1,Y
BCC NOSWTC
STA V
LDA C1,Y
STA C1,X
LDA V
STA C1,Y
NOSWTC: INC U
LDA P
CMP U
BCS NEXTU
INC J
LDA PM1
CMP J
BCS NEXTJ
JMP START ;return to START
LSTPCB: LDX K ;BASIC returns control to here after
LDA E0,X printing a sclusion so that the (P)-th
STA L piece can be taken out
LDA #1
STA J
TAKEOUT: JSR LOOKUP
LDA #0
STA A0,X
INC J
    
```

Listing 3 continued on page 48



## Solve your personal energy crisis. Let VisiCalc™ Power do the work.

With a calculator, pencil and paper you can spend hours planning, projecting, writing, estimating, calculating, revising, erasing and recalculating as you work toward a decision.

Or with VisiCalc and your Apple® II you can explore many more options with a fraction of the time and effort you've spent before.

VisiCalc is a new breed of problem-solving software. Unlike prepackaged software that forces you into a computerized straight jacket, VisiCalc adapts itself to any numerical problem you have. You enter numbers, alphabetic titles and formulas on your keyboard. VisiCalc organizes and displays this information on the screen. You don't have to spend your time programming.

Your energy is better spent using the results than getting them.

Say you're a business manager and want to project your annual sales. Using the calculator, pencil and paper method, you'd lay out 12 months across a sheet and fill in lines and columns of figures on products, outlets, salespeople, etc. You'd calculate by hand the subtotals and summary figures. Then you'd start revising, erasing and recalculating. With VisiCalc, you simply fill in the same figures on an electronic "sheet of paper" and let the computer do the work.

Once your first projection is complete, you're ready to use VisiCalc's unique, powerful recalculation feature. It lets you ask "What if?," examining new options and planning for contingencies. "What if" sales drop 20 percent in March? Just type in the sales figure. VisiCalc instantly updates all other figures affected by March sales.

Or say you're an engineer working on a design problem and are wondering "What if that oscillation were damped by another 10 percent?" Or you're working on your family's expenses and wonder "What will happen to our entertainment budget if the heating bill goes up 15 percent this winter?" VisiCalc responds instantly to show you all the consequences of any change.

Once you see VisiCalc in action, you'll think of many more uses for its power. Ask your dealer for a demonstration and discover how VisiCalc can help you in your professional work and personal life.

You might find that VisiCalc alone is reason enough to own a personal computer.

VisiCalc is available now for Apple II computers with versions for other personal computers coming soon. The Apple II version costs just \$99.50 and requires a 32k disk system.

For the name and address of your nearest VisiCalc dealer, call (408) 745-7841 or write to Personal Software, Inc., Dept. B, 592 Weddell Dr., Sunnyvale, CA 94086. If your favorite dealer doesn't already carry Personal Software products, ask him to give us a call.

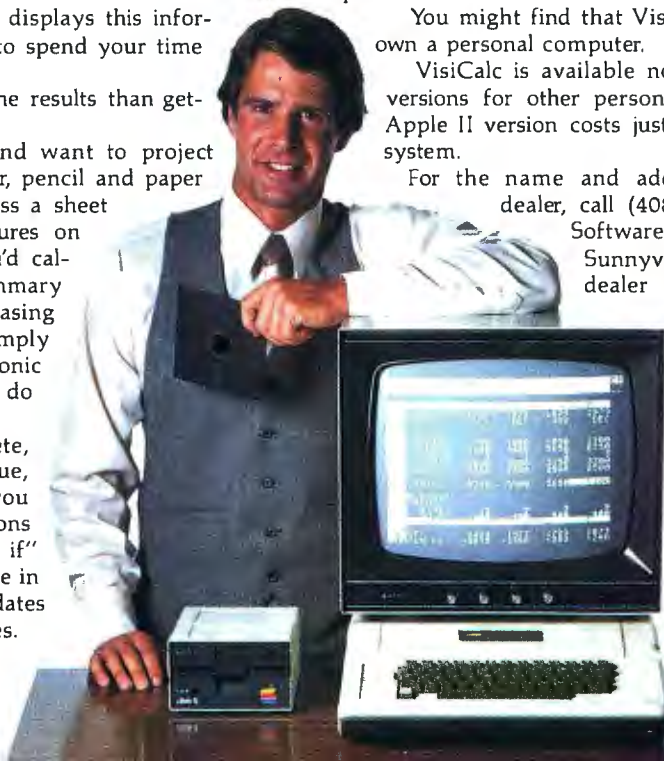

# PERSONAL SOFTWARE

VisiCalc was developed exclusively for Personal Software by Software Arts, Inc., Cambridge, Mass.

TM—VisiCalc is a trademark of Personal Software, Inc.

\*Apple is a registered trademark of Apple Computer, Inc.



Listing 3 continued:

```
LDA SM1
CMP J
BCS TAKEOUT
LDX L
LDA #0
STA AO,X
JMP REMOVE
LOOKUP: LDY J ;put square number in Y register
LDA I ;if (I) and (K) are the same as in the
CMP OLDI ;previous call to LOOKUP, go to MIDDLE,
BNE TOP ;otherwise to TGP
LDA K
CMP OLDK
BNE TOP
JMP MIDDLE
TOP: LDA Q
STA BXLO
LDA #0
STA BXHI
LDX #8
MULT1: ASL BXLO ;one byte multiplication
BCC STEP1 ;routine figures (Q)*(K)
CLC
ADC K
STEP1: DEX
BEQ STORE1
ASL A
JMP MULT1
STORE1: ADC I ;add (I) to it
STA BXLO ;store result in BXLO
LDX SM1
MULT2: DEX ;multiply this by (S)-1 and store the
BEQ STORE2 ;two-byte result in BXLO and BXHI
ADC BXLO
BCC MULT2
INC BXHI
CLC
JMP MULT2
STORE2: ADC INDEXLO ;add the two-byte quantity (INDEX) to (BX)
STA BXLO
LDA BXHI
ADC INDEXHI
STA BXHI
LDA SPACELO ;add the two-byte quantity (SPACE) to (BX)
ADC BXLO ;to get (BY)
STA BYLO
LDA SPACEHI
ADC BXHI
STA BYHI
LDA D ;if (D)≠3, go to MIDDLE
CMP #3
BNE MIDDLE
CLC
LDA SPACELO ;add the two-byte quantity (SPACE) to (BY)
ADC BYLO ;to get (BZ)
STA BZLO
LDA SPACEHI
ADC BYHI
STA BZHI
MIDDLE: LDA (BXLO),Y ;load X coordinate of square
STA TEMP
LDA #0
LDX #8
MULT3: ASL TEMP ;multiply it by (WY)
BCC STEP3
CLC
ADC WY
STEP3: DEX
BEQ ADD
ASL A
JMP MULT3
ADD: CLC
ADC (BYLO),Y ;add Y coordinate of square
STA TEMP ;store result in TEMP
LDX D ;if (D)=3, go to DIM3
CPX #3
BEQ DIM3
CLC
```

Text continued:

case of the Commodore PET, the BASIC driver should be loaded last. Before it is loaded, the page number on which the assembly routine starts should be placed into location 135 decimal, using the POKE statement. This insures that the arrays defined by BASIC will not interfere with the assembly routine or the table.

Before running, the user should check lines 3 and 21 of the BASIC driver routine, to determine whether or not they are correct for the problem under consideration. When run, the driver routine asks the user for input with prompts that are fairly self-explanatory. However, a few specific hints may be helpful.

Although the program will work no matter how the box is oriented, it will run fastest if the dimensions WX, WY, and WZ are chosen to be in descending order (ie: WX>WY>WZ), due to the mechanics of the search procedure. Failure to do this may lengthen the running time by a factor of ten or more.

When entering the off-limits squares, and also the coordinates of any fixed squares, the coordinates are defined for polyominoes so that the lower left-hand corner of the box (excluding boundary) has the coordinates (1,1); and for Soma Cubes the corner with the lowest coordinate values has coordinates (1,1,1).

In entering the initial permutation of pieces, the order in which the machine goes through the permutations should be kept in mind. Thus, entering the piece numbers in ascending order: 1,2,3,...,P will result in an exhaustive search, whereas any other initial permutation will cause only a subset of the complete set of permutations to be considered.

Any pieces which are to be specified as fixed should be put at the beginning of the initial permutation. For example, to find all of the solutions with pieces 2 and 4 fixed in particular locations, the initial permutation array should have 2 and 4 at the beginning, and the rest of the numbers in ascending order, (ie: 2, 4, 1, 3, 5, 6, 7, . . . , P). The number of fixed pieces should then be entered as two, after which the computer will ask for the coordinates of each square of pieces 2 and 4.

The program does not check to see if the coordinates entered by the user for a fixed piece correspond to a legal

Listing 3 continued on page 50

**PET / TRS-80 / APPLE: Personal Software brings you the finest!**

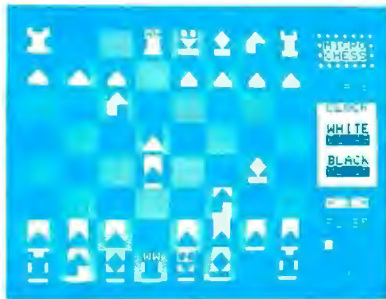

**MICRO  
CHESS**  
The Industry's First  
Gold Cassette  
Over 50,000 Sold

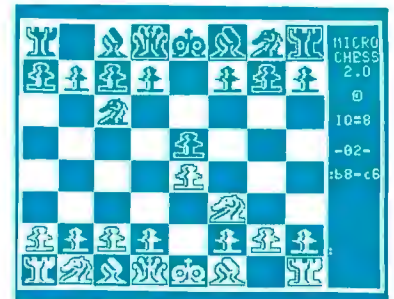

**MICROCHESS** is the industry's best selling computer game. And no wonder—because MICROCHESS gives you more than just a chessplaying program: A convenient, foolproof set of commands and error checks ... complete instructions in a 5½" by 8½" booklet ... a cassette that's guaranteed to load, with disk versions coming soon ... and several levels of difficulty to challenge you not just once, but time after time. It's available through well over three hundred computer stores and many mail order sources ... always

originating from Personal Software. What's more, every Personal Software product is selected to give you these same benefits of easy availability, reliable cassettes, readable documentation, a carefully thought out user interface ... and most important, continuing challenge and enjoyment, not just once but time after time. If you haven't already, order your own gold cassette: MICROCHESS, by Peter Jennings, for 8K PETs, 16K APPLES, and 4K Level I and II TRS-80s ..... **\$19.95**



**TIME  
TREK**  
A Tour De Force  
In Real Time  
Strategy Games



**TIME TREK** by Brad Templeton for 8K PETs and Joshua Lavinsky for 4K Level I and II TRS-80s adds a dramatic new dimension to the classic Star Trek type strategy game: REAL TIME ACTION! You'll need fast reflexes as well as sharp wits to win in this constantly changing game. Be prepared—the Klingons will fire at you as you move, and will move themselves at the same time, even from quadrant to quadrant—but with practice you can change course and speed, aim and fire in one smooth motion, as fast as you can press the keys. Steer under power around obstacles—evade enemy

shots as they come towards you—lower your shields just long enough to fire your phasers, betting that you can get them back up in time! With nine levels of difficulty, this challenging game is easy to learn, yet takes most users months of play to master. ADD SOUND EFFECTS with a simple two-wire hookup to any audio amplifier; the TRS-80 also produces sound effects directly through the keyboard case, to accompany spectacular graphics explosions! You won't want to miss this memorable version of a favorite computer game ..... **\$14.95**

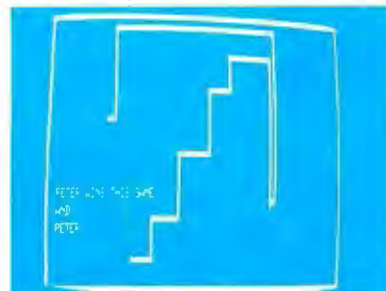

**BLOCKADE** by Ken Anderson for 4K Level I and II TRS-80s is a real time action game for two players, with high speed graphics in machine language. Each player uses four keys to control the direction of a moving wall. Try to force your opponent into a collision without running into a wall yourself! A strategy game at lower speeds, BLOCKADE turns into a tense game of reflexes and coordination at faster rates. Play on a flat or spherical course at any of ten different speeds. You can hear SOUND EFFECTS through a nearby AM radio—expect some razzing if you lose! ..... **14.95**

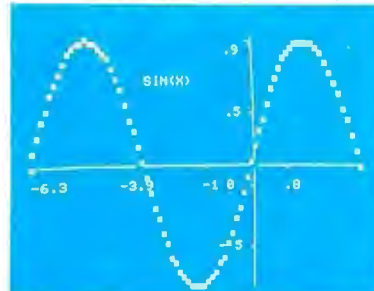

**GRAPHICS PACKAGE** by Dan Fylstra for 8K PETs includes programs for the most common 'practical' graphics applications: PLOTTER graphs both functions and data to a resolution of 80 by 50 points, with automatic scaling and labeling of the axes; BARPLOT produces horizontal and vertical, segmented and labeled bar graphs; LETTER displays messages in large block letters, using any alphanumeric or special character on the PET keyboard; and DOODLER can be used to create arbitrary screen patterns and save them on cassette or in a BASIC program ..... **\$14.95**

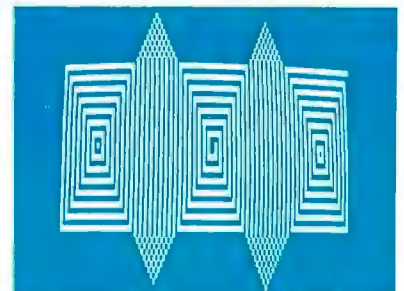

**ELECTRIC PAINTBRUSH** by Ken Anderson for 4K Level I and II TRS-80s: Create dazzling real time graphics displays at speeds far beyond BASIC, by writing 'programs' consisting of simple graphics commands for a machine language interpreter. Commands let you draw lines, turn corners, change white to black, repeat previous steps, or call other programs. The ELECTRIC PAINTBRUSH manual shows you how to create a variety of fascinating artistic patterns including the one pictured. Show your friends some special effects they've never seen on a TV screen! ..... **\$14.95**

**WHERE TO GET IT:** Look for the Personal Software™ display rack at your local computer store. For the name and address of the dealer nearest you, call Personal Software at (408) 745-7841. If you don't have a dealer nearby, you can call or mail us your order with your check, money order or VISA/Master Charge card number. For a free catalog, ask your dealer or use the reader service card at the back of this magazine.

**PERSONAL SOFTWARE INC.**

592 WEDDELL DR. • SUNNYVALE, CA 94086



Listing 3 continued:

```

ADC L           ;otherwise, add base square index
TAX            ;transfer result to X register
LDA K          ;store old (K) and (I) values
STA OLDK
LDA I
STA OLDI
RTS            ;return to main routine

DIM3: LDA #0
LDX #8

MULT4: ASL TEMP ;multiply (TEMP) by (#Z)
BCC STEP4
CLC
ADC WZ

STEP4: DEX
BEQ END
ASL A
JMP MULT4

END: ADC L           ;add base square index
ADC (BZLO),Y   ;add Z coordinate of square
TAX            ;transfer result to X register
LDA K          ;store old (K) and (I) values
STA OLDK
LDA I
STA OLDI
RTS            ;return to main routine
    
```

routine depends so little on the dimensionality of the pieces under consideration, the user could extend it to consider analogous problems in four or more spatial dimensions. Hard as these might be to visualize, the computations involved are not fundamentally different from those encountered in two and three-dimensional problems.

Another possibility is to assign colors to the various pieces and look for interesting properties of the resulting solutions. For example, the plastic Pentomino puzzle which provided the inspiration for this article had the following piece colors:

- X,P,Y : Red
- I,T : Yellow
- V,U,S, : Blue
- W,R,Z,L : Green

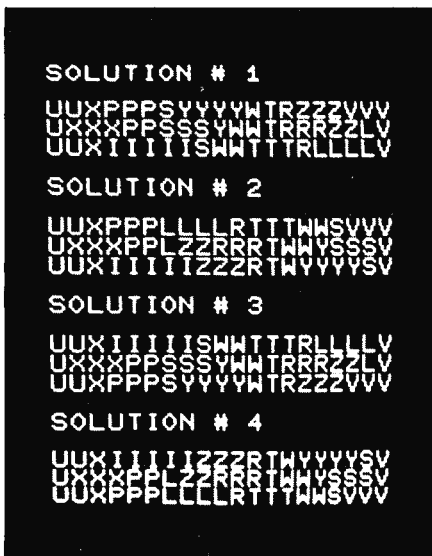

Photo 3: All of the solutions for Pentominoes in a 20 by 3 box. Solutions three and four are mirror images of solutions one and two, so there are only two fundamentally different solutions.

orientation of that piece, so care should be taken to insure that all of these numbers are entered correctly.

To stop the program in mid-run, the S key may be pressed at any time. This will cause execution to stop on the next return to the BASIC printout routine.

Photo 3 is a typical output of the Soma Cube — Polyominoes problem solver. The solutions are for Pentominoes in a 20 by 3 box.

### Conclusion

As general as this program is, it by no means exhausts the possibilities inherent in problems such as these.

In addition to squares, it is possible to tile the plane with other figures such as triangles and hexagons. It should not be hard to modify the program to consider figures made out of these shapes. At a more abstract level, since the assembly language

There is one and *only* one 10 by 6 solution using this set which is a true four-coloring (ie: a solution in which no two pieces of the same color touch each other). Can you find it?

These are only suggestions. The capabilities of the program and the uses to which it can be put depend ultimately on the interests and ingenuity of the user.

### BIBLIOGRAPHY

1. Golomb, Solomon W, *Polyominoes*, Charles Scribner's Sons, New York 1965.
2. Gardner, Martin, *The Scientific American Book of Puzzles and Diversions*, Simon and Schuster, New York, 1959.
3. Philpott, Wade E, *Polyomino and Polyiamond Problems*, Journal of Recreational Mathematics, 10:1, pages 2 thru 14 and 10:2, pages 98 thru 105, Baywood Publishing Company Inc, 1977-78.
4. *Introducing Soma*, Parker Brothers Inc, Salem MA, 1969.

CmC

# PET ANALOG INPUT

Analog to Digital Conversion System for the Commodore PET Computer

DAM SYSTEMS

Give the PET the ability to sense, measure, and control the world around it, with DAM SYSTEMS modules. Just plug the PETSET1 into the PET to set 16 channels of analog input. Screw terminals are provided for each channel so you can hook up joysticks, pots, or whatever appropriate sensors you have. Each of the 16 analog inputs, in the range of 0 to 5.12 volts, is converted to a decimal number between 0 and 255 (20 millivolts per count). Conversion time is 100 microseconds. In addition, the PETMOD provides two IEEE ports and one user port as well as a DAM SYSTEMS port. Software is provided. A one line program is all that is necessary to read a channel.

**PETSET1**

- 1- AIM161 - 16 ANALOG INPUTS-8 BITS-100 MICROSEC
- 1- PETMOD - PET ADAPTER-2 IEEE PORTS-1 USER PORT-1 DAM SYSTEMS PORT
- 1- CABLE A24 - 24 INCH INTERCONNECT CABLE
- 1- MANMOD1 - MANIFOLD MODULE-SCREW TERMINALS FOR INPUTS, REFERENCE, GROUND
- 1- POW1 - POWER MODULE

PETSET1a for 110 VAC \$295  
 PETSET1e for 230 VAC \$305  
 Order direct or contact your local computer store.

**CONNECTICUT microCOMPUTER, Inc.**  
 150 POCONO ROAD  
 BROOKFIELD, CONNECTICUT 06804  
 TEL: (203) 775-9659 TWX: 710-456-0052

VISA AND M/C ACCEPTED - SEND ACCOUNT NUMBER, EXPIRATION DATE AND SIGN ORDER. ADD \$3 PER ORDER FOR SHIPPING & HANDLING - FOREIGN ORDERS ADD 10% FOR AIR POSTAGE.



MODEL 800 • WITH SUNFLOWERS

# A NEW MASTERPIECE IN PRINTERS

Sometimes the true value of a product fails to relate to its selling price. Van Gogh's paintings once sold for less than \$1,000. Base 2's MODEL 800 printer sells for lots less than \$1,000, but it does more than printers costing twice its price (and a lot more than a Van Gogh painting).

Besides being beautiful to look at, the MODEL 800 prints up to six different character fonts with embedded elongation in any of five line densities (72, 80, 96, 120 and 132 characters per line), prints up to three copies and is equipped with a long-life cartridge ribbon. With such versatility as four interface modes (IEEE 488, industry standard parallel, 20ma current loop and RS232), baud rates up to 19,200, and with accommodations for 115VAC or 230VAC operation, the MODEL 800 matches any system decor.

As a note of further new world refinement, the MODEL 800 can be optionally equipped with high speed paper advance and graphics output, a versatile tractor feed mechanism, terminal buffer memory, tabs and form feed.

Requiring only a square foot of space, the MODEL 800 is smaller than its contemporaries; its rugged aluminum construction is designed to stand the test of time.

Isn't it time you added a new masterpiece to your collection?

Recommended retail price:

Standard MODEL 800	\$499
High speed paper advance	50
Tractor mechanism	50
Terminal buffer memory	50

**base 2 inc.** P.O. BOX 3548 FULL., CAL. 92634 / (714) 992-4344



Listing 4: Hexadecimal object code dump for the Soma Cube — Polyominoes program given in listing 3.

HEX DUMP OF

\*\*\*\*\*  
 \* SOMA/POLYOMINO SOLVER \*  
 \*\*\*\*\*

COPYRIGHT 1979 MACDONALD & GÜRSEL

PRINTOUT BY C. A. MCCARTHY'S

\*\*\*\*\*  
 \* CHEEP PRINT \*  
 \*\*\*\*\*

```

.: 1400 A6 00 FE 4C 18 BD 4C 18
.: 1408 85 01 B0 38 18 85 02 A0
.: 1410 01 84 0A 20 BC 16 BD 9C
.: 1418 18 D0 0D E6 0A A5 1A C5
.: 1420 0A B0 F0 4C 37 14 EA EA
.: 1428 A6 02 A5 01 D0 B4 19 90
.: 1430 CF 4C CD 14 EA EA EA A0
.: 1438 01 84 0A 20 BC 16 A5 02
.: 1440 9D 9C 18 E6 0A A5 1A C5
.: 1448 0A B0 F0 A6 0B EA EA EA
.: 1450 EA EA EA A5 02 9D 9C 18
.: 1458 A6 02 A5 0B 9D 60 18 EA

```

```

.: 1460 EA EA EA EA A5 1B C5 00
.: 1468 D0 03 60 EA EA A6 0B E8
.: 1470 BD 9C 18 F0 17 4C 6F 14
.: 1478 EA EA EA EA EA EA EA EA
.: 1480 EA EA EA EA EA EA EA EA
.: 1488 EA EA EA EA 86 0A A5 1F
.: 1490 C9 03 F0 20 8A EA EA EA
.: 1498 EA EA EA 18 69 01 AA BD
.: 14A0 9C 18 F0 10 EA EA 8A 18
.: 14A8 65 10 AA CA BD 9C 18 F0
.: 14B0 03 4C 27 15 A5 0A 85 0B
.: 14B8 EA EA EA EA E6 00 A5 0E
.: 14C0 C5 00 B0 04 A5 00 85 0E
.: 14C8 4C 00 14 EA EA A6 00 A9
.: 14D0 00 9D 4C 18 CA 86 00 BD
.: 14D8 38 18 85 02 BD 4C 18 85
.: 14E0 01 A5 0F EA EA EA C5 00
.: 14E8 90 03 4C C2 15 A4 02 EA
.: 14F0 EA EA EA EA BE 60 18 86
.: 14F8 0B EA EA EA EA EA EA A9
.: 1500 00 9D 9C 18 A0 01 84 0A
.: 1508 20 BC 16 A9 00 9D 9C 18
.: 1510 E6 0A A5 1A C5 0A B0 F0
.: 1518 A6 02 A5 01 D0 B4 19 B0
.: 1520 03 4C 00 14 4C CD 14 A4
.: 1528 02 EA EA EA EA EA BE 60
.: 1530 18 86 0B EA EA EA EA EA
.: 1538 EA A9 00 9D 9C 18 EA A5
.: 1540 0A 85 10 A0 01 84 0A 20
.: 1548 BC 16 A9 00 9D 9C 18 E6
.: 1550 0A A5 1A C5 0A B0 F0 A5

```

```

.: 1558 10 85 0A EA EA EA EA EA
.: 1560 18 69 01 EA EA AA BD 9C
.: 1568 18 F0 31 CA CA EA EA EA
.: 1570 EA EA EA EA EA EA EA EA
.: 1578 EA EA EA EA EA BD 9C 18
.: 1580 F0 1A 8A 38 E5 1D AA E8
.: 1588 BD 9C 18 F0 0F 8A 18 65
.: 1590 1D 65 1D AA BD 9C 18 F0
.: 1598 03 4C AB 15 A6 02 A5 01
.: 15A0 DD B4 19 B0 03 4C 00 14
.: 15A8 4C CD 14 A6 00 A9 00 9D
.: 15B0 4C 18 CA 86 00 BD 38 18
.: 15B8 85 02 BD 4C 18 85 01 4C
.: 15C0 27 15 A5 0E 85 01 C5 1B
.: 15C8 D0 02 C6 01 A9 7F 85 0D
.: 15D0 A5 01 18 69 01 85 0A A6
.: 15D8 01 A4 0A B9 38 18 DD 38
.: 15E0 18 90 11 A5 0D D9 38 18
.: 15E8 90 0A 84 11 B9 38 18 85
.: 15F0 0D EA EA EA E6 0A A5 1B
.: 15F8 C5 0A B0 DB A5 0D C9 7F
.: 1600 D0 10 C6 01 A5 0F EA EA
.: 1608 EA C5 01 D0 BF A9 00 85
.: 1610 12 60 E6 00 A5 00 85 0E
.: 1618 A6 01 BD 38 18 A4 11 99
.: 1620 38 18 A5 0D 9D 38 18 A5
.: 1628 00 85 0A A9 00 A6 0A 9D
.: 1630 4C 18 E6 0A A5 1B C5 0A
.: 1638 B0 F1 A5 20 C5 01 D0 03
.: 1640 4C 00 14 A5 01 18 69 01
.: 1648 85 0A A5 0A 18 69 01 85
.: 1650 0D A6 0A A4 0D BD 38 18
.: 1658 D9 38 18 90 0F 85 11 B9
.: 1660 38 18 9D 38 18 A5 11 99
.: 1668 38 18 EA EA E6 0D A5 1B
.: 1670 C5 0D B0 DD E6 0A A5 20
.: 1678 C5 0A B0 CE 4C 00 14 A6
.: 1680 02 BD 60 18 85 0B EA EA
.: 1688 EA EA EA A9 01 85 0A 20
.: 1690 BC 16 A9 00 9D 9C 18 E6
.: 1698 0A A5 1A C5 0A B0 F0 A6
.: 16A0 0B EA EA EA EA EA EA A9
.: 16A8 00 9D 9C 18 4C CD 14 EA
.: 16B0 EA EA EA EA EA EA EA EA
.: 16B8 EA EA EA EA A4 0A A5 01
.: 16C0 C5 23 D0 09 A5 02 C5 22
.: 16C8 D0 03 4C 21 17 A5 21 85
.: 16D0 13 A9 00 85 14 A2 08 06
.: 16D8 13 90 03 18 65 02 CA F0
.: 16E0 04 0A 4C D7 16 65 01 85
.: 16E8 13 A6 1A CA F0 0A 65 13
.: 16F0 90 F9 E6 14 18 4C EB 16
.: 16F8 65 26 85 13 A5 14 65 27
.: 1700 85 14 A5 24 65 13 85 15
.: 1708 A5 25 65 14 85 16 A5 1F
.: 1710 C9 03 D0 0D 18 A5 24 65
.: 1718 15 85 17 A5 25 65 16 85
.: 1720 18 B1 13 85 28 A9 00 A2
.: 1728 08 06 28 90 03 18 65 1D
.: 1730 CA F0 04 0A 4C 29 17 18
.: 1738 71 15 85 28 A6 1F E0 03
.: 1740 F0 0D 18 65 0B AA A5 02
.: 1748 85 22 A5 01 85 23 60 A9
.: 1750 00 A2 08 06 28 90 03 18
.: 1758 65 1E CA F0 04 0A 4C 53
.: 1760 17 65 0B 71 17 AA A5 02
.: 1768 85 22 A5 01 85 23 60 20

```

ANOTHER FIRST FROM MOUNTAIN HARDWARE.

# SUPERTALKER.

## FOR YOUR APPLE

SuperTalker is a peripheral system which permits the output of exceptionally high quality human speech through a loudspeaker under program control. Initially, words, sentences or phrases are digitized into RAM memory through a microphone. Speech data in RAM may be then manipulated like any other data. The system consists of a peripheral card, microphone, loudspeaker, and operating software. \$279 assembled and tested.



Available through Apple dealers worldwide.



## Mountain Hardware, Inc.

LEADERSHIP IN COMPUTER PERIPHERALS

300 Harvey West Blvd.

Santa Cruz, CA 95060 (408) 429-8600

# Step up to your next computer.



## STEP UP TO A C4P FROM OHIO SCIENTIFIC

You know about computers. In fact, you probably own one now. One that you might be thinking of expanding. We have a better idea. Take a giant step into the personal computing future with an amazing, new C4P from Ohio Scientific.

## SPEED SEPARATES THE COMPUTERS FROM THE TOYS

The C4P MF has execution speed that is twice as fast as Apple II or Commodore PET and over THREE times as fast as TRS-80. They are many times faster than the recently introduced flock of video game type computers. And, as if that weren't fast enough, the C4P nearly doubles its speed when equipped with the GT option.

Just look at the back panel of the C4P MF.



All the I/O you'll ever need!

## SOUND

- 1—Programmable tone generator 200 — 20KHz
- 1—8 bit companding digital to analog converter for music and voice output.

## HUMAN INPUT EXPANSION

- 2—8 axis joystick interfaces
- 2—10 key pad interfaces

## HOME INTERFACE

- 1—AC-12 AC remote control interface

## DISPLAY

- 32 x 64 with upper and lower case 2048 Characters.
- 256 x 512 effective Graphic Points
- 16 Colors

## SOFTWARE

Ohio Scientific offers a comprehensive library of both systems and applications software for the C4P.

The C4P is an outstanding premium computer — years ahead of the market. We know because there's nothing quite like it for the price, anywhere. And probably won't be for a very long time.

## C4P \$698

8K BASIC-in-ROM, 8K of static RAM and audio cassette interface. Can be directly expanded to 32K static RAM and two mini-floppy disks.

## C4P MF \$1695

All the features of the C4P plus real time clock, home security system interface, modem interface, printer interface, 16 parallel lines and an accessory BUS. The C4P MF starts with 24K RAM and a single mini-floppy and can be directly expanded to 48K and two mini-floppies. Over 45 diskettes now available including games, personal, business, educational and home control applications programs as well as a real time operating system, word processor and a data base management system.

Computers come with keyboards and floppies where specified. Other equipment shown is optional.

# OHIO SCIENTIFIC

1333 S. Chillicothe Road  
Aurora, Ohio 44202  
(216) 562-3101



# HERE'S THE OHIO SCIEN

The simple fact is nobody — nobody in the personal computer industry — offers more software than Ohio Scientific! Right now, as you read this, Ohio Scientific has just about 2 million bytes of software available for our C4P MF computer.

This software is also available for Ohio Scientific C8P DF. Most is available for the C1P MF and cassette-based Ohio Scientific computers. Consult full line price list for cassette software.

Software includes educational programs, personal programs, business programs, utility programs, game programs and operating systems. Each month Ohio Scientific is developing additional programs for your use and enjoyment.

Each diskette has 6 to 10 programs. Highlights of each are listed below.

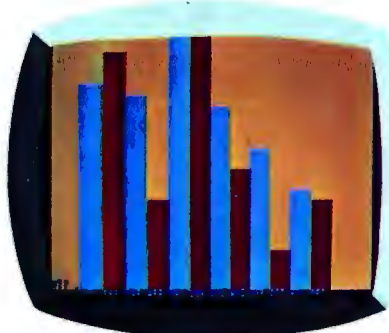

## Business Programs

- BD1 Ratio analysis, bonds, loan interest, bar graph and more. \$ 29
- BD2 BASIC word processor, mailing list, address book, advertisement demo and more. \$ 29
- \*BD3 Comprehensive annual histogram plotting & editing (color and B&W). Ohio Scientific's mini data base management systems. Master file create, edit, dump, report writer and much more. \$ 49
- MDMS—AUX. 1 Repack, keyfile, sort, report writer, record access and more. \$ 29
- MDMS—A/P Update anytime, print journals, age analysis, vendor list and more. \$ 29
- MDMS—A/R Update anytime, print journals, age analysis, customer list and more. \$ 29
- MDMS—INVENTORY Updates, editing, item search, summary report and more. \$ 29
- MDMS—PAYROLL Complete employee records including earnings and all tax deductions. \$ 29
- MDMS—MAILING LIST Enter, delete and print out. \$ 29
- MDMS—CHECKING, SAVINGS ACCOUNTS Precise disk-based account records for your finances. \$ 29
- MDMS—PERSONAL CALENDAR/ADDRESS-PHONE BOOK. Daily appointments, addresses and phone numbers at your fingertips. \$ 29
- \*OS-WP2 full word processing on a mini-floppy. \$200

- GD5 Baseball, Golf, Bowling, Hockey. \$ 29
- GD6 Poker, Blackjack, Spades, Hearts, Slot Machine. \$ 29
- \*GD7 (Joystick systems only) Joystick Sketch, Tiger Tank, Roadrace, Space Attack, Blockade. \$ 29
- \*GD8 (Joystick systems only) Zulu 9, High Noon, Star Wars, Bomber, Surround. \$ 29
- GD9 Othello, Concentration, Flip-Flop, Illusion and more. \$ 29
- \*GD10 (2 disk set) Cartoons, Fairy Tales and animations, including Hero, Three Little Pigs, Humpty Dumpty and many more. \$ 29

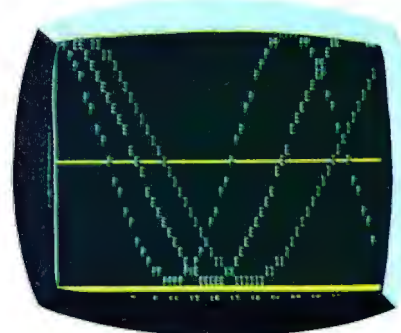

## Personal Programs

- PD1 Annuities, rate of return, biorhythm, calorie counter, checking and savings. \$ 29
- PD2 Trend line, base conversions, powers, integrals and more. \$ 29

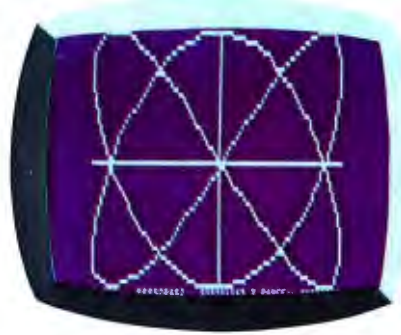

## Utility Programs

- 65D Aux. 1 Resequence, BASIC disassembler, memory test, sort and more. \$ 29
- \*Graphics 1 Fast, high resolution (64 x 128) plotting of functions and parametric equations, plus easy keyboard set up and storage of graphics displays. \$ 29
- \*DAC 1 (2 disk set) State-of-the-Art DAC music generation, capable of producing up to 4 note chords, with disk storage option. \$ 39
- \*Home Control II Advanced home control programs. \$ 39

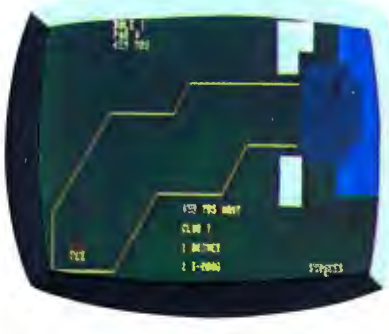

## Game Programs

- GD1 Starwars, Hectic, Bomber, Torpedo, Space War and Breakout. \$ 29
- GD2 Sketch, Racer, Destroyer, Lander, Hide 'n Seek, Bomber, Tiger Tank. \$ 29
- GD3 Star Trek, Cryptograms, Blackjack, Hangman, 23 Matches. \$ 29
- GD4 Frustration, Battleship, Tic-Tac-Toe, Civil War, Mastermind. \$ 29

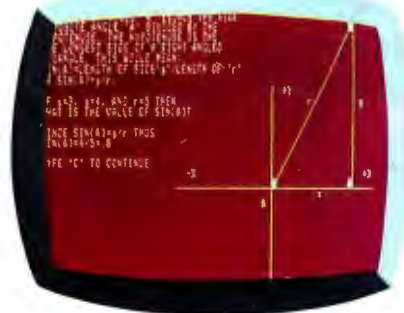

## Educational Programs

- ED1 Math, spelling and geography tutors; Hangman, an addition game and more. \$ 29
- ED2 Six "How To" lessons on beginning BASIC techniques. \$ 29
- ED3 Trig tutor, presidents, continents and solar system quizzes, math drills and more. \$ 29
- ED4 Comprehensive math disk covering trig functions, logarithmic functions, matrices and more. \$ 29
- ED5 Covers the metric system (tutor, quiz and conversions) Roman numerals and time telling. \$ 29
- ED6 Advanced sciences (2-disk set) including nuclear and organic chemistry, genetics, physics equations and function graphics. \$ 29
- \*ED7 Alphabet tutor and quiz, number tutor, memory match and recall game (color & B/W). \$ 29
- ED8 Language disk, covering vocabulary and verbs for German, French and Spanish. \$ 29
- ED9 Word search game and Hangman drawing, with large on-line data bases, and more. \$ 29
- MDMS—EDUCATION SYSTEM. Easily create your own quizzes and tutorials with built-in grading. \$ 29

\* Not available for C1P MF.



# TIFIC SOFTWARE STORY

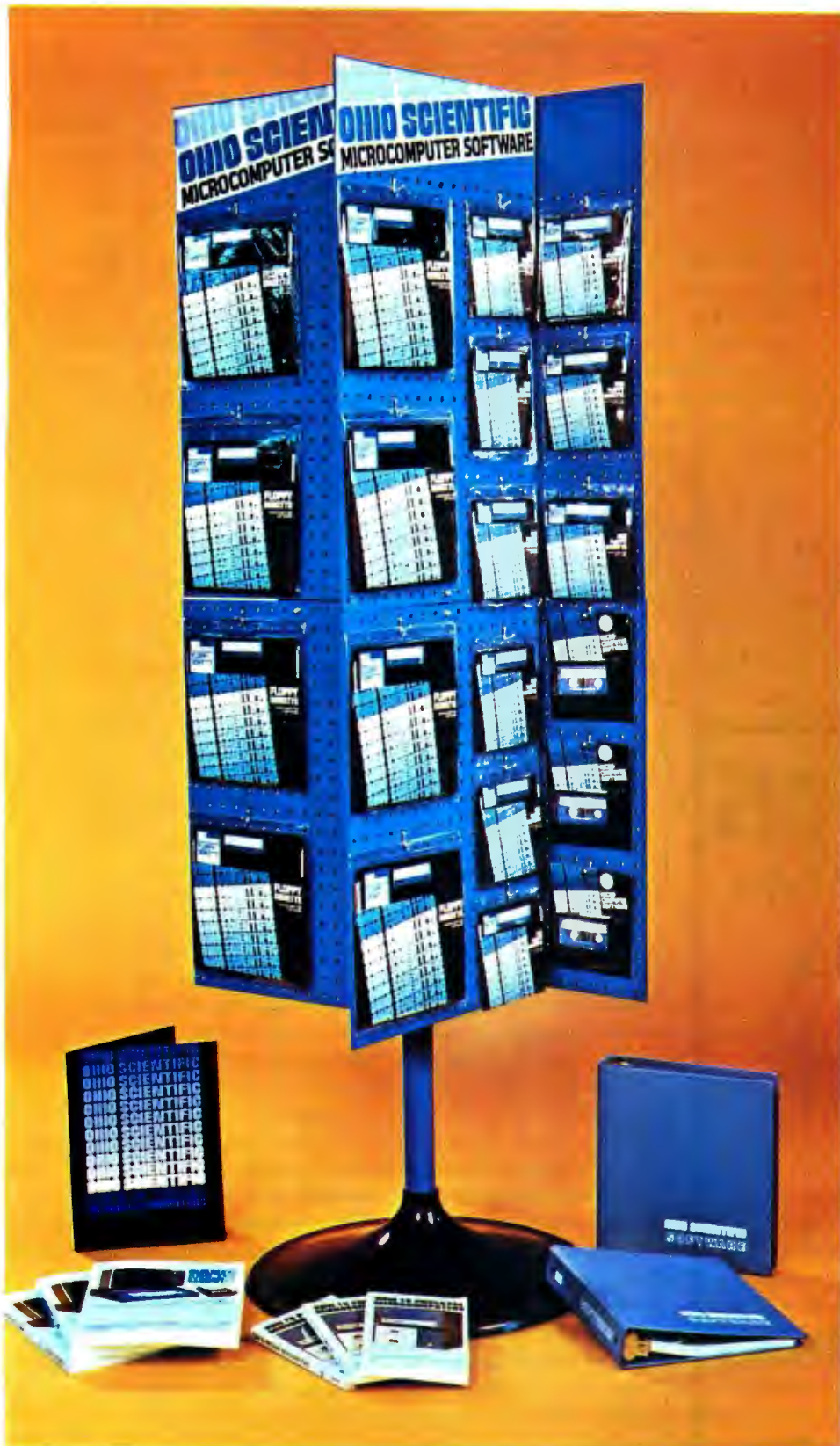

**Close to 2 million bytes of software available!**

Circle 300 on inquiry card.



## Operating Systems

(These programs come with your Ohio Scientific computer.)

- OS65D V3.1 The standard Ohio Scientific mini-floppy operating system. 9 digit floating decimal point, Microsoft BASIC, random, sequential files and graphics.
- \*Home Control I This new disk-based operating system affords the user flexible, real-time based AC monitoring and control.

## Standard

- \*Customer Demo. Self-starting demo for the first-time user. Introduces the main categories of Ohio Scientific personal computer software.
- \*Dealer Demo. More advanced demo, highlighting many of the optional accessories.

\*Not available for C1P MF.

**to be continued,  
continuously!**

All of Ohio Scientific's family of personal computers offer the fastest BASIC-in-ROM — or on Disk in the microcomputer industry. When ordering, be sure to specify series. Many additional educational, business and personal programs and games are available. Consult your Ohio Scientific Dealer.

## OHIO SCIENTIFIC

1333 S. Chillicothe Road  
Aurora, Ohio 44202  
(216) 562-3101



# Programming Quickies

## BASIC Game: GOBANG

John Allwork, 21 Brook Rd, Heaton Chapel,  
Stockport, ENGLAND

GOBANG is, as far as I can tell, a traditional game of the Orient. It is a large game of tic-tac-toe (noughts and crosses), played on a 19 by 19 inch board. The object of the game is to get 5 adjacent markers in a row horizontally, vertically or diagonally.

The program in listing 1 is written in BASIC; the only deviation from standard BASIC being that of the IF...THEN IF... rather than the less flexible IF...GOTO. The BASIC I used is a version of the MicroBASIC supplied by SwTPC, and the program was run on an EXOR-ciser system. The program and BASIC interpreter fit into 8 K bytes of memory, if the remark statements are omitted. Alternatively, the size of arrays T and M can be reduced, but reducing them too much inhibits the game. A 9 by 9 board appears to be the smallest size possible for a reasonable game. (Listing 2 shows a sample output of the 19 by 19 board.)

# MICROTEK OUTPERFORMS CENTRONICS

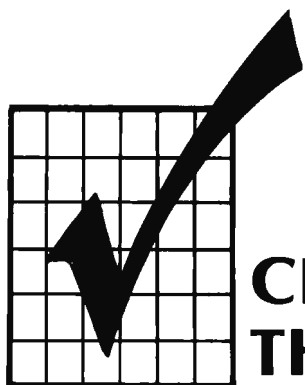

## CHECK THE CHART

# SEE PAGE 71

Listing 1: BASIC listing of the GOBANG game.

```

0001 REM GOBANG
0002 REM M IS ARRAY HOLDING BEST MOVE
0003 REM T IS BOARD, S IS PRIORITY OF THAT POSITION
0004 DIM M[19,19],T[27,27],S[81]
0005 REM SET UP PRIORITIES—SEE TABLE 1
0006 FOR I= 1 TO 81
0010 LET S[I]= 0
0015 NEXT I
0019 LET S[20]= 1
0020 LET S[10]= 40
0021 LET S[12]= 30
0022 LET S[13]= 47
0023 LET S[27]= 15
0024 LET S[28]= 20
0025 LET S[29]= 10
0026 LET S[30]= 40
0027 LET S[31]= 50
0028 LET S[32]= 30
0029 LET S[24]= 1
0030 LET S[36]= 39
0031 LET S[37]= 65
0032 LET S[38]= 40
0033 LET S[39]= 70
0034 LET S[40]= 100
0035 LET S[41]= 60
0036 LET S[42]= 30
0037 LET S[43]= 30
0038 LET S[44]= 30
0040 LET S[62]= 41
0041 LET S[72]= 31
0042 LET S[73]= 11
0043 LET S[74]= 41
0044 LET S[78]= 51
0045 LET S[80]= 90
0046 LET S[26]= 21
0047 LET S[79]= 40
0048 LET S[60]= 21
0049 LET S[61]= 11
0050 REM CLEAR BOARD AND BEST MOVE ARRAYS
0051 FOR I= 1 TO 27
0055 FOR J= 1 TO 27
0060 IF I < 19 THEN IF J < 19 THEN LET M[I, J]= 0
0065 REM MAKE FIRST MOVE
0070 NEXT J
0075 NEXT I
0076 LET C= - 1
0085 LET W= 14
0086 LET N= 14
0087 LET O= 14
0090 LET X= 14
0091 GOTO 0300
0095 GOSUB 0800
0096 REM REQUEST MOVE AND CHECK FOR VALIDITY
0097 INPUT Z,Y
0099 LET Y= Y+ 4
0100 LET Z= Z+ 4
0101 IF Y > 23 THEN GOTO 0097
0102 IF Z > 23 THEN GOTO 0097
0103 IF Y < 5 THEN GOTO 0097
0104 IF Z < 5 THEN GOTO 0097
0106 IF T[Y,Z] > 0 THEN GOTO 0097
0110 LET T[Y,Z]= 2
0115 LET I= Y
0120 LET J= Z
0125 REM STUDY LAST TWO MOVES
0127 GOSUB 1000
0128 IF C < > - 1 THEN GOTO 0310
0129 REM IF C= 0 COMPUTER HAS LOST
0130 LET I= W
0131 LET J= X
0141 GOSUB 1000
0145 REM SCAN BOARD FOR BEST MOVE
0150 REM NOTE LIMITS TO SPEED UP PROGRAM
0160 LET Q= - 1
0161 FOR I= N- 1 TO O+ 1
0162 FOR J= 5 TO 23
0200 IF T[I,J] > 0 THEN GOTO 0220
0201 LET A= M[I- 4, J- 4]
0205 IF A < Q THEN GOTO 0220
0210 LET W= I
0215 LET X= J
0216 LET Q= A
0220 NEXT J
0225 NEXT I

```

Listing 1 continued on page 58

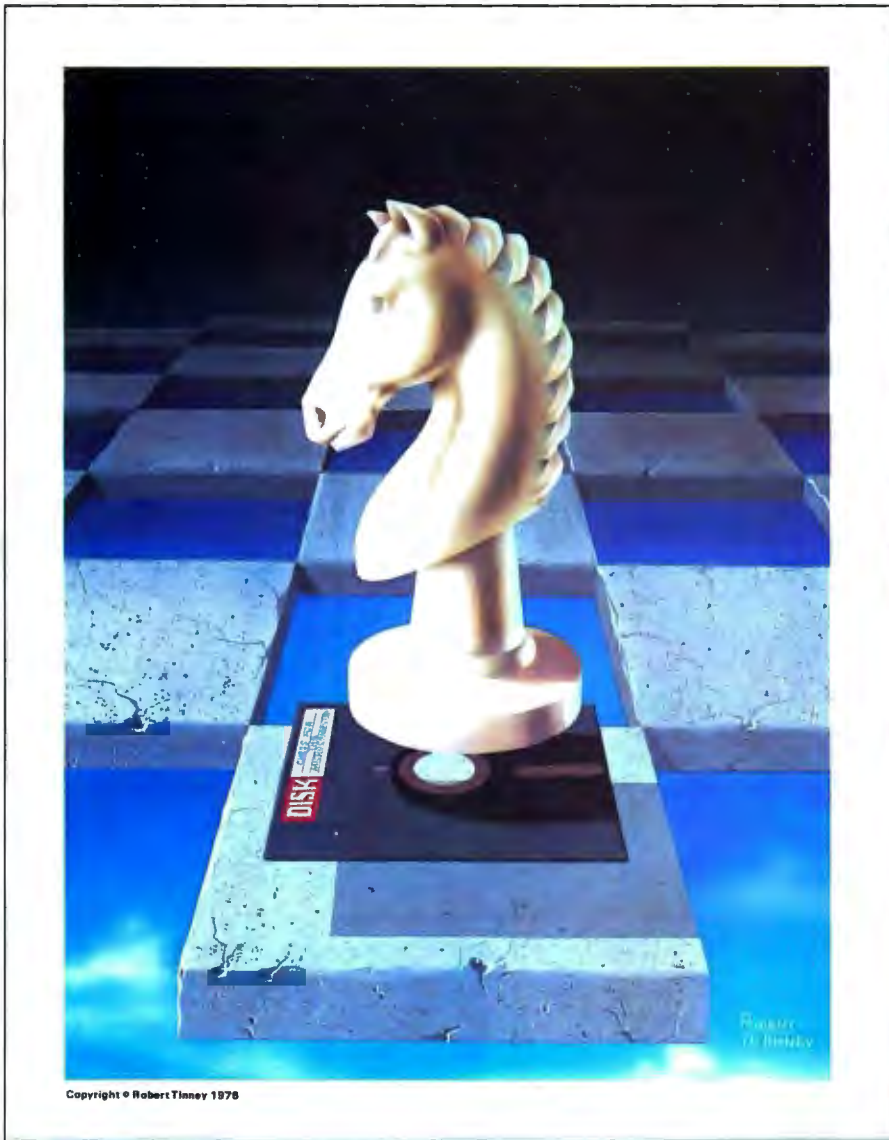

## Beautiful "Computer Chess" Reproduction—only \$4.95!

This dramatic reproduction of the October '78 Byte cover art has been produced with the same care and quality as limited edition prints—yet it is available for the price of a poster.

The overall size is 18" x 22", which includes a 1½" border. It is printed on heavy, 80 lb., matte finish, coated stock, excellent for the finest framing if desired.

The price of this quality reproduction is \$4.95, plus \$1.00 for mailing tube, handling, and postage. In addition, the artist, Robert Tinney, will select the 100 finest prints from this first edition for his personal signature and number. These 100 signed and numbered prints will be sold on a strictly first-come basis for \$24.00 plus \$1.00 postage and handling.

See coupon below for ordering.

Send me \_\_\_\_\_ of the \$4.95 posters, and \_\_\_\_\_ of the \$24.00 signed prints. I have included \$1.00 for postage and handling.

Please charge this to my  
 Visa/Master Charge: \_\_\_\_\_ Visa card number: \_\_\_\_\_  
 Name: \_\_\_\_\_ signature \_\_\_\_\_ Master Charge no.: \_\_\_\_\_  
 Address: \_\_\_\_\_ City: \_\_\_\_\_ State: \_\_\_\_\_ Zip: \_\_\_\_\_  
 Card expires: \_\_\_\_\_

**robert tinney graphics**  
 Make check payable to:  
 P.O. Box 45047  
 Baton Rouge, LA 70895





Listing 1 continued:

```

0299 PRINT "MY MOVE";X-4;" ";W-4
0300 LET T[W,X]=1
0301 IF M[W-4,X-4]<100 THEN GOTO 0095
0307 PRINT "I WIN"
0310 IF C=0 THEN PRINT "YOU WIN"
0330 GOTO 0050
0799 REM SUBROUTINE TO DISPLAY BOARD
0800 PRINT "      1 2 3 4 5 6 7 8 9 10 11 12 13 14 15 16 17 18 19"
0805 FOR I=5 TO 23
0810     IF I-4<10 THEN PRINT I-4;" ";
0811     IF I-4>9 THEN PRINT I-4;
0815     FOR J=5 TO 23
0820         IF [I,J]=0 THEN PRINT " .";
0825         IF T[I,J]=1 THEN PRINT " X";
0830         IF T[I,J]=2 THEN PRINT " O";
0835     NEXT J
0840     PRINT " "
0845 NEXT I
0850 RETURN
0990 REM SUBROUTINE TO CALCULATE BEST MOVE
0991 REM SCAN THRU MOVE AT I,J
0992 REM FOR FIVE SQUARES EITHER SIDE OF MOVE
0993 REM IN EIGHT DIRECTIONS,
AND UPDATE BEST MOVE ARRAY
1000 LET K=1
1001 LET L=-1
1002 IF I<N THEN IF I>5 THEN LET N=I
1003 IF I>O THEN IF I<23 THEN LET O=I
1004 REM UPDATE SCAN LIMITS
1005 LET U=I
1006 LET V=J
1007 REM I,J IS MOVE TO CHECK, D IS LOOP COUNT
1008 REM K,L ARE X AND Y DIRECTIONS THRU MOVE
1010 LET D=0
1011 LET D=D+1
1013 LET P=81
1020 REM CHECK STILL ON BOARD
1026 IF U>23 THEN GOTO 1090
1027 IF V>23 THEN GOTO 1090
1028 IF U<5 THEN GOTO 1090
1029 IF V<5 THEN GOTO 1090
1030 LET E=U-4
1031 LET G=V-4
1032 LET A=M[E,G]
1033 LET Q=T[U+K,V+L]
1034 REM CALCULATE PRIORITY OF POSITION
1035 LET R=T[U-K,V-L]*27+T[U-2*K,V-2*L]*9
1036 LET R=R+T[U-3*K,V-3*L]*3+T[U-4*K,V-4*L]
1037 LET B=Q*27+T[U+2*K,V+2*L]*9+T[U+3*K,V+3*L]*3
1038 IF R=80 THEN IF T[U,V]=2 THEN LET C=0
1039 IF T[U,V]<>0 THEN GOTO 1075
1040 REM S(R) IS PRIORITY; THE FOLLOWING ARE EXCEPTIONS
1041 REM SEE TABLE 2
1042 IF R<14 THEN IF R>11 THEN IF Q=1 THEN LET P=37
1044 IF R>71 THEN IF B>53 THEN IF B<63 THEN LET P=80
1046 IF R>71 THEN IF B>71 THEN LET P=80
1048 IF R>53 THEN IF R<63 THEN IF Q=2 THEN LET P=72
1050 IF P=72 THEN IF R=60 THEN LET P=31
1052 IF Q<>2 THEN GOTO 1058
1053 IF R=78 THEN LET P=80
1054 IF R=79 THEN LET P=80
1056 IF R=41 THEN LET R=81
1058 IF R<42 THEN IF R>35 THEN IF Q=1 THEN LET P=41
1059 IF R<33 THEN IF R>29 THEN IF Q=1 THEN LET P=41
1060 IF R>53 THEN IF R<63 THEN IF B>71 THEN LET P=80
1061 IF R>38 THEN IF R<42 THEN IF Q=1 THEN LET R=40
1062 IF R>35 THEN IF R<45 THEN IF B>35 THEN
IF B<45 THEN LET R=40
1063 IF R>27 THEN IF R<54 THEN IF B>38 THEN
IF B<42 THEN LET R=40
1064 IF R=79 THEN IF A=51 THEN LET M[E,G]=41
1065 IF R=0 THEN LET R=81
1066 IF S[P]>S[R] THEN LET R=P
1067 IF S[R]-S[R]/10*10=1 THEN IF A-A/10*10=1 THEN
IF S[R]<41 THEN LET R=74
1068 IF S[R]-S[R]/10*10=9 THEN IF A-A/10*10=9 THEN
IF S[R]<65 THEN LET R=37
1069 REM UPDATE BEST MOVE ARRAY
1070 IF S[R]>M[E,G] THEN LET M[E,G]=S[R]
1075 IF D>4 THEN GOTO 1090
1081 LET U=U+K
1082 LET V=V+L
1085 GOTO 1011
1089 REM CHANGE DIRECTION
1090 IF K=0 THEN IF L=-1 THEN RETURN
1095 IF K=-1 THEN IF L=-1 THEN LET K=0

```

```

1100 IF K=-1 THEN IF L=0 THEN LET L=-1
1105 IF K=-1 THEN IF L=1 THEN LET L=0
1110 IF K=0 THEN IF L=1 THEN LET K=-1
1115 IF K=1 THEN IF L=1 THEN LET K=0
1120 IF K=1 THEN IF L=0 THEN LET L=1
1125 IF K=1 THEN IF L=-1 THEN LET L=0
1130 GOTO 1005

```

**SAVE MORE THAN 20%**  
**NORTH STAR - INTERTUBE**  
**THINKER TOYS - HUH**

THE SMARTEST COMPUTERS AT THE SMARTEST PRICE  
 DOUBLE DENSITY

HORIZON-1-16K KIT	LIST	\$1599	\$1274
ASSEMBLED & TESTED		\$1899	\$1519
HORIZON-2-32K KIT		\$2249	\$1799
ASSEMBLED & TESTED		\$2549	\$2039
QUAD DENSITY			
HORIZON-2-32K		\$2999	\$2399
ASSEMBLED & TESTED			
PASCAL FOR NORTH STAR ON DISK			\$49
POWERFUL NORTH STAR BASIC			FREE
THINKER TOYS DISCUS/20		\$1149	\$949
MEASUREMENT SYSTEMS ASM MEMORY 64K			\$640
TOP QUALITY + TOP SPEED + LOWEST PRICE			
INTERTUBE II SMART TERMINAL		\$995	\$780
TRS-80 TO S-100 HUH KIT		\$295	\$260
ASSEMBLED & TESTED		\$375	\$350
HUH MINI 8100 KIT		\$115	\$103
ASSEMBLED & TESTED		\$155	\$139
MARYELLEN WORD PROCESSOR			\$38
BEST FEATURES OF IBM & NORTH STAR			
VERBATIM DISKS			\$29
WHICH COMPUTERS ARE BEST? BROCHURE			FREE

**AMERICAN SQUARE COMPUTERS**  
 KIVETT DR \* JAMESTOWN NC 27282  
 (919)-883-1105

Circle 13 on inquiry card.

SAVE!!

TRS-80



10, 15  
Percent  
and More!

on computers, peripherals, software and other Radio Shack® products.

Offered Exclusively By

**Pan American Electronics, Inc.** A **Radio Shack®**  
 Authorized Sales Center

1117 CONWAY MISSION, TEXAS 78572

East 212/283-0543 North Central 312/666-6098

West 213/564-5463 South Central 512/581-2765

(main telephone number)



NO TAXES on out-of-state shipments.  
 FREE delivery available on minimum orders.  
 WARRANTIES honored by Radio Shack®.



Listing 2: Sample output of the 19 by 19 board.

```

1  1 2 3 4 5 6 7 8 9 10 11 12 13 14 15 16 17 18 19
2  : : : : : : : : : : : : : : : : : : : : :
3  : : : : : : : : : : : : : : : : : : : : :
4  : : : : : : : : : : : : : : : : : : : : :
5  : : : : : : : : : : : : : : : : : : : : :
6  : : : : : : : : : : : : : : : : : : : : :
7  : : : : : : : : : : : : : : : : : : : : :
8  : : : : : : : : : : : : : : : : : : : : :
9  : : : : : : : : : : : : : : : : : : : : :
10 : : : : : : : : X : : : : : : : : : : :
11 : : : : : : : : : : : : : : : : : : : : :
12 : : : : : : : : : : : : : : : : : : : : :
13 : : : : : : : : : : : : : : : : : : : : :
14 : : : : : : : : : : : : : : : : : : : : :
15 : : : : : : : : : : : : : : : : : : : : :
16 : : : : : : : : : : : : : : : : : : : : :
17 : : : : : : : : : : : : : : : : : : : : :
18 : : : : : : : : : : : : : : : : : : : : :
19 : : : : : : : : : : : : : : : : : : : : :

```

```

?9,9
MY MOVE 10, 11
1  1 2 3 4 5 6 7 8 9 10 11 12 13 14 15 16 17 18 19
2  : : : : : : : : : : : : : : : : : : : : :
3  : : : : : : : : : : : : : : : : : : : : :
4  : : : : : : : : : : : : : : : : : : : : :
5  : : : : : : : : : : : : : : : : : : : : :
6  : : : : : : : : : : : : : : : : : : : : :
7  : : : : : : : : : : : : : : : : : : : : :
8  : : : : : : : : : : : : : : : : : : : : :
9  : : : : : : : : : : : : : : : : : : : : :
10 : : : : : : : : : : X : : : : : : : : : : :
11 : : : : : : : : : : X : : : : : : : : : : :
12 : : : : : : : : : : : : : : : : : : : : :
13 : : : : : : : : : : : : : : : : : : : : :
14 : : : : : : : : : : : : : : : : : : : : :
15 : : : : : : : : : : : : : : : : : : : : :
16 : : : : : : : : : : : : : : : : : : : : :
17 : : : : : : : : : : : : : : : : : : : : :
18 : : : : : : : : : : : : : : : : : : : : :
19 : : : : : : : : : : : : : : : : : : : : :

```

```

?10,9
MY MOVE 11, 9
1  1 2 3 4 5 6 7 8 9 10 11 12 13 14 15 16 17 18 19
2  : : : : : : : : : : : : : : : : : : : : :
3  : : : : : : : : : : : : : : : : : : : : :
4  : : : : : : : : : : : : : : : : : : : : :
5  : : : : : : : : : : : : : : : : : : : : :
6  : : : : : : : : : : : : : : : : : : : : :
7  : : : : : : : : : : : : : : : : : : : : :
8  : : : : : : : : : : : : : : : : : : : : :
9  : : : : : : : : : : : : : : X : : : : : : :
10 : : : : : : : : : : : : : : X : : : : : : :
11 : : : : : : : : : : : : : : X : : : : : : :
12 : : : : : : : : : : : : : : : : : : : : :
13 : : : : : : : : : : : : : : : : : : : : :
14 : : : : : : : : : : : : : : : : : : : : :
15 : : : : : : : : : : : : : : : : : : : : :
16 : : : : : : : : : : : : : : : : : : : : :
17 : : : : : : : : : : : : : : : : : : : : :
18 : : : : : : : : : : : : : : : : : : : : :
19 : : : : : : : : : : : : : : : : : : : : :

```

```

?9,10
7,6
MY MOVE 11, 10
1  1 2 3 4 5 6 7 8 9 10 11 12 13 14 15 16 17 18 19
2  : : : : : : : : : : : : : : : : : : : : :
3  : : : : : : : : : : : : : : : : : : : : :
4  : : : : : : : : : : : : : : : : : : : : :
5  : : : : : : : : : : : : : : : : : : : : :
6  : : : : : : : : : : : : : : : : : : : : :
7  : : : : : : : : : : : : : : : : : : : : :
8  : : : : : : : : : : : : : : : : : : : : :
9  : : : : : : : : : : : : : : : : : : : : :
10 : : : : : : : : : : : : : : : : : : : : :
11 : : : : : : : : : : : : : : : : : : : : :
12 : : : : : : : : : : : : : : : : : : : : :
13 : : : : : : : : : : : : : : : : : : : : :
14 : : : : : : : : : : : : : : : : : : : : :
15 : : : : : : : : : : : : : : : : : : : : :
16 : : : : : : : : : : : : : : : : : : : : :
17 : : : : : : : : : : : : : : : : : : : : :
18 : : : : : : : : : : : : : : : : : : : : :
19 : : : : : : : : : : : : : : : : : : : : :

```

```

?6,5
YOU WIN

```

I hope I have eradicated most of the bugs, but some may still exist (as with all programs); for example, I do not check to see if the board is full, because I have never encountered this situation with a 19 by 19 board.

# MICROTEK OUTPERFORMS ANADEX

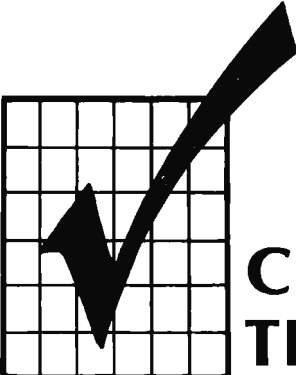

## CHECK THE CHART

## SEE PAGE 71



# PRINTER SURPRISE:

Plain paper • 80 columns • 5 x 7 dot matrix bi-directional impact printer

## Unbelievable

125 characters/second or 60 lines per minute  
many functions such as Vertical Format Unit

## Unbelievable

Full 96 characters, upper and lower case  
feed, 4½ x 9½ inches wide • prints original

## Unbelievable

Available now • dealer inquiries invited  
add 6% sales tax • use VISA, Master Charge,  
certified check or C.O.D. • single quantities,



See these printers and many other microcomputer products at Southern California's newest and most complete computer store, handling a wide range of business and personal computers.

## Super Brain, Inc.

1646 Westwood Blvd., Los Angeles, CA 90024, (213) 470-1318

TOKYO: 1-15-16 Akihabara Radio Kaikan 7F, Soto Kanda Chiyoda-Ku, Tokyo 101, Japan;  
Tel (03) 251-7337  
OSAKA: 4-41 Nippon Bashisuji, Naniwa-Ku, Osaka 556, Japan; Tel (06) 644-5071

# IMMEDIATE DELIVERY FROM STOCK

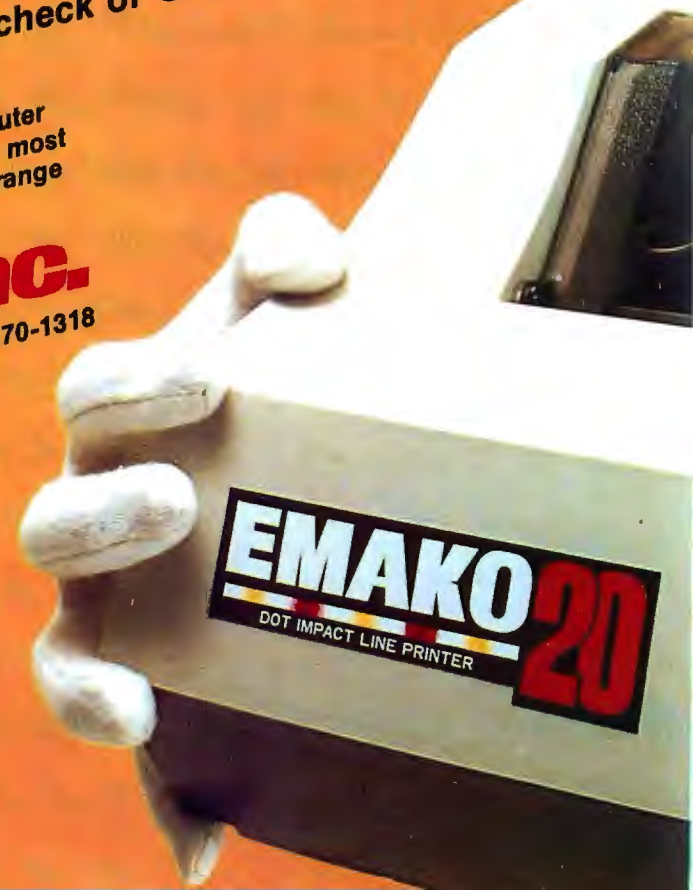

# Performance

- continuous printing, 100 million characters and more

# Quality

- adjustable sprocket plus three copies

# Price

- California residents Postal Money Order, only \$777





Table 2: Some exceptions encountered by the computer that necessitate redefining its strategy.

LINE NUMBER	PATTERN	PRIORITY
1042	X+-XX	65
1044	-0+00	90
1046	00+00	90
1048	0+0-	31
1050	0+0-0-	50
1053	0+000-	90
1054	0+000X	90
1056	0+XXX0	0
1058	X+XX-	60
1058	X+XXX	60
1059	X+X-X	60
1060	00+0-	90
1061	X+XXX	100
1062	XXX+X	100
1063	XXX+X	100
1064	REDUCES PRIORITY OF -000- TO 41 IF BLOCKED AT ONE END	
1067	INCREASES PRIORITY OF INTERSECTING ROWS OF 0'S	
1068	INCREASES PRIORITY OF INTERSECTING ROWS OF X'S	

Table 1: A lookup table that defines the computer's strategy.

0	+----	0	27	+X---	15	54	+0---	0
1	+---X	0	28	+X--X	20	55	+0--X	0
2	+---0	0	29	+X--0	10	56	+0--0	0
3	+--X-	0	30	+X-X-	40	57	+0-X-	0
4	+--XX	0	31	+X-XX	50	58	+0-XX	0
5	+--X0	0	32	+X-X0	30	59	+0-X0	0
6	+--0-	0	33	+X-0-	0	60	+0-0-	21
7	+--0X	0	34	+X-0X	0	61	+0-0X	11
8	+--00	0	35	+X-00	0	62	+0-00	41
9	+X--	0	36	+XX--	39	63	+0Y--	0
10	+X-X	40	37	+XX-X	65	64	+0X-X	0
11	+X-0	0	38	+XX-0	40	65	+0X-0	0
12	+XX-	30	39	+XXX-	70	66	+0XX-	0
13	+XXX	47	40	+XXXX	100	67	+0XXX	0
14	+XX0	0	41	+XXX0	60	68	+0XX0	0
15	+X0-	0	42	+XX0-	30	69	+0X0-	0
16	+X0X	0	43	+XX0X	30	70	+0X0X	0
17	+X00	0	44	+XX00	30	71	+0X00	0
18	+0--	0	45	+X0--	0	72	+00--	31
19	+0-X	0	46	+X0-X	0	73	+00-X	11
20	+0-0	1	47	+X0-0	0	74	+00-0	41
21	+0X-	0	48	+X0X-	0	75	+00X-	0
22	+0XX	0	49	+X0XX	0	76	+00XX	0
23	+0X0	0	50	+X0X0	0	77	+00X0	0
24	+00-	1	51	+X00-	0	78	+000-	51
25	+00X	0	52	+X00X	0	79	+000X	0
26	+000	21	53	+X000	0	80	+0000	90

The program relies on a lookup table (entry S, table 1) and some exception conditions (table 2) to determine the priority of move of the square in question. The last 2 moves (by nought and cross) are scrutinized, scanning through these squares for 4 squares either side of the move in all 8 directions. The priority is calculated and updated if greater than previously calculated. Finally the board is scanned for the highest priority and the move made in this square.

The computer always goes first, and is X, although this can easily be modified. On the EXORciser, it takes about 40 seconds to think of the best move, compared with 10 seconds on a NOVA 2 using the same program and a BASIC interpreter, so do not worry if there is not an immediate response.

The program plays a very good game, occasionally almost beating the author, and has beaten several people who have played. Changing the strategies radically alters the way the computer plays, and the strategies in table 1 and exceptions in table 2 are the best I have found so far, but try changing S(12) to 29, and S(13) to 49. I would be interested to hear from anybody who finds better strategies. ■

## MICROPOLIS • PERTEC • SHUGART • MPI

### DISK DRIVES AT AN AFFORDABLE PRICE

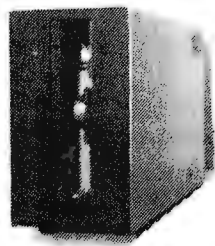

**\$499**

**MPI DISK DRIVE** With Power Supply And Cabinet. Features Include Automatic Diskette Positioning And Ejection, 18% More Storage Capacity. Included With Each Unit Is A 4 Drive Cable, Enhanced Disk Operating System, And 1 Year Unconditional Warranty. Available For Immediate Delivery. Satisfaction Guaranteed.

FOR THE TRS-80	
MPI•PERTEC DISK DRIVE WITH POWER SUPPLY AND CABINET	\$385
SHUGART DISK DRIVE WITH POWER SUPPLY AND CABINET	\$389
MICROPOLIS 77 TRACK DRIVE WITH MODIFIED NEWDOS+	\$689
NEWDOS+ENHANCED DISK OPERATING SYSTEM	\$99
2 DRIVE CABLE \$25	4 DRIVE CABLE \$35
16K ADD ON MEMORY SET (NEC 200ns)	\$95
FOR ANY MICROCOMPUTER	
SA-400 5 1/4" DISK DRIVE (DOUBLE DENSITY)	\$315
SA-801R 8" STANDARD FLOPPY DISK DRIVE	\$495
TARBELL DISK CONTROLLER FOR 8" DISK DRIVES (ASSEMBLED)	\$265
CP/M DOS WITH BASIC-E AND MANUALS	\$100
ANADEX DP-8000 80 COLUMN PRINTER	\$995

FOR FAST DELIVERY OR MORE INFORMATION, CALL (714) 641-0273

**AMS** AFFORDABLE MICROCOMPUTER SYSTEMS

2098-D SOUTH GRAND • SANTA ANA, CALIFORNIA 92705  
Formerly ADVANCED MICROCOMPUTER SYSTEMS

## Shape Table Conversion for the Apple II

Dave Partyka, 1707 N Nantuckett Dr, Lorain OH 44053

If you own an Apple II with high-resolution graphics, I'm sure you have tried using the shape table. If you are like me, you converted the points to their hexadecimal values, ran the shape subroutine, and got a completely different shape from what you wanted. After two or three tries and a lot of time, you finally got the shape the way you wanted it.

There has to be a better way, and there is. The program in listing 1 performs the plot conversion to hexadecimal and puts the values in the table starting at the decimal location you specify. After using this program, you will find it very easy to build shape tables. Instead of drawing arrows, you can use just the points.

This program follows the rules of the *Apple II Reference Guide*: a double move up or 00 will end the program and put a 0 at the end of the table. The value of the moves are the same as in the *Reference Guide*:

- 0 = Move up
- 1 = Move right
- 2 = Move down
- 3 = Move left
- 4 = Plot and move up
- 5 = Plot and move right
- 6 = Plot and move down
- 7 = Plot and move left

The program does not require that the user press the return key while entering the plot values. You can try this program using the example given in the *Apple II Reference Guide* on page 53. Assign the correct values to the shape vectors at the top of the page and the hexadecimal values given will be in your table. Remember that this program requires a decimal location, while the shape subroutine requires the hexadecimal value. ■

Listing 1: Shape table program for the Apple II.

```

10 INPUT "STARTING DECIMAL LOCATION",L
20 N=N+1:PRINT "PLOT ";N:;";";
30 Z=PEEK(-16384):IF Z<176 OR Z>183 THEN 30:
    POKE -16368,0:Z=Z-176:PRINT Z:
    IF N#1 THEN RETURN
40 E=1:IF Z=0 THEN D=1:A=Z:GOSUB 20
50 IF Z#0 THEN 60:IF D=1 THEN 90:E=0:GOTO 70
60 D=0:IF Z=2 OR Z=4 OR Z=6 THEN 70:
    Z=Z-1:A=A+8
70 B=Z/2:GOSUB 20:IF Z#1 AND Z#2 AND Z#3
    THEN 80:B=Z*4+B:E=1:GOSUB 20
80 B=B*16+A:POKE L,B:L=L+1:IF E#0 THEN 40:
    A=0:D=1:E=1:GOTO 50
90 PRINT "END OF TABLE":POKE L,0:END
    
```

## SMOKE SIGNAL BROADCASTING PRESENTS...

### THE SMOKE WRITER (VDB-1)

The SSB SMOKE WRITER incorporates the latest advances in electronic technology to bring you and the SS-50 bus a truly unique video display board. The SMOKE WRITER uses the MC6845 CRT Controller chip and provides total control over the display format.

**IT'S NEW**

The standard features of the SMOKE WRITER are:

**\$349.00**

- 80 x 24 display with 32 graphic characters. Optional character generator ROM with 128 ASCII characters plus 128 graphic characters.
- Upper and lower case characters with lower case descenders.
- Programmable character set, a total of 128 characters in a 2K EPROM; a 256 character 4K EPROM is optional.
- 1K EPROM for Software drivers.
- Reduced intensity or reversed video
- Programmable display rate (10 to 5000 character per second) equivalent to 100 to 50K baud.
- Protected fields.
- Addressable Cursor.
- 2K video display RAM accessible by the CPU as standard RAM Memory.
- 128 Bytes of Scratch pad RAM.

If you have a need for a fast and dependable video display board, Smoke Signal Broadcasting has what you are looking for. The SMOKE WRITER is right at home when used with a cursor based editor or in a business program that needs protected fields.

**SMOKE SIGNAL BROADCASTING**

31336 Via Colinas, Westlake Village, CA 91361, (213) 889-9340





# MicroPro International Corporation

"Professional Quality Software You Can Count On, Now!"

Proudly Presents

# WORD-STAR T.M.

Now, you can instantly turn your microcomputer into an incomparable word processor.

Hundreds of delighted users have thrown away their pencils and are using the first truly professional and complete word processor ever available on a microcomputer, WORD-STAR.

Everything you've heard, read, wished, thought about - it's here! it's now! and it's Dynamite!!

Just look at the product overview copies from our 200 page manual (prepared and printed using WORD-STAR).

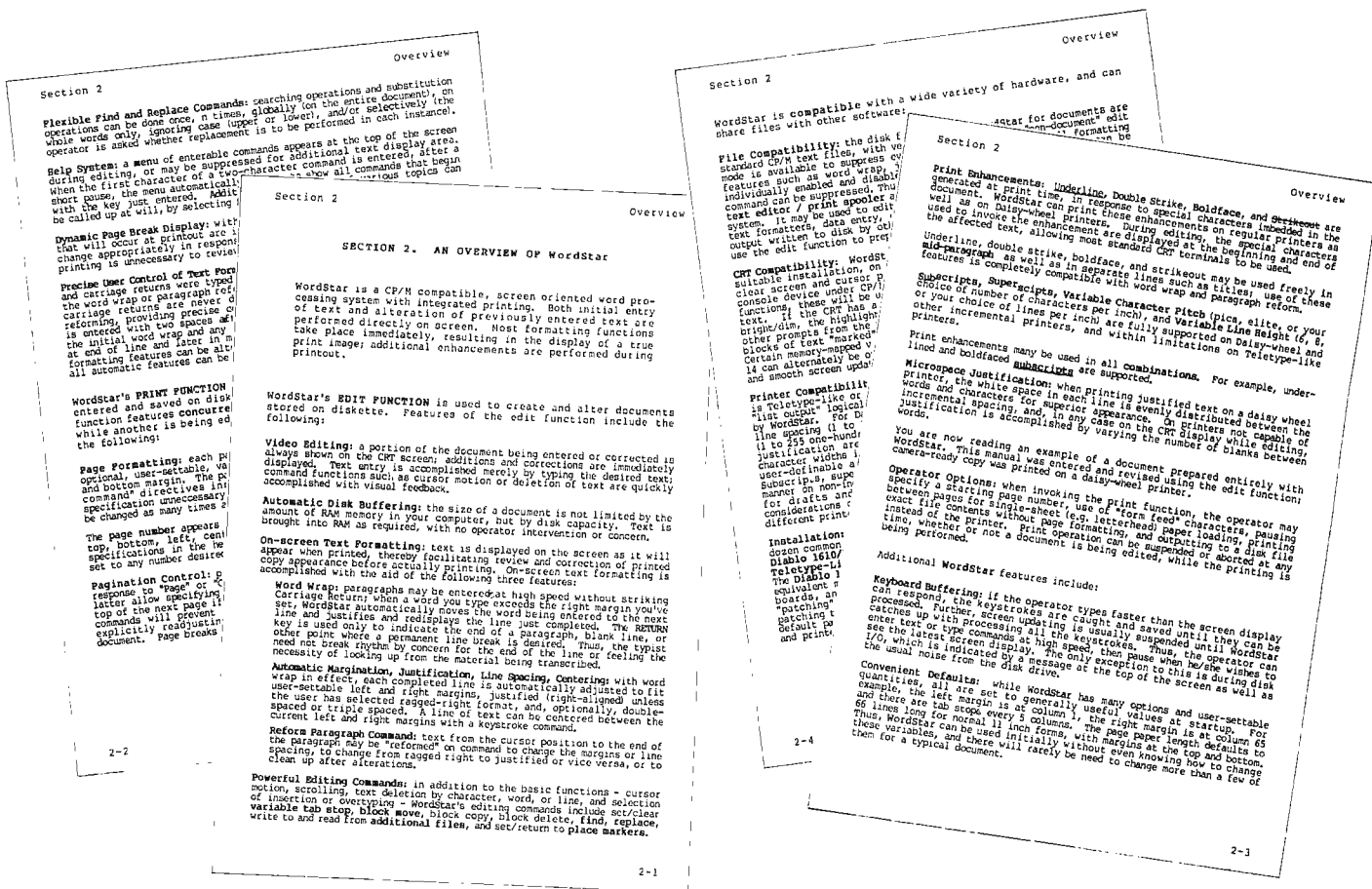

### MicroPro Price List:

	Software/Manual	Software/Manual
Word-Star T.M.	\$495/40	Super-Sort I T.M.
Word-Master T.M.	\$150/25	Super-Sort II T.M.
Tex-Writer T.M.	\$ 75/15	Super-Sort III T.M.
		\$250/25
		\$200/25
		\$150/25

For more information and the name of your nearest dealer, contact MicroPro International Corporation. Dealer/Distributor/O.E.M. Inquires Invited

**MICROPRO INTERNATIONAL CORPORATION**  
1299 4th Street, San Rafael, California 94901  
Telephone (415) 457-8990 Telex 340388

17" x 22"  
POSTER  
AVAILABLE

The most complete, integrated, word processing software system ever seen on a microcomputer.



MicroPro International Corporation  
"Professional quality software you can count on, now"



1299 Fourth Street, San Rafael, California 94901 • Telephone (415) 457-8990 • Telex 340388



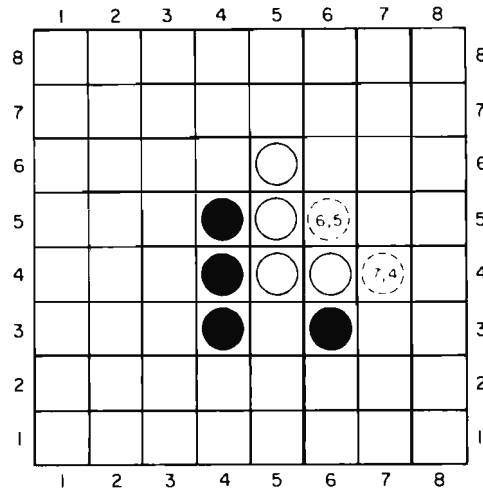

# Programming Strategies in the Game of Reversi

*Figure 1: Typical position in the game of Reversi. The game is played with counters having two different colors, one on each side. A player's turn consists of placing a counter (with the player's color face up) on the board so that it traps one or more enemy pieces between it and another friendly piece in a straight line. The trapped enemy pieces are then reversed in color. Thus, a play by Black to square (6,5), with the horizontal coordinate given first, would allow Black to turn over White's pieces at (6,4), (5,4) and (5,5). A play by Black to square (7,4) would allow Black to turn over White's pieces at (6,4) and (5,4). Play ends when neither player can make a legal move. The player with the greater number of counters showing wins the game.*

---

Peter B Maggs  
 2011 Silver Ct E  
 Urbana IL 61801

---

Board games such as checkers or chess can be fun and challenging to play, and programs that play these games can be fun and challenging to write. This article covers some of the decisions I made and methods I used in the programming of a board game called Reversi. It examines in turn the choice of a game, the programming language, the data structure and the details of the program structure.

## Choosing a Game

There are both legal and practical considerations in choosing a game to program. Since I earn a living teaching law, and program as a hobby, I will start with the legal aspects. Many games present no legal problems. For instance, chess and checkers are in the public domain and anyone is free to write programs for them, but copyrighted games could pose serious legal problems. While writing a program to play a copyrighted game solely for your own amusement at home would probably fall within the fair use exception to the copyright law, any attempt to distribute, publish or sell the program could be made only with the permission or tolerance of the copyright and trademark owner. There is a third category of game wherein the game itself is in the public domain, but playing equipment is sold under a trademark. Thus, while no one has any rights to three-dimensional tic-tac-toe, the manufacturer who sells sets for playing three-dimensional tic-tac-toe under a trademark has the right to prevent you from distributing a computer game with the same name. So, you are free to program and even sell three-dimensional tic-tac-toe, but you will have to make up your own name for it.

There are also practical problems in

choosing a game. The game you select should not only be free of serious legal complications, it should also be complex enough to be challenging, yet simple enough to be implemented with the hardware and software at your disposal (taking account of your own programming ability and free time). If you are clever enough, you can choose an extremely complex game like chess or Go. If you are a novice programmer with only a small programmable calculator, you might want to begin with something simple like tic-tac-toe.

Since my own equipment (A SOL-20 computer with 16 K of programmable memory, video monitor, Teletype, two cassette drives, BASIC and assembler languages) and my own programming ability both fall somewhere between the two extremes, I sought a moderately difficult game to program.

The game I selected is called "Reversi." According to the *Oxford English Dictionary*, Reversi was first mentioned in print in the 1880s and its rules were first published in the 1890s; thus the game has long been in the public domain. It is now enjoying a revival because of the marketing of a board and set of playing pieces for the game by Gabriel Industries under that firm's trademark, "Othello," and the publication of a well written book on the game. (See "Othello, a New Ancient Game," October 1977 BYTE, page 60, and the bibliography at the end of this article.)

The rules of the game are simple, but play can be quite complicated. The game is played on an 8 by 8 square board like a standard chess or checkerboard. The players start with a supply of 64 playing pieces, each shaped like a checker piece, but black on one side and white or red on the other. Players take alternate turns. If a player has no legal play, he or she loses his turn. When neither player has a legal play, the game ends.

A play consists of placing a piece on an unoccupied square on the board with the player's color up. Each of the first two plays by each player must be made to one of the four center squares. Thereafter, each player may place a piece on any unoccupied square that will result in the formation of an unbroken line (horizontal, vertical, or diagonal) of pieces, with one of his own pieces on each end and one or more of his opponent's pieces in the middle. The opponent's pieces in the middle are then turned over (see figure 1). At the end of the game, the player with the most pieces showing his color wins.

Strategy for the game can be complex — only the most basic ideas are covered in the

200 page book by Hasegawa mentioned in the bibliography. However, the various writers on the game do agree on some basic points: Corner squares are very valuable because they can never be taken; squares next to corners are dangerous because they can make it possible for one's opponent to take corners. Edge squares are usually valuable because they can be used to force turnovers of large numbers of opponent's pieces in middle squares. Control of strategic squares in the middle of the game is more important than having a substantial material advantage at that time.

### Programming Language

After I chose the game, the next step was to choose a programming language for the game. I really had only two choices because of the limitations of my own software library — BASIC or assembler. I chose BASIC because I can program much more easily in BASIC and because BASIC programs are more generally transferable to other computers than are assembler language programs, which will work with only one type of processor. With transferability in mind I made considerable efforts to avoid the use of the fancy special features available in the BASIC interpreters I have, since their use would make transfer a nightmare. Now that I have finished the programming, I am still happy with my choice, though I am now tempted to convert a few of the critical subroutines (which I will discuss later) into assembler language. This conversion would make the program run faster or to allow it to make a deeper analysis of its plays while running at the same speed.

### Data Structure

Before starting programming I had to choose a suitable data structure. Following methods used in one of the leading computer chess programs (see the article by Gillogly in the bibliography), I decided to represent the standard 8 by 8 chessboard as being surrounded by a border of out-of-bounds squares, thus making a 10 by 10 board. For computer purposes, this augmented board could most naturally be represented as a 10 by 10 array dimensioned by the BASIC statement DIM B(10,10). However, because many BASIC interpreters for microcomputers allow only one-dimensional arrays, and because use of a one-dimensional array simplified my program in various ways, I decided instead to represent the board by a single array of 100 elements: DIM B(100). (See figures 2 and 3.) Another array, DIM E(100), was

*Text continued on page 70*



# One of the best values computers is now



## \$1995 SPECIAL SYSTEM PRICE

includes H8 Computer with 16K memory, four-port serial I/O and operating software, plus H17 Floppy Disk System (shown here with optional second drive) and H19 CRT Terminal — all in kit form.

### Heathkit H8 Computer

- 8080A CPU has more software written for it than any other CPU
- 7 plug-in board positions for flexibility in configuring your system
- Up to 65K memory capacity
- Front panel keyboard for direct access to registers and memory

**\$289** kit purchased separately. Was \$379. **You save \$90.**  
**\$349.00** assembled

### Heathkit H17 Floppy Disk System

- Instant access to programs and data
- 102K bytes storage area
- 250 mS typical random access time

- Includes interface controller board  
**\$495.00** kit purchased separately  
**\$550.00** assembled

### Heathkit H19 Smart Video Terminal

- Z80 microprocessor-controlled
  - 25 x 80, upper and lower case
  - Direct cursor addressing
  - 8 user-programmable keys
- \$675.00** kit purchased separately  
**\$995** assembled

### 5% discount on software, memory and interfacing

Special 5% discount applies to all software, memory and interface

boards when purchased with the H8 system.

Seven plug-in board positions on the H8 let you configure any combination of memory and I/O's that suits you. Heathkit memory boards come in 16K, 8K and 4K increments. Interface boards are available for parallel, serial and cassette I/O's.

### Wide selection of software

Software for the H8 Computer includes operating systems software, MICROSOFT™ BASIC, FORTRAN, wordprocessing, plus innovative applications software for business and pleasure.

### HUG has over 400 programs

An extensive library of programs is available to owners of Heathkit Com-



# in high-performance \$90 better.

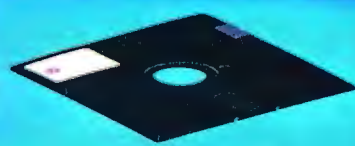

Circle 163 on inquiry card.

puters through the Heath User's Group (HUG). The experience of this computerite group can help you get the most from your computer.

### Plus Heathkit service

You get the most thorough documentation ever written when you buy your Heathkit Computer. So it's easy to get your system assembled and operating quickly.

And you get one of the most reliable service organizations after you buy. More than 55 service locations throughout the U.S., plus a factory service phone give you fast access to experts when you need them.

### It's all at your Heathkit Electronic Center

Computers, peripherals, software and accessories — in kit or assembled form — you'll find them all at your Heathkit Electronic Center. You'll even find educational support like

the special self-instruction programs that teach you BASIC and Assembly languages programming.

Check the white pages in the city nearest you for the location of your Heathkit Electronic Center\*

Alexandria, VA  
 Anaheim, CA  
 Atlanta, GA  
 Baltimore, MD  
 Boston, MA  
 Buffalo, NY  
 Chicago, IL  
 Cincinnati, OH  
 Cleveland, OH  
 Columbus, OH  
 Dallas, TX  
 Denver, CO  
 Detroit, MI  
 El Cerrito, CA  
 Fair Lawn, NJ  
 Frazer, PA  
 Hartford, CT  
 Houston, TX  
 Indianapolis, IN  
 Jericho, NY  
 Kansas City, KS  
 Los Angeles, CA  
 Louisville, KY  
 Miami, FL  
 Milwaukee, WI  
 Minneapolis, MN

New Orleans, LA  
 Norfolk, VA  
 Ocean, NJ  
 Oklahoma City, OK  
 Omaha, NB  
 Philadelphia, PA  
 Phoenix, AZ  
 Pittsburgh, PA  
 Pomona, CA  
 Providence, RI  
 Redwood, CA  
 Rochester, NY  
 Rockville, MD  
 Sacramento, CA  
 Salt Lake City, UT  
 San Antonio, TX  
 San Diego, CA  
 San Jose, CA  
 Seattle, WA  
 St. Louis, MO  
 St. Paul, MN  
 Tampa, FL  
 Toledo, OH  
 White Plains, NY  
 Woodland Hills, CA

### FREE CATALOG

Write for a **FREE** Heathkit Catalog containing the complete line of Heathkit Computers, plus nearly 400 other electronic kits for your home, work or pleasure.

Heath Company, Dept. 334-580,  
 Benton Harbor, Mich. 49022

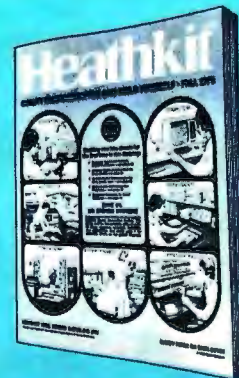

# Heathkit

\*Units of Schlumberger Products Corporation. Prices stated here are mail order and may be slightly higher at retail locations. CP-169



Figure 2: Integer numbers used to identify Reversi squares. These numbers correspond to the elements of one-dimensional 100 element BASIC arrays used by the author in his program to store a given Reversi board pattern.

91	92	93	94	95	96	97	98	99	100
81	82	83	84	85	86	87	88	89	90
71	72	73	74	75	76	77	78	79	80
61	62	63	64	65	66	67	68	69	70
51	52	53	54	55	56	57	58	59	60
41	42	43	44	45	46	47	48	49	50
31	32	33	34	35	36	37	38	39	40
21	22	23	24	25	26	27	28	29	30
11	12	13	14	15	16	17	18	19	20
1	2	3	4	5	6	7	8	9	10

3	3	3	3	3	3	3	3	3	3
3	0	0	0	0	0	0	0	0	3
3	0	0	0	0	0	0	0	0	3
3	0	0	0	0	0	0	0	0	3
3	0	0	0	2	2	0	0	0	3
3	0	0	0	2	2	0	0	0	3
3	0	0	0	0	0	0	0	0	3
3	0	0	0	0	0	0	0	0	3
3	0	0	0	0	0	0	0	0	3
3	3	3	3	3	3	3	3	3	3

Figure 3: Initial board position. These values are stored in the one-dimensional 100 element matrix B (see listing 1). They enable the program to tell where the four center squares and out-of-bounds squares are located. (The first four moves of the game must be made to the four center squares.)

0	0	0	0	0	0	0	0	0	0
0	64	-30	10	5	5	10	-30	64	0
0	-30	-40	2	2	2	2	-40	64	0
0	10	2	5	1	1	5	2	-30	0
0	5	2	1	1	1	1	2	5	0
0	5	2	1	1	1	1	2	5	0
0	10	2	5	1	1	5	2	10	0
0	-30	-40	2	2	2	2	-40	-30	0
0	64	-30	10	5	5	10	-30	64	0
0	0	0	0	0	0	0	0	0	0

Figure 4: Initial strategic values of the board squares stored in the E matrix (see listing 1), used by the program to evaluate it using a minimax strategy. The higher the value, the more desirable the square.

Text continued:

declared for storage of the strategic value of each square (see figure 4). Two more 100 element arrays were declared for use in saving different versions of the board while the computer was considering possible plays.

This rather lavish use of storage was made possible by the fact that I was using a 5 K BASIC package in a 16 K memory. If memory were at a premium, it would have been necessary to use a much more complex board representation which could pack each square into a few bits (see the article by Yost in the bibliography) and perhaps necessary to develop a method for storing changes in board positions without storing whole boards. However, if you have the storage you might as well use it.

Several simple techniques could be used to adapt my program for users with less memory space. If a BASIC with strings is available, board squares can be stored in

1 byte string variables rather than in multi-byte numerical variables. Alternatively, several board squares could be stored in one numerical variable, using the 1's position for the first square, the 10's position for the second square, etc. If the BASIC package has POKE and PEEK instructions, still another possibility is to store each square as 1 byte in memory with a POKE instruction and retrieve each square as needed with an appropriate PEEK instruction.

### Program Structure

Having chosen the data structure, I next had to choose a program structure. Just as I chose a simple data structure so that it would be easily adaptable to many types of games, I selected what I hoped would be a very adaptable program structure. In designing the program structure, I drew upon



# MICROTEK

## OUTPERFORMS THEM ALL!



### CHECK THESE FEATURES...

- 80 or 120 columns (software selectable)
- Double width printing
- Non-thermal paper, pin feed
- 125 CPS, 70 lines per minute
- 9 x 7 dot matrix
- Vertical format unit
- 96-character ASCII (upper and lower case)
- Adjustable forms width
- Parallel, serial (RS-232), and IEEE-488 interfaces available

### CHECK THIS CHART...

Features	MICROTEK MT-80P	Anadex DP-8000	Centronics 730-1 (Radio Shack 26-1154)	Super Brain LP-80	Integral Data 440	MPI 88T
9 x 7 Dot Matrix	Yes	Yes	No	No	No	No
Sustained thruput for full lines	70 LPM	84 LPM	21 LPM	63 LPM	42 LPM	60 LPM
Selectable condensed character set	Yes	No	No	No	Yes	Yes
Full function VFU	Yes	Yes	No	No	Yes	No
Built-in self test	Yes	No	No	No	Yes	No
Graphics option	No	No	No	No	Yes	No
Accepts single sheets of paper	No	No	Yes	No	No	Yes
Ribbon costs	\$2.00	\$3.00	\$4.50	\$4.00	\$12.00	\$9.95
Cost of 2k/4k buffer	\$42/\$80	\$45/NA	NA/NA	NA/NA	\$199* /NA	\$50/NA
Unit price	\$750	\$995	\$970-\$995	\$890	\$995	\$749

We've researched the under-\$1,000 80-column dot matrix printers currently available, and have made some key comparisons in the chart to the right. Check it out.

All the printers support the full 96-character ASCII set, print on pin feed non-thermal multi-copy paper, accept forms in various widths up to 9.5", and easily interface to all popular small computers.

If you want to print graphics or feed single sheets of paper through your printer, we can't help you. But if you want as much data buffer storage as you can get, a 9 x 7 dot matrix for better looking characters, a condensed character set that's great for printing multiple columns of numbers, a readily available low cost ribbon, and documentation that includes complete schematics and troubleshooting procedures, then we can help you a lot. And we can offer you something else that's new to the low-cost printer market. Our 30 day BUY BACK guarantee. If you buy a MICROTEK printer and are unhappy with it, for any reason, you can return it within 30 days for a full refund. It's that simple.

Does MICROTEK really outperform them all? You be the judge.

\* Memory buffer alone not available, includes graphics option

Comparison data from manufacturer's current (September '79) literature.

### NOW CHECK THIS COUPON...

Send me more information

MICROTEK, Inc., 7844 Convoy Court, San Diego, CA 92111  
(714) 278-0633

Name

Address

City

State

Zip

Phone

Dealer inquiries invited.



the rich body of published descriptions of chess playing programs on the theory that a program structure capable of supporting a chess game should be adequate for most simpler board games. (See the computer chess material listed in the bibliography.)

The program structure consists of the following parts which will be analyzed in turn: the main game control routine and subroutines for initialization; board display; move input; legal move checking; legal move generating; computer move selection; and board evaluation. The following discussion will consider each of these, since each typifies a routine needed for almost any board program.

First I'll discuss the main game control procedure. This procedure must first call the subroutine that gives initial values to the board squares and to the board evaluation array. Then it must display the board on the video screen or print it on the Teletype and ask Black to make the first move. It must call the appropriate subroutine to check each move made for legality, and must terminate the game and declare the score if there are no legal moves. If the user wants the computer to make a play, it must call the subroutine that selects a move for the computer.

The board initialization routine is the simplest: Since the board is empty at the start of the game, it is filled with zeroes, except for the four center squares that must be covered in the first four moves. The out-of-bounds squares are filled with threes (see figure 3). If this were a game such as checkers, which starts with pieces on the board, they would have to be indicated by assigning appropriate initial values for the occupied squares. The strategic value of each square (high for corner squares, low for center squares, negative for next to corner squares, etc) is also entered by the initialization subroutine into the evaluation array (see figure 4).

Next comes the board display routine. Here a simple Teletype oriented printout of the 8 by 8 board was chosen. It would have been more elegant and little more trouble to use POKE commands to directly alter squares on a board displayed on the video monitor, and to represent the pieces with good-looking symbols from my character generator, but I decided to forego these luxury features in the interests of program portability. I also made an effort to limit each display frame to 15 lines so it would not disappear off the top of a 16 line video display monitor.

Before a player is asked to move, the computer must see if that player has any legal moves. This is done by a subroutine

that checks for the existence of a legal move. It first searches for an empty square; if it finds one, it checks to see if there is an adjacent square occupied by an opponent. The flattening of the two-dimensional board into one dimension causes adjacent squares to be in positions that are +1, +11, +10, +9, -1, -11, -10, or -9 squares away from the square in question (see figure 2). These adjacent squares are checked in turn. If a square is found that is occupied by an opponent, the search continues in the same direction as long as more opponent's pieces are found. When the first square that does not have an opponent's piece is found, it is examined. If it contains one of the player's pieces, the move is legal; if it is empty or out-of-bounds, the move is illegal. This search process is continued until a legal move is found, or it is established that there is no legal move. Modifications of this search routine will work for games anywhere in the range between tic-tac-toe and chess, inclusively.

The next routine used is the input routine. I decided to ask the user to input two numbers, giving the x and y coordinates of the square to which the player wishes to move. I avoided alphabetic input since I wanted the program to work for BASIC without string variables. I also provided that the input of the coordinates (0,0) would be a signal that the user wants the computer to make the next move. Both approaches can be used for almost any board game.

Once a play is entered, the next step is to see if it is legal. If so, the computer must make the play and change the color of any pieces turned over by the play. If it is not legal, the computer must ask the player to try another play. The routine used to check and execute the move is very similar to that mentioned earlier for checking the legality of moves. However, unlike the legal move routine, the routine cannot stop after finding that a play allows turnovers in one direction, but must continue to make all turnovers in all directions the player is entitled to.

Some moves may affect the strategic value of board squares. For instance if a piece is placed in a corner, the squares next to that corner no longer are dangerous, so their values in the evaluation array must be changed from highly negative values to slightly positive. This is the only change in evaluation values made during the running of the present program. Undoubtedly it could be improved by introducing a number of other changes reflecting particular board configurations and the possibility that a square might have different values for

# DELTA IS READY . . .

WITH  
WITH  
WITH

## 32K or 16K RAM

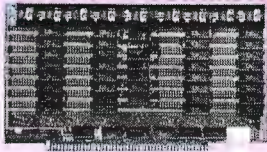

- 16K or 32K Static Memory. ● S-100 Bus Connector. ● 9 Regulators provide excellent heat distribution. ● Extended addressing (bank switching).
- Low power requirement. ● Phantom line.
- 20-Page operating manual. ● Full 1-year warranty. ● 32K version assembled and tested \$485.00. ● 16K version available assembled and tested, \$290.00.

## Double Density Disk Controller 8" or 5"

This One



Works!!

- Designed for CPM®. ● On Board Boot. ● 2MHz-4MHz Operation. ● Switch Selectable Write Precomp. ● "Personality Board" to modify drive configurations (no jumper wires). ● 2 Data separators; one digital, one analog. ● Drive Diagnostic Software included. ● Complete documentation. ● Runs without occupying any system RAM. ● Transparent Density Select. **\$385.00.**

SOLUTIONS  
SOLUTIONS  
SOLUTIONS

## DP Z-80 CPU

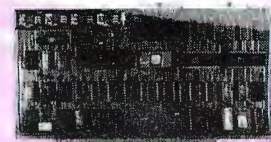

- 2MHz or 4MHz operation (jumper selectable).
  - Power on jump to On Board Eprom (2708 or 2716).
  - M1 Wait State for 160% thrupt enhancement with 450ns memory. ● 3 Parallel I/O ports.
  - Two Serial RS-232 I/O ports. ● Baud rates: 50 to 19.2K. **\$260.00.**
- (Cable and Eprom extra)

ALL  
YOU  
EVER  
NEED!!

## DP S-100 Mainframe



- 12 slot S-100 Motherboard with power supply +8@20a, ±16@6a (nylon card guides).
- Mates with disk systems shown in center column.
- Neat, compact, extremely reliable mainframe.
- Also available with S-44 2 user, 3 CPU system with features similar to Multi-user TRS-80 Expansion Package. **Kit \$295.00**

## Disk Drive Storage

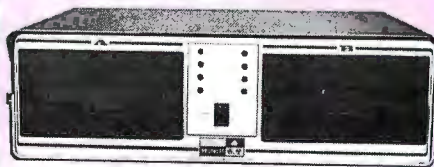

- Cabinet comes with multiple power.
- Supply to suit all popular disk drives ±5@5a, +24@6a.
- DP-1000K Twin double density Shugart SA-800B or Siemens FDD-100-8. (2 megabytes). **\$1350.00**
- DP-2000K Double sided, double density Shugart SA-850-R or Siemens FDD-200-8 (2 megabytes). **\$1850.00**
- Drive box less drives with ample power supply. **Kit \$295.00**

## Ultimate TRS-80 Expansion Package - 340K of Double Density



- Cost effective Z-80 15 slot dual drive S-44 5" computer. Mates with TRS-80 or with terminal.
- Excellent expandable starter system for small business.
- Also an unbeatable choice for dedicated word processor applications or industrial scientific use (80 x 24 video).
- The S-44 card set ensemble is specifically designed for business engineering and technical applications.
- 50-60 Hz (110/220VAC).
- Provides expansion to 64K CPM operating system, modems, multiuser, etc. **\$1775.00 (32K)**

West:

### DELTA PRODUCTS

1653 E. 28th Street  
Long Beach, Calif. 90806  
Tel: (213) 595-7505



East:

### DELTA PRODUCTS

1254 South Cedar Road  
New Lenox, Illinois 60451  
Tel: (815) 485-9072



Black and White in some circumstances. Chess playing programs often have entirely separate evaluation routines for beginning, middle and end game positions.

Finally come the most complicated and interesting subroutines, those for choosing a move for the computer. These use an approach suggested by Shannon in his classic article, an approach later refined by numerous other researchers (see the bibliography). This is the minimax algorithm. Assume that the computer is to make a play for White. It generates all legal moves for White (using the legal move checking procedure discussed above). As each legal move is generated, the computer considers all possible replies by Black. An evaluation routine is called to calculate the strategic value to Black of the board position after Black has played. The minimax strategy calls for the computer to select that legal play for White that *minimizes* the *maximum* value of the response Black can make.

For instance, suppose White has two legal plays, and that for the first play Black may make reply A with value to Black of 80, or reply B with value 90. For White's other possible move, Black may make reply C with value to Black of 100, or reply D with value 50 (see figure 5). Using the minimax strategy, White will choose the first move. This ensures that even if Black makes his best reply, he cannot achieve a board position worth more than 90 evaluation points.

This procedure can be extended to any depth. However, the number of moves to be evaluated, and consequently the computer time needed, rises at an astronomical rate. In the middle game in chess, each side may have 50 legal moves. This means that the complexity of search is of the order of  $50^n$ , where  $n$  represents the depth of the search. This is a very large number even for a relatively shallow search, which may explain why world championship computer chess matches are usually won by very large and fast computers. In Reversi there is an average of approximately 8 possible legal plays per turn. This means that

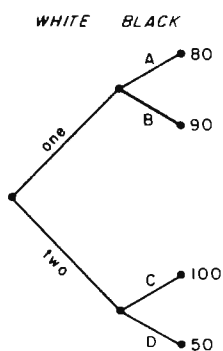

Figure 5: Minimax strategy tree, showing alpha-beta pruning. Minimax is a game theory strategy in which the object is to minimize the value of the opponent's maximum response. In this illustration, White has two moves to choose from: move one enables Black to counter with moves having strategic values of 80 or 90 (the higher the number, the better). Move two, on the other hand, enables Black to respond with moves having values of 50 or 100. Move one is the preferable move for White, since it minimizes Black's maximum response to 90, rather than 100. It is not necessary for the computer, playing the role of White, to analyze the move two branch any further, since it has already been eliminated by the minimax strategy. That branch can therefore be pruned to save computing time.

for a search of depth 2 (ie: to consider all possible moves by White and all possible replies by Black) 64 final board positions would have to be evaluated. A search of depth 4 would require 2796 evaluations.

Computer chess programmers have adopted a number of tricks to speed up the search process. Many of these tricks are adaptable to other types of board games; one of them is used here. This is what artificial intelligence specialists call alpha-beta pruning. A simple example may be given. Consider again the situation mentioned above, in which White has two legal plays. For play one, Black may make play A with value 90 or play B with value 80. For play two, Black may make play C with value 100 or play D with value 50 (see figure 5). Suppose the computer evaluates play one first. It discovers that the best that Black can do if White makes play one is to achieve a 90 point position. Now the computer starts to evaluate White's play two. It finds that Black has reply C which gives it a 100 point position. It need consider no further replies to play two, since it already knows enough to realize that play two is inferior to play one under the minimax approach, ie: Black has at least one reply to play two which is better for Black and hence worse for White than any of Black's replies to play one.

Another important method used for speeding the operation of chess programs, but not yet incorporated in my Reversi program, is that of saving particularly good moves (or particularly harmful replies by an opponent) and trying them in other situations. Thus Black may have a reply that is extremely damaging for almost any move White makes, plus a number of weaker replies. It pays to check Black's most powerful replies to previously checked White moves first, since a good reply to one move is often a good reply to other moves.

A sure way to speed up evaluations substantially and allow a deeper search is to use a compiled rather than interpreted language or to rewrite the program (or at least the move selection strategy) in assembler language. Again it is instructive to note that most championship chess programs are written in assembler language to obtain an extra edge in the depth of search possible under the time limits enforced in chess tournaments.

Once a game program is up and working, the most interesting point for further effort is to try to improve the program's strategy. It certainly helps to be a good player of the game, or at least to have read some background material on the theory of play. One ingenious method sometimes

# the Ultimate Software Tool:

AVAILABLE FROM



## Micro Data Base Systems, Inc.

A FULL NETWORK DATA MANAGEMENT SYSTEM FOR MICRO COMPUTERS

### MDBS IS A VERSATILE DATA BASE MANAGEMENT SYSTEM

- PROVIDES FLEXIBILITY OF A FULL NETWORK DATA BASE SYSTEM
- EFFECTIVE REPRESENTATION OF COMPLEX DATA STRUCTURES
- RECORDS CAN BE ORDERED ON VARIOUS SORT KEYS
- COMMANDS TO ADD, DELETE, UPDATE, SEARCH AND TRAVERSE THE DATA BASE
- SORTED, FIFO, LIFO, NEXT AND PRIOR SET ORDERING PROVIDED
- PROVIDES DATA PROTECTION
- STRAIGHTFORWARD USE OF ISAM-LIKE STRUCTURES
- COMPARABLE TO DATA BASE SYSTEMS PREVIOUSLY AVAILABLE ONLY ON LARGER COMPUTERS

### MDBS IS CODASYL ORIENTED WITH EXTENSIONS

- EXPLICIT REPRESENTATION OF MANY-TO-MANY SETS
- RECORD TYPES MAY OWN OTHER OCCURRENCES OF THE SAME RECORD TYPE
- DIFFERENT RECORD TYPES CAN PARTICIPATE IN A SINGLE SET
- MULTIPLE LEVELS OF READ/WRITE PROTECTION
- NAMES OF DATA ITEMS, RECORDS, SETS AND FILES ARE WHOLLY USER DEFINABLE

### MDBS IS FOR THE SERIOUS APPLICATIONS PROGRAMMER

- POWERFUL COMPONENT IN INFORMATION PROCESSING
- RELIEVES TEDIUM OF FILE HANDLING DETAILS
- OEMS CAN RAPIDLY AND INEXPENSIVELY DEVELOP APPLICATION SOFTWARE
- USEFUL IN DISTRIBUTED PROCESSING ENDEAVORS

### FEATURES

- WRITTEN IN Z-80 CODE FOR MAXIMAL EXECUTION EFFICIENCY AND MINIMAL MEMORY USAGE. (8080 VERSION EXTRA).
- ROUTINES ARE CALLABLE FROM BASIC (OR OTHER HOST LANGUAGES) TO FACILITATE FAST AND EASY APPLICATION PROGRAMMING.
- ROUTINES CAN BE ORGED TO SATISFY USER REQUIREMENTS.
- SUPPORTS DATA BASES SPREAD OVER SEVERAL DISK DRIVES (MAXIMUM OF 8). DISKS MAY BE MINI- OR FULL-SIZED FLOPPIES OR HARD DISKS.
- I/O AND HOST LANGUAGE INTERFACE ROUTINES ARE ISOLATED FOR EASY ADAPTATION. PATCHES FOR MANY COMMON OPERATING SYSTEMS/BASIC LANGUAGE COMBINATIONS AVAILABLE.

CP/M is a registered trademark of Digital Research Corp.  
TRS-80 is a registered trademark of Radio Shack/Tandy Corp.

### PACKAGE INCLUDES

**MDBS·DDL DATA DEFINITION LANGUAGE ANALYZER/EDITOR.** The user specifies data structures to be used in a concise Data Definition Language (DDL). The MDBS Data Definition Language Analyzer/Editor allows the user to interactively create and edit DDL specifications and to initialize the data base for use based on these specifications.

**200 PAGE USERS MANUAL** with extensive documentation of the MDBS System.

**MDBS·DMS DATA MANAGEMENT ROUTINES.** These are the routines callable from the host language (BASIC, PASCAL, etc.) which perform the data base operations of finding, adding, and deleting records; fetching and storing data items; and traversing the (possibly complex) data structure.

**SAMPLE APPLICATION PROGRAMS** written in North Star BASIC which illustrate various features of MDBS.

### REQUIREMENTS

- Z-80 Based System (8080 Systems Extra, 6502 Version Forthcoming)
- 8 to 16K Bytes (Depending on Options) in Addition to the Operating System, Host Language and Users Program.

SOFTWARE DELIVERED ON MINI- OR FULL-SIZED FLOPPY DISKS USING CP/M<sup>®</sup>, NORTH STAR, OR TRS-80<sup>®</sup> COMPATIBLE FORMATS

- MDBS INTRODUCTORY OFFER \$750.00
- USERS MANUAL (alone) \$35.00
- Distributors and OEMS Contact MDBS for Special Rates
- Application Programming Contracts will be Considered.

Indiana Residents Include 4% Sales Tax.

**MICRO DATA BASE SYSTEMS, INC.**

P.O. BOX 248 LAFAYETTE, IN 47902

(317) 742-7388



Listing 1: BASIC program for playing the game of Reversi.

```

1   REM **** REVERSI ****
2   REM ALL REMARKS MAY BE OMITTED TO SAVE MEMORY
50  REM VARIABLES
55  REM A(100) — FOR SAVING BOARD
60  REM B(100) — BOARD
62  REM C(100) — FOR SAVING BOARD
63  REM D(8) — DISTANCE TO NEXT SQUARE IN 8 DIRECTIONS
64  REM E(100) — VALUE OF BOARD SQUARES
65  REM F — VALUE OF OPPONENT'S BEST REPLY TO
66  REM COMPUTER'S BEST PLAY
67  REM G — VALUE OF OPPONENT'S BEST REPLY TO
68  REM COMPUTER'S CURRENT PLAY
69  REM H — VALUE OF OPPONENT'S CURRENT REPLY
70  REM I — NOT USED
71  REM J, K, L — COUNTERS
74  REM M — PLAY
75  REM N — COUNTER
76  REM O — NOT USED
77  REM P — PLAYER, BLACK=-1, WHITE=1
78  REM Q — TOTAL MOVES
79  REM R, S — NOT USED
80  REM T — LOGICAL VALUE, TRUE=1, FALSE=0
81  REM U — COUNTER
82  REM V, W — TO SAVE PLAY
84  REM Z — COUNTER
105 DIM A(100)
110 DIM B(100)
112 DIM C(100)
113 DIM D(8)
114 DIM E(100)
115 REM RANDOMIZE
118 REM IF YOUR COMPUTER HAS A RANDOMIZE COMMAND, SUBSTITUTE
119 REM IT FOR LINE 115 AND OMIT LINES 118 THROUGH 150
123 PRINT "TYPE A NUMBER BETWEEN 100 AND 1000":
125 INPUT N
130 IF N<100 THEN 123
135 IF N>1000 THEN 123
137 PRINT "RANDOMIZING"
140 FOR J=1 TO N
145     LET Z=RND(0)
150 NEXT J
171 LET D(1)=1
172 LET D(2)=11
173 LET D(3)=10
174 LET D(4)=9
175 LET D(5)=-1
176 LET D(6)=-11
177 LET D(7)=-10
178 LET D(8)=-9
182 REM INITIALIZE
185 GOSUB 9000
190 REM DISPLAY BOARD
200 GOSUB 8000
205 IF Q<5 THEN 295
210 REM CHECK FOR LEGAL PLAY
215 GOSUB 1300
220 IF T=1 THEN 295
225 LET T3=T3+1
226 IF T3<2 THEN 254
228 PRINT "THE GAME IS OVER"
229 LET N=0
230 LET J=0
231 FOR Z=12 TO 89
232     IF B(Z)=-1 THEN 239
234     IF B(Z) <> 1 THEN 244
235     LET J=J+1
237     GOTO 244
239     LET N=N+1
244 NEXT Z
245 PRINT "BLACK HAS ";N;" , WHITE HAS ";J;" PIECES"
248 PRINT "DO YOU WANT TO PLAY AGAIN (0=NO, 1=YES)":
250 INPUT T
251 RESTORE
252 IF T=1 THEN 185
253 GOTO 9998
254 PRINT
255 IF P=1 THEN 260
256 PRINT "BLACK HAS NO PLAY, LOSES TURN"
258 GOTO 950
260 PRINT "WHITE HAS NO PLAY, LOSES TURN"
270 GOTO 950
295 GOSUB 1100
380 IF M<> 1 THEN 500
390 IF Q>4 THEN 430

```

```

395 REM COMPUTER PLAYS
400 REM FIRST 4 PLAYS
402 LET M=45
403 IF B(M)=2 THEN 540
404 LET M=M+1
405 GOTO 403
430 GOSUB 3000
450 REM CHECK PLAY
500 IF M<1 THEN 800
510 IF M>100 THEN 800
520 IF Q>4 THEN 600
530 IF B(M) <> 2 THEN 800
540 LET B(M)=P
550 GOTO 830
600 GOSUB 1400
640 IF T<>0 THEN 950
800 PRINT "ILLEGAL PLAY"
820 GOTO 200
830 LET Q=Q+1
950 LET P=-P

```

Listing 1 continued on page 78

used in order to find better parameters for evaluation routines is to select a variety of values for use in these routines and to have the program run a tournament against itself using the different values. The winning values are then incorporated in the revised and improved program.

I hope this description and the listing of the Reversi program will inspire readers to make their own game playing programs. The books about board games mentioned in the bibliography list over 700 games, so there are plenty of games waiting to be programmed.

#### BIBLIOGRAPHY

1. Bell, R C, *Board and Table Games From Many Civilizations*, volumes 1 and 2, Oxford University Press, London, 1960 and 1969.
2. Gardner, Martin, *Martin Gardner's New Mathematical Diversions from Scientific American*, Simon and Schuster, New York, 1966, pages 75 thru 81.
3. Gillogly, J J, "The Technology Chess Program," *Artificial Intelligence*, volume 3, 1972, pages 145 thru 163.
4. Hasegawa, Goro, with Brady, Maxine, *How to Win at Othello*, Jove Publications, New York, 1977.
5. Levy, David, *Chess and Computers*, Computer Science Press, Woodland Hills CA, 1976.
6. Murray, H J R, *A History of Board Games Other Than Chess*, Oxford University Press, London, 1952.
7. Newborn, Monroe, *Computer Chess*, Academic Press, New York, 1975.
8. Shannon, C E, "Programming a Computer to Play Chess," *Philosophy Magazine*, series 7, volume 41, March 1950, pages 256 thru 275.
9. Yost, R R Jr, "Computer Models for Board Games," *BYTE*, January 1977, pages 78 thru 81.

**Special from ACS... New Low Cost Add-On Storage for your TRS-80<sup>®</sup>**

**TRS-80<sup>™</sup> Owners . . . ACS makes it easy for you to add-on disk storage with mini-disk storage systems . . . 102k bytes of additional on-line storage.**

● **COMPARE AND SAVE**

The FD-200<sup>™</sup> drive from ACS lets you store 102.4k bytes of data on one side of the disk...compared to only 80k bytes on a TRS-80<sup>™</sup> mini-disk drive....and 102.4k bytes on the other side, as well. That's almost 205k bytes per mini-disk, something you can't do with a TRS-80<sup>™</sup> drive. Completely compatible with your TRS-80<sup>™</sup>. Can be used as No. 0, 1, 2 or 3-drive.

4-DRIVE CABLE .....\$35.00

● **AVAILABLE IMMEDIATELY**

Ready when you are...one-, two-, three-, and four-drive systems from ACS.

● **NEW LOWER PRICE**

Good news from ACS...a single-drive FD-200<sup>™</sup> cost you only \$375.

Add \$20.00 for DOS 3.0 disk after September 1, 1979.

**\$375.**



Orders received by 6:00 p.m. shipped within 3 days on Master Charge, Visa, Certified Check or Money Order.

Personal Checks require 14 days to clear. No C.O.D. Collect calls not accepted. All Hardware warranted for 90 days. Software guaranteed for replacement only.

Prices subject to change without notice.

**AUTOMATED  
COMPUTER  
SOFTWARE SERVICE**

(615) 244-2798

Division of

**Computer World INC.**

625 Main Street • Nashville, TN 37206

Circle 7 on inquiry card.

**ORDER NOW AND SAVE!**

Send Check or Money Order payable to --

**ACS • 625 Main Street • Nashville, TN 37206**

Quan.	Description	Unit Price	Total
HANDLING CHARGE \$1.50			
TENN. RES. ADD 6% SALES TAX			
<b>TOTAL</b>			

Check  
 Money Order  
 MasterCard  
 Visa  
 Card No. \_\_\_\_\_  
 Exp. Date \_\_\_\_\_

Name \_\_\_\_\_  
 Address \_\_\_\_\_  
 City \_\_\_\_\_ State \_\_\_\_\_ Zip \_\_\_\_\_



Listing 1, continued:

```

955 IF E(M) <> 64 THEN 200
960 GOSUB 5000
970 GOTO 200
1099 REM * GET A PLAY *
1100 PRINT
1101 PRINT "IF YOU WANT THE COMPUTER TO PLAY, ENTER 0,0"
1115 IF P=1 THEN 1140
1120 PRINT "BLACK";
1130 GOTO 1145
1140 PRINT "WHITE";
1145 PRINT "'S TURN, ENTER X,Y";
1150 INPUT X,Y
1160 LET M=X+1+10*Y
1170 RETURN
1299 REM * CHECK FOR LEGAL PLAY *
1300 LET T=1
1301 PRINT "CHECKING";
1302 LET M=1
1310 IF U<4 THEN 1318
1316 LET U=0
1317 PRINT ", ";
1318 LET U=U+1
1320 IF B(M) <> 0 THEN 1390
1330 LET N=1
1340 LET J=D(N)
1350 IF B(M+J) <> -P THEN 1385
1370 LET K=M+J+J
1380 IF B(K)=3 THEN 1385
1381 IF B(K)=0 THEN 1385
1382 IF B(K)=P THEN 1394
1383 LET K=K+J
1384 GOTO 1380
1385 LET N=N+1
1386 IF N<9 THEN 1340
1390 LET M=M+1
1391 IF M<90 THEN 1310
1392 LET T=0
1394 RETURN
1399 REM * MAKE A PLAY *
1400 LET T=0
1410 IF B(M)=0 THEN 1430
1420 RETURN
1430 LET N=1
1440 LET J=D(N)
1444 IF B(M+J) <> -P THEN 1700
1470 LET K=M+J+J
1480 IF B(K)=3 THEN 1700
1490 IF B(K)=0 THEN 1700
1500 IF B(K)=P THEN 1530
1510 LET K=K+J
1515 GOTO 1480
1530 LET T=1
1531 LET L=M
1532 IF L=K THEN 1700
1533 LET B(L)=P
1534 LET L=L+J
1535 GOTO 1532
1700 LET N=N+1
1705 IF N<9 THEN 1440
1710 RETURN
2999 REM CHECK COMPUTER'S PLAYS *
3000 PRINT "THINKING";
3680 LET F=9999
3690 FOR Z=12 TO 89
3700 LET C(Z)=B(Z)
3710 NEXT Z
3750 LET M=12
3752 IF U<4 THEN 3759
3753 LET U=0
3755 PRINT ", ";
3759 LET U=U+1
3770 GOSUB 1400
3780 IF T=0 THEN 3860
3790 GOSUB 3900
3800 IF H>F THEN 3840
3802 IF H<F THEN 3810
3803 REM CHOOSE RANDOM OF EQUAL PLAYS
3804 LET Z=RND(0)
3806 IF Z>0.7 THEN 3840
3810 LET F=H
3815 REM FOUND BETTER MOVE
3820 LET W=V
3840 FOR Z=12 TO 89
3850 LET B(Z)=C(Z)
3855 NEXT Z
3860 LET M=M+1
3865 IF M<90 THEN 3752
3870 LET M=W
3875 PRINT
3880 RETURN
3899 REM * CHECK OPPONENT'S REPLIES *
3900 LET H=-99999
3920 FOR Z=12 TO 89
3925 LET A(Z)=B(Z)
3930 NEXT Z
3935 LET P=-P
3940 LET V=M
3950 LET M=12
3970 GOSUB 1400
3980 IF T=0 THEN 4080
3990 GOSUB 4130
4000 IF G<F THEN 4030
4014 REM FORGET THIS PLAY
4016 LET H=G
4020 GOTO 4100
4030 IF G<H THEN 4050
4035 REM FOUND MORE HARMFUL REPLY
4040 LET H=G
4050 FOR Z=12 TO 89
4060 LET B(Z)=A(Z)
4070 NEXT Z
4080 LET M=M+1
4090 IF M<90 THEN 3970
4100 LET M=V
4105 LET P=-P
4110 RETURN
4129 REM * EVALUATE *
4130 LET G=0
4140 LET Z=12
4150 IF B(Z)=P THEN 4190
4160 IF B(Z)=0 THEN 4300
4170 LET G=G-E(Z)
4180 GOTO 4300
4190 LET G=G+E(Z)
4195 REM FORGET THIS PLAY
4200 IF G>F THEN 4500
4300 LET Z=Z+1
4400 IF Z<90 THEN 4150
4500 RETURN
4999 REM ADJUST CORNER VALUES
5000 IF M<> 12 THEN 5100
5010 LET E(13)=5
5020 LET E(22)=5
5030 LET E(23)=5
5100 IF M<> 19 THEN 5200
5110 LET E(18)=5
5120 LET E(28)=5
5130 LET E(29)=5
5200 IF M<> 82 THEN 5300
5210 LET E(72)=5
5220 LET E(73)=5
5230 LET E(83)=5
5300 IF M<> 89 THEN 5400
5310 LET E(77)=5
5320 LET E(78)=5
5330 LET E(88)=5
5400 RETURN
7999 REM DISPLAY THE BOARD
8000 PRINT " 1 2 3 4 5 6 7 8"
8200 FOR Y=8 TO 1 STEP -1
8300 PRINT Y; " ";
8400 FOR X=1 TO 8
8500 IF B(X+1+Y*10)=1 THEN 8700
8550 IF B(X+1+Y*10)=-1 THEN 8900
8600 PRINT " - ";
8650 GOTO 8990
8700 PRINT " W ";
8800 GOTO 8990
8900 PRINT " B ";
8990 NEXT X
8995 PRINT Y
8996 NEXT Y
8997 PRINT " 1 2 3 4 5 6 7 8"
8998 RETURN
8999 REM * INITIALIZE *
9000 FOR N=11 TO 90
9050 READ E(N)
9060 NEXT N
9066 FOR N=1 TO 100
9068 LET B(N)=0
9070 NEXT N
9074 FOR N=1 TO 10

```

```

9076      LET B(N)=3
9078      LET B(90+N)=3
9080      LET B(10*N-9)=3
9082      LET B(10*N)=3
9085      NEXT N
9087      LET B(45)=2
9088      LET B(46)=2
9089      LET B(55)=2
9090      LET B(56)=2
9172      LET U=5
9186      LET Q=1
9190      LET P=-1
9191      RETURN
9220      DATA 0, 64, -30, 10, 5, 5, 10, -30, 64, 0
9222      DATA 0, -30, -40, 2, 2, 2, 2, -40, -30, 0
9224      DATA 0, 10, 2, 5, 1, 1, 5, 2, 10, 0
9226      DATA 0, 5, 2, 1, 1, 1, 1, 2, 5, 0
9228      DATA 0, 5, 2, 1, 1, 1, 1, 2, 5, 0
9230      DATA 0, 10, 2, 5, 1, 1, 5, 2, 10, 0
9234      DATA 0, -30, -40, 2, 2, 2, 2, -40, -30, 0
9236      DATA 0, 64, -30, 10, 5, 5, 10, -30, 64, 0
9998      STOP
9999      END
    
```

Listing 2: Sample output of the program in listing 1.

```

IF YOU WANT THE COMPUTER TO PLAY,
ENTER 0, 0
BLACK'S TURN, ENTER X, Y
?3,4
    
```

```

      1  2  3  4  5  6  7  8
8  -  -  -  -  -  -  -  8
7  -  -  -  -  -  -  -  7
6  -  -  -  -  -  -  -  6
5  -  -  -  W  B  -  -  5
4  -  -  B  B  B  -  -  4
3  -  -  -  -  -  -  -  3
2  -  -  -  -  -  -  -  2
1  -  -  -  -  -  -  -  1
      1  2  3  4  5  6  7  8
    
```



**computer mart  
of new jersey**

Computer Mart of New Jersey  
501 Route 27  
Iselin, N.J. 08830  
(201) 283-0600

HOURS:  
Open at 10 am.  
Tuesday through Saturday

**the  
microcomputer  
people®**

**THE VITAL  
INGREDIENT:  
EXPERTISE**

Before you buy your new microcomputer, chances are you have a lot of questions. Important questions that could mean the difference between a working system and a wasted system. The vital ingredient is expertise. The microcomputer people at Computer Mart are expert at answering your questions and helping you put together the best system for your application. Whether it's for business, the home, or the laboratory, come see the experts at Computer Mart of New Jersey. We have the vital ingredient.

# BATTERY-WRAP

## WIRE WRAPPING TOOL

### MODEL BW-2630

- POSITIVE INDEXING
- ANTI-OVERWRAPPING
- BITS AVAILABLE FOR AWG 26, 28 & 30
- BATTERY OPERATED
- LIGHT WEIGHT



**\$19<sup>85</sup>**\*

**BATTERIES AND  
BIT NOT INCLUDED**

U S A  
FOREIGN  
PATENTS  
PENDING



<b>BW-2630</b>	<b>BATTERY-WRAP TOOL</b>	<b>\$19.85</b>
<b>BT-30</b>	<b>BIT FOR AWG 30</b>	<b>\$ 3.95</b>
<b>BT-2628</b>	<b>BIT FOR AWG 26 &amp; 28</b>	<b>\$ 7.95</b>
<b>RB-20</b>	<b>TWO NI-CAD BATTERIES</b>	<b>\$10.75</b>

**OK MACHINE & TOOL CORPORATION**  
3455 CONNER STREET, BRONX, N.Y. 10475, U.S.A.

PHONE (212) 994-6600 • TELEX: 125091

\*MINIMUM BILLING \$25.00 (ADD SHIPPING CHARGE \$2.00 / NEW YORK CITY / STATE RESIDENTS ADD APPLICABLE TAX.



# “onComputing™ really makes personal computers easy to understand.”



**Written in non-technical language, onComputing™ contains articles on the capabilities of microcomputers, getting started, latest reviews of personal computers, where to purchase and how to use your computer.**

**A**n anyone can learn the fundamentals of using a computer. **onComputing** readers receive practical advice and helpful hints on how to get the most out of a personal computer, explanations of computer terminology, and, periodically, an updated list of active computer clubs.

**B**enefit from the experience of other computer enthusiasts. Articles in **onComputing** are written by well known authors as well as competent amateurs. They share their ideas on how to use the computer as a tool for business, education, home entertainment, laboratory work and other applications.

**C**omputer experts edit **onComputing** for the new user, not the computer professional. The editors combine their esoteric knowledge of computer science and equipment to produce concise, non-technical material which can be readily understood by anyone interested in using a computer—for fun or profit.

**onComputing, Inc.**  
70 Main St., Peterborough, NH 03458

Start your subscription today.

EVERY THREE MONTHS **onComputing** will bring the latest developments in the field of personal computing: use, applications, books, selection—all in an easy-to-read style.

© onComputing, Inc. 1979

80 BYTE November 1979

**onComputing** Subscription Dept. P.O. Box 307, Martinsville, NJ 08836  
REGULAR subscription rate:

- U.S. 1 yr. (4 issues) @ \$8.50     Canada & Mexico, 1 yr. (4 issues) @ \$10.00
- FOREIGN (to expedite service, please remit in U.S. funds drawn on a U.S. bank.)
- Europe (and all other countries, except above), 1 yr. @ \$12.00—surface delivery.
- Start my subscription with current issue.     Start with Vol. 1 No. 1
- Bill Visa     Bill Master Charge     Bill me (North America only)

Card Number

Expiration

Signature

Name (please print)

Street/Apartment Number

City

State/Province/Country Code

7M89



# BYTE News . . .

**HOME BUS STANDARD BEING DEVELOPED:** Stanford Research Institute, Menlo Park California, and the Home Bus Standard Association, Washington DC, are conducting a feasibility study to develop a home bus standard. It will allow home electronic appliances to interact with one another over regular home wiring.

**TI MICROCOMPUTER PICTURE IN TRANSITION:** Although Texas Instruments finally introduced its 99/4 personal computer system in June, it is expected to be an interim product. TI failed to get FCC approval for the original version and also ran into processor production difficulties which forced the introduction of a high-priced personal computer system (\$1150). TI is still pursuing a rule change request with the FCC and the development of its 9985 stripped down version of its 9940 16-bit processor. TI hopes to then introduce a personal computer system for under \$500 which connects to a standard color-television receiver.

TI has also expanded its small business computer (99/7) marketing efforts. The 99/7, which starts at \$5000, will be marketed by Moore Business Forms, through over 750 sales offices as well as through computer stores and TI's own retail outlets.

**AT&T TESTING HOME INFORMATION SYSTEMS:** American Telephone and Telegraph Co has undertaken customer acceptance tests of several home information systems similar to the Viewdata system. Among the systems AT&T will test are the Knight-Ridder system (reported in the August BYTE News), a system developed by McDonnell Douglas, and a Bell Labs developed system.

The Knight-Ridder system test will take two years and involve 150 to 200 families in Miami, Florida. The system will transmit news, sports results, weather, and public information. The McDonnell Douglas system will be tested in Kansas City, Michigan, and New York. It will allow users to call a special number, key a special code on a push button phone, and receive the requested information in audible form. No details are as yet available on the Bell system.

**HEATH ACQUIRED BY ZENITH:** Heath Co, a leader in the consumer electronic kit business, was sold by Schlumberger Ltd to Zenith Radio Corp for \$64.5 million. In 1977 Heath introduced two personal computer kit systems, the H-8 which is based on the 8080 processor, and the H-11 which is based on the Digital Equipment Corp (DEC) LSI-11. Heath entered into a three-year contract with DEC. Heath also entered the adult-education market. Heath sales for the last several years have declined at a 3 to 5% rate.

Zenith, a manufacturer of radio and television receivers, has been diversifying. They have been making video monitors for terminals and cable-television converters. Immediately after the acquisition was completed, Heath announced an aggressive marketing program to sell assembled computer systems through a network of distributors and original equipment manufacturers.

**8-INCH WINCHESTER DISK MARKET STILL TRYING TO GET OFF THE GROUND:** Despite the publicity and advertising, only one manufacturer is presently shipping production quantities of 8-inch hard-disk drives. The company is International Memories Inc (IMI), which is currently shipping limited quantities of their 11 M byte drive at \$1775. IMI will introduce a 20 M byte unit early next year, and expects to reduce the price on the 11 M byte unit 10 to 20% by midyear as production is increased.

Micropolis expects to start shipping limited quantities of its 27 and 45 M byte drives soon. The introductory price for the 45 M byte drive is \$2688 and should drop to under \$2000 by midyear.

Shugart has not yet revealed its marketing plans for its 8-inch rigid drive.

**COMPUTERIZED PORTABLE HOME ENTERTAINMENT CENTER SHOWN:** Sharp Electronics recently showed a portable unit, about the size of a typical portable stereo system, which included the following: a television receiver with a 4.5 inch screen, an AM/FM radio, a stereo cassette, a digital clock, a calculator, and a personal computer. The computer's 48-key keyboard slides into the unit for storage, when it becomes necessary to transport the unit. The video screen is used for display, and the audio cassette recorder is for data and program storage. It uses BASIC, has graphics capabilities, and is expandable. No immediate marketing plans have as yet been announced.



**LOOK IT UP IN THE DATA DICTIONARY:** Data base management (DBM) systems are growing in size, sophistication, and popularity. Users, therefore, need more advanced tools for defining and keeping track of their data resources. Data dictionaries have been developed to do this and to augment existing data base management systems. The data dictionary is integrated into the data base management system's nucleus and utilities as well as managing the data resources.

On large computer systems such as the large IBM mainframes, the problem of managing these systems is acute, and data dictionaries are popular here. However, data dictionaries are now being developed for minicomputer systems as they increase in complexity. Someday you can expect to see them on microcomputer systems.

**IEEE-488 BUS INTERFACING SIMPLIFIED:** Now you can interface your computer system to the IEEE-488 bus without a special bus interface. ICS Electronics Corp, San Jose, California, has come up with an easy way of doing it. They have developed a 488-to-RS-232C interface and controller. Just place this device in the line between your terminal and processor and plug your IEEE-488 cable into the device. Now you can program your computer to process data coming from all those instruments with 488 interfaces.

**SILICON VALLEY-II DEVELOPING:** "Silicon Valley" is the nickname given to the area in California just south of San Francisco that has the highest concentration of integrated circuit manufacturers. A regional shift now appears underway as more and more integrated circuit manufacturers are opening facilities in Texas. Long the stronghold of Texas Instruments, the Dallas and Austin areas have seen the opening of plants by Mostek and Hitachi. Now, Motorola and Advanced Micro Devices are following suit. The desertion of California appears to be due to high operating costs.

**GTE TAKES ON VIEWDATA:** General Telephone and Electronics Corp has been licensed to offer Viewdata information services in the USA and Canada. Viewdata was developed by the British Post Office, and is a data base information system allowing users to access data on their television receivers via telephone lines.

**DUAL-SIDED FLOPPIES STILL IN SHORT SUPPLY:** Shugart expects to finally get into quantity production on dual-sided floppy disks by the end of the first quarter of 1980. Presently they are shipping only limited quantities. Originally introduced in early 1977, Shugart did not start shipping until early 1979. Media wear problems caused these delays and has limited production to 100 drives per day at best. Shugart has designed a completely new double-sided head which they expect will cure these problems. However, Shugart has found it necessary to increase the price of the drives. The SA850, an 8-inch drive, in 500-lot quantities will be priced from \$485 to \$580.

**FCC COMPLETES RADIO FREQUENCY RADIATION TESTS:** The FCC has completed its test of six personal computer systems and will release its data soon. Reportedly, the FCC has found that all but one exceed the interference levels permitted for devices that connect to television receivers (eg, games). The test included the Atari, Apple, PET, Heath, Southwest Technical Products, and Radio Shack systems. Only the Atari system passed. The rest caused excessive radio frequency (RF) radiation interference on nearby television receivers. None of these systems are required to meet the existing regulations. In the meantime, the large numbers of personal computer systems in use are beginning to generate interference complaints.

**8080 STILL GOING STRONG:** The 8080 microprocessor, introduced by Intel in 1974 and the integrated circuit that started the microprocessor "revolution," is still going great. This is despite improved successors such as the Z80 and 8085. An estimated 500,000 8080As are being made each month, and many purchasers are finding them in short supply. The 8080A is currently being made by five manufacturers. Prices for large quantities have gone back up to the \$3 to 4 range, after they had dipped as low as \$2.75 each in late 1978. Demand for the 8080A is expected to continue strong through mid-1980, and it should continue in production for several more years.

**MAIL:** I receive a large number of letters each month as a result of this column. If you write to me and wish a response, please include a stamped self-addressed envelope.

by Sol Libes  
ACGNJ  
1776 Raritan Rd  
Scotch Plains NJ 07076

# We're about to make a new name for ourselves.

Not that the old one was so bad. As Ithaca Audio, we've made quite a name for ourselves. As the source for CPU, memory, video display and disk controller boards to upgrade other makers' mainframes and peripherals. The company that makes those neat little RAM expansion kits. And the folks behind the world's only Z-80 Pascal compiler.

But as much as we've enjoyed improving other people's equipment, we've been quietly moving towards larger endeavors, with a lot of encouragement from our customers. Listening to people's problems, as well as their needs. And, as a prime mover behind the IEEE S-100 Bus Standard, answering some really knotty questions.

One of the results is our new identity. And our first new product: the Intersystems DPS-1. An IEEE S-100 compatible mainframe with features that live up to its looks. Dependable operation to 4 MHz. Twenty-card capacity. A modular power

supply. And something no one else has — built-in breakpoints to give you a faster, more powerful tool for testing software as well as hardware. *Directly* accessible from an easy-to-use front panel that's as *reliable* as it is functional. In short, an intelligently-designed computer for the intelligent user.

There's a lot more to Intersystems. In hardware. And software. All available through the nationwide dealer network we're now assembling.

You can watch this magazine for updates. Or contact us directly for straight, friendly answers and detailed information from key staff people. Just the way you always have. Because even though we're making a new name for ourselves, we'll never forget who made it possible.

## InterSystems

Ithaca Intersystems Inc.  
1650 Hanshaw Road/P. O. Box 91  
Ithaca, NY 14850/607-257-0190





# Alpha-Beta Pruning

---

W D Maurer  
George Washington University  
SEAS  
Washington DC 20052

---

.....  
Get your shears out, and  
get ready to cut back your  
game trees, thereby saving  
both space and time  
.....

Sooner or later, almost everyone with a small system gets the idea of programming it to play chess, checkers, or some other two-person board game. Most of us give up before we start because we have no idea how to determine the best move in any given situation. The other aspects of playing a game are generally no problem.

We can see how to represent 64 squares on a board by 64 bytes in memory, each of which contains a code number which might be 3 for Bishop, 6 for King, or 0 for a blank square, and so on. We can see how to write a program for each piece, determining where it can move in a given situation depending upon the rules of the game. For example, a Bishop can move as far as possible in any of four directions, so we have to write a program to search in one direction until it finds a square that is not blank (ie: the corresponding byte does not contain 0, the code for a blank square). If this square is  $n$  squares away from where the Bishop is currently positioned, then there are  $n - 1$  possible moves that the Bishop can make in that direction. This loop is then repeated, once for each of the four directions.

Finally, we can see how to write a

program that would find all of the pieces on the board, would determine the type of each piece, and would find all possible moves for each piece, according to its type. In this way we could get a list of all of the moves that could be made by one player in any given situation. But to find the best of these defies the low-level intuition that most of us rely upon.

In this article, I will describe a general procedure for programming board games, relying heavily on chess in my examples, but utilizing procedures that can be applied in any board game where you have to "look ahead." The logic is roughly as follows: if I make move X, then my

opponent will make move Y; if I make move Z, then my opponent can make move U, which is better for him than move Y, so I shouldn't make move Z; but if I make move W...and so on.

The first illustration will be from a famous dramatic finish to a chess game. This is illustrated in figure 1. White is already far ahead, having a Queen and a Knight, whereas Black has only a Rook and two pawns. To finish the game quickly, White lets Black capture his Queen, then gives checkmate with his Knight. For those who have forgotten their chess (and also to illustrate what the computer does when it sees this position), the entire finish of the game is illustrated in figure 2 (see page 88).

It is clear that the computer has to perform a complete analysis of the given position in a game; much more complete than that given in either figure 1 or figure 2. For example, look at White's first move: N-R6 double check. In chess terminology, as soon as White makes this move, Black's next move is "forced." There is nothing that Black can do except move K-R1. But what does this mean? Black actually has several moves, but all of the others are illegal because White would be able to capture his King. Specifically:

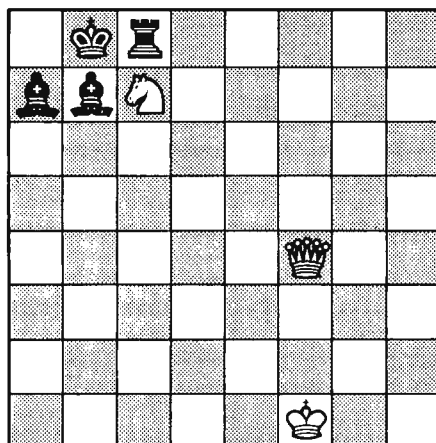

1. N-R6 dbl ch    K-R1  
2. Q-N7 ch        R x Q  
3. N-B7 mate

Figure 1: Chessboard layout just prior to the conclusion of a famous dramatic ending to a chess game.

- If Black plays R-B2 (interposing the Rook), then White plays NxK (capturing the King with his Knight).
- If Black plays PxN (capturing the Knight), then White plays QxK

*Text continued on page 90*

# 6809 PROCESSING POWER!

## The Percom SBC/9™. Only \$199.95.

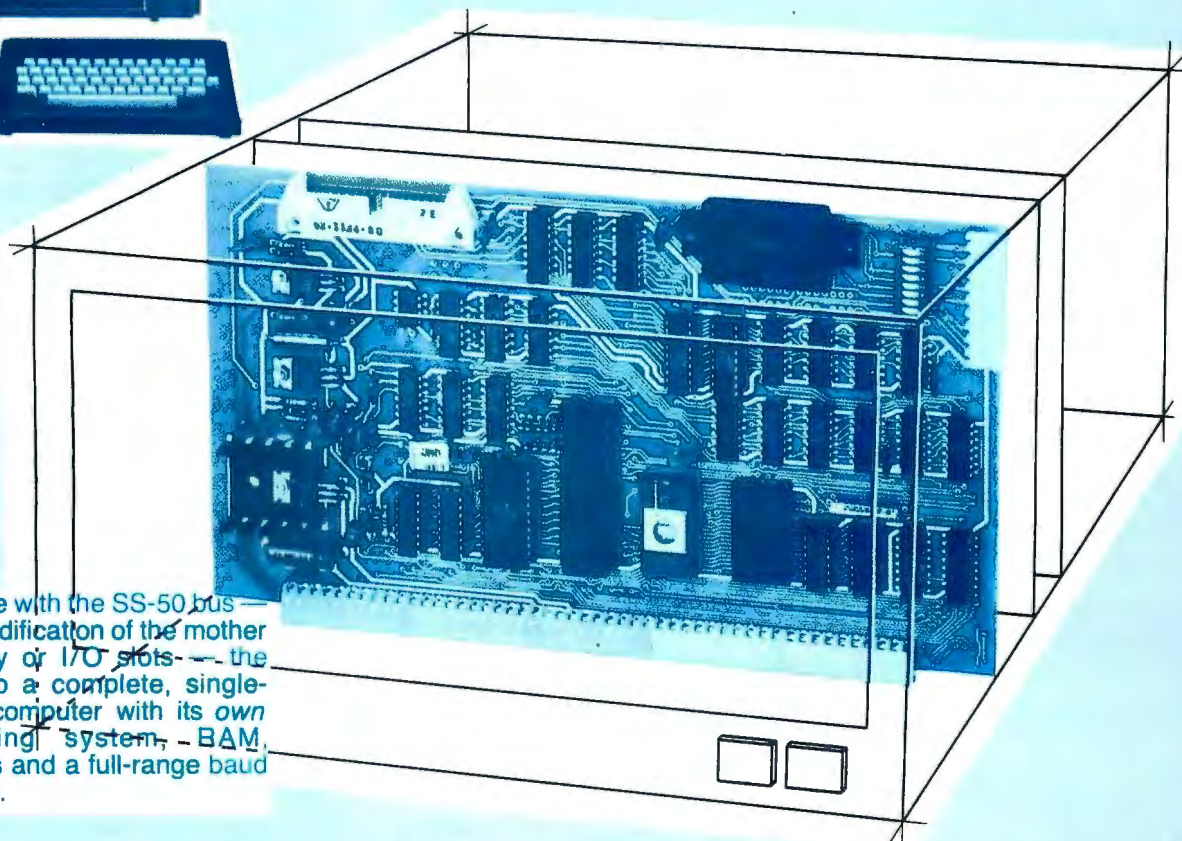

Fully compatible with the SS-50 bus — requiring *no* modification of the motherboard, memory or I/O slots — the SBC/9™ is also a complete, single-board control computer with its own ROM operating system, RAM, peripheral ports and a full-range baud clock generator.

## Make the SBC/9™ the heart of your computer and put to work the most outstanding microprocessor available, the 6809.

### the Mighty 6809

Featuring more addressing modes than any other eight-bit processor, position-independent coding, special 16-bit instructions, efficient argument-passing calls, autoincrement/autodecrement and more, it's no wonder the 6809 has been called the "programmers dream machine."

Moreover, with the 6809 you get a microprocessor whose programs typically use only one-half to two-thirds as much RAM space as required for 6800 systems, and run faster besides.

And to complement the extraordinary 6809, the Percom design team has developed PSYMON™, an extraordinary 6809 operating system for the SBC/9™.

### PSYMON™ — Percom SYstem MONitor

Although PSYMON™ includes a full complement of operating system commands and 15 externally callable™ trademark of Percom Data Company, Inc.

utilities, what really sets PSYMON™ apart is its easy hardware adaptability and command extensibility.

For hardware interfacing, you merely use simple, specific device driver routines that reference a table of parameters called a Device Control Block (DCB). Using this technique, interfacing routines are independent of the operating system.

The basic PSYMON™ command repertoire may be readily enhanced or modified. When PSYMON™ first receives system control, it initializes its RAM area, configures its console and then 'looks ahead' for an optional second ROM which you install in a socket provided on the SBC/9™ card. This ROM contains your own routines that may alter PSYMON™ pointers and either subtly or radically modify the PSYMON™ command set. If a second ROM is not installed, control returns immediately to PSYMON™

- Provision for multi-address, 8-bit bidirectional parallel I/O data lines for interfacing to devices such as an encoded keyboard.
- A serial interface Reader Control output for a cassette, tape punch/reader or similar device.
- An intelligent data bus: multi-level data bus decoding that allows multiprocessing and bus multiplexing of other bus masters.
- Extended address line capability — accommodating up to 16 megabytes of memory — that does not disable the on-board baud rate clock or require additional hardware in I/O slots.
- On-board devices which are fully decoded so that off-card devices may use adjoining memory space.
- Fully buffered address, control and data lines.

The SBC/9™, complete with PSYMON™ in ROM, 1K of RAM and a comprehensive users manual™ costs just \$199.95.

# PERCOM

PERCOM DATA COMPANY, INC.  
211 N. KIRBY GARLAND, TEXAS 75042  
(214) 272-3421

Percom 'peripherals for personal computing'

To place an order or request additional literature call toll-free 1-800-527-1592. For technical information call (214) 272-3421. Orders may be paid by check, money order, COD or charged to a VISA or Master Charge account. Texas residents must add 5% sales tax.

Circle 305 on inquiry card.

PRICES AND SPECIFICATIONS SUBJECT TO CHANGE WITHOUT NOTICE



# Welcome to Percom's Wide World

## SS-50 Bus LFD-400™ and LFD-800™ Systems



Each LFD mini-disk storage system includes:

- drives with integral power supplies in an enamel-finished enclosure
- a controller/interface with ROM operating system plus extra ROM capacity
- an interconnecting cable
- a comprehensive 80-page users manual

## Low-Cost Mini-Disk Storage in the Size You Want.

Percom LFD mini-disk drive systems are supplied complete and ready to plug in the moment they arrive. You don't even have to buy extra memory. Moreover, software support ranges from assembly language program development aids to high-speed disk operating systems and business application programs.

The LFD-400™ and -400EX™ systems and the LFD-800™ and -800EX™ systems are available in 1-, 2- and 3-drive configurations. The -400, -400EX drives store 102K bytes of formatted data on 40-track disks, and data may be stored on either surface of a disk. The -800, -800EX drives store 200K bytes of formatted data on 77-track disks.

The LFD-1000™ systems (not pictured) have dual-drive units which store 800K bytes on-line. The LFD-1000™ controller accommodates two drive systems so that a user may have as much as 1.6M bytes on-line.

### Mini-disk storage system prices:

MODEL	1-DRIVE SYSTEM	2-DRIVE SYSTEM	3-DRIVE SYSTEM
For the SS-50 Bus:			
LFD-400™	\$ 599.95	\$ 999.95	\$1399.95
LFD-800™	895.95	1549.95	2195.95
For the EXORciser* Bus:			
LFD-400EX™	\$ 649.95	\$1049.95	\$1449.95
LFD-800EX™	945.95	1599.95	2245.95
LFD-1000™	(dual) \$2495.00	(quad) \$4950.00	—

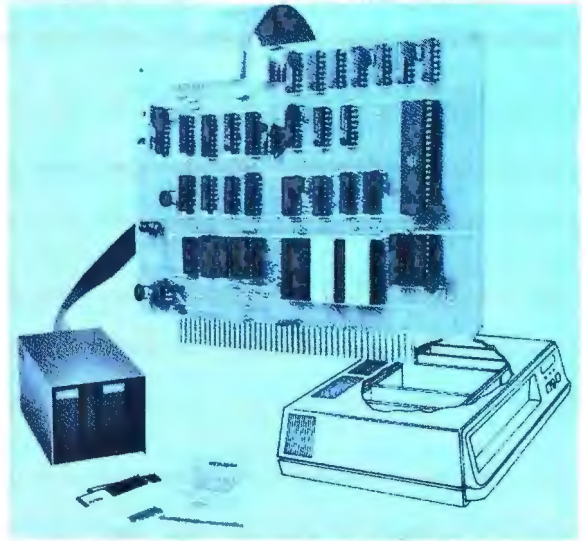

EXORciser\* Bus LFD-400EX™, -800EX™ Systems

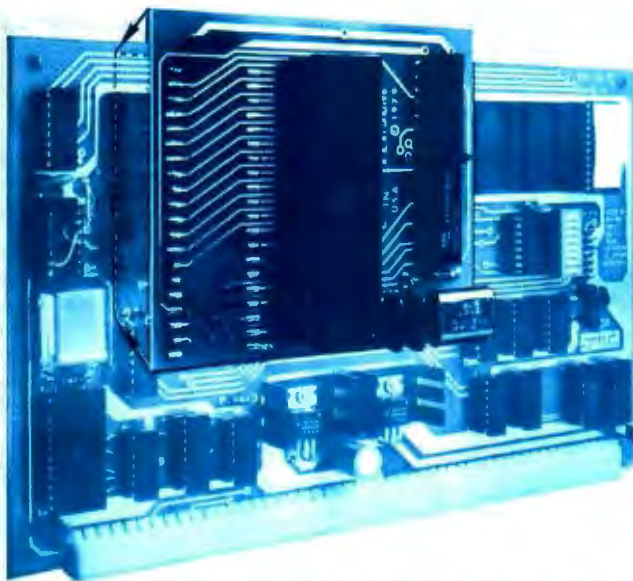

### Upgrade to 6809 Computing Power. Only \$69.95

Although designed with the SWTP 6800 owner in mind, this upgrade adapter may also be used with most other 6800 and 6802 MPUs. The adapter is supplied assembled and tested, and includes the 6809 IC, a crystal, other essential components and user instructions. Restore your original system by merely unplugging the adapter and a wire-jumpered

DIP header, and re-inserting the original components. Also available for your upgraded system is PSYMON™ (Percom System MONitor), the operating system for the Percom 6809 single-board computer. PSYMON™ on 2716 ROM costs only \$69.95. On diskette (source and object files), only \$29.95.

### Data Terminal & Two-Cassette Interface — the CIS-30+



- Interface to data terminal and two cassette recorders with a unit only 1/10 the size of SWTP's AC-30.
- Select 30, 60 or 120 bytes per second cassette interfacing; 300, 600 or 1200 baud data terminal interfacing.
- Optional mod kits make CIS-30+ work with any microcomputer. (For MITS 680b, ask for Tech Memo TM-CIS-30+-09.)
- KC Standard/Bi-Phase-M (double frequency) cassette data encoding. Dependable self-clocking operation
- Ordinary functions may be accomplished with 6800 Mikbug\* monitor

Prices: Kit, \$79.95; Assembled, \$99.95. Prices include a comprehensive instruction manual. Also available: Test Cassette, Remote Control Kit (for program control of recorders), IC Socket Kit, MITS 680b mod documentation and Universal Adapter Kit (converts CIS-30+ for use with any computer).



# of 6800 Microcomputing.

## 6800/6809 SOFTWARE

### System Software

**6800 Symbolic Assembler** — Specify assembly options at time of assembly with this symbolic assembler. Source listing on diskette ..... \$29.95  
**Super BASIC** — a 12K extended random access disk BASIC for the 6800 and 6809. Supports 44 commands and 31 functions. Interprets programs written in both SWTP 8K BASIC (versions 2.0, 2.2 & 2.3) and Super BASIC. Features: 9-digit BCD arithmetic, Print Using and Linput commands, and much more. Price ..... \$49.95  
**TOUCHUP™** — Modifies TSC's Text Editor and Text Processor for Percom mini-disk drive operation. Supplied on diskette complete with source listing ..... \$17.95

### Operating Systems

**INDEX™** — This easy-to-use disk-operating and file management system for 6800 microcomputers is fast. I/O devices are serviced by interrupt request. INDEX™ accesses peripherals the same as disk files — new devices may be added without changing the operating system. Other features: unlimited number of DOS commands may be added • over 60 system entry points • display only those files at or above user-specified file activity level • versions available for SWTP MF-68, Smoke's BFD-68 and Motorola's EXORciser\*. Price ..... \$99.95  
**MINIDOS-PLUSX™** — An extension of the original MINIDOS™ for LFD-400™ mini-disk systems, MINIDOS-PLUSX™ manipulates files by six-character names. Supports up to 31 files. Resident commands include Initialize, Save, Allocate, Load, Files (directory list), Rename and Delete. Supplied on 2708 ROM with a minidiskette that includes transient utilities such as Copy, Backup, Create, Pack and Print Directory. Price ..... \$34.95.  
**PSYMON™** — Percom SYStem MONitor for the Percom single-board/SS-50-bus-compatible 6809 computer accommodates user's application programs with any mix of peripherals **without** modifying programs. PSYMON™ also features character echoing to devices other than the communicating device, sophisticated register and memory dump routines and more. Price (on 2716 ROM) ..... \$69.95.  
**WINDEX™** — Described in detail elsewhere on this page.

### Business Programs

**General Ledger** — For 6800/6809 computers using Percom LFD mini-disk storage systems. Requires little or no knowledge of bookkeeping because the operator is prompted with non-technical questions during data entry. General Ledger updates account balances immediately — in real time, and will print financial statements immediately after journal entries. User selects and assigns own account numbers; tailors financial statements to firm's particular needs. Provides audit trail. Runs under Percom Super BASIC. Requires 24K bytes of RAM. Supplied on minidiskette with a comprehensive users manual. Price ..... \$199.95.

**FINDER™** — This general purpose data base manager is written in Percom Super BASIC. Works with 6800/6809 computers using Percom LFD-400™ mini-disk drive storage systems. FINDER™ allows user to define and access records using his own terminology — customize file structures to specific needs. Basic commands are New, Change, Delete, Find and Pack. Add up to three user-defined commands. FINDER plus Super BASIC require 24K bytes of RAM. Supplied on minidiskette with a users manual. Price ..... \$99.95  
**Mailing List Processor** — Powerful search, sort, create and update capability plus ability to store 700 addresses per minidiskette make this list processor efficient and easy to use. Runs under Percom Super BASIC. Requires 24K bytes of RAM. Supplied on minidiskette with a users manual. Price ..... \$99.95.

### From the Software Works

Development and debugging programs for 6800  $\mu$ Cs on diskette:  
 Disassembler/Source Generator ..... \$30.95  
 Reloc'ng Disas'mblr/Segmented Text Gen ..... \$40.95  
 Disassembler/Trace ..... \$25.95  
 Support Relocator Program ..... \$25.95  
 Relocating Assembler/Linking Loader ..... \$55.95  
 SmithBUG\*\* (2716 EPROM) ..... \$70.00

### 1/2-Price Special on Hemenway Software!

CP/68 $\frac{1}{2}$  disk operating system ..... \$ 49.97  
 STRUBAL+ $\frac{1}{2}$  compiler ..... \$124.97  
 EDIT68 text editor ..... \$ 19.97  
 MACRO-Relocating Assembler ..... \$ 39.97  
 Linkage Editor (LNKEDT68) ..... \$ 24.97  
 Cross Reference utility ..... \$ 14.97

\*trademark of Percom Data Company, Inc.

\* trademark of Motorola Corporation

†Trademark of Hemenway Associates Company

\*\*SmithBUG is a trademark of the Software Works Company

And 'looking into' is just what you do with the Electric Window™ as you peer right into memory space where characters are being input and manipulated. Display is memory-resident, programmable and generates up to 24 80-character lines.

Other features include:

- standard character generator plus provision for optional special character generator
- dual intensity, high-lighting alphanumeric display
- scrolling by a programmable register • programmable display positioning
- programmable interlaced or non-interlaced scan
- descenders on lower case letters • users manual with application instructions and listing of WINDEX™ driver.

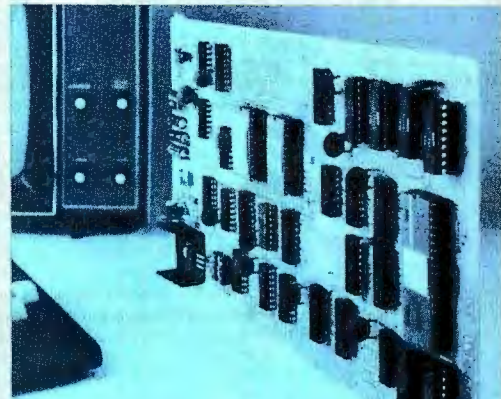

**The Electric Window.™**  
**Worth Looking Into. \$249.95**

WINDEX™ is a fast video display driver program for the Electric Window™. WINDEX™ also features: program and keyboard control of character generators • displayable control characters — under program control • automatic scrolling • a driver routine for the parallel input keyboard feature of the Percom 6809 Single-Board Computer, the SBC/9™ • auto-linking to PSYMON™, the ROM operating system for the SBC/9™. Prices: ROM version: \$39.95; LFD-400™ compatible diskette (source and object files): \$29.95.

## Now Available! the SBC/9™ MPU/Control Computer

(Single-Board-Computer/6809) — stands alone as a control computer, but also compatible with the SS-50 bus for use as an MPU card. Includes PSYMON™ (Percom SYStem MONitor) in a 1K ROM and provides for additional 1K of ROM. Also includes 1K of RAM. Features: Super Port — provision for multi-address, 8-bit bidirectional data lines • an intelligent data bus for multi-level data bus decoding • an on-board 110-baud to 19.2 kbaud clock generator • extended address capability — to 16 megabytes — without disabling baud clock or adding hardware. And much more. Supplied with PSYMON™ and comprehensive users manual. Price ..... \$199.95.

See full page ad elsewhere in this magazine for all of the SBC/9™ features.

### Full Feature Prototyping PC Boards

All of the features needed for rapid, straightforward circuit prototyping. Use 14-, 16-, 24- and 40-pin DIP sockets

- SS-50 bus card accommodates 34- and 50-pin ribbon connectors on top edge, 10-pin Molex connector on side edge • I/O card accommodates 34-pin ribbon connector and 12-pin Molex on top edge



**I/O Bus Card: \$14.95**

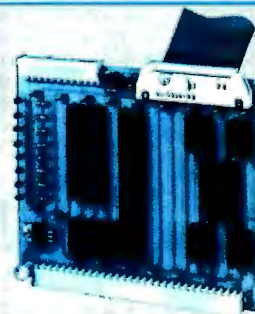

**SS-50 Bus Card: \$24.95**

- I/O card is 1-1/4 inches higher than SWTP I/O card • interdigitated power conductors • contacts for power regulators and distributed capacitance bypassing
- use wire wrap, wiring pencil or solder wiring • tin-lead plating over 2-oz copper conductors wets quickly, solders easily
- FR4-G10 epoxy-glass substrate.

To place an order or request additional literature call toll-free 1-800-527-1592. For technical information call (214) 272-3421. Orders may be paid by check, money order, COD or charged to a VISA or Master Charge account. Texas residents must add 5% sales tax.

PRICES AND SPECIFICATIONS SUBJECT TO CHANGE WITHOUT NOTICE.

Circle 307 on inquiry card.

# PERCOM

PERCOM DATA COMPANY, INC.  
 211 N. KIRBY GARLAND, TEXAS 75042  
 (214) 272-3421



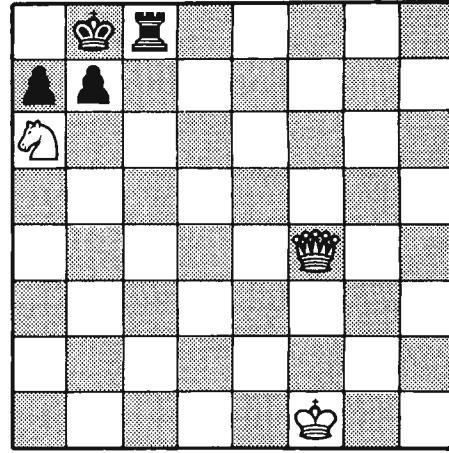
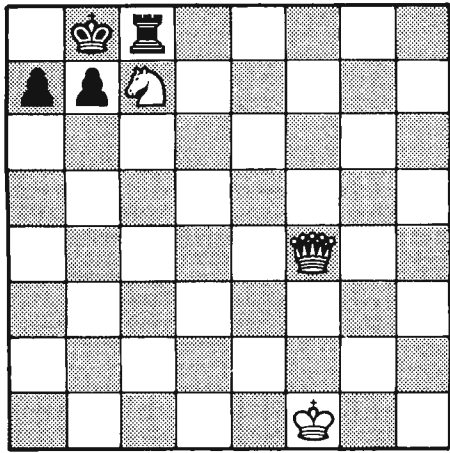

IT IS WHITE'S TURN TO MOVE, AND..... WHITE CHECKS WITH BOTH QUEEN AND KNIGHT. BLACK IS FORCED.....

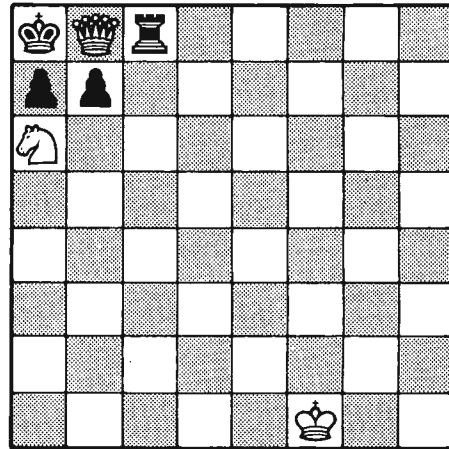
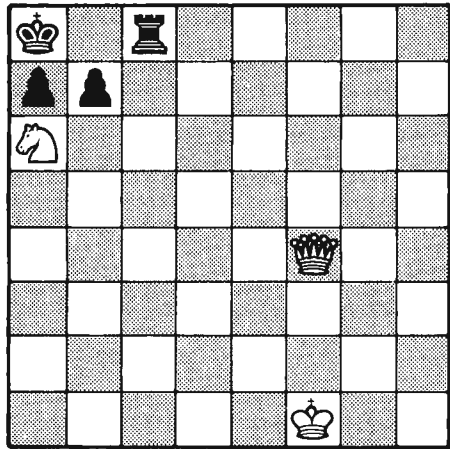

....TO MOVE INTO THE CORNER, AND.....NOW WHITE SACRIFICES THE QUEEN.

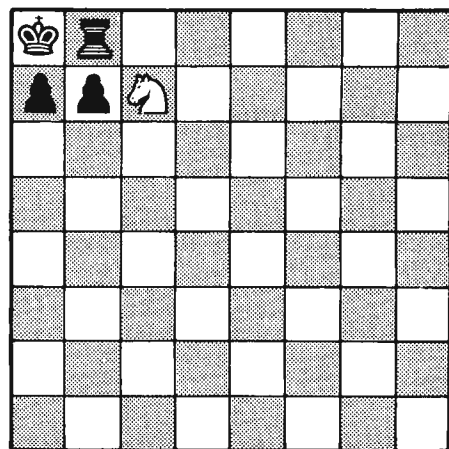
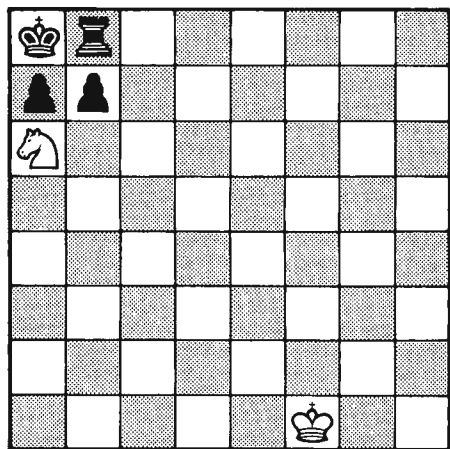

THERE IS NOTHING THAT BLACK CAN DO BUT ....WHEREUPON WHITE GIVES CHECKMATE. TO TAKE THE QUEEN.....

Figure 2: The sequence of moves that White makes to capture Black's King . . . CHECKMATE!

# a PERCOM SAMPLER



For your SS-50 bus computer — the CIS-30+

- Interface to data terminal and two cassette recorders with a unit only 1/10 the size of SWTP's AC-30.
- Select 30, 60, or 120 bytes per second cassette interfacing, 300, 600 or 1200 baud data terminal interfacing.
- Optional mod kits make CIS-30+ work with any microcomputer. (For MITS 680b, ask for Tech Memo TM-CIS-30+—09.)
- KC-Standard/Bi-Phase-M (double frequency) cassette data encoding. Dependable self-clocking operation.
- Ordinary functions may be accomplished with 6800 Mikbug™ monitor.
- Prices: Kit, \$79.95; Assembled, \$99.95.

Prices include a comprehensive instruction manual. Also available: Test Cassette, Remote Control Kit (for program control of recorders), IC Socket Kit, MITS 680b mod documentation, Universal Adaptor Kit (converts CIS-30+ for use with any computer).

MIKBUG® Motorola, Inc.

## In the Product Development Queue . . .

Coming PDQ. Watch for announcements.

**6809 Processor Card** — With this SS-50 bus PC board, you'll be able to upgrade with the microprocessor that Motorola designers describe as the "best 8-bit machine so far made by humans."

**The Electric Crayon™** — This color graphics system includes its own  $\mu$ P and interfaces to virtually any microcomputer with a parallel I/O port.

**Printer Interface** — For your TRS-80™. Interface any serial RS232 printer to your TRS-80™ with this system.

™ELECTRIC WINDOW, ELECTRIC CRAYON, Pilon-30 and Pilon-10 are trademarks of Percom Data Company, Inc.  
TRS-80 is a trademark of Tandy Corporation and Radio Shack which has no relationship to Percom Data Company.

Orders may be paid by check or money order, or charged to Visa or Master Charge credit account. Texas residents must add 5% sales tax.



For your data storage — Pilon-30™ and Pilon-10™ data cassettes

- Orders-of-magnitude improvement in data integrity over ordinary audio cassettes.
- Pilon-coated pressure pad eliminates lint-producing felt pad of standard audio cassettes.
- Smooth pilon coating minimizes erratic tape motion.
- Foam pad spring is energy absorbing. Superior to leaf spring mounted pad which tends to oscillate and cause flutter.
- Five-screw case design virtually precludes deformation during assembly.
- Price: \$2.49.

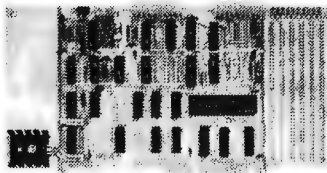

For your S-100 computer—the CI-812

- Both cassette and data terminal interfacing on one S-100 bus PC board.
- Interfaces two recorders. Record and playback circuits are independent.
- Select 30, 60, 120, or 240 bytes per second cassette interfacing, 110 to 9600 baud data terminal interfacing.
- KC-Standard/Bi-Phase-M (double frequency) encoded cassette data. Dependable self-clocking operation.
- Optional firmware (2708 EPROM) Operating System available.
- Prices: kit, \$99.95; assembled, \$129.95.

Prices include a comprehensive instruction manual. In addition to the EPROM Operating System, a Test Cassette, Remote Control Kit (for program control of recorders), and an IC Socket Kit are also available.

## CASSETTE SOFTWARE

For 8080/Z-80  $\mu$ Cs . . .

**BASIC ETC** — Developed by the co-authors of the original Tiny BASIC, BASIC ETC is easy to use yet includes commands and functions required for powerful business and scientific programs as well as for hobby applications. 9.5K bytes of RAM. 1200-baud cassette and 42-page user's manual . . . . . \$35.00

**Cassette Operating System** — EPROM (2708) COS for the Percom CI-812 dual peripheral interfacing PC card . . \$39.95

If you're programming on a 6800  $\mu$ C, you'll want these development and debugging programs written by Ed Smith of the Software Works:

**Disassembler/Source Generator** — Disassembles SWTP Resident Assembler, TSC Mnemonic Assembler/Text Editor or Smoke Signal Mnemonic Assembler/Text Editor and produces compacted source code suitable for re-editing. Prints or displays full assembly-type output listing. 4K bytes of RAM. (Order M68SG) . . . . . \$25.00

**Disassembler/Trace** — Use to examine (or examine and execute) any area of RAM or ROM. "Software-single-step" through any program, change the contents of CPU or memory location at any time, trace subroutines to any depth. 2.3K bytes of RAM. (Order M68DT) . . . . . \$20.00

**EPROM Support/Relocator Program** — This program relocates a program in any contiguous area of RAM or ROM to anywhere in RAM. Use to assemble and test programs in RAM, adjust programs for EPROM operating addresses and then block move to your EPROM burner address. 952 bytes of RAM. Loads at hex 1000. (Order M68EP) . . . . . \$20.00

**Relocating Assembler & Linking Loader (M68AS)** . . . . . \$50.00

**Relocating Disassembler & Segmented Source Text Generator (M68RS)** \$35.00

**Americana Plus** — 14 tunes for the Newtech Model 68 Music Board in machine language ready to load and run. Cassette compatible with Percom CIS-30+ and SWTP AC-30. Order MC-1SW . . \$15.95

## HARDWARE

**Newtech Model 68 Music Board** — Produces melodies, rhythms, sound effects, morse code, etc. from your programs. Includes manual with BASIC for writing music scores and assembly language routine to play them. Installs in SWTP I/O slot. Assembled & tested . . . . \$59.95

**The Percom ELECTRIC WINDOW™** — Memory-resident and programmable, this video display character generator board for your SS-50 bus displays up to 24 80-character lines. Features dual character generators, dual-intensity high-lighting. One programmable register controls scrolling. Compatible with standard video monitors . . . . \$249.95

**SS-50 Prototype Cards:**  
Large card (up to 70 40-pin ICs) \$24.95  
I/O size card . . . . . \$14.95

# PERCOM

PERCOM™ 'peripherals for personal computing'

PERCOM DATA COMPANY, INC.  
DEPT. B

211 N. KIRBY • GARLAND, TX. 75042

To order products or request additional literature, call Percom's toll-free number: 1-800-527-1592. For detail technical information call (214) 272-3421.



Text continued:

(capturing the King with his Queen).

- If Black plays anything else, then White can play either N×K or Q×K.

You might argue that the computer does not need to perform all of this analysis, because there is an old rule that states when you are in double check, you have to move your King—there is no other way out. This is perfectly true, but how do you know that you are in double check in the first place, without a similar analysis? It is easier to run through all of the moves, as described above, and verify that, in every case but one, Black's King would be captured. Additionally, look at the next position. Black does play K-R1, and now White plays Q-N8 check. This time Black is not in double check, but his next move is still forced, and Black's King can be captured in two different ways if he does not make the move he is forced to make. Specifically:

- If Black plays K×Q (capturing with

the King instead of with the Rook), then White plays N×K.

- If Black plays P-N3 (or any other move than R×Q or K×Q), then White plays Q×K.

When Black plays R×Q, White plays N-B7, which is checkmate. But the computer's job is still not finished. How can you tell that this is checkmate? The only way to tell is to look at all of Black's possible moves and make sure that White can capture Black's King in each case. From the computer's point of view, the game is never over until the King is actually captured.

A diagram of the analyses that have been carried out so far would look like figure 3. Each point (dot) in this figure denotes a position of the board. The lines between board positions denote moves. The actual moves that have been made are at the left, but there are other moves which were not taken. In Black's case, each of these led to Black's King being captured. In White's case, they were simply other possible moves that

were not made because White has a way, as shown, of winning the game. This diagram is called a *game tree*.

Figure 3: An illustration of the game tree diagram. A complete game tree diagram would enumerate all possible moves so that the optimum move could be chosen.

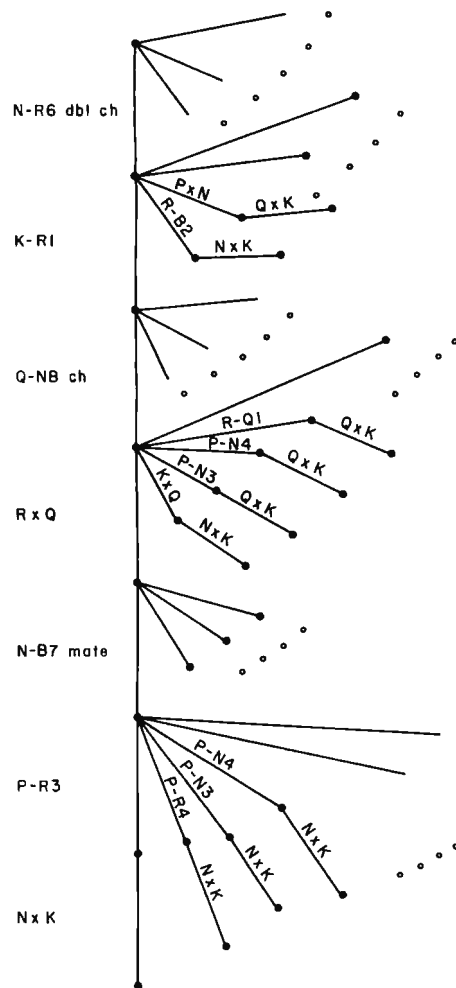

The game tree of figure 3 is a bit hard to visualize because there are so many possible moves. Therefore, in order to illustrate the processing of game trees by computer, I have drawn a simplified game tree in figure 4. In this game tree there are only two possible moves for White at each point, and only two possible moves for Black. This will almost never be the case in a real game situation; here it allows the tree to fit easily on one piece of paper, so that it can be readily visualized. Like any tree, this tree has leaves, branches, and a root; in this case A, B, C...through P are the leaves, 5 is the root, and all of the other nodes are branches.

## YOUR PERSONAL COMPUTER PROGRAM

Could Be Worth \$50 to \$100,000 In Royalty Payments

There is a big demand for Personal Computer Programs of all categories: Games, Entertainment, Educational, Personal Finance, Hobbies, Diet Nutrition, Small Business, Doctors, Lawyers, Dentists, Homeowners, etc.

You can give the programs you worked so hard to create "Maximum Exposure" with no risk of plagiarism by registering with PROTECT Registry and Referral Service.

- We will send your program description to 25 major marketers — all inquiries will be sent to you for direct negotiation.
- We will furnish copyright application materials with simple instructions, and also send in your copyright application.
- We will register your program and keep it on file for you.



GET STARTED TODAY  
SEND \$5.00 (Cash - Check - Money order) to:

# PROTECT, INC.

P.O. BOX 502

FRANKLIN PARK, IL. 60131

We will send you registry and copyright materials, major marketer list and details of our service.

(Your money cheerfully refunded if you are not satisfied with what you receive - Just Send Back ALL Materials Within 30 Days For Full Refund.)

In any game tree, the first question you must ask is whether or not it is complete. A game tree is complete if every one of its leaves corresponds to the end of the game. In figure 3, all leaves that are shown correspond to the end of the game (the King is captured), but there are some other leaves, not shown, that do not have this property. If a game tree is complete, it should be obvious that we can tell who ought to win, and the winning strategies. Suppose that the leaves B, L, A, C, and K represent a win for Black, and all other leaves represent a win for White. White (moving first) can win by moving to branch 4. Black will move to branch 1, and White now moves to branch U, winning regardless of Black's move (moving to leaf I or J).

Furthermore, this is the only winning strategy for White. If White's first move is to branch 3, then Black moves to branch Y, and Black now wins, no matter what White does (moving to branch Q or R). If White moves to branch V on his second move, then Black wins by moving to either K or L. This state of affairs will not always hold. There are positions in which White can win no matter what his first move is (suppose, for example, Black's winning positions were B, L, A, E, K...figure it out for yourself). There are also positions in which White cannot win, no matter what his first move is. If Black's winning positions are B, L, I, C, and K, and White starts by moving to 3, then Black moves to Y, whereas if White starts by moving to 4, Black moves to 1. In either case, Black can eventually win.

Now suppose that the game tree is not complete. This is presumably because it is so large that you would run out of memory if you tried to store the complete tree, so you would only store part of it. In this case it is still quite possible that there is a winning strategy for one player or the other. Suppose that Black's winning positions are B, L, I, C, and K, as in the last of the three examples above, but the other leaves of the tree are not winning positions for either White or Black. (In fact, these are not really leaves; if I had room to keep more of this game tree, I could consider further moves beyond each of these points.) It is clear that Black can still

## UP TO 2400 MEGABYTES OF HARD DISK CONTROL FOR THE S-100 BUS



**Konan's SMC-100 is versatile, fast, cost efficient. It's the disk controller that brings S-100 bus micro computers together with large capacity hard disk drives.**

### Versatile

Interfaces S-100 bus micro computers with all fixed or removable media disk drives with storage module (SMD) interfaces. Each Konan SMC-100 will control up to 4 drives ranging from 8 to 600 megabytes per drive, including most "Winchester" type drives. Up to 2400 megabytes of hard disk per controller! And you can take your pick of hard disk drives: Kennedy, Control Data, Fujitsu, Calcomp, Microdata, Memorex, and Ampex, for example.

### Fast

SMC-100 transfers data at fast, 6 to 10 megahertz rates, with full onboard sector buffering and sector interleaving, and a DMA that's faster than other popular S-100 DMA controllers.

### Cost efficient

SMC-100 is priced right to keep your micro computer system micro-priced. It takes advantage of low-cost-per-megabyte disk drive technology to make the typical cost less than \$80 per megabyte. The OEM/Dealer single quantity price is only \$1650, with driver ROM option. Excellent quantity discounts are available.

### SMC-100 availability:

Off the shelf to 30 days in small quantities. (Complete subsystems are on hand for immediated delivery.)

Konan has the answers. Talk to them today. Call direct on Konan's order number: 602-269-2649. Or write to Konan Corporation, 1448 N. 27th Avenue, Phoenix, Arizona 85009.

# KONAN™

1448 N. 27th Avenue • Phoenix, Arizona 85009 • 602-269-2649



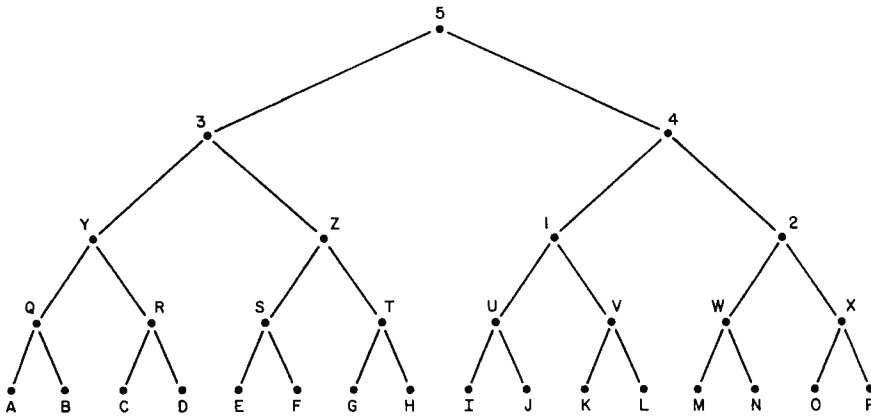

Figure 4: Simplified version of the game tree that assumes each player has only two possible moves.

win, no matter what White does, and for exactly the same reason as before.

In most cases, however, the game tree will be far from complete. In chess, for example, you might be in the middle of the game, and neither White nor Black can win the game in the next twenty-five moves. You can

still use game trees, but in a slightly different way. The first thing to do is code your knowledge as to when one position is better than another in terms of material gained and lost. For example, if White captures a pawn and loses a Bishop, or captures a Knight and loses a Rook, then Black

is obviously ahead. But what if White captures the Queen and loses both Rooks? Is that good or bad? What if White captures two pawns, but loses a Knight?

The usual pawn and piece values are: Queen = nine pawns, Rook = five pawns, Bishop and Knight are three pawns apiece. Greatly improved tables of values have been constructed; table 1 is a reprint of values (in abridged form) from R M Hyatt, the author of a chess program called BLITZ. Through the use of such a table, you can derive, for any position, a total numerical score that represents the value of that position. The function which computes this score is called the *evaluation function* corresponding to the given table.

You might think that with such an evaluation function there would be no further need for game trees. You could simply try all of the possible moves, and then choose the one with the largest value of the evaluation function. This, however, would lead to a very bad chess-playing program, rather like someone who had been playing for only a few months. The reason, of course, is that the evaluation function is only an approximation. It is very easy to lose a piece after you have made what seems to be the best move according to your evaluation function, because you have not looked far enough ahead. The best game programs use a combination of game trees and an evaluation function, together with the special technique of *alpha-beta pruning*, the subject of this article.

Once more I will set up an artificially small and simple game tree, in order to illustrate how this works. Consider the game tree of figure 5, which is exactly the same as the game tree of figure 4 except that a value of the evaluation function at each of the leaves of the tree has been specified. The evaluation function at the branches has *not* been specified, because this will be computed in a different way. Specifically, look at the leaves A and B. Since the value of the function is 26 at A, and 37 at B, you can conclude that, since it is Black's turn to play, at the branch Q Black will play to branch A. (This move assumes that the higher the value of the evaluation function, the better the position is for White, and the worse

## CHECKS IN MICRO-QUANTITIES?

# NOW THERE'S A WAY.

Wondering how to use your micro to print checks for personal and business use? Now, from ARIES, there is a way to do it easily with **continuous checks in small quantities**. And, without a huge investment.

Micro check printing eliminates time consuming, error-prone handwriting of PERSONAL, PAYROLL, or ACCOUNTS PAYABLE checks. For home or small business use, it's an idea whose time has come: A new way to make your micro pay off.

### NOW AVAILABLE FROM ARIES:

<p><b>PERSONAL CHECKS</b></p> <p>8 1/2" width (7 1/8" without margins) 3 1/2" depth 200 @ \$39.00 500 @ \$79.00</p>	<p><b>BUSINESS CHECKS</b></p> <p>8 1/2" width (7 1/8" without margins) 7" depth (includes 3 1/2" voucher, 3 1/2" check) 200 @ \$48.00 500 @ \$95.50</p> <p style="font-size: small;">Use for either Payroll or Accounts Payable</p>
---	---

Includes imprinting of payer at upper left of check—4 lines of 30 positions each, bank name and address, transit and routing numbers, and the MICR encoding at the bottom

Brochure and Samples Available Upon Request. Prices Good thru 1979  
Include BANK MICR Encoding Sheet With Order

**NO ONE ELSE OFFERS MICRO CHECK-PRINTING SO EASILY. WITH ARIES YOUR MICRO PAYS OFF.**

## ARIES

Computer Products  
P.O. Box 7932B Eugene OR 97401  
Price include freight anywhere in Continental U.S.

# SPECIAL DELIVERY

CENTRONICS MODEL 730 MINIPRINTER

A totally new printer has arrived. It delivers some special advantages to small business and home computer systems. New, expanded paper-handling capabilities. Excellent print quality and long-run reliability. All these high quality features at an affordable price is indeed *special delivery*.

**3-in-1 Paper Handling** Model 730's exclusive three-in-one paper handling system gives you built-in flexibility. Payroll checks on pre-printed continuous forms. Inventory listings on fanfold. Direct mail on cut sheets. General information on roll paper. The 730 does it all.

**Exceptional Print Quality** Model 730's 7 x 7 dot matrix prints clear, legible characters — even when printing multiple copies. The adjustable print head utilizes the same free-flight technology as Centronics' 700 Series — the most

successful line of dot matrix printers in the world — to give you longer head life and smoother operation.

**Outstanding Reliability** The simplicity of the Model 730's design employs fewer parts for higher reliability and less maintenance. You get more in-service time for your money.

**Compact Design** Model 730 packs all this performance capability into a stylish unit that can fit right on your desktop. It's no larger than a portable typewriter and weighs less than 10 pounds.

For all its features, Model 730 is priced within the budget of even the most cost-conscious systems owner. For more information on the Model 730, other products or employment opportunities, write or call today: Centronics Data Computer Corporation, Hudson, NH 03051, (603) 883-0111.

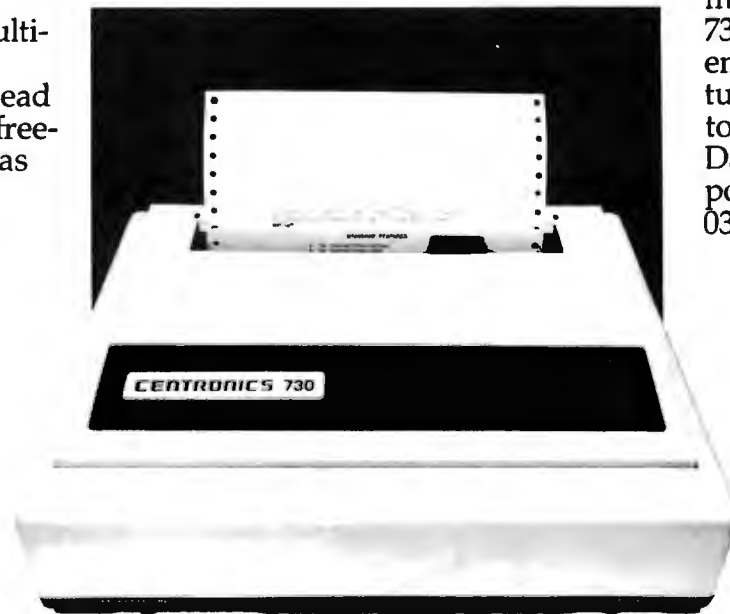

## CENTRONICS PRINTERS DELIVER THE WORD



the position is for Black. Black will make the move that gives the *lower* evaluation function value. Again, this is only an approximation, but it becomes a better one as the tree gets larger.)

In the same way you may conclude that, since it is Black's turn to move, at branch R Black will move to branch D, since 28 is less than 29. Let us go back to branch Y. Here it is White's turn to play, and White wants to make the move that results in the *highest* value of the evaluation function. Does this mean 37, the largest of the four values at A, B, C, and D? No, it does not. If White plays

to Q, Black will play to A. If White plays to R, Black will play to D. Therefore, you should compare only A and D. Since 28 is larger than 26, White should play from Y to R.

This potential source of confusion suggests that you should mark the nodes Q, R, S, T, and so on, with the *expected* evaluation function values (ie: the values that would ensue if Black makes the best play, in a highly approximate sense, on the next move). In this case Q would receive the value 26, R would receive the value 28, and in general each node would receive the *lowest* of the values of the nodes below it. This, of course,

is only because it is Black's turn to move. On the next level up, it is White's turn to play, and you can mark each of the nodes Y, Z, 1, and 2 with the *highest* of the values of the nodes below it, because White now wants to make the ultimate value of the evaluation function as large as possible. Continuing this all the way to the top of the tree, you get the situation illustrated in figure 6. The expected value for White at the top of the tree is 25. By following the figure 25 down through the tree, you will see that, at this point in the game, White is expected to move to node 4, Black to reply by moving to node 1, White to then move to U, and Black to play to J.

This does not, of course, have to be what actually happens in the game. Black might be a poor player, and play to node 2 instead of node 1, or Black might discover, upon looking more moves ahead, that node 2 is actually a better play than node 1. This tends to happen in actual games. As you look further ahead (ie: as you consider trees with greater and greater numbers of levels), expected moves at all levels, even the top level, can change.

At this point a very important question is raised: is it really necessary to generate this whole tree? It would be nice to find certain nodes that do not have to be constructed.

Consider the situation at node Z. White has two possible moves: one to node S and one to node T. At node S, White gets a score of at least twenty-two on the next move. Is this a better move for White than the move to node T? To determine the answer, look at node T. The first thing you will see is that if White moves to node T, then Black can move to node G. If Black does that, White ends up with a score of only thirteen. By this point you already know what White should not move to node T because he can do better by moving to node S.

Now look at node H. If White moves to node T, then Black could also move to node H, leaving White with a score of eleven. This is a better move for Black than the move to node G. The point is that *this does not matter*. As soon as you look at node G, you know that White should not move to node T. When you are aware of this it does not matter what

Capturing the Queen	9000
Capturing a Rook	5000
Capturing a Knight or Bishop	3000
Capturing a pawn	1000
Doubled pawns	-30
Tripled pawns	-100
Isolated pawns	-90
Two pawns next to each other	10
One pawn guarding another	36
Knight on opponent's side of the board	40
Same, with pawn guarding it	60
Bishop on strong diagonal	24
Rook on open file	60
Doubled Rooks on open file	170
Rook behind passed pawn	60
Rook on seventh rank, two unmoved opposing pawns	100
Rook on seventh rank, three unmoved opposing pawns	200
Rook on seventh rank, four unmoved opposing pawns	300
Rook moved before castling has occurred	-200
King moved before castling has occurred	-200
Castled King	300
Piece or pawn moved twice in the opening	-30
Taking two moves instead of one to get to a square	-30
Knight never moved	-36
Knight in front of King's pawn or Queen's pawn	-120
Bishop never moved	-20
Bishop in front of King's pawn or Queen's pawn	-120

Table 1: An abbreviated table of the approximate numerical values assigned to a variety of possible moves.

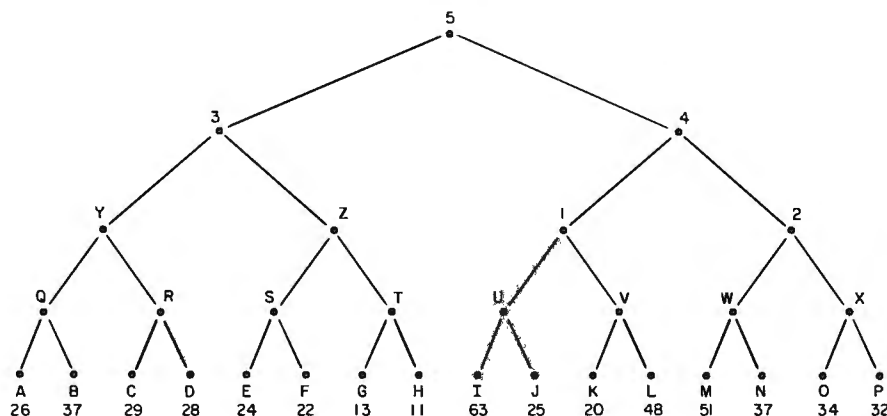

Figure 5: Same game tree as that shown in figure 4, along with a specification of the evaluation function at each leaf of the tree.

# THERE IS A DIFFERENCE IN TRS-80 DISK DRIVES CAPACITY

Expansion interface – gives your TRS-80 the disk capacity it needs, and much, much more!

10 to 40 MByte, 8" Winchester drive – expands capacity far beyond Model II storage.

Single sided minifloppy – up to 150 KBytes of storage capacity.

Single or double sided 8" floppies – up to 2.5 MBytes in dual drive cabinet – for the serious TRS-80 user.



LOBO DRIVES' new family of disk memory products provides you with a choice of memory capacities you need to effectively execute the complex business software you've developed for your TRS-80\*. LOBO DRIVES' selection of readily available, software compatible drives permits you to expand your inventory, payroll, customer list, and accounts receivable files as your business grows.

And LOBO DRIVES brings you more... a new plug-in expansion interface that provides an easy way to add hardware enhancements, communications capability, and programmable features... and it comes with the LOBO DRIVES famous 1 year, 100% parts/labor warranty.

Call or write for the complete LOBO DRIVES story. Find out just how competitively priced a family of high capacity drives can be...



935 Camino Del Sur Goleta,  
California 93017.  
(805) 685-4546

"CAN YOU REALLY AFFORD TO PAY LESS?"

## Quantity discounts available – Dealer inquiries invited

Yes, I want to know more about LOBO Drives and what they can do for my TRS-80. Send me information on: TR-2

- |   |   |
|---|---|
| <input type="checkbox"/> 5 1/4-in. Floppy drive                             | <input type="checkbox"/> 8-in. Winchester hard disk, 10 Mbyte drive |
| <input type="checkbox"/> 8-in. Floppy drive<br>Single sided<br>Double sided | <input type="checkbox"/> Double density expansion interface         |

Name \_\_\_\_\_

Company \_\_\_\_\_

Address \_\_\_\_\_

City \_\_\_\_\_ State \_\_\_\_\_ Zip \_\_\_\_\_

Phone No. \_\_\_\_\_

If dealer, provide resale no. \_\_\_\_\_

\* TRS-80 is a registered trademark of Radio Shack, a Tandy Company.



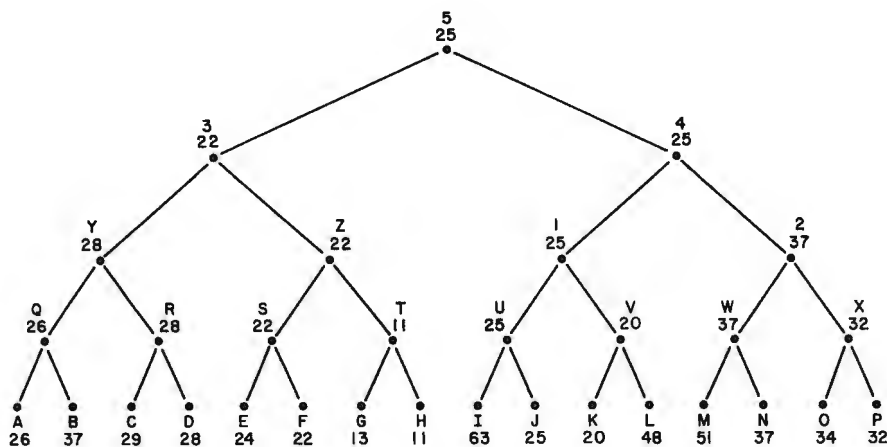

Figure 6: A more informative version of the game tree shown in figures 4 and 5. Here the expected evaluation function values are shown at each of the nodes.

score node H has—in fact, you do not have to generate node H at all. This kind of logic can be applied to either

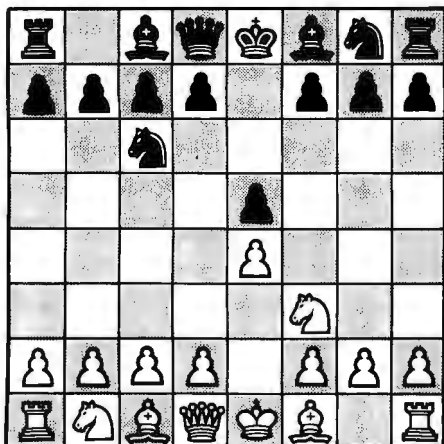

Figure 7: A simple example to illustrate the principle of alpha-beta pruning. It is now White's turn to move. An obvious bad move would be NxP. Black's reply would be NxN, and White would have captured a pawn but lost a Knight.

player; it is called *alpha cutoff* in a case like this, where it is White's original move that is being considered (as at node Z here). It is called *beta cutoff* when it is Black's original move that is being considered. *Alpha-beta pruning* is the combination of alpha cutoff and beta cutoff within the general framework described here.

For an example of beta cutoff, look at node 4. It is Black's turn to move. By considering node 1 and all the nodes beneath it (that is, nodes U, V, I, J, K, and L), you will note that Black can eventually expect a score of twenty-five if he moves to node 1. The next question is whether or not a move to node 2 would be any better for Black. Suppose Black moves to node 2, and that White moves to node W. By analyzing the nodes (M and N) beneath node W, you will find that Black can achieve a score of either fifty-one or thirty-seven. Black would naturally choose thirty-seven, that is, node N. But if that is the best

that Black can do, then the answer to the original question must be no; that is, a move from node 4 to node 2 would *not* be any better for Black than a move to node 1. Once you know this, it is not necessary to consider node X at all and, more important, you do not have to consider nodes O or P either. In other words, you have pruned not just a single leaf, but a branch with leaves below it.

An informal example of alpha-beta pruning is given in figure 7. Here it is White's turn to move. White has many possible moves, but an obvious *bad* move for White is NxP. In order to determine that this move is bad, it is not necessary to figure out Black's best move; it is only necessary to note that Black can move NxN. Any other possible moves need not be considered as long as White has *any* move that does not result in the loss of a piece, and as long as NxP is not really a viable sacrifice. ■

## Glossary

**alpha-beta pruning:** In order to guarantee a winning strategy an entire tree search of a complete game tree would be necessary. Alpha-beta pruning is an algorithm devised to optimize the use of game trees by reducing the number of branches needed to be searched.

**game tree:** A graphic representation of the decision making process involved in a sequence of moves between two opponents. A complete game tree is a representation in which all the terminal nodes correspond to the end of the game.

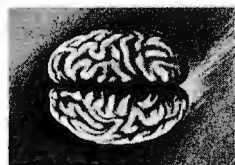

### 8086 Boards

CPU with \$650.  
Vectored Interrupts  
PROM-I/O \$495.  
RAM \$395.  
8K x 16/16K x 8

### ANALOG Boards

A/D 16 Channel, \$495.  
12 Bit, High Speed  
D/A 4 Channel, \$395.  
12 Bit, High Speed



### VIDEO DIGITIZATION

Real Time Video \$850.  
Digitizer and Display  
Computer Portrait  
System \$4950.

### S-100 Boards

Video and/or Analog  
Data Acquisition  
Microcomputer Systems



The High Performance S-100 People  
TECMAR, INC.  
23414 Greenlawn • Cleveland, OH 44122  
(216) 382-7599

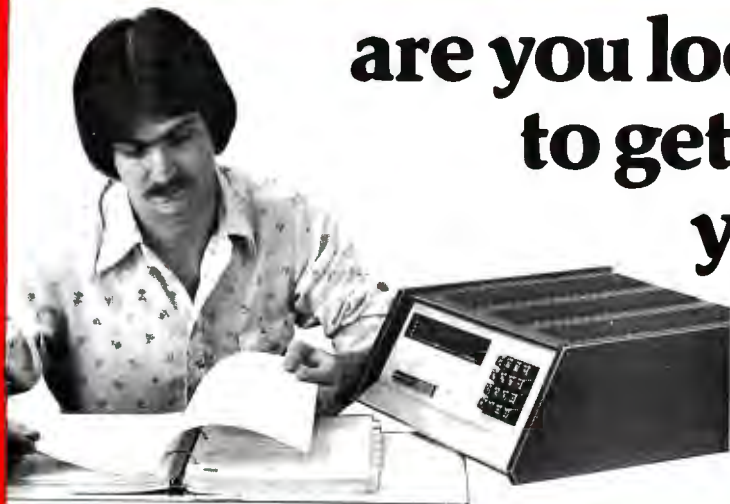

# are you looking for ways to get the most from your computer?

Let the easy-to-use  
**Heathkit® Computer  
Language Programs**  
show you the way!

## Heathkit Assembly Language Programming Self-Instruction Program.

- Use the full capacity of your computer system
- Execute computer programs *much* faster
- Store more information in less memory space

Assembly Language, the most powerful and versatile language you can use, enables you to do **anything** your computer system is capable of doing. It puts you in **total command** of your computer.

Codes are shorter and more explicit in Assembly Language, which means your computer system's memory can be used more efficiently.

Every computer system operation has a mnemonic in Assembly Language. Your computer programs can run much faster, since you waste no time interpreting them.

You can learn how to program your computer system in Assembly Language with the help of the Heathkit Assembly

Language Programming Self-Instruction Program. Learn at your own pace through a special text designed for self-study. An exercise workbook provides hands-on experience to back up the special text, with programming exercises performed by you on your computer. You'll find the learning fast, fun and thorough.

The Heathkit Program is designed for computer systems using the popular 8080/8085 microprocessor series, and the popular Heathkit Z80 microprocessor. But concepts of the program can be applied to any computer.

The time has never been better to learn the language that puts your computer's full potential within your reach. Send your order today for the Heathkit Assembly Language Programming Self-Instruction Program and put yourself in the driver's seat!

**Order No. EC-1108: \$49.95, plus \$2.60 shipping & handling.**

## Heathkit BASIC Language Programming Self-Instruction Program.

- The easiest of all computer languages to use
- Now the easiest of all languages to learn

BASIC is the easiest computer language to learn and to use, because it uses English statements and commands. And more programs are written in BASIC than in any other language.

With a working knowledge of BASIC, you can adapt and run hundreds of existing programs. You can exchange programs with others. And you can write new programs, tailored to your specific requirements.

**Send Today or Phone (616) 982-3411 for faster service on Heath Revolving Charge, VISA or Master Charge.**

The Heathkit Self-Instruction Program covers all the formats, commands, statements and procedures in 14 easy-to-follow segments. A special workbook provides programming instructions and experiments to perform on your own computer. And you'll learn practical, problem-solving techniques.

You're missing the full range of programs available to you until you learn BASIC Language. Send today for the Heathkit BASIC Language Programming Self-Instruction Program.

**Order No. EC-1100: \$39.95, plus \$2.40 shipping & handling.**

Heath Company, Dept. 334-592, Benton Harbor, MI 49022



Heath Company  
Dept. 334-592  
Benton Harbor, MI 49022

SHIP MY ORDER TO:

Name \_\_\_\_\_ (please print)

Address \_\_\_\_\_

City \_\_\_\_\_ State \_\_\_\_\_

Zip \_\_\_\_\_

PLEASE RUSH ME:

- Assembly Language Self-instruction Program  
EC-1108 ..... \$49.95, plus \$2.60 shipping & handling.
- BASIC Language Self-instruction Program  
EC-1100 ..... \$39.95, plus \$2.40 shipping & handling.

Total price .....

Michigan residents add

4% sales tax .....

Add shipping & handling ..... Total shipping & handling

Total .....

Enclosed please find  check  money order for \$ \_\_\_\_\_

or charge to my  Heath Revolving Charge  VISA  Master Charge: Code = \_\_\_\_\_

Acct. # \_\_\_\_\_ Exp. Date \_\_\_\_\_

Signature \_\_\_\_\_  
(necessary to send merchandise)

Prices are mail order and subject to change without notice.

ED-130

### MONEY-BACK GUARANTEE OF SATISFACTION

If you are not completely satisfied with the EC-1100 BASIC Program or the EC-1108 ASSEMBLY Program, simply return programs for a full refund of purchase price.



# Interfacing the PET to a Line Printer

---

P K Govind  
National Center for  
Atmospheric Research  
Atmospheric Technology Div  
POB 3000  
Boulder CO 80307

---

## Introduction

From both software and hardware points of view, this article presents a design example for interfacing the 8-bit user port on the Commodore PET 2001 personal computer to an external device. The design example will show how the user port may be used to develop a handshake interface to a line printer. We shall begin with a brief discussion of the programmable features of the user port.

## Peripheral Interface Port

The 8-bit port, described in the PET user manual, is actually a part of the MCS6522 peripheral interface adapter (PIA), manufactured by MOS Technology. The 6522 is a general purpose I/O (input/output) device, configured as two 8-bit I/O ports A and B. It provides handshaking logic associated with parallel data transfers occurring through I/O port A. Counter and timer, and elementary serial I/O logic are associated with the MCS6522 port B. In the PET 2001, most features of port B are reserved for internal use, leaving port A as the only peripheral interface port available to the user.

To the user, the MCS6522 peripheral interface adapter appears as sixteen contiguous memory locations. Table 1 identifies the sixteen ad-

PET Memory Location	Function Provided by the 6522
59456	Output register for I/O port B.
59457	Data register for port A with handshake.
59458	I/O port B data direction register.
59459	I/O port A data direction register.
59460	Read timer 1 counter (low-order byte). Write to timer 1 latch (low-order byte).
59461	Read timer 1 counter (high-order byte). Write to timer 1 latch (high-order byte).
59462	Access timer 1 latch (low-order byte).
59463	Access timer 1 latch (high-order byte).
59464	Read low-order byte of timer 2 and reset counter interrupt. Write to low-order byte of timer 2 but do not reset interrupt.
59465	Access high-order byte of timer 2; reset counter interrupt on write.
59466	Serial I/O shift register.
59467	Auxiliary control register.
59468	Peripheral control register.
59469	Interrupt flag register.
59470	Interrupt enable register.
59471	Data register for I/O port A without handshake.

**Table 1:** Internal registers of the 6522 peripheral interface adapter given in terms of addresses in the PET memory address space. Addresses that are of direct concern to the PET user (for interfacing to port A) are shown in *italic* characters.

dressable locations of the 6522. Locations of direct concern to the PET user (for interfacing to port A) are in *italic* characters.

The characteristics and functions of the interface lines on the peripheral interface port A are determined by the operating mode selected under program control. Two modes of operation may be selected under program control: *basic input/output*

without handshake, *strobed input/output* with handshake. By selecting the correct operating mode for the data direction register (this may be done using the BASIC statement POKE 59459,X where X=0 for input and 1 for output), interface lines may be configured to fulfill specific interface requirements. Device strobes may be easily generated by software without utilizing external logic by



## HOW STANLEY BEEMER AND MICROSOFT'S COBOL-80 TURNED THE OFFICE ON ITS EAR.

Stanley's office staff says Stanley always stays one step ahead. So no one was surprised when he showed up with Microsoft's COBOL-80 for the office computer. That's when things started happening.

As Stanley explains, "Suddenly, the whole business operation is more efficient. I use it for everything: inventory, payroll, record keeping, customer and employee files. Since COBOL is the standard language for business and commercial applications, more programs are written in COBOL than any other language. Believe me, nothing beats it in terms of powerful use of disk files, data manipulation facilities and interactive terminal communications."

Stanley added loudly, "And that's versatility and efficiency I'd like to see more of around here."

"My COBOL-80 package from Microsoft includes the MACRO-80 assembler, LINK-80 linking loader and LIB-80 relocatable library manager. I can even call FORTRAN, BASIC, assembler and COBOL modules from a COBOL-80 program. It's perfect—a total software development package," exclaimed Stanley.

Microsoft's COBOL-80 is an ANSI-74 standard COBOL that supports such advanced data manipulation verbs as COMPUTE, INSPECT, STRING, UNSTRING AND SEARCH: three-dimensional arrays; full COPY facility; and com-

plete screen handling capability. The optional packed decimal format saves on mass storage by as much as 40%. And as Stanley puts it, "With my floppy disk system, that's a big plus."

Stanley can't say enough about his new addition to the office. "COBOL-80 supports indexed and relative files, including DYNAMIC access, FILE STATUS, START, READ NEXT, DELETE and REWRITE. Best of all, interactive ACCEPT/DISPLAY gives the most powerful screen handling capability possible.

"Frankly," says Stanley, "Microsoft COBOL-80's performance is so superior it's set a whole new standard of efficiency for my staff. My new motto? 'Shape up or ship out.' Thanks Microsoft, my office will never be the same."

The COBOL-80 package for the CP/M or ISIS-II operating system with documentation is \$750. Documentation may be purchased separately for \$20. Dealer purchases and OEM license agreements available on request.

# MICROSOFT



10800 N.E. Eighth Suite 819  
Bellevue, Washington 98004  
206/455-8080 Telex 328945

We set the standard.

Circle 232 on inquiry card.





# Disco-Tech<sup>T.M.</sup> DDT<sup>T.M.</sup>

**Disc Drive Timer**  
for TRS-80 (16K, 32K, 48K)  
& Apple Microcomputers  
*Works with any disc drive.*

*Radio Shack (new & old model drives), Shugart, MPI, Pertec & Vista.*

Get the bugs out of your disc drives with DDT. DISCO-TECH's brand-new program which lets you analyze and adjust disc drive motor speed within a tenth of an RPM (in a total 300) with a real time graphic display. Anybody can do it! All you need is DDT, two screwdrivers, and five minutes' time. No more down time and costly repairs. DDT is faster, easier, more accurate than strobe timing - and DDT is the ONLY way to adjust a Pertec, short of taking it to a repair shop. Incorrect motor speed causes lost data and program incompatibility. DDT lets you check disc drive motor speed *routinely* with a detailed motor speed analysis, so your drives are always running right.

*Be sure to specify TRS-80 or Apple.*

Cassette \$14<sup>95</sup> Apple available on diskette only.

Diskette \$19<sup>95</sup> Postpaid  
Check, M.O., Visa, Mastercharge  
California residents add 6% sales tax.

\*\*\*\*\*

## MLUP-1

Machine Language Utility  
Package No. 1

TRS-80 Level II or Disc BASIC  
(16K, 32K, 48K)

Six machine language routines to make your TRS-80 more efficient, versatile and trouble-free.

KEYBOARD DEBOUNCE/REPEAT -  
FORMATTED INPUT - UPWARD  
SCROLLING - DOWNWARD  
SCROLLING - SHIFT & DELETE -  
SHIFT AND INSERT

**\$25** Postpaid

Write today for complete details or to order.



microcomputer products  
a division of  
Morton Technologies, Inc.  
P.O. Box 11129, Santa Rosa, Ca. 95406  
*Dealer inquiries invited.*



**Listing 1: PRINTSCREEN**, a program in BASIC which provides a hard copy of any characters displayed on the PET's video display. An image of the text appearing on the screen is sent to the printer. Note that here the program was used to create its own listing. The data transfer rate is about 6 characters per second.

```
5 REM FILENAME "PRINTSCREEN"
10 REM OUTPUT DATA TO EXTERNAL DEVICE
15 REM HANDSHAKE WITH LINE PRINTER
16 REM CB2 FOR DATA STROBE; TO DEVICE
18 REM CA1 FOR ACKNOWLEDGE; FROM DEVICE
20 POKE 59459,255:REM DIRECTION OUT
25 GOSUB 100:REM HANDSHAKE NOT READY
34 FOR I=1 TO 25 :REM SCAN ROWS
35 FOR J=1 TO 40 :REM SCAN COLUMNS
36 V=PEEK(32767+J-1+40*(I-1))
37 IF V>64 THEN V=V+32 :REM LOWER CASE
38 IF V<=26 THEN V=V+64:REM UPPER CASE
39 IF V=128 THEN V=V-96:REM SPACE
40 IF J=1 THEN 180 :REM PRINT SPACE
50 POKE 59457,V AND 127:REM SEND VALUE
51 GOSUB 150:REM READY TO OUTPUT
52 GOSUB 100:REM NOT READY
56 ACK=PEEK(59469)AND2:REM INT FLG REG
58 IF ACK <> 2 THEN 56:REM ACKNOWLEDGE
70 NEXT J
```

READY.

RUN

READY.

LIST 71-97

```
72 POKE 59457,13:REM CR
73 GOSUB 150:REM READY
74 GOSUB 100:REM NOT READY
76 POKE 59457,10:REM LF
78 GOSUB 150:REM READY
80 NEXT I
82 GOSUB 100
84 POKE 59457,128 :REM STOP PRINT
85 PRINTCHR$(147) :REM CLEAR SCREEN
86 END
```

READY.

RUN

changing the contents of decimal location 59468 (the peripheral control register).

### Interfacing to a Line Printer

This example demonstrates how the PET parallel port can be interfaced to a line printer. The first step in the design is to examine the specification for the printer, and to identify the control and data signals which must be supported by the inter-

READY.  
LIST 98-199

```
98 REM SUBROUTINES
100 REM SET CB2 TO LOGIC 1:NOT READY
110 POKE(59468),PEEK(59468) OR 224
120 RETURN
150 REM SET CB2 TO LOGIC 0 :REM READY
160 POKE (59468),PEEK(59468)AND31OR192
170 RETURN
180 V=32 AND 127 :REM SPACE
182 GOSUB 150:REM READY
184 GOSUB 100:REM NOT READY
186 GOTO 50
```

READY.  
RUN

READY.  
POKE 59468,14

READY.  
LIST 200-

```
200 PRINT" Upper and Lower Case "
240 PRINT"ABCDEFGHIJKLMNPOQRSTUVWXYZ"
250 PRINT"abcdefghijklmnopqrstuvwxyz"
300 PRINT" These listings were made on
310 PRINT" TI Model 810 printer"
READY.
RUN 200
Upper and Lower Case
ABCDEFGHIJKLMNPOQRSTUVWXYZ
abcdefghijklmnopqrstuvwxyz
These listings were made on
TI Model 810 printer
```

READY.  
RUN 5

face. Figure 1 is a block diagram of the interface design. A *data strobe/acknowledge* interface is supported. The ACKNLG signal notifies the PET that a character transferred to the printer by a data strobe has been accepted. After ACKNLG is issued, the printer is considered idle.

### Software Driver

The software driver implemented for the example was specifically

# SELECTOR III - C2

## THE INFORMATION MANAGEMENT SYSTEM

Includes these Application Sub-Programs. . .

Sales Activity, Inventory, Payables, Receivables, Check/Expense Register, Library Functions, Mailing Labels, Appointments, Client/Patient Records



Circle 213 on inquiry card.

### RANDOM, MULTI-KEY RECORD RETRIEVAL under CP/M, CDOS, IMDOS, ADOS . . .

**SELECTOR III-C2** ALLOWS INSTANT RECALL OF ANY RECORD USING ANY INFORMATION ITEM IN THE RECORD. That statement deserves re-reading, because that ability makes **SELECTOR III-C2** the most powerful information management system in microcomputers today!

The three major activities in business computing are...Word Processing, Financial Accounting, and the storing, processing, and reporting of information. The latter is where **SELECTOR III-C2** shines and fills the professional and personal need.

The system represents the state of the art using Micro-Ap's unique record indexing, query, and report writing methods. It's 'menu driven' and uses screen displays with all the instructions and error sensing that allow the novice to quickly learn the system and accomplish his tasks.

With **SELECTOR III-C2** you...

- define a record format assigning up to 24 fields as 'key' fields -meaning that records can be instantly recalled by name, date, quantity, ZIP Code, or whatever.
- create a file and begin entering edited and verified data immediately.
- browse through your file in key field order, making whatever changes or deletions needed.
- select collections of records meeting your exact requirements and arranged in the order wanted.
- create a unique report that contains the precise information you need - with numerical totals, averages, maxima, and minima -for any period of time and summarized by name, date...or by any item you want.
- bring an application on-line in hours instead of months.

**SELECTOR III-C2** is a 'turn-key' system that can manage most applications as is. It includes source-code and pre-defined record formats and sub-programs to perform the tasks listed at top of page. Programmers can easily add other sub-programs - using the system's powerful utilities - to perform virtually any special computation or function required.

The system runs under CBASIC Vers. 2, and is priced at \$345. It's available in a variety of CP/M, disk formats including Dynabyte; North Star; Micropolis; TRS-80; Helios II; Heathkit; iCOM; Altair; Im-sai; Cromemco; and others.

Available from computer stores worldwide

**LIFEBOAT Associates**

2248 Broadway, Suite 34,  
New York, N.Y. 10024 • (212) 580-0082

Or order direct from

**MICRO-AP**

9807 Davona Drive, San Ramon, CA 94583  
(415) 828-6697



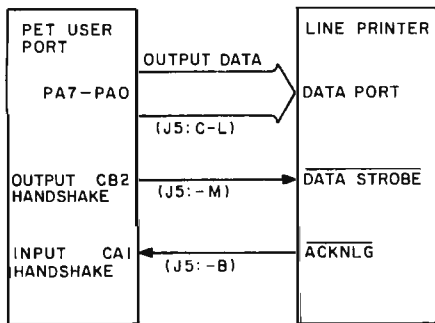

Figure 1: Block diagram of printer interface using the PET user port (MCS6522 port A). J5 is the PET user port connector; pins are labeled alphabetically. Pin assignments at the line printer are not given since they vary between different manufacturers.

figure 2, and a program listing is included in listing 1. The program is called PRINTSCREEN. It scans the twenty-five lines on the PET screen and transmits the data displayed there to the user port, one character at a time. You will observe that transferring data to the parallel port using BASIC is relatively slow. In this example, the data transfer rate is about six characters per second. ■

- PA7-PA0: Output data used to support printer data port.
- DATA STROBE: Signals to printer that data is available at the printer data port.
- ACKNLG: Signals to the PET that the printer has accepted the data.
- J5: -A PET user port connector J5-Pin A.

designed to generate a hard copy listing of the image displayed on the PET screen.

The PET video display presents 1000 characters arranged in twenty-five lines of forty characters each. The display is continuously refreshed from a section of memory called *display memory*. By direct access to these 1000 locations, and using the programmable I/O port connected to a line printer, you can generate a hard copy of the screen image. The flowchart of the procedure is shown in

#### REFERENCES

1. *An Introduction to Your New PET* Commodore Systems, 901 California Ave, Palo Alto CA 94304.
2. *PET User Notes*, Volume 1, Issue 2, January 1978. PET User Group, POB 371, Montgomeryville PA 18931.
3. *An Introduction to Microcomputers, Volume II: Some Real Products* Adam Osborne and Associates, POB 2036, Berkeley CA 94702.

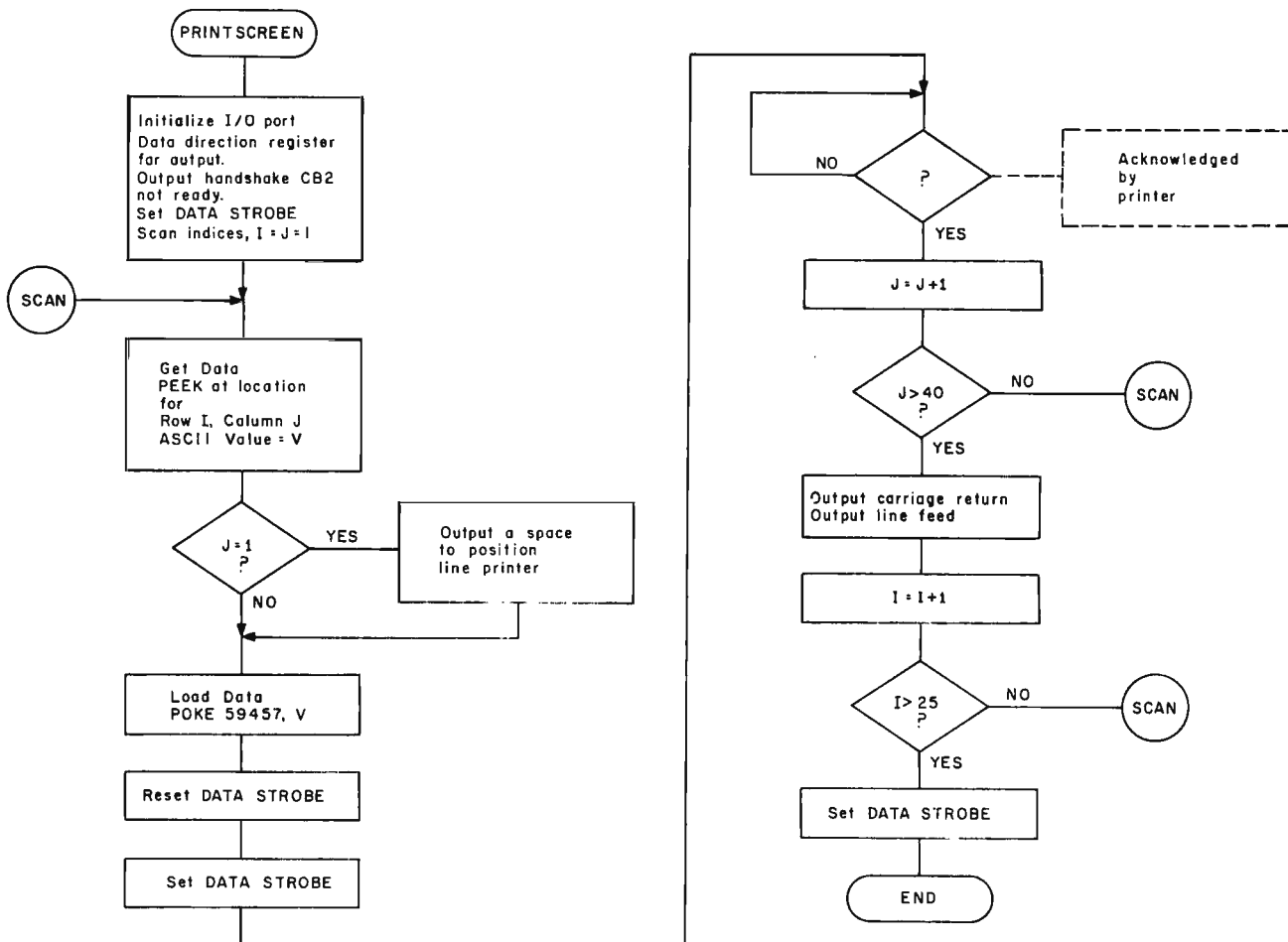

Figure 2: Flowchart of the BASIC program PRINTSCREEN. This program transmits images of text on the PET video display screen to the line printer.

# NOW... Exclusively Yours from ACS

# TRS-80™-DOS 3.0

ACS is not affiliated with Radio Shack or Tandy Corp.

## Disk Operating System by the Original Author

DOS 3.0  
EFFECTIVE SEPTEMBER 1  
ONLY **\$49.95**

Check these DOS 3.0 features... that go far beyond 2.1

- NO KEY BOUNCE • UPWARDS COMPATABLE FROM 2.1 • CHECK EOF
- SEEK • RE-READ • RE-WRITE • LOC • VARIABLE LENGTH RECORDS
- SKIP • DISK LOGGING OF MESSAGES • BOOT • CHAIN • WRITE EOF
- PURGE • SET • RESET • ROUTE • RUN & LOAD FOR 1 DRIVE SYS.
- XFER • FORMAT W/O ERASE • DIR FROM BASIC • PATCH • LINK
- USER DEFINED KEYS • KEY AUTO REPEAT • UPPER AND LOWER
- CASE DRIVER • SHIFT LOCK • RS-232-C DRIVERS
- PAUSE • USER DEVICE CONTROL BLOCKS
- MULTI PROTOCOL COMMUNICATIONS

### HARDWARE FOR TRS-80™

- Pertec Disk Drives FD-200 ..... \$375.00 ea.  
These are 40-track Drives that are completely compatible with the TRS-80™ and Radio Shack Drives. 3.0 DDS included. Will allow Turning Diskette over and Write on other side.
- 4-Drive Cable for Pertec Drives ..... \$35.00
- DECwriter III, 132 Character ..... \$2500.00  
110 to 9600 baud EIA tractor feed keyboard printer. This is truly the nicest printer available. (30 day delivery)
- 701 Centronics TRACTOR FEED Bidirectional Printer ..... \$1500.00  
2½ times as fast as the Radio Shack 779 Printer, has full size 132 Char. Carriage Bell tone. Complete with Cable plug in and use. Shipped Freight COD.
- 200 ns 16K Dynamic Memory Clips for Keyboard or Expansion Interface, Lifetime Guarantee, complete ..... \$110.00  
Lifetime Guarantee. Complete with Instructions and Jumper Blocks.
- 10 Key Numerical Keypad Kit ..... \$79.95
- TRS-80™ Level II - 16k ..... \$750.00
  - Expansion Interface ..... \$275.00
  - RS-232-C Interface ..... \$ 89.00

### ORDER NOW AND SAVE

Just list the items you want and mail this convenient coupon.

### SOFTWARE BY ACS

- Monitor No. 3 ..... \$29.95  
Complete Machine Language Monitor for TRS-80™ features: Find, EDIT, Relocate, Symbolic Dump to Tape, etc.
- Monitor No. 4 ..... \$49.95  
All of the commands that reside in Monitor No. 3, plus: RS-232 I/O, Disk Program I/O, Symbolic Dump to Disk for Loading into Disk Editor/ASM., Track & Sec I/O for modification.
- PCLEND ..... \$15.95  
Will Patch ASCII files of Basic Programs or text or DATA FILES so that they may be loaded into the Disk Version of the Electric Pencil for Editing purposes comes on Cassette that will automatically create a Disk file of PCLEND.
- MAKE TAPE AND MAKE DISK**  
for Cassette Dealers ..... \$69.95  
These are two programs that will allow you to take any type of Program from Disk and store it on tape for mailing purposes. When the user receives the program in the mail on cassette, it is loaded into the computer which will automatically make a Disk file of the program.
- CP/M & C BASIC for the TRS-80™ ..... \$150.00  
CP/M Includes: MOVCPM, STAT, PIP, Dump, DDT, ASM (8080), ED, plus 6 user manuals.
- C BASIC 2 Includes: XREF2, CBAS2, and manuals. .... \$99.95
- G2 LEVEL III BASIC for TRS-80™ ..... Special \$39.95
- TELCOM - Telecommunications for the TRS-80™ ..... \$29.95  
Telecommunications for the TRS-80™ allows one TRS-80™ to communicate with another through the RS-232-C over the phone line.

Orders received by 6.00 p.m. shipped next day on Master Charge, Visa, Certified Check or Money Order. Personal Checks require 14 days to clear. No C.O.D. Collect calls not accepted. All Hardware warranted for 90 days except Radio Shack equipment which is warranted by ACS for one full year. Software guaranteed for replacement only. Prices subject to change without notice.



## AUTOMATED COMPUTER SOFTWARE SERVICE

(615) 244-2798

Division of **Computer World** INC.

625 Main Street • Nashville, TN 37206

Send Check or Money Order payable to -

SOFTWARE • P.O. Box 60097 • Nashville, TN 37206

Quan.	Description	Unit Price	Total

HANDLING CHARGE \$1.50  
TENN. RES. ADD 6% SALES TAX **TOTAL**

Check  
 Money Order  
 MasterCharge  
 Visa  
Card No. \_\_\_\_\_  
Exp. Date \_\_\_\_\_

Name \_\_\_\_\_

Address \_\_\_\_\_

City \_\_\_\_\_ State \_\_\_\_\_ Zip \_\_\_\_\_



# A Spacecraft Simulator

---

Gary Sivak  
19 Madison Trail  
Hopatcong NJ 07843

---

This article describes a BASIC program that enables the user to design and put into orbit a multistage spacecraft launched from Earth-based conditions. By asking for engine throttle settings, thrust angles, and firing times, your computer puts you at the controls of a multistage spacecraft of your own design as you pilot it from the Earth's surface into orbit. Continuous data displays of the user's status after each maneuver are presented, as well as arrays of altitude and range information for possible plotting at the end of the mission. The following is a description of the program operation.

The program first asks for and verifies all ship design parameters, the first being the number of stages. Then the iteration time (dt) in seconds and the height in miles of the desired orbit are required. During each iteration, the computer calculates formulas of the form:

$$V_{final} = V_{initial} + \text{acceleration} \times dt \quad (1)$$

The final values are then taken as the initial ones for the next iteration. An iteration time evenly divisible into one second is recommended; 0.1 seconds is suggested for faster than real-time computation. A figure of 0.01 seconds, for example, will give a slightly better mathematical accuracy but at the expense of ten times more processing time.

The craft is assembled from top down, the weight of the payload in

*Text continued on page 108*

Listing 1: BASIC listing of the rocket launcher program.

## ROCKET LAUNCHER PROGRAM

```
10 DIM A(100),A0(100),A1(7),A2(7),A3(6),A4(6)
20 PRINT "DESIGN AND ORBIT A SPACE SHIP. TYPE NO. STAGES UP TO 6. "
30 INPUT A5
40 PRINT "VERIFICATION, ";A5;" STAGES."
50 A6 = A5 + 1
60 PRINT "ENTER ITERATION TIME IN SEC., AND ORBIT HEIGHT IN MI. "
70 PRINT ".1 SEC. IS OK AND .01 BETTER, BUT WITH MORE CPU TIME. "
80 INPUT A7,A8
90 PRINT "VERIFICATION, ITERATION TIME ";A7;" , ORBIT HEIGHT ";A8
100 PRINT "ENTER PAYLOAD WEIGHT IN POUNDS. "
110 INPUT A2(A6)
120 A1(A6) = 0.0
130 PRINT "VERIFICATION, PAYLOAD WEIGHT, ";A2(A6)
140 FOR A9 = 1 TO A5
150 B = A6 - A9
160 B0 = 3 + 1
170 PRINT "ENTER STAGE ";B;" FUEL AND HULL WEIGHTS IN LBS. "
180 INPUT A1(B), A2(B)
190 PRINT "STAGE ";B;" FUEL ";A1(B);" LBS., HULL ";A2(B);" LBS. "
200 A2(B) = A2(B) + A2(B0) + A1(B0)
210 B1 = A2(B) + A1(B)
220 PRINT "ENTER STAGE ";B;" THRUST AT LEAST ";B1;" .LBS. "
230 INPUT A3(B)
240 PRINT "STAGE ";B;" THRUST, ";A3(B);" LBS. "
250 PRINT "ENTER SPECIFIC IMPULSE OF STAGE ";B;" FUEL/OXIDIZER. "
260 PRINT "THIS IS THE THRUST-TO-BURN RATE RATIO. "
270 PRINT "FOR GASOLINE =250, PEROXIDE =300, LIQUID HYDROGEN =500. "
280 INPUT A4(B)
290 PRINT "VERIFICATION, STAGE ";B;" SPECIFIC IMPULSE ";A4(B)
300 NEXT A9
310 B2 = 10
320 B3 = B2 * A7
330 B4 = 360
340 B5 = B3 / 100.0
350 B6 = 5280. * .3048
360 B7 = 6.67E-11 * 5.983E24
370 B8 = ATN(1.) / 45.
380 B9 = 90.
390 C = 1.0
400 C0 = SQR(B7/9.80665)
410 C1 = C0
420 C2 = SQR(B7/(C0+B6*A8)) / .3048
430 C3 = 0.0
440 C4 = 0.0
450 C5 = 0.0
460 C6 = 0.0
470 C7 = 0.0
480 C8 = 0.0
```

*Listing 1 continued on page 108*

# POWER!

## PROGRAMMING THE

# Z80

PROGRAMMING THE

# Z80

RODNEY ZAKS

SYBEX

Now! A step-by-step approach to making your Z 80 work for you! This book features I/O and addressing techniques, Z 80 instruction set and more! Exercises check your progress at each step.  
Rodney Zaks  
Ref. C280, 460 pp . . . . . \$11.95

Also available in this series:  
Programming the 6502 . . . \$11.95  
6502 Applications Book . \$12.95  
6502 Games Book . . . . . \$12.95  
ASK FOR COMPLETE CATALOG

#### TO ORDER:

**By Phone:** (415) 848-8233. Visa, MC, American Express.

**By Mail:** Indicate quantity desired. Include payment.

**Shipping:** Add \$1.50 per book (UPS) or 75¢ (4th class - allow 4 weeks delivery).

**Tax:** In California, add tax.

SYBEX, INC.  
Dept. B 11  
2020 Milvia Street,  
Berkeley, California 94704







**LA34  
DECwriter IV  
\$1229.00**

- Tabs
- 132 columns
- 10, 12, 13.2, 16.5 characters/inch
- 2, 3, 4, 6, 8 or 12 lines/inch
- Optional tractor feed
- 110 or 300 baud
- RS232C/ASCII
- Friction feed/up to 15" wide paper
- 9x7 dot matrix, impact printing
- Upper/lower case

**Teletype  
Model 43 KSR  
\$1095.00**

- 110 or 300 baud
- RS232C/ASCII
- Pin feed/8 1/2" H x 11" W paper is perfect for filing and copying

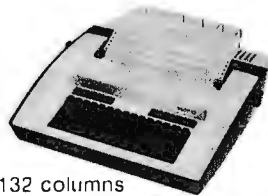

- 132 columns
- Upper/lower case, true descenders
- Dot matrix, impact printing

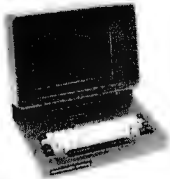

**The 550 BANTAM  
from Perkin-Elmer  
\$799.00**

**All the features of the  
Hazeltine 1400 &  
LSI ADM-3A plus**

- Shiftlock Key
- Print Key
- Integrated Numeric Pad
- Editing Functions
- Extremely Compact 15" W x 19" D x 14" H
- Silent fan-free operation
- Upper/Lower Case
- 7x10 Character Matrix
- White or Black Characters
- Transparent Mode
- Addressable Cursor
- Tab Function
- Backspace Key

**PENRIL 300/1200  
MODEM  
Originate/Auto-Answer  
\$799.00**

- RS232
- Full duplex over voice grade phone lines
- 1 year warranty
- Stand alone



- 0-300 or 1200 baud
- Bell 212A & 103/113 compatible
- FCC certified for direct connection to phone lines via RJ11C voice jack (standard extension phone jack)

**USR-300 Series**

**USR-310 Originate**



**Acoustic Coupler  
\$159.00**

- 0-300 Baud
- Bell 103/113 compatible
- Stand Alone
- RS232
- 1 Year Warranty
- Crystal Controlled
- State of the Art LSI circuitry
- 5 stage active filters

**USR-330  
Originate/  
Auto-Answer**



**Modem  
\$339.00**

FCC certified for direct connection to phone lines via standard extension phone jack

**USR-320  
Auto-Answer Modem  
\$319.00**

**U.S. ROBOTICS, INC.**

1035 W. LAKE ST.  
CHICAGO, ILL. 60607

Sales (312) 733-0497  
General Offices (312) 733-0498  
Service (312) 733-0499

**Give them  
the Gift of  
Life**



**ST. JUDE  
CHILDREN'S  
RESEARCH  
HOSPITAL**

*Danny Thomas, Founder*

St. Jude Children's Research Hospital is the only research institution dedicated solely to the conquest of catastrophic diseases of childhood.

In less than twenty years, the knowledge and new treatment procedures developed there have brought hope to suffering children who once would have been called incurable.

This knowledge is freely shared with pediatricians and physicians all over the world. Children admitted to St. Jude Children's Research Hospital study programs receive total medical care without cost.

This unique hospital needs help to continue. Inflation keeps eating away at the value of the dollar and increases the cost of operation. At the same time, the very success that allows children under its care to live longer means that St. Jude must provide free care to an increasing number of patients.

Please join in this effort to save children everywhere. Write: ALSAC-St. Jude Children's Research Hospital, 539 Lane Ave., Memphis, TN 38105 for further information.

Please give these children the Gift-of-Life by sending a tax-deductable gift.

**DIGITAL RESEARCH**

- CP/M\* Floppy Diskette Operating System — Packages supplied on diskette complete with 8080 assembler, text editor, 8080 debugger and various utilities plus full documentation. CP/M available configured for most popular computer/disk systems including: North Star Single, Double or Quad density, Altair 8" disks, Helios II, Exidy Sorcerer, Vector MZ, Polymorphic 8813, Heath H17 or H89, TRS-80, iCOM 3712 and iCOM Micro Disk plus many other configurations available off the shelf! ..... **\$145/\$25**
- MAC — 8080 Macro Assembler. Full Intel macro definitions. Pseudo Ops include RPC, IRP, REPT, TITLE, PAGE, and MACLIB. Z-80 library included. Produces Intel absolute hex output plus symbols file for use by SID (see below) ..... **\$100/\$15**
- SID — 8080 symbolic debugger. Full trace, pass count and break-point program listing system with back-trace and histogram utilities. When used with MAC, provides full symbolic display of memory labels and equated values ..... **\$85/\$15**
- TEX — Test formatter to create paginated, page-numbered and justified copy from source text files, directable to disk or printer ..... **\$85/\$15**
- DESPOOL — Program to permit simultaneous printing of data from disk while user executes another program from the console ..... **\$50/\$10**

**MICROSOFT**

- Disk Extended BASIC — Version 5, ANSI compatible with long variable names, WHILE/WEND, chaining, variable length line records ..... **\$300/\$25**
- BASIC Compiler — Language compatible with Version 5 Microsoft interpreter and 3-18 times faster execution. Produces standard Microsoft relocatable binary output. Includes Macro-80. Also linkable to FORTRAN-80 or COBOL-80 code modules ..... **\$350/\$25**
- FORTRAN-80 — ANSI 66 (except for COMPLEX) plus many extensions, includes relocatable object compiler, linking loader, library with manager. Also includes MACRO-80 (see below) ..... **\$400/\$25**
- COBOL-80 — ANSI 74 Relocatable object output. Format same as FORTRAN-80 and MACRO-80 modules. Complete ISAM, interactive ACCEPT/DISPLAY, COPY, EXTEND ..... **\$625/\$25**
- MACRO-80 — 8080 Z80 Macro Assembler. Intel and Zilog mnemonics supported. Relocatable linkable output. Loader, Library Manager and Cross Reference List utilities included ..... **\$149/\$15**
- EDIT-80 — Very fast random access text editor for text with or without line numbers. Global and intra-line commands supported. File compare utility included ..... **\$89/\$15**

**MICRO FOCUS**

- CIS COBOL (standard) — ANSI 74 COBOL standard compiler fully validated by U.S. Navy tests to ANSI level 1. Supports many features to level 2 including dynamic loading of COBOL modules and a full ISAM file facility. Also, program documentation, interactive debug and powerful interactive extensions to support protected and unprotected CRT screen formatting from COBOL programs used with any dumb terminal ..... **\$850/\$50**
- CIS COBOL (compact) — COBOL subset compiler for use on a 32k byte microcontroller. Valuable range of COBOL language features, many at level 2 and including ISAM and the CIS COBOL interactive screen formatting of dumb terminals ..... **\$650/\$30**
- Forms 1 — CRT screen editor to build application CRT formats with protected and unprotected field areas. Output is COBOL data description for copying into CIS COBOL programs. Eliminates the tedium of writing screen input and output formats by hand and greatly speeds interactive application programming. Output requires CIS COBOL compact compiler ..... **\$125/\$20**
- Forms 2 — Forms 1 screen editor plus indexed file application program generator. Automatically creates a query and update program which reads files using CRT protected and unprotected screen formats. No programming experience needed. Output program directly compiled by either of CIS COBOL compilers ..... **\$200/\$20**

**EIDOS SYSTEMS**

- KISS — Keyed Index Sequential Search. Offers complete Multi-Keyed Index Sequential and Direct Access file management. Includes built-in utility functions for 16 or 32 bit arithmetic string/integer conversion and string compare. Delivered as a relocatable linkable module in Microsoft format for use with FORTRAN-80 or COBOL-80, etc. .... **\$535/\$23**
- KBASIC — Microsoft Disk Extended BASIC with all KISS facilities, integrated by implementation of nine additional commands in language. Package includes KISS REL as described above, and a sample mail list program ..... **\$995/\$45**

\*CP/M is a trade name of Digital Research

\*\*Z80 is a trademark of Zilog, Inc.

\*\*\*UNIX is a trademark of Bell Laboratories

\*\*\*\*WHATSI7? is a trademark of Computer Headware.

†CP/M for Heath TRS-80 Model I and Polymorphic 8813 are modified and must be used especially compiled versions of system and applications software

††Polymorphic 8813 CP/M scheduled for September 15 release

*All Micropro prices are discounted!*

**MICROPRO**

- Super-Sort I — Sort, merge, extract utility as absolute executable program or linkable module in Microsoft format. Sorts fixed or variable records with data in binary, BCD, Packed Decimal, EBCDIC, ASCII, floating, fixed point, exponential, field justified, etc. Even variable number of fields per record! ..... **\$225/\$25**
- Super-Sort II — Above available as absolute program only ..... **\$175/\$25**
- Super-Sort III — As II without SELECT/EXCLUDE ..... **\$125/\$25**
- Word-Star — Menu driven visual word processing system for use with standard terminals. Text formatting performed on screen. Facilities for text pagination, page number, justify, center, indent, underscore. User can print one document while simultaneously editing a second. Edit facilities include global search and replace, read/write to other text files, block move, etc. Requires CRT terminal with addressable cursor positioning ..... **\$445/\$25**
- Word-Master Text Editor — In one mode has super-set of CP/M's ED commands including global searching and replacing, forward and backwards in file. In video mode, provides full screen editor for users with serial addressable-cursor terminal ..... **\$125/\$25**

**SOFTWARE SYSTEMS**

- CBASIC-2 Disk Extended BASIC — Non-interactive BASIC with pseudo-code compiler and runtime interpreter. Supports full file control, chaining, integer and extended precision variables, etc. .... **\$109/\$15**

*Structured systems prices are discounted!*

**STRUCTURED SYSTEMS GROUP**

- General Ledger — Interactive and flexible system providing proof and report outputs. Customization of COA created interactively. Multiple branch accounting centers. Extensive checking performed at data entry for proof, COA correctness, etc. Journal entries may be batched prior to posting. Closing procedure automatically backs up input files. All reports can be tailored as necessary. Requires CBASIC ..... **\$899/\$25**
- Accounts Receivable — Open item system with output for internal aged reports and customer-oriented statement and billing purposes. On-Line Enquiry permits information for Customer Service and Credit departments. Interface to General Ledger provided if both systems used. Requires CBASIC ..... **\$699/\$25**
- Accounts Payable — Provides aged statements of accounts by vendor with check writing for selected invoices. Can be used alone or with General Ledger and/or with NAD. Requires CBASIC ..... **\$699/\$25**
- LETTERRIGHT — Program to create, edit, and type letters or other documents. Facilities to enter, display, delete and move text with on video screen presentation. Designed to interface with NAD for form letter mailings. Requires CBASIC ..... **\$179/\$25**
- NAD Name and Address selection system — Interactive mail list creation and maintenance program with output as full reports with reference data or restricted information for mail labels. Transfer system for extraction and transfer of selected records to create new files. Requires CBASIC ..... **\$79/\$20**
- QSORT — Fast sort/merge program for files with fixed record length, variable field length information. Up to five ascending or descending keys. Full back-up of input files created. .... **\$95/\$20**

**GRAHAM-DORIAN SOFTWARE SYSTEMS**

- PAYROLL SYSTEM — Maintains employee master file. Computes payroll withholding for FICA, Federal and State taxes. Prints payroll register, checks, quarterly reports and W-2 forms. Can generate ad hoc reports and employee form letters with mail labels. Requires CBASIC. Supplied in source code. .... **\$590/\$35**
- APARTMENT MANAGEMENT SYSTEM — Financial management system for receipts and security deposits of apartment projects. Captures data on vacancies, revenues, etc. for annual trend analysis. Daily report shows late rents, vacancy notices, vacancies, income lost through vacancies, etc. Requires CBASIC. Supplied in source code. .... **\$590/\$35**
- INVENTORY SYSTEM — Captures stock levels, costs, sources, sales, ages, turnover, markup, etc. Transaction information may be entered for reporting by salesman, type of sale, date of sale, etc. Reports available both for accounting and decision making. Requires CBASIC. Supplied in source code. .... **\$590/\$35**
- CASH REGISTER — Maintains files on daily sales. Files data by sales person and item. Tracks sales, overruns, refunds, payouts and total net deposits. Requires CBASIC. Supplied in source code. .... **\$590/\$35**
- tiny C — Interactive interpretive system for teaching structured programming techniques. Manual includes full source listings ..... **\$75/\$40**

Prices and specifications subject to change without notice

**SOFTWARE WITH MANUAL ALONE**

- BDS C Compiler — Supports most major features of language, including Structures, Arrays, Pointers, recursive function evaluation, linkable with library to 8080 binary output. Lacks data initialization, long & float type and static & register class specifiers. Documentation includes "C" Programming Language book by Kernighan & Ritchie ..... **\$110/\$15**
- Whitesmith's C Compiler — The ultimate in systems software tools. Produces faster code than Pascal with more extensive facilities. Conforms to the full UNIX Version 7 C Compiler as described by Kernighan and Ritchie, and provides available over 75 functions for performing I/O, string manipulation and storage allocation. Compiler output in A-Natural source. Supplied with A-Natural (see below) requires 60K CP/M ..... **\$600/\$30**
- A-Natural — Narrative assembler with linking loader, librarian, extensive 8080 linking library in A-Natural relocatable format and translators from A-Natural source to Microsoft MACRO-80 source and from A-Natural rel to source ..... **\$330/\$15**
- ALGOL 60 Compiler — Powerful block-structured language featuring economical run time dynamic allocation of memory. Very compact (24K total RAM) and implementing almost all Algol 60 report features plus many powerful extensions including string handling direct disk address I/O etc. Requires Z80 CPU ..... **\$199/\$20**
- Z80 Development Package — Consists of: (1) disk file line editor, with global inter and intra-line facilities; (2) Z80 relocating assembler, Zilog/Mostek mnemonics, conditional assembly and cross reference table capabilities; (3) linking loader producing absolute Intel hex disk file. .... **\$95/\$20**
- ZDT — Z80 Debugger to trace, break and examine registers with standard Zilog/Mostek mnemonic disassembly displays. Includes manual to DOT. \$35 when ordered with Z80 Development Package ..... **\$50/\$10**
- DISTEL — Disk based disassembler to Intel 8080 or TDX/XTan Z80 source code, listing and cross reference files. Intel or TDX/XTan pseudo ops optional. Runs on 8080. .... **\$65/\$10**
- DISILOG — As DISTEL to Zilog Mostek mnemonic files. Runs on Z80 only ..... **\$65/\$10**
- TEXTWRITER III — Text formatter to justify and paginate letters and other documents. Special features include insertion of text during execution from other disk files or console, permitting receipt documents to be created from linked fragments on other files. Lists for sorted index, table of contents and footnote insertions. Ideal for contracts, manuals, etc. .... **\$125/\$20**
- Postmaster — A comprehensive package for mail list maintenance. Features include indexed record extraction and label production. Form letter program is included which provides neat letters on single sheet or continuous forms. Requires CBASIC ..... **\$150/\$25**
- WHATSI7?\*\*\* — Interactive data-base system using associative tags to retrieve information by subject. Hashing and random access used for fast response. Requires CBASIC ..... **\$125/\$25**
- XYBASIC Interactive Process Control BASIC — Full disk BASIC features plus unique commands to handle bytes, rotate and shift, and to test and set bits. Available in integer, Extended and ROMable versions. Integer Disk or Integer ROMable ..... **\$295/\$25**  
Extended Disk or Extended ROMable ..... **\$395/\$25**
- SMAL/80 Structured Macro Assembled Language — Package of powerful general purpose text macro processor and SMAL structured language compiler. SMAL is an assembler language with IF, THEN, ELSE, LOOP, REPEAT, WHILE, DO, END, BEGIN, END constructs ..... **\$75/\$15**
- SELECTOR II — Data Base Processor to create and maintain single key data bases. Prints formatted, sorted reports with numerical summaries. Available for Microsoft and CBASIC (state which). Supplied in source code ..... **\$195/\$20**
- SELECTOR III — Multi (ie. up to 24) Key version of Selector II. Comes with applications programs including Sales Activity, Inventory, Payables, Receivables, Check Register, Expenses, Appointments, and Client/Patient. Requires CBASIC. Supplied in source code ..... **\$295/\$20**  
Enhanced version for CBASIC-2 ..... **\$345/\$20**
- CPM/374X Utility Package — Has full range of functions to create or re-name an IBM 3741 volume, display directory information and edit the data set contents. Provides full file transfer facilities between 3741 volume data sets and CP/M files ..... **\$195/\$10**
- BASIC UTILITY DISK — Consists of: (1) CRUNCH-14 — Compacting utility to reduce the size and increase the speed of programs in Microsoft Basic and TRS-80 Basic. (2) DPFUN — Disk file creation subroutines for computing natural logarithm, exponential functions including square root, natural log, log base 10, sin, arc sin, hyperbolic sin, hyperbolic arc sin, etc. Furnished in source on diskette and documentation ..... **\$50/\$35**
- STRING BITS — Fortran character string handling. Routines to find, fill, pack, etc. separate, concatenate and compare character strings. This package completely eliminates the problems associated with character string handling in FORTRAN. Supplied with source ..... **\$45/\$15**
- Flippy Disk Kit — Template and instructions to modify single sided 5 1/4" diskettes for use of second side in single sided drives ..... **\$12/\$20**

Software for most popular 8080/Z80 computer disk systems including NORTH STAR, iCOM, MICROPOLIS, DYNABYTE DB8/2, EXIDY SORCERER, SD SYSTEMS, ALTAIR, VECTOR MZ, 8" IBM, HEATH H17 & H89, HELIOS, IMSAI VDP42 & 44, REX, POLYMORPHIC 8813, OHIO SCIENTIFIC and IMS 5000 formats.

# Shoppingist

## No. 1

\*The Software Supermarket is a trademark of Lifeboat Associates

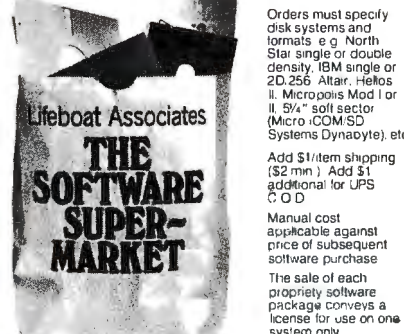

Lifeboat Associates, 2248 Broadway, N.Y., N.Y. 10024  
(212) 580-0082 Telex 668585



Listing 1 continued:

```
490 C9 = 0.0
500 D = 0.0
510 D0 = 0.0
520 D1 = 0.0
530 D2 = 0.0
540 D3 = 0.0
550 PRINT "THE SHIP CAN SWIVEL ";B2;" DEG/SEC. "
560 PRINT "EARTH'S GRAVITY IS 32.174 FT/SEC/SEC. "
570 PRINT "FORWARD VELOCITY NEEDED FOR ORBIT ";C2;" FT/SEC. "
580 D = D + 1
590 D4 = A2(D) / 2.2046
600 D5 = A3(D) / A4(D) / 2.2046
610 D6 = A1(D) / 2.2046
620 D7 = D6
630 D8 = A3(D)/2.2046*9.80665
640 PRINT "IGNITION OF STAGE ";D;"; ENTER THE STAGE NUMBER. "
645 INPUT X1
650 GO TO 1090
660 PRINT "ENTER THROTTLE SETTING IN %, FROM 0 TO 100, "
670 PRINT "THRUST ANGLE IN DEG. FROM -";B4;" TO ";B4
680 PRINT "AND BURN TIME IN SECONDS. "
690 INPUT D9, E, E0
700 D9 = ABS(D9 / 100.0)
710 E1 = D9 * D8
720 E2 = D9 * D5 * A7
730 E3 = E2 / 100.
740 E4 = E0 - (A7 / 100.0 )
750 E5 = C5 * C1
760 E6 = 0.0
770 IF E0 = 0.0 THEN 1080
780 IF C1 < C0 THEN 1080
790 E6 = E6 + A7
800 E7 = D7 - E2
810 E8 = E1 / (D4 + (D7 + E7 ) / 2.0 )
820 IF E7 >= E3 THEN 850
830 E7 = 0.0
840 E8 = 0.0
850 IF ABS( E - B9 ) < B5 THEN 930
860 IF E < B9 THEN 890
```

Listing 1 continued on page 110

Text continued:

pounds being required first. For each stage, the computer then asks for the weights of the fuel and hull (or tanks), the maximum thrust desired, and the specific impulse of the fuel. To insure the possibility of achieving orbit, a fuel to hull weight ratio of 4 or 5 to 1 is suggested. A thrust of about 20 percent more than the minimum amount required to lift the ship is suggested, so that the ship has sufficient acceleration, even when heavily laden with fuel.

Specific impulse is a figure of merit for fuel performance, the thrust to burn-rate ratio. Suggested values for different fuels are given in the program. Knowing the thrust and specific impulse defines the burn rate, and knowing the amount of fuel on board designates how long it will last at full throttle expenditure. Next, a printout chart, to be described shortly, displays initial fuel, altitude, and the velocity status of the ship.

At this point, the flight begins; the user is in control, and must specify the throttle setting, firing angle, and burn time for each maneuver. The force on the ship (in newtons) is first computed from the throttle setting

## ∞ INFINITE BASIC ∞™

**RELOCATABLE MODULES FOR THE TRS LEVEL II AND DOS SYSTEMS  
LOAD ANY OR ALL MODULES. FOR \$49.95 THE CORE PACKAGE INCLUDES:**

### ∞ MATRIX PACKAGE ∞

Over 30 BASIC commands including:

- ∞ Matrix Read, Inverse, Transpose, and Identity. Simultaneous Equations!!!
- ∞ Add, Subtract, or Multiply Scalars, Vectors, or Multi-dimension arrays!!!
- ∞ Dynamically Reshape, Expand, Delete Arrays, Change arrays in mid-program.
- ∞ Copy array elements, set arrays to scalar, zero arrays, move arrays.
- ∞ Tape array read and write including string arrays.

### FOR \$29.95 more get the ∞ BUSINESS PACKAGE ∞

- ∞ Eliminate round-off error!! Multiple precision packed decimal arithmetic. 127-digit max. accuracy
- ∞ Binary search or sorted arrays. Insert new elements in sorted arrays!!!
- ∞ Automatic page headings, footings, and pagination. Includes forced end-of-page.
- ∞ Automatic hash for record retrieval!!! And more for your professional packages.

### COMMAND PROCESSOR 'COMPROC' for \$19.95 (DOS only)

Extend DOS-AUTO command to perform multiple steps either at power-up or as a user command  
Execute a script consisting of a sequence of commands or data from a BASIC command file.

### REMODEL + PROLOAD for \$34.95 (Specify 16, 32, or 48K version)

Renumber any section of a program, MOVE program segments, DELETE program lines.  
Combine programs with renumber and merge. Load or save any portion of program from tape.

### DISK SORT PROGRAM 'DOSORT' for \$34.95 (Specify 32 or 48K, minimum 2 disk system)

SORT/MERGE multi-diskette sequential files. Multiple variables and keys.  
Includes machine language in-memory sorts, comparators and string handling.

### COPY SYSTEM TAPES with 'COPYSYS' for \$14.95 (Non-DOS)

### ∞ STRING PACKAGE ∞

Over 40 BASIC commands including:

- ∞ Left and right justify, truncate, rotate. Text justification. String centering.
- ∞ Delete or insert substring, Pack strings, Convert to upper or lower case.
- ∞ Translate characters, Reverse strings, Verify function, Number of occurrences.
- ∞ Masked string searches for simple or array variables. Encrypt or decrypt strings.
- ∞ Compress/uncompress character string arrays to 6 bits or less per character.
- ∞ AND the famous RACET machine language SORTS. Multi-key multivariable and string. Sort 1000 elements in 9 sec!!

### FUTURE ∞ ADD-ON PACKAGES ∞ will include ∞ STATISTICS ∞ INPUT/OUTPUT ∞ GRAPHICS ∞

Attn: TRS Add-On OEM's: We can support your special hardware add-ons with direct BASIC commands.  
System Houses: We license System House usage of ∞ INFINITE BASIC ∞ modules.

Check, VISA, M/C C.O.D.  
Calif. residents add 6%

Telephone Orders Accepted  
(714) 637-5016

WHEN ORDERING PLEASE  
ADVISE PUBLICATION SOURCE

**RACET COMPUTES**  
702 Palmdale, Orange CA 92665



# Something New on the Horizon from Technical Systems Consultants

## **Extended BASIC for 6800 and 6809**

Finally, a BASIC for serious business applications or scientific programming is available. All the features of our regular BASIC are supported—and more. Floating point calculations are carried out to an internal accuracy of 17 digits. Most math functions are accurate to 16 digits with a minimum accuracy of 13.5 digits. Integer variables have been included to allow fast execution of control loops and array indexing. Even with the double precision math package, this BASIC is still one of the fastest around.

The business programmer will appreciate the versatile PRINT-USING capabilities which include dollar and asterisk fill, trailing minus sign, imbedded commas, and scientific notation. New string functions have been added for string searching (INSTR) and for creating a string which is the date (DATE\$). DPEEK and DPOKE are 16-bit peek and poke type functions. The SCALE command has been included to eliminate the round-off errors typically encountered in binary math packages. The INCH\$ function allows single-character input from the terminal. Programmer control of control C breaks is also included.

Overall, the Extended BASIC is the most complete BASIC offered for micro users and is only available on FLEX™ disk. A system with at least 32K of user space is recommended. Specify 8" or 5" media (5" 6800 is FLEX™ 2.0) and either the 6800 or 6809 version when ordering.

<b>AP68-12</b>	<b>6800 Extended BASIC</b>	<b>\$100</b>
<b>SP09-6</b>	<b>6809 Extended BASIC</b>	<b>\$100</b>

## **BASIC Precompiler**

This program allows the creation of BASIC programs without the use of line numbers or restrictive two-character variable names. Alphanumeric line and subroutine labels may be used, as well as variable names of any length. Comment lines are marked with non-alphanumerics for easy readability. The output of the precompiler is in the standard BASIC compiled form. This allows applications programs to be written, precompiled, and then distributed in a non-source form. The precompiler can only be used with one of Technical Systems Consultants' BASICs. Specify 8" or 5" (5" 6800 is FLEX™ 2.0) when ordering.

<b>AP68-13</b>	<b>Single Precision 6800 Precompiler</b>	<b>\$40</b>
<b>AP68-14</b>	<b>Double Precision 6800 Precompiler</b>	<b>\$50</b>
<b>SP09-7</b>	<b>Single Precision 6809 Precompiler</b>	<b>\$40</b>
<b>SP09-8</b>	<b>Double Precision 6809 Precompiler</b>	<b>\$50</b>

*FLEX is a registered trademark of Technical Systems Consultants, Inc.*



**technical systems  
consultants, inc.**

Box 2570, West Lafayette, IN 47906  
(317) 463-2502



Listing 1 continued:

```

870 B9 = 39 + B3
880 GO TO 900
890 B9 = 39 - B3
900 E9 = 39 * B8
910 C4 = COS(E9)
920 C = SIN(E9)
930 F = E8 * C4
940 F0 = E8 * C
950 F1 = C5 + F * A7
960 C6 = ( C5 + F1 ) / 2.0
970 C7 = C7 + C6 * A7
980 F2 = F0 + C6**2 / C1 - B7 / C1**2
990 F3 = C8 + F2 * A7
1000 F4 = C1 + ( C8 + F3 ) / 2.0 * A7
1010 IF D9 <> 0.0 THEN 1030
1020 F1 = E5 / F4
1030 D7 = E7
1040 C5 = F1
1050 C8 = F3
1060 C1 = F4
1070 IF E6 < E4 THEN 770
1080 C3 = C3 + E6
1090 D2 = D2 + 1
1100 A(D2) = ( C1 - C0 ) / .3048
1110 IF C9 >= A(D2) THEN 1130
1120 C9 = A(D2)
1130 IF A(D2) >= 0.0 THEN 1150
1140 A(D2) = 0.0
1150 IF A(D2) < 400000.0 THEN 1170
1160 D3 = D3 + 1
1170 F5 = A(D2) / 5280.
1180 F6 = C8 / .3048
1190 F7 = F6 * 15./22.
1200 F8 = C5 / .3048
1210 F9 = F8 * 15./22.
1220 A0(D2) = C7 / B6
1230 G = 100. * D7 / D6
1240 G0 = D7 / D5
1250 G1 = B7 / C1**2 - C6**2 / C1
1260 G2 = D8 / (D4 + D7) / .3048
1270 G3 = G2 * 15. / 22.
1280 G4 = G2 - ( G1 / .3048 )
1290 G5 = G4 * 15. / 22.
1300 G6 = G1 / .3048 / G2
1310 G7 = 100. * G6
1320 G8 = 90.0
1330 IF G6 >= 1.0 THEN 1350
1340 G8 = ATN( G6 / SQRT( 1.0 - G6**2 ) ) / 38
1350 G9 = SQRT( B7 / C1 ) / .3048
1360 H = 100. * F8 / C2
1370 H0 = 100. * A(D2) / ( A8 * 5280. )
1380 H1 = 100. * F8 / G9
1390 H2 = ( C2 - F8 ) / G2
1400 H3 = ( G9 - F8 ) / G2
1410 IF F6 = 0.0 THEN 1440
1420 H4 = ( A8*5280. - A(D2) ) / F6
1430 IF H4 <= 9999.99 THEN 1460
1440 H4 = 9999.99
1450 REM-TIMES OVER 9999.99 SET TO 9999.99 TO NOT EXCEED DISPLAY.
1460 IF D3 <> 1.0 THEN 1480
1470 PRINT "4000 FT. ACHIEVED, YOU ARE IN VACUUM."
1480 PRINT "FLIGHT TIME", "FUEL LEFT", "AT FULL THROT.", "SHIP ANGLE"
1490 PRINT C3; "SEC.", G; "%", G0; "SEC.", B9; "DEG."
1500 PRINT " "
1510 PRINT "ALTITUDE", "ASCENT RATE", "FORWARD V.", "RANGE"
1520 PRINT A(D2); "FT.", F6; "FT/SEC", F8; "FT/SEC", A0(D2); "MI."
1530 PRINT F5; "MI.", F7; "MI/HR.", F9; "MI/HR."
1540 PRINT " "
1550 PRINT "MAX ACCEL", "MAX VERT ACCEL", "ANGLE (C.A.)", "THROT (C.A.)"
1560 REM-ANGLE (C.A.), CRITICAL ANGLE FOR CONST. ASCENT AT FULL THROT.
1570 REM-THROT (C.A.), CRITICAL THROT. OF CONST. ASCENT AT 90DEG.
1580 PRINT G2; "FT/S/S", G4; "FT/S/S", "FULL THROT.", "VERT. POS."
1590 PRINT G3; "MI/H/S", G5; "MI/H/S", G8; "DEG.", G7; "%"
1600 PRINT " "
1610 PRINT H; "% ORBITAL VELOCITY", H0; "% ORBITAL HEIGHT."
1620 PRINT H1; "% VELOCITY NEEDED FOR ORBIT AT CURRENT ALTITUDE."
1630 PRINT " "
1640 PRINT " ", " ", "TIME TO ACHIEVE:"
1650 PRINT "ORB. ALT.", "ORB. VEL.", "CUR. ALT. ORB. VEL."
1660 PRINT "AT CUR. RATE", "AT FULL THROT.", "AT FULL THROT."
1670 PRINT H4; "SEC.", H2; "SEC.", H3; "SEC."
1680 PRINT " "

```

Listing 1 continued on page 111

and maximum specified thrust. Also, note that a firing angle of ninety degrees is vertically upward, and angles less than ninety degrees are to the right, or east, etc. A one hundred percent throttle setting at ninety degrees for fifteen or twenty seconds is suggested to gain altitude before beginning to swivel the ship to achieve horizontal orbital velocity.

The amount of fuel used during an iteration is simply the throttle setting, times the maximum burn rate, times dt. This amount, subtracted from the weight of the fuel at the beginning of an iteration, gives the amount remaining at the end. The amount of fuel available during an iteration is taken as the average of the amounts before and after. This is added to the weight of the tanks and the upper stages that the engines must lift, and is the instantaneous weight (in kilograms) of the craft. Dividing into the thrust force yields the current engine thrust acceleration A, during the iteration, in meters per second per second (m/s<sup>2</sup>).

For a given firing angle, the horizontal and vertical components of this acceleration,  $a_{ih}$  and  $a_{iv}$ , are taken. Horizontal velocities and the range are computed by:

$$V_{jh} = V_{ih} + a_{ih} \times dt \quad (2)$$

$$V_{avh} = (V_{ih} + V_{jh}) / 2 \quad (3)$$

$$\text{range} = \text{range} + V_{avh} \times dt \quad (4)$$

where, for a particular iteration,  $V_{ih}$  is the initial horizontal velocity,  $V_{jh}$  is the final horizontal velocity, and  $V_{avh}$  is the average of the two.

The total outward vertical acceleration  $a_{rv}$  is computed by adding centrifugal acceleration to the engine acceleration and subtracting gravity's downward contribution as follows:

$$a_{rv} = a_{iv} + (V_{avh}^2 / r_{iv}) - GM / r_{iv}^2 \quad (5)$$

where,  $r_{iv}$  is the initial value of the vertical distance of the ship from the Earth's center,  $G$  is the gravitational constant, and  $M$  is the mass of the Earth. From the vertical acceleration, the velocities and altitude are computed just as the horizontal components were computed in equations 2 thru 4.

From physics, it will be noted that if no external force is applied by the engines, the rocket's angular momentum is a constant. For each maneuver, therefore, the computer retains

The following constants were used in listing 1:

- G: Gravitational constant,  
 $6.67 \times 10^{-11} \text{Nm}^2/\text{kg}^2$
- M: Mass of the earth,  
 $5.983 \times 10^{24} \text{kg}$
- g: Gravitational acceleration,  
 $9.80665 \text{ N/kg}$ ,  
 $\text{m/sec}^2 = 32.174 \text{ ft/sec}^2$

- 0.3048 meters/foot
- 2.2046 pounds/kg

the product of horizontal velocity and distance from the Earth's center. If the engines are off during an iteration, the new horizontal velocity is set equal to this product divided by the new vertical distance value at the end of the iteration. Thus, angular momentum is conserved. As the ship coasts towards Earth, its horizontal velocity increases slightly, and would decrease slightly if the ship were receding. Quantities are then reinitialized and the next iteration begins.

When a firing sequence is completed, an important quantity  $Q$  is computed. It is the ratio of the net downward acceleration (gravitational minus centrifugal) to the total acceleration. The engines can currently deliver:

$$Q = \left( \frac{GM}{r_{iv}^2} - \frac{V_{avh}^2}{r_{iv}} \right) / a_i \quad (6)$$

Multiplied by 100, this is the critical throttle setting which will cause the ship to hover if stationary, or move vertically at a constant speed without accelerating. It is also the sine of the critical angle of ascent at which the vertical component of thrust equals the current weight of the ship. The angle, equal to the inverse sine of  $Q$  is alternatively computed from:

Listing 1 continued:

```

1690 IF H < 100.0 THEN 1760
1700 IF H0 < 100.0 THEN 1760
1710 D0 = D0 + 1
1720 IF D0 > 1 THEN 1760
1730 PRINT "IN DESIRED ORBIT. TO CONTINUE ENTER 1, TO PLOT ENTER 2. "
1740 INPUT H5
1750 IF H5 = 2 THEN 1920
1760 IF C3 = 0.0 THEN 660
1770 IF D7 <= E3 THEN 1800
1780 IF A(D2) <= 0.0 THEN 1800
1790 GO TO 660
1800 IF A(D2) = 0.0 THEN 1890
1810 IF D < A5 THEN 580
1820 D1 = D1 + 1
1830 IF D1 <> 1 THEN 1850
1840 PRINT "LAST STAGE SHUTDOWN."
1850 IF D0 <> 0.0 THEN 1880
1860 IF A(D2) <= 0.0 THEN 1880
1870 GO TO 660
1880 IF A(D2) > 0.0 THEN 1920
1890 H6 = INT( SQR( F6**2 + F8**2 ) + .5)
1900 H7 = INT( SQR( F7**2 + F9**2 ) + .5)
1910 PRINT "YOU CRASHED AT ";H6;" FT/SEC. ";H7;" MI/HR. "
1920 PRINT "AFTER ";D2;" PLOT POINTS: "
1930 FOR H8 = 1 TO D2
1940 REM-PLOT A(H8) Y-AXIS, VS. A0(H8) X-AXIS, ALTITUDE VS. RANGE.
1950 NEXT H8
1960 H9 = 25.0
1970 REM-LOWER 25% CUTOFF OF ALTITUDE FOR A BLOWUP PLOT.
1980 I = C9 * H9 / 100.0 * 1.0001
1990 I0 = D2 + 1
2000 I0 = I0 - 1
2010 IF A(I0) > I THEN 2000
2020 I1 = 100.0 * A0(I0) / A0(D2)
2030 PRINT "LOWER ";H9;"% OR ";I;" MI. OF MAX ALT. ATTAINED."
2040 PRINT "FIRST ";I1;"% OR ";A0(I0);" MI. OF TOTAL RANGE."
2050 PRINT "WITH ";I0;" STEPS:"
2060 FOR I2 = 1 TO I0
2070 REM-PLOT A(I2) Y-AXIS, VS. A0(I2) X-AXIS, LOWER ALT. VS. RANGE."
2080 NEXT I2
2090 END

```

$$\text{angle} = \tan^{-1} (Q / \sqrt{1.0 - Q^2})$$

At this time, distance and velocity values are converted from metric to English units for display purposes.

The first information printed consists of the elapsed flight time, the current ship angle, and the fuel left, both as a percentage of the original amount, and the number of seconds left at full throttle. Next, the program prints the altitude in miles and feet, the ascent rate and forward velocity in miles per hour and feet per second, and the number of miles down range.

The next printed information consists of the critical angle and throttle values of constant ascent, the maximum acceleration the engines can deliver, and the maximum vertical acceleration against gravity in both miles per hour per second and feet per second<sup>2</sup>. For example, if the engine can deliver about 40ft/s<sup>2</sup> the

ship can accelerate at 8ft/s<sup>2</sup> against gravity.

Next the percentages of the orbital velocity and altitude are presented. The final items displayed are the time to achieve orbital altitude at the current ascent rate, and the time to achieve orbital velocity at the current full throttle rate of horizontal acceleration.

At this point the user is ready for the next move, and must again specify a new throttle setting, firing angle, and burn time. Finally, at the end of the mission (either when you achieve orbit, or run out of fuel), you can plot a picture of your trajectory, altitude versus range, and an expanded plot of the start of your mission, the lower 25 percent of your total attained altitude.

Have fun. As you will soon learn, getting your spacecraft to achieve orbit is no easy task. ■



# SYNCHRO-SOUND

The ORIGINAL Computer People Who KNOW computers and offer EVERYTHING you need in Small Computer Systems

Compare PRICE, QUALITY, DELIVERY, SERVICE and you'll see why you don't have to look anywhere else!



**TEXAS INSTRUMENTS**  
810 Multi-Copy Impact Printer  
ONLY **\$1599.00**  
SINGLE QUANTITY PRICE

We carry a full line of Texas Instruments products



**SUPER SPECIAL!**



**LA 34 DECwriter IV Teleprinter**  
**\$1095.00**  
SINGLE QUANTITY PRICE

**TERMINALS**

LEAR-SIEGLER ADM-3A.... } **CALL\*** for prices  
ADM-31.... }  
ADM-42.... }

**HAZELTINE**

1400.... } **CALL\*** for prices  
1410.... }  
1500.... }  
Mod 1 Edit.... }



**COMPUTERS**

**NORTHSTAR** Horizon II (kit).... } **CALL\*** for price



**PRINTERS**

**QUME** Sprint—5/45 KSR  
\$2995.00  
Typewriter Quality Printer Terminal



**DIGITAL SYSTEMS**

**DSC-2** Dble Density Dual Drive Disk.... } **CALL\*** for prices

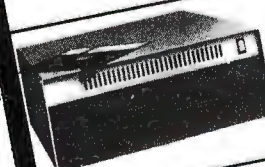

**TELETYPE**

43.... } **CALL\*** for price



**CROMEMCO** System 3.... } **CALL\*** for price



**CENTRONICS**

Micro.... } **CALL\*** for prices  
779-2.... }  
700-2.... }  
703-0.... }



**MORE SPECIALS**

Okidata SL 125	\$2595.00	Livermore Acoustic Coupler	249.00
Javelin 9" Monitor	159.95	Centronics Micro Printer	395.00
Persci 277 Dble Density	1395.00	5" Scotch Diskette Box/	34.95
Imsai PCS 80/15	599.00	8" Scotch Diskette Box/	39.95
Anadex DP 8000 Printer	995.00		

\* Our prices are too low to advertise. Please call or write. We now carry a full line of Alpha-Micro Products

We have a full staff of Programmers and Computer Consultants to design, configure and deliver a Turnkey Computer System to meet your specific requirements.



**SYNCHRO-SOUND** ENTERPRISES, INC.  
The Computer People  
193-25 Jamaica Avenue, Jamaica, New York 11423  
TWX 710-582-5886

PHONE ORDERS, CALL:  
NEW YORK — 212/468-7067  
LOS ANGELES — 213/628-1808  
CHICAGO — 312/641-3010  
DALLAS — 214/742-6090

# The National Micropastime

---

Joseph J Roehrig  
JJR Data Research  
POB 74  
Middle Village NY 11379

---

During the past few years I have spent too many Saturdays soldering integrated-circuit sockets into printed-circuit boards and have not had enough time to enjoy a good baseball game. I fulfill my need to participate in our national pastime by having my personal computer simulate the play of a baseball game. I can be the manager of any team I choose. All I have to do is input a few baseball statistics. Presto! Out comes a baseball simulation (assuming that the system I shall describe is set up).

## System Demonstration

The search for baseball statistics is easy. *The Sports Encyclopedia: Baseball*, published by Grosset and Dunlap, has all that you could want. A program called Input (shown in listing 1) is used to enter the statistics into the computer. Figure 1 shows the program Input working.

First you enter a file name to correspond to the team (the 1975 Boston Red Sox in the sample run) whose statistics are being entered. Next, the program requires the name and data for seventeen players who are not pitchers. Yastrzemski is input along with his batting code of 1 (0 = bats right, 1 = bats left, 2 = bats from either side), number of times at bat (543), hits (146), doubles (30), triples (1), home runs (14) bases on balls (87), and strikeouts (67). The computer asks us if the data input is correct. A carriage return indicates

**Listing 1:** Program Input which accepts data from the terminal and stores it in disk files for use by the baseball simulation. This program and others in the system are written in North Star BASIC and use the North Star disk system.

```
10 DIMB(7),N$(10)
12 J$="-----"
15 INPUT"TEAM FILE ? ",F$
20 OPEN#0,F$
90 !"HITTERS"
100 FORA=0TO16
110 INPUT"NAME ? ",N$
120 !"BATS,AB,H,D,T,HR,BB,KO"
130 INPUT1" ? ",B(7),C,B(1),B(2),B(3),B(4),B(5),B(6)
132 IFC=0THENC=1
135 INPUT" OK ? ",Z$IFZ$="" THEN110
137 B9=B(1)\H=C-R(1)
140 C=C+B(5)\B(1)=B(1)/C
142 FORF=2TO4\B(F)=B(F)/B9 \IFF=2THEN146
144 B(F)=B(F)+B(F-1)
146 NEXT\B(5)=(B9+B(5))/C\B(6)=B(6)/H
155 N$=N$+J$
160 WRITE#0,N$,B(7)\FORE=1TO6\WRITE#0,B(E)\NEXT\NEXT
190 !"PITCHERS"
200 FORA=0TO9
210 INPUT"NAME ? ",N$
220 !"THROWS,IF,H,BB,KO",
230 INPUT1" ? ",B(0),C,B(1),B(2),B(3)
232 IFC=0THENC=1
235 INPUT" OK ? ",Z$IFZ$="" THEN210
237 I=C*2.75
240 C=(C*2.75)+B(1)+B(2)
250 B(1)=B(1)/C
260 B(2)=(B(2)/C)+B(1)
270 B(3)=B(3)/C
275 N$=N$+J$
280 WRITE#0,N$,B(0),B(1),B(2),B(3)
290 NEXT\Z=0\FORA=1TO13B\WRITE#0,Z\NEXT\CLOSE#0\END
```

---

```
TEAM FILE ? 75--BOSTON
HITTERS
NAME ? YASTREMSKI
BATS,AB,H,D,T,HR,BB,KO
? 1,543,146,30,1,14,87,67 OK ?
PITCHERS
NAME ? WISE
THROWS,IF,H,BB,KO ? 0,255,262,72,141 OK ?
```

**Figure 1:** Portion of sample execution of the program Input of listing 1. Normally data is entered for sixteen nonpitching players and ten pitchers.



**Listing 2:** A program, Roster, which reads data from a disk file concerning composition of a given baseball team and displays it on the terminal for inspection by the user. Figure 2 shows an example of its use.

```

10 DIMB(6),N$(10)
12 N$=""
15 INPUT"TEAM FILE ? ",F$
17 !""
20 OPEN#0,F$
25 !"ID ",
30 !"HITTERS      BATS HITS  2B  3B  HR  BB  KO"
40 FORA=0TO16
50 READ#0,N$FORB=0TO6\READ#0,B(B)\NEXT
55 !%2I,A," ",
60 !N$,TAB(16),B(0),
65 !%5F3,B(1),B(2),B(3),B(4),B(5),B(6)
70 NEXT
75 !" "\! " "\! "ID ",
80 !"PITCHERS     R-L HITS  BB  KO"
90 FORA=0TO9
100 READ#0,N$,B(0),B(1),B(2),B(3)
105!%2I,A," ",
110 !N$,TAB(16),B(0),
120 !%5F3,B(1),B(2),B(3)
130 NEXT\END

```

everything is all right. Any other input allows for the reentry of the data.

Figure 1 omits the other sixteen entries and shows the first of ten pitcher entries. Here, the player's name Wise is entered along with his throwing arm designation of 0 (0=right, 1=left), innings pitched (255), hits (262), bases on balls (72), and strikeouts (67).

The next step is to see what information was entered and how the computer translates this data. In order to accomplish this program Roster (listing 2) is run. Figure 2 shows that the execution of this program asks for a file name, and 75—BOSTON is entered to correspond to the information just fed into the computer. The computer assigned identification numbers to the seven-

teen nonpitchers and ten pitchers, and translated all of the historical statistics into percentages.

That was a lot of data entry. Since I would not want to redo the entire input job again to change one player, program Fix (listing 3) was written; its execution is shown in figure 3. All that must be done to change an entry is to enter a file name and a hitter's identification number (from 0 thru 16), or a number greater than 16 as the identification number to change a

pitcher. Once the pitcher correction section is entered, an identification number greater than 9 ends the program execution.

### Hypothetical Matchup

With this data I am ready to play a fictitious World Series between the 1961 New York Yankees (led by Roger Maris, who hit 61 home runs that year, along with Mickey Mantle and Whitey Ford) and the 1963 Los Angeles Dodgers (who beat the 1963

TEAM FILE ? 75-BOSTON

ID	HITTERS	BATS	HITS	2B	3B	HR	BB	KO
0	YASTREMSKI	1	.232	.205	.212	.308	.370	.169
1	DOYLE	1	.296	.219	.240	.281	.340	.051
2	BURLESON	0	.234	.171	.178	.219	.306	.101
3	PETROCELLI	0	.217	.156	.167	.240	.309	.199
4	EVANS	0	.244	.212	.265	.381	.349	.201
5	LYNN	1	.297	.269	.309	.429	.402	.255
6	RICE	0	.290	.167	.190	.316	.350	.313
7	FISK	0	.300	.161	.207	.322	.393	.182
8	COOPER	1	.293	.179	.242	.389	.352	.157
9	CARBO	1	.204	.256	.293	.476	.410	.291
10	GRIGGIN	0	.226	.087	.087	.101	.285	.133
11	BENIQUEZ	0	.262	.192	.247	.274	.351	.144
12	MILLER	1	.163	.095	.143	.143	.326	.230
13	HEISE	0	.208	.111	.111	.111	.238	.061
14	MONTGOMERY	0	.221	.227	.250	.295	.241	.245
15	BLACKWELL	2	.172	.115	.192	.192	.298	.123
16	CONEGLIARO	0	.108	.143	.143	.429	.231	.180

ID	PITCHERS	R-L	HITS	BB	KO
0	WISE	0	.253	.323	.136
1	TIANT	0	.250	.318	.135
2	LEE	1	.259	.324	.074
3	MORET	1	.218	.343	.132
4	CLEVELAND	0	.249	.324	.112
5	WILLOUGHBL	0	.237	.320	.149
6	POLE	0	.267	.351	.110
7	DRAGO	0	.229	.333	.143
8	SEGUI	0	.230	.369	.146
9	BURTON	1	.260	.346	.175

Figure 2: Execution of the program Roster of listing 2. The file name is the same as that used for program input.

**CYGOL**

## ARE YOU PROTECTED ?

Against... Power blackouts?  
Software bombouts?  
Floppy Freakouts?

You will be if you've got a NVM-804 series non-volatile memory board. Long term S-100 compatible data retention is yours now at a low introductory price.

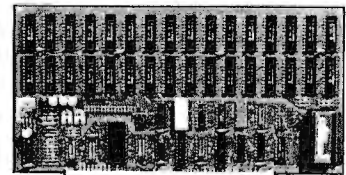

Assembled and tested  
4K x 8 \$395  
Includes postage & handling  
Ohio residents  
add 4 1/2% sales tax

**CYGOL 1395 Golf Street Dayton, OH 45432**



# The face is (becoming) familiar

No surprise... it stands out in the crowd. The quality and reliability that Industrial Micro Systems' customers have grown accustomed to is now available in our complete system. A system that will grow with your needs.

You can start with a minimum 16K, single disk system. The system shown above can be expanded to 608K-Bytes of fast RAM with three double-sided, double-density drives. And more to come.

The microcomputer industry standard CP/M™ operating system is delivered with the system. PASCAL is available. Industrial Micro Systems users are developing an impressive array of application software.

The system is offered in rack mount and table top versions and also in our own desk enclosure.

In addition to gaining in familiarity, the Industrial Micro Systems picture for total system products should be coming into focus for everyone. Advanced, reliable electronics... industry standard software... and functional, high quality enclosures.

Industrial Micro Systems, your source for *complete* systems. And the prices are right.

Ask your dealer to see the full Industrial Micro Systems line of products and be watching for exciting new additions soon to come from Industrial Micro Systems, 628 N. Eckhoff St., Orange, CA 92668. (714) 633-0355.

*After November 1, please call (714) 978-6966.*

**INDUSTRIAL MICRO SYSTEMS, INC**  
The great unknown.

Circle 169 on inquiry card.

\* CP/M is a trademark of Digital Research, Inc.



# matrox microprocessor displays

ALTR-2480



ALT-256

ALT-512

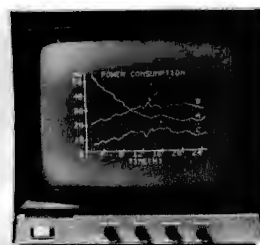
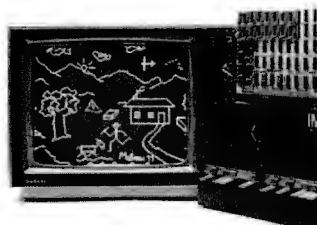

## S100 BUS

### Standard TV Monitor Controllers

**ALPHANUMERICS:** Transparent Memory insures clean video while leaving CPU free to perform other tasks. 24 x 80 or 2 pages 24 x 40. 96 ASCII characters with descenders plus 32 graphics symbols. Normal/inverse video and blink available on a per character basis.

**GRAPHICS:** 256 x 256 high resolution monochrome self-contained graphics display and a software controlled ALT-512 provides 512 horizontal x 256 vertical or two 256 x 256 images allowing grey scale or high speed animation X-Y addressing of memory located in I/O area allows CPU maximum work space.

**COMBINED:** The ALT-256 and ALT-512 graphics boards allow easy connection to the ALTR-2480 providing full alpha/graph capability on two cards.

Matrox offers a highly diversified selection of modules and PC boards allowing customers to solve display problems rapidly and cost effectively. These ready to use sub-systems are available off the shelf in self-contained module, for any uP, or on PC boards. bus compatible with DEC LSI-11, PDP-11, Mostek/Protog STD, Intel/NSC SBC Multibus, Motorola Exorciser, Custom Designs as well as the MTX A1 & MTX B1. Alpha chips - the single chip keyboard & display controllers - give Matrox the most extensive display capability in the industry

matrox electronic systems

The Visible Solutions Company

5800 ANDOVER AVENUE, T.M.R., MONTREAL, QUE. H4T 1H4  
TEL: (514) 735-1182 TELEX: 05-825651  
U.S. ONLY, TRIMEX BUILDING, MOORE'S, N.Y. 12958

Listing 3: A program, Fix, which allows the user to selectively correct data for a single player that has been stored on the disk by the Input program.

```

10 DIMB(7),N$(10)
12 J$="-----"
15 INPUT"TEAM FILE ? ",F$
20 OPEN#0,F$
90 !"HITTERS"
100 INPUT"# ? ",A\IFA>13THEN190\A=A*47
110 INPUT"NAME ? ",N$
120 !"BATS,AB,H,D,T,HR,BB,KO"
130 INPUT1" ? ",B(7),C,B(1),B(2),B(3),B(4),B(5),B(6)
132 IFC=0THENC=1
135 INPUT" OK ? ",Z$\IFZ$<>" THEN110
137 B9=B(1)\H=C-B(1)
140 C=C+B(5)\B(1)=B(1)/C
142 FORF=2TO4\B(F)=B(F)/B9 \IFF#2THEN146
144 B(F)=B(F)+B(F-1)
146 NEXT\B(5)=(B9+B(5))/C\B(6)=B(6)/H
155 N$=N$+J$
160 WRITE#0ZA,N$,B(7),B(1),B(2),B(3),B(4),B(5),B(6),NOENDMARK
170 GOTO100
190 !"PITCHERS"
200 INPUT"# ? ",A\IFA> 9THEN310\A=799+(A*32)
210 INPUT"NAME ? ",N$
220 !"THROWS,IP,H,BB,KO",
230 INPUT1" ? ",B(0),C,B(1),B(2),B(3)
232 IFC=0THENC=1
235 INPUT" OK ? ",Z$\IFZ$<>" THEN210
237 D=C*2.75
240 C=(C*2.75)+B(1)+B(2)
250 B(1)=B(1)/C
260 B(2)=(B(2)/C)+B(1)
270 B(3)=B(3)/C
275 N$=N$+J$
280 WRITE#0ZA,N$,B(0),B(1),B(2),B(3),NOENDMARK
300 GOTO 200
310 CLOSE#0\END
    
```

```

TEAM FILE ? 75-BOSTO
HITTERS
# ? 0
NAME ? YASTREMSKI
BATS,AB,H,D,T,HR,BB,KO
? 1,543,146,30,1,14,87,67 OK ?
# ? 99
PITCHERS
# ? 0
NAME ? WISE
THROWS,IP,H,BB,KO ? 0,255,262,72,141 OK ?
# ? 99
    
```

Figure 3: Sample execution of the program Fix of listing 3. This program allows selective correction of the input data.

Yankees in four straight games in the 1963 World Series on the strong pitching of Sandy Koufax and Don Drysdale). To play this hypothetical series, all that is necessary is to load the program called Game and enter the file names 61-YANKS and 63-LA (assuming these files have been created in the manner just described).

Simulation of the first five games of this hypothetical World Series obtains the following results:

- Game 1: Dodgers 6, Yankees 2.
- Game 2: Yankees 3, Dodgers 1.
- Game 3: Dodgers 6, Yankees 3.
- Game 4: Yankees 11, Dodgers 4.
- Game 5: Yankees 2, Dodgers 1.

### Detailed Play of Game 6

The series now stands with the Yankees having won 3 and the Dodgers 2 games. A win by the Yankees ends the series, so I will show the details of the sixth game. Program Game is loaded and executed as shown in figure 4. The computer asks for a random number; 41 is input. Next, the file name of the visiting team is entered, followed by that of the home team. It is now time to enter the Dodger batting order.

This is done by entering the identification number (taken from the computer roster, a sample was shown in figure 2) and position number of

Text continued on page 122



## When you don't have a stand to sit on.

Trimm's universal printer stand can get you up and running for just \$94.95. Our stand is as rugged as they come and as attractive as you want. It has a large chrome rear-mounted paper basket, plastic cushioned leveler feet and textured black baked enamel finish.

Take delivery within days of your order. Trimm ships immediately.

The Trimm stand comes packaged and ready for immediate assembly and mounting of your printer. Please specify your printer model when ordering.

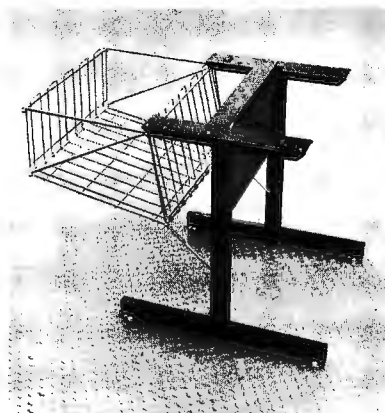

\$94.95 (or less, when you want more.  
Distributor inquiries invited.)

Trimm stand fits:  
Most Centronics 700 series  
Texas Instruments 810-820  
NEC Spinwriter series  
Okidata Slimline series  
Lear Siegler 300  
Diablo 1600 & 2300 series

**TRIMM**  
Enclosure Products

Computer and Peripheral Desks,  
Tables, Vertical Enclosures, Printer  
Stands, Accessories.

Trimm Enclosure Products 11939 Sherman Road, No. Hollywood, CA (213) 982-0400



# Rx AVAILABLE WITHOUT PRESCRIPTION!

## THE ONLY SYSTEM OF ITS KIND YOUR MICROCOMPUTER WILL EVER NEED!

### GLOBAL™ DATABASE MANAGEMENT SYSTEM

for PROGRAMMERS, ACCOUNTANTS, BOOK-KEEPERS, DOCTORS, LAWYERS, PUBLISHERS, SCIENTISTS, MANUFACTURERS, WHOLESALERS, RETAILERS, MANAGERS, LANDLORDS, REAL ESTATE AGENTS, TEACHERS, STUDENTS, ETC.

**Extremely comprehensive, versatile user-oriented management system for database creation and list maintenance. Runs under CP/M\* and CBASIC2\*\* on a microcomputer system in only 40K RAM.**

Completely user-defined file structure with sequential, random and linked file maintenance; user-defined number of fields; data transfer between records; automatic high speed search algorithms with global search function; built-in ISAM; fast sort/merge utility; record selectable output can be formatted (with/without headings, column titles, totals, etc.) and printed on various forms (labels, envelopes, preprinted forms, etc.); links to CP/M commands or programs with automatic return to Global; provides status reports on diskette, data file and hardware environment; disk used as extended memory.

Supplied on standard 8" IBM disk, complete with BASIC subroutine library in source code, with comprehensive manual. **\$295**

\*Trademark of Digital Research plus delivery  
 \*\*Trademark of Software Systems Add Sales Tax where applicable

AVAILABLE FROM  
**COMPUTER EMPORIUM, Ltd.**  
 11 West 46th Street  
 New York, N.Y. 10036 212/226-2038  
 OR ORDER DIRECT FROM



1505 Ocean Ave. Brooklyn, N.Y.  
 212/252-5002

Figure 4: Predicted play of a hypothetical baseball game between the 1961 New York Yankees and the 1963 Los Angeles Dodgers, using the Game program described in this article. The entry for NUM? is a seed for generating random numbers; the entries for the TEAM? inquiries are file names to reference data stored on disk by the Input program. The user enters the batting order and pitching staffs, and play of the game proceeds according to statistical probabilities.

```

NUM? 41
TEAM ? 63-LA
TEAM ? 61-YANKS
GIVE THE LINE-UP
BATTING 1 ID, POS # ?2,6
BATTING 2 ID, POS # ?1,4
BATTING 3 ID, POS # ?5,8
BATTING 4 ID, POS # ?6,7
BATTING 5 ID, POS # ?4,3
BATTING 6 ID, POS # ?3,5
BATTING 7 ID, POS # ?7,2
BATTING 8 ID, POS # ?0,9
BATTING 9 ID, POS # ?10,10
ID# OF PITCHER ? 3
GIVE THE LINE-UP
BATTING 1 ID, POS # ?15,1
ID, POS # ?1,4
BATTING 2 ID, POS # ?2,6
BATTING 3 ID, POS # ?4,9
BATTING 4 ID, POS # ?5,8
BATTING 5 ID, POS # ?7,2
BATTING 6 ID, POS # ?0,3
BATTING 7 ID, POS # ?10,7
BATTING 8 ID, POS # ?8,10
BATTING 9 ID, POS # ?3,5
ID# OF PITCHER ? 6

INNING # 1
WILLS----- IS OUT
GILLIAM---- SINGLE
RUNNER ON FIRST
DAVIS W--- DOUBLE PLAY

RICHARDSON SINGLE
RUNNER ON FIRST
KUBEK----- SINGLE
RUNNER ON FIRST RUNNER ON THIRD
MARIS----- IS OUT
 1 RUNS SCORE 63-LA 0 61-YANKS 1
RUNNER ON SECOND
P,H, OR B ?
MANTLE----- H. R.
 2 RUNS SCORE 63-LA 0 61-YANKS 3
P,H, OR B ? P
P# ? 9
HOWARD----- IS OUT
SKOWRON---- SINGLE
RUNNER ON FIRST
CERV----- STRIKES OUT

INNING # 2
DAVIS T---- STRIKES OUT
HOWARD----- H. R.
 1 RUNS SCORE 63-LA 1 61-YANKS 3
P,H, OR B ?
MCMULLEN-- STRIKES OUT
ROSEBORO-- IS OUT

LOPEZ----- SINGLE
RUNNER ON FIRST
BOYER----- IS OUT
RUNNER ON SECOND
RICHARDSON IS OUT
KUBEK----- WALK
RUNNER ON FIRST RUNNER ON SECOND
MARIS----- IS OUT

INNING # 3
FAIRLY----- IS OUT
OLIVER----- IS OUT
WILLS----- IS OUT

MANTLE----- SINGLE
RUNNER ON FIRST
HOWARD----- SINGLE

WILLS----- SS OK ?
GILLIAM---- 2B OK ?
DAVIS W--- CF OK ?
DAVIS T---- LF OK ?
HOWARD----- 1B OK ?
MCMULLEN-- 3B OK ?
ROSEBORO-- C OK ?
FAIRLY----- RF OK ?
OLIVER----- DH OK ?
FODRES----- OK ?

GONDER----- P OK ? NO
RICHARDSON 2B OK ?
KUBEK----- SS OK ?
MARIS----- RF OK ?
MANTLE----- CF OK ?
HOWARD----- C OK ?
SKOWRON---- 1B OK ?
CERV----- LF OK ?
LOPEZ----- DH OK ?
BOYER----- 3B OK ?
DALEY----- OK ?
    
```

Figure 4 continued on page 120

# Designing Digital Systems

Two programmed learning courses: hardware and software; theory and application.

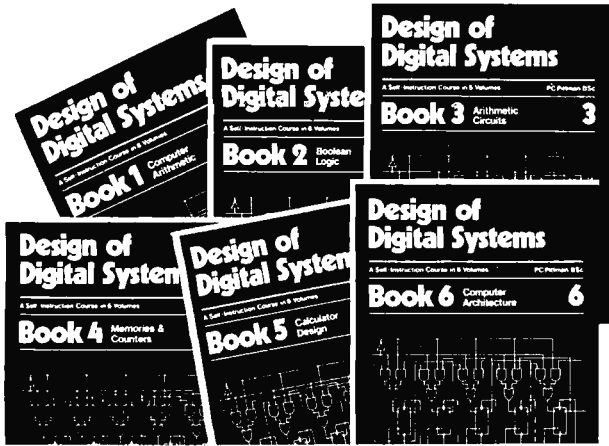

**Design of Digital Systems - six volumes**

## ADVANCED COURSE DESIGN OF DIGITAL SYSTEMS

Six large-format volumes — each 11 1/4" x 8 1/4".

### CONTENTS

The contents of Design of Digital Systems include:

Book 1: Octal, hexadecimal and binary number systems; representation of negative numbers; complementary systems; binary multiplication and division.

Book 2: OR and AND functions; logic gates; NOT, exclusive-OR, NAND, NOR and exclusive - NOR functions; multiple input gates; truth tables; DeMorgan's Laws; canonical forms; logic conventions; Karnaugh mapping; three-state and wired logic.

Book 3: Half adders and full adders; subtractors; serial and parallel adders; processors and arithmetic logic units (ALUs); multiplication and division systems.

Book 4: Flip-flops; shift registers; asynchronous counters; ring, Johnson and exclusive-OR feedback counter; random access memories (RAMs); read-only memories (ROMs).

Book 5: Structure of calculators; keyboard encoding; decoding display data; register systems; control unit; program ROM; address decoding; instruction sets; instruction decoding; control program structure.

Book 6: Central processing unit (CPU); memory organization; character representation; program storage; address modes; input/output systems; program interrupts; interrupt priorities programming; assemblers; executive programs, operating systems, and time-sharing.

### OUR CUSTOMERS

Design of Digital Systems has been bought by more than half the 50 largest corporations in America, and by Motorola, Intel, DEC, National Semiconductor, Fairchild, General Instrument, Hewlett-Packard, Heath Co., M.I.T., NASA, Smithsonian Institute, Bell Telephone Labs. And many, many more, as well as corporations and individuals in over 50 countries.

## BASIC COURSE



**Digital Computer Logic & Electronics**

### CONTENTS

Digital Computer Logic and Electronics is designed for the beginner. No mathematical knowledge other than simple arithmetic is assumed, though you should have an aptitude for logical thought. It consists of 4 volumes — each 11 1/2" x 8 1/4" — and serves as an introduction to the subject of digital electronics.

Contents include: Binary, octal and decimal number systems; conversion between number systems; AND, OR, NOR and NAND gates and inverters; Boolean algebra and truth tables; DeMorgan's Laws; design of logical circuits using NOR gates; R-S and J-K flip-flops; binary counters, shift registers and half-adders.

## NO RISK GUARANTEE

There's absolutely no risk to you. If you're not completely satisfied with your courses, simply return them to GFN within 30 days. We'll send you a full refund, plus return postage.

## TAX DEDUCTIBLE

In most cases, the full cost of GFN's courses can be a tax deductible expense.

## PHONE ORDERS - FREE

To order by phone, call (603) 224-5580 with your credit card information. It won't cost you a dime, because we'll deduct the cost of your call from the price of the courses you order.

## TO ORDER BY MAIL

You may use the order form below if you wish, but you don't need to. Just send your check or money order (payable to GFN Industries, Inc.) to the address below. If you don't use the order form, make sure your address is on your check or the envelope, and write "DDS" (Design of Digital Systems), "DCLE" (Digital Computer Logic & Electronics), or "both" (both courses) on your check.

There are no extras — no sales tax. And we pay all shipping costs.

We also accept company purchase orders.

## AIR MAIL

The prices shown include surface mail postage anywhere in the world. Air mail postage costs an extra \$10 for both courses (10 volumes).

## DISCOUNTS

Call or write for details of educational and quality discounts, and for dealer costs.

## SAVE \$5

If you order both courses, you save \$5. Order at no obligation today.

To: GFN Industries, Inc., Bldg. 7-20, 203 Loudon Road, Concord, NH 03301		
Please send me		
___ sets of Design of Digital Systems .....	\$19.95	\$ _____
___ sets of Digital Computer Logic & Electronics .....	\$14.95	_____
___ sets of both courses .....	\$29.90	_____
Enclosed is check/money order (payable to GFN Industries, Inc.) for total \$ _____		
NAME .....		
ADDRESS .....		
CITY/STATE/ZIP .....		
		RB



**GFN Industries, Inc.**  
Bldg. 7-20  
203 Loudon Road  
Concord  
NH 03301

- \* Order free by phone
- \* No sales tax
- \* No shipping charges
- \* Money-back guarantee
- \* Tax deductible
- \* Save \$5

Call (603) 224-5580 to order by phone - free.

7 days, 24 hours

Circle 140 on inquiry card.



# CP/M<sup>®</sup> SOFTWARE TOOLS

## NEW ED-80 TEXT EDITOR

ED-80 offers a refreshing new approach for the creation and editing of program and data files conversationally—and it saves you money. Its powerful editing capabilities will satisfy the most demanding professional—yet it can still be easily used by the inexperienced beginner.

### Look at These Outstanding Features:

- FULL SCREEN window displays with forward and backward scrolling for editing your data a page-at-a-time, rather than line-by-line.
- Provides you with all the features found on the large main-frame and minicomputer editors, such as IBM, UNIVAC, CDC, and DEC.
- Commands include forward or backward LOCATE, CHANGE, and FIND; and INSERT, DELETE, REPLACE, APPEND, SAVE, PRINT, WINDOW, MACRO, TABSET, SCALE, DUMP, and others.
- Compatible with existing CP/M edit and text formatted files, with CBASIC, and with Microsoft's MBASIC, FORTRAN, COBOL, and ASSEMBLER.
- CHANGE commands allow you to make conditional changes and to use variable length strings.
- Designed for CP/M and derivative operating systems, including LIFEBOAT, CDOS, IMDOS, DOS-A, ADOS, etc.
- GET and PUT commands for concatenating, moving, duplicating, and merging your edit files on the same or different diskettes.
- Provides you with fast memory-to-memory COPY commands, and an intermediate buffer for copying lines over-and-over.
- Repays your initial investment many times over with unique time-saving editing capabilities.
- Saves your last LOCATE, CHANGE, FIND, and APPEND command for easy re-execution.
- Simple line-oriented commands for character string editing.
- Automatically displays the results of every edit command for your verification.
- Single keystrokes for your most commonly used commands.
- Safeguards to prevent catastrophic user errors that result in the loss of your edit file.
- INLINE command for your character-oriented editing.
- Designed for today's high speed CRT's, video monitors, and teletypewriter terminals.
- Thoroughly field tested and documented with a comprehensive User's Manual and self-instructional tutorial.

And remember — in today's interactive programming environment — your most important software tool is your text editor. ED-80 is already working in industry, government, universities, and in personal computing to significantly cut program development time and to reduce high labor costs. Why not let ED-80 begin solving your text editing problems today? ORDER NOW and we'll pay the postage!



Mail to: SOFTWARE DEVELOPMENT & TRAINING, INC.  
P.O. Box 4511, Huntsville, AL 35802

ED-80 is protected by copyright and furnished under a paid-up license for use on a single computer system.

- Please send additional information.
- Send Diskette, User's Manual and paid-up license ..... \$99.00  
Specify SINGLE DENSITY Disk Make/Model, Size, Hard/Soft Sector  
Make/Model \_\_\_\_\_  B" or  5"  HS or  SS
- Send User's Manual (credited on purchase of paid-up license) ..... \$10.00
- Check or Money Order enclosed for ..... \$ \_\_\_\_\_
- Please charge my credit card:  VISA  Master Charge
- Card No. \_\_\_\_\_ Bank No. \_\_\_\_\_ Exp. Date \_\_\_\_\_

NAME \_\_\_\_\_  
ADDRESS \_\_\_\_\_  
CITY \_\_\_\_\_ STATE \_\_\_\_\_ ZIP \_\_\_\_\_  
SIGNATURE \_\_\_\_\_ PHONE \_\_\_\_\_

C-1

**SOFTWARE DEVELOPMENT & TRAINING, INC.**  
Post Office Box 4511 — Huntsville, Alabama 35802  
Dealer Inquiries Welcomed  
© CP/M is a trademark of Digital Research

Figure 4 continued:

```

RUNNER ON FIRST  RUNNER ON THIRD
SKOWRON----  DOUBLE PLAY
  1 RUNS SCORE  63-LA      1  61-YANKS  4
P,H, OR B ?
CERV-----  SINGLE
RUNNER ON FIRST
LOPEZ-----  SINGLE
RUNNER ON FIRST  RUNNER ON SECOND
BOYER-----  STRIKES OUT
    
```

```

INNING # 4
GILLIAM----  SINGLE
RUNNER ON FIRST
DAVIS W----  IS OUT
DAVIS T----  SINGLE
RUNNER ON FIRST  RUNNER ON SECOND
HOWARD----- STRIKES OUT
MCMULLEN---  IS OUT
    
```

```

RICHARDSON  WALK
RUNNER ON FIRST
KUBEK-----  DOUBLE
RUNNER ON SECOND  RUNNER ON THIRD
MARIS-----  IS OUT
MANTLE----- H. R.
  2 RUNS SCORE  63-LA      1  61-YANKS  6
P,H, OR B ? P
P# ? 22@
  2
    
```

```

HOWARD----- SINGLE
RUNNER ON FIRST
SKOWRON----  IS OUT
RUNNER ON SECOND
CERV-----  IS OUT
    
```

```

INNING # 5
ROSEBORO--- STRIKES OUT
FAIRLY----- IS OUT
OLIVER----- WALK
RUNNER ON FIRST
WILLS----- WALK
RUNNER ON FIRST  RUNNER ON SECOND
GILLIAM----  SINGLE
  1 RUNS SCORE  63-LA      2  61-YANKS  6
RUNNER ON FIRST  RUNNER ON THIRD
P,H, OR B ?
DAVIS W----  IS OUT
    
```

```

LOPEZ-----  IS OUT
BOYER-----  WALK
RUNNER ON FIRST
RICHARDSON  DOUBLE PLAY
    
```

```

INNING # 6
DAVIS T----  IS OUT
HOWARD----- STRIKES OUT
MCMULLEN---  IS OUT
    
```

```

KUBEK-----  SINGLE
RUNNER ON FIRST
MARIS-----  SINGLE
RUNNER ON FIRST  RUNNER ON THIRD
MANTLE----- DOUBLE PLAY
  1 RUNS SCORE  63-LA      2  61-YANKS  7
P,H, OR B ?
HOWARD----- IS OUT
    
```

```

INNING # 7
ROSEBORO--- IS OUT
FAIRLY----- IS OUT
OLIVER----- SINGLE
RUNNER ON FIRST
WILLS----- SINGLE
RUNNER ON FIRST  RUNNER ON SECOND
GILLIAM----  IS OUT
    
```

```

SKOWRON----  SINGLE
RUNNER ON FIRST
CERV-----  IS OUT
LOPEZ-----  IS OUT
BOYER-----  IS OUT
    
```

Figure 4 continued on page 122

5-STAR EDITION  
for users of  
Radio Shack's TRS-80\*



for users of  
Radio Shack's TRS-80\*

# TRS-80 TRANSFORMED WITH PROFESSIONAL SOFTWARE PACKAGES

## AND MUCH MORE

Software with Manual or Manual Alone

CP/M-operating system modified for use with TRS-80 computer and disks. In addition to the standard CP/M utilities of Editor, Assembler, Debugger etc., we have added: DCV2 (Utility to convert system tapes to CP/M files,) DISKAS & CASDISK (Utilities to back up files to tape and recover to disk,) MOVER (Program to transfer files with single drive systems) **\$145/\$25**

All items listed below operate in conjunction with the CPM operating system.

**MAC** — 8080 Macro Assembler. Full Intel macro definitions. Pseudo Ops include RPC, IFP, REPT, TITLE, PAGE and INCLUDE. Z-80 library included. Produces Intel absolute hex output plus symbols file for use by SID (see below) **\$100/\$15**

**SID** — 8080 symbolic debugger. Full trace, pass control and breakpoint program tracing system with backtrace and histogram utilities. When used with MAC, provides full symbolic display of memory labels and equated values **\$15/\$15**

**TEX** — Text formatter to create paginated, page-numbered and justified copy from source text files. It releases to disk or printer **\$15/\$15**

**DESPOOL** — Program to permit simultaneous printing of data from disk while user executes another program from the console **\$10/\$10**

**Disk Extended BASIC** — Version 5 ANSI compatible with long variable names, WHILE/WEND chaining, variable length file records **\$300/\$25**

**BASIC Compiler** — Language compatible with Version 2 Microsoft interpreter. 10 lines faster execution. Produces standard M-Cross/relocatable binary output. Includes Macro-80. Also linkable to FORTRAN-80 or COBOL-80 code modules **\$250/\$25**

**FORTRAN-80** — ANSI 66 (except for COMPLEX) plus many extensions. Includes relocatable object compiler, linking loader, library with manager. Also includes MACRO-80 (see below) **\$400/\$25**

**MACRO-80** — 8080/280 Macro Assembler (Intel) and Zilog mnemonics supported. Relocatable/linkable/output Loader, Library Manager and Cross Reference List utilities included **\$140/\$15**

**EDIT-80** — Very fast random access text editor for text with or without line numbers. Global and in-place commands supported. File compare utility included **\$89/\$15**

**CIS COBOL (standard)** — ANSI 73 COBOL standard compiler fully validated by U.S. Navy tests to ANSI level 1. Supports many features to level 2 including dynamic loading of COBOL modules and a full ISAM file facility. Also, program segmentation, interactive debug and powerful interactive extensions to support protected and unprotected CRT to see formatting from COBOL programs used with any dumb terminal **\$550/\$50**

**CIS COBOL (compact)** — COBOL subs et compiler for use on a 32K byte microcomputer. Vastly range of COBOL language features, many at level 2 and including ISAM and the CIS COBOL interactive screen formatting of dumb terminals **\$650/\$50**

**Forms 1** — CRT screen editor to build application CRT formats with protected and unprotected field areas. Output is COBOL data descriptions for copying into CIS COBOL programs. Eliminates the chore of writing screen input and output descriptions by hand and greatly speeds interactive application programming. Output requires CIS COBOL compiler/interpreter **\$115/\$15**

**Forms 2** — Forms 1 screen editor plus indexed file application program generator. Automatically creates a query and update files using CP/M protected and unprotected screen formats. No programming experience needed. Output program is fully compatible with the CIS COBOL compiler/interpreter **\$115/\$15**

**CBASIC-2** Disk Extended BASIC — Non-relocatable BASIC with pseudo-code compiler and runtime interpreter. Supports full file control, chaining, integer and extended precision variables, etc. **\$110/\$15**

**BDS C Compiler** — Supports most major features of language including Structures, Arrays, Pointers, recursive function evaluation. Linkable with library to 8080 binary output. Lacks data initialization, long a float type and static & register class specifiers. Documentation includes "C" Programming Language book by Kernighan & Ritchie **\$110/\$15**

**ALGOL 60 Compiler** — Powerful block-structured language featuring economical runtime dynamic allocation of memory. Very compact (28K total RAM) system implementing almost all Algol 60 report features plus many powerful extensions including string handling direct disk access I/O etc. Requires Z80 CPU **\$199/\$20**

**Z80 Development Package** — Consists of (1) disk file editor, with global enter and in-line facilities, (2) Z80 relocating assembler, Zilog/Moskex mnemonics conditional assembly and cross reference table capabilities, (3) linking loader producing absolute Intel hex disk file **\$50/\$10**

**ZDT** — Z80 Debugger to trace, break and examine registers with standard Zilog/Moskex mnemonic disassembly displays. Facilities similar to DDT. \$25 when ordered with Z80 Development Package **\$50/\$10**

**TEXTWRITER III** — Text formatter to justify and paginate letters and other documents. Special features include insertion of text during execution from other disk files or console, permitting recipe documents to be created from linked fragments on other files. Has facilities for sorted index, table of contents and footnote insertions ideal for contracts, manuals, etc. **\$125/\$20**

**Postmaster** — A comprehensive package for mail list maintenance. Features include keyed record extraction and label production. A form letter program is included which provides neat letters on single sheet or continuous forms. Requires CBASIC **\$150/\$25**

**SELECTOR III** — Multi (re up to 24) Key version of Selector I. Comes with applications programs including Sales Activity Inventory, Payables, Receivables, Check Register, Expenses, Appointments, and Client/Patient. Requires CBASIC. Supplied in source code **\$295/\$20**

**Enhanced version for CBASIC-2** **\$345/\$20**

**Filppy Disk Kit** — Template and instructions to modify single sided 5 1/4" diskettes for use of second side in single sided drives **\$12.50**

Lifeboat Associates, specialists in microcomputer disk software, is proud to offer the first professional disk-based language and utility package for the Radio Shack TRS-80 computer. Written by Microsoft, creators of Level II BASIC, the package runs on a TRS-80 system with 32K RAM, one or more drives and TRSDOS. The software is supplied on diskettes and consists of:

**FORTAN** a true relocatable machine code compiler for ANSI FORTRAN X3.9 (except COMPLEX variables).

**MACRO ASSEMBLER** a disk-based macro assembler utilizing Zilog mnemonics and producing relocatable code.

**LINKING LOADER** to link-edit and load FORTRAN and assembler modules for execution.

**SUBROUTINE LIBRARY** a complete library of subroutines existing as relocatable linkable modules for FORTRAN or assembler programs—e.g., double precision square root, natural log, transcendental, etc.

**DISK TEXT EDITOR** to create and modify FORTRAN and assembler programs as disk files; also can be used as a general purpose text editor for correspondence and other documents.

This high-powered professional software package with full documentation is available at the

DISCOUNT PRICE OF **\$150.** PER COMPUTER SYSTEM

The Macro Assembler, Loader, Editor, and Cross Reference Utilities alone **\$80**

The Fortran Compiler, Loader, Editor, and extensive library of scientific functions alone **\$80**

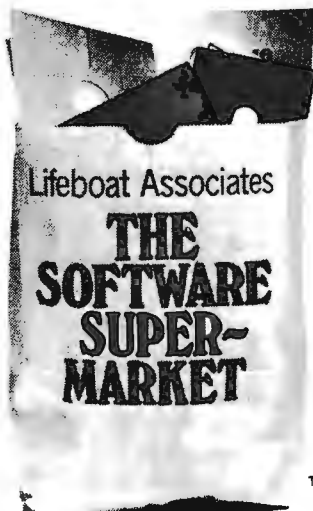

Lifeboat Associates  
2248 Broadway, New York, N.Y. 10024  
Telex: 668-585  
(212) 580-0082

Lifeboat Associates  
2248 Broadway  
New York, N.Y. 10024  
Telex: 668-585

Please send the following:

Software	Price
<input type="checkbox"/> manual alone	
<input type="checkbox"/> manual alone	
<input type="checkbox"/> Check <input type="checkbox"/> UPS C.O.D.	shipping
<input type="checkbox"/> Visa <input type="checkbox"/> MasterCard	\$1. for C.O.D.
	Total

Account # \_\_\_\_\_ Exp. Date \_\_\_\_\_

Signature \_\_\_\_\_

My computer configuration (specify disk system) \_\_\_\_\_

Name \_\_\_\_\_

Address (No P.O. Box) \_\_\_\_\_

City \_\_\_\_\_ State \_\_\_\_\_ Zip \_\_\_\_\_

## G2 Level III BASIC by Microsoft

Powerful extensions to Level II BASIC including 10 machine language user calls, long error messages, keyboard debounce, graphics commands and much more. Price includes User Manual, a Quick-Reference Card and a pre-programmed cassette tape. **\$45**

\*Radio Shack and TRS-80 are trademarks of Tandy Corporation.



Text continued:

each player. The position numbers are standard baseball scoring symbols: 1=pitcher, 2=catcher, 3=first baseman, 4=second baseman, 5=third baseman, 6=shortstop, 7=left fielder, 8=center fielder, 9=right fielder, and 10=designated hitter (yes, I am using the designated hitter). The computer asks OK? and a carriage return signifies that all is well. This is done for the nine batting positions, and then the pitcher identification number is entered.

When the Yankee batting order is entered, I intentionally make a mistake. Jesse Gonder was entered as the pitcher, batting leadoff. The computer asks OK?, but this time "NO" is entered (anything except a carriage return will do) and the computer rejects the input.

Game 6 matches pitchers Podres and Daley. The Yankees start quickly and score 3 runs in the first inning powered by Mickey Mantle's two-run home run.

After each run is scored, the Game program branches to the *substitute* subroutine. As seen in figure 4, that

Figure 4 continued:

```

INNING # 8
DAVIS W---- IS OUT
DAVIS T---- IS OUT
HOWARD----- H. R.
  1 RUNS SCORE 63-LA      3 61-YANKS  7
P,H, OR B ? B
P# ? 9
BATS, P# ? 6,13
POS ? 5
BATS, P# ? 0,0
ZIMMER----- IS OUT

RICHARDSON IS OUT
KUBEK----- IS OUT
MARIS----- H. R.
  1 RUNS SCORE 63-LA      3 61-YANKS  8
P,H, OR B ?
MANTLE----- SINGLE
RUNNER ON FIRST
HOWARD----- IS OUT

INNING # 9
ROSEBORN---- IS OUT
FAIRLY----- IS OUT
BLIVER----- IS OUT
  
```

in the first inning after Maris made an out to score the first Yankee run, the computer asked "P, H or B". A carriage return in response to this inquiry means "no substitute" and the game continues. Entry of P means a pitching change, H means a substitute for any of the players on the team currently batting, and B means that

both changes P and H are desired.

Following Mickey's home run, a pitching change is made—Norm Sherry replaces Podres. The game continues with the Yankees pecking away and adding to their lead. The Dodgers score a run in the eighth inning, but it appears certain that they will lose the game and the series. For

NEW FROM

**SORD**

New low-cost, big capacity small business computer with the processing speed of a minicomputer

**M200 mark VI**  
Hard disk based system

SORD has taken its outstanding low-cost general-purpose M200 mark II Computer System and added a Z80A (4MHz) CPU, a high-speed APU, and a BASIC Compiler to achieve a remarkable new large-capacity hard disk based system with the processing speed of a minicomputer.

**Features**

- Z80A (4MHz) CPU
- 64KB RAM
- High-speed APU
- 11.4MB Winchester hard disk drive (max. 45.6MB)
- 350KB minifloppy disk drive (back-up)
- Extended BASIC

**Software Options**

- BASIC Compiler (APU Version)
- FORTRAN IV
- COBOL
- Multi-user BASIC (available soon)

\*\* Our low-cost, easy-to-operate

● **SORD Word Processor** available as an option

**Bench mark test**

B. No.	M200 mark II		M200 mark II + APU		M200 mark VI	
	2.5MHz		2.5MHz + APU		4MHz + APU (1 wait)	
	Interpreter	Compiler	Interpreter	Compiler	Interpreter	Compiler
1	2.8 SEC	2.3 SEC	1.2 SEC	0.9 SEC	0.86 SEC	0.71 SEC
2	11.4	2.1	7.7	0.9	5.45	0.72
3	25.5	8.6	16.6	1.9	11.6	1.45
4	25.0	8.9	16.4	1.9	11.6	1.54
5	26.7	9.0	17.2	2.0	12.2	1.55
6	42.4	20.1	27.4	7.0	19.3	5.2
7	55.0	23.0	49.4	11.0	34.5	7.9
	users area 28KB			users area 32KB		



Model M223 mark VI

Interested distributors and OEM's please contact our office.

**SORD COMPUTER SYSTEMS, INC.**

Isoma No. 2 Bldg., 42-12 Nishi-Shinkoiwa 4-chome, Katsushika-ku, Tokyo, Japan 124 Phone: 1031696-6611 Telex: 2622393SORD JI Cable: SORDCOMPSSY TOKYO

**SORD U.S.A., INC.**

International Trade Center, 8300 NE Underground Drive, Kansas City, Missouri 64161, U.S.A. Phone: (816)454-6300 Telex: 42204 (SORDUSA) NC SC

**Distributors**

COMPUCENTRE  
Montreal, Quebec  
H1J 1Z4, Canada  
Phone: (514) 354-3810

GEPSI  
Paris, France  
Phone: 233.61.14  
Telex: 220104 (ILORESOL F)

MITSUMI & CO. (AUSTRALIA) LTD.  
Melbourne, Australia  
Phone: 60 148178  
Telex: 30245 (IMELMM AA)

COMPTONIX AG  
Horgen, Switzerland  
Phone: 01/725 04 10  
Telex: 58799 (CPTX CH)

I. M. E.  
Pomezia (Rome), Italy  
Phone: (06) 91 21.641-2-3  
Telex: 511220 (IMELEC I)

COMPUMAX ASSOCIATES (N.Z.) LTD.  
Palmerston North, New Zealand  
Phone: 70451

DECTRAE LIMITED  
Nottingham, England  
Phone: 0602.861-774  
Telex: 377678 (VIDEUR G)

MULTIPLEX COMPUTER  
Lille Skensved, Denmark  
Phone: (03) 66 8511  
Telex: 43574 (AWILCO DK)

SAMPO CORPORATION  
Taipei, Taiwan  
Phone: 7712 111, 782 1311  
Telex: 31109 (SEMCO)

N.V. EGEMIN S.A. (BENELUX)  
Schoten, Belgium  
Phone: (031)45. 27. 90  
Telex: 32525 (EGEMIN B)

SCANDINAVIA MINI COMPUTER AB  
Goteborg, Sweden  
Phone: 031-22 8430  
Telex: 54-21-389 (AQUAMAT S)

BANGKOK DOCUMENT CO., LTD.  
Bangkok, Thailand  
Phone: 2527508  
Cable: DOCUMENT BANGKOK



## DOUBLE DENSITY — A CAN OF WORMS?

DATASPEED believes it's time to put a long-standing rumor to rest. Double density disk recording is alive and well and living in hundreds of DATASPEED disk controllers around the world. Many companies are advertising double density disk controllers — some have even delivered a few — but hundreds of delivered AND WORKING systems prove that DATASPEED is the front-runner in double density disk systems.

## ½ MEGABYTE OF DISK STORAGE — \$295 ASSEMBLED

The DATASPEED CONDUCTOR™ disk controller will put ½ megabyte of storage on any standard 8" disk — reliably. It also allows DOUBLE-SIDED recording for a fantastic 1 megabyte of storage on a single flexible diskette — reliably. We guarantee it.

THE CONDUCTOR can also offer the same guaranteed reliability for 5¼" diskettes in either single or double density and single or double sided modes. THE CONDUCTOR comes fully assembled and fully tested and can even be ordered with a customized, ready to go CP/M™ that performs disk accesses almost twice as fast as most other double density CP/M's.

## DRIVE SYSTEMS — FROM \$1095

DATASPEED is also offering COMPLETE DISK systems. For instance, you can order a single drive system for just \$1095 that includes:

- 1 Shugart SA800 8" disk drive (½ megabyte)
- 1 DATASPEED CONDUCTOR disk controller
- 1 cable with connectors for 2 drives
- 1 attractive horizontal cabinet with space for 2 drives
- 1 2 drive power supply

The above system also includes everything you need to upgrade to a dual drive system at a later date — just plug in any standard 8" disk drive and you've got 1 megabyte of disk storage — or you can order a double drive system from us (as above but with 2 Shugart drives) for just \$1649.

## FREE OSBORNE ACCOUNTING SOFTWARE

For a limited time, DATASPEED will include with any drive system — FREE — the entire Osborne accounting software package (CBASIC-2™ Version) on double density diskettes. (Requires CBASIC-2 — available from DATASPEED for \$95 — manuals available separately). The software is available elsewhere in this publication for up to \$750!!!

*(OFFER EXPIRES JAN. 15, 1980)*

## AVAILABLE NOW!!

DATASPEED is shipping controllers and drive systems off the shelf. Not in three months or six months — NOW!!! To order, see your local computer retailer — or order directly from us. (Because of the extraordinary prices, the complete drive systems are only available directly from DATASPEED). We accept checks, Master Charge and Visa.

## ASK ABOUT OUR VIDEO CONTROLLER

Also, ask about the new DATASPEED memory-mapped video controller!! It features an 80x24 character format, user programmable character set, 128 bytes of user RAM, 1 or 2K of user ROM and HARDWARE SCROLLING!! Available now for \$295.



DATASPEED, INC.  
1302 NOE STREET  
SAN FRANCISCO, CALIFORNIA 94131  
Telephone (415) 282 - 5616





BOX SCORE

63 LA						61-YANKS					
NAME	POS	AB	H	HR	RBI	NAME	POS	AB	H	HR	RBI
WILLS----	SS	3	1	0	0	RICHARDSON	2B	4	1	0	0
GILLIAM----	2B	4	3	0	1	KUBER-----	SS	4	3	0	0
DAVIS W----	CF	4	0	0	0	MARIS-----	KF	5	2	1	2
DAVIS T----	LF	4	1	0	0	MANTLE-----	CF	5	4	2	5
HOWARD-----	1B	4	2	2	2	HOWARD-----	C	5	2	0	0
MC MULLEN----	3B	3	0	0	0	SKOWRON----	1B	4	2	0	1
ZIMMER-----	3B	1	0	0	0	CERV-----	LF	4	1	0	0
ROSEBORO----	C	4	0	0	0	LOPEZ-----	DH	4	2	0	0
FAIRLY-----	RF	4	0	0	0	BOYER-----	3B	3	0	0	0
OLIVER-----	DH	3	1	0	0						

PITCHERS		IP	H	R	ER	K	BB
FERRANOSKI	4.7	6	2	1	0	1	
PODRES-----	1.3	3	3	3	0	0	LOSSER
SHERRY-----	3.0	8	3	3	2	2	
DALEY-----	7.7	8	3	2	5	2	WNNER
DUREN-----	1.3	0	0	0	0	0	

VISITORS	1	2	3	4	5	6	7	8	9	-	T
HOME	0	1	0	0	1	0	0	1	0	0	3
8324	3	0	1	2	0	1	0	1	0	0	8

READY RETURN TO END ?

Figure 5: Box score from the game played in figure 4.

this reason, a pinch hitter and a new pitcher are entered in order to illustrate all of the possible input situations occurring in this simulation. In answer to the question "P, H or

B" in the Dodgers' half of the eighth inning, a B is input. A pitcher's identification number is solicited and 9 is entered, corresponding to Yankee Ryne Duren. Next, the computer asks

for the batting (Dodgers) team's substitutes with the question "Bats, P#". Here it is necessary to input what place in the nine batting positions (1 thru 9) the substitute will bat in and the player's identification number. The numbers 6 and 13 are typed in. Six is the sixth batting position; 13 represents Don Zimmer's identification number.

The "Bats, P#" question is again asked, and the user can continue to make substitutes or you can enter a 0 for the batting position in order to end the substituting. In the example, 0,0 is input and the game continues. The Yankees go on to win the sixth

game 8 to 3 and the series 4 games to 2 games. Figure 5 shows the box score for the final game of the series. Typing a carriage return ends the game at this point; typing any other character plays another game between the same two teams.

If the option to play another contest is selected, the computer asks "Line-ups OK"; and typing a carriage return lets the programmer play another game just by entering the identification numbers of two new

## New to the U.S.! Produced and widely used in England— COMPLETE CP/M BUSINESS PACKAGE.

INCLUDES EVERYTHING FROM INVENTORY TO SALES SUMMARY  
PROMPTS USER, VALIDATES EACH ENTRY, MENU DRIVEN

Approximately 60-100 entries/inputs require only 2-4 hours weekly and your entire business is under control.

**\*PROGRAMS ARE INTEGRATED—**

- 01 = ENTER NAMES/ADDRESS, ETC
- 02 = \*ENTER/PRINT INVOICES
- 03 = \*ENTER PURCHASES
- 04 = \*ENTER A/C RECEIVABLES
- 05 = \*ENTER A/C PAYABLES
- 06 = ENTER/UPDATE INVENTORY
- 07 = ENTER/UPDATE ORDERS
- 08 = ENTER/UPDATE BANKS
- 09 = EXAMINE/MONITOR SALES LEDGER
- 10 = EXAMINE/MONITOR PURCHASE LEDGER
- 11 = EXAMINE/PRINT INCOMPLETE RECORDS
- 12 = EXAMINE PRODUCT SALES

**SELECT FUNCTION BY NUMBER—**

- 13 = PRINT CUSTOMER STATEMENT
- 14 = PRINT SUPPLIER STATEMENTS
- 15 = PRINT AGENT STATEMENTS
- 16 = PRINT TAX STATEMENTS
- 17 = PRINT WEEK/MONTH SALES
- 18 = PRINT WEEK/MONTH PURCHASES
- 19 = PRINT YEAR AUDIT
- 20 = PRINT PROFIT/LOSS ACCOUNT
- 21 = UPDATE END MONTH FILES
- 22 = PRINT CASH FLOW FORECAST
- 23 = ENTER/UPDATE PAYROLL (NOT YET AVAILABLE)
- 24 = RETURN TO BASIC

**WHICH ONE? (ENTER 1-24)** Each program goes to sub menu, e.g.: (9) allows A. LIST ALL SALES; B. MONITOR SALES BY STOCK CODES; C. RETRIEVE INVOICE DETAILS; D. AMEND LEDGER FILES; E. LIST TOTAL ALL SALES.

- VERY FLEXIBLE. • ADD YOUR OWN FUNCTIONS. • EASY TO INTEGRATE.

All programs in BASIC for CP/M.

Package includes 31 programs. Version 2: \$750 Complete listing in BASIC also available: \$300

John D. Owens Associates is the U.S. Distributor for G.W. COMPUTERS, LTD, the producers of this beautiful package.

**WE EXPORT TO ALL COUNTRIES — OVERSEAS CALLERS USE (212) 448 6298 ONLY**

**JOHN D. OWENS ASSOCIATES, INC.**

12 SCHUBERT STREET, STATEN ISLAND, NEW YORK 10305

(212) 448 6283

DAY, EVENING, WEEKEND, HOLIDAY CALLS WELCOME!

(212) 448 6298

We have no reader inquiry number. Please write or call.

# PRODIGY: YOUNG AND BRILLIANT



The result? Incredible speed and storage capacity, and economical systems development and maintenance.

---

*... "Though it may look like many other microcomputer systems — . . . Prodigy One literally speeds away from them." — . . . Max Schindler, Software Editor-ELECTRONIC DESIGN.*

---

Every so often an individual is born exhibiting extraordinary talent at a very early age. Often, they rise above the multitude establishing themselves as masters in their fields. These individuals are called prodigies.

The Prodigy computer is so advanced, it clearly establishes itself as a master in the field of small business computing.

Modular design and single board construction mean reliability, expandability, and ease of service. But it is SOFTWARE which truly sets Prodigy apart. Unlike other computers, software was a major design consideration rather than an afterthought. Prodigy utilizes a highly advanced operating system and the PROTEGE\* to provide some very impressive features:

- |                        |                 |
|------------------------|-----------------|
| ■ DATA BASE MANAGEMENT | ■ INDEXED FILES |
| ■ VIRTUAL CODE         | ■ SPOOLING      |
| ■ DATA COMPRESSION     | ■ MULTI-TASKING |

Your local Prodigy dealer maintains an extensive library of field proven application software. Available applications include General Ledger, Accounts Receivable, Accounts Payable, Payroll, Medical Billing, and a remarkable system for the Personnel Placement Industry. All are easy to use yet provide a level of sophistication unheard of in its price class. And Prodigy also does word processing!

Prodigy systems are supported by a nationwide organization of thoroughly trained, experienced professionals. Your Prodigy dealer is a SINGLE source for hardware, software and a level of service that continually insures effective, trouble free operation.

Speed, sophistication, and low cost; an incredible combination for a small business computer. Would you expect less from a prodigy?

**PRODIGY**  
**SYSTEMS, INC.**

497 LINCOLN HIGHWAY • ISELIN, N.J. 08830 • (201) 283-2000

\*Prodigy's easy to use compiler-based small business applications development language. Prodigy also supports other popular languages such as FORTRAN, COBOL, BASIC, and PASCAL.

Circle 331 on inquiry card.

BYTE November 1979 125



pitchers. If anything other than a carriage return is entered, the computer branches to the lineup entry section of the program and the user will be required to enter new lineups.

You can keep track of batting averages, earned run averages, and other statistics by loading the program Stats (listing 4) and entering the appropriate file name. This will give you a complete printout of all the statistics as shown in figure 6. The statistics shown are for all six games of the "World Series" that was just played.

The statistics keep accumulating each time the program is run. Therefore, I have provided program Erase (shown in listing 5). Figure 7 shows this program being used; the user merely supplies the file name. This program erases statistics extracted only from the games played, not the ratings information shown on the roster (figure 2) for each player. That

**Listing 4:** *The Stats program, which computes and displays statistics from box scores of simulated baseball games. An example of its use is shown in figure 6.*

```

1 DIM#$(270)
5 LINE 80
10 INPUT "FILE NAME ? ",F#\OPEN#0,F#
12 FORA=0TO16\N=(A*10)+1\READ#0,N$(N,N+9),Z,Z,Z,Z,Z,Z,Z\NEXT
14 FORA=0TO9\N=170+((A*10)+1)\READ#0,N$(N,N+9),Z,Z,Z,Z\NEXT
20 I*NAME AB H HR RBI AVE NAME IP H R ER KO BB W L ERA",
30 I* KO BB W L ERA\FORA=1TO79\I*=",\NEXT\!"
40 FORA=0TO16\B=1119+(A*20)\READ#0,ZB,C,D,E,F\G#0
50 IFC>0THENG=D/CNT1=T1+CNT2=T2+D\T3=T3+EXT4=T4+F
60 N=(A*10)+1\N$(N,N+9),Z4I,C,D,Z3I,E,Z4I,F,Z5F3,G," ",
70 IFA>9THEN90\B=1459+(A*35)\N=171+(A*10)
72 READ#0,ZB,C,D,E,F,G,H,I\J=INT(I/100)\K=I-(100*J)
74 P1=P1+CNF2=P2+D\NP3=P3+ENP4=P4+FNF5=P5+GNF6=P6+HNF7=P7+J\NP8=P8+K
76 E9=0\IFC>0THENE9=(F*27)/C\C=INT(C/3)
78 I$(N,N+9),Z4I,C,D,E,F,G,H,Z3I,J,K,Z6F2,E9,
90 !*"\NEXT
100 FORA=1TO79\I*=",\NEXT\!"
110 IF I1>0THENT5=T2/T1\IFP1>0THENP9=(P4*27)/P1\NP1=INT(P1/3)
120 I* " ,Z4I,T1,T2,Z3I,T3,Z4I,T4,Z5F3,T5,
130 I* " ,Z4I,P1,P2,P3,P4,P5,P6,Z3I,P7,P8,Z6F2,P9

```

is how I run my complete computerized baseball simulation.

### Necessary System Components

What do you need to run these programs? An 8080-based micropro-

cessor system that can be linked to a North Star floppy-disk system, a North Star disk-operating system including BASIC, 24 K bytes of memory, and a terminal. The memory requirement is large because of the size

6a FILE NAME ? 61-YANKS																	
NAME	AB	H	HR	RBI	AVE	NAME	IP	H	R	ER	KO	BB	W	L	ERA		
SKOWRON---	20	4	0	1	.200	FORD-----	8	12	10	3	5	7	0	1	3.12		
RICHARDSON	24	4	0	2	.167	TERRY-----	13	9	2	1	8	6	2	0	.68		
KUBEK-----	23	7	0	0	.304	ARROYO-----	8	3	0	0	5	3	0	0	.00		
BOYER-----	19	3	0	0	.158	STAFFORD---	0	0	0	0	0	0	0	0	.00		
MARIS-----	23	9	4	8	.391	COATES-----	0	0	0	0	0	0	0	0	.00		
MANTLE-----	23	6	2	5	.261	SHELDON---	0	0	0	0	0	0	0	0	.00		
BERRA-----	7	0	0	0	.000	DALEY-----	11	14	7	5	8	3	1	0	3.86		
HOWARD-----	23	8	2	5	.348	TURLEY-----	0	0	0	0	0	0	0	0	.00		
LOPEZ-----	16	5	0	4	.313	RENIFF-----	4	6	2	2	0	2	1	0	4.15		
BLANCHARD---	7	3	0	1	.429	DUREN-----	6	6	3	2	5	0	0	1	2.84		
CERV-----	16	8	2	3	.500												
GARDNER---	0	0	0	0	.000												
DEMASTRI---	0	0	0	0	.000												
REED-----	0	0	0	0	.000												
TORGESSON---	0	0	0	0	.000												
GONIER-----	0	0	0	0	.000												
JOHNSON---	0	0	0	0	.000												
-----																	
		201	57	10	29	.284			53	50	24	13	31	21	4	2	2.21

  

6b FILE NAME ? 63-LA																	
NAME	AB	H	HR	RBI	AVE	NAME	IP	H	R	ER	KO	BB	W	L	ERA		
FAIRLY-----	22	3	1	1	.136	KOUFAX-----	13	14	8	4	9	5	1	0	2.70		
GILLIAM-----	24	12	1	4	.500	DRYSDALE---	17	13	5	4	8	5	0	2	2.12		
WILLS-----	24	4	0	1	.167	PERRANOSKI	9	8	2	1	0	5	1	0	1.00		
MCMULLEN---	20	3	0	2	.150	PODRES-----	5	9	6	5	2	1	0	1	9.00		
HOWARD-----	21	5	2	4	.238	MILLER-----	0	1	2	0	0	1	0	1	.00		
DAVIS W-----	24	8	1	5	.333	RICHERT---	0	0	0	0	0	0	0	0	.00		
DAVIS T-----	25	6	0	4	.240	CALMUS-----	0	0	0	0	0	0	0	0	.00		
ROSEBORO---	21	1	0	0	.048	WILLHITE---	0	0	0	0	0	0	0	0	.00		
MOON-----	6	3	0	0	.500	ROEBUCK---	0	0	0	0	0	0	0	0	.00		
TRACEWSKI---	0	0	0	0	.000	SHERRY-----	7	12	6	4	6	6	0	0	4.91		
OLIVER-----	14	5	0	3	.357												
WALLS-----	0	0	0	0	.000												
CAMILLI-----	0	0	0	0	.000												
ZIMMER-----	1	0	0	0	.000												
FERRIA-----	0	0	0	0	.000												
BREEDING---	0	0	0	0	.000												
NEN-----	0	0	0	0	.000												
-----																	
		202	50	5	24	.248			52	57	29	18	25	23	2	4	3.12

**Figure 6:** Statistics for six games of the "World Series" between the 1961 Yankees (6a) and the 1963 Dodgers (6b).

# Say "ADI/OS"

TM - COMPCO

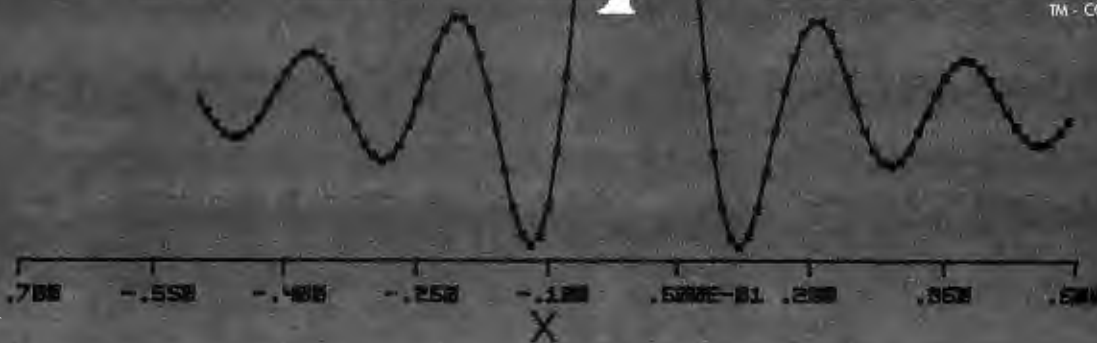

## to your data acquisition and display problems with COMPCO'S Analog - Digital I/O System.

The complete ADI/OS system includes everything required for a research and development laboratory, and many OEM systems: 16 channels of single-ended analog input (or 8 differential channels); two double-buffered D/A channels for driving a X-Y display (display not included); 32 bits of programmable digital I/O; 4 completely independent RS232 serial ports with software-selectable Baud rates; a Microterm MIME-I CRT terminal; a Houston Instruments HIPLØT incremental plotter; and an ALTOS 8000-2 microcomputer system, with 4MHz Z80\* processor, 64K of RAM memory, twin Shugart double-density floppy disk drives, CP/M<sup>1</sup> operating system, and Microsoft FORTRAN. COMPCO's GSP interactive graphics package is included to provide graphics output on the CRT terminal, HIPLØT plotter, and/or a X-Y display. A FORTRAN-callable subroutine package is also provided to perform the analog data acquisition. In addition, two unused serial ports may be used to drive a modem (permitting the system to talk to a larger machine), an additional CRT terminal for color graphics, or a serial line printer such as a TI-810 or NEC Spinwriter. \*Z80 is a trademark of Zilog 1 TM - Digital Research

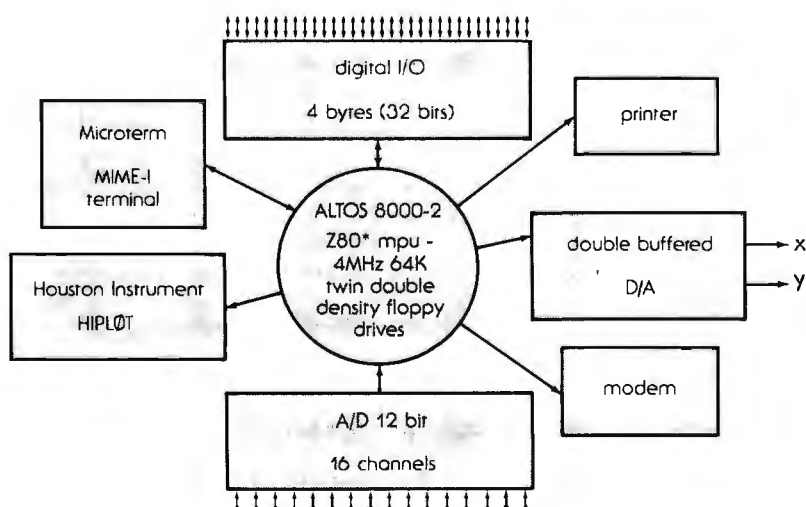

This entire ADI/OS system is available from COMPCO for  
**\$9,995**

OEM, Institutional and Dealer Inquiries Invited

# Compco

8705 North Port Washington Road  
Milwaukee, Wis. 53217 414/351-3404  
**COMPUTER SPECIALISTS**



**Listing 5: The Erase program, which deletes from the data file statistics developed from the games which have been simulated by the Game program. The roster ratings information is retained. See figure 7 for an example.**

```

10 INPUT"FILE TO BE ERASED ? ",F$
20 OPEN#0,F$
30 B=1114\READ#0ZB,C\FORA=1T0138\WRITE#0,Z\NEXT
40 CLOSE#0

```

**Listing 6: The Game program, written in North Star BASIC, which uses data based on historical performance of real baseball players to simulate any desired contest between various teams. This program occupies 24 K bytes of programmable memory when used with the North Star BASIC system.**

```

1 INPUT"NUM? ",A\FORB=0T0A\C=RND(0)\NEXT
5 LINE#0
10 DIMH(1,16,14),F(1,9,17),N$(540),S(1,8,2,1),F$(20),T$(20)
15 DIMH$(24),S1(1,10),B(8),R(8)
17 H$="SINGLEDUBLETRIPLEH, R, "
20 F$=" F C1B2R3BSSLFCFRFDH"
30 FORA=0T01N=(A*10)+10\INPUT"TEAM ? ",T$(B-9,B)\F$=T$(B-9,B)
40 OPEN#0,F$\B=270*\A\FORC=0T016\B=B+10
50 READ#0,N$(B-9,B)\FORD=0T06\READ#0,H(A,C,D)\NEXTD\NEXTC
60 FORC=0T09N=B+10\READ#0,N$(B-9,B)\FORD=0T03\READ#0,F(A,C,D)\NEXTD
65 NEXTC\CLOSE#0\NEXTA
67 FORA=0T01
70 "GIVE THE LINE-UP "\FORC=0T08\ "BATTING",C+1," ",
80 INPUT"ID, FOS # ? ",D,ENS(A,C,0,0)=D\N(A,C,0,1)=E
81 IFE<10RE>10THEN80
82 F=(A*270)+(D*10)+1\G=E*2
83 IFD>16THEN80\TAB(40),
84 IN$(F,F+9)," ",F$(G-1,G),\INPUT" OK ? ",Z$
86 IFZ$<>" "THEN80\NEXTC
90 INPUT"ID# OF PITCHER ? ",W(A+2)
91 IFW(A+2)>9THEN90\TAB(40),
92 F=(A*270)+170+(10*W(A+2))+1\IN$(F,F+9)," ",
94 INPUT" OK ? ",Z$\IFZ$<>" "THEN90\NEXTA
100 J=9\B=1
110 FORA=0T01N=" "INNING #",A\FORB=0T01
112 IFA<>9URB<>1THEN115\IF$1(1,10)>S1(0,10)THENEXIT970
115 C=W(B)\D=1\IFB=1THEND=0\F=W(D+2)
120 FORE=0T02\IFS(B,C,E,1)>0THENF=5(B,C,E,0)\NEXT
125 G=(270*B)+(10*F)+1
127 L=0\IFH(B,F,0)=2THEN130
128 IFH(B,F,0)=P(D,P,5)THEN129\L=.015\G0T0130
129 L=-.015
130 H=.5*(H(B,F,5)+P(D,P,2))+L+W(D+4)\H(B,F,7)=H(B,F,7)+1
135 IN$(G,G+9)," ",
140 G=RND(0)\IFG>HTHEN800
150 H=.5*(H(B,F,1)+P(D,P,1))+L+W(D+4)
160 IFG>HTHEN700\F(D,P,5)=P(D,P,5)+1
170 H=RND(0)\FORG=2T04\IFH(B,F,G)>HTHENEXIT190
180 NEXT\G=1
190 H=G*6\H$(H-5,H)\H(B,F,8)=H(B,F,8)+1\G0SUB7000\G0SUB5900
195 IFG=4THENH(B,F,9)=H(B,F,9)+1
200 C=C+1\IFC>8THENC=0\W(B)=C\E9=0
205 IFA>8ANDB=1\ANDS1(1,10)>S1(0,10)THENEXIT960
210 IFO<>3THEN120\G0T0950
200 "WALK"\H(B,F,7)=H(B,F,7)-1\F(D,P,9)=P(D,P,9)+1\G=1\G0SUB6950
210 G0SUB5950\G0T0200
300 H=.5*(H(B,F,6)+P(D,P,3))\IFRND(0)>HTHEN820
310 "STRIKES OUT"
315 P(D,P,8)=P(D,P,8)+1\G0T0830
320 IFRND(0)<.98THEN825\G=1\K=1\ "ERROR"\O9=09+1\G0SUB6000\G0T0200
325 IFRND(0)>.50RB(1)=0R0>1THEN828\ "DOUBLE PLAY"\O=0+2\B(1)=0\O9=09+2
326 R(1)=0\IF3>09THENG0SUB7000
327 B=0\N=1\IF3>0THENG0SUB6000\F(D,P,4)=P(D,P,4)+2\G0T0200
328 "IS OUT" \G=0\IFRND(0)>.5THEN830\K=1\IF09<2THENG0SUB7000
329 IFO<2THENG0SUB6000
330 O=0+1\F(D,P,4)=P(D,P,4)+1\O9=09+1\G0T0200
350 FORG1=1T08\B(G1)=0\NR(G1)=0\NEXT\O=0\O9=0\ "NEXT\NEXT
360 IFS1(0,10)>S1(1,10)THEN970\G=10\I=10\G0T0110
970 G1=W(6)\G2=W(7)\G3=W(8)\G4=W(9)\F(G1,G2,10)=P(G1,G2,10)+100
971 F(G3,G4,10)=P(G3,G4,10)+1
972 G0SUB1000\FORG1=0T01\FORG2=0T016\FORG3=7T010

```

Listing 6 continued on page 130

RUN

```

FILE TO BE ERASED ? 61-YANKS
READY
RUN

```

```

FILE TO BE ERASED ? 63-LA
READY

```

**Figure 7: Sample execution of the program Erase of listing 5. This program purges statistics from simulated games; it does not alter the roster ratings information.**

of program Game. With Game loaded in memory, only 132 bytes out of 24 K bytes are free, even after releasing the memory allocation for the functions ATN, SIN, COS, LOG, and EXP. The actual memory used by Game is 11,432 bytes.

Table 1 shows the North Star directory of the disk used to store the six programs of the package and the data files. Each team data file is eight blocks long. Five of the programs in the package are short. Programming details will be given only for the one long program, Game. It is likely that if the user wishes to enhance or modify the package, program Game will have to be changed. If you understand the workings of Game, the rest is simple. The North Star BASIC code for Game appears in listing 6.

Table 2 describes the operations of Game by line number groups, while table 3 defines the key variables. Figure 8 is a flowchart of the major divisions of program operation.

## Use of Statistics

The program determines if a batter gets a hit by adding his hits rating to the pitcher's hits rating (consult figure 2). This result is combined with the pitcher's tiring factor and a factor determined by the relationship between the batter's hitting side (right or left) and the pitcher's throwing arm (right or left). This result is then multiplied by 0.5 and compared to a random number. Look at table 4 for an example.

If the random number is below the final hit factor, the batter gets a hit. Note that the hits rating is not the player's batting average, because the player has the possibility of walking. Next, a walk rate is determined: Yas-trzemski's .370 plus Wise's .323 multiplied by 0.5 = .3465.

This walk rate is compared to the same random number as before to

# THERE'S A BRAIN IN THIS BEAUTIFUL BODY.

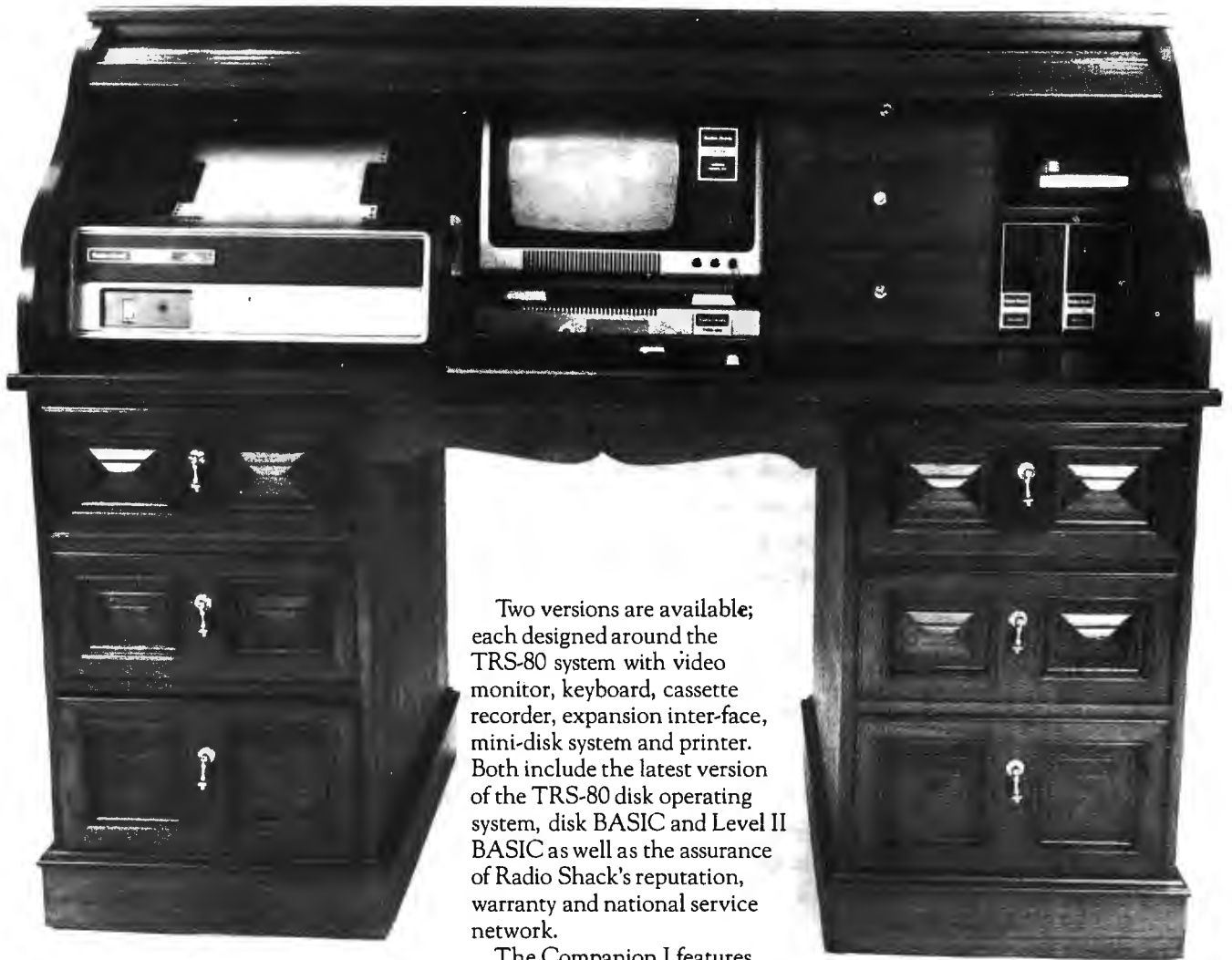

Two versions are available; each designed around the TRS-80 system with video monitor, keyboard, cassette recorder, expansion inter-face, mini-disk system and printer. Both include the latest version of the TRS-80 disk operating system, disk BASIC and Level II BASIC as well as the assurance of Radio Shack's reputation, warranty and national service network.

The Companion I features 16K of memory, the TRS-80 Quick Printer I and a single mini-disk drive.

The Companion II highlights include 32K of memory, the TRS-80 tractor feed line printer and dual mini-disk drives.

Either version can be expanded to accommodate additional memory and mini-disk drives.

## ANNOUNCING COMPANION I & II.

Beneath this beautiful teakwood roll-top desk exterior, there beats a heart of pure Radio Shack TRS-80 Microcomputer.

But don't let the good looks fool you. This beauty's got a brain that's right at home in your office, home, classroom or laboratory.

And we haven't forgotten the brain food either. A full set of cassettes, diskettes and paper accompanies the clear and concise instructions of the Companion User's Guide. All this brain matter comes pre-assembled in a body you can love and live with.

The perfect companions from PRODATA.

## **PRODATA, INC.**

These packages are competitively priced at \$3,495 and \$4,995 FOB Ft. Worth, Texas, and ready for immediate delivery. We'll pay the air freight charges on all prepaid orders within the Continental U.S.A. For more information, write or call PRODATA, Inc., 98-1122 Kahapii Street, Aiea, Hawaii 96701, Telephone: 808-488-5348.

Assembly Office: 3620 Lake Pontchartrain Drive, Arlington, Texas 76016.

*Dealer inquiries invited.*



Listing 6 continued:

```

973 H(G1,G2,G3+4)=H(G1,G2,G3+4)+H(G1,G2,G3)\H(G1,G2,G3)=0\NEXT\NEXT
974 FORG2=0T09\FORG3=4T010\N(G1,G2,G3+7)=F(G1,G2,G3+7)+F(G1,G2,G3)
976 F(G1,G2,G3)=0\NEXT\NEXT\NEXT\FORG1=0T010\W(G1)=0
978 S1(0,G1)=0\N(S1(1,G1)=0\NEXT\W9=0
990 INPUT* RETURN TO END ? *,Z%\IFZ%=*"THEN998
992 INPUT*LINE-UPS OK ? *,Z%\IFZ%<*"THEN67
994 !T$(1,10),\INPUT* PITCHER ? *,W(2)
995 !T$(11,20),\INPUT* PITCHER ? *,W(3)
996 GOTO100
998 GOSUB2000\FREE(0)\END
1000 !*BOX SCORE*\!*
1010 FORG=0T01\B=(G*10)+10\G1=40*G
1020 !TAB(G1),T$(B-9,B),\NEXT\!*
1022 !*\FORG=0T01\G1=40*G
1024 !TAB(G1),*NAME POS AB H HR RBI*,
1026 NEXT\!\!*
1030 FORG=0T08\FORG1=0T02
1050 G4=0\FORG3=0T01\IFS(G3,G,G1,1)=0THEN1080\G5=40*G3\G6=S(G3,G,G1,0)
1060 B=(270*G3)+(10*G6)+10\G4=1\G7=(S(G3,G,G1,1)*2)
1070 !TAB(G5),N$(B-9,B),* *,F$(G7-1,G7),* *,
1075 FORG8=7T010\Z4I,H(G3,G6,G8),\NEXT
1080 NEXT\IFG4=1THEN!\NEXTG1\NEXTG
1090 !*\!*PITCHERS IF H R ER K BB*\!*
1110 FORG1=0T01\FORG2=0T09\IFF(G1,G2,4)>0THEN1130
1120 IFF(G1,G2,5)>0THEN1130\IFF(G1,G2,8)>0THEN1130\GOTO1160
1130 G3=(G1*270)+170+(10*G2)+1\G4=F(G1,G2,4)/3
1140 !N$(G3,G3+9),Z5F1,G4,
1150 FORG4=5T09\Z3I,F(G1,G2,G4),\NEXT\IFF(G1,G2,10)=100THEN!* WINNER*,
1152 IFF(G1,G2,10)=1THEN!* LOSSER*,\!*
1160 NEXT\NEXT\!\!* 1 2 3 4 5 6 7 8 9 - T*
1170 !*VISTORS*\FORG1=0T010\Z3I,S1(0,G1),\NEXT\!*
1180 !*HOME *,\FORG1=0T010\Z3I,S1(1,G1),\NEXT\RETURN
2000 FORA=0T01\B=(A*10)+1\OPEN#0,T$(B,H+9)\B=1114
2010 READ#0ZB,C\FORB=0T016\READ#0,H(A,B,7),H(A,B,8),H(A,B,9),H(A,B,10)
2020 FORC=11T014\H(A,B,C)=H(A,B,C)+H(A,B,C-4)\NEXT\NEXT
2030 FORB=0T09\READ#0,P(A,B,4),P(A,B,5),P(A,B,6),P(A,B,7),P(A,B,8)
2035 READ#0,P(A,B,9),P(A,B,10)
2040 FORC=11T017\N(A,B,C)=F(A,B,C)+F(A,B,C-7)\NEXT\NEXT
2050 B=1114\READ#0ZB,C\FORB=0T016
2060 WRITE#0,H(A,B,11),H(A,B,12),H(A,B,13),H(A,B,14)\NEXT
2070 FORB=0T09\WRITE#0,P(A,B,11),P(A,B,12),P(A,B,13),P(A,B,14)
2075 WRITE#0,P(A,B,15),P(A,B,16),P(A,B,17)\NEXT\CLOSE#0
2080 NEXT\RETURN
5900 K=G\IFRND(0)>.6THENK=K+1\GOTO6000
5950 K=1\IFB(1)=0THEN6005\IFB(2)=0THEN5960\GOTO6000
5960 B(2)=P+1\GOTO6005
6000 FORG1=3T01STEP=1\N(G1+K)=B(G1)\B(G1)=0\NEXT
6005 IFB=4THENB(B)=P+1\IFG<4THENB(G)=P+1\G4=0
6010 G2=0\FORG1=4T08\IFB(G1)=0THEN6040\G4=G4+1\W=B(G1)-1\B(G1)=0
6020 L=A-1\IFA>9THENL=N\S1(B,L)=S1(B,L)+1\S1(B,10)=S1(B,10)+1
6030 B(G1)=0\N(B,F,10)=H(B,F,10)+1\N(D,U,6)=F(D,U,6)+1
6040 NEXT\IFG4<1THEN6042\IG4,* RUNS SCORE *,
6041 !T$(1,10),S1(0,10),* *,T$(11,20),S1(1,10)
6042 IFG4<2THEN6043\W(4+D)=W(4+D)+.025
6043 H=0
6048 IFB(1)=0THEN6050\!*RUNNER ON FIRST *,\M=1
6050 IFB(2)=0THEN6060\!*RUNNER ON SECOND *,\M=1
6060 IFB(3)=0THEN6070\!*RUNNER ON THIRD *,\M=1
6070 IFM=1THEN!\IFG4=0THENRETURN\GOSUB2000\GOSUB6100\RETURN
6100 INPUT*P,H, OR B ? *,Z%\IFZ%=*"THENRETURN\IFZ%="*THEN6150
6110 W(D+4)=0\INPUT*F# ? *,Z%\IFZ>9THEN6110\W(2+B)=Z\F=Z
6120 IFZ%="* THENRETURN
6150 INPUT*BATS, F# ? *,Z,Z1\Z=Z-1\IFZ>8THENRETURN\IFZ<0THENRETURN
6160 FORG1=0T02\IFS(B,Z,G1,1)=0THENEXIT6180
6170 NEXT\!*TWO SUBS ALREADY USED THERE*\GOTO6150
6180 S(B,Z,G1,0)=Z1\INPUT*POS ? *,Z1\IFZ1>10THENZ1=10
6190 S(B,Z,G1,1)=Z1\GOTO6150
6200 IFW9=0THEN6220\IFB+1=W9THENRETURN
6210 IFS1(0,10)=S1(1,10)THEN6230\IFS1(B,10)>S1(D,10)THEN6220\RETURN
6220 W(B)=D\W(2)=W(2+D)\W(6)=B\W(7)=W(2+B)\W9=1+B\RETURN
6230 W9=0\RETURN
6950 K=1\IFR(1)=0THEN7005\IFR(2)=0THEN6960\GOTO7000
6960 R(2)=P+1\GOTO7005
7000 IF0>2THENRETURN\FORG1=3T01STEP=1\R(G1+K)=R(G1)\R(G1)=0\NEXT
7005 IFG=4THENR(B)=P+1\IFG<4THENR(G)=P+1
7010 FORG1=4T08\IFR(G1)=0THEN7040
7020 W=R(G1)-1
7030 R(G1)=0\N(D,U,7)=F(D,U,7)+1
7040 NEXT\RETURN

```

?			
*LI			
ERASE	4	4	2
ERASE2	8	4	2
INPUT	12	6	2
INPUT2	18	6	2
ROSTER	24	6	2
ROSTER2	30	6	2
GAME	36	22	2
GAME2	58	22	2
STATS	80	6	2
STATS2	86	6	2
61-YANKS	92	8	3
69-METS	100	8	3
75-BOSTO	108	8	3
63-LA	116	8	3
62-METS	124	8	3
FIX	132	6	2
FIX2	138	6	2
*			

Table 1: Directory of the disk files consisting of the baseball-simulation programs and data. Each team data file is eight blocks long on this North Star Computer floppy disk system.

determine if the batter gets a base on balls. Assuming that the batter makes an out, a strikeout possibility is determined in a similar manner with a new random number (.169 + .136 x 0.5 = .1525 is the Yastrzemski/Wise strikeout factor). If the batter is not a strikeout victim, another random number is generated to see if he hits into a double play, reaches base on an error, or advances the runners that might be on base.

### Hits, Runs, and Errors

On the occasions when a batter gets a hit, a random number is compared first to his double rate, then his triple rate, and finally his home run rate (Yastrzemski has ratings of .205, .212, and .308 for these hits). [By a pleasant coincidence, this article was edited on the same day that Carl Yastrzemski hit his home run number hexadecimal 190...RSS]. If at any point in the comparisons the rate exceeds the random number, the comparison process ceases and the batter is awarded the type of hit currently being considered. If all comparisons fail, the hit is assumed to be a single-base hit. A new random number is generated to see if the possible base runners advance one base more than the hit is valued at (single = 1, double = 2, etc).

The variable array (with seven elements) is used to keep track of base

Text continued on page 134

# Do TRS-80's new lower prices mean you get "cheaper" computers?

## No Way!



### Here's why . . .

Production costs drop and manufacturing efficiency rises when you deliver more than 100,000 TRS-80<sup>™</sup> Model I systems built in your own factories in less than two years. No other computer — ever — has had customer acceptance on such a scale.

Sure, TRS-80 Model I is the price leader, but then you know better than to make your decision based on price alone. You've got to be convinced you get 1) full quality and features, and that 2) our more than 100 service locations furnish faster service, and that 3) we continue to add new software and hardware for TRS-80, even though our list is already one of the industry's longest.

Level I — 4K  
Ideal Starter  
System

**\$499**

Was \$599 last year

Level II — 16K  
Advanced System  
with Calculator Keypad

**\$849**

Was \$988 last year

### New Model I/II Catalog

Come in and get your copy of our new 24-page computer catalog and you'll decide that TRS-80 is your unique opportunity to own a full-featured, fully serviced, fully supported microcomputer at a really nice price.



### New TRS-80 Model II

A bigger, more powerful "brother" to the TRS-80. Completely new, it's a business microcomputer with capabilities beginning where Model I approaches upper limits. Storage capacity up to 2 megabytes. Order now for early delivery.

**\$3450**

1/2-Megabyte  
Basic System



These two cards honored at most Radio Shack stores

**Radio Shack<sup>®</sup>**  
The biggest name in little computers<sup>™</sup>

A Division of Tandy Corporation • Fort Worth, Texas 76102  
Over 7000 Locations in 40 Countries

Retail prices may vary at individual stores and dealers.

Circle 318 on inquiry card.



# Multi Variable Task

software system

**FAMOS™**

**MULTI-TASKING DOS:**

- 8080/z80
- Device independent file system
- Multi-sessioning/spooling
- Full user accounting
- All files dynamic
- Multi-user file security
- Intersystem communications

**\$100 BUS SUPPORT**

**MVT-BASIC™**

**MULTI-USER COMPILER**

- Powerful file, string I/O
- Chaining . . . parameter passing
- ISAM/sort facilities
- Random, sequential files
- Machine language calls
- Error trapping

**HARD DISKS SUPPORTED**

**MVT-WORDFLOW™**

**MULTI-USER WORD PROCESSING SYSTEM**

- Concurrent data processing
- Automatic field insertion
- Global search/replace
- Library file insertion
- "Cutting & pasting"/block moves
- Full WP printer support
- Multiple printers/concurrent
- Wordwrap/variable line spacing
- All options under user control

**IMMEDIATE DELIVERY**

AVAILABLE TO MANUFACTURERS/  
OEM FOR PRIVATE LABEL  
MARKETING



9241 Reseda Blvd., Suite 203  
Northridge, CA 91324  
Phone: (213) 349-9076

Line Numbers	Operation Performed
1 thru 20	a) Generate seed for random number b) dimension variables c) read descriptive data
30 thru 65	Read data from disk files
67 thru 94	Batting order input section
100	Set start and end inning
110 thru 990	Play game
992 thru 998	Select pitchers for new game
1000 thru 1180	Subroutine for printing box game
2000 thru 2080	Subroutine to write updated statistics to disk file
5900 thru 6070	Subroutine to determine run scored and position of base runners
6100 thru 6190	Subroutine for player substitutions
6200 thru 6230	Subroutine for determining winning and losing pitchers
6950 thru 7040	Subroutine for calculating earned runs

Table 2: Operations performed by various lines of BASIC code in the Game program of listing 6.

Variable and Dimensions	Use
S(1,8,2,1)	1 = Teams 8 = batting order 2 = up to three players in each batting position 1 = identification number and position
T\$(20)	Team names
P\$(20)	Position names
H(1,16,14)	1 = Teams 16 = seventeen players 14 = 0 to 6 = player ratings 7 to 10 = at bats, hits, home runs, and runs batted in for the game 11 to 14 = total at bats, hits, home runs, and runs batted in as read and written to disk
P(1,9,9)	1 = Teams 9 = ten pitchers 9 = 0 to 3 = player ratings 4 to 10 = innings pitched, hits, runs, earned runs, strikeouts, walks and win or loss for the game 11 to 17 = total innings pitched, hits, runs, earned runs, strikeouts, walks and wins or losses as read and written to disk
W(9)	0 who's up (visiting team) 1 who's up (home team) 2 visiting team's pitcher 3 home team's pitcher 4 visiting team pitcher's tiring factor 5 home team pitcher's tiring factor 6 leading team number (0 or 1) 7 identification number for leading pitcher 8 trailing team number 9 identification number for trailing pitcher
B(7)	1 runner on first 2 runner on second 4-3 runner on third 4-7 runs scored
R(7)	same as B(7), but tracks earned runs

Table 3: Use and size of array variables in the Game program of listing 6.

Yastrzemski Hits	= 232
Wise Hits	= 253
Pitcher tiring factor (assume 0)	= .000
Left handed batter versus right handed pitcher	= .015
	$.500 \times .5 = .250$

Table 4: Statistical determination of the probability of batter Yastrzemski producing a safe hit from a pitch thrown by Wise. The hits factors for pitcher and batter are added together, along with a factor for pitcher tiring and a factor for the relationship of a left-handed batter facing a right-handed pitcher. The sum of these factors is multiplied by 0.5 and then compared with a random number. If the random number is less than the computed probability, Yastrzemski has hit safely.

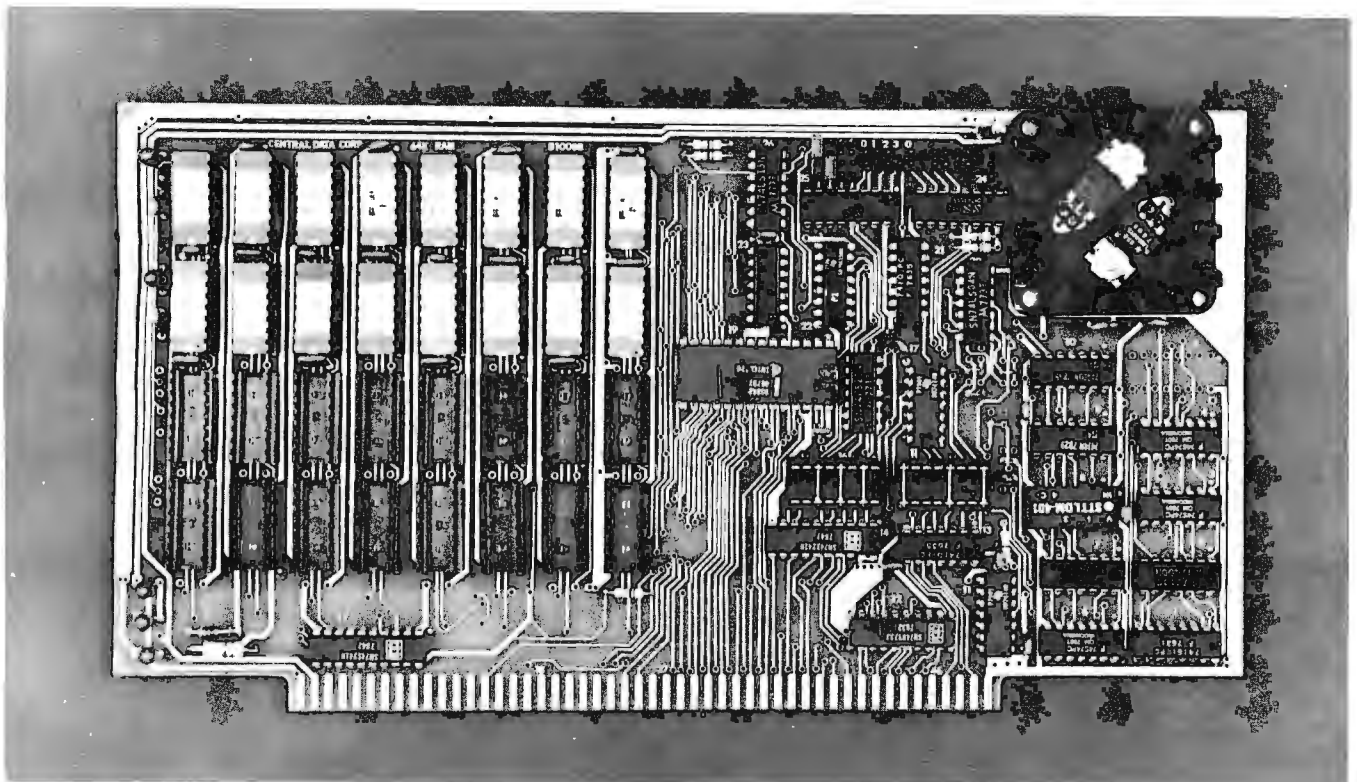

32K Board Pictured Above

# New RAM Prices.

## From The Dynamic Memory Company.

16K—\$249    32K—\$375  
48K—\$500    64K—\$625

Ever since we started making these memory boards over a year ago we have continued to lower our prices to stay competitive. Due to your confidence in us, we are again able to lower our prices! Our reliability has been proven by months of superior performance in thousands of installations. Our low-power boards are being used by quality-minded systems manufacturers across the country and overseas.

### 4MHz boards now available.

After receiving hundreds of requests, our engineering staff has come up with a new version of our board which runs on 4MHz Z-80 systems. It wasn't easy to come up with a high speed board which would operate as reliably as our 450ns version, but after months of careful design and testing, we did it. The price of the 250ns board is \$10 per 16K additional.

Circle 44 on inquiry card.

### All of our features remain.

Our boards didn't become great sellers only because of the price. We still offer you our deselect feature which allows our RAM to overlap with any fixed memory areas in your system. Also, the RAM area of our board is fully socketed so that you can expand the board yourself.

Other standard features include: plug selectable addressing on 16K boundaries (shorting plugs are placed over wire-wrap pins to address the board — located on the top of the board for easy changes), S-100 and Z-80 compatibility and totally invisible refresh — no wait states.

### Fully assembled, tested, and guaranteed.

All of our boards go through a rigorous testing procedure. They are then placed on burn-in running a series of memory tests to detect any other possible faults. After you receive the board, you are backed by us with a one year warrantee.

### Low power consumption keeps your computer from "losing its cool."

The total power consumption of our 16K board is typically less than 4 watts (+8V @ 300ma, +16V @ 150ma and -16V @ 20ma). Boards with additional memory typically increase power consumption only 1 watt per 16K!

### Standard S-100 Interface.

Our board is designed to interface with any standard S-100 CPU. All of the timing of the board is independent of the processor chip, and the board is set up for different processors by changing two plugs on the board.

### Contact your local dealer.

To find out more about our RAM boards, contact your local dealer. If he is unable to help you, call or write us for a fast response. Central Data Corporation, 1207 North Hagan Street, Champaign, IL 61820. (217) 359-8010

**Central Data**



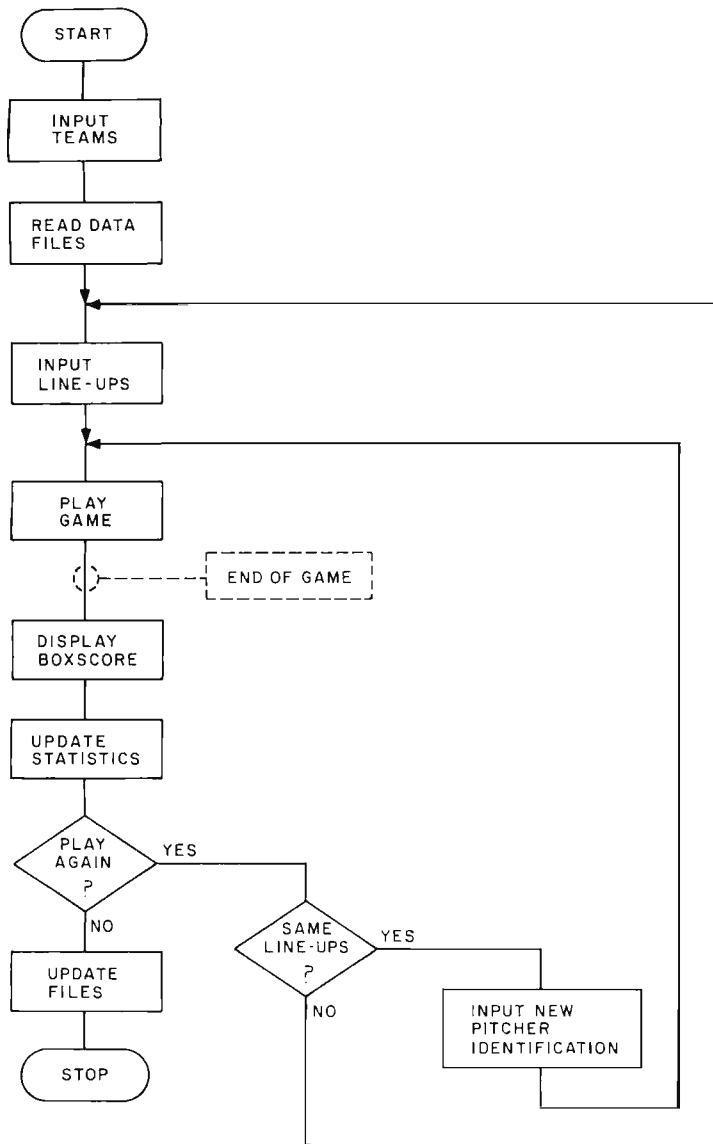

Figure 8: Flowchart of the major divisions of operation of the Game program of listing 6.

Text continued:

runners; all B values are set to 0 every half inning. If a batter gets a single that advances all runners by one base, variable B(4) is set to equal the value of B(3), B(3) is set to B(2), B(2) to B(1), and B(1) is set to a value of 1 plus the opposing pitcher's identification number. If a batter gets a single-base hit that moves runners two bases, B(5) is set to the value of B(3) and B(3) is set to 0, B(4) is set to the value of B(2) and B(2) to 0, B(3) to B(1) and B(1) to 0, and B(1) is set to a value of 1 plus the opposing pitcher's identification number. A similar process is used on outs that advance runners.

This procedure is done in the sub-

routine beginning with line 5900 in listing 6. The second half of this subroutine determines if any runs are scored by seeing how many of the B array elements with subscripts between 4 and 7 are not 0. Each positive number indicates one run. When I first wrote the program, the B array elements were set to either 0 or 1. However, by using the *pitcher's identification number plus 1*, all runs scored can be attributed to the record of the appropriate pitcher.

A similar tracking of runners and runs is recorded in the variable array R (with seven elements). This is needed to register *earned* runs only. All errors are assumed to be outs. Therefore, certain runners and advances

are ignored, and innings end earlier with this variable allowing for the proper calculation of earned runs.

A subroutine for calculating winning and losing pitchers (beginning with line 6200 in listing 6) is consulted after each run is scored. If the particular run scored breaks a tie (the game starts with the score 0 to 0), a new winning pitcher is recorded. If the run causes a tie, the current winning and losing pitchers are removed from their particular status.

As demonstrated in the sample, a substitution can be made only after a run is scored. This is due to the fact that the subroutine at line 6100 is currently consulted only at that point. If you desire the option of a substitution after every play, merely add the program line:

```
122 GOSUB 6100
```

and remove the current:

```
"GOSUB 6100"
```

from line 6070.

### Program Testing

After you enter the Game program into your computer, a test routine will be necessary to check for possible errors made during the program's entry. Changes in line 990 and in line 6100 of listing 6 will permit the program to loop and play numerous games without requiring any input from the user after the lineups are assigned. The revised lines are:

```
990 C9=C9+1: IF C9=50
    THEN 998 : GOTO 100
6100 RETURN
```

These modifications make the program play fifty consecutive games (C9=50 determines the number of games) with the same lineups and without asking the user for any substitutions.

In order to test the program after I wrote it, I played the 1961 New York Yankees against the 1962 New York Mets for fifty games. The results were amazing. The Yankees (who won 109 of 162 *real* games for a winning percentage of 67% in 1961) won 35 of the 50 games in the simulation for a 70% winning average. The Mets (who won 40 of 160 games, or 25%,

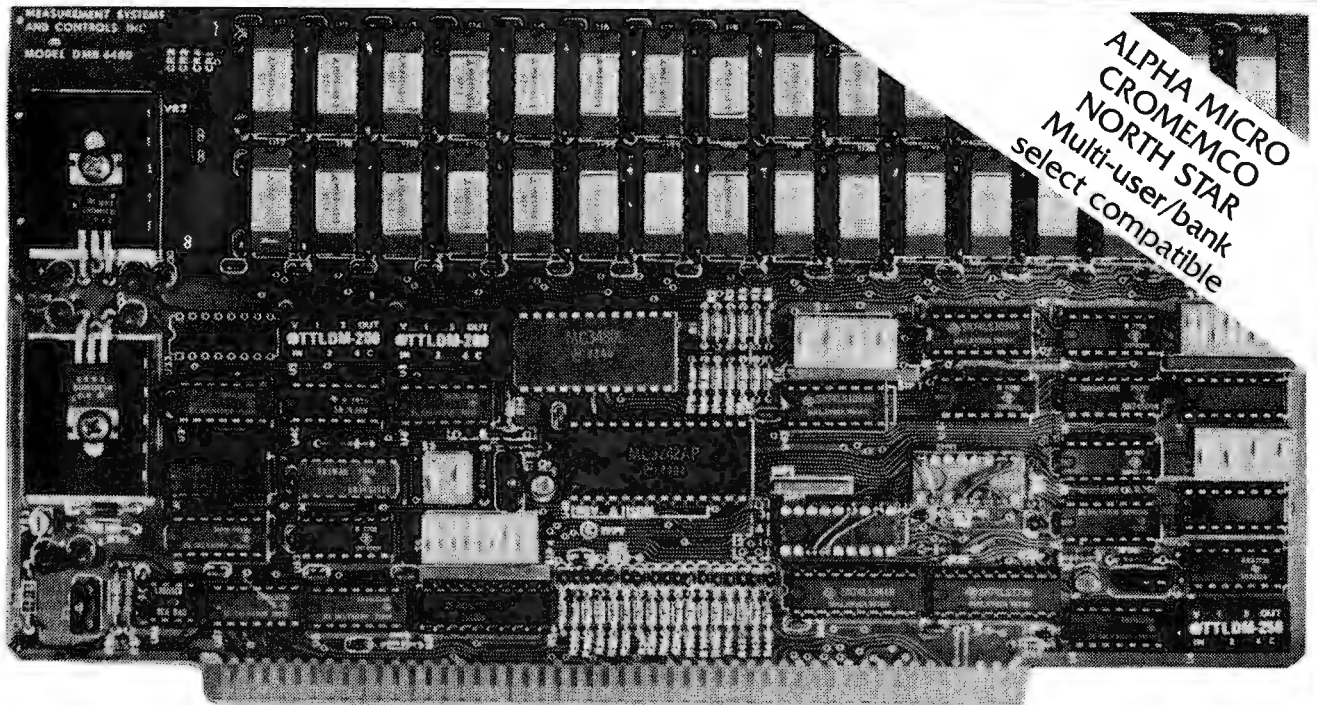

**Model DMB-6400 Series dynamic 64k byte RAMS incorporate the features which are standard in the DM-6400 Series and adds bank select for multi-user-timesharing applications.**

- ALPHA MICRO, CROMEMCO, and NORTH STAR output port bank select.
- Memory bank size can be incremented to 64k bytes in 16k increments.
- Four (4) 16k byte, functionally independent memory banks.
- Eight (8) 64k byte banks of memory per output port for expansion to 512k bytes for each output port.

**Model DM-6400 Series dynamic 64k memory boards feature IEEE S-100 compatible timing and on board transparent refresh.**

- Memory selectable and deselectable in 4k byte increments.
- 25 MHz on board crystal oscillator for independent timing.

**DMB-6400 and DM-6400 Common Features:**

- 4 MHz Z80 operation with no wait states.
- Tested and burned-in.
- Low power- 8 watts maximum.
- Reliable, expandable memories.

**ONE YEAR GUARANTEE**

THE FOLLOWING PRODUCTS ARE AVAILABLE

- |   |   |  |  |
|---|---|--|--|
| <input type="checkbox"/> DMB-6400/64K RAM | <input type="checkbox"/> DMB-3200/32K RAM | <input type="checkbox"/> DM-6400/64K RAM | <input type="checkbox"/> DM-3200/32K RAM |
| <input type="checkbox"/> DMB-4800/48K RAM |   | <input type="checkbox"/> DM-4800/48K RAM |  |

**U.K. & EUROPEAN REPRESENTATIVE:**  
 ABACUS COMPUTERS LTD.  
 62, NEW CAVENDISH STREET  
 LONDON, W1M 7LD U.K.  
 TEL: 01-580/8841 TELEX: 881-3085

**AUSTRALIAN REPRESENTATIVE:**  
 COMPUTERLAND OF MELBOURNE  
 555 COLLINS STREET  
 MELBOURNE, VIC3000  
 TEL: 625581

**MEASUREMENT**  
 systems & controls  
 incorporated

867 North Main Street ● Orange, CA 92668  
 Telephone: 714/633-4460



9a

FILE NAME ?	61-YANKS					NAME	IP	H	R	ER	KO	BB	W	L	ERA
NAME	AB	H	HR	RBI	AVE										
SKOWRON---	174	43	3	7	.244	FORD---	476	471	228	202	291	251	39	11	3.82
RICHARDSON	233	68	4	27	.292	TERRY---	0	0	0	0	0	0	0	0	.00
KUBEK---	220	70	6	32	.318	ARROYO---	0	0	0	0	0	0	0	0	.00
BOYER---	193	48	0	15	.249	STAFFORD---	0	0	0	0	0	0	0	0	.00
MARIS---	227	71	9	84	.313	COATES---	0	0	0	0	0	0	0	0	.00
MANTLE---	184	66	10	29	.359	SHELDON---	0	0	0	0	0	0	0	0	.00
BEKRA---	199	54	9	33	.271	DALEY---	0	0	0	0	0	0	0	0	.00
HOWARD---	204	90	25	67	.441	TURLEY---	0	0	0	0	0	0	0	0	.00
LOPEZ---	0	0	0	0	.000	RENTFF---	0	0	0	0	0	0	0	0	.00
BLANCHARD-	194	45	18	38	.232	DUREN---	0	0	0	0	0	0	0	0	.00
CERV-----	0	0	0	0	.000										
GARDNER---	0	0	0	0	.000										
DEMASTRI--	0	0	0	0	.000										
REED-----	0	0	0	0	.000										
TORGESSON-	0	0	0	0	.000										
GONDER---	0	0	0	0	.000										
JOHNSON---	0	0	0	0	.000										
-----							476	471	228	202	291	251	39	11	3.82

9b

FILE NAME ?	62-METS					NAME	IP	H	R	ER	KO	BB	W	L	ERA
NAME	AB	H	HR	RBI	AVE										
THRONEBERR	0	0	0	0	.000	CRAIG-----	455	555	332	270	158	178	11	39	5.34
NEAL-----	228	48	3	11	.211	HOOK-----	0	0	0	0	0	0	0	0	.00
CHACON---	170	49	0	14	.288	JACKSON---	0	0	0	0	0	0	0	0	.00
MANTILLA---	0	0	0	0	.000	MACKENZIE--	0	0	0	0	0	0	0	0	.00
ASHBURN---	207	58	4	24	.280	ANDERSON--	0	0	0	0	0	0	0	0	.00
HICKMAN---	195	51	5	29	.262	HILLER-----	0	0	0	0	0	0	0	0	.00
THOMAS---	220	59	8	35	.268	CISCO-----	0	0	0	0	0	0	0	0	.00
CANNIZZARO	175	39	0	15	.223	DAVIAULT---	0	0	0	0	0	0	0	0	.00
KANEHL---	0	0	0	0	.000	HUMTER-----	0	0	0	0	0	0	0	0	.00
CHRISTOPHE	192	36	4	23	.188	MILLER-----	0	0	0	0	0	0	0	0	.00
WOODLING---	0	0	0	0	.000										
TAYLOR---	0	0	0	0	.000										
COLEMAN---	0	0	0	0	.000										
HODGES---	205	59	27	59	.288										
BOUCHEE---	0	0	0	0	.000										
COOK-----	200	72	0	18	.360										
BELL-----	0	0	0	0	.000										
-----							455	555	332	270	158	178	11	39	5.34

Figure 9: Individual player statistics derived from the simulated play of fifty baseball games between the 1961 New York Yankees (9a) and the 1962 New York Mets (9b). In this fifty-game series the pitcher-tiring factor was set to 0. In team results, the Yankees won 39 of 50 (78%) of the games, and the Mets won 11 of 50 (or 22%).

in 1962) won the other 15 games for a 30% winning average.

The numbers of hits and runs scored in this simulation were a little bit high, since the designated hitter was used (this did not occur in either 1961 or 1962) and the pitchers were never removed after tiring. Every time 2 runs are scored in an inning and for every scoring occasion in an inning after the 2 runs have been scored, the pitcher's hit rating is worsened by 0.025. This is done in line 6042 of the Game program.

A second test of fifty games was run. However, this test eliminated the tiring factor by changing the equation

in line 6042. This line is branched to by other program statements; thus it could not be removed. Instead it became a nonfunctioning line:  $W(D+4)=W(D+4)$ . The program was again tested.

In the second test, the Yankees won 39 (or 78%) of the games, while the Mets won only 11 (or 22%). The individual statistics appeared reasonable and are shown in figure 9. The model was clearly performing accurately with the statistically better team winning the majority of the games. The program Game was modified back to its original form, and the World Series described at the

beginning of this article was run using the model.

Due to memory limitations, other enhancements were left out of this baseball-simulation model. For example, the display message for outs could be replaced by regular baseball scoring (6-3 meaning ground-out from shortstop to the first baseman), home run rates could be determined by the size of the field the simulation is assumed to be played in, and prepared lineups for each team could be stored on disk to facilitate play. If you modify these programs, please write to me. I would like to know the details. ■

# Let your LSI-11\* break the 28K barrier

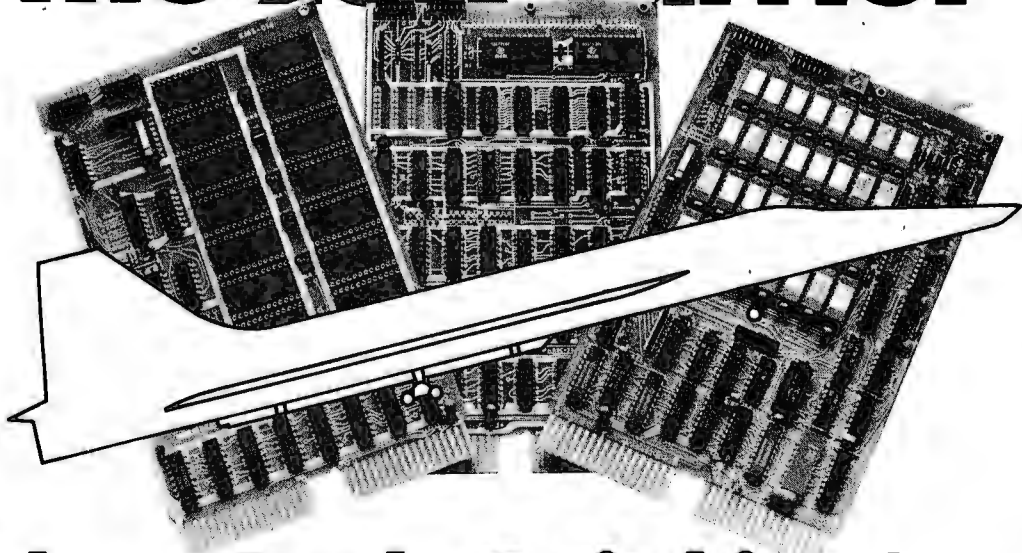

## With our Bank-Switching family

In LOCAL mode our memory is functionally just like DEC memory. But when you run out of memory space you're not lost. Add an inexpensive Bank-Switch Controller (BSC-256) and you can go to **two megabytes**. Add another and go to **four megabytes**.

So don't get boxed in with other brands of LSI-11\* memory. Break free. Join the family:

<b>RMA-032</b>	32K by 16 bit RAM. On-board refresh	\$1200 (Single qty.)
<b>RMS-016</b>	16K by 16 bit ROM. (Intel 2716)	\$300 (Single qty.)
<b>BSC-256</b>	The Bank-Switch Controller	\$300 (Single qty.)

*Substantial quantity discounts are available. For a free copy of our Bank-Switching manual, call or write on your company letterhead.*

*Digital Pathways Inc.  
4151 Middlefield Road  
Palo Alto, CA 94306  
(415) 493-5544*

*\*Registered trademark of Digital Equipment Corporation*



# DIGITAL PATHWAYS



# The Comprint 912 printer. No one else can match our speed, our print quality, our quiet operation, or our reliability. Not for \$660 they can't.

Our Comprint 912 is the best printer for the money. Period. Any printer that can match our price can't even begin to match our performance. And any printer that boasts performance like ours doesn't even come close to our price. No matter what your application; computer reports, listings, CRT hard copy, message

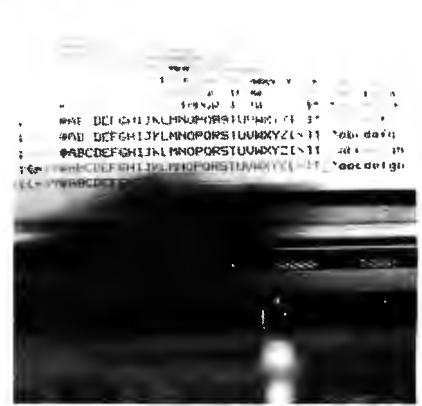
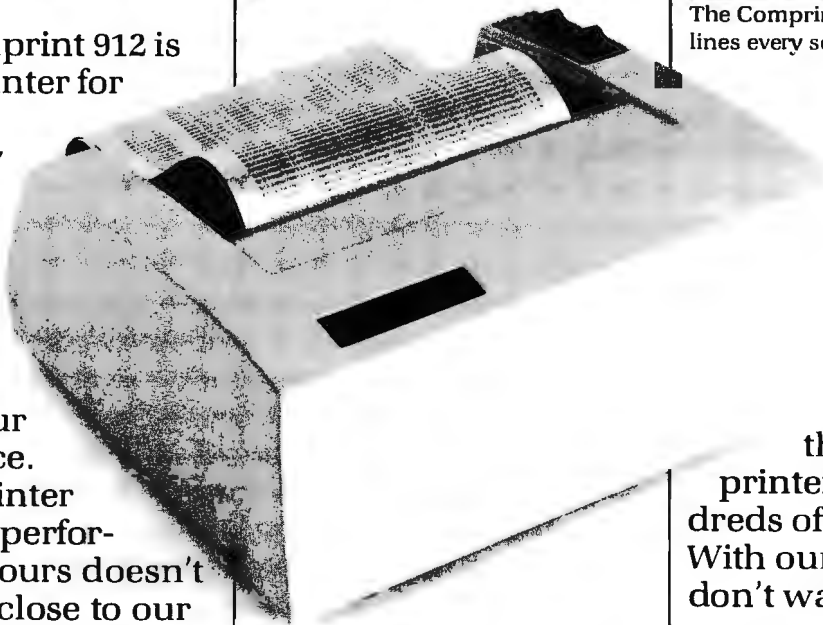

The Comprint 912 prints nearly 3 lines every second.

**Speed.**  
At 225 characters per second (170 LPM) the Comprint 912 is up to 4 times faster

than impact printers costing hundreds of dollars more. With our printer you don't waste time and money waiting for your print-out.

### Print Quality.

Our 9x12 matrix provides sharp, crisp characters. Compare that with our competition. Their very best is a 9x7 matrix, which means no lower case descenders and cramped letters. With the Comprint 912 you don't have to put up with the irritation of fuzzy, hard to read computer printing. This

receiving, scientific/ industrial data logging, or anything you can think of, the Comprint 912 is the performance leader in printers under \$1000.

First consider our performance.



CRT hardcopy is an excellent application for the Comprint 912.

exceptional print quality in ly by the Comprint 912 in 7 nless reliability, 6 month rallel I/O and 8 1/2" wide been shipped to happy custc offer a 6 month warranty, twice the industry standard. The key to all this superior performance is our special

The superior print quality provided by the Comprint 912 is obvious in this actual size sample.

means increased productivity. And because the Comprint 912 makes better originals, our originals make better Xeroxes.

**Quiet Operation.**

Most computer printers are irritatingly noisy. They can disrupt concentration and reduce the efficiency of anyone working near them. They're noisy because they're

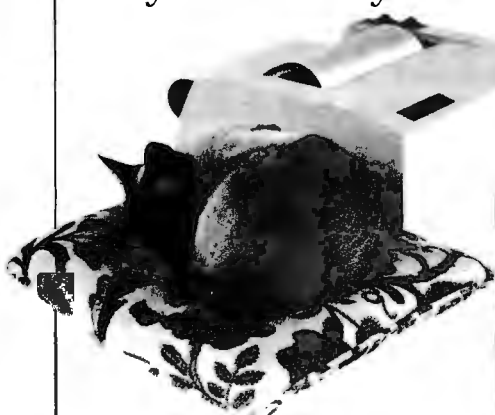

The Comprint 912 is quiet because it's electronic not mechanical.

impact. The Comprint 912 has no mechanical print head banging on the paper. It's electronic. It's quiet.

**Reliability.**

Since the Comprint 912 prints electronically, rather than mechanically like ordinary impact printers, we have fewer moving parts and less vibration. The Comprint 912 has fewer things to go wrong and less wear. That's why we



Fewer moving parts in the Comprint 912 mean greater reliability.

paper. This aluminized "silver paper" works just like ordinary paper. It won't fade or discolor and actually costs less than plain paper and one time ribbons. For the vast majority of printing applications it's just plain better than plain paper. Especially when you consider the hidden costs of plain paper printers due to their inferior performance compared to the Comprint 912. And on those rare occasions when you really do

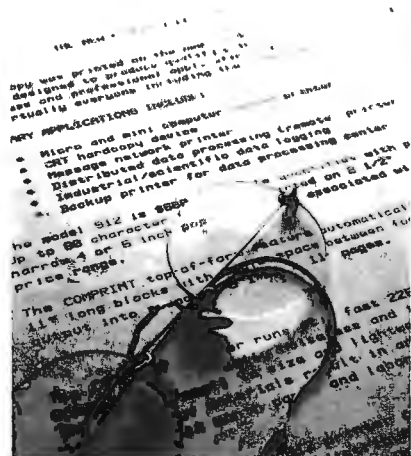

need a plain bond paper copy, just run your Comprint 912 printout through your plain bond copy machine and you've got it. Even though our paper is special, it's available everywhere; from your dealer or distributor, or from us.

Now consider our price.

**The Comprint 912.**

\$660 with parallel interface, \$699 with serial interface.

We could talk about our other advantages, like our 80-character lines on 8-1/2" wide paper, or our compact, light-weight size, and the fact that the Comprint 912 has no ribbons to mess with, no chemicals, nothing to add but paper.

But you have to see for yourself. Before you buy any printer, insist on seeing the Comprint 912, the performance leader, at your local computer store or industrial distributor. Or contact us for a descriptive brochure, a sample print-out, and applications literature.



The performance leader.

**Computer Printers International, Inc.**

340 E. Middlefield Rd.  
Mountain View, California 94043  
415 969-6161



# Stack It Up

---

Charlton H Allen  
20B Blossom St  
Nashua NH 03060

---

Most microprocessors currently available employ a stack of some sort. This stack is either a scratch memory in the processor itself or an addressable programmable memory characterized by retrieval of information in the reverse order of storage using a pointer. In the common parlance, a stack is a LIFO (last in first out) mechanism. It is a very useful feature for preserving the proper

order of subroutine call and return points with minimal hassle. Experienced programmers using 8080 type machines quickly discover its other uses; for example, a direct register store instruction is three bytes long on the 8080, whereas a register stack instruction is only one byte. As a result, saving registers used by subroutines and restoring them later is cheaper if the stack is used in preference to some directly addressed memory area. More importantly, perhaps, the availability of such a mechanism greatly simplifies the writing of reentrant routines, ie: ones which do not modify themselves in the process of execution. Note, however, that all the mechanisms provided in microprocessors to date for stack operations are explicitly fixed mode and singular. There is only one stack, and it operates on entities of the same width, in number of bits, as the accumulator(s). Moreover, these entities have no attribute other than their fixed width, in bits.

In contrast, several large scale computers, such as the Burroughs 5500 processor with which I am familiar, employ a more generalized stack mechanism in which:

- The storage area for the stack(s) is independent of the central processor's memory, ie: not directly addressable.
- The entities being stored and retrieved have attributes of type (integer, logical, real, string, array) and of length (array size).
- Multiple stacks may be processed simultaneously and independently.

To achieve the latter, the stack controller requires a "stack control block" in central processor addressable memory to be uniquely associated with each active stack. Otherwise, such stack controllers bear approximately the same relation to the central processor and its addressable memory as a

Listing 1: PARSE, a translation procedure written in an informal ALGOL.

```
STRING PROCEDURE PARSE(Exp):
STRING Exp;
BEGIN
  EXTERNAL INTEGER PROCEDURE Intoken ;
  LOGICAL Endinput, Errflag ;
  INTEGER Position, I, J, T ;
  INTEGER ARRAY S = ( 1 -1 -2 2 -9,
                    -3 3 4 -4 -9,
                    5 -5 -6 6 -9,
                    -7 7 8 -8 -9,
                    -9 -9 -9 -9 -9);

  STACK Q ;

  Errflag := Endinput := false;
  PARSE := null; Position := 0
  I := Intoken(Exp, Position, Endinput);
  J := Intoken(Exp, Position, Endinput);
  COMMENT I is last token, J is current ;
  IF Endinput THEN Errflag := true
  ELSE WHILE NOT Endinput DO BEGIN
    T := S(I,J); IF T < 0 THEN Errflag := true
    ELSE CASE T OF BEGIN
      COMMENT valid sequence of tokens ;
      CASE1: BEGIN
        Q := PARSE; PARSE := null;
        END;
      CASE2: null;
      CASE3: PARSE := PARSE . Q;
      CASE4: PARSE := PARSE . Exp(Position) . '$';
      CASE5: BEGIN
        Q := PARSE . '$'; PARSE := null;
        END;
      CASE6: PARSE := PARSE . Exp(Position);
      CASE7: PARSE := PARSE . Q;
      CASE8: PARSE := PARSE . Exp(Position) . Exp (Position-1);
    END;
    I := J;
    J := Intoken(Exp, Position, Endinput);
  END;
  WHILE NOT Q = empty DO PARSE := PARSE .Q;
  IF Errflag THEN PARSE := null;
END.
```

high speed data channel, in that the data transfers are generally effected through cycle stealing direct memory addressing, and an unmaskable interrupt to the central processor occurs only when an error condition, stack overflow or underflow, is detected.

I don't seriously propose such a stack controller for the representative homebrew computer system. I do propose, however, to show by example that incremental programming development in that direction can provide correspondingly simpler solutions to a large class of computing problems.

### A Problem

One of the curious properties of calculators using Polish notation techniques is that any expression using the operators provided on the keyboard can be evaluated in an absolute minimum of keystrokes. Moreover, the required number of temporary storage areas, depth of stack, is at most the number of operands for the most complex operator. In an exactly analogous way, a stack of depth two or a second accumulator is sufficient in digital computers for evaluating any size expression using operators corresponding to native instructions, provided that the terms are calculated in the correct order. The price one pays for this admittedly pleasing property is learning to think things from the inside out. The user mentally seeks the interior of the expression, innermost term in parentheses, and works outward in calculation left to right. The pity is that it doesn't come easily to lots of folks since most people use the algebraic method of solving expressions which is the way they were taught in school. *[If a larger stack is used the expression can be evaluated from the left to right with the intermediate answers pushed onto the stack. . .RC]*

### A Solution

The main problem with Polish notation is really one of representation. One wants to enter an expression in the same way it appears in, for example, a statistics handbook. If that could be done, if a way could be found to rearrange expressions from algebraic form to Polish notation, a mathematical calculator or computer could be constructed having the computational efficiency of Polish notation without sacrificing ease of use. In fact, this process of rearrangement has been intrinsic to most higher level programming language compilers and interpreters for many years. The manner in which the rearrangement is done is most easily explained in terms of a program

Input string: 1 + ((A+B)/C) - (D\*(E-F)/G) / H

Position	i	j	t	PARSE	Q
1	4			null	empty
2	4	3	8	+1	
3	3	1	5	null	+1\$
4	1	1	1	null	null, +1\$
5	1	1	1	null	null, null, +1\$
6	1	4	2		
7	4	3	8	+A	
8	3	4	6	+AB	
9	4	2	7		null, +1\$
10	2	3	4	+AB/\$	
11	3	4	6	+AB/\$C	
12	4	2	7		+1\$
13	2	3	4	+AB/\$C-\$	
14	3	1	5	null	+AB/\$C-\$\$, +1\$
15	1	4	2		
16	4	3	8	*D	
17	3	1	5	null	*D\$, +AB/\$C-\$\$, +1\$
18	1	4	2		
19	4	3	8	-E	
20	3	4	6	-EF	
21	4	2	7	-EF*D\$	+AB/\$C-\$\$, +1\$
22	2	3	4	-EF*D\$/\$	
23	3	4	6	-EF*D\$/\$G	
24	4	2	7	-EF*D\$/\$G+AB/\$C-\$\$	+1\$
25	2	2	3	-EF*D\$/\$G+AB/\$C-\$\$+1\$	empty
26	2	3	4	-EF*D\$/\$G+AB/\$C-\$\$+1\$/\$	
27	3	4	6	-EF*D\$/\$G+AB/\$C-\$\$+1\$/\$H	

Figure 1: Sample parsing process resulting from use of program PARSE.

which does just that by use of a stack only slightly more general than the native stack in microprocessors.

### Explanation

Listing 1 is a procedure for parsing, computer jargon for rearranging, generalized binary operator expressions. In somewhat less prosaic language: PARSE is a program which takes an algebraic form expression and rearranges it to produce a sub-Polish notation form expression containing references, where needed, to the runtime stack. Its output presumes that the result of each calculation is immediately placed on the stack.

Note that PARSE does not count parentheses. In fact, it does not even use them directly. Instead, it uses an external procedure called INTOKEN to scan the input expression, EXP, and produce encoded tokens depending on the current input:

- 1 for a left parenthesis.
- 2 for a right parenthesis.
- 3 for an operator.
- 4 for a constant or symbol.
- 5 if none of these.

Text continued on page 144





**PRB-1 DIGITAL LOGIC PROBE**

- DC to > 50 MHz
- 10 Msec. pulse response
- 120 K $\Omega$  Impedance
- Automatic pulse stretching to 50 Msec.
- Automatic resetting memory
- Open circuit detection
- Automatic threshold resetting
- Compatible with all logic families 4-18 VDC
- Range extended to 15-25 VDC with optional PA-1 adapter
- Supply O.V.P. to  $\pm$  70 VDC
- No switches/no calibration

PRB-1	DIGITAL LOGIC PROBE	\$36.95
-------	---------------------	---------

**PROTOTYPE BOARD CM-100**

TERMINALS: 1,020 TEST POINTS. 188 separate 5 point terminals, plus 2 horizontal bus lines of 40 common test points each.

SIZE: 6 1/2" Wide, 5" Long.

CM-100	MODULAR PROTOTYPE BOARD	\$25.95
--------	-------------------------	---------

**PROTOTYPE BOARD CM-200**

TERMINALS: 630 TEST POINTS. 94 separate 5 point terminals, plus 4 bus lines of 40 common test points each. SIZE: 6" Wide, 3 1/2" Long.

CM-200	MODULAR PROTOTYPE BOARD	\$16.45
--------	-------------------------	---------

**PROTOTYPE BOARD CM-300, CM-400**

CM-300 and CM-400 have two separated rows of five interconnected contacts each. Each pin of a DIP inserted in the strip will have four additional tie-points per pin to insert connecting wires. They accept leads and components up to .032 in. diameter. Interconnections are readily made with RW-50 Jumper Wire. All contact sockets are on a .100 in. square grid (1 1/4 in. wide).

CM-300	MODULAR PROTOTYPE BOARD	\$9.95
CM-400	MODULAR PROTOTYPE BOARD	\$2.45

**MODULAR BUS STRIP**

CM-500 is a bus strip to be used in conjunction with CM-300 and CM-400 for distribution of power and common signed lines. Two separate rows of common terminals, grouped into clusters of five. All contact sockets are on a .100 in. square grid.

CM-500	MODULAR BUS STRIP	\$1.95
--------	-------------------	--------

**JUMPER WIRES**

50 Preformed wires, from 1 1/2 to 4 inches, 20 AWG solid wire, white insulation.

RW-50	JUMPER WIRES	\$2.98
-------	--------------	--------

**"CLIP AND STRIP" TOOL**

For cutting and stripping 1 in. insulation from 30 AWG wire.

CAS-130	CLIP AND STRIP	\$1.98
---------	----------------	--------

THE ABOVE CUT AND STRIP TOOL IS NOT APPLICABLE FOR NYLON OR TEFLON INSULATION

**MINI SHEAR**

MS-10	MINI-SHEAR	\$4.95
-------	------------	--------

**MINI SHEAR WITH SAFETY CLIP**

MS-20	MINI-SHEAR WITH CLIP	\$5.95
-------	----------------------	--------

**VACUUM VISE**

ABS construction, 1 1/2 in. wide jaws.

VV-1	VACUUM VISE	\$3.49
------	-------------	--------

**WIRE WRAPPING HITS**

**WK-2, WK-3, WK-4**

WK-2-B	WIRE-WRAPPING KIT (BLUE)	\$12.95
WK-2-Y	WIRE-WRAPPING KIT (YELLOW)	\$12.95
WK-2-W	WIRE-WRAPPING KIT (WHITE)	\$12.95
WK-2-R	WIRE-WRAPPING KIT (RED)	\$12.95
WK-3B (BLUE)	WIRE-WRAPPING KIT	\$16.95
WK-4B (BLUE)	WIRE-WRAPPING KIT	\$25.99

**WIRE WRAPPING HIT WK-5**

BW-630, WSU-30M, CON-1, EX-1, INS-1416, TRS-2, MS-20, 14, 16, 24 and 40 DIP sockets, WWT-1, WD-30-TR1, H-PCB-1.

WK-5	WIRE-WRAPPING KIT	\$74.95
------	-------------------	---------

**PC BOARD**

4 x 4.5 x 3/16 in. board, glass coated EPOXY laminate, solder coated 1 oz. copper pads. The board has provision for a 22/44 two sided edge connector. .156 in. spacing. Edge contacts are non-dedicated for maximum flexibility.

The board contains a matrix of .040 in. diameter holes on .100 in. centers. Component side contains 76 two-hole pads.

Two independent bus systems are provided for voltage and ground on both sides of the board.

H-PCB-1	HOBBY BOARD	\$4.99
---------	-------------	--------

**TERMINAL BOARD**

.062 thick glass coated epoxy laminate. Outside dimensions 6.3 in. x 3.94 in. Not plated.

A-PC-01	TERMINAL BOARD	\$3.45
---------	----------------	--------

**PC BOARD**

Same specifications as A-PC-01 except matrix pattern is copper plated and solder coated on one side.

A-PC-02	PRINTED CIRCUIT BOARD	\$5.95
---------	-----------------------	--------

**PC BOARD**

Same specifications as A-PC-01. Each line of holes is connected with copper plated and solder coated parallel strips on one side.

A-PC-03	PRINTED CIRCUIT BOARD	\$5.95
---------	-----------------------	--------

**PC BOARD**

Same specifications as A-PC-01. One side has horizontal copper strips, solder coated. Second side has vertical parallel bars.

A-PC-04	PRINTED CIRCUIT BOARD	\$7.95
---------	-----------------------	--------

**PC BOARD**

The A-PC-05 features numbered contacts for easy reference along with a numbered matrix for easy hole locations. Made of .062 in. thick epoxy laminate. 4.5 in. x 5 in. Edge Connector Board.

A-PC-05	PRINTED CIRCUIT BOARD	\$5.45
---------	-----------------------	--------

Same as A-PC-05 except outside dimensions are 4.5 in. x 6.5 in. Edge Connector Board.

A-PC-06	PRINTED CIRCUIT BOARD	\$6.95
---------	-----------------------	--------

Same as A-PC-05 except outside dimensions are 4.5 in. x 7 in. Edge Connector Board.

A-PC-07	PRINTED CIRCUIT BOARD	\$8.95
---------	-----------------------	--------

**TERMINALS**

WWT-1	SLOTTED TERMINAL	\$4.98
WWT-2	SINGLE SIDED TERMINAL	\$2.98
WWT-3	IC SOCKET TERMINAL	\$4.98
WWT-4	DOUBLE SIDED TERMINAL	\$1.98

**TERMINAL INSERTING TOOL**

For inserting WWT-1, -2, -3 and -4 terminals.

INS-1	INSERTING TOOL	\$2.49
-------	----------------	--------

**P.C.B. TERMINAL STRIPS**

TS-4	4-POLE	\$1.39
TS-8	8-POLE	\$2.19
TS-12	12-POLE	\$2.99

**MODULAR TERMINAL STRIPS**

TS-6MD	2-POLE	\$1.79
--------	--------	--------

(3 per Package)

**PC CARD GUIDES**

TR-1	CARD GUIDES	\$1.89
------	-------------	--------

QUANTITY — ONE PAIR (2 PCS.)

**PC CARD GUIDES & BRACKETS**

TRS-2	GUIDES & BRACKETS	\$3.79
-------	-------------------	--------

QUANTITY — ONE SET (4 PCS.)

**PC EDGE CONNECTOR**

44 pin, dual read-out, .156 in. spacing, wire-wrapping.

CON-1	P.C. EDGE CONNECTOR	\$3.49
-------	---------------------	--------

MINIMUM ORDER \$25.00. SHIPPING CHARGE \$2.00. N.Y. CITY AND STATE RESIDENTS ADD TAX

**OK MACHINE & TOOL CORPORATION**

3455 Conner St. Bronx, N.Y. 10475 (212) 994-6600 Telex 125091

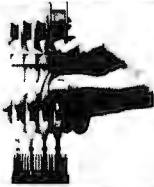

### JUST WRAP™ WIRE WRAPPING TOOL

WHY CUT? WHY STRIP? WHY SLIT?  
WHY NOT JUST WRAP?

JW-1-B	BLUE WIRE	\$14.95
JW-1-W	WHITE WIRE	\$14.95
JW-1-Y	YELLOW WIRE	\$14.95
JW-1-R	RED WIRE	\$14.95



### RIBBON CABLE ASSEMBLY SINGLE END

26 AWG Rainbow Coded flat cable.

SE 14-24	WITH 14 PIN DIP PLUG 24" LONG (609MM)	\$3.55
SE 14-48	WITH 14 PIN DIP PLUG 48" LONG (1218MM)	\$4.25
SE 16-24	WITH 16 PIN LONG DIP PLUG 24" LONG (609MM)	\$3.75
SE 16-48	WITH 16 PIN LONG DIP PLUG 48" LONG (1218MM)	\$4.45

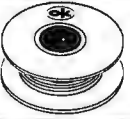

### JUST WRAP REPLACEMENT ROLLS

R-JW-B	BLUE WIRE	50 ft. Roll	\$2.98
R-JW-W	WHITE WIRE	50 ft. Roll	\$2.98
R-JW-Y	YELLOW WIRE	50 ft. Roll	\$2.98
R-JW-R	RED WIRE	50 ft. Roll	\$2.98

### UNWRAP TOOL FOR JUST WRAP

JUW-1	UNWRAPPING TOOL	\$3.49
-------	-----------------	--------

### JUST WRAP HIT

JWK-6	JUSTWRAP KIT	\$24.95
-------	--------------	---------

### "HOBBY" WIRE WRAPPING TOOL BATTERY POWERED

BW-2630	FOR AWG 26-30	\$19.95
---------	---------------	---------

Use "C" size NICAD Batteries, not included. Bits not included.

BT-30	BIT FOR AWG 30	\$3.95
BT-2628	BIT FOR AWG 26-28	\$7.95

### HOBBY WRAP TOOLS



WSU-30	REGULAR WRAP	\$6.95
WSU-30M	MODIFIED WRAP	\$7.95

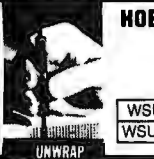

### RIBBON CABLE ASSEMBLY DOUBLE END

DE 14-2	WITH 14 PIN DIP PLUG - 2"	\$3.75
DE 14-4	WITH 14 PIN DIP PLUG - 4"	\$3.85
DE 14-8	WITH 14 PIN DIP PLUG - 8"	\$3.95
DE 14-12	WITH 14 PIN DIP PLUG - 12"	\$4.07
DE 14-16	WITH 14 PIN DIP PLUG - 16"	\$4.12
DE 14-24	WITH 14 PIN DIP PLUG - 24"	\$4.15
DE 16-2	WITH 16 PIN DIP PLUG - 2"	\$4.15
DE 16-4	WITH 16 PIN DIP PLUG - 4"	\$4.25
DE 16-8	WITH 16 PIN DIP PLUG - 8"	\$4.35
DE 16-12	WITH 16 PIN DIP PLUG - 12"	\$4.47
DE 16-16	WITH 16 PIN DIP PLUG - 16"	\$4.52
DE 16-24	WITH 16 PIN DIP PLUG - 24"	\$4.55
DE 24-6	WITH 24 PIN DIP PLUG - 6"	\$6.05
DE 24-8	WITH 24 PIN DIP PLUG - 8"	\$6.50
DE 24-12	WITH 24 PIN DIP PLUG - 12"	\$6.90
DE 24-16	WITH 24 PIN DIP PLUG - 16"	\$7.10
DE 24-24	WITH 24 PIN DIP PLUG - 24"	\$7.70

QUANTITY 2 PLUGS, 2 COVERS

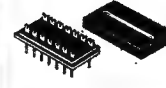

### DIP PLUG WITH COVER FOR USE WITH RIBBON CABLE

14-PLG	14 PIN PLUG & COVER	\$1.45
16-PLG	16 PIN PLUG & COVER	\$1.59

### RIBBON CABLE ASSEMBLY DOUBLE END

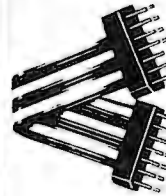

### DIP SOCKETS

14 DIP	14 PIN DIP SOCKET	\$0.79
16 DIP	16 PIN DIP SOCKET	\$0.89
24 DIP	24 PIN DIP SOCKET	\$1.49
36 DIP	36 PIN DIP SOCKET	\$2.49
40 DIP	40 PIN DIP SOCKET	\$2.99

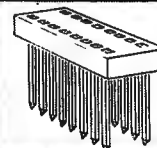

### PRE-STRIPPED WIRE WRAPPING WIRE

Wire for wire wrapping, AWG-30 (0.25mm) KYNAR® wire, 50 wires per package stripped 1" both ends.

KYNAR-PENNSWALT

30 R 50 010	30 AWG Blue Wire 1" Long	\$1.99
30 Y 50 010	30 AWG Yellow Wire 1" Long	\$1.99
30 W 50 010	30 AWG White Wire 1" Long	\$1.99
30 R 50 010	30 AWG Red Wire 1" Long	\$1.99
30 B 50 020	30 AWG Blue Wire 2" Long	\$1.07
30 Y 50 020	30 AWG Yellow Wire 2" Long	\$1.07
30 W 50 020	30 AWG White Wire 2" Long	\$1.07
30 R 50 020	30 AWG Red Wire 2" Long	\$1.07
30 B 50 030	30 AWG Blue Wire 3" Long	\$1.16
30 Y 50 030	30 AWG Yellow Wire 3" Long	\$1.16
30 W 50 030	30 AWG White Wire 3" Long	\$1.16
30 R 50 030	30 AWG Red Wire 3" Long	\$1.16
30 B 50 040	30 AWG Blue Wire 4" Long	\$1.23
30 Y 50 040	30 AWG Yellow Wire 4" Long	\$1.23
30 W 50 040	30 AWG White Wire 4" Long	\$1.23
30 R 50 040	30 AWG Red Wire 4" Long	\$1.23
30 B 50 050	30 AWG Blue Wire 5" Long	\$1.30
30 Y 50 050	30 AWG Yellow Wire 5" Long	\$1.30
30 W 50 050	30 AWG White Wire 5" Long	\$1.30
30 R 50 050	30 AWG Red Wire 5" Long	\$1.30
30 B 50 060	30 AWG Blue Wire 6" Long	\$1.38
30 Y 50 060	30 AWG Yellow Wire 6" Long	\$1.38
30 W 50 060	30 AWG White Wire 6" Long	\$1.38
30 R 50 060	30 AWG Red Wire 6" Long	\$1.38

### TRI-COLOR DISPENSER

WD-30-TRI	TRI-COLOR DISPENSER	\$5.95
-----------	---------------------	--------

R-30-TRI	REPLACEMENT ROLLS	\$3.95
----------	-------------------	--------

### WIRE DISPENSER

WD-30-B	BLUE WIRE	\$3.95
WD-30-Y	YELLOW WIRE	\$3.95
WD-30-W	WHITE WIRE	\$3.95
WD-30-R	RED WIRE	\$3.95

### DISPENSER REPLACEMENT ROLLS

R-30B-0050	30-AWG BLUE 50 FT. ROLL	\$1.98
R-30Y-0050	30-AWG YELLOW 50 FT. ROLL	\$1.98
R-30W-0050	30-AWG WHITE 50 FT. ROLL	\$1.98
R-30R-0050	30-AWG RED 50 FT. ROLL	\$1.98

KYNAR-PENNSWALT

### HOOK-UP WIRE

HK-18	18 AWG	25 FT.	SOLID CONDUCTOR	\$1.20
HK-20	20 AWG	25 FT.	SOLID CONDUCTOR	\$1.98
HK-22	22 AWG	50 FT.	SOLID CONDUCTOR	\$1.35
HK-24	24 AWG	50 FT.	SOLID CONDUCTOR	\$1.35
HK-26	26 AWG	50 FT.	SOLID CONDUCTOR	\$1.35
SHK-18	18 AWG	25 FT.	STRANDED CONDUCTOR	\$1.20
SHK-20	20 AWG	25 FT.	STRANDED CONDUCTOR	\$1.98
SHK-22	22 AWG	50 FT.	STRANDED CONDUCTOR	\$1.35
SHK-24	24 AWG	50 FT.	STRANDED CONDUCTOR	\$1.35
SHK-26	26 AWG	50 FT.	STRANDED CONDUCTOR	\$1.35



### DIP IC INSERTION TOOLS WITH PIN STRAIGHTNER

Narrow profile. Pin straightener built into tool. Automatic ejector.

INS-1416	14-16 PIN DIP /IC INSERTER	\$3.49
----------	----------------------------	--------

### MOS, CMOS-SAFE

GROUND STRAP NOT INCLUDED

MOS-1416	14-16 PIN, MOS CMOS SAFE INSERTER	\$7.95
MOS-2428	24-28 PIN, MOS CMOS SAFE INSERTER	\$7.95



### 36-40 PIN CMOS-SAFE IC INSERTION TOOL

Aligns bent out pins. Includes terminal lug for attachment of ground strap.

MOS-40	36-40 PIN CMOS SAFE INSERTION TOOL	\$7.95
--------	------------------------------------	--------

### DIP IC EXTRACTOR TOOL

Extracts all LSI, MSI and SSI devices of from 8 to 24 pins.

EX-1	EXTRACTOR TOOL	\$1.49
------	----------------	--------

### 24-40 CMOS-SAFE EXTRACTOR TOOL

Removes 24-40 pin IC's, .600" centers. CMOS safe. Includes terminal lug for attachment of ground strap.

EX-2	CMOS SAFE EXTRACTOR TOOL	\$7.95
------	--------------------------	--------

MINIMUM ORDER \$25.00, SHIPPING CHARGE \$2.00, N.Y. CITY AND STATE RESIDENTS ADD TAX

## OK MACHINE & TOOL CORPORATION

3455 Conner St., Bronx, N.Y. 10475 (212) 994-6600 Telex 125091

Listing 2: INTOKEN encodes the current character in the input expression, Exp. As before, an informal ALGOL type notation is used.

```

INTEGER PROCEDURE INTOKEN (Exp, Position, Endinput):
LOGICAL Endinput;
INTEGER Position ;
STRING      Exp;
BEGIN INTOKEN := 0;
  IF Position = SIZE(Exp) THEN Endinput := true
  ELSE BEGIN
    Position := Position + 1;
    WHILE Exp(Position) = ' ' DO Position := Position + 1,
    IF Exp(Position) = '(' THEN INTOKEN := 1
    ELSE IF Exp(Position) = ')' THEN INTOKEN := 2
    ELSE IF Exp(Position) = ANY( '+', '-', '*', '/' ) THEN INTOKEN := 3
    ELSE BEGIN
      INTOKEN := 5;
      COMMENT Presume error first, determine otherwise later;
      IF NOT ( 0 > Exp(Position) OR '9' < Exp(Position) )
      THEN BEGIN
        INTOKEN := 4;
        WHILE NOT ( 0 > Exp(Position) OR '9' < Exp(Position) )
        DO Position := Position + 1; Position := Position - 1;
      END ELSE
      IF NOT ('A' > Exp(Position) OR 'Z' < Exp(Position) )
      THEN BEGIN
        INTOKEN := 4;
        WHILE NOT ('A' > Exp(Position) OR 'Z' < Exp(Position) )
        DO Position := Position + 1; Position := Position - 1;
      END;
    END;
  END;
END;
END.

```

Listing 3: Single stack control routines written for the 8080 processor. STACK places a string of characters on a LIFO list, followed by the length of the string. POPSD removes the length of the last entered string, if any, from the list. POPUP removes the last entered string, if any, from the list. (Note: These routines are not debugged; in fact, the symbol STACK is multiply defined, so that it won't assemble correctly. They are included here only to suggest an appropriate technique.)

```

STACK:  PUSH    PSW      ; COMMENT The following presumes
        PUSH    B        ; external procedures ABUF and
        PUSH    D        ; RBUF whose functions are,
        PUSH    H        ; respectively,
        XCHG   ; acquire a buffer of byte size
        LHL D, STACK ; specified by A, returning
        PUSH    H        ; address in H,L or zero if
        POP     B        ; none available
        ADI    3        ; release a buffer addressed by
        CALL   ABUF     ; H,L to the buffer pool ;
        MOV    A,H      ;
        ORA    L        ; STACK: SAVE(H,L);
        JZ     STKOF   ; ABUF(A+3); IF 0
        SHLD  STACK    ; THEN SET(Carry)
        MOV    A,C      ; ELSE BEGIN
        STAX  H        ; COMMENT Stack entry contents:
        INX   H        ; +0 addr of previous entry
        MOV   A,B      ; +2 size of current item
        STAX  H        ; +3 current item
        INX   H        ;
        POP   PSW     ; caller provides size in A,
        MOV   B,A     ; item data address in H,L ;
        STAX  H        ; RESET(Carry);
        ORA   A        ; MEMORY(H,L) := Stack;
        JZ    STKCX   ; Stack := (H,L);
        INX   H        ; (H,L) := (H,L) + 2;
STKCY:  LDAX  D        ; MEMORY(H,L) := A;
        STAX  H        ; (H,L) := (H,L) + 1;
        INX   H        ; RESTORE(D,E); SAVE(D,E);
        INX   D        ; WHILE NOT A = 0 DO
        DCR   B        ; BEGIN
        JNZ   STKCY   ; MEMORY(H,L) := MEMORY(D,E);
STKCX:  POP   H        ; (H,L) := (H,L) + 1;
        POP   D        ; (D,E) := (D,E) + 1;
        POP   B        ; A := A - 1;

```

Listing 3 continued on page 146

Text continued:

Another peculiar property of PARSE, presuming you haven't figured out how it works yet, is that only one complete INTOKEN scan of the input expression is required because of the use of a stack, Q, for retaining the symbols for intermediate expressions. INTOKEN recognition of parentheses (output codes 1 and 2) effectively controls stacking and popping up symbols for intermediate expressions in the required order.

The operation of PARSE depends critically on the array S. In use, its row subscript is presumed the value of the last INTOKEN output, its column subscript the value of the current INTOKEN output. Specifically, if the last input token was a left parenthesis and the current input token was 'E' (a symbol or constant) then INTOKEN's last and current outputs would be 1 and 4; the matching element in S (row 1 column 4) has value 2, so that the statement CASE2 would be performed. Subsequently, J replaces I and INTOKEN is again invoked to evaluate J anew; a new element of S is fetched using the new values of I and J as subscripts; and the element of the CASE statement list matching the new value taken from S is performed. This process is repeated until INTOKEN sets Endinput true, indicating the end of the input string Exp has been detected. Since the last two tokens might be right parentheses, and PARSE does not in fact process the last token since tokens are used only in pairs, the stack Q is always flushed before PARSE finishes.

PARSE is presented in informal ALGOL only in the hope the process per se of suitably rearranging algebraic form expressions can be made more easily understood than via an equivalent 8080 assembly language program which might prove to be a transliteration nightmare for the novice LSI-11 or PPS-8 programmer. Contrarily, the step by step listing of PARSE and the associated control indices in figure 1 should aid in understanding what PARSE is really doing, with respect to the hypothetical expression. The function of INTOKEN, recognizing and encoding the elements of an expression, is sufficiently straightforward that an explicit statement of it is hardly necessary, but listing 2 is included nonetheless in informal ALGOL. The remaining question, perhaps, is one of making the stack Q of PARSE operable on a microcomputer. To that end, listing 3 shows a hypothetical implementation of single stack control routines STACK, POPUP, and POPSD using 8080 assembler format.



# Everybody's making money selling microcomputers. Somebody's going to make money servicing them.

**New NRI Home Study Course Shows You How to Make Money Servicing, Repairing,  
and Programming Personal and Small Business Computers**

Seems like every time you turn around, somebody comes along with a new computer for home or business use. And they're being gobbled up to handle things like payrolls, billing, inventory, and other jobs for businesses of every size...to perform household functions like budgeting, environmental systems control, indexing recipes, and more.

## **Growing Demand for Computer Technicians... Learn in Your Spare Time**

Even before the microprocessor burst upon the scene, the U.S. Department of Labor forecast over a 100% increase in job openings for the decade through 1985. Most of them *new* jobs created by the expanding world of the computer. NRI can train you at home to service both microcomputers and their big brothers. Train you at your convenience, with clearly written "bite-size" lessons that you do evenings or weekends without quitting your present job.

## **Assemble Your Own Microcomputer**

NRI training includes practical experience. You start with meaningful experiments building and studying circuits on the NRI Discovery Lab® Then you build your own test instruments like a transistorized volt-ohm meter, CMOS digital frequency counter...equipment you learn on, use later in your work.

And you build your own microcomputer, the only one designed for learning. It looks and operates like the finest of its kind, actually does more than many commercial units. But NRI engineers have designed components and planned assembly so it demonstrates important principles, gives you working experience in detecting and correcting problems. It's the



kind of "hands-on" training you need to repair and service units now on the market.

## **Mail Coupon for Free Catalog No Salesman Will Call**

Send today for our 100-page, full-color catalog. It describes NRI's new Microcomputer Technology course in detail, shows all equipment, kits, and lesson plans.

And it also tells about other NRI courses... Complete Communications with 2-meter

transceiver...TV/Audio/Video Systems Servicing with training on the only designed-for-learning 25" diagonal color TV with state-of-the-art computer programming. With more than a million students since 1914, NRI knows how to give you the most in home training for new opportunity. If coupon has been removed, write to NRI Schools, 3939 Wisconsin Ave., Washington, D.C. 20016.

## **RUSH FOR FREE CATALOG**



### **NRI Schools**

McGraw-Hill Continuing  
Education Center  
3939 Wisconsin Avenue  
Washington, D.C. 20016

Please check for one free catalog only.

**NO SALESMAN WILL CALL**



All career courses  
approved under GI Bill.  
 Check for details.

- Computer Electronics Including Microcomputers
- TV/Audio/Video Systems Servicing
- Complete Communications Electronics with CB • FCC Licenses • Aircraft, Mobile, Marine Electronics
- CB Specialists Course
- Amateur Radio • Basic and Advanced

- Digital Electronics • Electronic Technology • Basic Electronics
- Small Engine Repair
- Electrical Appliance Servicing
- Automotive Mechanics
- Auto Air Conditioning
- Air Conditioning, Refrigeration, & Heating Including Solar Technology

Name \_\_\_\_\_ (Please Print) \_\_\_\_\_ Age \_\_\_\_\_

Street \_\_\_\_\_

City/State/Zip \_\_\_\_\_

Accredited by the Accrediting Commission of the National Home Study Council

170-119



Now what? Well, for a start let's observe that PARSE will work only with binary operator expressions. Right? Well, not quite. Note that PARSE passes the buck for recognition. If INTOKEN can recognize unary

Listing 3, continued:

```

STC                                ; END;
CMC                                ; END;
RET                                ; RESTORE(H,L);
STKOF: POP      H                  ;
POPUF: POP      D                  ;
      POP      B                  ;
      POP      PSW                 ;
      STC                                ;
      RET                                ;
;
;
POPSD: PUSH     H                  ; POPSD: IF Stack = 0
      STC                                ; THEN SET(Carry)
      LHL D    STACK              ; ELSE BEGIN
      MOV     A,H                  ; COMMENT Give caller size
      ORA     L                    ; of next entry to pop, for
      JZ     POPZD                 ; buffering as needed
      INX     H                    ; RESET(Carry);
      INX     H                    ; SAVE(H,L);
      CMC                                ; (H,L) := Stack + 2;
      LDAX   H                    ; A := MEMORY(H,L);
      JMP    POPXD                 ; RESTORE(H,L);
POPDZ: SUB      A                  ; END;
POPCD: POP      H                  ;
      RET                                ;
;
;
; The following must be in R/W
; memory, since Stack is the
; list-origin address, and LHLI
; is externally modified to
; effect an indirect LHL D.
;
LHLI:  LHL D    0                  ;
      RET                                ;
STACK: 0                            ;
POPU:  PUSH     PSW                 ; POPUP: IF Stack = 0
      PUSH     B                    ; THEN SET(Carry)
      PUSH     D                    ; ELSE BEGIN
      PUSH     H                    ; COMMENT Target area is
      LHL D    STACK              ; specified by caller H,L;
      XCHG                                ; RESET(Carry);
      POP      H                    ; SAVE(D,E,H,L);
      MOV     A,D                  ; (D,E) := Stack;
      ORA     E                    ; B := MEMORY(D,E + 2);
      JZ     POPUF                 ; SAVE(D,E,H,L);
      PUSH     H                    ; (D,E) := (D,E) + 3;
      PUSH     D                    ; WHILE NOT B = 0 DO
      INX     D                    ; BEGIN
      INX     D                    ; COMMENT Zero-length entries
      LDAX   D                    ; are removed but not copied
      ORA     A                    ; MEMORY(H,L) := MEMORY(D,E);
      JZ     POPCX                 ; (D,E) := (D,E) + 1;
      INX     D                    ; (H,L) := (H,L) + 1;
      MOV     B,A                  ; B := B - 1;
POPCY: LDAX   D                    ; END;
      STAX   H                    ; RESTORE(D,E,H,L);
      INX   H                    ; Stack := MEMORY(D,E);
      INX   D                    ; RBUF(D,E);
      DCR   B                    ; RESTORE(D,E,H,L);
      JNZ   POPCY                 ; END;
POPCX: POP      D                  ;
      XCHG                                ;
      SHLD   LHLI+1                ;
      CALL  LHLI                    ;
      SHLD   STACK                  ;
      LHL D    LHLI+1              ;
      CALL  RBUF                    ;
      POP   H                      ;
      POP   D                      ;
      POP   B                      ;
      POP   PSW                    ;
      STC                                ;
      CMC                                ;
      RET                                ;

```

operators, it can also stuff in a dummy operand on the fly, since PARSE initializes Position, and thereafter leaves it alone. That is, the common unary operators are special cases of a binary and either zeroes or ones: NOT FRED is equivalent to ones exclusive-OR FRED; NEGATIVE VIBES is equivalent to 0 - VIBES; and INVERSE HYPOTHESIS is equivalent to 1/HYPOTHESIS.

How about the results? PARSE can easily be modified to directly generate machine language code if INTOKEN is modified to create or at least have access to a symbol table; or its output can be used, as is, by an interpretive calculator program. Obviously, 8080 machines and, for that matter, most microprocessors lack multiply and divide instructions, but nonnative operations can easily be interpreted as operator subprogram calls. PARSE makes no presumption about the computer on which it's run except the availability of a stack to use with its output referenced by '\$'. The operators, for example, for which PARSE was developed in the form shown were character string operators of combination and proximity. The PARSE output was interpreted by a program for searching large textual files on an IBM System 360 disk unit. The point is that the results are what you make of them, PARSE being no more than a procedure for rearrangement of expressions.

A final apology before getting under way. FORTRAN freaks may by now have noticed an "error" in that although the tokens 1 and H in the example of figure 1 are at the same parenthesis level, the add-1 parse precedes the divide-H in the final step. Why? I prefer to ask why one bothers anyway with operator priorities so long as the desired order of computation can be explicitly specified by using parentheses. The example of figure 1, in fact, was contrived in part to illustrate that PARSE as shown here presumes a strict left to right evaluation at any parentheses level. Operators are not "ranked" as in FORTRAN and several other higher level programming languages.

One More Time

If the available stack mechanism is only once more generalized, to provide multiple stacks simultaneously, some conceptual simplification of a large class of problems occurs. As a near trivial example, we illustrate in listing 4 a 2 stack sorting procedure. In essence, it removes records (strings) from a file one at a time and manipulates the two stacks, Highside and Lowside, back and forth until the new record fits in the inclusive interval of values bounded by the top

# We supply memory.

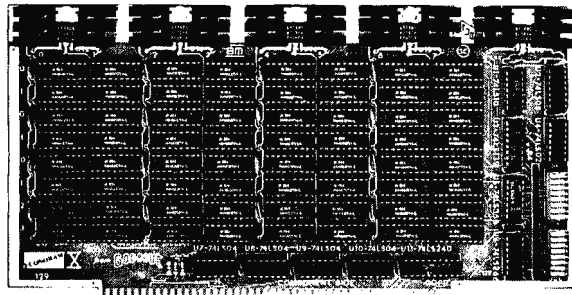

All our Econoram\* memory is fully static, zips along at 4 MHz with the Z-80 or 5 MHz with the 8085, supports a number of popular busses, is available from us through computer stores world-wide, includes a 1 year limited warranty, and comes in three configurations to suit your needs. For lowest cost, choose an "unkit" with sockets and bypass caps pre-soldered in place for an easy, one-evening assembly. When you just can't wait to get going, order our assembled and tested version. For critical systems, specify boards qualified under our **Certified System Component (CSC)** high-reliability program. These boards are extensively tested, burned in for 200 hours, and are immediately replaced in event of failure within 1 year of invoice date. Refer to chart below for pricing.

Name	Buss & Notes	Unkit	Assm	CSC
<b>8K Econoram IIA</b>	S-100	<b>\$149</b>	<b>\$179</b>	<b>\$239</b>
<b>16K Econoram IV</b>	S-100	<b>\$269</b>	<b>\$329</b>	<b>\$429</b>
<b>16K Econoram VIIA-16</b>	S-100	<b>\$279</b>	<b>\$339</b>	<b>\$439</b>
<b>24K Econoram VIIA-24</b>	S-100	<b>\$398</b>	<b>\$485</b>	<b>\$605</b>
<b>16K Econoram IX</b>	Dig Grp	<b>\$319</b>	<b>\$379</b>	n/a
<b>32K Econoram IX</b>	Dig Grp	<b>\$559</b>	<b>\$639</b>	n/a
<b>32K Econoram X</b>	S-100	<b>\$529</b>	<b>\$649</b>	<b>\$789</b>
<b>32K Econoram XI</b>	SBC/BLC	n/a	n/a	<b>\$1050</b>
<b>16K Econoram XII</b>	S-100 (1)	<b>\$329</b>	<b>\$419</b>	<b>\$519</b>
<b>24K Econoram XII</b>	S-100 (1)	<b>\$429</b>	<b>\$539</b>	<b>\$649</b>
<b>32K Econoram XIII</b>	S-100 (2)	<b>\$559</b>	<b>\$699</b>	<b>\$849</b>
<b>16K Econoram XIV</b>	S-100 (3)	<b>\$289</b>	<b>\$349</b>	<b>\$448</b>
<b>16K Econoram XV-16</b>	H8 (4)	<b>\$329</b>	<b>\$395</b>	n/a
<b>32K Econoram XV-32</b>	H8 (4)	<b>\$599</b>	<b>\$729</b>	n/a
<b>16K Memory Expansion</b>	(5)	<b>\$87.20</b>	n/a	n/a
<b>16K x 16 or 32K x 8 Econoram XVI — coming soon!</b>				

#### Notes

- (1) Bank select board — 2 independent banks addressable on 8K boundaries.
- (2) Bank select board — 2 independent banks addressable on 16K boundaries.
- (3) Extended addressing (24 address lines). Single block addressable on 4K boundaries.
- (4) Bank select option for implementing memory systems greater than 64K.
- (5) Chip set expands memory in Radio Shack-80, Apple, and Exidy Sorcerer machines.

\*Econoram is a trademark of Godbout Electronics.

**Coming soon: 4 MHz Z-80 CPU board, 5 MHz 8085 CPU board, and the Spectrum Color Graphics Board.**

## NEW!

### The Godbout Box!

By the time you read this, we will be shipping our industrial-grade enclosure. It's perfectly suited to creating a powerful system based on our line of S-100 boards (or anyone else's, if you're so inclined). It's rack mount or desk mount (with sliders for pulling it out of the rack if desired), neat-looking, heavy duty, and comes with the back panel pre-punched to accept a variety of connectors. Oh yes, and let's not forget the power supply for powering all your boards; it comes with the box, too. See your computer store for details, or write us direct.

### Active Terminator Board \$34.50 kit

Plugs into any S-100 motherboard (although ours don't need it) to reduce ringing, noise, crosstalk, and other buss-related problems. Here is an upgrade that is simple and effective.

# We supply the S-100 revival.

**Why S-100?** Because S-100 machines are not consumer-oriented toys — but flexible, modular, professional-level systems that are easy to upgrade, modify, and adapt to specific applications. As a result, over the years the S-100 buss has proven to be the ideal choice for commercial, industrial, and scientific applications. It doesn't obsolete itself, but simply adapts to innovation.

We use the experience we've acquired in the past, along with the very best technology offered by the present, to build products for the future... products that meet, and often exceed, the demands of the new wave of professional S-100 users. Our expanded S-100 line is the right approach at the right time; we invite you to write for further information.

## NEW!

### HIGH-PERFORMANCE S-100 MOTHERBOARDS

**19 slot: \$174 unkit\*, \$214 assm**

**12 slot: \$129 unkit\*, \$169 assm**

**6 slot: \$ 89 unkit\*, \$129 assm**

\*Edge connectors and termination resistors are pre-soldered in place for assembly.

These 3rd generation motherboards, designed to work with the latest 5 and 10 MHz CPUs coming on line, exceed the latest S-100 specs and offer superior performance. Includes true active termination (with half of the termination load at each end of every buss line), grounded Faraday shield between all buss signal lines to minimize crosstalk, and edge connectors included for all slots. All sizes fit Godbout, Vector, TEI, IMSAI, and similar enclosures.

These high quality motherboards are a welcome addition to any system — or the start of a great one.

## NEW!

### 3P + S "Interfacer II" S-100 I/O board

**\$189 unkit, \$249 assm, \$324 CSC**

Incorporates 1 channel of serial I/O (with all the features of a port from the 2S "Interfacer"), along with 3 full duplex parallel ports. The parallel section uses LSTTL octal latches for latched input and output data with 24 mA drive current, attention/enable/ and strobe bits for each parallel port (with selectable polarity), interrupts for each input port, and separate 25 pin connectors with power for each channel along with a status port for interrupt mask and port status. All in all, this is an incredibly versatile and flexible board.

## NEW!

### Memory Management S-100 board

**\$59 kit, \$85 assm, \$100 CSC**

Now you can add bank select and extended addressing to older S-100 machines like the Altair, IMSAI, Sol, Polymorphic, etc. Either use this board with our new extended addressing boards, or retrofit our high density Econorams (the ones with phantom or extra qualifier lines) for use with the Memory Management Board to get up to 1/2 a megabyte of memory space for your computer.

### 2S "Interfacer" S-100 I/O board

**\$189 unkit, \$249 assm, \$324 CSC**

Dual serial port with 2 full duplex parallel ports for RS-232 handshake; EIA232C line drivers and receivers (1488, 1489) along with current loop (20 mA) and TTL signals on both ports. On-board crystal controlled timebase with independently selectable Baud rate generators for each port (up to 19.2 Kbaud). Hardware UARTs don't tie up the CPU. And, there's much more... this is a no-excuses serial board that does things the others only dream about.

### 2708 S-100 EROM board \$85 unkit

4 independently addressable 4K blocks, with dipswitch selectable jump start built right into the board. Includes all support chips and manual, but does not include EROMs.

**TERMS:** Cal res add tax. Allow 5% for shipping, excess refunded. VISA®/Mastercharge® call our 24 hour order desk at (415) 562-0636. COD OK with street address for UPS. Prices good through cover month of magazine.

**CompuPro™**

Bldg. 725, Oakland Airport, CA 94614

from

**GODBOUT**  
ELECTRONICS

**FREE CATALOG:** Send us your name and address... we'll take care of the rest. In return, you'll get pages and pages of technical information, pricing, specials, kits, and lots more. Include 4¢ in stamps for 1st class delivery.



Listing 4: A SORT procedure expressed in informal ALGOL type notation demonstrates use of two stacks.

```

STRING ARRAY PROCEDURE SORT(File);
STRING ARRAY File;
BEGIN
  INTEGER          K;
  STRING           This;
  STACK Highside, Lowside;
  Lowside := File (1);
  Highside := File (2);
  COMMENT top function references item
  on the top of some stack;
  IF TOP(Lowside) > TOP(Highside)
  THEN BEGIN
    This := Highside;
    Highside := Lowside;
    Lowside := This;
  END;
  COMMENT size function produces the
  current number of elements in array;
  K := 3;
  WHILE K ≤ SIZE(File) DO
  BEGIN
    This := File(K);
    K := K + 1;
    WHILE This < TOP(Lowside) DO Highside := Lowside;
    WHILE This > TOP(Highside) DO Lowside := Highside;
    Highside := This;
  END;
  WHILE NOT(Lowside = empty) DO Highside := Lowside;
  K := 1;
  WHILE K ≤ SIZE(File) DO
  BEGIN
    SORT(K) := Highside;
    K := K + 1;
  END;
END.

```

elements of the two stacks. The procedure has two virtues:

- It's easy to describe and understand.
- It requires an absolute minimum of workspace.

The price one pays is speed. It's probably one of the two or three slowest sorting algorithms around. ■

The program examples which appear in this article are written in an informal ALGOL type notation. The basic unit of ALGOL is the statement. It can be either a simple statement such as:

```
Position := 0;
```

which is read "position is evaluated as 0," or a compound statement defined by BEGIN . . . END such as:

```

BEGIN
  Q := PARSE; PARSE := null;
END

```

which is read "Q is evaluated parse, PARSE is evaluated null."

The statements defined between the BEGIN and END statements are not restricted to type. A preceding conditional such as (IF . . . THEN . . . ELSE) will affect the entire command statement. One of the constituents of the statement may well be another compound statement. For example, to add an array of samples having subscripts 1 through Limit which is specified elsewhere we could write:

```

BEGIN
  Subscript := 1; Sum := 0;
  WHILE Subscript < Limit DO
  BEGIN
    Sum := Sum + Sample(Subscript);
    Subscript := Subscript + 1;
  END;
END;

```

The WHILE statement's operand (the statements after the DO) rather intuitively is in execution so long as the conditional part (Subscript < Limit) is true.

The CASE statement is simpler in effect. It acts approximately like an indexed jump. It has two operands. The first of these (T in the PARSE procedure) is an integer, and the second is a list of statements bracketed by BEGIN and END. The first operand selects for execution the statement from the list whose position matches the value of the index specifier.

Following are the informal extensions that have been made to ALGOL and used in the programs:

- The period indicates concatenation of character strings. Presuming values of 'WHAT' and 'STUFF' for symbols A and B, A . B will have a value of 'WHATSTUFF.'
- Q is declared to be of type STACK which, however implicit in most implementations of ALGOL-60, was not construed to be explicitly available. It is, in effect, a LIFO indexed character string array.
- Null and empty are used for assigning values, respectively, of a character string of length zero and a stack having zero entries.

## Stocking genuine DEC computer spares

...

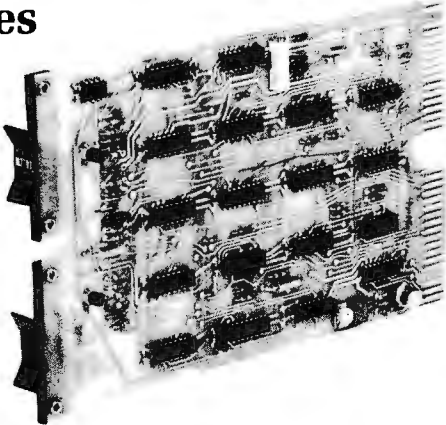

call

**Radgo.** Radgo is stocked and staffed to help you with your requirements for most general purpose K&M series and many computer spare modules manufactured by Digital Equipment Corporation — at factory prices. We also stock a large assortment of COMPUTER SUPPLIES.

Call today:  
(513) 752-6880.  
Outside Ohio:  
(800) 543-1986

**radgo**

3988 McMann  
Cincinnati, Ohio 45245

# ComputerLand®

## Introducing the Personal Computing Shopping Centers



### Off-The-Shelf Software

In the past few years, many fine personal computers have been available, but not much software to use with them. ComputerLand has now taken the lead to make personal computing software available to everyone with Soft Spot™, an exclusive, custom-designed, self-merchandising fixture. You can select off-the-shelf programs for personal use in finance, time-budgeting, education, sophisticated games, stock portfolio evaluation and much, much more.

Soft Spot™ will assist you in quickly selecting the educational, recreational, and practical software you want, starting at \$7.95 from major suppliers like Apple Computer, Inc., Personal Software, Program Design, Inc., Commodore, Powersoft, Softape, and others. Stop in today at ComputerLand's Soft Spot™, and choose from a wide variety of the finest software available.

### A Storehouse of Knowledge

Main Brain™ is your one-stop center for books, self-study courses and other educational media on personal computing. Self-study cassettes, video tape courses, "in-person" lecture programs and more is available to you from well-known publishers such as Sybex, Osborne and Associates, and Hayden.

Main Brain™ has self-service instructions to assist you in choosing from a variety of desired multi-media products from "introductory" through "hands-on" to "in-depth" levels. It's all available to you at ComputerLand's Main Brain™, your one-stop center for educational media on personal computing.

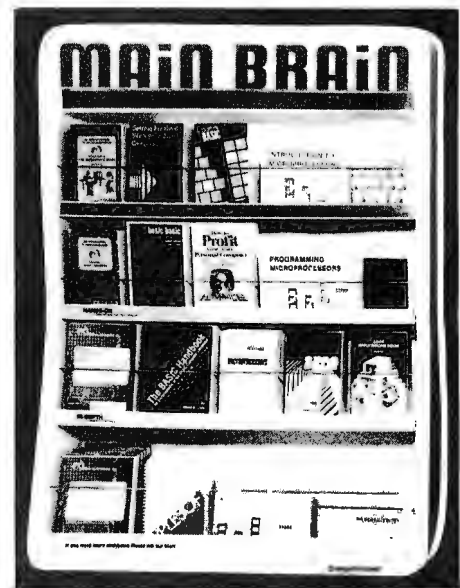

### Available at all participating ComputerLand stores . . . . .

- |                       |                      |                       |                    |                        |                      |                      |
|-----------------------|----------------------|-----------------------|--------------------|------------------------|----------------------|----------------------|
| Huntsville, AL        | San Jose, CA         | Tampa, FL             | Bloomington, MN    | Portland, OR           | Federal Way, WA      | Burlington, Canada   |
| Phoenix, AZ           | San Rafael, CA       | Atlanta, GA           | Hopkins, MN        | Harrisburg, PA         | Tacoma, WA           | Calgary, Canada      |
| Little Rock, AR       | Santa Maria, CA      | Honolulu, HI          | Independence, MO   | Lehigh Valley, PA      | Madison, WI          | Toronto, Canada      |
| Belmont, CA           | Santa Rosa, CA       | Arlington Heights, IL | Springfield, MO    | Paoli, PA              | Milwaukee, WI        | Winnipeg, Canada     |
| Dublin, CA            | Thousand Oaks, CA    | Downers Grove, IL     | St. Louis, MO      | Austin, TX             | INTERNATIONAL        | Copenhagen, Denmark  |
| El Cerrito, CA        | Tustin, CA           | Mundelein, IL         | Omaha, NE          | Dallas, TX             | Adelaide, Australia  | Paris, France        |
| Hayward, CA           | Walnut Creek, CA     | Niles, IL             | Nashua, NH         | South West Houston, TX | Brisbane, Australia  | Manila, Philippines  |
| Lawndale, CA          | Colorado Springs, CO | Oak Lawn, IL          | Cherry Hill, NJ    | Houston Bay Area, TX   | Melbourne, Australia | Singapore            |
| Los Altos, CA         | Denver, CO           | Peoria, IL            | Bergen County, NJ  | Salt Lake City, UT     | Perth, Australia     | Stockholm, Sweden    |
| Los Angeles, CA       | North Denver, CO     | Indianapolis, IN      | Morristown, NJ     | Tyson's Corners, VA    | Sydney, Australia    | and other            |
| Pasadena, CA          | Fairfield, CT        | Overland Park, KS     | Buffalo, NY        | Bellevue, WA           | Brussels, Belgium    | locations worldwide. |
| Sacramento, CA        | Hartford, CT         | Louisville, KY        | Ithaca, NY         |                        |                      |                      |
| Saddleback Valley, CA | Newark, DE           | Boston, MA            | Nassau County, NY  |                        |                      |                      |
| San Bernardino, CA    | Boca Raton, FL       | Rockville, MD         | Charlotte, NC      |                        |                      |                      |
| San Diego, CA         | Ft. Lauderdale, FL   | Grand Rapids, MI      | Cleveland East, OH |                        |                      |                      |
| San Diego East, CA    | Jacksonville, FL     | Rochester, MI         | Cleveland West, OH |                        |                      |                      |
| San Francisco, CA     | Miami, FL            | Southfield, MI        | Columbus, OH       |                        |                      |                      |
|                       |                      |                       | Oklahoma City, OK  |                        |                      |                      |

Product availability may vary by regional location

**ComputerLand®**  
WE KNOW SMALL COMPUTERS

14400 Catalina St., San Leandro, CA (415) 895-9363

NEECO PROUDLY  
ANNOUNCES THE  
COMPUTHINK

# MINIMAX

"FULLY INTEGRATED COMPUTER SYSTEM"



MINIMAX SERIES COMPUTER



PRINTER NOT  
INCLUDED IN PRICE

**THE MINIMAX SERIES WAS DESIGNED  
TO OFFER THE MARKET MINICOMPUTER  
CAPABILITIES AT MICROCOMPUTER PRICES.  
COMPARE THE CAPABILITIES & PRICE!**

**CONTACT NEECO FOR FULL SPECS - FREE MINIMAX MANUAL.**

## MEET THE MINIMAX COMPUTER



MINIMAX I - \$4495

MINIMAX I - .8 MEGABYTE  
ON LINE MINIFLOPPY STORAGE

MINIMAX II - \$5995

MINIMAX II - 2.4 MEGABYTE  
ON LINE 8" FLOPPY STORAGE

THE MINIMAX WAS DESIGNED AND IS MANUFACTURED BY COMPUTHINK  
COMPUTER CORP. DISTRIBUTED IN EUROPE AND THE EASTERN U.S. BY NEECO.

THE MINIMAX SERIES COMPUTER WAS DESIGNED BY INDUSTRY PROFESSIONALS.  
COMPARE THE PRICE AND FEATURES TO ANY OTHER COMPUTER IN ITS CLASS!

- THE MINIMAX SERIES COMPUTER IS AN INTEGRATED, COMPACT UNIT CONTAINING THE CPU, DUAL DENSITY DISK STORAGE, 12 INCH CRT, AND FULL STYLE KEYBOARD, WITH SEPARATE NUMERIC ENTRY PAD. ALL KEYS (INCLUDING CURSOR) WITH FULL REPEAT. • HYBRID 2 MEGAHERTZ 6502 CPU • 108K SYSTEM RAM (48K USER) • FASTEST FLOPPY DISK ACCESS (24K LOADS IN 4.2 SECONDS) • 16K ROM CONTAINS COMPUTHINK BASIC (AN EXTENDED MICROSOFT BASIC) WITH EXTENDED PRECISION, DOS INCLUDES COMPLETE FILE I/O WITH FULL RANDOM ACCESS, COMPLETE MONITOR WITH DEBUG & TRACE, AND TINY 6502 ASSEMBLER. • COMPLETE HIGH RESOLUTION GRAPHICS WITH INDIVIDUAL DOT (240x512) POINT SCREEN ADDRESSABILITY. • FULL SCREEN TEXT EDITING WITH OVERWRITE, INSERTION OR DELETION. • SPLIT SCREEN/WINDOW MODES. • INDIVIDUAL FIELD EDITING WITH FIELD PROTECT AND AUTO SKIP TO NEXT FIELD. • DISK STORAGE SYSTEM TRANSFERS 6K PER SECOND WITH AUTO VERIFY AND PARITY CHECK. • 12 INCH CRT-64 CHARACTERS BY 30 LINES. UP TO THREE PROGRAMMABLE CHARACTER FONTS FOR LANGUAGES OR SPECIAL CHARACTERS. • SWITCHABLE 110 OR 220V OPERATION. • • • • HYBRID CPU IS MICROPROGRAMMABLE WITH 64 USER DEFINABLE OPCODES. CHOICE OF 800K OR 2.4 MEGABYTE DISK STORAGE. • FULL SERIAL RS-232C PORT WITH PROGRAMMABLE BAUD RATES AND MODEM CONTROL SIGNAL. • DEDICATED DISK PORT. • PRINTER PORT SUPPORTS PARALLEL COMMERCIAL PRINTERS. • 24 PIN I/O USER PORT. • PAGEMATE DATABASE AVAILABLE. • PLM COMPILER AVAILABLE. • BUSINESS PACKAGES AVAILABLE. • COMPLETE DIAGNOSTICS & SCHEMATICS INCLUDED. • COMPLETE USER MANUAL INCLUDED.

## COMPUTHINK .4 & .8 MEGABYTE DISK DRIVES FOR THE NEW 16/32K PETS!

DISK SYSTEMS INCLUDE DISKMON OPERATING  
SYSTEM IN ROM AND INTERFACE TO 16/32 PETS!



FOR 8K PETS  
(small keyboards)  
.4 Megabytes of Disk  
Storage for 8K PETS!  
(Requires Expandamem)  
400K-8S DISK SYSTEM INCLUDES RANDOM  
ACCESS IN DOS-LOADS 20K IN 4 SECONDS!  
24K Expandamem Memory \*1295  
32K Expandamem Memory \*615

**\$1295**

- Dual Minifloppy Drives with 200K per diskette side for total 400K/800K on line
- 800K model accesses all 4 diskette sides via dual read and write arm system
- Dual Density Hardware and DOS loads 20K (with verification) in 4.2 seconds complete
- DISKMON (DOS) adds 17 commands to BASIC including Random Access and printer support
- System comes complete with plug in internal board containing 8K RAM, DOS, and Disk Controller Hardware—Board plugs directly onto internal memory expansion pins
- System does not utilize IEEE or USER Port, system functions directly from memory port
- All DISKMON DOS commands reside interactively with BASIC—disk directory command and format command do not interfere with program in RAM—DOS command were designed for simplicity of use. System was manufactured for heavy commercial use
- System installs completely in less than ten minutes—immediately ready for use
- \*1295 and \*1595 prices include all hardware, DOS complete user manual, and demo utility diskette
- Available software includes PLM Compiler (\*250) Retocatable Assembler (\*170), Source-Editor Program (\*170), Autolink Linking Loader (\*170) and a complete Database system (Pagemate \*495)
- Call or write for complete product information and specifications—User manual \*10

(PRODUCT AVAILABILITY IS AUG/SEPT—CALL FOR INFO)

ALL 16/32K MODELS INCLUDE AN	400K-16N . . . . .	*1295
INTERNAL PLUG-IN INTERFACE	400K-32N . . . . .	*1295
BOARD CONTAINING DOS, 8K OF	800K-16N . . . . .	*1595
RAM, AND CONTROLLER	800K-32N . . . . .	*1595



**NEECO**

Microcomputer Systems Division

NEW ENGLAND ELECTRONICS CO., INC.  
679 HIGHLAND AVE., NEEDHAM, MA 02194  
MON-FRI, 9:00-5:30, E.S.T.

**(617) 449-1760**





# NEECO

Microcomputer Systems Division

## PROUDLY ANNOUNCES THE NEWEST HARDWARE AND SOFTWARE FOR YOUR PET!

The PET is now a truly sophisticated  
Business System with the announcement  
of these peripherals and software packages.



PRODUCT	DESCRIPTION	PRICE	AVAILABILITY
PET 2001—8KN (Large Keys)	8K RAM	\$ 795	DEC/JAN
PET 2001—8K	8K RAM	\$ 795	IMMEDIATE
PET 2001—16KN (Large Keys)	16K RAM*	\$ 995	IMMEDIATE
PET 2001—32KN (Large Keys)	32K RAM	\$1295	IMMEDIATE
PET 2023 PRINTER	ROLL FEED	\$ 850	IMMEDIATE
PET 2022 PRINTER	TRACTOR/ROLL	\$ 995	IMMEDIATE
ROMRETRO KIT	UPDATED O/S	\$ 90	IMMEDIATE
PET 2040	DUAL FLOPPY*	\$1295	IMMEDIATE
PET C2N	2nd Cassette	\$ 100	IMMEDIATE

\*The 16K/32K (large keyboard) units do not include a cassette drive. Order C2N Cassette. 2040 Floppy Drive requires a 16K or 32K unit. 8K RAM Retrofit available July.

ALL PETS ARE FULLY TESTED BY NEECO BEFORE SHIPMENT. NEECO IS A FULL CUSTOMER-ORIENTED BUSINESS. CALL FOR OUR FREE CATALOG. SEND US A COPY OF THIS AD WITH AN ORDER AND WE WILL WARRANTEE YOUR COMMODORE PET FOR ONE FULL YEAR!

## PET-DISK BASED BUSINESS SOFTWARE

SOFTWARE/APPLICATION	REQUIRES	AUTHOR	AVAILABILITY	PRICE
WORDPRO II / WORD PROCESSING	2040 + 16K PET	PRO/MICRO	IMMEDIATE	\$100
WORDPRO III / WORD PROCESSING	2040 + 32K PET	PRO/MICRO	DECEMBER	\$200
GENERAL LEDGER	2040 + 32K PET	CMS SOFTWARE	IMMEDIATE	\$295*
ACCOUNTS PAYABLE	2040 + 32K PET	CMS SOFTWARE	DECEMBER	\$295*
ACCOUNTS RECEIVABLE	2040 + 32K PET	CMS SOFTWARE	DECEMBER	\$295*
MAILING LIST	2040 + 32K PET	CMS SOFTWARE	IMMEDIATE	\$100
NEECOLEDGER	COMPUTHINK .4 M DRIVE + 32K PET	NEECO	IMMEDIATE	\$795
NEECOMAILER	COMPUTHINK .4 M DRIVE + 32K PET	NEECO	IMMEDIATE	\$150

\*The CMS Software (G/L, A/R, A/P) are based on Osborne & Associates trial tested business basic software. Software is complete with full documentation and user instructions. All packages require a printer for output. Commodore recommends the NEC Spinwriter (available from NEECO) as the output printer for WORDPRO.

DEALER INQUIRIES INVITED ON SOFTWARE & NEC (PET) SPINWRITER

## FOR WORD PROCESSING NEC IS BEST!

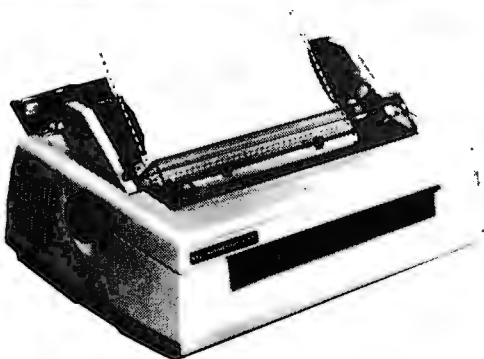

THE NEC SPINWRITER  
MODEL 5530-P (Centronics I/O  
modified for PET)

- \* 55 characters per second output speed
- \* Changeable thimble for different typstyles
- \* Less than 1% warranty malfunction rate
- \* IBM quality letter output
- \* Dealer inquiries invited

# \$2995

\*Price includes IEEE interface to PET. IEEE Port is available for use with 2040 Dual Disk.

\*The NEC 5530-P is the output printer recommended by Commodore for their Word Processing System.



# NEECO

Microcomputer Systems Division

NEW ENGLAND ELECTRONICS CO., INC.  
679 HIGHLAND AVE., NEEDHAM, MASS. 02194  
SHOWROOM HRS.: MON. - FRI. 9:30 - 5:30. EST.

## (617) 449-1760

MASTERCHARGE OR VISA ACCEPTED  
TELEX NUMBER 951021, NEECO

# Writing Animated Computer Games

---

Tony Estep  
Vice President  
Kidder, Peabody and Company Inc  
10 Hanover Sq  
New York NY 10005

---

**Listing 1:** 8080 assembly-language program to create an animated computer game.

```

0100          0005 *GALLOON*
0100          0010 * A PROGRAM ILLUSTRATING SOME PRINCIPLES OF
0100          0015 * PROGRAMMING AN ANIMATED GAME
0100          0020 *
0100          0025 * COPYRIGHT 1979 TONY ESTEP
0100          0030 *
0100          0035 VMBAS EQU    00C00H
0100          0040 MIDL EQU    0CE1EH ;ALL THESE RELATE TO THE SOL/20 &
0100          0045 CLSCN EQU    0C0D5H ;ITS VEM AND SCREEN CLEAR ROUTINE
0100          0047 SCBOT EQU    0CF00H ;MIDDLE OF LOWEST LINE
0100          0050 RAR EQU    93H ;THESE ARE ARROWS ON KEYBOARD
0100          0055 LAR EQU    81H
0100          0060 UAR EQU    97H
0100          0065 DAR EQU    9AH
0100          0070          ORG    100H ;SO IT WILL RUN WITH CPM
0100 31 0C 06          0075          LXI    SP,STACK+46
0100 0D D5 C0          0080          CALL   CLSCN ;FOR NON-SOL, WRITE SIMPLE ROUTINE TO CLEAR
0100 21 00 CC          0085          LXI    H,VMBAS
0100 36 20          0090          MVI    M,' '
0100 0B 79 02          0095 BEGIN CALL   WAIT
0100 0E AF          0100 GO          XRA    A ;INITIALIZE FLAGS
0100 32 A3 03          0105          STA    C1
0100 32 9E 03          0110          STA    FLG1
0100 32 88 04          0115          STA    NSCR
0100 32 89 04          0120          STA    PSCR
0100 3E 01          0125          MVI    A,1
0100 32 47 04          0130          STA    BFLG1
0100 32 30 05          0135          STA    RAFL
0100 32 EA 04          0140          STA    STRIF
0100 CD D5 C0          0145          CALL   CLSCN
0100 21 00 CC          0150          LXI    H,VMBAS
0100 36 20          0155          MVI    M,' '
0100 21 1E CE          0160          LXI    H,MIDL
0100 22 F6 02          0165          SHLD  CORNR
0100 CD 89 01          0170          CALL   SHIP
0100 CD 6A 02          0175          CALL   DELAY
0100 CD 6A 02          0180          CALL   DELAY
0100 CD 6A 02          0185          CALL   DELAY
0100 CD 6A 02          0190          CALL   DELAY
0100 CD 6A 02          0195          CALL   DELAY
0100 CD 6A 02          0200          CALL   DELAY
0100 CD 6A 02          0205          CALL   DELAY
0100 014C          0210 *****
0100 014C          0215 *MAIN LOOP STARTS HERE
0100 CD C1 01          0220 RUNIT CALL   TAKOF ;PUT BLANKS IN SHIP IMAGE
0100 CD 89 01          0225          CALL   SHIP ;PUT IT ON SCREEN

```

Listing 1 continued on page 154

Text continued on page 158

# MUFS FOR EVERYONE (ESPECIALLY DEALERS)

## MULTIPLE FLOPPY SYSTEM

MUFS is a prom resident supervisor for the Vector Graphic System B which allows menu selection of all the following operating and disk system configurations\* without changing a single board on the system, or plugging in and unplugging peripherals.

Disk Drive Configuration	Disk Size	Disk Controller	Disk Density	Drive Assignment	Operating System
Persci 277	8"	Micromation	Single/Double	A, B	CP/M
Shurgart SA450	5 1/4"	Northstar	Single/Double	C, D	CP/M
Persci 277	8"	Micromation	Single/Double	A, B	CP/M
Micropolis MODII	5 1/4"	Micropolis	Quad	C, D	CP/M
Persci 277	8"	Micromation	Single/Double	A, B	CP/M
Shugart SA450	5 1/4"	North Star	Single/Double	A, B	CP/M
Micropolis MODII	5 1/4"	Micropolis	Quad	A, B	CP/M
Micropolis MODII	5 1/4"	Micropolis	Quad	0, 1	MDOS
Micropolis MODII	5 1/4"	Micropolis	Quad	1, 2	MZOS
Micropolis MODII	5 1/4"	Micropolis	Quad	A, B	OASIS
Shugart SA450	5 1/4"	North Star	Single/Double	1, 2	DOS
Persci 277	8"	Alpha Micro*	Single	1, 2	AMOS*

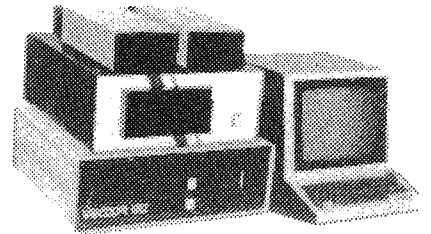

Those configurations using two types of drives permit file copy from one type to another with the facilities of 'PIP'. MUFS includes Vector Graphics complete System B, all the above mentioned disks/controllers with operating systems fully configured and operational on the System B. OASIS, AMOS and the ALPHA MICRO CPU/Disk Controller are extra. MUFS also includes UNIVID (Universal Video, which allows the mindless terminal which comes with the System B to emulate the Hazeltine 1500 and Adam-3A). Additionally, MUFS also includes the communications software (IC) described below (IC is available separately). With MUFS, computer/software dealers can develop/copy/demo most all of their software on a single system with the snap of a disk drive door! Since MUFS supports multiple terminals, the 'Mime' terminal is available as an option. If purchased, this allows MUFS to run software designed specifically for either memory mapped or serial I/O (most software works on either).

### IC FOR CP/M\*\* INTERSYSTEM COMMUNICATIONS

- Communicates with other computers through a user selected RS232-C Port
- Transmits ASCII Data to/from all computers (Maxi, Mini, Micro, Time Sharing and Single User). Transmits ASCII and Binary Data between CP/M Systems.
- Supports multiple terminals and printers which can be local or remote, and can be logged on and off the system.
- Supports 9600 Baud to printers with the X-on/X-off feature
- Permits an IC installed computer to function both as a computer, and as a terminal or systems console to other computers, with software switching between the two modes.
- Permits dealers to operate customers computers remotely, patching software, sending new software, testing the customer's computer, etc.
- When sending data, IC is programmed to automatically wait for the receiving computer if it cannot keep up with a steady Baud rate.
- Thoroughly tested with 7 different computer systems, full and half duplex.
- Software available on diskette only, or diskette/prom (prom version boots faster)
- Does not require an interrupt capability

### DOC FOR NORTH STAR OPTIMIZATION

- #### DOCUMENTATION
- Prints formatted program listings with user selected spacing, titling, dating, and paging
  - Prints an alphabetized cross reference listing of all variables with an ordered list of the line numbers they are used in.
  - For all lines which are the destination of a 'GOTO' type statement prints a list of all line numbers containing a reference to the selected destination line.

- Optimizes speed of execution primarily through reduction in execution time of 'GOTO' type statements. This results from a reduction in the number of statements through statement concatenation.
- Optimizes program size through removal of all unnecessary blanks. Optionally removes REM statements. Saves 3 BYTES for every short statement concatenated into a longer statement.

- #### CONFIDENTIALITY
- Protects the confidentiality of your programs by inhibiting the North Star list and edit functions once a program has been optimized by DOC. Offers virtually as much protection as compiler basics.

#### PRICES:

MUFS \$9,500.00 OASIS OPTION - \$500.00  
 IC DISKETTE VERSION \$150.00  
 DOC \$59.00

MIMETERMINAL OPTION \$825.00

ALPHA MICRO CP/U AND DISK CONTROLLER OPTION - \$2,190.00  
 DISKETTE/PROM VERSION \$200.00  
 MANUALS AVAILABLE SEPARATELY FOR \$10.00 EA.  
 DEALER QUANTITY DISCOUNTS AVAILABLE FOR IC/DOC

SEND ORDERS AND INQUIRES TO:

MINI BUSINESS SYSTEMS • 2461 S. Main • P.O. Box 15587 • Salt Lake City, Utah 84115 • PH (801) 467-1571

\*Amos is not menu selectable, and does require removal and insertion of some board's in the S-100 Bus

\*\*CP/M is a trademark of Digital Research



Listing 1 continued:

```

0152 2A F2 02      0230      LLD  IR
0153  E5           0235      PUSH R
0154 2A F4 02      0240      LLD  UD
0155  E5           0245      PUSH R
0156 2A F5 02      0250      LLD  QUERR
015D C1           0255      POP  R
015E 09           0260      LLD  B
015F D1           0265      POP  R
0160 19           0270      DAD  D
0161 22 F6 02      0275      SHL  CORR ;NEW LOCATION FOR SHIP
0164 CB AC 01      0280      CALL MOVE ;NEW GRAPH IN SHIP IMAGE
0167 CD B5 01      0285      CALL SHIP ; PUT I. OF SCREEN
016A CD B6 01      0290      CALL KYCRK ;CHECK KEYBOARD
016B CD B5 02      0295      CALL LOPB ;CHECK TO SEE IF WE'RE AT TOP OR BOTTOM OF SCR.
0170 CD 55 02      0300      CALL BRKRS ;IS A BRACKET DROPPING?
0173 CD 6A 02      0305      CALL DELAY
0176 CD 00 03      0310      CALL PVAL
0179 CD C9 03      0315      CALL BRACKR ;IS THERE A BRACKET ON SCREEN?
017C CD 36 05      0320      CALL PRDFP ;WAS IT OFF WAYBE
017F AF           0325      XRA  A
0180 32 B7 04      0330      STA  STKTF
0183 CD 8A 04      0335      SCRRY CALL SCORE ;UPDATE SCORE
0186 C3 4C 01      0340      JIP  RUNIT
0189                                     0345      *****
0189 2A F6 02      0350      SHIP LLD  CORR ;MOVES REFLECT IMAGE OF SHIP
018C CD 48 04      0355      CALL HTP ; ONO SCREEN
018F 3A FA 02      0360      LDW  LEND
0192 77           0365      RMW  B,A
0193 23           0370      INX  R
0194 CD 48 04      0375      CALL HTP
0197 3A F5 02      0380      LDW  BLK
019A 77           0385      RMW  B,A
019B 23           0390      INX  R
019C CD 48 04      0395      CALL HTP
019F 3A FE 02      0400      LDW  WILT
01A2 77           0405      RMW  B,A
01A3 23           0410      INX  R
01A4 CD 46 04      0415      CALL HTP
01A7 3A FE 02      0420      LDW  REWD
01AA 77           0425      RMW  B,A
01AD C9           0430      RET
01AC 3E 10      0435      MOVW  W1 A,10H ;THE GRAPHICS SWITCH WAKE UP THE SHIP
01AE 32 F8 02      0440      STA  WILT ;ARE MADE INTO A PICTURE IN MEMORY
01B1 3E 90      0445      W1  A,90H
01B3 32 F5 02      0450      STA  BLK
01B6 3E 3C      0455      W1  A,3CH
01B8 32 FA 02      0460      STA  LEND
01B9 3E 3E      0465      W1  A,3EH
01BD 32 FB 02      0470      STA  REWD
01C0 C9           0475      RET
01C1 3E 20      0480      MOVW  W1 A,' ' ;REPLACES SHIP GRAPHICS WITH BLANKS
01C3 32 F8 02      0485      STA  WILT ;SO THAT 'SHIP' ROUTINE WILL BLANK
01C6 32 F9 02      0490      STA  BLK ;OUT PICTURE OF SHIP
01C9 32 F4 02      0495      STA  LEND
01CC 32 FB 02      0500      STA  REWD
01CF C9           0505      RET
01D0 DB FA      0510      STATUS IN  OFWJ ;THESE INPUT ROUTINES ARE FOR SOL
01D2 2F           0515      CWA
01D3 B6 01      0520      ANI  1

```

Listing 1 continued on page 156

## WILD & CRAZY ASSEMBLY PROGRAMMERS

The number 2 manufacturer of stand alone POS terminals needs experienced assembly programmers to help introduce 14 new software based products in 1979. Challenging assignments currently exist at all levels including applications, diagnostics and systems software development. Great benefits including yearly vacation to Europe. Starting salary 16-30K. Please call or write Dave Adams, (617) 246-2815. N.E. Recruiters, 6 Lakeside Office Park, Wakefield, MA 01880.

Collect calls accepted. Strict confidence assured. All fees, relocation and interviewing expenses assumed by company.

Circle 289 on inquiry card.

## •• CRT INTERFACES •• black • white/color

Monitors \* Combination Revt/monitor sets  
\* Modulator kits \* B-W Cameras \* Color  
Cameras \* Audio Subcarrier kits \* Parts

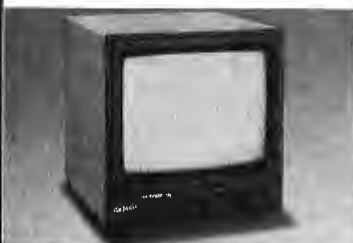

WRITE or PHONE for DETAILS & PRICING.

DIAL: 402-987-3711

Dealers welcomed. Well established program.

13-B Broadway **ATV Research** Dakota City, NE. 68731

Circle 19 on inquiry card.

## AIRCRAFT SIMULATOR FOR APPLE II

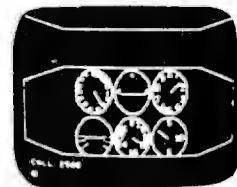

### PROGRAMMERS SOFTWARE EXCHANGE

Three versions on cassette for \$19.95

1. Presents the pilot with a flying situation which must be successfully completed to avoid a crash.
2. Presents a simulated instrument panel during an IFR flight for prolonged practice.
3. Provides machine code for building flight problems and displaying them on the screen.

Satisfaction guaranteed!

P. S. E. (501) 843-6037  
P.O. BOX 199  
CABOT, ARKANSAS 72023

Circle 334 on Inquiry card.



# Tomorrow's tools. For today's problems.

You might say we make time machines. CSC's smarter tools for testing and design help you make the most of your time in every corner of electronics, by working *smarter* instead of harder, for far less than you'd expect.

We give your head a head start with a variety of solderless breadboarding systems that let you translate ideas directly into working circuits, as fast as you can think.

We offer the most logical way to test logic—The Logical Force™—portable, circuit-powered digital instruments that dramatically cut the time (and cost) of diagnosing state-oriented logic. Available singly or in Logical Analysis Test Kits. The Logical Force

simplifies design, maintenance, field service, education . . . wherever you need logical answers at a logical price.

Also instrumental in making life easier are CSC's value-packed test instruments. Including palm-size frequency counters that go from audio to past 550 MHz. Our Ultravari-able Pulse Generator™ that lives up to its name with a range of 0.5Hz to 5 MHz and a duty cycle variable over ten-million-to-one. A function generator whose VCO is externally sweepable over 100:1.

There's a lot more, too. All in our new 38-page catalog, crammed full of smarter ideas in testing and design. Send for your free copy today.

## Smarter tools for testing and design.

CONTINENTAL SPECIALTIES CORPORATION

70 Fulton Terr., New Haven, CT 06509 (203) 624-3103 TWX 710-465-1227  
OTHER OFFICES: San Francisco (415) 421-8872 TWX 910-372-7992  
Europe: CSC UK LTD Phone Saffron-Walden 0799-21682 TLX 817477  
Canada: Len Finkler Ltd., Ontario



Call toll-free for details  
**1-800-243-6077**  
8:30AM-5PM Eastern Time

Available at selected local distributors. © Copyright 1979 Continental Specialties Corporation

Listing 1 continued:

```

01D5 C9          0525      RET
01D6 DB FC      0530 INP   IN   OPCH
01D8 C9          0535      RET
01D9 CD D0 01   0540 KYCHK CALL STATUS
01DC C8          0545      RZ
01DD CD D6 01   0550 CALL   INP
01E0 FE 93      0555 CPI    RAR ;RIGHT ARROW
01E2 CA FA 01   0560 JZ     RIGHT
01E5 FE 81      0565 CPI    LAR ;LEFT ARROW
01E7 CA 05 02   0570 JZ     LEFT
01EA FE 97      0575 CPI    UAR ;UP ARROW
01EC CA 10 02   0580 JZ     UP
01EF FE 9A      0585 CPI    DAR ;DOWN ARROW
01F1 CA 1B 02   0590 JZ     DOWN
01F4 FE 20      0595 CPI    ' ' ;SPACE BAR DROPS BALLOON
01F6 CA 53 02   0600 JZ     BLANSET
01F9 C9          0605      RET
01FA 2A F2 02   0610 RIGIN LBLD LR ;THESE ROUTINES UPDATE THE OFFSETS TO
01FD 11 01 00   0615 LXI   D,1 ;THE SHIP POSITIONS
0200 19          0620 DAD   D
0201 22 F2 02   0625 SHLD  LR
0204 C9          0630      RET
0205 2A F2 02   0635 LEFT LBLD LR
0208 11 FF FF   0640 LXI   D,-1
020B 19          0645 DAD   D
020C 22 F2 02   0650 SHLD  LR
020F C9          0655      RET
0210 2A F4 02   0660 UP   LBLD UD
0213 11 C0 FF   0665 LXI   D,-64 ;64 CHARACTER WIDE SCREEN SO YOU GO U/D 1 LINE
0216 19          0670 DAD   D
0217 22 F4 02   0675 SHLD  UD
021A C9          0680      RET
021B 2A F4 02   0685 DOWN LBLD UD
021E 11 40 00   0690 LXI   D,64
0221 19          0695 DAD   D
0222 22 F4 02   0700 SHLD  UD
0225 C9          0705      RET
0226 3E 01      0710 BALLI MVI   A,1
0228 32 FD 02   0715 STA   BLNF
022B 2A F6 02   0720 LBLD  CORNR
022E 11 41 00   0725 LXI   D,41H
0231 19          0730 DAD   D
0232 22 F4 02   0735 SHLD  BLNR
0235 2A FE 02   0740 BALLI LBLD BLNR ;BLANK OUT BALLOON
0238 36 20      0745 MVI   N,' '
023A 11 40 00   0750 LXI   D,64 ;MOVE IT DOWN A LINE
023D 19          0755 DAD   D
023E 22 FE 02   0760 SHLD  BLNR
0241 36 8C      0765 MVI   N,8CH
0243 7C          0770 MOV   A,H
0244 FE D0      0775 CPI   0D0H
0246 CA 4A 02   0780 JZ     DOWN ;HIT BOTTOM
0249 C9          0785      RET
024A 3E 00      0790 BALLI MVI   A,0
024C 32 FC 02   0795 STA   BLNF
024F 32 FD 02   0800 STA   BLNF
0252 C9          0805      RET
0253 3E 01      0810 BLANSET MVI  A,1
0255 32 FC 02   0815 STA   BLNF

```

Listing 1 continued on page 158

## TUNE-UP YOUR PET®...\$109.95 with enclosure \$134.95

- Exact Pet keyboard layout
- Double-shot keytops with graphics legends
- Duplicate Return, Space and Shift keys on numeric pad for programming ease
- Added function key which can be hard wired as a system reset
- Flexible cable and connector supplied

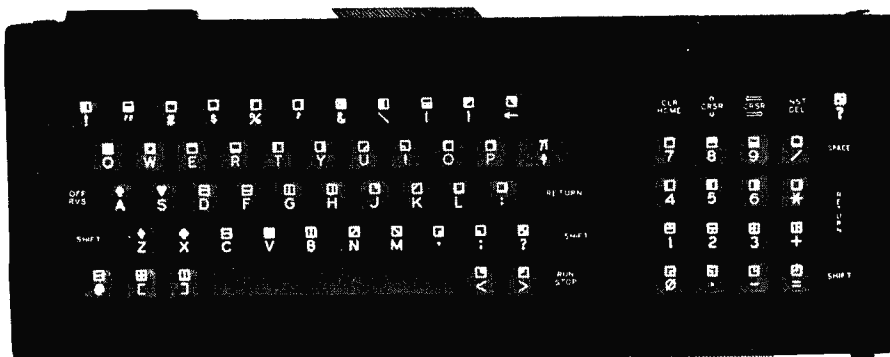

\* TM of Commodore Business Machines, Inc.

**Century Research & Marketing, Inc.**  
4815 W. 77th St.  
Mpls., MN 55435

**Erhardt & Jost Electronics**  
Rossligasse 2  
CH 4450 Sissach  
Switzerland



# NEW FROM MOUNTAIN HARDWARE. CONTROL FROM YOUR APPLE.



## INTROL/X-10.

### COMPUTERIZE YOUR HOME.

The Introl/X-10 peripheral system for your Apple\* Computer allows you to remotely control lights and electrical appliances in your home.

### YOU'RE ALREADY WIRED.

Introl/X-10 operates by utilizing your computer's intelligence to command the BSR System X-10 to send signals over regular 110 volt household wiring. That means you can control any electrical device in your home without additional wiring.

### READY TO USE.

Introl/X-10 comes with complete software to control devices on pre-determined schedules, and features:

- Control devices at a specific time.
- Select a daily or weekly schedule.
- Specify a day of the week, or an exact date for a particular event.
- Specify an interval of time for an event.
- Rate device wattages for a running account of power consumption during your schedule for energy management.
- Used with our Apple Clock™ your schedules may run in "background" while other programs may run at the same time in "foreground."

### EVERYTHING YOU NEED.

The Introl Controller board plugs into a peripheral slot of your Apple. With an ultrasonic transducer it transmits control signals to the BSR/X-10 Command Console which may be plugged into any convenient AC outlet near your computer. On command, signals are sent to remote modules located at the devices you wish to control. Up to 16 remote module addresses may be controlled from your Apple.

### AVAILABLE NOW.

The Introl/X-10 System consists of the Introl Controller board with timer and ultrasonic transducer, the X-10 Command Console and three remote modules. \$279. Complete and tested. If you already have a BSR System X-10, the Introl Controller board is available separately for \$189. Additional remote modules are available at \$15. See your computer dealer for a demonstration. Or, return the coupon below for complete information.

Available through computer dealers worldwide

\*Apple is a trademark of Apple Computer Inc.  
BSR/System X-10 is a trademark of BSR, Ltd.

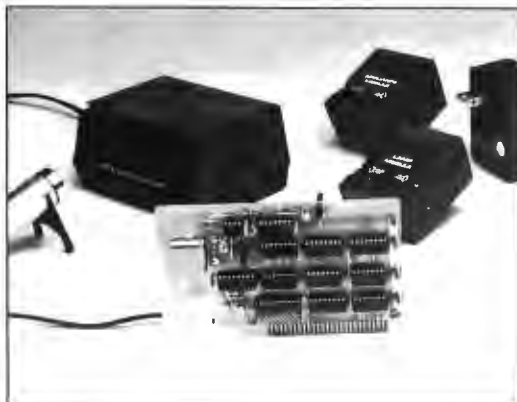

### Mountain Hardware, Inc.

LEADERSHIP IN COMPUTER PERIPHERALS  
300 Harvey West Blvd., Santa Cruz, CA 95060  
(408) 429-8600

Sounds great.

Home control from my Apple?  
That sounds like a great system. Send me all the details.

Name \_\_\_\_\_

Address \_\_\_\_\_

City \_\_\_\_\_ State \_\_\_\_\_ Zip \_\_\_\_\_

Phone \_\_\_\_\_

Listing 1 continued:

```

0258 C9          0820 RET
0259 3A FD 02   0825 BLNCH LDA BLNF
025C FE 01     0830 CPI 1
025E CA 35 02  0835 JZ BLNI
0261 3A FC 02   0840 LDA BLMD
0264 FE 01     0845 CPI 1
0266 C0        0850 RNZ
0267 CD 26 02  0855 CALL BALH
026A E5        0860 DELAY FUSH H ;A USEFUL ALLPURPOSE TIMING ROUTINE
026B 2F 6E 05  0865 LHL D SPEED
026E EB        0870 XCHG
026F 15        0875 DELAI DCR D
0270 C2 6F 02  0880 JNZ DELAI
0273 1D        0885 DCR E
0274 C2 6F 02  0890 JNZ DELAI
0277 E1        0895 POP H
0278 C9        0900 RET
0279 21 DA CD  0905 WAIT LXI H,VOMBAS+474
027C 11 94 05  0910 LXI D,MSG
027F CD 64 05  0915 CALL PRINT
0282 21 14 CE  0920 LXI H,VOMBAS+532
0285 11 A2 05  0925 LXI D,MSG2
0288 CD 64 05  0930 CALL PRINT
028B 21 D0 CF  0935 LXI H,VOMBAS+976
028E 11 70 05  0940 LXI D,MSG1
0291 CD 64 05  0945 CALL PRINT
0294 CD D0 01  0950 IN1 CALL STATUS
0297 CA 94 02  0955 JZ IN1
029A CD D6 01  0960 CALL INP
029D FE 30     0965 CPI '0'
029F CA 00 00  0970 JZ OH ;REBOOT CP/H
02A2 FE 31     0975 CPI '1'
02A4 CA B9 02  0980 JZ FAST
02A7 FE 32     0985 CPI '2'
02A9 CA C0 02  0990 JZ MED
02AC FE 33     0995 CPI '3'
02AE CA C7 02  1000 JZ SLOW
02B1 FE 34     1005 CPI '4'
02B3 CA CE 02  1010 JZ SPASTIC
02B6 C3 79 02  1015 JMP WAIT ;GOT A BAD CHAR
02B9 21 19 00  1020 FAST LXI H,19H
02BC 22 6E 05  1025 SHLD SPEED ;HERE WE SET PARAMETERS FOR DELAY LOOP
02BF C9        1030 RET
02C0 21 24 00  1035 MED LXI H,24H
02C3 22 6E 05  1040 SHLD SPEED
02C6 C9        1045 RET
02C7 21 32 00  1050 SLOW LXI H,32H
02CA 22 6E 05  1055 SHLD SPEED
02CD C9        1060 RET
02CE 21 38 00  1065 SPASTIC LXI H,38H
02D1 22 6E 05  1070 SHLD SPEED
02D4 C9        1075 RET
02D5 2A F6 02  1080 TOPB LHL CORNR
02D8 7C        1085 MOV A,H
02D9 FE CC     1090 CPI OCH ;TOP 2 DIGITS OF VOMBAS
02DB CA EA 02  1095 JZ TOP
02DE FE CF     1100 CPI OCFH ;BOTTOM OF SCREEN
02E0 CA EB 02  1105 JZ BOT
02E3 C9        1110 RET
    
```

Listing 1 continued on page 160

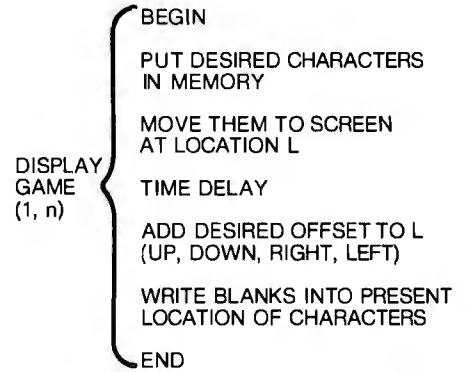

Figure 1: A Warnier-Orr diagram describing the steps involved in simulating motion.

Text continued:

rewrite its screen, so the programmer might think that computer games could represent extremely smooth movement.

However, the movement has to be represented in finite increments, which will be determined by the minimum distance between the characters or points that can be written on the screen. In the case of a typical video display board which can put 1024 characters on the screen, the user must move in increments of  $\frac{1}{1024}$ th the height of the screen when moving vertically and  $\frac{1}{1024}$ th the width of the screen when moving horizontally. This means that the movement will necessarily be a little jerky, but smooth enough for games.

The whole essence of writing an animated game is to put a picture on

## S-100 USERS: GIVE YOUR COMPUTER THE GIFT OF SIGHT!

The DS-80 Digisector® is a random access video digitizer. It works in conjunction with a TV camera (either interlaced or non-interlaced video) and any S-100 computer conforming to the IEEE standards. Use it for:

- Precision Security Systems
- Moving Target Indicators
- Computer Portraiture
- Fast To Slow Scan Conversion
- Robotics
- Reading UPC Codes, schematics, paper tape, musical scores



● IMAGE PROCESSED BY DS-80 ●

### CHECK THESE FEATURES:

- High resolution** — a 256 x 256 picture element scan
- Precision** — 64 levels of grey scale
- Speed** — Conversion time of 14 microseconds per pixel
- Versatility** — scanning sequences user programmable
- Economy** — a professional tool priced for the hobbyist; comes fully assembled, tested and burned in, with fully commented portrait printing software.

Price: \$349.95 MasterCharge and Visa

THE **MICRO WORKS**

P.O. BOX 1110, DEL MAR, CA 92014 (714) 942-2400

**U** pgrade your Level II TRS-80 and brighten your programming without the cost of a Radio Shack expansion interface and disk drives.

Microsoft's Level III BASIC is an enhancement to the Level II, loading from a cassette tape right on top of the Level II ROM. It contains all Disk BASIC features not already in Level II, except for file management commands. And it adds six new Level III exclusives not available in Level II or Disk BASIC.

No one knows better than Microsoft how to increase your TRS-80's BASIC power. Microsoft created the TRS-80 Level II and Disk BASIC plus the industry standard Microsoft BASIC.

Advanced graphics is Level III's most exciting addition to the TRS-80—and it's exclusive. Draw a line, outline or solid box by specifying just two points, then save it and put it back with BASIC statements. You'll find yourself writing more programs with charts, graphs and even animation.

Other Level III exclusives include 26 user-definable single stroke instructions so you can enter any command, statement or string with a shift-key entry. New SAVE and LOAD commands improve the reliability of loading tape programs by eliminating problems with cassette recorder volume sensitivity. Aggravating keyboard bounce is also eliminated. INPUT # LEN and LINE INPUT # LEN statements allow you to write programs with a time limit. And, joy of joys, Level III has automatic line renumbering.

TRS-80 power increases with Level III's seven Disk BASIC features. Ten user-defined subroutines can be used in a program. Error messages are spelled out. LINE INPUT instruction accepts punctuation marks within a string and eliminates the automatic "?" from the INPUT

prompt. A more flexible MID\$ increases string manipulation power. INSTR function searches a string for a specified substring. And Level III performs hex and octal conversion.

Level III even adds new capabilities to a TRS-80 system with an expansion interface by outputting to the RS-232 port in BASIC and setting and reading time and date from BASIC.

Level III occupies only 5.2K RAM with something for every TRS-80 from the 16K Level II minimum system requirement and up. It can be stored on disk as a file, but it only works in conjunction with Level II; it will not operate with Disk BASIC. Programs written in Level III BASIC are stored on cassette tape.

The users manual is full of how-to-use descriptions, sample programs and a complete graphics section. The reference card provides a quick-find list of commands, statements, functions and other Level III features. Manual, reference card and Level III cassette tape for only \$49.95.

Microsoft Level III BASIC is sold at Computer retailers nationwide. If your local computer store doesn't have Level III, ask them to call us. You can call us, too, for the name of your nearest Microsoft dealer. Phone (206) 454-1315. Or write Microsoft Consumer Products, 10800 Northeast Eighth, Suite 819, Bellevue, WA 98004

**MICROSOFT**  
CONSUMER PRODUCTS

**Now! The most powerful TRS-80 BASIC you can buy,  
from the #1 name in microcomputer system software.**





Listing 1 continued:

```

02E4 21 40 00      1115  GOP   LXI   H,-64
02E7 22 F4 02      1120      SHLD  UD
02EA C9            1125      RET
02EB 21 C0 FF      1130  BOT   LXI   H,-64
02EE 22 F4 02      1135      SHLD  UD
02F1 C9            1140      RET
02F2 00 00         1145  LR    DN   0
02F4 00 00         1150  UD    DN   0
02F6 1E CC         1155  CORN: DN   0CE1H1 ;STARTS AT MIDDLE OF SCR:
02F8 10           1160  WHIP: DB   10H ;SHIP GRAPHICS
02F9 90           1165  BLK   DB   90H
02FA 3C           1170  LEAD  DB   3CH
02FB 3E           1175  REED  DB   3EH
02FC 00           1180  BLND  DE   0
02FD 00           1185  BLNF  DB   0
02FE 00 00         1190  BLNR  DN   0
0300 3A A3 03      1195  PEAL  LDA   C1
0303 FE 01         1200      CPI   1
0305 CA 3D 03      1205      JZ    SHUT1
0308 CD A4 03      1210      CALL  RND
030B D6 F0         1215      SUI   0FH
030D D8            1220      RC
030E 87            1225      ADD   A
030F 87            1230      ADD   A
0310 5F            1235      MOV   E,A
0311 16 00         1240      MVI   D,0
0313 21 C0 CF      1245      LXI   H,SCBOT ;MIDDLE OF BOTTOM OF SCR:
0316 19            1250      DAD   D
0317 22 45 04      1255      SHLD  PLOC1
031A 36 18         1260      MVI   M,18H
031C 23            1265      INX   H
031D 36 18         1270      MVI   H,18H
031F 23            1275      INX   H
0320 36 18         1280      MVI   M,18H
0322 11 EF FF      1285      LXI   D,-65
0325 19            1290      DAD   D
0326 36 96         1295      MVI   M,96H
0328 11 C0 FF      1300      LXI   D,-64
032B 19            1305      DAD   D
032C 19            1310      DAD   D
032D 22 A1 03      1315      SHLD  PY1
0330 3E 01         1320      MVI   A,1
0332 32 A3 03      1325      STA   G1
0335 AF            1330      XRA   A
0336 32 47 04      1335      STA   BPLG1
0339 CD 98 03      1340      CALL  OFF1
033C C9            1345      RET
033D CD 0F 05      1350  SHUT1 CALL  JETON:
0340 CD 8E 03      1355      CALL  OHI
0343 CD B6 03      1360      CALL  RND4
0346 FE 01         1365      CPI   1
0348 CA EB 04      1370      JZ    JET1
034B FE 02         1375      CPI   2
034D CA EB 04      1380      JZ    JET1
0350 2A A1 03      1385  TEMP  SHLD  PY1
0353 22 C7 03      1390      SHLD  BL1
0356 3E 01         1395      MVI   A,1
0358 32 9E 03      1400      STA   FLG1
035B CD D6 03      1405      CALL  RND4

```

Listing 1 continued on page 164

the screen, leave it there for a short length of time, then write blanks over the parts wanted to be moved and re-write them in the next space of the motion sequence. After another delay, the process is repeated. It does not take much thinking to realize that the main body of the game will be a loop with these essential elements, plus whatever keyboard checking, score updating, message displaying, and the like are wanted as the game progresses.

This lends itself to a fairly modular program structure (see figure 1). The program I am going to use to illustrate this process is quite simple; elaborate discussion of program logic. Let us start with a description of the program from the point of view of a player.

Let us write a program in which the player flies a motorized delta-wing over his friend's backyard computer-controlled peashooter. The peashooter fires a pea and a water jet at you as you cruise past. When you are hit the peashooter receives 100 points. You try to position yourself directly over your friend's backyard and drop a water balloon on the peashooter. If you hit him with the balloon, you receive 100 points. To make it interesting, we will have the gunner appear and disappear at random times and places.

Before we start burning up coding sheets, or typing madly into the

## KEYED FILE ACCESS

### Create Interactive Systems In Hours With--

- MULTIPLE KEY INDEXING
- OPTIMIZED RANDOM ACCESS
- SUPER FAST SEQUENTIAL ACCESS
- DUPLICATE KEY VALUES ALLOWED
- ANY NUMBER OF DATA FILES SUPPORTED
- COMPLETE REAL TIME INSERTION  
AND DELETION CAPABILITIES

# FAIR COM

2606 Johnson Drive  
Columbia, Mo. 65201  
314-445-3304

Making Micro's Work Like Maxi's

MICRO B+™ brings the state-of-the-art in file accessing—the B TREE INDEX—to application programmers writing in CBASIC-II under CP/M\* or derivative. The B TREE INDEX gives unparalleled performance: fast insertion, retrieval, and deletion without the need to ever reorganize the index! Let Fair Com turn your micro on to B TREES.

Special introductory offer: Return this ad with your order and save \$50. Offer good through December 15, 1979.

Available on 8" soft sector disks.

MICRO B+™ in CBASIC-II source code, with manual and demonstration program...\$195\*\*. Manual and demonstration disk in CBASIC-II intermediate code...\$25. Look for MICROSOFT and other versions soon.

To order, send check or money order. VISA and MASTERCARD welcome, send card number, expiration date and your signature.

\*Trademark of Digital Research \*\*Single CPU License

# \$3,995

## Million-Character Computer System One-Year Transferable Warranty

\$3,995

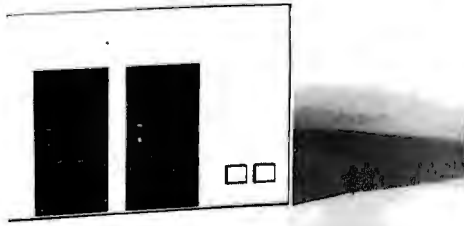

SEE System 6684 Unique Standard Features

- CPU integrated into Diskette Cabinet with peripheral ports in rear of cabinet
- 4 Full communications ports RS232 or 20 mA/60 mA CL; 75 to 19,200 bits/sec.

\$4,995



SEE System 6784 Unique Standard Features

- CPU integrated into video terminal cabinet with peripheral ports in rear
- Video has 16 programmable function keys, 128 high resolution characters with graphics, numeric keypad, reversed video, full editing, 24 x 80 display

### Standard Features on All Systems

- Central Processing Unit with 12 slots; 2 MHz (expandable to 4MHz with pipelining architecture)
- 8 Free Slots for expansion; capacity for 442,368 characters of memory within standard chassis
- 49,152 characters of 200 ns random access memory; 150 ns memory optional
- 8 vectored interrupts; all input and output is interrupt driven
- 1.2 million characters, double sided, dual 8" diskettes. IBM 3740 compatible
- Printer controller; Centronics compatible
- Magnum BASIC. Extremely fast business BASIC with full editing capabilities, print using, sequential and random files, integer and floating point arithmetic with up to 16 digits precision; N-dimensional matrices and much more. A superset of Microsoft 16K extended disk BASIC
- Interactive conversational macro assembler and editor for 6800 family microprocessors.
- One-year transferable limited warranty on parts and labor for all SEE hardware
- Guaranteed 24-hour turn-around time on repairs

### Optional Features on All Systems

- Up to 64 interconnected, intelligent terminals with no degradation of response time. Each is a stand alone CPU. True distributed processing
- Expandable to 12 MB of 150 ns RAM for each terminal
- Up to 64 RS232 ports with full communications. Talks to any peripheral or CPU with RS232 interface
- Expandable to 4 MB of diskette storage
- Up to 660 MB hard disk storage with removable modules
- ANSI standard 10.5 inch tapes (1600 BPI)
- 11 MB cartridge tape system
- Matrix and word processing printers from 55 CPS to 1400 LPM
- Choice of 6809 and/or 6512 CPU board with speed of up to 4 MHz with 150 ns memory
- Interactive relocatable macro assembler, development system and DOS for 6502 and 6512 microprocessors. Can assemble source programs up to 2 MB long
- PASCAL compiler
- FORTRAN compiler
- BASIC compiler
- COBOL compiler
- Powerful word processing software
- Comprehensive business software, incl. General Ledger, Accounts Receivable, Accounts Payable, Inventory, Payroll; Packages for Physicians, Publishers, Manufacturers, etc.

**Quantity discounts to bona fide dealers, OEMS, and schools**  
**Special configurations and modular shipment available**  
**A few distributorships available in the United States and other countries**



**SYSTEMS ENGINEERING ENTERPRISES**

1749 Rockville Pike, Rockville, Maryland 20852  
(301) 468-1822

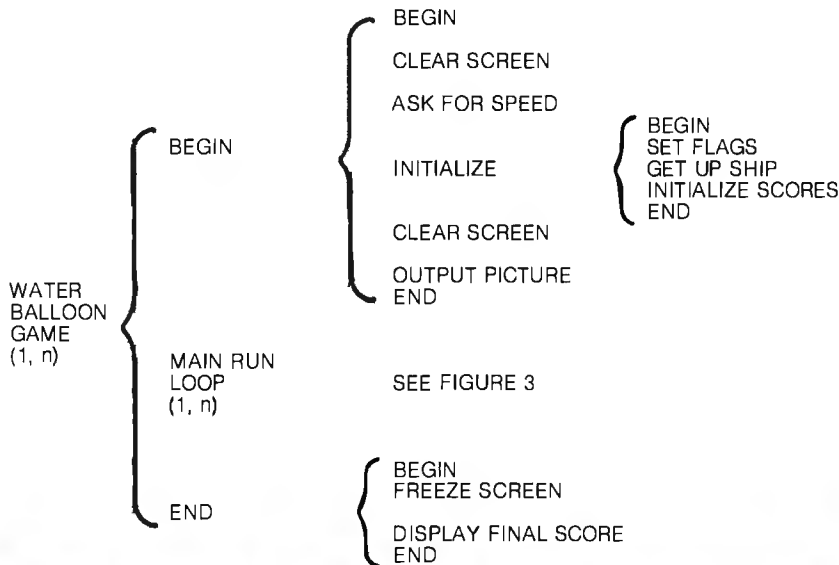

Figure 2: The modular components of the balloon game.

assembler, consider what functions must be added to those in figure 1 to round out the whole game. To get everything ready to play, an initialization routine is needed to clear the screen, set the scores to 0, and so on. After waiting for the player to set the speed, put the delta-wing on the screen, give him a chance to get his fingers on the buttons and survey the situation, and then we will enter the main loop.

The main loop, figure 2, will contain the functions described before; it will put the peashooter and ship on, leave them there for a short time, then write blanks over them and rewrite them, in a new location if required. In addition, there will be keyboard checks to see if the player has fired his acceleration rockets to change the movement of the delta-wing, and update the score. Check for hits by a water balloon or peashooter and see if a water balloon is being dropped. Move the peas and water jet which are being fired, and put on impact marks if any hits have been scored.

Figure 3 summarizes the functions performed in the main loop, and names the subroutines which perform those functions. There are a number of possible changes that could be made in this program to tailor the program to the user's personal taste. The programmer should be able to figure out where to put the wrench by reference to the diagrams and the comments in the listing.

Most of the housekeeping functions of this program are no different from those found in any assembly-language program, so it will be assumed that the user can find the way through those, but a few more comments about the animation techniques might be worthwhile. For an illustration, follow the progress of a pea fired from the peashooter.

Starting at line 1195 the program checks to see if a peashooter is on the screen, since you want peas to come only from a real peashooter. If one is there, jump to SHOT1, where you check to see if a water jet is already on the screen (water jets last for two

*Text continued on page 168*



## Plug in and Print

### Built-in Interface for TRS-80, PET and Apple II Computers

Axiom has made it simple for TRS-80, PET and Apple II users. Just go to your computer store and pick up an Axiom printer with the appropriate built-in interface. Take it home, plug it in and start printing. We even supply the cable and connector.

There are two models: The EX-801 prints upper and lower case alphanumeric characters and all the

graphic symbols used by your computer. The EX-820 goes a step further, providing precise alignment of both horizontal and vertical dot patterns for a true hardcopy of computer generated graphics. With up to 128 dots per inch resolution, the only limit is your imagination. The price is right, too. Just \$535 for the EX-801. So visit your computer store today.

# AXIOM

5932 San Fernando Road, Glendale, CA 91202  
(213) 245-9244 • TWX: 910-497-2283



# Bringing Music Home

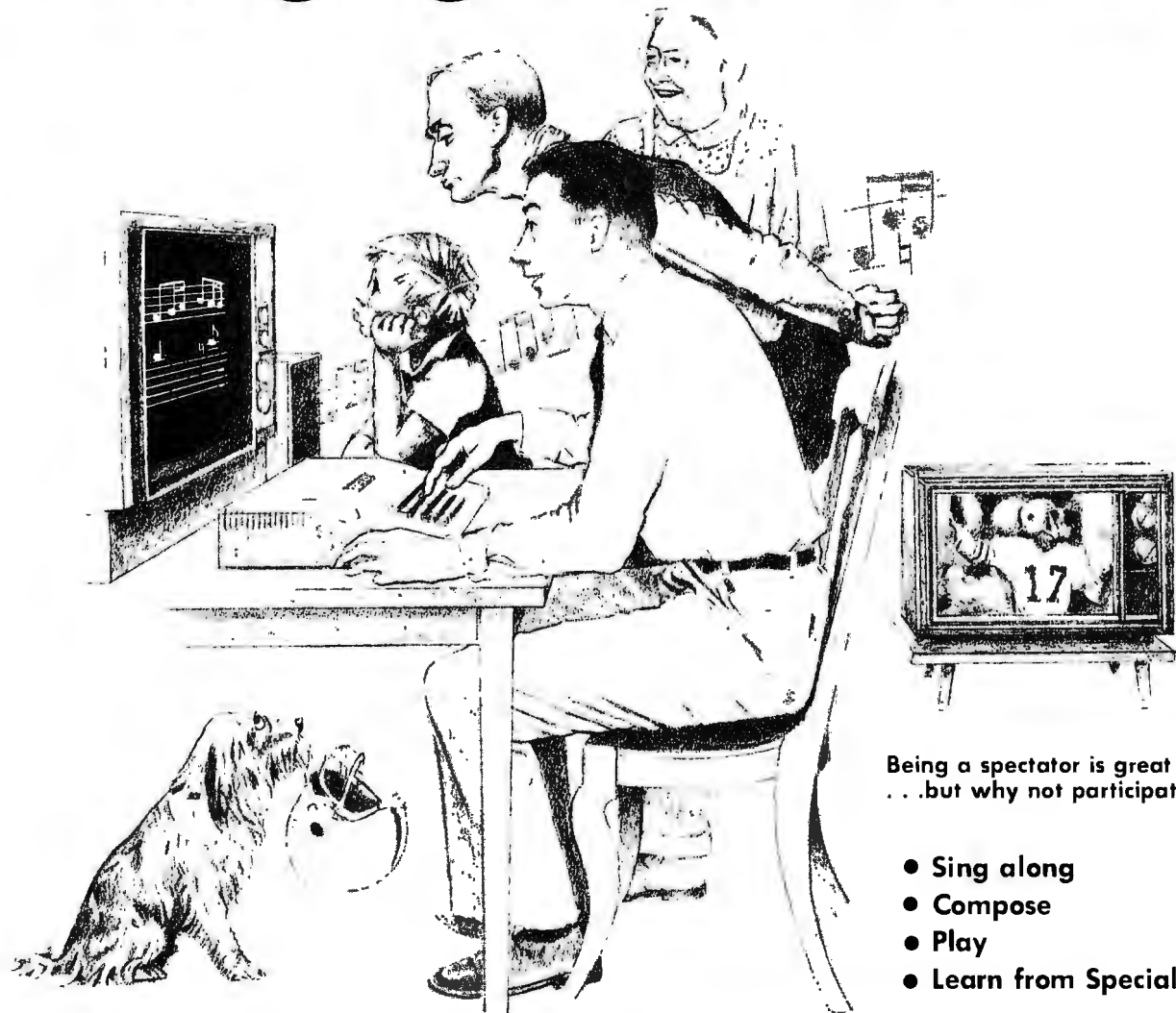

Being a spectator is great  
...but why not participate?

- Sing along
- Compose
- Play
- Learn from Specialists

## LET MICRO MUSIC TURN YOUR APPLE II® INTO A FAMILY MUSIC CENTER!

VISIT THE APPLE DEALER NEAREST YOU AND ASK FOR A DEMONSTRATION OF MMI'S MICRO COMPOSER™  
The MICRO COMPOSER LETS YOU—

- Play up to 4 simultaneous voices
- See all 4 voices at the same time you're hearing the music—a must for music editing!
- Enter music notes by a fast, simple and well-tested coding system.
- Program the pitch, rhythm, and timbre of the music. Tempo is varied by the Apple paddle.
- Choose 7 different tone colors for each voice or create your own tone color.
- Compose, edit, display, and play music through an interactive, command-driven language that's easy to learn.
- Save your music on disk or cassette.
- Hear quality music sound at low cost through the MICRO MUSIC™ DAC card. No amplifier needed! Designed for MMI by Hal Chamberlin and Micro Technology Unlimited.
- Select from future MMI music instruction software to accompany the MICRO MUSIC DAC.

Ask your local dealer for information on MMI products, or contact:



Micro Music Inc 309 W. Beaufort, University Plaza, Normal, Illinois 61761 (309) 452-6991

The MICRO COMPOSER is an APPLE II® compatible, low-cost music system designed by the folks at MMI. Our music software was designed by leading experts in music education. A simple step-by-step instruction manual leads you through entering, displaying, editing, and playing music with up to four voices—soprano, alto, tenor, and bass. You can change the sound of each voice to reed, brass, string, or organ sounds and you can even color your own music sounds!



HAVE FUN! THE MICRO COMPOSER comes complete with an instruction manual, software disk or cassette—in either Integer or Applesoft ROM BASIC, and the MICRO MUSIC DAC music card. Just plug the MICRO MUSIC DAC into the APPLE extension slot and connect the audio cable to a speaker.

Suggested retail price \$220.

APPLE II is a trademark of Apple Computer Inc.

Listing 1 continued:

035E 5F	1410	MOV	E,A
035F 16 00	1415	MVI	D,0
0361 21 B8 FF	1420	LXI	H,-69
0364 19	1425	DAD	D
0365 22 9F 03	1430	SHLD	INCR1
0368 2A 9F 03	1435	SHLD	INCR1
036B E5	1440	PUSH	H
036C D1	1445	POP	D
036D 2A C7 03	1450	SHLD	BL1
0370 36 20	1455	MVI	H,' '
0372 01 40 06	1460	LXI	B,64
0375 09	1465	DAD	B
0376 36 20	1470	MVI	H,' '
0378 2A C7 03	1475	SHLD	BL1
037B 19	1480	DAD	D
037C 7C	1485	MOV	A,H
037D FE C8	1490	CPI	0CDH ;MISSILE IS OFF TOP OF SCREEN
037F CA 98 03	1495	JZ	OFF1
0382 36 07	1500	MVI	H,07H
0384 22 C7 03	1505	SHLD	BL1
0387 11 40 00	1510	LXI	D,64
038A 19	1515	DAD	D
038B 36 0A	1520	MVI	H,0AH
038D C9	1525	RET	
038E 3A 9E 03	1530	CALL	FLG1
0391 FE 01	1535	CPI	1
0393 C0	1540	RNZ	
0394 F1	1545	POP	PSW
0395 C3 6E 03	1550	JMP	SHD1
0398 3E 00	1555	MVI	A,0
039A 32 9E 03	1560	STA	FLG1
039D C9	1565	RET	
039E 00	1570	FLG1	DB 0
039F 00 00	1575	INCR1	DW 0
03A1 00 00	1580	PY1	DW 0
03A3 00	1585	G1	DB 0
03A4 21 C0 03	1590	RND	LXI H,RND ;A RANDOM NUM ROUTINE WHICH DOESN'T
03A7 EB	1595	XCHG	;REPEAT FOR 40,000 TRIES
03A8 21 C2 03	1600	LXI	H,RND1
03AB 7E	1605	MOV	A,H
03AC 3C	1610	INR	A
03AD 0F	1615	RRC	
03AE 47	1620	MOV	B,A
03AF 1A	1625	LDAX	D
03B0 07	1630	RLC	
03B1 80	1635	ADD	B
03B2 77	1640	MOV	H,A
03B3 78	1645	MOV	A,B
03B4 12	1650	STAX	D
03B5 C9	1655	RET	
03B6 CD A4 03	1660	RND1	CALL RND
03B9 1F	1665	RAR	
03BA 1F	1670	RAR	
03BB E6 07	1675	ANI	7
03BD C6 01	1680	ADI	1
03BF C9	1685	RET	
03C0 00 00	1690	RND	DW 0
03C2 00 00	1695	RND1	DW 0
03C4 C3 50 03	1700	SHLD1	JMP TRAP

# Our 1<sup>st</sup> Anniversary Computer Sale

**The CBM™ 16K** \$995  
**Cassette Recorder** free

- Expand to 32K for an additional \$149
- Dual floppy disk drive 2040 w/cable \$1295
- Single floppy disk drive \$895
- Pin feed printer 2023 \$849
- Tractor feed printer 2022 w/cable \$995
- Inventory management software - requires 16K system w/dual floppy and printer \$125
- Text editor software - requires 16K system w/ dual floppy and printer \$125



- Apple II 16K \$1195
- Buy an Applesoft Card for only \$35
- Apple II Plus 16K \$1195
- Buy an Integer Card for only \$35
- 16K Expansion Memory \$95\*
- PASCAL Language System \$459
- 15% OFF** on all Apple software and interface boards. All merchandise is factory warranted.
- \*\$10.00 installation charge is required.

All sales cash. No COD's. 3 1/2% service charge on CHECKS, VISA AND MASTERCARD.  
 Sale ends December 15, 1979. NO REFUNDS.  
 Add 2% for shipping and handling. California residents add 6% sales tax.  
 Allow 2 weeks for cashiers check to clear, 4 weeks for personal checks. Prices subject to change without notice.



15818 Hawthorne Blvd.  
 Lawndale, CA 90260  
 (213) 370-4842

03C7	C0	CF	1705	ELL	MOV	SCBOP	
03C9	3A	47	04	1710	PEVCI	LDA	BPLC1
03CC	FE	01		1715		CPI	1
03CE	C8			1720		RZ	
03CF	3A	EA	04	1725		LDA	SHRIF
J3D2	FE	G1		1730		CPI	1
03D4	C8			1735		RZ	
03D5	2A	45	04	1740	LALD	PLCC1	
03D8	7E			1745	MOV	A,M	
03D9	FE	20		1750		CPI	' '
03D8	CA	ED	03	1755	JZ	XPLD1	
03DE	23			1760	INX	H	
03DF	7E			1765	MOV	A,M	
03E0	FE	20		1770		CPI	' '
03E2	CA	ED	03	1775	JZ	XPLD1	
03E5	23			1780	INX	H	
03E6	7E			1785	MOV	A,M	
03E7	FE	20		1790		CPI	' '
03E9	CA	ED	03	1795	JZ	XPLD1	
03EC	C9			1800	RET		
03ED	22	24	04	1805	XPLD1	SHLD	BLO ; A VERY DUMB-LOOKING EXPLOSION
03F0	3E	01		1810		MVI	A,1
03F2	32	47	04	1815		STA	BPLG1
03F5	3E	2B		1820		MVI	A,'+' ; THESE ARE CHARACTERS WHICH INDICATE A HIT
03F7	CD	26	04	1825		CALL	BLOP
03FA	CD	6A	02	1830		CALL	DELAY
03FD	3E	23		1835		MVI	A,'#'
03FF	CD	26	04	1840		CALL	BLOP
0402	CD	6A	02	1845		CALL	DELAY
0405	3E	20		1850		MVI	A,' '
0407	CD	26	04	1855		CALL	BLOP
040A	2A	C7	03	1860		LALD	DL1
040D	77			1865		MOV	M,A
040E	01	40	00	1870		LXI	B,64
0411	09			1875		DAD	B
0412	77			1880		MOV	M,A
0413	3E	00		1885		MVI	A,0
0415	32	A3	03	1890		STA	G1
0418	3A	89	04	1895		LDA	PSCR
041B	C6	01		1900		ADI	1
041D	32	89	04	1905		STA	PSCR
0420	32	9E	03	1910		STA	PLG1
0423	C9			1915		RET	
0424	00	00		1920	BLOP	DN	0
0426	06	05		1925	BLOP	MVI	B,5
0428	2A	24	04	1930		LALD	BLOP
042B	11	FC	FF	1935		LXI	D,-4
042E	19			1940	BLP1	DAD	D
042F	77			1945		MOV	M,A
0430	23			1950		INX	H
0431	77			1955		MOV	M,A
0432	23			1960		INX	H
0433	77			1965		MOV	M,A
0434	23			1970		INX	H
0435	77			1975		MOV	M,A
0436	77			1980		MOV	M,A
0437	23			1985		INX	H
0438	77			1990		MOV	M,A
0439	23			1995		INX	H
043A	77			2000		MOV	M,A
043B	23			2005		INX	H
043C	77			2010		MOV	M,A
043D	11	BA	FF	2015		LXI	D,-70
0440	05			2020		DCR	B
0441	C8			2025		RZ	
0442	C3	2E	04	2030		JMP	BLP1
0445	C0	CF		2035	PLCC1	DN	SCBOP
0447	00			2040	BPLG1	DE	0
0448	7E			2045	HIT	MOV	A,M
0449	FE	20		2050		CPI	' '
044B	C8			2055		RZ	
044C	FE	10		2060		CPI	10H
044E	C8			2065		RZ	
044F	FE	90		2070		CPI	90H
0451	C8			2075		RZ	
0452	FE	3C		2080		CPI	3CH
0454	C8			2085		RZ	
0455	FE	3E		2090		CPI	3EH
0457	C8			2095		RZ	
0458	22	24	04	2100		SHLD	BLOP
045B	3E	2A		2105		MVI	A,'*'
045D	CD	26	04	2110		CALL	BLOP
0460	CD	6A	02	2115		CALL	DELAY
0463	3E	4F		2120		MVI	A,'C'
0465	CD	26	04	2125		CALL	BLOP
0468	CD	6A	02	2130		CALL	DELAY
046B	3E	20		2135		MVI	A,' '
046D	CD	26	04	2140		CALL	BLOP
0470	3A	88	04	2145		LDA	PSCR
0473	C6	01		2150		ADI	1
0475	32	8E	04	2155		STA	PSCR
0478	21	00	00	2160		LXI	H,0

Listing 1 continued on page 166

## 64KB MICROPROCESSOR MEMORIES

- S-100 - \$750.00
- SBC 80/10 - \$750.00
- LSI - \$750.00
- 6800 - \$750.00



CI-S100 64K x 8

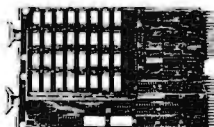

CI-1103 32K x 16

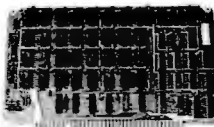

CI-6800 64K x 8



CI-8080 64K x 8

**CI-S100** — 64K x 8 on a single board. Plugs directly into the IMSAI, MITS, TDL, SOL and most other S-100 Bus computers. No wait states even with Z80 at 4Mhz. Addressable in 4K increments. Power requirement 6 watts. Price \$750.00.

**CI-1103** — 8K words to 32K words in a single option slot. Plugs directly into LSI 11, LSI 11/2, H11 & PDP 1103. Addressable in 2K increments up to 128K. 8K x 16 \$390.00. 32K x 16 \$750.00 qty. one.

**CI-6800** — 16KB to 64KB on a single board. Plugs directly into Motorola's EXORcisor and compatible with the evaluation modules. Addressable in 4K increments up to 64K. 16KB \$390.00. 64KB \$750.00.

**CI-8080** — 16KB to 64KB on single board. Plugs directly into Intel's MDS 800 and SBC 80/10. Addressable in 4K increments up to 64K. 16KB \$390.00. 64KB \$750.00

Tested and burned-in. Full year warranty.



**Chrislin Industries, Inc.**

Computer Products Division

31352 Via Colinas • Westlake Village, CA 91361 • 213-991-2254



Listing 1 continued:

047B 22 F4 02	2165	SHLD	UD
047E 22 F2 02	2170	SHLD	LR
0481 21 1E CE	2175	LXI	H,MIDL
0484 22 F6 02	2180	SHLD	CORNR
0487 C9	2185	RET	
0488 00	2190	NSCR	DB 0
0489 00	2195	PSCR	DB 0
048A 21 04 CC	2200	SCORR	LXI H,VDRBAS+4
048D 11 EC 05	2205	LXI	D,BLHSG
0490 CD 64 05	2210	CALL	PRINT'
0493 23	2215	INX	H
0494 3A 89 04	2220	LDA	PSCR
0497 CD AB 04	2225	CALL	SCOUT'
049A 21 30 CC	2230	LXI	H,VDRBAS+4B
049D 11 C4 05	2235	LXI	D,TMHS
04A0 CD 64 05	2240	CALL	PRINT
04A3 23	2245	INX	H
04A4 3A 88 04	2250	LDA	NSCR
04A7 CD AB 04	2255	CALL	SCOUT'
04AA C9	2260	RET	
04AB FE 0A	2265	SCOUT	CPI 0AH ;A VERY DUMB HEX-TO-DECIMAL CONVERTER
04AD D2 BA 04	2270	JNC	LTR
04B0 C6 30	2275	ADI	30H
04B2 77	2280	MOV	M,A
04B3 23	2285	INX	H
04B4 36 30	2290	MVI	M,30H
04B6 23	2295	INX	H
04B7 36 30	2300	MVI	M,30H
04B9 C9	2305	RET	
04BA FE 14	2310	LTR	CPI 20
04BC D2 CC 04	2315	JNC	TWEN
04BF 36 31	2320	MVI	M,31H
04C1 23	2325	INX	H
04C2 C6 26	2330	ADI	38
04C4 77	2335	MOV	M,A
04C5 23	2340	INX	H
04C6 36 30	2345	MVI	M,30H

04C8 23	2350	INX	H
04C9 36 30	2355	MVI	M,30H
04CB C9	2360	RET	
04CC 36 32	2365	TWEN	M,32H
04CE 23	2370	INX	H
04CF C6 1C	2375	ADI	28
04D1 77	2380	MOV	M,A
04D2 23	2385	INX	H
04D3 36 30	2390	MVI	M,30H
04D5 23	2395	INX	H
04D6 36 30	2400	MVI	M,30H
04D8 FE 35	2405	CPI	35H
04DA CA DE 04	2410	JZ	OVER
04DD C9	2415	RET	
04DE 21 96 CD	2420	OVER	LXI H,VDRBAS+40B
04E1 11 CC 05	2425	LXI	D,PRINT
04E4 CD 64 05	2430	CALL	PRINT
04E7 C3 0B 01	2435	JMP	BEGIN
04EA 00	2440	STIMP	DE 0
04EB 3E 03	2445	JENI	MVI A,3
04ED 32 30 05	2450	STA	RAFL
04F0 CD E6 03	2455	CALL	INDM
04F3 5F	2460	MOV	E,A
04F4 16 00	2465	MVI	D,0
04F6 21 BE FF	2470	LXI	H,-66
04F9 19	2475	DAD	D
04FA 22 9F 03	2480	SHLD	INCP1
04FD 2A 9F 03	2485	LHLD	INCP1
0500 E5	2490	PUSH	H
0501 D1	2495	POP	D
0502 2A A1 03	2500	LHLD	PY1
0505 06 0C	2505	MVI	B,12
0507 19	2510	RX2	DAD D
0508 36 04	2515	MVI	M,4
050A 05	2520	DCR	B
050B C2 07 05	2525	JNZ	RX2
050E C9	2530	RET	
050F 3A 30 05	2535	JEXON	LDA RAFL
0512 FE 01	2540	CPI	1
0514 C8	2545	RZ	
0515 3D	2550	DCR	A
0516 32 30 05	2555	STA	RAFL
0519 FE 01	2560	CPI	1
051B C2 31 05	2565	JNZ	RAS
051E 2A 9F 03	2570	LHLD	INCP1
0521 E5	2575	PUSH	H
0522 D1	2580	POP	D
0523 2A A1 03	2585	LHLD	PY1
0526 06 0C	2590	MVI	B,12
0528 19	2595	RX3	DAD D
0529 36 20	2600	MVI	M,20H
052B 05	2605	DCI	B
052C C2 28 05	2610	JNE	RX3
052F C9	2615	RET	
0530 01	2620	RAFL	DB 1
0531 F1	2625	RX5	POP PSW
0532 F1	2630	POP	PSW
0533 C3 4C 01	2635	JMP	RUNTI
0536 CD A4 03	2640	PEAF	CALL RND
0539 D6 D2	2645	SUI	ODR
053B D8	2650	RC	
053C D6 03	2655	SUI	3
053E D0	2660	RAC	
053F 2A 45 04	2665	LHLD	PLOC1
0542 06 20	2670	MVI	B,20H
0544 70	2675	MOV	M,B
0545 23	2680	INX	H
0546 70	2685	MOV	M,E
0547 23	2690	INX	H
0548 70	2695	MOV	M,B
0549 11 BF FF	2700	LXI	D,-65
054C 19	2705	DAD	D
054D 70	2710	MOV	M,B
054E AF	2715	XRA	A
054F 32 A3 03	2720	STA	G1
0552 32 9E 03	2725	STA	PLG1
0555 3E 01	2730	MVI	A,1
0557 32 47 04	2735	STA	EPGL
055A 2A C7 03	2740	LHLD	BL1
055D 70	2745	MOV	M,B
055E 11 40 00	2750	LXI	D,64
0561 19	2755	DAD	D
0562 70	2760	MOV	M,E
0563 C9	2765	RET	
0564 1A	2770	PRINT	LDAX D
0565 FE 00	2775	CPI	0
0567 C6	2780	RZ	
0568 77	2785	MOV	M,A
0569 23	2790	INX	H
056A 13	2795	INX	D
056B C3 64 05	2800	JMP	PRINT
056E 00 00	2805	SPEED	DI 0

  
**Make your own interface easily**  
 for Apple II<sup>®</sup> and Superkim<sup>®</sup> with  
**Vector 4609 Universal Plugbord!**

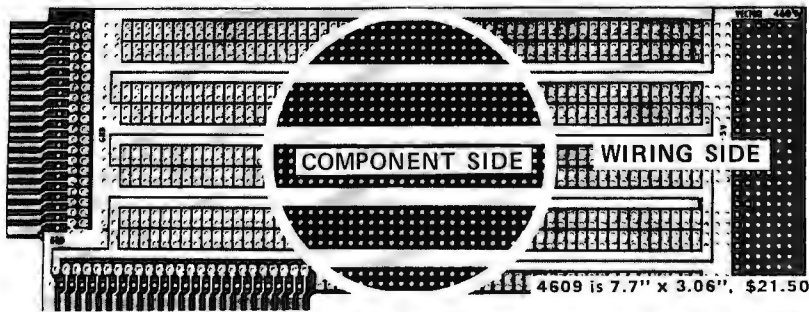

**HIGH CAPACITY:**  
22 16-pin DIPs or 2 40-pin plus 18 sixteen-pin DIPs.

**VERSATILE**  
.1 inch grid; .042 inch diameter holes.

- Extra I/O connector—gold plated.
- Extended length! Extra area! No interference.
- Wrap wire or solder.
- Quick solder mounting of any IC sockets.
- Hot tinned 2 ounce copper power & ground buses between IC leads for easy connection.

**Vector Electronic Company**  
INCORPORATED

12460 Gladstone Avenue, Sylmar, California 91342  
phone (213) 365-9661, TWX (910) 496-1539

① T. M. APPLE COMPUTER, Inc. 680679      ② T. M. MICROPRODUCTS

Listing 1 continued on page 168

**Now!  
For the  
S-100 bus**

# 8086 Power

**WITH 16-BIT WORD LENGTH**

## 8086 CPU

This card brings state-of-the-art performance to the S-100 bus. It may be used to upgrade existing 8-bit systems by "swapping" the CPUs or it may form the foundation for a high performance 16-bit system. It will operate with 8-bit, 16-bit, or mixed memory and peripherals. It has a 1-megabyte addressing range. It can be factory upgraded at nominal cost from 4 Mhz. to 8 Mhz. when the faster CPU chip is available. Price — \$895.

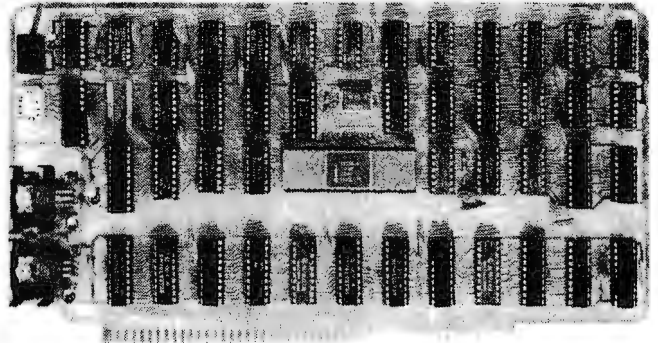

## CPU Support Card

This is a companion to our 8086 CPU. It includes a 2K monitor with machine language debugger and disk bootstrap loader, serial port with software-selected baud rate, time-of-day clock with battery backup capability, two general purpose timers/counters, and a vectored interrupt controller with 7 interrupts generated on board and 8 accepted from the bus. Price — \$395.

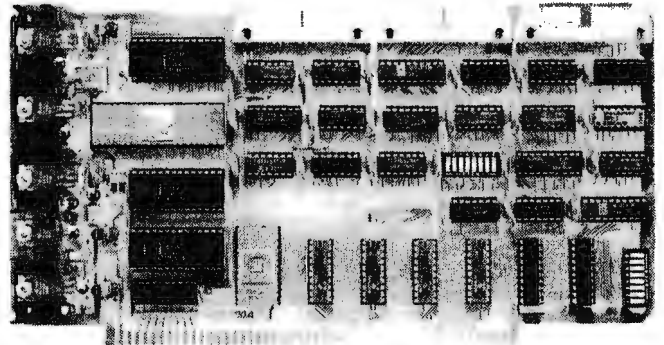

## 8/16 Memory Card

Through the use of the sXTRQ line of the proposed IEEE Standard, this memory board will appear to be 8K by 16 bits to our 8086 CPU or 16K by 8 bits to 8-bit CPUs. It is offered with 250 nsec. memory chips only and will perform without wait states with our 8086 CPU using an 8 Mhz. clock. It has 24-bit extended addressing. Price — \$595.

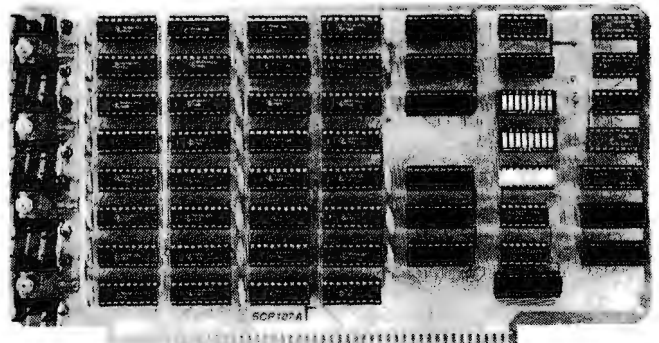

(Prototypes shown)

## Z80/8086 Cross Assembler

This cross assembler runs under CP/M and its derivatives. Its mnemonics are the same as or similar to Intel's ASM-86. It is available in 5" soft-sectored, 5" North Star, or 8" soft-sectored (IBM) formats. Price — \$250.

## Microsoft BASIC-86

Microsoft's BASIC interpreter for the 8086 is essentially identical in features to their 5.0 release for the 8080 and is ANSI compatible. It is a "stand-alone" version and includes all disk and terminal I/O drivers. Programs written for any earlier version of Microsoft BASIC will run under BASIC-86 with little or no modification. Price — \$350.

## MCS-86 User's Manual

By Intel — Feb., 1979, edition. This is the primary hardware and software reference manual for the 8086 CPU. Price — \$6.25. (Includes shipping)

**AVAILABLE NOW!**

STOCK TO TWO WEEKS

**Call for more information  
or the name of  
our nearest dealer**

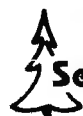

**Seattle Computer Products, Inc.**

1114 Industry Drive, Seattle, WA. 98188  
(206) 575-1830

Listing 1 continued:

```

0570 2A 2A 53 45      2810 MSG1  ASC  ***SET SPEED, 1 THRU 4, 1=FASTEST ***
      54 20 53 50
      45 45 44 2C
      20 31 20 54
      48 52 55 20
      34 2C 20 31
      3D 46 41 53
      54 45 53 54
      20 2A 2A
0593 00              2815      DE  0
0594 2A 2A 20 42      2820 MSG  ASC  *** BALLOON ***
      41 4C 4C 4F
      4F 4E 20 2A
      2A
05A1 00              2825      DE  0
05A2 43 6F 70 79      2830 MSG2  ASC  'Copyright 1979 Tony Estep'
      72 69 67 66
      74 20 31 39
      37 39 20 54
      6F 6E 79 20
      45 73 74 65
      70
05BB 00              2835      DE  0
05BC 44 52 4F 50      2840 BLN5C ASC  'DROPPER'
      50 45 52
05C3 00              2845      DE  0
05C4 53 48 4F 4F      2850 'MINE' ASC  'SHOOTER'
      54 45 52
05CB 00              2855      DE  0
05CC 2A 2A 20 46      2860 FIN5C ASC  *** FINAL SCORE ***
      49 4E 41 4C
      20 53 43 4F
      52 45 20 2A
      2A
05DD 00              2865      DE  0
05DE      2870 STACK DS  50

BALN  0226  BDOWN 024A  BEGIN  010B  BFLG1  0447
BL1   03C7  BLAK  02F9  BLN5C  05DC  BLN1  0235
BLNCH 0259  LEND  02FC  BLNF  02FD  BLNR  02FE
BLN5E 0253  BLOP  0426  BLON  0424  BLP1  042E
BOT   02EB  CLSCH  C0D5  CORNR  02F6  DAR  009F
DELAY 026F  DELAY  026A  DOWN  021E  FAST  02B9
FIN5S 05CC  FLG1  039E  G1     03A3  GO   010E
HIT   0448  IN1   0294  INCR1 039F  INP  01D6
JET1  04EB  JETON 050F  KYCHK 01D9  LAR  00B1
LEFT  0205  LEND  02FA  LR    02F2  LTR  04BA
MID   02C0  MIDL  CE1E  MSCR  0488  NSG  0594
MSG1  0570  MSG2  05A2  OFF1  0398  ON1  038E
OVER  04DE  PEAL  0300  PEACH 03C9  PEADF 0536
PLOC1 0445  PRINT 0564  PSCR  0489  PUTOR 01AC
PY1   03A1  RAFL  0530  RAR   0093  READ 02F3
RIGHT 01FA  RND  03A4  RND1  03C2  RND4  03B6
RNDM  03C0  RUNIT 014C  RX2   0507  RX3   0528
R5S   0531  SCROT  CFC0  SCORE 048A  SCOM  0183
SCOUT 04AB  SH1   0368  SH1L  03C4  SH1P  0189
SHOT1 033D  SLOW  02C7  SPAST 02CE  SPEED 056E
STACK 05DE  STATU 01D0  STRIF 04EA  TAKOF 01C1
TEMP  0350  THN5G 05C4  TOP   02E4  TOPB  02D5
TWEN  04CC  UP    0097  UD    02F4  UP    0210
VORBA 0C00  WAIT  0279  WILL  02F8  XPLD1 03ED

```

Text continued:

cycles, as you will see when you play). If there is no water jet there, then a random number test decides whether to shoot a pea or water jet. If it is a pea, control falls through to TEMP. This locates the starting point for the pea line and then sets the flag that tells the program that a pea is being fired. The program keeps track of that, since it will be on for several program cycles, until it makes a hit or goes off the screen.

Next, we determine the random direction of fire, and at last the program is ready to start the pea in motion. An increment is computed and stored at lines 1425 thru 1450.

Note at SHB1 that the user should reload the HL register pair with the same values that are already in it. This is a practice I always follow when I will be coming to an entry point from a number of different places. The idea is to eliminate parameter passing, or rather to pass the parameters through a named storage location, which makes it much easier to debug. Be that as it may, you can readily see how in the ensuing instructions, the heart of the matter is reached. Write hexadecimal 20 into the area occupied by the pea and its trail (hexadecimal 07 and 0A respectively in the Processor Technology video display module (VDM) character set), then add the increment. Check to see if it is off the screen, and if not put the characters into the new

# DOCMAIL™

## LOW COST DOCUMENT AND MAILING LIST SYSTEM

**You** can produce, edit and sort mailing, identification and inventory lists using index files.

**You** can create, format and justify documents, reports and personalized business letters using document control files.

This system of more than 10 CBASIC programs runs on your 8080 or Z-80 computer using CP/M and 24K or more bytes of memory.

**Manual** includes instructions with examples and a quick reference guide.

**BONUS:** An 8080 assembly file for a bi-directional print driver.

**\$50:** DOCMAIL system on 8" diskette, sample files and manual.

**\$10:** Manual only.

# RBB Software Products™

P.O. BOX 2111  
YORBA LINDA, CALIFORNIA 92686  
(714) 637-5965



```

CAN I MOVE PARAGRAPHS AROUND?
YES! AUTOTYPE has a Holding Buffer that can be used to save any amount of text and then Unhold it to the location you want. AUTOTYPE even allows you to do multiple Unholds!

CAN I MERGE CUSTOMERS NAMES INTO LETTERS?
YES! AUTOTYPE contains a "merge" character that may be placed anywhere in text. Then, at the time text is printed, a separate file may be merged into the letter and then printed! Another feature that NO OTHER WORD PROCESSOR has!

CAN I ENTER TEXT IN SOME OTHER FORMAT THAN 64 CHARACTERS WIDE?
YES! AUTOTYPE has a screen redimension command. The screen can be set from 16 characters wide to 120 characters wide. There's even horizontal scrolling to view the text! Once more, we're far beyond the competition!

CAN IT HANDLE TEXT LARGER THAN MY COMPUTERS MEMORY?
YES! Most other Word Processors demand that the entire text be inside the computer. AUTOTYPE allows you to "spool" your text from the disk. This means that you can have edit files that are over 200 type written pages long!

CAN IT UNDERLINE?
CAN IT BOLDFACE?
CAN IT INDENT?
CAN IT HYPHENATE?
YES! YES! YES! YES! AUTOTYPE has ALL the standard Word Processor features including underlining text, boldface printing and paragraph indentation. AUTOTYPE also has soft and hard hyphens. Soft hyphens are used at the end of lines and disappear if moved!

WHAT ABOUT INSERTING IN THE MIDDLE OF A WORD?
Certainly! AUTOTYPE allows inserting anything anywhere! You can move single letters or entire chapters right into the middle of any word. Now THAT'S POWER!

```

```

CAN I SEARCH AND REPLACE?
YES! But, there's more! AUTOTYPE allows simple searches or search and replace. AUTOTYPE also allows wild card characters in the search string for probable matching! A very simple feature that AUTOTYPE makes very powerful!

CAN IT DO AUTOMATIC PAGE NUMBERING AND TITLING?
Of Course! Any length title up to the current line length. Page numbers can start anywhere. And if that's not enough, the number of blank lines below the title is adjustable!

DOES IT HAVE "DYNAMIC" PRINT FORMATTING?
OH YES! And with a flare! The pages that you see printed here were all printed from the same file. Only the print MACRO was altered! What's more, they were all printed on a standard serial printer. Complete "dynamic" print formatting can be accomplished with NO alteration of text!! Let's see the competition make that claim!

CAN IT DO SUBSCRIPTS AND SUPERSSCRIPTS?
YES! Once again, AUTOTYPE has the features to be called a true processor of words and not just another word processor.

CAN IT VERTICAL TAB?
YES! And do negative vertical tabs to the top of page also! This is invaluable for two column printing.

CAN YOU ADJUST THE INDENT, LINE LENGTH AND JUSTIFICATION?
COMPLETELY! Either in the text itself, by manual formatting commands or with a print MACRO. Only AUTOTYPE gives you that kind of choice!

WILL IT EXECUTE A SERIES OF COMMANDS AUTOMATICALLY?
YES! That's one of AUTOTYPE's standard features. No other Word Processor has the ease of use or the powerful commands that AUTOTYPE has.

ARE THE TABS ADJUSTABLE?
All tab stops are displayed graphically with a simple command. Tab removal and setting are simple cursor movements and a single key command! No more "guessing" where your tabs are set. They're all laid out in front of you!

HOW MUCH DOES AUTOTYPE COST?
$195. This question is the easiest to answer. It's simple. We want you to use your computer to its fullest extent. And we want you to be able to do it at a reasonable price. This is the one area where our competition is way ahead of us!! They simply charge more than we do!

HOW DO I ORDER?
We thought you'd never ask! Just fill out the order form below and mail to INFINITY MICRO. Or call us directly and place your order. It'll be shipped the same day.

```

```

CAN I SEARCH AND REPLACE?
YES! But, there's more! AUTOTYPE allows simple searches or search and replace. AUTOTYPE also allows wild card characters in the search string for probable matching! A very simple feature that AUTOTYPE makes very powerful!

CAN IT DO AUTOMATIC PAGE NUMBERING AND TITLING?
Of Course! Any length title up to the current line length. Page numbers can start anywhere. And if that's not enough, the number of blank lines below the title is adjustable!

DOES IT HAVE "DYNAMIC" PRINT FORMATTING?
OH YES! And with a flare! The pages that you see printed here were all printed from the same file. Only the print MACRO was altered! What's more, they were all printed on a standard serial printer. Complete "dynamic" print formatting can be accomplished with NO alteration of text!! Let's see the competition make that claim!

CAN IT DO SUBSCRIPTS AND SUPERSSCRIPTS?
YES! Once again, AUTOTYPE has the features to be called a true processor of words and not just another word processor.

CAN IT VERTICAL TAB?
YES! And do negative vertical tabs to the top of page also! This is invaluable for two column printing.

CAN YOU ADJUST THE INDENT, LINE LENGTH AND JUSTIFICATION?
COMPLETELY! Either in the text itself, by manual formatting commands or with a print MACRO. Only AUTOTYPE gives you that kind of choice!

WILL IT EXECUTE A SERIES OF COMMANDS AUTOMATICALLY?
YES! That's one of AUTOTYPE's standard features. No other Word Processor has the ease of use or the powerful commands that AUTOTYPE has.

ARE THE TABS ADJUSTABLE?
All tab stops are displayed graphically with a simple command. Tab removal and setting are simple cursor movements and a single key command! No more "guessing" where your tabs are set. They're all laid out in front of you!

HOW MUCH DOES AUTOTYPE COST?
$195. This question is the easiest to answer. It's simple. We want you to use your computer to its fullest extent. And we want you to be able to do it at a reasonable price. This is the one area where our competition is way ahead of us!! They simply charge more than we do!

HOW DO I ORDER?
We thought you'd never ask! Just fill out the order form below and mail to INFINITY MICRO. Or call us directly and place your order. It'll be shipped the same day.

```

Word Processors are here. Just thumb through the pages of this magazine. There are at least five different companies selling them. So, which one's for you? How do you judge the differences? And what about cost. Are you willing to pay the 300 plus dollars that some of the companies are asking?

Well go ahead and compare! AUTOTYPE comes out ahead in EVERY category!

Features? AUTOTYPE has more powerful features than ANY other Word Processor on the market. But, don't take our word. Go ahead, compare! AUTOTYPE has an exclusive MACRO programming capability. No other Word Processor can make that claim. AUTOTYPE also has a scratch Holding Buffer. Again, no one else even comes close.

Price? AUTOTYPE beats 'em all! With a price tag of \$195, AUTOTYPE is well below the competition. But, again, don't just take our word. Go ahead, look for yourself. Then fill out the order form below to start processing words instead of using a word processor!

**CAN I MOVE PARAGRAPHS AROUND?**

YES! AUTOTYPE has a Holding Buffer that can be used to save any amount of text and then Unhold it to the location you want. AUTOTYPE even allows you to do multiple Unholds!

**CAN I MERGE CUSTOMERS NAMES INTO LETTERS?**

YES! AUTOTYPE contains a "merge" character that may be placed anywhere in text. Then, at the time text is printed, a separate file may be merged into the letter and then printed! Another feature that NO OTHER WORD PROCESSOR has!

**CAN I ENTER TEXT IN SOME OTHER FORMAT THAN 64 CHARACTERS WIDE?**

YES! AUTOTYPE has a screen redimension command. The screen can be set from 16 characters wide to 120 characters wide. There's even horizontal scrolling to view the text! Once more, we're far beyond the competition!

**CAN IT HANDLE TEXT LARGER THAN MY COMPUTERS MEMORY?**

YES! Most other Word Processors demand that the entire text be inside the computer. AUTOTYPE allows you to "spool" your text from the disk. This means that you can have edit files that are over 200 type written pages long!

**CAN IT UNDERLINE?  
CAN IT BOLDFACE?  
CAN IT INDENT?  
CAN IT HYPHENATE?**

YES! YES! YES! YES! AUTOTYPE has ALL the standard Word Processor features including underlining text, boldface printing and paragraph indentation. AUTOTYPE also has soft and hard hyphens. Soft hyphens are used at the end of lines and disappear if moved!

**WHAT ABOUT INSERTING IN THE MIDDLE OF A WORD?**

Certainly! AUTOTYPE allows inserting anything anywhere! You can move single letters or entire chapters right into the middle of any word. Now THAT'S POWER!

**CAN IT SEARCH AND REPLACE?**

YES! But, there's more! AUTOTYPE allows simple searches or search and replace. AUTOTYPE also allows wild card characters in the search string for probable matching! A very simple feature that AUTOTYPE makes very powerful!

**CAN IT DO AUTOMATIC PAGE NUMBERING AND TITLING?**

Of Course! Any length title up to the current line length. Page numbers can start anywhere. And if that's not enough, the number of blank lines below the title is adjustable!

**DOES IT HAVE "DYNAMIC" PRINT FORMATTING?**

OH YES! And with a flare! The pages that you see printed here were all printed from the same file. Only the print MACRO was altered! What's more, they were all printed on a standard serial printer. Complete "dynamic" print formatting can be accomplished with NO alteration of text!! Let's see the competition make that claim!

**CAN IT DO SUBSCRIPTS AND SUPERSSCRIPTS?**

YES! Once again, AUTOTYPE has the features to be called a true processor of words and not just another word processor.

**CAN IT VERTICAL TAB?**

YES! And do negative vertical tabs to the top of page also! This is invaluable for two column printing.

**CAN YOU ADJUST THE INDENT, LINE LENGTH AND JUSTIFICATION?**

COMPLETELY! Either in the text itself, by manual formatting commands or with a print MACRO. Only AUTOTYPE gives you that kind of choice!

**WILL IT EXECUTE A SERIES OF COMMANDS AUTOMATICALLY?**

YES! That's one of AUTOTYPE's standard features. No other Word Processor has the ease of use or the powerful commands that AUTOTYPE has.

**ARE THE TABS ADJUSTABLE?**

All tab stops are displayed graphically with a simple command. Tab removal and setting are simple cursor movements and a single key command! No more "guessing" where your tabs are set. They're all laid out in front of you!

**HOW MUCH DOES AUTOTYPE COST?**

\$195. This question is the easiest to answer. It's simple. We want you to use your computer to its fullest extent. And we want you to be able to do it at a reasonable price. This is the one area where our competition is way ahead of us!! They simply charge more than we do!

**HOW DO I ORDER?**

We thought you'd never ask! Just fill out the order form below and mail to INFINITY MICRO. Or call us directly and place your order. It'll be shipped the same day.

# WORD PROCESSING POWER IS HERE! With AUTOTYPE®

Mail To:  
**INFINITY MICRO**  
P.O. BOX 4627  
SANTA CLARA, CA 95050  
(408) 988-1867

**VIDEO**

- Memory mapped Video at CC00 hex. as 64 characters by 16 lines. Processor Tech or equivalent.
- \*Cursor addressable terminal. (ADM-3A)
- \*Cursor addressable terminal. (HAZELTINE 1500)

**DISK**

- CP/M on IBM standard 8"
  - CP/M on Micropolis MOD I
  - CP/M on Micropolis MOD II
  - CP/M on North Star
  - CP/M on Double Density 8"
- Please specify Manufacturer.

NAME \_\_\_\_\_  
ADDRESS \_\_\_\_\_  
CITY \_\_\_\_\_ STATE \_\_\_\_\_ ZIP \_\_\_\_\_  
PHONE \_\_\_\_\_

Please ship \_\_\_\_\_ AUTOTYPE disks and manuals immediately! Please find enclosed \$ \_\_\_\_\_ @ \$195/each.  
\*Available Nov-Dec of 1979  
Copyright © 1979 Infinity Micro

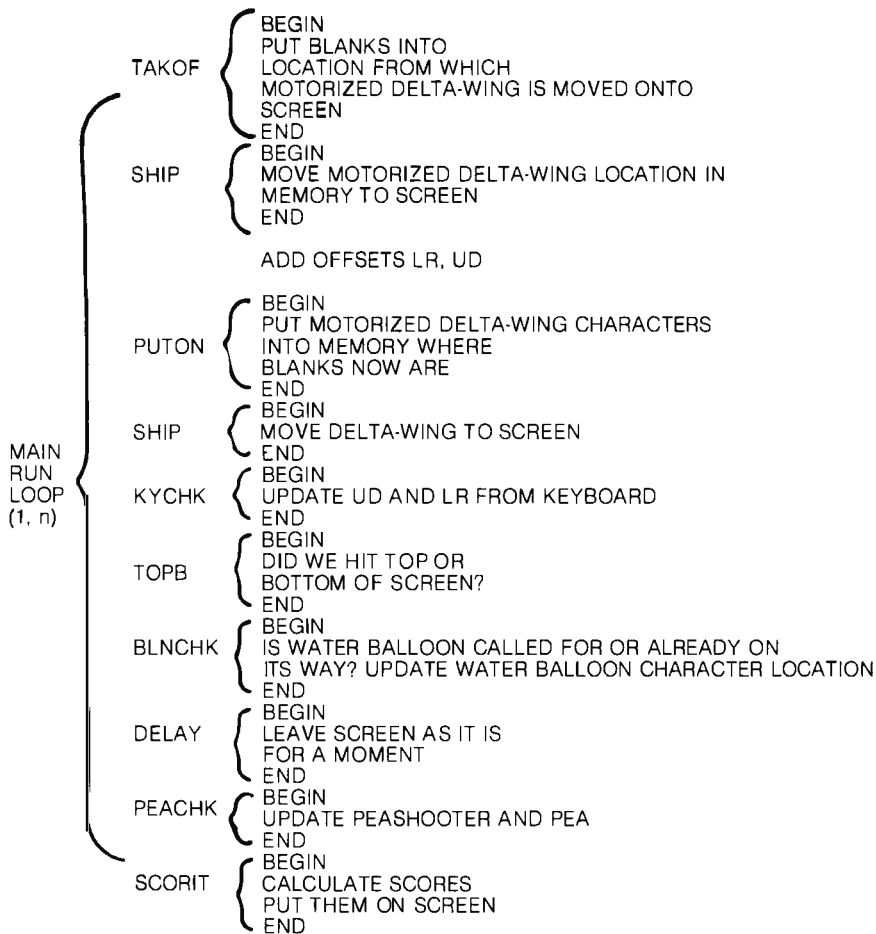

**Figure 3:** A summary of the functions performed in the main loop, along with a definition of the individual tasks executed by each subroutine.

locations, and return. Checking for a hit is done when the ship is displayed.

I hope that playing around with this program will prove to be as much fun for you as it was for me. In order to adapt it to your system, you may need to change the control keys, the clear routine, and the display location, but if you have a SOL-20 it will work as is. If you tackle the development of an animated game, you will find the simple principles embodied in this program will work in much more elaborate games. One final note: when you first play this, you will be positive that it is impossible to win. The "random" peashooter seems to have an incredible sixth sense about where to aim his pea. However, it can be done . . . in fact, my seven-year-old can beat it on speed 1, so hang in there! Good luck, and have fun. ■

## G. W. COMPUTERS LTD.

### This is how your business appears on the screen

Approximately 60-100 entries/inputs require only 2-4 hours weekly and your entire business is under control.

**\*PROGRAMS ARE INTEGRATED —**

- 01 = ENTER NAMES/ADDRESS, ETC
- 02 = \*ENTER/PRINT INVOICES
- 03 = \*ENTER PURCHASES
- 04 = \*ENTER A/C RECEIVABLES
- 05 = \*ENTER A/C PAYABLES
- 06 = ENTER/UPDATE INVENTORY
- 07 = ENTER/UPDATE ORDERS
- 08 = ENTER/UPDATE BANKS
- 09 = EXAMINE/MONITOR SALES LEDGER
- 10 = EXAMINE/MONITOR PURCHASE LEDGER
- 11 = EXAMINE/PRINT INCOMPLETE RECORDS
- 12 = EXAMINE PRODUCT SALES

**SELECT FUNCTION BY NUMBER**

- 13 = PRINT CUSTOMER STATEMENT
- 14 = PRINT SUPPLIER STATEMENTS
- 15 = PRINT AGENT STATEMENTS
- 16 = PRINT TAX STATEMENTS
- 17 = PRINT WEEK/MONTH SALES
- 18 = PRINT WEEK/MONTH PURCHASES
- 19 = PRINT YEAR AUDIT
- 20 = PRINT PROFIT/LOSS ACCOUNT
- 21 = UPDATE END MONTH FILES
- 22 = PRINT CASH FLOW FORECAST
- 23 = ENTER/UPDATE PAYROLL (NOT YET AVAILABLE)
- 24 = RETURN TO BASIC

**WHICH ONE? (ENTER 1-24)**

Each program goes to sub menu, e.g.:

- (9) allows: A. LIST ALL SALES; B. MONITOR SALES BY STOCK CODES;
- C. RETRIEVE INVOICE DETAILS; D. AMEND LEDGER FILES;
- E. LIST TOTAL ALL SALES.

Think of the possibilities and add to those here if you wish.

Price for current package Version 1 is \$550, or Version 2 (including aged debtors analysis, etc.) is \$750, or full listing, \$300.  
**PET 16/32K disk-based version, SWTP 6800, IMS/CPM/Z80/S-100. Compatible systems shortly available for Apple and Tandy.**

PET Software Distributor for USA is:  
 Grass Valley Computer Sys  
 P O Box 678  
 Rough & Ready, CA 95795  
 (916) 272-2793

Contact: **Tony Winter on 01-636-8210**  
**89 Bedford Court Mansions**  
**Bedford Avenue**  
**London W1, UK**

Z80/CPM Software Distributor for USA is:  
 Owens Associates  
 12 Shubert Street  
 Staten Island, NY 10405  
 (212) 448-6283



## NOW YOU CAN OWN A SMALL COMPUTER THAT PAYS FOR ITSELF!

If you've wanted to own your own computer, but didn't think you could afford it, we may have the answer you've been looking for.

Computer Ideas, Inc. has developed a small computer system that can be used for many purposes . . . in business, in the home, and as a source of full or part-time earnings to help you pay for it.

Designed around a Digital PDP-11 computer, our new system features a 3-color matrix plotter/printer (Centronics 102BL) that produces sharp, graphic printouts in color on standard computer paper in minutes.

The equipment is reliable, versatile, and easy to operate. It can be used in business to relieve you of a lot of paperwork. And in the home for money management, fun and games, learning, and more.

The key to making it pay for itself is its capability to produce color pictures or portraits that can be transferred to tops, T-shirts, jackets and other apparel. There is nothing else like it on the market today, and many owners have discovered it to be a proven moneymaker in high-traffic areas such as shopping malls, resort areas, fairs, and other locations. Everybody is a photo sketch customer! Every sale is for cash! The profit margin is high.

So if you want to own your own computer . . . and put some big dollars in your pocket in your spare time, call or write for more information on how we make it easy for you to do both!

### Computer Ideas, Inc.

10 Keith Way, Hingham, Mass. 02043

(617) 749-9555

### See your nearest dealer

**MASSACHUSETTS**  
Anthony Ghelli  
56 Shady Lane  
Hatchville, Ma 02536  
617-563-9200

**NEW YORK, MAINE,  
NEW HAMPSHIRE,  
SOUTHERN CALIFORNIA**

Computer Ventures, Inc.  
P. O. Box 954  
Acton, Ma 01720  
617-263-8601

**RHODE ISLAND, CONNECTICUT**

Computer Achievements  
Old Northfield Road  
Thomaston, Ct 06787  
203-283-4179

**NEW JERSEY**

KELCO  
2 Mt. Prospect Avenue  
Dover, Nj 07801  
201-361-3331

**VIRGINIA, DELAWARE,  
MARYLAND, WASHINGTON, D.C.,  
WEST VIRGINIA, PENNSYLVANIA**

Baby World  
3700 Old Silver Hill Road  
Marlow Heights, MD 20031  
301-899-2180

**GEORGIA, SOUTH CAROLINA, NORTH  
CAROLINA**

Giant Photos  
P. O. Box 3313  
Anderson, SC 29621  
803-225-6201

**TEXAS, OKLAHOMA**

High Plains Computer Foto  
Rehm Rte. Box 444  
Dalhart, TX 79022  
806-249-2092

**ARIZONA, NEW MEXICO**

Bob Johnson Enterprises  
5008 West Northern Avenue  
Glendale, Arizona 85301  
602-939-9241

**ILLINOIS**

Fairview Computer Foto  
5026 Jarvis Avenue  
Skokie, Ill 60077  
312-673-6146

**COLORADO, KANSAS, MISSOURI**

H & H Joint Venture  
7812 Foster  
Overlook Park, Kansas 66204  
913-341-2200

**MICHIGAN**

Gwen Ross  
3258 Kearsley Lake Drive  
Flint, Michigan 48506  
313-736-2618

**N. CALIFORNIA, UTAH, NEVADA, IDAHO**

A. D. P. Systems  
95 West 100 South  
Logan, Utah 84321  
801-752-2770

Travis Weaver  
Roy, Utah 84067  
801-731-2904

**WESTERN CANADA**

Computer Silhouette, Inc.  
112-6780 Buswell Street  
Richmond, B.C. V6Y 2Y7  
604-278-9758

**EASTERN CANADA and the  
UNITED KINGDOM**

John Cho  
50 Blackwell Avenue, Unit No. 21  
Agincourt, Ontario M1B 1K2  
416-291-7500

John Van Hall  
1300 Young Street, Suite 804  
Toronto, Ontario  
416-929-0715

**FRANCE, HOLLAND, SPAIN**

Martos & Haak International  
Stationsplein 64  
2011 LM Haarlem, The Netherlands  
023-323731 or 023-325803

**GERMANY**

Martin K. Beck  
H. Wolfgang Haug  
7800 Freiburg i.B.R.  
Jacobstrasse 15, West Germany  
04761-250-41

**SWITZERLAND, ITALY, GREECE, AUSTRIA,  
SAUDI ARABIA, TURKEY, BULGARIA,  
RUMANIA, YUGOSLAVIA, HUNGARY, IRAQ,  
JORDAN, SYRIA, KUWAIT, KUTAR, ABU  
DABI, UNITED ARAB EMIRATES**

Micropro, Inc.  
P.O. Box 18, Pilgrim Terrace  
Houghton, Mi 48931  
906-482-8489

**KOREA**

United Young Co., Inc.  
1225 Broadway, Room 804  
New York, N.Y. 10001  
212-889-3523

**AUSTRALIA, NEW ZEALAND**

CGH Business Service  
Unit 10 Wellard  
56-58 Matheson Road  
Applecross, Western Australia 6153  
09-364-7475



# Five Useful Programs for the SC/MP

---

Associate Professor Charles A Kapps  
Temple University  
School of Business Administration  
Philadelphia PA 19122

---

Now that you are the proud owner of one of the least expensive microprocessor kits, what can be done with it? Before that question is answered, why do you own the SC/MP to begin with? You may be someone interested in learning about microprocessors or computers, and since you are a cautious person of modest means, you have chosen to begin slowly.

No computer is useful unless it has a means of communicating with the outside world. The SC/MP is no exception. The SC/MP kit by itself provides no such capability. Thus, some sort of I/O (input/output) hardware must be obtained, such as a teletypewriter. This article assumes that you have the minimum of I/O hardware, probably a video display, which is likely to cost three times as much as the computer. (This is an important thing to know about computers. They are worse than automobiles because the accessories really account for most of the cost. This is even true with the big number-crunching computers).

The main limitation of such a system is it is not feasible to attempt to write very large programs. This is not only because of the SC/MP's rather meager amount of memory (256 bytes). It is also due to the fact that, without any means of assembling, editing, and backing up programs, it becomes humanly impossible to do any serious programming endeavors. For this reason, the programs in this article have been kept short and simple. For more ambitious readers, these programs can be combined or added to in order to accomplish more sophisticated tasks.

## Input and Output on the SC/MP

A thorough search of the manuals provided with the SC/MP kit provides little information about programming input and output functions. Clearly, input and output are possible, because the KITBUG monitor program provided in read only memory is able to perform those functions. The assembly listing of KITBUG, which is provided in the *SC/MP Kit User's Manual*, shows how input and output are accomplished. The input and output portions of the monitor are located at the end of the listing, and occupy hexadecimal locations 186 thru 1FB of the read only memory (over 100 bytes).

The main reason those functions require so much coding is that the SC/MP has neither a parallel I/O port nor an internal universal asynchronous receiver/transmitter (UART), as a more sophisticated processor might. Instead, it is necessary to have a program which simulates the primary functions of a universal asynchronous receiver/transmitter, namely converting between parallel-byte data and asynchronous serial data (ANSI). For example, the output program transmits a 0 (note that the actual bits are inverted). This is the start bit. The program must then idle for 1/110 second because the transmission rate is 110 baud. The least significant bit (LSB) of the data byte is then transmitted, and the program again idles for 1/110 second. This is repeated until all data bits are transmitted. Finally, the program outputs a 1 and idles for 1/55 second for the 2 stop bits needed by a teletypewriter. For input, a similar procedure is operated in reverse.

After study of these programs, it should be possible to imitate these processes and incorporate them into our own programs. Although studying other people's programs is often a good way to learn how to program, copying these programs is not the best thing to do here.

As every good programmer knows, basic processes should be written in the form of subroutines which can be called from various places in the main program. This rule was followed by the writers of KITBUG, and all the various areas of the program assume the form of subroutines. These subroutines can be called from anywhere, including your own program area. In particular, there are 4 subroutines which are useful for all kinds of programs:

PUTC	This subroutine prints a single ASCII character on the output device.
GECO	This program reads 1 character typed in at the keyboard, and returns the ASCII code.
PHEX1 and PHEX2 GHEX	Here are 2 different entry points to a subroutine which converts a byte into a 2-digit hexadecimal number and prints it. This program reads a hexadecimal number of up to 4 digits, and returns the 16-bit value as 2 bytes.

# Get Ready to Make Your Own Magic

Announcement I. The first eight Personal Programs<sup>®</sup> from Aladdin Automation are waiting for you now at your neighborhood computer retailer or direct from Aladdin.

Now you can get your full share of Aladdin magic in every one of these Personal Programs<sup>®</sup>:

**M**ath-Ter-Mind<sup>®</sup> A delightful, educational learning experience for your pre-school child. Watch the smile on your child's face as a correct answer makes the mathematician smile on the screen before you. A nursery song also serves as a reward for learning elementary addition and subtraction. With Aladdin's Math-Ter-Mind<sup>®</sup> your child's pathway to learning will be fun-filled . . . for both of you. Math-Ter-Mind<sup>®</sup> The first release from the Aladdin Education<sup>®</sup> Series. (nursery song currently available only on Apple II<sup>®</sup> program)

**L**unar Lander In a controlled descent, you're just seconds away from your first landing on the cold, forbidding surface of the moon. As you navigate your delicate spacecraft downward to the safety of Moonbase, you must be ever watchful of the dangers rising to meet you with each passing moment: a fuel level fast approaching zero; deadly meteor showers that come from any direction, at any time; sheer-faced rock cliffs and rough terrain; choosing the correct landing pattern and rate of descent. Aladdin's Lunar Lander. Your chance to reach out and touch the stars . . . without leaving the safety and comfort of your own chair. The first release from the Aladdin Simulation<sup>®</sup> Series.

**C**raps All eyes in the casino are on you. The dice are in your hands. Lady Luck sits at your shoulder, whispering . . . "Just one more time Try your luck just one more time." You throw . . . and watch the dice tumbling on the screen. With Aladdin's Craps you play against the computer, so it's awfully tough to win. But when you do, it's an experience you're likely never to forget. Craps. An exciting, heart-pounding Personal Program<sup>®</sup>. The first release from the Aladdin Las Vegas<sup>®</sup> Series.

**M**astermind A challenging game of intrigue, centuries old, that will give you full chance to test your powers of logic, deduction and reason. And test them you will, as you try and solve the computer's puzzle, using clues as they're provided one-by-one. You control the degree of difficulty in this classic Personal Program<sup>®</sup> that offers one simple, yet all-consuming challenge: beat the Mastermind in a direct, one-on-one battle of wits. Aladdin's Mastermind. The first release from the Aladdin Old Favorites<sup>®</sup> Series.

**T**ic-Tac-Toe Five different levels of difficulty allow a person of any age or skill to take part in this relaxing, enjoyable game that can act as a learning tool, as well. Level I, for example, is suitable for children and is excellent also for teaching simple mathematics. The computer plays just about perfectly at Level V. Just about, that is, so go ahead and take your best shot. See if you can beat the computer in this traditional favorite of young and old alike. Tic-Tac-Toe. Another first release from the Aladdin Old Favorites<sup>®</sup> Series.

**J**ungle Island<sup>®</sup> Shipwrecked in a raging storm at sea, miraculously you survive only to find yourself stranded on a seemingly deserted jungle island. Without food, water or supplies of any kind, you begin to try and find your way to safety. The computer will be your eyes and ears as you explore your jungle island and all the mysteries and dangers that lie in wait for you. Jungle Island<sup>®</sup>. A captivating first release from the Aladdin Adventure<sup>®</sup> Series.

**S**tix<sup>®</sup> Aladdin's Stix<sup>®</sup> can be played with 2 to 5 piles of sticks and between 1 and 19 sticks in each pile. The object: to be the one to pick up the last stick. Sounds simple? Yes, but you're playing against the computer. Take heart, though, because you can control the degree of difficulty in this update of the ancient game of Nim. Stix<sup>®</sup>. Another first release from the Aladdin Old Favorites<sup>®</sup> Series.

**S**uper Pro Football<sup>®</sup> Here's your chance to be more than just an armchair quarterback. With Aladdin's Super Pro Football<sup>®</sup> you can replay any Super Bowl game, from the first, between Green Bay and Oakland, to last year's classic victory by Pittsburgh over Dallas. For once you can turn back the clock and go for that one big play that made the difference between victory and defeat in pro football's biggest game of all. Super Pro Football<sup>®</sup>. The first exciting release from the Aladdin Super Pro<sup>®</sup> Series.

Visit your neighborhood computer retailer or contact Aladdin direct to get your full share of the magic in Announcement I, the first eight Personal Programs<sup>®</sup> from Aladdin Automation

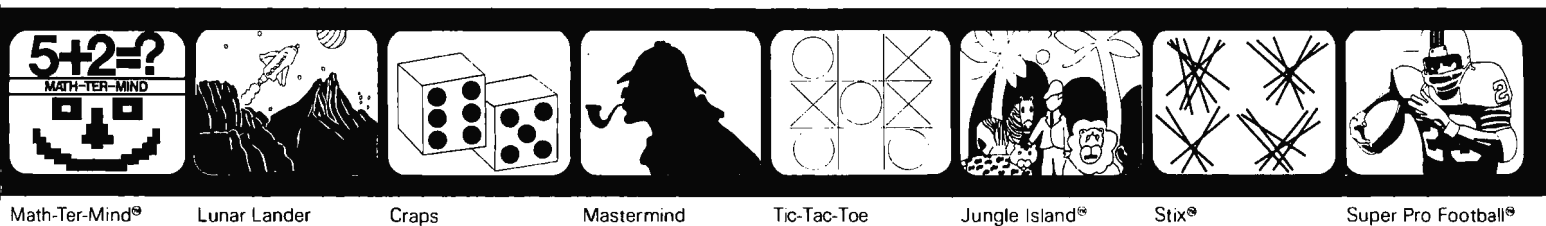

Math-Ter-Mind<sup>®</sup> Lunar Lander Craps Mastermind Tic-Tac-Toe Jungle Island<sup>®</sup> Stix<sup>®</sup> Super Pro Football<sup>®</sup>

Welcome to the All-New World of Aladdin. And Get Ready to Make Your Own Magic



Circle 3 on inquiry card.

## Using System Subroutines

Before these subroutines can be used, or any subroutines written by someone else, you must be familiar with all of the usage conventions of the subroutines. These conventions include:

- how to call and return from the subroutine
- how to pass information back and forth
- special conventions, such as the saving and restoring of registers, temporary storage used, etc

The standard method for calling subroutines in KITBUG is to use pointer register 3 to contain the return address. This is done by loading pointer register 3 with the address of the subroutine. Then execute the instruction XPPC P3; this exchanges pointer register 3 and the program counter. This leads to the subroutine, and since the program counter value at the time of the call is saved in pointer register 3, the subroutine returns the same way it was called, with XPPC P3.

Of special note here is a peculiarity of the SC/MP processor. Most computers increment their program counters between the fetch and execute cycles. In the SC/MP, the program counter is incremented after the execute cycle. This is, in effect, the same as incrementing it just before the next fetch. The result is that whenever a jump is executed (such as the XPPC instruction), the effective address must be one less than the actual address where you want to jump. For example, the PUTC sub-

routine is located at hexadecimal 01C5, so when you call PUTC, you must load 1C4 into pointer register 3.

Note that after control has been returned from the subroutine, pointer register 3 no longer has its initial value. In fact, it has the last value that the program counter had in the subroutine, and thus points to the end of the subroutine. Normally this would mean that pointer register 3 would have to be reloaded in order to call the subroutine a second time. Actually, the writers of KITBUG foresaw this problem, and were kind enough to make life simple. Every return instruction (XPPC P3) is followed by a jump back to the beginning of the subroutine. This allows a subroutine to be called several times, merely by executing XPPC P3 instructions.

The second matter pertaining to subroutine calling conventions is concerned with how data is passed back and forth between the calling program and the subroutine. The first 3 of the subroutines, PUTC, GECO, and PHEX, deal only with a single byte of information. For these subroutines, the byte is simply passed by means of the accumulator. For example, PUTC prints a single character. When PUTC is called, the ASCII code of the character to be printed must be loaded into the accumulator, then the subroutine is called by executing XPPC P3. (It is assumed that pointer register 3 has already been set up.)

For example, the following program segment would cause an A to be displayed:

```
LDI    C4      ; this loads
XPAL   P3      ; 1C4 into pointer register 3
LDI    01      ; note 1C4 = 1C5 - 1
XPAH   P3      ; the location of PUTC
LDI    41      ; 41 is ASCII code for A
XPPC   P3      ; call PUTC
                          ; control is returned here
```

Subroutine GHEX is not quite as simple, because the data being transferred is a 16-bit quantity, and therefore will not fit in the accumulator. The answer to what GHEX does with its results lies in the third category of subroutine conventions: special conventions.

All of the subroutines in KITBUG use a special convention for dealing with temporary data, saving registers, etc. Note that KITBUG cannot use its own program area for storing data. KITBUG resides in read only memory. KITBUG must then be able to use some of the 256 bytes of programmable memory for its storage needs. It does this through a common storage area known as the *stack*. The stack is an array which holds data in a last-in-first-out fashion. The stack resides in the higher addresses of programmable memory, and advances downward as data is added. Pointer register 2 is used to point to the most recently added piece of information on the stack. Since all of the KITBUG subroutines use the stack, pointer register 2 may not be used except in carefully prescribed and compatible ways.

When the program is started, KITBUG loads pointer register 2 from locations 0FFB and 0FFC. (Note that because of the addressing overlap, these locations are the same as 02FB and 02FC.) Unless these locations are

## At last . . . the mechanical interface

Turn your electric typewriter into a low cost, high quality hard copy printer.

30 Day Delivery

User list  
\$439<sup>00</sup>

Dealer Inquiries  
Invited.

Now available with  
interfaces for most  
personal computers:  
TRS-80, Apple, GPIB, etc.



The all new  
I/O Pak from  
Rochester Data,  
Inc. interfaces the keyboard  
of any commercially available  
electric typewriter with any  
computer. The result: low cost, high  
quality hard copy.  
**Write today for more information.**

**ROCHESTER DATA**

Incorporated

3100 Monroe Avenue, Rochester, New York 14618



modified, they will contain 0. Thus, pointer register 2 will initially be 0. When an item is stored on the stack, it is done with the instruction ST @-1(P2). Negative auto-indexing is performed before the effective address is computed. Therefore, the effective address is OFFF. (Note that borrows and carries do not propagate into the most significant 4 bits during effective address computation.) Since the address OFFF is the same as 02FF on the SC/MP, the stack will effectively start at the high end of the programmable memory and proceed downward. This is probably the best place for the stack anyway, so the best thing to do about initializing the stack is nothing.

### Program 1: Output

The first program, listing 1, is a simple program which can be used for checking out the machine. It also illustrates how to use subroutine PUTC.

The program is written in an infinite loop and repeatedly prints a message. The message is stored in the form of an ASCII character string starting at location hexadecimal 0220. An ASCII code for 0 is used to terminate the message. Control characters such as carriage return and line feed must be included in the message. In

the example, the message is simply "HELLO." However, any message could be put in its place. If the I/O (input/output) device is a video display, rather than a teletypewriter, some interesting geometric patterns can often be formed by typing messages with random characters and control characters mixed together.

The functioning of the program is quite simple: locations 200 thru 205 set pointer register 1 equal to 0220, the beginning of the message string. Hexadecimal locations 0206 thru 020B set pointer register 3 to point to PUTC, the printout subroutine. At 020C a character is loaded into the accumulator. Auto-indexing is used, so that repeated executions of this instruction will cause successive characters to be fetched. At 020E there is a jump back to the beginning if the zero end code is reached; otherwise, PUTC is called at location 0210, which causes the character in the accumulator to be printed. Then jump back to 0206 to print the next character. (Note that as stated above, it is not necessary to reload pointer register 3 every time the subroutines are called. Therefore, there could be a jump to location 020C and the program would work just as well. This can be done by changing location 0212 to F9.)

*Text continued on page 178*

*Listing 1: The program will print an ASCII message over and over. The message is a string of ASCII character codes followed by a 0.*

```

1          .NLIST TTM
2          .TITLE PROGRAM #1
3          ;THIS PROGRAM PRINTS OUT A MESSAGE
4          ;OVER AND OVER FOREVER.
5          ;THE MESSAGE TAKES THE FORM OF
6          ;ANY STRING OF ASCII CHARACTER CODES
7          ;FOLLOWED BY A TERMINATION CODE OF ZERO
8          0200      . = 0200
9          0200      C4 20  START:  LDI    ^L<STRING>      ;P1 IS USED AS A
10         0202      31          XPAL   P1                ;POINTER TO THE
11         0203      C4 02          LDI    ^U<STRING>      ;MESSAGE STRING
12         0205      35          XPAH   P1
13         0206      C4 C4  LOOP:   LDI    ^L<PUTC>-1      ;P3 MUST BE ONE LESS
14         0208      33          XPAL   P3                ;THAN THE ADDRESS
15         0209      C4 01          LDI    ^U<PUTC>        ;OF PUTC = 1C5
16         020B      37          XPAH   P3
17         020C      C5 01          LD     @1(P1)          ;GET NEXT CHARACTER
18         020E      9B F0          JZ    START            ;ZERO IS END CODE
19         0210      3F          XPPC   P3                ;OTHERWISE PRINT CHARACTER
20         0211      90 F3          JMP   LOOP            ;AND LOOP
21         0220      . = 0220
22         0220      4B 45  STRING: .ASCII /HELLO<<CR><LF><<0>
23         0222      4C 4C
24         0224      4F 0D
25         0226      0A 00
26         0001      P1=%1
27         0002      P2=%2
28         0003      P3=%3
29         01C5      PUTC=01C5
30         000D      CR=0D
31         000A      LF=0A
32         .END     START

```

#### SYMBOL TABLE

CR	= 000D	LF	= 000A	LOOP	0206
PUTC	= 01C5	P1	= %0001	P2	= %0002
P3	= %0003	START	0200	STRING	0220

ERRORS DETECTED: 0  
FREE CORE: 17525. WORDS

,PROG1=PROG1

# Enhance your computer library with a complete assortment of PAPERBYTE® and BYTE BOOKS™!

**SUPERWUMPUS** is an exciting computer game incorporating the original structure of the WUMPUS game along with added features to make it even more fascinating. Programmed in both 6800 assembly language and BASIC, SUPERWUMPUS is not only addictively fun, but also provides a splendid tutorial on setting up unusual data structures. This is a PAPERBYTE® book.

ISBN 0-07-019342-8  
 Author: Jack Emmerichs  
 Pages: 56  
 Price: \$6.00

**TINY ASSEMBLER 6800:** Version 3.1 has an updated version of the user's guide, the source, object and PAPERBYTE® bar code formats of both Version 3.0 and 3.1. This book is the most complete documentation possible for Jack Emmerichs' Tiny Assembler.

ISBN 0-07-019341-X  
 Author: Jack Emmerichs  
 Pages: 80  
 Price: \$9.00

**RA6800ML: AN M6800 RELOCATABLE MACRO ASSEMBLER** provides the necessary background for coding programs in the 6800 assembly language, and for understanding the innermost operations of the Assembler. The PAPERBYTE® bar code representation of the Assembler's relocatable object file is included.

ISBN 0-07-028056-8  
 Author: Jack E. Hemenway  
 Pages: 184  
 Price: \$25.00

**LINK68: AN M6800 LINKING LOADER** provides everything necessary for the user to easily learn about the system. In addition to the source code and PAPERBYTE® bar code listings, there is a detailed description of the major routines of the Linking Loader, including flowcharts.

ISBN 0-07-024120-1  
 Authors: Robert D. Grappel & Jack E. Hemenway  
 Pages: 72  
 Price: \$8.00

**BASEX**, a new compact, compiled language for microcomputers, has many of the best features of BASIC and the 8080 assembly language—and it can be run on any of the 8080 style microprocessors: 8080, Z-80, or 8085.

Subroutines in the BASEX operating system typically execute programs up to five times faster than equivalent programs in a BASIC interpreter—while requiring only about half the memory space. The author, Paul Warne, has also included a BASEX Loader program which is capable of relocating programs anywhere in memory.

This is a PAPERBYTE® book.  
 ISBN 0-07-068290-9  
 Author: Paul Warne  
 Pages: 88  
 Price: \$8.00

**TRACER: A 6800 DEBUGGING PROGRAM** includes a reprint of "Jack and the Machine Debug" (from the December 1977 issue of BYTE magazine), TRACER program notes, complete assembly and source listing in 6800 assembly language, object program listing, and machine readable PAPERBYTE® bar codes of the object code.

ISBN 0-07-024121-X  
 Authors: Robert D. Grappel & Jack E. Hemenway  
 Pages: 24  
 Price: \$6.00

**MONDEB: AN ADVANCED M6800 MONITOR-DEBUGGER** features ease of use and minimum memory requirements while retaining maximum versatility. The result is an extremely versatile program. The size of the entire MONDEB is less than 3K. This is a PAPERBYTE® book.

ISBN 0-07-049556-4  
 Author: Don Peters  
 Pages: 88  
 Price: \$5.00



# PAPERBYTE BOOKS are BYTE BOOKS with bar codes included!

**BAR CODE LOADER** contains the general bar code loader algorithm description in flowchart form plus detailed assemblies of program code for 6800, 6502, and 8080 processors. Individuals with computers based on these processors can use the software directly. Individuals with other processors can use the provided functional specifications and detail examples to create equivalent programs. This is a PAPERBYTE® book.

ISBN 0-07-008856-X  
Author: Ken Budnick  
Pages: 32  
Price: \$2.00

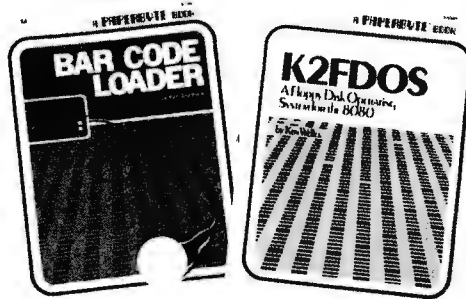

**K2FDOS: A FLOPPY DISK OPERATING SYSTEM FOR THE 8080.** K2FDOS is a complete software package and includes all the information and specific routines necessary to bootstrap and run a powerful floppy disk operating system on an 8080-based microcomputer. This small (4K), but powerful, system includes many of the file handling features of large operating systems. It comes complete with source code listings in the hexadecimal format, and machine readable (PAPERBYTE® bar code format listings for individual K2FDOS programs.

ISBN 0-07-069206-8  
Author: Kenneth B. Welles  
Pages: 192  
Price: \$20.00

## The following BYTE BOOKS are collections of favorite articles from past issues of BYTE magazine, plus new material.

**THE BYTE BOOK OF COMPUTER MUSIC** combines the best computer music articles from past issues of BYTE magazine with exciting new material—all written for the computer experimenter interested in this fascinating field.

An ardent do-it-yourselfer or armchair musicologist will find this book to be a useful addition to the library.

ISBN 0-07-043097-7  
Editor: Christopher P. Morgan  
Pages: 144  
Price: \$10.00

**CIARCIA'S CIRCUIT CELLAR** offers a detailed look at the marvelous projects which let you do useful things with your microcomputer. Each article is a complete tutorial. Using amusing anecdotes to introduce the articles and an easy-going style, Steve presents each project so that even a neophyte need not be afraid to try it.

ISBN 0-07-010960-5  
Author: Steve Ciarcia  
Pages: 128  
Price: \$8.00

**PROGRAMMING TECHNIQUES** is a series of collected articles concerned with the art and science of computer programming. The first volume in the Programming Techniques series is entitled PROGRAM DESIGN. The purpose of the book is to provide the personal computer user with the techniques needed to design efficient, effective, maintainable programs.

ISBN 0-07-037825-8  
Editor: Blaise W. Liffick  
Pages: 96  
Price: \$6.00

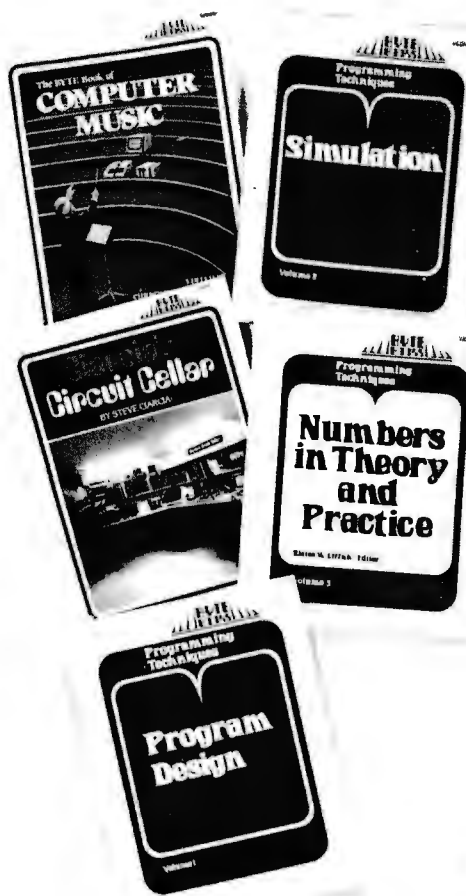

**SIMULATION** is the second volume in the Programming Techniques series. Both theoretical and practical applications are included. Particularly stressed is simulation of motion, including wave motion and flying objects, and the use of simulation for experimentation.

ISBN 0-07-037826-6  
Editor: Blaise W. Liffick  
Pages: 126  
Price: \$6.00

**NUMBERS IN THEORY AND PRACTICE** is the third book in the series. It includes information of value to both the novice and the experienced personal computer user. The mechanics of the binary system are discussed, including software division and multiplication, as well as floating point numbers, numerical methods, random numbers, and the mathematics of computer graphics.

ISBN 0-07-037827-4  
Editor: Blaise W. Liffick  
Pages: 192  
Price: \$8.95

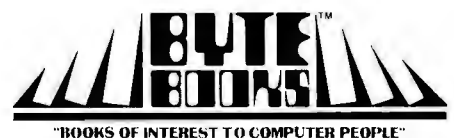

To order PAPERBYTE or BYTE BOOKS use attached card.

Please allow six to eight weeks for processing your order.

BYTE BOOKS Division • 70 Main Street • Peterborough, New Hampshire 03458



# Teratek's

## POSTMASTER

# Tomorrow's mail system. Today.

One package does it ALL.

Postmaster offers the most powerful and flexible mail-management system available.

**Batch Entry:** Entering names and addresses to a mailing list is simple. Repeated elements of a record need only be entered once.

**Powerful Record Extraction:** Used in conjunction with the **Optional Reference Field**, this feature allows simple creation of user specified "target-files."

**Dedicated Record Editor:** List, modify or delete records. Allows intact or extracted backup of original file.

**Automatic "ID" Field Insertion:** (optional) Key in a name, and a unique 10 character record identifier will be entered automatically to the Reference area.

**Envelopes:** Postmaster prepares single or continuous envelopes.

**Mailing Labels:** Standard or user-specified formats up to five across are supported by Postmaster. User may specify any number of labels per name.

**Form Letters:** Prepare and edit form letters in a variety of formats, on either single or continuous forms. Optional capability of allowing text or salutation "Inserts" for some or all letters in any print run.

**Dedicated Record Sorting:** Sorted files are re-written to disk. The sort may be in either ascending or descending order. Uses the FAST Shell-Metzner sorting algorithm.

**Attractive Reports:** Neat, paginated reports on either 80 or 132 column paper. The 80 column option allows your CRT to provide an attractive report display.

**Clear, Complete Documentation:** The manual will explain in simple English how to get started right away. Sample data and form-letter files are included on the disk to allow new users to experiment (learn) quickly.

**Quality That's Affordable and Available:** The Postmaster programs are available in a variety of 5" and 8" disk formats (40k of RAM, CP/M and CBASIC2 are required). Among the formats supported are TRS-80, North Star, Heath H8 and H89, standard 8" IBM, Vector MZ and other CP/M derivatives capable of running CBASIC.

COMPLETE PACKAGE: \$150. MANUAL ALONE: \$25.

(Credited toward subsequent purchase)

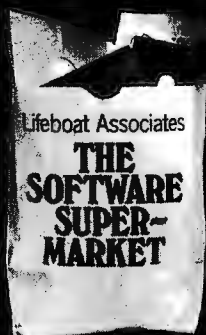

LIFEBOAT ASSOCIATES

2248 Broadway, New York, N.Y. 10024 ☐ (212) 580-0082 ☐ Telex: 668585

*Text continued:*

In order to run this, or any program in this article, it is necessary to initialize the register save locations of KITBUG. These are OFF7 thru OFFF. (In the kit setup these are equivalent to 02F7 thru 02FF.) Locations OFF7 and OFF8 should contain 0200 (02 in OFF7, 00 in OFF8). The remaining locations, especially OFFB and OFFC (the stack initialization), should contain 0. Typing G to KITBUG then causes the program to run.

### Program 2: Output and Input

The second program, listing 2, is much longer than the first, but is not conceptually more complex. This program combines some message printout with some input.

The program is designed to do the following: first, it prints out HELLO, I'M A COMPUTER, WHO ARE YOU? The computer then waits for a name to be typed, such as JOHN DOE. It responds HI, JOHN DOE, I'M PLEASSED TO MEET YOU, and jumps back to the monitor. The initialization registers are saved, so that the program can be rerun by simply typing G.

The input is managed by subroutine GECO. GECO is called by executing XPPC P3, as usual. Routine GECO waits until something is typed at the keyboard. It then returns to the program with the ASCII code for the character typed in the accumulator.

Printout for program 2 is handled by a subroutine of my own called PRINT. This is found starting at line 49 of the listing. PRINT is basically the same as program 1, but modified to have the form of a subroutine. Instead of looping endlessly, when done printing a message, it returns from where it was called. Note that PRINT calls PUTC. Whenever a subroutine calls another subroutine, pointer register 3 must be saved for the return. PRINT uses the stack for this purpose. Note the basic rules for using the stack. Whatever is added to the stack by a subroutine must be removed before exiting. PRINT uses pointer register 1 to point to the message it is printing. Pointer register 1 must be set by the main program before PRINT is called.

The first thing program 2 does is to save pointer register 3. The reason is that KITBUG treats the program as if it were a subroutine. Saving pointer register 3 makes it possible to return to KITBUG when it is done. There is a catch, however. Because of the peculiarity of how the SC/MP treats the program counter, KITBUG must subtract 1 from the number in memory locations OFF7 and OFF8 before using it as a jump address. Unfortunately, this will get you into a loop if you try to get subsequent entries to the program by typing G a second time. The problem is that KITBUG does not add 1 back on to the program counter value when you return. To get around this, put 200 into pointer register 3, and then return using an XPPC P1. This fools KITBUG into working properly. The rest of the program is straightforward, and consists of calls to PRINT and GECO.

To keep this program as short as possible, advantage was often taken of the fact that registers (particularly the high-order parts of pointer registers) already contain the right value. Thus, these registers are not reloaded. This saves 2 or 3 bytes of program here and there, and since the programs are being entered into the computer by

Listing 2: This program outputs a prompt, accepts some input, and then outputs another message which has your input embedded.

```

1          .NLIST TTM
2          .TITLE PROGRAM #2
3          ;THIS PROGRAM TYPES A MESSAGE
4          ;PROMPTING YOU TO TYPE SOMETHING.
5          ;IT THEN ANSWERS WITH A MESSAGE
6          ;WHICH HAS YOUR TYPEIN IMBEDDED.
7
8          0200      . =200
9          0200      C4 3E  START:  LDI    ^L<PRINT>-1    ;SET UP TO
10         0202      33          XPAL   P3              ;CALL THE
11         0203      CE FF          ST     @-1(P2)        ;PRINT SUBROUTINE
12         0207      C4 02          LDI    ^U<PRINT>      ;BUT SAVE THE OLD
13         0208      37          XPAH   P3              ;VALUE OF P3 ON
14         020A      CE FF          ST     @-1(P2)        ;THE STACK
15         020C      C4 60          LDI    ^L<MSG1>       ;SET P1
16         020D      31          XPAL   P1              ;TO POINT
17         020F      C4 02          LDI    ^U<MSG1>       ;TO
18         0210      35          XPAH   P1              ;FIRST MESSAGE
19         0211      3F          XPPC   P3              ;CALL PRINT
20         0213      C4 85          LDI    ^L<GECO>-1     ;SET UP
21         0214      33          XPAL   P3              ;TO CALL
22         0216      C4 01          LDI    ^U<GECO>       ;INPUT ROUTINE
23         0217      37          XPAH   P3              ;IN KITBUG
24         0219      C4 90          LDI    ^L<MSG2>       ;P1 POINTS TO INPUT
25         021A      31          XPAL   P1              ;BUFFER (HIGH PART OF P1 OK)
26         021B      3F          XPPC   P3              ;CALL GECO
27         021D      CD 01          ST     @1(P1)         ;SAVE CHARACTER IN BUFFER
28         021F      E4 0D          XRI   CR             ;COMPARE WITH CR
29         0221      9C F9          JNZ   LOOP           ;LOOP UNTIL CR TYPED
30         0223      CD FF          ST     @-1(P1)        ;CHANGE CR TO ZERO
31         0225      C4 3E          LDI    ^L<PRINT>-1     ;SET UP CALL
32         0226      33          XPAL   P3              ;TO PRINT AGAIN
33         0228      C4 02          LDI    ^U<PRINT>      ;
34         0229      37          XPAH   P3              ;
35         022B      C4 B0          LDI    ^L<MSG3>       ;P1POINTS TO MESSAGE 3
36         022C      31          XPAL   P1              ;(HIGH PART OF P1 OK)
37         022D      3F          XPPC   P3              ;CALL PRINT
38         022E      C4 90          LDI    ^L<MSG2>       ;P1 POINTS TO BUFFER
39         0230      31          XPAL   P1              ;(HIGH PART STILL OK)
40         0231      3F          XPPC   P3              ;CALL PRINT
41         0233      C4 C0          LDI    ^L<MSG4>       ;P1 POINTS TO MESSAGE 4
42         0234      31          XPAL   P1              ;(HIGH PART STILL OK)
43         0235      3F          XPPC   P3              ;CALL PRINT
44         0237      C6 01          LD     @1(P2)        ;GET ORIGINAL P3 OFF
45         0238      35          XPAH   P1              ;STACK AND PUT IN P1
46         023A      C6 01          LD     @1(P2)        ;WE HAVE TO DO FUNNY
47         023B      31          XPAL   P1              ;BUSINESS WITH P3 SO THAT
48         023D      C4 00          LDI    0             ;IT WILL EQUAL 200
49         023E      33          XPAL   P3              ;FOR RESTART (HIGH ORDER PART OK)
50         023F      3D          XPPC   P1              ;RETURN TO KITBUG
51         0241      C4 C4  PRINT:  LDI    ^L<PUTC>-1     ;PRINT SUBROUTINE
52         0242      33          XPAL   P3              ;P3 IS SET TO PUTC
53         0244      CE FF          ST     @-1(P2)        ;BUT IS ALSO SAVED
54         0246      C4 01          LDI    ^U<PUTC>       ;ON STACK FOR
55         0247      37          XPAH   P3              ;RETURN
56         0249      CE FF          ST     @-1(P2)        ;
57         024B      C5 01  PLOOP:  LD     @1(P1)         ;GET CHARACTER
58         024D      98 03          JZ    POUT          ;DONE IF ZERO
59         024E      3F          XPPC   P3              ;OTHERWISE CALL PUTC
60         0250      90 F9          JMP   PLOOP       ;AND LOOP
61         0252      C6 01  POUT:  LD     @1(P2)        ;RESTORE
62         0253      37          XPAH   P3              ;P3
63         0255      C6 01          LD     @1(P2)        ;FROM
64         0256      33          XPAL   P3              ;STACK
65         0257      3F          XPPC   P3              ;
66         0259      90 E6          JMP   PRINT      ;JI
67         0259      90 E4          JMP   PRINT      ;JUMP BACK IF RECALLED
68         0260      48 45  . =260
69         0262      4C 4C  MSG1:  .ASCII /HELLO, I'M A COMPUTER.<CR><LF>
70         0264      4F 2C
71         0266      20 49
72         0268      27 4D
73         026A      20 41
74         026C      20 43
75         026E      4F 4D
76         0270      50 55
77         0272      54 45

```

Listing 2 continued on page 180

Listing 2 continued:

```
0274      52 2E
0276      0D 0A
69 0278      57 4B      .ASCIZ  /WHO ARE YOU?<CR><LF>
027A      4F 20
027C      41 52
027E      45 20
0280      59 4F
0282      55 3F
0284      0D 0A
0286      00
70          0290      MSG2=290
71          02B0      .=02B0
72 02B0      0A 0A      MSG3:  .ASCIZ  <LF><LF><LF><LF>/HI /
02B2      0A 0A
02B4      48 49
02B6      21 20
02B8      00
73          02C0      .=02C0
74 02C0      2C 0D      MSG4:  .ASCIZ  /,<CR><LF>/I'M PLEASED TO MEET YOU./
02C2      0A 49
02C4      27 4D
02C6      20 50
02C8      4C 45
02CA      41 53
02CC      45 44
02CE      20 54
02D0      4F 20
02D2      4D 45
02D4      45 54
02D6      20 59
02D8      4F 55
02DA      2E 00
75          0001      P1=%1
76          0002      P2=%2
77          0003      P3=%3
78          000D      CR=0D
79          000A      LF=0A
80          0186      GECO=0186
81          01C5      PUTC=01C5
82          0200      .END      START
```

#### SYMBOL TABLE

CR	= 000D	GECO	= 0186	LF	= 000A
LOOP	021A	MSG1	0260	MSG2	= 0290
MSG3	02B0	MSG4	02C0	PLOOP	0249
POUT	0250	PRINT	023F	PUTC	= 01C5
P1	=%0001	P2	=%0002	P3	=%0003
START	0200				

ERRORS DETECTED: 0

hand, it is worth it. However, in the broader sense of programming, taking advantage of these kinds of savings is not a good practice because it destroys the possibility of incorporating programs into a larger system.

### Program 3: Time

The third program, listing 3, has some practical utility. It is a digital clock. The logic of the program is simple, consisting of one major loop containing a counter and a delay loop. The delay loop is adjusted so that the time around the entire loop is exactly 1 minute. The count is displayed each time through the loop.

This program was designed to produce output for a video display, so each line overwrites the previous line. The program could be modified to produce output on a teletypewriter, by adding a line feed to the output.

Output for this program uses the routine PHEX, which prints out the 2-digit hexadecimal numbers contained in the accumulator. In this case we are dealing with decimal, not hexadecimal, but since the SC/MP has decimal

instructions this only means that neither digit will be greater than 9.

PHEX has two entry points, PHEX1 and PHEX2, the difference being PHEX1 follows its output with a space, and PHEX2 does not. PHEX2 is generally used when a multi-byte number is to be printed. Here two 2-digit numbers for hours and minutes are being printed, so PHEX1 is used. This occurs in lines 8 thru 15 of the program.

The minutes are then incremented. When 60 is reached, go back to 0 and increment the hours. Thirteen hours gets reset to 1.

The program then delays for the remaining part of a minute, and then loops, printing out the next minute's time.

The delay is controlled by the numbers at locations 0228, 022C, and 022E. The numbers shown in the listing worked for the author's own setup, and kept time within a few seconds a day. The timing is controlled by the actual crystal frequency on the SC/MP board. Other



# MICROCOMPUTER BOOKSHELF

## AN INTRODUCTION TO MICROCOMPUTERS

**Volume 0 — The Beginner's Book**  
by Adam Osborne

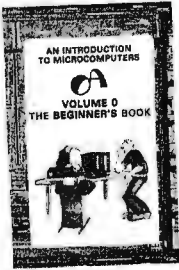

This book introduces computer logic and terminology to the complete beginner in the field of microcomputers. Numerous illustrations and photographs combine with clear, easy-to-follow text to provide an elementary but broad-based background.

#26-8 \$7.95

**Volume 1 — Basic Concepts**  
by Adam Osborne

A must for anyone in the computer field, this best-selling text explains hardware and programming concepts common to all microprocessors.

#02-0 \$9.50

**Volume 2 — Some Real Microprocessors**  
by Adam Osborne et al.

This unique reference provides objective descriptions of virtually every microprocessor on the market today. Lets you know what's available, how they work (or don't work), and how to use them. Loose-leaf. Binders and yearly updates (six issues) sold separately.

Vol. 2 book, 1978 ed. #15-2 \$25.00  
Vol. 2 binder #16-0 \$ 5.00  
Vol. 2 1978/79 updates #97 \$25.00  
Vol. 2 1979/80 updates #94 \$25.00

**Volume 3 — Some Real Support Devices**  
by Jerry Kane et al.

Same objective, in-depth coverage as Volume 2, but applied to support devices: memory, data converters, data communication devices, direct memory access controllers, busses, and much more. Loose-leaf. Binders and yearly updates (six issues) sold separately.

Vol. 3 book, 1978 ed. #18-7 \$15.00  
Vol. 3 binder #19-5 \$ 5.00  
Vol. 3 1978/79 updates #98 \$25.00  
Vol. 3 1979/80 updates #95 \$25.00

## RUNNING WILD - THE NEXT INDUSTRIAL REVOLUTION

by Adam Osborne

A 24-hour work week? Bionic man? Job redistribution? No one should miss this enlightening survey of the microelectronics industry and forecast for the future. Photos and illustrations. Intended for all audiences.

#28-4 \$3.95

## OSBORNE SOFTWARE

**Some Common BASIC Programs**  
by Lon Poole et al.

76 short practical programs, most of which can be used on any microcomputer with any version of BASIC. Complete with listings, remarks, descriptions and examples. Special PET cassette and TRS-80 cassette versions.

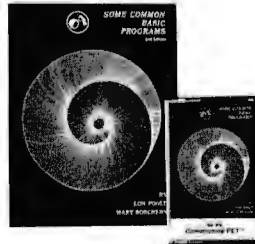

SCBP book #06-3 \$9.50  
SCBP PET cassette #25-X \$15.00  
SCBP TRS-80 cassette #32-2 \$15.00

## CBASIC

Payroll with Cost Accounting - CBASIC #22-5 \$15.00  
Accounts Payable/Receivable - CBASIC #23-3 \$15.00  
General Ledger - CBASIC #24-1 \$15.00

**OSBORNE/McGraw-Hill**

## ASSEMBLY LANGUAGE PROGRAMMING

8080A/8085 • 6800 • Z80

6809

**NEW**  
6502

These books explain assembly language programming, the functions of assemblers and assembly instructions, and basic software development concepts. Numerous practical programming examples are included for each. All books by Lance Leventhal.



6502 ALP #27-6 \$9.50  
Z80 ALP #21-7 \$9.50  
6800 ALP #12-8 \$9.50  
8080A/8085 ALP #10-1 \$9.50  
6809 ALP (check box below to be notified of availability)

## Also:

Z80 Programming for Logic Design #11-X \$9.50  
6800 Programming for Logic Design #05-5 \$9.50  
8080 Programming for Logic Design #04-7 \$9.50



Please notify me when 6809 ALP is available.

NAME: \_\_\_\_\_

ADDRESS: \_\_\_\_\_

CITY: \_\_\_\_\_ STATE: \_\_\_\_\_

ZIP: \_\_\_\_\_ PHONE: \_\_\_\_\_



**OSBORNE/McGraw-Hill, Inc.**

630 Bancroft Way, Dept. 126

Berkeley, CA 94710

(415) 548-2805

TWX 910-366-7277

Book/Cassette #	Price	Quantity	Amount
#			
#			
#			
#			
			Subtotal
			Shipping
			TOTAL

Calif. residents add 6% sales tax.

S.F. BART residents add 6-1/2 % sales tax.

No tax on update subscriptions.

California residents tax

**SHIPPING** (Shipping for large orders to be arranged)

- All foreign orders \$4.00 per item for airmail
- No charge in the U.S. on update subscriptions.
- \$0.45 per item 4th class in the U.S. (allow 3-4 weeks)
- \$0.75 per item UPS in the U.S. (allow 10 days)
- \$1.50 per item special rush shipment by air in the U.S.

For faster shipment or credit card, phone (415) 548-2805

Listing 3: Looping through several time delays is used to keep track of time. This program displays the time accurate to the minute.

```

1          .NLIST TTM
2          .TITLE PROGRAM #3
3          ;THIS PROGRAM DISPLAYS THE
4          ;TIME OF DAY ON A CRT
5          ;THE TIME IS RE-WRITTEN
6          ;EVERY MINUTE
7          0200      .=200
8          0200      C4 3D START: LDI      ^L<PHEX1>-1      ;GET ADDRESS
9          0202      33          XPAL      P3              ;OF NUMERIC
10         0203      C4 01      LDI      ^U<PHEX1>          ;PRINT ROUTINE
11         0205      37          XPAH      P3              ;IN P3
12         0206      C0 39      LD        HOUR            ;GET HOUR
13         0208      3F          XPPC      P3              ;CALL PHEX1
14         0209      C0 37      LD        MINUTE          ;GET MINUTE
15         020B      3F          XPPC      P3              ;CALL PHEX1
16         020C      C0 34      LD        MINUTE          ;GET MINUTE
17         020E      02          CCL              ;CLEAR LINK
18         020F      EC 01      DAI        1              ;ADD ONE
19         0211      C8 2F      ST        MINUTE          ;STORE NEW VALUE
20         0213      EC 40      DAI        40             ;DOES MINUTE = 60?
21         0215      9C 10      JNZ       DELAY           ;NO SO DELAY ONE MINUTE
22         0217      C8 29      ST        MINUTE          ;MINUTE = 0
23         0219      C0 26      LD        HOUR            ;GET HOUR
24         021B      EC 00      DAI        0              ;ADD 1 (LINK = 1)
25         021D      C8 22      ST        HOUR            ;HOUR = HOUR + 1
26         021F      EC 87      DAI        87             ;IS HOUR = 13?
27         0221      9C 04      JNZ       DELAY           ;NO SO DELAY
28         0223      C4 01      LDI        1              ;OTHERWISE
29         0225      C8 1A      ST        HOUR            ;HOUR = 1
30         0227      C4 1E      DELAY: LDI      01E         ;WE WILL DELAY
31         0229      C8 18      ST        COUNT           ;225 = (FF-1E) TIMES
32         022B      C4 22      DL:      LDI      22         ;THEN DELAY
33         022D      8F FF      DLY      OFF             ;131070 MICRO CYCLES
34         022F      A8 12      ILD      COUNT           ;INCREMENT COUNT
35         0231      9C F8      JNZ       DL              ;LOOP UNTIL OVERFLOW
36         0233      C4 C4      LDI      ^L<PUTC>-1        ;GET CHARACTER PRINT
37         0235      33          XPAL      P3              ;IN P3
38         0236      C4 0D      LDI      CR              ;LOAD CARRIAGE RETURN
39         0238      3F          XPPC      P3              ;CALL PUTC
40         0239      90 C5      JMP      START           ;GO BACK TO THE BEGINNING
41         0240      HOUR=240
42         0241      MINUTE=241
43         0242      COUNT=242
44         000D      CR=0D
45         0001      P1=%1
46         0002      P2=%2
47         0003      P3=%3
48         013E      PHEX1=013E
49         01C5      PUTC=01C5
50         0200      .END START

```

#### SYMBOL TABLE

COUNT = 0242	CR = 000D	DELAY 0227
DL = 022B	HOUR = 0240	MINUTE= 0241
PHEX1 = 013E	PUTC = 01C5	P1 = %0001
P2 = %0002	P3 = %0003	START 0200

ERRORS DETECTED: 0

crystals might require different settings. Location 022C has the fine setting; the other values give a coarser setting.

#### Programs 4 and 5: Calculation

Programs 4 and 5, listings 4 and 5, are designed to perform calculator-like arithmetic functions. Program 4 is an

adder, and program 5 is a multiplier. The functions were kept separate in order to make the programs simple; however, an enterprising reader could easily combine the functions into a single program, and even include subtraction and division.

Both programs use the decimal addition instruction, as did program 3. Multiplication is performed in a very sim-

# Assemble Your Christmas List From BITS' List Of The Latest

## Z-80 AND 8080 ASSEMBLY LANGUAGE PROGRAMMING by Kathie Spracklen

For the programmer who has encountered BASIC or FORTRAN and who would like to learn assembly language programming, this book teaches the Z-80 instruction set as a first assembly language. It is a thorough introduction from one of the authors of the successful chess program SARGON. 168pp. \$7.95

## ASSEMBLERS, COMPILERS, AND PROGRAM TRANSLATION by Peter Calingaert

This book is concerned with computer programs which translate other computer programs; assemblers, compilers, macro processors, linkers, interpreters, and loaders. Their structure and function are covered in detail. It's a book for programmers with experience in assembly language and a high level language programming, who are interested in languages or working in microcomputer application systems. 270pp. Hardcover \$17.95

## DESIGNING MICROCOMPUTER SYSTEMS by Udo W. Pooch & Rahul Chattergy

This book discusses the hardware aspects of microcomputer systems. 8080, Z-80, and 6800 based microcomputer systems, their structure and operating characteristics, are covered with chapters on interfacing and on selecting a microcomputer. For those with a minimal background in electronics or computers. 214pp. \$8.95

## BOOLEAN ALGEBRA FOR COMPUTER LOGIC by Harold E. Ennes

A basic introduction to Boolean logic, which is the foundation of computer technology. Binary numbers, truth tables, logic expressions, logic circuits, Venn diagrams, and Karnaugh map techniques for reduction are covered. Practice problems and their solutions are included. Fundamental! 128pp. \$5.50

## PROGRAM DESIGN AND CONSTRUCTION by David A. Higgins

This is a book on structured program design. It relates the fundamental design tools needed to analyze problems and synthesize a logical solution using Warnier-Orr diagramming. Then the techniques for constructing a program from the logical design are presented, using BASIC examples. It is written for the microcomputer system user and details a simple but elegant process by which correct, working programs can be created. 188pp. \$8.95

## 8080/8085 SOFTWARE DESIGN by Titus, Rony, Larsen, & Titus

From the Blacksburg Continuing Education Series, this is an introduction to assembly language programming. The book covers the processors' architecture, their instruction set, its use, and programming techniques for subroutines, math routines, and number base conversion. Their I/O programming techniques include hardware descriptions. Many program examples. 334pp. \$9.50

## THE INTEL DATA BOOK SERIES

From the wizards of Silicon Valley, the people who introduced the microprocessor to the world, here are the details and documentation on their products which are some of the most widely used microcomputer components:

### THE INTEL COMPONENT DATA CATALOG

An information-packed catalog and data book of RAM, ROM, Memory Support, Telecom, Microprocessors and Single Chip Microcomputers, Peripherals, Development systems and more! 980pp. \$5.00

### USER'S MANUALS

User's manuals include hardware data on processors, their support chips and peripheral interface chips; system design information (from the people who designed the components); instruction set details and programming techniques; real application examples illustrating hardware and software use; and system development aid products information.

MCS-80™ User's Manual (8080A microprocessor) 432pp.	\$7.50
MCS-85™ User's Manual (8085A microprocessor) 323pp.	\$5.00
MCS-86™ User's Manual (8086/8086-4 16-bit microprocessor) 204pp.	\$5.00

### THE INTEL PERIPHERAL DESIGN HANDBOOK

All of Intel's microprocessor and microcomputer peripheral interface chips are described: data sheets, applications notes, and article reprints. 542pp. \$5.00

## 32 BASIC PROGRAMS FOR THE PET COMPUTER by Tom Rugg and Phil Feldman

Here are 32 fully documented programs, ready to run on your Commodore PET 2001 computer, including applications programs, educational programs, games, graphic display programs, math programs, and more. The program instructions are detailed enough to allow you to modify any program and sample runs are included. 267pp. \$15.95

## FROM THE COUNTER TO THE BOTTOM LINE by Carl Warren & Merl Miller

Microcomputers are bringing the cost of automated bookkeeping within the budget of many small businesses. This book, by two authors prominent in the microcomputer world, can help you carefully weigh the costs and benefits of computerizing your business system. 289 pp. \$12.95

## 1980 Hayden Computer Calendar

1980 Hayden Computer Calendar

- Full color original computer art
- Complete program for perpetual calendar
- Computer anecdotes



— A perfect Christmas gift for computerists  
\$5.95

### POSTAL CHARGES

1B2119

U.S.: \$.75/book to a maximum of \$3.00  
Foreign: \$1.00/book to a maximum of \$4.00 (surface rate)  
Air Mail (foreign only): \$7.00/book

# BITS™

inc

Books to erase the impossible

25 Route 101 West, PO Box 428, Peterborough, NH 03458



DIAL YOUR BANK CARD ORDERS  
TOLL FREE 800-258-5477

MON-FRI 9-5

(in N.H. dial 924-3355)



Listing 4: Calculator functions can be easily programmed into the SC/MP. This routine inputs 2 numbers and outputs the sum.

```

1          .NLIST TTM
2          .TITLE PROGRAM #4
3          ;THIS PROGRAM ADDS
4          ;TWO NUMBERS, WHEN TYPED IN AS
5          ;"253+792="
6          ;INPUT HAS FOUR DIGIT MAX
7          ;OUTPUT IS FIVE DIGITS
8
9          0200      0200      . = 200
10         0200      C4 DF START: LDI      ^L<GHEX>-1      ;SET P3
11         0202      33          XPAL      P3              ;TO ADDRESS
12         0203      C4 00          LDI      ^U<GHEX>          ;OF
13         0205      37          XPAH      P3              ;GHEX
14         0206      3F          XPPC      P3              ;CALL GHEX TWICE
15         0207      3F          XPPC      P3              ;TO GET TWO NUMBERS
16         0208      02          CCL          ;CLEAR OLD CARRY
17         0209      C2 01          LD        1(P2)          ;GET LOW HALF 2D NO
18         020B      EA 03          DAD      3(P2)          ;ADD TO LOW HALF 1ST NO
19         020D      CA 03          ST        3(P2)          ;STORE AT BOTTOM OF STACK
20         020F      C6 02          LD        @2(P2)         ;GET HIGH HALF 2D NO
21         0211      EA 00          DAD      0(P2)          ;AND BUMP STACK POINTER
22         0213      CA 00          ST        0(P2)          ;ADD HIGH HALF 1ST NO
23         0215      C4 C4          LD        ^L<PUTC>-1      ;STORE ON TOP OF STACK
24         0217      33          LDI      ^L<PUTC>-1      ;P3 SET FOR CHARACTER PRINT
25         0218      C4 30          XPAL      P3              ;HIGH P3 IS OK (REALLY)
26         021A      F4 00          LDI      30              ;GET ASCII 0
27         021C      3F          ADI      0              ;ADD CARRY FOR FIFTH DIGIT
28         021D      3F          XPPC      P3              ;PRINT 0 OR 1
29         021F      C4 43          LD        ^L<PHEX2>-1    ;PRINT 0 OR 1
30         0220      33          XPAL      P3              ;P3 SET FOR BYTE PRINT
31         0222      C6 01          LD        @1(P2)         ;POP HIGH BYTE OFF STACK
32         0223      3F          XPPC      P3              ;AND PRINT
33         0225      C6 01          LD        @1(P2)         ;POP LOW BYTE
34         0226      3F          XPPC      P3              ;AND PRINT
35         0228      C4 C4          LDI      ^L<PUTC>-1    ;P3 SET AGAIN FOR CHARACTERS
36         0229      33          XPAL      P3              ;HIGH P3 STILL OK
37         022B      C4 0D          LD        CR          ;GET CARRIAGE RETURN
38         022C      3F          XPPC      P3              ;PRINT
39         022E      C4 0A          LD        LF          ;GET LINE FEED
40         022F      3F          XPPC      P3              ;PRINT
41         0200      90 CF          JMP      START        ;PRINT
42         0001          P1=%1
43         0002          P2=%2
44         0003          P3=%3
45         000D          CR=0D
46         000A          LF=0A
47         00E0          GHEX=00E0
48         01C5          PUTC=01C5
49         0144          PHEX2=0144
          .END START

```

SYMBOL TABLE

```

CR      = 000D      GHEX = 00E0      LF      = 000A
PHEX2  = 0144      PUTC  = 01C5      P1      = %0001
P2      = %0002    P3     = %0003    START   = 0200

```

ERRORS DETECTED: 0

ple way by repeated addition. Thus  $573 \times 426$  is computed by adding 426 to itself 573 times. This may seem like a very slow procedure, but in fact, the SC/MP is fast enough that computation time does not become noticeable until the multiplier is in the 1000s. The computational delay is then about 1.2 seconds per 1000.

Input to the program is performed using GHEX. This program reads a 4-digit hexadecimal number from the keyboard. Since these numbers are decimal, not hexa-

decimal, this means only that digits greater than 9 must be avoided. Since a 4-digit number cannot fit in 1 byte, GHEX cannot return its answer in the accumulator, as did the other subroutines. GHEX returns the 2-byte result on the stack. (The least significant byte is first, or at the higher address.)

The first 6 lines of both programs cause the data to be read in. Notice that lines 5 and 6 simply call GHEX twice.

*Text continued on page 188*

**RADIO SHACK COMPUTER OWNERS  
TRS-80 MODEL I AND MODEL II**

**TRS-80<sup>TM</sup> MONTHLY NEWSLETTER**

- PRACTICAL APPLICATIONS
- BUSINESS
- GAMBLING • GAMES
- EDUCATION
- PERSONAL FINANCE
- BEGINNER'S CORNER
- NEW PRODUCTS
- SOFTWARE EXCHANGE
- MARKET PLACE
- QUESTIONS AND ANSWERS
- PROGRAM PRINTOUTS
- .... AND MORE

PROGRAMS AND ARTICLES PUBLISHED IN OUR FIRST 12 ISSUES INCLUDE THE FOLLOWING:

- A COMPLETE INCOME TAX PROGRAM (LONG AND SHORT FORM)
- INVENTORY CONTROL
- STOCK MARKET ANALYSIS
- WORD PROCESSING PROGRAM (FOR DISK OR CASSETTE)
- LOWER CASE MODIFICATION FOR YOUR VIDEO MONITOR OR PRINTER
- PAYROLL (FEDERAL TAX WITHHOLDING PROGRAM)
- EXTEND 16-DIGIT ACCURACY TO TRS-80 FUNCTIONS (SUCH AS SQUARE ROOTS AND TRIGONOMETRIC FUNCTIONS)
- NEW DISK DRIVES FOR YOUR TRS-80
- PRINTER OPTIONS AVAILABLE FOR YOUR TRS-80
- A HORSE SELECTION SYSTEM\*\*\*ARITHMETIC TEACHER
- COMPLETE MAILING LIST PROGRAMS (BOTH FOR DISK OR CASSETTE SEQUENTIAL AND RANDOM ACCESS)
- RANDOM SAMPLING\*\*\*BAR GRAPH
- CHECKBOOK MAINTENANCE PROGRAM
- LEVEL II UPDATES\*\*\*LEVEL II INDEX
- CREDIT CARD INFORMATION STORAGE FILE
- BEGINNER'S GUIDE TO MACHINE LANGUAGE AND ASSEMBLY LANGUAGE
- LINE RENUMBERING
- AND CASSETTE TIPS, PROGRAM HINTS, LATEST PRODUCTS COMING SOON (GENERAL LEDGER, ACCOUNTS PAYABLE AND RECEIVABLE, FORTRAN 80, FINANCIAL APPLICATIONS PACKAGE, PROGRAMS FOR HOMEOWNERS, MERGE TWO PROGRAMS, STATISTICAL AND MATHEMATICAL PROGRAMS (BOTH ELEMENTARY AND ADVANCED) ... AND

**FREE WORD PROCESSING PROGRAM (Cassette or Disk)**  
For writing letters, text, mailing lists, etc., with each new subscriptions or renewal.

**LEVEL II RAM TEST -**

Checks random access memory to ensure that all memory locations are working properly.

SEND FOR OUR 36 PAGE SOFTWARE CATALOG (INCLUDING LISTINGS OF HUNDREDS OF TRS-80 PROGRAMS AVAILABLE ON CASSETTE AND DISKETTE) \$2.00 OR FREE WITH EACH SUBSCRIPTION OR SAMPLE ISSUE.

**COMPUTRONICS**  
MATHEMATICAL APPLICATIONS SERVICE™

Box 149 New City, New York 10956



**24 HOUR ORDER LINE**  
**(914) 425-1535**



ONE YEAR SUBSCRIPTION \$24 .....

TWO YEAR SUBSCRIPTION \$48 .....

SAMPLE OF LATEST ISSUE \$ 4 .....

START MY SUBSCRIPTION WITH ISSUE \_\_\_\_\_

(#1 - July 1978 • #7 - January 1979 • #12 - June 1979)

NEW SUBSCRIPTION \_\_\_\_\_ RENEWAL \_\_\_\_\_

CREDIT CARD NUMBER \_\_\_\_\_ EXP. DATE \_\_\_\_\_

SIGNATURE \_\_\_\_\_

NAME \_\_\_\_\_

ADDRESS \_\_\_\_\_

\*\*\* ADD \$6/YEAR (CANADA, MEXICO) · ADD \$12/YEAR AIR MAIL · OUTSIDE OF U.S.A., CANADA & MEXICO \*\*\*

# Our MacroFloppy™ goes twice the distance. For \$695.



Introducing the Micropolis MacroFloppy™:1041 and :1042 disk drive sub-systems. For the S-100/8080/Z-80 bus. Packing 100% more capacity into a 5¼-inch floppy disk than anyone else. 143K bytes, to be exact. For as little as \$695.

The MacroFloppy:1041 comes with the Micropolis Mod I floppy packaged inside a protective enclosure (without power supply). And includes an S-100 controller. Interconnect cable. Micropolis BASIC User's Manual. A diskette containing Micropolis BASIC, and a compatible DOS with assembler and editor. The :1041 is even designed to be used either on your desk top, or to be integrated right into your S-100 chassis.

The MacroFloppy:1042 comes with everything the :1041 has, and more. Such as d.c. regulators, its own line voltage power supply, and, to top it off, a striking cover. Making it look right at home just about anywhere.

Both MacroFloppy systems are fully assembled, tested, burned-in, and tested again. For zero start-up pain, and long term reliability. They're also backed up by our famous Micropolis factory warranty.

And both systems are priced just right. \$695 for the MacroFloppy:1041 and \$795 for the MacroFloppy:1042.

You really couldn't ask for anything more.

At Micropolis, we have more bytes in store for you.

For a descriptive brochure, in the U.S. call or write Micropolis Corporation, 7959 Deering Avenue, Canoga Park, California 91304. Phone (213) 703-1121.

Or better yet, see your local dealer.

## MICROPOLIS™

More bytes in store for you.

Listing 5: As an extension of the addition routine, the multiplication routine inputs 2 numbers and multiplies them.

```

1      .NLIST TTM
2      .TITLE PROGRAM #5
3      ;THIS PROGRAM MULTIPLIES
4      ;TWO NUMBERS WHEN TYPED IN AS
5      ; "357X942"
6      ; INPUT HAS FOUR DIGIT MAX
7      ; OUTPUT IS EIGHT DIGITS
8
9      0200      C4 DF      . = 200      START: LD1      ^L< GHEX> - 1      ; SET P3
10     0202      33                XPAL      P3                ; TO ADDRESS
11     0203      C4 00                LD1      ^U< GHEX>                ; OF
12     0205      37                XPAH      P3                ; CHEX
13     0206      3F                XPPC      P3                ; CALL GHEX TWICE
14     0207      3F                XPPC      P3                ; TO GET TWO NUMBERS
15     0208      C4 06                LD1      6                ; SET UP LOOP
16     020A      C8 65                ST       TEMP                ; TO PUT SIX ZEROS
17     020C      C4 00      L1:      LD1      0                ; ON STACK
18     020E      CE FF                ST       @-1(P2)                ; LAST FOUR ZEROS ARE
19     0210      B8 5F                DLD      TEMP                ; INITIAL PRODUCT
20     0212      9C F8                JNZ      L1                ; FIRST TWO EXTEND MULTIPLICAND
21
22     0214      02                L2:      CCL                ; TO EIGHT DIGITS
23     0215      C2 09                LD       9(P2)                ; CLEAR OLD CARRY
24     0217      EC 99                DAI      99                ; AND SUBTRACT
25     0219      CA 09                ST       9(P2)                ; ONE FROM
26     021B      C2 08                LD       8(P2)                ; MULTIPLIER
27     021D      EC 99                DAI      99                ; BOTH HALVES
28     021F      CA 08                ST       8(P2)                ; IN TENS COMPLIMENT
29     0221      06                CSA                ; THERE IS NO CARRY ON
30     0222      94 13                JP       OUT                ; LAST ADD 0-1 = 9999
31     0224      02                CCL                ; SO GET OUT
32     0225      C6 04                LD       @4(P2)                ; OTHERWISE CLEAR CARRY
33     0227      C4 04                LD1      4                ; TEMPORARILY BUMP STACK BY 4
34     0229      C8 46                ST       TEMP                ; COUNT = 4 DIGITS
35     022B      C6 FF      L3:      LD       @-1(P2)                ; FOR LOOP
36     022D      EA 04                DAD      4(P2)                ; NOW ADD
                                ; MULTIPLICAND TO

```



# MetaFloppy™ goes beyond.

The Micropolis MetaFloppy™ gives you more than four times the capacity of anyone else's 5¼-inch floppy. Because it uses 77 tracks instead of the usual 35.

The field-proven MetaFloppy, with thousands of units delivered, comes in a complete family of models. And, like our MacroFloppy™ family of disk drives, MetaFloppy is designed for the S-100/8080/Z-80 bus.

For maximum capacity, choose our new MetaFloppy:1054 system. Which actually provides you with more than a million bytes of reliable on-line storage. For less money than you'd believe possible.

The MetaFloppy:1054 comes complete with four drives in dual configuration. A controller. Power supply. Chassis. Enclosure. All cabling. A new BASIC software package. And a DOS with assembler and editor. There's even a built-in Autoload ROM to eliminate tiresome button pushing.

If that's more storage than you need right now, try our MetaFloppy:1053, with 630,000 bytes on-line. Or our MetaFloppy:1043, with 315,000 bytes on-line. Either way, you can expand to over a million bytes on-line in easy stages, when you need to. Or want to.

In other words, if your application keeps growing, we've got you covered. With MetaFloppy.

The system that goes beyond the floppy.

For a descriptive brochure, in the U.S. call or write Micropolis Corporation, 7959 Deering Avenue, Canoga Park, California 91304. Phone (213) 703-1121.

Or better yet, see your local dealer.



**MICROPOLIS™**  
More bytes in store for you.

```

37  022F  CA  00          ST      0(P2)      ;PRODUCT AS EIGHT DIGIT
38  0231  B8  3E          DLD     TEMP      ;OR FOUR BYTE ADD
39  0233  9C  F6          JNZ     L3        ;LOOP UNTIL DONE, THEN
40  0235  90  DD          JMP     L2        ;DECREMENT MULTIPLIER AGAIN
41  0237  C4  04  OUT:   LDI     4         ;WHEN DONE
42  0239  C8  36          ST      TEMP     ;PRINT OUT FOUR BYTES
43  023B  C4  43  L4:   LDI     ^L<PHEX2>-1 ;SET P3 TO PHEX2
44  023D  33          XPAL    P3        ;HIGH P3 IS OK
45  023F  C6  01          LD      @1(P2)   ;POP PRODUCT OFF STACK
46  0240  3F          XPPC   P3        ;PRINT
47  0241  B8  2E          DLD     TEMP     ;DECREMENT AND LOOP
48  0243  9C  F6          JNZ     L4        ;NOTE INSTRUCTIONS AFTER L4
49                                     ;CANNOT BE SKIPPED
50  0245  C6  06          LD      @6(P2)   ;BUMP GARBAGE OFF STACK
51  0247  C4  C4          LDI     ^L<PUTC>-1 ;SET P3 TO PUTC
52  0249  33          XPAL    P3        ;HIGH P3 IS OK
53  024A  C4  0D          LDI     CR       ;PRINT CARRIAGE RETURN
54  024C  3F          XPPC   P3        ;THEN
55  024D  C4  0A          LDI     LF       ;LINE FEED
56  024F  3F          XPPC   P3        ;AND
57  0250  90  AE          JMP     START    ;GO BACK TO BEGINNING
58          0270          TEMP=270
59          00E0          GHEX=00E0
60          0144          PHEX2=0144
61          01C5          PUTC=01C5
62          0001          P1=%1
63          0002          P2=%2
64          0003          P3=%3
65          000D          CR=0D
66          000A          LF=0A
67          0200          .END      START

```

## SYMBOL TABLE

```

CR      = 000D      GHEX   = 00E0      LF      = 000A
L1      = 020C      L2     = 0214      L3      = 022B
L4      = 023B      OUT    = 0237      PHEX2  = 0144

```

Listing 5 continued on page 188

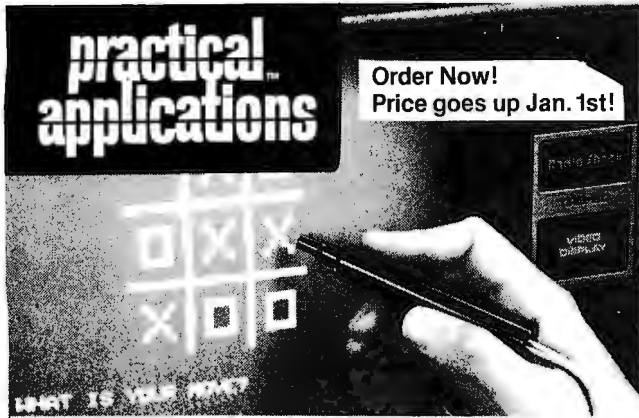

## LIGHT-PEN FOR YOUR TRS-80

**PLUGS RIGHT IN!** Exclusive design includes two sample programs and complete documentation so you can write your own programs in Basic. Long life from standard 9-volt battery. **A bargain at only \$24.95!**

**PRACTICAL APPLICATIONS™** (415) 592-6633  
1313 Laurel Street, Suite 15, San Carlos, Calif. 94070

- Please send me \_\_\_\_\_ TRS-80 Light Pens (\$24.95 each enclosed. Calif. residents add tax).
- Send your catalogs.

Name \_\_\_\_\_

Address \_\_\_\_\_

City \_\_\_\_\_ State \_\_\_\_\_ Zip \_\_\_\_\_

TRS-80 is a trademark of Tandy Corp.

8Y1179

### Dealerships Available

#### MULTI-TERMINAL SMALL BUSINESS COMPUTERS

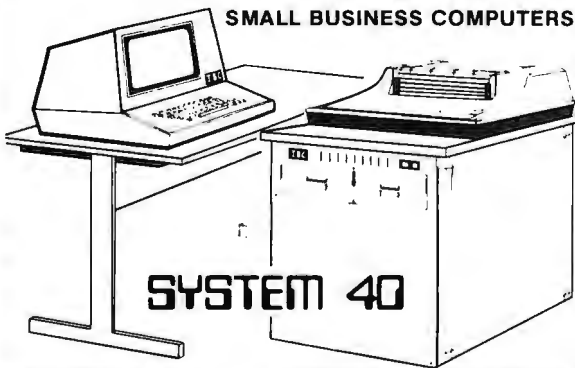

## SYSTEM 40

IBC System 40 with 64K byte memory, 2.4M byte disk storage, cabinet, and multi-user operating system with BASIC	\$4,500	• Up to 6 CRT's/printers can operate independently and simultaneously. System 40 has dynamic memory allocation, reentrant code, and vectored interrupt. Operating system runs foreground, background, interactive, and batch. BASIC has multiple key ISAM.
Additional 2.4M byte disk storage	1,750	
Additional 20M byte disk storage (3rd quarter 1979)	3,600	• Applications software for accounting, order entry/inventory control, and manufacturing available soon.
CRT terminal	895	
Printer 150 cps	1,895	
Character printer (55 cps)	2,695	

#### IBC/INTEGRATED BUSINESS COMPUTERS

22010 Wilmington Ave., Suite 306, Carson, CA 90745

(213) 518-4245 \*Prices are OEM: quantity one

Listing 5 continued:

PUTC = 01C5      P1 = %0001      P2 = %0002  
P3 = %0003      START '0200      TEMP = 0270

ERRORS DETECTED: 0  
FREE CORE: 17525. WORDS

, PROC5= PROC5

Text continued:

This causes 2 numbers to reside in the top 4 locations on the stack. GHEX "knows" a number has been typed when a nonhexadecimal character, such as W, is typed. Thus, to add 2 to 2 with program 4, the programmer could type 2W2W. "2+2 =" could also be typed, which is much more impressive when demonstrating the program. (Note that GHEX always gives a 2-byte result, even though fewer than 4 digits are typed.)

Lines 14 thru 21 add the 2 numbers, leaving the result on the stack. Note that there may be overflow indicating a fifth digit of 1. Lines 22 thru 26 create this fifth digit of 0 or 1 and print it. (Note the comment on line 23. Originally, the high part of pointer register 3 was 00, but GHEX will leave it as 01. *nb* earlier comments on this programming practice.)

Lines 27 thru 32 pop the rest of the sum off the stack and print it. Lines 33 thru 39 type a carriage return and line feed and loop back to the beginning to solve another problem.

Program 5 is designed to produce an 8-digit or 4-byte result, because the product of two 4-digit numbers can have 8 digits. Steps 14 thru 19 form a loop which places 6 0s on the stack. The lower 4 0s form an accumulator for the product. The 2 other 0s combine with the 2-byte multiplicand to extend its precision to 4 bytes or 8 digits. This simplifies addition of the multiplicand to the product accumulation.

Lines 20 thru 39 form a loop for adding the multiplicand to the product accumulator. The multiplier is decremented each time through the loop. Decrementing is accomplished by adding 9999, which is a 10's complement negative 1.

Finally, steps 40 thru 56 print the result and loop back to the beginning. Note that in the loop beginning at line 42, pointer register 3 is reloaded each time through the loop. If this were not done, subsequent calls would end up at PHEX1 rather than PHEX2, and blank spaces would be interspersed in the result.

### Conclusion

The 5 programs described in this article are intended to be simple demonstration programs that can be easily hand loaded into a minimal system. They are also designed to illustrate some of the basic concepts involved in programming the SC/MP. I hope that these programs will give the reader some ideas which can be used to design the applications for the SC/MP. The reader may also be able to apply the concepts of this article to other microcomputer kits, since many of them, such as the KIM-1, have useable system subroutines in read only memory. ■

# Introducing



COMPUTER SHOPPER, the first complete publication listing business, commercial and personal computer equipment is coming this fall with the type of information you can use every month.

Just \$5 brings you a full year of late breaking ads for available equipment, software and accessories for mini, micro and big system computers AND you can run YOUR FIRST CLASSIFIED AD WITHOUT CHARGE under this Charter Subscription offer.

#### EACH ISSUE OF COMPUTER SHOPPER GIVES YOU:

- Ads from individuals, brokers and manufacturers, nationwide
- Categorized ads so you can find them instantly
- Large 11 by 14 easy-to-read format
- Low classified ad rates - 10¢ a word
- Short turn-around advertising time — your ad is in print in 10 days
- Free ad typesetting
- Nationwide circulation guaranteed

COMPUTER SHOPPER is YOUR place to buy or sell any computer equipment because it has been designed after extensive research into the needs and wants of America's computer buyers and sellers.

To reach more than 20,000 computer-owning firms each month, COMPUTER SHOPPER has been launched on a \$78,000 budget by Patch Publications, a proven specialist in reader service

advertising, including its flagship photographic publication, *Shutterbug Ads*.

Using in-house computer facilities and professional typesetting, Patch's experienced production team makes COMPUTER SHOPPER easily affordable for firms and individuals by using modern techniques and large-space advertising to offset normal costs.

EVEN A LIMITED-TIME COMPUTER USER can get any buy, sell or want-to-find message into this nationwide market for a most reasonable cost . . . only 10¢ a word.

And to prove how successful this ad can be for you, this Charter Subscription Offer includes your own complimentary classified ad. Use it to sell your used equipment or to find components you need.

Just select the correct category listed at left, include it, plus your ad wording on a separate sheet . . . then return it with your subscription acceptance.

DON'T MISS a single timely issue of COMPUTER SHOPPER. Send the coupon with your ad today, knowing you can cancel anytime and receive a 100% refund for all unmailed issues.

**COMPUTER SHOPPER**  
P.O. Box F-1, Titusville, FL 32780  
305-269-3211, 8 a.m. - 5 p.m.

#### LIST OF CATEGORIES IN COMPUTER SHOPPER

##### Mini Computers

Burroughs Systems  
Data General Systems For Sale  
Data General Systems Wanted  
Data General, Software, Parts,  
Peripheral  
Datapoint Systems  
Datapoint Software, Parts, Peripheral  
DEC Systems For Sale  
DEC Systems Wanted  
DEC Software, Parts, Peripheral  
IBM Systems For Sale  
IBM Systems Wanted  
NCR Systems  
NCR, Software, Parts, Peripheral  
Misc. Minicomputers (Hardware &  
Software)

##### Micro Computers

Apple Computers For Sale  
Apple Computers Wanted  
Apple, Software, Peripheral  
Northstar Computers

Northstar, Software, Peripheral  
Ohio Scientific  
Ohio Scientific, Software Peripheral  
PET Computers  
PET Software, Peripheral  
TRS-80 Computers For Sale  
TRS-80 Computers Wanted  
TRS-80, Software, Peripheral  
Misc. Microcomputers  
Misc. Microcomputer Software,  
Peripheral

##### Peripheral & Misc. Equipment

Card Readers  
Disc Drives  
Line Printers  
Punched Card Equipment  
Tape Drives  
Crt's  
Misc. Equipment  
Misc. Large Systems  
Misc. Software  
Misc. Accessories & Supplies

#### SPECIAL Charter Subscription OFFER Save \$5.00

Yes, I want to become a charter subscriber of COMPUTER SHOPPER, the nationwide computer marketplace. Enter my Charter Subscription for the half price rate of \$5.00 for 1 year (12 issues). If I'm not totally satisfied with my first issue, I can have a full refund and I keep the first issue FREE.

Name \_\_\_\_\_

Address \_\_\_\_\_

City \_\_\_\_\_ State \_\_\_\_\_ Zip \_\_\_\_\_

Payment Enclosed  Master Charge  VISA

Card # \_\_\_\_\_ Exp. Date \_\_\_\_\_

I have enclosed my complimentary classified ad.  
 I'd like to run my ad later. Please send me a Certificate.

Mail to: **COMPUTER SHOPPER, P.O. BOX F-1  
TITUSVILLE, FL 32780** or call **305-269-3211**



**NEW!**

Introduction to Low Resolution

# GRAPHICS

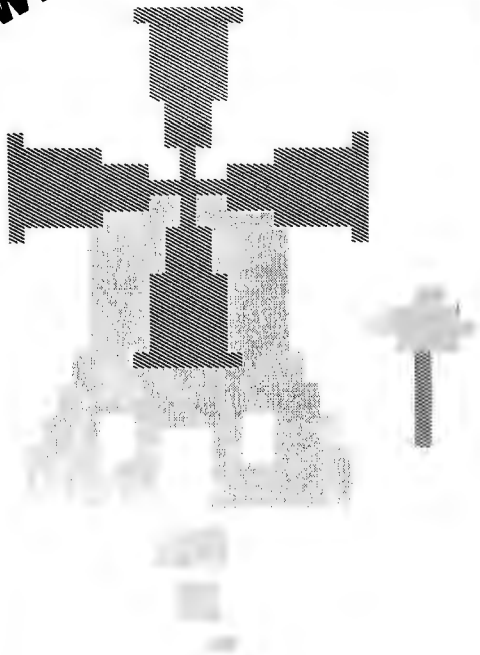

Now you can produce amazing computer graphics — even if you can't draw a straight line. Literally! Learn how to draw lines and shapes, make graphs, draw pictures and even do animations. The simple secrets of how to do all this are contained in SCELBI's new book "Introduction to Low Resolution Graphics."

Today's exciting personal and small business computing machines are generally provided with at least some kind of "low resolution" graphics capability. What is low resolution graphics? It is graphics presented on a point-by-point basis where the number of points is limited to about 8000 or less. The APPLE II by APPLE Computers, Inc., the Radio Shack TRS-80 and the Commodore PET all have low resolution graphics capability. So do many other kinds of microcomputers.

What can you do with low resolution graphics? Lots of things . . .

If you know how! You can plot plain and simple or fancy and complex graphs to consolidate data, for business or pleasure purposes. But you can do so much more than that! You can use the capability to improve the presentation and impact of almost anything you want your computer to tell people. It can be used to animate games or data, clarify and amplify educational materials, or just plain entertain people. Get started putting your computer to new and exciting uses through the world of graphics. Anyone can learn and apply these easy-to-understand techniques. Order your copy today!

## Shows How to Draw

- *Straight lines*
- *Triangles*
- *Circles*
- *Elipses*
- *Borders*
- *Reverse backgrounds*
- *Deck of playing cards*
- *A clown that winks*
- *Football grid*
- *Animated football game*

*In addition to these fundamentals of drawing and animation, the book tells how to synchronize computer-generated sounds to your illustrations.*

\$9.95 □ No. 65 (use coupon on facing page)

**NEW!**

# Z80 Software Gourmet Guide & Cookbook

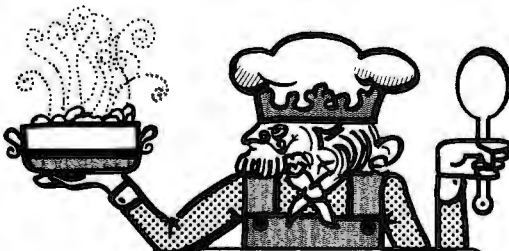

Put Together  
Your Own Z80 Programs  
Using These  
Time-Tested Recipes

---

- Utility Routines —
- Stack Operations —
- Search and Sort Routines —
- Floating Point Routines —
- Z80 Instruction Set —
- And More —

## You need this cookbook!

You'll be able to put together programs without having to start from scratch. You'll have the most useful routines at your command — already programmed and ready-to-use. You'll get a plain-talk explanation of how the powerful Z80 instruction set works. And that's a big value to everyone, Z80 owner or not!

## Why is it called a cookbook?

Because it's a book of recipes. It contains routines, subroutines and short programs. These are the ingredients. All you do is take a pinch of this, a pinch of that. Combine the ingredients, and voila — your own masterpiece! Just the program to suit your taste.

## Time tested recipes.

## Check These Features

- *Handy reference to Z80 instruction set*
- *Search and sort routines*
- *Many general purpose utility routines*
- *Flow charts and source listings*
- *I/O and interrupt programming*
- *Machine codes given in both hexadecimal and octal notation*
- *How to control and manipulate Z80 stack*
- *Code and numeric conversion routines*

Although the Z80 cookbook is brand new, SCELBI's software cookbook idea has been around for years. The recipes are really time tested! Tens of thousands of our 6800 and 8080 cookbooks have been used throughout the U.S. and in countries around the world. Add the "Z80 Software Gourmet Guide & Cookbook" to your recipe filebox. Order today!

\$14.95 □ No. 75 (use coupon on facing page)



**SCELBI  
Publications**



**Z80  
Instruction  
Handbook**

A complete guide to the Z80 instruction set. Machine codes presented in both octal and hexadecimal format. An index lists instructions alpha-

betically along with machine codes and timing information. Industry-standard mnemonics used throughout.

\$4.95\* No. 20

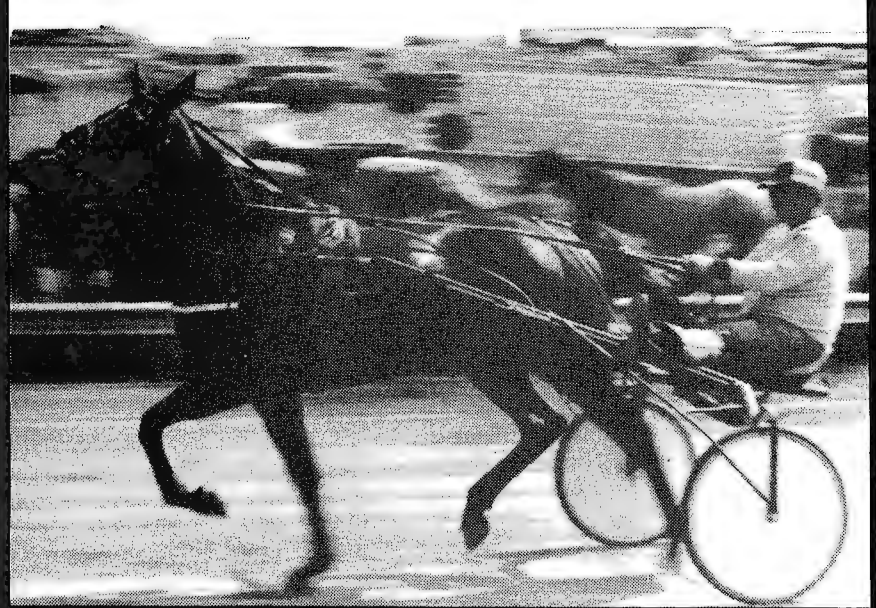

*Hot to Trot...  
for Computers?*



**Personal  
Information  
Management  
System**

Plain talk on what a computer can do for you. How to use a computer without knowledge of programming. 15 examples include

personal mailing list, accounts payable — even an intelligent ham radio log. For the TRS-80, PET and others.

\$9.95\* No. 10

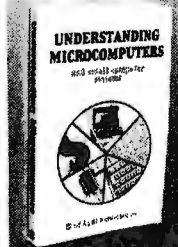

**Understanding  
Microcomputers**

300-page no-nonsense easy-reading text. Simple-to-use glossary. Extra knowledge for reading and understanding computer magazines and manufacturer's literature. Instruc-

tions for microcomputers. Machine language programming. Input/output devices. Gives an intro to BASIC.

\$9.95\* No. 90

**Calculating with  
BASIC**

**Calculating  
with BASIC**

A variety of programs to help the student, scientist, engineer, technician or hobbyist apply the language to practical problems. Covers

mathematics, finance and statistics, mechanical engineering and electronics. For fun Hangman and Space Capture games are provided.

\$7.95\* No. 30

**MICRO  
COMPUTER**



**POTPOURRI**

**Microcomputer  
Potpourri**

Reference for beginner, technician, engineer. Glossary with all the jargon. Helps beginners understand computer magazines, mfg. literature and serves as refer-

ence for the pro. Reviews microprocessor chips in detail. Complete text on understanding microcomputers.

\$2.95\* No. 70



**SCELBI Publications, P. O. Box 3133, Milford, CT 06460 203-874-1573**

**\*IMPORTANT ORDERING INFO!** Include \$1.00 shipping/handling for each item. Prices shown are for North American customers. Master Charge, VISA, Postal and Bank Money Orders preferred. Personal checks delay shipping up to 4 weeks.

No. 10  No. 20  No. 30  No. 65  No. 70  No. 75  No. 90

Name (please print) \_\_\_\_\_

Card No. \_\_\_\_\_ Bank No. \_\_\_\_\_ Exp. \_\_\_\_\_

Address \_\_\_\_\_

City/State \_\_\_\_\_ Zip \_\_\_\_\_

Signature \_\_\_\_\_ Amt. Enc. \_\_\_\_\_

**See SCELBI books at your favorite  
computer or electronics store.**

# Programming Quickies

## Keyboard Input Software for the Z80

Kerry W Newcom, 10 Evergreen Ave, Burlington MA 01803

Every program that uses terminal or keyboard input must scan the incoming data to determine its validity. The order of keyboard entries is unpredictable, and interactive programs will often fail because all input sequences are not tested. In some cases, testing all input combinations may be impractical or impossible as the number of valid input strings increases.

These problems usually force a choice between two unpleasant alternatives. One alternative is to rely on complex error checking and error messages. The other is to guarantee operation for only a small set of rigidly defined inputs. Error checking sometimes takes more lines of code than the routine that will eventually process the data, while rigidly defined input specifications result in an unfriendly and unforgiving user interface.

The routine KEYIN, shown in listing 1, circumvents these problems by checking as narrow or wide a range of data inputs as desired by the calling routine. KEYIN will not return an invalid input to the calling routine, and bad data can be rejected by a single error message. KEYIN will also convert hexadecimal, decimal, or octal digits to binary while it is doing the error checking. KEYIN may be called by routines with vastly different requirements for alphanumeric data checking.

Knowledge of two variables and the table on which they operate is central to understanding how KEYIN works. The variables are stored in locations TBLPNT and TBLCNT. TBLPNT holds the address pointer for the table, and TBLCNT holds the number of entries in the table. The table these variables operate on may be placed in read-only or programmable memory. If the table is in read-only memory, TBLPNT can move up or down the table as subroutines require larger or smaller sets of input characters. If the table is in programmable memory, one may put its contents under program control in addition to moving TBLPNT.

For example, a subroutine may want to allow entry of one or more hexadecimal digits followed by an alphabetic command such as G for go or R for run. The table for this example would be constructed as shown in listing 2. The routine that calls KEYIN should place the address of TABLE in the location TBLPNT and the number of entries in the table (18 in this example) in location TBLCNT. The variable BASE should be set to 16 for hexadecimal decoding.

When KEYIN is called, routine KEYIN2 will load reg-

Listing 1: Z80 assembler code for the KEYIN routine. The program uses a table, as shown in listing 2, to determine acceptable input.

```

LINE  ADDR  R  OBJECT
-----
15
16  F200          TBLPNT EQU 0F200H
17  F202          TBLCNT EQU 0F202H
18  F204          BASE  EQU 0F204H
19  0007          BELL  EQU 07H
20
21
22  F000          *MARS          CODE 0F000H
23  F000  D5      KEYIN:  PUSH DE
24  F001  C5      PUSH BC
25  F002  F5      PUSH AF
26  F003  210000  LD HL,0           ;INITIALIZE HL
27  F006  E5      KEYIN1: PUSH HL      ;SAVE NUMERIC INPUT
28  F007  2A00F2  KEYIN2: LD HL, (TBLPNT) ;LOAD THE TABLE POINTER
29  F00A  ED4B02F2 LD BC, (TBLCNT)      ;LOAD # OF ENTRIES IN TABLE
30  F00E  CD4AF0  CALL CHARNE       ;ACCEPT INPUT WITHOUT ECHO
31  F011  EDB1      CPIR              ;SEARCH THE TABLE
32  F013  2B07      JR Z, KEYIN3      ;IF VALID ENTRY NOT FOUND
33  F015  3E07      LD A, BELL        ;THEN BEEP
34  F017  CD3BF0  CALL CHAROUT      ;OR WRITE AN ERROR MESSAGE
35  F01A  1BE8      JR KEYIN2         ;GO BACK AND GET NEXT ENTRY
36  F01C  CD3BF0  KEYIN3: CALL CHAROUT ;ELSE ECHO CHARACTER
37  F01F  E1      POP HL            ;RESTORE NUMERIC INPUT
38  F020  47      LD B,A           ;SAVE CURRENT INPUT IN REG.B
39  F021  79      LD A,C           ;LOAD COUNT REMAINDER INTO A
40  F022  ED5B04F2 LD DE, (BASE)      ;LOAD BASE INTO DE
41  F026  8B      CP E
42  F027  300A      JR NC, KEYIN4
43  F029  2B0B      JR Z, KEYIN4
44  F02B  29      ADD HL, HL
45  F02C  29      ADD HL, HL
46  F02D  29      ADD HL, HL
47  F02E  29      ADD HL, HL
48  F02F  85      ADD A, L
49  F030  6F      LD L, A
50  F031  1B03      JR KEYIN1        ;AND GET THE NEXT ENTRY
51  F033  F1      KEYIN4: POP AF
52  F034  7B      LD A,B
53  F035  C1      POP BC
54  F036  D1      POP DE
55  F037  C9      RET
56
57  EEFE          DECODE EQU 0EEFEH
58
59
60
61
62  F038  C5      CHAROUT: PUSH BC
63  F039  F5      PUSH AF
64
65  F03A  01FEED  -----HARDWARE DEPENDENT CODE-----
66  F03D  ED7B      LD BC, DECODE    ;I/O ADDRESS DECODING
67  F03F  C86F      CHAR1: IN A,(C)   ;CHECK STATUS OF OUTPUT DEVICE
68  F041  2BFA      BIT 5, A         ;IF NOT READY
69  F043  2BFA      JR Z, CHAR1      ;THEN LOOP
70  F044  0EFF      LD C, 0FFH      ;ELSE SET DECODE FOR DATA UNIT
71
72  F045  F1      POP AF
73  F046  ED79      OUT (C),A       ;WRITE TO OUTPUT DEVICE
74  F047  C9      POP BC
75  F048  C9      RET
76
77  F04A  C5      CHARNE: PUSH BC
78
79  F04B  01FEED  -----HARDWARE DEPENDENT CODE-----
80  F04E  ED7B      LD BC, DECODE    ;I/O ADDRESS DECODING
81  F050  C877      CHAR1: IN A,(C)   ;CHECK STATUS OF INPUT DEVICE
82  F052  CB77      BIT 6, A         ;IF NOT READY
83  F054  2BFA      JR Z, CHAR1      ;THEN LOOP
84  F055  2BFA      LD C, 0FFH      ;ELSE SET DECODE FOR DATA IN
85
86  F056  ED7B      IN A, (C)
87  F058  C1      POP BC
88  F059  C9      RET
89

```

```

ERROR COUNT 0
CPU (SEC)=7
ASSEMBLY COMPLETE - NO ERRORS

```

Listing 2: Table setup to allow KEYIN to recognize the commands G and R for go and run, along with a hexadecimal number.

```

TABLE:  DEFM 'GR'
        DEFM 'FEDCBA9876543210'

```



**Listing 3:** Multiple tables allow KEYIN to search for one of several different valid commands. Here tables are set up to search for RUN, RES (reset) and REG (register).

```
TABLE:   DEFM 'R'
TABLE1:  DEFM 'EU'
TABLE2:  DEFM 'SG'
```

ister pair HL with the table pointer and load register pair BC with the number of entries in the table. The routine CHARNE is called and it will accept one character from the keyboard without echoing the character. The routines CHAROUT and CHARNE are hardware dependent and are shown here only to illustrate how KEYIN interacts with the user. CHAROUT can be any routine that sends one character to an output device, and CHARNE can be any routine that accepts one character from an input device. The keyboard entry is passed back from CHARNE to KEYIN in register A.

After CHARNE accepts an entry, the CPIR instruction in KEYIN2 begins searching TABLE for a valid entry. If a valid entry is found, the input character is echoed back to the terminal. If a valid entry is not found, an error message may be returned or the input may simply be ignored or rejected with an audible signal as it is here. Routine KEYIN2 will be reexecuted until it recognizes a valid entry.

The CPIR instruction decrements the BC register pair as it compares the input character against the characters in the table. This is important since the value that is left in the BC register pair will be the binary value of the hexadecimal input when the CPIR instruction terminates. When a valid entry is found, KEYIN checks register C against the variable BASE. If the value in register C is greater than or equal to BASE, KEYIN will return to the calling routine with hexadecimal input in register pair HL and the nonhexadecimal character in register A. If the value in register C was less than BASE, its binary value will be placed in the register pair HL and KEYIN will reset the table pointer and counter and wait for another character.

Another use of KEYIN is searching a tree for valid input. As an example, assume that a program would like to evaluate three similar commands and reject all others. For this example, valid command strings are RESET, REGISTER, and RUN. TABLE would be set up with R as the root letter followed by branches EU and SG, as shown in listing 3. Before KEYIN is called, TBLPNT is set to address TABLE, TBLCNT is set to one and BASE is set to zero. On the first call to KEYIN, all inputs will be rejected except R. Once R is input, the calling routine sets TBLPNT to TABLE1 and TBLCNT to two. Now only the letters E and U will be accepted by KEYIN. If a U is input, a valid command has been found and the appropriate action can be taken. If the input was an E, the calling routine sets TBLPNT to TABLE2 and KEYIN is called again. KEYIN will now only accept the letters S and G, and the appropriate action may be taken once a valid input is accepted.

In general, KEYIN will allow n-way branching from the root or any branch of a tree by setting TBLCNT to n, TBLPNT to the first of the n acceptable inputs, and BASE to zero for character input. ■

	List	Our Price
<b>CROMEMCO 20% DISCOUNT</b>		
System III	5990	4792
System II	3990	3192
System II with 10 Meg Disk	9995	7996
<b>NORTH STAR 16% DISCOUNT (or more)</b>		
Horizon I — 32K Ram asm	2099	1763
Horizon I — 16K Ram asm	1899	1595
Horizon I — 32K Ram kit	1849	1553
Horizon I to Horizon 2	450	378
32K Ram asm	659	525
<b>VECTOR GRAPHICS 20% DISCOUNT</b>		
Vector MZ-2 (630K disk) 48K Ram	3750	3000
Soroc IQ120	995	790
Perkin Elmer Bantam CRT	996	750
Intertube II	995	750
Integral Data IP125	799	699
Escon Selectric Interface	496	422
NEC 5510 RO Word Processor Printer	2900	2450

Professional A/r, A/p, Ledger, Payroll, Medical Billing software with customization available. Send for our catalog — Some prices are too low to quote.

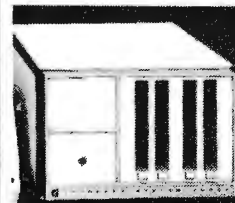

**SARA TECH  
COMPUTERS**  
P.O. Box 692  
400 Base  
Venice, FL  
33595  
(813)485-3559



## Now learn the electronics of microprocessing.

Enjoy the challenge and excitement of learning about microprocessing hardware — how it functions and how to repair it — by actually building your own equipment as you learn.



National Technical School's Microcomputer Division offers three such learn-by-doing courses that you can enjoy at home, in your spare hours. Each combines clear, concise lessons with Heath and NTS-designed digital equipment — a combination our students tell us makes for "lively" home study. Find out more about these valuable NTS Microcomputer Courses. Send today for our colorful 65-page catalog — it's FREE! **No obligation. No salesman will call. Approved for veteran training.**

### NATIONAL TECHNICAL SCHOOLS

TECHNICAL-TRADE TRAINING SINCE 1905  
Resident and Home-Study Schools  
4000 South Figueroa St. Los Angeles, Calif. 90037

Clip And  
Mail Today!

**NATIONAL TECHNICAL SCHOOLS** Dept. 252-119  
4000 South Figueroa Street • Los Angeles, California 90037  
Please rush your FREE 65-page color catalog

Name \_\_\_\_\_  
Address \_\_\_\_\_  
City \_\_\_\_\_  
State \_\_\_\_\_ ZIP \_\_\_\_\_

Check if interested in G.I. Bill information.  
 Check if interested ONLY in classroom training in Los Angeles.

# TRS-80 Resolutions



## HARDSIDE™

Your market for new and used micro-computer equipment.

Telephone 603-673-5144

COD orders require 25% cash deposit

Prices do not include shipping

### SOFTSIDE

SoftSide is for those who have adopted a TRS-80, and unleashed their imaginations. - a magazine that helps you discover the endless variety of tasks your new friend will do for you.

Every month we publish games, household applications, educational aids, business programs.

SoftSide means Software! 1 Year - 12 issues \$18.00

### PROG 80

A bi-monthly magazine for the serious programmer who wants to know HOW his computer works and WHY. Machine language, construction projects, specialized applications software . . . not just for the advanced computer hobbyist, but for the computerophile who wants the most from his machine.

1 Year - 6 issues \$15.00



### APPLE SEED

If you're an Apple II owner, you've been longing for a good software publication and hoping someone would get around to it.

We have. Apple Seed is to the Apple II what SoftSide is to the TRS-80. And it's brand new. Apple II enthusiasts will eat up this special introductory offer! 1 Year - 12 issues \$15.00

UNIT	NEW		USED	
	RETAIL LIST PRICE	HARDSIDE DISCOUNT PRICE	WE'LL PAY	WE'LL SELL
Level I 4K	\$499	\$449	\$275	\$375
Level II 4K	\$619	\$557	\$370	\$475
Level I 16K	\$729	\$656	\$365	\$475
Level II 16K	\$649	\$764	\$500	\$650
Level II 16K, No Keypad -		\$669	\$450	\$600
EXPANSION INTERFACE				
... 0K	\$299	\$269	\$175	\$240
... 16K	\$448	\$369/\$403	\$225	\$315
... 32K	\$597	\$469/\$537	\$275	\$390
DISK DRIVES				
Radio Shack #0	\$499	\$449	\$275	\$399
Radio Shack #1	\$499	\$449	\$250	\$375
Percom TFD-100		\$399		
Percom TFD-200 dual density 197K		\$675		

PRINTERS	NEW		USED	
	RETAIL LIST PRICE	HARDSIDE DISCOUNT PRICE	WE'LL PAY	WE'LL SELL
* Centronics 779	\$1559	\$1000	\$650	\$850
Tractor Feed				
* Centronics P1	\$499	\$399	\$250	\$325
Quick Printer II	\$219	\$197	\$125	\$175
Line Printer II	\$999	\$899		
Line Printer III	\$1999	\$1799		
* Requires Cable R/S 26-1401	\$39	\$35	\$20	\$30
TRS-80 HARDWARE ACCESSORIES				
Telephone Interface II	\$199	\$179	\$100	\$150
16K Memory Kits	\$149	\$99		
RS232C Serial Interface	\$99	\$89	\$50	\$75
TRS-232 Interface		\$49		
Data Dubber		\$49		
Line Cord Suppressor/Filter		\$32		

# DMS.

## ACTION GAMES

**Taipan** by Art Canfil. Sail the China seas, dodging pirates and cutthroats, to make your fortune trading in arms and opium. Level II, 16K. \$9.95.

**Slalom** by Denso Hamlin. Choose between Slalom, Giant Slalom and Downhill. Level II, 16K \$7.95.

**Air Raid** by Small Systems Software. High speed machine language program with large and small aircraft flying at different altitudes. Ground-based missile launcher aimed and fired from keyboard. Planes explode when hit, cause damage to nearby aircraft. Score tallied for hits or misses. Level I or II, 4K \$14.95.

**All Star Baseball** by David Bohlke, Level II, 16K \$7.95.

**Batter Up** by David Bohlke. Level II, 16K \$5.95.

**X-Wing Fighter II** by Chris Freund. Piloting an X-Wing fighter, you're out to destroy the Death Star! A new, improved version of an exciting space favorite. Level II, 16K. \$9.95.

**Ten Pin** by Frank Rowlett. A game of coordination, the scoring is true to the rules of the sport. Level II, 16K \$7.95.

**Balloon Race** by Dean Powell. High above the Atlantic, your balloon must be cleverly maneuvered with the prevailing winds to reach Paris. Level II, 16K, \$9.95.

**Adventures** by Scott Adams. Feel as if you're manipulating HAL from 2001 when you play these machine language games. Hardly any rules, finding out is part of the fun. Two adventures on 32K disk, \$24.95. Tape - choose from Land Adventure, Pirate's Cove, Mission Impossible, The Count, Voodoo Castle, Strange Odyssey, and Fun House. \$14.95 each.

**Dog Star Adventure** by Lance Micklus. You're trapped aboard an enemy battleship... can you find the gold, rescue the princess, discover the plans and safely escape? Level II, 16K \$9.95.

**Journey To The Center Of The Earth** by Greg Hassett. Excellent introduction to the excitement of ADVENTURE. Written in BASIC for ease of understanding, yet fast and fun!! Level II, 16K tape \$7.95.

**Amazin' Mazes** by Robert Wallace. Ever-changing maze situation. Level II, 16K \$7.95.

**Kamikaze** by Russell Starkey. Command your ship against attacking suicide planes. Machine language graphics make this fast and fun! L II, 16K \$7.95

**Space Battles** by Level IV. Assume the role of Galactic mercenary, roaming the universe in search of enemy aliens and the bounty you reap from destroying their ships! Danger, thrills, fast action - and financial headaches as well! Features three levels of play; fast, machine language graphics; real-time input; Level II, 16K Tape or 32K Disk. Tape - \$14.95; Disk - \$19.95.

## SIMULATIONS

**3-D Tic Tac Toe** by Scott Adams. Three skill levels - author warns you to practice before tackling computer's third skill level. II, 16K \$7.95

**Star Trek III.3** by Lance Micklus. One of the most advanced Star Trek games ever written. Level II, 16K \$14.95.

**End Zone** by Roger W. Robitaille, Sr. Authentic football simulation, right down to the 2-minute warning. Level I or II, 16K \$7.95

**Cribbage** by Roger W. Robitaille, Sr. You versus the computer - cribbage played by standard rules. Level II, 16K, \$7.95.

**'Round The Horn** by Rev. George Blank. You're the captain of a clipper ship racing from New York to San Francisco. Level II, 16K \$9.95.

**Concentration** by Lance Micklus. One of the most popular television games. Level II. 16K \$7.95.

**Safari** by David Bohlke. You're in the running for a film contract at a major Hollywood studio. To qualify, you must photograph the most wild animals in their natural habitat. Level II, 16K \$7.95.

**Pork Barrel** by Rev. George Blank. Place you in the shoes of an aspiring Congressman. Level II, 16K \$9.95.

**Backgammon** by Scott Adams. Level II, 16K \$7.95

**Chess Companion** by M. Kelleher. Combines chess clock features with ability to record your moves while action is fast and furious. Level II, 16K \$7.95

**Sargon Chess** by Dan and Kathe Spracklen. Winner of the 1978 San Jose Microcomputer Chess Tournament. Level II, 16K \$19.95.

## PERSONAL

**RPN Calculator** by Russell Starkey. A self-documenting calculator program. Uses Reverse Polish Notation with 4-level stack, 100 memories, scientific functions. Level II, 16K \$9.95.

**Home Financial Management** by M. Kelleher. Turns your computer into a personal financial advisor. Level II, 16K \$9.95.

**Ham Radio** by M. Kelleher. Amateur Frequency Allocations, ID Timer, Q-signal File, Amateur Log Routine, Propagation Forecasting. L II, 16K \$9.95  
**Special Disk-enhanced version, 32K** \$24.95

**Educator Assistant** by Steve Reisser. Five programs of value to educators. Compute percentage, individual student averages, class averages, standard test scores, final grades. L II, 16K \$9.95 D, \$14.95.

**Typing Tutor** by 80US. A set of programs designed to teach you touch typing. Takes you from basics to high-speed drill, with quizzes and grades. Progress at your own pace, and have fun mastering an enormously useful skill. Level II, 16K - \$19.95.

**Personal Finance** by Lance Micklus. 33 different budgets can be easily adapted by user to fit his individual needs. A 2-part program, entry and search. Level II, 16K \$9.95.

**Advanced Personal Finance** by Lance Micklus. Same as above with advanced analysis routine. Supports Disk Files D, 32K \$24.95.

**Basic Statistics** by Steve Reisser. Pearson product-movement correlation coefficient, chi-square, Fisher T-test, sample analysis of variance, Z-scores and standard scores, with a random number generator built in to simulate data. L II, 16K \$20.00.

## DEALER INQUIRIES INVITED

Telephone orders accepted for Master Charge or VISA accounts. Call Monday through Friday, 9:00 a.m. to 9:00 p.m.

EST at: 603-673-5144



# TRS-80 SOFTWARE EXCHANGE

P.O. BOX 68, Milford, NH 03055

## UTILITIES

**8080-Z80 Conversion** by M. Kelleher. Permits you to enter 8080 codings and returns the Z80 equivalent. L II, 16K \$15.00.

**KVP Extender** by Lance Micklus. Corrects keyboard bounce, upper case lock, permits use as a terminal, screen printing. On tape (\$24.95) or disk (\$29.95)

**Level III Basic** by Microsoft. The most powerful BASIC you can buy for the TRS-80 in 5k of space, opens up fantastic new dimensions! Disk programming power, graphics commands, editing commands, long error messages, hex and octal constants and conversions, user-defined functions, much more! You get power that might otherwise cost you hundreds of dollars in additional equipment. It's like getting a whole new computer! \$49.95.

**MMSFORTH** by Miller Microcomputer Services. New version of the powerful, fast FORTH language compiler for TRS-80. Disk version offers virtual memory, supports one to four disk drives, has both disk and tape input/output capabilities. A stack-oriented structured language at an affordable price. MMSFORTH cassette version, Level III, 16K \$39.95  
MMSFORTH disk version, Level II, 16K \$49.95  
MicroFORTH primer \$15.00

**TRS-80 Fortran**. Includes the finest Z-80 development software available: Z-80 Macro Assembler, text editor, linkage loader, plus ANSI Fortran IV on two minidisquettes - requires a 32K system with one disk drive. NEW REDUCED PRICE \$150. (separately \$80. ea.)

**System Copy** by Kalman Bergen. Makes backup copies of object ("system") tapes. Features include copy, verify read, rename, verify write. No knowledge of machine language required. Level II, 16K \$9.95.

**NEWDOS** by Apparat. DISK ERRORS SOLVED! Stop blaming your drive, fix your DOS with NEWDOS: an enhanced disk-operating system capable of correcting over 70 errors in TRSDOS 2.1 to improve reliability, and key bounce, enable DOS commands to be called from BASIC and much more! Available NOW for 16K systems with a minimum of 1 disk drive. \$49.95.

**NEWDOS +** by Apparat. Includes all the features of the original NEWDOS and adds 7 new utilities, including SUPERZAP, Disk Editor/Assembler, Disassembler, and Level I BASIC for Disk. \$99.95

## NEW TITLES

Secrets of Tarot	\$9.95
Magic Paper Calculator	9.95
Directory (Disk)	9.95
Alien Invasions	9.95
Form Letter Typewriter	24.95
Casino Anthology	7.95
Five Card Stud	
Five Card Draw	
Slot Machine	
War Game	7.95

WRITE FOR OUR FREE 80-PAGE CATALOG



## A Proposed Graphics Software Standard, Part 1

Vincent C Jones, 1913 Sheely Dr, Ft Collins CO 80526

A major stumbling block to making good software available in the personal computer market is the lack of standardization. Each manufacturer and software developer establishes internal standards for software and hardware interfaces, and they are usually incompatible with one another. Reasons for this vary from the experimenter's attempts to save 1 byte of memory in a 14 K byte program, to the mainframe manufacturer seeking to protect a development investment. The net result is the same. Extensive modifications are typically required to run software on any machine that differs from the original development's hardware and software configuration.

In an effort to prevent this fragmenting effect from overwhelming graphics applications programming, the following graphics interface software protocol is proposed as a standard.

This two-part article presents a complete microcomputer-oriented graphics software protocol and the algorithms required to implement it on typical raster scan graphics displays. The functions of hardware initialization, screen erase, point display, line generation, character generation, and animation are defined, and their implementation is demonstrated with a sample 8080/Z80 assembly language version for the Cromemco Dazzler. The power of a standard protocol is illustrated by a diagnostic demonstration program using the proposed 1 K byte 8080 assembly language protocol standard.

The standard actually proposes two separate but dependent protocols. The top-level protocol is machine independent. It defines a standard display coordinate system, several standard display modes, the available functions, and what these functions do. For example, a request for a red line from the center of the screen to the bottom right corner would always require the following command sequence:

CHAR (RED)	Set the current color to RED
CURSOR (128,128)	Move to the center of the screen
LINE (255,0)	Draw the line

Obviously, not all displays are capable of color; a black and *white display* would draw a white line instead. To compensate for any deficiencies in the hardware that is being used, a feedback path is included to inform the

user program of the available capabilities. General-purpose programs can check to verify that the display being used is suitable and, if necessary, display an error (or warning) message, or use a different algorithm to accomplish the task at hand. For example, a TV tennis game could check to see if full color was available. If so, it could use red paddles, a yellow ball, a green court, and white boundaries. If only three colors were available, the paddles and ball could be the same color. If only a black and white display was available, all markings could be in white with a black court and background.

The lower-level protocol defines the calling sequences used in a particular programming language. When necessary, it also defines where the routines are loaded in memory, and the addresses of their calling vectors. Returning to the example of drawing a red line, an 8080 (or Z80) assembly language program would use the instruction sequence:

```
MVI A,11H ;Code for Red
CALL 0113H ;Vector for CHAR
LXI H,8080H ;X = 128, Y = 128
CALL 010AH ;Vector for CURSOR
LXI H,FF00H ;X = 255, Y = 0
CALL 0110H ;Vector for LINE.
```

Similarly, a BASIC program would read:

```
REM — Set the current color to RED
CHA 17
REM — Move to the center of the
screen
CUR 128,128
REM — Draw the line down to corner
LIN 255,0.
```

Suitable standards for other languages remain to be developed. Reader suggestions are welcome.

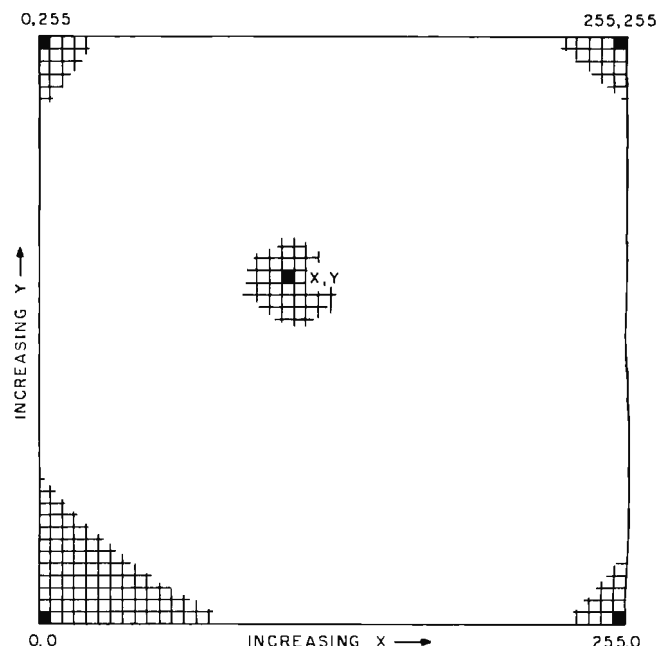

Figure 1: Standard coordinate system used in the proposed graphics software standard.

# 5 reasons why you should not buy the electric pencil II™

© 1978 Michael Shrayer



Check the appropriate box(es):

- You love typing the same copy 20 thousand times a day.
- Your secretary can type 250 words per minute.
- You're dying to spend \$15,000 on a word processing system, just for the tax investment credit.
- All your capital assets are tied up in a 10-year supply of correction fluid.
- You never commit a single thought to paper.

If you have checked one or more boxes, you do not need The Electric Pencil. On the other hand, you may want to join the thousands of people who haven't checked a single box.

The Electric Pencil II is a *Character Oriented Word Processing System*. This means that text is entered as a string of continuous characters and is manipulated as such. This allows the user enormous freedom and ease in the movement and handling of text. Since line endings are never delineated, any number of characters, words, lines or paragraphs may be inserted or deleted anywhere in the text. The entirety of the text shifts and opens up or closes as needed in full view of the user. The typing of carriage returns or word hyphenations is not required since lines of text are formatted automatically.

As text is typed and the end of a line is reached, a partially completed word is shifted to the beginning of the following line. Whenever text is inserted or deleted, existing text is pushed down or pulled up in a wrap around fashion. Everything appears on the video display as it occurs, which eliminates guesswork. Text may be reviewed at will by variable speed scrolling both in the forward and reverse directions. By using the search or search and replace functions, any string of characters may be located and/or replaced with any other string of characters as desired.

Numerous combinations of line length, page length, line spacing and page spacing permit automatic formatting of any form. Character spacing, bold face, multicolumn and bidirectional printing are included in the Diablo versions. Multiple columns with right and left justified margins may be printed in a single pass.

## Wide screen video

Versions are available for Imsai VIO video users with the huge 80x24 character screen. These versions put almost twice as many characters on the screen!!!

## CP/M versions

Digital Research's CP/M, as well as its derivatives, including IMDOS and CDOS, and Helios PTDOS versions are also available. There are several NEC Spinwriter print packages. A utility program that converts The Electric Pencil to CP/M to Pencil files, called **CONVERT**, is only \$35.

## Features

- CP/M, IMDOS and HELIOS compatible
- Supports four disk drives
- Dynamic print formatting
- DIABLO and NEC printer packages
- Multi-column formatting in one pass
- Print value chaining
- Page-at-a-time scrolling
- Bidirectional multispeed scrolling controls
- Subsystem with print value scoreboard
- Automatic word and record number tally
- Cassette backup for additional storage
- Full margin control
- End-of-page control
- Non-printing text commenting
- Line and paragraph indentation
- Centering
- Underlining
- Bold face

## Upgrading policy

Any version of The Electric Pencil



**MICHAEL SHRAYER SOFTWARE, INC.**  
 1198 Los Robles Dr  
 Palm Springs CA 92262  
 (714) 323-1400

may be upgraded at any time by simply returning the *original* disk or cassette and the price difference between versions, plus \$15 to Michael Shrayer Software. Only the originally purchased cassette or diskette will be accepted for upgrading under this policy.

## Have we got a version for you?

The Electric Pencil II operates with any 8080/Z80 based microcomputer that supports a CP/M disk system and uses an Imsai VIO, Processor Tech. VDM-1, Polymorphic VTI, Solid State Music VB-1B or Vector Graphic video interface. REX versions also available. Specify when using CP/M that has been modified for Micropolis or North Star disk systems as follows: for North star add suffix A to version number; for Micropolis add suffix B, e.g., SS-IIA, DV-IIB.

Vers.	Video	Printer	Price
SS-II	SOL	TTY or similar	\$225.
SP-II	VTI	TTY or similar	225.
SV-II	VDM	TTY or similar	225.
SR-II	REX	TTY or similar	250.
SI-II	VIO	TTY or similar	250.
DS-II	SOL	Diablo 1610/20	275.
DP-II	VTI	Diablo 1610/20	275.
DV-II	VDM	Diablo 1610/20	275.
DR-II	REX	Diablo 1610/20	300.
DI-II	VIO	Diablo 1610/20	300.
NS-II	SOL	NEC Spinwriter	275.
NP-II	VTI	NEC Spinwriter	275.
NV-II	VDM	NEC Spinwriter	275.
NR-II	REX	NEC Spinwriter	300.
NI-II	VIO	NEC Spinwriter	300.
SSH	SOL	Helios/TTY	250.
DSH	SOL	Helios/Diablo	300.

## Attention: TRS-80 Users!

The Electric Pencil has been designed to work with both Level I (16K system) and Level II models of the TRS-80, and with virtually any printer you choose. Two versions, one for use with cassette, and one for use with disk, are available on cassette.

The TRS-80 disk version is easily transferred to disk and is fully interactive with the READ, WRITE, DIR, and KILL routines of TRSDOS 2.1.

Version	Storage	Price
TRC	Cassette	\$100.
TRD	Disk	\$150.

**Demand a demo from your dealer!**

**WE ARE KNOWN FOR OUR PROMPT,  
COURTEOUS SERVICE**

**TELETYPE MODEL 43**

- 4320 AAA (TTL interface) ..... \$985
- 4320 AAK (RS232 interface) ..... \$1,085  
with transformer to operate on 50Hz, 220v, installed  
inside cabinet ..... add \$100  
*We stock paper and ribbon for the Teletype Model 43*

**PET, NEC SPINWRITER, DIABLO, CENTRONICS,  
TRS-80, PER SCI also available.**

- HAZELTINE 1500** (assembled only) ..... \$945
- 1510 ..... \$1,085  
with 50Hz, 220v current adaptation ..... \$100  
also available with Danish, German or French  
character sets ..... add \$30

**INTERTUBE II** ..... \$800

**IMS 5000 SERIES, COMPLETE Z80 SYSTEM**

2 I/O ports, 1 K EPROM bootstrap loader, double density, dual 5 1/4" disks, CP/M. S-100, 12 slot mainframe. A new rising star! No waiting.

**MARINCHIP SYSTEMS M9900**

**ELEGANT 16 BIT CPU, S-100 COMPATIBLE.**

Multi-user, multi-processor operating system. PASCAL, Extended precision commercial BASIC, FORTH, META & applications package. Complete kit and DISCEX software \$550; Assembled \$700. We configure systems to meet your budget & your needs. Hard Disk interface (with software) available.

**IMS MEMORY, 16K Fully static, 250 ns** ..... \$280

**TEI S-100 Mainframes**

- 12 slot — MCS 112 ..... \$433
  - 22 slot — MCS 122 ..... \$609
- These mainframes are completely assembled, tested and contain everything required for plug-in operation.

**TARBELL Floppy Disk Controller** ..... \$255

**KONAN HARD DISK CONTROLLER** ..... \$1,550  
S-100 compatible, plugs into S-100 mainframe.

**INTERTUBE SUPER BRAIN** ..... \$2,885  
Dual Z80, dual floppy double density, 4Mhz., CP/M.  
Contained in Intertube II.

**INNOTRONICS** —the most reliable 8" floppy drive on the market! MTBF greater than 8,500 hours. Head life greater than 15,000 hours under normal operating conditions. Shugart compatible.  
Drive alone ..... \$ 545  
2 drives with power supply and cabinet ..... \$1,525

**SIEMENS DRIVES**

8" Double Density, Shugart Compatible ..... \$420

**MODEM: "THE CAT" from Novation** ..... \$190  
Originate/Answer. 300 baud.

**TO ORDER:** We ship within 24 hours after receipt of certified check, money order or cashiers check. Credit cards: add 4%. Personal checks: allow ten days. \$12 shipping for terminals. \$3 for memories and modem. New York residents include sales tax. Prices and availability subject to change without notice.

**—WE EXPORT TO ALL COUNTRIES—  
—OVERSEAS CALLERS USE (212) 448-6298 ONLY—**

**We have no reader inquiry number. Please call or write.**

**JOHN D. OWENS ASSOCIATES, INC.**  
12 SCHUBERT STREET (New Address)  
STATEN ISLAND, NEW YORK 10305

**DAY, EVENING, WEEKEND, HOLIDAY CALLS WELCOME!**  
**(212) 448-6283 (212) 448-6298**

**The Standard Display**

The protocol defines a standard display device to circumvent hardware differences. The standard device displays 256 lines with 256 points on each line. As shown in figure 1, the origin (X = 0, Y = 0) is defined as the bottom leftmost point on the display. X increases to a maximum value of 255 as you move to the right, Y increases to 255 as you rise to the top. This defines the first quadrant of the standard Cartesian coordinate system. Each picture element (pixel) may be black, white, red, green, blue, yellow, cyan, or magenta (any combination of the three primary colors).

The display to be used is programmed to imitate the standard. To facilitate this procedure, four standard display modes are defined. Mode 0 requests the maximum possible resolution while mode 1 requests the maximum choice of colors. This allows for displays, such as the Cromemco Dazzler, which offer a trade-off between resolution and color. Two additional modes provide the ability to deliberately select larger pixels. Mode 2 is 128 by 128 resolution and mode 3 is 64 by 64 resolution. Regardless of the resolution actually used, the coordinate system remains at 256 by 256, as defined above. General-purpose applications programs can check to determine the available resolution and range of colors, whether the display is black and white or color, whether or not individual points can be erased, and if dual-buffered animation is available.

**The Standard Functions**

A five command repertoire is generally considered to be the bare minimum for a general-purpose graphics display. These commands provide all the output capabilities normally found on commercial nonintelligent graphics terminals, such as the Tektronics 4010. The routines are:

- PAGE:** Next page, ie, erase the entire screen.
- CURSOR (X,Y):** Position the cursor at the point X,Y.
- DOT:** Set the pixel defined by the cursor position to the currently selected color.
- LINE (X,Y):** Set the pixels along the line connecting the current cursor position to the point X,Y to the currently selected color.
- CHAR (VAL):** Display the character whose ASCII value is VAL at the current cursor position using the currently selected color.



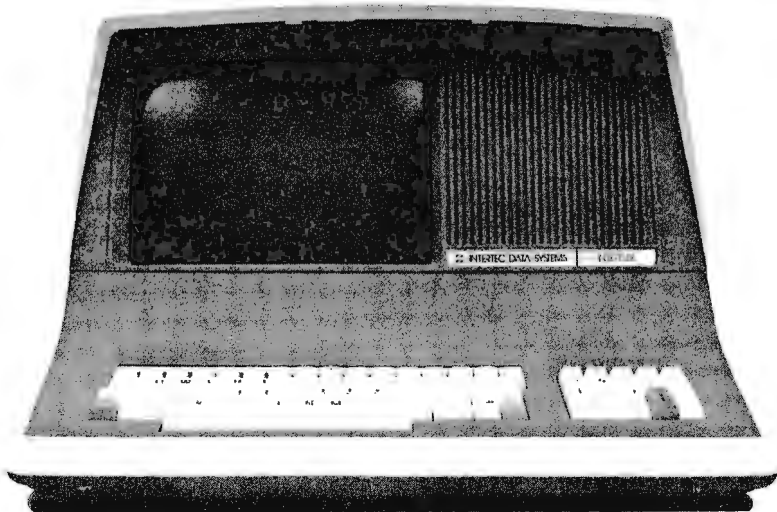

INTERTEC'S

# INTERTUBE II<sup>®</sup>

VIDEO DISPLAY TERMINAL

ATTENTION OEM'S and DEALERS:

Your customers request InterTube terminals for one simple reason. They outperform the competition so well that it's foolish to consider any other terminal. Add to that InterTube's rugged design which insures you of the reliability that brings customers back. And modular design engineering that makes service a snap!

But best of all, the InterTube is readily available. Just a quick call and you'll have units in stock. Immediately! And our scheduled delivery program will help you keep them in stock.

Good margins, good service, good delivery. Simple? You bet it is! InterTube II dealerships and OEM agreements are now available in many areas. Contact us today and start selling from stock tomorrow!

The InterTube II Video Display Terminal is truly representative of the latest state-of-the-art advances in microprocessor technology. Its basic teletypewriter compatibility combined with its numerous "smart" terminal features satisfy the universal requirement for a low-cost, high performance video terminal.

You get everything you need. An upper and lower case character set displayed on a sharp 8 X 10 dot matrix. A full 24 line by 80 character screen. A status line displayed in reverse video. A complete ASCII keyboard with an 18-key numeric pad.

You get full cursor addressing, automatic repeat of all keys and individual backspace and shiftlock keys. Plus, a graphics mode for easy design and display of all types of forms. And an RS-232 serial printer port.

And you get everything your operators need to make their jobs a pleasure. A hooded display that cuts glare and gives extra privacy. A wide bandwidth monitor for sharp images everywhere on the screen. Below-the-line character descenders to make reading easier. A programmable white-on-black or black-on-white display and a self-test mode for easy maintainability.

You get high powered text editing with such features as character and line insert/delete, full and/or partial block transmit, programmable end-of-line terminators, and protected fields. All standard! And all for a retail price you won't believe . . . only \$995. Incredible!

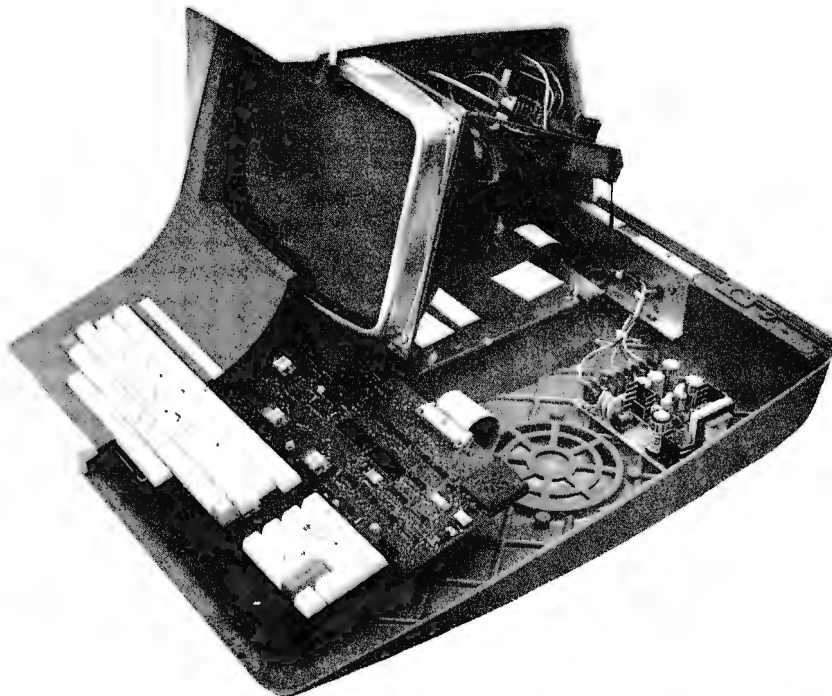

Corporate Headquarters: 2300 Broad River Road • Columbia, South Carolina 29210 • 803 / 798-9100 • TWX: 810-666-2115

To facilitate matching the hardware requirements of many displays, an initialization command is also required:

**INITG:** Initialize the graphics subsystem.

Finally, a 2-buffer animation command is included for interactive graphics and game playing:

**ANIMAT:** Display the refresh buffer currently being filled and open a second refresh buffer for filling.

Display mode and current color selection are provided by the routine CHAR through ASCII control characters. Standard carriage control characters are also recognized. Display description parameters are returned by the routine INITG.

Let us now examine the function of each of the seven routines in detail.

### INITG

The INITG function serves three primary functions. As an aid to the user, the display software is initialized to a standard configuration; the cursor is positioned at  $X = 0$ ,  $Y = 0$ , the current color is set to white, the display is cleared, animation is disabled, and the display mode is set for maximum resolution (mode 0). Special options peculiar to the particular display are also disabled so that

general-purpose programs do not have to be aware of them to function correctly. Secondly, this routine performs any initialization functions required by the display hardware. For those displays which refresh from program memory, the routine establishes the refresh buffers. If the display is under program control, it is turned on. Finally, INITG sets the display description variables to the appropriate values. Failure to initialize the display before using any of the other functions may lead to unpredictable and potentially disastrous results.

### PAGE

The PAGE function clears the display screen. No other changes are made to the state of the display: the cursor is not moved, the current color is not changed, and the display mode is unaffected.

### CURSOR

The CURSOR function sets the display cursor to a particular pixel on the screen. This establishes the initial location for the display functions which affect individual pixels on the screen. Coordinates are always interpreted on the 256 by 256 pixel matrix regardless of the actual resolution of the display. This is true even when the display mode is deliberately set to a lower resolution mode.

When in a lower resolution mode, the low-order bits of the position requested are ignored. For example, when in 128 by 128 resolution mode (mode 2), the points (8,4), (8,5), (9,4), and (9,5) will all be interpreted as the same pixel (the low-order bit in each coordinate has no effect).

## SPECIALIZING IN QUALITY MICROCOMPUTER HARDWARE

INDUSTRIAL • EDUCATIONAL • SMALL BUSINESS • PERSONAL

BUILDING BLOCKS FOR MICROCOMPUTER SYSTEMS, CONTROL & TEST EQUIPMENT

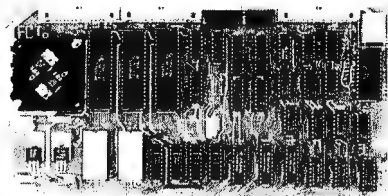

**R<sup>2</sup> I/O**  
2K ROM  
2K RAM  
3 Serial Ports  
1 Parallel Port  
**WIRED: \$295.00**

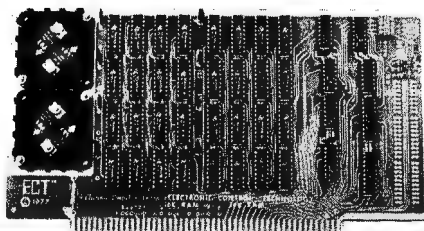

**16 K RAM**  
FULLY STATIC  
MEMORY  
**KIT: \$279.00**  
**WIRED: \$310.00**

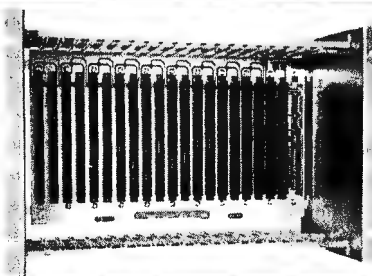

**ECT-100-F**  
RACKMOUNT  
CARD CAGES  
**KIT: \$200.00**  
**WIRED: \$250.00**



**TT-10**  
TABLE TOP  
MAINFRAMES  
**KIT: \$340.00**  
**WIRED: \$395.00**

POWER SUPPLIES, CPU's, MEMORY, OEM VARIATIONS

**ELECTRONIC CONTROL TECHNOLOGY (201) 686-8080**

763 RAMSEY AVE.  
HILLSIDE, N.J. 07205

# WHATSIT<sup>™</sup> for Apple II\*.

Finally, the world's most popular data base query system can be used in one of the world's most popular personal computers— Apple II\*.

WHATSIT<sup>™</sup> is also available for:

- Northstar Basic & CP/M.\*\*
- IBM single & double density, Icom micro, Micropolis Mod I & II, Helios II, Altair Hard Sector.

See it at the  
West Coast Computer  
Faire, booth 327.

## INFORMATION UNLIMITED

P.O. Box 8372  
Merrillville, Indiana 46410  
(219) 924-3522

Dealer inquiry welcome.



\* - Whatsit is a trademark of Computer Hardware  
\* - Apple II is a trademark of Apple Computers, Inc.  
\*\* - CP/M is a trademark of Digital Research

# Z<sub>S</sub> - SYSTEMS

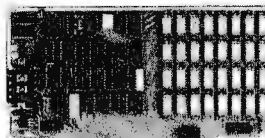

## 64K RAM BOARD

The Z<sub>S</sub>-SYSTEMS 64K RAM board is designed to operate in any Z80 based microcomputer having S-100 bus. It uses 16K dynamic RAM chips, & features:

- Board select
- Bank select
- Transparent on-board refresh
- 2 or 4MHz operation (w/ no wait state)
- Memory disable

Compatible with Cromemco and M/PM multiuser. Fully assembled, burned in, & tested. Available from stock to 60 days  
As low as \$500.00 in quantities of 100

Price of one..... \$695.00

With 16K RAM,..... \$359.00  
Plus shipping charges

## FLOPPY DISK CONTROLLER

Handles with no modification up to:

- \* 4 standard 8" drives (Shugart or compatible) or
  - \* 3 minidrives 5"
- Run with 2 or 4 MHz CPU

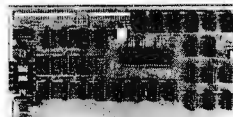

Use CP/M Disk Operating System Using the 1771 LSI controller  
Price of one..... \$245.00  
PC board only..... \$35.00

SEND FOR FREE INFORMATION

6 months warranty on our boards with normal use

## Z<sub>S</sub>-SYSTEMS

PO Box 1847, San Diego, CA 92112  
(714) 447-3997



# FROM THE ORIGINATOR OF THE TRS-80 PROJECT HEADQUARTERS FOR PASCAL

## PASCAL COMPILER

Pascal/MT<sup>™</sup> is designed to run under CP/M. It provides an efficient development cycle plus efficiently executing object programs using a highly structured language so fewer programming errors are made. Pascal/MT has extensions to standard Pascal.

### Features:

- \*Compiler executes only in 32K.
- \*Direct I/O manipulation.
- \*Logical Functions allow bit manipulation.
- \*Assembly languages interface.
- \*Object programs execute ten times faster than P-code system.
- \*Includes real time symbolic debugger.
- \*Accurate 16 digit BCD business arithmetic.

Package Includes System Diskette and Instruction Book (Requires CP/M)  
price..... \$100<sup>00</sup>

"Pascal Users Manual and Report" is available and highly recommended, price... \$9<sup>95</sup>

## UCSD PASCAL

The powerful, general purpose language system, originally developed for large, complex system, is now available from FMG for your TRS-80. This new FMG/UCSD Pascal System greatly increases the value and capability of the TRS-80.

### Package Includes:

- \*Operating System
- \*Screen Editor
- \*280 Macro Assembler
- \*Library
- \*Pascal Compiler
- \*Utilities and System Reference Book

Price..... \$150<sup>00</sup> (Requires 48K, 2 drive System) available without Macro Assembler, Linker and Library (not for compiling programs)... price \$100<sup>00</sup>

High Level Languages for the TRS-80  
BASIC • FORTRAN • COBOL • PASCAL

Call or write for complete information



P.O. Box 16020 (B11) • (817) 294-2510  
Fort Worth, Texas 76133

TRS-80 is a registered trademark of Radio Shack • CP/M is a registered trademark of Digital Research Corp

## TRS-80 COMMUNICATOR

New RS232 Communication Program that allows your TRS-80 to transmit or receive programs and data files. Also makes the TRS-80 into a remote terminal. Requires Radio Shack RS232.

CP/M version..... \$25<sup>00</sup>  
TRS DOS version..... \$30<sup>00</sup>

## CP/M<sup>®</sup> OPERATING SYSTEM

New 1.5 Version

Includes RS-232 and I/O Byte implementation, Editor, Assembler, Debugger and Utilities for 8080 and Z80 Systems.

### Package Includes:

- \*CP/M System Diskette 5 1/4"
- \*CP/M Features and facilities Manual
- \*CP/M Editor's Manual
- \*CP/M Assembler Manual
- \*CP/M Debugger Manual
- \*CP/M Interface Guide

PRICE..... \$150<sup>00</sup> (Requires 16K and one drive min.)

Set of 5 manuals..... \$25<sup>00</sup>

Update for 1.4 version owners, new disc supplied..... \$20<sup>00</sup>



# TRS-80 BUSINESS PROGRAMS

*So good, they're guaranteed!!!*

These are the best . . . & we're willing to back them up with our software guarantee!\* Created by Data Access' professional staff, our programs are versatile, comprehensive, AND easy to use.

Using BASIC and ASSEMBLER, they're fast ready to "RUN". They are powerful tools that can expedite clerical tasks, and expand management reporting.

**All programs:**

- + Have Data Base Management System
- + Use ISAM or Hash Access Techniques
- + Give Instant Record Retrieval
- + Have Interactive Screen Displays
- + Use Error Trapping Entry Procedures
- + Include Thorough Documentation
- + Provide Comprehensive Reporting
- + Utilize Fast Assembler Routines
- + Run under DOS 2.2
- + Include Complete Support
- + Run On 2, 3, or 4 Disk Drives

**On-Line Inventory** ..... \$600  
Up to 1800 Items on 4 Drives. Distributor/Jobber orientation. Includes invoice printing!

**Point of Sale w/Inventory Control** ..... \$750  
Complete retail inventory management system. On the Screen: builds sales ticket, price items, checks for sale prices and qty's, interactive low stock alerts, allows price & qty changes (w/audit), Cash, Check, 6 Credit Cards or Company Charge, & Reporting: Daily Ticket Journal, Inventory Transaction Journal, Salesman's Report, Stock Status, Profit, & Low Stock Reports. MORE!

**Accounts Receivable** ..... \$500  
Up to 1200 accounts on 4 Drives.Full Trial Balance, Aging, Credit Checking, Monthly Statements. Also prints mailing labels for accounts!

**General Ledger w/Check Writer** ..... \$500  
Prints Checks in Cash Disbursements JL! 600 Accounts & 2100 Transactions/Month on 3 Drives; 300/900 on 2! Supports multiple cost/profit centers, user has complete control of formatting. Prints Balance Sheet, Income Statement (P&L), Ledgers, Journals, Transaction Reports, Posting Reports . . . A Total General Ledger System!

**Payroll** ..... \$500  
Up to 600 employees on 4 Drives! Handles Federal, State, Tips, Dues & Deductions. Complete user control of all payroll functions. Prints on the same check as the General Ledger!

**Mailing List** ..... \$200  
Up to 1800 Names on 4 Drives! Six character alphanumeric key & 4 character select code for each record. Sort by key, name, state or ZIP code!

**MANUALS ONLY** ..... \$20 each

**WRITING YOUR OWN???????**

Save Days, Weeks, Months with Data Access' proven utility packages. On diskette . . .

**Memory Sort** ..... \$39  
Speed operation of BASIC programs! VERY FAST in memory assembler sort. Supplied pre-linked to load at any 4K boundary through 48K.

**Disk Sort Routines** ..... \$79  
Make the most of disk capacity & speed! Reads random data from disk, performs FAST assembler sort, and returns alphanumerically sorted list ready to pass to other program operations in BASIC. Reads & sorts 1000 records in less than 5 Minutes! Sorts as many records as can be contained on your disks!

**Data Base Manage w/ISAM** ..... \$175  
Complete database handling system! ISAM directory; interactive record create, delete, edit, display and print; file compress and backup; routines for loading assembler programs from BASIC; disk sort; INKEY data entry subroutines; random and sequential access to any record. Interactive data base specification. All source included!

*\*Data Access Corporation guarantees that its programs will load & run, and that they are free from programming defects. A licensing agreement is required for each installation of the above programs.*

**DEALER INQUIRES INVITED**

Call for the name of the dealer in your area, or order direct from:

## DATA ACCESS CORPORATION

11205 SOUTH DIXIE HIGHWAY  
MIAMI, FLORIDA 33156  
(305) 238-7919

\*TRS-80 is a trademark of Radio Shack.

Mnemonic	ASCII	Hexadecimal	Standard Function
MAXR	NUL	00	<i>Display Mode Selection</i>
MAXC	SOH	01	Maximum resolution
R128	STX	02	Maximum colors
R64	ETX	03	128 by 128
RXXX	EOT	04	64 by 64
			Undefined
BS	BS	08	<i>Carriage Control</i>
HT	HT	09	Backspace (optional)
LF	LF	0A	Horizontal tab (optional)
VT	VT	0B	Line feed
FF	FF	0C	Vertical tab (optional)
CR	CR	0D	Form feed
			Carriage return
SO	SO	0E	<i>Character Style</i>
SI	SI	0F	Undefined
			Undefined
BLK	DLE	10	<i>Current Color Selection</i>
RED	DC1	11	Black
BLU	DC2	12	Red
MAG	DC3	13	Blue
GRN	DC4	14	Magenta
YEL	NAK	15	Green
CYN	SYN	16	Yellow
WHI	ETB	17	Cyan
N	ETX	18	White
O			Eight
E	GS	1F	optional colors

Table 1: Standard control character functions.

When changing between display modes, cursor position is not required to be maintained by the interface software. To avoid erroneous results, all changes to display mode should be followed by a cursor positioning command.

### DOT

The DOT function sets the display pixel indicated by the cursor to the currently selected color. With some displays in low-resolution mode, several physical pixels may be affected. For example, the Matrox ALT-256\*\*2 turns on (or off, as selected) sixteen hardware pixels for every "dot" when in a 64 by 64 resolution mode.

### LINE

The LINE function generates the line connecting the pixel defined by the cursor to the pixel requested. Both endpoints are included in the line. Therefore, a line of zero length is logically equivalent to a call to DOT. Care must be exercised when erasing or otherwise changing the color of a line, since the pixels in a line from pixel A to pixel B may differ from those used when the line is drawn from pixel B to pixel A. When lines are drawn in lower resolution modes, the pixels used are the size made by the DOT function at that resolution.

### CHAR

The CHAR function provides the capability to display alphanumeric as well as graphical data. In addition, control characters provide limited cursor positioning and control over display mode and current color as shown in table 1. Control characters that are not recognized are ignored. Note that form feed positions the cursor only—it does not erase the screen.

Characters are positioned so that the cursor defines the

lower left corner of a normal character (characters with descenders will extend below the cursor position). The cursor is left at the next character position. No check is made to detect characters off the edge of the screen. Parity is ignored. Lowercase characters, if not supported, are converted to uppercase.

## ANIMAT

The function ANIMAT provides for flicker-free changes in the display by permitting the user to load one refresh buffer while displaying another. Each call to ANIMAT displays the buffer which is being filled, and opens another buffer for filling. This buffer exchange is performed at the start of the next vertical blanking period. Those displays without the ability to utilize multiple buffers but which *do* allow the erasing of individual pixels (such as the Matrox ALT-256\*\*2) will just delay until the start of the next vertical blanking period. In either case, no changes are made to either buffer, and the cursor position is maintained. The ANIMAT function does nothing on those displays which support neither double buffering nor selective erase. To return to normal mode where updates are displayed in real time, it is necessary to reinitialize with INITG.

## Standard Calling Sequences

To encourage maximum software interchange, two standard programming language protocols are currently defined. The first protocol is for 8080 and Z80 assembly language users, the second is for BASIC programs. By following one of these protocols, a program written for one display will work with any other display of sufficient resolution and color flexibility. The standard display and function definitions described previously are common to both protocols.

## 8080 Assembler Protocol

The 8080 assembly language interface is loaded into hexadecimal memory locations 0104 to 04FF. This provides a standard location for the package, regardless of memory size. To avoid conflict with programs requiring use of the restart (RST) instruction and most popular 8080 monitors, a lower starting address is not used. The first 21 bytes (hexadecimal 0104 to 0118) are the entry points to the different routines, as indicated in table 2. All arguments are passed to the called routine in register pair HL, except for the CHAR routine, which uses register A. The contents of all registers and flags are preserved, except for the INITG routine.

Routine INITG is called with the address of the first unused memory location above the program, to indicate

Routine	Vector Address (hexadecimal)	Parameters
INITG	104	HL = first free address
PAGE	107	Returns display description in HL
CURSOR	10A	None
DOT	10D	H = X coordinate; L = Y coordinate
LINE	110	None
CHAR	113	H = X end coordinate; L = Y end coordinate
ANIMAT	116	A = ASCII value of character
		None

Table 2: 8080 assembly language standard vector addresses.

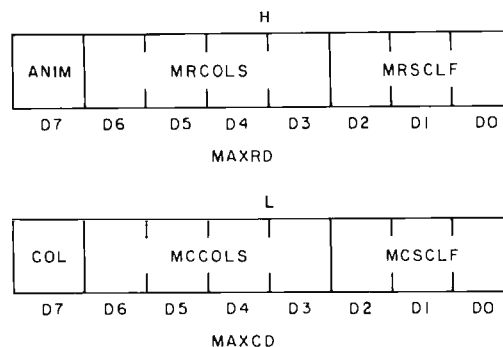

ANIM =	0 - Delay to start of vertical blanking. 1 - Double buffered animation supported.
COL =	1 - Display is in color. 0 - Display is black and white.
MRCOLS	- Colors (grey shades) in MAXR mode.
MCCOLS	- Colors (grey shades) in MAXC mode.
MRSCLF	- $\frac{256}{\text{Display resolution}}$ in MAXR mode.
MCSCLF	- $\frac{256}{\text{Display resolution}}$ in MAXC mode.

Figure 2: 8080 assembly language standard display parameter fields.

available space for refresh buffers. While some displays do not require this information, it should always be included for compatibility. The address in HL is replaced by INITG with a 2-byte description of the display being used (all other registers and flags are left undisturbed). The format for these bytes is given in figure 2. The colors and scale factor fields which are available in register H describe the display when maximum resolution is selected; the same fields in register L describe the maximum color selection mode.

The available colors field gives the number of colors, other than white, to which a point can be written. If the field is zero, it means that the way to erase what has been written is to page the display. The scale factor field indicates the physical size of display points in standard coordinates. If the X and Y scale factors differ, the larger of the two is used. For example, if the display had 64 lines with 100 points on each, the scale factor would be four, based on the Y axis resolution.

The animation and color fields apply to all display modes. If the animation field is one, the display supports double buffered animation. If this field is zero, it is impossible to build one display scene while another is displaying. In this case the ANIMAT routine is a delay until the start of vertical blanking. The color/black and white field is self-explanatory: if it is one, the display is in color; otherwise it is black, grey, and white. Note that this field has no real meaning if the number of available colors is zero or one.

## BASIC Protocol

For maximum flexibility and machine independence, a BASIC language usage protocol is also defined. Table 3 summarizes the commands and their arguments. Display initialization (IGR command) sets the variables A1

# GREAT PET SOFTWARE

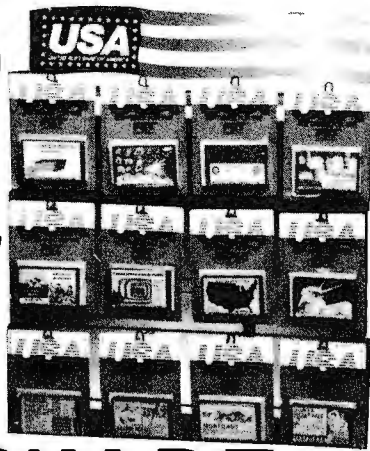

"Precise, humanized, well documented an excellent value" are the applauds now being given to United Software's line of software. These are sophisticated programs designed to meet the most stringent needs of individuals and business professionals. Every package is fully documented and includes easy to understand operator instructions.

**DATABASE MANAGEMENT SYSTEM** - A comprehensive, interactive system like those run on mainframes! Six modules comprising 42% of programming allow you to: create, edit, delete, display, print, sort, merge, etc., etc. - databases of up to 10,000 records. Printer routines automatically generate reports and labels on demand. 60 pages of concise documentation are included. Requirements - 16-32K PET and 2040 Dual Disk (printer optional). . . . **Cost \$125**

**ACCOUNTS RECEIVABLE/PAYABLE** - A complete, yet simple to use accounting system designed with the small businessman in mind. The United Software system generates and tracks purchase orders and invoices all the way through posting "controlled" accounts payable and accounts receivable subsystems. Keyed Random Access file methods makes data access almost instantaneous. The low-cost solution for the first time computer user with up to 500 active accounts. Requirements - 32K PET, Dual Disk, any 80-column printer. . . . **Cost \$175**

**CASH RECEIPTS & DISBURSEMENTS** - Makes it a breeze to track all outgoing payments made by any type of business operation. Checks are tracked by number and categorized by type of expense. Sorting, summary, and audit trails make it easy to post to general ledger. This system also categorizes incoming receipts. Uses KRAM file access method. Requirements - 32K PET, Dual Disk (printer optional). . . . **Cost \$99.95**

**KRAM - Keyed Random Access Method** - The new, ultra-fast access method for the PET Disk, provides keyed retrieval/storage of data, in either direct or sequential mode, by either full or partial key values. Written by United Software in 6502 machine code, and designed with the PET in mind, it exploits all the benefits of the PET Disk, allowing full optimization of your system. KRAM provides flexibility never seen on a micro before. KRAM is modeled after a very powerful access method used on large-scale IBM Virtual Storage mainframes. So "KRAM" all you can into your PET - it will love you for it. . . . **Cost \$79.95**

(Sublicenses available to software houses.)

<b>PROGRAMS FOR ENTERTAINMENT</b>	Super Startrek . . . . .	14.95
Space Intruders	PET Music Box . . . . .	29.95
("Best Game of 1979") . . .		\$19.95
Jury/Hostage . . . . .		12.50
Kentucky Derby/Roulette . .		9.95
Alien I.Q./Tank . . . . .		9.95
Tunnelvision/Maze Chase . .		14.95
Submarine Attack . . . . .		9.95
Battle of Midway . . . . .		7.95
Laser Tank Battle . . . . .		9.95
Swarm . . . . .		14.95
<b>UNITED SOFTWARE PROGRAMS FOR BUSINESS</b>	Checkbook . . . . .	\$15.95
	Mortgage . . . . .	15.95
	Finance . . . . .	12.95
	Bonds . . . . .	12.95
	Stock Analyzer . . . . .	22.95
	Stock Options . . . . .	24.95
	6502 Macro Assembler . . .	49.95

Look for the RED-WHITE-BLUE United Software Display at your local computer dealer, or send check or moneyorder, plus \$1.00 shipping to:

**UNITED SOFTWARE OF AMERICA**  
750 Third Ave.                      Dealer inquiries invited  
New York, N.Y. 10017

Mnemonic	Function	Arguments
IGR	INITG	None
PAG	PAGE	None
CUR	CURSOR	<X>, <Y>
DOT	DOT	None
LIN	LINE	<X>, <Y>
CHA	CHAR	<numeric ASCII value>
ANM	ANIMAT	None
TXT	PRINT	Equivalent to print except on display

Variable Name	Display Parameter
A1	X scale factor, high-resolution mode
A2	Y scale factor, high-resolution mode
A3	Available colors, high-resolution mode
A4	X scale factor, maximum color mode
A5	Y scale factor, maximum color mode
A6	Available colors, maximum color mode
A7	Animation support
A8	Grey scale

Table 3: BASIC standard protocols.

through A8 to reflect the display parameters. The scale factors A1, A2, A4, and A5, normally given exactly, are permitted to be rounded off to the nearest integer. These variables are ordinary BASIC variables and may be used and set as desired by the program.

The additional command TXT provides the user with the full flexibility of the BASIC PRINT command. Text and variables are displayed using the formats requested in the TXT statement starting at any location on the screen by using CUR to position the cursor. All characters are displayed using the current color.

## Function Algorithms

To facilitate development of this standard, the algorithms used to produce the Matrox ALT-256\*\*2 and the Cromemco Dazzler implementations of the 8080 assembly language standard are provided here. Of particular interest to most readers will be the line and character generation algorithms, which are independent of the hardware configuration of the display used.

For those readers not familiar with Nassi-Schneiderman design charts, a brief explanation is in order. More detailed information can be found in the original article published in the *SIGPLAN Notices* (August 1973). The Nassi-Schneiderman chart is a stylized flowchart for structured programming. By supporting only standard structured programming constructs (see figure 3) and not GOTOs and off page connectors, the chart forces the software designer to avoid the convolutions and obscurities in logic which make programs excruciating to debug and impossible to maintain.

The INITG and DOT routines are the only routines which normally require extensive adaptation to suit different displays. Since the Matrox ALT-256\*\*2 is the only currently available low-cost display which is not direct memory access (DMA) refreshed from program memory and an enhanced 8080 assembly language package that is compatible with this standard is available from Matrox, the special considerations required to program I/O port driven displays are not included in this article. For direct memory access displays, the only other adaptations normally required are the refresh memory size parameter in



## 25 START-AT-HOME COMPUTER BUSINESSES

In "Low Capital, Startup  
Computer Businesses"

CONSULTING • PROGRAMMING • MICRO COMPUTER OPPORTUNITIES • SOFTWARE PACKAGES • FREELANCE WRITING • SEMINARS • TAPE/DISC CLEANING • FIELD SERVICE • SYSTEMS HOUSES • LEASING • SUPPLIES • PUBLISHING • HARDWARE DISTRIBUTORS • SALES AGENCIES • USED COMPUTERS • FINDER'S FEES • SCRAP COMPONENTS • AND MORE . . .

Plus — ideas on moonlighting, going full-time, image building, revenue building, bidding, contracts, marketing, professionalism, and more. No career tool like it. Order now — if not completely satisfied, return within 30 days for full immediate refund.

• 8 1/2 x 11 ringbound • 156 pp. • \$20.00

Phone Orders 901-761-9090



## DATASEARCH incorporated

4954 William Arnold Road, Dept. B, Memphis, TN 38117

Rush my copy of "Low Capital Startup Computer Businesses" at \$20.

NAME/COMPANY \_\_\_\_\_  
ADDRESS \_\_\_\_\_  
CITY/STATE/ZIP \_\_\_\_\_

Check Enclosed     VISA     Master Charge

# \_\_\_\_\_ Exp. Date \_\_\_\_\_

## THE BRAND NEW EXCEL TX-80 DOT MATRIX PRINTER

ONLY \$560<sup>00</sup>

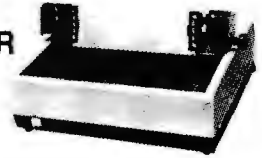

### STANDARD FEATURES:

- 80 columns on plain paper with adjustable paper width
- 150 characters per second (70 lines per minute) throughput;
- Friction feed standard, tractor feed at \$25 more
- 96 character set (upper and lower case) plus PET's\* graphic set
- Elongated character (double width printing)
- Microprocessor control and self-test when power up
- Centronics compatible parallel interface
- 90 days warranty parts and labor

### OPTIONAL INTERFACE BOARDS & CABLE SETS:

- PET\*, APPLE II\*, TRS-80\* and serial interface board available at \$60 each
- All our interface boards reside inside the printer and does not require extra power supply
- Cable for each interface is available at extra cost

### SEND ORDERS TO:

P. O. Box 1147  
El Cerrito, Calif. 94530  
Phone: (415) 465-4240

## EXCEL COMPANY

MICRO COMPUTER SYSTEMS  
618 GRAND AVENUE  
OAKLAND, CALIF. 94610

We are the original PET\* Keyboard Interface people

\*Trade Marks of Commodore, Apple & Tandy Corp.

### TERMS:

- Checks, Master Charge and Visa accepted • Allow up to 4 weeks for delivery
- Please add \$15 per printer for shipping & handling • Calif. residents add 6% sales tax.

### MONITOR \$149, 12" B&W

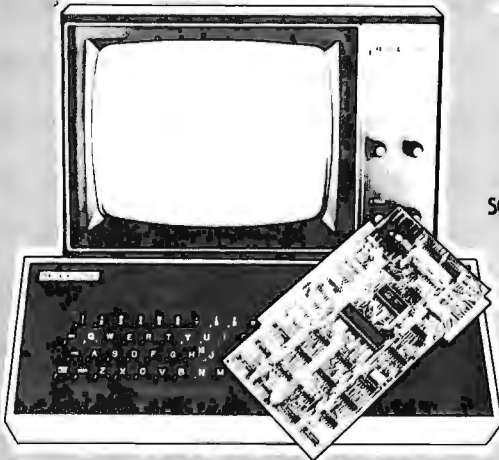

**COMPLETE KEYBOARD TERMINAL \$375**  
Full Kit \$325 (includes SCT-100)

## Stand Alone Video Terminal

### SCT-100 VIDEO BOARD FEATURES

- 64x16 line format with 128 displayable characters
- Serial ASCII or BAUDOT with multiple Baud rates
- \$197 Assembled or \$167 Kit (Partial Kit \$99)
- Full cursor control with scrolling and paging
- On board power supply
- Serial interface RS232 or current loop
- Purchase SCT-100 alone or complete terminal

## XITEX CORP.

9861 Chartwell Drive  
Dallas, Texas 75243 (214) 349-2490

ORDER BY PHONE/Overseas orders & dealers welcome



## XITEX MORSE TRANSCIVER



### MRS100 FEATURES:

- Connects directly with any ASCII or Baudot Teletype®/Terminal
- Operates from 1 to 150 WPM with Auto-Sync.
- Displays WPM rate of copied signal plus FIFO buffer status.
- Contains a built-in 80 Hz bandpass filter and sidetone oscillator.

\$295 Assembled & Tested • \$225 Complete Kit • \$95 Partial Kit



### NEW FROM XITEX...ABM-100

Universal Converter ASCII • Baudot • Morse  
The ABM-100 is a universal code converter for translating between ASCII and Baudot, or between Morse and ASCII (or Baudot). Also used as a TTY\* speed converter. Assembled and tested the ABM will operate from a single +5V supply and sells for \$129. Write for complete details . . . . .

# Up Your Output.

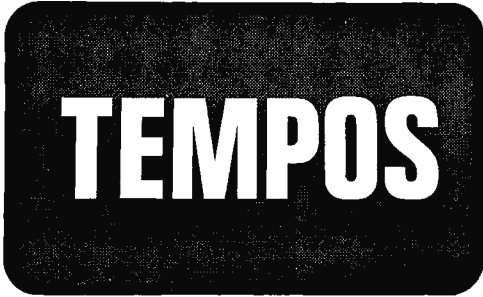

## MULTI-TASKING!

The TEMPOS Operating System is quickly becoming the standard in Multi-User, Multi-Tasking operating systems for 8080 and Z80 microcomputers. Multi-Tasking means that, even with only one user at one terminal, more than one job can be running on the system *simultaneously!* If you have ever had to go get a cup of coffee while you wait for your computer to print listings, you *know* the advantages of a system that will handle one job while you are working on another. TEMPOS is a true time sharing system, and the maximum number of jobs is limited only by your memory.

## MULTI-USER!

Want to share your computer with another user? With TEMPOS all it takes is another terminal . . . up to seven interactive terminals are allowed! And with Re-Entrant programs, each user does not need a complete copy in memory. We include three Re-Entrant programs (the OPUS/THREE High-Level Language, the TEXTED Text Editor, and FILES, a disc file directory/manipulator) or write your own! In addition, we include an assembler, a linking loader, over a half-dozen other utility programs and over 60 system subroutines, callable by the programmer!

## PROVEN!

With TEMPOS, you get a package that has been tested in our facilities for over two years, and in the field at over 50 different installations. We have used this system ourselves for everything from writing high-level languages to developing applications to text editing to games. TEMPOS is undoubtedly the most flexible software tool on the market . . . and you can have it for much less than you think!

## COMPATIBLE!

TEMPOS is available for many different systems; pre-written drivers may include yours. Or, using our interactive System Generation Routine, you can add your own. Call or write now for our free catalog and the name of a dealer near you. The TEMPOS Operating System is available for \$787.00, the manual set (price may be credited toward the purchase of the TEMPOS package) for \$21.50 (prices include shipping within the U.S.).



1642 S. Parker Road, Suite 300, Denver, Colorado 80231  
(303) 755-9694

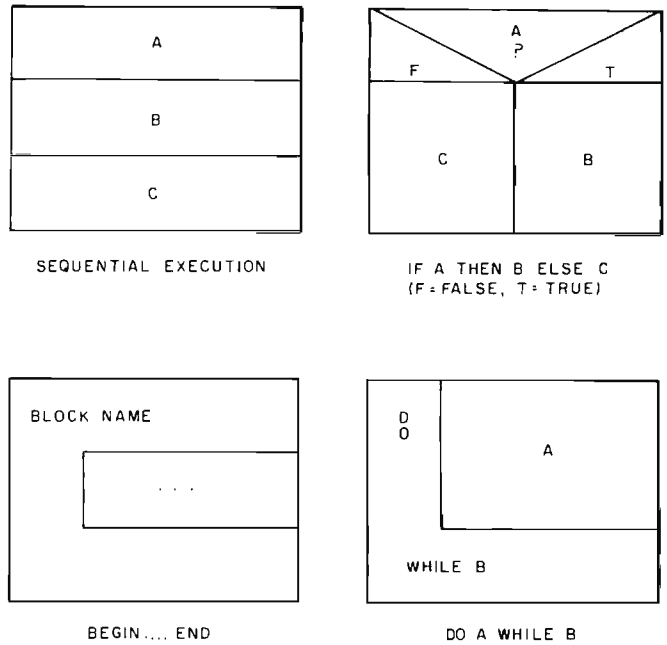

Figure 3: Nassi-Schneiderman charts, a system of stylized flowcharts which are designed for use with structured programming techniques. Each of the charts physically resembles the program section it emulates. The charts are read from top to bottom.

PAGE, the color and mode select controls in CHAR, and the scale factors used by the internal subroutine SCALE.

### INITG Logic

Initialization is normally required for both hardware and software (see figure 4). The first step is to establish the refresh buffer. This requires taking the address which defines the top of the user program and moving up to the first address legal for refresh buffers. This address is needed by other routines, as well as for starting the display hardware. The different variables and flags are then set to the required values, and the page routine is called to clear the screen. The appropriate display

Legal Refresh Address	
F	T
Move up to next legal address	OK
Save refresh buffer address	
Set Animation Inactive flag	
Set Cursor to X = 0, Y = 0	
Set Current Color to White	
Set Mode to MAXR	
Turn off all nonstandard options	
Call PAGE to clear the screen	
Start the display hardware	

Figure 4: The INITG function. INITG serves three purposes as an aid to the user: it initializes the system, performs any initialization functions required by the display software, and sets the display description variables to the appropriate values.

## North Star\* and PASCAL Users:

*Mike's*  
announces

Hard disk and 8" drive interfaces to North Star DOS and BASIC and PASCAL

### TIMESHARING for the Horizon—

Interrupt-driven, bank switching timesharing software; supports North Star DOS and BASIC and PASCAL.

A complete selection of business application software is available for North Star\* systems.

Write or call for descriptive literature.

### Micro Mike's, Incorporated

905 South Buchanan \* Amarillo, Texas 79101 \* USA  
(806) 372-3633

# VULCAN = DBMS

THE PROFESSIONAL DATABASE MANAGEMENT SYSTEM

For 8080/Z80 systems under CP/M or PTDOS

- \* VULCAN is a complete database management system that has 38 powerful, easy to learn, English-like commands to manipulate files, records, fields, and scratch-pad variables.
- \* VULCAN has a command repertoire which includes such commands as: SORT, REPORT, APPEND, INSERT, EDIT, COPY, REPLACE, LOCATE, DISPLAY, DO, LIST, and LOOP.
- \* VULCAN structured data records can be selectively chosen for processing using complex Boolean, string, or mathematical expressions.
- \* VULCAN can be used in interacter or program mode. The program mode uses modern structured command programs to combine powerful DBMS operations.
- \* VULCAN is written in assembly language for efficient information processing and requires 36K bytes CP/M system and one or more disk drives.
- \* VULCAN can accept or store data in standard ASCII files to be compatible with BASIC, FORTRAN, etc.

\*VULCAN (CP/M or PTDOS) \$490  
Manual only \$ 25

### SCDP

Software Consultation Design and Production

6542 Greeley St.

Tujunga, CA 91042 (213) 352-7701

California residents add 6% sales tax.

## DATA TERMINAL EQUIPMENT — FROM MICROMAIL



### LA34 DECwriter IV

**\$1,199.00**

- Upper/lower case, 9x7 dot matrix
- 10, 12, 13.2, 16.5 characters/inch
- 2, 3, 4, 6, 8 or 12 lines/inch
- 22"W x 7"H x 15 1/2"D, 25 lbs.
- 110 or 300 baud, RS 232C serial ASCII
- Friction feed, paper width to 15"

### New from DIABLO

DIABLO 1640 **\$2,690.00**

Receive-only **\$2,331.00**

High-quality daisywheel printing at 45 cps.

DIABLO 1650 **\$2,779.00**

Receive-only **\$2,419.00**

Metal daisywheel printing at 40 cps.

### T.I. 810 printer **\$1,695.00**

- Includes upper/lower case
- 150 characters per second
- RS 232C serial interface
- Adjustable forms tractor

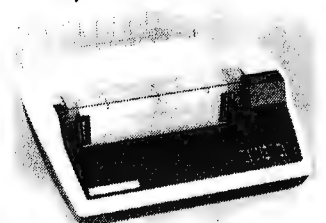

### SOROC IQ 120 **\$795.00**

- RS 232C, upper/lower case, full ASCII
- Numeric keypad, protected fields
- Cursor keys plus addressable cursor
- Auxiliary extension port



### SOROC IQ 140 **\$1,250.00**

- RS 232C and 20mA current loop
- Extensive editing features
- 25th line terminal status display
- 16 function keys (32 with shift)



### NEC Spinwriter

Call or write for prices

To Order: Send certified check (personal or company checks require two weeks to clear) including handling\* and 6% sales tax if delivered within California.

\*Handling: Less than \$2,000, add 2%; over \$2,000, add 1%. Everything shipped freight collect in factory cartons with manufacturer's warranty.

# MICROMAIL

MICROMAIL • BOX 3297 • SANTA ANA, CA 92703

(714) 731-4338



PAGE

ADR = Refresh buffer address	
CNT = Refresh buffer length	
D 0	Set [ADR] to zero (black)
	ADR = ADR + 1
	CNT = CNT - 1
UNTIL CNT equals 0	

Figure 5: The PAGE function. PAGE is used to clear the display screen.

CURSOR

Call SCALE to interpret coordinates
Set the software cursor to the scaled values.

Figure 6: The CURSOR function which sets the display cursor to a particular pixel on the screen.

description is generated, and control is returned to the calling program.

PAGE Logic

The PAGE command clears all the memory used for display refresh (see figure 5). The most general algorithm, and the one that is charted, is clear byte, increment address, decrement byte count, and test for done. In machines with indexed addressing, the byte count can

double as an index register. In machines with a memory-to-memory block transfer instruction, it is usually possible to clear one byte and transfer it to all of the display refresh memory.

CURSOR Logic

The CURSOR routine must convert from standard coordinates to software coordinates (see figure 6). Software coordinates are required by the LINE and CHAR algorithms to have a one-to-one correspondence with the actual display pixels being used. CHAR further requires X coordinates to increase to the right and Y coordinates to increase to the top. Since LINE must also scale its arguments, CURSOR and LINE can usually share the same internal scaling routine for efficiency.

DOT Logic

DOT is the only routine (other than PAGE) which actually modifies the refresh memory (see figure 7). Both LINE and CHAR use it to modify the desired pixels in the display. This routine is extremely hardware-dependent. Indeed, one of the primary reasons for defining this protocol was protection from differing display idiosyncracies. The DOT routine must translate the coordinates in the software cursor to the actual corresponding bits in memory. Remember that the software cursor is scaled so that a unit change in a coordinate is equivalent to the adjacent pixel. The logic presented here assumes a linear scan through refresh memory to generate the entire display, a line at a time, with the top line displayed first. Note that this algorithm is not adequate for the Dazzler, nor is it suitable for self-refreshed displays like the

**FOR YOU  
YOUR WIFE  
YOUR CHILD  
YOUR HOME  
YOUR SCHOOL  
YOUR BUSINESS**

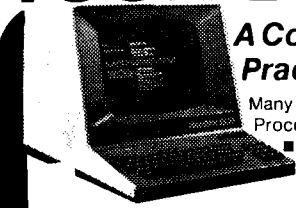

**A Computer System Both Practical and Affordable!**

- Word Processing
- Accounting
- Bookkeeping
- Games
- Personal Records
- Menu Planning
- Educational Development
- Tax Preparation
- Homework, etc.

BYTE SHOP EAST offers a wide selection of hardware to meet your specific needs; SORCERER, PET, APPLE, NORTH STAR, IMSAI, DIGITAL, and many, many others. BYTE SHOP EAST has a complete library of books and magazines to meet your needs.

Come in to our computer stores for a FREE demonstration!

**BYTE SHOP EAST, INC**

130 East 40th St.  
(Corner of Lexington Ave.)  
New York 10016  
Tues.-Fri. 10 - 6 Sat. 10 - 5  
(212) 889-4204

2721 Hempstead Turnpike  
(Just East of Wantagh Pkwy)  
Levittown, N.Y. 11756  
Tues.-Fri. 12 - 8 Sat. 10 - 5  
(516) 731-8116

DOT

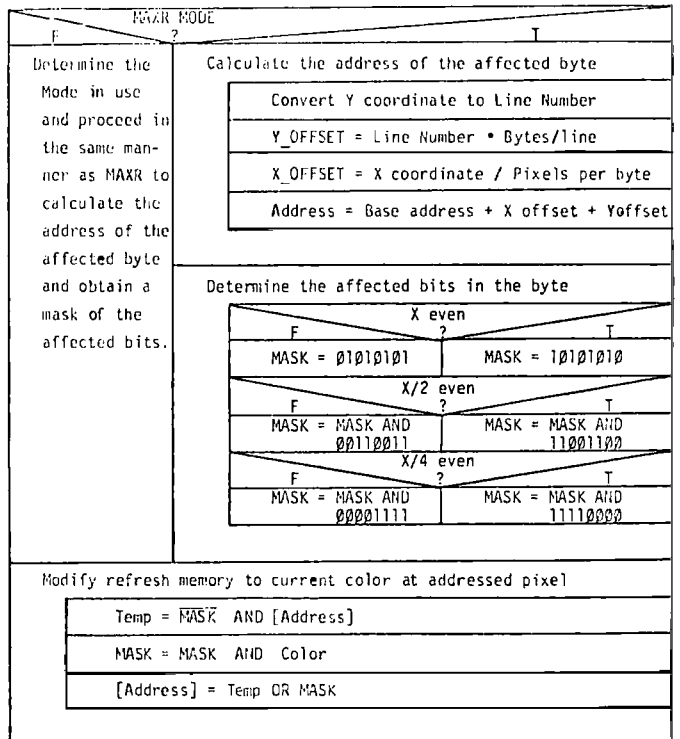



Figure 7: The DOT function which sets the display pixel indicated by the cursor to the currently selected color.

**DUNJONQUEST™ Presents**



**THE TEMPLE OF APSHAI**  
VISIT THE VAULT OF THE DEAD!

The Vault of the Dead is but one of the many dark and fearsome mysteries within the ruined Temple of Apshai. The Temple of Apshai is your first adventure in the DUNJONQUEST™ series of fantasy role playing games.

DUNJONQUEST™ is a complete game system and The Temple of Apshai is a complete fantasy adventure game for you and your microcomputer.

- Take your favorite character—or let the computer create one for you!
- Let the Book of Lore guide you through a DUNJONQUEST™ within the Temple.
- Decide to fight the monsters or grab the treasure and run—but don't think too long—they'll come after you!

**The Temple of Apshai—for the TRS-80 (Level II, 16K) and PET (32K) microcomputers.**

Ask your local dealer or send a check for \$24.95 to:

**Automated Simulations-Department Y**  
P.O. Box 4232, Mountain View, CA 94040  
California residents please add 6% sales tax.

*OVER 200 ROOMS!  
OVER 30 MONSTERS!  
OVER 70 TREASURES!*

**You don't have to buy it just for the low price.**

**You can buy it for the quality, too!**



**If you've been looking for a less expensive floppy disc drive, but not wanting to sacrifice quality - your search is over!**

You get both in the Remex RFD1000B! For only \$395 look at what you get: ■ 8" Floppy Drive ■ Single or Double Density ■ Hard or Soft Sectoring ■ Media Protection Feature ■ Single Density Data Separator ■ 90 Day Factory Warranty

**REMEM RFD1000B**  
**\$395**  
VOLUME DISCOUNTS AVAILABLE

**AVAILABLE OPTIONS**

Door Lock, \$20     Connectors, \$10  
 Write-Protect, \$20     Interface Manual, \$2

**SIRIUS SYSTEMS**, P.O. Box 9748, Knoxville, TN., 37920  
Phone Orders accepted 9AM-7PM (E.S.T.): 615/577-1072  
 Check     Money Order     C.O.D.     MC     VISA     AE

NAME \_\_\_\_\_ CARD # \_\_\_\_\_  
ADDRESS \_\_\_\_\_ EXPIRATION DATE \_\_\_\_\_  
CITY \_\_\_\_\_ STATE \_\_\_\_\_ ZIP \_\_\_\_\_ CARDHOLDERS SIGNATURE \_\_\_\_\_

Add \$7.00 per Drive for Shipping/Handling. Tennessee residents add 6% sales tax. Foreign orders add 10% (payment in U.S. currency only).

**A COMPLETELY REFURBISHED "SELECTRIC" ASCII -  
TERMINAL FOR THE SMALL BUSINESSMAN OR SERIOUS HOBBYIST.**

# The AJ 841 I/O terminal. Now available from dealers nationwide.

Demand for our AJ 841 I/O computer terminal has been great. And now it's getting even greater. So call your local computer shop dealer right away. Supply is limited! You may never have another opportunity like this one to buy your own professional terminal.



**The AJ 841 features:**

- Choice of serial RS 232 or parallel interface
- ASCII code
- 14.9 cps printout
- High quality Selectric printing
- Heavy-duty Selectric mechanism
- Off-line use as typewriter
- Documentation included
- 30-day warranty on parts and labor (details available on request)

**Call toll-free now**

For location of your nearest AJ dealer, call toll-free:

**800/538-9721**

California residents call 408/263-8520.



LINE

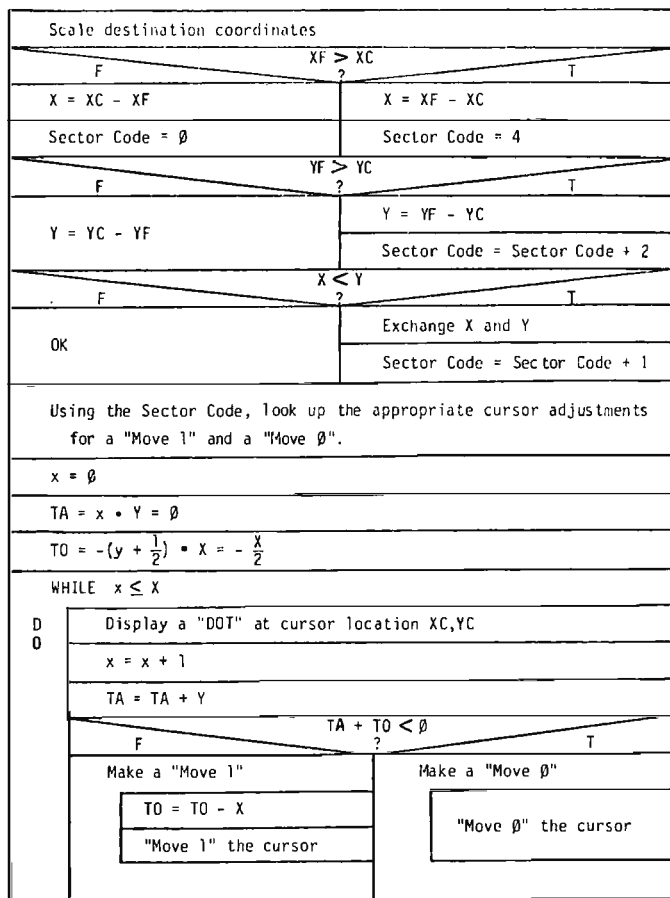

Figure 8: The LINE function which generates the line connecting the pixel defined by the cursor to the pixel requested.

Matrox ALT-256\*2. The former divides the display into four quadrants, each in its own block of memory with every byte describing points on more than one line. The modifications to the algorithm are explained in the sample implementation, and need not concern the non-Dazzler owner. The Matrox's refresh memory is directly addressed by X,Y coordinates and no conversion is required.

The first step is to determine the address of the byte which contains the requested point. The cursor Y coordinate is converted to a display line number which, when multiplied by the number of bytes per line, gives the offset into the refresh buffer of the first byte on the line. The X coordinate corresponds directly to the desired point along the line. Dividing the X coordinate by the number of points in each byte gives the offset from the first byte in the line. Taking the base address of the refresh buffer (set up by INITG) and adding the offsets to the desired line in the buffer and the desired point on the line yields the address of the byte which requires modification.

The second step is to determine which bits in the byte correspond to the desired pixel. The hypothetical display depicted by the Nassi-Schneiderman chart has eight pixels in each byte. The selected bits are then changed to match the current color, and the refresh memory is updated to reflect the revised point. An effective procedure is to generate a mask which contains ones at bit positions

corresponding to the addressed point, and zeros elsewhere in the byte. The byte of refresh memory is ANDed with the complement of the mask to delete the old contents. The mask itself is then ANDed with the bit pattern for a byte with every pixel. The current color and the result are ORed into the cleaned up byte of refresh memory.

LINE Logic

Perhaps the most crucial facet of any graphics system is its line generator (see figure 8). Before introducing the actual algorithm used, it may prove beneficial to discuss its theoretical development.

We wish to generate an arbitrary line from a point (XC, YC) to a point (XF, YF) (see figure 9). The goal is to determine those discrete points (xn, yn) which best approximate the desired line.

To simplify the derivation, we will only consider generating a line from point (0,0) to point (X,Y), where X is greater than or equal to Y and both are greater than or equal to 0 (figure 10). (This situation is general because any arbitrary line may be rotated and translated to match the proposed conditions.) Under these conditions, there is a point along the line for every value of x (0 ≤ x ≤ X), and for every value of x there is only one value of y. Closer examination reveals that for any value of x, the y value for the following point (x + 1) will either remain unchanged or increase by 1. No other value of y is possible. Furthermore, it can be shown that the decision to increment y for the next x is based solely on whether the point (x + 1, y + 1/2) lies above or below the line. If it lies above the line, y remains unchanged. If it lies below the line, y is incremented. In the event (x + 1, y + 1/2) is exactly on the line, either option is correct. For convenience, "on the line" is arbitrarily treated as equivalent to "above the line."

Assuming that we have a method to determine the position of the point (x + 1, y + 1/2) relative to the desired line, we can generate an optimal approximation of the line from (0,0) to (X,Y), where X ≥ Y ≥ 0, using the following algorithm:

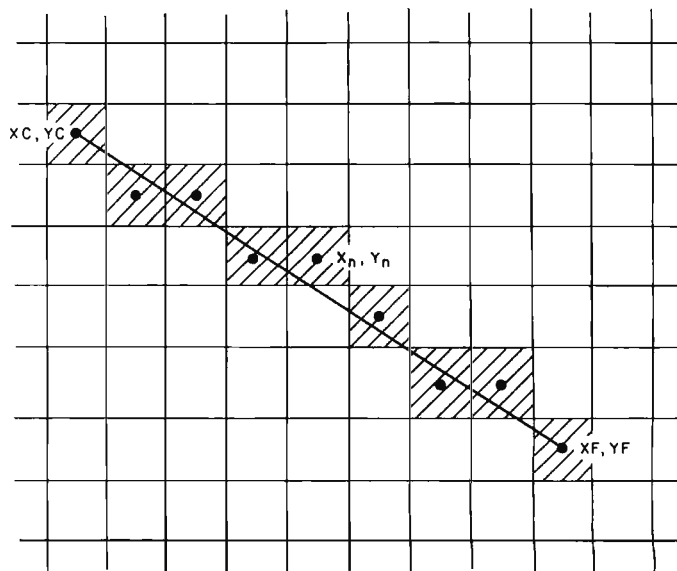

Figure 9: Generating an arbitrary line.



# Low Power 32K RAM for Heath® H8 computers

## DG-32D 32K RAM FEATURES:

- ✓ Plugs into Heath® H8 Computer
- ✓ Ready to use. Fully assembled, tested & burned in
- ✓ Operates with existing Heath memory
- ✓ Protected Memory Output Buffers in the event of Address error.
- ✓ Utilizes popular 4116 RAM devices
- ✓ Memory Address DIP switch changeable
- ✓ Arranged as 4 Independent 8K Blocks
- ✓ Low Power Consumption: Less than 6 watts, typical
- ✓ Transparent Refresh
- ✓ One year guarantee
- ✓ Compatible with all current H8 peripherals.

Heath® and H8 are registered trademarks of the Heath Corporation, Benton Harbor, Michigan.

**D·G ELECTRONIC  
DEVELOPMENTS CO.**

**\$479**

D·G Electronic Developments Co. brings you a totally compatible, fully assembled and tested 32K RAM for Heath® H8 computers. The DG-32D has less than 6 watts power consumption. This allows you to add a full 32K bytes of Random Access Memory without taxing or replacing your computer's power supply. Engineered to plug-in and run without any user modifications, the DG-32D can be used with or without existing H8 RAM without modification. Protection of the memory output buffers is provided in the event of assigning two blocks to the same address space. The DG-32D is the ideal answer to expansion of the Heath H8 computer . . . Low power consumption, low price, high capacity, total engineering and exacting production methods.

Ordering Information: DG-32D RAM available only from DG Electronic Developments Co., P.O. Box 1124, 1827 South Armstrong, Denison, Texas 75020. Check, money-order, VISA or Master Charge. Phone orders accepted on charge orders. NO COD's. Foreign orders add 30%. Texas residents add 5%. For VISA or Master Charge orders call 214-465-7805. \$479.00 freight prepaid.

**32K RAM for HEATH® H8**

# WHAT'S IT?

(Wow! How'd All That Stuff get In There?)

from Computer Headware  
... the Self-Indexing Query System  
for your Apple II, North Star, or CP/M machine

Distributed by:

- Information Unlimited / 219-924-3522  
P.O. Box 8372, Merrillville, Indiana 46410
- Lifeboat Associates / 212-580-0082 (CP/M model only)  
2248 Broadway, Suite 34, New York City 10024
- Structured Systems Group, Inc. / 415-547-1567  
5208 Claremont Avenue, Oakland, California 94618

# DYNACOMP

Quality software for: Altair  
North Star  
TRS-80 (Level II)

Sophisticated software written by recognized computer professionals. Each program is supplied with complete documentation. All programs can be run with standard terminals (32 character or wider) and within 12K program memory space.\*

## FLIGHT SIMULATOR

(as described in SIMULATION, Volume II)

- Realistic and extensive three-dimensional simulation of take-off, flight and landing.
- Based on aerodynamic equations and real airfoil.
- Practice instrument approaches and navigation using radials and compass headings.

Price: \$17.95

SIMULATION, Volume II (BYTE Publications): \$6.00

## VALDEZ\* (Requires 16K of program memory)

- Exciting simulation of supertanker navigation in Prince William Sound and Valdez Narrows using radar map.
- Detailed physical model of ship response and tidal patterns.
- Chart course through ship and iceberg traffic.

Price \$14.95

## BRIDGE 2.0

- Complete contract and duplicate bridge game.
- Computer both **bids** and **plays**.
- Computer will play offense or defense according to the bid.
- Challenging entertainment for the advanced player.
- Excellent learning tool for the bridge novice.

Price: \$17.95

## HEARTS 1.5

- An entertaining computer simulation of this popular card game.
- Play against two computer opponents.
- Beware the Black Maria!

Price: \$14.95

## NORTH STAR TEXT EDITOR

(Update of program described in BYTE, June 1979)

- Designed as an easy to use (and remember) basic text editor.
- Works through unmodified North Star DOS.
- Line oriented editing, variable line width, simple paragraph indexing.

Price: \$14.95 (Available only on North Star diskette)

## NORTH STAR COMPRESSION PROGRAM

- Removes all unnecessary spaces and remark statements from program.
- Requires only a single disk drive.
- Any size program may be processed.
- Increases execution speed of programs while using less memory.

Price: \$9.95 (Available only on North Star diskette. Requires release 4 or higher North Star BASIC.)

Except where noted, all software is available on North Star diskettes, and Altair and TRS-80 cassettes.

Additionally, Microsoft BASIC ASCII listings are available on paper tape and cassette (modem compatible, 300 baud).

All orders processed within 48 hours. Write for more detailed descriptions of these and other programs available from **DYNACOMP**.

# DYNACOMP

P.O. Box 162

Webster, New York, 14580

New York residents please add 7% NYS sales tax.

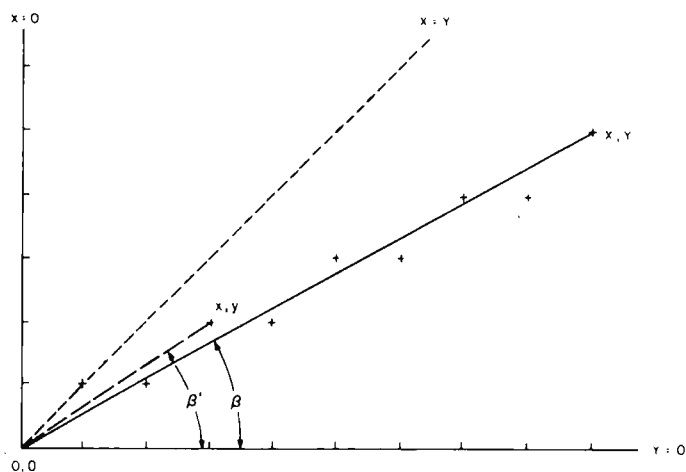

Figure 10: Simplified line generation.

- 1) Initialize  $x \leftarrow 0, y \leftarrow 0$ .
- 2) Display the point  $(x,y)$ .
- 3) Test for done:  $x = X$ ?
- 4) Calculate the position of the point  $(x + 1, y + \frac{1}{2})$  relative to the desired line.
- 5) Set  $dy$  to 1 if below the line; 0 if on or above.
- 6) Calculate the next point:  
 $x \leftarrow x + 1$   
 $y \leftarrow y + dy$
- 7) Go to step 2.

There are only two obstacles to overcome before implementing this algorithm: step 4 and the restrictive initial conditions. Let us examine each in turn.

A brief excursion into trigonometry is required to evaluate step 4. Referring to figure 10, if we call the angle between the desired line and the X axis  $\theta$ , and the angle formed by the current point  $(x,y)$  the origin and the X axis  $\theta'$ , then if  $(x,y)$  lies above the desired line,  $\theta < \theta'$ . Conversely, if  $(x,y)$  lies below the desired line,  $\theta > \theta'$ . Of course, if the two coincide,  $\theta = \theta'$ . We know from trigonometry that for angles in the first quadrant, the greater the angle, the greater its tangent. We also know that the tangent of  $\theta$  is  $\frac{Y}{X}$ , while that of  $\theta'$  is  $\frac{y}{x}$ . Therefore, we can easily determine the position of any point relative to the desired line by comparing the quotients  $\frac{Y}{X}$  and  $\frac{y}{x}$ .

Unfortunately, performing division on microcomputers is a time-consuming process. Using the properties of inequalities to eliminate the divisions, we can build a decision table (see table 4) which requires only multiplication. Returning to our original algorithm, we set  $dy$  to 1 if:

$$(x + 1) \times Y > X \times (y + \frac{1}{2})$$

and to 0 if it is not. Further advantage can be gained by realizing that at each iteration the product on the left side of the inequality increases by  $Y$ , while the right either remains the same or increases by  $X$ . By remembering the

Circle 376 on inquiry card.

**PET PRODUCTS**  
Programs — Workbooks  
for Floppy Disk — for Cassette



See your Dealer Dealer Inquiries Invited

**T I S**  Put your PET to work!

PROGRAMS	WORKBOOKS	
SW-1* MAILB mailing list system	WB-1 Getting Started with Your PET	\$3.95
SW-2* CHECKBOOK record	WB-2 PET String and Array Handling	\$3.95
SW-3* ACCOUNTS keep track of who owes you how much	WB-3 PET Graphics	\$4.95
SW-4 MEDIT create and maintain data files	WB-4 PET Cassette I/O	\$4.95
SW-5* CALENDAR appointments, meetings at a glance	WB-5 Miscellaneous PET Features	\$3.95
	WB-6 PET Control and Logic	\$3.95



\*These programs are special purpose data base management systems. They all can:

- Sort numeric or string fields
- Select based on numeric or string (=)
- Select based on substring match
- Select based on range of entry number

Prices: \$9.90 each for programs using cassette storage for data  
\$12.95 each using sequential floppy disk storage for data.  
Price includes 40 - 60 page instruction manual

Add \$2.00 for shipping and handling

Money back guarantee

TIS  
P.O. Box 921, Dept. B  
Los Alamos, NM 87544

On bank card orders, give all numbers  
PET is a trademark of Commodore Business Machines

## From S-100 to IEEE-488

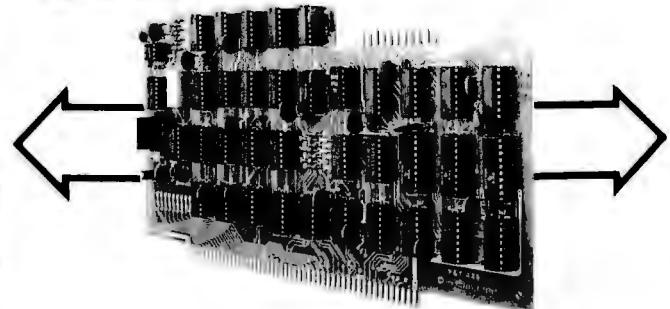

### P&T-488 + S-100 computer = Intelligence for your Instrumentation System

The P&T-488 permits an S-100 computer to operate as a talker, listener, or controller on the IEEE-488 instrumentation bus for less than half the cost of calculator-based systems. Software packages which give access to the 488 bus from high level languages such as BASIC are available for CP/M, North Star DOS /BASIC, and Cromemco CDOS. Or "roll your own" system with the custom system package of assembly language drivers. P&T-488, assembled and tested, + any software package: \$400 (domestic USA)



**PICKLES & TROUT**  
P.O. BOX 1206. GOLETA, CA 93017. (805) 967-9563

# THE MM-103 DATA MODEM AND COMMUNICATIONS ADAPTER

S-100 bus compatible

## FCC APPROVED

Both the modem and telephone system interface are FCC approved, accomplishing all the required protective functions with a miniaturized, proprietary protective coupler.

## WARRANTY

One year limited warranty. Ten-day unconditional return privilege. Minimal cost, 24-hour exchange policy for units not in warranty.

**LOW PRICE—\$359.95—** For Modem AND Coupler

plus shipping & handling



## HIGH QUALITY

-50 dBm sensitivity. Auto answer. Auto originate. Auto dialer with computer-controlled dial rate. 61 to 300 baud (anywhere over the long-distance telephone network), rate selection under computer control. Flexible, software-controlled, maskable interrupt system.

## ASSEMBLED & TESTED

Not a kit! (FCC registration prohibits kits)

**Potomac Micro-Magic, Inc.**

Write for brochure:  
First Lincolnia Bldg., Suite B1  
4810 Beauregard St.  
Alexandria, Va. 22312

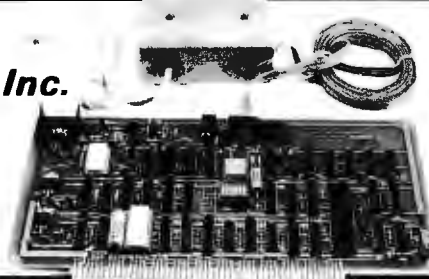

Call for further information:  
VOICE: (703) 750-3727  
MODEM: (703) 750-0930 (300 baud)





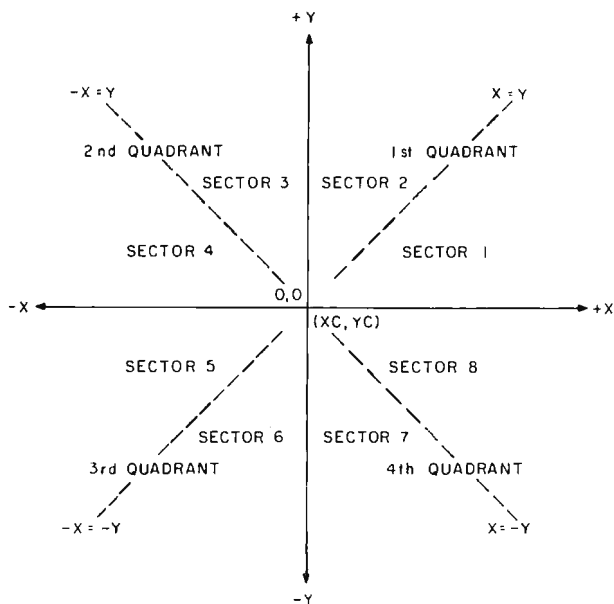

Figure 11: Quadrant and sector definition.

products from the previous iteration, and whether or not  $y$  is incremented, the multiplication can be reduced to addition. For maximum efficiency, the right-hand product can be maintained negated so that the comparison can be made with a single addition.

The restriction that the line runs from  $(0,0)$  to a point  $(X,Y)$  with  $X \geq Y \geq 0$  requires the use of coordinate translations, rotations, and reflections. The first step is to translate the line so that it starts at  $(0,0)$ . Since the line originates at the cursor, we would traditionally subtract the cursor from the other endpoint to obtain its relative position. However, because a 256 by 256 display does not give us room for a sign-bit in an 8-bit byte, it is first necessary to rotate the line to the first quadrant and then calculate the magnitude of the endpoint displacements from the cursor.

While all these coordinate transformations may seem complicated, the actual implementation is quite simple. Consider the command to generate the line from the current cursor position  $(XC, YC)$  to a final point  $(XF, YF)$ . The first step is to compare  $XF$  to  $XC$ . If  $XF \geq XC$  then we are in the first or fourth quadrant (see figure 11); otherwise, we are in the second or third. Similarly, if  $YF \geq YC$ , we are in the first or second quadrant; otherwise, the third or fourth quadrant. By combining the two results, the quadrant is uniquely determined, and we can proceed to determine the magnitude of the  $X$  and  $Y$  displacements,  $XM$  and  $YM$ , as shown in table 5. Finally  $XM$  and  $YM$  are compared to determine the exact sector.

The easiest technique for remembering this multiple logical decision is to weight the results of each decision and check the sum. Each sector is then assigned an equivalent weight, and the sector parameter table is reordered accordingly. Column 2 of table 6 applies a weight of 4 to  $(XF > XC)$ , 2 to  $(YF > YC)$  and 1 to  $(YF > YP)$ .

Once the sector is determined, we have all the information required to construct any arbitrary line. Referring to

	Above	On	Below
Angle Relationship	$\theta < \theta'$	$\theta = \theta'$	$\theta > \theta'$
Tangent Relationship	$\frac{Y}{X} < \frac{y}{x}$	$\frac{Y}{X} = \frac{y}{x}$	$\frac{Y}{X} > \frac{y}{x}$
Relationship after Multiplying through by $x \cdot X$	$xY < Xy$	$xY = Xy$	$xY > Xy$
Result of $xY - Xy$	Negative	Zero	Positive

Table 4: Point position relative to a line.

Quadrant	XM	YM
1	$XF - XC$	$YF - YC$
2	$XC - XF$	$YF - YC$
3	$XC - XF$	$YC - YF$
4	$XF - XC$	$YC - YF$

Table 5: Component magnitudes in the four quadrants.

Sector	Sector Weight	X	Y	Move 0		Move 1	
				x incr	y incr	x incr	y incr
1	6	XM	YM	+1	0	+1	+1
2	7	YM	XM	0	+1	+1	+1
3	3	YM	XM	0	+1	-1	+1
4	2	XM	YM	-1	0	-1	+1
5	0	XM	YM	-1	0	-1	-1
6	1	YM	XM	0	-1	-1	-1
7	5	YM	XM	0	-1	+1	-1
8	4	XM	YM	+1	0	+1	-1

Table 6: Coordinate equivalents for each sector.

step 5 of the fundamental sector 1 algorithm, we call setting  $dy$  to 0 "move 0," setting  $dy$  to 1 "move 1," and generate the equivalence chart in table 6. As the algorithm steps along in transformed coordinates, it uses the "move 0" and "move 1" to modify the cursor position using  $X$  and  $Y$  increments appropriate for the sector the line is actually in.

### CHAR Logic

One of the most common formats for displaying characters is the 5 by 7 matrix of points (see figure 12). However, not many people realize why 5 by 7 is the smallest common size. The limiting width is, of course, the minimum number of points capable of displaying the three separate parallel lines required for the letters  $M$  and  $W$ . This sets the minimum possible width to 5, but why must 7 be the minimum height? The answer is, it need not be! However, human engineering studies have indicated that the average person finds it easier to read characters which are proportioned the same as in standard printing. Ratios of width to height far removed from the "normal" 0.75 increase fatigue and error rates.

To generate easily read lowercase characters, even larger matrices are required. This is a result of the greater complexity and finer detail of the lowercase characters. The full ASCII character set can be generated with a 7 by 9 matrix if provision is made for characters with descenders ( $g, j, p$ , etc). This requires the use of an extra

# HOW TO START YOUR OWN SYSTEMS HOUSE



A practical guide for the small EDP entrepreneur. 213-page manual covers all aspects of starting and successfully operating a Small Business Computer company.

5th revised edition June 1979. From the contents:

- The Systems House Industry
- Hardware, Software or Both?
- Market Selection & Evaluation
- Industry Application Opportunities
- Equipment Selection
- Becoming a Distributor
- Product Pricing
- Getting Your Advertising Dollars Worth
- The Selling Cycle
- Financing For The Customer
- Questions You Will Have To Answer Before The Customer Buys
- Solving The Service Problem
- Protecting Your Product
- How To Write A Good Business Plan
- Raising Capital

Send \$36.00 (check, VISA or Mastercharge) to:



**Essex Publishing Co., Dept. B**  
285 Bloomfield Avenue  
Caldwell, N.J. 07006



Credit card orders: Send card #, date exp. Add \$2.00 for rush, air mail shipping. N.J. residents add 5% sales tax. For faster shipment on credit card orders, phone (201) 783-6940.

## 3G LIGHT PEN PET TRS-80 LEVEL II

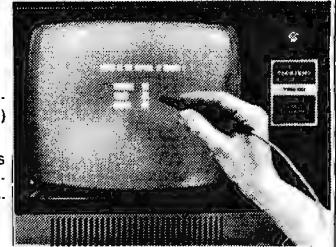

### TRS-80

- Economy — \$19.95  
(Plugs into tape recorder. Batteries and sample program included.)
- Professional — \$34.95  
(Plugs into expansion port. Allows other expansion port use. No batteries needed. Includes Demo-Game Cassette.)

### PET

- Professional — \$29.95  
(Plugs into user port. No batteries needed. Sample program included.)

**No assembly necessary — ready to plug in.** Demonstration program and complete documentation so you can write your own programs in BASIC.

MAIL COUPON TODAY

**3G Company, Inc. Dept. (503) 662-4492**  
Rt. 3, Box 28A, Gaston, OR 97119

- TRS-80 Economy \$19.95     TRS-80 Professional \$34.95     PET Professional \$29.95  
ADD \$1.50 for mailing and handling (\$6.00 foreign)

Card No. \_\_\_\_\_ Exp. date \_\_\_\_\_  
Signature \_\_\_\_\_  
NAME \_\_\_\_\_  
ADDRESS \_\_\_\_\_  
CITY \_\_\_\_\_ STATE \_\_\_\_\_ ZIP \_\_\_\_\_

**REMEMBER, 3G OFFERS A 30 DAY UNCONDITIONAL MONEY BACK GUARANTEE!**

# WITH MICROAGE WHOLESALE, THE DIFFERENCE IS...

## ... knowledge.

We grew up with the microcomputer industry. We know the marketplace, the product, the people. We're especially good at integrating products of different makes to achieve the right system for you and your customers. Our consumer guide, the **MicroShopper**, and the **MicroAge Wholesale Price Book** have become the industry standards.

## ... performance.

Our enthusiasm and dedication to serve resellers with better products at lower prices have helped contribute to the growth of the microcomputer industry. Our research and development department tests for assurance of reliability in every new product we bring to the marketplace. Not every item passes our performance standards. For resellers who commit to volume merchandising, we offer the most cost-competitive pricing in the industry.



## ... organization.

Our computerized order processing, our staff of over 100 industry-trained people and 30,000 sq. ft. of facilities — including two regional warehouses and a support center — enable us to provide fast delivery and reliable service to resellers in the U.S. and over 45 countries worldwide. Toll-free ordering plus the largest inventory in the industry mean quicker delivery than you can get from most manufacturers.

## ... integrity.

We're committed to offering what works for you and for us. Call now place your order and be...

**MICROAGE®**  
WHOLESALE

The nation's leading independent microcomputer wholesaler  
1425 W. 12th Place • Tempe, Arizona 85281  
For information — (602) 967-1421 — Cable MICROAGE  
Toll-free order line  
**1-800-528-1415**

... **A SATISFIED CUSTOMER**

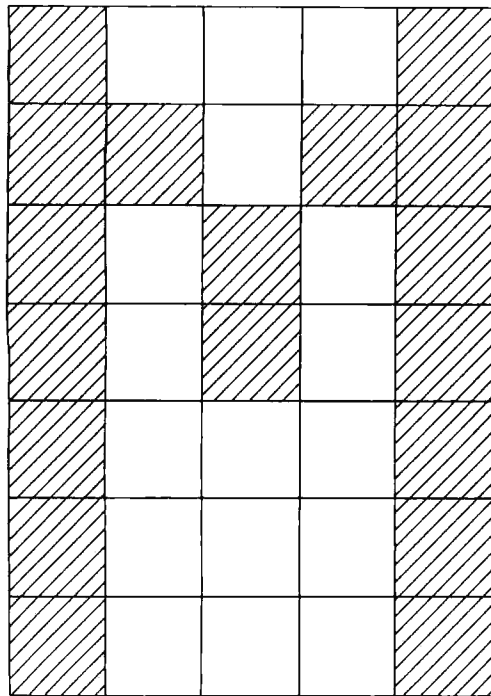

Figure 12: Typical character generation.

Char Size	LC	Char/Line (256 by 256)	Lines/Page (256 by 256)	Memory For Tables (bytes)
9 x 11	Y	25	18	1200
7 x 9	Y	32	21	864
5 x 7	N	42	32	320
4 x 5*	N	64	32	192

\*See text

Table 7: Effects of differently sized character matrices.

bit to determine if the matrix is displayed normally or shifted down two positions. As far as the display is concerned, the character uses a 7 by 11 matrix of display points. Larger display matrices can be used for greater legibility and varying character fonts, but even a 7 by 11 character matrix severely restricts the total number of characters that will fit on the low-resolution displays for which this standard is designed. If even one row of blank points is left between adjacent characters, then only sixteen 7 by 9 characters will fit across a 128-wide display. Memory requirements for large matrix character pattern storage are also severe. The table space required is directly proportional to the area of the matrix (see table 7).

A character matrix size less than the "absolute minimum" 5 by 7 was desirable, since even 5 by 7 characters require 320 bytes for their lookup table. Readable versions of 58 of the 64 uppercase printing ASCII characters can be generated within a 4 by 5 matrix. The remaining 6 characters (#, \$, &, %, M, and W) fit in a 5 by 5 matrix. Since these are normally considered wide characters, their unity width-to-height ratio is not objectionable.

To simplify table lookups and the special handling of 5 wide characters, 3 bytes are used for each character. Twenty bits are used for the 4 by 5 display matrix; the four extra bits are used as flags to define the specific parameters for each character. Two flag-bits are used to indicate the width of the character. Proportional spacing also fits the maximum number of characters into any given space. The third flag-bit is used by 5 wide characters to indicate whether the first column is all ones (M and W), or must be retrieved from an auxiliary lookup table (#, \$, %, and &). The remaining flag is used to indicate descending characters (, ; and \_). These characters are displayed two positions lower than their matrices indicate. Each character is therefore displayed in an n by 7 display area, where n ranges from 2 to 5.

The basic character generation algorithm (figure 13) is applicable to any size character matrix, whether the character is stored by column (more efficient for 5 by 7 and 6 by 8 matrix characters), or by row (more efficient for variable 4 by 5, 7 by 9, and 8 by 11). If the character set being used does not include lowercase, it is necessary to shift lowercase characters to their uppercase equivalents. Comparing the ASCII value of the character to 32 separates control characters for special handling.

The character table is ordered by ASCII value and lookup is done by indexing on the ASCII value requested. Since the first 32 ASCII characters are control characters,

CHAR	
Remove parity bit from character	
Control Character	
F	T
Lower case	
F	T
OK	Convert to upper case
F	NUL ?
OK	MODE = MAXR
Determine Char. Table entry	
F	SOH ?
OK	MODE = MAXC
Retrieve byte with flags	
Calculate next char position	
F	STX ?
OK	MODE = R128
Five wide	
F	T
M or W	
F	T
OK	Adjust cursor Y = Y - 8
Look up 1st Pretend col. in the retrieved Aux. Table all ones	
F	ETX ?
OK	MODE = R64
Put up a "DOT" in the first column for each one in the entry	
F	LF ?
OK	Adjust cursor X = 0, Y = -6
Move cursor right 1 col	
F	FF ?
OK	Adjust cursor X = 0
Set width to 4 columns	
F	CR ?
OK	Adjust cursor X = 0
Descender	
F	T
OK	DLE ?
Look up the bottom row and put up a "DOT" at each position indicated by a one.	
F	DC1 ?
OK	COLOR = black
Do the same for the 2nd row	
F	DC2 thru ETB ?
OK	COLOR = red
Do the same for the 3rd row	
F	T
OK	Set COLOR as requested
Do the same for the 4th row	
Do the same for the Top row	
Set cursor to next char. pos.	
Similarly check for and act on any optional control char to be implemented	

Figure 13: The CHAR function which provides the capability to display alphanumeric as well as graphical data.



## Belais' Master Index to Computer Programs in BASIC Gives You Access to \$14,836.14 Worth of Computer Programs for Just \$7.95!

You paid hundreds or even thousands of dollars for your new microcomputer. By now it may be dawning on you that a \$1,000 computer with no software is just \$1,000 worth of scrap metal!

But computer programs cost money. In a recent survey of 1,984 computer programs offered for sale in the top three home computer magazines, the average price was found to be \$27.94. What a rip-off!

You don't need to spend hundreds of dollars to get a complete library of programs for your computer. That is, you don't if you have *Belais' Master Index to Computer Programs in BASIC*.

*Belais' Master Index* gives reviews of 531 programs that have appeared in 10 major home computer magazines—programs that you can type into your computer for free!

This large 8 1/2 x 11, 192-page directory is packed with information. This is not just a simple listing of article titles, but a complete reference work!

Each BMI review is complete—it has everything you need to know about a program. A brief index line capsulizes the review for quick reference. Source information shows you where the program can be found. Any updates or corrections are shown so you know the program is accurate and complete. The text of the review gives you a full description of what the program does. In addition, the review gives detailed technical information about what hardware and software the program needs. Everything you need to know is right at your fingertips!

We don't provide the program listings themselves, of course. But we do tell you where you can pick them up—even ones that appeared in print years ago.

You don't have to be a programming wizard to use *Belais' Master Index*. That's because BMI lists only *finished, ready-to-run* programs in BASIC, the easy-to-use language enjoyed by millions.

Even if you're a master programmer, you'll appreciate *Belais' Master Index*. Why slave away hours, days, or even weeks writing a program when someone else has probably

already done the work for you? These programs are working, documented, and ready-to-go.

Programs like: *Circuit Design*, *Psychoanalysis*, *PASCAL Compiler*, *Forrester's World Simulation*, and *Color T.V. Tester*. Never again will you have trouble answering that question, "But what are home computers good for?"

Then again, there's always MONEY. Maybe you haven't thought of all the ways your "fun" computer could turn out a little of the green stuff for you. Maybe you haven't—but a lot of other people have, and they've written up their ideas for you to use. *Belais' Master Index* lists dozens of programs that you can use to set up your own business.

If you already have a business, *Belais' Master Index* has the programs to turn your home computer into a full-fledged business system. General ledger, billing, payroll, mailing lists, word processing—no matter what type of business you have, *Belais' Master Index* has the programs you need.

All this and save \$2.00, too! The cover price of *Belais' Master Index to Computer Programs in BASIC* is \$9.95. But because you're buying by mail, we don't have to pay a commission to a bookstore. So we're going to pass the savings along to you. Order now and you can get your copy of *Belais' Master Index* for just \$7.95!

To order, write your name, address, and the words "Belais' Master Index" on a piece of paper. Make out your check for \$7.95 plus \$1 shipping (Calif. residents add 5¢ sales tax), payable to FALCON PUBLISHING.

If you want to use your VISA or Master Charge card, give the total for your order, your account number, the expiration date of your card, and your signature.

Send your order to Falcon Publishing, Dept. AC, 140 Riverside Ave., P.O. Box 688, Ben Lomond, CA 95005

We absolutely guarantee you'll find *Belais' Master Index* one of the most useful books on your shelf. If you're not completely satisfied, return it to us within 30 days and we'll refund every cent you paid. You can't lose, so order NOW!

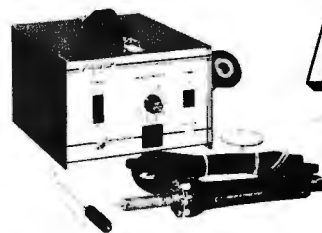

MODEL PC-10: Finger Controlled

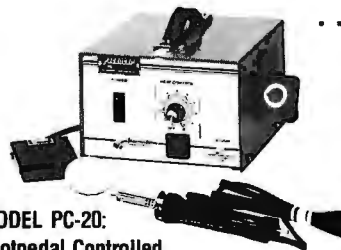

MODEL PC-20: Footpedal Controlled

### STANDARD SYSTEM FEATURES

- Lightweight and Portable
- Internal Vacuum Pump
- Sodr-X-Tractor Handpiece
- Variable Temperature Control

# Pacenter™

## Desoldering Systems

REMOVE ANY COMPONENT FROM ANY PCB... QUICKLY AND SAFELY

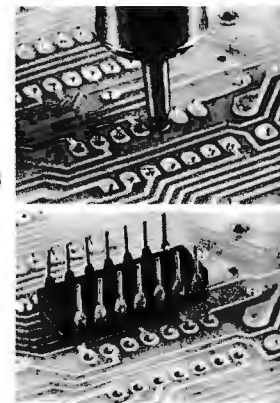

**PAGE**  
INCORPORATED

9329 Fraser Street ■ Silver Spring, Md. 20910 ■ (301) 587-1696

# 6800 SYSTEM SOFTWARE

Unmatched • Field Proven • Documented • Industry Wide

### SDOS™

A totally interrupt-driven (both disk and other peripherals) disk operating system, including type-ahead. Provides device independent, byte addressable random files. Supports any mixture of disk drives up to 2.5 BILLION bytes per drive. Disk files can grow dynamically to match application needs. Automatic, overlapped read-ahead on sequential files and LRU sector buffer pooling on random-access files optimize disk I/O. System utilities allow operator file manipulation, disk initialization, backup with wildcard file selection, and disk structure repair facilities to handle the infrequent but unavoidable disasters that occur in the real world. Turn-key application systems can be easily built, coupled with SD Business Basic. 242 pages of documentation.

### IDB

A RAM or EPROM-based assembly language debugger. Provides single-step with register display, multiple real-time conditional breakpoints, memory dump, multiple data display and entry modes. Can be used to debug interrupt-driven code. 39 pages of documentation.

6800 Hardware supported:

Conrac Model 480 (AMI MDC) + ICOM floppy  
WaveMate + Perci floppy (1771 + DMA)  
Electronics Product Associates + ICOM floppy  
Motorola EXORcisor + EXORdisk I or II  
SWTP + mini or DMAF floppy (FLEX)  
CMI 6800 + Winchester (16M) + Calcomp floppy (1771 + DMA)  
MSI 6800 + FD-8 mini-floppy or 10M cartridge disk  
Mizar Labs + double density Micropolis drives (1791 + DMA)  
SSB Chieftain—mini or 8-inch floppy  
Computer and Data Machines (England)

### BUSINESS BASIC COMPILER

A super fast application oriented BASIC. 10 digit BCD for values to 100 million dollars with pennies. Random access to variable size, variable content records. Long, meaningful variable names, formatted output, IF-THEN-ELSE with multiple statements per line, and error-trapping make this BASIC extremely powerful. Compiled code, automatic integer optimization, and fast floating point make applications written in SD Basic run faster than on virtually any other microcomputer, and protect the source code of the application. 104 pages of documentation.

### EDIT

A powerful and easy to use text editor with change, delete, insert, and remove commands. Automatic display of text or context changes, macro facilities for complex or repetitive editing. 44 pages of documentation.

### ASM

A lovely 2 pass assembler with conditional assembly, long labels, symbol table dump and cross-reference, error cross-reference, extensive arithmetic and listing control. 103 pages of documentation.

Write for a free catalogue or contact the hardware manufacturer.

All SD software comes with a 1 year warranty.

INNOVATION IN SOFTWARE



**SOFTWARE DYNAMICS**  
2111 W. Crescent, Suite G  
Anaheim, CA 92804  
(714) 635-4760

Circle 95 on inquiry card.

# CP/M<sup>®</sup>2

## NOW BETTER THAN EVER

- Control Program for Microcomputers.
- Includes Editor, Assembler, Debugger, Utilities.
- Supports Floppy Disks and Hard Disks.
- For 8080, 8085, Z-80, MDS, Cromemco.
- **\$150**-Diskette and Documentation
- **\$25**-Documentation only

# MP/M<sup>™</sup>

## NEW INDUSTRY STANDARD

- Multi-terminal access.
- Multi-programming.
- CP/M-compatible.
- Real-time features.
- **\$300**-Diskette and Manual
- **\$25**-Manual only

# DIGITAL RESEARCH

## OPTIONAL SOFTWARE PACKAGES

### MAC<sup>™</sup> MACRO ASSEMBLER:

- Compatible with new Intel macro standard.
- Complete guide to macro applications.
- **\$90**-Diskette and Manual.

### SID<sup>™</sup> SYMBOLIC DEBUGGER:

- Symbolic memory reference.
- Built-in assembler/diassembler.
- **\$75**-Diskette and Manual.

### TEX<sup>™</sup> TEXT FORMATTER:

- Powerful text formatting capabilities
- Text prepared using CP/M Editor.
- **\$75**-Diskette and Manual.

### DESPOOL<sup>™</sup>

- Background print utility.
- Use with CP/M
- **\$50**-Diskette and Manual.

# DIGITAL RESEARCH<sup>®</sup>

P.O. Box 579 • Pacific Grove, California 93950  
(408) 649-3896

## ANIMAT

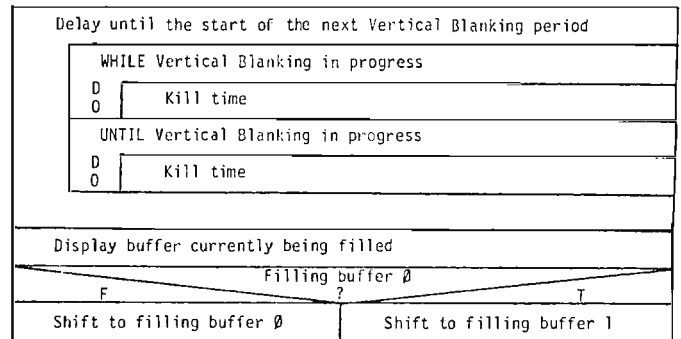

Figure 14: The ANIMAT function which provides for flicker-free changes in the display by permitting the user to load one refresh buffer while displaying another.

the physical contents of the table start with character 32 (blank). To index into the table, the ASCII value of the first table entry is subtracted from the value requested. This index value is then multiplied by the number of bytes per character, and the product is added to the address of the first character in the table in order to obtain the address of the first byte of the character desired. The cursor is then sequenced through the character matrix, turning on the points indicated. Only the points actually making up the character are affected, so background data is not erased and an overprint results.

Control characters are handled separately. Mode and color changes will depend on the DOT routine. Since these will be overly hardware-dependent, their implementation is left as an exercise to the reader. Carriage control characters modify the cursor position without otherwise affecting the display. Any unrecognized characters should be ignored.

## ANIMAT Logic

The first requirement of the ANIMAT logic is to wait for vertical blanking to start (see figure 14). Most displays provide an input port with a status-bit which indicates when vertical blanking is in progress. By delaying until the status-bit indicates normal scan, then delaying until it indicates vertical blanking in progress, we are assured of a full vertical blanking period being available. If the display being programmed does not support changing the location of the refresh buffer by software controls, the routine is finished.

Displays in which refresh buffer locations can be changed are programmed to provide double buffering. After waiting for the vertical blanking period, the refresh buffer currently being filled is put on display. The alternate buffer is then opened for filling. Note that this algorithm is valid whether the buffer being filled is displayed (first call to ANIMAT after an INITG) or is being filled while another buffer is being displayed (all subsequent calls to ANIMAT).

In part 2 we will present an implementation of the 8080 assembly language protocol for the proposed graphics software standard, plus a series of demonstration programs. ■

# Creative Software Introduces: Programs & Products for the TRS-80 (16K level II)

1	AM	\$1500.00	CASH	EXPENSIVE REPAIRS
2	AM	\$1500.00	CHECK (BALANCE)	EXPENSIVE PAID
3	Q	\$1500.00	CREDIT CARD	TRAVEL FOR THE BUS
4	EX	\$1500.00	CASH	BUYING BROWN SHOES
5	EX	\$1500.00	CHECKS	EXPENSIVE COLLEGE
6	FX	\$1100.00	CASH	BUYING NEW CAR
7	GI	\$1000.00	DEBTS & TRIBUTES	BUYING
8	HM	\$900.00	CREDIT CARD	BUYING THINGS ALL
9	TX	\$800.00	RUMMED CHECK	BUYING THINGS FOR
10	NO	\$700.00	1 CHECKS TO ALLEN	BUYING THE I.R.S.
TO CONTINUE, PRESS OTHER.				

YOU SPENT THE FOLLOWING AMOUNTS IN EACH CATEGORY FOR THE MONTH OF APRIL 2001: - - -

ALTO	\$1500.00	TRUCK	\$500.00
APPOINTMENT	\$1500.00	TRUCKS	\$500.00
CLOTHES	\$1500.00	MEDICAL/PHYSICAL	\$500.00
ENTERTAINMENT	\$1500.00	INSURANCE PREMIUMS	\$500.00
EDUCATION	\$1500.00	SAVINGS	\$500.00
FOOD	\$1500.00	UTILITIES	\$500.00
GIFTS	\$1500.00	VACATION	\$500.00
HOUSEHOLD	\$1500.00	WISDOM/PHYSICAL	\$500.00
TOTAL AMOUNT SPENT WAS \$15000.00.			
TOTAL TIME WAS \$5679.10.			
DO YOU WANT TO SEE A SPENDING PROFILE FOR THIS MONTH? (Y OR N)			

**NEW!** A super **JOYSTICK interface** for the **TRS-80!** Three sockets allow you to use one Fairchild™ or two Atan™ joysticks with no modifications to the **TRS-80**. Joystick interface with two programs, separate power supply and instructions.

Only ..... \$65.00  
**Joysticks (Fairchild™ or Atan™), each** ..... \$12.50

## Household Finance I & II ..... \$15.00

Part I: Inputs data on each household expenditure; lists, adds, updates, changes or deletes previously input items. Writes data to cassette tape. Part II: Reads data tape. Provides monthly and yearly summaries of financial data, single category summaries, and graphs a spending profile.

## Household Utility 1 ..... \$12.00

(Includes Calendar, Loans and Buy or Rent Programs)

## Household Utility 2 ..... \$12.00

(Includes Compound Interest, Amortization and Car Costs Programs)

### ALSO: New Programs for the PET:

#### PET Word Processor ..... \$75.00

Complete word processing capabilities including upper/lower case, string search, string change and many other features found on commercial word processors. Package includes both text editor and formatter and requires 16K or 32K PET.

#### PET Space War II ..... \$10.00

Fantastic real-time action! You are in complete control of the Enterprise as you fend off aliens to search the universe for colonizable planets. Requires the Creative Software single joystick for the PET.

#### PET Road Race ..... \$10.00

Another great machine-language program gives you a choice of three different tracks as you battle with your opponent to finish the race. Includes oil slicks, automatic lap counters, and an elapsed time clock showing time to tenths of seconds. Requires the Creative Software dual Joystick.

Many other **Creative Software** products are available for the **PET** and **TRS 80**. If your local dealer doesn't carry **Creative Software** products or program information, write directly to the address below. When placing an order please note:

Specify computer & program(s). Add \$1.50 shipping for each program ordered, \$2.50 for joystick interface. California residents add 6% sales tax. **VISA MASTERCARD** accepted. Include card number and expiration date.



# 68 MICRO JOURNAL™ ★

Months ahead of all others with 6800/09 articles & new products

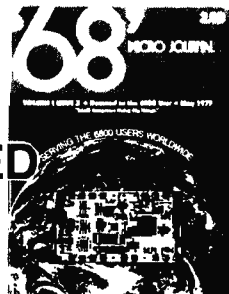
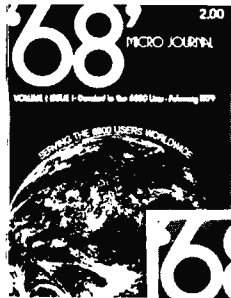

THE ONLY  
 6800/09  
 USER-ORIENTED  
 MAGAZINE

**Crunchers Corner** — Bryant (A monthly programming tutorial) \* **Flex™** to **BFD** — Puckett \* **Tiny Music** — Thompson \* **Semiconductor, Part 1** — Kinzer \* **Soup Up Your TVT** — Pass \* **Hints & Kinks** — fixes (soft & hard) \* 50 pages plus Each Month!

**Crunchers Corner** — Bryant \* **A Look at the SWTPC CT-82** — Ferguson \* **6800 Relative Branch Calculation (Hand)** — Berenbon \* **Relative Calculator (Machine)** — Heatherington \* **Maillist (Disk)** — Lilly \* **Modems** — Schuman \* **Semiconductor - Part 2** — Kinzer \* **Locate** — Pigford \* **A20 MA, Printer-SWTPC** — Perdue \* **AS-50 Monitor Board** — Pentecost \* **TSC Basic** for 6800 — Shirk \* Plus Much-Much More!

**Crunchers Corner** — Bryant \* **A Case for the Small DOS** — Mauch \* **MF-68 Motor Fix** — Sorrels \* **Transfer (FLEX 1 to 2 or 5)** — Womack \* **6800 Delay** — Berenbon \* **Make Like a 6809** — Feintuch \* **Games (Basic)** — Harmon \* **Boot (Flex-BFD)** — Puckett \* **Freeze Display (SSB)** — Johnson \* **Paper Tape Reader** — Adams \* **FLEX™ Fixes and Much More!**

### MAGAZINE COMPARISON (2 years)

Monthly Averages  
 6800 Articles

KB	BYTE	CC	DOBB'S	TOTAL PAGES-
7.8	6.4	2.7	2.2	19.1 ea. mo.
Average cost for all four each month: \$5.88				
(Based on advertised 1-year subscription price)				
68 cost per month, \$1.21				
That's Right! Much, Much More for About 1/5 the Cost!				

EFFECTIVE SEPT. 1, 1979  
 1-Year \$14.50 2 Years \$26.00 3 Years \$36.50

OK, PLEASE ENTER MY SUBSCRIPTION  
 Bill My: Master Charge  — VISA   
 Card # \_\_\_\_\_ Exp. Date \_\_\_\_\_  
 For  1-Year  2 Years  3 Years  
 Enclosed: \$ \_\_\_\_\_

Name \_\_\_\_\_  
 Street \_\_\_\_\_  
 City \_\_\_\_\_ State \_\_\_\_\_ Zip \_\_\_\_\_  
 My Computer Is: \_\_\_\_\_

**68 MICRO JOURNAL**  
 3018 Hamill Road  
 HIXSON, TN 37343

FOREIGN ADD:  
 \$9.50 Per Yr. Surface  
 \$29.00 Per Yr. Air Mail

★ MORE 6800 ARTICLES THAN ALL OTHERS COMBINED ★



# Book Reviews

## 8080/8085: Assembly Language Programming

Lance R Leventhal  
Osborne and Associates Inc  
Berkeley, California 1978  
467 pages softcover  
\$9.50

8080/8085: Assembly Language Programming is another in the series of Osborne and Associates' books on microcomputers. Those who are familiar with earlier works published by this company know that, in its contents, the entire series is comprehensive. Unfortunately, these books have been extremely difficult to read due to the use of bold

and regular type and the appearance of obscure abbreviations in their diagrams. I am pleased to say that this new book upholds the reputation for completeness, and it is also quite readable.

Chapter 1 defines and justifies assembly language programming. I doubt that anyone who purchases this book needs this chapter, but it is reassuring to us assembly language enthusiasts.

Chapter 2 describes how an assembler works and gives a very complete view of all the available features. As with all this publisher's books, it is not merely an overview. This chapter will greatly assist you in choosing among the available assemblers.

Chapter 3 is technical writing at its finest. Each assembly language instruction given is elaborated upon with diagrams the reader has become acquainted with in the earlier books—minus the incomprehensible abbreviations. Bold type is used only where it should be—for titles.

Chapters 4 thru 13 give sample programs ranging from very simple to extraordinarily complex. The early examples are slightly beyond the information given in chapter 3, but they progress through arithmetic and tables to I/O (input/output) routines and interrupts. Each chapter ends with self-testing examples where the answers, but not

the methods, are given. These self-tests are well-thought-out variations of earlier examples and, therefore, double the learning experience.

The final chapters give detailed advice on programming. These are mandatory if one expects his programs to be useful to anyone else. Leventhal repeatedly emphasizes that commercial programs must be written for the program buyer, not the writer.

In summary, this is an excellent encyclopedia of assembly language programming. If you understand all of this book and have it for reference, you will have few problems.

Bruce R Evans MD  
16 Marwin Rd  
Pickering Ontario  
CANADA  
L1V 2N7

## Technical Aspects of Data Communication

John E McNamara  
Digital Press  
Digital Equipment Corp,  
Educational Services Dept  
12 Crosby Dr  
Bedford MA 07130  
\$19.95

*Technical Aspects of Data Communication* by John E McNamara is the book I was looking for five years ago. It could have saved me hundreds of hours of searching and reading. The last paragraph of the introduction states why: "This book will not teach anyone everything about data communication. Knowledge of data communication is acquired by a bootstrapping process in which one learns enough to read the next book or explore the next problem, from which one learns enough to go on further. This book is intended to fill

# SUPERPASCAL

5-10 times faster...  
and more!

Meet Pascal/Z,<sup>TM</sup> the fast, flexible compiler with higher speed, greater efficiency and improved debugging:

- **True Z-80 native code Pascal compiler**—5-10X faster than competing P-code implementations—no interpreter required.
- **The only multi-tasking Pascal**—produces ROMable re-entrant code.
- **Optimized** for fastest execution—recognizes and exploits special cases.
- **Easily transportable**—all hooks to your system made through support library.
- **Includes IEEE standard** floating point package.

Single copy on CP/M-compatible disk includes compiler, companion macro-assembler & source of the library, \$275. OEM licenses available. Write or call for more information.

## InterSystems<sup>TM</sup>

Ithaca Intersystems Inc., 1650 Hanshaw Road/P.O. Box 91,  
Ithaca, NY 14850/607-257-0190/TWX: 510255 4346

© 1979 Ithaca Intersystems Inc.

a place in that process."

This book deals with the real nitty-gritty of data communications from "what is a stop bit?" all the way through an explanation of packet switching. All the information is presented in practical terms rather than through math and theory. A glossary in the back of the book defines all the terms used. Various accompanying tables list character codes, pin connections, and usable line lengths. If you need to know what a UART is and how it works, there is an appendix devoted entirely to UARTs.

If you need to know about asynchronous or synchronous communication, common protocols and what they are suited for, how telephones work, the characteristics of different modems, and what types of automatic-calling units are available and how to write a program to talk to them, you can find it in this book. If you only need to know what pin 8 on the 25-pin connector on your terminal is used for, you can also find that information in this book.

There are about 400 pages of good reference information with readable explanations for anyone who must deal with data communications hardware or software. *Technical Aspects of Data Communication* is well worth the price. ■

Phil Hughes  
POB 2847  
Olympia WA 98507



### Broken Text

Several readers have brought to our attention that line 1790 of the Quest program on page 181 of the July 1979 BYTE is difficult to read. The line should read 1790 ON A1 GOTO 1000, 9999, 1760. ■

Start Computing For Just \$129.95 With An 8085-Based Professional Computer Kit—

# Explorer/85

100% compatible with all 8080A and 8085 software & development tools!

No matter what your future computing plans may be, Level "A"—at \$129.95—is your starting point.

Starting at just \$129.95 for a Level "A" operating system, you can now build the exact computer you want. Explorer/85 can be your beginner's system, OEM controller, or IBM-formatted 8" disk small business system... yet you're never forced to spend a penny for a component or feature you don't want and you can expand in small, affordable steps!

Now, for just \$129.95, you can own the first level of a fully expandable computer with professional capabilities—a computer which features the advanced Intel 8085 cpu, thereby giving you immediate access to all software and development tools that exist for both the 8085 and its 8080A predecessor (they are 100% software compatible)—a computer which features onboard S-100 bus expansion—plus instant conversion to mass storage disk memory with either 5-1/4" diskettes or standard IBM-formatted 8" disks.

For just \$129.95 (plus the cost of a power supply, keyboard/terminal and RF modulator, if you don't have them already), Explorer/85 lets you begin computing on a significant level... applying the principles discussed in leading computer magazines... developing "state of the art" computer solutions for both the industrial and leisure environment.

### Level "A" Specifications

Explorer/85's Level "A" system features the advanced Intel 8085 cpu, an 8355 ROM with 2k deluxe monitor/operating system, and an 8155 ROM-I/O—all on a single motherboard with room for RAM/ROM/PROM/EPROM and S-100 expansion, plus generous prototyping space.

(Level "A" makes a perfect OEM controller for industrial applications and is available in a special Hex Version which can be programmed using the Netronics Hex Keypad/Display.)

**PC Board:** glass epoxy, plated through holes with solder mask  
• I/O: provisions for 25-pin (DB25) connector for terminal serial I/O, which can also support a paper tape reader... provision for 24-pin DIP socket for hex keypad/display... cassette tape recorder input... cassette tape recorder output... LED output indicator on SOD (serial output) line... printer interface (less drivers)... total of four 8-bit plus one 6-bit I/O ports • Crystal Frequency: 6.144 MHz • Control Switches: reset and user (RST 7.5) interrupt... additional provisions for RST 5.5, 6.5 and TRAP interrupts onboard • Counter/Timer: programmable, 14-bit binary • System RAM: 256 bytes located at F800, ideal for smaller systems and for use as an isolated stack area in expanded systems... RAM expandable to 64k via S-100 bus or 4K on motherboard.

**System Monitor (Terminal Version):** 2k bytes of deluxe system monitor ROM located at F000 leaving 0000 free for user RAM/ROM. Features include tape load with labeling... tape dump with labeling... examine/change contents of memory... insert data... warm start... examine and change all registers... single step with register display at each break point, a debugging/training feature... go to execution address... move blocks of memory from one location to another... fill blocks of memory with a constant... display blocks of memory... automatic baud rate selection... variable display line length control (1-255 characters/line)... channelized I/O monitor routine with 8-bit parallel output for high speed printer... serial console in and console out channel so that monitor can communicate with I/O ports.

**System Monitor (Hex Version):** Tape load with labeling... tape dump with labeling... examine/change contents of memory... insert data... warm start... examine and change all

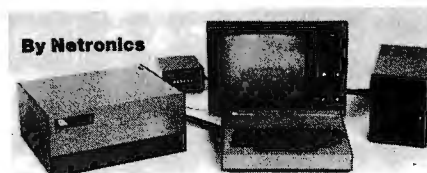

registers... single step with register display at each break point... go to execution address. Level "A" in the Hex Version makes a perfect controller for industrial applications and can be programmed using the Netronics Hex Keypad/Display.



Hex Keypad/Display.

### Level "B" Specifications

Level "B" provides the S-100 signals plus buffers/drivers to support up to six S-100 bus boards and includes: address decoding for onboard 4k RAM expansion select-able in 4k blocks... address decoding for onboard 8k EPROM expansion select-able in 8k blocks... address and data bus drivers for onboard expansion... wait state generator (jumper select-able), to allow the use of slower memories... two separate 5 volt regulators.



Explorer/85 with Level "C" card cage.

Level "C" includes a sheet metal superstructure, a 5-card gold plated S-100 extension PC board which plugs into the motherboard. Just add required number of S-100 connectors

### Level "D" Specifications

Level "D" provides 4k or RAM, power supply regulation, filtering decoupling components and sockets to expand your Explorer/85 memory to 4k (plus the original 256 bytes located in the 8155A). The static RAM can be located anywhere from 0000 to EFFF in 4k blocks.

### Level "E" Specifications

Level "E" adds sockets for 8k of EPROM to use the popular Intel 2716 or the TI 2516. It includes all sockets, power supply regulator, heat sink, filtering and decoupling components. Sockets may also be used for soon to be available RAM IC's (allowing for up to 12k of onboard RAM).

### Order A Coordinated Explorer/85 Applications Pak!

**Experimenter's Pak (SAVE \$12.50)**—Buy Level "A" and Hex Keypad/Display for \$199.90 and get FREE Intel 8085 user's manual plus FREE postage & handling!

**Student Pak (SAVE \$24.45)**—Buy Level "A," ASCII Keyboard/Computer Terminal, and Power Supply for \$319.85 and get FREE RF Modulator plus FREE Intel 8085 user's manual plus FREE postage & handling!

**Engineering Pak (SAVE \$41.00)**—Buy Levels "A," "B," "C," "D," and "E" with Power Supply, ASCII Keyboard/Computer Terminal, and six S-100 Bus Connectors for \$514.75 and get 10 FREE computer grade cassette tapes plus FREE 8085 user's manual plus FREE postage & handling!

**Business Pak (SAVE \$89.95)**—Buy Explorer/85 Levels "A," "B," and "C" (with cabinet), Power Supply, ASCII Keyboard/Computer Terminal (with cabinet), 16k RAM, 12" Video Monitor, North Star 5-1/4" Disk Drive (includes North Star BASIC) with power supply and cabinet, all for just \$1599.40 and get 10 FREE 5-1/4" minidisettes (\$49.95 value) plus FREE 8085 user's manual plus FREE postage & handling!

Continental U.S.A. Credit Card Buyers Outside Connecticut

**CALL TOLL FREE 800-243-7428**

To Order From Connecticut Or For Technical Assistance, Etc. Call (203) 354-9375

### Netronics R&D Ltd., Dept. RE 10 333 Litchfield Road, New Milford, CT 06676

Please send the items checked below—

- Explorer/85 Level "A" Kit (ASCII Version), \$129.95 plus \$3 p&h.
- Explorer/85 Level "A" Kit (Hex Version), \$129.95 plus \$3 p&h.
- 8k Microsoft BASIC on cassette tape, \$64.95 postpaid.
- 8k Microsoft BASIC in ROM Kit (requires Levels "B," "D," and "E"), \$99.95 plus \$2 p&h.
- Level "B" (S-100) Kit, \$49.95 plus \$2 p&h.
- Level "C" (S-100 6-card expander) Kit, \$39.95 plus \$2 p&h.
- Level "D" (4k RAM) Kit, \$69.95 plus \$2 p&h.
- Level "E" (EPROM/ROM) Kit, \$5.95 plus 50¢ p&h.
- Deluxe Steel Cabinet for Explorer/85, \$49.95 plus \$3 p&h.
- ASCII Keyboard/Computer Terminal Kit (features a full 128 character set, upper & lower case, full cursor control, 75 ohm video output convertible to baudot output, selectable baud rate, RS232-C or 20 ma. I/O, 32 or 64 character by 16 line formats, and can be used with either a CRT monitor or a TV set (if you have an RF modulator), \$149.95 plus \$2.50 p&h.
- Hex Keypad/Display Kit, \$69.95

plus \$2 p&h.

- Deluxe Steel Cabinet for ASCII Keyboard/Terminal, \$19.95 plus \$2.50 p&h.
- Power Supply Kit (± 8V @ 5 amps) in deluxe steel cabinet, \$39.95 plus \$2 p&h.
- Gold Plated S-100 Bus Connectors, \$4.85 each, postpaid.
- RF Modulator Kit (allows you to use your TV set as a monitor), \$8.95 postpaid.
- 16k RAM Kit (S-100) Board expands to 64k, \$199.95 plus \$2 p&h.
- 32k RAM Kit, \$329.95 plus \$2 p&h.
- 48k RAM Kit, \$459.95 plus \$2 p&h.
- 64k RAM Kit, \$589.95 plus \$2 p&h.
- 16k RAM Expansion Kit (to expand any of the above up to 64k), \$139.95 plus \$2 p&h each.
- Intel 8085 cpu User's Manual, \$7.50 postpaid.
- Special Computer Grade Cassette Tapes, \$1.90 each or 3 for \$5, postpaid.
- 12" Video Monitor (10 MHz bandwidth), \$139.95 plus \$5 p&h.
- North Star Double Density Floppy Disk Kit (One Drive) for Explorer/85 (includes 3 drive S-100 controller, DOS, and extended BASIC with per-

sonalized disk operating system—just plug it in and you're up and running!), \$699.95 plus \$5 p&h.

- Power Supply Kit for North Star Disk Drive, \$39.95 plus \$2 p&h.
- Deluxe Case for North Star Disk Drive, \$39.95 plus \$2 p&h.
- Experimenter's Pak (see above), \$199.90 postpaid.
- Student Pak (see above), \$319.85 postpaid.
- Engineering Pak (see above), \$514.75 postpaid.
- Business Pak (see above), \$1599.40 postpaid.

Total Enclosed \$  
(Conn. res. add sales tax) By—  
 Personal Check  M.O./Cashier's Check  Visa  Master Charge  
(Bank # \_\_\_\_\_)

Acct. # \_\_\_\_\_  
Signature \_\_\_\_\_ Exp. Date \_\_\_\_\_  
Print Name \_\_\_\_\_  
Address \_\_\_\_\_  
City \_\_\_\_\_  
State \_\_\_\_\_ Zip \_\_\_\_\_  
 Send Me Information

# Build a Simple Digital Oscilloscope

Frank DeCaro  
103 Spit Brook Rd, Apt C-2  
Nashua NH 03060

A digital-logic probe is a convenient device for examining signals. A typical probe has one or more light emitting diodes (LEDs) to indicate logic states. The LED lights to indicate a high (1) logic state, and turns off to indicate a low (0) logic state. It is not possible, however, to compare these signals with the state of the system clock. The system clock is the square wave source from which all other signals are derived.

The digital oscilloscope presented here allows comparison of selected signals with the system clock. The schematic diagram is given in figure 1. The digital oscilloscope converts a serial digital signal into a visible display on 16 LEDs. Each LED corresponds to  $\frac{1}{2}$  of a clock cycle. Figure 2 shows some typical waveform traces and their corresponding displays on the digital oscilloscope. Figure 3 shows a typical method of connection for displaying serial waveforms. One limitation of the 16 LED display is that it cannot completely show a signal which is derived from the clock signal by dividing by more than 8.

A block diagram of the digital oscilloscope is shown in figure 4. The major sections are:

- data and enable sequencer
- enable strobe
- data strobe
- latch
- display

The clock is fed into a circuit which divides the frequency by 8. These 2 signals comprise the data and enable sequencer. Eight clock cycles are required for the sequencer to complete 16 transitions. The 16 address inputs

*Text continued on page 226*

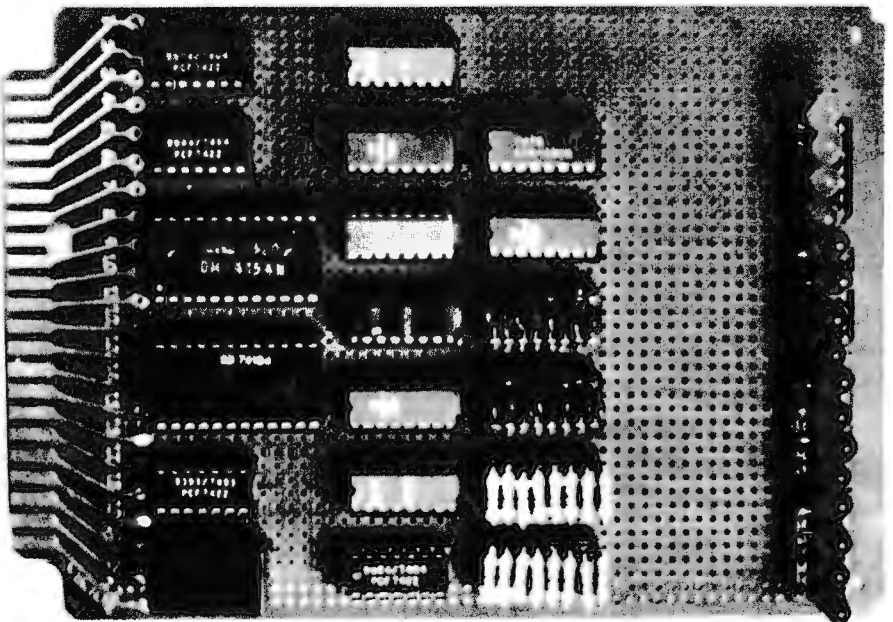

Photo 1: Digital oscilloscope as constructed on a project board. The photo shows the original design (the schematic diagram in figure 1 shows an updated version which eliminates all capacitors on the output lines).

Device	Type	+ 5 V	GND
IC1	74154	24	12
IC2	7404	14	7
IC3	7404	14	7
IC4	7404	14	7
IC5	7474	14	7
IC6	7474	14	7
IC7	7474	14	7
IC8	7474	14	7
IC9	7474	14	7
IC10	7474	14	7
IC11	7474	14	7
IC12	7474	14	7
IC13	74154	24	12
IC14	7493	5	10

Table 1: Power and ground connections for integrated circuits in figure 1 schematic diagram.



# SORCERER\* SOFTWARE!

All programs on cassette. Only 8k of memory required.

**FASTGAMMON™** by Bob Christiansen. Backgammon players love this machine language program that provides a fast, skillful opponent. Eight-page instruction manual includes rules of backgammon. **\$19.95**

**PLOT** by Vic Tolomei. Now Apple owners will be envious of how easy you can get good graphics on your SORCERER. PLOT includes both a super high resolution mode and a quick low resolution mode. Both are accessible from your BASIC programs using simple commands. Hi-res & lo-res examples included on tape. **\$14.95**

**SHAPE MAKER™** by Don Ursem. Construct special characters and fancy shapes with ease using this on-screen character editor. Detailed 12-page instruction booklet includes example applications. **\$14.95**

**DEBUG** by Bob Pierce. Debug machine language programs by stepping through one instruction at a time. Relocatable. Several display options. Multiple break points. Modify memory and registers. **\$14.95**

**Z-80 DISASSEMBLER** by Vic Tolomei. Decode machine language programs, including SORCERER's monitor and ROM-PAC's, with this Z-80 Disassembler written in BASIC. Prints out machine code, Zilog mnemonics, and ASCII. **\$14.95**

**MAGIC MAZE™** by Vic Tolomei. A challenging maze game. Ten levels of play. Holding your lantern, you wander through a maze trying to stay on the right path and avoid pitfalls. Automatic scoring tells you how good a pathfinder you are. **\$11.95**

**SOFTWARE INTERNALS MANUAL FOR THE SORCERER** by Vic Tolomei. A must for anyone writing software for the SORCERER. Seven chapters: Intro to Machine Language, Devices & Ports, The Monitor, Cassette Interface, BASIC structure, Video & Graphics, The Keyboard. Indexed. Includes diagrams and software routines. 64 pages. **\$14.95**



## QUALITY SOFTWARE

6660 Reseda Blvd., Suite 103, Reseda, CA. 91335  
Telephone 24 hours, seven days a week: (213) 344-6599

**WHERE TO GET IT:** Ask your nearest Sorcerer dealer to see Quality Software's Sorcerer programs. Or, if you prefer, you may order directly from us. MasterCard and Visa cardholders may telephone their orders and we will deduct \$1 from orders over \$19 to compensate for phone charges. Or mail your order to the address above. California residents add 6% sales tax. Orders outside North America add \$5 for registered airmail, pay in U.S. currency.

\* The name "SORCERER" has been trademarked by Exidy, Inc.

# IMMEDIATE DELIVERY

Domestic & Export

# DEC LSI -11 COMPONENTS

A full and complete line with software support available.



## Mini Computer Suppliers, Inc.

25 CHATHAM ROAD  
SUMMIT, NEW JERSEY 07901  
SINCE 1973

(201) 277-6150 Telex 13-6476

**6800, 64K BYTE RAM AND CONTROLLER SET**  
MAKE 64K BYTE MEMORY FOR YOUR 6800 OR 6502. THIS CHIP SET INCLUDES:  
\* 32 MSK 4116-3 16KX1, 200 NSEC RAMS.  
\* 1 MC3480 MEMORY CONTROLLER.  
\* 1 MC3242A MEMORY ADDRESS MULTIPLEXER AND COUNTER.  
\* DATA AND APPLICATION SHEETS. PARTS TESTED AND GUARANTEED.  
**\$325.00 PER SET**

**\$100 FULLY ASSEMBLED MOTHERBOARDS— FULLY SOCKETED, INDUSTRIAL GRADE**  
\* 8 SLOT ASSEMBLED \$149.00  
\* 19 SLOT ASSEMBLED \$199.00



**64K BYTE EXPANDABLE RAM**  
DYNAMIC RAM WITH ON BOARD TRANSPARENT REFRESH. GUARANTEED TO OPERATE IN NORTHSTAR, CROMEMCO, VECTOR GRAPHICS, SOL AND OTHER 8080 OR Z-80 BASED \$100 SYSTEMS \* 4MHZ Z-80 WITH NO WAIT STATES.  
\* SELECTABLE AND DESELECTABLE IN 4K INCREMENTS ON 4K ADDRESS BOUNDARIES.  
\* LOW POWER—8 WATTS MAXIMUM.  
\* 200NSEC 4116 RAMS.  
\* FULL DOCUMENTATION.  
\* ASSEMBLED AND TESTED BOARDS ARE GUARANTEED FOR ONE YEAR AND PURCHASE PRICE IS FULLY REFUNDABLE IF BOARD IS RETURNED UNDAMAGED WITHIN 14 DAYS.

	ASSEMBLED / TESTED	KIT
64K RAM	\$566.00	\$565.00
48K RAM	\$529.00	\$499.00
32K RAM	\$469.00	\$429.00
16K RAM	\$389.00	\$359.00
WITHOUT RAM CHIPS	\$319.00	\$289.00

**EPROM**  
2716-450NSEC ..... **\$49.00**



**VISTA V-200 MINI-FLOPPY SYSTEM**  
\* \$100 DOUBLE DENSITY CONTROLLER  
\* 204 KBYTE CAPACITY FLOPPY DISK DRIVE WITH CASE & POWER SUPPLY  
\* MODIFIED CPM OPERATING SYSTEM WITH EXTENDED BASIC  
**\$695.00**  
\* EXTRA DRIVE, CASE & POWER SUPPLY **\$395.00**

**16K X 1 DYNAMIC RAM**  
THE MK4116-3 IS A 16,384 BIT HIGH SPEED NMOS DYNAMIC RAM. THEY ARE EQUIVALENT TO THE MOSTEK, TEXAS INSTRUMENTS OR MOTOROLA 4116-3.  
\* 200 NSEC ACCESS TIME. 375 NSEC CYCLE TIME.  
\* 16 PIN TTL COMPATIBLE.  
\* BURNED IN AND FULLY TESTED.  
\* PARTS REPLACEMENT GUARANTEED FOR ONE YEAR.  
**\$9.50 EACH IN QUANTITIES OF 5**

**BETA COMPUTER DEVICES**  
P.O. BOX 3465  
ORANGE, CALIFORNIA 92665  
(714) 533-7280



**MOTOROLA MEMORY ADDRESS MULTIPLEXER— MC 3242A**  
THE MC 3242A IS AN ADDRESS MULTIPLEXER AND REFRESH COUNTER FOR 16 PIN, 16K DYNAMIC RAMS THAT REQUIRE A 128 CYCLE REFRESH.  
\* CONTAINS MEMORY REFRESH COUNTER.  
\* MULTIPLEXES SYSTEM 14 BIT ADDRESS TO THE 7 ADDRESS PINS OF THE RAMS.  
\* COMPATIBLE WITH 3480 MEMORY CONTROLLER.  
\* PART IS GUARANTEED.  
**\$12.50 EACH**

**MOTOROLA DYNAMIC MEMORY CONTROLLER— MC3480L**  
MEMORY CONTROLLER DESIGNED TO SIMPLIFY CONTROL OF 16 PIN 4K OR 16K DYNAMIC RAMS.  
\* GENERATES RAS/CAS AND REFRESH TIMING SIGNALS FOR 16K TO 64K BYTE MEMORIES.  
\* GENERATES MEMORY READ/WRITE TIMING.  
\* DIRECT INTERFACE WITH MOTOROLA OR INTEL 3242A ADDRESS MUX AND REFRESH COUNTER.  
\* PART GUARANTEED.  
**\$13.95 EACH**

**\$100 MAINFRAME AND CARD CAGE**  
\* W/ SOLID FRONT PANEL **\$239.00**  
\* W/ CUTOUTS FOR 2 MINI-FLOPPIES **\$239.00**  
\* 30 AMP POWER SUPPLY ..... **\$119.00**

CALIF RESIDENTS PLEASE ADD 6% SALES TAX. MASTERCHARGE & VISA ACCEPTED. PLEASE ALLOW 14 DAYS FOR CHECKS TO CLEAR BANK. PHONE ORDERS WELCOME.

**Z-80 CPU • Z-80 CPU • Z-80 CPU • Z-80 CPU**  
\* 2MHZ OR 4MHZ SWITCH SELECTABLE  
\* 2 SERIAL PORTS  
\* 2 PARALLEL PORTS  
\* SELECTABLE BAUD RATES 150-9600  
\* POWER ON JUMP TO ON BOARD 2708 OR 2716 EPROM (BOARD DELIVERED WITHOUT EPROM)  
**\$325.00**

**KIM/SYM/AIM-65—32K EXPANDABLE RAM DYNAMIC RAM WITH ON BOARD TRANSPARENT REFRESH THAT IS COMPATIBLE WITH KIM/SYM/AIM-65 AND OTHER 6502 BASED MICROCOMPUTERS.**  
\* PLUS COMPATIBLE WITH KIM/SYM/AIM-65. MAY BE CONNECTED TO PET USING ADAPTOR CABLE. SS44-E BUS EDGE CONNECTOR.  
\* USES +5V ONLY (SUPPLIED FROM HOST COMPUTER BUS). 4 WATTS MAXIMUM.  
\* BOARD ADDRESSABLE IN 4K BYTE BLOCKS WHICH CAN BE INDEPENDENTLY PLACED ON 4K BYTE BOUNDARIES ANYWHERE IN A 64K BYTE ADDRESS SPACE.  
\* BUS BUFFERED WITH 1 LS TTL LOAD.  
\* 200NSEC 4116 RAMS.  
\* FULL DOCUMENTATION  
\* ASSEMBLED AND TESTED BOARDS ARE GUARANTEED FOR ONE YEAR, AND PURCHASE PRICE IS FULLY REFUNDABLE IF BOARD IS RETURNED UNDAMAGED WITHIN 14 DAYS.

	ASSEMBLED / TESTED	KIT
WITH 32K RAM	\$495.00	\$459.00
WITH 16K RAM	\$425.00	\$389.00
WITHOUT RAM CHIPS	\$355.00	\$319.00
HARD TO GET PARTS ONLY (NO RAMS)	\$189.00	\$159.00
BARE BOARD AND MANUAL		\$59.00



**TRS-80 16K MEMORY EXPANSION KIT**  
THIS KIT PROVIDES THE IC'S TO EXPAND THE TRS-80 MAINFRAME FROM 4K BYTES TO 16K BYTES OR MAY BE USED IN THE EXPANSION CHASSIS. THE KIT INCLUDES:  
\* 8 MSK 4116-4 16K X 1, 200 NSEC RAMS.  
\* 1 DIP PROGRAMMING SWITCH.  
\* 1 SET OF EASY TO FOLLOW INSTRUCTIONS THAT ONLY REQUIRES A SCREWDRIVER TO SUCCESSFULLY COMPLETE THE INSTALLATION.  
**\$80.00 PER KIT**

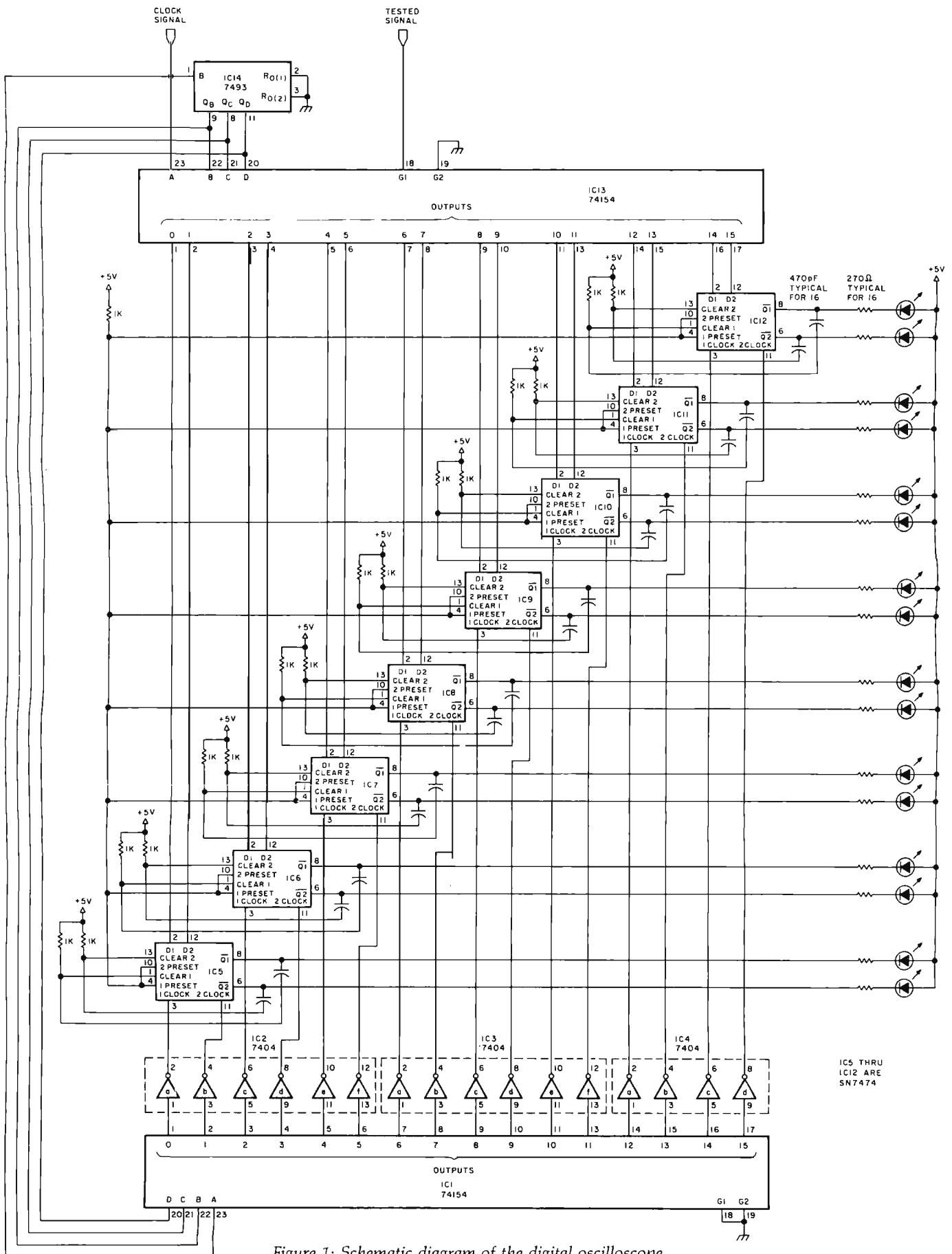

Figure 1: Schematic diagram of the digital oscilloscope.

**T.D.Q.  
TAPE DATA QUERY**

**THE IDEAL SOLUTION FOR PERSONAL AND  
VERY-SMALL BUSINESS DATA MANAGEMENT**

**PET-8K**

**TRS-80-LVL II**

- \* COMPLETE CASSETTE FILE MANAGEMENT SYSTEM
- ENGLISH-LIKE COMMAND LANGUAGE
- REPORT GENERATOR
- UTILITY PACKAGE
- NO PROGRAMMING KNOWLEDGE REQUIRED
- REQUIRES 2 CASSETTE RECORDERS
- \* T.D.Q. APPLICATION CASEBOOK

- COMPLETE DIRECTIONS TO MICRO-COMPUTERIZE:
- INVENTORY CONTROL
  - ACCOUNTS RECEIVABLE
  - ACCOUNTS PAYABLE
  - ORDER PROCESSING
  - LABEL PRINTING
  - CHECK PRINTING
  - INVOICE PRINTING
  - CUSTOMER DIRECTORY
  - APPOINTMENT SCHEDULING
  - VENDOR MASTER FILE
  - PAYROLL JOURNAL
  - CHECKBOOK JOURNAL
  - TELEPHONE BOOK
  - RENT COLLECTION

\*\*SPECIAL YEAR-END SALE PRICE - \$100.00\*\*  
INCLUDES:

CASEBOOK; 2 CASSETTES; 3 USER'S MANUALS & REF. CARDS  
ORDERS MUST BE RECEIVED BY JAN. 31, 1980  
SEND CHECK OR MONEY-ORDER TO:

**H. GELLER COMPUTER SYSTEMS**  
P.O. BOX 350  
NEW YORK, N.Y. 10040  
(N.Y. RESIDENTS ADD SALES TAX)

**POCKET ASCII  
TERMINAL**

**MIDGET  
DUPLEX UNIT  
WITH MAN-SIZED  
CAPABILITIES**

Here's \$395 worth of convenience for anyone working with digital systems. Carry it anywhere in a pocket, valise or toolkit to enter and retrieve data, run diagnostics, change constants, test data links, etc.



- Look at its facilities:
- Transmits 128 ASCII codes
  - Can display last 30 characters received
  - Displays full 64-character ASCII set on clear 16-segment LEDs
  - 25-line RS232/c compatible interface
  - Single 5V supply required at 400mA typical
  - 110 or 300 baud transmission selectable
  - Parity codes, stop bits settable to your standard
  - Obeys bell, cursor and data format control codes

Phone or write us for more details now:  
**GR ELECTRONICS LTD;**  
1640 Fifth Street,  
Santa Monica, CA 90401.  
Telephone: (213) 395-4774.  
Telex: 65-2337 (BT Smedley SNM).



**Powerful  
Apple/TRS 80  
Software**

*by Systems  
Design  
Lab*

See your dealer  
Or for immediate delivery  
SEND CHECK OR MONEY ORDER TO:

- HIRES GRAPHIC PRINTER** Print in Hires all the standard alphanumeric keyboard characters in addition to 16 user defined characters. Will append to yours with 2 easy call statements. ( 3 16k) \* ..... \$19.95
- HIRES PLAYGROUND** Load a picture or any Hires screen from tape or disk and then do text editing with any of the standard keyboard or 16 user defined characters. ( 3 16k) \* ..... \$24.50
- THE FORECASTER II** The Forecaster II does a linear regression trend analysis on your data and automatically labels the Hires graph screen for easy reading. ( 3 16k) \* ..... \$17.95
- DUAL RACE** Dual Race is a very exciting fast paced and challenging auto race game for two players. (> 16k) ... \$14.95
- MAILING LIST** This versatile program has many features such as alphanumeric sort of any field, vertical spacing adjustment, printer interrupt for label adjustment, search any field and print labels, and much more. ( 3 32k) \* ..... \$24.95
- MULTIPLE REGRESSION ANALYSIS** This program may be used in business, education, or in any field where historical data is used to predict future events. Includes the correlation matrix, the inverted matrix, the sum, mean, standard deviation and much more. ( 3 16k) \* ... \$19.95
- TURF ANALYSIS** Take the guesswork out of handicapping with this new and easy way to handicap horse racing on the APPLE II. This program provides incredibly accurate predictions through the use of multiple regression. ( 3 16k) \* Also Available in TRS 80. .... 19.95

- MATRIX INVERT** This program will quickly find the inverse and determinant to a symmetrical matrix or solve a system of symmetrical linear equations. ( 3 16k) \* ..... \$11.95
- THE PLOTTER** With the APPLE II, this program will allow you to easily plot equations in High Resolution Graphics in just seconds. ( 3 16k) \* ..... \$12.95
- MANDALA SUPREME** You can now create artistic objects with the APPLE II similar to the popular Double Bessel Function within minutes. ( 3 16k) \* ..... \$14.95
- SOLO RACE** Solo Race is a very exciting and challenging Low Resolution auto race game where you drive a race car over curvy roads and around obstacles. (> 16k) ... \$9.95
- FUNPAK I** The Funpak I is a small library of 5 programs all rolled into one: The Rat Race Maze, Mine Field, Canyon Bomber, Music Machine and Sound (> 16k) \$9.95



**PRO FOOTBALL** Never before has there been a program that can predict such unbelievably accurate pointspreads with the APPLE II. You may predict any game within seconds from data saved on cassette or disk. The data file will instantly give you a complete rundown of the season's activity. Each program includes a complete prior season data file. ( 3 22k) \* Also Available in TRS 80 .... \$19.95

**COLLEGE FOOTBALL** Similar to the PRO FOOTBALL program. This program contains over 78 major college football teams and a complete prior season data file. ( 3 35k) \* ..... \$19.95

\* Requires an Applesoft rom card



**2612 Artesia Blvd., Suite B-1  
Redondo Beach, CA 90278  
(213) 374-4471**

**Javelin  
Monitors  
\$159.95**



● LED ON  
○ LED OFF

SIGNAL

DISPLAY

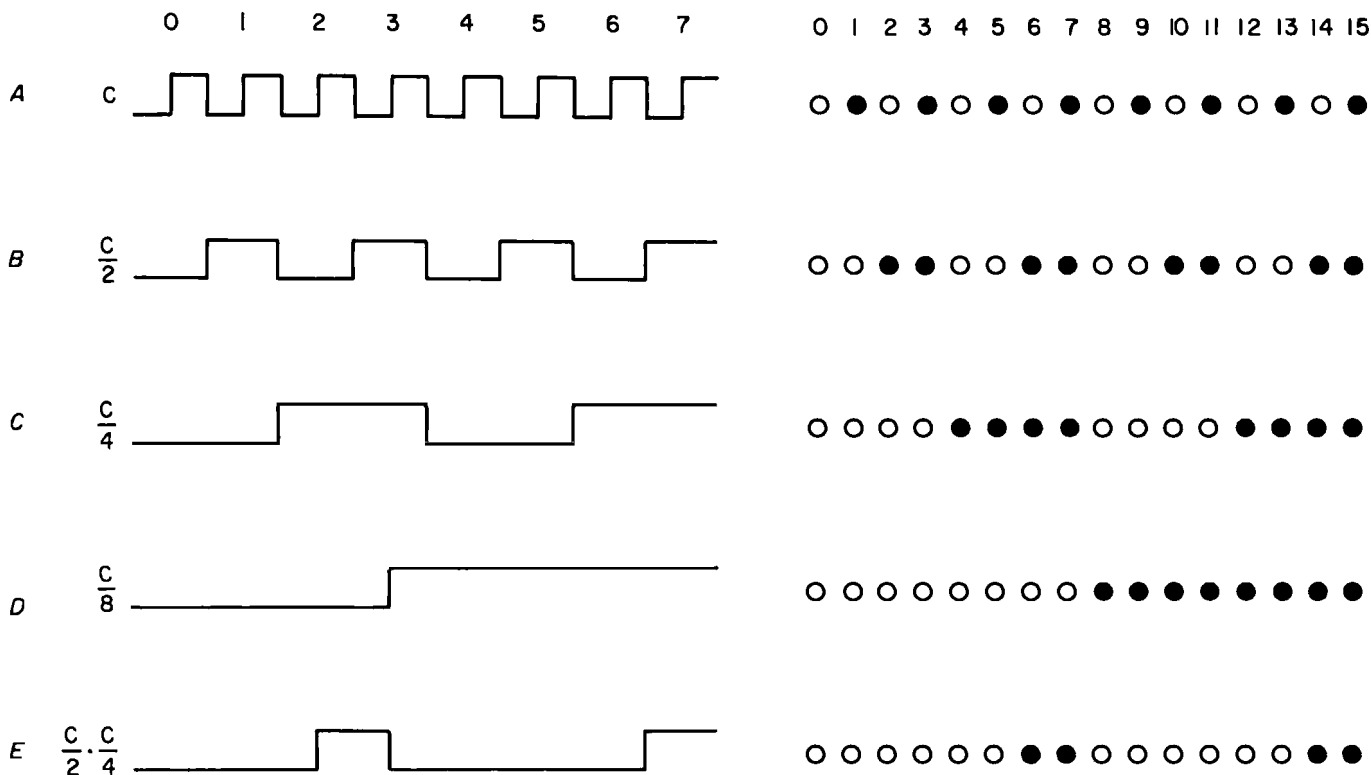

Figure 2: Comparison of waveforms as they might be displayed on an analog oscilloscope, and as they are displayed on the digital oscilloscope. The dark circles indicate lighted light emitting diodes (LEDs). The open circles show unlighted LEDs.

Text continued:

of the enable and data strobes are sequentially scanned.

The data and enable strobe signals are sent to latches. The data strobe provides the information to be stored when the enable strobe of the same latch goes low. The latches are updated every 8 clock cycles. The output of each latch is used to drive an LED. The LED will glow if the output of the latch is low (a 0 state). In this manner, the serial digital signal is mapped onto the array of 16 LEDs.

The digital oscilloscope is also useful as a logic design and analysis aid. It can generate a truth table for a combinational logic network of up to 4 inputs. To accomplish this, simply connect the clock signal, the clock divided by 2, the clock divided by 4, and the clock divided by 8 to the inputs of the logic network (pins 23, 22, 21, and 20 of IC1.) Connect the output of the logic network to the signal input of the digital oscilloscope. Figure 5 illustrates how to make these connections to a logic network. ■

# Texas Instruments Home Computer TI-99/4

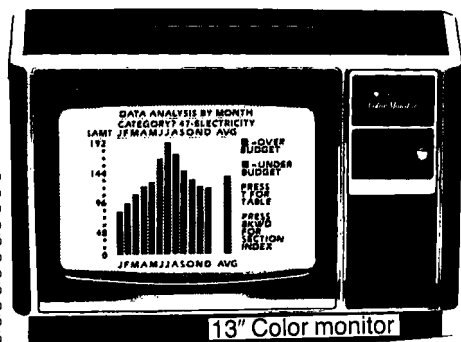

You Don't Have To Be A Genius To Own The TI Home Computer



(The genius is built in)

- Speech Synthesizer \$149.95
- Video Graphs 19.95
- Early Learning Fun 29.95
- Beginning Grammar 29.95
- Diagnostic 29.95
- Home Financial 29.95
- Football 29.95
- Physical Fitness 29.95
- Early Reading 29.95
- Household Budget 44.95
- Speech Editor 44.95
- Investment Anal. 44.95
- Personal Record kpg. 44.95
- Video Chess 69.95
- Statistics 44.95
- Tax/Investment-Record 69.95

Send \$1.00 for 12 page Color Brochure. (Refundable with your TI-99/4 order.)

Superior color, music, sound and graphics-- and a powerful extended BASIC--all built in. Plus a unique, new Solid State Speech Synthesizer.



FACTORY DIRECT SALES  
Dept. 404  
1317 E. Colorado St.  
Glendale, CA 91205  
Phone: (213) 245-1417

ORDER TODAY

Retail Store Hours Tues -Fri 10AM to 6PM  
Sat 9AM to 5PM Closed Sunday & Monday

20% deposit required on C.O.D. orders  
 Check  Money Order  VISA  Master Charge  
CA residents add 6% sales tax (No C.O.D. outside continental U.S.A.)

**SATISFACTION GUARANTEED OR YOUR MONEY BACK!**

Copyright ©1979 Factory Direct Sales

- 26K ROM
- Up to 72K total memory capacity
- 16-color graphics capability
- Built-in equation calculator

**ORDER NOW SAVE \$150**

Retail Price \$1150

Your Price

**\$999<sup>95</sup>**

Price subject to change without notice  
Returns guaranteed

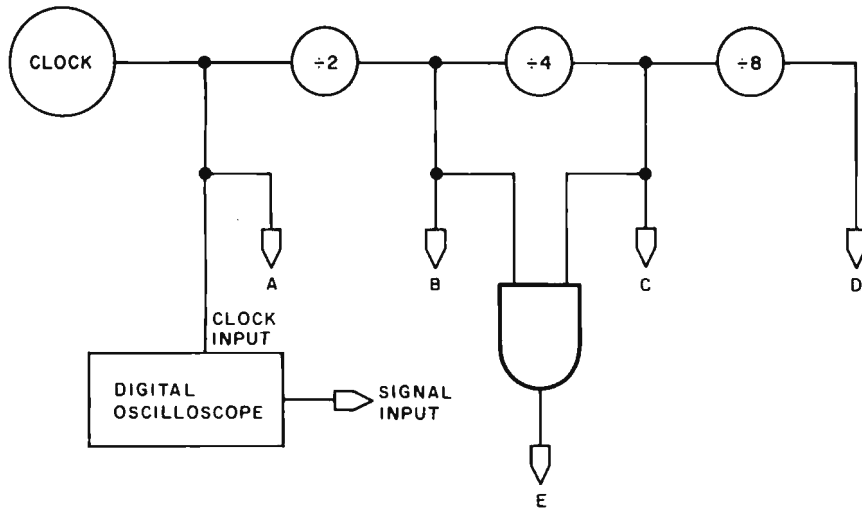

Figure 3: Typical method of connection for displaying serial waveforms.

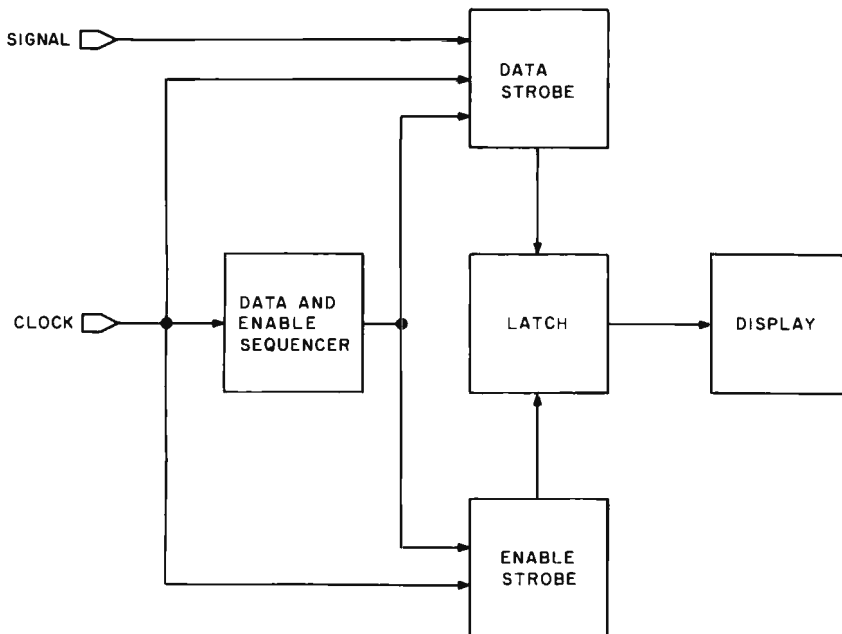

Figure 4: Block diagram of digital oscilloscope function.

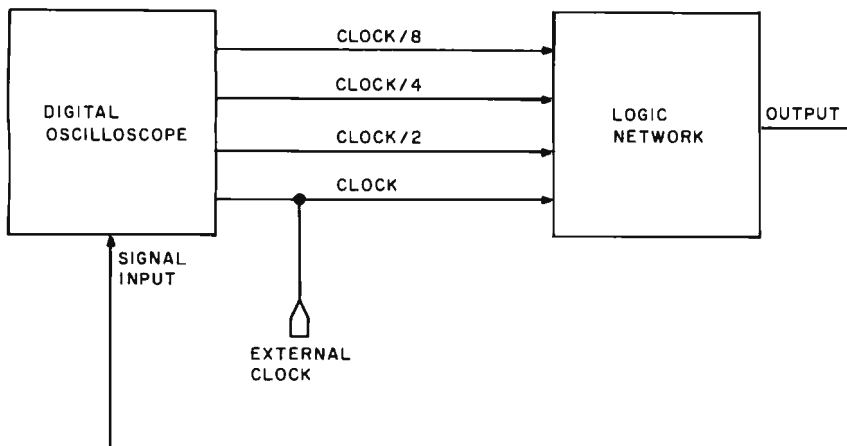
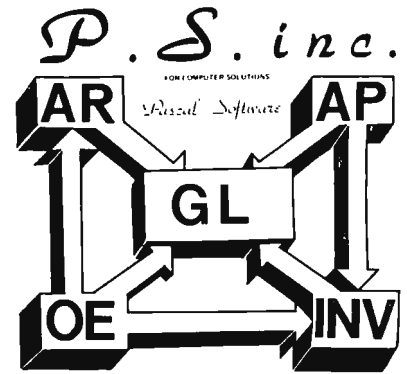

Figure 5: Connections to determine truth table for a logic network.



USE OUR  
BUSINESS SOFTWARE  
for  
GREATER PROFIT  
through  
MORE EFFICIENT  
OPERATION

INCLUDES :

- ❖ GENERAL LEDGER
- ❖ ACCOUNTS PAYABLE
- ❖ ACCOUNTS RECEIVABLE
- ❖ ORDER ENTRY
- ❖ INVENTORY CONTROL

This totally integrated, single entry system is easy to learn and easy to use because it is "Menu" oriented.

The software requires a minimum system consisting of 48K memory, CRT, Printer, dual floppy disc. It is ready to run on the following systems :

- ❖ DEC PDP - 11
- ❖ AM - 100
- ❖ PASCAL MICROENGINE
- ❖ CIT PENSÉE

We are working on the following systems and feel we can install our software on them within 30 days ARD: Data General, General Automation, LSI 4/10,4/30, Some Z80 Systems

Price for the total system is \$2995.00. Order a user manual (\$25.00 plus \$2.00 shipping & handling) or the Demo Floppy & Manual (\$65.00 plus \$2.50 shipping & handling) to reserve this price for you beyond our expected price increase Nov 1, 1979.

TO ORDER USE OUR TOLL FREE NUMBER  
**1-800-437-4774**

VISA AND MASTERCARD WELCOME  
OR SEND CHECK OR MONEY ORDER TO

P. S. INC, 619 NP AVE, BOX 2017 L  
FARGO, ND 58107  
(PH) 701/235-8145

*P.S. inc.*

DEALER INQUIRIES INVITED

# Event Queue

In order to gain optimum coverage of your organization's computer conferences, seminars, workshops, courses, etc, notice should reach our office at least three months in advance of the date of the event. Entries should be sent to: Event Queue, BYTE Publications, 70 Main St, Peterborough NH 03458. Each month we publish the current contents of the queue for the month of the cover date and the two following calendar months. Thus a given event may appear as many as three times in this section if it is sent to us far enough in advance.

## NOVEMBER 1979

November 1

**Invitational Computer Conference**, Cherry Hill NJ. This conference is directed to the quantity buyer and will feature the newest developments in computer and peripheral technology. Contact B J Johnson and Associates, 2503 Eastbluff Dr, Suite 203, Newport Beach CA 92660.

November 5-7

**Thirteenth Asilomar Conference on Circuits, Systems and Computers**, Asilomar Hotel and Conference Grounds, Pacific Grove CA. Contact Roger C Wood,

Electrical and Computer Engineering Dept, University of California, Santa Barbara CA 93106.

November 5-8

**Electronics Production Engineering Show**, Kosami Exhibition Center, Seoul Korea. This international industrial exposition will be devoted to the needs of manufacturers of electronic products in Korea. Contact Expoconsul, Clapp and Poliak International Sales Division, 420 Lexington Ave, New York NY 10017.

November 6-8

**IEEE Third International Conference on Computer Software and Applications**, The Palmer House, Chicago IL. Contact IEEE Computer Society, POB 639, Silver Spring MD 20901.

November 6-8

**Midcon/79 Show and Convention**. O'Hare Exposition Center and Hyatt Regency O'Hare, Chicago IL. Contact Electronic Conventions Inc, 999 N Sepulveda Blvd, El Segundo CA 90245.

November 6-8

**New England Printed Circuits and Micro-Electronics Exposition**, Northeast Trade Center, Woburn MA. This show is devoted to the equipment, materials, tools, supplies, and test instruments needed to manufacture electronic and microelectronic circuits, components, and systems. The show is sponsored by the International Electronics Packaging Society. Contact Industrial and Scientific Conference Management Inc, 222 W Adams St, Chicago IL 60606

November 6-8

**Third Digital Avionics Systems Conference**, Ft Worth TX. This conference will probe the expectations and challenges of the digital revolution in avionics systems. Contact John C Ruth, Technical Program Chairman, POB 12628, Ft Worth TX 76116.

November 8-10

**Entering a Decade of Experience - Where Are We and Where Are We Going?**, Atlanta Hilton, Atlanta GA. Sponsored by the Society for Computer Medicine, this conference will cover microprocessing in medicine, computers and medical records, automated ill-patient monitoring and other related topics. Contact the Society for Computer Medicine, Suite 602, 1901 N Ft Myer Dr, Arlington VA 22209.

November 12-14

**Computer Cryptography**, The George Washington University, Washington DC. The objective of this course is to provide each participant with a working knowledge of the use of

## Introducing...

# MINI-FLEX<sup>T.M.</sup>

## Designed Specifically to Protect 5" Diskettes



The Newest  
Member of The  
Advance Access  
Diskette  
Protection Family

For Further Information  
**CALL TOLL FREE**  
**800 323-0254**



**ADVANCE ACCESS GROUP**

10526 W. Cermak Westchester, IL 60153 312 952-5210

"Manufacturers of Information Processing Supplies"



cryptography in computer applications. Contact Continuing Education, George Washington University, Washington DC 20052.

November 12-16

**Communications Satellite Antenna Technology**, University of Southern California, Los Angeles CA. This course is for engineers engaged in the design of military or commercial satellite communication systems, spacecraft antenna and ground stations. Multiple beams, frequency reuse,

polarization control, the new generation of satellites, and other topics will be discussed. For more information, call (213) 741-2410.

November 13-15

**DPMA Education Foundation Sponsors Systems Conversion Symposium**, Washington DC. The theme of the three-day meeting is "Converting Today's Systems to Tomorrow's Technology." Hardware and software aspects of computer conversion, strategies and techniques, and transi-

tion to a distributed data base system will be discussed. Contact Ken Burroughs, DBD Systems Inc, 1500 N Beauregard St, Alexandria VA 22311.

November 14-16

**Advanced Programming Techniques Using Pascal**, Allentown PA. This class will teach Pascal programmers how to build a comprehensive and effective Pascal-based software development environment. Emphasis will be on programming exercises with

group and individual instruction. Contact Software Consulting Services, 901 Whittier Dr, Allentown PA 18103.

November 14-16

**1979 International Micro and Minicomputer Conference**, Astro Village, Houston TX. This conference concerns micro and minicomputer systems, a survey of the range of current applications, and exploration of potential areas for future development. Emphasis will be

## FOR THE VERY BEST IN NORTHSTAR® COMPATIBLE SOFTWARE

### DATA BASE MANAGERS SPECIAL!! \$10.00 OFF of Selector-III C2

**Selector-III C2:** SuperSoft is proud to offer the Selector-III C2 at a special \$10.00 discount. Selector III allows instant recall of any record using any information item in the record. This makes Selector-III the most powerful Data Base Management System in micro-computers today! You can define a data format and begin entering your data in minutes. Helps bring applications on line in hours instead of months. (Note: Selector-III C2 requires CP/M and C BASIC 2, not supplied - also 48K Ram required for some applications) Selector-III C2 is: \$335.00 (\$10.00 off list!). (Manual alone: \$20.00)

### BUSINESS

**CRS - Client Record System.** A complete program package for the Insurance agent. CRS will provide you with very fast online access to your client records, print reports and mail labels, and give you all the information you will need to increase your sales through the use of CRS as a **MARKETING TOOL**.

CRS stores a complete record for each client that includes the name, address, telephone #, as well as provisions for customer #, salesman # and up to six policies (expandable if needed). The policy information is complete with both the type of coverage and the company that is underwriting it, as well as exp. date, premium, term, and payment schedule. You also have a remark field.

You can search the files by any field, and CRS supports a powerful 'sieve' search to provide you with all the information you need to increase insurance sales. CRS comes with two(2) user's manuals, one for the owner, and one for office personnel! (minimal system: one drive, 40K RAM starting 2000H) \$250.00 (Manual: \$40.00)

### TEXT PROCESSORS

**TFS - Text Formatting System.** At least a full featured text processor for NorthStar that you can rely on! TFS has left & right margin justification, page numbering, chaptering, page headings, centering, paged output & MORE. Supports powerful text manipulations including: global & local 'search and change,' file merges and block moves. This means that you can restructure your text file at any time to look the way you want it to, you can even 'chain' files together from disk for documents larger than your current memory.

TFS is completely 'load and go' therefore you can start using it at once. You get two(2) user's manuals: one is a Quick Start manual to get you going in minutes, the other is an in depth study of TFS. (TFS requires RAM from 0000H to 2000H) \$75.00 (Manual only: \$20.00)

### COMPUTER AIDED INSTRUCTION

**MISS - Microcomputer Instructional Support System.** A complete, self-contained CAI package applicable to home, school or business education. Includes everything needed to create a sophisticated computer learning environment. MISS allows one to create any type lesson complete with wrong answer branching, re-test, and complete record keeping. The student is prompted 100% of the way and need have no special knowledge. A special feature is the optional use of a unique algorithm which separates spelling errors from incorrect responses. Absolutely no programming knowledge is required. MISS is completely interactive and maintains complete records on any number of students and lessons (limited only by disk space). MISS is a completely flexible system that will allow you to either create lessons or to purchase pre-programmed lessons which run under MISS. Complete with user's manual . . . \$40.00. (Manual alone: \$10.00)

### ASSEMBLERS

**ARIAN - A complete 8080 assembler that interfaces directly to your DOS.** ARIAN is completely 'load and go'. Features include: dynamic file and RAM allocation, custom disk and RAM command capability, several library routines directly accessible by the user. Also, a complete text editor, and system executive. ARIAN is both powerful and easy to learn and use; it is an assembler that you can grow with. Comes complete with a 51 page user's manual (ARIAN requires RAM from 0000H to 2000H) \$50.00 (Manual alone: \$10.00)

**ARIAN Utility Package - Several disk based utilities.** Includes a complete DEBUG Package: \$50.00

### PROGRAMMING LANGUAGES

**'Tiny' Pascal - This is the famous Chung/Yuen 'tiny' Pascal.** FAST - ELEGANT - STRUCTURED. Local and global variables plus procedure and function independence make 'tiny' Pascal great for high speed applications. Compiles to 8080 code that executes up to 25 times faster than BASIC. You also receive SOURCE to 'tiny' Pascal written in Pascal. This means that you can compile the compiler! Add features, relocate, etc. (you will need 36K to do this) \$40.00

### UTILITIES

**DEBE - (Does Everything But Eat!)** This is a must for NorthStar users. You can: COMPACT & EXPAND BASIC programs. Compacting removes unnecessary spaces and remarks. This saves money and makes for programs run faster. Expanding puts them back again.

Cross-reference BASIC programs by variables and transfer statements.  
Global substitutions of variables and transfer statements.  
Formatted print outs of BASIC programs as well. \$40.00

### SPECIFY SINGLE OR DOUBLE DENSITY

## FOR THE VERY BEST IN TRS-80 COMPATIBLE SOFTWARE

### 'Tiny' Pascal FOR TRS-80

Now you too can have Pascal! The famous Chung/Yuen 'tiny' Pascal has been specially designed for the TRS-80! The full power and elegance of 'tiny' Pascal is at your command. Programs written in 'tiny' Pascal run at least 4 times faster than the same program in BASIC! 'tiny' Pascal is also a great way to learn Pascal programming, & fun too.

Best of all, you only need a 16K Level II TRS-80! No disk is required. The 'tiny' Pascal operating system is self-contained and very easy to use.

'Tiny' Pascal is a subset of standard Pascal & includes: RECURSIVE PROCEDURE/FUNCTION, IF-THEN-ELSE REPEAT/UNTIL, 'PEEK' & 'POKE', WHILE DO, CASE, MORE! (Plus full graphics for your TRS-80).

You can save and load programs to and from tape in both source or compiled form. You get all this and more, plus a user's manual for \$40.00

### Energy-Miser

Energy Miser is a complete heating/cooling analysis program for your home, office or business! With Energy Miser you can calculate heat loss because of poor insulation, leaky doors and windows, poor planning and more. With Energy Miser you can predict the annual savings on your utility bills for various improvements or modifications, including: use of solar power, better insulation, opening and closing drapery, etc.

But there is even more: Energy Miser can also calculate your Return on Investment. That is, you can find your break point for converting to solar, for insulating better, etc. Energy Miser even takes into consideration the Energy Tax Credit! Energy Miser is a program designed to save your money!

Energy Miser is a proven program written by a professional and includes a complete user's manual for \$22.50. (Minimum System 16K Level II, No Disk Required)



ALL ORDERS PREPAID OR C.O.D.  
ILLINOIS RESIDENTS ADD 5% SALES TAX

**SUPERSOFT**

P.O. Box 1628  
Champaign, IL 61820  
(217) 344-7596

placed on technical papers and exhibits. Contact Dr S C Lee, School of Electrical Engineering and Computer Sciences, University of Oklahoma, Norman OK 73019.

November 15

**Invitational Computer Conference**, Southfield MI. See November 1 for details.

November 15-19

**White House Conference on Library and Information Services**, Washington DC. This conference has been called to help shape policies on public access and dissemination of information in this country. Two issues to be covered are the libraries' ability to help stop functional illiteracy and the use of computers, cable television, audio and video systems as alternative routes of information delivery. Contact Susanne

Roschwalb, (202) 466-7800 or Vera Hirschberg, (202) 653-6252.

November 27-29

**Sixth Datacomm**, Pacific Grove CA. This symposium is sponsored by the IEEE Computer Society, the IEEE Communications Society, and the Association for Computing Machinery. Some of the subjects of the eleven sessions are electronic fund transfer, protocols, routing and flow control, new data network services in Europe, and local networks.

For more information, contact Sixth Datacomm, POB 639, Silver Spring MD 20901.

November 28-30

**Business and Personal Computer Sales Expo '80**, Philadelphia Civic Center, Philadelphia PA. Contact

Produx 2000 Inc, Roosevelt Blvd and Mascher St, Philadelphia PA 19120.

November 29-30

**Metric Management Workshop**, Dallas North Park Inn, Dallas TX. The workshop is designed to help personnel at all levels plan and implement a cost-effective transition to metric in their company. The sessions will cover establishing a metric plan and strategy, assigning responsibility for the transition within the existing organizational structure, and developing a sensible approach to controlling conversion costs. Contact Len Boselovic, ANMC, 1625 Massachusetts Ave NW, Washington DC 20036.

for third party sellers of computer systems, word processing systems, peripherals and software packages and media will focus on solutions to business problems normally encountered in structuring a successful dealership and the operational aspects of the dealership from both the supplier and the customer side. Contact The Interface Group, 160 Speen St, Framingham MA 01701.

December 3-5

**Implementing Cryptography in Data Processing and Communications Systems**, New York NY. Going beyond an introduction to cryptographic systems, the seminar will stress implementation of the DES and address public key implementation considerations. Contact Ms Jansen, Cryptotech, 12 State Rd, Bellport NY 11713.

DECEMBER 1979

December 2-6

**MUSE North American Annual Meeting**, Bahia Mar Hotel and Yachting Center, Ft Lauderdale FL. This conference of Modcomp Users Exchange (MUSE) will feature technical sessions, workshops and user/manufacturer interface sessions on the use of Modcomp computers and their related software. Contact Kathy Black, MUSE, 4620 W Commercial Blvd, Suite 6C, Tamarac FL 33319.

December 3-5

**Winter Simulation Conference**, Holiday Inn, Embarcadero, San Diego CA. This conference will feature papers and panel discussions on discrete and combined (discrete and continuous) simulations. Contact Professor Robert E Shannon, University of Alabama in Huntsville, School of Science and Engineering, POB 1247, Huntsville AL 35807.

December 3-5

**The Application of Computer Technology to Accounting Systems**, Washington DC. The theme of the conference is "Information Systems as a Management Tool for the Financial Executive." It is sponsored by the Association of Government Accountants (AGA). Contact Ken Burroughs, DBD Systems Inc, 1500 N Beauregard St, Alexandria VA 22311.

December 8-9

**Data Processing for Businesspeople**, Cherry Hill Inn, Cherry Hill NJ. Management Information Corporation presents this seminar to meet the needs of company management in understanding computers. The seminar includes basic concepts of data processing alternatives (service bureaus, timesharing), small business computer systems, program packages availability and selection, managing the computer system, and the future of data processing. Contact Management Information Corporation,

December 3-5

**COMDEX '79**, MGM Grand Hotel, Las Vegas NV. This conference and exposition

**TRS-80 PERIPHERALS**

<p><b>DISK DRIVES</b> 40 tracks, 2 sides with power supply &amp; case <b>\$320.</b></p> <p><b>VERBATIM DISKETTES</b> \$3.00 <b>DYSAN DISKETTES</b> \$4.60</p>	<p><b>16k MEMORY KITS</b> for TRS-80, APPLE, SORCERER <b>\$70.</b></p> <p>w/jumpers and instructions <b>LIFETIME GUARANTEE!!!!</b></p>	<p><b>PRINTERS</b> from CENTRONICS, INTREGAL DATA, NEC SPINWRITER, TEXAS INSTRUMENTS. <b>\$379.</b></p> <p><b>ALL AT GREAT SAVINGS!!</b></p>
---	--	--

TRS-80 computers in stock!!

We also carry APPLE, SORCERER, PET, SO SALES products. WE WILL NOT BE UNDERSOLD.

**TRS-80 SOFTWARE**

GAMES	UTILITIES	BUSINESS
<b>ANDROID NIM</b> ..... \$14.00 nim robots that wink and respond. Excellent graphics and sound.	<b>NEWDOS+</b> ..... \$99.00 Enhanced DOS. Contains many improvements over TRS00S. 7 useful utilities built in. For 40 track use also.	<b>GL. AR. AP. PAYROLL INTERAC-</b> <b>TIVE</b> \$350. reports include unbilled invoices, open/closed accounts, ageing, Trial balance, income statement, balance sheet.
<b>STAR TREK III</b> ..... \$14.00 Travel through the galaxy on the Enterprise and destroy Klingons. New updated version.	<b>NEWDOS</b> ..... \$49.00 Same as above without utilities.	<b>HANDLES</b> 200 accounts, 1750 transactions. Based on Osborne method. Stand alone of each \$95
<b>AIR RAID</b> ..... \$14.00 Real time shooting gallery.	<b>SYSTEM INTEGRATION TEST</b> <b>INVENTORY II</b> ..... \$99.00 activity listing, complete listing, selected listing, minimum quantity search, 1000 items per disk	<b>ALL ABOVE PROGRAMS</b> <b>BY SBSG</b>
<b>SARGON:CHESS</b> ..... \$19.00 Best chess for TRS-80	<b>MICROSOFT FORTRAN</b> \$325.00	<b>ELECTRIC PENCIL</b> ..... \$99.00 by Michael Shrayor
<b>LIBRARY 100</b> ..... \$49.00 100 games, utilities, and business programs in one package. Great value!	<b>CPM</b> ..... \$150.00	<b>disk</b> ..... \$150.00 <b>BEST</b> word processor for the TRS-80
	<b>RENUMBER</b> ..... \$14.00 disk	
	<b>GZ LEVEL III</b> ..... \$49.00	
	<b>FOURTH</b> by MSS ..... \$35.00	

The above list is just a brief summary of some of our most popular software. We have a large selection of other software for many uses and for many computers. Documentation for any of our programs is available on request. If you have any questions, please call. We would like to hear from you.

TO ORDER, CALL OR WRITE:

**MIDWEST COMPUTER PERIPHERALS**  
1467 S. MICHIGAN AV.  
CHICAGO, IL. 60605  
(312) 251-5028

**C.O.D.**

FALL SPECIAL  
10% Discount on  
all Software orders  
over \$100

\*TRS-80 is a Registered Trademark of Tandy Corp.

# BYTE's Bits

140 Barclay Ctr, Cherry Hill NJ 08034.

December 10-11

**Mini and Microcomputers in Control**, Galt Ocean Mile Hotel, Ft Lauderdale FL. This symposium will cover computer architecture and hardware for control, languages for control, algorithms for control, hierarchical control, methodology, and other topics. Contact The Secretary, Computers in Control Symposium, POB 2481, Anaheim CA 92804.

December 10-12

**Project Management for Computer Systems**, Chicago IL. This seminar will illustrate techniques for planning, implementing, installing, and controlling projects. Contact The University of Chicago, 1307 E 60th St, Chicago IL 60637.

December 10-13

**1979 Fall DECUS US Mini/Midi Symposium**, San Diego CA. This symposium is an opportunity for Digital Equipment Computer users to participate in a technical exchange. Contact DECUS, One Iron Way, MR2-3, Marlboro MA 01752.

December 10-14

**IEEE Computer Society's Tutorial Week 79**, Hotel Del Coronado, San Diego CA. Fifteen different one-day seminars will be offered throughout the week. Contact IEEE Computer Society, POB 639, Silver Spring MD 20901.

## JANUARY 1980

January 3-4

**Hawaii International Conference on System Sciences**, Honolulu HI. The conference will cover developments in theory or practice in software and hardware, and advanced computer systems applications in selected areas with emphasis on medical infor-

mation processing and computer-based decision support systems for upper-level managers in organizations. For more information, contact Perry G Patteson, Office of Management Programs, University of Hawaii, 2404 Maile Way, Honolulu HI 96822.

January 23-26

**International Microcomputers Minicomputers Microprocessors (IMMM)**, Harumi Exhibition Centre, Tokyo Japan. This is a show for manufacturers, commercial and financial establishments, service industries and institutions, and design engineers interested in buying computer systems, components and services. For more information, contact Industrial and Scientific Conference Management Inc, 222 W Adams St, Chicago IL 60606.

January 28-30

**Principles of Programming Languages**, Las Vegas NV. This symposium concerns practical and theoretical aspects of principles and innovations in the design, definition, and implementation of programming languages. Some topics are algorithms and complexity bounds for language processing tasks, specification languages, error detection and recovery, and unusual or special-purpose languages that raise issues of principle. Contact Professor John Werth, Department of Mathematical Sciences, University of Nevada, Las Vegas NV 89154.

January 30-February 1

**MIMI '80 Asilomar**, Asilomar Conference Grounds, Pacific Grove, CA. This symposium covers all aspects of mini and microcomputers including technology, hardware, software engineering, languages, education and more. Contact The Secretary, MIMI '80 Asilomar, POB 2481, Anaheim CA 92804. ■

### The Formation of a New Personal Computer Society

Do personal computer owners need a national organization? A personal computer user named Abby Gelles would answer in the affirmative. She was interacting with a number of the attendees of the National Computer Conference Personal Computer Festival last June when the usual pro and con arguments were raised in her conversations. She is convinced there is a need.

So, with some kindred spirits in New York City, Abby has formed the *Personal Computer Society*. You can find out about what she is proposing by writing her at: Ms Abby Gelles, Executive Director,

Personal Computer Society, POB 147, Village Sta, New York NY 10014.

### ICS Announces New Courses

Integrated Computer Systems Inc (ICS), 3304 Pico Blvd, POB 5339, Santa Monica CA 90405, has announced the fall and winter schedule for their Short Course series. Courses on computer graphics, digital signal processing, troubleshooting microprocessor systems, and other topics, will be covered. The courses will be held in cities around the United States from November through February. These courses are structured for technical and managerial personnel. ■

## PHOTO ETCH<sup>TM</sup> PRINTED CIRCUIT KIT Makes circuits THREE WAYS

- 1 FULL SCALE ARTWORK MASTER
- 2 MAGAZINE ART ILLUSTRATION → FILM POSITIVE → NEGATIVE → DEVELOPED PHOTO RESIST IMAGE ON COPPER CLAD CIRCUIT BOARD → ETCHED CIRCUIT BOARD
- 3 DIRECT ETCH DRY TRANSFERS APPLIED TO COPPER CLAD BOARD

Copy circuits right from a magazine using special photo film. No camera or darkroom used. Page is not destroyed in process. Do your own master art, make negatives, sensitize boards and etch one or a hundred circuits; all identical, all perfect.

For one-of-a-kind PC's, use special dry transfer patterns as a direct etch resist right on the blank copper board.

Do it all with the ER-4. In stock at parts distributors or order direct. Add 7% shipping. Minimum factory order: \$30.00.

ER-4 Complete Photo Etch Set	\$29.95
ER-2 Assorted Etch Resist Patterns & Tapes	4.25
ER-3 1/4 lb. Dry Ferric Chloride (makes one pint)	1.85
ER-5 Six sheets Pos-Neg Copy Film, 5"x6"	4.75
ER-6 Film Process Chemicals	2.50
ER-71 Photo Resist Liquid (negative) does 1700 in <sup>2</sup>	6.50
ER-8 Photo Resist Developer, 16 oz.	2.95
ER-12 Power Etch bubble pump unit*	7.25

\*not included in ER-4 set

the **DATAK** corp.  
65 71st St. • Guttenberg, N. J. 07093



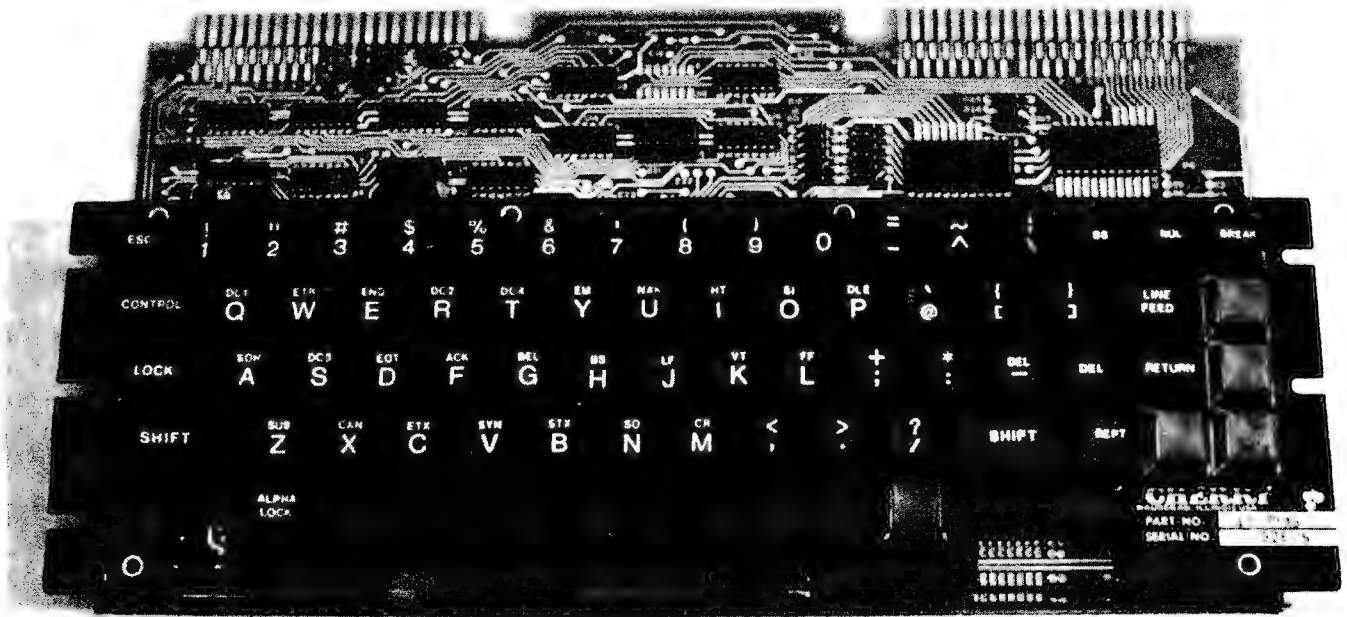

---

Dan S Parker  
 1007 Third St #3  
 Davis CA 95616

---

In the few short years since the birth of the personal computer, the list of peripheral devices has grown tremendously: printers, video displays, mass storage devices, and keyboards. At first, many of these items were overruns from original manufacturers, or were removed from used business or military systems. Documentation was scarce and complete schematics were often nonexistent. Keyboards were available in a myriad of styles, but not with all the features of a professional unit. If they were encoded at all, it was often in half ASCII (upper case ASCII only, as available on the Teletype Model 33).

#### About the Author

*Dan S Parker is presently completing work on a PhD degree in Physics at the University of California at Davis. His area of research is magnetic properties of rare earth crystals in solid state, low temperature physics. He is also actively developing a data acquisition and cryogenic control microcomputer for his research equipment.*

No more! Enter the PRO, Cherry's new entry into the personal computer keyboard market (Cherry model B70-05AB). Aptly named, it is indeed a professional keyboard that comes fully assembled, tested, and ready for installation in your computer system. Its features rival those of keyboards found in expensive terminals.

#### General Features

The PRO features the full 128 ASCII character set of upper case, lower case, and control characters. A total of 67 gold contact keys, engraved in white on durable matte black injection molded plastic, are easy on the eyes. The shift, shift lock, control, linefeed, and return keys are oversize for easier operation (see photo 1). Cherry lists the operating force of the keys at 2.5 ounces. They feel solid, positive, and very smooth. The keys are wave soldered to 1/16 inch glass epoxy circuit board material and anchored to a 1/16 inch black anodized aluminum cover subplate. No wobble in those keys or flexing of the circuit board when a key is pressed.

Five of the keys are unassigned and

## NEW ALL PURPOSE COMPUTER DESK

by **DONTHO**

WALNUT FINISH 60Wx28Hx26D

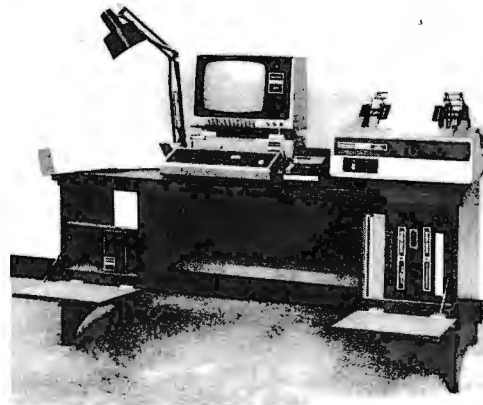

available for user defined functions. They can be relabeled (clear plastic covers to put labels under) and are all momentary contact. The operation and customizing manual is easy to read and has the full set of diagrams including schematics.

**Electrical Specifications**

The PRO operates from a single +5 V power supply and draws 325 mA maximum current as listed in the operator's manual. I measured it and found that it draws considerably less: 200 mA nominal. Outputs are via one of two 22 pin edge connectors and are TTL and DTL (transistor-transistor logic and diode-transistor logic) compatible. Pinouts include the seven ASCII bits, optional parity, +5 V, ground, strobe and inverted strobe, shift, break, repeat, control, and keyboard lockout. Cherry has conveniently placed these contacts so that only one side of a 22 pin edge connector (not supplied) is needed. Thus a single readout 22 pin connector may be used. The other pins are available with solder pads for customizing.

A second 22 pin edge connector (the one in the upper right of photo 1) is designed for piggybacking a numeric keypad onto the PRO. The matrix scanning technique employed makes it easy to modify key assignments and generate custom output codes.

The strobe pulse is generated 2.5  $\mu$ s after a key is pressed to insure data stability and is nominally 100  $\mu$ s wide. This seems to be ideal for both the Dajen SCI and Processor Technology 3P+S that I've used the keyboard with. The manual describes how to modify this timing.

**Customizing**

The keyboard is truly designed for the experimenter; Cherry is to be commended for making the keyboard user adaptable with a minimum of effort. As shipped, the keyboard is ready to use for most applications. As an example of the ease of modification, two of the integrated circuits are provided in sockets. Changing these two circuits to other integrated circuits (not provided but standard parts) and making no other changes converts the board to negative logic. Yet a different exchange of these two circuits results in a positive logic 3 state output so that two or more PRO keyboards can be wired in parallel. Still a fourth choice of circuits gives high voltage CMOS drive compatibility.

- SILENT 50 CFM FAN FILTERS AIR AND VENTILATES DISK DRIVE AND DISKETTE STORAGE AREA.
- LEFT CABINET IS 15w x 14h x 24d HOLDS 4 DISK DRIVES AND 90 DISKETTES.
- FOUR ELECTRICAL OUTLETS INSIDE CABINET.
- SIX OUTLETS (5 USABLE) ON BACK OF DESK. ALL CONTROLLED BY MASTER SWITCH.

DESK  
PRICE**\$369.00**DEALER  
INQUIRIES  
INVITED

Right cabinet of same dimensions is open in back to feed paper to printer. Eliminates paper on floor. Front provides storage for manuals or notebooks.

Completely assembled. Price FOB Wakarusa, Ind. Allow two weeks for shipment.

**UP TO 60% TIME SAVINGS!****MAILING LIST**by **DONTHO**

ELIMINATES AT LEAST 60% OF TIME REQUIRED TO ASSEMBLE DATA IN MAILING LIST ● REPEAT KEY (@) ENTERS LAST DATA SUCH AS SURNAME, CITY AND STATE, ZIP CODE ETC. ● DOES AWAY WITH MOST TYPING ERRORS. ● SORTS ABOUT 650 NAMES IN ONE MINUTE. ● PRINTS ON STANDARD LABELS BY NAME, CITY, STATE, ZIP CODE, SELECT CODE #1 OR #2, OR ANY TWO OF THESE. ● KEYBOARD ADJUSTMENT OF L & R PRINT POSITIONS.

REQUIRES 32K MEMORY, DISK DRIVE & DOS. HOLDS ABOUT 250 NAMES ON DOS, AND ABOUT 650 ON CLEAN DISKETTE.

ANY IMPROVEMENTS TO PROGRAM WITHIN ONE YEAR WILL BE FURNISHED TO PURCHASERS FREE OF CHARGE.

MAILING LIST \$79.95 delivered

ORDER BY MONEY ORDER-PERSONAL CHECK-  
VISA OR MASTERCARD**DONTHO SCIENTIFIC, INC.**

P.O. BOX 864 MICHIGAN CITY, IN 46360

PHONE (219) 872-2364

**OUR POLICY**

We will ship no product we are not fully prepared to guarantee.

All schematic reference points, integrated circuit designations, and modification points are marked on the circuit board. All of the keys are equipped with dual plated-through holes so that the link connecting them can be cut to isolate the keyswitch. This makes it easy to add custom features. A large number of solder pads and a spare integrated circuit pad have also been provided.

A provision has been made for the addition of an automatic repeat key by installing a 74123 monostable multivibrator in a provided integrated circuit pad along with appropriate timing capacitors and resistors. The manual's suggested timing components made this very easy to implement. My only complaint is that the holes on the empty pad are filled with solder which has to be removed (eg: the board is wave soldered).

The repeat function has two modes. In the first mode, holding down any key for more than 1/2 second causes that character to repeat at about nine characters per second. In the second mode, simultaneously holding down the repeat and character keys causes the automatic repeat.

A few of the other documented changes that can be made include the generation of odd or even parity, latched output, and a shift control mode in which, by depressing

both the shift and control keys, additional 8 bit codes can be generated.

### Alpha Lock versus Shift Lock

Shift lock and alpha lock are not the same thing, and a lot of confusion among experimenters and dealers seems to exist about this point. Put simply, alpha lock (often called caps lock or teletypewriter lock) simply locks out the lower case characters so that the keyboard generates only numbers and upper case letters. In this mode the shift key still operates and gives the shifted mode characters above the numbers such as ") (\*&%\$#. The advantage of this mode is that much software, like most BASICs and assemblers, accepts only upper case letters and numbers.

In the second mode, with the alpha lock not engaged, the keyboard generates upper and lower case just like a typewriter, such as might be needed for text editing. In both modes the shift and shift lock keys are active. The alpha lock key is shown in photo 1 just to the left of the space bar and is an alternate action key, as is the shift lock key. My preference would have been to position the alpha lock key a bit further from the main section of the keyboard.

### Enclosures

The PRO comes without an enclosure but is provided with mounting wings. A recommended panel cutout diagram is included with the manual for custom cutting if you so desire. Fortunately, the cutout is simplified by a minimum of contour "stair step" cuts. Dimensions of the keyboard are 14 by 7 1/4 by 7/8 inches (34.6 by 18.4 by 0.9 cm). The thickness is measured from bottom of the printed circuit board to top of aluminum cover plate. Hence the keyboard can be mounted extremely low profile either flat or tilted. At present, the only custom precut keyboard enclosures available commercially, I believe, are offered by Electrolabs (POB 6721, Stanford CA 94305) and Ironman (POB 1260D, Southgate CA 90280). A number of firms offer blank enclosures which also appear to be suitable for use with the PRO. Better yet, make your own.

### Concluding Remarks

The PRO is priced at \$135 in single quantities. For two to four pieces, the price is \$107 each, directly from Cherry. The price plummets to \$94.50 for five or more keyboards. Delivery takes two or three weeks.

For more information, contact Cherry Electrical Products Corp, 3600 Sunset Av, Waukegan IL 60085. ■

**Qjit**  
... in touch  
with reality

(602) 299-9831  
P.O. BOX 35879  
TUCSON, ARIZ  
85740

temperature, velocity, moisture, water level,  
darkness and light, magnetic fields, pressure,  
the presence or absence of people or objects,  
amplifiers, analog memories and  
mathematical functions . . .

**Qjit** - if you're willing to build your own  
a division of J R Conwell Corporation



## TRS-80 disk software

**DATA BASE MANAGER IDM-III 32K** \$49

You can use it to maintain a data base & produce reports without any programming. Define file parameters & report formats on-line. Features key random access, multi-keys, sort, field arith, audit log. Enhanced version \$69.

**ACCOUNT** manage client accounts & accounts receivable. Order entry. Print invoices, statements & reports. 32K \$69.

**WORD PROCESSOR 16K** \$39

Our Word-III is the first word processor specifically designed for the TRS-80 that uses disk storage for text. Written in BASIC. No special hardware and text limit. Use for letters, manuals & reports. 32K version features upper/lower case without hardware change. \$49.

**MAILING LIST 16K** \$35

Lets you maintain data base and produce reports & labels sorted in any field. Random access. 2-digit selection code used. 32K version fast SHELL sort \$49. Advanced version with report writer \$59.

**INVENTORY 16K** \$39

While others use inefficient sequential file, we use 9-digit alphanumeric key for fast on-line random access. Reports give order info, performance summary, etc. Enhanced 32K version \$49.

**KEY RANDOM-ACCESS UTIL 16K** \$19

Lets you access a record by specifying a key. Features hashing, blocking, buffering technique.

Send \$5 for each manual.

MOD-II, superior, integrated software available.

## MICRO ARCHITECT

96 Dothan St., Arlington, MA 02174

APPLE • CENTRONICS • TEXAS INSTRUMENTS  
 HORIZON • VECTOR GRAPHIC • CROMEMCO  
 • RADIOSHACK • HP • MICROPOLIS • SOROC  
 • OSI • SWTP • M • IBM • NEC •  
 PET • DIABLO • HAZELTINE  
 • HEATH • D • IMSAI •  
 DEC • PET • • SOL  
 • WANG • • LSI •



## WE'VE GOT YOU COVERED!

Cover Craft Dust Covers protect your hardware and your investment. Save maintenance, downtime and look great. Our Dust Covers come in hundreds of sizes each custom designed to fit a particular model of terminal, CPU, Line Printer, Floppy Disk. They're a proven way to help eliminate dust and dirt accumulation, improve system reliability and save many times the cost in reduced maintenance and downtime. What's more, your satisfaction is 100% guaranteed.

Cover Craft Dust Covers are available from your local computer retailer or contact Cover Craft. **\$6.95 - \$9.95**

Can you afford to wait any longer?

**COVER CRAFT**  
 P.O. Box 555, Amherst, NH 03031  
 Telephone (603) 673-8592

## NO FRILLS! NO GIMMICKS! JUST GREAT DISCOUNTS MAIL ORDER ONLY

### HAZELTINE

1400 .....  
 1410 .....  
 1420 .....  
 1500 .....  
 1500(Kit) ....

Call For Prices.

### CENTRONICS

779-2 ..... 995.00  
 700-2 ..... 1350.00  
 703 tractor ..... 2195.00  
 Micro Printer ..... 395.00

### NORTHSTAR

Horizon I assembled... 1629.00  
 kit ..... 1339.00  
 Horizon II assembled... 1999.00  
 kit ..... 1599.00

### TELETYPE

Mod 43 ..... 995.00

### DIGITAL SYSTEMS

Computer ..... \$4345.00  
 Double Density  
 Dual Drive ..... 2433.00

### IMSAI

VDP 80/1000 ..... \$5895.00  
 16K Memory assem... 399.00  
 PCS 80/15 ..... 599.00

### DEC

LA 34 ..... 1149.00

### CROMEMCO

System III \$1000 off... 4990.00

10% off on Cromemco products

### TEXAS INSTRUMENTS

810 Printer ..... 1595.00

Optima Cabinets (New) .... 99.95

5" Scotch Diskette ... Box/29.95

8" Scotch Diskette ... Box/34.95

Most items in stock for immediate delivery. Factory-fresh, sealed cartons.

**DATA DISCOUNT CENTER** P.O. Box 100  
 135-53 Northern Blvd., Flushing, New York 11354, 212/465-6609

N.Y.S. residents add appropriate Sales Tax. Shipping FOB N.Y.  
 BankAmericard, Master Charge add 3%. COD orders require 25% deposit.

## MAGSAM™ KEYED FILE MANAGEMENT SYSTEM

Sophisticated applications made simple.

Put data at your fingertips...easily accessed, displayed, and updated by key. MAGSAM™ allows your CBASIC programs to create and access sophisticated keyed file structures through simple CBASIC statements.

Powerful, affordable, and easy to use.

MAGSAM™ is now available in three versions offering an array of features and capabilities. Standard MAGSAM™ features include random by key, sequential by key, generic by key, randomly by record number, and physical sequential access techniques. Each MAGSAM™ Package includes the MAGSAM™ file manager, tutorial program, file dump utility, User Guide, Reference Card, and one year update service.

- **MAGSAM™** — Most advanced version. Secondary Indexing with any number of keys, and Record and Key Deletion with automatic reuse of freed space. .... \$145†
- **MAGSAM II™** — Single Key support with full Record and Key Delete capability. .... \$99†
- **MAGSAM I™** — Entry level version. Single Key support without Delete functions. .... \$75†
- **MAGSAM™ User Guide only** — comprehensive tutorial and reference manual. .... \$15

Available for 8" soft sector, Micropolis, and TRS-80 disk formats. Requires CP/M™ or derivative and CBASIC. Distributed as CBASIC subroutines in source form.

Visa and Mastercharge welcome. Dealer and OEM inquiries invited.

**MAG**

**MICRO APPLICATIONS GROUP**  
 7300 CALDUS AVENUE  
 VAN NUYS, CA 91406

\* Trademark of Digital Research. † Single site license

# Clubs and Newsletters

---

## ACM Special Interest Group Publishes Newsletters

---

The Special Interest Group on Language Analysis and Studies in the Humanities' *SIGLASH Newsletter* is published in March, June, September and December by the Association for Computing Machinery (ACM). The newsletter contains unreferenced papers, reviews of books and articles, abstracts of members' work, a "rap" section for short communications, announcements of general interest, and letters to the editor. Membership in this special interest group, which includes the newsletter, is \$4 a year for ACM members and \$10 for non-ACM members. Contact

ACM Inc, POB 12105,  
Church St Station, New  
York NY 10249.

---

## Tri-State Computer Club

---

The Tri-State Computer Club is a newly established hobbyist group serving the river cities in the Ohio, West Virginia and Kentucky areas. They have over 40 members representing 6800s, TRS-80s, Digital Equipment Corporation (DEC) and Heath equipment. The meetings are held on the second Saturday of the month at 3:30 PM in the Lawrence County OH public library. Meetings are open and the public is invited to attend. Contact Douglas

Troughton, 508 Colony Dr,  
Wheelersburg OH 45694.

---

## Apple Computer Users Group in Honolulu HI

---

Honolulu HI now has its own Apple Computer Users Group. The Honolulu Apple Users Society (HAUS) supports a newsletter containing the latest up-to-date information concerning the Apple, including program tips and techniques, listings, reviews, etc. Meetings are held the first Monday of each month at the Computerland store in Honolulu. The president is Bob McDowell, and Randy Brumback is vice-president. The club holds weekly sessions on programming, BASIC, hi-res graphics, etc. Annual dues are \$10 which include a newsletter. Additionally, the group is interested in exchanging information and software with other clubs. Contact Bill Mark, 98-1451-A Kaahumanu St, Aiea HI 96701 or phone (808) 488-2026.

---

## PPC Journal for Hewlett-Packard Programmable Calculator Users

---

The *PPC Journal* is the monthly publication of the Personal Programmers Club (PPC) which is a volunteer, nonprofit, loosely organized, world-wide group of Hewlett-Packard programmable calculator users. The purpose of the publication is to disseminate user information related to the selection, evaluation, care and application of all Hewlett-Packard programmable calculators. The journal is available through membership in PPC. Inter-

ested individuals should write to PPC, 2541 W Camden Pl, Santa Ana CA 92704. A sample issue of the *PPC Journal* and other information materials may be obtained by sending a self-addressed 9 by 12 inch envelope with 2 ounces of first class US postage attached.

---

## Non-Mikbug 6800 Series System User Group

---

According to a letter received from Mark Siebart, he is attempting to set up a users group and newsletter for non-MIKBUG 6800 series systems with emphasis on the Capitol Radio Engineering Institute (CREI) and National Radio Institute (NRI) machines. These are based on a J-Bug compatible monitor using the MEK format. Anyone interested in such a group should write to Mark at 2599 Caulfield, San Diego CA 92154.

---

## Bulletin for TRS-80 tiny-c and Assembler

---

The TRS-80 *tiny-c and Assembler Programming Bulletin* specializes in programs and techniques for Radio Shack's editor and assembler and *tiny-c* associates' *tiny-c* interpreter for the TRS-80. An annual subscription (4 issues) costs \$8.50 and a single issue is priced at \$2.50. Contact Rob Varty, 2193 Haygate Cr, Mississauga, Ontario CANADA L5K 1L7.

---

## Wake is the Word for Washington Area KIM Enthusiasts

---

WAKE, Washington Area KIM Enthusiasts, meets each month at the McGraw-Hill Continuing Education Center in Washington DC to study operation, expansion and applications of KIM-1 microcomputers. The

## What you 'C' is what you get!

### C Compiler for CP/M\*

*New, and available now! An easily affordable compiler incorporating most of the features of the full C language.*

#### BD SOFTWARE

**System requirements:** CP/M and at least 24K of RAM

**Variable Types:** char, int, unsigned

**Composite Types:** arrays, structures, unions

**Pointers:** to variables, structures, unions and functions

**Features:** is a structured language, all functions (Programs) recursive; more powerful expression operators than any other von Neuman type language; allows free-formatted source; close enough to UNIX\*\*C to make conversions feasible.

**Speed:** On 2 MHz 8080, the statement for (i = 1; i < 30000; i++) x = 5; takes about 4 seconds to execute.

**Package contains:** compiler, linker, library manager; standard function library; sample source files include games, a terminal emulator with disk I/O plus the source for many standard library functions; BDS C User's Guide; Book—*The C Programming Language* by Dennis Ritchie and Brian Kernighan of Bell Labs.

**Price:** \$110

*Recipient of the Computer Lib Seal of Approval*

\*CP/M is a trademark of Digital Research Corp  
\*\*UNIX is a trademark of Bell Laboratories

## Lifeboat Associates

2248 Broadway, New York, N.Y. 10024 (212) 580-0082 Telex 668585

# CATCH THE S-100 INC. BUS!



	LIST PRICE	OUR SPECIAL CASH PRICE
S-100's Three Ring Binder w/Ten Vinyl Jackets for 5 1/4 Mini Floppies (Holds Twenty Diskettes Plus Directory Pocket)	13.00	7.00
Imesai "8080" Kit complete w/Front Panel	750.00	625.00
S.D. Single Board Computer Kit	239.00	200.00
Godbout ECONORAM™ II	129.00	110.00
Anadex DP 8000 U/L Case	995.00	850.00
S.S.M. 10/4, 2P + 2S	159.00	135.00
Georgia Magnetics 8" Diskettes Soft Sectored per Box of 10	45.00	30.00
Shugart SA 400 5 1/4", Dual Density, Bare Drive	450.00	295.00

Subject to Available Quantities • Prices Quoted Include Cash Discounts, Shipping & Insurance Extra.

We carry all major lines such as S.D. Systems, Cromemco, IMSAI, Vector Graphics, North Star, Sanyo, ECT, TEI, Godbout, Thinker Toys, Hazeltine, IMC For a special cash price telephone us.

Bus... **S-100, inc.**  
 Address... **7 White Place**  
**Clark, N.J. 07066**  
 Interface... **201-382-1318**

# DISCOUNT PRICES

Microcomputers & Peripherals

## BYTES BOOKS ARGAINS

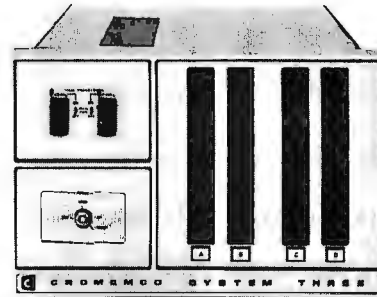

**Cromemco • SWTPC • Lear-Siegler  
 Hazeltine • RCA • North Star  
 Verbatim • Perkin Elmer and others**

Fast, off the shelf delivery.  
 Call TOLL FREE 800/523-5355

**MARKETLINE SYSTEMS, Inc.**  
 2337 Philmont Ave., Huntingdon Valley, Pa. 19006  
 215/947-6670 • 800/523-5355

Dealer Inquiries Invited

## 16K STATIC RAM

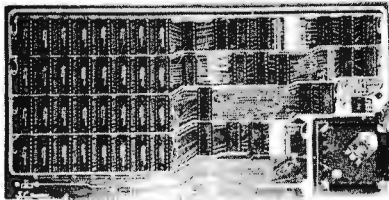

with  
**\$275** 450 ns  
**\$300** 250 ns  
 memory chips

Assembled, Tested and Guaranteed

**Static TMS 4044 or equivalent** - Fully Static 4Kx1 Memory Chips for full DMA capability, no tricky timing problems.

**Fully S-100 Bus Compatible** - All lines fully buffered, Dip Switch Addressable in two 8K block, 4K increments. Write Protectable in 2 blocks, Memory Disable using Phantom, Battery back up capability.

**Bank Select** - Using output port 40H (Cromemco software compatible)-addressable to 512KB of Ram for time share or Memory Overlap, also has alternate ports 80 H, COH.

**Guaranteed** - Parts and labor for one year. You may return the undamaged board within 10 days for a full refund.

**Orders** - You may phone for Visa, MC, COD (\$4 handling charges for COD) orders. Personal checks must clear prior to shipping. Shipping-Stock to 72 hours normally. Will notify expected shipping date for delay beyond this. Illinois residents add 5% tax. Please include phone number with order.

**S.C. Digital** P.O. Box 906 Phone:  
 Aurora, IL 60507 (312) 897-7749

## the ULTIMATE in CHEAP VIDEO

**BOOK & KIT ONLY \$42.95**

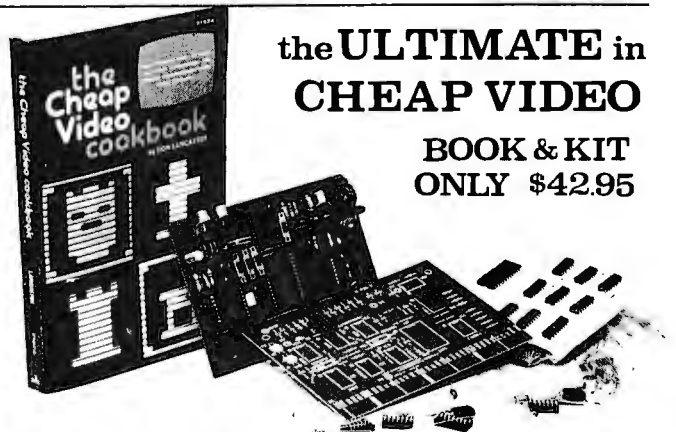

Don Lancaster's "Cheap Video" concept allows almost unlimited options, including:

- \* **Scrolling** - Full performance cursor.
- \* **Line/Character formats** of 16/32, 24/80, 32/64.... or almost anything.
- \* **Graphics** - up to 256 X 256 B & W; 96 X 128 COLOR (requires low-cost option modules)
- \* **Works with 6502, 6800 and other micros.**

**SPECIAL OFFER:** Buy the Kit (upper case alphanumeric option included) & get the Book at 1/2 price.

**EDIA ELECTRONICS, DEPT 11-B, 1020 W. WILSHIRE BLVD., OKLAHOMA CITY, OK 73116**

I'm Sold, PLEASE RUSH.....  SEND FREE CATALOG

TVT-65g Kit & Cheap Video Cookbook - \$42.95 (enclosed)

TVT-65g Kit only (book required for assembly) - \$39.95

name: \_\_\_\_\_

address: \_\_\_\_\_

city: \_\_\_\_\_ state: \_\_\_\_\_ zip: \_\_\_\_\_

**EDIA ELECTRONICS DEPT 11-B, 1020 W. WILSHIRE BLVD., OKLAHOMA CITY, OK 73116**



meetings are at 7:30 PM on the third Wednesday of every month. For a copy of the current WAKE newsletter, send a stamped, self-addressed envelope to WAKE, c/o Ted Beach, 5112 Williamsburg Blvd, Arlington VA 22207 or phone (703) 538-2303.

---

Microcomputer  
Investors  
Association

---

The most recent issue of the MicroComputer Investors Association journal contains 200 pages with 20 articles that deal with utilizing microcomputers to make and manage investments. Practical computer programs accompany half of the articles. The Association is a nonprofit group which was formed 3 years ago to enable members to share data and information. An information packet is

available for \$1. Contact Jack Williams, MCIA, 902 Anderson Dr, Fredericksburg VA 22401.

---

Free Newsletter  
for Science and  
Technology  
Educators

---

*Hands On!* is a free newsletter published 3 times a year by the Technical Education Research Centers (TERC), 575 Technology Sq, Cambridge MA 02139. TERC is a nonprofit curriculum research and development corporation. Billed as a forum for science and technology educators, the latest issue of the newsletter contains articles such as *A Biased Introduction to the World of the 6502 Microprocessor; Toward Affordable Computers: Networking and Graphics; Microcomputers in Instru-*

*ment and Control* and much more. To be added to TERC's mailing list, contact the company at the above address.

---

Computer Club  
in Venezuela

---

The Cuatro Computer Club, Los Pinos Ave, EDF Airoso 5, La Florida, Caracas VENEZUELA, has a monthly newsletter entitled *Micronews*. The newsletter includes short programs on computer graphic art and game programs, as well as future conferences and events, and anecdotes.

---

The Delmarva  
Computer Club

---

The Delmarva Computer Club has been formed to create a community awareness of microcomputer uses for business and pleasure. The club meets at

Arcadia High School in Oak Hill VA at 7:30 PM on the first and third Wednesday of each month. Beginners are able to get hands-on programming instruction in BASIC, and advanced members work on community projects and software development and exchange. Contact Jean Trafford, POB 36, Wallops Island VA 23337.

---

Albany-  
Schenectady NY  
Microcomputer  
Society

---

Capital Area Microcomputer Society (CAMS) is a newly organized group interested in information exchange among members, solving software and hardware problems, and presentation of programs of general interest. Presently there are about 30 members and meetings are held at various locations around the Capital District on the second Wednesday of each month. Contact Stanley L Mathes, Box 348 Ridge Rd, RD#1, Scotia NY 12302, (518) 372-3767.

---

Electronotes for  
Musicians

---

*Electronotes 99* is a newsletter for knowledgeable designers, technicians and hobbyists in the music synthesizer field. There are projects, diagrams, items for sale and articles of general interest to sound engineers and designers. For more information, contact *Electronotes 99*, 1 Pheasant Ln, Ithaca NY 14850.

---

Utah Computer  
Association

---

The Utah Computer Association (UCA) meets every second Thursday of the month at 7 PM at Murray High School, 5440 S State St, Salt Lake City UT. The club also has special interest groups that meet at different times to review new products and exchange

## TRS-80® BUSINESS SOFTWARE

### Why not buy THE GENUINE ARTICLE???

The Osborne & Associates applications (Payroll with Cost Accounting, Accounts Payable & Accounts Receivable, and General Ledger) are on their way to becoming the standard applications software in the microcomputer field.

The genuine O&A software is written in CBASIC® for the CP/M® Operating System. Any other combination of language and operating system represents a reprogramming effort... for the TRS-80, Model I, several organizations have done such a reprogramming in Disk BASIC under TRSDOS. These packages have certain drawbacks such as having some features of the application removed. In addition, the fact that they are written in a source interpreter BASIC causes the comments in the source programs (if these are distributed at all) to be removed in the interest of saving space and execution time. Since CBASIC is a compiled language, comments cost nothing (in either space or execution time) in the executable version of the file—but such comments are invaluable in the later program maintenance and modification that is always required on applications software. Without having such comments, it is easy to spend many times the cost of the software on just one modification/maintenance effort. A buyer should take this into consideration when looking at the apparent cost of the package. The CBASIC source programs we sell are heavily commented to aid the programmer.

Our programs are **THE GENUINE ARTICLE**... the CBASIC source code as developed by Osborne & Associates. We furnish the buyer BOTH the TRS-80, Model I version (requires a 48K Model I with two or more disks) AND the unmodified 8" version (for later use on the TRS-80, Model II or other 8" CP/M system)... at no extra charge. By using our DOWNLOAD program, it is possible to start using the applications on the Model I, and then when the Model II is up and running at a later date, download the data files from the Model I to the Model II and keep running the same applications without disrupting your operation.

The Osborne & Associates books have been rewritten to reflect the CP/M, CBASIC versions of the applications. These books can be purchased either from your local computer store or from us directly. We can see no percentage in your buying other than **THE GENUINE ARTICLE**... which is what we sell... the Osborne & Associates source programs in CP/M and CBASIC.

CP/M Operating System.....	\$150.00
CBASIC Compiler.....	95.00
O&A Payroll w/Cost Accounting.....	250.00
O&A Accts. Rec./Accts. Payable.....	250.00
O&A General Ledger w/Cash Journal.....	250.00
O&A CBASIC books for above (each).....	15.00
DOWNLOAD program.....	95.00

TRS-80 is a registered trademark of Radio Shack, a Tandy company  
CP/M is a registered trademark of Digital Research  
CBASIC is a registered trademark of Software Systems



8041 NEWMAN AVENUE • SUITE 208 • HUNTINGTON BEACH, CALIFORNIA 92647 • (714) 848-1922

# 6809!

## MD-690 b Single Board Computer

- 1K RAM
- 10K PROM space
- Parallel keyboard input
- Memory-mapped video firmware
- Fully S-100 compatible (including 8080 type I/O)
- MONBUG II monitor included
- 2400 baud cassette interface
- 20 I/O lines
- RS-232 level shifters
- Real time clock
- DMA
- 6809

**\$299 Assembled**

**\$239 Kit**

**Please rush me the following...**  
 MicroDasys P.O. BOX 36051, LOS ANGELES, CA 90036, USA

NAME \_\_\_\_\_ Exp. Date: \_\_\_\_\_  
 COMPANY \_\_\_\_\_  CPU Card (Kit)  CPU Card (Assembled)  
 ADDRESS \_\_\_\_\_  
 CITY \_\_\_\_\_ STATE \_\_\_\_\_ ZIP \_\_\_\_\_  
Calif. residents add 6%



**BET, YOU DIDN'T KNOW!**

OAE'S new PP-2708/16 PROM Programmer is the only programmer with all these features:

- Converts a PROM memory socket to a table top programmer: No complex interfacing to wire—just plug it into a 2708 memory socket\*
- A short subroutine sends data over the address lines to program the PROM
- Programs 2 PROMS for less than the cost of a personality module. (2708s and TMS 2716s)
- Connect 2 or more in parallel — super for production programming
- Complete with DC to DC switching inverter and 10

turn cermet trimmers (for precision pulse width and amplitude alignment)

- All packaged in a handsome aluminum case

PP-2708/16 .. A & T \$325.  
 PP-2716 (Programs Intel's 2716) ..... A & T \$295.

# OAE

Oliver Advanced Engineering, Inc.  
 676 West Wilson Avenue  
 Glendale, Calif. 91203  
 (213) 240-0080

### OMNICOOMPUTER PRODUCTS

## S-100 • TRS-80 APPLE • PET ADD-ONS

### SPEECH SYNTHESIZER

Quality, intelligible natural sounding COMPUTALKER Speech Synthesizer, a proven superior product since 1976, comes complete with Load'N'Go software, user documentation and source programs.

CT-1	S-100 Bus Plug-In.....	\$495
CT-1T	TRS-80 add on w/interconnect to self contained enclosure.....	595
CT-1A	Apple add on w/interconnect to self contained enclosure.....	595
CT-1P	Pet add on w/interconnect to self contained enclosure.....	595

### FLEXIBLE DISK DRIVES

Quality single or dual headed single or multi-drive configurations. Interconnects to self contained enclosures. Load'N'Go software and cable interconnects available when required.

Flip Sided		35/40 TRACKS	Dual Sided		
40F1	Single Drive	\$400	40D1	Single Drive	\$500
40F2	Two Drives	\$700	40D2	Two Drives	\$800
40F3	Three Drives	\$990	40D3	Three Drives	\$1090

### ALL PRODUCTS

Fully Warranted—Sold Direct—Shipped Direct from Stock. Please contact us for prompt, personal, professional service.

DIAL (714)

# NO.1 OMNI

(714) 661-6664

32422 Alipaz St., San Juan Capistrano, CA 92675

## Main/Frames from \$200

- 14 Basic Models Available
- Assembled & Tested
- Power Supply: 8v@15A, ± 16v@3A
- 15 Slot Motherboard (connectors optional)
- Card cage & guides
- Fan, line cord, fuse, power & reset switches, EMI filter
- 8v@30A, ± 16v@10A option on some models



Rack mounted from \$200

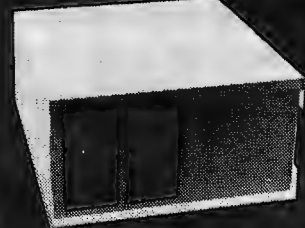

8" Floppy Main/Frame (includes power for drives and mainframe) from \$365

Write or call for our brochure which includes our application note:

# 'Building Cheap Computers' INTEGRAND

8474 Ave. 296 • Visalia, CA 93277 • (209) 733-9288  
 We accept BankAmericard/Visa and MasterCard

# New CRT SENSATION!

You have been reading about our astounding Pascal MICROENGINE™ CPU that executes Pascal 13x faster than an LSI-11 and 3x faster than a PDP-11-34. Your orders show it! That is our Model X-90.

Now meet another sensation in our X-pert Systems™ configuration. CRT Model X-920.

Trademark Western Digital Corporation

DISPLAY/EDIT TERMINAL  
Model X-920

**\$968\***

**\$856\*** (Without 18 function keys)



**STANDARD FEATURES (partial list)**

- Microprocessor controlled
- Serial RS232C and 20 ma current loop
- 10 baud rates—75 to 19,200
- 24 lines x 80 characters
- 96 ASCII displayable characters
- Upper and lower case
- 12 x 10 character resolution
- Dual intensity display
- Clear full intensity data only
- Programmable reverse video
- Programmable underline
- 105 keys with alpha lock
- 14 key numeric pad with decimal
- 16 special function keys
- 8 edit function keys
- 2 block transmission keys
- Self test mode
- Protect mode
- Block mode
- 80 storable tabbing
- Insert/delete character and line
- Scrolling
- Addressable cursor
- A host of other features, including cursor controls and remote commands such as clear to nulls, spaces, end of line, end of screen, set hulo, zero intensity, set blink, etc
- **Optional** screen print & 2nd page memory

For our system or for yours, in commercial, technical, educational or personal applications, the Computex X-920 is unmatched in its price class.

Coming soon is our Model X-8000. This high performance 16-bit CPU, using the Z-8000, addresses 8M bytes of memory directly!

All features of the Hazeltine 1400 and ADM-3A

- Plus: 128 ASCII characters, 7 x 10 matrix, Reverse video, Print key, Shiftlock, Transparent mode, Backspace Tabbing, Integrated numeric pad.



**\$799\***

List price **\$956\***

PERKIN-ELMER (Model 550)

Off the shelf delivery now on the Model X-920 and P-E Model 550. Same day shipping on all orders with certified cash payment. Specify shipping and add 40 lb cost. Any difference refunded. A \$25 connecting cable free with every CRT ordered before December 1.

Customer satisfaction is guaranteed. Full refund with the return of any product within 10 days. Service contracts available. Systems catalog \$1. Pascal MICROENGINE™ owners manual \$19.95 (postpaid).

\*LIMITED TIME cash price. 10% down guarantees priority IL residents add 5% sales tax. Master Charge and VISA accepted.

(312) 684-3183  
**COMPUTEX**  
The Computer Experts  
5710 Drexel Avenue  
Chicago, IL 60637

information on programs. Their newsletter, *Bits*, is published monthly and includes articles concerning club meetings, programs and instructions for microcomputers, advertisements, and general information for computer users. Membership in the club is \$7.50 per year which includes subscription to *UCA Bits*. For more information, contact UCA, 378 E 9800 S, Sandy UT 84070.

### Chicago Area Computer Hobbyist Exchange

The Chicago Area Computer Hobbyist Exchange (CACHE) meets at 1 PM on the third Sunday of the month at the Northern Illinois Gas Building, Golf and Shermer, Glenview IL. Annual dues are \$10 which includes the monthly newsletter, the *CACHE Register*. For further information, call the club's hotline at (312) 849-1132 or write to CACHE, POB 52, S Holland IL 60473.

### Computer Club in Tucson

The Pima Community College Computer Club has been formed at the East Side campus at 7830 E Broadway and meets the second Friday of each month at 7:30 PM. Most of the members have already purchased systems, but those still searching for the best buy are welcome, as are nonstudents. Contact Mike Blicharz (602) 749-9157 or Saul Levy (602) 793-0670.

### Institute for Computers in Jewish Life (ICJL)

The ICJL recently sponsored a conference on the use of the microprocessor in Jewish education. The conference was open to all educators interested in the application of computers in education. The *Use of Microprocessors in Jewish Education* newsletter covers programs used for teaching

## NEW, never before available! A Complete Programming Course for the 8080!

### Free Software



by Weller, Shatzel & Nice

A comprehensive text teaching 8080 assembly language programming in depth; a workbook paralleling the text with exercises and example programs to illustrate; and an editor/assembler/debugger that allows the user to gain real experience in assembly language programming on 8080/8085 or Z80 machines.

#### TEXT

**Practical Microcomputer Programming:** The Intel 8080 Over 300 pages of heavily documented programming information. #093 \$23.95

#### WORKBOOK

**Workbook for Practical Microcomputer Programming:** The Intel 8080 Study guide that parallels the text, with many worked-out examples. #228 \$9.95

#### SOFTWARE

**An Editor/Assembler System for 8080/8085 Based Computers** Will run on any 8080/8085 or Z80 machines, includes coupon for FREE object code on paper tape. 148 pp. #157 \$15.95

**All three books — A complete course!** \$49.85

### BITS carries over 200 titles of books on microcomputing, including —

**Basic BASIC, 2nd ed.** by James Coan. Contains step-by-step instructions with many illustrations and example programs for learning BASIC. 256 pp. #014 \$8.95

**PASCAL User Manual and Report, 2nd ed.** by Jensen & Wirth. Mainly tutorial, with many examples, also a concise reference for programmers. 167 pp. #088 \$7.90

**Practical Microcomputer Programming: The Z-80** by W. J. Weller. Comprehensive text on assembly language programming. Free software (editor/assembler & debug monitor) coupon included. 481 pp. #156 \$32.95

Postage \$.75/item USA, \$1.00/item foreign, to a maximum charge of \$3.00. Foreign airmail \$7.00/item.

### DIAL YOUR BANK CARD ORDERS

TOLL FREE 800-258-5477 master charge

(In N.H. dial 924-3355)



or enclose your check with this ad:

**BITS** Inc Books to erase the impossible  
POB 428, 25 Route 101 West, Peterborough NH 03458

Ask for our new, FREE Catalog



**Pascal / MT**

from

**Meta Tech**

**8080 / Z80**

- COMPILER & SYMBOLIC DEBUG!
- RUNS UNDER CP/M (& Derivatives)
- Generates Romable Machine Code
- Needs only 32K bytes
- Output is 10X faster than P-code
- Efficiently compiles a subset of Standard Pascal

Available for ALL CP/M Systems

**\$99.95**

Options include: real/business arithmetic multi tasking, interrupt procedures, etc.

Call/Write      Meta Tech  
3308 Midway Drive  
Suite 289  
San Diego, CA 92110  
[714] 223-5566 X289

Dealer Inquiries Invited

It's **sub** **LOGIC** for graphics!

**3D GRAPHIC SOFTWARE**  
for Apple II, TRS-80, 8080 and Z80, M6800, and BASIC.  
Plus **Graphic Drivers** for Dazzler, Matrox ALT-256 and 512, and Vector Graphics.

**HARDWARE**  
Matrox ALT-256 and ALT-512 S100 displays, and the new SubLOGIC 50/T80 Hi-Res for TRS-80.



We're open 9 to 6, Monday thru Friday, central time. Give us a call.

The engineering & graphics people  
(217) 359-8482

**sub** **LOGIC**  
Box V, Savoy, IL 61874

**WORD PROCESSING**  
TEXTWRITER IS THE ULTIMATE TEXT FORMATTER  
For CP/M, TRS-80, Northstar & Micropolis

- **PERSONALIZED FORMLETTERS**  
Names, addresses, etc. replaced by entries from a mail list file or from the keyboard
- **REPORTS & MANUALS**  
Table of contents & alphabetized index printed automatically
- **CONTRACTS & SPECIFICATIONS**  
Standard paragraphs or sections stored in files and inserted by name when printed
- **BOOKS & ARTICLES**  
Footnotes collected & printed at page bottom, chapters kept in separate files chained together when printed

**Ask Your Dealer For A Demonstration**

**Textwriter III \$125**

Manual alone - \$15  
Add \$2 per order for shipping  
Foreign airmail \$7.50  
\$1 extra UPS COD  
California residents add 6% sales tax

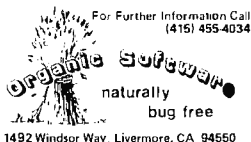

**FUN & PROFIT**

**HEAVYWEIGHT BOXING** — You match 40 contemporary or all time great boxers in computer fights. What-if bouts like Jack Johnson vs Ali or Marciano vs Larry Holmes are possible with this super enjoyable game program.  
**\$24.95** Postpaid

**STOCK MARKET** — Now you can invest in the stock market with this stock market simulation for 1 to 4 players. Buy on margin, sell short, then figures your Federal Taxes! Includes calculations for long and short term capital gains.  
**\$19.95** Postpaid

**1979 INCOME TAX** — Does 1040 schedules A, B, D, G and TC. **Specify if you have a printer when ordering this program.**  
**\$39.95** Postpaid

Send check or money order to:  
Dealer inquiries invited.

**SOFT SALES**  
**1524 UNIVERSITY AVE.**  
**ST. PAUL, MINN. 55104**

Circle 58 on inquiry card.

# DESKS AND STUFF

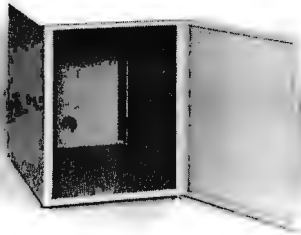
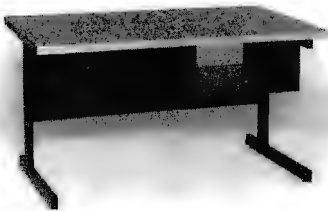

Computer terminals, business systems, lab components . . . they all need desks and enclosures. That's what we're all about. Computer Furniture and Accessories offers a standard line of furniture suitable for a wide variety of applications. Handsome, rugged, economical furniture in all shapes, sizes and colors. Basic models shipped from stock in days, not months. And we're nice people to deal with. What more could you ask for?

# CF&A

**Computer Furniture and  
Accessories, Inc.**  
1441 West 132nd Street  
Gardena, CA 90249  
(213) 327-7710

parts of the Bar Mitzvah, for determining proper times of prayer and other daily responsibilities in a Jewish home. Other courses of interest to everyone concerned with Jewish education are included. For more information, write to the ICJL, Hebrew Theological College, 7135 N Carpenter Rd, Skokie IL 60077.

---

### The Eastern Iowa Computer Club

---

This group meets on the last Sunday of each month. Their newsletter deals with the events of the meeting and future activities of the club. They have printed game programs in the report and are currently working on a software contest. The club invites inquiries from other computer groups and users. For more information, contact the Eastern Iowa Computer Club, POB 164, Hiawatha IA 52233.

---

### The Homebrew Computer Club

---

The Homebrew Computer Club, POB 626, Mountain View CA 94042, meets at the Fairchild Auditorium in the Stanford Medical Center on the third Wednesday of each month from 7 to 10 PM. The group exchanges programs, works out bugs and tries out new microcomputer systems. Their newsletter covers new products, conferences, and has a section of used computers for sale.

---

### The Popular Computing Newsletter

---

This is a newsletter for TRS-80 users. It includes programming tips, various programs for home and business, reviews of books and programs, and one edition has programs for two games and a program for add-on interest comparison. It is available from Popular Computing Inc, POB 16875, FT Lauderdale FL 33318, at \$24 for one year, \$36 for two years, and \$48 for three years. ■

# HAYDEN TESTS APPLIES AND EXCITES YOUR PROGRAMMING

**New! PROBLEMS FOR COMPUTER SOLUTION, Second Edition** (Spencer) Offers a wide selection of problems for solution for those who wish to test their programming skills. Problems include mathematical disciplines, science, business, game playing, and more. #5191-3, \$5.95

**New! BASIC COMPUTER PROGRAMS FOR THE HOME** (Sternberg) Each program is documented with a description of its functions and operation, a listing of the BASIC program, a symbol table, sample data, and one or more output samples. #5154-9, \$10.95

**New! STIMULATING SIMULATIONS, Second Edition** (Engel) contains twelve "simulations programs," which are game programs. Written in BASIC, they are original and well-documented. #5170-0, \$4.95

**1980 HAYDEN COMPUTER CALENDAR — the first and only Computer Calendar being offered anywhere!** This truly unique item includes: full-color original computer art throughout • a complete program for a perpetual calendar • computer anecdotes • only \$5.95!

**Available at your local  
computer store!**

Or Write to:

**Hayden Book Company, Inc.**  
50 Essex Street, Rochelle Park, N.J. 07662

Prices subject to change without notice

## NAVAJO RUG PATTERNS

Create Navajo rug style patterns in infinite variety on your 6800 or 680X computer's alphanumeric display or printer. Enter simple control directives to determine dimensions, borders, lines of symmetry, diagonal motifs and background. Watch as patterns with depth, sophistication and subtle beauty pour hypnotically onto your display. You control the patterns but you never cease to be amazed at the result. Easy to control yet endlessly fascinating, these patterns also have obvious commercial possibilities. Includes assembly language listings, instructions and examples. Send your check for \$19.98 to:

**Sterling Software**  
 15832 Lime Grove Road  
 Poway, Calif. 92064  
 (714) 748-1750

California residents please add 6% sales tax.



**MICAH presents**  
**OSBORNE BUSINESS SOFTWARE**  
*in CBASIC2 or CROMEMCO 16K BASIC*

**\* features \***

- Four Complete Packages---
  - General Ledger
  - Accounts Receivable
  - Accounts Payable
  - Payroll with Cost Accounting
- Strong support from Osborne Manuals
- CBASIC2 runs under CP/M or under CDOS version 1.07 on Cromemco computers
- 16K BASIC runs on Cromemco computers
- Cursor addressing routines for Hazeltine, Lear Siegler and Cromemco (Beehive) Terminals
- Source Codes and Installation Instructions provided along with disks
- Automatic Command Start-up
- Easy to apply to all of your business and systems needs

**\* hardware required \***

- One or more 8" or 5" Floppy Drives
- CRT with cursor addressing
- 132-Column Printer

**\$95 per package**

TO ORDER  
 Add \$5 for shipping  
 Call add to 1.25 Sales Tax  
 CREDIT CARD: ACCESS/PLUS  
 AT: P.S. N. RECHABLE  
 (Osborne Manual \$15 each)

• DEALER INQUIRIES INVITED

OTHER MICA H PRODUCTS OF DISTINCTION

• EXPAND (Allows CP/M to run Cromemco Software)	• CHIOS (CP/M for Cromemco Computers)	• MICROLOC (Versatile Printer Graphics)
• DUPI (Disk Utilities for CP/M and CDOS)	• DPM (Conversion to PAD)	• DRIVE (Customized Printer Drivers)
• DUPI2 (Disk Utilities for Cromemco)	• SPROUT (Cromemco Format Utility)	• BLACKACK (Tutorial Case) Action

• Call or Write for Free Catalogue and More Information •

• We will Customize any of our programs at our Standard Consulting Rates •



**Ah! MICA H... Satisfyin' Software**  
*That turns your system on!*  
 Micro Applications and Hardware  
 Box 22212  
 San Francisco, California 94122 USA  
 phone: 415/ 664-0778

• CONSULTANTS and SOFTWARE DEVELOPERS •

# NOTICE TO ALL TRS-80 USERS

VR Data regrets the pricing error in our October ad (page 274) on the TRS-80 equipment. As the industry's largest discounter of TRS-80 equipment . . . the following prices reflect our discount policy:

TRS-80 Model II	\$3208.50
• 32k RAM	
• ½ MEG Disk	
ADDITIONAL 32k RAM	\$418.50
ADDITIONAL DISK DRIVE (1st):	
	\$1069.50
ADDITIONAL DISK DRIVE (2nd, 3rd)	
	\$558.00

## ED SMITH'S SOFTWARE WORKS NEW 6809 SOFTWARE TOOLS

**CROSSMAC A 6800 TO 6809 CROSS ASSEMBLER** version of RRMAC which runs on your 6800 to produce relocatable 6809 object code from existing (6800) or new (6809) source files. Handles deleted 6800 instructions via macros. Supplied with 6809 machine language linking loader.

**M68CX ..... \$200.00**

**RRMAC RELOCATABLE RECURSIVE MACROASSEMBLER and LINKING LOADER** for 6809. The one macro assembler with real macro capabilities. Retains all features of 6800 version.

**M69RR ..... \$150.00**

**M6809 RELOCATABLE DISASSEMBLER AND SEGMENTED SOURCE TEXT GENERATOR.** An invaluable tool for modifying large object programs for reassembly on your system.

**M69RS ..... \$50.00**

**M6809 RELOCATING ASSEMBLER and LINKING LOADER** is a version of RRMAC without its macro capabilities. Retains all of RRMAC's programmer convenience features.

**M69AS ..... \$75.00**

All programs come complete with Programmer's Guide and extensively commented assembly listing. Available on cassette or mini-floppy. Specify cassette, SSB disk, mini-Flex disk or FLEX 2.0 disk. Order directly by check or MC/Visa. California residents add 6% sales tax. Customers outside of U.S. or Canada add \$5 for air postage & handling.

Dealer inquiries welcome. FLEX is a trademark of TSC

**Ed Smith's SOFTWARE WORKS**  
 P.O. Box 339, Redondo Beach, CA 90277, (213) 373-3350



# Heuristics

SpeechLink™

# 2000

## Talk To Your Computer . . .

- Voice data entry to the Apple® computer
- Voice control of your Apple® system
- User variable vocabulary (64 words and up)
- Applesoft & Integer Basic compatible with or without disk operating system

## Useful For . . .

- Collecting inventory data
- Running the Apple® as a terminal
- Controlling production test equipment (say "test 2")
- Menu selection of programs (say "stocks")
- Entering stock market data
- Educational programs for the kids (say "square")

See your computer dealer.  
 Model 2000 suggested retail price  
 \$259, model 20A \$189.

**Heuristics**  
INC

1285 HAMMERWOOD AVENUE  
 SUNNYVALE, CALIFORNIA 94086  
 408/734-8532

Apple® is a registered trademark of Apple Computer Corporation

# DeskTop Wonders

## Extended Multiplication with the TI-58

Michael E Manwaring, 3608 73rd Ave N,  
 Minneapolis MN 55429

Most calculators have 8 to 10 digits of display. A few have as many as 14 digits. For most applications, we have very little interest in any more than 8 significant digits; there are, however, a few fields, such as cryptology, in which someone might want many more digits of answer. The Number Cruncher is a mathematical program that will enable the user to multiply two numbers with a total of up to 90 digits, using a TI-58. The TI-59 can handle a total of 300 digits using this program.

After entering the program (see listing 1), press E. Subroutine E clears the memories, sets the program pointers, and repartitions the memory space to give the

Listing 1: TI-58 program for multiplying two numbers with an answer totaling up to 90 digits long.

```

TI 58
NUMBER PUNCHING 017 11 A 048 13 C
018 72 ST+ 049 97 DSC
019 01 01 050 06 06
LABEL LIST 020 69 DP 051 01 01
021 21 21 052 31 31
022 69 DP 053 73 RC+
023 22 22 054 05 05
024 92 RTN 055 65 *
025 76 LBL 056 73 RC+
026 12 B 057 03 03
027 72 ST+ 058 54 )
028 01 01 059 74 SM+
PROGRAM LIST 029 97 DSC 060 01 01
030 00 00 061 73 RC+
031 00 00 062 01 01
032 38 38 063 69 DP
033 69 DP 064 33 33
034 21 21 065 55 +
035 69 DP 066 01 1
036 24 24 067 52 EE
037 92 RTN 068 06 6
038 43 RCL 069 54 )
039 01 01 070 59 INT
040 42 STD 071 69 DP
041 03 03 072 21 21
042 69 DP 073 74 SM+
043 33 33 074 01 01
044 61 GTD 075 65 *
045 00 00 076 01 1
046 33 33 077 52 EE
047 76 LBL 078 06 6
    
```

Listing continued on opposite page

Listing 1 continued:

079	22	INV	104	29	29	129	61	GTO
080	52	EE	105	43	RCL	130	14	D
081	54	)	106	09	09	131	43	RCL
082	69	DP	107	42	STO	132	02	02
083	31	31	108	01	01	133	42	STO
084	22	INV	109	97	DSZ	134	07	07
085	74	SM*	110	04	04	135	43	RCL
086	01	01	111	00	00	136	04	04
087	69	DP	112	49	49	137	42	STO
088	21	21	113	43	RCL	138	00	00
089	97	DSZ	114	02	02	139	43	RCL
090	07	07	115	75	-	140	01	01
091	00	00	116	01	1	141	42	STO
092	49	49	117	54	)	142	05	05
093	69	DP	118	44	SUM	143	42	STO
094	35	35	119	01	01	144	09	09
095	43	RCL	120	92	RTN	145	69	DP
096	02	02	121	76	LBL	146	35	35
097	42	STO	122	14	D	147	43	RCL
098	07	07	123	73	RC*	148	03	03
099	43	RCL	124	01	01	149	42	STO
100	08	08	125	99	PRT	150	08	08
101	42	STO	126	69	DP	151	61	GTO
102	03	03	127	31	31	152	00	00
103	69	DP	128	91	R/S	153	53	53
						154	00	0
						155	00	0

greatest possible capacity. The partition will be displayed. Now you can enter the multiplications, 6 digits at a time, pressing **A** after each 6 digits of the first multiplicand, reading from left to right.

Each multiplicand is divided into groups of 6 digits from right to left, then the numbers are entered from left to right. If the number of digits in a multiplicand is not exactly divisible by 6, the first group of digits of that multiplicand will have less than 6 digits. When the first multiplicand has been entered, the second multiplicand may be entered in the same manner by pressing **B** after each group of 6 digits.

For example, 6,853,233,214,307,635,533,673. × 5,822,756,618,783,644,505,626,130. must be entered in the following manner:

6853	A
233214	A
307635	A
533673	A
5	B
822756	B
618783	B
644505	B
626130	B

When the multiplicands have been entered, press **C** to calculate the result and enter it into computer memory. It may take 5 seconds for each 6 digits of the multiplicands entered to perform this step. When the calculation is completed, a meaningless number is displayed. The result can be extracted from memory by pressing **D** several times. Pressing **D** causes the result to be read from left to

right. In this case, the result is on the order of  $4 \times 10^{46}$ , so it will be necessary to press **D** 8 times to recall the entire result. If **D** is pressed one too many times, the last entered group of digits from the second multiplicand will be displayed. Each time **D** is pressed 6 more digits of the result are displayed.

D	0
D	39904
D	709058
D	677695
D	645793
D	103475
D	894028
D	753563
D	675490

It appears at first that the TI-58 uses the 10-digit display value in its calculations. In reality, all calculations are done using a 13-digit internal register or accumulator which allows it to multiply two 6-digit numbers and retain all eleven or twelve digits.

The algorithm used in this program is very similar to the old method of pencil and paper multiplication, where you multiplied one digit of one multiplicand by one digit of the other multiplicand at a time, carrying the tens digit to be added to the next multiplication. The main difference is that instead of multiplying and carrying one digit at a time, the computer does 6 digits at a time, greatly speeding up the calculation. ■

## Calculator Airborne Navigation

### The HP-25 Finds Ground Speed and True Heading

---

L J Kuhns  
801 Hastings Dr  
Kissimmee FL 32741

---

The program in listing 1 calculates the ground speed and true heading for all quadrants when the true course, wind direction, air speed, and wind speed are known.

The addition of 0.1 degrees to the wind direction eliminates any problems with head and tail winds (which otherwise result in division by zero) without any major effect on the answer.

Storage of 180 degrees and 360 degrees facilitates taking care of the different quadrants for making drift corrections.

**GTC HAS IT!**



**TEXAS INSTRUMENTS TI-99/4**

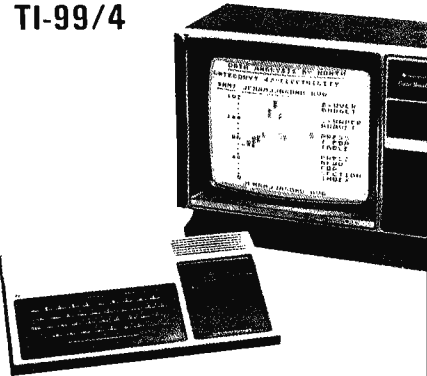

**Home Computer**

- 26 K ROM extended TI BASIC.
- 16 color graphics, and music and sound effects.
- High quality 13" color monitor.
- 16 K RAM user memory.

**CTC'S DISCOUNT PRICE FOR THE COMPLETE SYSTEM; CONSOLE & 13" COLOR MONITOR**

**\$1099**

Order now. Subject to availability by manufacturer.  
Price subject to change without notice.  
Returns guaranteed prior to delivery.



**The Computer People**

San Diego's largest Discount Computer & Calculator Store. 5560 Ruffin Road. San Diego. CA 92123

Please ship me the following merchandise.

**TI HOME COMPUTER PRODUCTS**

PHC004M	TI-99/4 Home Computer	\$1099.00	\$ _____
PHA2000	Dual Cassette Cable	6.95	\$ _____
PHP1100	Remote Controls (Pair)	29.95	\$ _____
PHP1500	Speech Synthesizer	149.95	\$ _____

**COMMAND MODULES**

PHM3000	Diagnostic	29.95	\$ _____
PHM3001	Demonstration	69.95	\$ _____
PHM3002	Early Learning Fun	29.95	\$ _____
PHM3003	Beginning Grammar	29.95	\$ _____
PHM3004	Number Magic	19.95	\$ _____
PHM3005	Video-Graphs	19.95	\$ _____
PHM3006	Home Financial Decisions	29.95	\$ _____
PHM3007	Household Budget Management	44.95	\$ _____
PHM3008	Video Chess	69.95	\$ _____
PHM3009	Video Chess	29.95	\$ _____
PHM3010	Physical Fitness	29.95	\$ _____

**Special Prices on Calculators, Micro Computers, Accessories**

TI-Programmer Calculator	49.95	\$ _____
HP-41C Programmable Calculator	249.95	\$ _____
HP-41C Card Reader	159.95	\$ _____
HP-41C Printer	319.95	\$ _____
HP-41C Memory Module	39.95	\$ _____
SDROC 10-120	849.	\$ _____
Hazeltine 1400	695.	\$ _____
IMSAI VDP-42/32K	4,695.	\$ _____
IMSAI PCS-44/32K	3,695.	\$ _____
IMSAI I-8080	931	\$ _____
IMSAI I-8080 Kit	699.	\$ _____
IMSAI IKB-1 Intelligent Keyboard	275.	\$ _____
Cromemco Z-2H Computer System with 64 K, Dual Floppy, 10MB Hard Disk	8,995.	\$ _____

TOTAL \$ \_\_\_\_\_  
Shipping, add 3% \$ \_\_\_\_\_  
Cal. residents add 6% tax \$ \_\_\_\_\_  
Amount enclosed \$ \_\_\_\_\_  
(check or money order)

Charge to my  VISA  MASTER CHARGE  
Acct # \_\_\_\_\_ Bank # \_\_\_\_\_ Exp. Date \_\_\_\_\_

Signature: \_\_\_\_\_  
(Required if using credit card)

Name \_\_\_\_\_  
Street or P.O. \_\_\_\_\_  
City \_\_\_\_\_ State \_\_\_\_\_ Zip \_\_\_\_\_

**NAVIGATION - CALCULATES GROUND SPEED AND TRUE HEADING FOR ALL QUADRANTS**

DISPLAY		KEY ENTRY	COMMENTS	REGISTERS
LINE	CODE			
00			0.1° ADDED TO	R <sub>0</sub> TRUE COURSE (DEGREES)
01	2401	RCL 1	WIND DIRECTION	
02	2400	RCL 0	TAKES CARE OF	
03	41	—	TAIL AND HEAD	R <sub>1</sub> WIND DIRECTION + 0.1°(DEGREES)
04	2407	RCL 7	WINDS	
05	41	—		R <sub>2</sub> AIR SPEED MILES/HR.
06	2304	STO 4		
07	2407	RCL 7		R <sub>3</sub> WIND SPEED MILES/HR.
08	51	+		
09	1551	8 ≥ 0		R <sub>4</sub> AIR SPEED θ
10	1313	GTO 13		
11	1312	GTO 12		R <sub>5</sub> WIND SPEED θ
12	2304	STO 4		
13	2404	RCL 4		R <sub>6</sub> 180°
14	1541	8 × < 0		
15	1320	GTO 20		R <sub>7</sub> 360°
16	09	9		
17	00	0		
18	51	+		
19	2304	STO 4		
20	1404	f SIN		
21	2403	RCL 3		
22	61	×		
23	2402	RCL 2		
24	71	÷		
25	1504	8 SIN <sup>-1</sup>		
26	2305	STO 5		
27	2404	RCL 4		
28	2406	RCL 6		
29	51	+		
30	1551	8 ≥ 0		
31	32	CHS		
32	2405	RCL 5		
33	1551	8 ≥ 0		
34	32	CHS		
35	51	+		
36	2406	RCL 6		
37	51	+		
38	1404	f SIN		
39	2403	RCL 3		
40	61	×		
41	2405	RCL 5		
42	1404	f SIN		
43	71	÷		
44	1541	8 × < 0		
45	32	CHS		
46	74	RS	GROUND SPEED	
47	2400	RCL 0		
48	2405	RCL 5		
49	51	+	TRUE HEADING ■	



# CIRCUIT BREAKER PRICE SLASHING

## 16K MEMORY UPGRADE KITS

- 300 NS for TRS-80\* \$69.00
- 250 NS for TRS-80\*, Apple II, Sorcerer (specify) \$75.00
- 200 NS for TRS-80\*, Apple II, Sorcerer (specify) \$85.00

All kits complete with jumpers and instructions.  
90 DAY WARRANTY

## LETTER QUALITY HIGH SPEED PRINTER

NEC Spinwriter  
\$2679.00

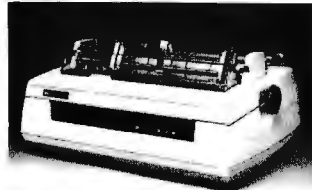

Includes TRS-80\* interface software, quick change print fonts, 55 cps, bidirectional, high resolution plotting, graphing, proportional spacing. 90 DAY WARRANTY.

## DISK OPERATING SYSTEMS

Radio Shack DOS 2.2—No key bounce \$14.95

NEWDOS by Apparat†—No key bounce \$49.95

Enhancements to DOS 2.1, enhanced RENUM, BASIC variables and constants locator, enable/disable passwords, automatic validity check for disk write, load and save up to 30% faster, diskette space allocated in 1-granule increments instead of 2, BASIC open "E" allows additions to sequential files, "JKL" option outputs screen display to printer, DOS commands executable from BASIC, one-step entry to BASIC from DOS. LIST, EDIT, and DELETE abbreviations. BASIC scrolling.

NEWDOS "PLUS" by Apparat† \$99.95

NEWDOS plus the following functions: enhanced DIRCHECK command, improved EDITOR, ASSEMBLER, DISASSEMBLER. SUPERZAP. Machine language RELOCATOR, LEVEL I on disk.

DOS 3.0 by the original author of 2.1 \$49.95

No key bounce. Check EOF, write EOF, SEEK, REREAD, REWRITE, LOC, variable length records, SKIP, disk logging of messages, BOOT, CHAIN, PAUSE, PURGE, SET, RESET, ROUTE. RUN and LOAD for 1 drive system. XFER, FORMAT w/o ERASE. DIR from BASIC, PATCH, LINK, user defined keys, key auto repeat, upper and lower case driver, shift lock, RS-232 drivers, MULTI PROTOCOL COMMUNICATIONS.

## TRS-80\* COMPATIBLE HARDWARE

### DISK DRIVES

More capacity than Radio Shack 35 track (80K Bytes) drives. Fully assembled and tested. Ready to plug-in and run the moment you receive it. Can be intermixed with each other and Radio Shack drive on same cable. TRS-80\* compatible silver enclosure. 90 DAY WARRANTY.

CCI-100 40 Track (102K Bytes)	\$324.00
CCI-200 77 Track (197K Bytes)	\$594.00
2 Drive Cable	\$25.00
4 Drive Cable	\$35.00

### PRINTERS

779 CENTRONICS TRACTOR FEED PRINTER \$1050.00  
Same as Radio Shack line printer

701 CENTRONICS TRACTOR FEED PRINTER \$1499.00  
2½ times faster than line printer, full 132 characters, carriage bell tone.

P1 CENTRONICS PRINTER \$349.00  
Same as Radio Shack quick printer.

CENTRONICS CABLE for TRS-80\* \$39.00  
For use with above printers.

PAPER TIGER (IP440) Up to 198 cps \$ 994.00  
With 2K Buffer and Graphics \$1189.00

HILOT DIGITAL PLOTTER by Houston Instrument \$ 995.00  
X-Y Plotter, RS-232-C or Parallel Interface.  
7" x 10" plot size. Multi-colored pens included.

## TRS-80\* COMPLETE SYSTEMS

TRS-80* LEVEL II-4K	reg. \$540.00	\$494.00
TRS-80* LEVEL II-16K with 10 key keypad	reg. \$799.00	\$764.00
TRS-80* Expansion Interface		\$254.00
TRS-80* RS-232-C Interface		\$84.00

### MISCELLANEOUS

TRS-232 by SMALL SYSTEMS SOFTWARE RS-232-C or Teletype Current Loop output from cassette port. \$49.00

CAT MODEM \$169.00

Originate and answer same as Radio Shack Telephone Interface II.

## DISKETTE TRS-80\* BUSINESS SOFTWARE BY SBSG

Free enhancements and upgrades to registered owners for the cost of media and mailing. 30 day free telephone support from vendor. User references supplied upon request.

**Fully Interactive Accounting Package:** Requires 2,3, or 4 drives. Includes General Ledger, Accounts Payable, Accounts Receivable, and Payroll. Report generating. Well documented and fully tested by accountants.

Complete package (Requires 3 or 4 drives)	\$389.00
Individual Modules (Require 2 or 3 drives)	\$99.00

**Inventory II:** Requires 2 or 3 drives. Handles up to 1000 items per disk drive. Reports include complete activity, inventory, listing, and minimum quantity search. \$95.00

**Mailing List Name & Address II System:** Requires 2 drives. Use with Electric Pencil files for automatic insertion of name, address and greetings in letters. Has ability to print envelopes. Menu driven. Includes enter, delete, update, search, extract, merge and print. Up to 1250 names per diskette. Will sort up to 600 names in 7 minutes. 40 page manual. Zip code sort is excellent for bulk mail applications. \$129.00

**Intelligent Terminal System ST-80 III:** Enables a TRS-80\* to act as a dial-up terminal on any standard time sharing network. Provides a TRS-80\* with control key, ESC Key, Repeat Key, Rub Out Key, Break Key, full upper and lower case support, selectable printer output and program selectable transmission rates. \$150.00

Note: SBSG maintains a time-sharing computer where you can dial-up and leave your problems, 24 hours, 7 days a week.

**Word Processing System:** The Electric Pencil from Michael Shrayer.  
Diskette \$150.00  
Cassette \$99.00

**File Management System:** For specialized storage needs. Sorts files in ascending or descending order on 3 separate fields. Scannable. Some applications have been fixed assets, phone numbers, names, slides, albums. Selectively totals numeric and dollar fields. Display and print capability. \$49.00

**MMSFORTH System Diskette:** A complete professional FORTH system. Requires 16K TRS-80\* and 1 drive. \$45.00  
Book on FORTH. Contains documentation. \$15.00

# The CPU SHOP

TO ORDER CALL TOLL FREE 1-800-343-6522

Massachusetts residents call 617/242-3350

For detailed technical information, call 617/242-3350

Hours: 10 AM - 6 PM (EST) Monday - Saturday

\*TRS-80 is a Tandy Corporation Trademark † Requires Radio Shack TRSDOS\*

39 Pleasant Street, Dept. B-11  
Charlestown, Massachusetts 02129

Freight collect, F.O.B.  
Charlestown

Massachusetts residents add  
5% sales tax

Dealer Inquiries Invited





# What's New?

## FUN and GAMES

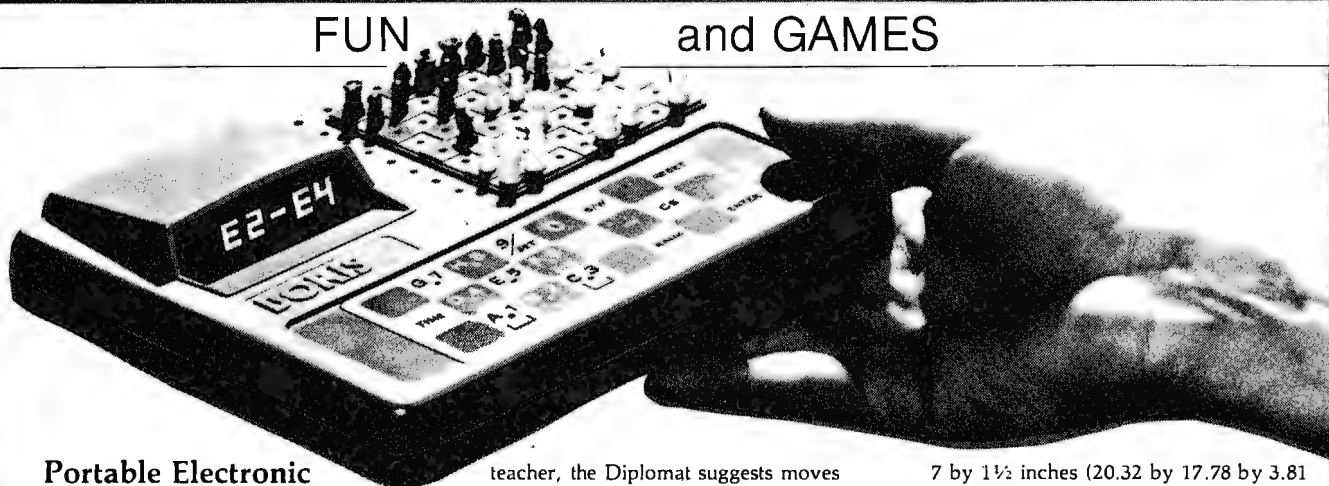

### Portable Electronic Chess Game

The Boris Diplomat is a compact, portable, battery-operated electronic chess computer. Designed with various operational strengths, the Diplomat will play at a level that will teach a child or will keep the attention of a master. As a

teacher, the Diplomat suggests moves for the unsure beginner. The Position Programmer allows more advanced players to set up special board positions to practice specific strategies. Beginners use the Position Programmer to remove pieces for handicapping or for practice of specific positions. The Diplomat has a built-in chess board with pieces, is 8 by

7 by 1½ inches (20.32 by 17.78 by 3.81 cm), and operates several hours on six AA battery cells or on the AC adapter which is included.

The price of the Boris Diplomat is \$119.95. For further information, contact Chafitz Inc, 1055 First St, Rockville MD 20850.

Circle 624 on inquiry card.

### Programmable High-Performance Toy Vehicle

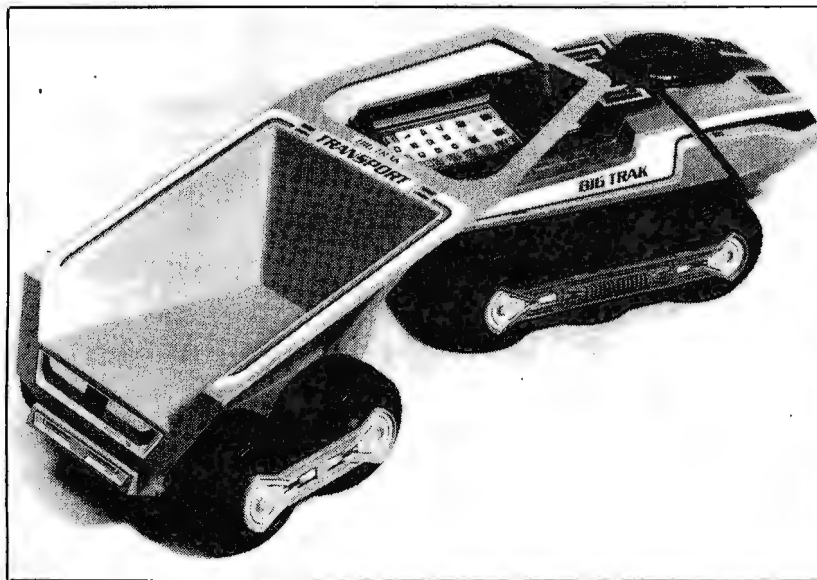

Milton Bradley's Big Trak is a toy vehicle which is programmed to follow an extremely complex route. Big Trak advances for as many as 99 units, each unit being the measure of its own 13-inch length. By pushing the Repeat button, it travels twice as far. It gives the same performance in reverse. The vehicle pivots either right or left in a full circle or more. It also pivots in tiny fractions of a circle, for Big Trak possesses 60 swiveling positions. It can make a turn, proceed in a straight line,

turn again, and continue traveling on whatever course has been set.

Big Trak has a total of 16 programming steps which direct its functions. By estimating the distances and punching in commands, the user may send it around tables, chairs, and other obstacles, and have it return. The user may input a command which will call up its arsenal of weaponry, firing a single shot, or short or long bursts of sound and light laser-cannon fire. It may be strategically deployed, firing at some target as it

### Voice Controlled Toy Van

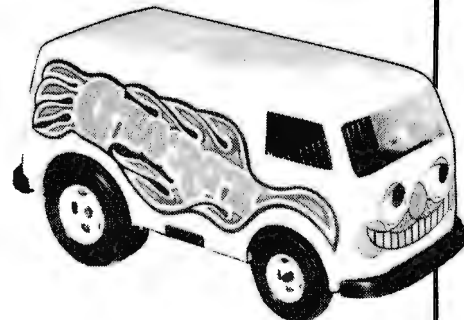

George, the toy van controlled by voice, is available from Beneficial Marketing, Suite 1920, Wall St Plz, New York NY 10005. George will go where you tell him only to the extent that you control him with your voice. The number of words used, the length of the words, and the combination of words are all controls. George is priced at \$24.95.

Circle 625 on inquiry card.

maneuvers, or lurk silently in ambush.

Big Trak has a companion item called Big Trak Transport. The Transport attaches to Big Trak and hauls and dumps loads on a preprogrammed command. The approximate retail price of Big Trak is \$43 and the Big Trak Transport is priced at \$13. For further information, contact Milton Bradley Co, Springfield MA 01101.

Circle 626 on inquiry card.

### COMPUCRUISE

Put a computer in your car, which gives you the most effective and functional cruise control ever designed, plus complete trip computing, fuel management systems, and a remarkable accurate quartz crystal time system.

So simple a child can operate, the new CompuCruise combines latest computer technology with state-of-the-art reliability in a package which will not likely be available on new cars for years to come. • Cruise Control • Time, E.T., Lap Timer, Alarm • Time, Distance, Fuel to Arrival • Time, Distance, Fuel to Empty • Time, Distance and Fuel on Trip • Current or Average MPG, GPH • Fuel Used, Distance since Fillup • Current and Average-Vehicle Speed • Inside, Outside or Coolant Temperature • Battery Voltage • English or Metric Display. \$199.95



### FLOPPY DISK STORAGE BINDER

This black vinyl three-ring binder comes with ten transparent plastic sleeves which accommodate either twenty, five-inch or ten, eight-inch floppy disks. The plastic sleeves may be ordered separately and added as needed. A contents file is included with each sleeve for easy identification and organizing. Binder & 10 holders \$14.95 Part No. B800; Extra holders 95¢ each. Part No. 800

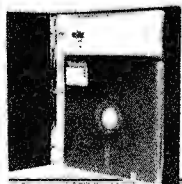

### OPTO-ISOLATED PARALLEL INPUT BOARD FOR APPLE II

There are 8 inputs that can be driven from TTL logic or any 5 volt source. The circuit board can be plugged into any of the 8 sockets of your Apple II. It has a 16 pin socket for standard dip ribbon cable connection. Board only \$15.00. Part No. 120, with parts \$69.95. Part No. 120A.

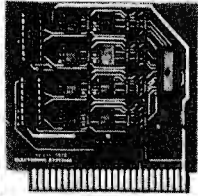

### TIDMA

• Tape Interface Direct Memory Access • Record and play programs without bootstrap loader (no prom) has FSK encoder/decoder for direct connections to low cost recorder at 1200 baud rate, and direct connections for inputs and outputs to a digital recorder at any baud rate • S-100 bus compatible • Board only \$35.00 Part No. 112, with parts \$110 Part No. 112A



### SYSTEM MONITOR

8080, 8085, or Z-80 System monitor for use with the TIDMA board. There is no need for the front panel. Complete with documentation \$12.95.

### 16K EPROM

Uses 2708 EPROMS, memory speed selection provided, addressable anywhere in 65K of memory, can be shadowed in 4K increments. Board only \$24.95 part no. 7902, with parts less EPROMs \$49.95 part no. 7902A.

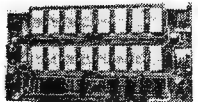

### ASCII KEYBOARD

TTL & DTL compatible • Full 67 key array • Full 128 character ASCII output • Positive logic with outputs resting low • Data Strobe • Five user-definable spare keys • Standard 22 pin dual card edge connector • Requires +5VDC, 325 mA. Assembled & Tested. Cherry Pro Part No. P70-05AB. \$135.00.

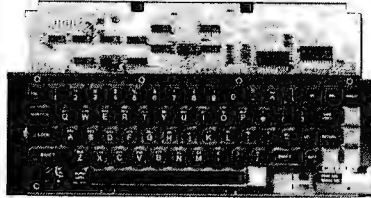

### ASCII KEYBOARD

53 Keys popular ASR-33 format • Rugged G-10 P.C. Board • Tri-mode MOS encoding • Two-Key Rollover • MOS/DTL/TTL Compatible • Upper Case layout • Data and Strobe inversion option • Three User Definable Keys • Low contact bounce • Selectable Parity • Custom Keycaps • George Risk Model 753. Requires +5, -12 volts. \$59.95 Kit.

### ASCII TO CORRESPONDENCE CODE CONVERTER

This bidirectional board is a direct replacement for the board inside the Trendata 1000 terminal. The on board connector provides RS-232 serial in and out. Sold only as an assembled and tested unit for \$229.95. Part No. TA 1000C

### DISK JACKET™

Made from heavy duty .0095 matte plastic with reinforced grommets. The mini-diskette version holds two 5-1/4 inch diskettes and will fit any standard three ring binder. The pockets to the left of the diskette can be used for listing the contents of the disk. Please order only in multiples of ten. \$9.95/10 Pack.

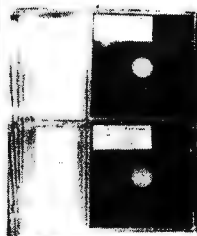

### VIDEO TERMINAL

16 lines, 64 columns • Upper and lower case • 5x7 dot matrix • RS-232 in • RS-232 out with TTL parallel keyboard input • On board baud rate generator 75, 110, 150, 300, 600, & 1200 jumper selectable • Memory 1024 characters (7-21L02) • Video processor chip SFF96364 by Neculonic • Control characters (CR, LF, →, ←, ↑, ↓, non destructive cursor, CS, home, CL • White characters on black background or vice-versa • With the addition of a keyboard, video monitor or TV set with TV interface (part no. 107A) and power supply this is a complete stand alone terminal • also S-100 compatible • requires +16, & -16 VDC at 100mA, and 8VDC at 1A. Part no. 1000A \$199.95 kit.

### INTERNATIONAL MICROPROCESSOR DICTIONARY

English, French, Danish, German, Italian, Hungarian, Norwegian, Polish, Spanish, Swedish. 10 languages, 28 pp. SYBEX. Ref. IMD. \$4.95



### RS-232/20mA INTERFACE

This board has two passive, opto-isolated circuits. One converts RS-232 to 20mA, the other converts 20mA to RS-232. All connections go to a 10 pin edge connector. Requires +12 and -12 volts. Board only \$9.95. Part no. 7901, with parts \$14.95 Part No. 7901A.



### COMPUCOLOR II

Model 3, 8K \$13.95, Model 4, 16K \$15.95, Model 5, 32K \$18.95. Prices include color monitor, computer, and one disk drive.



### PET COMPUTER

With 32K & monitor - \$1195, Dual Disk Drive - \$1195.



### Apple II

### OR APPLE II PLUS

16K - \$995, 32K - \$1059, 48K - \$1123. Disk & cont. \$599



### 6502 APPLICATIONS BOOK Z80 APPLICATIONS BOOK

This book will teach you how to connect a board to the outside world and implement practical applications for the 6502, (or Z80). Applications range from home control (a complete alarm system, including heat sensor), to industrial applications. You will learn techniques ranging from simulated traffic control to analog-digital conversion. All experiments can be realized with a minimum of external (low-cost) components. They are directly applicable to any 6502-based board such as SYM, KIM, AIM 65. This book also studies in detail input-output techniques and components, and is the logical continuation of C202 (or C280). By Rodney Zaks. SYBEX. 6502: Ref. D302; Z80: Ref. D380. Each \$12.95

### T.V. INTERFACE

• Converts video to AM modulated RF. Channels 2 or 3. So powerful almost no tuning is required. On board regulated power supply makes this extremely stable. Rated very highly in Doctor Dobbs' Journal. Recommended by Apple • Power required is 12 volts AC C.T., or 5 volts DC • Board only \$7.60 part No. 107, with parts \$13.50 Part No. 107A

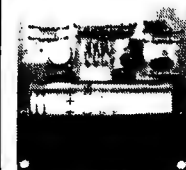

### PARALLEL TRIAC OUTPUT BOARD FOR APPLE II

This board has 8 triacs capable of switching 110 volt 6 amp loads (660 watts per channel) or a total of 5280 watts. Board only \$15.00 Part No. 210, with parts \$119.95 Part No. 210A.

**To Order:** Mention part no., description, and price. In USA shipping paid by us for orders accompanied by check or money order. We accept C.O.D. orders in the U.S. only, or a VISA or Master Charge no., expiration date, signature, phone no., shipping charges will be added. CA residents add 6.5% for tax. Outside USA add 10% for air mail postage and handling. Payment must be in U.S. dollars. Dealer inquiries invited. 24 hour order line (408) 448-0800



Send for FREE Catalog... a big self-addressed envelope with 41¢ postage gets it fastest!

**ELECTRONIC SYSTEMS** Dept. B, P. O. Box 21638, San Jose, CA USA 95151



## TRS-80 E.S. SERIAL I/O

- Can input into basic
- Can use LLIST and LPRINT to output, or output continuously
- RS-232 compatible
- Can be used with or without the expansion bus
- On board switch selectable baud rates of 110, 150, 300, 600, 1200, 2400, parity or no parity odd or even, 5 to 8 data bits, and 1 or 2 stop bits. D.T.R. line
- Requires +5, -12 VDC
- Board only \$19.95 Part No. 8010, with parts \$59.95 Part No. 8010A, assembled \$79.95 Part No. 8010C. No connectors provided, see below.

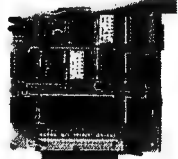

EIA/RS-232 connector Part No. D825P \$6.00 with 9', 8 conductor cable \$10.95 Part No. D825P9

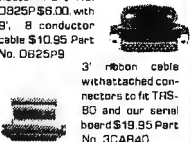

3' ribbon cable with attached connectors to fit TRS-80 and our serial board \$19.95 Part No. 3CBA40.

## MODEM

- Type 103
- Full or half duplex
- Works up to 300 baud
- Originate or Answer
- No coils, only low cost components
- TTL input and output
- Connect B & speaker and crystal mic. directly to board
- Uses XR FSK demodulator
- Requires +5 volts
- Board only \$7.60 Part No. 109, with parts \$27.50 Part No. 109A



## DISKETTES



Box of 10, 5" \$29.95, 8" \$39.95. Plastic box, holds 10 diskettes, 5" - \$4.50, 8" - \$6.50.

## APPLE II\* SERIAL I/O INTERFACE



Baud rate is continuously adjustable from 0 to 30,000

- Plugs into any peripheral connector
- Low current drain. RS-232 input and output
- On board switch selectable 5 to 8 data bits, 1 or 2 stop bits, and parity or no parity either odd or even
- Jumper selectable address
- SOFTWARE
- Input and Output routine from monitor or BASIC to teletype or other serial printer
- Program for using an Apple II for a video or an intelligent terminal.
- Also can output in correspondence code to interface with some electrics.
- Also watches OTR
- Board only \$15.00 Part No. 2, with parts \$42.00 Part No. 2A, assembled \$62.00 Part No. 2C

## 8K EPROM PIGEON

Saves programs on PROM permanently (until erased via UV light) up to 8K bytes. Programs may be directly run from the program saver such as fixed routines or assemblers.

- S-100 bus compatible
- Room for 8K bytes of EPROM non-volatile memory (2708's).
- On-board PROM programming
- Address relocation of each 4K of memory to any 4K boundary within 64K
- Power on jump and reset jump option for "turnkey" systems and computers without a front panel
- Program saver software available
- Solder mask both sides
- Full silkscreen for easy assembly.
- Program saver software in 1 2708 EPROM \$25. Bare board \$35 including custom coil, board with parts but no EPROMS \$139, with 4 EPROMS \$179, with 8 EPROMS \$219.

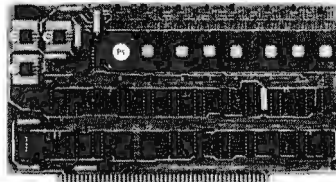

## WAMECO PRODUCTS WITH

### ELECTRONIC SYSTEMS PARTS

**FDC-1** FLOPPY CONTROLLER BOARD will drive shugart, pertek, remex 5" & 8" drives up to 8 drives, on board PROM with power boot up, will operate with CPM (not included). PCBD ..... \$42.95

**FPB-1** Front Panel. (Finally) IMSAI size hex displays Byte or instruction single step. PCBD ..... \$42.95

**MEM-1A** BKx8 fully buffered, S-100, uses 2102 type RAMS. PCBD ..... \$24.95, \$168 Kit

**GMB-12** MOTHER BOARD, 13 slot, terminated, S-100 board only ..... \$34.95 \$89.95 Kit

**CPU-1** 8080A Processor board S-100 with B level vector interrupt PCBD ..... \$25.95 \$89.95 Kit

**RTC-1** Realtime clock board. Two independent interrupts. Software programmable. PCBD ..... \$25.95, \$60.95 Kit

**EPM-1** 1702A 4K EPROM card PCBD ..... \$25.95 \$49.95 with parts less EPROMS

**EPM-2** 2708/2716 16K/32K EPROM card PCBD ..... \$24.95 \$49.95 with parts less EPROMS

**GMB-9** MOTHER BOARD. Short Version of GMB-12. 9 Slots PCBD ..... \$30.95 \$67.95 Kit

**MEM-2** 16Kx8 Fully Buffered 2114 Board PCBD ..... \$25.95, \$269.95 Kit

## T.V. TYPEWRITER

- Stand alone TVT
- 32 char/line, 16 lines, modifications for 64 char/line included
- Parallel ASCII (TTL) input
- Video output
- 1K on board memory
- Output for computer controlled cursor
- Auto scroll
- Non-destructive cursor
- Cursor inputs: up, down, left, right, home, EOL, EOS
- Scroll up, down
- Requires +5 volts at 1.5 amps, and -12 volts at 30 mA
- All 7400, TTL chips
- Char. gen. 2513
- Upper case only
- Board only \$39.00 Part No. 106, with parts \$145.00 Part No. 106A

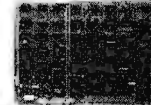

## TAPE INTERFACE

- Play and record Kansas City Standard tapes
- Converts a low cost tape recorder to a digital recorder
- Works up to 1200 baud
- Digital in and out are TTL
- Output of board connects to mic. in of recorder
- Earphone of recorder connects to input on board
- No coils
- Requires +5 volts, low power drain
- Board only \$7.60 Part No. 111, with parts \$27.50 Part No. 111A



## UART & BAUD RATE GENERATOR

- Converts serial to parallel and parallel to serial
- Low cost on board baud rate generator
- Baud rates: 110, 150, 300, 600, 1200, and 2400
- Low power drain +5 volts and -12 volts required
- TTL compatible
- All characters contain a start bit, 5 to 8 data bits, 1 or 2 stop bits, and either odd or even parity.
- All connections go to a 44 pin gold plated edge connector
- Board only \$12.00 Part No. 101, with parts \$35.00 Part No. 101A, 44 pin edge connector \$4.00 Part No. 44P

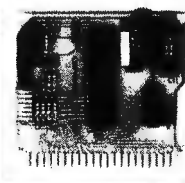

## HEX ENCODED KEYBOARD

E.S. This HEX keyboard has 19 keys, 16 encoded with 3 user definable. The encoded TTL outputs, B-4-2-1 and STROBE are debounced and available in true and complement form. Four onboard LEOs indicate the HEX code generated for each key depression. The board requires a single +5 volt supply. Board only \$15.00 Part No. HEX-3, with parts \$49.95 Part No. HEX-3A, 44 pin edge connector \$4.00 Part No. 44P.

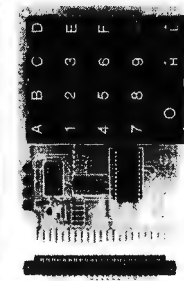

## RS-232/ TTL INTERFACE

- Converts TTL to RS-232, and converts RS-232 to TTL
- Two separate circuits
- Requires -12 and +12 volts
- All connections go to a 10 pin gold plated edge connector
- Board only \$4.50 Part No. 232, with parts \$7.00 Part No. 232A 10 Pin edge connector \$3.00 Part No. 10P



## RS-232/TTY INTERFACE

This board has two active circuits, one converts RS-232 to 20mA, and the other converts 20mA to RS-232. Requires +12 and -12 volts. Board only \$4.50 Part No. 600, with parts \$7.00 Part No. 600A.

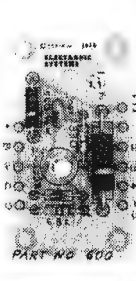

## S-100 BUS ACTIVE TERMINATOR

Board only \$14.95 Part No. 900, with parts \$24.95 Part No. 900A



## DC POWER SUPPLY

- Board supplies a regulated +5 volts at 3 amps., +12, -12, and -5 volts at 1 amp.
- Power required is 8 volts AC at 3 amps., and 24 volts AC C.T. at 1.5 amps.
- Board only \$12.50 Part No. 60B5, with parts excluding transformers \$42.50 Part No. 60B5A



**To Order:** Mention part no. description, and price. In USA shipping paid by us for orders accompanied by check or money order. We accept C.O.D. orders in the U. S. only, or a VISA or Master Charge no., expiration date, signature, phone no., shipping charges will be added. CA residents add 6.5% for tax. Outside USA add 10% for air mail postage and handling. Payment must be in U. S. dollars. Dealer inquiries invited. 24 hour order line (408) 448-0800



Send for FREE Catalog ... a big self-addressed envelope with 41¢ postage gets it fastest!

**ELECTRONIC SYSTEMS** Dept. B, P. O. Box 21638, San Jose, CA USA 95151

# What's New?

## FUN and GAMES

### Game Playing Device Is Also a Teaching Calculator

Mathemagician is a teaching calculator and game-playing device for adults and children of all ages. It can teach children arithmetic operations: multiplication tables, division tables, addition and subtraction. Children and adults can play any of six different games, which are: Number Machine, Counting On, Walk the Plank, Gooey Gumdrops, Football, and Lunar Lander. Mathemagician's games can be played by one or two people. All functions let the user know at the end of each problem if he or she has given the correct answer, and if not, will then display the correct answer.

Mathemagician sells for \$29.95. For

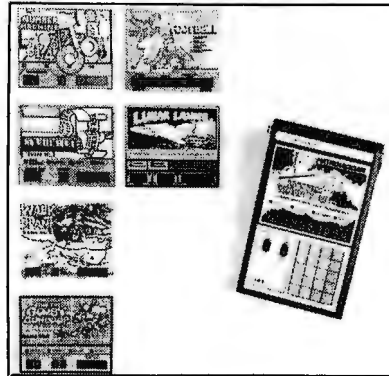

further information, contact APF Electronics Inc, 444 Madison Ave, New York NY 10022.

Circle 627 on inquiry card.

### Microvision Features Seven Different Game Cartridges

Milton Bradley's Microvision is a hand-held mini "video" game with its own screen. The electronically operated Microvision comes equipped with the game Blockbuster; moreover, six additional game cartridges may be purchased, including Bowling, Pinball, Connect 4, Star Trek Phaser Strike, Vegas Slots, and Mindbuster. Microvision is priced at \$51.25. Game cartridges

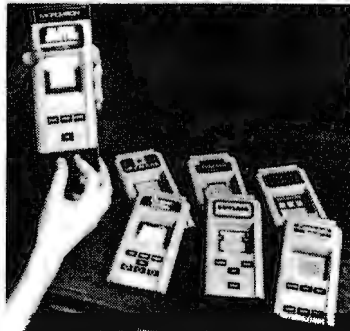

### Electronic Robot Promises Preschool Fun

Alphie is an electronic toy robot offering action, lights, sounds, music and games for children 3 to 8 years old. Preschoolers will enjoy Alphie's Question and Answer games. Once the child makes a decision, Alphie lights up the correct answer. If the child has made the right selection, Alphie plays a rendition of Sousa's "Stars and Stripes Forever." If the child's answer does not match, Alphie gives a good-natured "razzberry." Alphie also plays other tunes, and there is a choice of five popular children's songs.

Slightly older children will enjoy playing Robot Land. In this color matching game, the child tries to beat Alphie or a friend by being the first to move a miniature Alphie piece along the path from the Robot Factory to Spaceship XK-3. In the Lunar Landing game, children count the tones Alphie makes in order to be first to assemble an Alphie puzzle on the lunar game board.

Alphie is priced at approximately \$28. For further information, contact Playskool Inc, 4501 W Augusta Blvd, Chicago IL 60651.

Circle 630 on inquiry card.



### Game Software for the TRS-80

The Software Association has announced a new line of entertainment programs for the TRS-80. All programs are written in machine language and provide fast response times. The initial offerings include:

Z-Chess — a full-featured chess opponent providing seven levels of difficulty, from Blitz to Expert. Six moves of look-ahead are possible, and Z-Chess can solve mate-in-two problems quickly. Numbered squares and a board setup mode are provided for ease of play.

Back-40 — a backgammon challenger with an unrivaled graphic board display. Doubling is permitted, and every feature of a regulation backgammon match is provided including the score.

Dr Chips — a fascinating program based on Doctor and Eliza programs. Machine language allows Dr Chips to analyze sentences and talk back instantly.

All programs require a 16 K byte Level II machine. Z-Chess is priced at \$17.95, Back-40 and Dr Chips are \$14.95 each. For further information, contact The Software Association, POB 58365 Houston TX 77058.

Circle 628 on inquiry card.

range in price from \$16.50 to \$18. Contact Milton Bradley Co, Springfield MA 01101.

Circle 629 on inquiry card.

# The DATA-TRANS 1000

A completely refurbished  
IBM Selectric Terminal with  
built-in ASCII Interface.

## \$1395

### Features:

- 300 Baud
- 14.9 characters per second printout
- Reliable heavy duty Selectric mechanism
- RS-232C Interface
- Documentation included
- 60 day warranty - parts and labor
- High quality Selectric printing
- Off-line use as typewriter
- Optional tractor feed available
- 15 inch carriage width

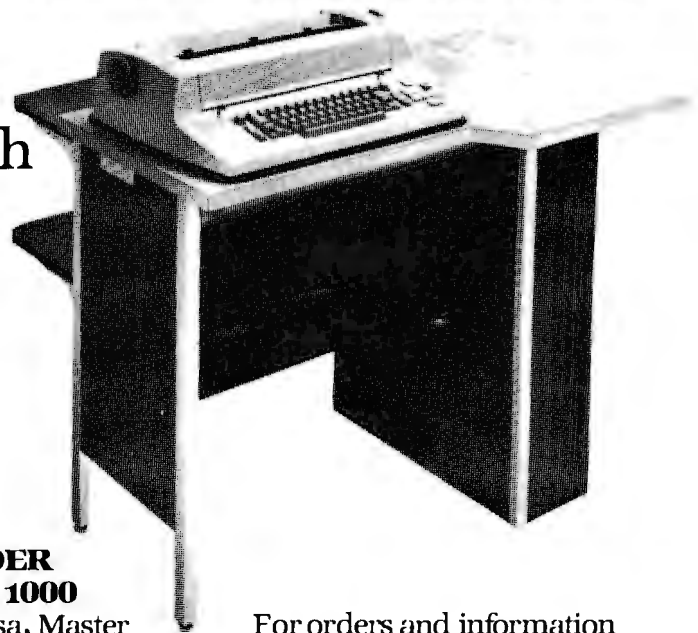

### HOW TO ORDER DATA-TRANS 1000

1. We accept Visa, Master Charge. Make cashiers checks or personal check payable to:

### DATA-TRANS

2. All orders are shipped F.O.B. San Jose, CA  
3. Deliveries are immediate

For orders and information  
**DATA-TRANS**  
2154 O'Toole St.  
Unit E  
San Jose, CA 95131  
Phone: (408) 263-9246

#### MICRO-PROCESSORS: FROM CHIPS TO SYSTEMS

This book covers all aspects of microprocessors, from the basic concepts to advanced interfacing techniques, in a progressive presentation. It is independent from any manufacturer, and presents uniform **standard** principles and design techniques, including the interconnect of a **standard** system, as well as specific components. It introduces the MPU, how it works internally, the system components (ROM, RAM, UART, PID, others), the system interconnect, applications, programming, and the problems and techniques of system development. By R. Zaks. SYBEX. Ref. C201. \$9.95

#### MICRO-PROCESSOR INTERFACING TECHNIQUES

Microprocessor interfacing is no longer an art. It is a set of techniques, and in some cases just a set of components. This comprehensive book introduces the basic interfacing concepts and techniques, then presents in detail the implementation details, from hardware to software. It covers all the essential peripherals, from keyboard to floppy disk, as well as the standard buses (S100 to IEEE 488) and introduces the basic troubleshooting techniques. (2nd Expanded Edition). By Austin Lesea and R. Zaks. Ref. C207 SYBEX. \$11.95

#### PROGRAMMING THE 6502 PROGRAMMING THE Z80 PROGRAMMING THE 8080\*

It covers all essential aspects of programming, as well as the advantages and disadvantages of the 6502 and should bring the reader to the point where he can start writing complete applications programs. For the reader who wishes more, a companion volume is available: The 6502 Applications Book. By R. Zaks. 6502: Ref. C202; Z80: Ref. C280; 8080: Ref. C208. SYBEX. Each \$10.95



#### 44 BUS MOTHER BOARD

Has provisions for ten 44 pin (.156) connectors, spaced 3/4 of an inch apart. Pin 20 is connected to X, and 22 is connected to Z for power and ground. All the other pins are connected in parallel. This board also has provisions for bypass capacitors. Board cost \$15.00 Part No. 102. Connectors \$3.00 each Part No. 44WP.



#### AN INTRODUCTION TO PERSONAL AND BUSINESS COMPUTING

No computer background is required. The book is designed to educate the reader in all the aspects of a system, from the selection of the microcomputer to the required peripherals. By Rodney Zaks. Ref. C200. SYBEX \$6.95

#### TVT COOKBOOK

Bk 1064 — by Don Lancaster. Describes the use of a standard television receiver as a microprocessor CRT terminal. Explains and describes character generation, cursor control and interface information in typical, easy-to-understand Lancaster style. \$9.95

#### COMPUTER PROGRAMMING HANDBOOK

A complete guide to computer programming & data processing. Includes many worked-out examples. By Peter Staak. TAB \$9.95

#### DIGITAL CASSETTE

5 min. each side. Box of 10 \$9.95. Part No. C-5.



**To Order:** Mention part no., description, and price. In USA shipping paid by us for orders accompanied by check or money order. We accept C.O.D. orders in the U.S. only, or a VISA or Master Charge no., expiration date, signature, phone no., shipping charges will be added. CA residents add 6.5% for tax. Outside USA add 10% for air mail postage and handling. Payment must be in U.S. dollars. Dealer inquiries invited. 24 hour order line (408) 448-0800



Send for FREE Catalog . . . a big self-addressed envelope with 41¢ postage gets it fastest!

**ELECTRONIC SYSTEMS** Dept. B, P. O. Box 21638, San Jose, CA USA 95151

# What's New?

of INTEREST to DESIGNERS

## Muscles for Robots

This 12 V DC, 17 RPM, reversible gearmotor has been designed for robotic applications. The motor produces 11 inch-pounds of torque and operates on 750 mA full load current. The motor is priced at \$18. Contact Gledhill Electronics, POB 1644, Marysville CA 95901.

Circle 634 on inquiry card.

## Pascal Processor for the S-100 Bus

The Pascal-100 processor is a 16-bit central processor board for the S-100 bus, especially designed for use with the Pascal programming language. The processor directly executes p-code instructions generated by the Pascal compiler written at the University of California, San Diego (UCSD Pascal). It runs the latest version of the entire UCSD Pascal operating system, including the Pascal compiler, screen editor, filing system, BASIC compiler, graphics package, games library, computer-based learning system, and utilities and cross-assemblers for other micro and minicomputers.

Other features of the Pascal-100 processor include support of up to 128 K bytes of directly addressed main memory, 16-bit data bus transfers, vectored interrupts and floating point operations. The processor complies with the Institute of Electrical and Electronic Engineers standard for the S-100 bus, and will also operate with most peripheral and memory boards designed prior to the standard.

The Pascal-100 processor is priced at \$995. For further information, contact David Lewis, Dicom Research Corp, Terrace Hill, Ithaca NY 14850.

Circle 635 on inquiry card.

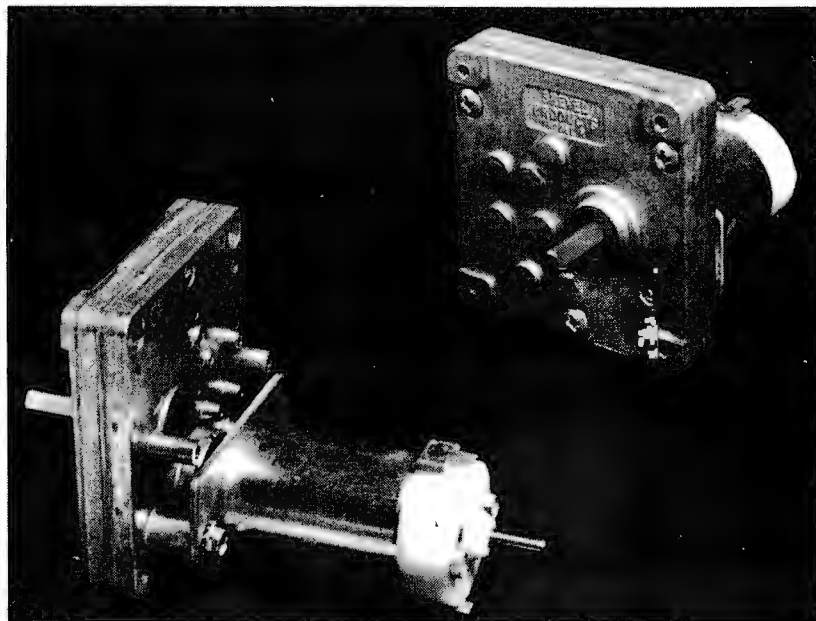

## Microprocessor Controller Card

The System A process control board utilizes an 8085 microprocessor and can interface to 76 I/O (input/output) lines. The board contains 4 K bytes of erasable read-only memory and up to 4.6 K bytes of programmable memory. It also has RS-232 teletypewriter control and 14-bit binary counter and timers. The board can be purchased with a resident program that allows the user to program interface requirements and data rates from an external source. Minimal configuration boards may also be purchased. The board dimensions are 4 by 5 inches (10.16 by 12.20 cm). The System A board starts at \$295. For further information, contact FH and M

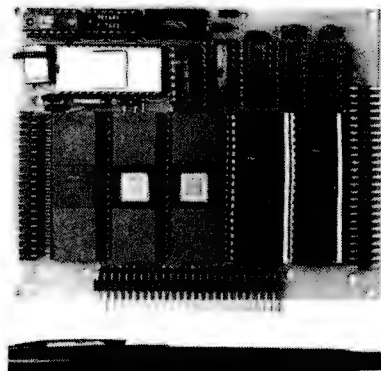

Enterprises Inc, 1850 Gravers Rd, Norristown PA 19401.

Circle 636 on inquiry card.

## Hewlett-Packard Introduces High-Resolution Optical Reflective Sensor

The HEDS-1000 is a fully integrated module designed for optical reflective sensing. The module contains a 0.007 inch (0.178 mm) diameter light-emitting diode (emitting visible 700nm wavelength light) and a matched integrated circuit photodetector. A bifurcated aspheric lens is used to direct the active areas of the light-emitter and the detector to a single image spot 0.171 inch (4.34 mm) in front of the package. The reflected signal can be sensed directly from the photodiode or through an internal transistor that can be configured as a high-gain amplifier. Applications

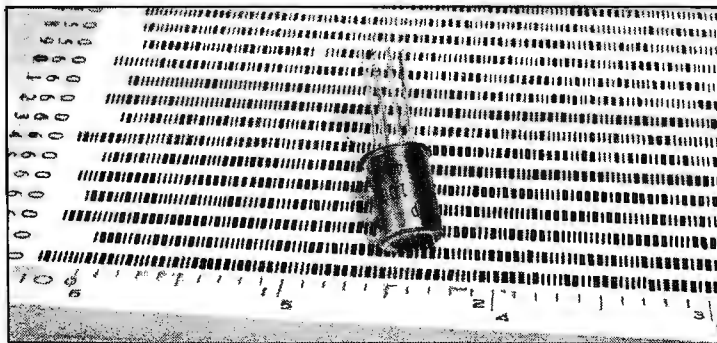

include pattern recognition, object sizing, optical limit switching, tachometry, defect detection, dimensional monitoring, line locating, mark and bar code scanning, and paper edge detection.

For further information, contact Hewlett-Packard, Optoelectronics Division, 640 Page Mill Rd, Palo Alto CA 94304.

Circle 637 on inquiry card.



# BK PRECISION Transistor Testers



**MODEL 520B**

### Industrial Transistor Tester

- Now with Hi/Lo Drive
- Worries in-circuit when others won't
- Identifies all three transistor leads
- Removes lead connection
- Audibly and visually indicates GOOD transistor
- Automatic NPN/PNP determination
- Positive Si/Ge identification
- Tests diodes, SCR's, FET's, and Darlington
- CSA approved version available



**MODEL 510**

### Portable Transistor Tester

- Fast/GOOD/NO-GOOD in-circuit transistor testing
- Fast and thorough GOOD/BAD out-of-circuit testing
- Tests FET's and SCR's in-circuit out-of-circuit
- Connects in-circuit to any component lead
- Checks positive emitter-base collector identification in-circuit—positive base identification in Hi/Lo Drive
- Light-Emitting Diode indicator NPN-GOOD/PNP-OK
- Positive Si-Ge Over 100 hours of testing from single set of "AA" cells
- Digital visibility—no adjustments; nothing to go pot or calibrate
- Includes carry-case and leads



**MODEL 501A**

### Semiconductor Curve Tracer

- Displays characteristic curves for all semiconductor devices on your scope
- Measures breakdown voltage non-destructively
- Identify unknown devices
- Complete with FP-50 probe

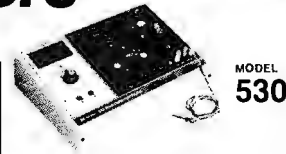

**MODEL 530**

### Lab-Quality Semiconductor Tester...

- Measures I of bipolar transistors up to 1500 MHz
- Nondestructive testing of transistor and diode breakdown voltages
- Measures transistor beta or FET g<sub>m</sub>
- Measures all transistor breakdown and leakage parameters
- Fast testing of transistors, FET's, and SCR's—in or out-of-circuit
- Base diagrams are not required
- No biasing information required
- Identifies all silicon transistors and SCR's
- Automatic identification of PNP/NPN types and N- or P-channel FET's

**New from B&K ... Before you buy, check our prices...**



**MODEL 820**

### New Portable Digital Capacitance Meter

- Measures capacitance from 0.1pF to 1F
- Resolves to 0.1pF
- 10 ranges to accuracy and resolution
- 4 digit easy-to-read LED display
- 95% accuracy
- Special lead insertion jacks or banana jacks
- Fuse protected
- Uses either rechargeable or disposable batteries
- Overrange indication



**MODEL 3010**

### New Low Distortion Function Generator

- Generates sine, square and triangle waveforms
- Variable amplitude and fixed TTL square-wave outputs
- 0.1 Hz to 10 MHz sine waves
- Push button range and function selection
- Typical sine wave distortion under 0.5% from 1 Hz to 100 kHz
- Variable DC offset for engineering applications
- VCC external input for sweep-frequency tests



**MODEL 3020**

### New Sweep/Function Generator

- Four instruments in one package—sweep generator, function generator, pulse generator, tone burst generator
- Covers 0.0049-20 MHz
- 1000:1 tuning range
- Low distortion high-accuracy outputs
- Three-step attenuator plus remote control
- Internal linear and log sweeps
- Tone burst output in front-panel or externally programmable



**MODEL DP-50**

### New Digital Pulsar Probe



**MODEL DP-100**

- Multifamily compatible with TTL, DTL, RTL, HTL, CMOS, MOS and NMOS
- Displays DC to 50 MHz
- Displays pulse presence and logic state
- Memory mode to "freeze" pulse display
- Pulse mode stretches short pulses
- 2 megohm input impedance
- Input overload protected
- Detects pulses to 10 nanoseconds
- Generates "one shot" pulse or continuous 50% pulse train
- Automatically senses logic state and changes state to its complement
- Multifamily—Compatible with TTL, DTL, RTL, HTL, NMOS and CMOS
- High current drive will pull shorted logic outputs high or low
- Short duty cycle pulse will not damage circuitry under test
- Fully overload protected
- Companion to DP-50 digital probe



**MODEL 2815**

### New 3 1/2-Digit DMM with LCD Readout

- 0.1% DC accuracy
- 0.5% LCD display for high readability
- 100A current range
- Low battery warning
- Fully overload protected
- Auto zero and auto polarity
- Built-in tilt stand
- Only 6.1 x 4.2 x 1.6 deep
- 100A/1000A, 0.01 resolution
- Battery life of over 100 hours
- Shielded to stay accurate in RF fields

**Call TOLL FREE (800) 645-9518**  
In N.Y. State call (516) 752-0050

## FORDHAM

**YOUR ONE STOP DISCOUNT CENTER**  
Master Charge, Bank Americard, Visa, C.O.D.'s accepted.  
Send for new catalog of over 3,000 items 164 pages of test equipment.  
CB tools, tubes, components and electronic supplies

RADIO SUPPLY CO., INC.  
855R Conklin St.  
Farmingdale, N.Y. 11735

ADD \$3.00 TO COVER SHIPPING, HANDLING & INSURANCE N.Y. Res. add approx sales tax.

**HICKOK 3 1/2 Digit Mini-Multimeter**  
MODEL LX 303 \$69.50

**GOULD 15 MHz Dual Trace**  
Triggers in excess of 25 MHz  
Model OS255 \$795 (including probes)

**SENCORE TV-VTR-MATV and Video Analyzer**  
Model VA48 \$875.00 Reg. \$975.00

**ESSE CONTINENTAL SPECIALTIES**  
100 MHz 8-Digit Counter \$119.00  
• 20 Hz - 100 MHz Range • 8" LED Display • Fully Automatic  
• Includes 100 IPC chip lead mount & dial indicator  
Model MAX-100

**Sinclair PDM35 digital MultiMeter**  
Model 2800 \$52.95

**Auto Stereo 40 Watt Power Booster POW-40**  
Model 9995 \$24.95

**PORTABLE VOM MULTITESTER**  
20,000:1 VDC • 10,000:1 VAC  
Model 1500 \$19.95

**CODE-A-PHONE Telephone Answering Devices**  
Model 1400 \$199.95

**BK PRECISION 3 1/2-Digit Portable DMM**  
• Overload Protected • Battery or AC operation • 3" high LED Display  
• Auto Zeroing Model 2800  
comes complete with test leads, operating manual and spare fuse

**Weller Xcelite**  
Model 995M \$42.95 Model TC 100/ST \$269.95 Model 99PR \$15.95

**Logic Monitor**  
• Automatically displays static and dynamic logic • Works with DTL, HTL, TTL and CMOS • 16 LED display  
• Current power reduction  
Model LM-1 \$52.95 complete

**Wahl NEW ISO-TIP "Quick Charge"**  
12 units \$27.95  
Model 7800

**NLS 15 MHz Mini Oscilloscope**  
Model MS 15  
Reg. \$318.00 \$269.95

**Service Master Attache Style Tool Kit Tool Cases**  
Model 995M \$42.95 Model TC 100/ST \$269.95 Model 99PR \$15.95

**BSR SYSTEM X-1000 Remote Control for Lights & Appliances**  
4 Piece Starter Kit Reg. \$87.95 \$79.95

**Microflame Deluxe Gas Torch Kit**  
Model 4400 Reg. \$39.95 \$29.95

**ESSE Logic Probe**  
Model LP-1 \$40.00

**Miniature High Fidelity Stereo Speaker System**  
Reg. \$139.00 \$69.50

**BSR SYSTEM X-1000 Lamp Modules**  
One (1) Command Console \$14.95  
Two (2) Lamp Modules 14.95  
One (1) Appliance Module 39.95

**HICKOK Function Generator**  
Model 270 \$169.15

**ESSE 30MHz Dual Trace with Delay Line**  
Reg. \$1050 \$889.95 with probes

**Magnifier 700 Series LAMP**  
Model MC 10A \$49.50

**Bearcat Scanner**  
Model 250 \$299.95

**In-Dash AM/FM 8 Track Stereo C-777**  
\$52.50  
**AM/FM Cassette Stereo**  
CAS 888 \$57.50

**ESSE Function Generator**  
Model 2001 \$127.50  
Sine, square, triangle and separate TTL Square wave output

**Chess Challenger**  
• Ten levels of play  
Model LCX \$179.95

**BK PRECISION SUPER SPECIAL 30MHz Portable Frequency Counter**  
Model 1827 \$199.95

**Weller Controlled Output Soldering Station**  
Reg. \$35.00 \$45.00

**ESSE Chess Challenger**  
• Ten levels of play  
Model LCX \$179.95

**RC Circuit Box/RCA-VIZ**  
• 36 resistors  
• 15 capacitors (10 megohm)  
• 18 capacitors (100 pF to 0.77 uF)  
Model WC 412A Reg. \$41 \$36 (includes test leads)

**Regency Touch K100 Scanner**  
Reg. \$269 \$199.95

**BK PRECISION Substitution Box**  
Model 2910

**ESSE Function Generator**  
Model 2001 \$127.50  
Sine, square, triangle and separate TTL Square wave output

**RC Circuit Box/RCA-VIZ**  
• 36 resistors  
• 15 capacitors (10 megohm)  
• 18 capacitors (100 pF to 0.77 uF)  
Model WC 412A Reg. \$41 \$36 (includes test leads)

**Regency Touch K100 Scanner**  
Reg. \$269 \$199.95

**FREE 1979 Catalog**  
Call TOLL FREE (800) 645-9518 For N.Y. State call (516) 752-0050

**"We Will Beat Any Advertised Price"**

**FORDHAM**  
855R Conklin St. Farmingdale, N.Y. 11735

# What's New?

## MASS STORAGE

### Intelligent Disk System for S-100 Computers

A 10 M byte intelligent rigid disk system has been introduced by Corvus Systems, 900 S Winchester Blvd, San Jose CA 95128. Plug compatible with the Radio Shack TRS-80, Apple and all S-100 bus-type computers, the system adds cost-effective mass storage to these computers, while maintaining total compatibility with existing hardware and software.

The disk system

consists of a compact IMI 7710 disk drive employing Winchester technology with two 8-inch rigid disks; a Corvus Z80 intelligent disk controller with comprehensive disk diagnostics; and an intelligent personality module and associated software for each form of computer. Each drive has a capacity of 10 M bytes of formatted storage. Up to four drives can be supported in a simple daisy chain.

The price

of the system is \$5350, including disk drive, controller, and personality module. Add-on disk drives are priced at \$2900.

Circle 631 on inquiry card.

### Where Do New Products Items Come From?

The information printed in the new products pages of BYTE is obtained from "new product" or "press release" copy sent by the promoters of new products. If in our judgement the information might be of interest to the personal computing experimenters and homebrewers who read BYTE, we print it in some form. We openly solicit releases and photos from manufacturers and suppliers to this marketplace. The information is printed more or less as a first in first out queue, subject to occasional priority modifications. While we would not knowingly print untrue or inaccurate data, or data from unreliable companies, our capacity to evaluate the products and companies appearing in the "What's New?" feature is necessarily limited. We therefore cannot be responsible for product quality or company performance.

### 5-Inch Disk Drive Is Compatible with Shugart SA-400

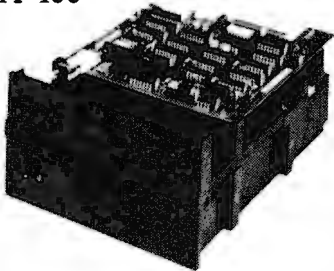

The Teac FD-50A 5-inch disk drive moves its data-transfer head directly to the selected track, giving the drive a track-to-track access time of 25 ms and an average access time of 298 ms. A precision built stepper motor ensures accurate head positioning while an improved head configuration is used for precise erasing. In its basic 35-track configuration, the capacity of the FD-50A is 109.4 K bytes (unformatted). This may be extended if desired by addressing an additional 5 tracks. Recording on a total of 40 tracks expands the capacity to 125 K bytes. Up to four FD-50A 5-inch disk drives can be daisy-chained to a single controller. The FD-50A is fully plug-to-plug and disk-compatible with the Shugart SA-400.

For further information, contact Teac Corp, 3-7-3, Naka-cho, Musashino, Tokyo, JAPAN.

Circle 632 on inquiry card.

### 5-Inch Double Density Disk Drive for TRS-80

Percom Data Company has expanded its TFD line of add-on 5-inch disk systems for the Radio Shack TRS-80 computer to include a dual drive unit featuring double-density storage. Designated the TFD-1000, the unit provides 800 K bytes of on-line storage. Two systems (four drives) may be used with a TRS-80 to provide 1.6 M bytes on line.

The TFD-1000 is supplied complete with an interconnecting cable (which accommodates either one or two units), a Peripheral Adapter Module (PAM) printed circuit card, Percom's MICRODOS operating system, and support documentation. The PAM card replaces the RS-232C card in the TRS-80

expansion interface and includes RS-232C circuitry so that serial interfacing capability is retained. The MICRODOS operating system, which replaces TRSDOS, was developed especially for business and professional applications. It provides full random-access capability, is faster than TRSDOS and requires less than 7 K bytes of programmable memory. It is supplied on a system disk that includes BASIC program examples and a menu of the programs. The menu is activated on power-up or reset.

The TFD-1000 complete with cable, operating system, PAM card and documentation costs \$2495. Two TFD-1000 units (four drives) cost \$4950. For further information contact the company at 211 N Kirby, Garland TX 75042.

Circle 633 on inquiry card.



# ProComp/New England *Super Christmas Sale*

Prices marked with \* good thru Dec 31. Mail and phone orders welcome. Prices FOB Boston, MA. Shipping costs billed COD. Mass residents add 5% sales tax.

## TRS-80 MEGABYTES .... and MORE!

The MEGABOX includes provision to add 32K of RAM and a UART with the RS-232 interface, so the MEGABOX can be used with the TRS-80 alone to provide a complete 48K system, capable of supporting a printer. (By MICROMATION, of course!)

One MByte Storage.....	\$2295	CP/M + TRS-80	
Two MByte Storage.....	\$3095	Software Patch.....	\$249 *
		Microsoft FORTRAN...	\$199 *

[ TRS-80 TM Tandy Corp. ]

### Add Capacity and Power to your S-100 System.

--- DISK STORAGE ---

Micromation ' Doubler '  
( 2D / Disk Controller ) ..... \$449.00

One MByte Disk Sub-System  
(Two REMEX 8" RFD-2000)  
(Controller / Housing & CP/M)..... \$2,295

Two MByte Disk Sub-System  
(Two REMEX 8" RFD-4000 dual head)  
(Controller / Housing & CP/M)..... \$2,595 \*

--- MEMORY BOARDS ---

Measurement Systems & Controls  
48K Dynamic (DM-4800)..... \$549.00 \*

Seattle Computer Products  
'16K Plus' Static (250ns)..... \$325.00 \*

### .... Add a PRINTER

- |  |  |
|--|--|
| • COMPRINT<br>(Parallel)..... \$589              | • Epson TX-80<br>(Parallel)..... \$739 |
| (Serial)..... \$549                              | (Serial)..... \$769                    |
| • Sanders Technology<br>MEDIA 12/7..... \$3589 * | • TI-825 (RO)..... \$1749              |

## A Special Value ProComp Custom System .....

We put it all together in a rugged TEI tabletop cabinet, then test it and burn it in.

You get all the advantages of a Cromemco System Two (plus an extra drive) for 15% less.

Take your pick of Operating Systems [ CDOS /or/ CP/M ]

- \* 3 MPI 5.25" Drives
- \* Cromemco ZPU ( CPU Card )
- \* Cromemco 4FDC Disk Controller
- \* 64K Measurement Systems & Controls  
Memory (Model DM-6400)

All for **ONLY \$3390.\***

MICROCOMPUTER SYSTEMS • SOFTWARE • BOARDS • SUPPLIES

# ProComp/New England

120 Boylston St. Fourth Floor Boston, MA. 02116 (617) 482-4450  
HOURS M-F 9-5 S 10-6 Write or call for our current price list.



# What's New?

## PUBLICATIONS

### Predict Object Motion With Your Programmable Calculator

*Countdown*, a book by Robert Eisberg and Wendell Hyde, will show the reader how to use a programmable calculator to accurately predict the motion of a variety of interesting objects. Using only basic math and physics, the book explains how to calculate the motion of skydivers, single and multistage rockets, Earth satellites, planets, and alpha particles. The book is written without the assumption that the reader has any familiarity with a programmable calculator. This 114 page paperback book is priced at \$6.95. For further information contact Dilithium Press, POB 92, Forest Grove OR 91776.

Circle 598 on inquiry card.



### Publications on Business Computing

BusinessComputing Press has announced a series of publications informing businessmen and professionals about the effective utilization of low-cost microcomputers in business. The bi-monthly journal, *BusinessComputing Review*, provides research reporting on business computers and applications software. The information is presented in a concise review format that simplifies the selection of systems based on business requirements. Related articles and commentary compliment the reviews.

The report, *Evaluating Small Business Software*, details the characteristics that any quality software package must possess in order to be used successfully. Specific evaluation criteria are provided for General Ledger, Accounts Receivable, Accounts Payable, Payroll, and Inventory Control packages.

*BusinessComputing Newsletter*, published 6 times annually, presents newsworthy information about the use of microcomputers in business. The newsletter contains tutorials on business computing and abstracts of new products. The newsletter is sent to subscribers of *BusinessComputing Review*.

*BusinessComputing Review* is available for an annual subscription rate of \$25. The report, *Evaluating Small Business Software*, is \$15 per copy. Contact Business Computing Press, POB 55056, Valencia CA 91355.

Circle 599 on inquiry card.

### TM990 Series Microcomputer Module Selection Guide Available from Texas Instruments

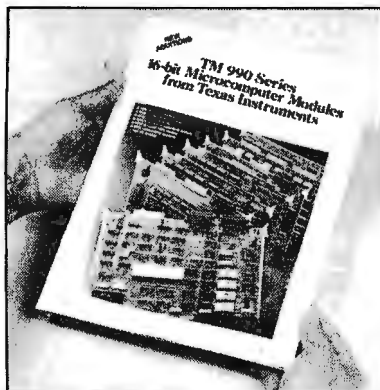

A 20-page product selection guide and catalog covering the TM990 Series of 16-bit microcomputer modules is available free from Texas Instruments Inc, POB 1443, MS-6404, Houston TX 77001. It provides engineers with a con-

venient reference to TI's line of TM990 Series microcomputer modules and other TM990 Series software, firmware, and hardware products. The publication, CL 377A, covers TM990 Series microcomputer modules; memory expansion modules; I/O (input/output) expansion modules; industrial AC and DC I/O modules; analog-to-digital and digital-to-analog interface modules; university educational module; and software development module. Product descriptions include key specifications and features.

Also included in CL 377A are descriptions, key features and specifications for TI's data entry and display Microterminal; firmware support, including TIBUG Monitor and line-by-line assembler; software, including Power BASIC high-level language and TIPMX Executive Library, a collection of assembly language programs available for users of TI's TMS9900 family of microprocessors; TM990 transportable cross support; Advanced Microprocessor Prototyping Lab (AMPL); and TM990 Series accessories.

Circle 600 on inquiry card.

### Computers for Business People

DDC Publications has announced the publication of a new book for people planning to buy a business computer system. The book, entitled *Winning the Computer Game* by Chris Kloek, presents a business computer guide to the layman or professional. The book recommends when a company should computerize, when it should not, how to buy systems and services, and how to live happily with them. *Winning the Computer Game* goes into detail on such subjects as custom versus packaged software, contract negotiation, installation management, and financing alternatives. Appropriate cautions are also provided.

The 178 page guide costs \$12.95 and is available from DDC Publications, 5386 Hollister Ave, Santa Barbara CA 93111.

Circle 602 on inquiry card.

### Free Technical Catalog

The 1979 edition of *Engineering Guide: AC/DC and DC/DC Power Sources* contains 44 pages and includes 10 pages of design, applications, and selection information for both linear and switch mode regulated power sources. Designed to help the engineer select the most cost effective power source for an application, this reference includes complete specifications, dimension drawings

and extended pricing information for 23 product families ranging from dual-in-line packaged single and dual output DC/DC converters to high-efficiency 76 W multioutput open frame power supplies. The Guide presents a variety of new products and lists price reductions for certain existing product groups. For further information, contact Semiconductor Circuits Inc, 218 River St, Haverhill MA 01830.

Circle 601 on inquiry card.



# The COMPUTER FACTORY

TO ORDER CALL (212) 687-5001

## SUPERBRAIN™

INTERTEC DATA SYSTEMS

32K ONLY \$2995

64K \$3245



More than an intelligent terminal, the SuperBrain outperforms many other systems costing three to five times as much. Endowed with a hefty amount of available software (BASIC, FORTRAN, COBOL), the SuperBrain is ready to take on your toughest assignment. You name it! General Ledger, Accounts Receivable, Payroll, Inventory or Word Processing... the SuperBrain handles all of them with ease.

### Features Include:

- two dual-density minifloppies with 320K bytes of disk storage
- 32K of RAM to handle even the most sophisticated programs
- a CPM Operating System with a high-powered text editor, assembler and debugger.

NEW!

## MINIMAX

The Minimax Series Computer is an integrated, compact unit containing the CPU, Disk Storage, 12 inch CRT, and Full Style Keyboard.

- Features Include:
- 2 Megahertz 6502 CPU
  - 108K System RAM
  - High Res. Graphics (240x512)
  - Switchable 110 or 220V Operation
  - Choice of Book or 2.4 Megabyte Disks
  - Business Packages Available
  - Serial and Parallel I/O
- MINIMAX I - .8 Megabyte on line minifloppy storage ..... \$4495  
 MINIMAX II - 2.4 Megabyte on line 8" floppy storage ..... \$5995



## Commodore Computer

These low cost Commodore PET Business Computers have virtually unlimited business capabilities: Accounts Receivable, Inventory Records, Payroll, and other accounting functions.

### PET 16N & 32N COMPUTERS

- Full size keyboard
- 16 or 32,000 Bytes Memory
- Level III Operating System
- Full Editor
- Upper/lower



### PET DUAL FLOPPY DISK

- Stores 360,000 Bytes on-line
- Microprocessor controlled
- Uses single or dual sided floppies



### HI-SPEED PRINTER

- 150 characters per second • Up to 4 copies • 11" wide
- Microprocessor controlled
- Prints All Graphics
- Full Formatting Capability



### PERIPHERALS FOR PET

- 24K Memory Expansion ..... \$499
- 16K Memory Expansion ..... 399
- PET to RS232 Serial ..... 169
- 2 Way Serial/Communication ..... 229
- Modem Board for PET ..... 375
- Analog to Digital Board for 16 Devices ..... 275
- Second Cassette Drive ..... 95
- Parallel Printer Interface ..... 169



NEW!



APPLE II PLUS ONLY \$1195

A complete self-contained computer system with APPLESOFT floating point BASIC in ROM, full ASCII keyboard in a light weight molded carrying case.

### Features Include:

- auto-start ROM • Hi-Res graphics and 15 color video output.
- Expandable to 48K.

Disk .....	\$595	Programmer's Aid .....	50
Add-on Disk .....	485	Speechlab .....	229
Pascal Card .....	495	Lightpen .....	250
Business Software .....	625	Communication Card .....	225
Monitor .....	149	Modem .....	200
Printer Card .....	180	EPROM Programmer .....	100

### NEW D. C. Hayes MICROMODEM II

- Combines the capabilities of a communications card and acoustic coupler.
  - Plugs directly into Apple slot and modular telephone jack.
  - Auto dial/receiver • FCC approved
- only \$379

### NEW Mountain Hardware SUPERTALKER

- Digitized speech recording and playback.
  - Must be heard to be believed!
  - Foreign language teaching pack available.
  - Software compatible.
- only \$279



- 16-bit microprocessor
- 16K RAM
- 13" color monitor (24 lines of 32 chrs.)
- 28K ROM operating system (includes 14K BASIC)
- Sound - 3 tones, 5 octaves
- 16 colors: 192 x 256 res.
- Large TI library of ROM programs available.

FINALLY TEXAS INSTRUMENTS TI-99/4 Home Computer

only \$1150

Includes 13" Color Monitor!

Many Peripherals. Coming soon!

Over 1000 software tapes, books, disks on display. Come in and browse.

NEW!

## CENTRONICS 704

- 180 cps Bi-Directional
- Upper/Lower Case
- 9 x 9 Matrix
- Tractor Feed
- Up to 15" Paper Width
- RS-252 Serial Interface



## CENTRONICS 753

- New Word Processing Dot Matrix Printer
- 130-150 cps • Proportional Spacing
- Tractor Feed • N x 9 Matrix

Call for Special prices

\$1495 Complete!

- 16K Model add \$200
- 32K Model add \$500



## CENTRONICS 730

Parallel \$995  
Serial \$1045

- 50 CPS • MICROPROCESSOR CONTROLLED!
- Tractor & Friction Feed • Uses Single Sheets, Roll, Fanfold • Upper & Lower Case • Light Weight!

## CompuColor II

COMPUCOLOR II Disk-Based Model 3 Advanced hardware and software technology gives you:

- 13" Color Display
- Advanced Color Graphics
- 51K Disk Built-in
- 16K ROM Operating System
- 8K RAM User Memory
- 4K RAM Refresh
- 880K Microcomputer
- RS232 I/O

## ANDERSON JACOBSON

841 I/O Terminal

- Ideal for word processing and small businesses.
- ASC II Code
- 15 cps Printout
- High Quality Selective Printing
- Use Keyboard for PET
- Reliably Accurate 80% Minimum
- Cartridge detachable by J.I.
- Serial: 15 Meter Error
- Plus \$35 Freight-in Charge



NOW IN STOCK

Parallel \$1095  
Serial \$1195



## DATA GENERAL micro NOVA

The ultimate in small Business Computers when matched with COMPUTER FACTORY's minicomputer. Software: Accounts Receivable/Payable, Inventory Control/Order Entry, General Ledger, Payroll Systems. ... from \$12,140 for 64K computer with cabinet, printer terminal, video terminal (suitable and multi-user operating system!)

RADIO SHACK • PET • SORCERER • APPLE • COMPUCOLOR • ETC.

PRINTERS • PRINTERS • PRINTERS

The COMPUTER FACTORY'S extensive inventory and wide selection of computer printers assures you of finding the printer best suited for your needs and specifications. The following printers work well with all known personal computers

CENTRONICS 779 ..... \$ 845  
 TRENDCOM 100 ..... 375  
 TRENDCOM 200 ..... 595  
 PAPER TIGER 440 ..... 580  
 w/int. .... \$1895

★ FREE \$35 of Software with purchase of any computer on this page.

Master Charge

Min Credit Card Order \$75

Open Mon.-Fri. 10-6 Sat. 10-4

NY residents add 8% sales tax

- Same day shipment on prepaid and credit card orders • Add \$5 shipping for computers, \$3 for boards, \$1 each cassette tape.

TO ORDER CALL (212) 687-5001

(46th St.)

The COMPUTER FACTORY

485 Lexington Avenue 750 Third Avenue New York, N.Y. 10017  
 Foreign order desk - Telex 640055

# What's New?

## SOFTWARE

### Add-on Graphics for Apple II Software

Superchip is a 16 K bit read-only memory designed to be plugged into the Apple II computer. The device provides an alternate set of I/O (input/output) service routines. The output routine can display, within the window concept, the full American Standard Code for Information Interchange (ASCII) character set (lowercase included), along with 32 new characters. User defined characters and character sets are also supported. Text is available in reverse video and may be freely mixed with high-resolution graphics. Characters can be rotated in 90 degree steps to achieve vertical and upside down printing. The new input routine permits the generation of all the new characters from the standard keyboard. An enhanced full screen editor is also provided with full cursor motion, character insertion and deletion, and several other features to increase the speed of editing. The Character Edit Program, which is available on cassette, permits one to construct or modify a character pattern by working with a magnified grid. Superchip was designed to be transparent to existing Apple software, and most programs run under it with no modification.

Superchip supports printing through either the communications or printer

### Full Standard PILOT on PET

Commodore PET owners can get full standard PILOT on a minimum size PET with the PETPILOT language processor and editor which is suitable for preparing long programs of up to 80,000 characters. The product features full BASIC in compute statements as well as two new keywords designed to make PILOT programming easier and faster. All language features of the most recent PILOT standard are implemented. Only the tape drive supplied with the PET is required to run any PILOT program. While simple PILOT programs can be created on a single drive PET, authors writing long programs will need the second cassette drive offered by Commodore.

The package offered by the PET-PILOT project contains both programs, a sample PILOT program, a teacher's manual, a quick reference card, and licenses to run the programs on a single PET. The basic package costs \$25. Specify the PET serial number to be licensed when ordering. Contact Dave Gomberg, 7 Gateview Ct, San Francisco CA 94116.

Circle 640 on inquiry card.

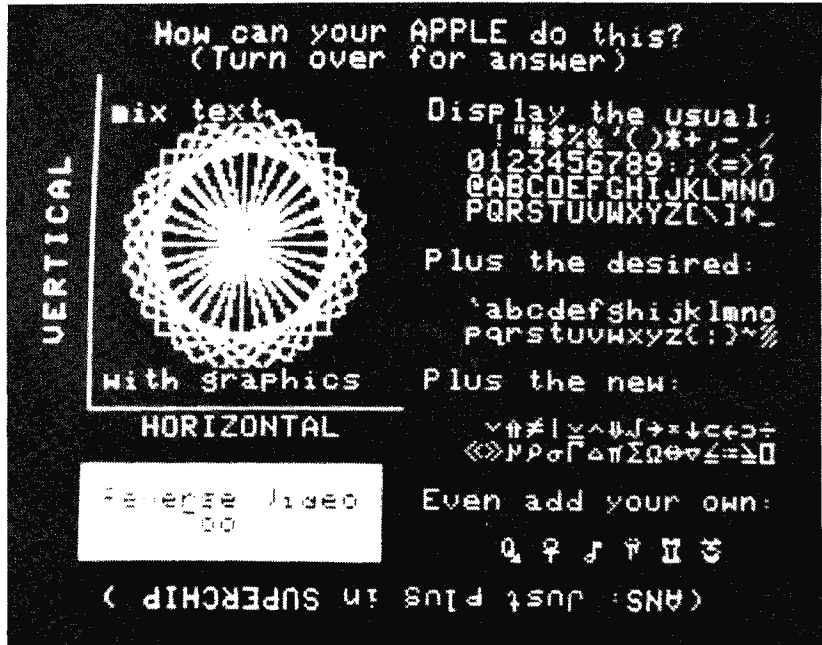

interface board and requires a 16 K byte system to operate. The Applesoft board is also supported. Superchip is priced at \$99.95, and the Character Edit Program is \$19.95. A disk interface is available

for \$19.95, and a word processing package costs \$19.95. For further information, contact Eclectic Rentals Inc, 2830 Walnut Hill Ln, Dallas TX 75229.

Circle 638 on inquiry card.

### User-Oriented Database Management System

Global is a comprehensive and versatile user-oriented database management system for database creation and list maintenance. Global runs under CP/M and CBASIC2 on a microcomputer system in 40 K bytes of programable memory. This general-purpose tool can be used for diverse applications such as inventory systems, mail lists, indexing collections, history reports, payroll files, accounting files, price lists, client lists, etc.

Some features include completely user-defined file structure with sequential, random, and linked file maintenance; user-defined number of fields; data transfer between records;

automatic high-speed search algorithms with global search function, built-in indexed sequential-access method, etc; fast sort and merge utility; record-selectable output that can be formatted and printed on various forms; links to CP/M commands or programs with automatic return to Global; status reports on disk, data file and hardware environment; and disk used as extended memory.

Global is supplied on standard 8-inch IBM-compatible disks and comes complete with a BASIC subroutine library supplied in source code, and a comprehensive manual for \$295. The manual alone is \$35. For further information, contact Global Parameters, 1505 Ocean Ave, Brooklyn NY 11230.

Circle 639 on inquiry card.

### Educational Software for Apple and TRS-80

Mind-Memory Improvement (Course Steps 1 and 2) has been designed for the Apple and the TRS-80 (Level I and II). It combines the advantages of the home computer with a teaching manual and audio cassettes. The Mind course teaches a system for memorizing lists of items easily. In addition, the course

develops memorizing skills for more difficult material as well as teaching a system for listening and remembering. Emphasis is placed on remembering people's names and faces. The price for Mind-Step 1 is \$24.95 and Mind-Step 2 is priced at \$29.95. Both courses are available for \$49.90. For further information, contact TYC Software, 40 Stuyvesant Manor, Geneseo NY 14454.

Circle 641 on inquiry card.

## 16K EPROM CARD-S 100 BUSS

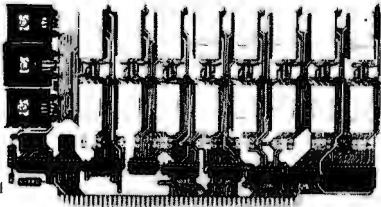

**\$59.95**  
KIT

OUR  
BEST  
SELLING  
KIT!

USES 2708's!

Thousands of personal and business systems around the world use this board with complete satisfaction. Puts 16K of software on line at **ALL TIMES!** Kit features a top quality soldermasked and silk-screened PC board and first run parts and sockets. All parts (except 2708's) are included. Any number of EPROM locations may be disabled to avoid any memory conflicts. Fully buffered and has WAIT STATE capabilities.

OUR 450NS 2708'S  
ARE \$8.95 EA. WITH  
PURCHASE OF KIT

ASSEMBLED  
AND FULLY TESTED  
ADD \$25

## 8K LOW POWER RAM KIT-S 100 BUSS SALE

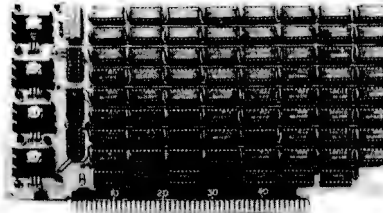

PRICE  
CUT!

**\$119.50**  
KIT

(450 NS RAMS!)

Thousands of computer systems rely on this rugged, work horse, RAM board. Designed for error-free, NO HASSLE, systems use.

### KIT FEATURES:

1. Doubled sided PC Board with solder mask and silk screen layout. Gold plated contact fingers.
2. All sockets included.
3. Fully buffered on all address and data lines.
4. Phantom is jumper selectable to pin 67.
5. FOUR 7805 regulators are provided on card.

Blank PC Board w/Documentation \$29.95  
Low Profile Socket Set...13.50  
Support IC's (TTL & Regulators) \$9.75  
Bypass CAP's (Disc & Tantalums) \$4.50

ASSEMBLED AND FULLY  
BURNED IN ADD \$30

## 16K STATIC RAM KIT-S 100 BUSS

PRICE CUT!

**\$279** KIT

FOR 250NS  
ADD \$10

FULLY  
STATIC, AT  
DYNAMIC PRICES

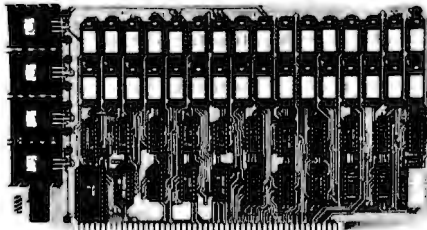

### WHY THE 2114 RAM CHIP?

We feel the 2114 will be the next industry standard RAM chip (like the 2102 was). This means price, availability, and quality will all be good! Next, the 2114 is FULLY STATIC! We feel this is the ONLY way to go on the S-100 Buss! We've all heard the HORROR stories about some Dynamic Ram Boards having trouble with DMA and FLOPPY DISC DRIVES Who needs these kinds of problems? And finally, even among other 4K Static RAM's the 2114 stands out! Not all 4K static Rams are created equal! Some of the other 4K's have clocked chip enable lines and various timing windows just as critical as Dynamic RAM's. Some of our competitor's 16K boards use these "tricky" devices. But not us! The 2114 is the ONLY logical choice for a trouble-free, straightforward design.

### KIT FEATURES:

1. Addressable as four separate 4K Blocks
2. ON BOARD BANK SELECT circuitry. (Cromemco Standard!). Allows up to 512K on line!
3. Uses 2114 (450NS) 4K Static Rams.
4. ON BOARD SELECTABLE WAIT STATES
5. Double sided PC Board, with solder mask and silk screened layout. Gold plated contact fingers.
6. All address and data lines fully buffered.
7. Kit includes ALL parts and sockets.
8. PHANTOM is jumpered to PIN 67.
9. LOW POWER: under 2 amps TYPICAL from the +5 Volt Buss.
10. Blank PC Board can be populated as any multiple of 4K.

BLANK PC BOARD W/DATA—\$33  
LOW PROFILE SOCKET SET—\$12 ASSEMBLED & TESTED—ADD \$30  
SUPPORT IC'S & CAPS—\$19.95

## 16K STATIC RAM SS-50 BUSS

PRICE CUT!

**\$275** KIT

FULLY STATIC  
AT DYNAMIC PRICES

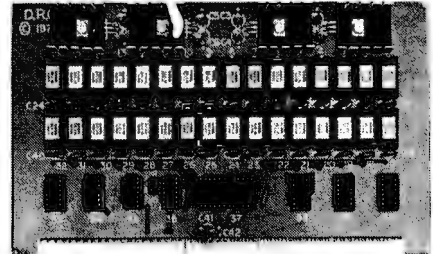

### KIT FEATURES:

1. Addressable on 16K Boundaries
2. Uses 2114 Static Ram
3. Runs at Full Speed
4. Double sided PC Board. Solder mask and silk screened layout. Gold fingers.
5. All Parts and Sockets included
6. Low Power: Under 2 Amps Typical

FOR SWTPC  
6800 BUSS!

ASSEMBLED AND  
TESTED - \$30

BLANK PC BOARD—\$33 COMPLETE SOCKET SET—\$12  
SUPPORT IC'S AND CAPS—\$19.95

## S-100 Z80 CPU CARD

ASSEMBLED AND TESTED! READY TO USE! Over 3 years of design efforts were required to produce a TRUE S-100 Z80 CPU at a genuinely bargain price! **4 MHZ! \$159.95**

FFATI IRFS:

- \* 2 or 4 MHZ Operation.
- \* Generates MWRITE, so no front panel required.
- \* Jump on reset capability
- \* 8080 Signals emulated for S-100 compatibility.
- \* Top Quality PCB, Silk Screened, Solder Masked, Gold Plated Contact Fingers.

Perfect For  
OEM's

## LOW POWER - 250NS 2114 RAM SALE!

4K STATIC RAM'S. MAJOR BRAND, NEW PARTS.  
These are the most sought after 2114's, LOW POWER and 250NS FAST. **\$7.50 ea. or 8 For \$55**  
SPECIAL SALE: (We reserve the right to limit quantities.)

NOT ASSOCIATED WITH DIGITAL RESEARCH OF CALIFORNIA. THE SUPPLIERS OF CPM SOFTWARE.

**Digital Research: Computers**  
(OF TEXAS)

P.O. Box 401565 • GARLAND, TEXAS 75040 • (214) 494-1505

PROC. TECH. QUILTS THE MICROPROCESSOR BUSINESS!  
FACTORY CLOSE OUT - SPECIAL PURCHASE!  
#16KRA

## 16K S-100 Dynamic Ram Board - \$149.95

ORIGINALLY PRICED AT \$429 each!

We purchased the remaining inventory of PT's popular 16K Ram Board when they recently closed their plant. Don't miss the boat! These are brand new, fully tested, ASSEMBLED and ready to go. All are sold with our standard 90 day limited warranty!!

72 Page Full Manual, Included Free!

TERMS: Add 50¢ postage, we pay balance. Orders under \$15 add 75¢ handling. No C.O.D. We accept Visa, MasterCard, and American Express cards. Tex. Res. add 5% Tax. Foreign orders (except Canada add 20% P & H) 90 Day Money Back Guarantee on all items.



# HOBBY

Your one-stop mail order

## California Computer Systems Available at HOBBY WORLD

### Model 2500A S-100 Wire Wrap Board

- S-100 BUS compatible
- Double sided PC board
- Plated thru holes
- Perimeter ground
- All S-100 BUS signals labeled and numbered
- Accommodates standard size IC sockets
- 4 to 220 regulator positions available
- Allows either positive or negative regulators
- Dense hole configuration

Cat No. 1600 \$ 27.00

### Model 2501A S-100 Solder Board

- S-100 BUS compatible
- Double sided PC board
- Plated thru holes
- Perimeter ground
- All S-100 BUS signals labeled and numbered
- Accommodates standard size IC sockets
- 4 to 220 regulator positions available
- Allows either positive or negative regulators
- Dense hole configuration

Cat No. 1604 \$ 27.00

### Model 2501A S-100 Mother Board

- 12 slot capability
- All 12 S-100 bus connectors included
- Low inductance inner-connect to reduce signal noise and crosstalk
- Active termination of all bus lines to further reduce signal noise and line reflections
- Distributed bypassing of all power lines
- Solder mask both sides of board
- Silkscreen of reference designations
- Simple strong board mounting
- Criss-cross BUS lines both sides of board
- All holes plated thru
- Solder plated circuit area

Cat No. 1616 Kit \$ 90.00  
Cat No. 1615 A&T \$ 105.00

### Model 2520A S-100 Extender/ Terminator

- Active and/or dynamic termination
- All power lines fused for protection
- All S-100 lines labeled and numbered
- Can be used as an extender and/or terminator
- Solder mask both sides of board
- Silkscreened reference designations
- Gold plated fingers

Cat No. 2520 Kit \$ 37.95

### Model 7811A Apple II Arithmetic Processor

- Based on AMD AM9511 device
- Fixed point 16 and 32 bit operation
- Floating point 32 bit operation
- Binary data formats
- Add, subtract, multiply, and divide
- Trigonometric and inverse trigonometric functions
- Square roots, logarithms, exponentiation
- Float to fixed and fixed to float conversions
- Stack oriented operand storage
- Programmed I/O data transfer
- End signal selectable interrupt
- Supports interrupt daisy chain
- Allows DMA daisy chain
- Power down ROM
- 256 bytes firmware (ROM) or software (RAM) space available

Cat No. 1635 \$375.00

### Model 7114A Apple II Prom Module

The 7114A PROM MODULE permits the addition or replacement of the Apple II firmware without the physical removal of the Apple II ROMS. This allows software/firmware replacement, change, and/or patch to be made on a ROM or BYTE BASIS. An on-board enable/disable toggle switch is also available.

- BYTE oriented program overlay
- Selectable prom overlay
- Power down of PROMS
- 14K PROM space available
- Uses +5 volt 2716 type proms
- Allows use of DMA/interrupt daisy chains

Cat No. 1631 A&T \$ 72.00  
Cat No. 1630 Kit \$ 62.00

### Model 2016B S-100 16K Static Memory

- Fully static operation
- Uses 2114 type static rams
- +8 VDC input at less than 2 amps
- Bank select available by hunk part and bank byte
- Phantom line capability
- Addressable in 4K blocks in 4K increments
- 4K blocks can be located anywhere within 64K bank
- May be used as a 4K, 8K, 12K or 16K memory board
- Led indicators for board/bank active indication
- Solder mask on both sides of board
- Silk screen with part and reference designation
- Available fully assembled and tested, as a kit, or as a bare board

Cat No. 1609A Kit 450ns \$285.00  
Cat No. 1601B Kit 200ns \$340.00  
Cat No. 1602A A&T 450ns \$330.00  
Cat No. 1602B A&T 200ns \$385.00

### Model 7470A Apple II 3 3/4 Digit BCD A/D Converter

The 7470 allows conversion of a DC voltage to a BCD number for computer monitoring and analysis. Typical inputs would be DC inputs from temperature or pressure transducers.

- Selectable interrupt on end of conversion
- 200µs per conversion
- -4 to +4 VDC full scale
- Plus or minus .05% nonlinearity
- Plus or minus 1 count quantization
- Correctible offset error
- Temperature coefficient adjustment
- Calibration adjustment
- Input offset adjustment
- Floating inputs
- Overrange and sign indicators
- Input filter
- Power down ROM
- Supports interrupt daisy chain
- Allows DMA daisy chain
- 256 byte firmware (ROM) or software (RAM) space available

Cat No. 1621 Kit \$115.00  
Cat No. 1622 A&T \$135.00

### Model 2200A Mainframe

- S-100 compatible
- Industrial/commercial quality construction
- Flip-top cover
- Excellent cooling capability
- 12 slot capability (uses model 2501A)
- Input 105, 115, or 125 VAC
- Output +8 VDC, 20A + -16 VDC 4A
- Active termination of all bus lines
- Fan and circuit breaker included
- Rugged construction
- All parts available separately

Cat No. 1612 Kit \$330.00  
Cat No. 1614 A&T \$375.00

### Model 7440A Apple II Programmable Timer Module

- Flexible external interface patch area for custom interface applications
- Selectable prescaler on timer
- 3 capable of 4mbz input
- Programmable interrupts
- Readable down counter indicates counts to go to time-out
- Selectable gating for frequency or pulse width comparison
- Three asynchronous external clock and gate/trigger inputs internally synchronized
- Three maskable outputs to patch area
- Power down ROM
- Supports interrupt daisy chain
- Allows DMA daisy chain
- 256 byte firmware (ROM) or software (RAM) space available

Cat No. 1617 Kit \$135.00  
Cat No. 1618 A&T \$145.00

### Apple II Model 7712A Synchronous Serial Interface

- Conforms to RS-232C (configuration A thru E)
- Supports half or full duplex operation
- DTE type configuration
- Failsafe RS-232C operation
- 14 STD CLK rates 50-19.2K BAUD plus EXT CLK
- BAUD rates dip switch selectable
- All BAUD rates crystal controlled
- Programmable interrupts from transmitter, receiver, and error detection logic
- Character SYNC by one or two SYNC codes
- Programmable SYNC code register
- Standard synchronous signaling rate per RS-269/ANSI X3.1-1976
- Peripheral/modem control functions
- Three bytes of fifo buffering on both transmit and receive date
- 7,8, or 9 bit transmission
- Optional odd, even, or no parity bit
- Parity, overrun, and overflow status checks
- Power down prom
- 256 bytes firmware (ROM) or software (RAM) space available
- Supports interrupt daisy chain
- Allows DMA daisy chain

Cat No. 1627 Kit \$ 90.00

### Apple II Model 7710A Asynchronous Serial Interface

- Parity, overrun, and framing error check
- Optional divide by 16 clock mode
- False start bit detection
- Software programmable interrupts
- Data double buffered
- One or two stop bit operation
- Power down PROM
- 256 bytes firmware (ROM) or software (RAM) space available
- Supports interrupt daisy chain
- Allows DMA daisy chain
- 134.5 BAUD available for selective interface
- Conforms to RS-232C (configuration A thru E)
- Supports half or full duplex operation
- DCR type interface
- Failsafe RS-232C operation
- 14 STD CLK rates 50-19.2K BAUD plus EXT CLK
- BAUD rates dip switch selectable
- All BAUD rates crystal controlled except EXT
- 8 and 9 bit transmission
- Optional even, odd, and no parity bit
- Programmable control register

Cat No. 1624 A&T \$145.00  
Cat No. 1623 Kit \$ 90.00

### Model 7720A Apple II Parallel Interface

- Two bi-directional 8 bit buses for interface to peripherals
- Two programmable control registers
- Two programmable data direction registers
- Four individually controlled interrupt input lines; two useable as peripheral control outputs
- Handshake control logic for input and output peripheral operation
- High impedance 3 state and direct transistor drive peripheral lines
- Programmable interrupts
- CMOS drive capability on side A peripheral lines
- 2 TTL drive capability on all A and B side buffers
- Power down ROM
- Supports interrupt daisy chain
- Allows DMA daisy chain
- 256 bytes firmware (ROM) or software (RAM) space available

Cat No. 1633 A&T \$105.00  
Cat No. 1632 Kit \$ 62.00

### Model 7500A Apple II Wire Wrap Board

The 7500A is used for the prototyping or building of unique circuits for the Apple II computer.

- All bus signals labeled on board
- Perimeter ground
- Size: 7 inch long x 2.75 inch high
- All holes plated thru
- Gold plated connector fingers

Cat No. 1606 \$ 19.00

### Model 7510A Apple II Solder Board

The 7510A is the same as the 7500A except it is designed for soldering of circuits.

Cat No. 1607 \$ 19.00

### Model 7590A Apple II Etch Board

The 7590A is a two sided copper board which allows the actual etching of circuits for use in the Apple II computer.

Cat No. 1608 \$ 19.00

### Model 7520A Apple II Extender Board

The 7520A is a handy tool when debugging or testing modules in the Apple II.

Cat No. 1611 Kit \$ 21.00

19511 Business Center Dr. Dept B11 Northridge, Ca. 91324



# WORLD<sup>®</sup>

computer store!

CALL TOLL FREE:  
(800)-423-5387

CA, HI, AK:  
(213) 886-9200



**BUY ANY 3 PROGRAMS, TAKE 10% OFF!**  
**BUY 10, TAKE 15% OFF**

## SMALL BUSINESS

### BOOKKEEPING

Based on the Dome Bookkeeping Journal, includes all phases except payroll.  
Cat No. 1043  
TRS-80 L2, 16K \$14.95

### ARCADE I

Kite flight, maneuver kites across terrain. Pinball, the excitement of arcade pinball.  
Cat No. 1986 PET, 8K \$7.95

### APPLE TALKER

Gives Apple the power of speech! Requires recorder and 2 mikes. Can be used as subtitles.  
Cat No. 1691 Apple II \$15.95

### APPLE LIS'NER

Communicate with your Apple via spoken words! Use your cassette recorder and mike.  
Cat No. 1692 Apple II \$19.95

### ADVENTURE

Explore an almost endless maze of treasures and pitfalls. Challenging and fun!  
TRS-80 L2, 16K.  
Cat No. 1723 \$14.95

### CUBES

Based on the game "Instant Insanity". Extremely challenging!  
Cat No. 1689 TRS-80, L2, 16K \$9.95

### CRIBBAGE

Plays according to Hoyle's Rules. You vs the computer.  
Cat No. 1179 TRS-80, L2, 16K \$9.95

### TAROT

Excellent graphics, frighteningly accurate!  
TRS-80 L1/L2 4K  
Cat No. 1042 \$5.95

### BACKGAMMON

You play against the computer! With hints on strategy, etc. Extremely good!  
TRS-80 L2-16K  
Cat No. 1481 \$10.95

### SANTA PAVARIA EN FIUMACCIO

Complex simulation of 15th century Italian citystate. Four levels of difficulty.  
Cat No. 1740 TRS-80, L2, 16K \$7.95

### INVENTORY MODULAR

Features cost/value summary, reports, recorder search, index, detailed report, read and write file, data base change.  
Cat No. 1038  
TRS-80 L2, 16K \$19.95

### PET GRAPHICS

DOODLER lets you draw and save for later use. PLOTTER plots curves given a function and a variable, LETTER formats large letters.  
Cat No. 1684 PET, 8K \$14.95

## SPACE GAMES I

Full color graphics, with ROCKET PILOT (advanced lunar lander), SAUCER INVASION (shooting down alien saucers), DYNAMIC BOUNCER (color demo).  
Cat No. 1731 APPLE II, 16K \$7.95

## SOUNDWARE

Add music and sound effects to your programs. Complete with software and hardware. Installs in seconds.  
Cat No. 1899 PET, 8K \$29.95  
Cat No. 1898 TRS-80, L2 \$29.95

## NEWDOS +

Better than TRSDOS! Allows DIR while in basic, and then returning to basic. DIRCHECK, DISASSEM, EDTASM, and SUPERZAP! A must for disk owners!  
Cat No. 1549 TRS-80, L2+ disks \$9.99

## RENUMBER

Renumbers program lines to your specifications. Machine language.  
TRS-80 L2, 4-48K.  
Cat No. 1039 \$14.95  
TRS-80 L2, 16-48K w/disk  
Cat No. 1680 \$24.95

## BARRICADE

Similar to breakout. A real time game, with options of speed, halls, angle, etc.  
TRS-80 L1/L2 16K.  
Cat No. 1362 \$14.95

## SYSCOP

Duplicates SYSTEM tapes (for backup).  
TRS-80 L2, 4K.  
Cat No. 1681 \$9.95

## ANDROID NIM II

Super improved version of NIM. Constant excitement!  
TRS-80, L2, 16K.  
Cat No. 1686 \$14.95

## TREK-X

A pet version of Star Trek, with optional sound effects. Superb graphics! Exciting!  
PET, 8K.  
Cat No. 1564 \$7.95

## TRS-232

Software driven RS232 output port for printers. Installs in seconds.  
TRS-80 L2, 4-48K.  
Cat No. 1199 \$49.95

## MACHINE LANGUAGE

RSM-2. Monitor and disassembler, interact directly with the Z80.  
TRS-80 L2, 16K  
Cat No. 1189 \$26.95  
TRS-80, L2, 16-48K, w/disk  
Cat No. 1190 \$29.95

## AIR RAID

An arcade-type real time game of target practice. Excellent Graphics.  
TRS-80 L1/L2 4K  
Cat No. 1186 \$14.95

## DISK/DISKETTE BINDERS

Organizes and protects your data files! 5 1/4" disks fit two per insert, 8" fit one per insert. Binders includes 10 inserts.  
Cat No. Description Price  
1450 5 1/4" binder \$9.95  
1651 8" binder \$9.95  
1653 extra 8" inserts .95  
1652 extra 5 1/4" inserts .95

## PET

### 8K PET \$750

With built-in cassette.  
Cat No. 1123

### 16K PET \$965

Large keyboard, plus numeric keypad.  
Cat No. 1824

### 32K PET \$1165

Standard keyboard, no graphics keys.  
Cat No. 1825

## EXIDY SORCERER

### SORCERER \$995

With 8K RAM. Cat No. 1999

### SORCERER \$1095

With 16K RAM. Cat No. 1904

### SORCERER \$1349

With 32K RAM. Cat No. 1772

Cat No. 1773 \$-100

Expansion \$329

Cat No. 1903 Development Pac 90

Cat No. 1775 Word processing pac 90

Cat No. 1776 Dual Disk 1825

## COMPUCOLOR

### 8K RAM 72KEY

\$1485 Cat No. 1865

### 16K RAM, 72 KEY

\$1680 Cat No. 1866

### 32K RAM, 72 KEY

\$2280 Cat No. 1867

Cat No. 1868 101 key option add \$140

Cat No. 1869 117 key option add \$210

Cat No. 1991 add-on disk \$500

Cat No. 1992 RS232 adaptor \$147

## VERBATIM CERTIFIED CASSETTES \$2.95 each

Certified specifically for personal computers such as the TRS-80, Apple, Pet, etc. Splice-free, leaderless, with folding recording tabs.  
Cat No. 1945

## TIL305

### DOT MATRIX READOUTS

\$5.50 4 for \$20

Pin-for-pin equal to MAN2A. Red LED, 5 x 7 matrix, plus decimal. 3" char. Cat No. 1931

## LEEDEX

### 12" MONITORS

Black and white, high resolution. Accepts composite input. No air shipments.  
Cat No. 1204 \$139

**BUY ANY 3 PROGRAMS, TAKE 10% OFF!**  
**BUY 10, TAKE 15% OFF**

## LEVEL II DISK

### CONVERSION

Allows level 2 tapes to be converted to disk, and executed directly from TRSDOS.  
TRS-80, L2, 16-48K w/disk.  
Cat No. 1309 \$9.95

## 8080/TRS-80

### EDITOR ASSEMBLER

Lets you create, assemble, execute, and debug using 8080 mnemonics. TRS-80, L2, 16K  
Cat No. 1188 \$29.95

## ELECTRIC PENCIL

The famous word processor for the TRS-80 L1/L2 16K  
Cat No. 1338 \$95  
L2 diskette version  
Cat No. 1338D \$145

## BRIDGE

### CHALLENGER

You and dummy play against the computer in regular contract bridge. Either you or comp sets up.  
TRS-80 L2, 16K  
Cat No. 1195 \$14.95

Apple 16K  
Cat No. 1196 \$14.95

## LEVEL III BASIC

Gives your TRS-80 the power of a full size system. Disk commands, advanced editing, etc.  
TRS-80 L2, 16K  
Cat No. 1332 \$49

## FORTRAN PLUS

By Microsoft! For TRS-80 L2 with 32K and single disk.  
Cat No. 1341 \$340

## STAR TREK III

The most advanced version we've seen!  
TRS-80 L2, 16K  
Cat No. 1041 \$14.95

## MICROCHESS

Graphic Chessboard with 3 levels of play.  
TRS-80 L1/L2, 4K  
Cat No. 1182 \$19.95  
Apple II  
Cat No. 1183 \$19.95

## TRS-80 UTILITY I

Duplik, duplicates basic, assembly, and machine language programs, copies level 1 onto level 2. Renum, for renumbering basic programs.  
Cat No. 1983 TRS-80 L2, 16K \$7.95

## TRS-80 UTILITY 2

CFETCH searches tapes for file names, merges programs with consecutive line numbers. CWRITE combines subroutines, basic or machine language.  
Cat No. 1984 TRS-80 L2, 16K \$7.95

## MICRO TEXT EDITOR

Full text editing, economical, features non-destructive cursor. Machine language, uses 3K ram.  
TRS-80, L2, 4K w/printer.  
Cat No. 1049 \$9.95

## TRS-80 CP/M

Allows software interchange with all other CP/M programs. 6 commands plus utilities.  
TRS-80, L2, 16K w/disk.  
Cat No. 1679 \$149.95

## NAME & ADDRESS SYSTEM

A modular mailing list system, handles 500-1000 names per disk. You can enter, correct, search, sort, and more!  
Cat No. 1738  
TRS-80 L2, 32K + 2 disks \$99.95

## HOUSEHOLD ACCOUNTANT

Budget and expense analysis, life insurance cost comparison, datebook.  
Cat No. 1985 TRS-80 L2, 16K \$7.95

## INVENTORY SYSTEM II

Handles up to 1000 items per disk, and features activity, complete inventory listings, selected inventory listings, minimum quantity search. Uses the following data fields: class #, item #, vendor #, location, quantity, cost, selling price, and date.  
Cat No. 1737  
TRS-80, L2, 32K w/2 disks \$99.95

## MACHINE LANGUAGE MONITOR

Allows you to interact directly with the TRS-80 at machine language level. 11pp manual.  
TRS-80 L1/L2  
Cat No. 1048 \$23.95

Send for  
FREE  
CATALOG

The best selection of computer accessories add-ons, factory fresh IC's, led's, semi's, software, PC aids, prototyping aids, books, test equipment, and more! Always updated! Dozens of new products every issue!

## HOW TO ORDER

Pay by check, COD, VISA, or Mastercard. Charge orders include expiration date. Order by phone or mail. Minimum order \$10. Please include phone number and magazine/issue you are ordering from. USA: add \$2 for shipping/handling ground, add \$3 for air. FOREIGN: Add \$3 for shipping/handling surface, \$6 for air. COD's \$1 add'l. Guaranteed satisfaction for 120 days or your money back! Not responsible for typographical errors. We reserve the right to limit quantities.

19511 Business Center Dr. Dept B11 Northridge, Ca. 91324

## APPLE II



### 8" DISK CONTROLLER

#### APPLE DOS COMPATIBLE

- DOUBLES APPLE II™ STORAGE
- SHUGART 800/801 COMPATIBLE
- STANDARD IBM™ 3740 FORMAT
- CPM™, UCSD PASCAL™ CAPABILITY

Available at your local APPLE Dealer. \$400.



SORRENTO VALLEY ASSOCIATES  
11722 SORRENTO VALLEY RD.  
SAN DIEGO, CA 92121

Circle 347 on inquiry card.

### DATA PROCESSING SUPPLIES

- BASF Floppies . . . \$2.98 ea.
- Mini Floppies . . . . 2.49 ea.
- Centronics Ribbons  
5.95 dz.

Other Supplies  
At Similar Bargains

Order Now from  
John Richards

**KEY SUPPLY CO.**  
2101 S. IH 35 Suite 300  
Austin, Texas 78741  
TOLL FREE (800) 241-7320

*All products from major manufacturers, fully guaranteed. No limit while quantities last!*

Circle 201 on inquiry card.

### Network Planning on TRS 80

Calculating PDM-critical path.  
3 relationtypes; max 100 activities  
each with max 6 relations with float  
Results disp. or printed in 5 sorts:  
EST, ECT, LST, ECT, Float. Cass. i/o  
For 16K/level II on cass.....\$ 127

#### Messages in big letters!

For demo, showroom, teaching etc.  
Over 200 words from cass. or key-  
board automatically displayed, rol-  
ling or paging 4 lines of 16 char.  
Upper/lower case 4x4 times bigger!  
For 16K/level II on cass.....\$ 49

Send check to

## INFOCIENT

postbox 173 9640 AD Veendam  
Netherland

Circle 179 on inquiry card.

### a TRS-80 basic renumbering program that does more

Renumber a program in any desired manner in one pass • renumbers even the longest programs in seconds • changes all line number references • rearranges program order • easily repeated use because commands are BASIC remarks • returns original BASIC program on errors • called from BASIC, returns to BASIC • specify 4 or 16K Level II or 32 or 48K DOS

Tested cassette/program both sides \$20

TRS-80 acting up? • check your RAM with our ver-sa-tile RAM check • runs until interrupted - finds permanent and intermittent bad memory • memory size independent

Tested cassette/program both sides \$10

**MICROBIOTIC COMPUTING, INC.**  
6515 ROSS AVENUE S.E.  
ALBUQUERQUE, NEW MEXICO 87108



- **APPLE II or APPLE II PLUS** \$1019.95
- **DCHAYES MODEMS** 339.95
- **FLOPPY DISK W/CONT.** 529.95
- **APPLE SOFT CARD** 159.95
- **PASCAL CARD** 459.95
- **ALF MUSIC SYNTHESIZER** 249.95
- **10 MEGA-BYTE DISK DRIVE (for APPLE)** 4695.00

**UCATAN COMPUTER STORE**

across from Ramada Inn  
PO Box 1000

Destin, Florida 32541

(904) 837-2022 or (904) 243-8565

Circle 309 on inquiry card.

### tinyFORTH

**tinyFORTH** is the TRS-80 cassette oriented version of the dictionary based computer language called FORTH.

**tinyFORTH** includes these features:

- ✓ Dictionary-oriented structured high-level language
- ✓ Built-in assembler and text editor
- ✓ Enhanced graphics
- ✓ Cassette tape input and output
- ✓ Interpreter for quick program development
- ✓ Compiler for fast execution
- ✓ **tinyFORTH** is faster, more compact, and more powerful than BASIC
- ✓ **tinyFORTH** and **FORTH** programs are interchangeable
- ✓ Easy to use.

**tinyFORTH** cassette for 16K TRS-80 and full documentation.....\$29.95  
Documentation Only .....\$9.95

All orders are fully guaranteed. Add \$1.50 for postage and handling. Order with check, money order, COD, Visa, or MasterCard. Specify TRS-80 level when ordering.

**The Software Farm**  
Box 2304 Dept. A4 Reston, VA 22090

Circle 333 on inquiry card.

### 8048 Family

A one board microcomputer utilizing the 8035 geared toward stand alone applications with:

- one 8-bit input port
- one 8-bit output port
- one 8-bit bidirectional port
- fully programmable hand shake lines on each port
- crystal based timer
- 64 bytes RAM, expandable to 1k bytes
- provisions for program memory to 4k bytes
- single supply capability [+5V]
- low cost (\$4.95 - singles)

Money order, Check, or C.O.D.  
Send orders to:

**Adroit Electronics, Inc.**  
5 East Long Street  
Suite 1012  
Columbus, Ohio 43215  
614-221-3060

Circle 5 on inquiry card.

### IN CALIFORNIA COMPUTER STORE OF SAN LEANDRO

Mainframes  
Personal Computers  
S100 Bus Boards  
Systems  
Software  
Peripherals  
Supplies  
Books  
Magazines

701 MacArthur Blvd  
SAN LEANDRO, CA  
(415) 569-4174

Circle 70 on inquiry card.

### SURPLUS ELECTRONICS

ASCII



ASCII

**IBM SELECTRIC  
BASED I/O TERMINAL  
WITH ASCII CONVERSION  
INSTALLED \$645.00**

- Tape Drives • Cable
  - Cassette Drives • Wire
  - Power Supplies 12V15A, 12V25A, 5V35A Others.
  - Displays
  - Cabinets • XFMRs • Heat Sinks • Printers • Components
- Many other items. SEND \$1.00 FOR CATALOG REFUNDABLE FIRST ORDER  
**WORLDWIDE ELECT, INC.**  
130 Northeastern Blvd.  
Nashua, NH 03060  
Phone orders accepted using  
VISA or MC  
Call 603-889-7661

Circle 391 on inquiry card.

# page

## Precut Wire Wrap Wire

PRECUT WIRE SAVES TIME AND COSTS LESS THAN WIRE ON SPOOLS

Kynar precut wire. All lengths are overall, including 1" strip on each end. Colors and lengths cannot be mixed for quantity pricing. All sizes listed are in stock for immediate shipment. Other lengths available. Choose from colors: Red, Blue, Yellow, Orange, Black, White, Green and Violet. One inch tubes are available at 50¢. State second choice on colors when possible.

Length	100	500	1,000	Length	100	500	1,000
2.5 inches	1.04	2.98	5.16	6.5 inches	1.60	5.37	9.84
3	1.08	3.22	5.65	7	1.66	5.63	10.37
3.5	1.13	3.46	6.14	7.5	1.73	5.89	10.91
4	1.18	3.70	6.62	8	1.78	6.15	11.44
4.5	1.23	3.95	7.12	8.5	1.82	6.41	11.97
5	1.28	4.20	7.61	9	1.87	6.76	12.51
5.5	1.32	4.48	8.10	9.5	1.92	6.93	13.04
6	1.37	4.72	8.59	10	1.99	7.26	13.57

Kit #1 Less than 2.7¢/ft. (#30)	\$7.95	Kit #2 Less than 2¢/ft. (#30)	\$19.95	KIT #3 Less than 1.7¢/ft. (#30)	\$24.95	Kit #4 Less than 1.6¢/ft. (#30)	\$44.95	#30 Spools	1-4	5-9	10+
250 3" 100 4"		250 2½" 250 5"		500 2½" 500 4½"		1000 2½" 1000 4½"		50 ft.	1.75	1.60	1.40
250 3" 100 5"		500 3" 100 5½"		500 3" 500 5"		1000 3" 1000 5"		100 ft.	3.00	2.75	2.50
100 4" 100 6"		500 3½" 250 6"		500 3½" 500 5½"		1000 3½" 1000 5"		250 ft.	4.75	4.50	4.25
		500 4" 100 6½"		500 4" 500 6"		1000 4" 1000 6"		500 ft.	8.50	8.00	7.50
		250 4½" 100 7"						1000 ft.	14.50	12.50	10.50

## Wire Wrap Tool

### BATTERY HOBBY TOOL\*

- Auto Indexing
- Anti-Overwrapping
- Modified Wrap
- Includes #30 Bit

BW2628	Tool .....	\$19.85
BT30	#30 Bit .....	2.95
BT2628	#26 Bit .....	7.95
BC1	Batteries & Charger...	11.00

\*Requires 2 "C" Niced Batteries



## NOVEMBER SALES!

### Solderless Breadboarding

SK10 ~~2/\$25.00~~ **\$18.50**  
The SK10's unique matrix configuration is embedded in a high temperature plastic molding. It gives you 64 pairs of 5 common spring contacts for principle circuit construction and a series of common buss strips (8) of 25 connections each.  
Dimensions: .33"h x 2.2"w x 6.5"l

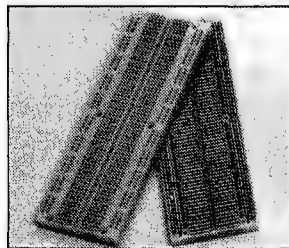

### TI Edge Card Connectors

44 pin ST	(.156" centers)	Gold	1.95
100 pin ST	(.125" centers)	Gold	2.50
100 pin WW	(.125" centers)	Gold	2.95

All are Gold 100 pin, IMSAI spacing.

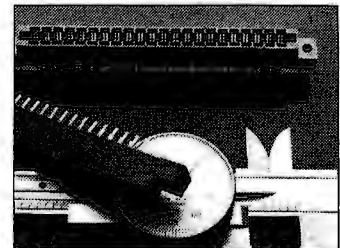

## RNIC Sockets

RN HIGH RELIABILITY eliminates trouble. "Side-wipe" contacts make 100% greater surface contact with the wide, flat sides of your IC leads for positive electrical connections.

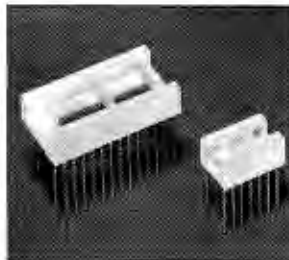

WIRE WRAP SOCKETS	Size	Quant./Tube	Price Ea.	Price/Tube
3-level Gold	08 pin WW	52	.31	\$16.12
Closed Entry Design	14 pin	60	.32	\$19.20
	16 pin	52	.34	\$17.68
All prices include Gold	18 pin	23	.50	\$11.50
2-level Sockets	20 pin	21	.65	\$13.65
Also Available	22 pin	19	.70	\$13.30
Sockets sold at these prices by the tube only.	24 pin	10	.70	\$7.00
	28 pin	10	.95	\$9.50
	40 pin	7	1.20	\$8.40

#### ORDERING INFORMATION

- Orders under \$25, add \$2 handling
- Blue Label or First Class, add \$1 (up to 3 lbs.)
- CODs, VISA & MC orders will be charged shipping
- Most orders shipped next day

AVAILABLE AT SELECTED LOCAL DISTRIBUTORS

page

135 E. Chestnut Street 5A, Monrovia, California 91016 Phone (213) 357-5005

## FLOPPY DISK REPAIR



- PerSci and Shugart
- Quick turnaround
- Eight inch and minis



COMPUTER SERVICE CENTER  
7501 Sunset Blvd  
Hollywood CA 90046  
213-851-2226

Circle 68 on inquiry card.

## TRS-80, PET, APPLE, SORCERER Hardware/Software Systems

Available now:

- HAM INTERFACE--including the most sophisticated RTTY systems money can buy.
- Baudot and ASCII printer interfaces.
- Electra Sketch®, ANIMATION GRAPHICS Compiler

Write or call for free catalog

**MACROTRONICS, inc.**

P.O. Box 518 (A) Keyes, CA 95328  
(209) 634-8888 / 667-2888

We are experiencing telephone difficulties, please keep trying.

Circle 206 on inquiry card.

C-10 SHORT CASSETTES 50 FT.

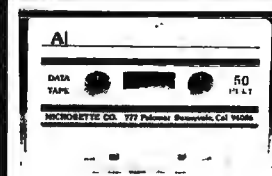

Qty.	Price
1	\$1.00
10	\$0.75
50	\$0.65

Premium tape and cassettes acclaimed by thousands of repeat order microcomputer users. Price includes labels, cassette box and shipping in U.S.A. VISA and M/C orders accepted. California residents add sales tax. Phone (408) 735-8832.

**MICROSETTE CO.**  
777 Palomar Avenue  
Sunnyvale, CA 94086

Circle 227 on inquiry card.

## Memorex Floppy Discs

Lowest prices. WE WILL NOT BE UNDERSOLD!! Buy any quantity 1-1000. Visa, Mastercharge accepted. Call free (800)235-4137 for prices and information. All orders sent postage paid.

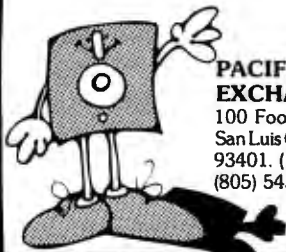

**PACIFIC EXCHANGES**  
100 Foothill Blvd.  
San Luis Obispo, CA  
93401. (In Cal. call  
(805) 543-1037.)

Circle 294 on inquiry card.

## CROMEMCO SYSTEMS DISCOUNTED

System 2 with 64k RAM—\$3195  
System 3 with 32k RAM—\$4795  
with 64k RAM—add \$ 595

Discounts up to 20% on most Cromemco hardware. We carry the full Cromemco line.

**TORREY PINES BUSINESS SYSTEMS**  
14260 Garden Rd., Suite 8A  
Poway Space Center  
Poway, California 92064

Add 3% for shipping and handling  
California residents add 6% sales tax

Circle 375 on inquiry card.

## LIFETIME GUARANTEED QUARTZ CRYSTALS

1.000	5.000	11.1550
1.8432	5.0688	12.440
2.000	5.185	14.3182
2.0971	5.2428	15.000
2.4576	5.7143	17.2422
2.500	6.000	18.000
3.000	6.144	18.432
3.2768	6.5536	20.000
3.579	6.7584	22.1184
4.000	8.000	27.300
4.1943	8.1818	32.000
4.1152	10.000	36.000

ALL ABOVE MIX 1-9 4.50  
MIX 10+ 3.95

ADD 5% SHIPPING  
CAL. RES. - ADD 6% SALES TAX

FREE OSCILLATOR SCHEMATICS WITH ANY ORDER

**QUALITY COMPUTER PARTS**  
P.O. BOX 743/CHATSWORTH, CA. 91311

Circle 323 on inquiry card.

### FIVE DISKLESS TRS-80 PROGRAMS:

- (1) TELEPHONE/ADDRESS/MAILING - NAME & ZIP SORT. EVEN RETRIEVES NAME FROM PHONE #. VERY QUICK ACCESS OF OVER 120 LISTINGS @ 16K, 300 @ 32K
- (2) CHECKBOOK - KEEP UP WITH THE BANK. CAN 170 EASILY ACCESSIBLE LISTINGS COVER A YEAR'S ACTIVITY?
- (3) TAX RECORDER - LISTS YOUR YEARLY TAX DEDUCTIBLE EXPENSES. ADDS ALL YOUR COLUMNS, SAVES PENCILS.
- (4) FOOD FOR THE HEAD - NUTRITIONAL CONTENTS OF FOODS, VITAMINS, MINERALS, AMINO ACIDS, CARBOHYDRATES, FATS, FIBER, PROTEIN, CALORIES. 16K \$40, 32K \$60
- (5) MANDALAS FOR THE CYBERNETIC AGE - WARNING: HIGHLY HYPNOTIC GRAPHICS. 2 SETS OF 4 INTERWEAVING DESIGNS.

ALL ABOVE LEVEL II. 16K \$30 OR AS NOTED.

LOWECO ALSO CARRIES MICROSOFT, TSE AND TBS FOR THE TANDY TRADEMARK TRS-80. SEND \$2 FOR CATALOG.

**LOWECO COMPUTER**  
1803 RODNEY  
LOS ANGELES CA 90027  
213-660-7530

Money Order, Cashier Check Speeds Delivery  
6% Sales Tax For Californians

Circle 207 on inquiry card.

## TRS-80 16K LEVEL II GAMES (Distributed on Cassette)

**MICRO FOOTBALL:** Superior Graphics display a playing field, moving players and a flying ball. A scoreboard (with clock) keeps track of the game. Two must play. The combination of the plays selected by the offense and defense determines the gain or loss. JUST LIKE THE REAL THING! Instructions included ..... \$12.95  
**MICRO GOLF:** 18 holes of Championship golf. You select the club and how hard you want to hit the ball. (Watch out for water and hazards). This game is a combination of skill and chance. IT'S LOADS OF FUN ..... \$6.95

Circle your choices and mail with a check to:

**GLA ENTERPRISES, INC.**  
P.O. Box 125  
Reisterstown, MD 21136

Select both and pay only \$15.95

ORDER NOW TO RECEIVE IN TIME FOR CHRISTMAS

(MD Residents Include Sales Tax)

## COMPLETE BUSINESS AND FINANCIAL ANALYSIS PROGRAM

Portfolio, home ownership, real estate, yield to maturity, ROI, economic order quantity, and more - all in a single input/output format. Many examples. Completely documented. Diskette or cassette. Specify system. In source code for popular BASICs - \$36.

**Microcomputer Applications, Inc.**  
4614 Trail Crest Circle  
Austin, Texas 78735  
(512) 892-0156

(Dealer Inquiries Invited)

Circle 225 on inquiry card.





# Radio Hut

201 LOCHWOOD MALL • DALLAS, TEXAS 75218  
ORDER BY PHONE—214-324-5509

## Rockwell AIM-65: The Head-Start in Microcomputers

AKIM-1 compatible machine with on-board printer and a real keyboard!  
\$369.95 w/1K RAM  
\$445.95 w/4K RAM  
4K assembler/editor in ROM: \$80  
8K BASIC in ROM: 95.00  
Power Supply: \$54.95  
Case of AIM-65 \$45.95

The EXPANDORAM is available in versions from 16K up to 64K, so for a minimum investment you can have a memory system that will grow with your needs. This is a dynamic memory with the invisible on-board refresh, and IT WORKS!

- Bank Selectable
- Phantom
- Power 8VDC, +16VDC, 5 Watts
- Lowest Cost Per Bit
- Uses Major Brand 16K RAMS
- PC Board is doubled solder masked and has silk-screen parts layout
- Extensive documentation clearly written

## SD EXPANDORAM



- Complete kit includes all Sockets for 64K
- Memory access time: 375ns, Cycle time: 500ns.
- No wait states required
- 16K boundaries and Protection, via Dip Switches
- Designed to work with Z-80, 8080, 8085 CPU's

## EXPANDORAM 64K Kit(16K Ram)

16K	.....	\$226.00
32K	.....	\$286.00
48K	.....	\$359.00
64K	.....	\$426.00
WITHOUT MEMORY	.....	\$159.00

Please write for catalog or call for prices

## SD'S PROM-100 PROM Programmer Board

The PROM-100 Programmer is a development tool for S-100 Bus computer systems. The Zero Insertion Force Programming Socket extends above the card cage height for easy access to PROM devices. Software verifies PROM erasure, verifies program loading and provides for reading of object file from Disk or PROM and programming into PROM/EPROM. Features include: On-board generated 25vdc Programming pulse, TTL compatible, maximum programming time for 16,389 bits is 100 seconds. Programs: 2708, Intel 2758, 2716, 2732 and TI 2516. DIP Selectable EPROM type.

PROM-100 Board Kit \$ 149.95

## SD SYSTEM'S POWERFUL MPB-100 Z80 CPU Board Kit

The MPB-100 provides a Z80 microprocessor based CPU for S-100 Bus systems. Front panel usage is optional making the MPB-100 suitable for upgrading existing systems to Z80 level. A PROM socket is provided on-board which makes the MPB-100 adaptable to process control applications. Features include: Power-on Jump to 4K boundaries, 2 Megahertz or 4 Megahertz operation, optional wait states, on-board PROM socket.

MPB-100 Kit \$ 199.00

## SD'S VERSAFLOPPY II Enhanced Flexible Disk Drive Controller

• IBM 3740 Compatible Soft Sektored Format for Single Density Drives • Operates with Single and Dual Sided Drives, Single or Double Density Drives and 5" and 8" Drives. . . in any combination of four simultaneously • Drive Select and Side Select Circuitry • S-100 Bus Compatible • Vectored Interrupt Operation Optional • Phase Locked Loop Data Recovery Circuit • Operates with Z80 CPU's • Uses FD1791-1 Controller Chip • The Versafloppy II incorporates all the possible features of a flexible disk drive controller into one board. Capable of handling four drives simultaneously, combinations of any variety are possible, such as 5 inch single sided — 8 inch dual density dual sided — 8 inch single sided — 5 inch dual density single sided. Most popular drives are controlled directly with the Versafloppy II. The operating system for the Versafloppy II is the extremely powerful SDOS available for SD Systems. The Versafloppy II also has diagnostic and control software available to complete your disk system. 290.00 Kit, 385.00 Assembled & Tested

### LEDS AND READOUT

Jumbo Red LED's	8/1.00
Jumbo Green LED's	4/.95
Jumbo Yellow LED's	4/.95
Jumbo Amber LED's	4/.95
MV Red	10/1.00
FND 70CC	.50
DL 707	.95
DL 747CA	1.65
DL 728CC	1.19
FND 800CC	1.50
Red Filter 4" Bezel	2.50
Green Filter 4" Bezel	2.50
Amber Filter 4" Bezel	2.50
4N25	1.60
4N26	1.25
4N27	1.10
4N28	.95
4N31	1.20

## SD'S VDB-8024 Video Display Board

The VDB-8024 features its own on-board Z80 microprocessor. This gives the capability of using software (included in ROM) to control functions and enhancements without interference with the computer's CPU. Included in the special features: 80 characters by 24 lines display, Keyboard power and interface. Composite and separate video output. 2K on-board RAM, a total of 256 available characters, full cursor control, Forward and Reverse Scrolling, Underlining, Field Reverse. Field Protect enhancements, programmable characters.

VDB-8024 KIT \$ 319.00

## SD'S "VERSAFLOPPY I" KIT

FEATURES: IBM 3740 Soft Sektored Compatible, S-100 BNS Compatible for Z-80 or 8080. Controls up to 4 Drives (single or double sided). Directly controls the following drives: Shugart SA400/450 Mini Floppy • Shugart SA800/850 Standard Floppy • PERSCI 70 and 277 • MFE 700/750 • CDC 9404/9406 \$139.00

## MINIATURE SPEAKER SPECIAL!

2 INCH — 8 OHM.  
PERFECT FOR CLOCKS! \$79

### IC SOCKETS

PIN	Solder Tin		Low Profile			
	PIN	PIN	PIN	PIN	PIN	PIN
8	.12	16	.17	24	.32	40 .54
14	.15	18	.24	28	.39	20 26

### DIP SWITCHES

	Pos	\$1.10	7	\$1.22
3	"	\$1.12	8	" \$1.26
4	"	\$1.16	9	" \$1.36
5	"	\$1.20	10	" \$1.30

## Z80 STARTER KIT

SD System's Z80 Starter Kit enables the novice to build a complete microcomputer on a single board. Featuring the powerful Z80 microprocessor the Z80 Starter Kit features: • Keyboard and Display • Audio interface • PROM Programmer • Expansion and Wire Wrap Area • On Board RAM • 4 Channel Counter/Timer • Z-BUG Monitor in PROM • I/O Ports.

**THE BEST SELLING COMPUTER KIT ANYWHERE**  
\$226.95 Kit \$369.95 A&T

## SD'S SBC-100 SINGLE BOARD COMPUTER

The SBC-100 provides a complete micro-computer on a single board! The Z80 microprocessor is used as the heart of the SBC-100. The SBC-100 meets all the requirements of a Z80 CPU board with the added features of I/O ports, counter/timer channels, on board RAM, provisions for PROM/ROM and a software programmable baud rate generator. S-100 Bus compatible, the SBC-100 features are: 8K bytes of available PROM, 1024 bytes on-board RAM, Serial I/O with both synchronous and asynchronous operation, Parallel I/O ports, Optional Vectored Interrupts, and Four Counter/Timer Channels. SD Monitor available for RS-232 and Video Terminals. Disk based system software also available.

SBC-100 KIT \$226.00

## COMPUTER CORNER

CPU's	
Z80	..... 10.99
Z80A	..... 13.99

### RELATED CHIPS

2114 (300ns)	..... 5.99
Z80 PIO	..... 9.95
Z80CTC	..... 11.95
2708	..... 8.99
4115	..... 8 for 34.95
4116	..... 8 for 80.00

### DISC CONTROLLER

1771	..... 29.95
------	-------------

**TERMS:** Orders under \$15.00 add 75¢ handling. No C.O.D. We accept Visa, MasterCard, and American Express cards. Tex. Res. add 5% Tax. Foreign orders (except Canada) add 20% P&H. 90 Day Money Back Guarantee on all items. Add 5% Postage and Handling, maximum \$5.00.

Color Burst Crystal (3.57MHz) ..... 89¢

While in Dallas visit our retail store at Lochwood Shopping Center, Garland Road and Jupiter.

**Radio Shack** DEALER  
COMPUTER CENTER

**MICRO MANAGEMENT SYSTEMS**



**Up To 15% Discount on TRS-80's**

WE HAVE THE HIGHLY RELIABLE LOGODISK DRIVE IN STOCK!

MINI MALL—DOWNTOWN SHOPPING CENTER  
CAIRO, GEORGIA 31728  
912-377-7120

Circle 229 on inquiry card.

**SPECIAL PRICE**  
**IBM SELECTRIC I/O TERMINAL**  
**\$950.00**

Price Includes:

- 15" Carriage, Correspondance Typewriter  
Off Line Use As A Typewriter  
On Line 15 cps Quality Printer, Word Processor
- RS 232 C Smart Terminal Interface, Clocked or Fixed BAUD Rates - 110 To 9600
- L Shape KDS Desk 33" x 44" x 28" Formica Top
- Connector Cable

IBM Installed Electronics, Selectric I/O Service Manual Available from IBM

Many Sold. IBM Selectric Trade-in Accepted

For Information Write or Call



**Mohawk Typewriter**  
286 Genesee St  
Utica, N.Y. 13502  
(315) 735-5201

Circle 245 on inquiry card.

**CASSETTE DUPLICATION**

TRS-80 (I & II), PET, APPLE, KIM, ATARI

Quality software duplication is more than copying cassettes. Microsette duplication uses a proprietary high speed duplicator designed specifically for computer program duplication. The finished products are of consistent quality, guaranteed to load. Minimum order is 100 with discounts for higher quantities. Call (408) 735-8832 for details.



**MICROSETTE CO.**  
777 Palomar Avenue  
Sunnyvale, CA 94086

Circle 228 on inquiry card.

**SWTPC 6800 OWNERS**

AD - 8/1

**ANALOG TO DIGITAL CONVERTER**

- 8 Analog Input Channels
- Very Fast - 25µs A/D Conversion Time
- 1 Analog Output Channel with Sample and Hold
- Bipolar Input and Output
- Full 8 Bit Resolution
- Uses Single I/O Slot
- Fully Assembled and Tested
- Full Documentation Provided

**\$109.50**

**CCM, INC**  
P.O. Box 2308  
Reston, Va. 22091

Circle 42 on inquiry card.

**STATISTICAL DATA & SOFTWARE FOR TRS80**

**DATEBANK** programs contain 10 years of monthly statistical data on ten related subjects. Includes graphs, tables, trends, internal/external comparison, and capacity for data file expansion/update.

Six **DATABANK** programs now available for TRS-80 16K Level II Cassette.

- \* General Economy
- \* Manufacturing & Trade
- \* Industrial Production
- \* Money & Credit
- \* Money Rates & Yields
- \* Commodity Spot Prices

\$29.95 each . . . . . 3 for \$84.95  
Free cassette storage album with order for all six programs. Money orders speed delivery.

**DATABANK**  
POB 9283, Ft Lauderdale, FL 33310

Circle 90 on inquiry card.

**HIGH-TECH jewelry**

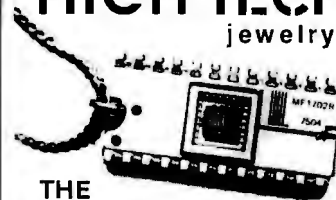

**THE COMPUTER MEMORY PENDANT**

A unique conversation piece and great way of telling your interests be known ten years ago such a jewel was unimaginable. Today this technology is transforming our lives and the stock exchange. The white ceramic and quartz package attracts attention, while a closer look reveals the intricacy and precision of the silicon circuit. This high tech symbol of the seventies is a genuine product of the micro-electronic revolution.

Pendant available on gold plated chain \$16.95 gold filled chain \$19.95 14K gold chain \$46.00 or as a stick pin \$14.95  
Send check or money order plus \$1.50 postage and handling to  
**HIGH-TECH JEWELRY** 290 LARKIN ST  
PO BOX 1099, BUFFALO, NY 14210

Circle 167 on inquiry card.

**MAXIMUM VALUE FOR YOUR DOLLAR**

NORTH STAR COMPUTER PRODUCTS		
DOUBLE DENSITY	KIT	ASM
HRZ-1-32K-D	\$1590.	\$1850.
HRZ-2-32K-D	1910.	2200.
MDS-A-D	550.	640.
EXTRA DRIVE	330.	
QUAD DENSITY	KIT	ASM
HRZ-1-32K-Q	\$1750.	\$2040.
HRZ-2-32K-Q	2230.	2560.
MDS-A-Q	720.	800.
EXTRA DRIVE	480.	

All HORIZONS now come standard with 3 ports and all edge connectors and minimum 32K memory.

BOARDS-DISCS	KIT	ASM
RAM-16K W/PARITY	\$300.	\$345.
RAM-32K W/PARITY	475.	520.
FPB-A	205.	270.

VERBATIM DISCS, BOX OF 10 . . \$29. PP  
We will try to beat any deal. Call:

**A.E.I.**  
3851 HACKETT AVE.  
LONG BEACH, CALIF. 90808  
(213) 421-4815

Circle 21 on inquiry card.

**Come Help Us Celebrate The Child**

St. Jude Children's Research Hospital continues its search for life-saving knowledge about catastrophic childhood disease. And this search continues because people care. There's no charge to patients or their families once admitted to its research studies by physician referral. The cost of drugs, equipment, and research programs is met primarily by public contributions. Help us celebrate the child by sending your tax-deductible check or request for further information to St. Jude Children's

Research Hospital,  
539 Lone Ave.,  
Memphis, TN 38105.

ST. JUDE CHILDREN'S RESEARCH HOSPITAL  
Denny Thomas, Fund

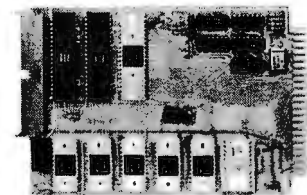

**SINGLE BOARD COMPUTER \$99.50\***

with 6800 MPU, 6850 serial I/O, 2 6820 parallel I/O (32 lines), 512 RAM, socket for 2708, 2716, EROM. Interface modules for industrial control, data acquisition, lab instrumentation, on 44 pin 4 1/2"x6 1/2" PCB's. RAM, ROM, CMOS RAM/battery, A/D, D/A, Driver/Sensor, Serial I/O, Parallel I/O, Counter/Timer, IEEE 488 GPIB, floppy controller.

\*OEM (500 piece) price

**WINTER** Corp.

1801 South Street  
Lafayette, IN 47904  
Phone (317) 742-8428

Circle 389 on inquiry card.

# save TRS-80

on add-on products for.....



## SUPER DISK .....

**\$695**

TF-7D Micropolis Largest capacity mini floppy, up to 195 Kbytes on 77 tracks with 77TKDOS+

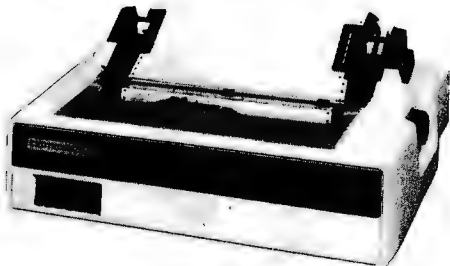

### PRINTERS

- LP779 Centronics 779 w/tractors ..... \$4099
- LP700 Centronics 700 ..... \$4495
- LP701 Centronics 701 ..... \$1759
- NEC Spinwriter ..... \$2499
- LP702 Centronics 702 ..... \$1899
- DP8000 Anadex Printer ..... \$ 990
- LP1 Centronics P1 ..... \$ 399
- Centronics cables ..... \$ 39

### SOFTWARE

Improve TRS-80 Performance With  
**NEW DOS+**

Over 200 modifications, corrections and enhancements to TRS DOS. Includes utilities. Available in two versions.

- 35 Track Version ..... \$ 99
- 40 Track Version ..... \$110
- Accounts Receivable .. \$ 39
- Inventory Control ..... \$ 39
- Electric Pencil ..... \$150
- Job Entry/Status ..... \$75
- General Ledger ..... \$79
- Game Diskette ..... \$19
- AJA Word Processor ..... \$75
- Radix ..... \$99

SEND FOR FREE CATALOG

ALL PRICES CASH DISCOUNTED • FREIGHT FOB/FACTORY

### NEW PRODUCTS

- Small System RS232 Interface ..... \$ 49.00
- Expansion Interface w/32K ..... \$499.00
- AC Line Interference Eliminator ..... \$ 18.95
- AC Isolator (6 connectors) ..... \$ 45.95
- Telephone Interface ..... \$179.95
- Verbatim 5" soft sector Diskettes ..... \$ 3.39
- 16KM 16K RAM Kit Computer ..... \$ 82.00
- 16 Key Pad Kit ..... \$ 68.00

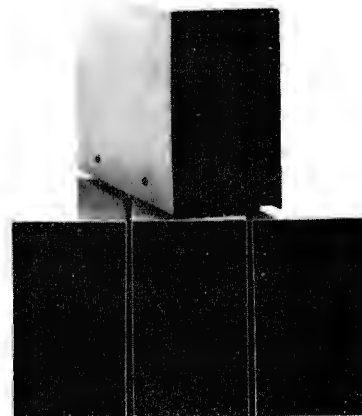

### Choose From A Complete Family Of DISK DRIVES...IN STOCK

ALL DISK DRIVE SYSTEMS COME COMPLETE WITH POWER SUPPLY AND CHASSIS.

- TF-1 Pertec FD200, 5 1/4", 40 track use both sides ..... \$382
- TF-3 Shugart SA400, 5 1/4", 35 tracks same as tandy ..... \$389
- TF-5 MPI 5 1/4", 40 track door lock and auto diskette ejection ..... \$379
- TDH-1 Pertec dual head 35 track same capacity as 2 drives ..... \$499
- Four Drive Cable ..... \$35. Two Drive Cable ..... \$25.

220 volt versions available.

### ADD-ON DISK DRIVES

DOES NOT INCLUDE POWER SUPPLY OR CHASSIS

- Pertec FD200 ..... \$282.00
- Shugart SA400 (unused) ..... \$286.00
- Pertec FD250 (Dual Head) ..... \$399.00
- MPI B-51 ..... \$279.00
- MP B-52 (Dual Head) ..... \$349.00



**MICROCOMPUTER  
TECHNOLOGY  
INCORPORATED**

2080 South Grand Ave.  
Santa Ana, CA 92705  
(714) 979-9923



6000 E. Evans Ave., Bldg. 2  
Denver, CO 80222  
(303) 758-7275

pparat, Inc.

# What's New?

## PERIPHERALS

### Real-Time Third Octave Audio Spectrum Analyzer

This real-time audio spectrum analyzer is designed to fit inside the Commodore PET computer. The analyzer divides the audio spectrum from 20 Hz to 20 kHz into 31 one-third octave bands, and displays those bands, with their relative amplitudes, on the PET screen. The unit can be used for measuring sound and noise levels, for optimizing the equalization of a music or public address system, for checking the frequency response of audio components, and for speech and sound pattern recognition (useful for voice control systems).

Because of the capabilities of the Commodore PET, great flexibility in the manipulation of the analyzed data is permitted. The PET can store and recall spectral data, and make comparisons with past, future, or other channel data. There is a Peak Hold feature, which enables the unit to determine whether any preset levels have been exceeded. Programs to access the analyzer are

written in BASIC; accordingly, three programs are provided with the unit: interactive operation, self-test, and minimal operation.

The analyzer comprises a single circuit board, which installs in about 5 minutes inside the PET. It has 31 one-third octave filters, detectors, an analog-to-digital converter, a 1 K byte read-only memory which contains machine language routines, and the necessary peripheral circuitry for transferring data into the PET memory. The board draws its power from the PET transformer.

The cost of the analyzer is \$595. For further information, contact Eventide Clockworks Inc, 265 W 54th St, New York NY 10019.

Circle 642 on inquiry card.

### New Tractor-Feed Impact Printer

The Model 440 Paper Tiger printer is a low-cost impact printer from Integral Data Systems Inc, 14 Tech Cr, Natick MA 01760. Standard Paper Tiger

features include full upper and lowercase 96-character set; adjustable form width; forms control with eight standard form lengths; both 80- and 132-column formats; choice of six or eight lines per inch vertical spacing; software-selectable character density; automatic multiline buffering; and both RS-232C serial and Centronics-compatible parallel interfaces. Multiple transmission rates from 110 to 1200 bits per second (bps) are also switch selectable. The new printer uses a stepper motor paper feed, and an automatic re-inking mechanism extends ribbon life. A variable character-size feature permits program controlled highlighting and formatting of copy.

The modular Paper Tiger uses a single printed circuit board that contains all printer electronics and uses a printhead rated at a life of over 100 M characters. An optional 2 K byte buffer and graphics package provides full dot-plotting graphics capability. The larger 2 K byte buffer holds the contents of a full video screen or 1920 characters. The Paper Tiger is priced at \$995.

Circle 643 on inquiry card.

NOW PRESENTING...

## Software for Apple II<sup>®</sup>

for your Entertainment · Business · Education



### Star Attractions:

**FILEMASTER 2** programs: *FORMAT & RETRIEVAL* comprise a powerful data file manager. Great for everything from phone lists to legal abstracts. Needs 32K. Design your own data structure. Up to 500 characters per record. Up to 15 searchable fields in any combination. On Disk . . . . . \$34.95

**SPACE** Multi-faceted simulation of life in interstellar society. You and opponents must make life & death decisions. Keeps track of your progress from one game to next. Needs 48K and Applesoft ROM. Disk . . . . . \$29.95

**Pot O'Gold I or our All New Pot O' Gold II** A collection of 49 programs for 16K Apple. Everything from Logic to action games. Only a buck a game. Specify I or II. Price each: Tape \$49 . . . . . Disk \$54

**ADVENTURE** Fight off pirates and vicious dwarfs. 700 travel options, 140 locations, 64 objects. Needs ROM & 48K. Disk . . . \$29.95

**16K CASSETTE INVENTORY** Use item number, description, stock amount, reorder amount, restock date, cost & sell price. Holds up to 140 items. Tape . . . . . \$35

**32K DISK INVENTORY:** Use stock numbers description, vendor, record of purchase and sales date, amount on hand, cost & sell price, total value. Holds up to 300 items. Disk . . . . . \$40

With Parts Explosion: Disk . . . . . \$50

**32K DATA BASE** Cross file for phone lists, bibliographies, recipes. Run up to 9 lines of 40 columns each. Search by item anywhere. Disk . . . . . \$20

**24K HI-RES LIFE SIMULATION** Conway's equations on 296x180 screen. A mathematical simulation to demo population growth with birth, death and survival as factors. Tape . . . . . \$10

**16K CIRCUIT LOGIC DEVELOPMENT AID** Evaluate circuits of up to 255 gates, including AND, OR, NOR, NAND, XOR, XNOR and INVERTER. Tape . . . . . \$10

**16K MORSE CODE TRAINER** Learn Morse Code, and transmit or receive over radio. Tape . . . . . \$10

**16K DEVIL'S DUNGEON:** Adventure through dark passages where monsters, demons, poisonous gas, dropoffs threaten . . . all to discover fantastic treasures. Comes with instruction book. Tape . . . \$10

**16K PACIFICA:** Discover the floating island and rescue the beautiful princess. To win you must recover the enchanted crown, but you face the threat of magic spells and demons. Tape . . . . . \$9.95

**RAINBOW'S CASINO** 9 gambling games: Roulette, Blackjack, Craps, Horseshoe, and a few originals that Vegas hasn't heard about. Needs 16K. Tape . . . . . \$29.95

**16K SPACE WAR:** You in your space capsule battle against the computer's saucer . . . in hi-res graphics. Tape . . . . . \$12

**16K MEMORY VERIFY** Diagnostic routine to check range of memory. Indicates faulty addresses, data in memory cell, and faulty data. Tape . . . . . \$5

**16K APPLEDDION** Music synthesis composes original Irish jigs. Enter your own music and save on tape or disk. Includes 3 Bach fugues. Tape . . . . . \$10

**16K APPELVISION** Demo for Hi-Res graphics and music. Tape . . . . . \$10

**32K COMPU-READ** 5 programs to teach you speed reading, in stages. Includes synonym and antonym identification. You control your rate of speed, or keep up with the computer's pace. Disk . . . . . \$24.95

**48K PERCEPTION I, II, III** random shapes and sizes must be matched. In III, you control format and display time and get weighted scores. Needs ROM. Each Disk . . . . . \$24.95

**32K STORY TELLER** Use your bizarre imagination and input key words for fantastic and funny tales. Never the same story twice. Tape . . . . . \$12.95

**32K WAR/RESCUE** Engage in 10 battles with your infantry against the Apple robots. Calculate Apple's strategy and win more battles than the computer. Tape . . . . . \$12.95

**24K POLAR PLOT** Plot polar equations in Hi-Res Graphics. Tape . . . . . \$10

**32K SHAPE SCALER** Utility to generate and animate Hi-Res graphic shapes. Simple routine provided to inspect position of shapes, and specify precise X/Y coordinates and scale. Needs ROM. Disk . . . . . \$13.95

**32K ZINTAR/PROPHET** Great party game. Under control of the mighty Zintar's edict you take a very special trip to the world of Krintar. Heightened visual graphics. Needs ROM. Disk . . . . \$16.95

**APPLE MONITOR PEELED** Everything you wanted to know about the Apple Monitor but couldn't figure out. User-written manual in plain English clears your confusion. Only . . . . . \$9.95



Rainbow Plaza Shopping Center, Dept. 11B  
9719 Reseda Blvd., Northridge, CA 91324  
Telephone: (213) 349-5560

Don't see what you've been looking for, here? Then write for our FREE SOFTWARE CATALOG. We're saving one just for you!

To order software, add \$2 shipping. To transfer tape versions to disk add \$5. California residents add 6% sales tax. Sorry, we can not ship to P. O. Boxes. VISA/MASTERCHARGE Welcomed!



# THE INFLATION FIGHTER



\*\$749

\*Suggested retail price.  
Substantial OEM and dealer  
discounts available

You can't buy more  
capability for less . . . But  
you can buy less for more.

MPI presents the perfect answer to your inflation-riddled printer budget. THE MODEL 88T DOT MATRIX PRINTER. The first in a series of new full-capability low-cost printers designed specifically for the general use computer market. The Model 88T is a fully featured printer with a dual tractor/pressure-roll paper feed system and a serial or parallel interface. The tractor paper feed system provides the precision required to handle multi copy fanfold forms, ranging in width from 1 inch to 9.5 inches. For those applications where paper costs are important, the pressure-roll feed can be used with 8.5 inch roll paper. A long-life ribbon cartridge gives crisp, clean print without messy ribbon changing. The microprocessor controlled interface has 80, 96 or 132 column formatting capability while printing upper and lower case characters bi-directionally at 100 characters per second.

With all of these features, **plus** quality construction, continuous duty print head and attractive styling, the Model 88T would easily sell at the competition's "under \$1000" (\$999.99) tag. But we are offering it for only \$749; this should make you happy and several hundred dollars richer.

Write for complete specifications and pricing information.



MICRO PERIPHERALS, INC. 2099 WEST 2200 SOUTH / SALT LAKE CITY, UTAH 84119 / (801) 973-6053

# FREE UP TO \$170 IN MERCHANDISE WITH THE PURCHASE OF ONE OF THE FOLLOWING PET-CBM ITEMS!!

ASK ABOUT EDUCATIONAL DISCOUNTS ON PET

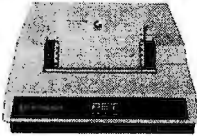

- ### PET SPECIALS
- PET 16N 16K full size graphics keyboard \$ 995
  - PET 16B 16K full size business keyboard \$ 995
  - PET 32N 32K full size graphics keyboard \$1295
  - PET 32B 32K full size business keyboard \$1295
  - PET 8K 8K small keyboard, integral cassette \$ 795
  - PET 2040 Dual Disk Drive — 343,000 bytes \$1295
  - PET 2022 Tractor Feed Printer \$ 995
  - PET 2023 Pressure Feed Printer \$ 849
  - PET C2N External Cassette Deck \$ 95

- Axiom EX-801 PET Printer(with graphics) \$475.00
  - Axiom EX-820 PET Plotter \$790.00
  - Atari 400 and 800 Write for Price
  - IEEE - RS232 Printer Adaptor for PET \$ 79.50
  - BETSI PET to S-100 Interface & Motherboard \$119.00
  - PET Connectors-Parallel or IEEE \$ 1.95
  - Cassette Port \$ 1.45
  - Personal Information Management System— \$ 8.90
  - Protect-A-Pet dust cover \$ 9.50
  - Programmers Toolkit - PET ROM Utilities \$ 45.00
  - Microchess for PET (Peter Jennings) \$ 17.90
  - PET 4 Voice Music Board (MTUK-1002-2) \$ 44.90
  - Music Software (K-1002-3C) for PET \$ 16.90
  - CmC Word Processor program for PET \$ 25.00
  - Bridge Challenger program for PET \$ 13.45
  - Adventure 1 for 24K PET \$ 7.95
  - Adventure 2 for 24K PET \$ 7.95
  - Tunnel Vision/Kat & Mouse-maze - PET \$ 7.95
  - Graphics Utility Package for PET \$ 13.45
  - Stimulating Simulations-Book & PET tape \$ 13.45
  - Kite Fight - 2 player action game - PET \$ 7.95
  - Write for PET Software List
  - Drive Test - machine language arcade game \$ 4.90
  - Word Processor for PET — Machine Language version. Auto scroll, insert, delete, form letter append, etc.
  - 8K Version \$24.00 16K or 32K with disk \$95.00
- \*Amount of Free Merchandise with Purchase of PET-CBM Item.

WRITE FOR 6502 AND S-100 PRODUCT LIST

# FREE! UP TO \$170 IN MERCHANDISE



MINIMUM ORDER \$10.00

# A B Computers

115-8 E. Stump Road  
Montgomeryville, PA 18936  
(215) 699-8386

- |        |       |   |             |
|--------|-------|---|-------------|
| LIST   | FREE* | KIM-1 \$159 (Add \$30 for Power Supply)                   | SYM-1 \$222 |
| \$ 995 | \$130 | BAS-1 Microsoft ROM Basic for                             | SYM \$ 85   |
| \$ 995 | \$130 | Memory Plus   | \$199       |
| \$1295 | \$170 | SYM Assembler in ROM                                      | \$ 85       |
| \$1295 | \$170 | SEA-16 New 16K Static RAM                                 | \$325       |
| \$ 795 | \$100 | Seawell Motherboard-4K RAM                                | \$139       |
| \$1295 | \$170 | KTM-2 Synertek Keyboard and Video Interface with Graphics | \$290       |
| \$ 995 | \$130 | RAM 16 4MHz 16K Static RAM                                | \$270       |
| \$ 849 | \$110 | 2716 EPROM (5 volt)                                       | \$ 45       |
| \$ 95  | \$ 12 | 6550 RAM (for 8K PET)                                     | \$12.70     |
|        |       | 6502 Microprocessor Chip                                  | \$ 9.95     |
|        |       | 6522 VIA  | \$ 9.75     |
|        |       | 6520 PIA  | \$10.50     |

- 2114 L 450ns \$5.70 24 @ \$5.15 100 @ \$4.45

### BOOKS

- Hands on Basic with a PET \$ 9.90
- Programming the 6501 (Zaks) \$ 9.90
- 6502 Applications Book (Zaks) \$11.90
- 6500 Programming Manual (MOS) \$ 6.50
- 6500 Hardware Manual \$ 6.50
- Programming a Microcomputer: 6502 \$ 8.90
- Basic for Home Computers \$ 5.90

- 3M "Scotch" B" disks 10/\$31
- 3M "Scotch" 5" diskettes **SALE** 10/\$35
- Verbatim 5" diskettes 10/\$27
- Diskette Storage Pages each \$4.45
- (Write for quantity prices)

- Cassettes (all tapes guaranteed)
- Premium quality, high output lownoise in 5 screw housing with labels:
- C-10 10/5.95 50/25.00 100/48.00
  - C-30 10/7.00 50/30.00 100/57.00

# BECKIAN ENTERPRISES



All Prime Quality — New Parts Only  
Satisfaction Guaranteed

EDGE CARD CONNECTORS: GOLD PLATED. (Not Gold Flash)  
BODY: Non brittle, Solvent res., G.E. Valox.  
CONTACTS: Bifurcated; Phos/Bronze: Gold over Nickel.  
ABBREVIATIONS: S/T Solder Tail; S/E Sold. Eyelet;  
W/W Wire Wrap 3; SW/W Short W/Wrap;

PART #	Description	Row Sp.	1-4	5-9	10-24
5010	50/100 S/T ALTAIR	.140	3.75	3.50	3.30
5020	50/100 S/T IMSAI	.250	3.95	3.75	3.50
5030	50/100 W/W IMSAI	.250	4.10	3.90	3.70
5040	50/100 S/E ALT/IMSAI	.140	5.00	4.50	4.25
5050	50/100 S/T CROMEMCO	.250	6.25	6.00	5.75
1450	IMSAI CARD GUIDES		0.16	0.14	0.12
<b>100" Contact Center Connectors.</b>					
1020	13/26 S/E Imsai MIO:	.140	2.10	1.85	1.75
1040	25/50 S/E	.140	2.95	2.75	2.50
1050	25/50 S/T	.140	3.00	2.80	2.60
1060	36/72 W/W Vector.	.200	4.80	4.60	4.30
1065	36/72 S/T Vector.	.200	4.00	3.75	3.50
1070	40/80 S/E PET	.140	4.80	4.50	4.30
1075	40/80 W/W PET	.200	5.00	4.65	4.35
1080	40/80 S/T PET	.140	4.90	4.60	4.25
1085	43/85 S/E Cos.ELF	.140	5.00	4.75	4.50
1090	43/86 S/T Cos.ELF	.140	5.10	4.85	4.60
1093	43/86 S/T Cos.ELF	.200	4.95	4.70	4.45
1095	43/86 W/W Cos.ELF	.200	5.50	5.20	4.90
POLARIZING KEYS: For Above					
<b>156" Contact Center Connectors.</b>					
1550	6/- S/E PET,Etc	.140	1.30	1.10	0.90
1560	6/12 S/T PET:NSC.	.140	1.35	1.15	0.95
1575	12/24 S/E PET	.140	2.15	1.95	1.75
1580	12/24 S/T PET	.140	2.10	1.90	1.70
1590	15/30 S/E GRI Keybd.	.140	2.25	2.05	1.85
1620	18/36 S/E	.140	2.40	2.20	2.00
1650	22/44 S/E KIM, VECTOR	.140	2.20	2.00	1.80
1660	22/44 S/T KIM, VECTOR	.140	2.00	1.80	1.70
1670	22/44 W/W KIM, VECTOR	.200	2.40	2.20	2.00
1690	36/72 W/W	.200	3.90	3.75	3.50
1710	36/72 S/E	.140	3.50	3.30	3.10
1720	36/72 S/T	.200	3.30	3.10	2.90
1730	43/86 S/T Mot. 6800	.140	4.40	4.15	3.90
1740	43/86 S/T Mot. 6800	.200	4.35	4.10	3.85
1750	43/86 W/W Mot. 6800	.200	4.45	4.25	4.10
POLARIZING KEYS: For Above					

RS232 & 'D' TYPE SUBMINIATURE CONNECTORS:	1-4	5-9	10-24
DE9P Male	1.45	1.35	1.25
DE9S Female	1.93	1.80	1.70
DE110963-1	2pc. Grey Hood	1.20	1.10 1.00
DA15P Male	1.95	1.80	1.70
DA15S Female	2.80	2.60	2.40
DA51211-1	1pc. Grey Hood	1.25	1.15 1.10
DA110963-2	2pc. Grey Hood	1.22	1.10 1.05
DB25P Male	2.20	2.10	1.90
DB25S Female	3.20	3.00	2.70
DB51212-1	1pc. Grey Hood	1.30	1.20 1.10
DB51226-1A	2pc. Black Hood	1.40	1.30 1.20
DB110963-3	2pc. Grey Hood	1.35	1.25 1.15
DC37P Male	3.70	3.50	3.35
DC37S Female	4.90	4.70	4.40
DC110963-4	2pc. Grey Hood	1.95	1.85 1.75
DD50P Male	4.40	4.30	4.10
DD50S Female	4.90	4.70	4.50
DD51218-1	1pc. Grey Hood	2.30	2.10 1.90
DD110963-5	2pc. Grey Hood	2.40	2.20 2.00
D20418-2 Hardware Sets	0.75	0.70	0.65

I.C. SOCKETS, GOLD.  
WIRE WRAP 3 TURN.  
14 pin \$0.36 ea.  
16 pin 0.38 ea.

I.C. SOCKETS.  
Dip Solder. Tin.  
14 pin \$0.15 ea.  
16 pin 0.17 ea.

8080 PRIME  
\$8.00 ea.

2708 EPROMS PRIME  
\$14.00 ea.

### CONNECTORS FOR CENTRONICS 700 SERIES:

Amphenol 57-30360 For Back of Centronics 700 Series:  
Price: \$9.00ea. 5 pcs. \$7.50ea.

WHISPER FANS: Excellent for Computer cabinet cooling. Extremely quiet.  
Dim. 4-3/4" x 1-1/2" thick. U.L. Listed. \$1-4 \$5-9 \$10-24  
\$22.00 \$19.00 \$18.00

WRITE FOR LARGER QUANTITY DISCOUNTS. DEALER INQUIRIES ARE WELCOME.

WE ARE CONNECTOR (EDGE CARD) SPECIALISTS. IF YOU DO NOT SEE WHAT YOU NEED IN THIS ADVERTISEMENT, PLEASE WRITE US. WE WILL REPLY.

TERMS: Minimum Order \$10.00: Add \$1.25 for handling and shipping. All orders over \$25.00 in USA and Canada: WE PAY THE SHIPPING.

NOTE: CA residents please add 6% sales tax.  
NO C.O.D. SHIPMENTS OR ORDERS ACCEPTED.

MAIL ORDERS TO: **Beckian Enterprises**  
P.O. Box 3089  
Simi Valley, CA 93063

# A low cost Modem for your APPLE that lets you be a part of it all.

Complete with software on cassette **\$284<sup>95</sup>**

Keep up with the latest information, share your ideas and programs with other hobbyists, time-share clubs, colleges, businesses, friends . . . anywhere, everywhere across the country.



The MICRONET MODEM, an originate-answer and auto-answer modem, part of the Automodem II series, is furnished with an FCC registered coupler and two inter-connecting cables and plugs into any standard telephone jack.

MICRONET . . . enhanced by a handsomely styled and coordinated enclosure with a simple inexpensive interface to the APPLES' game jack, allows you to make full use of all the input/output slots provided for other peripherals. Full compatibility with Bell, Westinghouse 103, and Westinghouse 113.

Don't be left behind . . .

Order the MICRONET MODEM today!

Manufactured by Micromate Electronics, Inc.

Dealer's Inquiries Invited

## ASCII KEYBOARD \* KIT \$79.95



### ASCII KEYBOARD KIT — Assembled and Tested \$95.95

• Single +5V Supply • Full ASCII Set (Upper and Lower Case) • Parallel Output • Positive and Negative Strobe • 2-Key Rollover • 3 User Definable Keys • P.C. Board Size: 17-3/16" x 5" • Control Characters Molded on Key Caps • Optional Provision for Serial Output. OPTIONAL: Metal Enclosure \$27.50 • Edge Con. \$2.00 • Sockets \$4.00 • Upper Case Lock Switch \$2.50 • Shift Register (for Serial Output) \$2.00. Dealer inquiries invited.

## APPLE II I/O BOARD \* KIT \$49.00

### APPLE II I/O BOARD KIT — Plugs into Slot of Mother Board

• 1 8-Bit Parallel Output Port (expands to 3 Ports) • 1 Input Port • 15mA Output Current Sink or Source • Can be used for peripheral equipment such as printers, floppy discs, cassettes, paper tapes, etc. • 1 Free Software Listing for SWTP PR40 or IBM selectric. PRICE: 1 Input and 1 Output Port \$49.00, 1 Input and 3 Output Ports \$60.00. Dealer inquiries invited.

## VENUS 2001 VIDEO BOARD kit \$199<sup>95</sup>

Assembled and Tested \$259.95 • Complete Unit with 4K Memory and Video Driver on Eprom assembled and tested \$339.95. OPTIONAL: • Sockets \$10.00 • 2K Memory \$30.00 • 4K Memory \$50.00 • Video Driver Eprom \$20.00.

**S-100 Plug-In • Parallel Keyboard Port** — On board 4K Screen Memory (optional). On board Eprom (optional) for Video Driver or Text Editor Software. **Up and down scrolling through video memory** — Reverse Video, Blinking Characters. **Display:** 128 ASC 11 Characters 64x32 or 32x16 Screen Format (Jumper Selectable). 7 by 11 Dot Matrix Characters.

**American or European TV Compatible** (CRT Controls Programmable). Dealer inquiries invited.



## THE APPLESTICK™ \$49<sup>95</sup>

Just plug it into your game connector and make your present games more enjoyable.

The APPLESTICK is a wonderful add-on for your Apple II. With an APPLESTICK you can enjoy the smooth, easy control of a true 360° joystick.

Manufactured by Micromate.

Not recommended for scientific applications requiring linearity.

## new! A DREAM COME TRUE!

Introducing: **30 MZH**

**DUAL TRACE**

**PORTABLE**

**SCOPE**

for an **\$555.**



MODEL MS 230

• Dual trace 2-channel; separate, chopped or alternate modes • 30 megahertz bandwidth • External and internal trigger • Time base -0.05, Microseconds to 0.2 SEC/div 21 settings • Battery or line operation • Line synchronization mode • Power consumption less than 50W • Vertical gain 0.1 to 50 volts/div-12 settings • Size: 2.9" H, 6.4" W, 8.5" D • Weighs only 3.5 lbs with batteries • Complete with input cable and rechargeable batteries and charger unit.

OPTIONAL: Leather case \$45.00 • 10:1 probe \$27.00 (2 for \$49.00)

**MS-215 — 15 MHZ DUAL TRACE PORTABLE SCOPE — \$399<sup>00</sup>**

**MS-15 15 MHZ SINGLE TRACE SCOPE — \$299<sup>00</sup>**

SHIPPING \$3.50 / California residents add 6% sales tax

**ELECTRONICS WAREHOUSE Inc.**

15820 Hawthorne Boulevard  
Lawndale, CA 90260  
(213) 370-5551



# ★ EXCITING MAIL ORDER DISCOUNTS ★

## NOVATION CAT

ACOUSTIC MODEM

- ANSWER, ORIGINATE
- 300 BAUD
- BELL 103
- LOW PROFILE DESIGN

**\$179<sup>00</sup>**

## MICROPOLIS™ MetaFloppy DRIVES



1043 (Single) 315Kb **\$995<sup>00</sup>**  
 1053 (Dual) 630Kb **\$1695<sup>00</sup>**

- QUAD DENSITY DESIGN
- COST EFFECTIVE STORAGE
- 4 TIMES STANDARD CAPACITY EVEN AFTER FORMATTING!



OR APPLE II PLUS

**\$975<sup>00</sup>**

- COLOR • GRAPHICS • SOUND

APPLE DISK II \$495.00  
 INCLUDES CONTROLLER

## SD EXPANDORAM

- |                                 |                      |          |
|---------------------------------|----------------------|----------|
| • 64K S-100 DYNAMIC RAM BOARD   | WITHOUT MEMORY _____ | \$149 00 |
| • WORKS WITH Z-80, 8080 & 8085  | 16K KIT _____        | 215 00   |
| • POWER CONSUMPTION 5 WATTS     | 32K KIT _____        | 269 00   |
| • BANK SELECT • PHANTOM REFRESH | 48K KIT _____        | 349 00   |
| • NO WAIT STATES REQUIRED       | 64K KIT _____        | 409 00   |

ADD \$50 FOR ASSEMBLED & TESTED

## PORTABLE MINISCOPES

LOW POWER CONSUMPTION

MS-15 SINGLE TRACE 15 MHz **\$289**  
 MS-215 DUAL TRACE 15 MHz **\$389**  
 MS-230 DUAL TRACE 30 MHz **\$519**

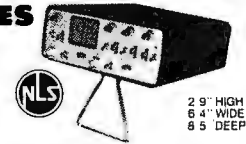

2 9" HIGH  
 6 4" WIDE  
 8 5" DEEP

## SOROC IQ 120

- SERIAL RS232C
- FULL ASC II UPPER/LOWER CASE
- NUMERIC KEYPAD CURSER KEYS
- SCREEN CONTROL & PROTECTED FIELDS

**\$775<sup>00</sup>**

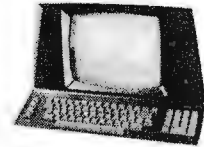

## LEEDEX VIDEO 100

- 12" BLACK & WHITE MONITOR
- VIDEO BANDWIDTH 12MHz ± 3db
- COMPOSITE VIDEO INPUT

**\$129<sup>00</sup>**

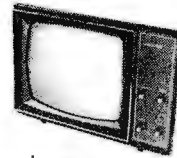

• TO ORDER •

Phone orders invited, using credit cards. Or send personal check or money order. Add 1% for packing and handling. California resident add 6% sales tax. All equipment is shipped freight collect in factory carton with manufacturers warranty. All equipment subject to availability and price change without notice.



COMPUTER SPECIALTIES

6363 EL CAJON BLVD., SUITE 203,  
 SAN DIEGO, CA. 92115 • (714) 579-6330

## We've Moved!

*Pacific Office Systems* — formerly at 2600 El Camino Real, Palo Alto, CA 94306  
 New Address: 918 INDUSTRIAL AVENUE, PALO ALTO, CA 94303  
 New Telephone: (415) 493-7455

### PRINTER TERMINALS



- ASCII SELECTRIC PRINTER/TYPEWRITER: Why settle for less than letter-quality printout from your computer? IBM Model 725 can be used as off-line typewriter or on-line printer. Complete with solenoids, power supply, case and ASCII interface card (TTL to CPU parallel port). Interface includes programmable ASCII translation table on EPROM with up to 8 tables for use with various type spheres. Feedback signals on completion of each print cycle insures fastest printing speed (15 cps), cleaned and adjusted. Price: programmed w/3 translation tables (one type sphere) . . . . . \$795.00
- SELECTRIC I/O TERMINALS by GTE/Information Systems). Both ASCII & IBM code versions with micro-computer interface software & hardware (RS-232 connector). Cassette drive models permit up to 2100 baud data transfer rate as well as off-line data storage, use as memory typewriter, & use as data entry device for office personnel familiar with Selectric typewriters but not computers. Wide-carriage, interchangeable type spheres; optional built-in modem. All units cleaned, adjusted & warranted.  
 Model 55-11  
 (IBM Correspondence code) . . . . . \$ 795.00  
 Model 5550  
 (corres. code, built-in cassette drive) . . . \$1195.00  
 Model 5560  
 (ASCII code, built-in cassette drive) . . . \$1295.00

- "DAISY-WHEEL" I/O TERMINALS: Both DIABLO and QUME versions of the industry standard "daisy-wheel" printing terminals are available. All have keyboards w/full ASCII character set & RS-232 serial interface. Models in stock usually include Diablo 1550, DTC 300 & 300Q, GenCom: 300 & 300Q, and others. Prices for refurbished units range from \$1800.00 to \$2100.00
- DIABLO HYTYPE I Model 1200 PRINTER MECHANISM: Used, complete and tested. Requires power supply, case & mCPU interface. Tested: . . . \$750.00  
 6' Ribbon cable and connector  
 for printer Main Logic PCB . . . . . \$ 10.00  
 "As-is" spare printer PCB's for parts  
 (Logic, Heat Sink, Control); each . . . . . \$ 20.00  
 New Pin-lead Platen (14"): . . . . .  
 \$50 if bought w/printer; separately . . . \$100.00

### MODEMS

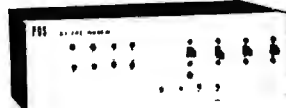

- POS 103/202 "MIA" or "MATCH" MODEM: BELL 103 and/or BELL 202 FREQUENCIES: Unique POS control design permits use in one housing of both Bell-compatible 103 (0-300 baud) and 202 (0-1200 baud) modem modules originally made by VADIC Corp. for a telephone company subsidiary. FEATURES: RS-232 serial interface, auto-answer, auto-dial, LED display, telephone line interface via acoustic coupler, manual DAA, or auto-answer DAA (sold separately). FULLY ADJUSTED; no special tools required. 3,000 mile range over standard dial-up telephone lines.  
 POS 103 MODEM . . . . . \$179.95  
 POS 202 MODEM . . . . . \$249.95  
 POS 202 MODEM (Auto-Answer) . . . . . \$279.95  
 POS 103/202 MODEM . . . . . \$399.95

### TAPE DRIVES & CONTROLLERS



- POS-100 NRZ1 TAPE DRIVE CONTROLLER/FORMATTER: Designed as interface between S-100 bus mCPU and 9-track, 800 BPI, NRZ1 tape drive. Allows microcomputerist to read and write IBM-compatible 1/2" mag tapes. Software provided for 8080 or Z-80 systems. Requires modification for drives of various mfrs. Std. version: 2 MHz/8080/Z-80 CPU for use with 12"/sec. PERTEC-style Tape Drive. Price: (Includes S-100 card, controller card, 10' cable, software listing) . . . . . \$750.00
- NRZ1 TAPE DRIVE by CIPHER Data Products: Full size PI RTEC-style 800 BPI drive model 1008XX; 2400' Tape, 9 track, 25 to 37 ips, used, refurbished. Wt. approx. 120 lb. Price: . . . . . \$1500.00
- CONVERT 15" IBM OFFICE SELECTRIC TO I/O TYPEWRITER: Kit includes assembled solenoids, switches, wire harness, magnet driver PCB plus instructions for installation and mCPU interface . . . \$200.00
- DIGITAL CASSETTE DRIVE (from GTE/IS Terminal): 1800 baud, 6"/sec; AC motor; fwd/revnd circuitry plus tape head, no read/write electronics . . . \$25.00
- FORMS TRACTORS, Moore Variable width Form A-1 liner" for print terminals:  
 a) Model 565P for 15" Carriage  
 IBM Selectrics (used) . . . . . \$75.00  
 b) Model K81 for QUME or DIABLO  
 Hytype I or II printers (new) . . . . . \$90.00
- POWER SUPPLIES for Disk Drive, mCPU, tested under load shown:  
 No. 519 (w/lan & AC cord): +5V reg.  
 12V reg., +24V, @1A (10 lb.) . . . . . \$39.95

NO RISK!! 15 DAY APPROVAL ON ALL MAIL ORDERS

Full documentation included PLUS interface instructions where indicated. All equipment is shipped insured FOB Palo Alto within 14 days after check clears or COD order is received. Prices may change without notice. Call or write for details, quantity prices, catalog. 15 day return privilege PLUS 90 day no charge replacement of defective parts. All orders shipped from stock. No back orders, no substitutions. Master Charge and VISA accepted.



# 10-DAY FREE TRIAL

Send for our  
**FREE Catalog**



## \$100 FREE ACCESSORIES WITH 16K or 32K PET

Buy our 16K or 32K PET and we'll give you your first \$100 worth of accessories. FREE. Just indicate on your order that you have reduced the cost of your accessories by \$100.

**FREE Terminal Package with 8K PETs**

**SAVE \$69**

4K - Keyboard C	\$ 595
8K - Keyboard C	\$ 795
16K - Keyboard B	\$ 995
16K - Keyboard N	\$ 995
32K - Keyboard C	\$1295
32K - Keyboard B	\$1295
32K - Keyboard N	\$1295
C - calculator keyboard (only version with tape deck)	
B - Large Keyboard (graphics not on keys)	
N - large keyboard with graphics symbols	
Used 8K PET with 90-day warranty	\$650



## Hazeltine 1400

LIST SALE

~~\$850~~ **\$740**

## SUPER SALE PRICE TOO LOW TO ADVERTISE

Immediate Delivery — 2-Year Factory Warranty

You may have seen the Hazeltine advertised at \$850. You may have seen it sale prices at \$749 or even \$699 but our new price is so low that we can't even advertise it. Call us for a quote. Hurry, we have a limited quantity at this price. The B048-based Hazeltine 1400 has a 12" screen, 24 x 80 display, TTY-style keyboard, addressable cursor, and RS-232 I/O from 110 to 9600 baud.

Hazeltine 1410 — \$835	Hazeltine 1510 — \$1195
Hazeltine 1500 — \$1069	Hazeltine 1520 — \$1499

### PET ACCESSORIES

Commodore Dual Floppy Disk Drive	\$995.00
Commodore Printer (tractor feed)	\$995.00
Second Cassette — from Commodore	\$95.00
Commodore PET Service Kit	\$30.00
Beeper - Tells when tape is loaded	\$24.95
Petunia - Play music from PET	\$29.95
Video Buffer - Attach another CRT	\$29.95
Combo - Petunia and Video Buffer	\$49.95
New Serial Printer Interface for PET	\$79.95

Call for Availability  
PET - Compatible Selectric in Desk ..... \$895.00

**SAVE \$195** **COMMODORE DISK DRIVES**  
Reg. \$1,295 Sale \$1,100



**apple II plus**  
**\$200 FREE ACCESSORIES**

The new Apple II with Applesoft BASIC built-in! Eliminates the need for a \$200 Firmware Card and includes new Autostart ROM for easy operation. This combined with the FREE accessories from NCE could save you up to \$400 on a 48K Apple II system!

16K Apple II Plus — \$1195 (take \$100 in free accessories)
32K Apple II Plus — \$1345 (take \$150 in free accessories)
48K Apple II Plus — \$1495 (take \$200 in free accessories)

Apple II Accessories

Centronics Printer Interface	\$225
Disk and Controller	\$595
Second Disk Drive	\$495
Parallel Printer Card	\$180
Communications Card	\$225
Hi-Speed Serial Card	\$195
Firmware Card	\$200
Hobby/Proto Card	\$24
Microverse RF Mod	\$35
Sanyo M2544 Recorder	\$55

**IN STOCK NOW!**  
EVERY ITEM IN THIS ADVERTISEMENT IS IN STOCK AND READY TO SHIP, EXCEPT WHERE NOTED.

**NOW Graphics printer \$1,098 for Apple II**

Now you can print high resolution graphics from your Apple using the IP-225 printer and graphics option from IDS. The IP-225 is a tractor feed printer with 96 possible characters. Line length is 80/132 col. with a speed of 50/80 cps. We include software which allows it to use either parallel or serial interface at 1200 baud. ABSOLUTELY FREE (you save \$50)!

**PET OWNERS... REMOTE TERMINAL for only \$69**

A self-contained module and program cassette enables your PET to function as a 300 baud terminal. Supports Upper/Lower case, Rubout, Escape & all control functions. Output is TTL.

**FREE WITH 8K PET PURCHASE**

**NEW! 800K DISK & MEMORY EXPANSION**

You can instantly turn your PET into a speedy and efficient professional computer. Its easy with the new 400K Disk Drive and Memory Expansion from Computhink Add up to 32K internally then load 20K program in only 3 seconds!

800K Disk Drive	\$1,295.00
Memory Expansion 16K	\$425.00
24K	\$525.00
32K	\$675.00

**NEW from Heath Data Systems**

**The All-In-One Computer**  
Dual 2-80 Processors • Built-in 102K Floppy Disk • 16K to 48K RAM • 25 x 80 Character Display • Upper/Lower Case and Line Graphics • 80 Character Keyboard with Keypad • 8 User-definable Keys • Two BASIC's and Auto-Script Word Processing available • Can support CP/M

Heath's third generation of computers is a compact, hi-style desktop unit which includes a complete terminal, a computer and a disk All-in-One! System includes Bootstrap in ROM, other programs available separately. HDOS operating system includes Heath's BASIC, an assembler and text editor along with important disk utilities. Microsoft language requires HDOS.

WH89 with 16K RAM	\$2,295
WH89 with 32K RAM	\$2,445
WH89 with 48K RAM	\$2,595
WH17 Second Disk Drive	\$550
Dual-port Serial Interface	\$85
HDOS Operating System	\$100
Microsoft BASIC	\$100
Word Processing	\$395



**CAT COUPLER**

New 300 baud Originate/Answer Acoustic Coupler. Looks good, works great priced at **\$189**

**LOW COST PRINTER FOR PET \$395**

**IN STOCK NOW**

**1+1=3-RIGHT!**

**EDUCATORS ORDER YOUR FREE PET TODAY!**

Between now and Nov. 30th any educational institution which buys 2 PET's at list price will receive a 3rd PET. ABSOLUTELY FREE! That's right. FREE! For example, buy 2 8K PET's at \$795 each and get 1 8K PET. FREE. Buy 1 16K at \$995 and 1 32K at \$1,295 and your school will receive 1 16K PET absolutely FREE! Join the hundreds of public & private schools, colleges, and Universities who have bought from us with confidence. Look at our PET box in the upper left hand corner of this ad for descriptions and prices of the Commodore PET product line. If you need more information just call, we love questions.

**SANYO MONITOR**  
9-inch ~~\$240~~ **\$169** 15-inch ~~\$400~~ **\$279**



**CompuMart** SINCE 1971

Department BYB9  
270 Third St., Cambridge, Ma., 02142

To Order Call 1(800)343-5504  
in Mass. (617) 491-2700



Member: Computer Dealers Association

**IMPORTANT ORDERING INFORMATION**  
All orders must include 4% shipping and handling. Michigan residents add 4% for state sales tax. All foreign orders (except Canada) need an additional 10% for shipping and handling.

Phones open from 9:00 a.m. to 7:00 p.m. EST Monday-Friday, 10:00 a.m. to 5:00 p.m. Saturdays • P.O.'s accepted from D & B rated companies — shipment contingent upon receipt of signed purchase order • All prices subject to change without notice • Most items in stock for immediate shipment — call for delivery quotation • Sorry, no C.O.D.'s • In the Ann Arbor area? Retail store open 11:00 a.m. to 7:00 p.m. Tuesday-Friday, 10:00 a.m. to 5:00 p.m. Saturdays (Closed Sunday and Monday)

**If not satisfied, return your purchase with-in 10 days for full refund of purchase price!**



## Transistor Checker



— Completely Assembled —  
— Battery Operated —

The ASI Transistor Checker is capable of checking a wide range of transistor types, either "in circuit" or out of circuit. To operate, simply plug the transistor to be checked into the front panel socket, or connect it with the alligator clip test leads provided. The unit safely and automatically identifies low, medium and high-power PNP and NPN transistors. Size: 3 1/2" x 6 1/2" x 2 1/2". "C" cell battery not included.

**ON SALE!** Trans-Check \$19.95 ea.

## Custom Cables & Jumpers



**DB 25 Series Cables**

Part No.	Cable Length	Connectors	Price
DB25P-4-P	4 Ft.	2-DP25P	\$15.95 ea.
DB25P-4-S	4 Ft.	1-DP25P/1-25S	\$16.95 ea.
DB25S-4-S	4 Ft.	2-DP25S	\$17.95 ea.

**Dip Jumpers**

Part No.	Length	Pin Configuration	Price
DJ14-1	1 ft.	1-14 Pin	\$1.59 ea.
DJ16-1	1 ft.	1-16 Pin	1.79 ea.
DJ24-1	1 ft.	1-24 Pin	2.79 ea.
DJ14-1-14	1 ft.	2-14 Pin	2.79 ea.
DJ16-1-16	1 ft.	2-16 Pin	3.19 ea.
DJ24-1-24	1 ft.	2-24 Pin	4.95 ea.

For Custom Cables & Jumpers, See JAMECO 1979 Catalog for Pricing

## CONNECTORS

25 Pin-D Subminiature

DB25P (as pictured)	PLUG (Meets RS232)	\$2.95
DB25S	SOCKET (Meets RS232)	\$3.60
DB51226-1	Cable Cover for DB25P or DB25S	\$1.75

### PRINTED CIRCUIT BOARD-CARD

156 Spacing-Tin Double Lead-Out - Bifurcated Conduits - Fits 054 to 070 P.C. Cards

15/30 SE	PINS (Solder Eyelet)	\$1.95
18/36 SE	PINS (Solder Eyelet)	\$2.49
22/44 SE	PINS (Solder Eyelet)	\$2.95
22/44 WW	PINS (Wire Wrap)	\$3.95
50/100 WW	PINS (Wire Wrap)	R681-1 \$6.95

## 4-Digit Clock Kit

- Bright .36" ht. red display
- Sequential flashing colon
- 12 or 24 hour operation
- Extruded aluminum case (black)
- Pressure switches for hours, minutes & hold functions
- Includes all components, case and wall transformer
- Size: 3 1/4" x 3 1/4" x 1 1/4"

**JE730** ..... \$14.95

## Jumbo 6-Digit Clock Kit

- Four .630" ht. and two .300" ht. common anode displays
- Uses MM5314 clock chip
- Switches for hours, minutes and hold functions
- Hours easily viewable to 30 feet
- Simulated walnut case
- 115VAC operation
- 12 or 24 hour operation
- Includes all components, case and wall transformer
- Size: 6 1/2" x 3 1/2" x 3 1/2"

**JE747** ..... \$29.95

- Bright .300 ht. comm. cathode display
- Uses MM5314 clock chip
- Switches for hours, minutes and hold modes
- Hours easily viewable to 20 ft.
- Simulated walnut case
- 115 VAC operation
- 12 or 24 hr. operation
- Incl. all components, case & wall transformer
- Size: 6 3/4" x 3 1/8" x 1 3/4"

**JE701**

**6-Digit Clock Kit** \$19.95

## REMOTE CONTROL TRANSMITTER & RECEIVER

Can be used as remote control for TV, stereo, VCR, etc. Includes 12V battery and 9V battery.

**\$19.95**

## Digital Stopwatch Kit

- Use Intersil 7205 Chip
- Plated thru double-sided P.C. Board
- LED display (red)
- Times to 99 min. 99.99 sec. with auto reset
- Quartz crystal controlled
- Three stopwatches in one: single event, split (cumulative) & Taylor (sequential timing)
- Uses 3 penlite batteries
- Size: 4 1/2" x 2 1/2" x .90"

**JE900 \$39.95**

## MICROPROCESSOR COMPONENTS

8080A/8088A SUPPORT DEVICES		MICROPROCESSOR MANUALS	
8080A	CPU	M-280	User Manual
8212	8-Bit Input/Output	M-CDP802	User Manual
8214	Priority Interrupt Control	M-2550	User Manual
8216	Bi-Directional Bus Driver		
8224	Clock Generator/Driver		
8226	Bus Driver		
8228	System Controller/Bus Driver		
8238	System Controller		
8251	Prog. Comm. I/O (USART)		
8253	Prog. Interval Timer		
8255	Prog. Periph. I/O (PPI)		
8257	Prog. DMA Controller		
8258	Prog. Interval Control		
	8680/8680 SUPPORT DEVICES		
MC6800	MPU		
MC6802CP	MPU with Clock and Ram		
MC6804PI	128X8 Static RAM		
MC6821	Periph. Inter. Adapt (MC6820)		
MC6828	Priority Interrupt Controller		
MC6830L8	1024X8 Bit ROM (MC68A30-8)		
MC6850	Asynchronous Comm. Adapter		
MC6852	Synchronous Data Adapt		
MC6850	0-500 bps Digital MODEM		
MC6862	2400bps Modulator		
MC6890A	Quad 3-State 8-Bit Trans. (MC68T26)		
	MICROPROCESSOR CHIPS—MISCELLANEOUS		
Z801790C	CPU		
Z801740-1	CPU		
CDP1802	CPU		
2650	MPU		
5525	MPU		
6801	8-Bit MPU w/clock, RAM, I/O lines		
P9085	CPU		
TMS9900JL	16-Bit MPU w/hardware, multiply & divide		
	SHIFT REGISTERS		
MM5400H	Dual 25 Bit Dynamic		
MM5403H	Dual 50 Bit Dynamic		
MM5404H	Dual 16 Bit Static		
MM5405H	Dual 100 Bit Static		
MM5410H	Dual 64 Bit Accumulator		
MM5415H	500/512 Bit Dynamic		
2504T	1024 Dynamic		
2518	Hex 32 Bit Static		
2522	Dual 132 Bit Static		
2524	5 1/2 State		
2525	1024 Dynamic		
2527	Dual 256 Bit Static		
2528	Dual 250 Static		
2529	Dual 2408 Bit Static		
2532	Quad 60 Bit Static		
3341	File		
74LS670	4X4 Register File (TriState)		
	UART'S		
A-Y-5-1013	30K BAUD		
	MICROPROCESSOR MANUALS		
M-280	User Manual	\$7.50	
M-CDP802	User Manual	7.50	
M-2550	User Manual	5.00	
	ROM'S		
2513(2140)	Character Generator (upper case)	\$9.95	
2513(3021)	Character Generator (lower case)	9.95	
2516	Character Generator	10.95	
MMS230N	2048-Bit Read Only Memory	1.95	
	RAM'S		
1101	256X1 Static	\$1.49	
1103	1024X1 Dynamic	.99	
2101(8101)	256X4 Static	3.95	
2102	1024X1 Static	1.75	
2102	1024X1 Static	1.95	
2111(8111)	256X4 Static	3.85	
2112	256X4 Static MOS	4.95	
2114	1024X4 Static 450ns	7.95	
2114L	1024X4 Static 450ns low power	10.95	
2114L-3	1024X4 Static300ns	10.95	
2114L-3	1024X4 Static 300ns low power	11.95	
5101	256X4 Static	7.95	
5209(2107)	4096X1 Dynamic	4.95	
7489	16X4 Static	1.75	
748200	256X1 Static Tristate	4.95	
83421	256X1 Static	2.95	
UPD414	4K Dynamic 16 pin	4.95	
UPD416	16K Dynamic 16 pin 250ns	9.95	
(MK4116)			
TMS4014	4K Static	14.95	
TMS4015	1024X4 Static Dynamic 350ns (house marked)	14.95	
2117	16.384X1 Dynamic	9.95	
MM5262	2KX1 Dynamic	4/1.00	
	PROM'S		
1702A	FAMOS	\$5.95	
2716INTEL	16K EPROM	\$9.95	
1702B	16K EPROM	49.95	
(2716)	Requires single +5V power supply		
1MS2532	4KX8 EPROM	89.95	
2708	8K EPROM	10.95	
27161	16K EPROM	29.95	
	Requires 3 voltages, -5V, +5V, -12V		
5203	FAMOS	14.95	
6301-17611	1024 Tristate Bipolar	3.49	
6330-17602	256 Open C Bipolar	2.95	
8253	32X8 Open Collector	3.95	
82S15	4096 Bipolar	19.95	
82S123	32X8 Tristate	3.95	
74186	512 TTL Open Collector	9.95	
74188	256 TTL Open Collector	3.95	
74S287	1024 Static	2.95	

8080A/8088A SUPPORT DEVICES

MICROPROCESSOR MANUALS

ROM'S

RAM'S

MISCELLANEOUS

UART'S

PROM'S

REGULATED POWER SUPPLY

ADAPTER BOARD

5V-1 AMP POWER SUPPLY

ADAPTER BOARD

5V-1 AMP POWER SUPPLY

ADAPTER BOARD

5V-1 AMP POWER SUPPLY

ADAPTER BOARD

5V-1 AMP POWER SUPPLY

ADAPTER BOARD

5V-1 AMP POWER SUPPLY

ADAPTER BOARD

5V-1 AMP POWER SUPPLY

ADAPTER BOARD

5V-1 AMP POWER SUPPLY

ADAPTER BOARD

5V-1 AMP POWER SUPPLY

ADAPTER BOARD

5V-1 AMP POWER SUPPLY

ADAPTER BOARD

5V-1 AMP POWER SUPPLY

ADAPTER BOARD

5V-1 AMP POWER SUPPLY

ADAPTER BOARD

5V-1 AMP POWER SUPPLY

ADAPTER BOARD

5V-1 AMP POWER SUPPLY

ADAPTER BOARD

5V-1 AMP POWER SUPPLY

ADAPTER BOARD

5V-1 AMP POWER SUPPLY

ADAPTER BOARD

5V-1 AMP POWER SUPPLY

ADAPTER BOARD

5V-1 AMP POWER SUPPLY

ADAPTER BOARD

5V-1 AMP POWER SUPPLY

ADAPTER BOARD

5V-1 AMP POWER SUPPLY

ADAPTER BOARD

5V-1 AMP POWER SUPPLY

ADAPTER BOARD

5V-1 AMP POWER SUPPLY

ADAPTER BOARD

5V-1 AMP POWER SUPPLY

ADAPTER BOARD

5V-1 AMP POWER SUPPLY

ADAPTER BOARD

## The Incredible

"Pennywhistle 103"



**\$139.95** Kit Only

The Pennywhistle 103 is capable of recording data to and from audio tape without special requirements for the recorder and its ability to communicate directly with another modern and terminal or telephone "banning" and communications to addition. It is free of critical adjustments and built with non-precision, readily available parts.

Data Transmission Method ..... Frequency-Shift Keying, full-duplex (half-duplex selectable).

Maximum Data Rate ..... 300 Baud.

Data Format ..... Asynchronous Serial (return to mark level required between each character).

Receive Channel Frequencies ..... 2025 Hz for space, 2225 Hz for mark.

Transmit Channel Frequencies ..... Switch selectable: low (normal) ..... 1070 space, 1270 mark, High = 025 space, 2225 mark

Receive Sensitivity ..... 46 dbm acoustically coupled.

Transmit Level ..... 15 dbm nominal Adjustable from -6 dbm to -20 dbm.

Receive Frequency Tolerance ..... Frequency reference automatically adjusts to allow for operation between 1800Hz and 2400Hz.

Digital Data Interface ..... EIA RS-232C or 20 mA current loop (receiver is optoisolated and non-polar)

Power Requirements ..... 120 VAC, single phase, 10 Watts

Physical ..... All components mount on a single 5" by 9" printed circuit board. All components included.

Requires a VOM, Audio Oscillator, Frequency Counter and/or Oscilloscope to align

## TRS-80 16K Conversion Kit

Expand your 4K TRS-80 System to 16K. Kit comes complete with:

- 8 each UPD416-1 (16K Dynamic Rams) 250NS
- Documentation for conversion

**TRS-16K \$75.00**

## COMPUTER CASSETTES

- 6 EACH 15 MINUTE HIGH QUALITY C-15 CASSETTES
- PLASTIC CASE INCLUDED
- 12 CASSETTE CAPACITY
- ADDITIONAL CASSETTES AVAILABLE #C-15-\$2.95 ea.

**CAS-6 \$14.95**

(Case and 2 Cassettes)

## SUP'R MOD II

UHF Channel 33 TV Interface Unit Kit

Wide Band 8/W or Color System

- Converts TV to Video Display for home computers, CCTV camera, Apple II, works with Cromeco Dazzler, SOL-20, IRS-80, Challenger, etc.
- Mod II is pretuned to Channel 33 (UHF).
- Includes coaxial cable and antenna transformer

**MOD II \$29.95 Kit**

## MOD II

ULTRA-VIOLET PRODUCTS, INC.

## EPRM Erasing Lamp

- Erases 2708, 2716, 1702A, 5203C, 5204Q, etc.
- Erases up to 4 chips within 20 minutes.
- Maintains constant exposure distance of one inch
- Special conductive foam liner eliminates static build-up
- Built-in safety lock to prevent UV exposure
- Compact - only 7/8" x 2-7/8" x 2"
- Complete with holding tray for 4 chips

**UVS-11E** ..... \$69.95

## IDEAL FOR TRS 80 CASSETTE CONTROLLER

Plug/Jack interface to any computer system requiring remote control of cassette functions

The CC100 controls cassette motor functions, monitors tape location with its internal speaker and requires no power. Eliminates the plugging and unplugging of cables during computer loading operation from cassette.

#CC-100 \$29.50

## new Micro-Miniature Joystick

- 2 each 100K pots (Linear Taper)
- Printed Circuit Board Mount
- Size: 1" x 1-3/16" x 1-3/16"

**Micro-Miniature Joystick \$4.95**

Spec Sheets - 25¢  
1980 Catalog Available - Send 41¢ stamp  
Postage - Add 5¢ plus \$1 Insurance (if desired)

**FREE 1980 CATALOG**

**Jameco ELECTRONICS**

PHONE ORDERS WELCOME (415) 592-8097

MAIL ORDER ELECTRONICS - WORLDWIDE  
1021 HOWARD AVENUE, SAN CARLOS, CA 94070  
ADVERTISED PRICES GOOD THRU NOVEMBER



**CALIFORNIA COMPUTER SYSTEMS**

**16K RAM BOARD.** Fully buffered addressable in 4K blocks. IEEE standard for bank addressing 2114's PCB ..... \$26.95  
**Kit 450 NSEC** .....\$259.95  
**PT-1 PROTO BOARD.** Over 2,600 holes 4" regulators. All S-100 buss functions labeled, gold fingers. PCB ..... \$25.95  
**PT-2 PROTO BOARD.** Similar to PT-1 except set-up to handle solder tail sockets. PCB .....\$25.95



**FORMERLY CYBERCOM/SOLID STATE MUSIC.**

**PB-1 2708 & 2716 Programming Board** with provisions for 4K or 8K EPROM. No external supplies require test tool sockets. Kit .....\$124.95  
**CB-1 8080 Processor Board.** 2K of PROM 256 BYTE RAM power on/rest Vector Jump Parallel port with status Kit .....\$119.00 PCB .....\$30.95  
**MB-6B Basic 8KX8 ram** uses 2102 type rams, S-100 buss. Kit 450 NSEC.....\$139.95 PCB.....\$26.95  
**MB-7 16KX8, Static .RAM** uses  $\mu$ P410 Protection, fully buffered Kit.....\$299.95  
**MB-8A 2708 EROM Board,** S-100, 8KX8 or 16Kx8 kit without PROMS \$75.00 .....PCBD \$28.95  
**MB-9 4KX8 RAM/PROM Board** uses 2112 RAMS or 82S129 PROM kit without RAMS or PROMS \$72.00  
**IO-2 S-100 8 bit parallel /IO port,** 3/4 of boards is for kludging. Kit .....\$46.00 PCB.....\$26.95  
**IO-4 Two serial I/O ports** with full handshaking 20/60 ma current loop: Two parallel I/O ports. Kit .....\$130.00 PCB .....\$26.95  
**VB-1B 64 x 16 video board,** upper lower case Greek, composite and parallel video with software, S-100. Kit.....\$125.00 PCB.....\$26.95  
**Altair Compatible Mother Board,** 11 x 11 1/2 x 1/8". Board only .....\$39.95. With 15 connectors.....\$94.95  
**Extended Board full size.** Board only .....\$ 9.49  
**With connector** .....\$13.45  
**SP-1 Synthesizer Board S-100** PCB.....\$42.95 KIT.....\$135.95

**WMC inc. WAMECO INC.**

**FDC-1 FLOPPY CONTROLLER BOARD** will drive shugart, pertek, remic 5" & 8" drives up to 8 drives, on board PROM with power boot up, will operate with CPM™ (not included). PCB .....\$42.95  
**FPB-1 Front Panel.** IMSAI size, hex displays. Byte, or instruction single step. PCB .....\$47.50  
**MEM-1 8KX8 fully buffered, S-100,** uses 2102 type rams. PCB .....\$25.95  
**QM-12 MOTHER BOARD,** 13 slot, terminated, S-100 board only .....\$34.95  
**CPU-1 8080A Processor board S-100** with 8 level vector interrupt PCB .....\$26.95  
**RTC-1 Realtime clock board.** Two independent interrupts. Software programmable. PCB .....\$23.95  
**EPM-1 1702A 4K Eprom card PCB** .....\$25.95  
**EPM-2 2708/2716 16K/32K EPROM CARD PCB** .....\$25.95  
**QM-9 MOTHER BOARD, Short Version of QM-12,** 9 Slots PCB .....\$30.95  
**MEM-2 16K x 8 Fully Buffered 2114 Board PCB** .....\$26.95  
 8080A .....\$9.95 5101-8P ..... \$ 8.40  
 8212 .....2.49 2114 (450 NS) low pwr ... 7.25  
 8214 .....4.49 2114 (250 NS) low pwr ... 7.99  
 8224 .....3.49 2102A-2L ..... 1.50  
 2708 .....9.49 2102A-4L ..... 1.20  
 5101-1P .....6.90 4116 .....8/89.95

**NOV. SPECIAL SALE ON PREPAID ORDERS**  
 (Charge cards not included on this offer)  
**WAMECO PWR SUPPLY AND TERMINATOR BOARD**  
 12 Regulators for driving external equipment .....\$24.95  
**8KX8RAM.** Fully buffered 450 NSEC. 2.5 amp typical assembled parts may be unmarked or house numbered ....\$99.99

**MIKOS PARTS ASSORTMENT WITH WAMECO AND CYBERCOM PCBDS**

**MEM-2 with MIKOS #7 16K ram** with L2114 450 NSEC ..... \$249.95  
**MEM-2 with MIKOS #13 16K ram** with L2114 250 NSEC ..... \$279.95  
**MEM-1 with MIKOS #1 450 NSEC 8K RAM** .....\$119.95  
**CPU-1 with MIKOS #2 8080A CPU** ..... \$94.95  
**MEM-1 with MIKOS #3 250 NSEC 8K RAM** .....\$144.95  
**QM-12 with MIKOS #4 13 slot mother board** ..... \$89.95  
**RTC-1 with MIKOS #5 real time clock** ..... \$54.95  
**EMP-1 with MIKOS #10 4K 1702 less EPROMS** ..... \$49.95  
**EPM-2 with MIKOS #11 16-32K EPROMS less EPROMS** ..... \$59.95  
**QM-9 with MIKOS #12 9 slot mother board** ..... \$79.95  
**FPB-1 with MIKOS #14 all parts for front panel** .....\$134.95

MIKOS PARTS ASSORTMENTS ARE ALL FACTORY PRIME PARTS. KITS INCLUDE ALL PARTS LISTED AS REQUIRED FOR THE COMPLETE KIT LESS PARTS LISTED. ALL SOCKETS INCLUDED.

VISA or MASTERCHARGE. Send account number, interbank number, expiration date and sign your order. Approx. postage will be added. Check or money order will be sent post paid in U.S. If you are not a regular customer, please use charge, cashier's check or postal money order. Otherwise there will be a two-week delay for checks to clear. Calif. residents add 6% tax. Money back 30 day guarantee. We cannot accept returned IC's that have been soldered to. Prices subject to change without notice. \$10 minimum order. \$1.50 service charge on orders less than \$10.00.



(415) 592-1800  
 P. O. Box 424 • San Carlos, California 94070  
 Please send for IC, Xistor and Computer parts list

# WAMECO

## THE COMPLETE PC BOARD HOUSE EVERYTHING FOR THE S-100 BUSS

**NEW! POWER SUPPLY AND TERMINATOR BOARD. PROVIDES UP TO 12 REGULATORS TO DRIVE ALL THOSE PERIPHERALS FROM THE COMPUTERS POWER SUPPLIES. TERMINATES THE MOTHER BOARD.**

**KIT (ALL HEAT SINKS, RESISTORS, CAPACITORS AND PARTS FOR TERMINATOR EXCLUDES THE 12 REGULATORS) .....\$55.95**  
**PCBd. ....\$30.95**

**AT YOUR DEALER NOW!**

**FUTURE PRODUCTS: 80 CHARACTER VIDEO BOARD, IO BOARD WITH CASSETTE INTERFACE.**

**DEALER INQUIRIES INVITED, UNIVERSITY DISCOUNTS AVAILABLE AT YOUR LOCAL DEALER**



WAMECO INC. 111 GLENN WAY #8, BELMONT, CA 94002 (415) 592-6141





## BUILD YOUR OWN LOW COST

# MICRO-COMPUTER POWER SUPPLIES

FOR S-100 BUS, FLOPPY DISCS, ETC.

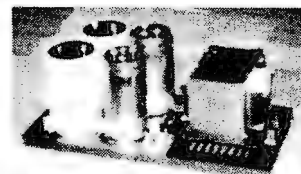
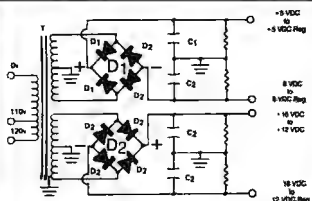

### POWER TRANSFORMERS (WITH MOUNTING BRACKETS)

ITEM NO.	USED IN KIT NO.	PRI. WINDING TAPS	SECONDARY WINDING OUTPUTS			SIZE W x D x H	UNIT PRICE
			2x 8 Vac	2x 14 Vac	2x 24 Vac		
T <sub>1</sub>	1	0V, 110V, 120V	2x 7.5A	2x 2.5A	—	3 3/4" x 3 3/8" x 3 1/8"	19.95
T <sub>2</sub>	2	0V, 110V, 120V	2x 12.5A	2x 3.5A	—	3 3/4" x 4 3/8" x 3 3/8"	25.95
T <sub>3</sub>	3	0V, 110V, 120V	2x 9A	2x 2.5A	2x 2.5A	3 3/4" x 4 3/8" x 3 3/8"	27.95
T <sub>4</sub>	4	0V, 110V, 120V	2x 4.5A	—	2x 4.5A	3 3/4" x 3 3/8" x 3 1/8"	19.95

### POWER SUPPLY KITS (OPEN FRAME WITH BASE PLATE, 3 HRS. ASSY. TIME)

ITEM	USED FOR	@+8 Vdc	@-8 Vdc	@+16 Vdc	@-16 Vdc	@+28 Vdc	SIZE WxDxH	UNIT PRICE
KIT 1	18 CARDS SOURCE	15A	—	2.5A	2.5A	—	12" x 6" x 4 7/8"	46.95
KIT 2	SYSTEM SOURCE	25A	—	3A	3A	—	12" x 6" x 4 7/8"	54.95
KIT 3	DISC SYSTEM	18A	1A	2A	2A	4A	14" x 6" x 4 7/8"	62.95
KIT 4	DISC SOURCE	8A	1A	—	—	8A	10" x 6" x 4 7/8"	44.95

EACH KIT INCLUDES: TRANSFORMER, CAPACITORS, RESIS., BRIDGE RECTIFIERS, FUSE & HOLDER, TERMINAL BLOCK, BASE PLATE, MOUNTING PARTS AND INSTRUCTIONS.

### REGULATED POWER SUPPLY "R2" ASSY. & TESTED, OPEN FRAME, SIZE: 9" (W) x 5" (D) x 5" (H) ..... \$69.95

SPECS: +5V ±1%, @ 5A, +24V, +1%, @ 5A. OVERCURRENT PROTECTION AND ±5% ADJ. FOR BOTH VOLTAGES.

REMARK: IDEAL FOR ROCKWELL AIM-65 MICROCOMPUTER. ALSO -5V, @ 1A OPTIONAL, \$5.00 ADDITIONAL.

SHIPPING FOR EACH TRANSFORMER: \$4.75. FOR EACH POWER SUPPLY: \$5.00 IN CALIF. \$7.00 IN OTHER STATES. CALIF. RESIDENTS ADD 6% SALES TAX. OEM WELCOME.

## SUNNY INTERNATIONAL

(TRANSFORMERS MANUFACTURER)

Telephone: (213) 633-8327

STORE:

7245 E. ALONDRA BLVD.  
PARAMOUNT, CA 90723  
STORE HOURS: 9 AM-6 PM



MAIL ORDER:  
P.O. BOX 4296  
TORRANCE, CA 90510

# 10% OFF 20% OFF

YOUR OWN TRS-80 SYSTEM AT TREMENDOUS SAVINGS

### 1 TRS-80 Complete System

Includes: CPU/Keyboard, Power Supply, Video Monitor, Cassette Recorder, Manual, and Game Cassette.

### 2 Line Printer

### 3 Mini Disk System

### 4 C-10 Cassettes

### 5 Verbatim Diskettes



### DISK DRIVES NOW IN STOCK!

ITEM	REG. PRICE	OUR PRICE
Level II—4K	\$698.00	\$628.20
Level II—16K	\$988.00	\$889.20
Expansion Interface	\$299.00	\$269.10
Mini Disk Drive	\$ 495.00	\$ 385.00
Centronics 779 Printer	\$1599.00	\$1175.00
Centronics 101 Printer	\$1595.00	\$1400.00
Anadex DP-8000 Printer	\$1295.00	\$ 995.00
Centronics P1 Printer	\$ 534.00	\$ 445.00
Trendata 1000	\$1495.00	\$1295.00
Memory Kit-(16K)	\$ 199.00	\$ 98.00
FREE INSTALLATION		
Verbatim Diskettes ea.	\$ 5.95	\$ 4.95
3	\$ 17.89	\$ 12.00
10	\$ 59.00	\$ 37.00
Maxell Diskettes ea.	\$ 10.00	\$ 7.50
3	\$ 30.00	\$ 21.00
10	\$ 100.00	\$ 60.00
C-10 Cassettes	\$ 4.95	\$ 4.50
5	\$ 24.75	\$ 18.75
25	\$ 29.95	\$ 23.95
C-30 Cassettes	\$ 29.95	\$ 23.95
Paper (9 1/2" x 11" fanfold, 3500 sheets)	\$ 35.00	\$ 29.95
<b>TRS-80 MODEL II</b>		<b>\$3208.50</b>
• 32K RAM		
• 1/2 MEG DISK		
ADDITIONAL 32K RAM		418.50
ADDITIONAL DISK DRIVE (1ST)		1069.50
ADDITIONAL DISK DRIVE (2ND + 3RD)		558.00

### INNOVATIONS

### Centronics 730 Same as Line Printer II

\* Special 1st 25 units sold  
Similar to Line Printer III  
**\$ 850 Reg. \$ 895**

Anadex 9500  
**\$1,295 Reg. \$1,999**

\* All printers include cables

There are new developments every day—  
write or call for the latest information.

Outlet Hours: Mon.-Fri.; 9 am.—7 pm.  
Sat. 12—5 pm.

**VRData** corp.

777 Henderson Boulevard N-6  
Folcroft Industrial Park  
Folcroft PA 19032  
(215) 461-5300



TOLL FREE  
1-(800) 345-8102 \*Orders only!

FOREIGN and DOMESTIC DISTRIBUTORSHIPS AVAILABLE . . .

# SAVE THE WHALE

The Fin Whale is the world's greatest long-distance communicator.

Scientists believe that loud, deep-tone, low-frequency sounds made by Fin Whales (frequencies around 20 hertz, or cycles per second) actually travel underwater for distances of at least 500 miles, and under optimum conditions might carry for a radius of over 4,000 miles, potentially reaching an area greater than the entire Atlantic Ocean.

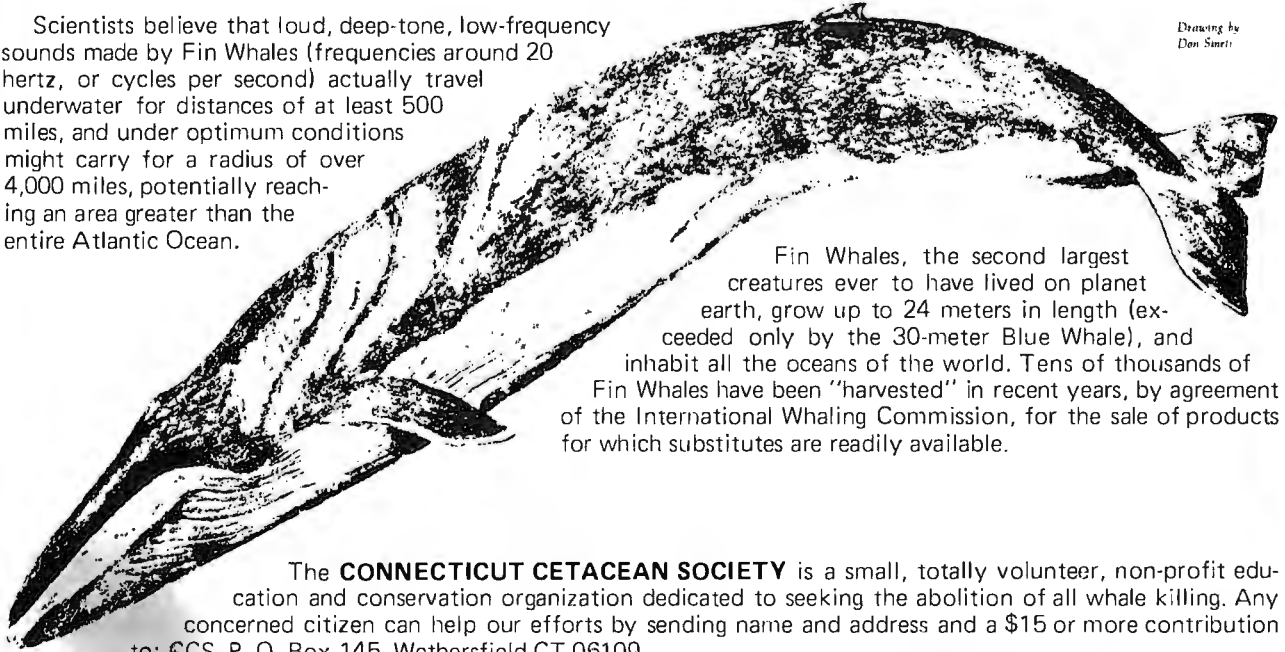

Fin Whales, the second largest creatures ever to have lived on planet earth, grow up to 24 meters in length (exceeded only by the 30-meter Blue Whale), and inhabit all the oceans of the world. Tens of thousands of Fin Whales have been "harvested" in recent years, by agreement of the International Whaling Commission, for the sale of products for which substitutes are readily available.

The **CONNECTICUT CETACEAN SOCIETY** is a small, totally volunteer, non-profit education and conservation organization dedicated to seeking the abolition of all whale killing. Any concerned citizen can help our efforts by sending name and address and a \$15 or more contribution to: CCS, P. O. Box 145, Wethersfield CT 06109.

		11542-1 Knott St Garden Grove CA 92641 (800) 854-6411 (714) 891-2663		<b>SHUGART</b>		<b>TRS-80</b>	
<b>MICROBYTE 16K RAM BOARD</b> • FULLY S-100 COMPATIBLE • USES LOW POWER MM5257 4Kx1 STATIC RAMS • 2MHZ OR 4MHZ OPERATION • 4K BANK ADDRESSABLE • EXTENDED MEMORY MANAGEMENT • NO DMA RESTRICTIONS • ASSEMBLED & TESTED 2MHZ \$280.00    4MHZ \$300.00		<b>4116's (250NS)</b> FOR APPLE OR TRS-80 <b>8 for 64.00</b> <b>16 for 120.00</b> FULLY GUARANTEED		<b>SA800 DISK DRIVE</b> INSTALLED IN DUAL CABINET W/PWR SUPPLY. ASSEMBLED & TESTED (1) DRIVE INSTALLED <b>\$695.00</b> (2) DRIVES INSTALLED <b>\$1125.00</b>		<b>FLOPPY DISK DRIVE</b> WITH CABINET & POWER SUPPLY, COMPATIBLE WITH RADIO SHACK INTERFACE. ASSEMBLED & TESTED. 1 YR. WARRANTY. <b>\$425.00</b> INTERFACE CABLES (\$35.00)	
<b>MICROBYTE 32K RAM BOARD</b> • FULLY S-100 COMPATIBLE • USES LOW POWER MM5257 4Kx1 STATIC RAM • 2MHZ OR 4MHZ OPERATION • 4K BANK ADDRESSABLE • EXTENDED MEMORY MGMT. • ON BOARD 8-BIT OUTPUT PORT • NO DMA RESTRICTIONS • ASSEMBLED & TESTED 2MHZ \$580.00    4MHZ \$595.00		<b>SPECIAL</b> •1@12VOLTS CERAMIC CAPS <b>10¢ each</b> OR <b>100/\$9.00</b>		<b>2708's</b> LOW POWER 450 NANO SEC. <b>\$8.25 each</b> OR <b>8 for \$64.00</b>		<b>18-PIN</b> LOW-PROFILE SOCKETS <b>17¢ ea.</b>	
<b>ORDERING INFORMATION</b> NAME, ADDRESS, PHONE SHIP BY: UPS OR MAIL SHIPPING: ADD \$2.50 UP TO (5) LBS. CREDIT CARDS CHARGED APPROPRIATE FRT.		<b>TERMS</b> WE ACCEPT CASH, CHECK MONEY ORDERS, VISA & MASTER CHARGE CARDS. (U.S. FUNDS ONLY) TAX: 6% FOR CALIF. RESIDENTS ONLY.		<b>8251</b> TESTED @ 4 MHZ U-ART <b>\$4.50 ea</b>		<b>2716's</b> 5 VOLT ONLY LOW PWR 450 NS. <b>\$35.00 ea.</b>	
				<b>CABLE ASSEMBLY</b> (2) 50 PIN CARD-EDGE CONNECTORS ON 4 FT. RIBBON CABLE <b>\$15.00 ea.</b>		<b>REGULATORS</b> 320T-5 ..... .75 340T-5 ..... .65 320T-12 ..... .75 340T-12 ..... .65	
				<b>79 L\$ 244</b>		<b>IMSAI CONN.</b> 100 PIN • SOLDER TAIL <b>\$3.00 each</b> OR 10 for \$2.60 ea.	
				<b>\$3.00 each</b>			





# California Digital

Post Office Box 3097 B • Torrance, California 90503

## FREE Paper Tiger

With Purchase of The INTEGRAL DATA 440

Your Choice, \$200 Value

- 1) Graphics Option Package
  - 2) Interface for APPLE II
  - 3) TRS-80 Printer Interface
- California Digital has recently researched the complete low cost printer market. It is our opinion that the IDS-440 Paper Tiger is, without doubt, the most versatile and offers the best value of any printer costing under \$1,000.

This quality dot matrix printer incorporates such features as to allow print densities up to 132 characters per line. Full forms handling capabilities and tractor feed mechanism adjustable to 9.5". The Paper Tiger is engineered to accept either parallel or RS232 serial ASCII. 110/220V.50/60Hz.

\*\*\*\* \$995.00 plus shipping \*\*\*\*

## S-100 Mother Board

Quiet Buss

\$2995  
8803-18  
18 slot  
IMSAI

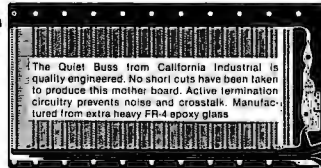

The Quiet Buss from California Industrial is quality engineered. No short cuts have been taken to produce this mother board. Active termination circuitry prevents noise and crosstalk. Manufactured from extra heavy FR-4 epoxy glass.

## TELETYPE MODEL 43

Even if we have to give them away, we're going to ship more 43's in 1979 than the aggregate of all our competitors.

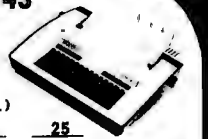

Model 43AAA TTL)  
EACH 3 10 25  
\$925. 875. 850. 825.  
RS-232 Interface "K" Add \$750.00 plus shipping

## Minidisk Drive for TRS-80

your choice \$388.  
Lobo or Vista  
Includes Interface Cable

## FREE PLASTIC LIBRARY CASE

with purchase of each box of ....  
Verbatim mini-diskettes. \$5 value.  
\$24.95  
BOX of 10  
DISKETTES

## CONNECTORS

your choice  
DB25P male plug & hood  
or  
DB25S female  
\$395  
Qty. ea. male hd.  
10 3.45 2.45 1.15  
25 3.15 2.25 1.05  
100 2.85 1.90 .95  
500 2.25 1.60 .85  
1K 1.97 1.37 .73

## Edge Connectors

GOLD 100 PIN  
IMSAI/ALTAIR  
Imesai solder .125x.250 \$3.95 3/4 \$9.00  
Imesai w/.125 centers \$4.95 3/4 \$13.00  
Altair solder altair.140row \$5.95 3/4 \$15.00  
SPECIALS  
22/44 Kim eyelet.156" \$1.95 3/4 \$5.00  
25/50 solder tab .156" \$1.09 3/4 \$2.00  
36/72 wide post w/w.156 \$1.95 3/4 \$5.00

## SYSTEM X-10

It's not often that California Digital ventures into the distribution of consumer products, but we have recently come across to our product line. This is the System X-10 manufactured by the Distri-rite company. This stereo auto system will remotely control any light or appliance in your home or office. Command signals are transmitted from the command console over your existing wiring. From your bed or easy chair you can control up to 16 different electrical devices inside and outside your home. Use the System X-10 to control your stereo, television or any light fixture on the premises.  
The modular system is available in the following components:  
Ultrafast Master Control Console ..... \$24.95  
Battery Operated Ultrasonic Controller ..... 12.95  
Appliance Module, Lamp Module or Wall Switch ..... 13.95

## SPECIAL

APPLE II  
16K MEMORY  
COLOR • GRAPHICS • SOUND  
\$988  
PLUS SHIPPING  
Mfg. Sub. Retail... \$1195

TEN \$39 for 50+ \$365  
**Scotch** Certified Digital CASSETTES  
Won't drop a BIT!  
DISKETTES \$550  
8inch Soft (IBM)  
8inch 32 sector  
Mini Soft sec.  
Mini 10 sector  
Mini 16 sector  
CALIFORNIA INDUSTRIAL is an Authorized Dealer of Scotch Brand Data Products

**Shugart Associates**  
SAB800-R Floppy Disk Drive  
The most cost effective way to store data processing information, when random recall is a prime factor. The SAB800 is fully compatible with the IBM 3740 format. Write protect circuitry, low maintenance & Shugart quality.  
\$449.50

**\$85 KEYBOARD**  
ASCII ENCODED  
KEYTRONIC ASCII & ASCII complement.  
\* Ten key data pad  
\* Cursor controls  
\* Six user switches  
\* Alpha Lock  
\* Auto repeat  
\* Single 5 volt.  
\* Glass read.  
NEW

Buying a CRT Terminal?  
**Hazeltine • Soroc • Lear Siegler**  
Well if you really insist upon purchasing one of the above terminals, sure, we'll sell it to you. But when the keyboard starts to double bounce, the screen fades and the power supply just craps out don't call us, complain to the manufacturer.  
The alternative, take a serious look at the ADDS Regent 25, we have, and concluded that this terminal offers, the best value in today's market. Through years of research the ADDS Company has evolved a low maintenance, extremely durable CRT terminal capable of withstanding an abusive 24 hour duty cycle. The Regent 25 features Intel 8085 micro-processor controlled circuitry along with the Cherry Switch long-life capacitance keyboard.  
18 key cursor and numeric pad doubles to allow for user definable special functions. True descending lower case characters along with a fully addressable cursor makes the Regent 25 the ideal word processing terminal. High-resolution screen is capable of displaying 96 upper and lower case ASCII characters and 32 control codes. This unique feature assist in the debugging of programs. The Regent 25 is switch selectable to display six European languages along with katakana.  
Clearly, the Regent 25 is not your average terminal, but than, ADDS is not your average terminal company.

**MINIATURE SWITCHES**  
your choice  
10 50 100 1k  
\$.98 \$88 .81 .73 .66  
SPDT Miniature Toggles  
7101 C&K ON-NONE ON  
7107 jbt ON-OFF (mnt. ON)  
7108 CK ON-(moment. ON)  
Rocker JBT DPDT  
Rotary 3P-4-Pos.  
Rotary 3P-6-Pos.  
Push B (N.O.) \$3.9ea. 4/51

**MEMORY**  
TRS-80 \$65  
APPLE II 65  
16k memory (8) 4116's  
Installation is simple. Anyone who has ever changed a spark plug should be able to up-grade his microcomputer.  
How can California Digital offer these memory up-grade sets at 25% below our competition? Simple, we buy in volume, wholesale to dealers and sell the balance directly to owners of personal micro-systems. These 16K dynamic memory circuits are factory prime and unconditionally guaranteed for one full year. N.O.W. before you change your mind, pick up the telephone and order your up-grade memory from California Digital. Add \$3 for TRS80 jumpers.  
STATIC 1-31 32-99 100-5C -999 1K+  
21L02 450nS. 1.19 .99 .95 .90 .85  
21 L02 250nS. 1.49 1.39 1.25 \* \* \*  
2114 1Kx1-150 5.95 5.50 5.25 4.75 4.50  
2114 1Kx1-300 8.95 8.50 8.00 \* \* \*  
-044 4Kx1-450 5.95 5.50 5.25 \* \* \*  
-044 4Kx1-250 9.95 9.50 9.00 \* \* \*  
-045 1Kx1-150 8.95 8.50 8.00 \* \* \*  
-045 1Kx1-250 9.95 9.50 9.00 \* \* \*  
5257 low pow. 5.95 5.50 5.00 4.80 4.60

**Regent 25**  
from  
**APPLIED DIGITAL DATA SYSTEMS**  
\$850  
Well if you really insist upon purchasing one of the above terminals, sure, we'll sell it to you. But when the keyboard starts to double bounce, the screen fades and the power supply just craps out don't call us, complain to the manufacturer.  
The alternative, take a serious look at the ADDS Regent 25, we have, and concluded that this terminal offers, the best value in today's market. Through years of research the ADDS Company has evolved a low maintenance, extremely durable CRT terminal capable of withstanding an abusive 24 hour duty cycle. The Regent 25 features Intel 8085 micro-processor controlled circuitry along with the Cherry Switch long-life capacitance keyboard.  
18 key cursor and numeric pad doubles to allow for user definable special functions. True descending lower case characters along with a fully addressable cursor makes the Regent 25 the ideal word processing terminal. High-resolution screen is capable of displaying 96 upper and lower case ASCII characters and 32 control codes. This unique feature assist in the debugging of programs. The Regent 25 is switch selectable to display six European languages along with katakana.  
Clearly, the Regent 25 is not your average terminal, but than, ADDS is not your average terminal company.

**DISCOUNT Wire Wrap Center**  
IC SOCKETS  
Wire wrap low profile  
pin ea. 25 50 ea. 25 50  
8 17 16 15  
14 37 36 35 18 17 16  
16 38 37 36 19 18 17  
24 99 93 85 36 35 34  
40 169 155 139 63 60 58  
SOFT \$98  
KYNAR WIRE WRAP  
500 1,000 11,000  
\$9. \$15. \$105.  
\$2995  
BW 630  
OK HOBBY WRAP-30 wire wrap & strip tool  
\$545

**PORTABLE DATA ENTRY SYSTEM**  
\$13950  
These used data terminals were originally designed for chain store inventory control and order entry systems. The operator enters the inventory control number, merchandise on hand and the unit price. After all pertinent data has been entered into the recorder, the main warehouse is telephoned, the handset is placed in the acoustic coupler and all the recorded information is transmitted back to the master computer. With a little imagination and one of these portable entry systems, you should be able to exchange programs and computer information with associates across the country. All units were removed from service in working condition. Original cost \$2,500. Each system comes complete with:  
\* Portable Cassette Drive Unit  
\* Reusable Entry Keyboard with LED Display  
\* Five Gould "D" NCads  
\* Acoustical Coupler  
\* Battery Charger  
\* DB25 Cable  
\* Shoulder strap  
\* Full Documentation

**SPECIAL CIRCUITS**  
Z80A 4MHz. 24.95  
8080A CPU 9.95  
8085 22.50  
8086 Intel 16 bits 85.00  
TMS9900 16 bits 49.95  
AY5-1013A UART 4.95  
Floppy Disc Controllers WD 1771 single D. 39.95  
WD 1781 Double D. 65.00  
WD 1791 1 1/2 D 3740 \*

**EPROMS** 1-15 16-83 64+  
1702A 2K 4.95 4.50 4.00  
2708 8K 9.95 9.50 9.00  
2716 5v16K 39.95 35.00 \*  
2716 T1 24.88 20.00 \*  
2532 85.00 \* \*

**(213)679-9001**  
All merchandise sold by California Digital is premium grade. Sorry, no COD's. Orders are shipped the same day received. California residents add 6%. Foreign orders add 10%. Orders over \$25, when accompanied by payment, are shipped at our expense. Otherwise, please add \$2.

# FLOPPY SYSTEMS

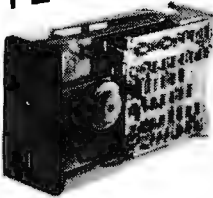

8" Siemens FDD120-8  
All Siemens options included in this drive may be configured hard or soft and single or double density. We find this to be an extremely reliable drive. \$399.00



5 1/4" BASF Magical Miniature Mini drive only 2/3 the size of others is reliable and durable and quickly gaining in popularity with our customers. Single or dual density fast access times \$274.00



Tarbell Controller may be re-configured to control 5 1/4" drives and includes short cable for one drive. KIT \$179.00, ASM \$265, but only \$219 with purch. of 2 drives.



Cable Kits For 8" Drives with 10' 50 cond. cable and connectors. Also power cable and connectors. Flat cable assem if you wish. For one drive 27.50, two 33.95, three 38.95

Cable Kits for 5 1/4" Drives as above, but 34 cond. For one drive 24.95, two 29.95.

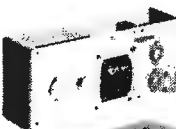

"Power One" Model CP206 Power Supply adequate for at least two drives. 2.8A/24V 2.5A/5V, 0.5A/-5V beautiful quality. \$99.00

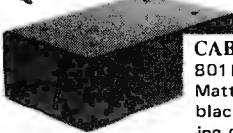

CABINETS for FDD120 and 801 R drives, or CP206 supply. Matte finish in mar resistant black epoxy paint and stacking design 29.95

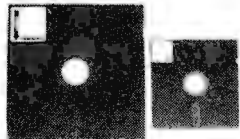

DISKETTES (3M, MRX, BASF, Georgia Magnetics, & Victor Borge)  
8" \$39.95/10  
5 1/4" \$29.95/10

32K / 16K Static RAM, 4MHz.

(Showing Amazing Similarity to Tarbell's unit) (16K Shown in photo)

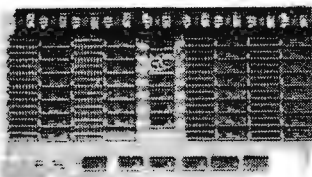

32K - \$549.00 16K - \$349.00

## "BACK TO SCHOOL" KEYBOARD SPECIAL

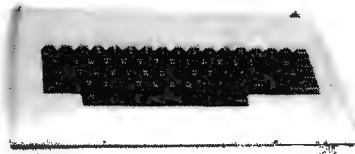

CHERRY "PRO" Keyboard \$119.00  
Streamlined Custom Enclosure \$34.95  
BOTII ONLY \$124.95 !!!!!!!

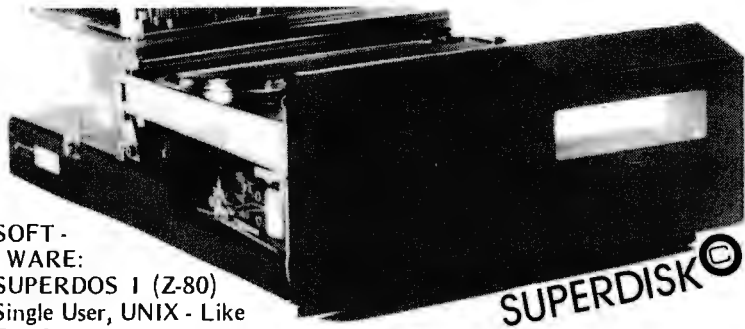

10MBy DRIVE \$3300

S - 100 DMA CONTROL \$495

POWER UNIT \$395.00

SOFT-WARE:  
SUPERDOS 1 (Z-80)  
Single User, UNIX - Like File System, AND Totally Upward Compatible From "XX/X" (What did you say, Digital Research??)

PS: SUPERDOS-1 runs on the TRS-80, and can transform it from a toy computer to a real business machine !!!

For the first time in something like 10 years, a new STANDARD in removable media has evolved. Selected by Datapoint, and others who have not yet announced, this drive is beautifully simple and easy, if not trivial to maintain. 920kBy/sec. transfer rate, 3600 RPM 39 lbs and only 125 Watts.

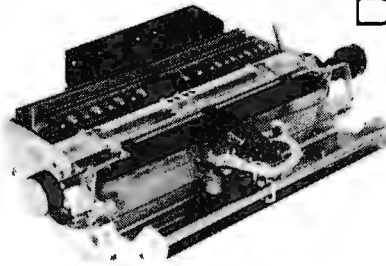

## Daisy Wheel Printers

### Qume Sprint 3\45

PRINTER (factory warr.) \$1199.00  
POWER SUPPLY (Boschert) \$349.00 (shown mounted on rear of printer)  
COMBINATION SPECIAL \$1499.00

## DATA DISPLAY MONITORS

Used 12" Sylvania monitors. Composite Video, 15 MHz, 120VAC. Rebuilt with NEW P39 anti-glare tube \$119.00  
New P4, 109.00, used P4 79.00.



"OEM STYLE" as above, will fit any case. (Both versions serviced by qualified tech). Identical to above but subtract \$12.00

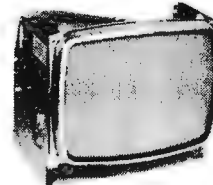

## Doppler Motion Sensor Intrusion Detector

Extremely effective microwave motion detector for detecting unwanted visitors. Ignores mice and other non-larcenous creatures. Operates on 12VDC or from small transformer supplied. Output is relay closure for alarm control interface, or to switch on lights annunciators. Will operate THROUGH door of closet or thin wall. Best application seems to be to turn on outside lights to help invited guests, and to intimidate unwanted ones. \$159.00  
Water Repellent Cover \$24.95

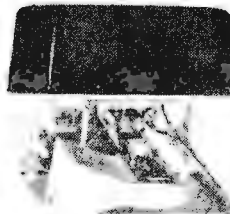

New!

## Electrolabs

POB 6721, Stanford, CA 94305  
415-321-5601 800-227-8266  
Telex: 345567 (Electrolab Pla)  
Visa MC Am. Exp.

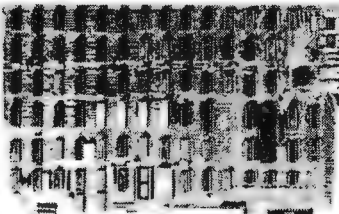

## ESAT 200B

BI-LINGUAL 80x24 COMMUNICATING TERMINAL

Scrolling, full cursor, bell, 8x8 matrix, 110 - 19,200 baud, Dual Font Applications. Arabic & Hebrew, Multilingual Data Entry Forms Drawing, Music, & Switchyards. \$349.00

## SOCKET SPECIAL



"Won't Let Go"

Low Profile

Solder Tail

1 CENT/ Pin !! (0.75/1000's)

8 14 16 18 20 22 24 28 40

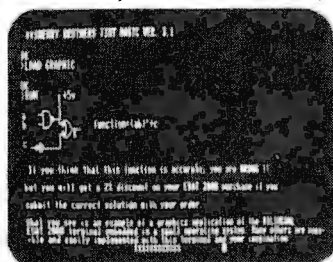

# A NEW System CONCEPT!!

**BRAND NEW POWER!!**  
**BRAND NEW OPERATING SYSTEM!!**  
**UN-INTERRUPTABLE POWER CAPABILITY!!**  
**DON'T LOSE YOUR DATA!!**

**FEATURING: Expandability** — hardware and OS expand — up to 16 users. **Double density** — (it works!!!) UNIX like operating system (OS-1). Supports all CP/M utilities and programs. Time sharing capability. Turnkey software included.

## BUSINESS DATA WORK SAVER®!!!

Standard features: Enclosure, 10 slot backplane, Z-80 CPU, 32K RAM, I/O and controllers, Bantam terminal, Paper Tiger Printer, OS-1, Two floppies (8" or 5 1/4"). Basic compiler with application programs for accounts payable, accounts receivable, general ledger and payroll **\$6495.00**

## WORD SAVER®!!!

### MULTI-USER

### UP TO EIGHT STATION WORD PROCESSING

Standard features: Enclosure, 10 slot backplane, Z-80 CPU, 48K RAM, Daisy Wheel Printer, ESAT Terminal with two fonts (Arabic, Hebrew, Cyrillic, Greek, Catakana, any custom font for \$50.00) Three floppies: (8" or 5 1/4") OS-1. Word processor package with additional memory which is expandable up to eight users (each extra terminal \$900.00) **\$8695.00**

## ELECTROLABS

POB 6721 Stanford, CA 94305  
 415-321-5601 800-227-8266  
 Telex: 345567 (Electrolab Pla)

**OPTIONS:** 10 MBy hard disk (available now!!!) Extra memory, graphics, etc. Call or write for further details. This is the most advanced microcomputer system available at this time.

CP/M\* Source Code - FREE! when you purchase "OS-1"

Electrolabs' new operating system for the Z-80 designed to have exactly the appearance of UNIX\*\*, including virtual I/O, "set TTY", a tree and a shell, filters and pipes PLUS total compatability with CP/M software!

# OS-1<sup>®</sup> FEATURES

(Because OS-1 is truly a comprehensive "OS", and not merely a file handling "DOS", we have changed the name from "Superdos" to "OS-1")

- VIRTUAL I/O** - copy with a single command between floppy and hard disk, or from TTY to printer to tape to disk... etc., etc.
- No messy I/O routines to write, & no awkward transfers.
- SECURITY** - 9 modes of file protection, user and login protection.
- MULTI-USER** - up to 256 passwords. (non-simultaneous users)
- 16MBy FILE SIZE** - but no limit to no. of directories per device, thus allowing EASY implementation of gigantic storage devices.
- "SET TTY"** - for printer or crt: tabs, page width, buffer, cursor, UC/LC, fonts, formfeed, arbitrary control characters etc., etc.
- "LOGIN"** - automatically executes user selected programs and "set TTY".
- OCCUPIES 12KBy** - only 50% larger than CP/M, but 500% more features.
- CP/M & CDOS COMPATABLE** - your library is guaranteed to run!

\* (Naturally, we are not giving away the version of CP/M written by Digital Research, Please pardon our pun, but they might object. What we ARE giving you is a greatly enhanced version of CP/M which resides on OS-1, and allows the user of OS-1 to run any and all of his programs, packages or system utilities which are already running on CP/M. We give you the source code at no charge so that you may modify any part of the CP/M to suit your own system requirements. At no charge, you also receive the enhancement allowing 4MBy files instead of 256K.)

OS-1 (with debugger, linker and screen oriented editor)	\$199.00
Update service, per year	29.00
Symbolic Debugger	150.00
MACRO-Assembler (Creates relocatable code)	150.00
"C" Compiler	660.00
FORTRAN Compiler	100.00
BASIC Compiler (very fast)	150.00

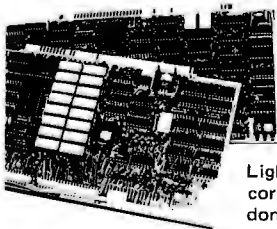

# Graphics

High Resolution 480 x 512  
 for B&W and Color Imaging and Graphics

Light pen, A-D, D-A, TV synchro (needs no time base correction or adjustment with anything between random interface & NTSC commercial standard), T.V. single frame grabber ("snapshot"). Up to 1 Byte of attributions per pixel.

## LSI-100 & S-100 applied to:

**Graphic Presentation** — such as computer generated animation & other graphic displays up to 256 colors & up to 256 b&w gray scales. **Image Analysis** — using built-in FRAME GRABBER, for medical image enhancement, contour analysis, & pattern recognition. **Commercial TV Tilting & Advertising** — using synchronization capability. **Interactive graphics** — using light pen accessory.

## BASIC CONFIGURATION —

LSI-11 \$1995, S-100 \$1265.  
 For TRS-80/Exidy Add \$595.00  
 Includes: Data Board - 32K (480 x 512 x 1 pixel) D-A 16 level video generator. Video Synchronization Circuitry, Address Control & Timing Board.

**FEATURES** — High speed. DMA or 2KBy window memory mapped interface. Full NTSC commercial color capability. Low power consumption. Excellent Software

## Options — Accessories — Software

Options include: light pen, auxiliary outputs, text mode, memory and much more. Accessories include: b&w and color cameras and monitors, Software: "Plot" 2D or 3D, "Tilting", "Contour", "Image Enhancement", "Vector Curve Generation".

Call for price and details

\*CPM and \*\*UNIX

trademarks of Digital Research and Western Electric respectively,

Circle 115 on inquiry card.

## Electrolab's System Switcher Model SP04



Tames

# RAW POWER

for the

## LSI-11/23 ★

And Hard Disks

## FEATURES:

- \* Brown-Out Proof
- Line Frequency Indifferent
- Very Low EMI
- U.L. Approved
- 20 KHz
- High Efficiency
- Soft Start
- Extremely Lightweight
- Open Frame Design
- Short Circuit and
- OV Protection
- 20,000 Hour MTBF (MIL 217B)
- Adaptable to Un-Interruptable Power applications.
- and
- Low Cost!! (just look at DEC's price)

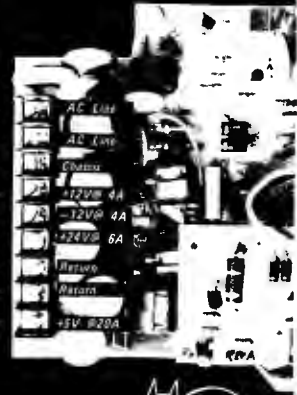

Electro Labs





# ADVANCED COMPUTER PRODUCTS

P.O. Box 17329, Irvine, CA 92713  
(714) 558-8813

# HOLIDAY COMPUTER SPECIALS

**... and it's COLOR** **SALE \$100.00 OFF**  
**"The Compucolor II"**  
*... a personal colorgraphics system for the modern computer man ...*

- ★ Color Graphics 13" Color CRT
- ★ Proven 8080A CPU System
- ★ 16K Extended Disk Basic
- ★ Up to 117\* Key Keyboard
- ★ Up to 32K\* RAM
- ★ Minidisk Drive 51.2K Bytes/Side



Model 3 w/8K, 72 Key Keyboard, RS232 **SALE TAKE OFF** (\$1495.00 / \$1695.00 / \$1995.00)  
 Model 4 w/16K, 72 Key Keyboard, RS232 **\$100.00 OFF** (\$1995.00)  
 Model 5 w/32K, 72 Key Keyboard, RS232 **\$100.00 OFF** (\$1995.00)  
 Options: 101 Key Keyboard ..... Add \$150.00  
 117 Key Keyboard ..... Add \$225.00  
 Formatted Diskettes ..... 2/\$19.95  
 Programmed Diskettes ..... \$19.95  
 Diskette Library Inc. Hangman, Othello, Math, Chess, Startrek, Blackjack, Cubic Tic Tac Toe, Finance Vol. I, Finance Vol. II, Bonds and Securities, Assembler, Text Editor, Personal Data Base.

**EXIDY SORCERER ONLY \$799.00**



**\$799 w/8K**  
**\$1099 w/16K**  
**\$1249 w/32K**  
**\$1449 w/48K**

- ★ New Word Processing Pac ..... \$99.00
- ★ INCLUDES: Keyboard & enclosure, 90 day Warranty, MICROSOFT BASIC, Video & Cassette Cable, Complete Documentation
- ★ \$100 Expansion Module ..... Add \$299.00
- ★ Cassette recorder ..... Add \$44.95
- ★ Sanyo 9" Monitor ..... Add \$169.95

User programmable or use cartridges. Combines the desirable features of the PET, APPLE and TRS-80 into a complete expandable computer system.  
 ★ I/O expansion kit ..... \$149.00  
 ★ Vista V-200 add-on mini floppy for Exidy. (requires exp. module) w/CPM ..... \$699.00

**KIM-1**  
**Now only \$179.00**



- ★★ Power Supply ..... Add \$59.95
- ★★ Cassette Recorder ..... Add \$44.95
- ★★ Sanyo 9" Monitor ..... Add \$169.95
- ★ Add enclosure \$29.95

**SYM-1 IN STOCK**  
 Reg. \$269.00  
**Now \$249.00**



- ★ KIM-1 Compatible
- ★ 4K ROM Monitor
- ★ 1K Bytes 2114 RAM
- ★ 65K Memory Expansion
- ★ User EPROM 2716
- ★★ Power Supply ..... Add \$59.95
- ★★ Cassette Recorder ..... Add \$44.95
- ★★ Sanyo 9" Monitor ..... Add \$169.95

School & group discounts available. Buy now and receive \$100.00 worth of discount coupons: i.e.,  
 ★ SRM-1 1K Static RAM exp. reg. 42.00 ..... disc. \$32.00  
 ★ PEX-1 I/O Port, reg. \$60.00, disc. \$50.00  
 ★ SYM BAS-1 Basic ROM (Microsoft) reg. \$159.00 ..... disc. \$109.00  
 ★ KTM-2 CRT/TV Keyboard, reg. \$349.00 ..... disc. \$319.00  
 SYM Enclosure ..... \$39.95

**AIM 65**



**\$375.00**

ADVANCED INTERACTIVE MICROCOMPUTER

- ★ On Board 20 column alphanumeric printer
- ★ Alphanumeric 20 character display
- ★ Terminal style Keyboard 54 Keys
- ★ 6502 based CPU

w/1 K RAM ..... \$375.00\*  
 w/4K RAM ..... \$450.00\*  
 Assembler ROM ..... Add \$85.00  
 BASIC IN ROM ..... Add \$100.00  
 Power Supply ..... Add \$99.95  
 Enclosure ..... Add \$44.95

**RCA COSMAC VIP**



**NEW LOW PRICE \$249.00**

Assembled, Regular price ..... \$299.95  
 w/Sanyo 9" Monitor ..... \$169.95

- VP-590 Color Board ..... 69.95
- VP-595 Sound Board ..... 49.95
- VP-570 4K Expansion Board ..... 95.95
- VP-580 Expansion Keyboard ..... 15.95
- VP-700 Tiny Basic ROM ..... 49.95
- VP-710 VIP Game Manual ..... 10.95

**LOW LOW APPLE II PLUS \$990.00**

APPLE's new upgraded APPLE II w/16K is now in stock and available for the lowest price ever, only \$990.00. You can add:  
 ★★ M & R Modulator for \$29.95  
 ★★ Sanyo tape recorder for \$44.95  
 ★★ 16K upgrade kit for only \$74.95 ea.

This is a limited offer and we reserve the right to change without notice.

**NORTH STAR HORIZON ★DOUBLE DENSITY★**

Now in stock North Star Z-80 based high-performance computer.

- ★ 180K Bytes per Disk
- ★ Z-80 Processor
- ★ Motherboard
- ★ 2 Serial + 1 Parallel Port Avail.
- ★ 32 K RAM

Horizon I Kit **Sale \$1849.00**



North Star Double Density Disk Subsystem Kit

**PROCESSOR TECHNOLOGY SALE**  
**SOL-20 DEALERS & USERS INVITED!**

WE PURCHASED Processor Technology's entire inventory of spare parts, work in process, and finished goods. This material will be sold on a first come first served basis. Advanced will continue to support some SOL products on a limited basis so make sure you get a copy of our complete inventory listing and a place on our SOL mailing list.

- ★ New SOL-20 w/o Memory \$1095.00
- ★ SOL-20 Keyboards \$139.95
- ★ SOL-20 Bare Logic Boards \$125.00
- ★ NKRA Memory Boards up to 64K \$CALL

Plus more endless PTI bargains send for details.

**HERE ARE SOME EXAMPLES**

1979 CATALOG NOW AVAILABLE FOR ONLY \$1.00

# Widen the ability of your TRS-80



## The Vista V80: \$395

The Vista V80 Mini Disk System is the perfect way to widen the capabilities of your TRS-80\* Micro-computer. Quickly and inexpensively. Our \$395 price tag is about \$100 less than the Radio Shack equivalent. Our delivery time is immediate (24 hour turn-around from our Santa Ana, Ca. factory). And our system is fully interchangeable. That's just the start.

**It will give you 23% more storage capacity** by increasing useable storage from 55,000 to 65,000 bytes per drive with our new software patch.

**It can work 8 times faster** than the TRS-80 Mini-Disk system, because track-to-track access is 5ms versus 40ms for the TRS-80. You can realize this added speed

once the new double disk expansion interface is available without expensive modification of the existing unit.

**It has a better warranty** than any comparable unit warranty available – a full 120 days on all parts and service. When you consider how much more goes into the Vista V80, that shows a lot of faith in our product.

**A full 3 amp power supply** means you have 2½ times the power necessary to operate the V80, and full ventilation insures that there will be no problems due to overheating.

The Vista V80 Mini Disk System requires Level II Basic with 16K RAM Expansion interface (it operates from the Radio Shack interface system. It

comes complete with a dependable MPI Minifloppy disk drive, power supply, regulator board and vented case. It's shipped to you ready to run – simply take it out of the box and plug it in. You're in business. From the company that means business – Vista Computer Company.



The Vista Computer Company.  
Manufacturers of Quality  
Computer Systems  
and Software.

714/953-0523  
1401 Borchard  
Santa Ana, Ca. 92705



# JADE Computer Products

## JADE'S NEW MAINFRAME THE PIGGY IS HERE!

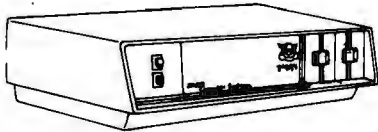

This sleek new mainframe is beautifully designed around JADE'S six slot ISO-BUS motherboard and an 18 amp power supply with provisions for up to 3 mini-floppy drives. This is a practical, state-of-the-art design whose looks just can't be beat!  
ENS-106320 (without drives) ..... \$475.00

## VISTA V80

TRS-80  
MINI-DISK  
SYSTEM

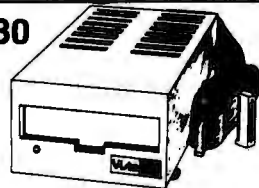

The V80 out-performs standard Radio Shack drives!--23% more storage capacity, 8 times faster access time, more reliable, and much less expensive. Includes disk drive, power supply, regulator board, and case. MSM-358000 \$395.00  
Interface cable for V80 WCA-3421 ..... \$24.95

## DISKETTE SPECIAL

5.25" SOFT, 10, OR 16 SECTOR

10 for \$29.95

8" SOFT SECTOR IBM COMPATIBLE

10 for \$34.95

## \$-100 CONNECTOR SALE

100 PIN IMSAI TYPE SOLDER-TAIL CONNECTOR

6 for \$17.50

12 for \$29.95

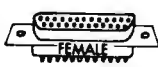

## RS-232 SET SPECIAL \$6.50

DB-25S, DB-25P, DB-25 COVER

DB-25S (FEMALE) ..... \$3.65  
DB-25P (MALE) ..... \$3.15  
DB-25C (COVER) ..... \$1.50

## SPST DIP SWITCHES



PART NUMBER	NUMBER OF SWITCHES	PRICE
SWD-103	3	\$1.18
SWD-104	4	\$1.20
SWD-105	5	\$1.24
SWD-106	6	\$1.28
SWD-107	7	\$1.30
SWD-108	8	\$1.34
SWD-109	9	\$1.36
SWD-110	10	\$1.38

## TEXTOL ZIP\* DIP II SOCKETS



16 PIN ZIP\* DIP II ... \$5.50  
24 PIN ZIP\* DIP II ... \$7.50  
40 PIN ZIP\* DIP II ... \$10.25

\* ZERO INSERTION PRESSURE

## JADE'S NEW INTELLIGENT CONTROLLER THE DOUBLE-D

Read/write in single or double density.  
8" or 5 1/4" drives.

CP/M compatible in either single or double density.  
On-board Z-80 CPU allows universal compatibility.  
Programmed data transfer. No DMA.

Controls up to 8 drives.

Software selectable density.

Our new controller utilizes the IBM standard formats for proven reliability. Data recovery is enhanced through the use of a phase-locked-loop data separation circuit and write precompensation. Single and double density disk drives can be mixed in the same system.

KIT ..... \$285.00  
ASSEMBLED & TESTED ..... \$349.00  
BARE BOARD WITH MANUAL ..... \$55.00  
MANUAL ..... \$10.00

## SD SYSTEMS VERSA-FLOPPY

KIT ..... \$159.95  
ASSEMBLED & TESTED ..... \$239.00

## TARBELL FLOPPY DISK INTERFACE

JADE KIT ..... \$190.00  
ASSEMBLED & TESTED ..... \$260.00

## FLOPPY DISK SPECIAL

TWO SIEMENS 8" DISK DRIVES  
JADE DOUBLE-D CONTROLLER KIT  
POWER SUPPLY FOR DRIVES  
CP/M OPERATING SYSTEM W/BASIC-E  
BOX OF 10 DOUBLE DENSITY DISKS  
INTERFACE CABLES--A \$1594.95 VALUE.  
JADE SPECIAL \$1225.00

## FLOPPY DISK DRIVES

NEW BASF MINI-FLOPPY ..... \$319.95  
Shugart SA400 compatible but only two-thirds the size! 40 track, double density 5 1/4" drive. Very low power consumption!

MPI B51 5 1/4" DRIVE ..... \$295.00  
Single or double density, up to 40 tracks, track-to-track access time of 5ms, Shugart SA400 compatible.

MPI B52 5 1/4" DRIVE ..... \$450.00  
Double-sided version of MPI B51.

SHUGART SA400 5 1/4" DRIVE ..... \$325.00  
Single density, 35 track.

SIEMENS FDD100-8 8" DRIVE ..... \$495.00  
Certified double density Shugart 801R replacement. Runs much cooler and quieter.

SIEMENS FDD200-8 8" DRIVE ..... \$575.00  
Double-sided, double density version of FDD100-8.

SHUGART 801R 8" DRIVE ..... \$575.00  
Hard or soft sectored, 400K byte drive.

PERSCI 277 DOUBLE 8" DRIVE ..... \$1595.00  
Limited quantity with slim line case & power supply.

## POWER SUPPLIES

For a single 5 1/4" disk drive.  
PSD-249A ..... \$52.00

For a single 8" disk drive.  
PSD-205A ..... \$89.95

For two 8" disk drives  
PSD-206A ..... \$125.00

For Rockwell AIM-65.  
PSX-030A ..... \$59.95

For KIM-1 or SYM-1.  
PSX-020A ..... \$59.95

## CP/M 2.0

Digital Research has done it again! This new release of their industry standard disk operating system is bound to be an even bigger hit than the original version. All of the fundamental file-size restrictions of release 1 have been eliminated, while maintaining full compatibility with the earlier versions. This new release can be field-configured by the user for a single mini-disk up through a multiple drive hard-disk system with 128 megabyte capacity. Field configuration can be accomplished easily through use of the Macro Library (DISKDEF) provided with CP/M 2.0.

A powerful operating system for only ... \$150.00

## INTEGRAL DATA SYSTEMS MODEL 440 PRINTER THE PAPER TIGER

Up to 198 CPS  
1.75 to 9.5 inch adjustable tractor feed.

Parallel and serial interface.

98 character ASCII set  
132 columns- 6 or 8 lines/inch

Eight software selectable character sizes.

110, 300, 600, 1200 baud.

PRM-33440 ..... \$995.00

For the Graphics Option with 2K Buffer add \$199.00

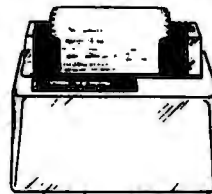

## JADE JP80-T PRINTER HARD COPY.....EASY PRICE!

JADE is proud to announce the low-cost solution to your hard copy needs. The JADE JP80-T printer is a high quality 80 column dot matrix printer with an adjustable width tractor feed mechanism. We are certain that you can not get a better printer in this price range!

FAST-150 cps print speed, 80 columns per line.

VERSATILE-adjustable tractor feed 2" to 10".

Upper and lower case 96 character ASCII set.

5 X 7 dot matrix with software selectable character widths.

Certronics-type parallel interface.

Interface/cables available for most popular microcomputers.

PRM-27081 ..... \$749.95

## CENTRONICS 730 PRINTER THE ANY-PAPER PRINTER

This printer can use roll paper, fanfold paper, or single sheets because it is equipped with both friction feed and pin feed mechanisms.

RS232 or parallel interface.

96 ASCII character set, upper and lower case.

80 characters per line, 7 X 7 dot matrix.

50 cps print speed.

Weights less than 10 pounds!

PRM-15730 ..... \$950.00

## EXIDY SORCERER

### FREE 12 INCH B & W MONITOR WITH EVERY 16K SORCERER

Flexibility is the key. The Sorcerer Computer gives you the flexibility of using ready-to-run, pre-packaged programs or doing your own thing and personalizing the programs for yourself. Whichever you choose. The Sorcerer is the personal computer that speaks your language.

The Sorcerer also provides full graphics capabilities. Each character formed by an 8 x 8 dot cell, can be programmed as a graphic symbol set. High resolution (512 x 240 addressable points) gives a total of 122,880 locations for super animation and extremely light plotting curves. The alphanumeric set gives 64 x 30 characters on the video screen.

With 16K of memory ..... \$1150.00

## LEEDEX MONITOR \$139.00

- 12" Black and White
- 12 MHZ Bandwidth
- Handsome Plastic Case

## JADE DISK CABLES

MINI-DISK CABLE KIT--Connects two 5 1/4" mini-floppies to your disk controller board and power supply. Includes 5' signal cable with three 34 pin edge connectors, plus power supply connectors and cables. WCA-3431K ..... \$34.95

SIGNAL CABLE ONLY--Connects one 5 1/4" drive to edge type controller card. WCA-3421A .. \$24.95  
For two 5 1/4" drives. WCA-3431A ..... \$29.95

8" DISK CABLE KIT--Connects two 8" disk drives to edge type controller card such as the Versafloppy and Double D. Includes 5' signal cable with three 50 pin edge connectors, plus power supply cables and connectors. WCA-5031K ..... \$38.45  
8" DISK CABLE KIT--Same as WCA-5031K except controller end of signal cable has a pin type connector such as the Tarbell controller. WCA-5032K ..... \$38.95



## TEXAS INSTRUMENTS



**TI-99/4**  
High quality 13 inch color monitor!  
Up to 72K total memory capacity.  
16-color graphics capability - easy to access high resolution graphics have special features that let you define your own characters, charts, graphs, etc.  
Music and sound effects - build three-note chords and adjust frequency, duration and volume quickly and simply. Five full octaves Built-in equation calculator—Unique convenience feature helps you find quick solutions to everyday math problems, as well as complex scientific calculations  
Programs are sealed securely in SOLID STATE SOFTWARE COMMAND MODULES These ROM pack actually add memory to the TI-99/4 so that the console's memory can be utilized for user input **SYO-8994A** ..... **\$1150.00**

### SD SYSTEMS Z-80 STARTER KIT

Based on the powerful Z-80 CPU, this kit is an ideal introduction to microprocessors. It has an on-board keyboard and display, plus cassette tape interface, and expansion provisions for two S-100 connectors. This "Do-it-all-Board" will also program the 2716 2K Kit ..... **\$249.95**  
Assembled and tested ..... **\$439.00**

### SD SYSTEMS SBC-100

An S-100 single board computer Z-80 CPU with 1024 bytes of RAM 8-32K bytes of PROM Serial I/O port.  
Kit ..... **\$239.95**  
Assembled ..... **\$369.95**

### Solid State Multic I/O 4

2 Serial and 2 Parallel I/O.  
Ports S-100 with full hand shaking.  
JADE Kit ..... **\$149.95**  
Assembled ..... **\$199.95**  
Bare Board ..... **\$29.95**

### PARALLEL/SERIAL INTERFACE

S-100 compatible, 2 serial I/O ports, 1 parallel I/O  
Kit ..... **\$124.95**  
Assembled & Tested ..... **\$179.95**  
Bare Board w/ Manual ..... **\$30.00**

### PROTO BOARD

Includes gold plated fingers S-100 size, holds 72-16 pin dips, accommodates all 8 thru 40 pin dip packages Reg. 19 95  
TSXA-140B ..... **\$16.95**

### SYM-1

6502- Based single board computer with keyboard/display. KIM 1 hardware compatible, complete documentation  
SYM-1 CPK-5002A ..... **\$245.00**  
SYM-1 CASE, ENX-000005 ..... **\$39.95**

## JADE'S NEW MOTHERBOARDS THE ISO-BUS

The only motherboard available today that is designed to IEEE S-100 Bus Standards—a unique network theory of design in which each signal line is surrounded by current mirrored ground lines, significantly reducing RF radiation virtually eliminating crosstalk. No need for active termination. The perfect foundation for a 4MHz system.

### 6-SLOT

BARE BOARD ..... **\$24.95**  
KIT ..... **\$49.95**  
ASSEMBLED & TESTED ..... **\$59.95**

### 12-SLOT

BARE BOARD ..... **\$39.95**  
KIT ..... **\$89.95**  
ASSEMBLED & TESTED ..... **\$99.95**

### 18-SLOT

BARE BOARD ..... **\$59.95**  
KIT ..... **\$129.95**  
ASSEMBLED & TESTED ..... **\$149.95**

## JADE MEMORY EXPANSION KITS FOR TRS-80 APPLE EXIDY

Everything you need to add 16K of memory to your computer. Your kit comes neatly packaged with easy to follow instructions. In just minutes your computer is ready to tackle more advanced software.

**\$1,150.00**

## THE BIG Z

### THE NEW Z-80 CPU BOARD FROM JADE

Features include ● S-100 Compatible available in 2MHz or 4MHz versions ● On-board 2708, 2716 or 2532 EPROM can be addressed on any 1K, 2K or 4K boundary with power-on jump to EPROM ● On-board EPROM may be used in SHADOW mode, allowing full 64K RAM to be used ● Automatic MWRITE generation in front panel is not used ● On-board USART for synchronous or asynchronous R232 operation (on-board baud rate generator) ● Reverse channel capability on USART allows use with buffered peripherals or devices with not-ready signal

2MHz Kit: CPU-30200K, 2lbs ..... **\$149.95**  
Assembled and Tested CPU 30200A 2lbs. .... **\$199.95**  
4MHz Kit: CPU-3020 1K, 2 lbs. .... **\$159.95**  
Assembled and Tested CPU-30201A, 2lbs. .... **\$209.95**

MICROPROCESSORS		6800 PRODUCT	
F8	\$16.95	6821P	\$5.25
Z80 (2MHz)	\$10.95	6828P	\$12.00
Z80A (4MHz)	\$14.95	6834P	\$16.95
CDP1802CD	\$24.95	6850P	\$4.80
6502	\$11.95	6852P	\$7.50
6800	\$12.50	6860P	\$9.25
6802	\$20.00	6862P	\$12.00
8008-1	\$15.95	6875L	\$7.30
8035	\$24.00	6800P	\$2.50
8035-B	\$24.00	CHARACTER GENERATORS	
8080-A	\$10.00	2513 Upper	\$7.95
8085	\$23.00	2513 Lower	\$6.75
TMS9900TL	\$49.95	2513 Upper (5 volt)	9.75
		2513 Lower (5 volt)	\$13.00
8080A SUPPORT DEVICES		MCM6571A up scan	\$13.00
8212	\$5.00	MCM6571A down scan	\$10.95
8214	\$4.65	PROMS	
8216	\$2.95	1702A	\$5.00
8224 (2MHz)	\$4.30	2708	\$12.95
8226	\$2.75	2716	\$49.00
8228	\$6.40	2716 (5v)	\$49.00
8238	\$6.40	2758 (5v)	\$30.00
8243	\$8.00	DYNAMIC RAMS	
8251	\$7.50	4116/4160 (200ns)	\$12.95
8253	\$20.00	2104/4096	\$4.75
8255	\$6.40	2107B-4	\$3.95
8257	\$19.95	TMS4027/4096	\$4.75
8259	\$19.95	STATIC RAMS	
8275	\$69.95	21L02 (450ns)	\$1.50
8279	\$17.70	21L02 (250ns)	\$1.75
USRT		2101-1	\$2.95
S2350	\$10.95	2111-1	\$2.95
UARTS		2112-1	\$2.95
AY5-1013A	\$5.25	2114L (450ns)	\$8.00
AY5-1014A	\$8.25	2114L (300ns)	\$9.00
TR1602B	\$5.25	TMS4044 (450ns)	\$8.00
TMS6011	\$5.95	TMS4044 (300ns)	\$9.95
IM6403	\$9.00	4100 (200ns)	\$9.95
BAUD RATE GENERATORS		4200A (200ns)	\$9.95
MC14411	\$10.00	MMS257 (450ns)	\$8.00
14411 Crystal	\$4.95	MMS257 (300ns)	\$9.95

JADE maintains an inventory of over 4000 line items. For price and delivery on items not listed (including hard to find 74LS devices) please give us a call.

## JADE Computer Products

4901 W ROSECRANS, HAWTHORNE, CA 90250  
213-679-3313

## PLACE ORDERS TOLL FREE

800-262-1710 INSIDE CALIFORNIA 800-421-5809 CONTINENTAL U.S.

WRITE FOR OUR FREE 1979 CATALOG FOR CUSTOMER SERVICE OR TECHNICAL INQUIRIES CALL 213-679-3317

TERMS OF SALE: Cash, checks, money orders, and credit cards accepted. Minimum order \$10.00. California residents add 6% sales tax. Minimum shipping and handling charge \$2.50. Prices are for U.S. and Canadian delivery only and are subject to change without notice. For export prices and information send for a JADE INTERNATIONAL CATALOG.



## ROCKWELL AIM-65

### THE HEAD-START IN MICROCOMPUTERS

A KIM-1 COMPATIBLE MACHINE WITH ON-BOARD PRINTER AND A REAL KEYBOARD!  
AIM-65 w/1K of RAM \$375.00  
AIM-65 w/4K of RAM \$450.00  
8K BASIC in ROM \$100.00  
4K Assembler/Editor \$80.00  
Power Supply \$59.95  
Case of AIM-65 \$49.95

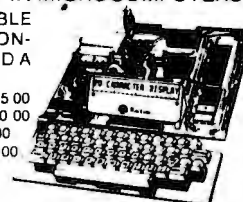

Special Package Price **\$599.00**  
4K AIM-65 8K BASIC ROM Power Supply, and Case

## SD SYSTEMS EXPANDORAM

Expandable to 32K or 64K

### EXPANDO-32K KITS

Uses 4115 (8K X 1, 250ns) Dynamic RAMs Can be expanded in 8K increments up to 32K

8K **\$159.95** 24K **\$249.95**  
16K **\$199.95** 32K **\$299.95**

### EXPANDO-64K KITS

Uses 4116 (16K X 1, 200ns) Dynamic RAMs Can be expanded up to 64K in 16K increments

16K **\$249.95** 48K **\$469.95**  
32K **\$369.95** 64K **\$569.95**

## STATIC RAM BOARDS

8K 2MHz KIT	\$125.95
8K 2MHz ASSEMBLED & TESTED	\$175.00
8K 4MHz KIT	\$149.95
8K 4MHz ASSEMBLED & TESTED	\$180.00
8K BARE BOARD & MANUAL	\$25.00
16K 2MHz KIT	\$250.00
16K 2MHz ASSEMBLED & TESTED	\$325.00
16K 4MHz KIT	\$285.00
16K 4MHz ASSEMBLED & TESTED	\$350.00
16K BARE BOARD & MANUAL	\$35.00
32K 2MHz KIT	\$539.95
32K 2MHz ASSEMBLED & TESTED	\$650.00
32K 4MHz KIT	\$619.95
32K 4MHz ASSEMBLED & TESTED	\$675.00

### SD SYSTEMS

## VDB-8024

An 80 by 24 I/O mapped video board for S-100 systems. An on-board Z-80 processor is used to control all functions. A total of 256 user-programmable characters are available, including 128 characters that are supplied with the board. This is virtually a stand-alone terminal!  
KIT ..... **\$319.95**  
ASSEMBLED AND TESTED ..... **\$469.95**

## JADE VB-1B

This 64 by 16 memory-mapped video board is ideal for use with word processing software such as the Electric Pencil  
KIT ..... **\$127.50**  
ASSEMBLED AND TESTED ..... **\$169.95**  
BARE BOARD/MANUAL ..... **\$35.00**

## VECTOR GRAPHICS FLASHWRITER II

The ultimate memory-mapped 80 character by 24 line video board. The Vector Graphics FWII has many advanced features: Onboard parallel keyboard port, Power-on jump circuit, 8 X 10 dot character matrix, and the optional ability to program your own characters and/or graphics symbols. This is THE perfect board for text editing systems  
ASSEMBLED AND TESTED ..... **\$320.00**

## NOVATION CAT

### ACOUSTIC MODEM

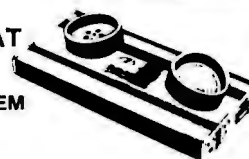

Features include 300 Baud Answer/Originate, Bell 103 Assembled and Tested ..... **\$189.00**



# Memory War Shop and Compare

Look for HUGE AD in Dec. Byte.

## The Vista V80:

**\$395<sup>00</sup>**



**widen the ability of your TRS-80**

The Vista V80 Mini Disk System is the perfect way to widen the capabilities of your TRS-80<sup>®</sup> Micro-computer. Quickly and inexpensively. Our \$395 price tag is about \$100 less than the Radio Shack equivalent. Our delivery time is immediate. And our system is fully interchangeable. That's just the start.

It will give you 23% more storage capacity by increasing useable storage from 55,000 to 65,000 bytes per drive with our new software patch.

It can work 8 times faster than the TRS-80 Mini-Disk system, because track-to-track access is 5ms versus 40ms for the TRS-80. You can realize this added speed once the new double disk expansion interface is available without expensive modification of the existing unit.

It has a better warranty than any comparable unit warranty available - a full 120 days on all parts and service. When you consider how much more goes into the Vista V80, that shows a lot of faith in our product.

A full 3 amp power supply means you have 2½ times the power necessary to operate the V80, and full ventilation insures that there will be no problems due to overheating.

The Vista V80 Mini Disk System requires Level II Basic with 16K RAM expansion interface (it operates from the Radio Shack interface system. It comes complete with a dependable MPI Minifloppy disk drive, power supply, regulator board and vented case. It's shipped to you ready to run—simply take it out of the box and plug it in. You're in business. From the company that means business - Vista Computer Company.

**DATA CABLES, VC80-2 (2 drive) \$29.95**  
**VC80-4 (4 drive) \$39.95**

**SPECIAL: Box of 10 DISKETTES**  
**\$20.00 with Purchase of VISTA 80**

- Use with TRS-80
- Parallel interface
- Continuous variable printing density 80-132 characters per line
- 5x7 dot matrix
- Prints on plain paper, sheets, rolls, fan fold
- Form thickness control
- Horizontal and vertical form positioning

### CENTRONICS 779 PRINTERS



**779-1** pinch roll friction feed  
 Reg. \$1250 **\$950<sup>00</sup>**  
**779-2** tractor feed  
 Reg. \$1400 **\$1050<sup>00</sup>**

**CENTRONICS 730 PRINTERS**  
**730-1 PARALLEL INTERFACE**  
**730-3 RS-232 INTERFACE**  
 SHOP and COMPARE

REG. ~~\$995~~  
**\$850.**  
 Reg. ~~\$1,045~~  
**\$895.**

## NOVATION CAT ACOUSTIC MODEM

- 0-300 Baud Regular \$198.00
- Bell 103
- Answer, Originate **Sale \$189.00**



**ORDER TOLL FREE 1-800-423-5633**

## FREE 15MHZ DUAL TRACE SCOPE\* SAVE \$124<sup>00</sup>



\*no not really, but here is our deal. The NLS MS-230 DUAL TRACE 30MHZ MINISCOPE, regularly sells for \$559.00, but we will sell it for \$435.00 (The price of the MS-215 Dual Trace 15 MHz Miniscope) when you purchase any 2 probes listed below and your order prepaid or paid by credit card.

- 30-Megahertz bandwidth • Accuracy 3% full scale • Internal, line or external trigger • Batteries and charger/transformer unit included • Graticule: 4 x 5 divisions, each division 0.25" • Time base: 1 micro sec. to 0.5 sec/div 21 settings • Vertical Gain: 0.01 to 50 Volts/div, 12 settings • Size: 2.9" H x 6.4" W x 8.5" D, 3.5 lbs. • TEST MOST DIGITAL LOGIC CIRCUITS INCLUDING MICROPROCESSORS •
- |  |       |                            |
|--|-------|----------------------------|
| MS-230 Dual Trace 30 MHz                               | ..... | 560 <sup>00</sup> \$435.00 |
| 41-141 Deluxe 10t/1 probe with 4 interchangeable tips  | ..... | \$27.00                    |
| 41-37 Deluxe 10t/10t probe with 4 interchangeable tips | ..... | \$38.50                    |
| 41-180 Leather carrying case                           | ..... | \$45.00                    |
| MS-15 Single trace 15 MHz                              | ..... | \$318.00                   |
| MS-215 Dual trace 15 MHz                               | ..... | \$435.00                   |



## M-XVI The true 16K Static Ram module for S-100 bus systems.

**ASSEMBLED & TESTED--100% BURN IN**

The M-XVI gives you unbelievable expansion capability for your S-100 bus system—even beyond 64K. Manufactured to the highest industry standards documented and designed to make assembly, use, and programming a snap. The M-XVI board is a true revelation for the serious hobbyist and use in practical business or industrial applications.

### FEATURES:

- Fully static
- Uses popular 2114 static RAMS
- + 5 volt operation only
- Bank Select available by bank port and bank byte
- Phantom line capability
- Addressable in 4K blocks
- 4K blocks can be addressed anywhere within 64K in 4k increments
- Meets IEEE proposed S-100 signal standards
- LED indicators for board selection and bank selection
- FR-4 epoxy PC boards
- Solder masked on both sides
- Silk screen of part number and part designator

## SPECIAL

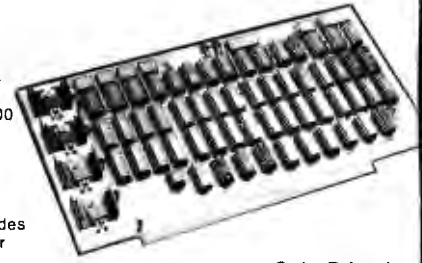

- 2016BA 450ns 2MHZ** Reg. ~~\$349<sup>95</sup>~~ **\$295<sup>00</sup>**
- 2016BB 300ns 4MHZ** Reg. ~~\$389<sup>95</sup>~~ **\$329<sup>00</sup>**
- 2016BY Bare Board only** **\$29<sup>95</sup>**

Sale Priced

### 3M Scotch® Brand DISKETTES

Part#	Sides/ Density	Sectoring	Price Box of 10
740-OP	1/single	Soft-IBM	\$39.95
740-2OP	2/single	Soft-IBM	\$75.00
740-32P	1/single	32-Shugart 80t	\$39.95
740-2-32P	2/single	32-Shugart 80t	\$75.00
741-0	1/double	Soft-Shugart 100t 5"	\$59.00
744-OK	1/single	Soft-Shugart SA400 (TRS-80)	\$51.00*
744-10K	1/single	Soft/110 SA400	\$51.00*
744-76K	1/single	Soft/116 Micropoints	\$51.00*

\*Price Includes K&S-ette/10 Storage Box a \$5.00 Value (TRS-80) "DON'T SETTLE FOR ANYTHING LESS THAN SCOTCH"

### TYPE TIL311/1707 HEXADECIMAL DISPLAY WITH LOGIC

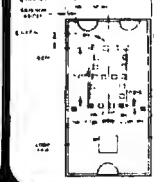

**\$9<sup>95</sup> ea.**  
**or**  
**4/\$34<sup>95</sup>**

### CONTINENTAL SPECIALTIES CORPORATION



### LOGIC MONITOR 1

Trace signals through all types of digital circuits. Unit clips over any DIP IC up to 16 pins. Each of its 16 contacts connects to a single-bit level detector that drives a high-intensity, numbered LED readout activated when the applied voltage exceeds a fixed 2 V threshold. Logic "1" turns LED on; logic "0" keeps LED off. A power-seeking gate network automatically locates supply leads and feeds them to the LM-1's internal circuitry. Saves minutes, even hours in design, troubleshooting, debugging of equipment. **Voltage Threshold:** 2 V ± 0.2 V. **Input Impedance:** 100,000 ohms. **Input Voltage Range:** 4-15 V max. across any two or more inputs. **Current Drain:** 200mA at 10 V. **Size:** 4" l. x 2" w. x 1.75" d. when open. **Weight:** 3 ozs.

CSC Model LM-1 Logic Monitor—Complete.

**\$59<sup>95</sup>**



**ORDER TOLL FREE 1-800-423-5633**

Look for HUGE AD in Dec. Byte.



# Memory War Shop and Compare

The EXPANDORAM is available in versions from 16K up to 64K, so for a minimum investment you can have a memory system that will grow with your needs. This is a dynamic memory with the invisible on-board refresh, and IT WORKS!

- Interfaces with Altair, IMSAI, SOL-8, Cromenco, SBC-100, and others.
- Bank Selectable
- Phantom
- Power 8VDC, ± 16VDC, 5 Watts
- Lowest Cost Per Bit
- Uses Popular 4116 RAMS
- PC Board is doubled solder masked and has silk-screen parts layout.

## SD EXPANDORAM

*The Ultimate S-100 Memory*

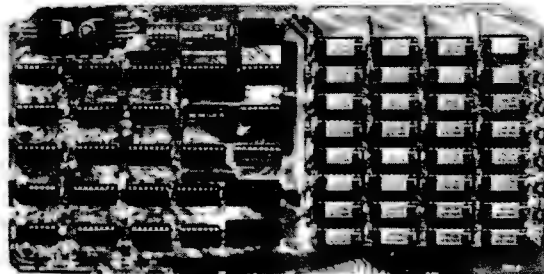

- Extensive documentation clearly written
- Complete Kit includes all Sockets for 64K
- Memory access time: 375ns, Cycle time: 500ns.
- No wait states required.
- 16K boundaries and Protection via Dip Switches
- Designed to work with Z-80, 8080, 8085 CPU's.

### EXPANDO 64 KIT (4116)

	SALE PRICE
16K .....	\$219
32K .....	\$285
48K .....	\$350
64K .....	\$415

Look for HUGE AD in Dec. Byte.

Look for HUGE AD in Dec. Byte.

### DISC DRIVES



**SHUGART SA 400 5 1/4"**  
110 KB, 35 tracks.  
**SHUGART SA 400 \$295.00**  
**SHUGART SA 400**  
with attractive metal case with cutouts for Data Cable switch, fuse and power cord  
**LOBO SA400-C \$325.00**  
**SHUGART SA400**  
with Cabinet and Power Supply Assembled, tested & guaranteed  
**LOBO SA400-PC \$395.00**  
**SHUGART 801R 8"**  
8.4 megabits, single or double density, hard or soft sector, write protect, and more  
**SHUGART 801R \$495.00**  
*Siemens FDD 200-8 8"*  
double density double density  
**\$650.00**

### DISC CONTROLLER

#### SD "VERSAFLOPPY" Kit

The Versatile Floppy Disk Controller **ONLY \$145.00**



**FEATURES:** IBM 3740 Soft Sector Controller, 5-100 BUS Compatible for Z-80 or 8080, Controls up to 4 Drives (single or double sided), readily controls the following drives:  
1. Shugart SA400/405 Mini Floppy.  
2. Shugart SA400/850 Standard Floppy.  
3. PDP11/70 and 277  
4. MFE 700/750.  
5. IBM 3740.  
6. IBM/Seimens FDD120-8  
34 Pin Connector for Mini Floppy, 36 Pin Connector for Standard Floppy Operates with installed CP/M operating system and C-Basic Compiler. The new "Versafloppy" from S.D. Computer Products provides complete control for many of the available Floppy Disk Drives, both Mini and Full Size. FDD1718-A Single Density Controller Chip Listings for Control Software are included in price.  
**CPM for SD Versafloppy \$100.00**

## SAVE \$100.00

### DM2700S DISK & CABINET with POWER SUPPLY

DM2700S includes Siemens FD120-8" Disk Drive with the following features:

- Single or Double Density
- Hard or Soft Sector
- Door Interlock
- Write Protect
- Hard Sector Detection
- 500 KB/S Transfer
- 800 KB formatted
- Bit density 6536 BP1
- Sugart 800 Series Compatible

- Cabinet includes:**
- 110V to 125V 60 Hz power supply
  - Data Cable
  - Fan
  - Accepts per SCI, Shugart, Siemens 8" Drives

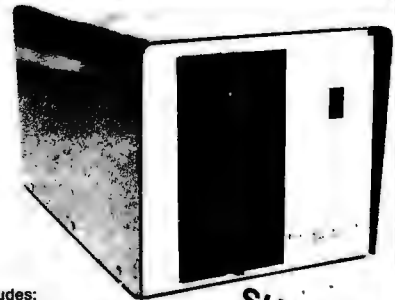

**DM2700S Disk Drive & Cabinet \$650.00**  
**DM2700 Cabinet, less Drive \$249.00**  
**\$225.00**

**SHOP & COMPARE**

**SAVE \$120.00**

**ASSEMBLED & TESTED SALE PRICED**

**M32 KSS-L (2 MHz)**

List \$650

**SALE \$530.00**

**M32 KSS-H (4 MHz)**

List \$680

**SALE \$560.00**

## THE MICROBYTE M32KSS 32K STATIC MEMORY BOARD

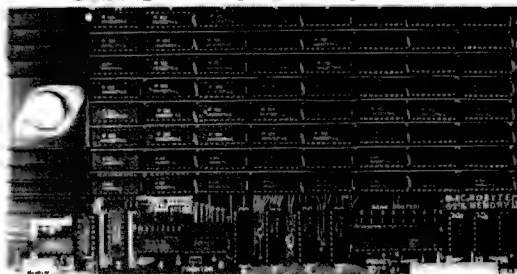

- Fully S100 Bus Compatible, IMSAI, SOL, ALTAIR, ALPHA MICRO.
- Uses National's Low Power 5257 4K x 1 Static Rams.
- 2 MHz or 4 MHz operation.
- Gold contacts for higher reliability.
- On board single 5 amp regulator.
- Thermally designed heat sink (board operating temperature 0° - 70°C).
- Commercially designed power bus, 7 ground bus bars, 0.1 uF decoupling capacitors.
- Fully tri-state buffered.
- Inputs fully low power Shottky Schmitt, Trigger buffered on all address and data lines.
- Phantom is jumper selectable to pin 67.
- Each 4K bank addressable to any 4K slot with in a 64K boundary.
- 4K hardware or software selectable.
- One on board 8-bit output port enables or disables the 32K in 4K blocks.
- Selectable port address.
- 4K banks can be selected or disabled on power on clear or reset.
- Will operate with or without front panel.
- Compatible with ALPHA MICRO, with extended memory management for selection beyond 64K.
- No DMA restriction.
- Low power consumption 2.3 - 2.5 amps.
- Fully warranted for 120 days from date of shipment.

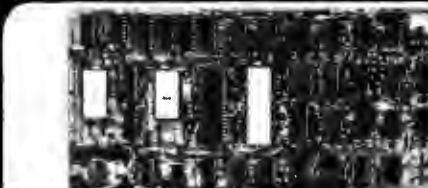

**\$299 KIT**  
**VDB-8024 Video Display Board**  
**With On-Board Z80 Microprocessor**

- Full HD Characters by 24 lines display
- Characters displayed by High Resolution 7x10 Matrix
- Keyboard/Power/Status Interface
- Composite Video Output
- Separate TTL Level Synchronizer and Video Outputs
- 2K Bytes Independent On Board Memory
- On Board CPU Memory Expansion
- 16K Bytes Display
- 86 Upper and Lower Case Characters
- 58 Special Character Set
- 128 Additional user Programmable Characters
- Full Cursor Control
- Forward and Reverse Scrolling Capability
- Operates as an Independent Terminal
- Variable Speed Display Rate
- Blinking, Underlining, Field Reverse, Field Protect and Combinations

### SD COMPUTER BOARDS

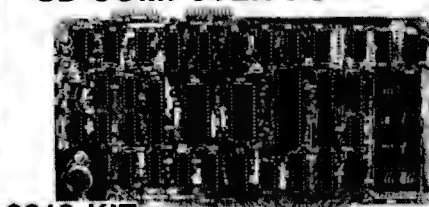

**\$219 KIT**  
**SBC-100 Single Board Computer**  
**with On-board RAM, PROM, CTC**

- Four Channel Counter/Timer (200-CTC)
- Software Programmable Band Rate Generator
- S-100 Bus Compatible
- No Front Panel Required for Operation
- Optional Vectored Interrupts
- Z80 Central Processing Unit
- 128K Bytes of Random Access Memory
- 8K Bytes of Available PROM
- Serial Input/Output Port with both Synchronous and Asynchronous Operation
- Parallel Input and Output Ports
- Two Bi-directional 8-bit IO Ports (Z80-PPI)
- Switch Selectable PROM or Monitor Reset
- 2K Bytes Z80 TV Monitor RAM
- Memory Expansion and Change
- Port Expansion and Change
- 80K CPU Register Expansion and Change
- 1 to 8 Programmable Breakpoints
- Single Steps through RAM or PROM
- Arithmetic, Load and Dump
- Vectored Interrupts provided by Z80-CTC and Z80-PPI
- Interface Exp. via standard Evaluation-type Z80 CPU

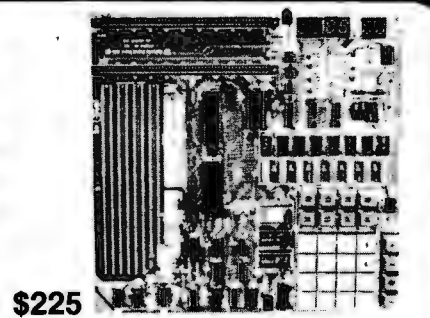

**\$225**  
**Z80 Starter Kit**  
**A Complete Microcomputer on a Board**

- Z80 Central Processing Unit with 128K Instructions
- On Board Keyboard and Display
- Random City Standard Cassette Interface
- PROM Programmer (Built-in-board) connectors
- User Manual for system circuitry
- Single, 5 Volt Operation with on-board power connector
- 1K Bytes of RAM (Expandable to 2K Bytes)
- 1K Bytes of ROM (Expandable to 2K Bytes)
- 4 Channel Hardware Counter/Timer (Z80-CTC)



## PRIORITY ONE ELECTRONICS

16723K Roscoe Blvd. Sepulveda, CA 91343

Terms: Visa, MC, BAC, Check, Money Order, C.O.D. U.S. Funds Only. CA residents add 6% sales tax. Minimum order \$10.00 Prepaid U.S. orders less than \$75.00 include 5% shipping and handling. MINIMUM \$2.50. Excess refunded. Just in case... please include your phone no.

Prices subject to change without notice.

We will do our best to maintain prices thru Dec. 1979.

phone orders welcome (213) 894-8171, (800) 423-5633 **OEM and institutional inquiries invited.**

**ORDER TOLL FREE 1-800-423-5633 ORDER TOLL FREE 1-800-423-5633**

Circle 312 on inquiry card.



# Unclassified Ads

## Unclassified Policy

Readers who are soliciting or giving advice, or who have equipment to buy, sell or swap should send in a clearly typed notice to that effect. To be considered for publication, an advertisement must be clearly noncommercial, typed double spaced on plain white paper, contain 75 words or less, and include complete name and address information.

These notices are free of charge and will be printed one time only on a space available basis. Notices can be accepted from individuals or bona fide computer users clubs only. We can engage in no correspondence on these and your confirmation of placement is appearance in an issue of BYTE.

Please note that it may take three or four months for an ad to appear in the magazine.

**FOR SALE:** Sharp and Associates Selectric conversion with instructions. Also Axiom EX-801P printer, 20/40/80 columns, software selectable, with cable and software driver for TRS-80. Like new. Make offer. J R Reich Jr, 585 E Market St. Marietta PA 17547.

**FOR SALE:** Morrow processor/front panel card. 8080, S-100, octal display, built-in keyboard, operating system in read-only memory. Works perfectly, with all documentation. \$82 postpaid in 48 states. Money order or certified check. Ron Tipton, POB 227, Greenwood MO 64034, (816) 537-7927.

**FOR SALE:** Super ELF operating and in good condition. Also have expansion board completed, but not connected. Includes RS-232, teletypewriter, cassette input/output (I/O), and 8-bit parallel I/O ports. Power supply for ELF board only. I'll include encoded ASCII keyboard. \$300. Jess Hillman, POB 642, Columbus MS 39701, (601) 327-1244 after 5 PM.

**WANTED:** 1802 computer systems and parts. Any condition, any quantity, immediate cash. Prefer RCA systems, but will accept ELF II by Netronics, memory, and support boards. Tom Inskip, 6504 Democracy Blvd, Bethesda MD 20034.

**FOR SALE:** Teletype ASR33 teletypewriter with paper-tape reader punch and stand. \$595 and shipping. 32 K static programmable memory, four 8 K, S-100 boards factory assembled and tested. \$150 each. I pay postage. Mark Lyon, 6320 Red Prairie Rd, Sheridan OR 97378.

**FOR SALE:** Vandenberg 16 K static-memory board. 4 MHz, each 4 K block addressable to any 4 K boundary; S-100 bus compatible; \$275. Also Practical Automation DMPT-6-3 96-column printer with cabinet, power supply, and two CY-480 universal printer controllers; serial or parallel hookup with all documentation and driving software; \$650. Both items presently in use with a SOL-20 system. Send SASE for sample printout. Larry Rosen, POB 2197, Williamson WV 25661.

**FOR SALE:** TRS-80, 16 K, Level II processor. Perfect working condition. In original carton with cassettes, cables, power pack, manuals, and software. Will include Pixie-Verter to connect to regular TV for \$10 more. Retail price \$690, will sell for \$595 or best offer. I pay freight anywhere in US. Charles Fields, 924 W Washington Pl, Broken Arrow OK 74012.

**FOR SALE:** IMSAI 8080 processor kit. Still in factory box with warranty. \$600 or best offer. (Interface boards also available.) I am moving. Jim Siegman, 17602 Oakwood Dr, Hazel Crest IL 60429, (312) 798-2536.

**FOR SALE:** Complete set of BYTE magazine thru December 1978. Excellent condition. Best offer. I pay shipping. Netronics/RCA Cosmac 1802 ELF II computer kit unassembled in original carton, RCA User's Manual, applications articles; all for \$75 or best offer, postpaid. Mike Au, 2006 Alaaloa St, Honolulu HI 96821, (808) 548-5318.

**WANTED:** TI-59 or HP-67 calculator with all standard accessories in perfect condition. The more accessories the better. Willing to trade Shugart SA400 minifloppy disk drive (never been used) for calculator. Best offer will be notified by mail or phone. Gary R Eschborn, 513 Follett Run Rd, Warren PA 16365.

**APPLE USERS:** Add line input capabilities to your Apple-soft II programs which will enable you to input commas, colons, quotes, etc. This fix is available for \$1 to cover the cost of postage and duplication. Jules H Gilder, 2022 79th St, Brooklyn NY 11214.

**FOR SALE:** PDP-8/L minicomputer; \$600. PDP-8/L with BAO8 memory extension 8 K and peripheral adapter; \$1200. Checked out with DEC diagnostics. Certified checks only. O Glaser, 508 3rd St. West Roundup MT 59072, (406) 323-2339.

**WANTED:** TRS-80 complete and ready to use. Level II with 16 K programmable memory; Level II with 4 K programmable memory; Level I with 16 K programmable memory, or Level I with 4 K programmable memory. I am also interested in TI-59. Price must be right. S Castiglioni, 2245 Glenwood Rd, Brooklyn NY 11210.

**PET OWNERS:** Group of three PET owners have 26 game programs. We will trade one for one for other PET programs. Those wishing to trade should send their cassette with programs. Keith Selby, 7205 S Utica Av Apt 1016 Cinnamon Stick Apartments, Tulsa OK 74136.

**FOR SALE:** Texas Instruments new TI-59 card programmable calculator with PC-100A printer. Includes aviation library, extra cards, programs, and PPX materials. Almost new. Meticulously maintained. Packed in original cartons. Sent UPS. \$287 total cost. Dave Balmer, POB 325, Union Lake MI 48085, (313) 739-4280 (bus) or 669-9319 (res).

**FOR SALE:** TRS-80 4 K, Level II 12 inch video display, CTR-41 cassette recorder, twenty program tapes. List price \$900, will sell for \$750. J Kennedy, 5179 Eliot St, Denver CO 80221, (303) 477-4114.

**FOR SALE:** Centronix printer Model 306. Prints 64 ASCII characters, 5 by 7 dot-matrix impact, 120 cps, up to 80 columns, tractor feed to 9 1/2 inches wide, parallel input. Includes RS-232 interface to 9600 bps, HW vertical form control, auto motor control, stand, and paper tray. Technical manual. Excellent condition. \$800. Tom Jacobs, 100 W University Pky Apt 3G, Baltimore MD 21210, (301) 467-0703.

**FOR SALE:** Texas Instruments SR-52 handheld programmable calculator. Factory reconditioned on April 13, 1978. In perfect working order. Unit comes with two AC adapters, three sets of cards, and copies of Statistics, Financial, and EE program libraries. Best offer. Donald L Mitchell, 24466 Mutholland Hwy, Calabasas CA 91302, (213) 347-3617.

**FOR SALE:** New factory-wired, Meca Alpha-1 dual-cassette. Includes Meca OS Version 3.0. Couldn't figure out how to use it with my system! Take advantage of my mistake. \$600 (or make reasonable offer). Send certified check or money order, I'll pay shipping. W D Wilkens, 24 N 3rd St, Womelsdorf PA 19567.

**FOR SALE:** Altair 8800A, VDM-11 video, MITS 1 K, S and D Sales 4 K, SwTPC/CT-1024 and seven or eight assorted boards with documentation. Mostly Mini Micro Mart stuff, not working. \$450 or best offer. Dave Johnson, 3054 Roundtree, Ypsilanti MI 48197, (313) 434-3832 after 6 PM EST.

**WANTED:** Seeking documentation for the Merlin display board. Also seeking super-dense graphics option and documentation. Dick Walter, 2891 Baylis Dr, Ann Arbor MI 48104, (313) 991-7944.

**FOR SALE:** Three 32 K static programmable-memory boards. S-100, assembled and working perfectly (with 2114's low-power 250 ns), used for 300 hours. \$495 each. Also have 2114s for \$5 each, 4116s at 150 ns for \$15 each, Dynamic N MOS ceramic 8 K by 1 22-pin with specification sheets, \$4 each, eight for \$30 and 4 K by 1 Dynamic 16 pin, \$3 each, eight for \$22. Richard Smith, 3648 Madrid Dr, San Jose CA 95132, (408) 946-0735.

**FOR SALE:** Apple 1 with 8 K programmable memory and 44-pin mother board, power supply, keyboard and 4 K BASIC on cassette plus documentation. \$250. National Multiplex SwTPC 2SIO controller board and CC-8 recorder set up for 4800 bps. Unit is for SWATBUG read-only memory with serial interface in control port. Documentation included. Best offer over \$330. Digital Group Phi-Deck controller card plus Triple I single-deck controller card and remote control box. Included is one Phi-Deck, documentation, and 8080/Z80 program on cassette. Unit used only a few times; guaranteed to work. Best offer over \$290. Items shipped collect. Clinton Cook, 2737 Beachwood Dr, Merced CA 95340, (209) 723-0516.

**FOR SALE:** SYM-1 in original carton and under warranty. First check for \$230 gets it. COD is ok. Darian Carr, 13709 Peyton, Dallas TX 75240.

**WANTED:** Jolt computer and Martin Research 8008-based computer. Can also use an Intel SIM-8 board. J Titus, POB 242, Blacksburg VA 24060, (703) 951-9030 or (703) 951-2684.

**WANTED:** I wish to purchase two random-beam video displays for use as vectored graphic displays. Displays must measure 12 inches or larger. Prefer working units, but can repair or modify if necessary. Will pay top dollar for quality equipment. Send description and price. Edward Rees, 8835 S Oak Park Dr, Apt #20, Oak Creek WI 53154, (414) 764-3093.

**FOR SALE:** IBM Selectric-based input/output (I/O) writer (Series 731), heavy-duty, all solenoids, 8 1/2 inch platen. Was working, now needs repair. Ideal for talented tinkerer. \$200, including cable and connector. Joe Brennan, 13 W 13th St, New York NY 10011, (212) 691-7939.

**FOR SALE:** TRS-80 which uses any RS-232 keyboard printer or video display as remote terminal. Performs all keyboard functions, places video-display data on terminal. Run BASIC or disk operating system from terminal. For information send SASE. H S Gentry, Rt 1 POB 39B, Earlysville VA 22936.

**FOR SALE:** H11 LSI processor with maximum memory. Also contains parallel and serial interface and cables. \$1000. Also, H10 paper-tape reader punch. \$150. H9 video terminal. \$300. Can be bought individually or save \$100 by buying all three. Complete with documentation, tapes, and several programs. Will deliver within a 200 mile radius. Jean P Bonin, 44 Pearl St, Sidney NY 13838.

**FOR SALE:** Up and running IMSAI 8080 with 22-slot mainframe, MIO board, 8 K Seals memory, 16 K Godbout memory, active terminator, logic-extender board, Poly VDM board, SDS 16 K erasable read-only memory board with 9.1 K IMSAI BASIC, microswitch keyboard. Cost over \$3000, will sell for first certified check for \$900. David Rosenblatt, POB 2600, Tampa FL 33601, (813) 988-3007.

# Reader Service

To get further information on the products advertised in *BYTE*, fill out the reader service card with your name and address. Then circle the appropriate numbers for the advertisers you select from the list. Add a 15-cent stamp to the card, then drop it in the mail. Not only do you gain information, but our advertisers are encouraged to use the marketplace provided by *BYTE*. This helps us bring you a bigger *BYTE*.

Inquiry No.	Page No.	Inquiry No.	Page No.	Inquiry No.	Page No.	Inquiry No.	Page No.
1	AB Computers 272	96	DG Electronic Development 211	223	Micromail 207	318	Radio Shack 131
8	Administrative Systems 206	99	Diablo (Div of Xerox Corp) 42	229	Micro Management Systems 268		• Rainbow Computing 270
5	Adroit Electronics Inc 264	86	Digital Pathways 137	204	Micro Mike's 207		• RBB Software Products 168
2	Advanced Access Group 228	95	Digital Research Corp (CA) 218	226	Micro Music 163	325	Rochester Data 174
4	Advanced Computer Products 286, 287	97	Disco-Tech 100		• Micropolis 186, 187	316	S-100 237
10	Affordable Microcomputer Systems 62	98	Dontho Scientific 233		• Micro Pro International 64, 65		• St Jude 106
3	Aladdin Automation 173	100	DRC (TX) 261	227	Microsette 266	320	Sara-Tech 193
6	Altos Computer Products 21	105	Dynacomp 212	228	Microsette 268	341	SC Digital 237
13	American Square Computer 58	115	Electrolabs 284, 285	232	Micro Soft 99	326	SCDP 207
12	Anderson Jacobson 209	120	Electronic Control Technology 200	233	Micro Soft (Consumer Prod Div) 159	329	Scelbi 190, 191
16	Apparat Inc 269	125	Electronic Systems 250, 251, 253	209	Microtek 56, 59, 71	330	Seattle Computer Products 167
17	Apple Computer 33	130	Electronics Warehouse 273	231	The Micro Works 158	319	Michael Shrayder Software 197
14	ARIES Computer Products 92	127	Essex Publishing 215	235	Midwest Computer Peripherals 230		• Shugart Associates 6, 7
11	ASAP Computer Products 281	131	Excel Company 205	230	Mikos 278	342	Sirius Systems 209
23	Atari Personal Computers 15	134	Factory Direct Sales 226	234	Mini Business Systems 153	337	68 Micro Journal 219
19	ATV Research 154	135	FAIRCOM 160	236	Mini Computer Suppliers 223	332	Ed Smith's Software Works 243
7	Automated Comp Software Service 77	133	Falcon Publishing 217	245	Mohawk Typewriter Repair 268	328	Smoke Signal Broadcasting 63
9	Automated Comp Software Service 103	138	FMG Corp 201	255	Morrow/Thinker Toys 44, 45		Softagon Inc 24
18	Automated Simulations 209	137	Fordham Radio Supply 255	257	Mountain Hardware 157	358	Soft Sales 241
21	Avionic Enterprises Inc 268	139	H Geller Computer Systems 225	258	Mountain Hardware 52		Software Dev and Training 120
24	Axiom 162	140	GFN Industries 119	260	mpi 271	306	Software Dynamics 217
22	base 2 inc 51	141	Gimix 46	278	MVT Microcomputer Systems 132	333	The Software Farm 264
15	Beckian Enterprises 272		GLA Enterprises 266	279	National Technical Schools 193		Soft Warehouse 43
	Beta Computer Devices 223	145	Global Parameters 118	281	NEECO 150	335	Solid State Music (SSM) 9, 10
	• Bits Inc 183, 240	150	Godbout Electronics 147	282	NEECO 151	340	Solid State Sales 282
36	BYTE Books 176, 177	151	GR Electronics Ltd 225	280	Netronics 221	345	Sord Computer Systems 122
33	Byte Shop East 208	153	GW Computers 170	289	New England Recruiters 154	346	Soroc 37
39	California Digital 283	159	H & E Computers 185	285	North Star Computer 19	347	Sorrento Valley Associates 264
40	CAP Electronics 248	161	Hayden Book Company 242		• NRI Schools 145	362	Source 32
41	CAP Electronics 248		Heath Company 23	299	Ohio Scientific Instrument CIV	356	Southwest Tech Products Corp CII
42	CCM Inc 268	163	Heath Company 68, 69, 97	300	Ohio Scientific Instrument 53-55	339	Sterling Software 243
44	Central Data 133	165	Heuristics 244	291	OK Machine and Tool 79, 142, 143	353	SubLogic 241
46	Centronics 93	167	High-Tech Jewelry 268	288	Oliver Advanced Engineering 239	354	Sunny International 280
48	Century Research & Marketing 156	170	Hobby World 262, 263	287	Omni Computer Corp 239	352	Superbrain 60, 61
47	Christin Industries 165	171	IBS/Integrated Bus Systems 188		onComputing 80		Supersoft 229
49	COMPICO 127	179	Industrial Micro Systems 115	295	Organic Software 241	349	Sybox 105
52	COMPRINT (Comp Printers Intl) 138, 139	174	Infinity Micro 169	292	Osborne/McGraw-Hill 181	355	Synchro Sound 112
53	Compucolor 35	179	Infocient Holland 264		• Owens Associates Inc 124, 198	351	System Design Lab 225
54	CompuMart 275	175	Information Unlimited 201	293	Pace Inc 217	350	Systems Engineering Enterprises 161
55	Computer Components of South Bay 164	176	Integral Data Systems 29	294	Pacific Exchanges 266	361	Talos 31
	Computer Factory of NY 259	177	Integrand 239	296	Pacific Office Systems 274	360	Tarbell Electronics 41
58	Computer Furniture & Accessories 242	180	Interlec Data Systems 199	298	Page Digital 265	363	Technical Systems Consultants 109
	Computer Hardware 211		Ithaca Intersystems Inc 83, 220	297	PAIA Electronics 237	364	Tecmar Inc 96
62	Computer Ideas Inc 171	195	Jade Co 290, 291	303	Pan American Electronic Inc 58	366	3-G Company 215
65	Computer Lab of NJ 8	200	Jameco 276, 277		(A Radio Shack Auth Sales Ctr)	368	3/M Company 13
75	Computerland 149	202	Jim-Pak 279	290	Patch Publishing Co 189	380	Robert Tinney Graphics 57
77	Computer Mart of NJ & PA 79	201	Key Supply 264	304	PerCom Data CIII	376	TIS 213
68	Computer Service Center 266	205	Konan 91	305	PerCom Data 85	375	Torry Pines Business Systems 266
67	Computer Specialties (CS) 274		Lifeboat Assoc 107, 121, 178, 236	307	PerCom Data 86, 87	381	Trim Enclosure Products 117
70	Computer Store of San Leandro 264	208	Lobo Drives International 95	308	PerCom Data 89	313	TRS-80 Software Exchange 194, 195
73	Computex 240	207	Loweco 266	301	Personal Software 47	309	Ucatan Computer Store 264
76	CT Micro Computer 50	206	Macrotronics 266	302	Personal Software 49		United Software of America 204
78	Continental Specialties 155	210	Marketline 237	314	Pickles & Trout 213	379	US Robotics 106
83	Corvus Systems 39	212	Matrox Electronic Systems Ltd 116	327	Potomac Micro Magic 213	377	Vector Electronics 166
79	Cover Craft 235	215	Measurement Sys & Controls 135	324	Practical Applications 188	378	Verbatim 25
81	C.P.U. Shop 247	217	MetaTech 241	312	Priority I 292, 293, 294	374	Vista Computer 288
	• Creative Software 219	216	Micro Age Wholesale 215		• PROCOMP/New England 257		• V R Data 243
80	Cromemco 1, 2	213	Micro Ap 101	315	Prodata 129	384	V R Data 280
85	CTC 246	218	Micro Applications Group 235	331	Prodigy 125	387	Wameco 278
	• Cybernetics Inc 238	219	Micro Applications & Hardware (MICAH) 243	334	Programmer's Software Exch 154		• Whales 281
87	Cygal 114		Micro Architect 235	336	Protect Inc 90	389	Wintek 268
89	Data Access Corp 202	214	Micro Architec 243	322	PS Inc 227	391	Worldwide Electronics 264
90	DATABANK 268		• Microbiotic Computing Inc 264	323	Q-Kit (Div J P Conwell Corp) 234	392	Xitex 205
91	Data Discount Center 235	225	Microcomputer Applications 266	203	Quality Computer Products 266	401	Z <sub>S</sub> Systems 201
92	The DATAK Corp 231	224	Microcomputer Tech Inc (MTI) 269	286	Quality Software 223		
93	DataSearch 205	220	Micro DaSys 11	311	Quest Electronics 289		
94	Data Speed 123	221	Micro DaSys 12, 239	310	RACET Computes 108		
126	Data-Trans 253	222	Micro Data Base Systems 75	338	RADGO 148		
128	Delta Products 73		• Micro Diversions 5	317	Radio Hut 267		

## BOMB— BYTE's Ongoing Monitor Box

Article No.	ARTICLE	Page
1	Ciarcia: The Intel 8086	14
2	Macdonald and Gursel: Solving Soma Cube and Polyomino Puzzles	26
3	Maggs: Programming Strategies in the Game of Reversi	66
4	Maurer: Alpha-Beta Pruning	84
5	Govind: Interfacing the Pet to a Line Printer	98
6	Sivak: A Spacecraft Simulator	104
7	Roehrig: The National Micropastime	113
8	Allen: Stack It Up	140
9	Estep: Writing Animated Computer Games	152
10	Kapps: Five Useful Programs for the SC/MP	172
11	DeCaro: Build a Simple Digital Oscilloscope	222
12	Parker: The Cherry Pro Keyboard	232

\*Correspond directly with company.

### August BOMB Results

The first and second place winners of the August BOMB were "Anyone Know the Real Time?" by Steve Ciarcia (page 50) and "An Overview of LISP" by John Allen (page 10). These articles placed 1.30 and 1.09 standard deviations above the mean. First and second prizes of \$100 and \$50 will be awarded to the authors. Third place went to "A Preview of the Motorola 68000" by A I Halsema (page 170) followed by "Exploring TRS-80 Graphics" by George H Yeager (page 82). ■

## From PERCOM

### One-Drive System:

**\$399.** (40-track) & **\$675.** (77-track)

### Two-Drive System:

**\$795.** (40-track drives) & **\$1350.** (77-track drives)

### Three-Drive System:

**\$1195.** (40-track drives) & **\$2025.** (77-track drives)

Requires Expansion Interface, Level II BASIC & 16K RAM.

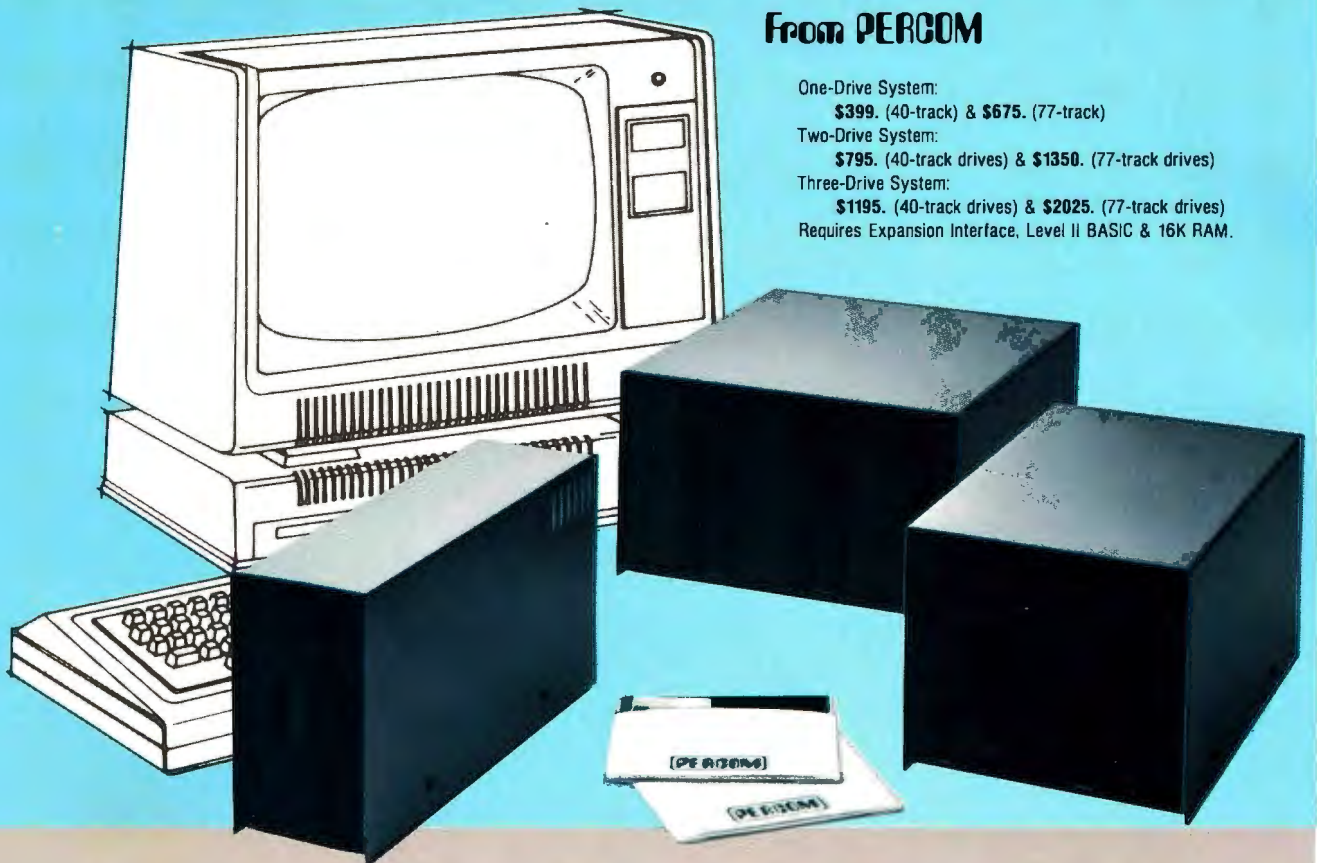

## Low Cost Add-On Storage for Your TRS-80\* . In the Size You Want.

When you're ready for add-on disk storage, we're ready for you.  
Ready with six mini-disk storage systems — 102K bytes to 591K bytes of  
additional on-line storage for your TRS-80\* .

- \* Choose either 40-track TFD-100™ drives or 77-track TFD-200™ drives.
- One-, two- and three-drive systems immediately available.
- Systems include Percom PATCH PAK #1™, on disk, at no extra charge. PATCH PAK #1™ de-glitches and upgrades TRSDOS\* for 40- and 77-track operation.
- TFD-100™ drives accommodate "flippy disks." Store 205K bytes per mini-disk.
- Low prices. A single-drive TFD-100™ costs just \$399. Price includes PATCH PAK #1™ disk.
- Enclosures are finished in system-compatible "Tandy-silver" enamel.

Whether you need a single, 40-track TFD-100™ add-on or a three-drive add-on with 77-track TFD-200™s, you get more data storage for less money from Percom.

Our TFD-100™ drive, for example, lets you store 102.4K bytes of data on one side of a disk — compared to 80K bytes on a TRS-80\* mini-disk drive — and 102.4K bytes on the other side, too. Something you can't do with a TRS-80\* drive. That's almost 205K bytes per mini-disk.

And the TFD-200™ drives provide 197K bytes of on-line storage per drive

— 197K, 394K and 591K bytes for one-, two and three-drive systems.

PATCH PAK #1™, our upgrade program for your TRSDOS\*, not only extends TRSDOS\* to accommodate 40- and 77-track drives, it enhances TRSDOS\* in other ways as well. PATCH PAK #1™ is supplied with each drive system at no additional charge.

The reason you get more for less from Percom is simple. Peripherals are not a sideline at Percom. Selling disk systems and other peripherals is our main business — the reason you get more engineering, more reliability and more back up support for less money.

In the Product Development Queue . . . a printer interface for using your TRS-80\* with any serial printer, and . . . the Electric Crayon™ to map your computer memory onto your color TV screen — for games, animated shows, business displays, graphs, etc. Coming PDAQ!

™ TFD-100, TFD-200, PATCH PAK and Electric Crayon are trademarks of PERCOM DATA COMPANY.

\*TRS-80 and TRSDOS are trademarks of Tandy Corporation and Radio Shack which have no relationship to PERCOM DATA COMPANY

# PERCOM

PERCOM DATA COMPANY, INC.  
211 N. KIRBY • GARLAND, TX. • 75042

To order add-on mini-disk storage for your TRS-80\*, or request additional literature, call Percom's toll-free number: 1-800-527-1592. For detailed Technical information call (214) 272-3421.

Orders may be paid by check or money order, or charged to Visa or Master Charge credit accounts. Texas residents must add 5% sales tax.

**Percom 'peripherals for personal computing'**



# Microcomputing comes of age.

## Ohio Scientific's OS-65U Level 3 operating system software brings new networking and distributed processing capabilities to microprocessor based computer systems.

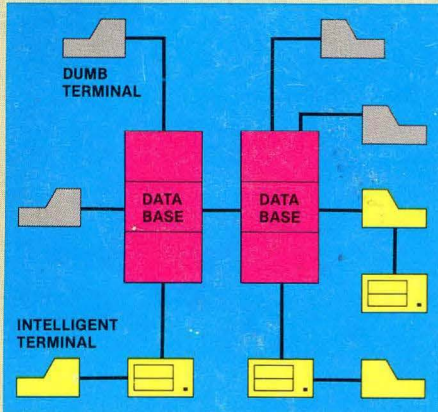

Until now, the only alternative for low cost multiple-user computer applications was time-shared systems. However, a serious drawback of microcomputer or mini-computer multi-user time-share systems is the fact that under heavy work loads they slow down to a crawl since the central processor time in such a system is shared by all of the users.

In a microprocessor based distributed processing system, using floppy based microcomputers as intelligent terminals (local systems) most of the work load is handled locally. Overall system performance does not degrade under heavy job loads. Each local system performs entry, editing and execution while utilizing the central data base for disk storage, printer output, and other shared resources.

For more demanding applications it is desirable to have several data bases, each with its own collection of local systems. Such an inter-connected set of data bases is called a network. Each data base and its local intelligent and dumb terminals is called a cluster.

### Level III

OS-65U Level 3 now supports this advanced networking and distributed processing capability as well as conventional single user operation and time-sharing. Level 3 now supports local clusters of intelligent microcomputer systems as well as

dumb terminals for the purpose of utilizing a central Winchester disk data base and other shared resources. The system also has full communications capability with other Level 3 data bases providing full network capability.

The system utilizes Ohio Scientific's low cost, ultra high performance computer systems throughout for intelligent terminals as well as data bases. This general systems configuration provides a cost/performance ratio never before attained in this class of computer power.

Level 3 resides in each network data base. A subset system resides in each intelligent terminal. Each data base supports up to 16 intelligent systems and up to 16 dumb terminals. However, since dumb terminals can heavily load the system, they should be kept to a minimum. Level 3 also supports a real time clock, printer management, and other shared peripherals.

### Data Base Requirements

Minimal requirements for a Level 3 network data base are a C3-C or C3-B computer system with 23 or 74 megabytes respectively, console terminal, 100K bytes RAM and a CA-10X 16 port I/O board for network and cluster communications.

### Intelligent Terminal Requirements

Any Ohio Scientific 8" floppy based computer with 56K RAM and one data base communications port.

### Connections

Intelligent terminals and networked data bases are connected by low-cost cabling. Each link can be up to 10,000 feet long at a transfer rate of 500K bits per second, and will cost typically 30¢ a foot (plus installation).

### Syntax

Existing OS-65U based software can be directly installed on the network with only *one* statement change! Level 3 has the most elegantly simple programming syntax ever offered on a computer network.

File syntax is as follows:

DEV A,B,C,D.	Local Floppies	} unchanged from single user and timeshare systems
DEV E	Local hard disks	
DEV K-Z	Specific network Data Bases	

Each of up to 8 open files per user can be from 8 separate origins. Specific file and shared peripheral contentions are handled by 256 network semaphores with the syntax Waite N Waite N, close.

The network automatically prioritizes multiple resource requests and each user can specify a time out on resource requests. Semaphores are automatically reset on errors and program completion providing the system with a high degree of automatic recovery.

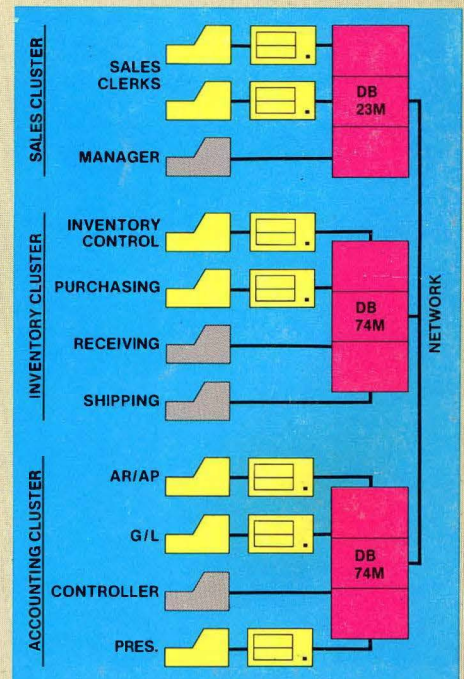

### A Typical System

A typical system with two network data bases will have 148 megabytes of disk, four intelligent subsystems equipped with dual floppies, two dumb terminals, a word processing printer, a fast line printer, network data base manager software and 1000 ft. of inter-connecting cable. Utilizing .7 MIPS processors throughout it will cost less than \$50,000 plus installation. GT option computers (1.2 MIPS) can be utilized at a slightly higher cost.

### One Step at a Time

Best of all, Ohio Scientific users can develop distributed processing systems economically one step at a time. A user can start with a single user floppy system, add a hard disk, then time-sharing, then a second Winchester data base for backup and finally cluster intelligent terminals to achieve a full network configuration.

## OHIO SCIENTIFIC

1333 S. Chillicothe Road  
Aurora, Ohio 44202  
(216) 562-3101

Circle 299 on inquiry card.