

JANUARY 1980 — Volume 5, Number 1 \$2.50 in USA/\$2.95 in Canada

BYTE®

the small systems journal
A MCGRAW-HILL PUBLICATION

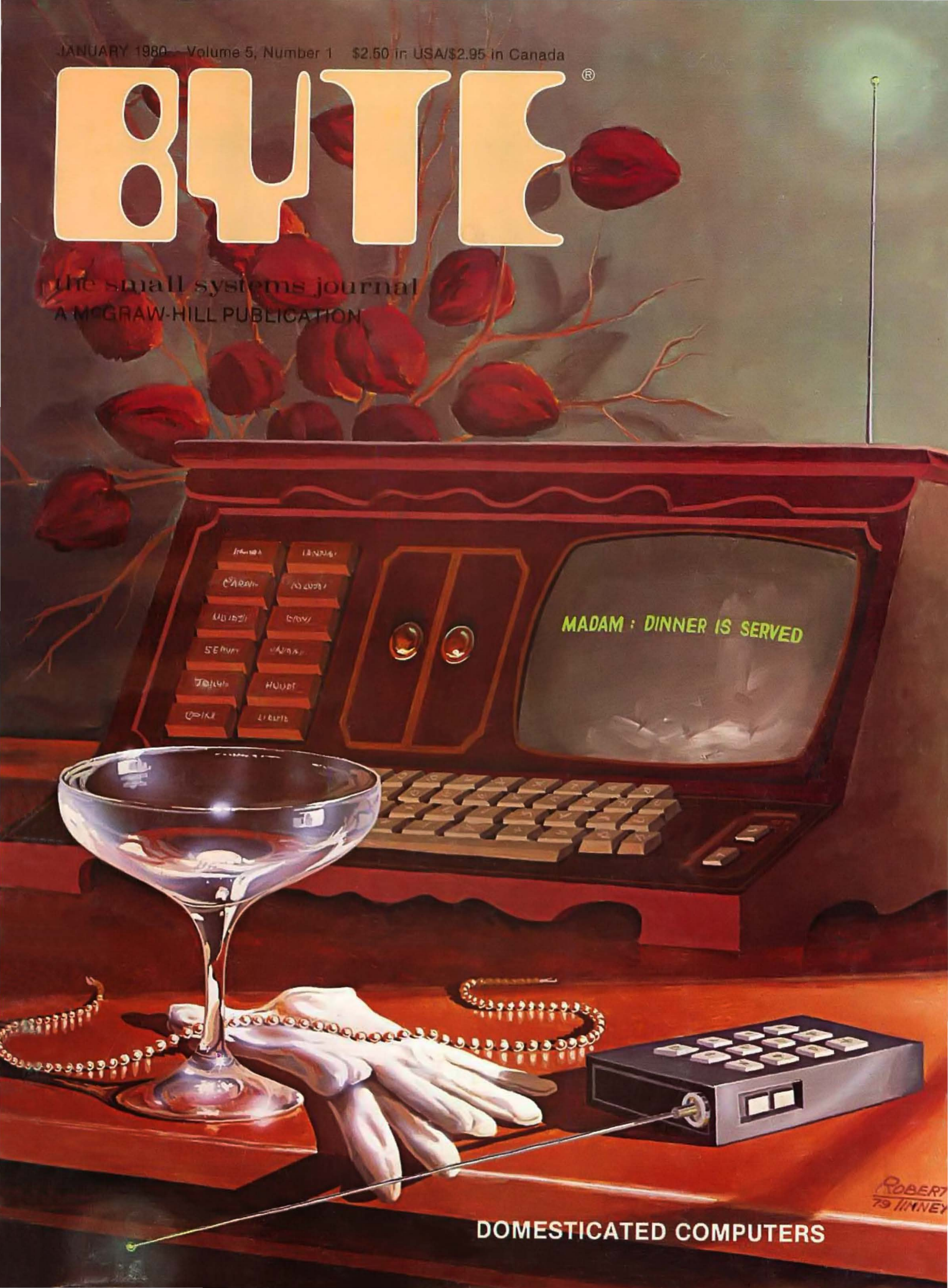

MADAM : DINNER IS SERVED

ROBERT
79 TINNEY

DOMESTICATED COMPUTERS



SYSTEMS - SOLUTIONS

If you have a problem that can be solved by a computer—we have a systems solution.

- Two central processors with maximum RAM capacities of 56K and 384 K bytes
- Three types of disk drives with capacities of 175K, 1.2M and 16M bytes
- Two dot matrix printers with 80 and 132 line capacity
- A Selectric typewriter interface and a daisy wheel printer

Match these to your exact need, add one or more of our intelligent terminals and put together a system from one source with guaranteed compatibility in both software and hardware.

Southwest Technical Products systems give you unmatched power, speed and versatility. They are packaged in custom designed woodgrain finished cabinets. Factory service and support on the entire system and local service is available in many cities.



SOUTHWEST TECHNICAL PRODUCTS CORPORATION
219 W. RHAPSODY
SAN ANTONIO, TEXAS 78216

(512) 344-0241

Circle 233 on Inquiry card.

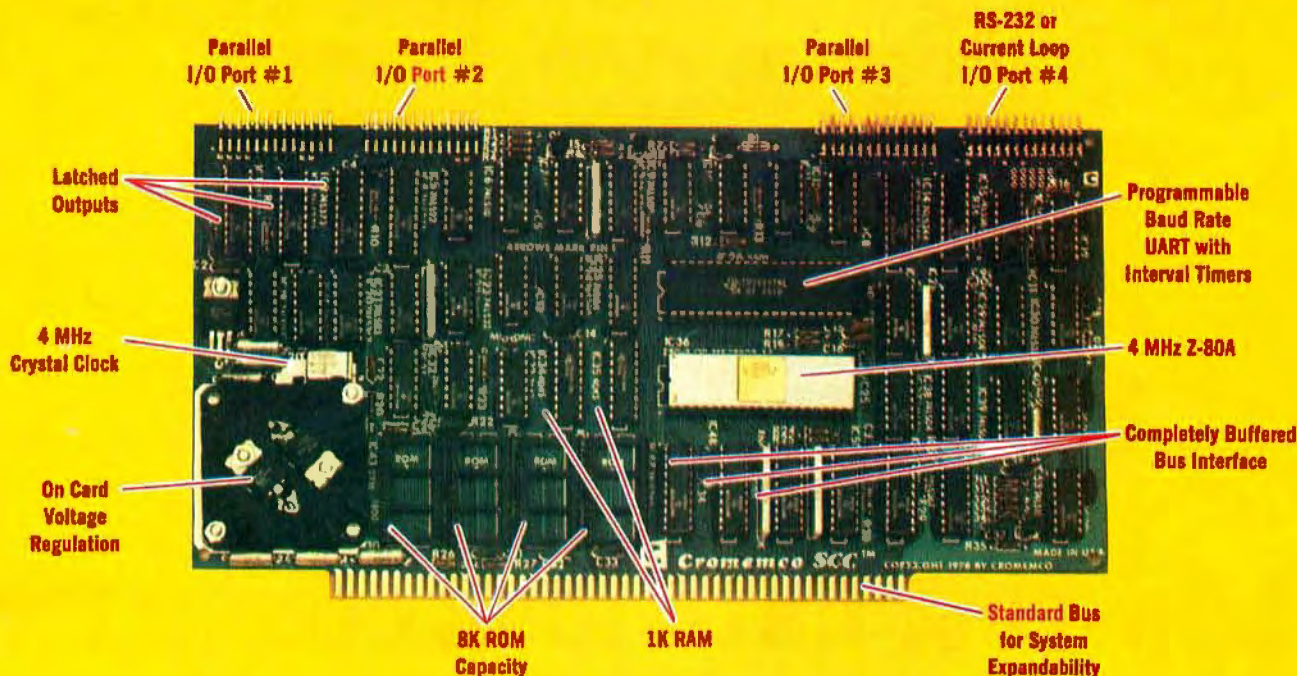

The single card computer with the features that help you in real life

COMPLETE COMPUTER

In this advanced card you get a professional quality computer that meets today's engineering needs. And it's one that's complete. It lets you be up and running fast. All you need is a power supply and your ROM software.

The computer itself is super. Fast 4 MHz operation. Capacity for 8K bytes of ROM (uses 2716 PROMs which can be programmed by our new 32K BYTESAVER® PROM card). There's also 1K of on-board static RAM. Further, you get straightforward interfacing through an RS-232 serial interface with ultra-fast speed of up to 76,800 baud — software programmable.

Other features include 24 bits of bi-directional parallel I/O and five on-board programmable timers.

Add to that vectored interrupts.

ENORMOUS EXPANDABILITY

Besides all these features the Cromemco single card computer gives you enormous expandability if you ever need it. And it's easy to expand. First, you can expand with the new Cromemco 32K BYTESAVER PROM card mentioned above. Then there's Cromemco's broad line of S100-bus-compatible memory and I/O interface cards. Cards with features such as relay interface, analog interface, graphics interface, optoisolator input, and A/D and D/A conversion. RAM and ROM cards, too.



Card Cage

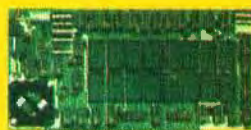

32K BYTESAVER PROM card

EASY TO USE

Another convenience that makes the Model SCC computer easy to use is our Z-80 monitor and 3K Control BASIC (in two ROMs). With this optional software you're ready to go. The monitor gives you 12 commands. The BASIC, with 36 commands/functions, will directly access I/O ports and memory locations — and call machine language subroutines.

Finally, to simplify things to the ultimate, we even have convenient card cages. Rugged card cages. They hold cards firmly. No jiggling out of sockets.

AVAILABLE NOW/LOW PRICE

The Model SCC is available now at a low price of only \$450 burned-in and tested (32K BYTESAVER only \$295).

So act today. Get this high-capability computer working for you right away.



Cromemco

incorporated

Specialists in computers and peripherals

280 BERNARDO AVE., MOUNTAIN VIEW, CA 94040 • (415) 964-7400



Low-cost hard disk computers are here

11 megabytes of hard disk and 64 kilobytes of fast RAM in a Z80A computer for under \$10K. Two floppy drives, too. Naturally, it's from Cromemco.

It's a reality. In Cromemco's new Model Z-2H you get all of the above and even more. With Cromemco you get it all.

In this new Model Z-2H you get not only a large-storage Winchester hard disk drive but also two floppy disk drives. In the hard disk drive you get unprecedented storage capacity at this price—11 megabytes unformatted.

You get speed—both in the 4 MHz Z80A microprocessor and in the fast 64K RAM which has a chip access time of only 150 nanoseconds. You get speed in the computer minimum instruction execution time of 1 microsecond. You get speed in the hard disk transfer rate of 5.6 megabits/sec.

EXPANDABILITY

You get expandability, too. The high-speed RAM can be expanded to 512 kilobytes if you wish.

And the computer has a full 12-slot card cage you can use for additional RAM and interface cards.

BROADEST SOFTWARE SUPPORT

With the Z-2H you also get the broadest software support in the

microcomputer field. Software Cromemco is known for. Software like this:

- Extended BASIC
- FORTRAN IV
- RATFOR (RATional FORtran)
- COBOL
- Z80 Macro Assembler
- Word Processing System
- Data Base Management

with more coming all the time.

SMALL, RUGGED, RELIABLE

With all its features the new Z-2H, including its hard disk drive, is still housed in just one small cabinet.

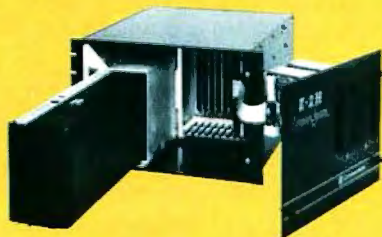

Hard disk drive at lower left can be interchanged just by sliding out and disconnecting plug. Seven free card slots are available. Z-2H includes printer interface card.

Included in that cabinet, too, is Cromemco ruggedness and reliability. Cromemco is time-proved. Our equipment is a survey winner for reliability. Of course, there's Cromemco's all-metal cabinet. Rugged, solid. And, there's the heavy-duty power supply (30A @ 8V, 15A @ +18 V, and 15A @ -18V) for circuitry you'll sooner or later want to plug into those free card slots.

CALL NOW

With its high performance and low price you KNOW this new Z-2H is going to be a smash. Look into it right now. Contact your Cromemco computer store and get our sales literature. Find out when you can see it. Many dealers will be showing the Z-2H soon—and you'll want to be there when they do.

PRESENT CROMEMCO USERS

We've kept you in mind, too. Ask about the new Model HDD Disk Drive which can combine with your present Cromemco computer to give you up to 22 megabytes of disk storage.

 **Cromemco**
i n c o r p o r a t e d
280 BERNARDO AVE., MOUNTAIN VIEW, CA 94040 • (415) 964-7400
Tomorrow's computers now

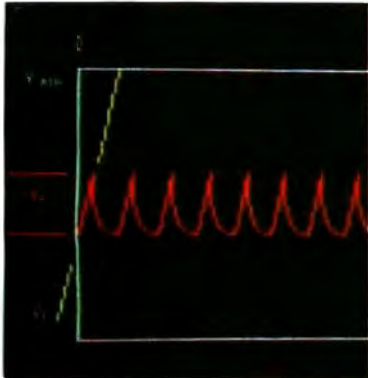

page 20



page 28

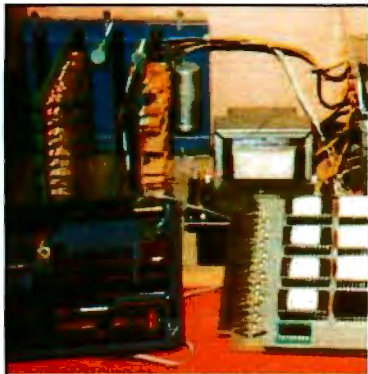

page 74

NOTICE:
 The 1980 Priority One
 Electronics Engineering
 Selection Guide
 begins on page 80-C1
 in this issue

Foreground

28 COMPUTERIZE A HOME by Steve Ciarcia

Controlling appliances in your home is one of the many chores that may be delegated to a personal computer. One product that is readily available is the Sears Home Control System used in this month's Ciarcia's Circuit Cellar.

56 A COMPUTER-CONTROLLED LIGHT DIMMER, PART 1: DESIGN

by John H Gibson You can use your computer in conjunction with programmable timers to easily control a light dimmer. Since programmable timers simplify both hardware and software in such applications, you may think of other applications.

74 A FURNACE WATCHDOG by Theron Wierenga

January is a month in which most of us show a greater than average concern for the state of our own home heating systems. After moving into a new house Theron decided to let his computer keep track of the furnace.

122 TELEPHONE DIALING BY COMPUTER by Edward Joyce

Your computer can ease the burden of remembering and dialing telephone numbers. This computer-controlled interface can dial your most frequently used numbers on Touch Tone telephone systems.

129 ANALYSIS OF POLYNOMIAL FUNCTIONS WITH THE TI-59 CALCULATOR, PART 2 by Pierre Chancé

This article describes the operation of the polynomial evaluation programs for the TI-59 given in part 1. One program calculates the roots of a sixth-order polynomial, while the other produces a plot of the function on the TI PC-100C printer.

156 ALPHA LOCK FOR YOUR ASCII KEYBOARD by Terry Conboy

This article presents a method to produce only uppercase letters from a keyboard capable of both uppercase and lowercase operation. Control and special characters are not shifted, and the shift lock can be easily turned off.

180 RELOCATING 8080 SYSTEM SOFTWARE by John Lipham

The ability to relocate programs in memory space is often helpful when you are changing from one system to another, or adding a new program to your present system. John discusses some of the problems that are encountered during relocation on the 8080 microprocessor and gives two programs that perform most of the work.

212 EIGHTEEN WITH A DIE, A LEARNING GAME PLAYER by Russell R Yost

People learn from their mistakes. Computers can too, if given the right program. Russell enabled his personal computer to learn how to win a simple game by writing the program described in this article.

Background

20 MAKING COLOR SLIDES WITH AN INTECOLOR MICROCOMPUTER

by Alan W Grogono An Intecolor intelligent color terminal (or other color-based computer) is used to generate color images that can be directly photographed. Slide production from a video image is relatively cheap, and the image can be altered during the design process with a minimum of effort.

100 WHAT COMPUTERS CANNOT DO by T G Lewis

Designers constantly try to build better and faster computers. Recent technology has produced many advances, but the question remains, "Is computing qualitatively better than when it first began?" T G Lewis discusses this issue.

118 INDIRECT ADDRESSING FOR THE 6502 by Kenneth Skier

The 6502 processor allows the user to perform certain indirect addressing operations. However, indirect addressing is not available for all instructions. Kenneth informs us of an easy way to perform indirect addressing on the 6502 when it is not normally available.

136 THE PLOT CONTINUES by Leslie B Walter

The plotter described in this article is capable of being run by hardware and software drivers and gets around some of the physical difficulties, such as large torque and wobble factors, that confront some plotter designs.

160 A COMPUTER-GENERATED REMINDER MESSAGE by E M Pass

This article describes a system that can help you to remember important future events. The system, called Tickler, is helpful in remembering to perform actions that have to be repeated periodically.

Nucleus

6 Editorial: The Era of Off-the-Shelf Computers Has Arrived

14 Letters

115 BYTE News

148, 151 Technical Forum: Aids to the Direct Reception of Weather Satellite Photographs;

An Improved Maze Program

174, 206, Programming Quickies: A

Pascal Checkbook Balancing Program; A

French-English Dictionary; Z80 User Stack Emulation

176 Book Reviews

194 Clubs and Newsletters

195, 199 BYTE's Bugs

196, 150 BYTE's Bits

200 Event Queue

230 What's New?

271 Unclassified Ads

272 Reader Service, BOMB

Publishers

Virginia Londoner, Gordon R Williamson

Associate Publisher

John E Hayes

Assistant

Jill E Callihan

Editorial Director

Carl T Helmers Jr

Executive Editor

Christopher P Morgan

Editor in Chief

Raymond G A Cote

Senior Book Editor

Blaise W Lifflick

Editors

Richard S Shuford, Gregg Williams

Assistant Editor

Bob Braisted

Editorial Assistants

Gale Britton, Faith Ferry

New Products Editor

Charles Freiberg

Clubs, Newsletters**Drafting**

Jon Swanson

Production Director

Nancy Estle

Senior Copy Editor

David William Hayward

Copy Editors

Faith Hanson, Warren Williamson,

Robin M Moss, Anthony J Lockwood

Art Director

Ellen Bingham

Production Art

Wai Chiu Li, Christine Dixon,

Holly Carmen LaBossiere, Deborah Porter

Typographers

Cheryl A Hurd, Debe L Wheeler,

Sherry McCarthy

Advertising Director

Patricia E Burgess

Assistants

Ruth M Walsh, Marlon Gagnon

Adv/Prod Coordinator

Thomas Harvey

Marketing Coordinator

Laura A Hanson

Circulation Manager

Gregory Spitzfaden

Assistants

Pamela R Heaslip, Agnes E Perry,

Melanie Bertoni, Barbara Ellis

Dealer Sales

Anne M Baldwin

Receptionist

Jacqueline Earnshaw

Traffic Department

Mark Sandagata, Thomas Yanni

Comptroller

Daniel Rodrigues

Assistant

Mary E Fluhr

National Advertising Sales Representatives:

Hajar Associates Inc

East

280 Hillside Av, Needham Heights MA 02194

(617) 444-3946

521 Fifth Av, New York NY 10017

(212) 682-5844

Midwest

664 N Michigan Av, Suite 1010,

Chicago IL 60611 (312) 337-8008

West, Southwest

1000 Elwell Ct, Suite 227, Palo Alto CA 94303

(415) 964-0706/(714) 540-3554

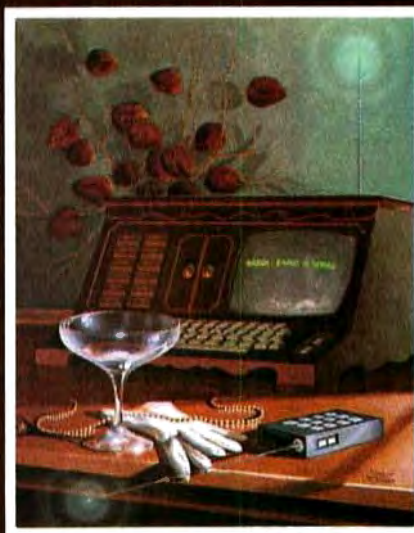

ON THE COVER

The theme of this issue's cover illustration is "the domesticated computer." Robert Tinney has taken the idea of the remote controlled appliances suggested by Steve Ciarcia's article on page 28 and combined it with some imaginative cabinetry in a household setting. In the process, Robert used his artistic license to employ radio imagery with antennae and aetheric airbrushing as an alternative to ultrasonic techniques described by Steve. Either way, practical means of safely controlling 110V appliances from the computer with total electrical isolation now exist — both for the homebrewer and as practical products advertised in this issue.

Officers of McGraw-Hill Publications Company: Paul F McPherson, President; Group Vice President: Daniel A McMillan; Group Vice President-Planning and Development: James E Boddorf; Senior Vice President-Editorial: Ralph R Schulz; Vice Presidents: Robert B Doll, Circulation; James E Hackett, Controller; William H Hammond, Communications; Thomas H King, Manufacturing; Edward E Schirmer, International.

BYTE is published monthly by BYTE Publications Inc, 70 Main St, Peterborough NH 03458, a wholly-owned subsidiary of McGraw-Hill, Inc. Address all mail except subscriptions to above address: phone (603) 924-7217. Address subscriptions, change of address, USPS Form 3579, and fulfillment questions to BYTE Subscriptions, PO Box 590, Martinsville NJ 08836. Second class postage paid at Peterborough NH 03458 and at additional mailing offices—USPS Publication No. 102410 (ISSN 0360-5280). Subscriptions are \$18 for one year, \$32 for two years, and \$46 for three years in the USA and its possessions. In Canada and Mexico, \$20 for one year, \$36 for two years, \$52 for three years. \$32 for one year air delivery to Europe. \$32 surface delivery elsewhere. Air delivery to selected areas at additional rates upon request. Single copy price is \$2.50 in the USA and its possessions, \$2.95 in Canada and Mexico, \$4.00 in Europe, and \$4.50 elsewhere. Foreign subscriptions and sales should be remitted in United States funds drawn on a US bank. Printed in United States of America.

Address all editorial correspondence to the editor at the above address. Unacceptable manuscripts will be returned if accompanied by sufficient first class postage. Not responsible for lost manuscripts or photos. Opinions expressed by the authors are not necessarily those of BYTE. Entire contents copyright © 1980 by BYTE Publications Inc. All rights reserved.

BYTE® is available in microform from University Microfilms International, 300 N Zeeb Rd, Dept PR, Ann Arbor MI 48106 USA or 18 Bedford Row, Dept PR, London WC1R 4EJ ENGLAND.



Subscription WATS Line: (800) 258-5485

Office hours: Mon-Thur 8:30 AM - 4:30 PM Eastern Time Friday 8:30 AM - Noon



MICROANGELO

TM

HIGH RESOLUTION INTELLIGENT GRAPHICS

Graphics boards have come and graphics boards have gone. None have really given you all the features at a competitive price that you've wanted—UNTIL NOW!

HIGH RESOLUTION 512 x 484 pixel display, from its own 32K random access memory.

INTELLIGENT Resident software emulates a terminal and also accepts high level commands for point, line, region, and variably sized and oriented character generation.

ROCK SOLID DISPLAY No snow, no jitter, no dropout. PERIOD.

INDEPENDENT Z80 driven at 4 Mhz on its own bus, so no address space from your host is used.

OBEDIENT Direct MicroAngelo via the light pen interface or high level software.

TALKATIVE High speed communication with your host over interrupting parallel ports.

EXTENSIBLE Room for up to 8K of PROM.

TIMELY 60 Hertz interrupting real time clock.

EASY TO USE Drop it into any S-100 host and you're up and running.

VERSATILE Composite or direct drive output; provision for external sync for a 512 x 512 display.

AFFORDABLE 895 dollars brings you the creative genius of MicroAngelo.

MicroAngelo is available now. Call Jim Mather at (703) 827-0888 or write us at Micro Diversions, Inc., 8455-D Tyco Road, Vienna, Virginia, 22180 and get creative!

**Look for
Shugart drives
in personal
computer systems
made by these
companies.**

Altos Computer Systems
2378-B Walsh Avenue
Santa Clara, CA 95050

Apple Computer
10260 Bandley Dr.
Cupertino, CA 95014

Commodore Business Machines, Inc.
3330 Scott Boulevard
Santa Clara, CA 95050

Digital Microsystems Inc.
(Formerly Digital Systems)
4448 Piedmont Ave.
Oakland, CA 94611

Industrial Micro Systems
633 West Katella, Suite L
Orange, CA 92667

North Star Computer
2547 9th Street
Berkeley, CA 94710

Polymorphic Systems
460 Ward Dr.
Santa Barbara, CA 93111

Problem Solver Systems
20834 Lassen Street
Chatsworth, CA 91311

Processor Applications Limited
2801 E. Valley View Avenue
West Covina, CA 91792

Technico Inc.
9130 Red Branch Road
Columbia, MD 21045

Texas Electronic Instruments
5636 Etheridge
Houston, TX 77087

Thinker Toys
1201 10th Street
Berkeley, CA 94710

Editorial

The Era of Off-the-Shelf Personal Computers Has Arrived

Carl Helmers

This issue marks the beginning of a new decade: the 1980s. It may be appropriate at this time to pause and see how technology has progressed. At the turn of a previous decade, the only computers I could get my hands on were those large and expensive behemoths of the 1960s, the IBM 360s, Univac 1108s, and DEC PDP-6s, which I used during my occasional employments while an undergraduate physics student. Those machines represented such large capital investments that there was no way I could possibly own one.

At the time I knew that minicomputers existed. But they too were quite expensive. The minicomputer of late 1969 was also very limited in peripherals and systems software. At that time minicomputers were usually made by Digital Equipment Corporation, used a Teletype with paper tape for mass storage, and they may have had all of 8 K words of memory with 12 bits per word. It was an era in small computers when \$30,000 might have purchased the hardware equivalent of today's \$500 single-board engineering system; for example, a Rockwell AIM-65 with some added memory and a power supply. (This single-board 6502-based computer includes printer, tape interface, systems software and keyboard. With all required purchases, it costs about \$500 to \$600. A system such as this is equivalent to (if not better than) one of the typical minicomputer "installations" of the late 1960s.)

As we entered the 1970s, the beginnings of the large-scale integration microcomputer technology had been made. In existence at that time were 4-bit computers in high-technology calculator products, as well as such great accomplishments as 1024-bit shift register memories (slow) and high-speed 64-bit transistor-transistor logic (TTL) memories (power hungry). Mass storage on small machines in 1969, if it was electronic, was done on various randomly or serially addressable tape devices. These tape units were sold at prices comparable to the present-day retail price of a dedicated Winchester technology 10-million-byte hard disk drive. But the more common mass storage was mechanical, eg: the paper-tape reader and punch on a Model ASR-33 Teletype. As we enter the next decade, we find a much different picture.

The 64-bit memory part of late 1969 has increased in size to today's latest technology 64 K bit dynamic memories. This is an increase in density of just over 3 decimal orders of magnitude ($1024 \cong 10^3$). The primitive 4-bit architectures of then current calculators have become the 32-bit architectures of current machines such as the Motorola 68000, which is now seeing its first limited deliveries to prototype laboratories. At the end product level, smart machines have taken off in myriad directions, ranging from the dedicated controllers of computerized toys and microwave ovens, to the modern personal computer.

With the new extremely large-scale integration devices, the era of the 32-bit personal computer with high-resolution graphics display, main memory of 256 K bytes and from 10 to 50 million bytes of hard disk capacity on line is nearly here. In 1980, such a system can be built with the central computer consisting of just 33 major parts: 32 memory chips and a 68000 microcomputer.

 **Shugart**

"My Shugart followed me home."

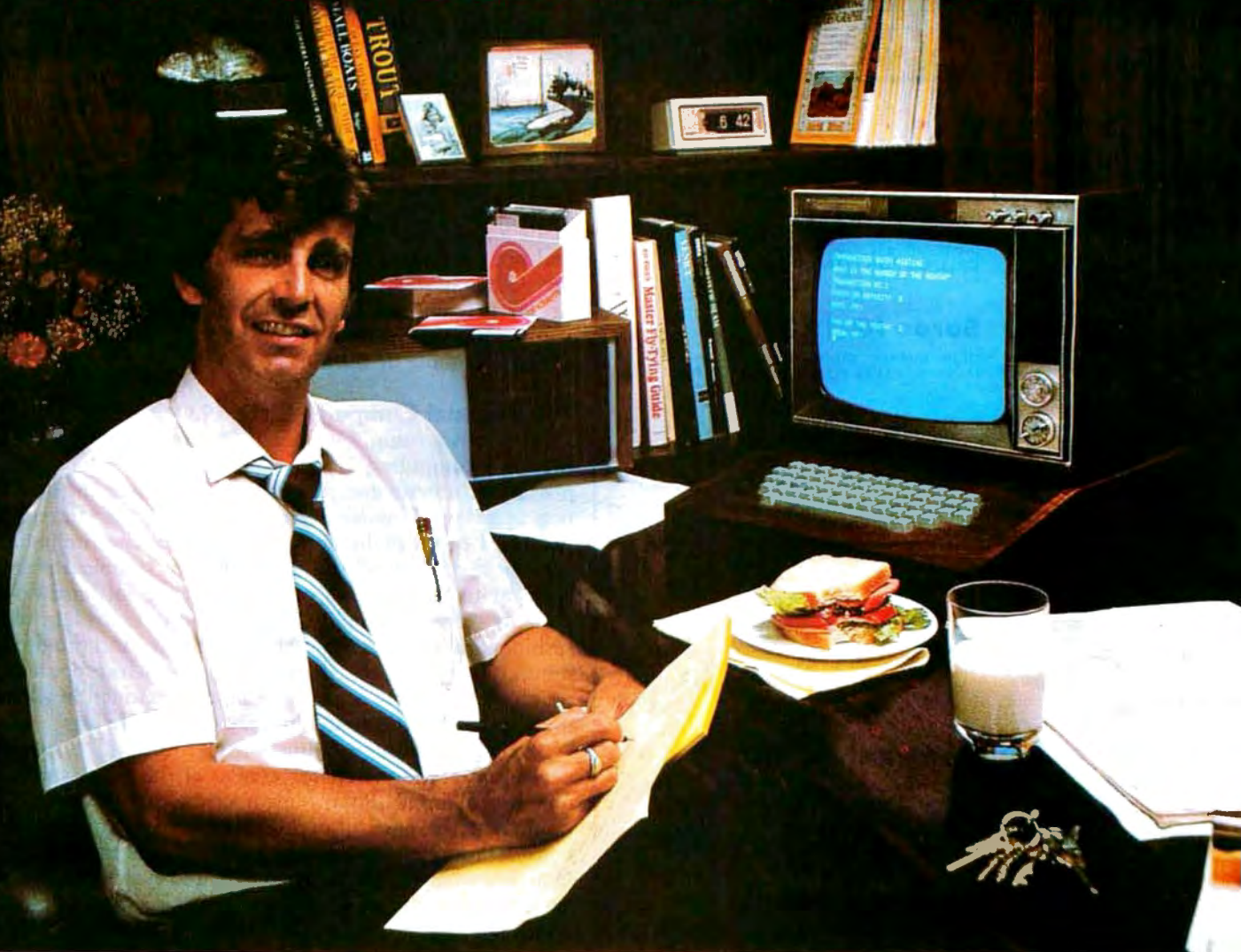

"After working all day with the computer at work, it's a kick to get down to Basic at home. And one thing that makes it more fun is my Shugart minifloppy™. We use Shugart drives at work, so when I bought my own system I made sure it had a minifloppy drive.

"Why? Shugart invented the minifloppy. The guys who designed our system at work tell me that Shugart is the leader in floppy design and has more drives in use than any other manufacturer. If Shugart drives are reliable enough for hard-working business computers, they've got to be a good value for my home system.

"When I'm working on my programs late at night, I can't wait for cassette storage. My minifloppy gives me fast random access and data

transfer. The little minidiskettes™ store plenty of data and file easily too.

"I made the right decision when I bought a system with the minifloppy. When you lay out your own hard-earned cash, you want reliability and performance. Do what I did. Get a system with the minifloppy."

If it isn't Shugart, it isn't minifloppy.

 **Shugart**

435 Oakmead Parkway, Sunnyvale, California 94086

See opposite page for list of manufacturers featuring Shugart's minifloppy in their systems.

™ minifloppy is a registered trademark of Shugart Associates

free freight

We'll pay the surface freight on all pre-paid products featured in this ad to any of 16,000 U.S. tariffed locations. No handling charges, add on costs, insurance fees or credit card fees!



TI 99/4

Built in equation calculator, 13" color monitor, 16-bit C.P.U., TI Basic w/13 digit precision, and more!
CALL US FOR LOW PRICE!



Soroc IQ 120

High quality, professional text-editing terminal. 73-key board, built in 2K RAM.
\$789



Hazeltine 1500

7X10 matrix, baud rates to 19,200; full keyboard with numeric pad, full function CRT at a new low price!
\$950



TI 810

Basic 150 cps serial. The industry leader at a new low price! Save over \$300.
\$1589



Centronics 730

100 cps, parallel, 3-way feed, 80-character buffer...the new leader in small printers from Centronics. Save \$100.
\$895



Comprint 912

Low priced electrostatic matrix printer, 225 cps.
Serial **\$535**
Parallel **499**



North Star Horizon

Call us for our low prices on the industry's most popular C.P.U.

Televideo 912 \$779
Centronics 704 \$1685
Heath WH 14 \$749

Over 2000 products from over 100 manufacturers. Prices subject to change without notice, products subject to availability. FOB Tempe, AZ (5% sales tax in Arizona)

Call now
TOLL FREE 1-800-528-1418
MICROWORLD®
1425 W. 12th Pl. • Tempe, AZ 85281 • (602) 894-1193

Ancillaries, such as buffers and read-only memories, might double that count to 66. In a very approximate systems sense, the manufacturing cost of an electronic system is proportional to the number of parts involved. This is exclusive of intangibles like software and aesthetics. So the manufacturing cost of such a device two years from now will make it the typical personal computer.

But what of right now? Where would we stand if there were to be no technological improvements in off-the-shelf personal computers? What is the state of today's technology? I am going to describe some of the criteria that make up the design of a good modern personal computer system — and then I will make some comments about a particular system I just purchased and upon which I am creating this editorial. The fact that I have made a particular choice reflects the *necessity for choice* and not necessarily that other machines might not have served me as well. I will leave comments about this particular machine until later while I go into more details about what I see as the state of the art in small computers at the beginning of the 1980s.

The Personal Computer Circa 1980 . . .

As of this writing, October 1979, the state of the art in personal computing is such that the user is king. It is possible to enter a computer store and witness the operation of a typical modern system, try it out, then purchase one just like it to take home and use. The discriminating user must pay attention to a number of technical points relevant to the function of systems: areas of hardware, systems software, applications software, and plain old-fashioned idiosyncracies such as aesthetics and programming styles enter into a decision about which computer to purchase. But there is a core of minimum function which must be met in the contemporary small computer.

Starting this tour of function at the level of system design, what are the characteristics of the processor and memory required? First, remember the often overlooked point that the particular processor used is an arbitrary consideration within a broad range. This is especially so in an era when high-level languages and systems software can insulate the programmer from needless details of low-level code.

In present-day personal computers the processors which are typically used are 8-bit devices: 8080s, 6502s, Z80s, 8085s, 6800s, and 6809s. In raw performance statistics, all of these are comparable within a factor of 2 or 3 depending upon the benchmark chosen. Each has its own strengths and weaknesses. The basic limitation of present-era computers is the 8-bit bus, which cycles at only a several megahertz rate (a typical system memory access time is 200 to 500 nanoseconds). Transferring a byte at a time is often the most significant speed limitation.

Thus the processor choice is relatively unconstrained among the various off-the-shelf computers available today. What of memory? Whatever the processor, the more memory available, the better the system. I believe that the convenient and pleasurable use of the small computer as it exists today requires a bare minimum of 32 K (ie: 32,768) bytes. Of the computers I use regularly, two have 64 K bytes and one has 53 K bytes. The primary criterion for selecting memory technologies for a user of a

At Intersystems, "dump" is an instruction. Not a way of life.

(Or, when you're ready for IEEE S-100, will your computer be ready for you?)

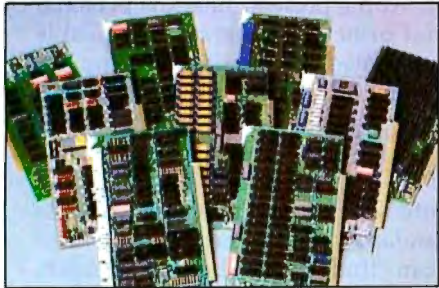

We're about to be gadflies again.

While everyone's been busy trying to convince you that large buses housed in strong metal boxes will guarantee versatility and ward off obsolescence, we've been busy with something better. Solving the *real* problem with the first line of computer products *built from the ground up to conform to the new IEEE S-100 Bus Standard*. Offering you extra versatility in 8-bit applications today. And a full 16 bits tomorrow.

We call our new line Series II™. And even if you don't need the full 24-bit address for up to 16 megabytes (!) of memory right now, they're something to think about. Because of all the perform-

ance, flexibility and economy they offer. Whether you're looking at a new mainframe, expanding your present one or upgrading your system with an eye to the future. (Series II boards are compatible with most existing S-100 systems and *all* IEEE S-100 Standard cards as other manufacturers get around to building them.)

Consider some of the features: Reliable operation to 4MHz and beyond. Full compatibility with 8- and 16-bit CPUs, peripherals and other devices. *Eight* levels of prioritized interrupts. Up to 16 individually-addressable DMA devices, with IEEE Standard overlapped operation. User-selectable functions addressed by DIP-switch or jumpers, eliminating soldering. And that's just for openers.

The best part is that all this heady stuff is available *now*! In our advanced processor—a full IEEE Bus Master featuring Memory Map™ addressing to a full megabyte. Our fast, flexible 16K Static RAM and 64K Dynamic RAM boards. An incredibly versatile and

economical 2-serial, 4-parallel Multiple I/O board. 8-bit A/D-D/A converter. Our Double-Density High-Speed Disk Controller. And what is undoubtedly the most flexible front panel in the business. Everything you need for a complete IEEE S-100 system. Available separately, or all together in our new DPS-1 Mainframe!

Whatever your needs, why dump your money into obsolete products labelled "IEEE timing compatible" or other words people use to make up for a lack of product. See the future now, at your Intersystems dealer or call/write for our new catalog. We'll tell you all about Series II and the new IEEE S-100 Bus we helped pioneer. Because it doesn't make sense to buy yesterday's products when tomorrow's are already here.

InterSystems™

Ithaca Intersystems Inc.,
1650 Hanshaw Road/P.O. Box 91,
Ithaca, NY 14850
607-257-0190/TWX: 510 255 4346

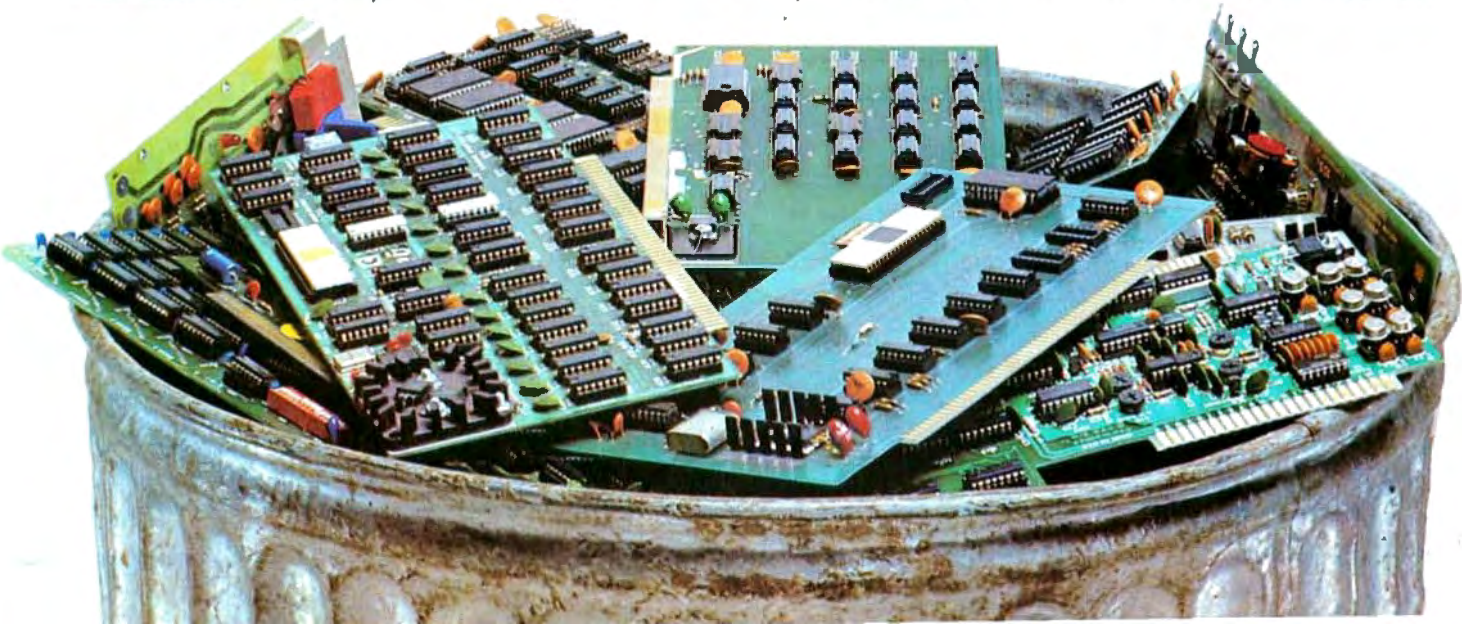

modern computer is that it be in the system, competently engineered, and reliable. Engineering jargon terms like "static" versus "dynamic" are meaningless once a product has passed the design stage and becomes a reliable mass-produced product. The fact that nearly all mass-produced computers use dynamic memory is a statement about the costs of various semiconductor engineering technologies. When I buy a computer off the shelf, I care only about the quantity of main memory available for use as a resource.

In addition to the need for adequate main memory, the next question is, what of magnetic mass storage? At a bare minimum, the personal computer should have on the order of 500 K bytes of on-line storage, preferably in two or more drives. In today's technology, the most prevalent magnetic medium is the 5- or 8-inch floppy disk, with single-, double- or quad-density recording. Although recently introduced in personal computers, the hard disk technology based on drive products, from firms like Shugart, IMI and Micromation, is not nearly as prevalent as it will be in 1980 and beyond; the standard configuration for most small computers is two or more floppy disk drives as 1979 draws to a close.

At the level of user interfaces, the standard display hardware of a usable small computer is the 24 (or 25) line by 80-character video display. In some machines this is built in as a board in the system itself; on others it is provided in the form of a high-speed serial link (typically 19.2 kbps) to a video terminal. In either design, the terminal interface has a standard keyboard similar to a typewriter, and both upper and lowercase text are sup-

ported. In this era, when the marginal cost of a full upper and lowercase text capability is low compared to system cost, there is no excuse for perpetuating primitive computers' use of only uppercase text. Still remaining at a hardware level, it is necessary to have a hard copy device for most effective use of a small computer (or a large computer for that matter). Rare is the person who can remember all the details of a program without hard copy; and rare is the computer system with sufficient redundant displays so that multiple independent pages of text can be conveniently viewed simultaneously. In a personal computer at prices within reason today, hard copy is a necessity.

What about the options and their availability? Does the computer in question have a de facto standard bus design which is used by independent companies to design compatible peripherals? At the present time, the personal computer world has four principal bus systems available — two that are represented by multiple computer manufacturers (S-100 and SS-50), and two that are represented by one computer manufacturer and many independent compatible peripherals manufacturers (Apple II and Radio Shack TRS-80). These bus designs allow owners of small computers to mix and match peripherals beyond those of the standard variety every manufacturer provides. Thus we can find music boards, modem boards, real-time clocks, and even hard disk memories which plug into the bus definitions of one or more of the widely used de facto standards.

Going on to the issue of software and its specifications,

Text continued on page 93

FINALLY, Apple II[®] software for the discerning computerist, and the not-so-discerning beginner

AppleAids[™]

Little Tricks[™]

A series of carefully explained subroutines containing a potpourri of useful programming techniques in Integer Basic and Applesoft, such as specific key stroke identification, timing loops, disappearing question marks on input, no question marks on input, and many more.

Cassette (16K) 14.95 Disk (32K) 19.95

Scroll Control[™]

Have you ever wondered why you cannot list an Integer Basic or Applesoft program one screen-page at a time? So have we, and we did something about it! Our machine language Scroll Control, hidden in RAM so as not to "bump" into your program, can be engaged or disengaged at a flick of the keyboard. Why be frustrated when instead you can control the scroll? Cassette 9.95 Disk 14.95

Complaw[™] Series

*Alitax Estimator[™]

This Applesoft program, prepared under the supervision of an attorney, estimates disposable income after alimony and child support payments and federal taxes. For use by laymen and attorneys. 1980 tables.

Cassette (24K) 9.95 Disk (32K) 14.95

*Pensioner[™]

A companion to Alitax Estimator in Applesoft designed to calculate the present value of a pension in states in which a pension is subject to division in marital dissolution cases.

Cassette (24K) 9.95 Disk (32K) 14.95

Form-It-Out[™]

A series of routines in Integer Basic and Applesoft containing detailed explanation and examples of programming techniques necessary to professionalize your screen output. Included are right and center justification, windowing, tabbing, cursor positioning among others.

Cassette (16K) 14.95 Disk (32K) 19.95

Track & Sector List[™]

This is the ultimate disk utility. Instead of a catalog, have you ever seen those dreaded words "I/O ERROR"? Is all lost? NO! Now your disk may be saved. Also you can eliminate bad sectors, remove control characters imbedded in file names, change the disk volume number, and more. This machine language program is supplemented by extensive tutorial documentation worth its weight in gold. Disk only (32K) 24.95

Hex and Decimal Learning Tree[™]

My ABC's[™]

An early learning Integer Basic program using over one hundred and fifty high resolution graphic letters and pictures in a drill-and-practice format designed to develop identification of capital and small letters, and association of letters with pictures. Scoring capability allows monitoring. Child tested and teacher recognized. Cassette (48K) 14.95 Disk 19.95

Now I Can Rhyme[™]

A companion to My ABC's in Integer Basic. The child selects those high resolution pictures which rhyme. Score-keeping capability allows monitoring. Incorporates progressive levels of difficulty.

Cassette (48K) 14.95 Disk (48K) 19.95

N.J. res. add 5% sales tax
Apple II and Applesoft are registered trademarks of Apple Computer, Inc. Add \$1/item, shipping and handling professional, but not a substitute for legal advice

SOFTAGON[™]
INCORPORATED

P.O. Box 774M
Morristown, NJ 07960
(201) 539-3770



New from SSM.



80 Character Video

With 80 characters per line our VB3 is the perfect video interface for  processing. It produces a standard 80x24 display of upper and lower case characters or as much as 80x51 for a full page of text. The matrix for graphic display goes up to 160x204. And with optional EPROM, as many as 256 user programmed characters or symbols can be produced.

VB3 is memory mapped for rapid screen updating. But it occupies memory only when activated. So one or more VB3s can be located at the same address with a full 65K of memory still available to the user.

It generates both U.S. and European TV rates and meets the new IEEE S-100 standard. Other features include keyboard input, black on white or white on black, one level of grey, underline, strike thru, blinking char., blank-out char., and programmable cursor. Software includes a CP/M compatible driver and a powerful terminal simulator.

VB3 is available in several configurations. Retail prices start at \$375 kit, \$440 assembled.



Z-80 CPU

We spent over a year designing the CB2 to assure that it will be the most fully S-100 compatible Z-80 CPU on the market.

It operates at 2MHZ or 4MHZ by DIP switch selection and includes two sockets for 2716/2732 EPROMs or TMS 4016 2K RAMs. Memory sockets can be disabled. Separate run/stop and single step switches allow system evaluation without the benefit of a front panel.

CB2 also features an MWRITE signal, firmware vector jump, and an output port to control 8 extended address lines (allowing use of more than 65K of memory). Jumper options generate the new IEEE S-100 signals to insure future S-100 compatibility.

Retail price — \$210 kit, \$275, assembled.

Our line. CPU, Video, I/O, RAM, EPROM, EPROM Programmer, Music, Prototyping, Terminator, Extender, and Mother boards. Available assembled or as kits.



8080 CPU

Our new CBIA is identical to our popular CB1 with the exception that the on-board RAM has been increased from 256 bytes to a full 1K.

It also features an optional 2K of 2708 EPROMs, power-on/reset vector jump, MWRITE, parallel input port with status and DIP switch addressing.

Retail price — \$159 kit, \$219 assembled.



2116 Walsh Avenue
Santa Clara, CA 95050 (408) 246-2707

Send for our free brochure and find out why SSM has become the favorite of discerning Hobbyists and OEMs.



Microcomputing comes of age.

Ohio Scientific's OS-65U Level 3 operating system software brings new networking and distributed processing capabilities to microprocessor based computer systems.

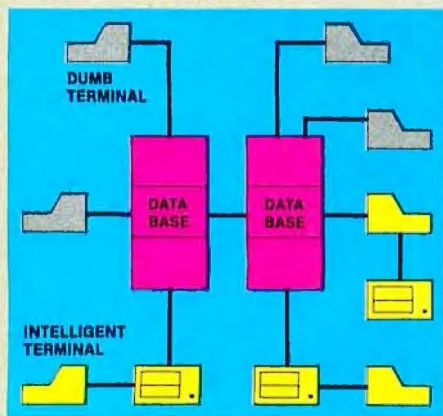

Until now, the only alternative for low cost multiple-user computer applications was time-shared systems. However, a serious drawback of microcomputer or mini-computer multi-user time-share systems is the fact that under heavy work loads they slow down to a crawl since the central processor time in such a system is shared by all of the users.

In a microprocessor based distributed processing system, using floppy based microcomputers as intelligent terminals (local systems) most of the work load is handled locally. Overall system performance does not degrade under heavy job loads. Each local system performs entry, editing and execution while utilizing the central data base for disk storage, printer output, and other shared resources.

For more demanding applications it is desirable to have several data bases, each with its own collection of local systems. Such an inter-connected set of data bases is called a network.

Each data base and its local intelligent and dumb terminals is called a cluster.

Level III

OS-65U Level 3 now supports this advanced networking and distributed processing capability as well as conventional single user operation and time-sharing. Level 3 now supports local clusters of intelligent microcomputer systems as well as

dumb terminals for the purpose of utilizing a central Winchester disk data base and other shared resources. The system also has full communications capability with other Level 3 data bases providing full network capability. The system utilizes Ohio Scientific's low cost, ultra high performance computer systems throughout for intelligent terminals as well as data bases. This general systems configuration provides a cost/performance ratio never before attained in this class of computer power.

Level 3 resides in each network data base. A subset system resides in each intelligent terminal. Each data base supports up to 16 intelligent systems and up to 16 dumb terminals. However, since dumb terminals can heavily load the system, they should be kept to a minimum. Level 3 also supports a real time clock, printer management, and other shared peripherals.

Data Base Requirements

Minimal requirements for a Level 3 network data base are a C3-C or C3-B computer system with 23 or 74 megabytes respectively, console terminal, 100K bytes RAM and a CA-10X 16 port I/O board for network and cluster communications.

Intelligent Terminal Requirements

Any Ohio Scientific 8" floppy based computer with 56K RAM and one data base communications port.

Connections

Intelligent terminals and networked data bases are connected by low-cost cabling. Each link can be up to 10,000 feet long at a transfer rate of 500K bits per second, and will cost typically 30¢ a foot (plus installation).

Syntax

Existing OS-65U based software can be directly installed on the network with only *one* statement change! Level 3 has the most elegantly simple programming syntax ever offered on a computer network.

File syntax is as follows:

DEV A,B,C,D,	Local Floppies	} unchanged from single user and timeshare systems
DEV E	Local hard disks	
DEV K-Z	Specific network Data Bases	

Each of up to 8 open files per user can be from 8 separate origins. Specific file and shared peripheral contentions are handled by 256 network semaphores with the syntax Wait N
Wait N, close.

The network automatically prioritizes multiple resource requests and each user can specify a time out on resource requests. Semaphores are automatically reset on errors and program completion providing the system with a high degree of automatic recovery.

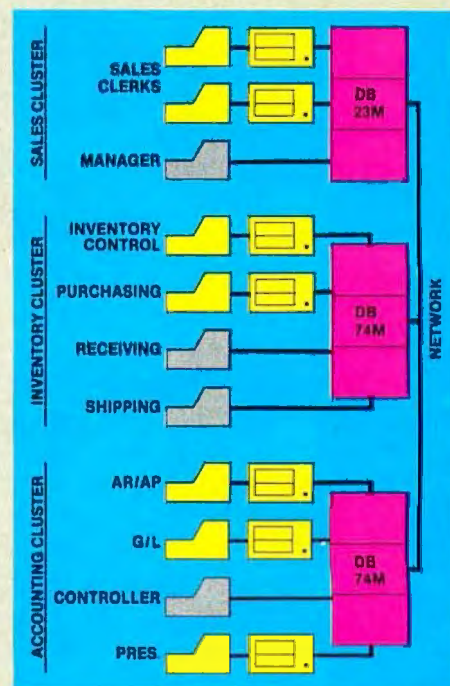

A Typical System

A typical system with two network data bases will have 148 megabytes of disk, four intelligent subsystems equipped with dual floppies, two dumb terminals, a word processing printer, a fast line printer, network data base manager software and 1000 ft. of inter-connecting cable. Utilizing .7 MIPS processors throughout it will cost less than \$50,000 plus installation. GT option computers (1.2 MIPS) can be utilized at a slightly higher cost.

One Step at a Time

Best of all, Ohio Scientific users can develop distributed processing systems economically one step at a time. A user can start with a single user floppy system, add a hard disk, then time-sharing, then a second Winchester data base for backup and finally cluster intelligent terminals to achieve a full network configuration.

For literature and the name of your local dealer, CALL 1-800-321-6850 TOLL FREE.

OHIO SCIENTIFIC
 1333 SOUTH CHILLICOTHE ROAD
 AURORA, OH 44202 • [216] 562-3101

The Microcomputers you should take seriously.

The Challenger III Series is the micro-computer family with the hardware features, high level software and application programs that serious users in business and industry demand from a computer system, no matter what its size.

Since its introduction in August, 1977, the Challenger III has become one of the most successful microcomputer systems in small business, educational and industrial development applications. Tens of thousands of Challenger III's have been delivered and today hundreds of demonstrator units are set up at systems dealers around the country.

The Challenger III systems offer features which make their performance comparable with today's most powerful mini-based systems. Some of these features are:

Three processors today, more tomorrow.

The Challenger III Series is the only computer system with the three most popular processors—the 6502A, 68B00 and Z-80. This allows you to take maximum advantage of the Ohio Scientific software library and programs offered by independent suppliers and publishers. And all Challenger III's have provisions for the next generation of 16 bit micros via their 16 bit data BUS, 20 address bits, and unused processor select codes. This means you'll be able to plug a CPU expander card with two or more 16 bit micros right in to your existing Challenger III computer.

Systems Software for three processors.

Five DOS options including development, end user, and virtual data file single user systems, real time, time share, and networkable multi-user systems.

The three most popular computer languages including three types of BASIC plus FORTRAN and COBOL with more

languages available from independent suppliers. And, of course, complete assembler, editor, debugger and run time packages for each of the system's microprocessors.

Applications Software for Small Business Users.

Ready made factory supported small business software including Accounts Receivable, Payables, Cash Receipts, Disbursements, General Ledger, Balance Sheet, P & L Statements, Payroll, Personnel Files, Inventory and Order Entry as stand alone packages or integrated systems. A complete word processor system with full editing and output formatting including justification, proportional spacing and hyphenation.

OS-DMS, the software star.

Ohio Scientific offers an Information Management system which provides end user intelligence far beyond what you would expect from even the most powerful mini-systems. Basically, it

allows end users to store any collection of information under a Data Base Manager and then instantly obtain information, lists, reports, statistical analysis and even answers to conventional "English" questions pertinent to information in the Data Base. OS-DMS allows many applications to be computerized without any programming!

The "GT" option yields sub-microsecond microcomputing.

Ohio Scientific offers the 6502C microprocessor with 150 nanosecond main memory as the GT option on all Challenger III Series products. The system performs an average of 1.5 million instructions per second executing typical end user applications software (and that's a mix of 8, 16 and 24 bit instructions!).

Mini-system Expansion Ability.

Challenger III systems offer the greatest expansion capability in the microcomputer industry, including a full line of over 40 expansion accessories.

Networking and Distributed Processing

OS-65U level 3 now provides networking capabilities as well as time sharing ability allowing Challenger III based systems to be expanded to meet the most demanding business applications.

Prices you have to take seriously.

The Challenger III systems have phenomenal performance-to-cost ratios. The C3-S1 with 48K static RAM, dual 8" floppies, RS-232 port, BASIC and DOS has a suggested retail price of under \$4000. 80 megabyte disk based systems start at under \$13,000. Our OS-CP/M software package with BASIC, FORTRAN and COBOL is only \$600, and other options are comparably priced.

For literature and the name of your local dealer, CALL 1-800-321-6850 TOLL FREE.

Circle 7 on Inquiry card.

C3-B wins Award of Merit at WESCON '78 as the outstanding microcomputer application for Small Business.

The Challenger III Series from Ohio Scientific.

C3-B



C3-S1



C3-OEM



OHIO SCIENTIFIC
1333 SOUTH CHILLICOTHE ROAD
AURORA, OH 44202 • (216) 562-3101

Letters

Tic Tac Rebuttal

In his letter to BYTE (October 1979, page 175), Mr Miller raises some interesting points. However, his comments about my Tic-Tac-Toe program (BYTE May 1979, page 196) do require further examination.

Apparently, aesthetics in programming is in the eye of the beholder; Mr Miller found my table-lookup method unappealing. It is more aesthetically pleasing to me to compute a move only once, then use it, rather than to recompute the same move each time it is used. Since a Tic-Tac-Toe game is readily represented as a decision tree, I felt that a table-lookup algorithm was the most natural implementation, and regretted the necessity of using more clumsy methods for the special cases.

A further advantage of a table-lookup method is its modularity; one move-logic block may be readily changed

without affecting other parts. You may recall that there was a logic bug in the published program (see "BYTE's Bugs," August 1979, page 194). This was easily corrected by changing only five numbers in the data table.

The concept is similar to that of a chess program; the better ones use a table-lookup for the early moves of the game, before things get too complicated.

As for taking advantage of the microprocessor's capabilities, it is more natural for it to increment an address to find a prestored number than to compute; its built-in computing power is limited to addition. More complicated computing must be done by "brute force and awkwardness" in the machine-language programming of the BASIC interpreter.

Mr Miller did not like for the computer to always move first. As I stated in the article, I wanted the computer to play an aggressive game. It is readily

apparent that the computer *cannot* play an aggressive game if the user moves first; it can then play only a defensive game, and wait for the user to blunder. Actually, I do have a user-first Tic-Tac-Toe program that uses a similar table-lookup method of play. While it plays the best possible game within the limits of a user-first game, it is still "curiously limited" and I felt that its inclusion would detract from the performance of the published program.

To play a rational Tic-Tac-Toe game, it is necessary but not sufficient for the program to be unbeatable. A rational program must not just respond to the current situation, but it must be goal-oriented. To set a "trap" requires three moves in the proper sequence. This planning ahead is readily done with a table-lookup method, but I suspect that it would be difficult to do by following Mr Miller's proposed system.

I suggest that Mr Miller submit a Tic-Tac-Toe program based upon his 9-step strategy. It is much more meaningful to compare the performance of working programs than to compare a working program with a theoretical one.

Delmer D Hinrichs
2116 S E 377th Ave
Washougal WA 98671

UNIX-type File Available

We applaud Jim Howell's plea ("Operating Systems: Let's Have Some UNIX-Inspired Software," September 1979 BYTE, page 82) for more sophisticated system software on microcomputers.

We would like to point out that UNIX-style file systems are, however, available already for microprocessors (at least the 6800s) in our SDOS product.

The SDOS file system supports files which may be randomly addressed to the byte; as many bytes as desired may be read or written in a single system call. Sector sizes of the disk hardware underlying the file system are completely invisible to the application program. Disks with different capacities and sector sizes can even be mixed on the same system. Regular I/O devices such as terminals and printers are treated identically, with the result being that applications object programs move unchanged from one SDOS hardware configuration to another.

SUPERPASCAL

5-10 times faster...
and more!

Meet Pascal/Z,TM the fast, flexible compiler with higher speed, greater efficiency and improved debugging:

- True Z-80 native code Pascal compiler — 5-10X faster than competing P-code implementations — *no interpreter required.*

- The only multi-tasking Pascal — produces ROMable re-entrant code.

- Optimized for fastest execution — recognizes and exploits special cases.

- Easily transportable — all hooks to your system made through support library.

- Includes IEEE standard floating point package.

Single copy on CP/M-compatible disk includes compiler, companion macro-assembler & source of the library, \$275. OEM licenses available. Write or call for more information.

InterSystemsTM

Ithaca Intersystems Inc., 1650 Hanshaw Road/P.O. Box 91,
Ithaca, NY 14850/607-257-0190/TWX: 510255 4346

© 1979 Ithaca Intersystems Inc.

SuperBrain™



The Honor Graduate

There's been a lot of talk lately about intelligent terminals with small systems capability. And, it's always the same. The systems which make the grade in performance usually flunk the test in price. At least that was the case until the SuperBrain graduated with the highest PPR (Price/Performance Ratio) in the history of the industry.

For less than \$3,000*, SuperBrain users get exceptional performance for just a fraction of what they'd expect to pay. Standard features include: two dual-density mini-floppies with 320K bytes of disk storage, up to 64K of RAM to handle even the most sophisticated programs, a CP/M Disk Operating System with a high-powered text editor, as-

*Quantity one. Dealer inquiries invited.

sembler and debugger. And, with SuperBrain's S-100 bus adapter, you can even add a 10 megabyte disk!

More than an intelligent terminal, the SuperBrain outperforms many other systems costing three to five times as much. Endowed with a hefty amount of available software (BASIC, FORTRAN, COBOL), the SuperBrain is ready to take on your toughest assignment. You name it! General Ledger, Accounts Receivable, Payroll, Inventory or Word Processing . . . the SuperBrain handles all of them with ease.

Your operators will praise the SuperBrain's good looks. A full ASCII keyboard with a numeric keypad and function keys. A non-glare, dynamically focused, twelve inch screen. All in an attractive desktop unit weighing less than a standard

office typewriter. Sophisticated users will acclaim SuperBrain's twin Z-80 processors which transfer data to the screen at 38 kilobaud! Interfacing a printer or modem is no problem using SuperBrain's RS-232C communications port. But best of all, you won't need a PhD in computer repair to maintain the SuperBrain. Its single board design makes servicing a snap!

So don't be fooled by all the freshman students in the small systems business. Insist on this year's honor graduate . . . the SuperBrain.

 **INTERTEC
DATA
SYSTEMS®**

2300 Broad River Road, Columbia, SC 29210
(803) 798-9100 TWX: 810-666-2115

Also, like UNIX, SDOS is completely interrupt-driven.

SDOS currently runs on seven manufacturers' systems, handling over ten different types of drives, including floppy, Winchester, and 10 M byte cartridge drives.

We point out the obvious disadvantages of systems such as FLEX and CP/M; they are tied (and thus tie the application) irrevocably to the floppy disk hardware to which they were originally attached. Further, file I/O under these systems requires a lot of knowledge (ie: code) in the application to perform random access.

Yes, the industry does generally need more sophisticated system software.

Ira D Baxter
Software Dynamics
2111 W Crescent, Suite G
Anaheim CA 92801

A Stitch in Time?

Karen Wolfe's article in October BYTE "Power Helps Analyze Electric Bills," (page 48) led me to analyze Karen's sewing power. With the assistance of a sewing machine and a pocket calculator, neither of them programmable, I reached

the following conclusions: For 100 hours running time on the sewing machine she probably spends close to eight hours a day sewing, including cutting, pinning, etc.

In a month Karen sews about 21 miles — that's 25,000 double seams the full length of the kid's jeans. 50 miles of thread speed through denim. Enough to weave 400 square feet of new cloth.

If Karen is ahead of the game and is in fact getting her stitches in in time, she is saving 189 miles of sewing each month. If she is not in time, she is wasting 18.9 miles of stitches, 45 miles of thread, and \$1.38 of electricity.

Ken Bramham
apt 160, 15 rue Leon Bloy
92260 Fontenay-aux-Roses
FRANCE

Willard Irwin Nico 1928 - 1979

Personal computing pioneer and author Bill Nico passed away recently in Houston, Texas. Bill died of cancer July 2, 1979 at the age of 50.

Bill Nico is perhaps most widely known for his writing. He wrote several articles for BYTE ("Shooting Stars,"

ANOTHER FIRST FROM MOUNTAIN HARDWARE.

SUPERTALKER.

FOR YOUR APPLE

SuperTalker is a peripheral system which permits the output of exceptionally high quality human speech through a loudspeaker under program control. Initially, words, sentences or phrases are digitized into RAM memory through a microphone. Speech data in RAM may be then manipulated like any other data. The system consists of a peripheral card, microphone, loudspeaker, and operating software. \$279 assembled and tested.



Available through Apple dealers worldwide.



Mountain Hardware, Inc.

LEADERSHIP IN COMPUTER PERIPHERALS
300 Harvey West Blvd.
Santa Cruz, CA 95060 (408) 429-8600

May 1976; "Sys 8½," January 1977; "Sweet Auto Line," February 1977) and was author of Heath Company's best selling, self-instructional courses *BASIC Programming* and *Assembly Language Programming*. One of Bill's personal friends was Robert Tinney, artist for many BYTE covers. Robert drew Bill on the December 1977 cover.

Not so well known is the fact that Bill Nico was one of the first real computer hobbyists in the US. Bill's homebrew 8080 computer built in 1974 had to be one of the first in the country.

Bill was also one of the best BASIC and 8080 programmers around. He could get more out of his disk-based IMSAI than anyone. He could write systems software and languages, but felt just at home with a small business package or a real-time industrial control program.

Bill was also pretty good at hardware. He was a professional logic designer and did a fair amount of consulting in this field. His home was perhaps one of the most fully automated in existence. It was a virtual electronic showplace. Bill was also an active amateur radio operator (W5PRZ).

It was only in recent years that Bill discovered his talent for teaching. Bill taught frequently in Heath's computer classes. His great empathy and personal awareness made him a gem of a teacher. His practical nature and down-to-earth approach made him the favorite of every student. It was hard not to learn in his classes.

Bill Nico was born August 30, 1928 in Los Angeles. He graduated from Burbank High in 1946 and served in the Army from 1950 to 1953. His electronics training came from Pierce College in Los Angeles. Bill worked in a variety of electronic engineering and sales jobs in California and Texas from 1953 to 1969. He was manager of the Heathkit Electronic Center in Houston from its opening in 1969 until 1975 when he left to form his own company. From 1975 to 1979 he operated as a consultant and writer from his Houston-based firm, Delta-t.

Those of us who knew and worked with Bill will miss him greatly.

Lou Frenzel
1588 Oak Ter
St Joseph MI 49085

Marsport Forces Resurface

Mr Reiland made some comments about my "Marsport" article (April 1979, page 84) in his letter to BYTE (October 1979, page 209). While I appreciate his compliments, I do differ with him on

The easy way to learn about computers: BUILD ONE



△ H8 Personal Computer with Dual Floppy System



△ H19 Smart Video Terminal

H14 Serial Printer

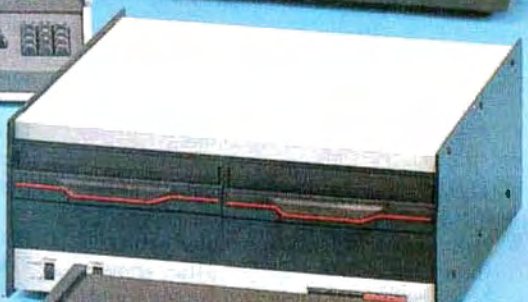
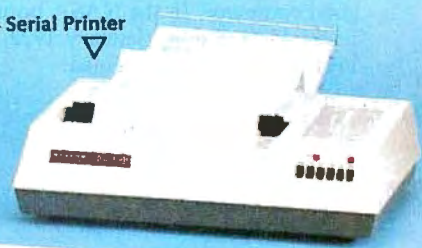

△ H89 All-In-One Computer

H11A 16-bit Computer (DEC® PDP-11/03 compatible) with Dual Floppy System



Self-Instruction Programs for Assembly and BASIC Programming △

Yes, you can do it. Heath makes it simple with easy-to-build kits and step-by-step assembly manuals that lead you from unpacking to final plug-in. And once you build your own computer, you'll know it inside-out. You'll know how to make it work for you. Software, designed especially for Heathkit Computers, includes innovative programs

for running your home or business, and exciting games your kids will enjoy. The Heathkit User's Group (HUG), made up of owners of Heathkit Computers, will share with you a library of over 400 programs that they've written to make your computer serve you in ways you never imagined. Heathkit Computers may be low-cost kits.

But they're not playthings. They're powerful, high-capacity computers designed for complex programming. You'll find complete systems — hardware, software, accessories — within the pages of the colorful, 104-page, Free Heathkit Catalog. And you'll find service any time you need it at 55 locations throughout the U.S. or at the Heathkit factory.

FREE CATALOG

For complete descriptions of Heathkit Computers and nearly 400 other electronic kits for your home, business or pleasure, send for the latest, free Heathkit Catalog. Or you can pick up your catalog at a nearby Heathkit Electronic Center.



If Coupon is missing write: Heath Co., Dept. 334-612, Benton Harbor, MI 49022

Heathkit Products are also sold and serviced at Heathkit Electronic Centers (units of Veritechnology Electronics Corporation) throughout the U.S. See your white pages. DEC is a registered trademark of Digital Equipment Corporation.

Heathkit Heath Company,
Dept. 334-612
Benton Harbor, MI 49022

YES Please send me my FREE Heathkit Catalog.
I am not currently receiving your catalogs.

Name _____

Address _____

City _____ State _____

CP-177 Zip _____

one point: he objected to my statement about a circular orbit, "The attraction of gravity is exactly balanced by the centrifugal force at all times." All that I can say is, if this is "confusion," I am in good company. In the NASA book *Space Mathematics* (January 1972, page 119), two forces are defined:

$$F_1 = mv^2/r$$

where:

F_1 = Centripetal force
 m = Mass
 v = Velocity
 r = Radius from center

$$F_2 = GMm/r^2$$

where:

F_2 = Gravitational force
 G = Universal gravitational constant
 M & m = Masses of the two bodies
 r = Radius between centers

They then say, "The physical situation, if these two forces are equal, is represented in . . . (a circular orbit)." (Emphasis added.) They further show how, by setting these two forces equal, one can solve algebraically for the circular orbit velocity. While their terminology is slightly different from mine, their meaning is obviously the same as I expressed.

One further point: Mr Reiland seemed

surprised that a three-dimensional landing simulation could be programmed on a programmable calculator. This program is far from the limit! I have since programmed a similar three-dimensional rendezvous simulation, that keeps track of two objects in their orbits simultaneously. In it, the spaceship is initially at rest on the surface of the primary, while a target satellite is in a random elliptical orbit. The user waits until the satellite is in the best position, lifts off, matches orbits with the satellite, and rendezvous with it. To try this more difficult exercise, send \$1 to cover my copying and postage costs for a 12-page write-up and listing for the HP-67/97 (as submitted to the Hewlett-Packard Users' Library). Include two blank magnetic cards and I can record the program on them.

Delmer D Hinrichs
 2116 S E 377th Ave
 Washougal WA 98671

It Happened Again

It has happened again. Every time I

decide to let my BYTE subscription lapse because of the high price of the magazine, along comes an issue so jam-packed with well-written, informative, readable articles, that I am forced to renew my subscription again. The most recent issue, the one on LISP (August 1979), just did it again.

The LISP articles simply covered almost everything one would want to know in an introduction, and did it well. In addition, there were excellent articles on more advanced subjects — symbolic math systems and pattern-directed languages being the prime cases to point to — for those who want to delve deeper, or who already knew LISP and its implications and implementations. All of these articles were well-written, too!

Amazing is the only word.

Dave Mellinger, LISP hacker
 c/o Datek Inc
 2336 Wilson Blvd
 Arlington VA 22201

Elegant Input Recognizer

While working on a Star Trek program, I came across the problem of command mnemonics. I wanted the user to be able to type commands as alphabetic mnemonics, not numbers (for example, TRP for torpedo). Also, I wanted him or her to be able to type in the initial of the mnemonic, also for expediency.

However, I did not want the remaining letters to be arbitrary (having the computer recognize only the first letter would mean that THE PHASERS would work for TRP). It's not easy to memorize the mnemonics, so users could easily make mistakes in typing in commands, thereby moving two quadrants west when they wanted to fire the photon torpedo banks. I have seen this happen on many occasions. So, I did a little brainstorming, and came up with this:

```
IF LEFT$(“TRP”,LEN(A$)) = A$
  THEN PRINT “TRP”
```

This works just as well for YES. This one-line comparison will allow "Y," "YE," or "YES," but not "YEAH," "ALYESKA," or even "YESNO." I agree that it is really not necessary to put all that user-input protection in a computer-assisted instruction (CAI) program, but if you want to use it, you can implement it very easily in any BASIC with LEFT\$ and LEN. It's also useful for other applications, such as my Star Trek problem.

Mits Hadeishi
 1460 W 182nd St
 Gardena CA 90248 ■

The
 Self-Indexing
 Query System

WHAT'SIT?

Wow! How'd All That Stuff get In There?



**COMPUTER
 HEADWARE**

BOX 14694
 SAN FRANCISCO 94114

ALTOS COMPUTER SYSTEMS PROUDLY ANNOUNCES

SUN-SERIES

ACS8000-6

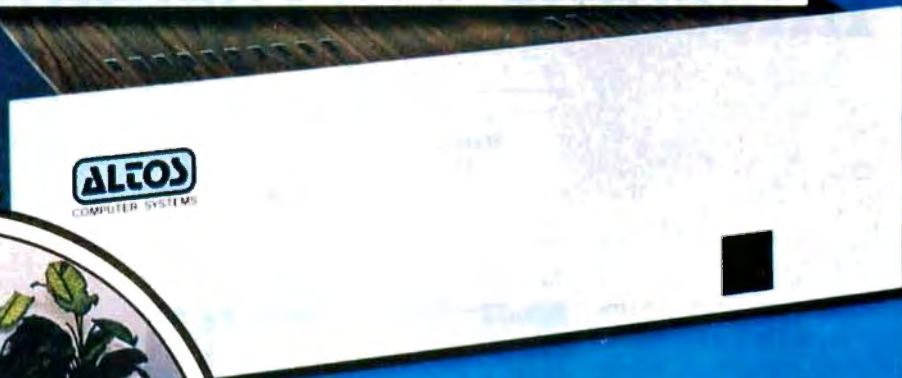
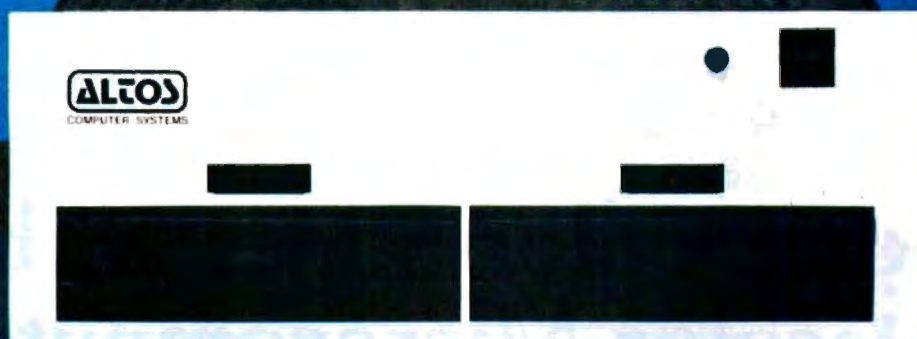

THE VERY FIRST

Double Density Z80 Micro-Computer
plus Twin 8" Floppies
plus 14.5Mb Winchester Disk
for under \$9,500!

And more! 4 user CP/M® for under \$12,000!

®CP/M is a registered trademark of Digital Research, Inc.

ALTOS COMPUTER SYSTEMS, LEADER IN SINGLEBOARD TECHNOLOGY
DOES IT AGAIN WITH ITS SINGLEBOARD ACS8000-6. TOTAL BUSINESS COMPUTER

HIGH TECHNOLOGY AGAIN

The new ACS8000-6 single board computer is packed with ultra-high technology: Z80 double-density computer, up to 208Kb of high speed RAM, Floppy-disk and Winchester Hard Disk controllers, DMA, up to 6 serial/2 Parallel I/O, optional 32 bit floating point processor . . .

All on One Board, fully socketed, fully documented reliable and maintainable.

ADVANCED MULTI-USER SOFTWARE

Our new ALTOS Multi-User Executive (AMEX) supports four independent CP/M compatible programs in any of six languages: Basic, Fortran, Cobol, Pascal, APL, C, and a wealth of complete business application packages.

WINCHESTER MASS STORAGE

We're staying with Shugart for both floppies and Winchester hard disk. Why? Simple, low price, solid reliability and they're our next door neighbor. Our single board computer supports up to 4 Mbytes of floppies and 58 Mbytes of Winchester running under AMEX.

MINI PERFORMANCE FOR 1/2 COST

Prices you will love. Entry level ACS8000-6 Hard Disk System \$9,450
2 users \$10,670, 4 users \$11,960,
AMEX separate at \$250.

AVAILABLE NOW! Circle 12 on inquiry card
Call for your nearest Altos dealer. (408)
244-5766. Telex 171562 ALTOS SNTA.

ALTOS

COMPUTER SYSTEMS

2338-A Walsh Avenue
Santa Clara, Ca. 95050

Making Color Slides with an Intecolor Microcomputer

Alan W Grogono
State University of New York
Upstate Medical Center
750 E Adams St
Syracuse NY 13210

Slides are required for many demonstrations and lectures. Instructional slides often consist of a few words or a simple diagram or graph which the lecturer wishes to discuss. In recent years such slides have commonly been prepared as a blue diazo (white writing on a blue ground). Even the simplest slide is subject to about twelve processes: rough drafting, typing, checking, type setting, rechecking, photography, developing negatives, brushing out imperfections, diazo exposure, pickling, cutting, and mounting. Misunderstandings and interpretations mean that it is not uncommon for one or more stages to be repeated; the process is moderately expensive, and a diazo slide tends to fade with time. This article describes a quick, convenient method of preparing color slides using a computer.

Equipment

The computer employed is an Intecolor eight-color intelligent terminal equipped with BASIC and dual floppy disk. The choice of camera and film may depend on individual circumstances, but the author suggests the following: a single-lens reflex (SLR) 35 mm camera, mounted on a tripod, with telephoto lens (to reduce barrel distortion). Close-up

1a

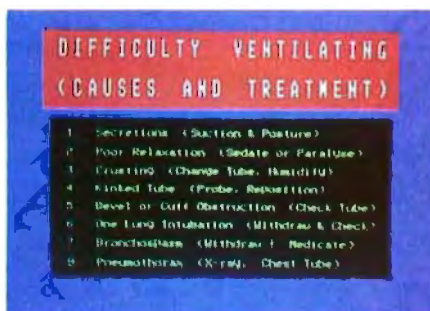

1b

pH	[H ⁺]
3	1000 mol / l
2	100 mol / l
1	10 mol / l
0	1 mol / l
-3	1 m mol / l
-6	1 mic mol / l
-9	1 n mol / l

Photo 1: Two examples of computer-generated slides containing color text material.

lenses or close focusing attachments are essential.

The computer allows images to be formed on a high-resolution screen offering eighty characters per line and either forty-eight lines of small letters or twenty-four lines of double-height

letters. Lines, bar graphs, vector graphics, and simple drawings can also be constructed. The color for the background and for the foreground (the character or line) can be separately selected from the eight available colors.

Software

A program called Menu is used to:

- prepare a new floppy disk for saving images,
- prepare images,

About the Author

Dr Grogono is an Associate Professor of Anesthesiology at the State University of New York, Upstate Medical Center, in Syracuse New York. He trained in London, England, and emigrated to the United States in 1974. He uses microcomputers with graphics for teaching, for recreation, and as described in the accompanying article, for color slide making. He has written many scientific papers in his specialty, anesthesiology, and is author and/or editor of several books. He is an active member of the American Heart Association and directs the Advanced Cardiac Life-Support Instructor's Course in Syracuse NY. For the New York State Society of Anesthesiologists annual meeting in New York, he runs the panel "Research by New Investigators." He is also a member of the Icarus high-speed hydrofoil sailing project which set a B-Class, World Sailing speed record in Weymouth, England, in 1976.

"Our reputation rests on digits, decimal points, and details. We wouldn't trust them to anything less than Scotch® Brand Data Cartridges."



Bill Birkett, Vice President,
Trade Graphics, Inc.,
Livonia, Michigan

The unique design of a data cartridge provides great reliability, high storage capacity and long tape life. And where could you possibly get better data cartridges than Scotch Brand, made by 3M, the people who invented the data cartridge system itself?

3M controls every step in manufacturing. Top quality magnetic tape and precision components are part of every Scotch Data Cartridge. Over twenty-five years of service to the computer industry assure you of the utmost reliability.

Scotch Data Cartridges are available in miniature DC 100A, the standard-size DC 300A and now, an extra-length DC 300XL with 50% more storage capacity. They are compatible with most cartridge systems including Hewlett-Packard, IBM, NCR, Tektronix and TI.

To find out where you can find Scotch Data Cartridges or virtually any other data recording medium, call toll-free: 800-328-1300. (In Minnesota, call collect: 612-736-9625.) Ask for the Data Recording Products Division.

**If it's worth remembering,
it's worth Scotch
Data Recording Products.**



- transfer the contents of the display memory onto the floppy disk

The program also places the computer into a suitable mode. The scroll mode is replaced by the page mode, and the screen image is made to correspond with the appropriate memory locations.

Image Preparation

Simple word slides are best prepared in *CRT mode* (a mode which allows direct user interaction with the graphics display). The keyboard allows letters to be positioned anywhere on the screen. Colored text, borders, and backgrounds are used for effect. Considerable rearrangement and adjustment is possible using the delete and insert keys for characters and lines. When the image is complete, the disk is inserted and the AUTO key is pressed to run the storage program. The image is automatically transferred to the disk to be photographed later. Examples of text slides prepared in this way are shown in photos 1a and 1b.

More complicated slides may be produced by employing a program to prepare the display (eg: to generate a graph or a histogram). Examples of slides prepared in this way are shown in photos 2a and 2b. When such a program is being written, it is important to remember that the process of transferring the image to disk uses a BASIC program that will replace the preparation program in memory.

Color Selection

Color slides are usually most successful when the image or letters are brighter than the background. With the bright foreground image, any spreading due to light-scatter on the cathode-ray tube, the film or the projection screen tends to enlarge a line or a character instead of extinguishing it. Therefore, of the sixty-four color combinations available, only about twenty are useful for slides.

If the alignment of the red, blue, and green electron beams in the cathode-ray tube is imperfect, the focus of the screen image may suffer. This problem may be minimized by judicious choice of foreground color. In such cases, use a color scheme in which the image is formed by turning only a single beam on and off as it

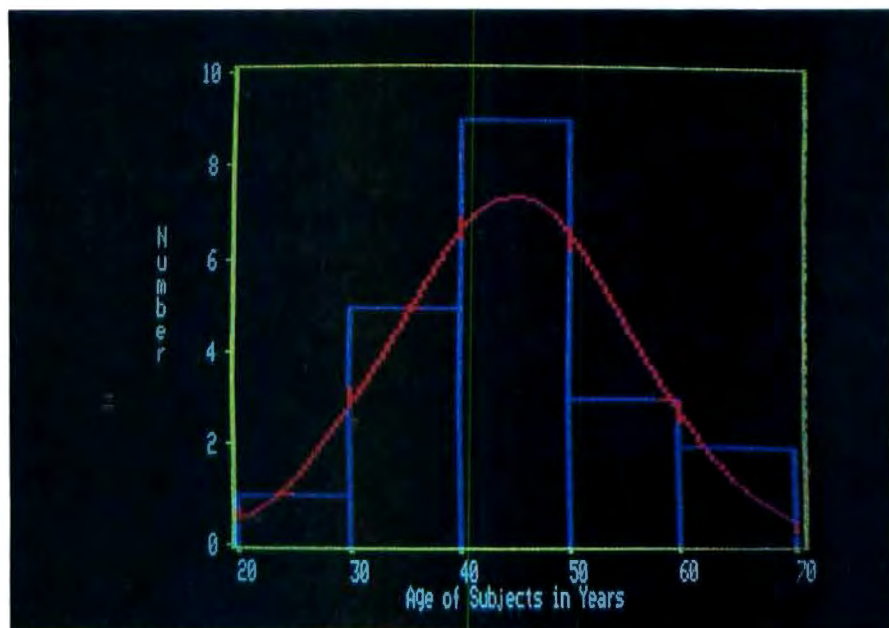

2b

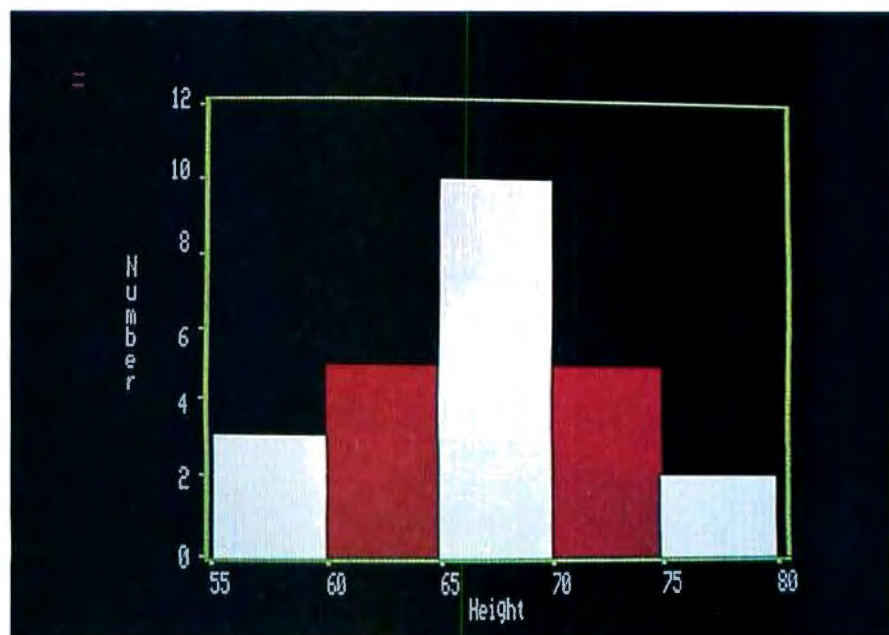

Photo 2: Two examples of computer-generated slides containing colored graphic material.

sweeps across the tube. For example, with white text on a magenta background, only the green electron beam is modulated, and a good image can be obtained even if the beam alignment is poor.

Photography

The images are recalled for photography using the same program. The program recalls the images one by one. Photographs must be made in ambient darkness to avoid unwanted reflections. Certain colors

tend to require more exposure than others (eg: red and blue on black backgrounds).

Color film does not always reproduce television images perfectly. Red, in particular, may appear somewhat brown. A Kodak CC40R filter is supposed to correct this, but the exposure time required is doubled. I have prepared slides with and without the filter. I currently use Kodak Ektachrome 64 (ER-135) with no filter. The films, filters, and exposures I used are shown in table 1.

A word of warning about returning

The Paper Tiger.™

At \$995, why settle for less.



The Paper Tiger sets a new standard for low-cost impact printers. More capability. More versatility.

- Eight software-selectable character sizes.
- 80 and 132 column formats.
- Full forms control.
- DotPlot™ graphics option.
- Connects directly to Apple II, TRS-80, and other personal computers.

Plus lots more. For a free brochure, print sample, or the name of the Paper Tiger dealer nearest you, write or call. Integral Data Systems, 14 Tech Circle, Natick, Massachusetts 01760.

Call toll-free 800-343-6412.

In Massachusetts, Alaska, and Hawaii call (617) 237-7610.

Circle 14 on Inquiry card



Integral Data Systems, Inc.

Film	Speed (ASA)	Filter	Exposure Seconds	Aperture f 3.5
Kodak Ektachrome ER 135	64	None	0.5	
Kodak Ektachrome ER 135	64	CC40R	1	
Kodak Kodachrome KM 135	25	None	1	
Kodak Kodachrome KM 135	25	CC40R	2	

Table 1: Exposures and films used to photograph displays on the Intecolor microcomputer.

films to the manufacturer for developing and mounting; if slides have a black background, an automatic film cutter may be unable to recognize the frame boundaries. Several films have been returned irreparably damaged, sometimes with half of a slide in one mount and the other half in the next mount. The use of colored back-

grounds is recommended for visual pleasure as well as preservation of your work. If you are in doubt, it is probably wise to ask for your film to be returned uncut.

Discussion

Slide preparation using a small computer and color-transparency film has a number of advantages; several colors can be used on a single slide, the photography is simplified, and the color slides are more durable. In addition, when the computer is suitably located, the drafting and checking are more convenient and may even be reduced to a single step. I now find it easy to design a slide at the keyboard. Decisions about spacing, positioning, and color can be made, revised, and implemented as the image is being prepared. This has reduced the first five steps to two, namely drafting the image and saving it on disk. The photographic process is reduced to making the exposures, developing the film, and mounting the slides — a considerable saving in steps and labor.

The quality of slides produced in this way is very pleasing. Audience members inquire how the slides are made and express appreciation of the color and the technique. Distortion is negligible, and the quality of curved and oblique graph lines is adequate for lecture slides (for the graphs the resolution is 1 in 160 on the X axis and 1 in 192 on the Y axis).

The cost of making slides is hard to evaluate. The lecturer's time and the time spent fetching, carrying, and checking are often assumed by the organization. However, even those costs that remain are significant. Between \$6 and \$10 is probably the minimum cost of laying out the simplest text and preparing a diazo slide. Slides for a one-hour lecture may cost approximately \$500.

Preparing slides on the computer simplifies the photographic process. This alone represents a saving of about \$2 per slide. The time spent designing the slide and arranging the layout can be reduced as well. However, any time spent employing the additional choices of colors and layouts may offset this potential savings to some extent. The disks used for storing the images cost \$5, or about 50 cents per slide. However, the disks are reusable and should therefore not represent an appreciable cost per presentation.

The greatest savings would be realized by those illustration departments that are frequently expected to prepare histograms, regression graphs, scatter diagrams and graphs of functions. A few appropriate programs would allow numerical data or mathematical functions to be directly converted to color images. A final advantage is that Ektachrome processing is commonly available commercially on a same-day basis. Slides can be prepared, photographed and reviewed in twenty-four hours.

The computing equipment described in this article costs about \$6000. Any illustration department handling much slide preparation, particularly that involving slides of graphs, should find it worthwhile to review the type of material they handle and its cost. The Intecolor computer has now been used to prepare hundreds of slides. A similar program will also work on the Compucolor II with only slight sacrifice in definition, resolution, and color rendition. ■

TRS-80/NORTH STAR SOFTWARE

By J. Roehrig as seen in Byte, Kilobaud and Personal Computing Magazines

1. Chess — written in Basic. Beats Microchess.
2. Scrabble — makes your computer a Scrabble opponent.
3. Baseball — based on Major League results, keeps all statistics. Players perform true to life. Seen in July 1978 Personal Computing and November 1979 Byte.
4. Bowling Secretary — keeps all necessary statistics. Seen in June 1978 Kilobaud.
5. Taxes — all new tax rates. Long form, short form, Schedules A, B, C and Income Averaging. Seen in March 1978 Personal Computing.
6. Accounting — double entry system produces Journal Entry Log, Balance Sheet and Income Statement.
7. Basketball — just like Baseball. Cover article from January 1979 Personal Computing.
8. Horse Racing — improved version of December and January 1980 Byte article. Graphics, horses run true to form, past performances maintained. Realistic win, place and show payoffs.
9. Trotters — same as above but for Trotters.
10. Handicapper — a systematic way to evaluate wagers at the Track or OTB.
11. Games — 3D TIC TAC TOE as in April 1978 Kilobaud, Boxing as in January 1978 Personal Computing and Football as in February 1978 Personal Computing.
12. Backgammon — a challenging opponent who uses the doubling cube. Very graphic.

NEW NEW NEW — TRS-80 Graphic Skill Games for 2 players or 1 against the computer: 13. Baseball 14. Boxing 15. Football 16. Golf 17. Bowling 18. Horse Racing

All programs have been improved; each has its own instruction booklet and sells for: Cassettes \$7, 6 for \$40, 12 for \$75, 18 for \$105
Diskettes \$10, 6 for \$55, 12 for \$100, 18 for \$140

SEND ORDERS TO:

JJR DATA RESEARCH
Box 74 Middle Village, NY 11379

or CALL C.O.D.'s TO: (516) 643-1931 (C.O.D.'s shipped within 48 hours)

CONCERNED ABOUT WINCHESTER BACKUP?

*Corvus has
the answer.*

Corvus—the company that brought Winchester technology to the microcomputer—is now delivering the solution to backup for less than \$1500.

It's called the Corvus MIRROR®, a backup employing low-cost removable media with a total capacity of up to 100 million bytes each. In approximately ten minutes, you can transfer an entire ten million byte disk without operator intervention.

Corvus is the company that gives you a complete systems solution to the mass storage needs of microcomputers. Our systems have fully compatible hardware and software for the Apple† (including Apple Pascal), S-100 Bus, TRS-80‡, and now the LSI-11 and ALTOS computers. We utilize proven Winchester technology with IMI-7710 drives. Up to four eight-inch disks can be used with our Z-80 based controller.

Interested in our new removable-media backup or our pace setting Winchester systems? Both are available now. Call or write for full information.

CORVUS SYSTEMS, Inc.

900 S. Winchester Boulevard
San Jose, California 95128
408/246-0461

†Apple is a registered trademark of Apple Computers, Inc.
‡TRS-80 is a registered trademark of Radio Shack, a Tandy Co.

Circle 16 on Inquiry card

One of the best values computers is now



\$1995 SPECIAL SYSTEM PRICE

Includes H8 Computer with 16K memory, four-port serial I/O and operating software, plus H17 Floppy Disk System (shown here with optional second drive) and H19 CRT Terminal — all in kit form.

Heathkit H8 Computer

- 8080A CPU has more software written for it than any other CPU
- 7 plug-in board positions for flexibility in configuring your system
- Up to 65K memory capacity
- Front panel keyboard for direct access to registers and memory

\$289 kit purchased separately. Was **\$379**. **You save \$90.**
\$349.00 assembled

Heathkit H17 Floppy Disk System

- Instant access to programs and data
- 100K bytes storage area
- 250 mS typical random access time

- Includes interface controller board
\$495.00 kit purchased separately
\$550.00 assembled

Heathkit H19 Smart Video Terminal

- Z80 microprocessor-controlled
 - 25 x 80, upper and lower case
 - Direct cursor addressing
 - 8-user-function keys
- \$675.00** kit purchased separately
\$995 assembled

5% discount on software, memory and interfacing

Special 5% discount applies to all software, memory and interface

boards when purchased with the H8 system.

Seven plug-in board positions on the H8 let you configure any combination of memory and I/O's that suits you. Heathkit memory boards come in 16K, 8K and 4K increments. Interface boards are available for parallel, serial and cassette I/O's.

Wide selection of software

No computer system is better than the software that supports it. The wide selection of H8 software includes operating systems software and MICROSOFT™ BASIC.

HUG has over 400 programs

An extensive library of programs is available to owners of Heathkit Com-

in high-performance \$90 better.



puters through the Heath User's Group (HUG). The experience of this computerite group can help you get the most from your computer.

Plus Heathkit service

You get the most thorough documentation ever written when you buy your Heathkit Computer. So it's easy to get your system assembled and operating quickly.

And you get one of the most reliable service organizations after you buy. More than 55 service locations throughout the U.S., plus a factory service phone give you fast access to experts when you need them.

It's all at your Heathkit Electronic Center

Computers, peripherals, software and accessories — in kit or assembled form — you'll find them all at your Heathkit Electronic Center. You'll even find educational support like

the special self-instruction programs that teach you BASIC and Assembly language programming.

Check the white pages in the city nearest you for the location of your Heathkit Electronic Center*:

Alexandria, VA
Anaheim, CA
Atlanta, GA
Baltimore, MD
Boston, MA
Buffalo, NY
Chicago, IL
Cincinnati, OH
Cleveland, OH
Columbus, OH
Dallas, TX
Denver, CO
Detroit, MI
El Cerrito, CA
Fair Lawn, NJ
Frazier, PA
Hartford, CT
Houston, TX
Indianapolis, IN
Jericho, NY
Kansas City, KS
Los Angeles, CA
Louisville, KY
Miami, FL
Milwaukee, WI
Minneapolis, MN

New Orleans, LA
Norfolk, VA
Ocean, NJ
Oklahoma City, OK
Omaha, NE
Philadelphia, PA
Phoenix, AZ
Pittsburgh, PA
Pomona, CA
Providence, RI
Redwood, CA
Rochester, NY
Rockville, MD
Sacramento, CA
Salt Lake City, UT
San Antonio, TX
San Diego, CA
San Jose, CA
Seattle, WA
St. Louis, MO
St. Paul, MN
Tampa, FL
Toledo, OH
White Plains, NY
Woodland Hills, CA

FREE CATALOG

Write for a **FREE** Heathkit Catalog containing the complete line of Heathkit Computers, plus nearly 400 other electronic kits for your home, work or pleasure.

Heath Company, Dept. 334-614
Benton Harbor, Mich. 49022



Heathkit

*Units of Veritechnology Electronics Corporation. Prices stated here are mail order and may be slightly higher at retail locations. CP-179 Prices subject to change without notice.

Circle 17 on inquiry card.

Computerize a Home

Steve Ciarcia
POB 582
Glastonbury CT 06033

I anxiously glanced around the Circuit Cellar. Devoid of the usual sounds of the stereo or television, the equipment fans imparted a distinctly uneasy sensation of mechanical presence.

The room was totally dark except for a few pilot lights and a video display. There were no games, no fast-moving program listings; only a single line was written on the screen. In the dim luminescence I could barely distinguish the furniture from the bookcases. A little experience navigating in the dark would have been useful, but I opted for modern technology and reassuringly patted the flashlight in my pocket.

I pushed the button on my digital watch and noted the time. As it neared the prearranged hour, I turned instinctively to the terminal. Soon I'd know which of us was in control!

Almost immediately the display changed and printed out "AUTOMATIC CONTROL INITIATED." Simultaneously I could hear a high-pitched noise. It sounded almost like an insect chirp. There are no crickets down here; it must be a subharmonic. So far so good, but did it work?

"Steve, did you just blow a fuse?" My wife stood in the doorway and called down the stairs. It didn't bother *her* that there weren't any lights on. After all, if you blow a fuse, shouldn't the lights be off?

"The kitchen light went off and the

bedroom light came on. Wait! The bedroom light just went off and the kitchen light came back on. Now they're both off."

I grinned in a way that only a Cheshire cat could appreciate. "Sorry, Joyce, just experimenting on the latest article." Chuckling softly, I continued. "I hope you don't mind, but the computer seems to have taken over."

"Can it make beds?" she replied.

I should have known that she wouldn't be taken in that easily. "OK, I'll tell the computer to keep its sphere of influence to the cellar. I'll let you know what the password is later."

As if by magic, the Circuit Cellar lights were activated. The test was successful.

Security Versus Control

Even though it may seem true at times, our house has not been taken over by a computer. I was simply testing the latest addition to my home control system.

In previous issues of BYTE, I presented a series of articles on the construction of a home security system. (See "Build a Computer Controlled Security System for your Home": Part 1, January 1979 BYTE, page 56; Part 2, February 1979 BYTE, page 162; Part 3, March 1979 BYTE, page 150.) This was not a theoretical dissertation. It was, in fact, an over-

view of the system installed in my house. The original concept was configured around a single-board 8085 system and designed primarily as an alarm controller. Even though it works, it has definite limitations.

Eventually I became dissatisfied with just having a super burglar alarm. It seemed a shame to dedicate all that hardware and expense to a function with such a limited capacity. The obvious step was to expand the concept to be a "home control" system where security is but one of many possible applications. To do this requires more memory; the single board has been replaced by a 26 K byte Z80-based computer with a video display. Operating in either high-level or assembly language, it is as adept at keeping the checking account straight as it is at scanning input ports searching for an intruder. Add to it the ability to activate and communicate with my large disk-based development system, and it is indeed a powerful tool.

The major difference between the two system concepts is the output control structure. As an alarm, the computer is strictly configured to scan and analyze a multitude of event inputs, such as door switches and motion sensors. Its decision process is immediate, but its output control is relatively limited. These generally consist of several lights, a siren, and an automatic phone dialer. Even in

Get Word Power!

with 
WpDaisy™
WORD PROCESSOR

**The best is now
even better...**

**New Features
New Commands
New Capabilities
New Manual**

Features Editor:

- Interactive editing with Dynamic Screen Imaging
- Direct insert with word wrap
- Extensive disk handling: DIR, ERASE, disk change, etc.
- Insert/Delete/Move
- Step by Character, Word, Line, Paragraph, Page, Screen
- 26 Temporary buffers
- Find/Replace with conditional test

Formatter:

- Fully integrated with Editor
- On-screen Preview
- Extended Page, Margin and Indent control
- Hyphenation
- Super- and Sub-scripting
- Operator prompts and input
- Center, underline, bold face, red print
- Type face control, height, pitch,
- Header/footer lines
- Page number control

**LIMITED
TIME OFFER!**
FREE MAIL MERGE™
form letter mailing
list package



★ ★ **COMING SOON** ★ ★

I/OS™ — new update from TSA/OS
I/Pascal™ — full Compiler/Linker system
I/SAL™ — new Structured Z80/8080
Assembler/Linker/Debugger system
...and more

Software for I/OS — TSA/OS — CDOS — SDOS —
other 8080/Z80 OS*M operating systems

Circle 18 on inquiry card.

Contact your dealer or...

InfoSoft
SYSTEMS INCORPORATED
25 SYLVAN ROAD SOUTH
WESTPORT - CONN 06880
(203) 226-8937

BYTE January 1980 29

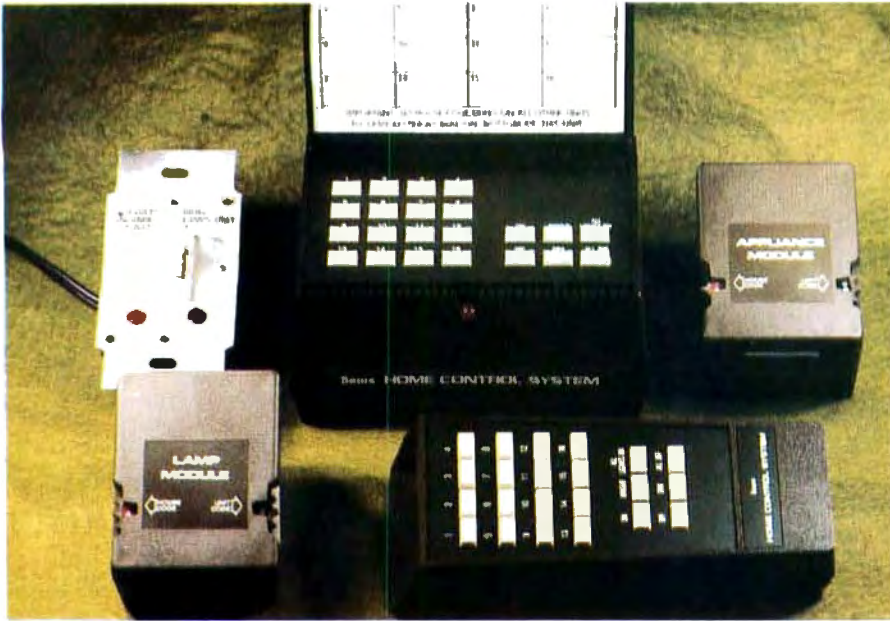

Photo 1: BSR X-10 system as marketed by Sears and called the Sears Home Control System.

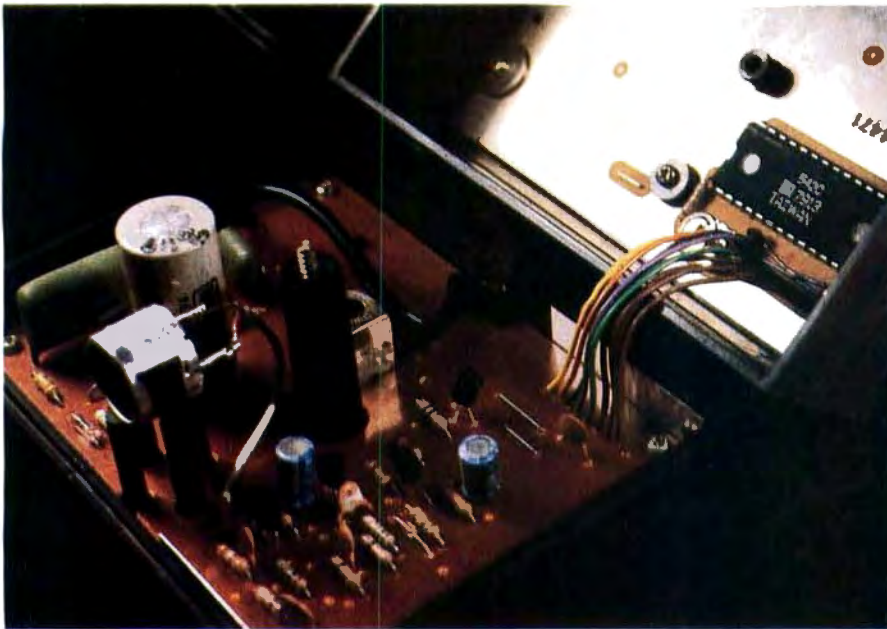

Photo 2: The internal electronics of the command-control console.

the sophisticated system I presented, these hardwired outputs were kept to a minimum to reduce costs.

Generalized home control extends computer control capability far beyond the few outputs of the original system. It is conceivable that all of the lights and AC outlets in the house could be affected. A few lights outside are barely enough. Lighting in the bedrooms, kitchen, and garage should be included, with the stereo and television thrown in for good

measure. If you live in a cold climate and use an automobile engine-block heater, why not turn it on automatically before you get up in the morning? Tired of searching around in the dark for the light switch? Let the door sensor from the alarm system trigger the lights as you walk into a room. How about some soft music ten minutes after you enter? The list is endless.

This expansion seems to be a contradiction considering my previous

concern over wiring costs. To accomplish this feat, either every AC outlet must be directly wired to the computer through relays as in the original system or the control capability must be added remotely to each light and appliance.

AC Remote Control

This latter suggestion is not as farfetched as it might seem. There have been many technological advances in the past year. One of the more significant achievements comes from BSR (USA) Ltd—specifically in the area of AC remote control. The BSR X-10 control system is shown in photo 1. Clockwise from the center, the five components are: command console, appliance module, cordless controller, lamp module, and wall-switch module. With these units, low-cost AC control is a reality.

The BSR X-10, also marketed by Sears as the Sears Home Control System, operates through carrier current transmission from the command console to the receivers. When a button is pushed on the command console to activate a remote receiver, a coded signal is sent through the house wiring. Each receiver monitors these transmissions and responds only when its particular code is sent.

Figure 1a is a block diagram of the \$39 command module and photo 2 shows its internal electronics. The heart of this, as well as the other system components, consists of custom large-scale integration (LSI) chips manufactured for BSR by General Instrument Corp. In normal operation the twenty-two-button keypad is continuously scanned. When a key is pressed, this designated function and a house code (previously set by a thumbwheel switch on the bottom of the command console) are combined into a single message. The digital message is directed to the transmitter section, where it modulates a 120 kHz carrier. The control signal appears on an oscilloscope as a series of pulse bursts. This is shown in photo 3.

There is a second method where the command console designates a control function and transmits a message. Each control console contains an ultrasonic receiver. In the picture this is the metallic cylindrical component with the two protruding pins and shielded cable soldered on them. The BSR X-10 system facilitates

MORE COLOR. MORE SOUND. MORE GRAPHICS CAPABILITIES.



ATARI 400



ATARI 800

Compare the built-in features of leading microcomputers with the Atari personal computers. And go ahead, compare apples and oranges. Their most expensive against our least expensive: the ATARI® 400™.

Start with graphics capabilities. The ATARI 400 offers 128 color variations. 16 colors in 8 luminance levels. Plus 29 keystroke graphics symbols and 8 graphics modes. All controlled from a full 57 key ASCII keyboard. With upper and lower case. And the system is FCC approved with a built-in RF modulator. That's just for openers.

Now, compare sound capabilities. Four separate sound channels and a

built-in speaker. With the optional audio/digital recorder, you can add Atari's unique Talk & Teach™ Educational System cassettes.

Here's the clincher: Solid state (ROM) software. For home management, business and entertainment. Or just plug in an Atari 10K BASIC or Assembler language cartridge and the full power of the computer is in your hands.

Memory? 8K expandable to 16K. And that's just for the ATARI 400 at a suggested retail of only \$549.99.

The ATARI® 800™ gives you all that and much more.

User-installable memory to 48K. A full-stroke keyboard.

With a high-speed serial I/O port that allows you to add a whole family of smart peripherals. Including up to four individually accessible disk drives. And a high speed dot-matrix impact printer. And, the Atari Program Recorder is included with the 800 system. Suggested retail price for the ATARI 800 (including recorder) is \$999.99.

Make your own comparison wherever personal computers are sold.

Or, send for a free chart that compares the built-in features of the ATARI 400 and 800 to other leading personal computers.



PERSONAL COMPUTER SYSTEMS

1265 Borregas Ave. Dept. C, Sunnyvale, California 94086. Call toll-free 800-538-8547 (in Calif. 800-672-1404) for the name of your nearest Atari retailer.

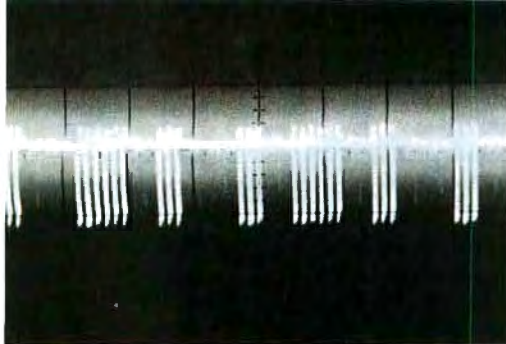

Photo 3: Oscilloscope picture of command-control console transmission on the AC line. (Photo courtesy of Mark Scheffler.)



Photo 4: Handheld cordless controller showing top and internal circuitry.

remote channel and function selection through a handheld ultrasonic transmitter. This unit is shown in photo 4 and diagrammed in figure 1c.

When a key is pressed, it is encoded and transmitted as a series of 40 kHz tone bursts. The command console, receiving this information through its ultrasonic receiver section, takes this data as if a button had been pushed on the command console. It then adds the house code and simultaneously transmits the command message over the house wiring.

The receiver part of the system is also quite sophisticated, considering that each receiver costs less than \$15. These receivers, shown in photos 5 and 6, can be placed virtually anywhere. An overhead light can be accommodated by replacing the standard on/off wall switch with a wall-switch module. An appliance such as a dehumidifier is controlled through an appliance module.

All receivers are basically the same. A block diagram of an appliance module is shown in figure 1b. The receiver section monitors the AC line waiting for a coded message corresponding to its unique house (A thru P) and unit device (1 of 16) code.

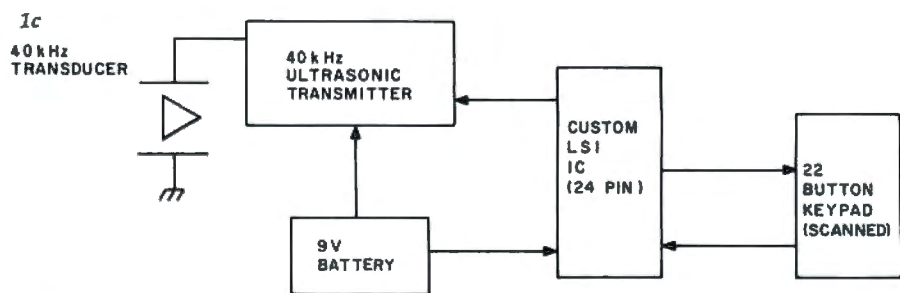
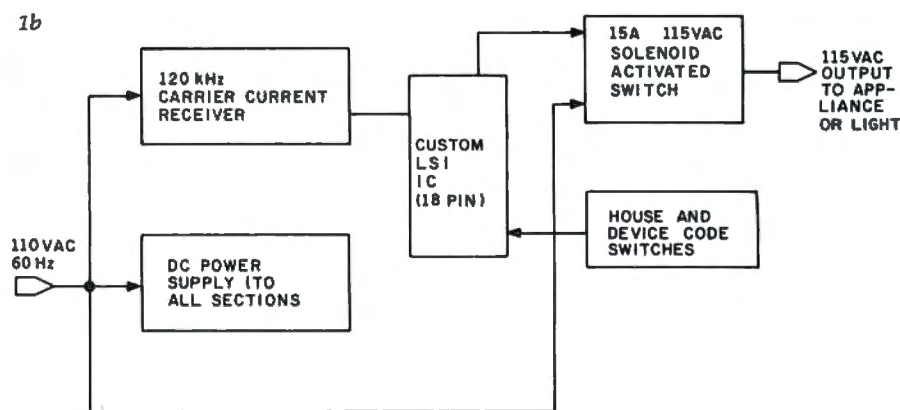
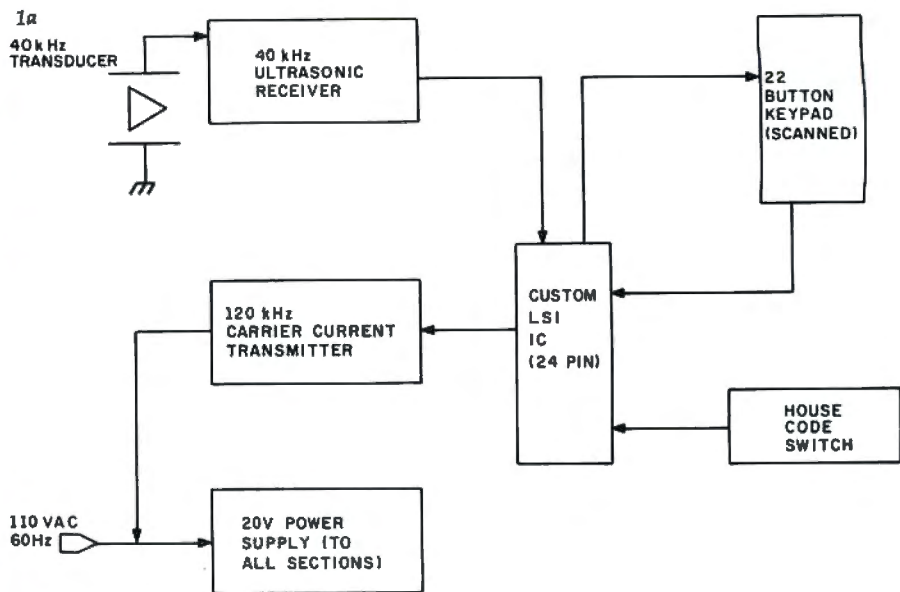

Figure 1: Block diagrams of the integral parts of the BSR X-10. The block diagram for the control console is given in figure 1a, the appliance module in figure 1b, and the remote control transmitter in figure 1c.

To turn on channel 10, simply press "10" and then the "ON" button sequentially. When the appliance module activates, it sounds like a relay engaging. In actuality, BSR uses an inexpensive solenoid to operate a 15 A push-button Microswitch.

The lamp and wall-switch modules use a triac instead of this pseudo-relay. Unlike the appliance module,

which only operates as an on/off switch, these units have the additional ability to automatically brighten or dim when the corresponding function buttons are pressed on the command console. Finally, all receivers can be locally activated without the command console. To turn on a light or motor, simply flip the power switch from on to off and

“onComputing™ really makes personal computers easy to understand.”



Written in non-technical language, onComputing™ contains articles on the capabilities of microcomputers, getting started, latest reviews of personal computers, where to purchase and how to use your computer.

An anyone can learn the fundamentals of using a computer. **onComputing** readers receive practical advice and helpful hints on how to get the most out of a personal computer, explanations of computer terminology, and, periodically, an updated list of active computer clubs.

Benefit from the experience of other computer enthusiasts. Articles in **onComputing** are written by well known authors as well as competent amateurs. They share their ideas on how to use the computer as a tool for business, education, home entertainment, laboratory work and other applications.

Computer experts edit **onComputing** for the new user, not the computer professional. The editors combine their esoteric knowledge of computer science and equipment to produce concise, non-technical material which can be readily understood by anyone interested in using a computer—for fun or profit.

onComputing, Inc.
70 Main St., Peterborough, NH 03458

Start your subscription today.

EVERY THREE MONTHS **onComputing** will bring the latest developments in the field of personal computing: use, applications, books, selection—all in an easy-to-read style.

onComputing Subscription Dept. P.O. Box 307, Martinsville, NJ 08836

REGULAR subscription rate:

- U.S. 1 yr. (4 issues) @ \$8.50 Canada & Mexico, 1 yr. (4 issues) @ \$10.00
- FOREIGN (to expedite service, please remit in U.S. funds drawn on a U.S. bank.)
- Europe (and all other countries, except above), 1 yr. @ \$12.00—surface delivery.
- Start my subscription with current issue. Start with Vol. 1 No. 1
- Bill Visa Bill Master Charge Bill me (North America only)

Card Number

Expiration

Signature

Name (please print)

Street/Apartment Number

City

State/Province/Country Code

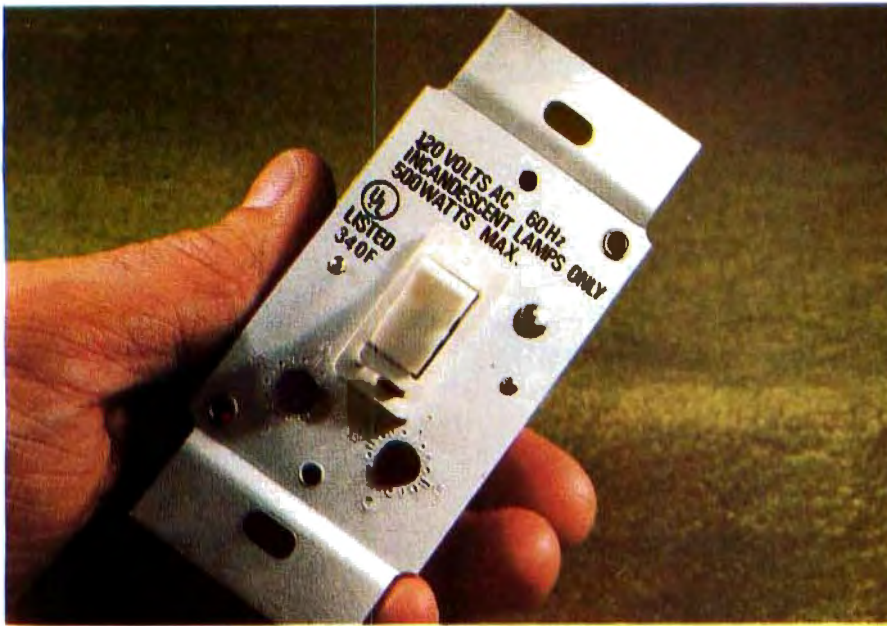

Photo 5: The wall switch module replaces standard wall switch and allows remote control. Two slotted-top rotary switches under the switch lever are for setting house and device codes.



Photo 6: The appliance module.

back to on again. This automatically triggers the receiver module into an on condition.

Controlling the BSR X-10

When I first started using the BSR X-10, I could hardly believe its versatility and low cost. The only problem is that operation of the BSR X-10 is completely manual. The only way to use the control receivers is through the command console or

ultrasonic transmitter and by physically pressing the buttons.

I would not say that I have a never-say-die attitude, but considering my original security system, with an average cost of \$250 per AC output channel, my future computer-controlled house depended heavily on less expensive input/output (I/O). It was absolutely necessary to find some method of utilizing the control receivers.

Three possible solutions came to mind:

- Directly synthesize the command-console waveform and transmit it directly onto the AC line.
- Brute force contact closure—attach either relays or complementary-metal-oxide semiconductor (CMOS) switches in parallel with the push buttons and activate the relays from the computer.
- Synthesize the waveform from the ultrasonic controller and let the computer “talk” to the command console.

Simulating the command-console output sounds simple in theory. (This is somewhat like estimating software costs.) Simulating the device-control code and using it to modulate a 120 kHz carrier frequency leads to contact with a hostile environment. The output from the computer must be attached to the AC line. This requires isolation through either transformers or optoisolators, plus many discrete components to properly match impedances. It is a shame to reinvent the wheel when BSR has already designed such an effective transmission system. Although possible in theory, this approach is too messy to warrant further consideration.

The second alternative is brute force. This can usually work, but you must be careful. In essence this method entails wiring relays or CMOS switches across the push buttons and remotely, but still mechanically or electronically, closing the contacts corresponding to a particular button. Figure 2a illustrates the keypad connections for both the command console and cordless controller. The configuration is a 3 by 8 scanning matrix. To turn on channel 6, simply short pins 28 and 18 together. Likewise, “dim” would be pins 25 and 23. While twenty-two separate single-pole, single-throw switches could be used, figure 2b demonstrates an easier alternative.

Two CMOS switches can be used in combination with the ultrasonic controller to provide this capability. Connected to 5 bits of a latched parallel output port, the two integrated circuits channel the appropriate lines together. To turn on channel 12, a row-select code of binary 001 would be set on B2, B1,

THE MOST POWERFUL MICROCOMPUTER SOFTWARE EVER DEVELOPED IS ALSO THE EASIEST TO USE

MIMP MICROSYSTEMS INFORMATION MANAGEMENT PACKAGE

AND **BUS-II**

GENERAL ACCOUNTING PROGRAM

FOR USE ON
OHIO SCIENTIFIC
MICROCOMPUTERS

MICROSYSTEMS INFORMATION MANAGEMENT PACKAGE

PUTS ANY OR ALL YOUR BUSINESS FILES INTO A POWERFUL DATABASE.

CREATE VIRTUALLY ANY RELATIONSHIP YOU CAN THINK OF. ENGLISH-SPEAKING REPORT GENERATOR.

POWERFUL USER COMMANDS NORMALLY FOUND ONLY IN LARGE COMPUTERS. SELF-EXPLANATORY, EASY TO USE, SUCH AS "INPUT," "OUTPUT," "LIST," "PRINT," "CHANGE," "DELETE," "EXCLUDE," "INCLUDE," AND, PERHAPS MOST IMPORTANT OF ALL, "HELP!"

STRAIGHTFORWARD INPUT AND EDITING ROUTINES— "IDIOT-PROOF."

OPERATOR'S MANUAL WITH FULL USER INSTRUCTIONS IS ON-LINE WITH HELP COMMANDS. PROBLEMS? JUST TYPE "HELP!"

COMMANDS CAN BE USED CONDITIONALLY ON ANY RECORD OR ON ANY FIELD WITHIN A RECORD.

IN-MEMORY SORT, OR, (FOR BIG FILES) DISK SORT.

ALL DATABASE FUNCTIONS ARE SUBROUTINES— CUSTOM PROGRAMMING SIMPLIFIED.

OPTIONAL CASH REGISTER POLLING AND CONTROL PACKAGE AVAILABLE TO QUALIFIED BUYERS (REQUIRES INSTALLATION CONSULTATION).

OVER TWO YEARS' IN-FIELD TESTING. MIMP WORKS— FLAWLESSLY.

ONE YEAR SUBSCRIPTION TO APPLICATIONS NEWSLETTER FREE WITH PURCHASE.

TYPICAL APPLICATIONS: INVENTORY, CUSTOMER FILES, CASH REGISTER CONTROL (OPTIONAL EXTRA), DOCTOR/DENTIST/LAWYER APPOINTMENTS OR CLIENT/PATIENT FILES, SALES RECORDS, MAILING LISTS.

INTRODUCTORY OFFER

\$295

THE KEY TO THIS SOFTWARE IS ITS SIMPLICITY OF OPERATION.

BUS-II

CPA-APPROVED COMPLETE ACCOUNTING SYSTEM: GENERAL LEDGER, ACCOUNTS PAYABLE, ACCOUNTS RECEIVABLE.

BRANCH ACCOUNTING HANDLES UP TO FIVE DIVISIONS.

COMPLETELY INTERACTIVE. SELF-UPDATING.

BATCH ACCOUNTING INSISTS ON BEING "IN BALANCE."

USER MENU. OPERATOR PROMPTING FOR CORRECT ENTRIES.

HIGHLY FLEXIBLE FORMATTING OF FINANCIAL REPORTS.

NO KNOWLEDGE OF DEBITS AND CREDITS REQUIRED (EXCEPT RECURRING JOURNAL ENTRIES— ASK YOUR ACCOUNTANT).

EXAMPLES OF REPORTS (FROM GENERAL LEDGER MODULE)

CHART OF ACCOUNTS

DETAILED GENERAL LEDGER

CASH RECEIPTS JOURNAL

CASH DISBURSEMENTS JOURNAL

JOURNAL ENTRIES JOURNAL

PROFIT-AND-LOSS JOURNAL

BALANCE SHEET

IDEAL FOR ACCOUNTING FIRMS AS WELL AS SMALL BUSINESSES.

PROVEN THROUGH YEARS OF USE.

THIS ACCOUNTING PACKAGE REQUIRES ONLY A HIGH SCHOOL-LEVEL UNDERSTANDING OF BOOKKEEPING.

ONLY

\$295

DUAL EIGHT-INCH FLOPPY DISK DRIVES REQUIRED.

MIMP & BUS-II OPERATE ON ALL OHIO SCIENTIFIC 8-INCH OR WINCHESTER DISK MICROCOMPUTERS W/48 K RAM.

USER-ORIENTED SYSTEMS

— NO PROGRAMMING REQUIRED

CREDIT CARD ORDERS

CALL

(304) 291-5400



ALL ORDERS SHIPPED PREPAID WITHIN CONTINENTAL U.S. PLEASE DO NOT SEND CASH. OVERSEAS ORDERS PLEASE INCLUDE POSTAGE— 5 LBS. SORRY, NO C.O.D.

digital technology
inc.

ROCKLEY ROAD

MORGANTOWN, WV 26505

Circle 20 on inquiry card

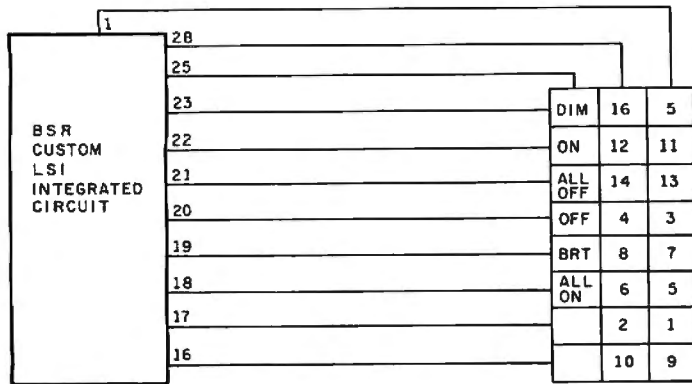

intact. The BSR X-10 is Underwriters' Laboratories listed. Attachments between the computer and the command module must be done carefully and only by experienced people. By maintaining the structural integrity of the components, you are not limited to use with the computer. The command console can be moved around the house, and it is placed within range of the computer only when automatic control is desired.

Practical accomplishment of this goal is achieved using the ultrasonic receiver found within the command module. An interface is constructed that formats function codes into message strings; these strings are transmitted to the command console as 40 kHz pulses. In essence, the interface simulates the activity of a cordless-controller unit.

Figure 3 describes in detail the communication between the two subsystem components. Each of the twenty-two buttons has a unique 5-bit code (listed in table 1). For example, channel 5 has a code of 00010 with respect to bit positions D8, D4, D2, D1, and F. The ALL LIGHTS ON key generates the code 00011.

The actual message that communicates this selection is approximately 100 ms long and is composed of thirteen 8 ms segments. Each segment consists of a burst of 40 kHz directed to an ultrasonic transducer. Data is pulse-width modulated. A logic 1 is a 4 ms burst and a logic 0 is a 1.2 ms burst.

To signify channel 5, the interface first sends a start bit to alert the receiver of the pending message transmission. This is a 40 kHz tone for 4 ms. Next, the 5-bit selection code is sequentially transmitted as a series of 1.2 and 4 ms bursts of 40 kHz. This is followed by transmission of the logical inversion of the 5-bit selection code and a 16 ms end-of-message tone. All messages use the same format; only the 5-bit selection code varies.

Figure 4 is an interface specifically designed to send this message and facilitate wireless remote control. Incorporating complete circuitry for address decoding and data storage, it appears to the computer as a single output port. Turning on the table lamp is as simple as sending a 1-byte output to the interface port. As with

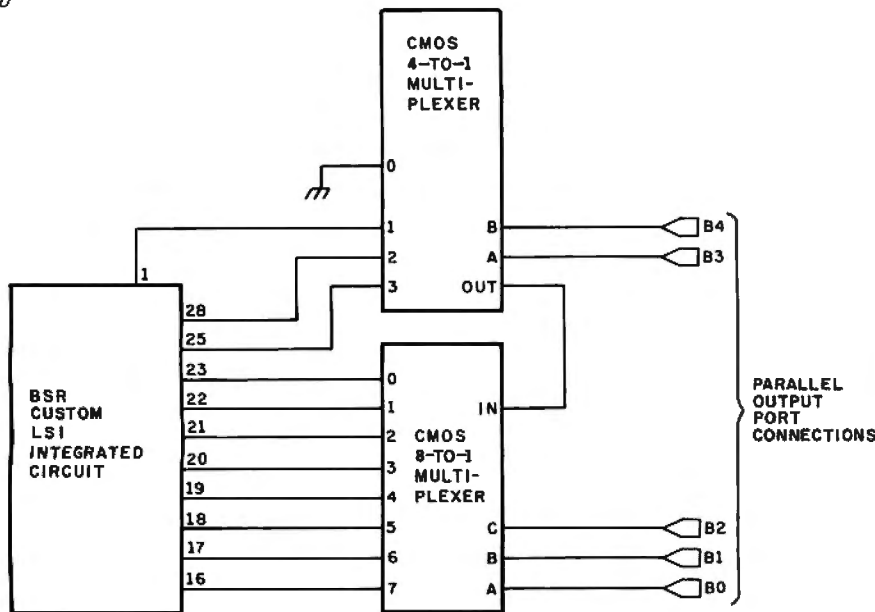

Figure 2: The keyboard in the BSR X-10 command console and remote control unit is connected to a custom LSI integrated circuit. Figure 2a shows the keyboard in relation to lines coming from the BSR custom integrated circuit. The functional schematic in figure 2b could be used to replace the keyboard with an I/O port.

and B0, respectively, and a column-select code of binary 10 would be set on B4 and B3. The ON key would be a code of 11100 for bits B4 thru B0, for example.

The circuit of figure 2b will work only with the handheld battery-controlled unit. The command-console electronics, which run on -20 V, can use the same logical concept, but relays must be substituted for the CMOS switches. The command console is not isolated and its electronics are floating at 120 VAC. To be totally safe, it is best not to bother with it.

Hardwiring to the handheld unit keyboard will work, but it also has some detrimental features. In operation, the ultrasonic unit consumes an

average of 30 mA, while peak currents are about 100 mA. Alkaline batteries are a must. Short of direct connection to the computer's power supply through a 9 V regulator, there is always the hazard of battery brown-out. If I were depending upon this system, I would not have a critical component powered by battery.

Talking to the BSR X-10

The sensible alternative is to construct an interface that facilitates cordless communication between the computer and the BSR X-10 command controller. Safety is the primary consideration. There is no hazard in using the controller or receivers as long as their cases are

8/16 RAM

Good
through
the
'80s

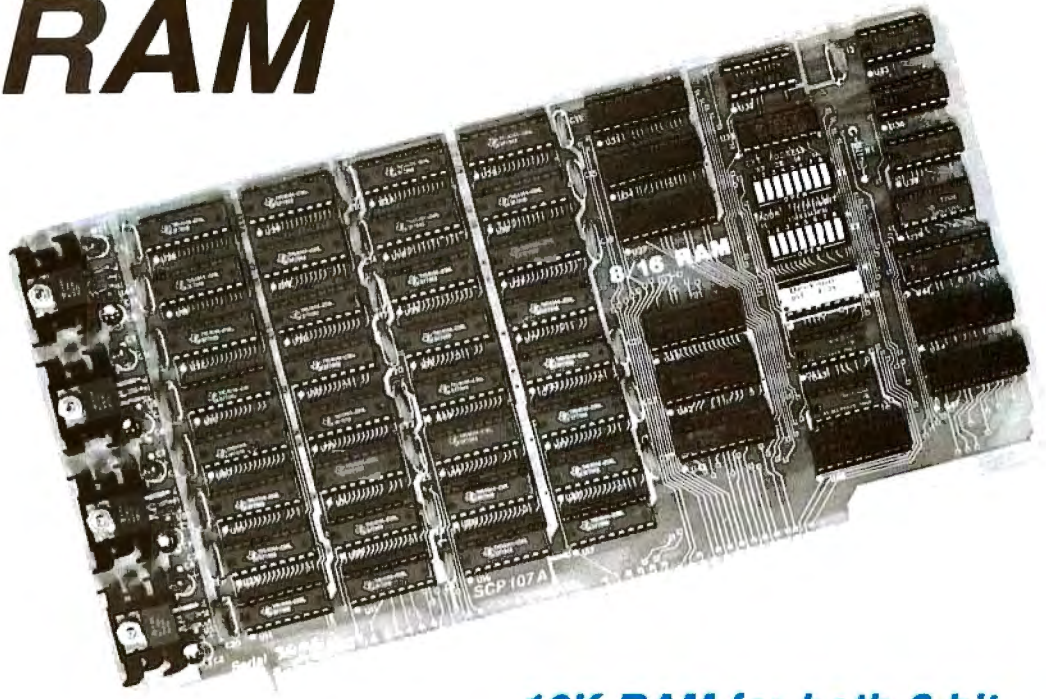

**16K RAM for both 8-bit
and 16-bit S-100 systems**

The 16-bit micros are coming — fast!

1980 will be the year of the 16-bit microprocessor. With their increased speed, with their expanded instruction sets which dramatically simplify programming, and with the sophisticated languages and operating systems their architectures support, the 16-bit micros promise a many-fold increase in computing power. Here at Seattle Computer, we have been shipping our 8086 CPU card since early November, but this is just the beginning for us. We plan to augment the capabilities of our 8086 with sophisticated new hardware for the disk and for serial communications, and with our new interrupt-driven, multi-user disk operating system. All will be introduced by mid-year. Not that we are alone in the 16-bit world — Microsoft BASIC is available now for the 8086, with other languages in the works. Several other firms have announced or are developing 8086 CPU cards, and no doubt systems using the Z8000 or 68000 will appear by the end of the year.

8/16 Fully Meets IEEE Standard

The 8/16 was designed to be in full compliance with the proposed IEEE Standard for the S-100 Bus. This Standard defines extensions which allow 16 data bits and 24 address bits while maintaining compatibility with the original bus. The 8/16 fully implements these extensions, and thus can be expected to interface smoothly with these new 16-bit machines.

How it works. . .

The 8/16 chooses a data path width of 8 or 16 bits by sampling the newly-defined bus line over which the "Sixteen Request" signal is sent. All 16-bit processors will use this signal. If it is present, the 8/16 organizes itself as 8K by 16 bits. If it is absent, the 8/16 is 16K by 8 bits wide, just like any other 8-bit memory. Thus data path width selection is automatic.

**Write or check reader service
card for information about our
other 8086 products**

For your 8-bit machine. . .

To use the 8/16 in your 8-bit machine, all you need to do is set the address of the board on its DIP switches and plug it into your computer. The 8/16 offers "extended addressing" as proposed by the IEEE, which is an alternative to "bank select" in opening address space beyond 64K. With extended addressing, memory can appear as a smooth, continuous block of up to 16 megabytes, any of which can be accessed at any time. This contrasts with bank select in which blocks of up to 64K are switched on and off by special software. If your system does not provide the 8 extra address lines required for extended addressing, this feature may be disabled and the extra lines ignored at the flip of a switch. The 8/16 is fully static so there is no need for concern over clocks or in applications using DMA. Our current one-year reliability on similar boards is 98% so you can expect years of trouble-free service from your 8/16.

. . .and then 16-bits

This is what the board was designed for. It is guaranteed to run with our 8086 CPU set when the clock is at 8 Mhz. As it was designed to the IEEE Standard, there should be no trouble interfacing to any manufacturer's CPU.

To order. . .

There are two ways to go. Check with your local dealer. If he does not have the 8/16 in stock, he can order it and have it for you in a few days. Or, you can order direct from the factory for \$525. Bank cards, CODs okay. There is a 10-day return privilege on factory orders. All boards are guaranteed for one year — both parts and labor. Available from stock.

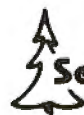

Seattle Computer Products, Inc.

1114 Industry Drive, Seattle, WA. 98188
(206) 575-1830

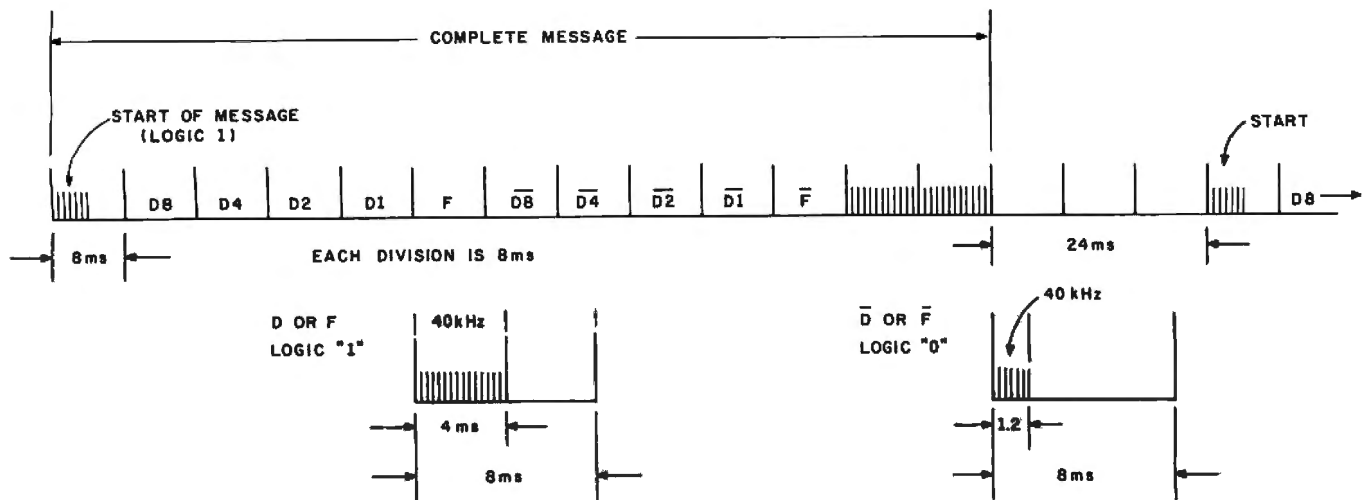

OUTPUT PORT BITS	INTERFACE FUNCTIONS
B0	F
B1	D1
B2	D2
B3	D4
B4	D8
B5	N/C
B6	N/C
B7	TRANSDUCER OUTPUT ENABLE

Figure 3: Description of coded message sent from the cordless controller to the command console via ultrasonic communication. The necessary codes are shown in table 1.

the majority of my designs, it is both processor and speed independent. It works equally well in BASIC or assembly language programs. Connected to port 9 (as in my example software), turning on a table lamp or the hall lights in BASIC is a one-line command, OUT 9,5 (from the code list of table 1). Turning it off is simply OUT 9,7.

The circuit will work on virtually any computer, although the pin designations in figure 4 refer specifically to the Radio Shack TRS-80 Model I. All connections are made directly to the computer address and data buses. In the TRS-80 this is done through the expansion connector. In a computer such as an Apple II, the circuit could be built to plug directly into the back-plane connector or to be connected by a ribbon cable.

The electronics can be divided into three subsystems: port latch and address decoding, pseudo pulse-width modulator, and message serializer. Photo 7 illustrates the prototype of figure 4.

ICs 9 thru 13 make up the address decoding and data latch. For a TRS-80, I have arbitrarily chosen an address of 127 decimal (in my software examples, I use port 9). When

the address bus and OUT line (corresponding to $\overline{I/O\ WRITE}$ on some systems) indicate execution of an output command, the contents of the data bus are stored in ICs 11 and 12.

CHANNEL NUMBER OR FUNCTION	BINARY CODE D8 D4 D2 D1 F	DECIMAL OUTPUT TO INTERFACE CIRCUIT
1	0 1 1 0 0	12
2	1 1 1 0 0	28
3	0 0 1 0 0	4
4	1 0 1 0 0	20
5	0 0 0 1 0	2
6	1 0 0 1 0	18
7	0 1 0 1 0	10
8	1 1 0 1 0	26
9	0 1 1 1 0	14
10	1 1 1 1 0	30
11	0 0 1 1 0	6
12	1 0 1 1 0	22
13	0 0 0 0 0	0
14	1 0 0 0 0	16
15	0 1 0 0 0	8
16	1 1 0 0 0	24
ALL OFF	0 0 0 0 1	1
ALL LIGHTS ON	0 0 0 1 1	3
ON	0 0 1 0 1	5
OFF	0 0 1 1 1	7
DIM	0 1 0 0 1	9
BRIGHT	0 1 0 1 1	11

Table 1: Cordless controller push-button codes and decimal equivalents.

Chief Relief

For years many small business system buyers thought that in order to get "real" performance and enough storage to be a "real" business system they would have to sacrifice the family jewels.

But with the introduction of the Smoke Signal Chieftain series office computers a lot of people's minds have been changed.

Because we designed the highly reliable Chieftain small business system with the most innovative combination of performance and efficiency around.

At your fingertips there are 64,000 characters of random access memory and you can address anywhere from 740,000 characters to 2 million characters with Smoke Signal's new double density controller. For larger concerns, there's a 20M byte hard disk available.

At a time when other small computer manufacturers tell you "you're on your own", Smoke Signal offers an abundance of easy-to-use software programs such as order entry, inventory control,

accounts receivable, invoice entry, payroll, word processing and much, much more. There's BASIC, COBOL and FORTRAN — even a multi-user BOS (Business Operating System) that allows for numerous users simultaneously.

Chieftain systems starting at under \$200.00 per month display performance on par with systems costing twice to three times as much.

So call (213) 889-9340 for your nearest authorized Smoke Signal dealer — he'll be glad to demonstrate the Chieftain's high reliability and ease of operation.



For dealers only, circle 22.
All other inquiries, circle 63.

SMOKE SIGNAL



BROADCASTING

31336 Via Colinas, Westlake Village, California 91361. (213) 889-9340



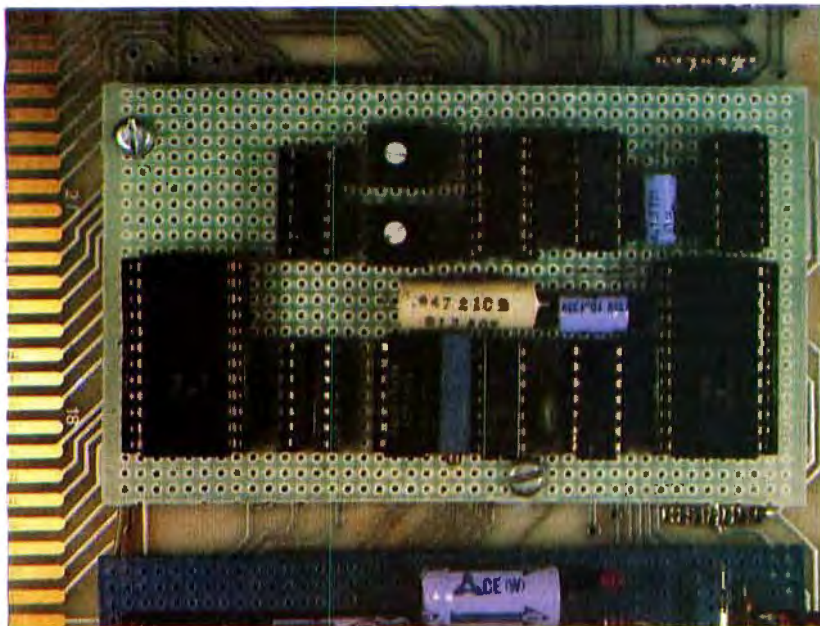

Photo 7: Prototype of the circuit shown in figure 4. The ultrasonic transducer is remotely located, and ICs 9, 10, 11, 12, and 13 are contained on another board.

Bits 0 thru 4 will contain the function code (from table 1) and bit 7 is used to turn the transmitter output on and off. For further information on ad-

dress decoding and output ports, I refer you to *Ciarcia's Circuit Cellar* from BYTE Books and the article entitled "Memory Mapped I/O," which

first appeared in the November 1977 BYTE, page 10.

In figure 4, the 5-bit function code, as well as its logical inversion, are attached to a 16-to-1 multiplexer, IC1. As the 4-bit counter IC7 increments, each of the input lines of the multiplexer is sequentially routed to the output, pin 10. With address position 0 permanently tied high and the next ten addresses wired as function-code inputs, the output of IC1 will reflect the first eleven 8 ms message segments.

ICs 3, 5, 6, and 8 act as a digital modulator. If the output of IC1 pin 10 is a logic 1 (such as the start bit), a 4 ms burst of 40 kHz will be routed through IC5 and appear at pin 6. A logic 0 on pin 10 results in a 1.2 ms burst. The timing of these events is rather critical. The rate of clock one (IC8d) should be as close to 125 Hz as possible (8 ms period), and clock two (IC8e and IC8f) should be similarly set to 40 kHz. Use potentiometer R1

As of the writing of this article, Mountain Hardware Inc (300 Harvey West Blvd, Santa Cruz CA 95060) has announced a plug-in card for the Apple II that, like the control card described in this article, transmits to the BSR X-10 Command Console. In addition, the company offers control software tailored to the Apple II with at least 32 K bytes of program-mable memory. Cost of the unit is \$189 for the controller board alone and \$279 for the controller board, the X-10 Command Console, and three remote modules.

The following items are available from:

The Micromint Inc
917 Midway
Woodmere NY 11598
Telephone: (516) 374-6793

1. Assembled and tested interface board and plastic encase \$79.50
2. Cable and connector for TRS-80 \$14.95
3. Cable and adapter board for Apple II \$29.95
4. Cable and adapter board for S-100 bus \$34.95
5. 0.5 A power supply \$9.95

New York residents please add 7% sales tax.

↓

**Make your own interface easily
for Apple II¹ and Superkim² with
Vector 4609 Universal Plugboard!**

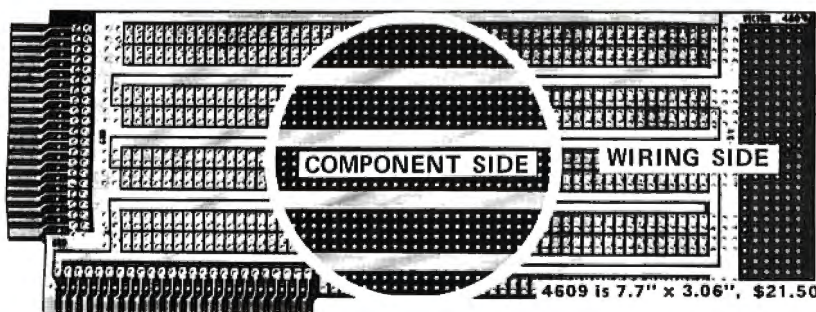

HIGH CAPACITY:

22 16-pin DIPs or 2 40-pin plus 18 sixteen-pin DIPs.

VERSATILE

.1 inch grid; .042 inch diameter holes.

- Extra I/O connector—gold plated.

- Extended length! Extra area! No interference.
- Wrap wire or solder.
- Quick solder mounting of any IC sockets.
- Hot tinned 2 ounce copper power & ground buses between IC leads for easy connection.

Vector Electronic Company

INCORPORATED

12460 Gladstone Avenue, Sylmar, California 91342
phone (213) 365-9661, TWX (910) 496-1539

1 T. M. APPLE COMPUTER, Inc. 680679

2 T. M. MICROPRODUCTS

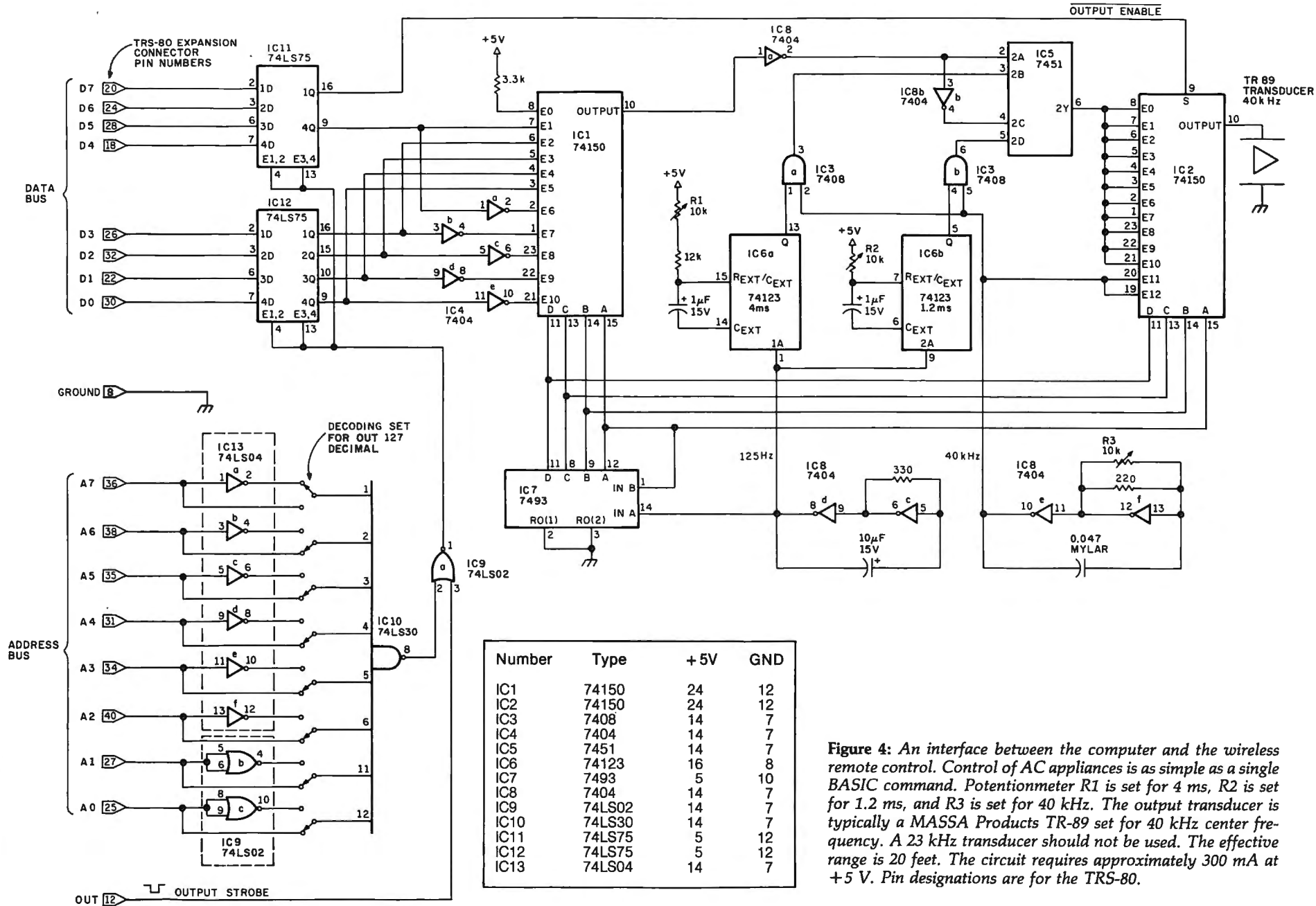

Figure 4: An interface between the computer and the wireless remote control. Control of AC appliances is as simple as a single BASIC command. Potentiometer R1 is set for 4 ms, R2 is set for 1.2 ms, and R3 is set for 40 kHz. The output transducer is typically a MASSA Products TR-89 set for 40 kHz center frequency. A 23 kHz transducer should not be used. The effective range is 20 feet. The circuit requires approximately 300 mA at +5 V. Pin designations are for the TRS-80.



HERE'S WHAT THE DOCTOR PRESCRIBES FOR YOUR AILING MICROCOMPUTER:
muLISP from the Soft Warehouse

- Over 80 primitively defined LISP functions.
- Infinite precision integer arithmetic expressed in any desired radix base from 2 through 36.
- Automatic dynamic memory management performed by an efficient garbage collector.
- Flexible but structured program control constructs including an extended COND and multiple exit LOOP.
- Extremely fast execution speed achieved by the use of shallow binding, address typing, and a closed pointer universe.

The Soft Warehouse can fill your prescription with the **muLISP-79™** Software System. It is fully integrated into the popular CP/M™ Operating System and available for a number of different drives.

If *Math Anxiety* is your affliction, we also offer the **muMATH-79™** Symbolic Math System. Read about it in the August '79 issue of *BYTE*.

Call or write us directly for more information.

©Copyright The Soft Warehouse 1979

the
SOFT WAREHOUSE™

P.O. Box 11174, Honolulu, Hawaii 96828
 Telephone (808) 734-5801

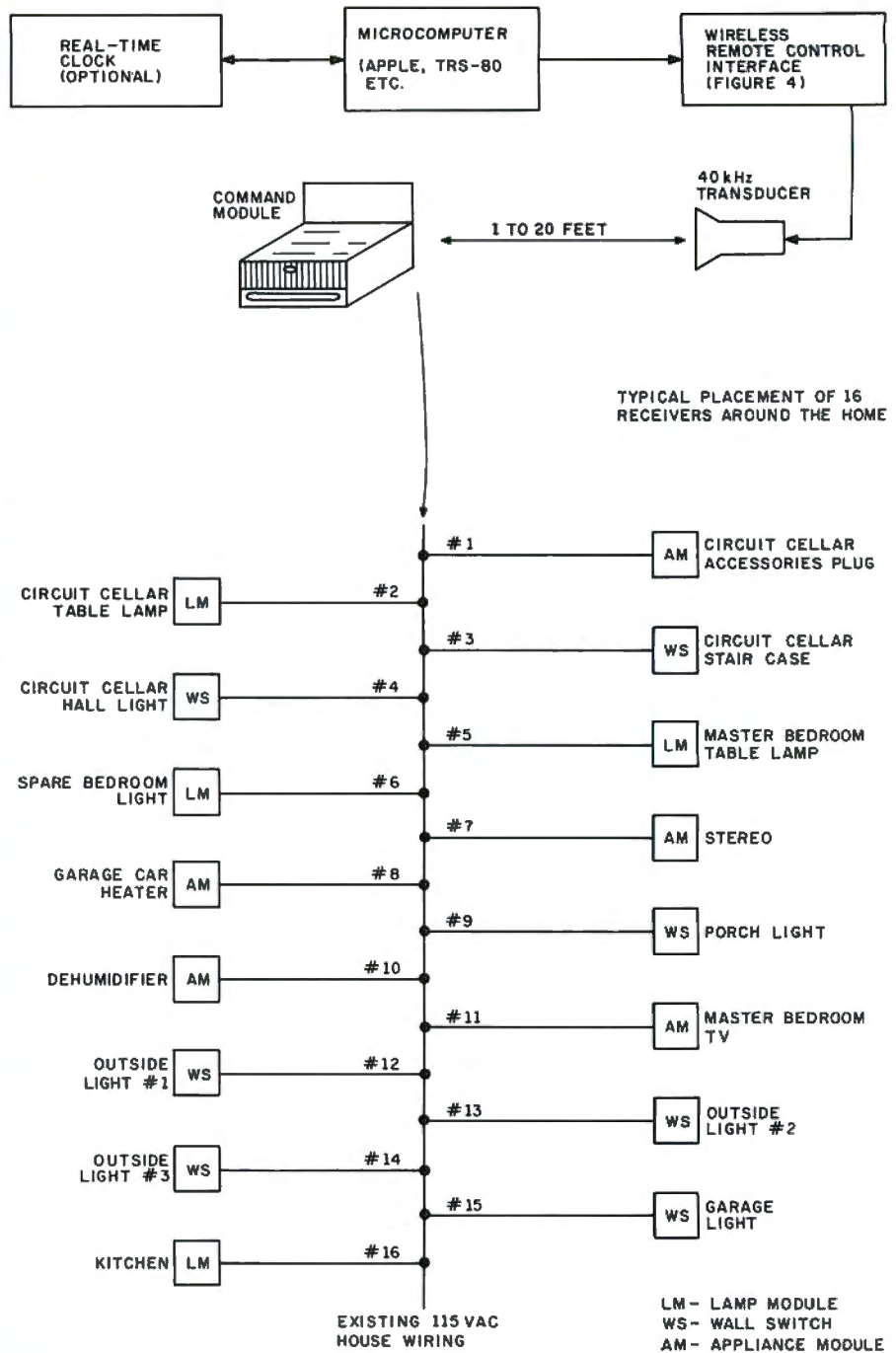

Figure 5: A typical application of the wireless remote control. All of the modules are connected over the house wiring.

to set the monostable multivibrator (or one-shot) IC6a to a period of 4 ms. Use R2 to set the one-shot IC6b to 1.2 ms.

The output of IC5 should generate the first eleven segments of the message. IC2, using the same technique as IC1, adds a 16 ms end-of-message tone burst as segments 12 and 13. The message is repeated in 24 ms as the counter (IC7) loops to 0. It will send the same data as long as the contents of ICs 11 and 12 have not

changed and the output-enable line has not been brought high.

All of the components (except possibly the 40 kHz transducers) are readily available. Low-power Schottky transistor-transistor logic (TTL) devices should be used where specified to properly interface with the TRS-80 or similar low-power bus systems.

One further note for prospective TRS-80 circuit builders. To use this

*Text continued on page 48
 Listing 1 on page 46*

6809 PROCESSING POWER!

The Percom SBC/9™. Only \$199.95.

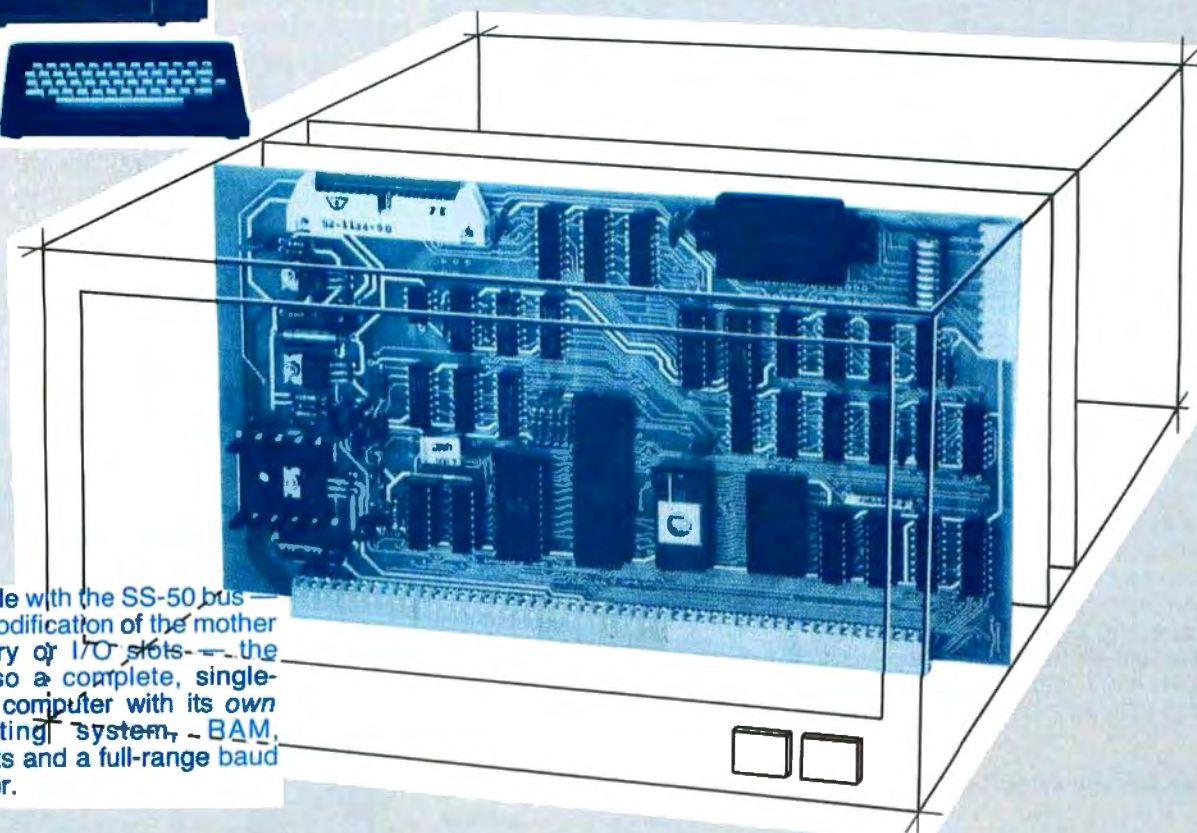

Fully compatible with the SS-50 bus — requiring *no* modification of the mother board, memory or I/O slots — the SBC/9™ is also a complete, single-board control computer with its own ROM operating system, BAM, peripheral ports and a full-range baud clock generator.

Make the SBC/9™ the heart of your computer and put to work the most outstanding microprocessor available, the 6809.

the Mighty 6809

Featuring more addressing modes than any other eight-bit processor, position-independent coding, special 16-bit instructions, efficient argument-passing calls, autoincrement/autodecrement and more, it's no wonder the 6809 has been called the "programmers dream machine."

Moreover, with the 6809 you get a microprocessor whose programs typically use only one-half to two-thirds as much RAM space as required for 6800 systems, and run faster besides.

And to complement the extraordinary 6809, the Percom design team has developed PSYMON™, an extraordinary 6809 operating system for the SBC/9™.

PSYMON™ — Percom SYstem MONitor

Although PSYMON™ includes a full complement of operating system commands and 15 externally callable

™ trademark of Percom Data Company, Inc.

utilities, what really sets PSYMON™ apart is its easy hardware adaptability and command extensibility.

For hardware interfacing, you merely use simple, specific device driver routines that reference a table of parameters called a Device Control Block (DCB). Using this technique, interfacing routines are independent of the operating system.

The basic PSYMON™ command repertoire may be readily enhanced or modified. When PSYMON™ first receives system control, it initializes its RAM area, configures its console and then 'looks ahead' for an optional second ROM which you install in a socket provided on the SBC/9™ card. This ROM contains your own routines that may alter PSYMON™ pointers and either subtly or radically modify the PSYMON™ command set. If a second ROM is not installed, control returns immediately to PSYMON™

- Provision for multi-address, 8-bit bidirectional parallel I/O data lines for interfacing to devices such as an encoded keyboard.
- A serial interface Reader Control output for a cassette, tape punch/reader or similar device.
- An intelligent data bus: multi-level data bus decoding that allows multiprocessing and bus multiplexing of other bus masters.
- Extended address line capability — accommodating up to 16 megabytes of memory — that does not disable the on-board baud rate clock or require additional hardware in I/O slots.
- On-board devices which are fully decoded so that off-card devices may use adjoining memory space.
- Fully buffered address, control and data lines.

The SBC/9™, complete with PSYMON™ in ROM, 1K of RAM and a comprehensive users manual™ costs just \$199.95.

PERCOM

PERCOM DATA COMPANY, INC.
211 N. KIRBY GARLAND, TEXAS 75042
(214) 272-3421

Percom 'peripherals for personal computing'

To place an order or request additional literature call toll-free 1-800-527-1592. For technical information call (214) 272-3421. Orders may be paid by check, money order, COD or charged to a VISA or Master Charge account. Texas residents must add 5% sales tax.

Circle 25 on inquiry card.

PRICES AND SPECIFICATIONS SUBJECT TO CHANGE WITHOUT NOTICE

Welcome to Percom's Wide World

SS-50 Bus LFD-400™ and LFD-800™ Systems



Each LFD mini-disk storage system includes:

- drives with integral power supplies in an enamel-finished enclosure
- a controller/interface with ROM operating system plus extra ROM capacity
- an interconnecting cable
- a comprehensive 80-page users manual

Circle 26 on inquiry card.

Low-Cost Mini-Disk Storage in the Size You Want.

Percom LFD mini-disk drive systems are supplied complete and ready to plug in the moment they arrive. You don't even have to buy extra memory. Moreover, software support ranges from assembly language program development aids to high-speed disk operating systems and business application programs.

The LFD-400™ and -400EX™ systems and the LFD-800™ and -800EX™ systems are available in 1-, 2- and 3-drive configurations. The -400, -400EX drives store 102K bytes of formatted data on 40-track disks, and data may be stored on either surface of a disk. The -800, -800EX drives store 200K bytes of formatted data on 77-track disks.

The LFD-1000™ systems (not pictured) have dual-drive units which store 800K bytes on-line. The LFD-1000™ controller accommodates two drive systems so that a user may have as much as 1.6M bytes on-line.

Mini-disk storage system prices:

MODEL	1-DRIVE SYSTEM	2-DRIVE SYSTEM	3-DRIVE SYSTEM
For the SS-50 Bus:			
LFD-400™	\$ 599.95	\$ 999.95	\$1399.95
LFD-800™	895.95	1549.95	2195.95
For the EXORciser™ Bus:			
LFD-400EX™	\$ 649.95	\$1049.95	\$1449.95
LFD-800EX™	945.95	1599.95	2245.95
LFD-1000™	(dual) \$2495.00	(quad) \$4950.00	—

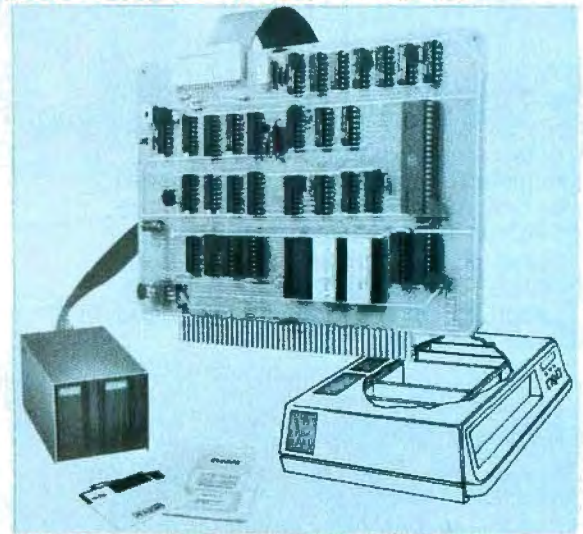

EXORciser™ Bus LFD-400EX™, -800EX™ Systems

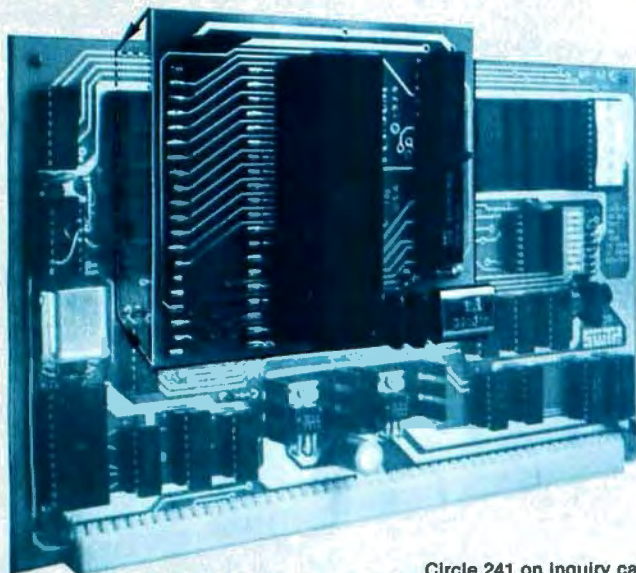

Circle 241 on inquiry card.

Upgrade to 6809 Computing Power. Only \$69.95

Although designed with the SWTP 6800 owner in mind, this upgrade adapter may also be used with most other 6800 and 6802 MPUs. The adapter is supplied assembled and tested, and includes the 6809 IC, a crystal, other essential components and user instructions. Restore your original system by merely unplugging the adapter and a wire-jumpered

DIP header, and re-inserting the original components. Also available for your upgraded system is PSYMON™ (Percom System Monitor), the operating system for the Percom 6809 single-board computer. PSYMON™ on 2716 ROM costs only \$69.95. On diskette (source and object files), only \$29.95.

Data Terminal & Two-Cassette Interface — the CIS-30+



Circle 242 on inquiry card.

- Interface to data terminal and two cassette recorders with a unit only 1/10 the size of SWTP's AC-30.
- Select 30, 60 or 120 bytes per second cassette interfacing; 300, 600 or 1200 baud data terminal interfacing.
- Optional mod kits make CIS-30+ work with any microcomputer. (For MITS 680b, ask for Tech Memo TM-CIS-30+-09.)
- KC Standard/Bi-Phase-M (double frequency) cassette data encoding. Dependable self-clocking operation.
- Ordinary functions may be accomplished with 6800 Mikbug™ monitor

Prices: Kit, \$79.95; Assembled, \$99.95. Prices include a comprehensive instruction manual. Also available: Test Cassette, Remote Control Kit (for program control of recorders), IC Socket Kit, MITS 680b mod documentation and Universal Adaptor Kit (converts CIS-30+ for use with any computer).

of 6800 Microcomputing.

6800/6809 SOFTWARE

System Software

6800 Symbolic Assembler — Specify assembly options at time of assembly with this symbolic assembler. Source listing on diskette \$29.95
Super BASIC — a 12K extended random access disk BASIC for the 6800 and 6809. Supports 44 commands and 31 functions. Interprets programs written in both SWTP 8K BASIC (versions 2.0, 2.2 & 2.3) and Super BASIC. Features: 9-digit BCD arithmetic, Print Using and Linput commands, and much more. Price \$49.95
TOUCHUP™ — Modifies TSC's Text Editor and Text Processor for Percom mini-disk drive operation. Supplied on diskette complete with source listing \$17.95

Operating Systems

INDEX™ — This easy-to-use disk-operating and file management system for 6800 microcomputers is fast. I/O devices are serviced by interrupt request. INDEX™ accesses peripherals the same as disk files — new devices may be added without changing the operating system. Other features: unlimited number of DOS commands may be added • over 60 system entry points • display only those files at or above user-specified file activity level • versions available for SWTP MF-68, Smoke's BFD-68 and Motorola's EXORCiser*. Price \$99.95
MINIDOS-PLUSX™ — An extension of the original MINIDOS™ for LFD-400™ mini-disk systems. MINIDOS-PLUSX™ manipulates files by six-character names. Supports up to 31 files. Resident commands include Initialize, Save, Allocate, Load, Files (directory list), Rename and Delete. Supplied on 2708 ROM with a minidiskette that includes transient utilities such as Copy, Backup, Create, Pack and Print Directory. Price \$34.95.
PSYMON™ — Percom SYstem MONitor for the Percom single-board/SS-50-bus-compatible 6809 computer accommodates user's application programs with any mix of peripherals **without** modifying programs. PSYMON™ also features character echoing to devices other than the communicating device, sophisticated register and memory dump routines and more. Price (on 2716 ROM) \$69.95.
WINDEX™ — Described in detail elsewhere on this page.

Business Programs

General Ledger — For 6800/6809 computers using Percom LFD mini-disk storage systems. Requires little or no knowledge of bookkeeping because the operator is prompted with non-technical questions during data entry. General Ledger updates account balances immediately — in real time, and will print financial statements immediately after journal entries. User selects and assigns own account numbers; tailors financial statements to firm's particular needs. Provides audit trail. Runs under Percom Super BASIC. Requires 24K bytes of RAM. Supplied on minidiskette with a comprehensive users manual. Price \$199.95.

FINDER™ — This general purpose data base manager is written in Percom Super BASIC. Works with 6800/6809 computers using Percom LFD-400™ mini-disk drive storage systems. FINDER™ allows user to define and access records using his own terminology — customize file structures to specific needs. Basic commands are New, Change, Delete, Find and Pack. Add up to three user-defined commands. FINDER plus Super BASIC require 24K bytes of RAM. Supplied on minidiskette with a users manual. Price \$99.95.
Mailing List Processor — Powerful search, sort, create and update capability plus ability to store 700 addresses per minidiskette make this list processor efficient and easy to use. Runs under Percom Super BASIC. Requires 24K bytes of RAM. Supplied on minidiskette with a users manual. Price \$99.95.

From the Software Works

Development and debugging programs for 6800 μ Cs on diskette:
 Disassembler/Source Generator \$30.95
 Reloc'ng Disas'mblr/Segmented Text Gen \$40.95
 Disassembler/Trace \$25.95
 Support Relocator Program \$25.95
 Relocating Assembler/Linking Loader \$55.95
 SmithBUG** (2716 EPROM) \$70.00

1/2-Price Special on Hemenway Software!

CP/68 \ddagger disk operating system \$ 49.97
 STRUBAL+ \ddagger compiler \$124.97
 EDIT68 text editor \$ 19.97
 MACRO-Relocating Assembler \$ 39.97
 Linkage Editor (LNKEDT68) \$ 24.97
 Cross Reference utility \$ 14.97

Circle 245 on inquiry card.

™trademark of Percom Data Company, Inc.

* trademark of Motorola Corporation

‡Trademark of Hemenway Associates Company

**SmithBUG is a trademark of the Software Works Company

And 'looking into' is just what you do with the Electric Window™ as you peer right into memory space where characters are being input and manipulated. Display is memory-resident, programmable and generates up to 24 80-character lines.

Other features include:

- standard character generator plus provision for optional special character generator
- dual intensity, high-lighting alphanumeric display
- scrolling by a programmable register • programmable display positioning
- programmable interlaced or non-interlaced scan
- descenders on lower case letters • users manual with application instructions and listing of WINDEX™ driver.



The Electric Window.™
Worth Looking Into. \$249.95

WINDEX™ is a fast video display driver program for the Electric Window™. WINDEX™ also features: program and keyboard control of character generators • displayable control characters — under program control • automatic scrolling • a driver routine for the parallel input keyboard feature of the Percom 6809 Single-Board Computer, the SBC/9™ • auto-linking to PSYMON™, the ROM operating system for the SBC/9™ • Prices: ROM version: \$39.95; LFD-400™ compatible diskette (source and object files): \$29.95. Circle 243 on inquiry card.

Now Available! the SBC/9™ MPU/Control Computer

(Single-Board-Computer/6809) — stands alone as a control computer, but also compatible with the SS-50 bus for use as an MPU card. Includes PSYMON™ (Percom SYstem MONitor) in a 1K ROM and provides for additional 1K of ROM. Also includes 1K of RAM. Features: Super Port — provision for multi-address, 8-bit bidirectional data lines • an intelligent data bus for multi-level data bus decoding • an on-board 110-baud to 19.2 kbaud clock generator • extended address capability — to 16 megabytes — without disabling baud clock or adding hardware. And much more. Supplied with PSYMON™ and comprehensive users manual. Price \$199.95.
 See full page ad elsewhere in this magazine for all of the SBC/9™ features. Circle #244.

Full Feature Prototyping PC Boards

All of the features needed for rapid, straightforward circuit prototyping. Use 14-, 16-, 24- and 40-pin DIP sockets • SS-50 bus card accommodates 34- and 50-pin ribbon connectors on top edge, 10-pin Molex connector on side edge • I/O card accommodates 34-pin ribbon connector and 12-pin Molex on top edge

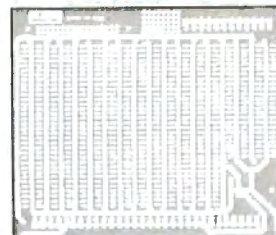

I/O Bus Card: \$14.95

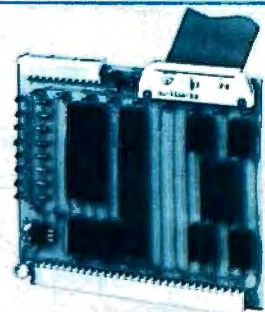

SS-50 Bus Card: \$24.95

- I/O card is 1-1/4 inches higher than SWTP I/O card • interdigitated power conductors • contacts for power regulators and distributed capacitance bypassing
- use wire wrap, wiring pencil or solder wiring • tin-lead plating over 2-oz copper conductors wets quickly, solders easily
- FR4-G10 epoxy-glass substrate.

Circle 246 on inquiry card.

To place an order or request additional literature call toll-free 1-800-527-1592. For technical information call (214) 272-3421. Orders may be paid by check, money order, COD or charged to a VISA or Master Charge account. Texas residents must add 5% sales tax.

PRICES AND SPECIFICATIONS SUBJECT TO CHANGE WITHOUT NOTICE

PERCOM

PERCOM DATA COMPANY, INC.
 271 N. KIRBY GARLAND, TEXAS 75042
 (214) 272-3421

Listing 1: Demonstration program for the Sears Home Control System.

```
LIST
90 REM THIS PROGRAM ALLOWS DIRECT COMPUTER CONTROL OVER THE SEARS HOME CONTROL SYSTEM
92 REM
94 REM COPYRIGHT 1979 STEVEN A. CIARCIA
96 REM
98 REM
100 REM SET UP TABLE OF CHANNEL/OUTPUT CODES
105 DIM C(20),S(20)
110 DATA 12,28,4,20,2,18,10,26,14,30
115 DATA 6,22,0,16,8,24
120 FOR X=1 TO 16
125 READ C(X) :REM C(X) IS CHANNEL NUMBER
130 NEXT X
135 GOSUB 200 :GOTO 300
190 REM
195 REM
200 PRINT "CURRENT STATUS IS :"
205 FOR X=1 TO 16
210 PRINT "CHANNEL ";X;" IS " ; IF S(X)=1 THEN PRINT"ON" ELSE PRINT"OFF"
220 NEXT X
225 RETURN
300 PRINT "DO YOU WANT TO CLEAR ALL OUTPUTS TO START?:INPUT A$
305 IF A$="YES" THEN F=1 :GOSUB 9050:FOR Z=1 TO 16:S(Z)=0 :NEXT Z :REM CLEAR BSR OUTPUTS
310 PRINT "SET CONTROLLER OUTPUTS BY ENTERING CHANNEL NO. AND FUNCTION"
315 PRINT"ENTER CHANNEL NO. (0 TO EXIT) ";INPUT C
317 IF C=0 THEN GOSUB 200 :GOTO 300
320 PRINT"CHANNEL ";C;" IS " ;IF S(C)=1 THEN PRINT"ON" ELSE PRINT"OFF"
325 PRINT"ON,OFF,NEXT,OR REVIEW ";INPUT A$
330 IF A$="ON" THEN S(C)=1:X=C:GOSUB 9000:F=5:GOSUB 9050 :GOTO 315:REM TURN CHANNEL C ON
340 IF A$="OFF" THEN S(C)=0:X=C:GOSUB 9000: F=7:GOSUB 9050 :GOTO 315:REM TURN CHANNEL C OFF
350 IF A$="NEXT" THEN C=C+1:GOTO 320
360 GOSUB 200 :GOTO 315
8996 REM
8998 REM
9000 REM BSR HOME CONTROL DRIVER
9010 REM C(X) IS CHANNEL CODE
9015 OUT 9,C(X) :REM SET CHANNEL
9020 GOSUB 9085
9025 RETURN
9050 REM FUNCTION DRIVER
9060 REM F FUNCTION CODE
9065 OUT 9,F
9070 GOSUB 9085
9075 OUT 9,128 :REM BIT 7 SHUTS OFF TRANSDUCER OUTPUT
9080 RETURN
9082 REM
9084 REM
9085 FOR Q 0 TO 900 :NEXT Q :RETURN :REM DELAY TIMER
```

READY

RUN

CHOOSE ONE OF THE FOLLOWING :

1. AUTOMATIC CONTROL SYSTEM ON
2. MANUAL CONTROL / CURRENT STATUS
3. PRINT THE CURRENT TIME
4. REVIEW DEFAULT SETTINGS AND ADD TO CONTROL LIST

YOUR CHOICE ? 4

```
DO YOU WANT TO REVIEW THE DEFAULT SETTINGS (Y/N) ? Y
1 .AT 2 HOURS 0 MINUTES TURN CHANNEL 10 ON
2 .AT 17 HOURS 0 MINUTES TURN CHANNEL 10 OFF
3 .AT 18 HOURS 30 MINUTES TURN CHANNEL 6 ON
4 .AT 19 HOURS 25 MINUTES TURN CHANNEL 6 OFF
5 .AT 19 HOURS 40 MINUTES TURN CHANNEL 6 ON
6 .AT 20 HOURS 20 MINUTES TURN CHANNEL 6 OFF
7 .AT 20 HOURS 35 MINUTES TURN CHANNEL 6 ON
8 .AT 21 HOURS 50 MINUTES TURN CHANNEL 6 OFF
9 .AT 22 HOURS 0 MINUTES TURN CHANNEL 6 ON
10 .AT 23 HOURS 50 MINUTES TURN CHANNEL 6 OFF
11 .AT 1 HOURS 50 MINUTES TURN CHANNEL 6 ON
12 .AT 2 HOURS 45 MINUTES TURN CHANNEL 6 OFF
```

Listing 1 continued on page 48

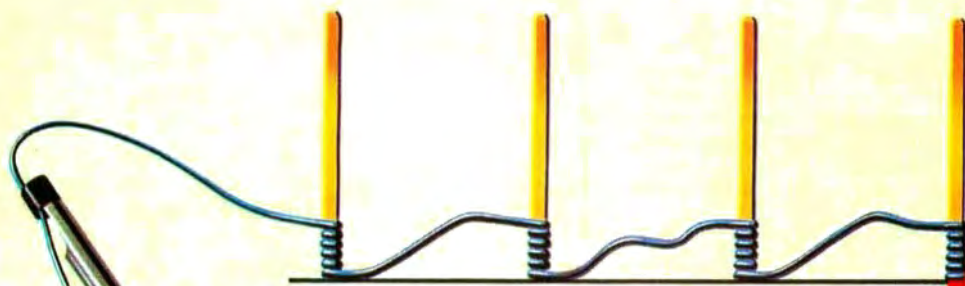

WHY CUT? WHY STRIP? WHY SLIT?
WHY NOT...

NEW

JUST WRAP™

WIRE WRAPPING TOOL

- AWG 30 Wire
- .025" Square Posts
- Daisy Chain or Point To Point
- No Stripping or Slitting Required
- ...JUST WRAP™...
- Built In Cut Off
- Easy Loading of Wire
- Available Wire Colors: Blue, White, Red & Yellow

U.S.A., FOREIGN PATENTS PENDING

traditional Wire-Wrapping



JUST WRAP Wire-Wrapping

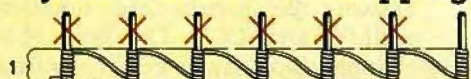

JUST WRAP TOOL WITH ONE 50 FT. ROLL OF WIRE		
COLOR	PART NO.	U.S. LIST PRICE
BLUE	JW-1-B	\$14.95
WHITE	JW-1-W	14.95
YELLOW	JW-1-Y	14.95
RED	JW-1-R	14.95
REPLACEMENT ROLL OF WIRE 50 FT.		
BLUE	R-JW-B	\$ 2.98
WHITE	R-JW-W	2.98
YELLOW	R-JW-Y	2.98
RED	R-JW-R	2.98
JUST WRAP-UNWRAPPING TOOL		
	JUW-1	\$ 3.49



OK MACHINE & TOOL CORPORATION 3455 CONNER ST.,
BRONX, N.Y. 10475 (212) 994-6600/TELEX 125091

*MINIMUM BILLING \$ 25.00/ADD SHIPPING CHARGE \$ 2.00/NEW YORK CITY/STATE RESIDENTS ADD APPLICABLE TAX.

Listing 1 continued:

```
13 .AT 16 HOURS 0 MINUTES   TURN CHANNEL 1 ON
14 .AT 22 HOURS 0 MINUTES   TURN CHANNEL 1 OFF
15 .AT 23 HOURS 0 MINUTES   TURN CHANNEL 4 ON
16 .AT 0 HOURS 30 MINUTES   TURN CHANNEL 4 OFF
17 .AT 19 HOURS 30 MINUTES  TURN CHANNEL 5 ON
18 .AT 21 HOURS 20 MINUTES  TURN CHANNEL 5 OFF
19 .AT 22 HOURS 0 MINUTES   TURN CHANNEL 5 ON
20 .AT 1 HOURS 0 MINUTES    TURN CHANNEL 5 OFF
```

```
1.....CHANGE LIST
2.....ADD TO LIST
0.....EXIT TO MENU
```

? 2

```
ENTER TIME ,CHANNEL, AND FUNCTION
ENTRY NO. 21 ? 2330,3,ON
ENTRY NO. 22 ? 0,0,0
```

```
1.....CHANGE LIST
2.....ADD TO LIST
0.....EXIT TO MENU
```

? 0

CHOOSE ONE OF THE FOLLOWING :

1. AUTOMATIC CONTROL SYSTEM ON
2. MANUAL CONTROL / CURRENT STATUS
3. PRINT THE CURRENT TIME
4. REVIEW DEFAULT SETTINGS AND ADD TO CONTROL LIST

```
YOUR CHOICE ? 1
AUTOMATIC CONTROL INITIATED
23 HOURS 43 MINUTES
```

Listing 2: Program to compare the time from a real-time clock against a list of operations to be performed at specific times. A sample run of the program demonstrates how the entries may be varied.

```
RUN
CURRENT STATUS IS :
CHANNEL 1 IS OFF
CHANNEL 2 IS OFF
CHANNEL 3 IS OFF
CHANNEL 4 IS OFF
CHANNEL 5 IS OFF
CHANNEL 6 IS OFF
CHANNEL 7 IS OFF
CHANNEL 8 IS OFF
CHANNEL 9 IS OFF
CHANNEL 10 IS OFF
CHANNEL 11 IS OFF
CHANNEL 12 IS OFF
CHANNEL 13 IS OFF
CHANNEL 14 IS OFF
CHANNEL 15 IS OFF
CHANNEL 16 IS OFF
DO YOU WANT TO CLEAR ALL OUTPUTS TO START
? YES
SET CONTROLLER OUTPUTS BY ENTERING CHANNEL NO. AND FUNCTION
ENTER CHANNEL NO. (0 TO EXIT) ? 2
CHANNEL 2 IS OFF
ON,OFF,NEXT,OR REVIEW ;
? ON
ENTER CHANNEL NO. (0 TO EXIT) ? 5
CHANNEL 5 IS OFF
ON,OFF,NEXT,OR REVIEW ;
? ON
ENTER CHANNEL NO. (0 TO EXIT) ? 2
CHANNEL 2 IS ON
ON,OFF,NEXT,OR REVIEW ;
? NEXT
CHANNEL 3 IS OFF
ON,OFF,NEXT,OR REVIEW ;
? REVIEW
CURRENT STATUS IS :
CHANNEL 1 IS OFF
```

Listing 2 continued on page 50

Text continued from page 42:

interface properly, you must have Level 2 BASIC to address output ports. Also, in most Level 2 systems, +5 V on the expansion connector has been disconnected at the factory. It will be necessary, therefore, to provide a separate 5 V 300 mA power supply for the interface electronics.

Using the Interface

A typical application is demonstrated in figure 5. The receivers can be placed around the home to control a variety of appliances and lights. With the addition of the real-time clock outlined in a previous Circuit Cellar article ("Anyone Know the Real Time?" August 1979 BYTE, page 50) you can add timed activation of these control functions as well.

Listing 1 shows a simple BASIC program that demonstrates the interface capabilities. The command console is plugged in and positioned within 20 feet on a direct unobstructed line with the interface output transducer. The program starts by asking if you want to clear all outputs and start fresh. Since the BSR X-10 is an open-loop control system, and you have no way of knowing which receivers are activated, this is a prudent choice.

To turn on channel 6, simply answer the appropriate questions with "6" and "ON". The status of all channels can be reviewed at any time.

The program responds by calling a control output routine. Turning channel 6 on requires two outputs to the command console. One sets channel 6 (as if pressing the 6 button), and the other sets the "on" function (as if pressing the ON button). To allow enough time for the command console to respond, delay loops are inserted. The result is a 2-second signal to set device code 6 and a 2-second message that tells it to turn on. The process can be reversed with a 6 and an OFF program command. All sixteen channels can be just as easily cycled.

Listing 2 is the logical extension of this basic concept. Using a real-time clock, you can create a list of precisely timed events. It can be used to control house lighting during vacations or to turn the coffee maker on at 6:30 AM. The program incorporates a default list of data statements. Each statement is formatted as time, chan-

Text continued on page 54



MicroPro International Corporation

"Professional Quality Software You Can Count On, Now!"

WORD-STAR™

THE BEST GETS BETTER! Yes, in just a few months, thousands of users now know that WORD-STAR™ is the word processing product that truly transforms the performance of Z-80, 8085, and 8080 microcomputers into a class with systems costing far more. Look at these recent enhancements: Print spooling; directory; foreign language adaptability; microspace justification; mailing list merge; CP/M*1.4, 2.0 & MPM compatible, and more. Examine our features and order yours now!

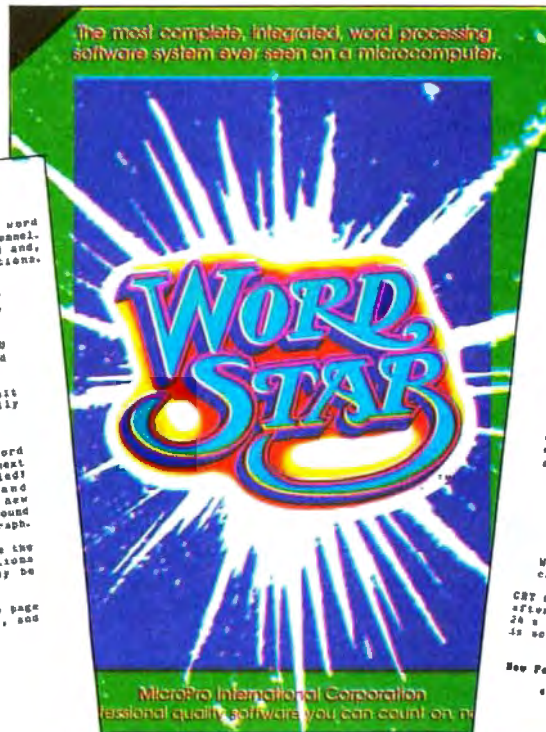

DESIGN OF WORDSTAR

WordStar is a screen oriented, CP/M compatible, integrated word processing system specifically designed for non-technical personnel. Text and command functions are fully prompted (a help level) and performed concurrently with complete cursor tracking of all functions. Concurrent printing while editing improves operator productivity.

- **Cursor-Tracked Screen Display:** Under user control, the CRT screen acts as a movable "window" into the text; all key strokes receive immediate visual updating.
- **Automatic Disk Buffering:** Text is moved between disk and CPU memory with no user intervention. Thus, file size is limited only by disk capacity.

On-Screen Printer-Image Text Formatting: Using the default margins or user-set margins, entered text is automatically formed into right and left justified lines. Ragged-right is a user selectable option. The Word-Wrap feature means that as you type past the right margin, the word being typed is moved to the left margin, justified! You can change the margin settings and settings (i.e., redisplay all or part of the text with the an illustration or for any other purpose such as this paragraph).

Split-Screen Help Menus: Four user-settable levels provide the learning operator with comprehensive prompting instructions without the need to refer to a manual. Help levels may be changed at any time to allow full screen utilization.

Status Line: Constantly updated, the status line displays page number, cursor line and column, name of file under edit, and command(s), if any, in current operation.

Powerful Editing Commands: include delete character, word, line or block; set/insert variable tab stop; block move, copy, delete and output to disk; find/replace; write/read from/to additional files; set/return to place markers; on-screen insert toggle; and more.

Dynamic Page Break Display: A horizontal dotted line, not part of the text, is shown on the screen at the point a printer page break would occur. The page break line is dynamically repositioned when text entry or deletion affects page size, visual edits of a print image allow even an inexperienced operator to perform sophisticated text composition.

The most complete, integrated, word processing software system ever seen on a microcomputer.



MicroPro International Corporation
Professional quality software you can count on!

WORDSTAR DESIGN (continued)

Concurrent Print Function: KEYLINE and GRABING simultaneously.

- **Pagination and Formatting:**
 - User override of default top/bottom margins.
 - Variable override of page length default.
 - Conditional and absolute pagination directives.

Printer Support: A wide range of letter quality and line printers are supported including Diablo, Nec, and Qume, as well as bidirectional printing. Features supported include: Subscripts, Superscripts, Variable Character Pitch (pica, elite, or your choice of number of characters per inch), Variable Line Height (6, 8, or your choice of lines per inch), and Alternate Ribbon Color are fully supported on Diablo, Nec, and Qume printers. Print enhancements may be used in all combinations. For example, underlined and boldfaced **underlined** are supported.

- **Microspace Justification:** When
 - printing justified text on a
 - daisy wheel printer, the white
 - space in each line is evenly
 - distributed.

WordStar is compatible with a wide variety of hardware, and can share files with other software.

CP/M Compatibility: WordStar's video edit function will operate, after suitable installation, on any CP/M or video board 16 x 80, is accessible as a CP/M console device.

New Features include:

- **Directory display:** Using a triple split screen WordStar allows scrolling text, and CP/M file directory independently on screen.
- **Install Program:** generates a version of WordStar for use on the most popular terminals and printers without the need for any "patching". Allows full speed, 1200 baud, printer operation.
- **Foreign Language:** As WordStar's menus and messages are totally external to the operating program they lend themselves to translated versions.

MicroPro Price List:

	Software/Manual		Software/Manual
Word-Star™	\$495/40	Super-Sort I™	\$250/25
Word-Master™	\$150/25	Super-Sort II™	\$200/25
Tex-Writer™	\$ 75/15	Super-Sort III™	\$150/25

For more information and the name of your nearest dealer, contact MicroPro International Corporation. Dealer/Distributor/O.E.M. Inquires Invited

MICROPRO INTERNATIONAL CORPORATION
1299 4th Street, San Rafael, California 94901
Telephone (415) 457-8990 Telex 340388

*Runs under Digital Research CP/M or its derivatives, in 48K RAM

Note: Micro Pro offers a reward for reporting and successful prosecution of unauthorized copying.

Listing 2 continued:

```
CHANNEL 2 IS ON
CHANNEL 3 IS OFF
CHANNEL 4 IS OFF
CHANNEL 5 IS ON
CHANNEL 6 IS OFF
CHANNEL 7 IS OFF
CHANNEL 8 IS OFF
CHANNEL 9 IS OFF
CHANNEL 10 IS OFF
CHANNEL 11 IS OFF
CHANNEL 12 IS OFF
CHANNEL 13 IS OFF
CHANNEL 14 IS OFF
CHANNEL 15 IS OFF
CHANNEL 16 IS OFF
ENTER CHANNEL NO.      (0 TO EXIT) ?
```

LIST

```
100 REM
110 REM THIS PROGRAM PROVIDES REAL TIME CONTROL OF AC APPLIANCES
120 REM BY CONNECTING THE SEARS HOME CONTROL SYSTEM AND A REAL TIME CLOCK
130 REM TOGETHER.
140 REM
150 REM COPYRIGHT 1979  STEVEN CIARCIA
160 REM
170 REM
180 GOSUB 350 :REM LOAD DATA TABLES
190 REM PROGRAM OPTIONS ARE MADE THROUGH MENU SELECTIONS
200 PRINT :PRINT: PRINT "CHOOSE ONE OF THE FOLLOWING : "
210 PRINT
220 PRINT"1.  AUTOMATIC CONTROL SYSTEM ON"
230 PRINT"2.  MANUAL CONTROL / CURRENT STATUS
240 PRINT"3.  PRINT THE CURRENT TIME"
250 PRINT"4.  REVIEW DEFAULT SETTINGS AND ADD TO CONTROL LIST"
260 PRINT
270 PRINT" YOUR CHOICE "; :INPUT Z1
280 IF Z1=1 THEN PRINT"AUTOMATIC CONTROL INITIATED" : GOTO 1190
290 IF Z1=2 THEN GOSUB 740 :GOTO 810
300 IF Z1=3 THEN GOSUB 1470 :PRINT :PRINT"THE PRESENT TIME IS "; :GOSUB 1130 :GOTO 200
310 IF Z1=4 THEN GOTO 940
320 GOTO 200
330 REM
340 REM
350 REM SET UP TABLE OF CHANNEL/OUTPUT CODES
360 DIM C(20),S(50)
370 DATA 12,28,4,20,2,18,10,26,14,30
380 DATA 6,22,0,16,8,24
390 FOR X=1 TO 16
400 READ C(X) :REM C(X) IS CHANNEL NUMBER
410 NEXT X
420 REM WHEN PROGRAM IS INITIATED THE FOLLOWING DATA TABLE CONSTITUTES THE DEFAULT CONTROL SETPOINTS
430 REM SETPOINTS ARE STORED AS DATA STATEMENTS IN THE FORM OF TIME,CHANNEL,AND FUNCTION
440 REM W=TOTAL NUMBER OF DATA STATEMENTS
450 REM
460 DIM W(50),A(50),B(50),A$(50),L(50)
470 W=20 :REM W=TOTAL NUMBER OF DEFAULTS
480 DATA 0200,10,"ON" :REM DEHUMIDIFIER
490 DATA 1700,10,"OFF"
500 DATA 1830,6,"ON" :REM SPARE BEDROOM LIGHTS
510 DATA 1925,6,"OFF"
520 DATA 1940,6,"ON"
530 DATA 2020,6,"OFF"
540 DATA 2035,6,"ON"
550 DATA 2150,6,"OFF"
560 DATA 2200,6,"ON"
570 DATA 2350,6,"OFF"
580 DATA 0150,6,"ON"
590 DATA 0245,6,"OFF"
600 DATA 1600,1,"ON" :REM CIRCUIT CELLAR ACCESS. PLUG
610 DATA 2200,1,"OFF"
620 DATA 2300,4,"ON" :REM CELLAR HALL
630 DATA 0030,4,"OFF"
640 DATA 1930,5,"ON" :REM MASTER BEDROOM
650 DATA 2120,5,"OFF"
660 DATA 2200,5,"ON"
670 DATA 0100,5,"OFF"
680 FOR L=1 TO W :READ A(L),B(L),A$(L) :REM SET TIME,CHANNEL,FUNCTION
```

Listing 2 continued on page 52

OLIVETTI PRINTERS

AVAILABLE NOW!

For years we have been our own biggest customer. Until now you couldn't buy an Olivetti printer unless you bought a complete Olivetti calculator. Now, for the first time, our complete line of OEM printers is available for immediate shipment in any quantity. For use in calculators, electronic scales, cash registers, mini computers, CRT hard copy output, data loggers, medical and scientific instruments, or any application where a paper tape printout is desired. Olivetti has a quality OEM printer for you.

For Further Information Please Contact:

Olivetti Corporation
 20370 Town Center Lane
 Cupertino, California 95014
 Telephone: 408/996/3867

PU1840—
 40 Column Thermal, 240 L.P.M.
 Dot Matrix, Plotter

PU1828—
 28 Column Thermal,
 240 L.P.M.,
 Dot Matrix, Plotter

PU1808—
 16 Column Thermal, 120 L.P.M.

PU1800—
 20 Column Thermal, 120 L.P.M.

Coming Soon:
 80 Column Thermal, 240 L.P.M.
 Dot Matrix, Plotter

Features:

- High Speed
- Low Cost—The Best Really Can Cost Less!
- Fewer Moving Parts
- Proven High Reliability and Long Life
- Over 3 Million In Use by Olivetti Alone
- Lightweight and Compact—Extremely Versatile
- Available With 6V or 18V Motor
- Low Power Usage
- Graphic Capabilities (PU1828 and PU1840)
- All Printers are Available With or Without Interface Boards

Optional Interface Boards

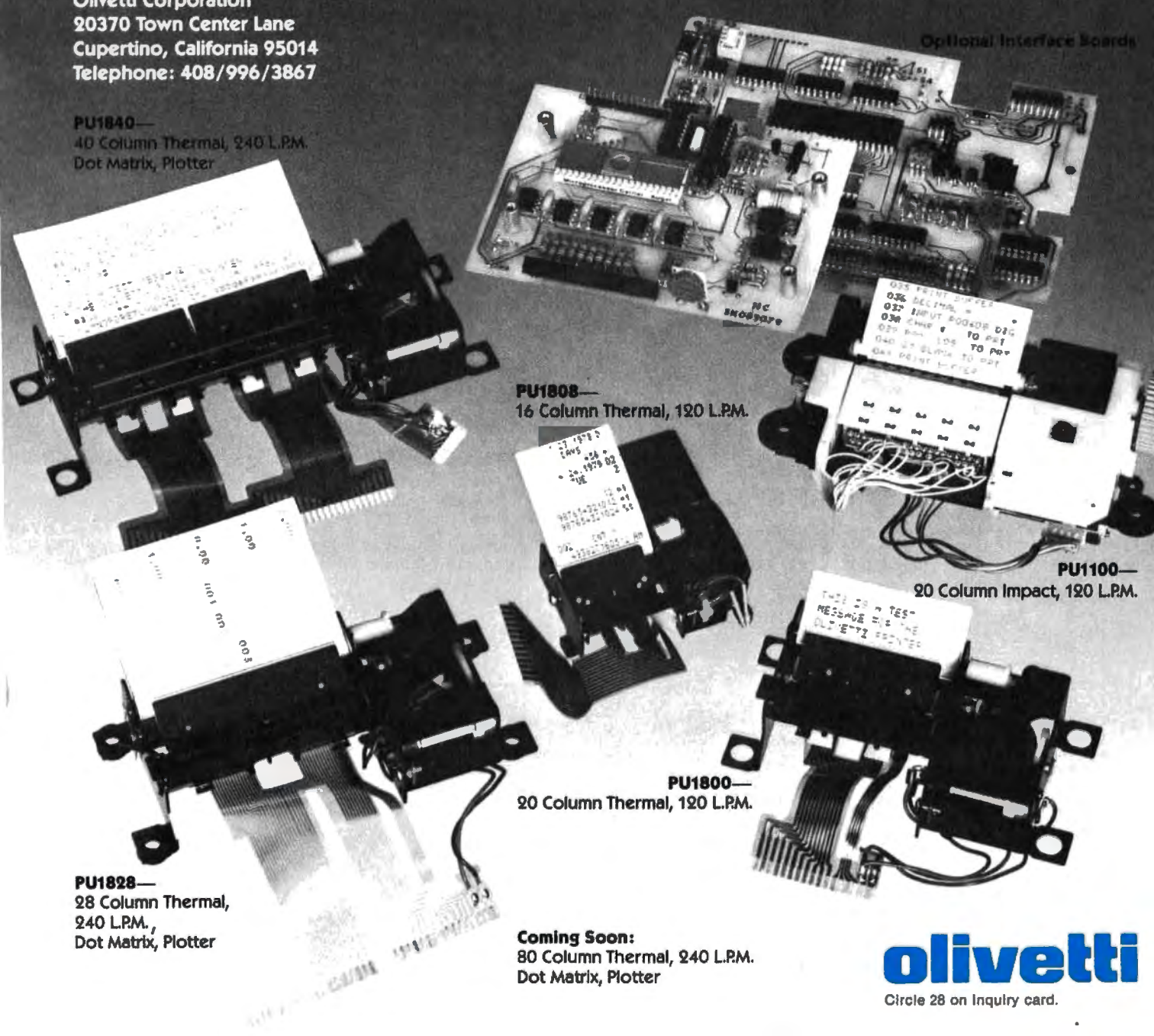

olivetti

Circle 28 on Inquiry card.

Listing 2 continued:

```

690 NEXT L
700 RETURN
710 STOP
720 REM
730 RE197 REM
740 PRINT "CURRENT STATUS IS : "
750 FOR X=1 TO 16
760 PRINT "CHANNEL ";X;" IS ";:IF S(X)=1 THEN PRINT"ON" ELSE PRINT"OFF"
770 NEXT X
780 RETURN
790 REM
800 REM
810 PRINT "DO YOU WANT TO CLEAR ALL OUTPUTS TO START?";INPUT A$
820 IF A$="YES" THEN F=1 :GOSUB 1380:FOR Z=1 TO 16:S(Z)=0 :NEXT Z :REM CLEAR BSR OUTPUTS
830 PRINT "SET CONTROLLER OUTPUTS BY ENTERING CHANNEL NO. AND FUNCTION"
840 PRINT"ENTER CHANNEL NO. (0 TO EXIT) ";:INPUT C
850 IF C=0 THEN GOTO 200
860 PRINT"CHANNEL ";C;" IS ";:IF S(C)=1 THEN PRINT"ON" ELSE PRINT"OFF"
870 PRINT"ON,OFF,NEXT,OR REVIEW ";:INPUT A$
880 IF A$="ON" THEN S(C)=1:X=C:GOSUB 1330:F=5:GOSUB 1380 :GOTO 840:REM TURN CHANNEL C ON
890 IF A$="OFF" THEN S(C)=0:X=C:GOSUB 1330: F=7:GOSUB 1380 :GOTO 840:REM TURN CHANNEL C OFF
900 IF A$="NEXT" THEN C=C+1:GOTO 860
910 GOSUB 740 :GOTO 840
920 REM
930 REM
940 PRINT: PRINT"DO YOU WANT TO REVIEW THE DEFAULT SETTINGS (Y/N) ";:IN-PUT B$
950 IF B$<>"Y" THEN GOTO 1000
960 FOR L=1 TO W
970 L1=INT(A(L)/100)
980 PRINT L;".";"AT ";L1;" HOURS ";A(L)-L1*100;" MINUTES ";:TURN CHANNEL ";B(L);" ";A$(L)
990 NEXT L
1000 PRINT:PRINT" 1.....CHANGE LIST";PRINT" 2.....ADD TO LIST"
1010 PRINT" 0.....EXIT TO MENU" :INPUT Z2
1020 IF Z2=0 THEN GOTO 200
1030 IF Z2=1 THEN PRINT"RECORD ENTRY TO BE CHANGED"; ELSE 1080
1040 INPUT Z3
1050 PRINT" PRESENTLY ";A(Z3),B(Z3),A$(Z3)
1060 INPUT "TIME ,CHANNEL,AND ON OR OFF ";A(Z3),B(Z3),A$(Z3) :IF A(Z3)=0 THEN 1000
1070 PRINT "CHANGE ANOTHER Y/N "; :INPUT Z4 :IF Z4="Y" THEN GOTO 1030 ELSE 1000
1080 IF Z2<>2 THEN GOTO 1000
1090 REM START ADDITIONS AT END OF DEFAULT LIST
1100 PRINT" ENTER TIME ,CHANNEL, AND FUNCTION"
1110 W=W+1 :PRINT"ENTRY NO. "; W,:INPUT A(W),B(W),A$(W) :IF A(W)=0 THEN W=W-1 :GOTO 1000
1120 GOTO 1110
1130 REM 4 DIGIT FORMAT ROUTINE
1140 T2=H1*10+H0 :T3=M1*10+M0
1150 PRINT T2;"HOURS ";T3;"MINUTES" :RETURN
1160 REM
1170 REM
1180 REM
1190 REM CONTROL OUTPUT SUBROUTINE----SETPOINT MONITOR
1200 T5=0
1210 GOSUB 1470 :REM GET TIME
1220 IF T1<>T5 THEN GOSUB 1130 :T5=T1 :REM PRINT TIME
1230 FOR L=1 TO W
1240 IF T1=A(L) THEN X=B(L) :GOSUB 1330 :GOSUB 1280
1250 NEXT L
1260 IF INP(0)<>0 THEN GOTO 200 :REM CHECK KEYBOARD FOR INTERRUPT INPUT
1270 GOTO 1210
1280 IF A$(L)="ON" THEN F=5:S(B(L))=1 :GOSUB 1400
1290 IF A$(L)="OFF" THEN F=7 :S(B(L))=0 :GOSUB 1400
1300 RETURN
1310 REM
1320 REM
1330 REM BSR HOME CONTROL DRIVER
1340 REM C(X) IS CHANNEL CODE
1350 OUT 9,C(X) :REM SET CHANNEL
1360 GOSUB 1460
1370 RETURN
1380 REM FUNCTION DRIVER
1390 REM F=FUNCTION CODE
1400 OUT 9,F
1410 GOSUB 1460
1420 OUT 9,128 :REM BIT 7 SHUTS OFF TRANSDUCER OUTPUT
1430 RETURN
1440 REM
1450 REM
1460 FOR Q=0 TO 900 :NEXT Q :RETURN :REM DELAY TIMER

```

Listing 2 continued on page 54

A FULL NETWORK DATA MANAGEMENT SYSTEM FOR MICRO COMPUTERS



the Ultimate Software Tool:

AVAILABLE FROM

Micro Data Base Systems, inc.

MDBS IS A VERSATILE DATA BASE MANAGEMENT SYSTEM

- PROVIDES FLEXIBILITY OF A FULL NETWORK DATA BASE SYSTEM
- EFFECTIVE REPRESENTATION OF COMPLEX DATA STRUCTURES
- RECORDS CAN BE ORDERED ON VARIOUS SORT KEYS
- COMMANDS TO ADD, DELETE, UPDATE, SEARCH AND TRAVERSE THE DATA BASE
- SORTED, FIFO, LIFO, NEXT AND PRIOR SET ORDERING PROVIDED
- PROVIDES DATA PROTECTION
- STRAIGHTFORWARD USE OF ISAM-LIKE STRUCTURES
- COMPARABLE TO DATA BASE SYSTEMS PREVIOUSLY AVAILABLE ONLY ON LARGER COMPUTERS

MDBS IS CODASYL ORIENTED WITH EXTENSIONS

- EXPLICIT REPRESENTATION OF MANY-TO-MANY SETS
- RECORD TYPES MAY OWN OTHER OCCURRENCES OF THE SAME RECORD TYPE
- DIFFERENT RECORD TYPES CAN PARTICIPATE IN A SINGLE SET
- MULTIPLE LEVELS OF READ/WRITE PROTECTION
- NAMES OF DATA ITEMS, RECORDS, SETS AND FILES ARE WHOLLY USER DEFINABLE

MDBS IS FOR THE SERIOUS APPLICATIONS PROGRAMMER

- POWERFUL COMPONENT IN INFORMATION PROCESSING
- RELIEVES TEDIUM OF FILE HANDLING DETAILS
- OEMS CAN RAPIDLY AND INEXPENSIVELY DEVELOP APPLICATION SOFTWARE
- USEFUL IN DISTRIBUTED PROCESSING ENDEAVORS

SOFTWARE DELIVERED ON MINI- OR FULL-SIZED FLOPPY DISKS
USING CP/M[®], NORTH STAR, OR TRS-80[®] COMPATIBLE FORMATS

- **MDBS INTRODUCTORY OFFER \$750.00**
- **USERS MANUAL (alone) \$35.00**
- **Distributors and OEMS Contact MDBS for Special Rates**
- **Application Programming Contracts will be Considered.**

Indiana Residents Include 4% Sales Tax.

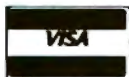

WE ACCEPT

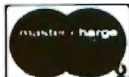

CP/M is a registered trademark of Digital Research Corp.
TRS-80 is a registered trademark of Radio Shack/Tandy Corp.

FEATURES

- WRITTEN IN Z-80 CODE FOR MAXIMAL EXECUTION EFFICIENCY AND MINIMAL MEMORY USAGE. (8080 VERSION EXTRA).
- ROUTINES ARE CALLABLE FROM BASIC (OR OTHER HOST LANGUAGES) TO FACILITATE FAST AND EASY APPLICATION PROGRAMMING.
- ROUTINES CAN BE ORGED TO SATISFY USER REQUIREMENTS.
- SUPPORTS DATA BASES SPREAD OVER SEVERAL DISK DRIVES (MAXIMUM OF 8). DISKS MAY BE MINI- OR FULL-SIZED FLOPPIES OR HARD DISKS.
- I/O AND HOST LANGUAGE INTERFACE ROUTINES ARE ISOLATED FOR EASY ADAPTATION. PATCHES FOR MANY COMMON OPERATING SYSTEMS/HOST LANGUAGE COMBINATIONS AVAILABLE, INCLUDING CP/M[®] WITH BASIC, FORTRAN AND COBOL, NORTH STAR DOS AND BASIC, ETC.

REQUIREMENTS

- **Z-80 Based System (8080 Systems Extra, 6502 Version Forthcoming)**
- **8 to 16K Bytes (Depending on Options) in Addition to the Operating System, Host Language and Users Program.**

PACKAGE INCLUDES

MDBS·DDL DATA DEFINITION LANGUAGE ANALYZER/EDITOR. The user specifies data structures to be used in a concise Data Definition Language (DDL). The MDBS Data Definition Language Analyzer/Editor allows the user to interactively create and edit DDL specifications and to initialize the data base for use based on these specifications.

250 PAGE USERS MANUAL with extensive documentation of the MDBS System.

MDBS·DMS DATA MANAGEMENT ROUTINES. These are the routines callable from the host language (BASIC, PASCAL, etc.) which perform the data base operations of finding, adding, and deleting records; fetching and storing data items; and traversing the (possibly complex) data structure.

SAMPLE APPLICATION PROGRAMS written in North Star BASIC which illustrate various features of MDBS.

MICRO DATA BASE SYSTEMS, INC

P.O. BOX 248 LAFAYETTE, IN 47902

(317) 742-7388

Listing 2 continued:

```
1470 REM THIS ROUTINE IS THE REAL TIME CLOCK INTERFACE DRIVER
1480 REM HARDWARE DESCRIBED IN AUG. '79 BYTE
1490 REM IT READS IN 2400 HR. FORMAT AND IS CONNECTED TO PORT B
1500 RO=0 :OUT 3,254 :REM TURN ON PANEL LIGHT
1510 OUT 8,1 :OUT 8,0 :T=INP(8) :D=T AND 16
1520 IF D=16 THEN 1530 ELSE 1510
1530 MO=T AND 15 :GOSUB 1630
1540 M1=T AND 15 :GOSUB 1630
1550 HO=T AND 15 :GOSUB 1630
1560 H1=T AND 15 :GOSUB 1630
1570 T1=(H1*10+H0)*100+(M1*10+M0) :REM TIME IN 2400 FORMAT
1580 IF RO=T1 THEN 1590 ELSE RO=T1 :GOTO 1510
1590 OUT 3,255 :REM TURN OFF PANEL LIGHT
1600 RETURN
1610 REM T1=TIME H1=TENS OF HOURS HO=HOURS
1620 REM M1=TENS OF MINUTES MO=MINUTES
1630 OUT 8,1 :OUT 8,0 :T=INP(8) :RETURN
```

READY

Text continued from page 48:

nel, and function. To turn on a coffee maker connected to a unit 6 appliance module simply write: DATA 0630,6, "ON". This technique allows us to set up a specific vacation or holiday repertoire. Just load the program and run it. The list of control data can be added to while the program is running. This allows specific actions such as shutting off the television at 2 AM in case you fall asleep during the late show. Entries such as these are retained only as long as the program is running. They must be reentered if the BASIC program is terminated.

Conclusion

I always try to present interfaces and applications that I think will interest BYTE readers. I consider this one is particularly significant considering the cost advantages over earlier technology. I will not replace the relay-controlled lighting in my home, but further expansion of AC control will use the hardware from this article. There are, of course, many situations where the BSR X-10 is inappropriate, but considering the sophistication when it is connected to a computer, I am going to look a lot harder for ones that apply.

Next Month:

It is getting a little cold in Connecticut, and Venezuela is our oil connection. As a result, I have installed a wood stove and have eight cords of wood piled up in the backyard. Realize that not just any stove can be put in the Circuit Cellar, so next month I will discuss my "Computer-Controlled Wood Stove." ■

\$24.95

...AND HOLDING

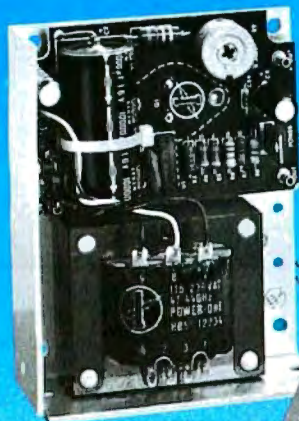

Model HB5-3/OVP

5V at 3A with Built-in OVP

Power One's B Case models started at \$24.95. Over 100,000 models and five years later, they're still only \$24.95!

- 115/230 VAC Input
- OVP Built-in
- .05% Regulation
- 2-Year Warranty
- 2-Hour Burn-in
- UL Recognized
- CSA Certified

Get all the details on our 84 standard open frames in our new 1978 catalog.

IN-STOCK NATIONWIDE...FOR IMMEDIATE DELIVERY

EASTERN REGIONAL SALES OFFICE: Schenectady, N.Y. (518) 399-9200 **ALA.:** Huntsville, Rakes Engr. & Marketing Corp. (205) 883-9200 **ARIZ.:** Phoenix, PLS Assoc. (602) 279-1531 **CAL.:** Pasadena, A-F Sis. Engr. (213) 681-5631; San Diego, A-F Sis. Engr. (714) 226-8424; San Jose, Richards Assoc. (408) 246-5880 **COL.:** Denver, PLS Assoc. (303) 773-1218 **CT.:** Litchfield, Digital Sis. Assoc. (203) 587-9778 **FLA.:** Orlando, OEM Marketing Corp. (305) 299-1000 **GA.:** Duluth, Rakes Engr. & Marketing Corp. (404) 476-1730 **ILL.:** Chicago, Coombs Assoc. (312) 298-4830 **IND.:** Indianapolis, Coombs Assoc. (317) 897-5424 **MD.:** Wheaton, Brimberg Sis. Assoc. (301) 946-2670; Baltimore, Brimberg Sis. Assoc. (301) 792-8661 **MASS.:** Waltham, Digital Sis. Assoc. (617) 899-4300 **MICH.:** Southfield, L.H. Dickelmaier Co. (313) 353-8210 **MINN.:** Minneapolis, Engr. Prod. Assoc. (612) 925-1883 **N.J.:** Whippany, Livera-Polk Assoc. (201) 377-3220; Marmora, Holdsworth (609) 396-4340 **N.M.:** Albuquerque, PLS Assoc. (505) 255-2330 **N.Y.:** Roslyn Hts., Livera-Polk Assoc. (516) 484-1276; Syracuse, C.W. Beach (315) 446-9587 **N.C.:** Charlotte, Over & Over Inc. (704) 527-3070 **OHIO:** Cleveland, Marlow Assoc. (216) 991-6500; Dayton, Marlow Assoc. (513) 434-5673 **OKLA.:** Tulsa, Advance Technical Sis. (918) 743-8517 **ORE.:** Portland, Jas. J. Backer (503) 297-3776; Salem, Jas. J. Backer (503) 362-0717 **PENN.:** Pittsburgh, Marlow Assoc. (412) 831-6113; Newtown Sq., Holdsworth & Co. (215) 358-8550 **TEX.:** Dallas, Advance Technical Sis. (214) 361-8584; Solid State Electr. (214) 352-2601; Houston, Advance Technical Sis. (713) 469-8688; Solid State Electr. (713) 772-8483 **UTAH:** Salt Lake City, PLS Assoc. (801) 466-8729 **WASH.:** Seattle, Jas. J. Backer (206) 285-1300; Radar Elec. Co. (206) 282-2511 **WIS.:** Milwaukee, Coombs Assoc. (414) 671-1945 **EUROPE:** Hanex, L.A., CA (213) 556-3807 **CANADA:** Duncan Instr., Weston, Ontario (416) 742-4448; Winnipeg, Manitoba, Cam Gard Supply Ltd. (204) 786-8481

"Think about" **POWER-ONE** INC.
D.C. POWER SUPPLIES

Power One Drive • Camarillo, CA 93010 • Phone: 805/484-2806 • TWX: 910-336-1297

SEE OUR COMPLETE PRODUCT LISTING IN EEM & GOLDBOOK

Call For Papers — Association for Computing Machinery Conference

Papers are invited on any aspect of computing. Papers must be received by February 18, 1980. For more information, contact Gordon Sherman, Technical Program Chairman, ACM 80, University of Tennessee Computer Center, Knoxville TN 37916, (615) 974-6758.



We're looking for the most original use of an Apple since Adam.

What in the name of Adam do people do with Apple Computers?

You tell us.

In a thousand words or less.

If your story is original and intriguing enough, you could win a one-week all-expense paid trip for two to Hawaii. Which is the closest we could come to paradise.

Win fabulous prizes for creative writing.

To enter, drop by your nearest Apple dealer and pick up an entry blank. Fill it out. Then write an article, in 1000 words or less, describing the unusual or interesting use you've found for your Apple.

A jury of independent judges will cast the deciding vote for the grand prize: a week for two, airfare included, in Hawaii.

The judges will also choose 16 additional winners, two each from eight categories:

graphics/music, entertainment, home, business, education, scientific, professional, and industrial. And each winner will choose from a long list of longed-after Apple peripherals—from Apple Disk II's to Graphics Tablets to printers. Or you can take a \$250 credit towards the purchase of any Apple product.

The contest ends March 31, 1980. All winners will be notified by May 15.

Entry forms are available at your participating Apple dealer. Call 800-538-9696, (800-662-9238 in California), for the one nearest you.

Mail the entry blank, your article and any photos to: Apple Computer, "What in the name of Adam" contest, 10260 Bandley Drive, Cupertino, CA 95014.

And may the juiciest application win.

Circle 31 on inquiry card.

apple computer 

A Computer-Controlled Light Dimmer

Part 1: Design

John H Gibson
Physics Department
Alma College
Alma MI 48801

Microcomputer hobbyists are generally and loosely classified as either software or hardware types, depending on where their dominant interests and fascinations lie. Software types find data manipulation a satisfying end in itself. They dream of ever-expanding memories, and they use their computers to organize their finances, keep kitchen records, and play complex video games. Hardware types look for ever more interesting ways to interface their microcomputers with the outside world. They lie awake at night devising new ways of making their computers control lights, appliances, and mechanical devices. Their homes are filled with wires, relays, and remote sensors.

I am a hardware type. I love to make electrical and mechanical devices respond to automatic control. My most recent interest, which I would like to share with you, has been in using a very simple microcomputer for lighting control.

Of all the control techniques developed by the microcomputer hobbyist, lighting control has remained the most primitive. Until recently, lighting control with a microcomputer was usually restricted to simple on and off switching. *Proportional control*, the controlled dimming of lights, required either expensive hardware or an impractically large software overhead and was therefore beyond the reach of most microcomputer hobbyists.

The recent appearance of peripheral programmable timers for microcomputers has changed all of this. Proportional lighting control with a microcomputer is now both inexpensive and easy to achieve.

Introduction to AC Phase Control

In traditional designs, lamp dimmers used either a rheostat to regulate the current through the lamp, or an

autotransformer to adjust the voltage across it. Either of these inherently analog devices requires that a knob be turned to change the lamp brightness, and neither device is amenable to microcomputer control.

Modern lamp dimmers use the technique of *proportional AC phase control*. A semiconductor switch in series with the lamp is opened and closed 120 times per second. The switch's operation is timed to permit a current to flow through the lamp only during a controlled fraction of each half cycle of the 60 Hz alternating voltage supplied by the power line. Because this is a switching process, it is inherently digital, and it is therefore a ready candidate for microcomputer control.

The switching device most commonly used for AC phase control is the *triac*. A triac is a semiconductor device that functions as a *latching switch*. Once turned on, the triac remains on and cannot be turned off until the current through it drops to zero.

Figure 1a is a drawing of a triac, and figure 1b shows its schematic symbol. The terminals through which the switched current flows are labeled *MT1* (main terminal 1) and *MT2* (main terminal 2). A third terminal, called the *gate*, is used to turn on the triac, that is, to establish conduction between main terminal 1 and main terminal 2. Because of its latching property, once the triac is turned on by the gate, it remains on until the current through main terminal 1 and main terminal 2 drops to zero.

Figure 2 illustrates the basic switching arrangement for AC phase control. A triac and a lamp are connected in series with the 120 V, 60 Hz AC power line. A mechanical push-button switch in series with the triac's gate is pushed and released 120 times per second, or once during each half cycle of the 60 Hz alternating voltage applied to the triac and lamp.



**INTRODUCING THE RAINBOW 2000...
THE PERIPHERAL WITH THE BRIGHTEST COLOR
GRAPHICS SINCE VINCENT VAN GOGH!**

The Rainbow 2000 is the first of a new generation in color peripherals providing a cost effective way to upgrade to full color and high resolution graphics.

By using standard RS 232 C communication interfacing, we made the Rainbow 2000 adaptable to any existing mini or advanced system. A Built-in 6K RAM memory allows the Rainbow 2000 to "stand alone" using just a keypad and color monitor, or it can be utilized with multi-

*TRS-80 is a registered trademark of Radio Shack, a Tandy Co.

terminal systems.

When we at Digitus designed the Rainbow 2000, we had the industrial and scientific user in mind, so we didn't skimp on the specs. We test each board extensively before it is packaged for sale, we use prime quality parts and we back each board with a full one-year guarantee.

So whether you're plotting family expenses on your *TRS-80, or monitoring a factory with an *IBM 370, let the Rainbow 2000 be your step up to color graphics.

*IBM 370 is a trademark of International Business Machine Inc.

The Rainbow 2000, Vincent would have given his right ear for one!

FOR FURTHER INFORMATION CALL OR WRITE:

Digitus Corporation
P.O. Box 10095
Towson, Maryland
21204

in Md. 301-467-3223

800-638-4259

DEALER INQUIRIES
WELCOMED



(a)

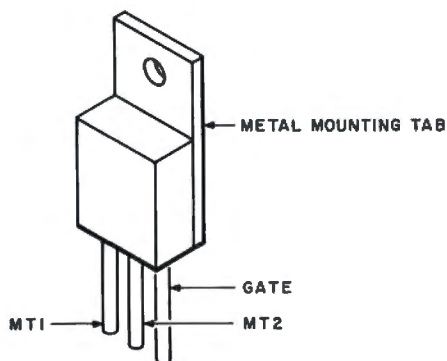

(b)

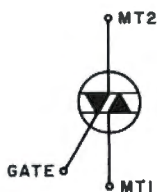

Figure 1: Sketch of triac (1a) and schematic symbol for a triac (1b).

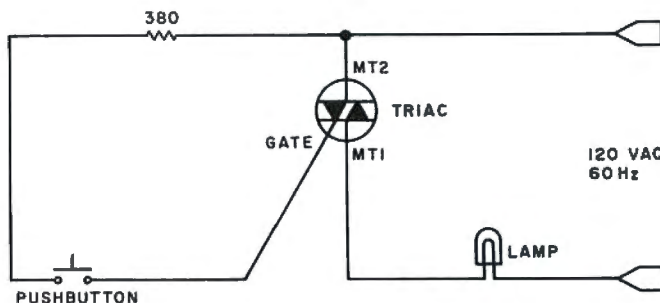

Figure 2: Basic switching arrangement for proportional AC phase control using a triac.

At the beginning of each AC half cycle, the triac does not conduct, so no current flows through it and the lamp. Then, a momentary (30 μ s) closure of the push-button switch sends a current pulse into the triac's gate. This current pulse turns on the triac, establishing conduction between main terminal 1 and main terminal 2.

Because the triac is a latching switch, it then remains on (even though the push button is released) until the end of the AC half cycle, when the current through it drops to zero. The triac then turns off and remains off until the next momentary closure of the push-button switch.

The 380 ohm resistor limits the gate current pulse to a value that will not damage the triac's gate.

Figure 3 illustrates when the current does and does not flow through the lamp during each AC half cycle. In this illustration, the push-button switch is open (and the triac off) for the first 5 ms of the 8.33 ms (1/120 second) positive half cycle. The push button is then momentarily closed.

At this time the triac turns on, and current flows through it and the lamp until the end of the positive half cycle, when the current drops to zero. The triac then turns off and remains off until the next momentary closure of the push button. The next push-button closure occurs during the negative half cycle, when the triac again turns on and remains on until the negative half cycle ends.

Current therefore flows through the lamp for only a fraction of each AC half cycle. The size of that fraction depends on how late in each half cycle the push button is momentarily closed and the triac turned on. The longer the delay in turning on the triac during each half cycle, the less power will be supplied to the lamp.

The simplified switching arrangement of figure 2 is for illustration only. Obviously, no mechanical switch can be pushed and released with the speed and timing accuracy needed to make this a reliable way of achieving proportional phase control of the power supplied to the lamp.

This does not mean that it is difficult to design circuits that will deliver properly timed trigger pulses to a triac. Many analog circuits that do this can and have been designed. They range in complexity from simple, manually adjusted resistor/capacitor phase-shift networks used in household lamp dimmers to sophisticated ramp-and-pedestal circuits that provide AC phase con-

the microcomputer people[®]

THE VITAL INGREDIENT: EXPERTISE

Before you buy your new microcomputer, chances are you have a lot of questions. Important questions that could mean the difference between a working system and a wasted system. The vital ingredient is expertise. The microcomputer people at Computer Mart are expert at answering your questions and helping you put together the best system for your application. Whether it's for business, the home, or the laboratory, come see the experts at Computer Mart of New Jersey. We have the vital ingredient.

Computer Mart of New Jersey
501 Route 27
Iselin, N.J. 08830
(201) 283-0600

HOURS:
Open at 10 am,
Tuesday through Saturday

FOR THE VERY BEST IN NORTHSTAR® COMPATIBLE SOFTWARE

DATA BASE MANAGERS SPECIALII \$10.00 OFF of Selector-III C2

SELECTOR-III C2: SuperSoft is proud to offer the Selector-III C2 at a special \$10.00 discount. Selector III allows instant recall of any record using any information item in the record. This makes Selector-III the most powerful Data Base Management System in micro-computers today! You can define a data format and begin entering your data in minutes. Helps bring applications on line in hours instead of months. (Note: Selector-III C2 requires CP/M and C BASIC-2, not supplied - also 48K Ram required for some applications) Selector-III C2 is: \$335.00 (\$10.00 off list!). (Manual alone: \$20.00)

INSURANCE AGENTS

CRS - Client Record System. A complete program package for the insurance agent. CRS will provide you with very fast online access to your client records, print reports and mail labels, and give you all the information you will need to increase your sales through the use of CRS as a MARKETING TOOL.

CRS stores a complete record for each client that includes the name, address, telephone #, as well as provisions for customer #, salesman # and up to six policies (expandable, if needed). Write for details.

CRS comes with two(2) user's manuals, one for the owner, and one for office personnel (minimal system: one drive, 40K RAM starting 2000H) \$250.00 (Manual: \$40.00)

TEXT PROCESSORS

TFS - Text Formatting System. At last a full featured text processor for NorthStar that you can rely on! TFS has left & right margin justification, page numbering, chaptering, page headings, centering, paged output & MORE. Supports powerful text manipulation including: global & local "search and change," file merges and block moves. This means that you can restructure your text file at any time to look the way you want it to, you can even "chain" files together from disk for documents larger than your current memory.

TFS is completely "load and go" therefore you can start using it at once. You get two(2) user's manual: one is a Quick Start manual to get you going in minutes, the other is an in depth study of TFS. (TFS requires RAM from 0000H to 2000H) \$75.00 (Manual only: \$20.00)

SPEECH SYNTHESIZER SOFTWARE

'ANGLOPHONE' - Lets any 8080/280 computer convert ordinary English into phonetic codes to drive Votrax, computer, and TRS-80 Voice synthesizers. This is a hardworking, tested program suitable for use in the most demanding situations. (Details below). Inquire for specific prices and media.

SPECIFY SINGLE OR DOUBLE DENSITY

TRS-80 COMPATIBLE SOFTWARE

'Tiny' Pascal FOR TRS-80

Now you too can have Pascal! The famous Chung/Yuen 'tiny' Pascal has been specially designed for the TRS-80! The full power and elegance of 'tiny' Pascal is at your command. Programs written in 'tiny' Pascal run at least 4 times faster than the same program in BASIC! 'tiny' Pascal is also a great way to learn Pascal programming, & fun too.

Best of all, you only need a 16K Level II TRS-80! No disk is required. The 'tiny' Pascal operating system is self-contained and very easy to use.

'Tiny' Pascal is a subset of standard Pascal & includes: RECURSIVE PROCEDURE/FUNCTION, IF THEN ELSE REPEAT/UNTIL, 'PEEK' & 'POKE', WHILE DO, CASE, MORE! (Plus full graphics for your TRS-80).

You can save and load programs to and from tape in both source or compiler form.

You get all this and more, plus a user's manual for \$40.00

SPEECH SYNTHESIZER SOFTWARE

'ANGLOPHONE': At last you can take complete advantage of your TRS-80 voice synthesizer. Forget about cumbersome phonetic codes. With 'Anglophone' you can simply use ordinary English. Completely interfaces with BASIC, or just about any other programming language. 'Anglophone' applies sophisticated pronunciation rules to transform normal English spelling into speech using the TRS-80 Voice Synthesizer. Minimum hardware: Level II, 16K, Voice Synthesizer. Comes complete with user's manual and test program.\$45.00



ALL ORDERS PREPAID OR C.O.D.
ILLINOIS RESIDENTS ADD 5% SALES TAX
(217) 344-7596

SUPERSOFT

P.O. Box 1628
Champaign, IL 61820

COMPUTER AIDED INSTRUCTION

M I S S - Microcomputer Instructional Support System. A complete, self-contained CAI package applicable to home, school or business education. Includes everything needed to create a sophisticated computer learning environment. MISS allows one to create any type lesson complete with wrong answer branching, re-test, and complete record keeping. The student is prompted 100% of the way and need have no special knowledge. A special feature is the optional use of a unique algorithm which separates spelling errors from incorrect responses. Absolutely no programming knowledge is required. MISS is completely interactive and maintains complete records on any number of students and lessons (limited only by disk space). MISS is a completely flexible system that will allow you to either create lessons or to purchase pre-programmed lessons which run under MISS. Complete with user's manual....\$40.00 (Manual alone: \$10.00)

ASSEMBLERS

ARIAN - A complete 8080 assembler that interfaces directly to your DOS. ARIAN is completely "load and go". Features include: dynamic file and RAM allocation, custom disk and RAM command capability, several library routines directly accessible by the user. Also, a complete text editor, and system executive. ARIAN is both powerful and easy to learn and use; it is an assembler that you can grow with. Comes complete with a 51 page user's manual (ARIAN requires RAM from 0000H to 2000H) \$50.00 (Manual alone: \$10.00)

ARIAN Utility Package - Several disk based utilities. Includes a complete DEBUG Package: \$50.00

PROGRAMMING LANGUAGES

'Tiny' Pascal - This is famous Chung/Yuen 'tiny' Pascal. FAST - ELEGANT - STRUCTURED. Local and global variables plus procedure and function independence make 'tiny' Pascal great for high speed applications. Compiles to 8080 code that executes up to 25 times faster than BASIC. You also receive SOURCE to 'tiny' Pascal written in Pascal. This means that you can compile the compiler! Add features, relocate, etc. (you will need 36K to do this) \$40.00

UTILITIES

D E B E - (Does Everything But Eat!) This is a must for NorthStar users. You can: COMPACT & EXPAND BASIC programs. Compacting removes unnecessary spaces and remarks. This saves money and makes programs run faster. Expanding puts them back again.

Cross-reference BASIC programs by variables and transfer statements. Global substitutions of variables and transfer statements. Formatted print outs of BASIC programs as well. \$40.00

Energy-Miser

Energy-Miser is a complete heating/cooling analysis program for your home, office or business! With Energy-Miser you can calculate heat loss because of poor insulation, leaky doors and windows, poor planning and more. With Energy-Miser you can predict the annual savings on your utility bills for various improvements or modifications, including: use of solar power, better insulation, opening and closing drapery, etc.

But there is even more: Energy-Miser can also calculate your Return on Investment. That is, you can find your break point for converting to solar, for insulating better, etc. Energy-Miser even takes into consideration the Energy Tax Credit! Energy-Miser is a program designed to save your money!

Energy-Miser is a proven program written by a professional and includes a complete user's manual for \$22.50. (Minimum System 16K Level II, No Disk Required)

'TALKING TERMINAL': The 'Talking Terminal' program turns a TRS-80 into a talking computer terminal. The 'Talking Terminal' program receives input from a remote computer and converts it to spoken words. Its many user options include: Instant Reply, spelled speech, silent or pronounced punctuation, and more. Minimum hardware: Level II, 16K, Voice Synthesizer, RS-232C board and expansion interface.\$145.00

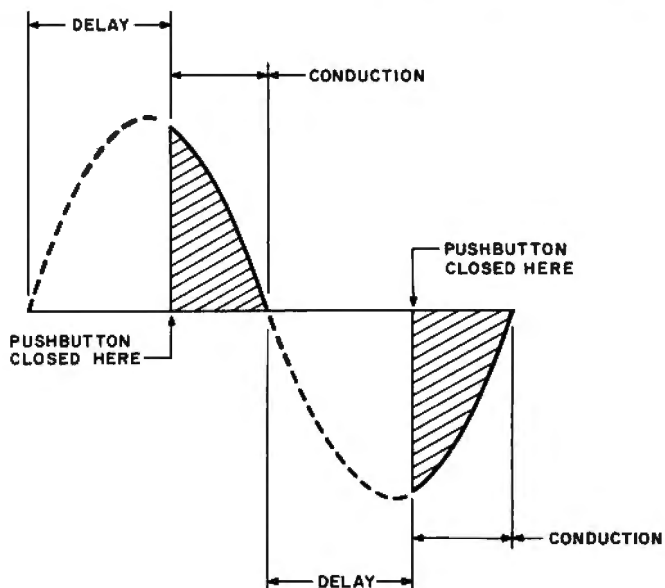

control in response to an input analog voltage level.

Unfortunately, none of these analog circuits is easily controlled by a microcomputer. For microcomputer control, something entirely different is needed.

Computer Control of the Triac

To begin, consider how to connect a microcomputer to a triac. Figure 4 shows a simple circuit for coupling a microcomputer's output to a triac's gate. The coupling device is a Motorola MOC3011 optically isolated triac driver. It consists of a light-emitting diode (LED) and an optically coupled silicon bilateral switch (SBS).

In operation, each microcomputer-generated current pulse through the LED produces a flash of light that trig-

Figure 3: Graph of the current flowing through the triac and lamp. During each AC half cycle, the current begins to flow when the push-button switch is momentarily closed and continues to flow until the current drops to zero. This example shows the push-button switch closed approximately 5 ms after the beginning of each 8.33 ms AC half cycle.

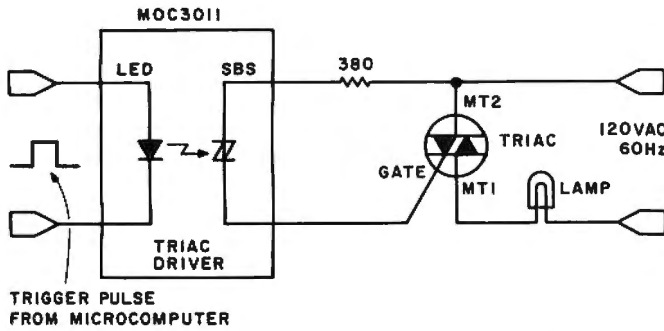

Figure 4: Electrical isolation between the computer and the triac is achieved with a device containing an LED and a silicon bilateral switch (SBS).

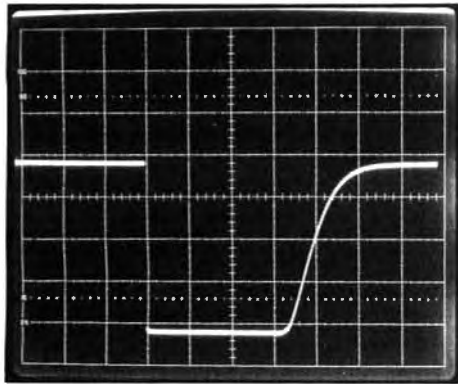

Photo 1: Output of the synchronizer. The waveform was recorded with a vertical scale factor of 1V per division and a horizontal time base of 100 μ s per division. Its zero is at the bottom line of the screen.

gers the silicon bilateral switch into momentary conduction. This sends a current pulse into the triac's gate, turning on the triac for the rest of that AC half cycle. The circuit operates just like the push-button circuit described earlier, except that the push button has been replaced by the silicon bilateral switch, and the triac is now turned on by each microcomputer-generated current pulse.

Electrical isolation is an important feature of this circuit. The MOC3011 permits the microcomputer to control the 120-VAC lamp circuit while remaining electrically insulated from it.

How is the microcomputer to generate the properly timed pulses needed to control the triac? Proportional AC phase control requires 120 pulses per second, with each pulse occurring at a controlled delay interval after the beginning of an AC half cycle. Part of this pulse generation can be performed by software, but there is also an important hardware requirement. The microcomputer can produce properly timed pulses only if it knows when each AC half cycle begins. That is, the microcomputer must be *synchronized* to the AC power line.

This design problem has a two-step solution. The steps are:

1. Design a circuit that generates a pulsed logic-level change at the beginning of each AC half cycle.
2. Use this pulsed logic-level change to signal the microcomputer at the beginning of each AC half cycle.

Figure 5 shows a synchronizing circuit that achieves the goal of step 1. The circuit's output remains at logic 1 (5 V), except when it goes to logic 0 for about 0.4 ms at the beginning of each AC half cycle. This output is the

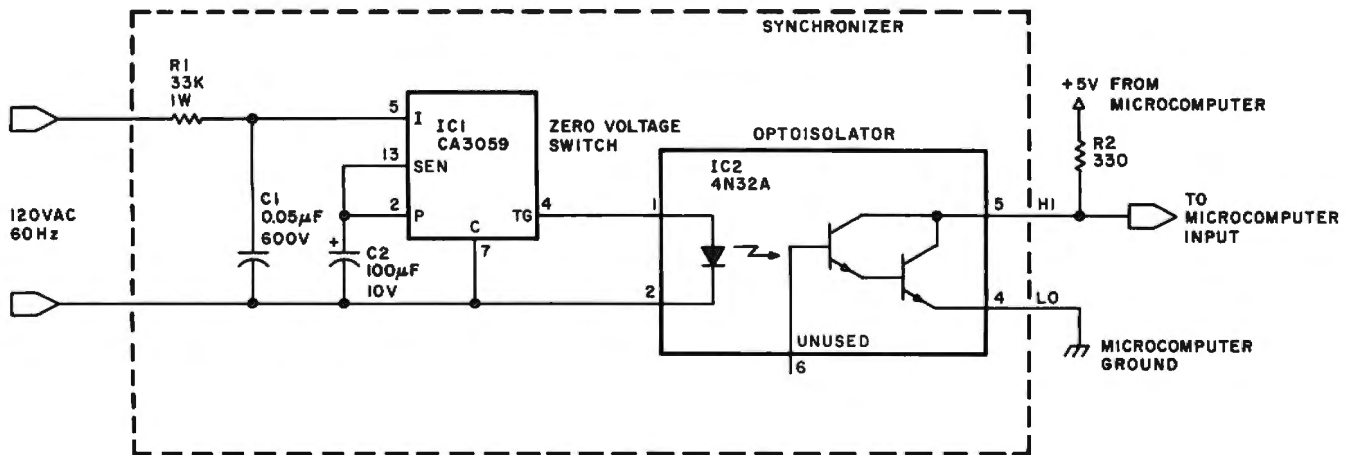

Figure 5: Synchronizer necessary to provide correct timing reference. IC1 is a zero voltage switch that produces a current pulse (from pin 4) at the beginning of each AC half cycle. This current pulse is optically coupled through IC2 to pull a current pulse through R2, thus generating a momentary logic 0 at the synchronizer's output. For convenience and electrical safety, the circuit shown inside the dotted line should be built into a protected, insulated enclosure.

put the pieces together!

MICROPROCESSOR INTERFACING TECHNIQUES

THIRD EDITION

RODNAY ZAKS
AUSTIN LESEA



TO ORDER

By Phone: (415) 848-8233. Visa, MC, American Express

By Mail: Indicate quantity desired. Include payment.

Shipping: Add \$1.50 per book (UPS) or 75¢ (4th class- allow 4 weeks delivery).

Tax: In California, add tax.

Microprocessor interfacing is no longer an art. It is a set of techniques, and in some cases, just a set of components. This book introduces basic interfacing concepts, and then presents in detail implementation techniques for both hardware and software. It covers the essential peripherals, from keyboard to floppy disk, as well as standard buses (S100 to IEEE 488) and introduces basic troubleshooting techniques. Ref. C207, 450pp, Third, (expanded) edition. \$13.95

AVAILABLE AT BOOKSTORES AND COMPUTER STORES EVERYWHERE



Dept. B1
2020 Milvia Street
Berkeley, CA 94704

pulsed logic-level change required.

How is the microcomputer signaled, as required by step 2? The answer to that question depends on how you plan to complete the design of the AC phase control.

One method is to connect the synchronizing signal to one of the microcomputer's interrupt inputs. Upon receipt of each interrupt, the computer enters a program-timing loop to count off the desired delay. At the end of the delay, the program generates an output pulse to trigger the triac and then waits for the next synchronizing interrupt.

An interrupt-driven microcomputer using program-timing loops can handle very simple AC phase control applications, but this scheme becomes unworkable for even moderately sophisticated programs. This is because a wide-range power control capable of adjusting a lamp from complete darkness to full brightness requires a timing loop that runs nearly the full duration of each AC half cycle, leaving almost no time to execute the rest of the program.

It would be much easier to let the microcomputer simply compute a *number* representing the delay time required and leave it to a peripheral timing device to actually count off each delay time and trigger the triac.

Now such a peripheral timing device will be discussed.

The Programmable Timer

A *programmable timer* is a peripheral device designed for connection to the microcomputer bus. It can be con-

figured (by software) so that, driven by an external signal (ie: the synchronizing signal discussed earlier), it generates an output pulse after each input pulse. It accomplishes this with the interval between input and output pulses equal to a *programmed* delay.

This is just what is necessary for an AC phase control. A programmable timer can relieve the microcomputer of all the processing required for delay timing and output pulse generation. With a programmable timer attached, the microcomputer is free to run sophisticated programs that need only load the timer with a new delay number each time a changed delay time is required.

To gain a closer look at the timer's operation, a simplified model will now be examined.

Figure 6 is a diagram of such a timer. In addition to its connections to the microcomputer bus, this timer also has a gate input \bar{G} and an output O. Inside the timer are three addressable registers. They are:

- an 8-bit, write-only *control register* used to establish the timer's operating mode (much as a control register configures the operation of a peripheral interface adapter (PIA));
- a 16-bit, write-only *latch*. Its contents are divided into two 8-bit bytes, called M, for the most significant byte, and L, for the least significant byte. These two bytes are placed in the latch by the program running in the microcomputer, and they may be changed by the program at any time;

FREE Catalog

New 4-way relief from problems with minicomputer supplies and accessories.

1. One-stop shopping.
Inmac (formerly known as Minicomputer Accessories Corporation) has a catalog of over 1000 products. Everything from racks and line-printer paper to connectors and cables. Each designed to help keep your minicomputer or word processing system up and running.

2. Hassle-free ordering.
Inmac lets you order by mail or phone. So keep this free catalog close. It makes those once-tough tasks like ordering your magnetic media easy, fast and foolproof.

3. Fast shipment of just the quantity you need.
Inmac ships your order within 24 hours from centers in California, New Jersey and Texas. In a bind? Call us for the many special services that can get your products to your installation even faster, with no minimum-order requirement.

4. Field-proven quality means precision performance.
Inmac guarantees every product in these 70 pages for at least 45 days. And even some for up to ten years.





Inmac
INTERNATIONAL MINICOMPUTER ACCESSORIES CORPORATION

**Send for your FREE
Inmac catalog or call
(408) 727-1970 today!**

2465 Augustine Drive, P.O. Box 4780, Santa Clara, CA 95051
© 1979 International Minicomputer Accessories Corporation

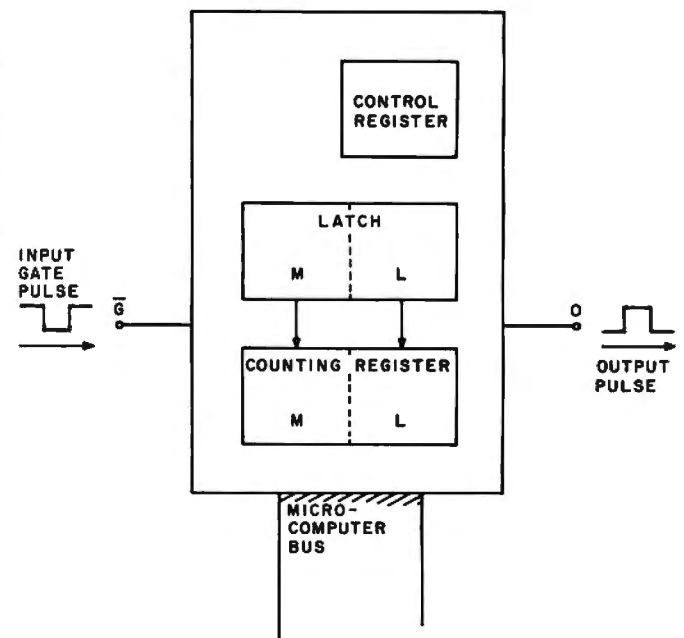

Figure 6: Model of the programmable timer, showing gate input \bar{G} , output O, the connection to the microcomputer bus, and the addressable registers. The arrows pointing from the latch to the counting register indicate the data transfer that takes place at the beginning of each count.

Compucolor II. The personal computer for the enterprising mind.

as your imagination. You need the Compucolor II.

It costs \$1595! That's an exceptional price for a system with an 8-color, 13" display screen, a built-in mini-disk drive, and 8K of user RAM. In fact the Compucolor II has the best cost/performance ratio available in a personal computer. And the price is tax deductible to the extent that you use it in personal tax computation or income-related applications. Consult your tax adviser for full details.

Completely portable, the hardware consists of a full-color screen and detachable keyboard. Simply plug it into the nearest outlet. Programming is easy, with 16K Extended Disk BASIC capabilities stored in ROM. You can also buy low-cost software. Our Sof-Disk™ programs cover a variety of exciting and practical applications. With them, you can beat the Compucolor II at its own games, guide investment decisions, tutor your children, handle financial records, and more.

To find out how much more, visit your nearest computer store. Compare all the systems. You'll choose the Compucolor II.



**Compucolor
Corporation**



*U.S. domestic price

Unretouched photo of screen

Compucolor Corporation • Intecolor Drive • Technology Park/Atlanta • Norcross, Georgia 30092 • Telephone 404/449-5996

BUY ONE of these great professional books when you join the

McGraw Hill



MINICOMPUTER SYSTEMS, Organization, Programming, and Applications. By Richard H. Eckhouse, Jr. and L. Robert Morris. 2nd Ed., 491 pp., illus. Updated, revised, and expanded, this is a book for every systems programmer, systems designer, computer scientist, and application specialist who wants to know more about microcomputer hardware, software, and design. 787/026 Pub Pr., \$21.95 Club Pr., \$17.75

MICROELECTRONICS: Digital and Analog Circuits and Systems. By Jacob Millman. 801 pp., 700 illus. Exciting news for the thousands of engineers who want a thorough refresher and updating on today's ICs. Will be welcomed by both digital and analog electronics engineers at every level of proficiency. 423/27X Pub Pr., \$24.50 Club Pr., \$19.50

AUTOMATIC DATA PROCESSING HANDBOOK. Edited by The Diebold Group. 976 pp., 269 illus. Written by a staff of internationally recognized authorities on ADP, this comprehensive handbook explains systems, programming and the languages, communications processes, and the design and installation of today's computers. 168/075 Pub Pr., \$38.95 Club Pr., \$25.75

THE Z-80 MICROCOMPUTER HANDBOOK. By William Barden, Jr. 304 pp., illus., paperbound. This book gives you the entire "state of the art" in microcomputer technology today. Arranged in three convenient and logically developed sections, the book discusses architecture and interface signals, then powerful interrupt sequences of Z-80 and interfacing examples of I/O memory devices. 784/914 Pub Pr., \$8.95 Club Pr., \$7.60

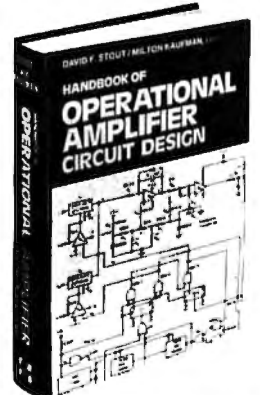

BE SURE TO CONSIDER THESE IMPORTANT TITLES AS WELL—

APPLYING MICROPROCESSORS, New Hardware, Software, and Applications. Edited by L. Altman & S. E. Scrupski. 191/803 Pub. Pr., \$19.50 Club Pr., \$15.50

57 PRACTICAL PROGRAMS & GAMES IN BASIC. By K. Tracton. 784/957 Pub. Pr., \$10.95 Club Pr., \$9.30

MICROPROCESSOR ARCHITECTURE AND PROGRAMMING. By W. F. Leahy. 784/612 Pub. Pr., \$19.95 Club Pr., \$14.95

MICROPROCESSOR AND MICROCOMPUTER SYSTEMS. By G. V. Rao. 783/659 Pub. Pr., \$24.50 Club Pr., \$19.50

THE BASIC COOKBOOK. By K. Tracton. 786/615 Pub. Pr., \$7.95 Club Pr., \$6.75

MICROPROCESSOR PROGRAMMING FOR COMPUTER HOBBYISTS. by N. Graham. 783/56X Pub. Pr., \$12.95 Club Pr., \$10.95

ILLUSTRATED DICTIONARY OF MICRO-COMPUTER TERMINOLOGY. By M. Hordeski. 786/831 Pub. Pr., \$12.95 Club Pr., \$10.95

HOME COMPUTER PROGRAMS. By J. W. Trudell, Jr. & M. Landberg. 787/042 Pub. Pr., \$8.95 Club Pr., \$7.60

FUNDAMENTALS OF COMPUTER ALGORITHMS. by E. Horowitz & S. Sahni. 788/380 Pub. Pr., \$19.95 Club Pr., \$15.95

ELECTRONICS DICTIONARY. By J. Markus. 404/313 Pub. Pr., \$24.50 Club Pr., \$19.50

HANDBOOK OF OPERATIONAL AMPLIFIER CIRCUIT DESIGN. By D. F. Stout; edited by M. Kaufman. 434 pp., 223 illus. Compact, concise, and highly concentrated, this unique "one-stop" designer's handbook contains an enormous amount of information. 617/97X Pub Pr., \$29.65 Club Pr., \$17.50

PRINTED CIRCUITS HANDBOOK. Edited by C. F. Coombs, Jr. 2nd Ed., 634 pp., 595 illus. Covering the subject of printed circuits from the design's idea to final acceptance, this enormously well-received work includes double-sided plated boards through printed boards and also the major variations such as multilayer and flexible circuits. 126/089 Pub Pr., \$32.50 Club Pr., \$24.50

PRINCIPLES OF INTERACTIVE COMPUTER GRAPHICS. By William M. Newman and Robert Sproull. 2nd Ed., 544 pp., illus. Now in a revised, updated Second Edition, this is a volume that has long been THE standard source of information for designers! 483/387 Pub. Pr., \$24.95 Club Pr., \$19.95

PROGRAMMABLE CALCULATORS. By Charles J. Sippl and Roger J. Sippl. 526 pp., illus. 6 1/2 x 10 format, paperbound. Profusely illustrated, this book analyzes pocket "programmable" calculators. The authors concentrate on the trade-up models that users will soon be purchasing. 784/493 Pub Pr., \$13.95 Club Pr., \$11.50

THE 8080A BUGBOOK: Microcomputer Interfacing and Programming. By Peter R. Rony, David G. Larsen, and Jonathan A. Titus. 416 pp., with figures, charts, and tables, paperbound. Gives you the basic concepts of microcomputer interfacing and the associated microcomputer I/O programming to develop your own interfaces. For the 8080 user, this book will be invaluable. 783/845 Pub Pr., \$9.95 Club Pr., \$8.45

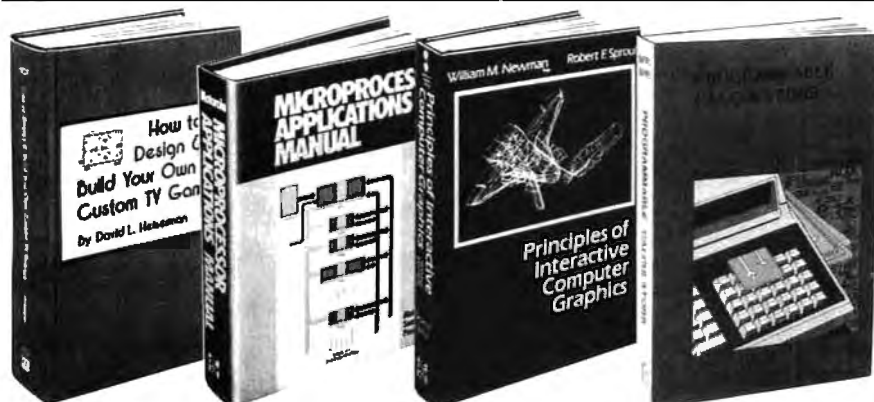

and GET ONE FREE (values up to \$60.00) COMPUTER PROFESSIONALS' BOOK CLUB.

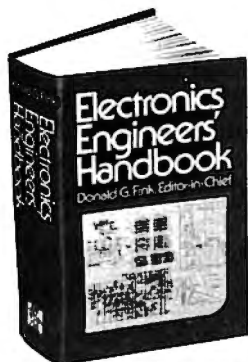

ELECTRONICS ENGINEERS' HANDBOOK. Editor in Chief, D. G. Fink. 2,104 pp., 2026 illus. Brings together in one instant-reference volume the essential principles, data, and design information known today on the components, circuits, equipment, and systems of all the various specialties that make up modern electronics.
209/804 Pub Pr., \$52.50 Club Pr., \$37.50

ELECTRONIC GAMES, Design, Programming and Troubleshooting. By W. H. Buchsbaum and R. Mauro. 335 pp., 338 illus. Information you need to design, program, and troubleshoot electronic games is right here in this widely popular hands-on guide.
087/210 Pub Pr., \$17.50 Club Pr., \$14.00

MEMORY DESIGN: Microcomputers to Mainframes Edited by LAURENCE ALTMAN. 192 pp., illus., 8½ x 11 format Keep "up" with memory chips, through this collection of key articles from *Electronics* magazine. Data, diagrams, and discussions put all the technology to work for you in one authoritative book—a volume so up to date, it's a pleasure to use.
191/549 Pub. Pr., \$18.50 Club Pr., \$15.50

PROGRAMMING LANGUAGES. By Allen B. Tucker, Jr. 439 pp., illus. Gives you not only the principles of design but the applications of six major programming languages. Shows you their strengths and weaknesses in solving various representative "benchmark" problems.
654/158 Pub Pr., \$22.00 Club Pr., \$16.50

MICROCOMPUTERS/MICROPROCESSORS Hardware, Software, and Applications. By John L. Hilburn and Paul N. Julich. 372 pp., illus. Expressly created for people involved in the design, use, or maintenance of digital systems using microcomputers. The authors describe the theory and workings behind microprocessor architecture, read-only memory (ROM), random-access memory (RAM), and input/output interfacing methods.
771/449 Pub Pr., \$22.50 Club Pr., \$16.50

LOGIC DESIGNER'S MANUAL. By John D. Lenk. 504 pp., illus. Written for logic IC users rather than for designers of logic ICs, this book uses time-tested existing commercial logic ICs to solve all design and application problems.
784/671 Pub Pr., \$18.95 Club Pr., \$15.75

HOW TO DESIGN AND BUILD YOUR OWN CUSTOM TV GAMES. By David L. Heiserman. 544 pp., illus. Shows you how to create and build TV games from scratch and modify the ones you already have.
786/585 Pub Pr., \$14.95 Club Pr., \$11.95

MICROPROCESSOR APPLICATIONS MANUAL. By Motorola Semiconductor Products, Inc. 720 pp., illus., 8½ x 11 format. With nuts-and-bolts practicality, this manual by the Motorola people (who should know) gives you detailed applications information on microprocessors and assumes no prior knowledge on your part about MPUs.
435/278 Pub Pr., \$38.00 Club Pr., \$26.50

PERSONAL COMPUTING: Hardware and Software Basics ELECTRONIC BOOK SERIES. 224 pp., 175 illus., outsized 8½ x 11 format Gives you comprehensive guidance to the present state of the art in personal computers—an overall survey of the technology, and methods available to perform various tasks, facts about the work others are doing—and just how they are doing it.
191/514 Pub. Pr., \$14.95 Club Pr., \$11.95

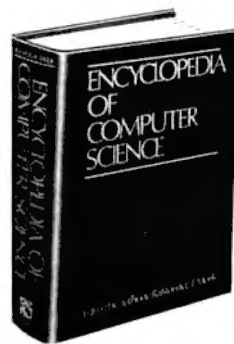

ENCYCLOPEDIA OF COMPUTER SCIENCE. Edited by Anthony Ralston and C. L. Meek. 1,500 pp., 60 illus., 100 charts, 7 x 10 format. This first and only in-depth coverage of the entire field of computer science in a single volume is comprehensive and completely up to date.
769/01X Pub Pr., \$60.00 Club Pr., \$39.95

ANALOG SYSTEMS FOR MICROPROCESSORS AND MINICOMPUTERS. By Patrick H. Garrett. 248 pp., illus. Explores all possibilities for analog systems in one applications oriented volume—with many specific examples.
786/496 Pub Pr., \$18.95 Club Pr., \$14.95

Choose any one of these books at the special club discount, and select any other as your gift Free of Charge when you enroll.

Why YOU should join now!

- **BEST BOOKS IN YOUR FIELD**—Books are selected from a wide range of publishers by expert editors and consultants to give you continuing access to the latest books in your field.
- **BIG SAVINGS**—Build your library and save money too! We guarantee savings of at least 15% off publishers' list prices on every book. Usually 20%, 25% or even higher!
- **BONUS BOOKS**—You will immediately begin to participate in our Bonus Book Plan that allows you savings between 70-80% off the publisher's price of many books.
- **CONVENIENCE**—14 times a year you receive the Club Bulletin FREE, fully describing the Main Selection and alternate selections, together with a dated reply card. If you want the Main Selection, you simply do nothing—it will be shipped automatically. If you want an alternate selection—or no book at all—you simply indicate it on the regular reply card and return it by the date specified. You will have at least 10 days to decide. If, because of late mail delivery of the Bulletin you should receive a book you do not want, just return it at the Club's expense.

As a Club member, you agree only to the purchase of four books (including your first selection) over a two-year period.

Computer Professionals' Book Club

P.O. Box 582, Hightstown, New Jersey 08520

Please enroll me as a member and send me the two books indicated, billing me for my first selection only at the discounted member's price, plus local tax, postage and handling. If not satisfied, I may return the books within 10 days and my membership will be canceled. I agree to purchase a minimum of 3 additional books during the next 2 years as outlined under the club plan described in this ad. Membership in the club is continuous but cancellable by me any time after the four book purchase requirement has been fulfilled.

Write Code # of
FREE selection here

Write Code # of
FIRST selection here

Orders from outside the U.S. must be prepaid with international money orders in U.S. dollars

Charge my VISA MASTER CHARGE* Exp. Date _____

Credit Card # _____ *MC Bank # _____

Signature _____

Name _____

Address _____

City, State, Zip _____

Corporate Affiliation _____

This order subject to acceptance by McGraw-Hill. All prices subject to change without notice. Offer good only to new members. A postage and handling charge is added to all shipments.

P39450

- a 16-bit, read-only counting register. A momentary logic 0 at the timer's gate input causes this register to be loaded with bytes M and L from the latch. The counting register then decrements on each cycle of the microprocessor clock. When the count reaches zero, a voltage pulse is delivered to the timer's output. Details of this operation will be described shortly.

For this application, the synchronizing signal should be connected to the timer's gate, and the timer's output used to trigger the triac.

Now examine the timer in detail by stepping through one cycle of its operation:

1. Upon receipt of a momentary logic 0 at its gate, the timer loads its counting register from the latch (without changing the number stored in the latch). If it is not already low (logic 0), the timer's output goes low.
2. The output remains low for an interval equal to $(M+1)L + 1$ periods of the microprocessor's clock. At

the end of this interval, the timer's output goes high (logic 1).

3. The output remains high for L periods of the microprocessor's clock. At the end of this time, the output again goes low.

4. The output remains low until another momentary logic 0 at the gate starts the cycle again.

This timing sequence is illustrated in figure 7 and example outputs are shown in the photo 2 sequence.

For this application, it is convenient to make L a fixed quantity and let M range from hexadecimal 00 to FF. This choice allows you (1) a fixed output pulse width LT, regardless of the delay chosen, and (2) program control of the timed delay by specification of a single 8-bit byte M.

How is the size of L chosen? The time for one complete cycle of the timer is:

$$\begin{aligned} \text{Timer cycle} &= \text{Delay time} + \text{Output pulse width} \\ &= [(M+1)L + 1]T + LT \\ &= (M+1)(L+1)T \end{aligned}$$

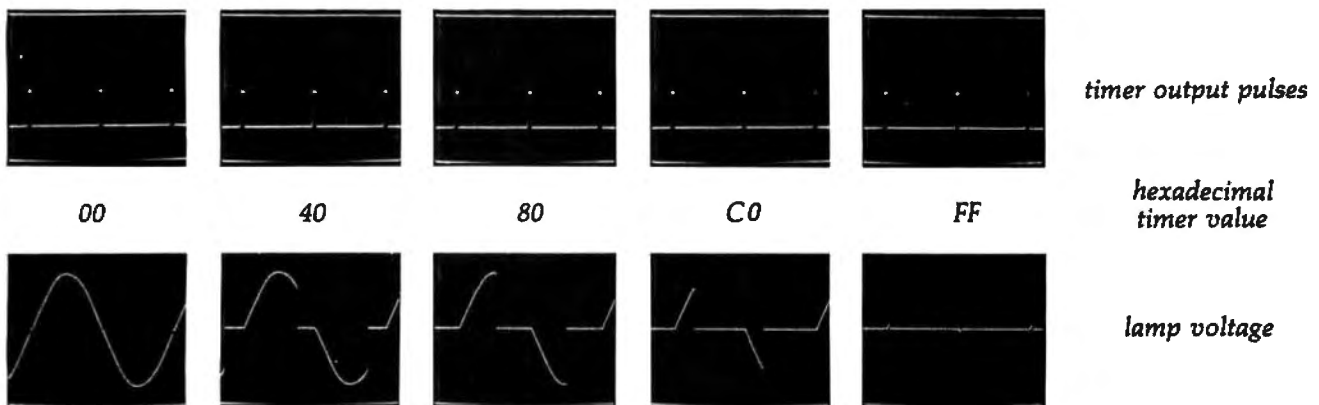

Photo 2: This series of photos shows how the timer's output pulses lag behind those from the synchronizer and how the alternating voltage across the lamp is determined by the delay value contained in the timer latch. The numbers indicate the hexadecimal value. The top row of photos shows how the timer's output pulses lag those from the synchronizer by a time proportional to the delay value. The synchronizer's output is the series of negative pulses across the top half of the screen, while the timer's output is the series of brief positive pulses (blips) across the bottom half. Both waveforms were recorded with a vertical scale factor of 2V per division and a horizontal time base of 2ms per division. The synchronizer's output has its zero at the screen's horizontal center line, while the timer's zero is at the bottom line.

The bottom row of photos shows the alternating voltage across the lamp as determined by the delay value in the timer's latch. The waveforms were recorded with a vertical scale factor of 50V per division and a horizontal time base of 2ms per division.

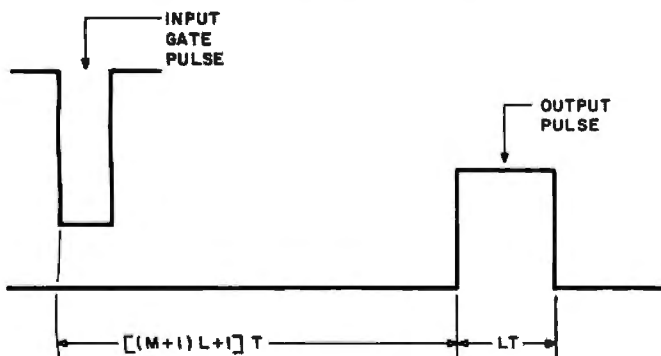

Figure 7: Timer input and output pulses in the single-shot, dual 8-bit operating mode. The output pulse begins at time $t = [(M+1)L + 1]T$ after the input gate pulse, where:

- M = most significant byte loaded from the timer latch into the counting register
- L = least significant byte loaded from the timer latch into the counting register
- T = period of microprocessor clock

Now...

You, the small systems user can enjoy the advantages of HI-performance *low cost* computer graphics

HIPLØT™ Digital Plotters

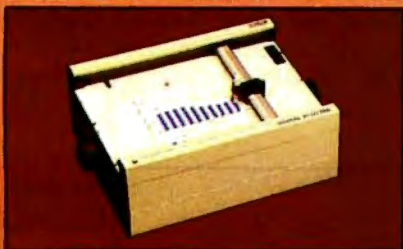

The perfect small system output device

- Displays data in easy to read graphical format
- Both serial and parallel inputs built-in.
- Used standard 8½" x 11" paper (DIN A4)
- Plotting speed up to 2.4 ips (60 mm per sec)
- Resolution of both 0.01 and 0.005 in. (0.1 mm and 0.2 mm)
- Baud rate and step size easily changed
- Completely assembled and ready to use
- Priced at \$1095*

HIPAD™ Digitizers

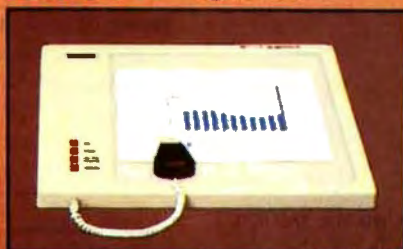

The perfect small system input device

- Resolution and repeatability of 0.005 in. (0.1 mm)
- Origin is completely relocatable
- RS232C and 8 bit parallel interface selectable at the connector
- Accuracies of ± 0.015 in. (0.4 mm)
- Optional LC display shows actual values being inputted
- Digitizing surface 11" x 11" (28 mm x 28 mm)
- Priced at \$795*

For complete information contact Houston Instrument, One Houston Square, Austin, Texas 78753. (512)837-2820. For rush literature requests persons outside Texas call toll free 1-800-531-5205. In Europe contact Houston Instrument, Rochesterlaan 6, 8240 Gistel Belgium. Phone 059/27 74 45.

**houston
instrument**

DIVISION OF BAUMCH & LOMB

"the graphics - recorder company"

Circle 38 on Inquiry card.

TM Trademark of Houston Instrument
*U.S. Domestic Price Only

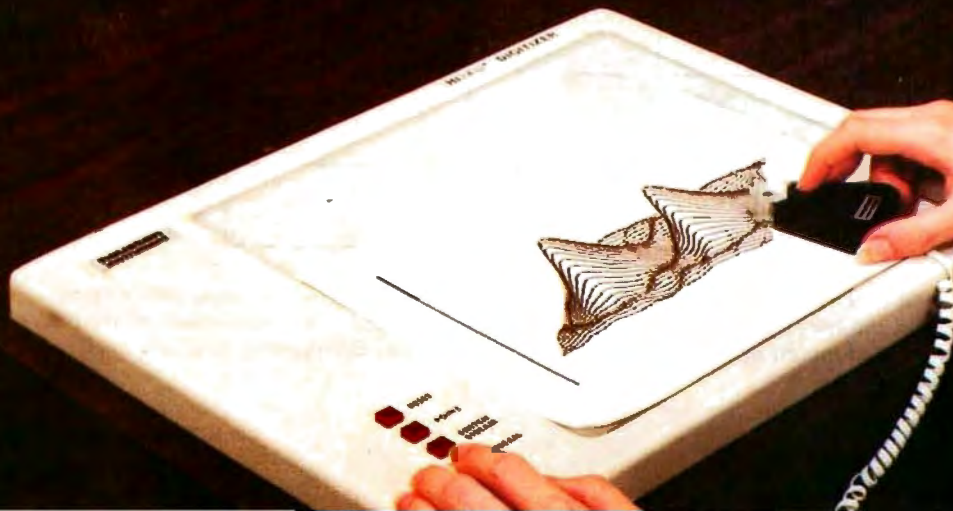
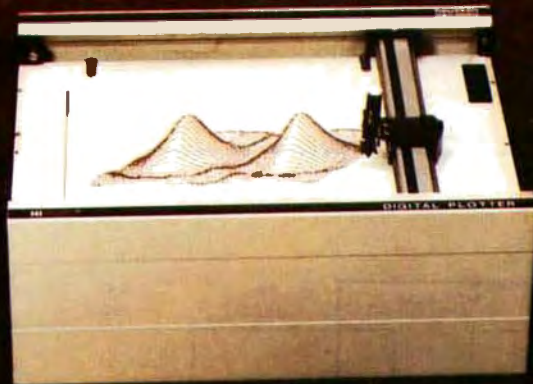

If the maximum value of M is hexadecimal FF or decimal 255, then the maximum time for one cycle of the timer is:

$$[\text{Timer cycle}]_{\max} = 256 (L+1) T$$

Each AC half cycle has a duration of 8333 μs . If you wish one cycle of the timer at maximum delay to just equal one AC half cycle, you must have:

$$8333 \mu\text{s} = 256 (L+1) T$$

which requires that:

$$L = \frac{8333 \mu\text{s}}{256 T} - 1$$

The value picked for L clearly depends on the period T of the microprocessor clock. For example, if the clock period is 2.5 μs (for a 400 kHz clock), the computed value for L is:

$$L = \frac{8333 \mu\text{s}}{256 (2.5 \mu\text{s})} - 1 = 12 = \text{hexadecimal 0C}$$

Using this computed value for L does not work in practice. This is because an intentional, small delay in the synchronizer causes the timed cycle actually to begin about 100 μs after the start of each AC half cycle, thus slightly reducing the time remaining in the half cycle for the timer to operate. However, for this particular example, a value of L = 11 = hexadecimal 0B does work well.

For this example, the timer's output pulse width therefore is:

$$LT = 11 \times 2.5 \mu\text{s} = 27.5 \mu\text{s}$$

Programmable Timer Module

Up to now you have been examining a slightly simplified model of the programmable timer. Now concern yourself with a real device, the Motorola MC6840 programmable timer module. Figure 8 is a pin-assignment diagram for the MC6840.

Each timer in the MC6840 has its own gate input (pins $\overline{\text{G1}}$, $\overline{\text{G2}}$ and $\overline{\text{G3}}$) and its own output (pins O1, O2 and O3). For this application, the synchronizing signal should be connected to all three gate inputs, and the individual timer outputs used to trigger three separate triacs. Figure 9 shows how each timer output should be connected to the AC circuit it controls. With the MC6840's three inde-

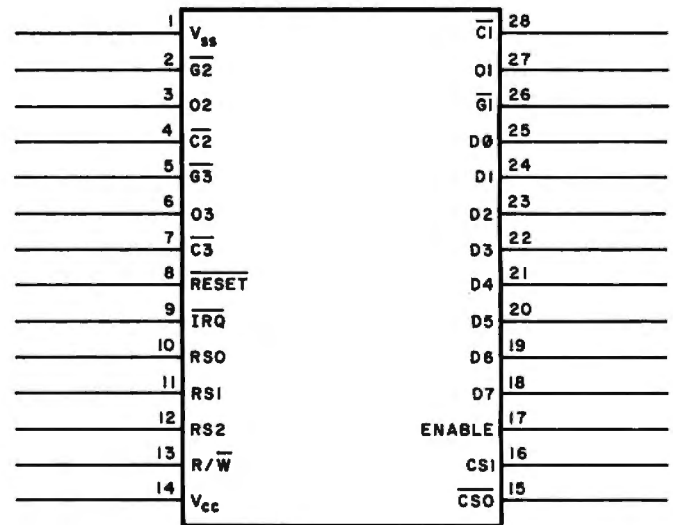

Figure 8: Pin-assignment diagram for the Motorola MC6840 programmable timer module.

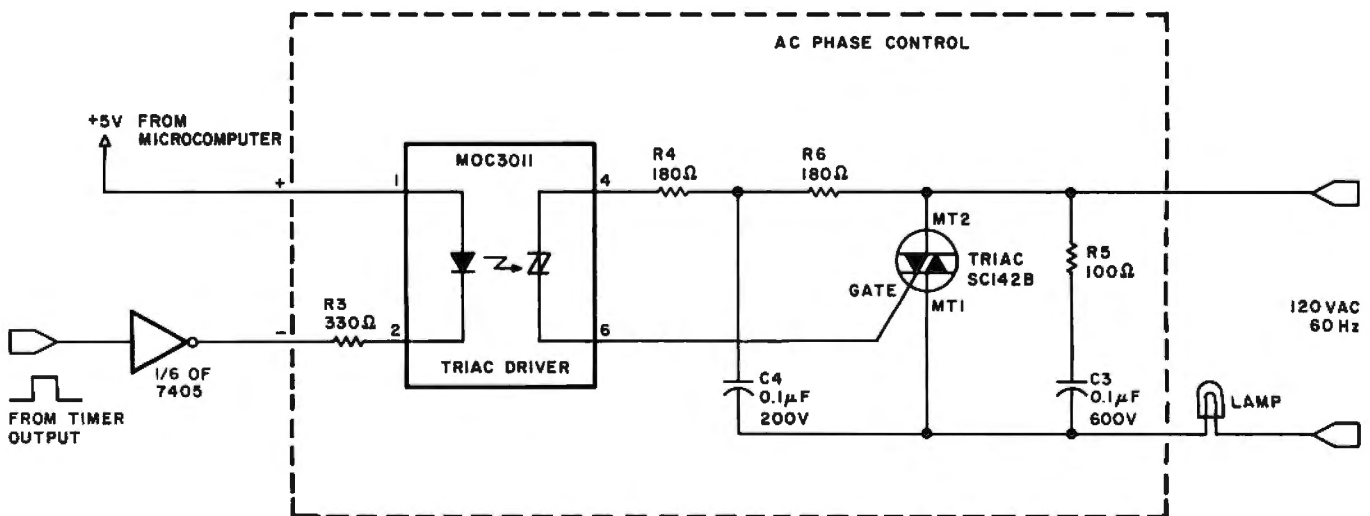

Figure 9: Circuit for connecting one timer output to the AC circuit it controls. The AC phase-control circuit contained within the dotted lines should be built into a metal box, and the triac's isolated mounting tab securely fastened to the inside wall of the box. (Substitution of a different triac without the isolated mounting feature will require the use of special mounting hardware to electrically isolate the triac from the wall of the enclosure.)

26 MEGABYTES

\$4995.



DRIVE A HARD BARGAIN!

Suddenly, S-100 microcomputer systems can easily handle 100 million bytes. Because Morrow Designs™ now offers the first 26 megabyte hard disk memory for S-100 systems—the DISCUS M26™ Hard Disk System.

It has 26 megabytes of useable memory (29 megabytes unformatted). And it's expandable to 104 megabytes.

The DISCUS M26™ system is delivered complete—a 26 megabyte hard disk drive, controller, cables and operating system—for just \$4995. Up to three additional drives can be added, \$4495 apiece.

The DISCUS M26™ system features the Shugart SA4008 Winchester-type sealed media hard disk drive, in a handsome metal cabinet with fan and power supply.

The single-board S-100 controller incorporates intelligence to supervise all data transfers, communicating with the CPU via three I/O ports (command, status, and data). The controller has the ability to generate interrupts at the completion of each command to increase system throughput. There is a 512 byte sector buffer on-board. And each sector can be individually write-protected for data base security.

The operating system furnished with DISCUS M26™ systems is the widely accepted CP/M* 2.0.

See the biggest, most cost-efficient memory ever introduced for S-100 systems, now at your local computer shop. If unavailable locally, write Morrow Designs™ 5221 Central Avenue, Richmond, CA 94804. Or call (415) 524-2101, weekdays 10-5 Pacific Time.

*CP/M is a trademark of Digital Research.

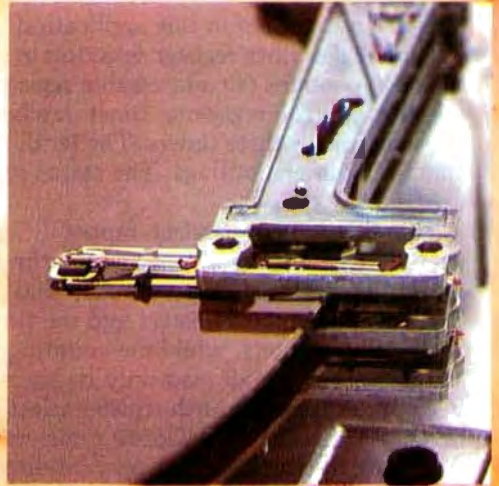

MORROW DESIGNS™
Thinker Toys™

Register select inputs			Operations	
RS2	RS1	RS0	$\overline{R/\overline{W}} = 0$	$\overline{R/\overline{W}} = 1$
0	0	0	CR2 bit 0 clear: Write CR3 CR2 bit 0 set: Write CR1	No operation
0	0	1	Write CR2	Read status register
0	1	0	Write M buffer register	Read M of counter 1
0	1	1	Write L of latch 1	Read L buffer register
1	0	0	Write M buffer register	Read M of counter 2
1	0	1	Write L of latch 2	Read L buffer register
1	1	0	Write M buffer register	Read M of counter 3
1	1	1	Write L of latch 3	Read L buffer register

Table 1: Register selection in the MC6840 programmable-timer module.

pendent timers, it is possible to control three different AC circuits.

Each timer in the MC6840 also has its own external-clock input (pins $\overline{C1}$, $\overline{C2}$ and $\overline{C3}$) for use when timer-counting frequencies different from that of the microprocessor clock are needed. The external-clock inputs are not needed in this application.

Table 1 describes register selection in the MC6840. The MC6840 contains ten addressable registers. Nine of these are the control registers, timer latches, and counting registers for the three timers. The tenth is a status register containing interrupt flags. The status register will not be used.

The three *register-select inputs* RS0, RS1, and RS2 should normally be connected to the microcomputer's low-order address lines A0, A1, and A2 respectively. Because the control registers and the timer latches are all write-only registers, while the counting registers and the status register are all read-only registers, the R/W input in effect serves as a fourth register select line. This feature precludes the use on MC6840 registers of any MC6800 processor instructions that operate directly on memory. Examples of such instructions are INC (increment), DEC (decrement), and CLR (clear).

The next section examines in detail how the MC6840 is programmed for proportional AC phase control.

System Power-Up

A system power-up or a momentary low-logic level on the MC6840's \overline{RESET} line causes the following actions:

- All three timer outputs are set low.
- All three timer latches are preset to hexadecimal FFFF, and the three counting registers are loaded from the latches.
- All three control registers are cleared, except that bit 0 of control register 1 is set. Setting this bit causes all three counting registers to be held in their preset state, so that the timers do not run.

Timer Initialization

The MC6840 is a versatile device with several

operating modes. This application requires that each timer in the MC6840 be configured for single-shot dual 8-bit operation. The MC6840 is initialized for this application by loading hexadecimal B6 into control register 3 (CR3), hexadecimal B7 into control register 2 (CR2), and hexadecimal B6 into control register 1 (CR1).

The order in which these registers are loaded is important. Control registers CR3 and CR1 share a single address space, with bit 0 of CR2 selecting whether control register CR3 or CR1 is accessed (CR2 bit 0 cleared selects CR3; CR2 bit 0 set selects CR1).

For example, if control registers CR3 and CR1 share address hexadecimal 8000 and CR2 occupies address 8001, then (recall that CR2 bit 0 is cleared on system power-up or \overline{RESET}) an appropriate initialization sequence is the following sequence of MC6800 instructions:

```
LDA A  #B6      Control word for CR3 and CR1
LDA B  #B7      Control word for CR2

STA A  $8000    Configure timer 3
STA B  $8001    Configure timer 2
STA A  $8000    Configure timer 1
```

Loading the Timer Latches

With the MC6840 initialized and the program running, the brightness of each lamp is controlled by the number stored in its associated timer latch. If not disturbed, these numbers remain unchanged, and the lamps glow with constant brightness. To change the brightness of any lamp, it is necessary only to load a new number into its timer's latch.

It is important that the two bytes of each timer latch be loaded in the proper order. Although table 1 may lead you to believe that the most significant bytes of the three latches have three different addresses, in reality these three addresses lead to a single 8-bit buffer. To load a particular latch, this buffer register must first be loaded with the most significant byte. Then, when the least significant byte is loaded into space L of the latch, the buffer's contents are automatically transferred to the latch's space M.

MICROTEK

SO RELIABLE WE GIVE YOU

365 DAYS WARRANTY

360	361	362	363	364
355	356	357	358	359
350	351	352	353	354
345	346	347	348	349
340	341	342	343	344
335	336	337	338	339
330	331	332	333	334
325	326	327	328	329
320	321	322	323	324
315	316	317	318	319
310	311	312	313	314
305	306	307	308	309
300	301	302	303	304
295	296	297	298	299
290	291	292	293	294
285	286	287	288	289
280	281	282	283	284
275	276	277	278	279
270	271	272	273	274
265	266	267	268	269
260	261	262	263	264
255	256	257	258	259
250	251	252	253	254
245	246	247	248	249
240	241	242	243	244
235	236	237	238	239
230	231	232	233	234
225	226	227	228	229

TOTAL PEACE OF MIND.

We are business people, just like you. We wouldn't stick our neck out unless we were certain we could back our claims and promises to the last letter. We wouldn't offer a legally binding long-term warranty on our Microtek MT-80, unless we were positive of its solid reliability.

We are sure that our versatile, alphanumeric line printer will provide you consistent, dependable performance. This is why we give you, not the usual 90-days in fine print, but an incredible 365-days warranty. We stand behind every product we make.

LOADED WITH INNOVATIONS

- 40, 80 or 120 columns (software selectable)
- Non-thermal paper, pln feed
- 125 CPS, 70 lines per minute
- 9 x 7 dot matrix
- Vertical format unit
- 96-character ASCII (upper and lower case)
- Adjustable forms width to 9½"
- Parallel, serial (RS-232C), and IEEE-488 interfaces available

OUR UNIT PRICE

\$750. Parallel
\$835. Serial (RS-232C)
\$895. IEEE-488



RELIABILITY

For more information contact:
MICROTEK, Inc.
7844 Convoy Court
San Diego, CA 92111
Tel. (714) 278-0633

Circle 40 on Inquiry card.

For example, suppose the three timer latches occupy hexadecimal addresses 8002 through 8007, and are assigned as follows:

M1: 8002
L1: 8003

M2: 8004
L2: 8005

M3: 8006
L3: 8007

If you wish to load M1, M2, and M3 with new delay numbers DELAY1, DELAY2, and DELAY3 but leave L1, L2, and L3 unchanged with hexadecimal 1E stored in each, the program sequence that would accomplish this is:

```
LDA A DELAY1
LDA B #$1E
STA A $8002
STA B $8003
```

```
LDA A DELAY2
STA A $8004
STA B $8005
```

```
LDA A DELAY3
STA A $8006
STA B $8007
```

It is important to understand that, even though L1, L2, and L3 remain constant, it is not possible to avoid reloading a latch's least significant byte each time you want to change its most significant byte. There is no other way to access the most significant bytes of the timer latches.

Controlled Fading

Proportional AC phase control is most interesting when it is used to fade lamps on and off at controlled rates. This has application to theatrical lighting control, planetarium operation, and control of multiple projectors in a slide show.

Controlled fading may be accomplished by using a program-timing loop to slowly increment or decrement a delay number toward some final value set by the program. The fading stops when the final value is reached. Fading up or down resumes when the program sets a new final value.

The basic timing element can be either the microprocessor's clock or a 120 Hz interrupt signal produced by the synchronizer. Of these two choices, I prefer the latter, simply because it is much slower and therefore easily used to achieve slow fading rates.

But even 120 Hz is too fast. If the delay number is decremented 120 times per second, a lamp fading from complete darkness (DELAY = FF) to full brightness (DELAY = 00) will do so in only 2.1 seconds.

An intermediate register is needed, one which may be incremented or decremented 120 times per second and the carry or borrow generated is used to increment or decrement the delay number.

Summary

You have been introduced to the basic principles of proportional AC phase control; seen how a triac is used for this purpose and how a programmable timer may be used to drive the triac; and looked closely at the Motorola MC6840 programmable timer module configured for this application. A method of using a program timing loop to slowly fade a lamp up and down in brightness has been outlined. You now have all the information necessary to try this on your own.

In part 2 of this article I shall create a program and circuit example on the Heathkit ET-3400 microprocessor trainer that will perform the lighting control functions discussed so far. ■

GIVE YOUR APPLE VISION FOR CHRISTMAS!

The DS-65 DigIsector® opens up a whole new world for your Apple II. Your computer can now be a part of the action, taking pictures to amuse your friends, watching your house while you're away, taking computer portraits... the applications abound! The DS-65 is a random access video digitizer. It converts a TV camera's output into digital information that your computer can process. The DS-65 features:

- **High resolution:** 256 X 256 picture element scan
- **Precision:** 64 levels of grey scale
- **Versatility:** Accepts either interlaced (NTSC) or industrial video input
- **Economy:** A professional tool priced for the hobbyist

The DS-65 is an intelligent peripheral card with on-board software in 2708 EPROM. Check these software features:

- Full screen scans directly to Apple Hi-Res screen
- Easy random access digitizing by Basic programs
- Line-scan digitizing for reading charts or tracking objects
- Utility functions for clearing and copying the Hi-Res screen

Let your Apple see the world!

DS-65 Price: \$349.95
Advanced Video FSII Camera Price \$299.00
SPECIAL COMBINATION PRICE: \$599.00

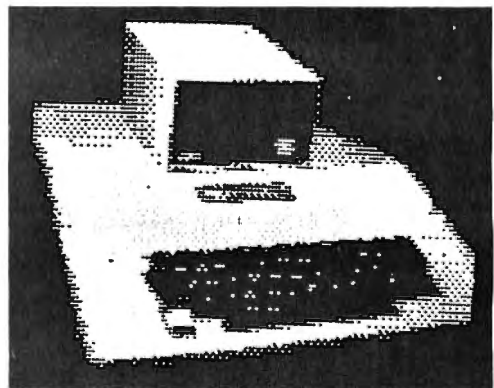

APPLE SELF-PORTRAIT

THE **MICRO**
WORKS

P.O. BOX 1110 DEL MAR, CA 92014 714-942-2400

TARBELL VDS-II

Vertical Disk Subsystem



SYSTEM INCLUDES:

- 2 Siemens 8" Disk Drives
- 1 Cabinet with Fan and Power Supply.
- 1 Tarbell Floppy Disk Interface, assembled & tested.
- 1 CP/M Disk Operating System.
- 1 Tarbell BASIC.
- All Cables and Connectors.
- Complete User Documentation.
- Fully factory assembled and tested.

VDS-II Single Density . . . \$1888
 VDS-IID Double Density \$1999

TARBELL DOUBLE DENSITY INTERFACE FOR 8" FLOPPY DISK

Under Tarbell Double-Density CP/M, single and double density disks may be intermixed. The system automatically determines whether single or double density is in place.

- Software select single or double density.
- Phase-locked-loop and write precompensation for reliable data recovery and storage.
- On-board phantom bootstrap PROM is disabled after bootstrap operation so all 64K memory address space is available to user.
- DMA in single or double density permits multi-user operation.

- Extended addressing provides 8 extra address bits, permitting direct transfers anywhere in a 16 megabyte address range.
- Select up to 4 drives, single or double-sided.
- New BIOS for CP/M included with interface on single-density diskette.

Double Density Interface only, assembled & tested. \$425.

CP/M is a registered trademark of Digital Research.

Tarbell
 Electronics

950 DOVLEN PLACE • SUITE B • CARSON, CALIFORNIA 90746
 (213) 538-4251 • (213) 538-2254

A Furnace Watchdog

Theron Wierenga
POB 2007
Holland MI 49423

Having recently moved into a new home and being a home computer enthusiast, I naturally began looking for an application for my homebrew microcomputer. During the big snowstorm of January 26, 1978, I was snowed in for four days. This situation encouraged the development of several ideas.

With forty-eight km (thirty mile) per hour winds producing 1.8 to 2.4 m (six to eight foot) snowdrifts alongside of the house, and with emergency food source information being broadcast on the local radio

station, it was natural that I began to think about the heating system in the house. During a conversation with my wife several questions arose, and we dug out an information booklet that had been supplied with the furnace. We also began to record the furnace on-off cycles.

More questions arose. How long was the burner on? What were the cycle times? How much gas did it burn per cycle, and what was the cost of this gas? What would be the effect if I used my fireplaces for heating? How much would additional insula-

tion help, and did it really help to turn the thermostat down at night?

It became obvious that the only way to answer these questions would be to monitor the burner cycles of the furnace on a continual basis. This seemed to be an ideal task for my homebrew 8080A microcomputer. By the time the storm had ended, my notebook contained schematic diagrams of all the additional circuitry that would be needed to interface the furnace burner to the computer, and the first drafts of the necessary software were written.

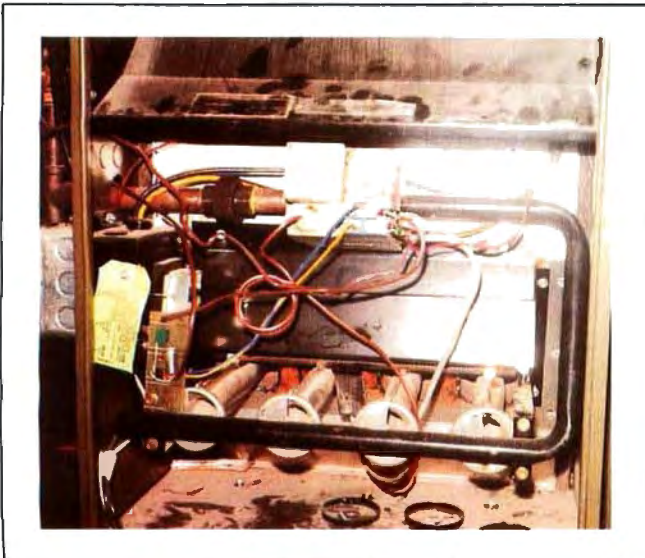

Photo 1: Interior of the gas furnace. The computer interface circuit board is at the lower left, just to the right of the light green paper tag. The gas solenoid is slightly above the center of the photograph.

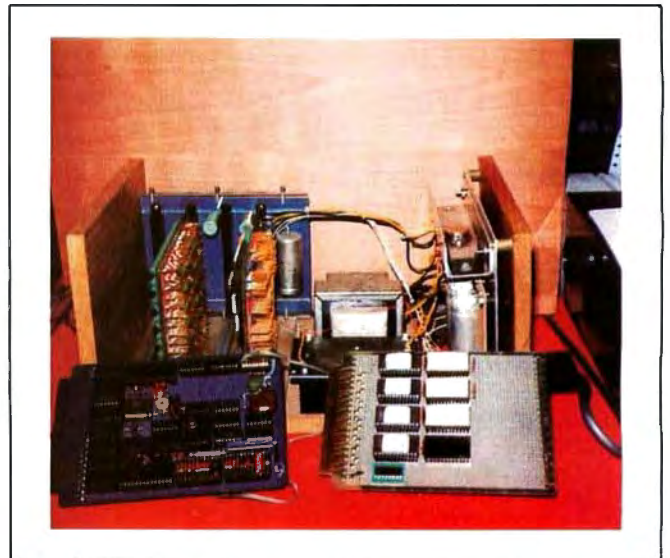

Photo 2: The author's homebrew 8080A-based microcomputer system. Two circuit boards of interest have been removed from the card cage and are displayed in the foreground. The real-time clock and cassette interface board is on the left; the programmable read-only memory board is on the right.

About the Author:

Theron Wierenga is a thirty-four-year-old assistant principal at Muskegon High School where he formerly taught physics and computer science. His undergraduate degree in physics is from Hope College, Holland MI. His master's degree is in educational leadership from Western Michigan University.

He has worked during summers at Brookhaven National Laboratory, and for the PLATO group at the University of Illinois at Urbana.

His recreational interests are early US postal history and electronics. He has designed and built many electronic projects, including a homebrew 8080A computer system and an Altair 8800 system. He is presently working on a Mite printer mechanism for a hard copy I/O device. His primary enjoyment comes from building hardware.

Computer

The microcomputer which was used is unique. It was assembled between May 1977 and January 1978, and uses the 8080A microprocessor. The circuitry was packaged on four 4½ by 6 inch (11.43 by 21.24 cm) wire-wrap boards joined by a motherboard using standard 44-pin double readout edge connectors on 0.156 inch (0.402 cm) centers. The four boards consist of:

8080A central processor, bus drivers, and a serial I/O (input/output) port using the Intel 8251 programmable communication interface.

4 K byte programmable memory using 21L02-type static memory devices.

8 K byte programmable read-only memory using Intel 2708 circuits.

Real-time clock, Kansas City format cassette interface, and a parallel I/O port.

After some effort and a little hair pulling, it was possible for me to squeeze a copy of Processor Technology's 5K BASIC into six 2708-type programmable read-only memories. A monitor (which resides in another 2708) contains routines to load memory, display memory, jump to a specified address, and begin program execution. The monitor can also fill blocks of memory, move blocks of memory, set the real-time clock, read the real-time clock, print the current time on the terminal, record programs on cassette, and play back programs from cassette.

UP TO 2400 MEGABYTES OF HARD DISK CONTROL FOR THE S-100 BUS



Konan's SMC-100 is versatile, fast, cost efficient. It's the disk controller that brings S-100 bus micro computers together with large capacity hard disk drives.

Versatile

Interfaces S-100 bus micro computers with all fixed or removable media disk drives with storage module (SMD) interfaces. Each Konan SMC-100 will control up to 4 drives ranging from 8 to 600 megabytes per drive, including most "Winchester" type drives. Up to 2400 megabytes of hard disk per controller! And you can take your pick of hard disk drives: Kennedy, Control Data, Fujitsu, Calcomp, Microdata, Memorex, and Ampex, for example.

Fast

SMC-100 transfers data at fast, 6 to 10 megahertz rates, with full onboard sector buffering and sector interleaving, and a DMA that's faster than other popular S-100 DMA controllers.

Cost efficient

SMC-100 is priced right to keep your micro computer system micro-priced. It takes advantage of low-cost-per-megabyte disk drive technology to make the typical cost less than \$80 per megabyte. The OEM/Dealer single quantity price is only \$1650, with driver ROM option. Excellent quantity discounts are available.

SMC-100 availability:

Off the shelf to 30 days in small quantities. (Complete subsystems are on hand for immediated delivery.)

Konan has the answers. Talk to them today. Call direct on Konan's order number: 602-269-2649. Or write to Konan Corporation, 1448 N. 27th Avenue, Phoenix, Arizona 85009.

KONAN™

1448 N. 27th Avenue • Phoenix, Arizona 85009 • 602-269-2649

Pick your Apple in downtown Chicago.

Mail order buying is fine for books. But here you get to work with actual machines, feel what they're like, make a hands-on decision, and get instant delivery, to boot.

No waiting.

As one of Apple Computer's top national dealers, we maintain a complete stock of hardware, software, courteous help, service when needed, and total support all the time. We make sure your new computer works right before you take it home, that the interfaces and peripherals work, that you understand the documentation, that the bugs are gone, and that you get everything you want. It's all here. Right now.

English spoken.

We speak all the popular computer languages, except gobbledegook. We also happen to be especially skilled at the language of value. For your home or your business.

Money talks.

For instance, this month's special is an entire Apple II Plus "Business Manager's System" (Apple II is a trademark of Apple Computer, Inc.) for the price of the hardware alone. It means you get the Apple II Plus computer with 48K of RAM, two disk drives, a 9" video monitor, a Centronics 779 printer and controller, plus all the top-quality turn-key business software in the "Controller" package, regularly \$625. The whole \$4,995 value is yours for just \$4,370!

REM PLENTY MORE.

In fact, you could think of all the Apple II hardware and software advertised elsewhere in this publication as a kind of catalog for our comfortable new store. Then come on in and check it all out in person. (Too bad if you don't live in Chicago or the suburbs. Come on vacation.) 106 E. Oak St., Chicago, Ill. 60611 (312) 337-6744.

THE COMPUTER ROOM

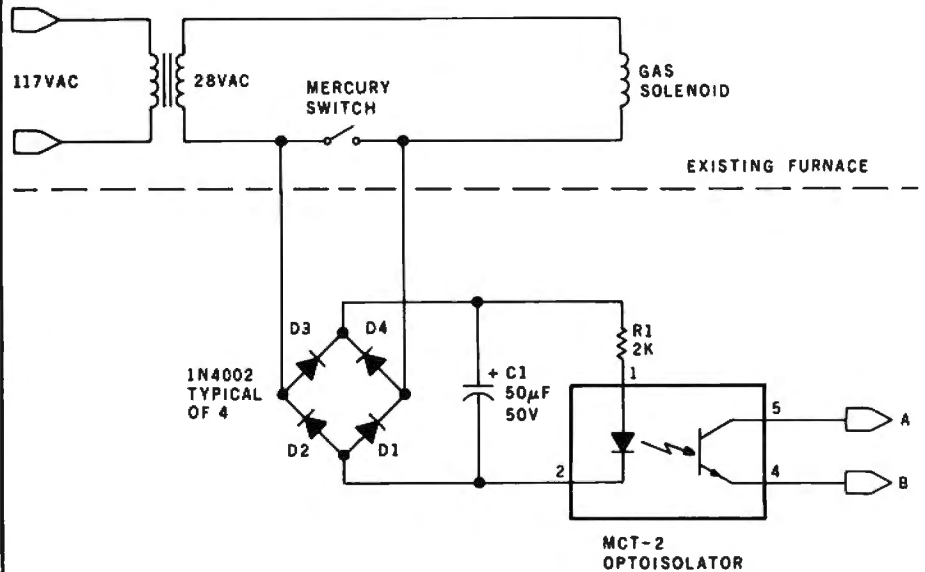

Figure 1: Electronic circuit that allows the computer to tell whether the furnace burner is on or off. The mercury switch is contained in the thermostat, and is connected in series with the gas solenoid and a source of 28 VAC electricity. The voltage difference between the contacts of the mercury switch is 28 VAC when the switch is open (when the furnace burner is off), and 0 VAC when the switch is closed (when the burner is on). When the furnace is off, the phototransistor in the optoisolator conducts in its saturated mode. When the furnace is on, the phototransistor does not conduct.

The only additional necessary hardware was a simple interface to the furnace that the computer could read to determine whether the burner was on or off.

Monitoring Hardware

The only information from the furnace needed by the computer is whether the burner is on or off. This could be supplied to the processor through 1 bit of a parallel input port. Since the computer has a real-time clock, it can then calculate the length of time the burner is on and the amount of gas used. I timed the gas meter over several long periods and found that the furnace took seventeen seconds to burn a cubic foot (28.32 liters) of gas. This measurement was confirmed by figures supplied by the manufacturer of the furnace.

Figure 1 shows how I obtained the one logical bit of information (on or off) from the furnace circuitry. The gas solenoid is connected to a 28 V AC source by the mercury switch in the thermostat. The bimetallic coil in the thermostat tips the switch on as the room temperature decreases, and tips it off as the temperature increases. The contacts of the mercury

switch show 28 VAC when open (furnace burner off) and 0 VAC when closed (burner on).

When the burner is off, the 28 V AC signal is passed to a bridge rectifier made of diodes D1 thru D4. The pulsed DC current is smoothed by capacitor C1 and flows through the light emitting diode (LED) in the optoisolator (OPTO-1), saturating the phototransistor. When the mercury switch closes, no current flows through the LED, and the phototransistor will be in the nonconducting state.

If you have a parallel input port available (actually only one bit of an 8-bit port is needed), you need only connect point A of the circuit to the input of the least-significant bit (LSB) of the port and point B to the system ground. A 1000 ohm pull-up resistor to the +5 V supply should also be connected to the input. A twisted pair of wires can be used to connect the circuitry in the furnace with the input port on the computer.

My computer did not originally have a parallel input port, so I had to construct a simple one with a minimum of parts. Referring to figure 2, an 8T95 three-state buffer was

MicroDaSys Software™ - CP/M™ Compatible

The Pencil Sharpener™ - Now with subscripts and superscripts! The form letter merge utility for the Electric Pencil II™. \$195. Order Code: PS1.

Osborne Accounting Packages. Complete CBASIC II source diskettes of the best accounting software at the lowest price. Accounts Payable, Receivable, Payroll and General Ledger. \$99 each. Order Codes: APO, ARO, PCO, GLO.

6800 and 6809 Cross Assemblers for 8080 and Z80 CP/M Systems. Full Mnemonic assemblers with complete options specification and output formatting. \$89 each. Order Codes: ASM68, ASM69.

For all software specify format: 8", 5" North Star, 5" Micropolis.

We Need Your Help!

An International Company Called MicroDaSys has designed a dynamite solution for the small businessman seeking a computer. We call it the "millie"™. It's a system that combines the absolute best business software available with fast, dependable hardware.

The "millie" is the smartest buy a small business can make. It comes with the most powerful accounting, word processing and applications software available. And to take advantage of that power, the "millie" uses the S-100 bus, eight inch disk drives and the universal CP/M3 operating system. It can be programmed in BASIC, FORTRAN, Pascal and dozens of other languages. Best of all, "millie" prices start at under \$3000. The one illustrated includes a reproduction-quality printer and full accounting and word processing software for just \$6995. "Millie" has been in use for over a year in the US, Europe, South America and Australia. It is a proven design, regularly updated as the state-of-the-art advances.

But an international company can't knock on doors. Without branch offices in every city of the US (and the world) we have the same problem as dozens of other computer manufacturers. We simply can't contact all of the small businessmen who could benefit from our "millie". That's where you come in.

We seek your help. Sell our "millie" as a complete, integrated system to your neighborhood businesses, universities, writers and other professionals. If

you're reading this magazine you probably have all the expertise required to demonstrate and sell "millies". All that's really required is the motivation to seek out prospective customers and the ability to present "millie's" features to them in a way most understandable to them. Put us in your customer's place.

We offer you a piece of the exciting computer market, the chance to work with the most sophisticated software and hardware available, and best of all, a handsome commission and no minimum purchase requirements (not even one!)

It's easy to sell "millies". You will be supported by an international advertising campaign, a dependable system made by a well known manufacturer, and the best documentation available. All you need is the enterprise to seek out new customers and provide them with the support they need (perhaps earning your own consulting fees) during and after installation. We will even supply you with potential sales leads in your area — Reader Service Questionnaires, Direct Mail Inquiries, and Telephone Responses. These are people who want you to sell them a "millie"! All you need to do is act!

You've got nothing to lose! There are absolutely no strings, no minimum purchases, no special degrees or instruction required, no retail store necessary. All that is required is the sincere desire to earn money selling our computers. Join the fascinating field of computer sales now. The market is ready if you are! Write or call today for your introductory sales package and complete info.

millie



For distribution in the Netherlands contact:
Computer Programming International BV
Burg Penstraat 3, Postbus 288, 3740AG Baarn, Holland

‡ CP/M is a registered trademark of Digital Research Corp.

Circle 45 on inquiry card.

MicroDaSys S-100 Products

8P2SM I/O Card. Eight 8-bit parallel I/O ports with handshaking, one serial RS-232 I/O port, one modem I/O port. Kit \$149, Assembled \$199. Order Codes 8P2SMK, 8P2SMA.

MD690a S-100 6800 CPU card. 10K PROM space, 1K RAM, 2400 baud cassette interface, 2 Parallel I/O Ports. Kit \$198, Assembled \$258. Order Codes: MD690aK, MD690aA

New!

ColorMaster™ 80 × 25 Full Color Memory-mapped Video Board. Kit \$399, Assembled \$499. Order Codes: CMK, CMA.

4P4S I/O Card. Four 8 bit parallel I/O ports with handshaking, four serial RS-232 or TTL I/O ports. Kit \$199, Assembled \$249. Order Codes: 4P4SK, 4P4SA.

Super Z™ - The amazing system on a board. Z80 Processor, two parallel I/O ports, serial RS-232 I/O port, counter/timer, 2708/2716 EPROM, and 48K Dynamic Ram -All on one card! Assembled only \$950. Order Code: SZ.

Manuals for hardware and software are \$15, creditable towards purchase.

6809! Single Board Computer

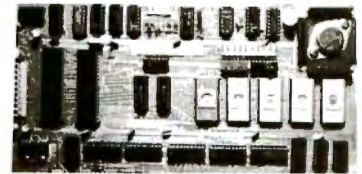

S-100 Compatibility. 6809 Computability

- 1K RAM
- 10K PROM space
- Parallel keyboard input
- Memory-mapped video firmware
- Fully S-100 compatible (including 8080 type I/O)
- MONBUG II monitor included
- 2400 baud cassette interface
- RS-232 level shifters
- 20 I/O lines

\$299 Assembled
\$239 Kit

Order Codes:
MD690aA
MD690bK

Disk Format:
(if applicable)

Please rush me the following.

Quantity	Order Code	Unit Price	Amount
			\$5
Shipping Total			

Check here for:
Millie Sales Package

MicroDaSys P.O. BOX 36051, LOS ANGELES, CA 90036, USA
Dept B1 Phone: (213) 935-4555 TWX: 910-321-2378

NAME _____
COMPANY _____
ADDRESS _____
CITY _____ STATE _____ ZIP _____
Exp. Date _____
Call, residents add 6%

Figure 2: A simple input port that can be used to transfer one bit of information concerning the furnace status to the computer. The address of this input port is hexadecimal 0D, determined by the eight-input NAND gate and the inverter.

Number	Type	+5 V	GND
IC1	8T95	16	8
IC2	74LS30	14	7
IC3	74LS00	14	7
IC4	74L04	14	7
IC5	74LS02	14	7

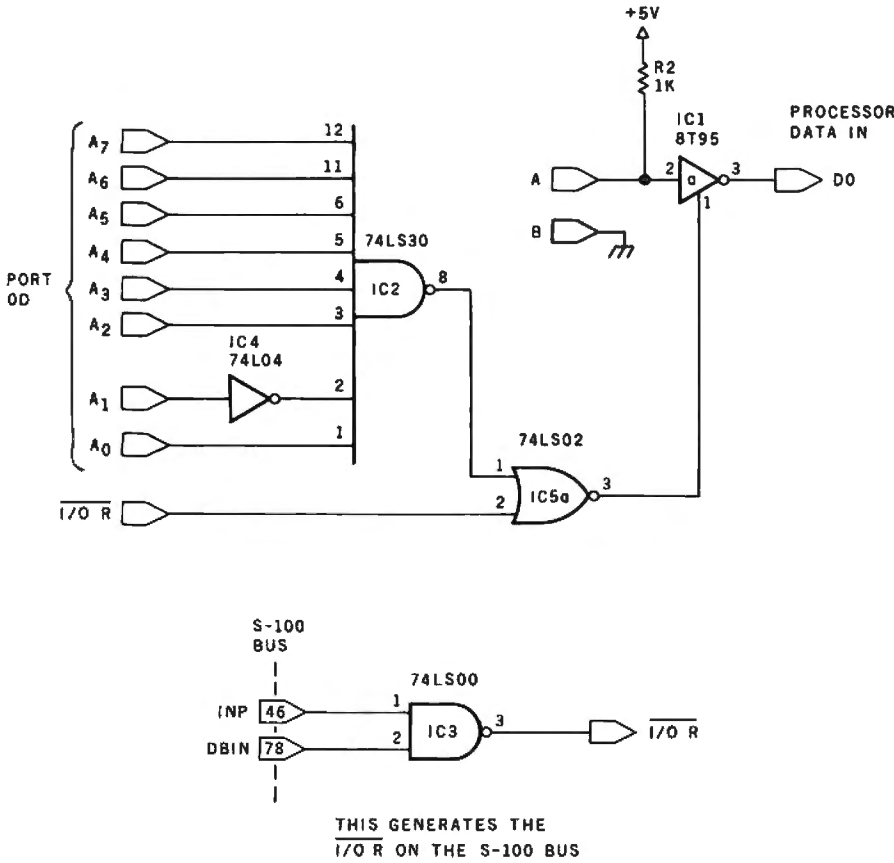

used, as the data bus in the computer is bidirectional. A 74LS30 8-input NAND gate and a single inverter decode the input port address, which is 0D hexadecimal or thirteen decimal. The I/O R signal from the Intel 8228 bus driver gates the input signal onto the bus. This I/O R signal can be duplicated in an S-100 bus machine by NANDing the input instruction (INP) signal from pin 46 together with the DBIN signal on pin 78.

Real-Time Clock

Before I begin to describe the software used, a few words about the real-time clock will be useful. The real-time clock that is used is my own design, and is unique to this computer. Any type of real-time clock could be used in the system. It makes no difference whether or not it uses extensive hardware, software timing loops, interrupts, etc— as long as the processor can obtain the time upon request and be able to convert this into the time of day in absolute daily elapsed seconds (ie: time of day 00:00:00 equals 0 seconds, time 02:03:04 equals $2 \times 3600 + 3 \times 60 + 4 = 7384$ seconds and time 23:59:59 equals 86,399 seconds). A subroutine is used in the BASIC program (in listing 1) beginning at line 600 to derive the absolute time in seconds from the twenty-four-hour real-time clock. Regardless of the type of real-time clock you use, some sort of subroutine will be necessary to calculate the time in absolute seconds. It is also very convenient to have a routine that prints out the current time in traditional form on your terminal.

Software

The main program used by this system (listing 1) is written in BASIC. The BASIC interpreter used is Processor Technology's 5K BASIC. Simply stated, the program continually monitors the furnace burner's state, and each time it shuts off, the computer prints out a line of information on the furnace's last burn cycle. A burn cycle is defined as the interval between two burner-off events.

To eliminate errors induced by switch bounce, ten read operations are done in sequence from the input port. If all of the ten inputs represent the same on or off state, then the pro-

Listing 1: The "watchdog" program, written in Processor Technology 5K BASIC. Once started, this program loops continuously, monitoring the status of the furnace and printing summary data as required. A flowchart is shown in figure 3.

```

10 REM = FURNACE WATCHDOG
12 REM - TO BE STARTED WITH FURNACE OFF
20 DIM M2(12)
22 I9=0;J9=0;G2=.21149
24 PRINT"INPUT MONTH,DAY"
28 INPUT M9,D9
30 PRINT"LAST DOLLAR TOTAL"
35 INPUT K
40 PRINT;PRINT
41 REM - GET TIME
42 GOSUB 600
43 S2=S
44 REM - STORE # DAYS IN MONTHS
45 FOR C=1 TO 12
46 READ M2(C)
48 DATA 31,28,31,30,31,30,31,31,30,31,30,31
49 NEXT C
50 L=0
55 REM - LOOP TO READ INPUT PORT 14
60 T=0
70 FOR C=1 TO 10
80 Z=CALL(12074)

```

Listing 1 continued on page 80



Solve your personal energy crisis. Let VisiCalc™ Software do the work.

With a calculator, pencil and paper you can spend hours planning, projecting, writing, estimating, calculating, revising, erasing and recalculating as you work toward a decision.

Or with the Personal Software™ VisiCalc program and your Apple® II you can explore many more options with a fraction of the time and effort you've spent before.

VisiCalc is a new breed of problem-solving software. Unlike prepackaged software that forces you into a computerized straight jacket, VisiCalc adapts itself to any numerical problem you have. You enter numbers, alphabetic titles and formulas on your keyboard. VisiCalc organizes and displays this information on the screen. You don't have to spend your time programming.

Your energy is better spent using the results than getting them.

Say you're a business manager and want to project your annual sales. Using the calculator, pencil and paper method, you'd lay out 12 months across a sheet and fill in lines and columns of figures on products, outlets, salespeople, etc. You'd calculate by hand the subtotals and summary figures. Then you'd start revising, erasing and recalculating. With VisiCalc, you simply fill in the same figures on an electronic "sheet of paper" and let the computer do the work.

Once your first projection is complete, you're ready to use VisiCalc's unique, powerful recalculation feature. It lets you ask "What if?," examining new options and planning for contingencies. "What if" sales drop 20 percent in March? Just type in the sales figure. VisiCalc instantly updates all other figures affected by March sales.

Or say you're an engineer working on a design problem and are wondering "What if that oscillation were damped by another 10 percent?" Or you're working on your family's expenses and wonder "What will happen to our entertainment budget if the heating bill goes up 15 percent this winter?" VisiCalc responds instantly to show you all the consequences of any change.

Once you see VisiCalc in action, you'll think of many more uses for its power. Ask your dealer for a demonstration and discover how VisiCalc can help you in your professional work and personal life.

You might find that VisiCalc alone is reason enough to own a personal computer.

VisiCalc is available now for Apple II computers with versions for other personal computers coming soon. The Apple II version requires a 32k disk system.

For the name and address of your nearest VisiCalc dealer, call (408) 745-7841 or write to Personal Software, Inc., 592 Weddell Dr., Sunnyvale, CA 94086. If your favorite dealer doesn't already carry Personal Software products, ask him to give us a call.

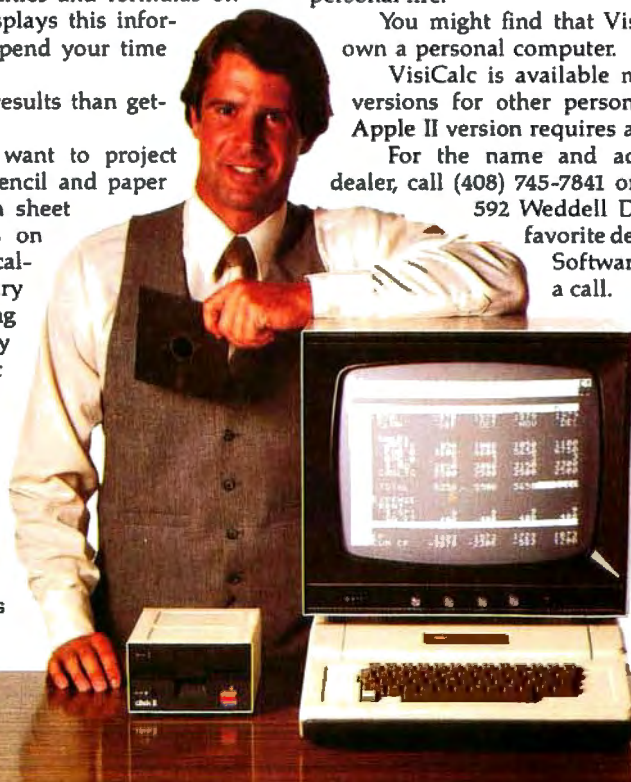

PERSONAL SOFTWARE

VisiCalc was developed exclusively for Personal Software by Software Arts, Inc., Cambridge, Mass.

TM—VisiCalc is a trademark of Personal Software, Inc.

*Apple is a registered trademark of Apple Computer, Inc.

Circle 46 on inquiry card.

Listing 1 continued:

```

90 T=T+Z
100 NEXT C
110 IF T=L THEN 40
120 IF T=10 THEN 160
130 IF T=0 THEN 210
140 GOTO 40
150 REM - GAS ON ROUTINE
160 GOSUB 600
170 G=S
180 L=10
190 GOTO 60
200 REM - GAS OFF ROUTINE
202 REM - DO CALCULATIONS AND PRINT OUT LAST BURN CYCLE
210 GOSUB 600
215 REM - HAS TIME CROSSED MIDNIGHT
220 IF G<S THEN 250
230 I=86400-G+S
240 GOTO 260
250 I=S-G
260 J=(I/1700)*62
262 I9=I9+I
264 J9=J9+J
265 K=K+J
266 REM - HAS TIME CROSSED MIDNIGHT
268 IF S2<S THEN 274
270 D=86400-S2+S
272 GOSUB 500
273 GOTO 275
274 D=S-S2
275 R=(I/D)*100
280 Q=CALL(6262)
288 PRINT TAB(1),M9,"/",D9,
290 PRINT TAB(11),"On",INT((I/60)*100)/100,"Min.",
292 PRINT TAB(27),INT(R*10)/10,"% of",INT((D/60)*100)/100,
294 PRINT TAB(43),"Min. cycle $",INT((J+.005)*100)/100,
296 PRINT TAB(65),"$",INT((K+.005)*100)/100
298 S2=S
300 GOTO 50
499 REM - MON/DAY UPDATE
500 D9=D9+1
510 IF D9<=M2(M9) THEN 560
520 D9=1
530 M9=M9+1
540 IF M9<13 THEN 560
550 M9=1
560 PRINT;PRINT;PRINT
565 PRINT"DAILY TOTALS -- On",INT((I9/864)*10)/10,"%
568 I8=I9/1700
570 PRINT TAB(16),"Cost is $",INT((I8*62)*100)/100
575 PRINT TAB(16),INT(I8*10)/10,"CCF Used"
580 PRINT;PRINT;PRINT
585 I9=0;J9=0
590 RETURN
599 REM - FETCH TIME IN SEC.
600 D1=CALL(12032)
610 D2=CALL(12041)
620 D3=CALL(12047)
630 D4=CALL(12053)
640 D5=CALL(12059)
650 D6=CALL(12065)
660 M=(10*D1+D2)*60+(10*D3+D4)
670 S=M*60+(10*D5+D6)
680 RETURN

```

Figure 3: Simplified flowchart of the watchdog program given in listing 1. Once started, the program loops continuously, checking the status of the furnace and printing summary data as required.

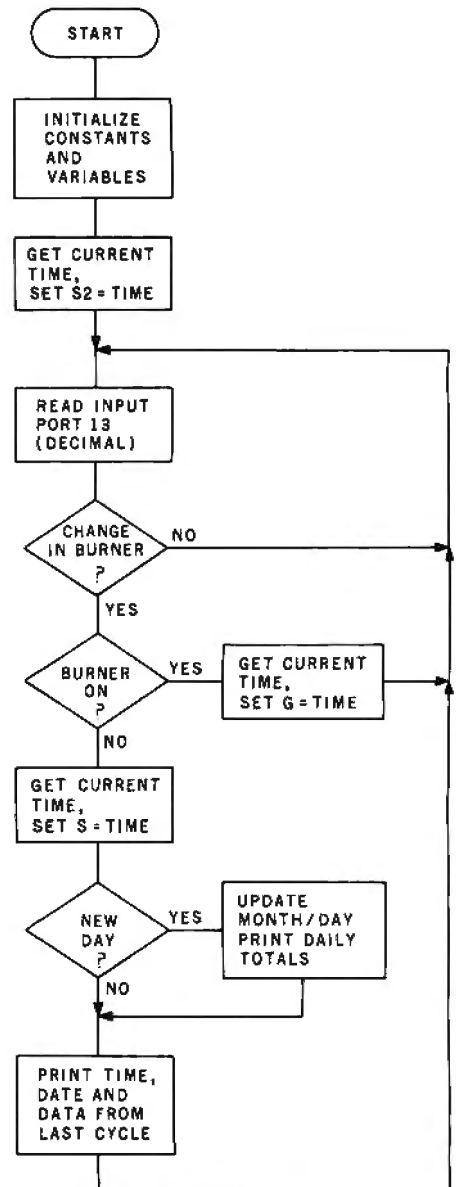

gram accepts this as a true indication of the burner's status. Figure 3 is a simplified flowchart of the program.

Essentially the program loops continually, looking for a change in the burner status. If there is a change, there are two different flow paths depending on whether the burner has just turned on or turned off. If the burner has just turned on, the current time is stored in the variable G. If it has just shut off, the current time and the value stored in G are used to calculate how long the burner was on and the percentage of time the burner



Even at 5:12 a.m., it's hard to quit playing Personal Software™ strategy games.

A quick game before turning in can become an all-night session when you load any of the Personal Software™ strategy games into your Apple,* PET* or TRS-80.* They'll challenge, teach and entertain you. And now there are two new games—Gammon Gambler™ and Checker King™—joining Bridge Partner,™ Time Trek™ and the best-selling Microchess.™

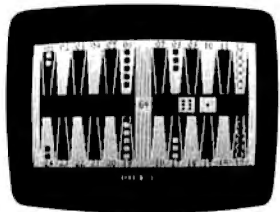

Gammon Gambler

Gammon Gambler is a sure bet. With ten levels of skill, you can begin a novice and become an expert. Whichever level you play, the computer moves so quickly you don't have to wait. The program follows U.S. tournament rules, and includes the doubling cube to spice up the game. Written for the Apple and PET by Willy Chaplin.

Checker King—you probably forgot how much fun it is! If you move and change your mind, take it back and move again—without a peep from the computer. Play eight skill levels. Add and remove pieces. Save three board positions for later play. And solve three challenging checker puzzles. Written by Michael Marks for the Apple, PET and TRS-80.

Microchess, the most widely used personal computer chess program, is a nearly perfect chess opponent for the total novice or the advanced enthusiast. Written by Peter Jennings for the Apple, PET and TRS-80.

Bridge Partner. You against the computer in over 10 million different hands of contract bridge. You can even specify the hands' high card points. Written by George Duisman for the Apple, PET and Level II TRS-80.

Time Trek is easy to learn, difficult to master and impossible to forget. Take command of a starship in real-time action to make the galaxy safe again. PET version by Brad Templeton. TRS-80 program by Joshua Lavinsky.

Personal Software, Inc., also produces the VisiCalc™ program (the software that's revolutionizing personal

computing), CCA Data Management System, the Vitafacts series and other exciting software for the Apple, PET and TRS-80.

Now that you've read about the Personal Software programs, go see a demonstration. For the name of your nearest Personal Software dealer, call (408) 745-7841 or write to Personal Software, Inc., 592 Weddell Drive, Sunnyvale, CA 94086.

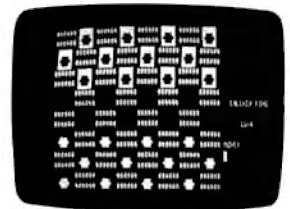

Checker King



PERSONAL SOFTWARE



STRATEGY GAMES SERIES

*Apple is a trademark of Apple Computer, Inc.; PET is a trademark of Commodore Business Machines, Inc.; TRS-80 is a trademark of the Radio Shack Division of Tandy Corp. Circle 47 on inquiry card.

Table 1: Use of variables in the BASIC program of listing 1. The physical items of data represented by each variable are shown here. During leap years (such as 1980), the array M2 must be modified to reflect the greater number of days in the month of February.

D	Number of total seconds in the previous burner cycle, from last burner-off event to current burner-off event.
D1	Most significant digit (MSD) of current time; number of tens of hours.
D2	One digit of current time; number of units of hours.
D3	One digit of current time; number of tens of minutes.
D4	One digit of current time; number of units of minutes.
D5	One digit of current time; number of tens of seconds.
D6	Least significant digit (LSD) of current time; number of units of seconds.
D9	The current day of the month.
G	Absolute daily elapsed time in seconds that the burner was on in the current cycle.
G2	Cost of gas in dollars for 100 cubic feet (2832 liters).
I	Number of seconds the burner was on in the previous cycle.
I8	Total number of units of gas used for the day, one unit = 100 cubic feet (2832 liters).
I9	Accumulated number of seconds the burner has been on during the day.
J	Cost, in dollars, for the previous burner cycle.
J9	Accumulated cost of gas for the total day.
K	Accumulated total cost of gas since the program was started.
L	Set to zero if the burner is currently off, set to ten if the burner is currently on.
M	Current time in minutes from 00:00:00.
M2	A subscripted array of twelve values containing the number of days in each month, ignoring leap years.
M9	The current month.
R	Percentage of time the burner was on during the previous burner cycle.
S	Absolute daily elapsed time in seconds from 00:00:00.
S2	Time, in absolute daily elapsed seconds, that the burner was off in the previous cycle.
Z	The value returned by a machine language subroutine, set to zero if the burner is off and to one if on.

was on during the last cycle. A calculation of the cost of the gas used is done, as well as the total running

cost. This information is then printed out on the terminal.

Table 1 describes the physical data

that the variables in the program represent. These descriptions should help in understanding the program's details.

There are eight places where the CALL function is used in the BASIC program. The CALL function branches to a machine language subroutine in the following way. An address (in decimal) is supplied as the argument, and program execution is transferred to that address. Any desired value to be returned to the BASIC program is put in the variable to the left of the equal sign by placing it in the HL register pair before returning from the subroutine. A RETURN instruction at the end of the machine language routine returns control back to the BASIC program. My machine language routines begin at hexadecimal address 2F00.

The CALL at line 80 simply reads input port hexadecimal 0D and returns either a logical zero or one to denote whether the burner is off or on, respectively.

The CALL at line 280 transfers control to a machine language routine that reads the real-time clock and prints the current time on the terminal in standard form. The variable Q is not used for any calculations, but rather just supplies the necessary syntax for the BASIC interpreter. A subroutine called TTOP, which resides at hexadecimal address 189D in the monitor, is used within this routine as well as in the machine language routines that begin at hexadecimal memory location 2F00. TTOP reads the real-time clock and stores the 6-digit time (as ASCII characters) beginning at hexadecimal memory location 2254.

The six CALLs beginning at line 600 are used to retrieve the individual digits of the current time of day from the real-time clock. The six digits are then used to calculate the absolute time of day in seconds.

The machine language subroutines are shown in listing 2 and are quite straightforward. The subroutines S1 through S6 each read a single digit of the time and return it to the BASIC program in the HL register pair. Subroutine S1 is always the first called, and the actual clock-read operation is done here just once. MASK is used to strip high-order bits from the ASCII character representation of

PASCAL/M™

A CP/M* COMPATIBLE PRODUCT

PASCAL/M is an implementation of the Standard Pascal programming language designed by Niklaus Wirth.

PASCAL/M does all input/output and file manipulation via calls to CP/M. The file interface intrinsics were chosen to promote Pascal program transportability and to provide a bridge between CP/M and the Standard Pascal language definition. In selecting and defining extensions to PASCAL/M, heavy weight was given to compatibility with other existing Pascal implementations. Over 40 extensions to Standard Pascal support:

- Console Cursor Controls
- Type String
- Untyped files (for memory image I/O)
- Segment procedures (memory sharing)
- String and Character procedures to support insertion, deletion and replacing of character data.

PASCAL/M provides single precision floating point (Type Real). Both Integer (16 bit) and long Integer (32 bit, 9 digit) arithmetic are supported. An optional version will support the AMD 9511A or the Intel 8231 math chips.

AVAILABLE VERSIONS		
CP/M Type	CPU Type	Disk Size
1.4	8080/85	8"
1.4	Z80	8"
Cromemco CDOS	Z80	8"
Northstar 2D (Lifeboat)	Z80	5-1/4"
2.0	8080/85	8"
2.0	Z80	8"
MP/M 1.0	8080/85	8"
MP/M 1.0	Z80	8"

PASCAL/M requires 56K RAM and one floppy disk. The package includes diskette with P Code Compiler, Interpreter, and Runtime Library; *Pascal User Manual and Report* by Jensen and Wirth; and *PASCAL/M User's Reference Manual*. The cost is \$350. For manuals only - \$35.. Dealer inquires welcomed. Visa/MC.

*CP/M is a trademark of Digital Research

Digital Marketing
2670 Cherry Lane
Walnut Creek, CA 94596
(415) 938-2880

December 1, 1979

Oregon Software

To the users of OMSI Pascal-1 for the PDP-11:

We are pleased to make available to you the new version (V1.2) of OMSI Pascal-1. V1.2 contains many enhancements and improvements, and you will find it easier to operate and even more reliable. The following overview outlines the most significant changes incorporated in the new version. For details, please ask for the V1.2 Language Specification and User's Guide(s).

Extended precision real arithmetic: a compiler switch causes all real calculations to be carried out with 15 digit precision (standard PDP-11 double precision four-word format). Extended precision is supported on all PDP-11 and LSI-11 processors, and on all operating systems. The precision of the library functions is also extended.

Debugger: the interactive debugger is now entirely Pascal-oriented, and is conversant with all user identifiers, types, scope rules, and the source program. The debugger has the capability, for example, to intercept a fatal error and display the last executed statements, or to accept and store commands for display of variables at a breakpoint.

Profiler: if you have ever wondered where your program spends its time, the Profiler can produce a listing and show you the number of times every line is executed.

Fatal error recovery: the system error procedure can be replaced by a Pascal-coded routine.

Direct access files: the procedure Seek(file,record) is a built-in procedure, and causes the file buffer to be positioned to any desired record.

File options: many enhancements have been made in file processing, allowing (for example) large buffers and spanned records on RSTS and RT11, and RSX file attributes including variable-length records. The RSTS file support uses 24-bit block numbers for RSTS V7 large file capability. All systems now support a full default filename when opening files.

Fast MACRO: most of the compilation time is actually spent in MACRO and the linking loader. On RSTS systems, a new utility (MAC) performs both of these functions in one-third of the time.

String package: included with V1.2 is a set of procedures and functions for handling dynamic length character strings. The package is written for portability in Standard Pascal.

Order information: to OMSI Pascal-1 licensees in warranty or extended support, V1.2 is available for the cost of handling, media, and shipping; other parties please contact Anne Smith, Vice-president for Sales.

Yours truly,



Donald Baccus

Vice-president, Software Engineering.

2340 SW Canyon Road Portland, Oregon 97201

(503) 226-7760 Cable: SOFTWARE TWX 910-464-4779

DESKS AND STUFF



Computer terminals, business systems, lab components . . . they all need desks and enclosures. That's what we're all about. Computer Furniture and Accessories offers a standard line of furniture suitable for a wide variety of applications. Handsome, rugged, economical furniture in all shapes, sizes and colors. Basic models shipped from stock in days, not months. And we're nice people to deal with. What more could you ask for?

CF&A

**Computer Furniture and
Accessories, Inc.**
1441 West 132nd Street
Gardena, CA 90249
(213) 327-7710

Listing 2: Machine language subroutines that are called by the BASIC program of listing 1, shown here in assembler for the 8080 processor. Routines S1 through S6 each read a single digit of the time from the real-time clock. The digit value is returned to the BASIC program in the HL register pair. S1 is always the first to be called, and the actual clock read operation is done only once. MASK strips the high-order bits from the ASCII character representation of the digit.

8080 MACRO ASSEMBLER, VER 2.0 ERRORS = 0 PAGE 1

```

; FURNACE WATCHDOG
; WRITTEN BY T. WIERENGA, FEB. 1978
;
; READ HOURS,MINUTES,SECONDS
;
189D      TTOP      EQU 189DH
2F00      ORG      2F00H
2F00      CD9D18   S1:   CALL TTOP      ; READ CLOCK
2F03      3A5422   LDA 2254H   ; STORE IN MEMORY
2F06      C3242F   JMP MASK    ; GET TENS HOURS
2F09      3A5522   S2:   LDA 2255H   ; GET UNITS HOURS
2F0C      C3242F   JMP MASK
2F0F      3A5622   S3:   LDA 2256H   ; GET TENS MINUTES
2F12      C3242F   JMP MASK
2F15      3A5722   S4:   LDA 2257H   ; GET UNITS MINUTES
2F18      C3242F   JMP MASK
2F1B      3A5822   S5:   LDA 2258H   ; GET TENS SECONDS
2F1E      C3242F   JMP MASK
2F21      3A5922   S6:   LDA 2259H   ; GET UNITS SECONDS
2F24      E60F     MASK: ANI 00FH
2F26      6F       MOV L,A     ; RETURN VALUE IN H,L
2F27      2600     MVI H,0
2F29      C9       RET

; READ INPUT PORT 13 (ODH)
; 0=FURNACE OFF, 1=ON
;
2F2A      DB0D     IN 13
2F2C      E601     ANI 1      ; LSB ONLY USED
2F2E      6F       MOV L,A     ; RETURN VALUE IN H,L
2F2F      2600     MVI H,0
2F31      C9       RET
    
```

END

NO PROGRAM ERRORS

8080 MACRO ASSEMBLER, VER 2.0 ERRORS = 0 PAGE 2

SYMBOL TABLE

* 01

A	0007	B	0000	C	0001	D	0002
E	0003	H	0004	L	0005	M	0006
MASK	2F24	PSW	0006	S1	2F00 *	S2	2F09 *
S3	2F0F *	S4	2F15 *	S5	2F1B *	S6	2F21 *
SP	0006	TTOP	189D				

!C B1B0

```

:102F0000CD9D183A5422C3242F3A5522C3242F3A78
:102F10005622C3242F3A5722C3242F3A5822C324BF
:102F20002F3A5922E60F6F2600C9DB0DE6016F2606
:022F300000C9D6
:0000000000
$
    
```

THE INFLATION FIGHTER

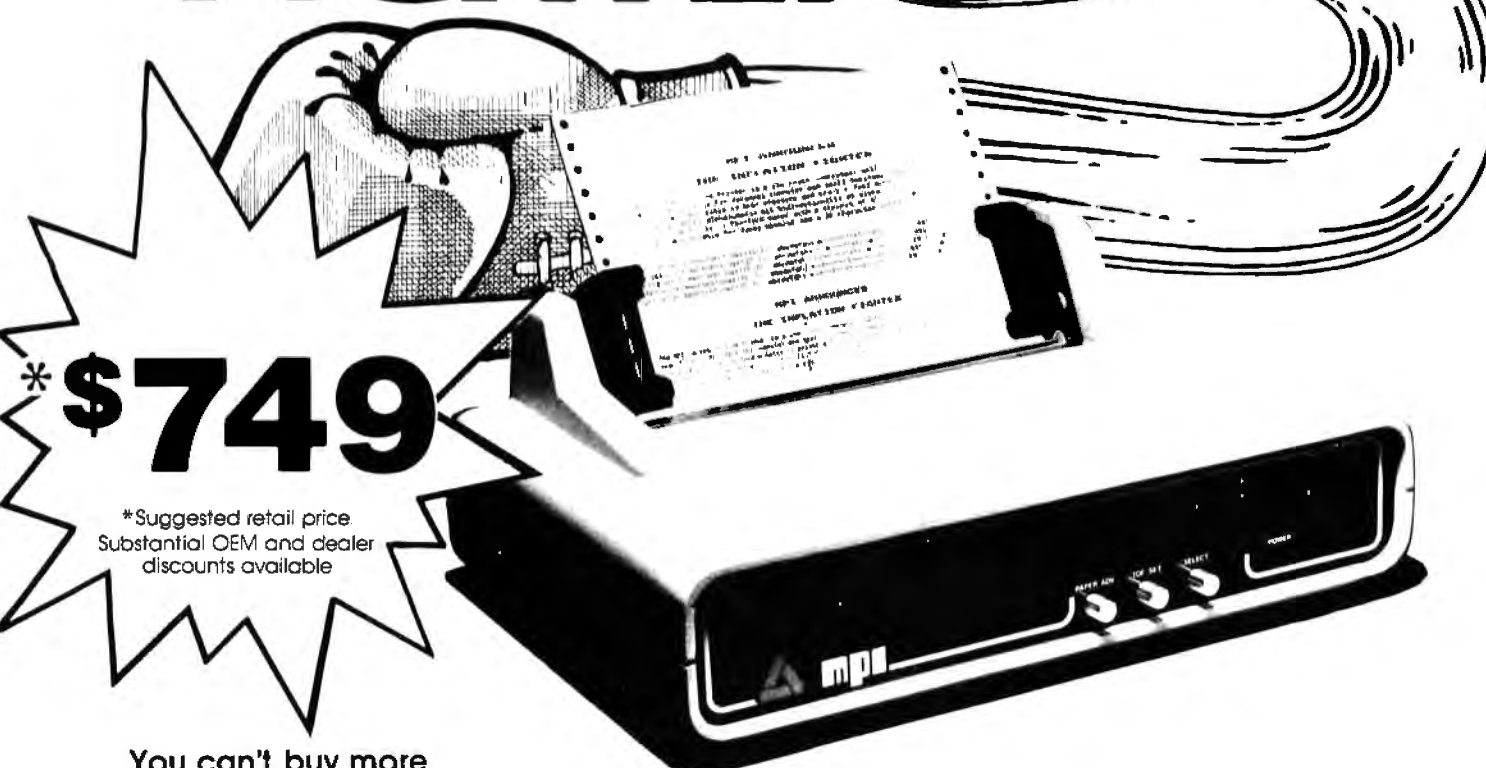

*\$749

*Suggested retail price
Substantial OEM and dealer
discounts available

You can't buy more
capability for less . . . But
you can buy less for more.

MPI presents the perfect answer to your inflation-riddled printer budget. THE MODEL 88T DOT MATRIX PRINTER. The first in a series of new full-capability low-cost printers designed specifically for the general use computer market. The Model 88T is a fully featured printer with a dual tractor/pressure-roll paper feed system and a serial or parallel interface. The tractor paper feed system provides the precision required to handle multi copy fanfold forms, ranging in width from 1 inch to 9.5 inches. For those applications where paper costs are important, the pressure-roll feed can be used with 8.5 inch roll paper. A long-life ribbon cartridge gives crisp, clean print without messy ribbon changing. The microprocessor controlled interface has 80, 96 or 132 column formatting capability while printing upper and lower case characters bi-directionally at 100 characters per second.

With all of these features, **plus** quality construction, continuous duty print head and attractive styling, the Model 88T would easily sell at the competition's "under \$1000" (999.99) tag. But we are offering it for only \$749; this should make you happy and several hundred dollars richer.

Write for complete specifications and pricing information.



MICRO PERIPHERALS, INC. 2099 WEST 2200 SOUTH / SALT LAKE CITY, UTAH 84119 / (801)973-6053

ads

Televideo SMART CRT TVI 912

Microprocessor Based
Reverse Video
Blinking, Underling
Tabbing
Numeric Keypad Standard
Upper/Lower Case Standard
Protected and Conversation
Modes
Lear Siegler Code Compatible
Eight Different Editing Features
One Page of Memory Standard
Single Unit Price \$840.00
(Quantity pricing available)
Add \$60.00 for Serial Printer Port
Add \$60.00 for Second Page
Memory
Add \$20.00 Shipping
Illinois Residents Add Appropriate
Sales Tax
Send for additional information,
check, money order or C.O.D.
certified check to the address
below.

...add the
sound dimension
to your system

NOISEMAKER®

Soundboard Uses Two G1 AY
3-8910 I.C.'s to Generate Sound
Effects Under Software Control
S-100 Bus Compatible
Breadboard Area Allows Easy
Adaptation to any System
On Board Audio Amplifier
Four 8-Bit I/O Ports
I/O Addresses are Switch
Selectable
PCB only, \$34.95
Send for additional information,
check or money order to:

**Ackerman
Digital Systems, Inc.**

110 North York Road • Suite 208
Elmhurst, Illinois 60126
Tel. 312-530-8992

Illinois Residents Add Appropriate State Sales Tax

Table 2: Example of the output produced by the BASIC watchdog program of listing 1.

01:50:25	2 / 22	On 9.78 Min.,	3.4 % of 285.41 Min. cycle	\$.07	\$ 3.27
02:25:42	2 / 22	On 11.23 Min.,	31.7 % of 35.43 Min. cycle	\$.08	\$ 3.36
03:00:45	2 / 22	On 11.31 Min.,	32.2 % of 35.06 Min. cycle	\$.08	\$ 3.44
03:34:40	2 / 22	On 11.51 Min.,	33.9 % of 33.91 Min. cycle	\$.09	\$ 3.53
04:08:46	2 / 22	On 11.45 Min.,	33.5 % of 34.1 Min. cycle	\$.09	\$ 3.61
04:43:22	2 / 22	On 11.65 Min.,	33.6 % of 34.58 Min. cycle	\$.09	\$ 3.7
05:18:22	2 / 22	On 11.5 Min.,	32.8 % of 35.01 Min. cycle	\$.09	\$ 3.79
05:53:31	2 / 22	On 12.33 Min.,	35.1 % of 35.13 Min. cycle	\$.09	\$ 3.88
07:23:36	2 / 22	On 65.9 Min.,	73.1 % of 90.08 Min. cycle	\$.49	\$ 4.37
09:56:08	2 / 22	On 10.1 Min.,	6.6 % of 152.53 Min. cycle	\$.08	\$ 4.45
10:35:23	2 / 22	On 11.88 Min.,	30.2 % of 39.26 Min. cycle	\$.09	\$ 4.54
11:16:10	2 / 22	On 11.26 Min.,	27.6 % of 40.78 Min. cycle	\$.08	\$ 4.62
12:00:01	2 / 22	On 10.88 Min.,	24.8 % of 43.83 Min. cycle	\$.08	\$ 4.7
12:44:40	2 / 22	On 10.5 Min.,	23.5 % of 44.66 Min. cycle	\$.08	\$ 4.78
13:33:57	2 / 22	On 10.03 Min.,	20.3 % of 49.28 Min. cycle	\$.07	\$ 4.85
14:25:37	2 / 22	On 9.7 Min.,	18.7 % of 51.66 Min. cycle	\$.07	\$ 4.93
15:27:48	2 / 22	On 9.28 Min.,	14.9 % of 62.16 Min. cycle	\$.07	\$ 5
16:32:27	2 / 22	On 9.21 Min.,	14.2 % of 64.66 Min. cycle	\$.07	\$ 5.06
17:27:30	2 / 22	On 10.53 Min.,	19.1 % of 55.03 Min. cycle	\$.08	\$ 5.14
18:17:55	2 / 22	On 11.48 Min.,	22.7 % of 50.43 Min. cycle	\$.09	\$ 5.23
20:43:56	2 / 22	On 117.3 Min.,	80.3 % of 146.01 Min. cycle	\$.88	\$ 6.1
21:19:56	2 / 22	On 14.43 Min.,	40 % of 36 Min. cycle	\$.11	\$ 6.21
DAILY TOTALS -- On 28 %					
Cost is \$ 3					
14.2 CCF Used					

each number to yield the binary value before it is returned to the BASIC program.

The input subroutine begins at hexadecimal memory address 2F2A. Only the least significant bit (LSB) of the byte input from input port 0D is used.

Some sample output from the mainline program is shown in table 2. Although a large amount of data is supplied by this program, it is difficult to visualize the trends in the daily consumption of gas without some additional analysis of the data. Therefore, a second BASIC program is used to produce a simple bar chart

of daily gas consumption.

The bar chart program appears as listing 3. Several sets of data, each consisting of three numeric values, are obtained from the "watchdog" program of listing 1. These data sets are entered into the DATA statements beginning at line 500. Each set is read as the variables H, M, and T, which are the hour and minute the burner shut off after each cycle, and the length of time it was on. The number of data sets should correspond to the number of burner cycles in the day being charted.

An array D of 144 entries is created. Each entry represents ten

PRODIGY: YOUNG AND BRILLIANT

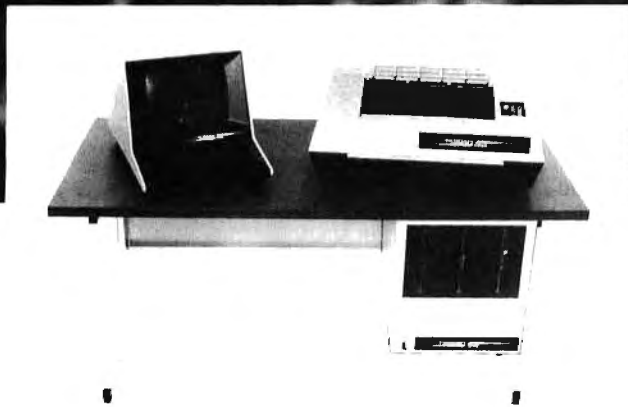

Every so often an individual is born exhibiting extraordinary talent at a very early age. Often, they rise above the multitude establishing themselves as masters in their fields. These individuals are called prodigies.

The Prodigy computer is so advanced, it clearly establishes itself as a master in the field of small business computing.

Modular design and single board construction mean reliability, expandability, and ease of service. But it is SOFTWARE which truly sets Prodigy apart. Unlike other computers, software was a major design consideration rather than an afterthought. Prodigy utilizes a highly advanced operating system and the PROTEGE* to provides some very impressive features:

- DATA BASE MANAGEMENT
- INDEXED FILES
- VIRTUAL CODE
- SPOOLING
- DATA COMPRESSION
- MULTI-TASKING

The result? Incredible speed and storage capacity, and economical systems development and maintenance.

... "Though it may look like many other microcomputer systems — ... Prodigy One literally speeds away from them." — ... Max Schindler, Software Editor-ELECTRONIC DESIGN.

Your local Prodigy dealer maintains an extensive library of field proven application software. Available applications include General Ledger, Accounts Receivable, Accounts Payable, Payroll, Medical Billing, and a remarkable system for the Personnel Placement Industry. All are easy to use yet provide a level of sophistication unheard of in its price class. And Prodigy also does word processing!

Prodigy systems are supported by a nationwide organization of thoroughly trained, experienced professionals. Your Prodigy dealer is a SINGLE source for hardware, software and a level of service that continually insures effective, trouble free operation.

Speed, sophistication, and low cost; an incredible combination for a small business computer. Would you expect less from a prodigy?

PRODIGY
SYSTEMS, INC.

497 LINCOLN HIGHWAY • ISELIN, N.J. 08830 • (201) 283-2000

*Prodigy's easy to use compiler-based small business applications development language. Prodigy also supports other popular languages such as FORTRAN, COBOL, BASIC, and PASCAL.

Circle 53 on inquiry card.

BYTE January 1980 87



AN OPEN LETTER ON THE TEXAS INSTRUMENTS TI-99/4 HOME COMPUTER

It's a fact that the new TI-99/4 is the most sought after home computer on the market today. However, the demand far exceeds the factory's ability to produce them, so they will be in short supply, for all dealers, for the foreseeable future.

As a practical and equitable solution, CTC has set up a priority shipping schedule for our customers.

Here's how it works.

You send us your order for a TI-99/4, with a \$150 deposit (cash or credit card). Upon receipt of your order and deposit, we record your name and the date it is received on our priority list, and send you a confirmation of its receipt and your position on the priority list by return mail.

As we receive our allocation of TI-99/4's we will ship them to our customers according to their position on our waiting list. Simply stated, it's 'First Come, First Served.'

Safeguards:

You may cancel your order any time upon 30 days written notice and receive a full refund of your \$150 deposit.

You may call us at any time and we will tell you your position on the list, and our best estimate of when you can expect delivery.

CTC'S DISCOUNT PRICE **\$1099**

CTC The Computer People

San Diego's largest Discount Computer & Calculator Store 5560 Ruffin Road, San Diego, CA 92123

Please ship me the following merchandise.

TI HOME COMPUTER PRODUCTS

PHC004M	TI 99/4 Home Computer	
	Deposit	\$150.00
PHA7000	Dual Cassette Cable	\$ 9.95
PHF1100	Remote Controls (Pam)	\$ 29.95
PHF1500	Speech Synthesizer	\$149.95

COMMAND MODULES

PHM3000	Diagnostic	\$ 29.95
PHM3001	Demonstration	\$ 69.95
PHM3002	Early Learning Fun	\$ 29.95
PHM3003	Beginning Grammar	\$ 29.95
PHM3004	Number Magic	\$ 19.95
PHM3005	Video Graphs	\$ 19.95
PHM3006	Home Financial Decisions	\$ 29.95
PHM3007	Household Budget Management	\$ 44.95
PHM3008	Video Chess	\$ 69.95
PHM3009	Football	\$ 29.95
PHM3010	Physical Fitness	\$ 29.95

TOTAL	\$
Shipping, add 3%	\$
Cal residents add 6% tax	\$
Amount enclosed	\$
(check or money order)	

Charge to my VISA MASTER CHARGE
 Acct # _____ Bank # _____ Exp. Date _____
 Signature: _____
 (Required if using credit card)
 Name _____
 Street or P.O. _____
 City _____ State _____ Zip _____

Listing 3: BASIC program that prints bar graphs from data accumulated by the watchdog program of listing 1. An example of the output of this program is shown in figure 4.

```

100 REM - BAR CHART PRINTOUT FOR
110 REM - FURNACE WATCH DOG
120 REM
130 DIM D(144)
135 REM - SET ARRAY TO ZERO
140 FOR I=1 TO 144
150 D(I)=0
160 NEXT I
165 REM - READ TIMES
170 READ H,M,T
175 IF T=0 THEN 250
177 REM - CALCULATE PLACE IN ARRAY
178 REM - AND LENGTH OF TIME ON
180 X=M*6+INT((M/10)+.5)
190 T=INT((T/10)+.5)
200 IF T>0 THEN 220
210 T=1
212 REM - FILL ARRAY WHEN ON
220 FOR I=X TO X-T+1 STEP -1
230 D(I)=1
240 NEXT I
245 GOTD 170
250 RESTORE
252 GOSUB 400
254 REM - PRINT OUT ARRAY AS 144 BARS
255 FOR J=1 TO 144
258 REM - CR IF=0
259 REM - BAR IF=1
260 IF D(J)=0 THEN 300
270 FOR K=1 TO 30
280 PRINT"X".
290 NEXT K
291 REM - PRINT TIME ON LAST BAR
292 IF D(J+1)<>0 THEN 300
294 READ H,M,T
296 PRINT" ",H,"HRS.",M,"MIN.",
300 PRINT
310 NEXT J
315 GOSUB 400
320 STOP
399 REM - PRINT LINE OF DASHES ROUTINE
400 FOR Z=1 TO 40
402 PRINT"-",
404 NEXT Z
406 PRINT
408 RETURN
500 DATA 1,50,9.78,2,26,11.23,3,1,11.31,3,35,11.51,4,9,11.45
510 DATA 4,43,11.65,5,18,11.5,5,53,12.33,7,24,65.9,9,56,10.1
520 DATA 10,35,11.88,11,16,11.26,12,0,10.88,12,45,10.5,13,34,10.03
530 DATA 14,26,9.7,15,28,9.28,16,32,9.21,17,28,10.53,18,18,11.48
540 DATA 20,44,111.3,21,20,14.43
999 DATA 0,0,0
    
```

minutes of time during the day. A value of one is assigned to an array entry if the furnace was on during the major part of the corresponding ten minute interval, otherwise the value is left at zero. This array is then printed as 144 lines, which are blank

if the array value is equal to zero and filled in with Xs if the value is equal to one. The time is printed alongside the filled-in bar corresponding to the time interval in which the burner shut off. A sample output of the program is shown in figure 4.

The Source for 6800/6809 Software

Technical Systems Consultants, Inc. is The Source for your 6800/6809 systems software needs. From FLEX™, the standard disk operating system of the 680X family, to Sort/Merge, your systems requirements can be filled with the highest quality software in the industry. Nowhere else can you find such variety from a single source. Here are some of the most popular:

Program Name	6800	6809
FLEX for SWTPc	\$90	\$90
FLEX for SSB	90	90
Extended BASIC	100	100
Extended BASIC Precompiler	50	50
BASIC	65	65
BASIC Precompiler	40	40
FLEX Sort/Merge	75	75
Text Editing System	40	35
Assembler	40	40
Text Processing System	60	N/A
Debug Package	55	75
FLEX Utilities	100	60

These packages are available on either 8" or 5" soft-sectored FLEX diskettes (5" 6800 is FLEX 2.0). Price includes user's manual and object code diskette. Certain programs are available on cassette. Contact Technical Systems Consultants for pricing. All orders should include 3 percent for postage and handling (8 percent on foreign orders). Master Charge and Visa are welcome.

*FLEX is a trademark of Technical Systems Consultants, Inc.



technical systems
consultants, inc.

Box 2574, West Lafayette, IN 47906
(317) 463-2502

The particular day shown in figure 4 is February 22 1978. Several interesting features can be determined from the output. The thermostat was turned down sharply before midnight, and the furnace did not come on again until 1:50 AM. The furnace cycled smoothly about every half hour until 5:53 AM. At about 6:30

AM when we arose for the morning, the thermostat was turned up. The burner was on for about one hour. The heat accumulated during this hour was not completely wasted when we left for work at about 7:30 AM, and the thermostat was again turned down. Notice that the burner did not cycle again for about 2½

hours. Between 9:56 AM and 6:18 PM (18:18 in 24-hour style), the cycle time lengthened as the outdoor temperature rose, and less energy was needed to maintain a constant temperature. At about 7:00 PM (19:00) we returned home and turned the thermostat up. The furnace ran for about one hour and fifty minutes. After this time it cycled once more before the thermostat was turned down for the evening. The furnace did not cycle again until after midnight.

The burner was on twenty-eight percent of the time during this particular day, and 40,210 liters (1420 cubic feet) of gas was burned at a cost of \$3. The weather was quite harsh. A low temperature of -18°C (0°F) and a high of -3°C (29°F) were recorded, and the winds were sixteen to twenty-five km per hour (ten to fifteen miles per hour).

A secondary fact that came out of the data concerns the use of a fireplace in our home. This fireplace is located in the living room, about six meters (twenty feet) around a corner from the thermostat. Whenever the fireplace is burning, even moderately, the living room area and nearby thermostat are kept warm enough that the furnace does not run at all. This encourages a considerable savings, since we use the fireplace often on evenings that we are home.

Conclusion

This system provides an excellent starting point for an individual interested in monitoring the consumption of energy used for heating. An extension of this system might be useful to a homeowner who adds a supplemental solar heating system to the conventional heating system already present in the home. Aside from monitoring the energy used, the computer in this situation could also monitor the solar energy generated. In addition, the computer could also operate the two heating systems, turning on the conventional furnace when there is not enough available solar energy.

Individuals may desire different specific information from the furnace watchdog, therefore they may have to write their own software for a systematic analysis of the data obtained. ■

Figure 4: Sample output of the bar chart program of listing 3. This provides a graphic record of data obtained from the watchdog program of listing 1.

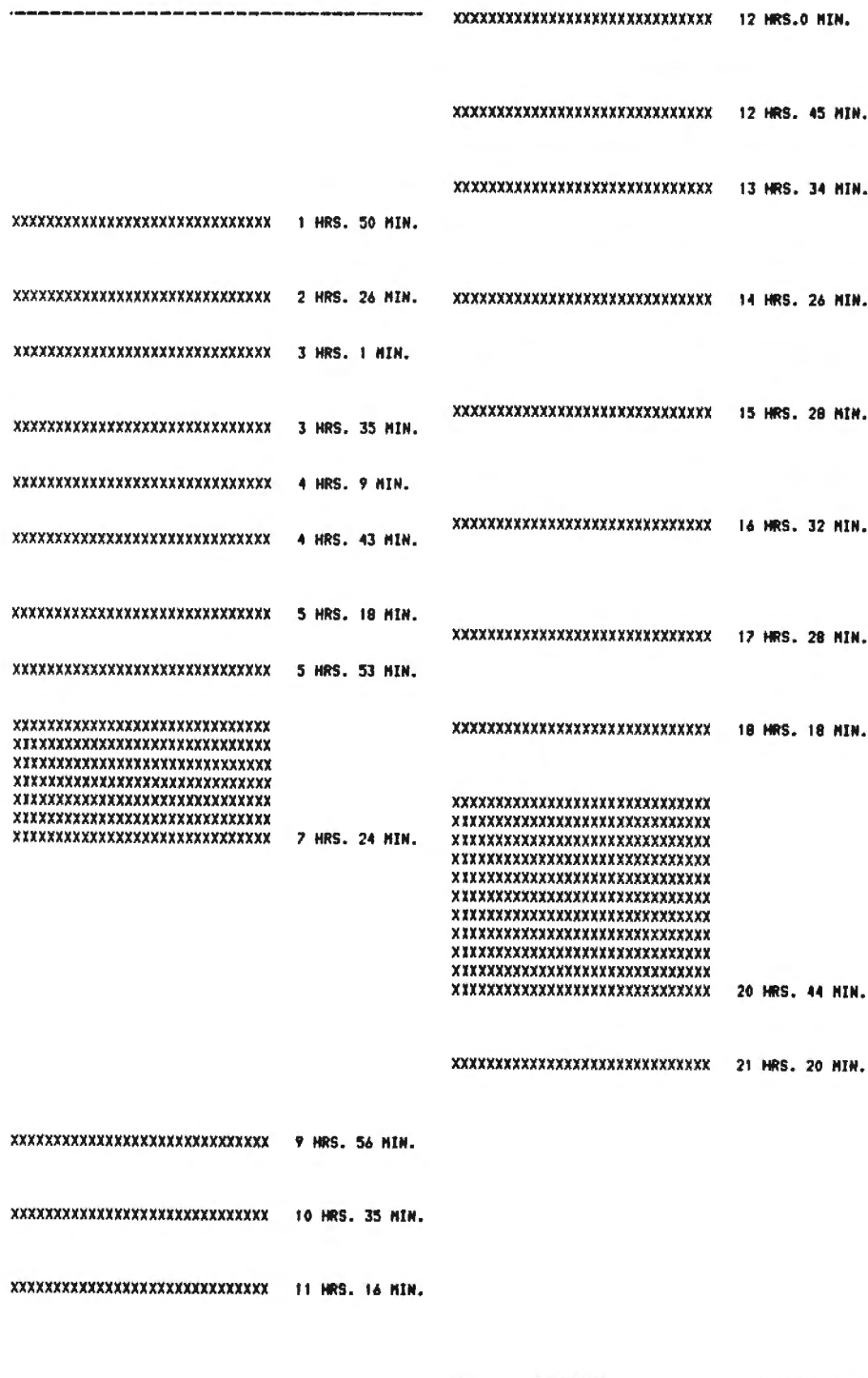

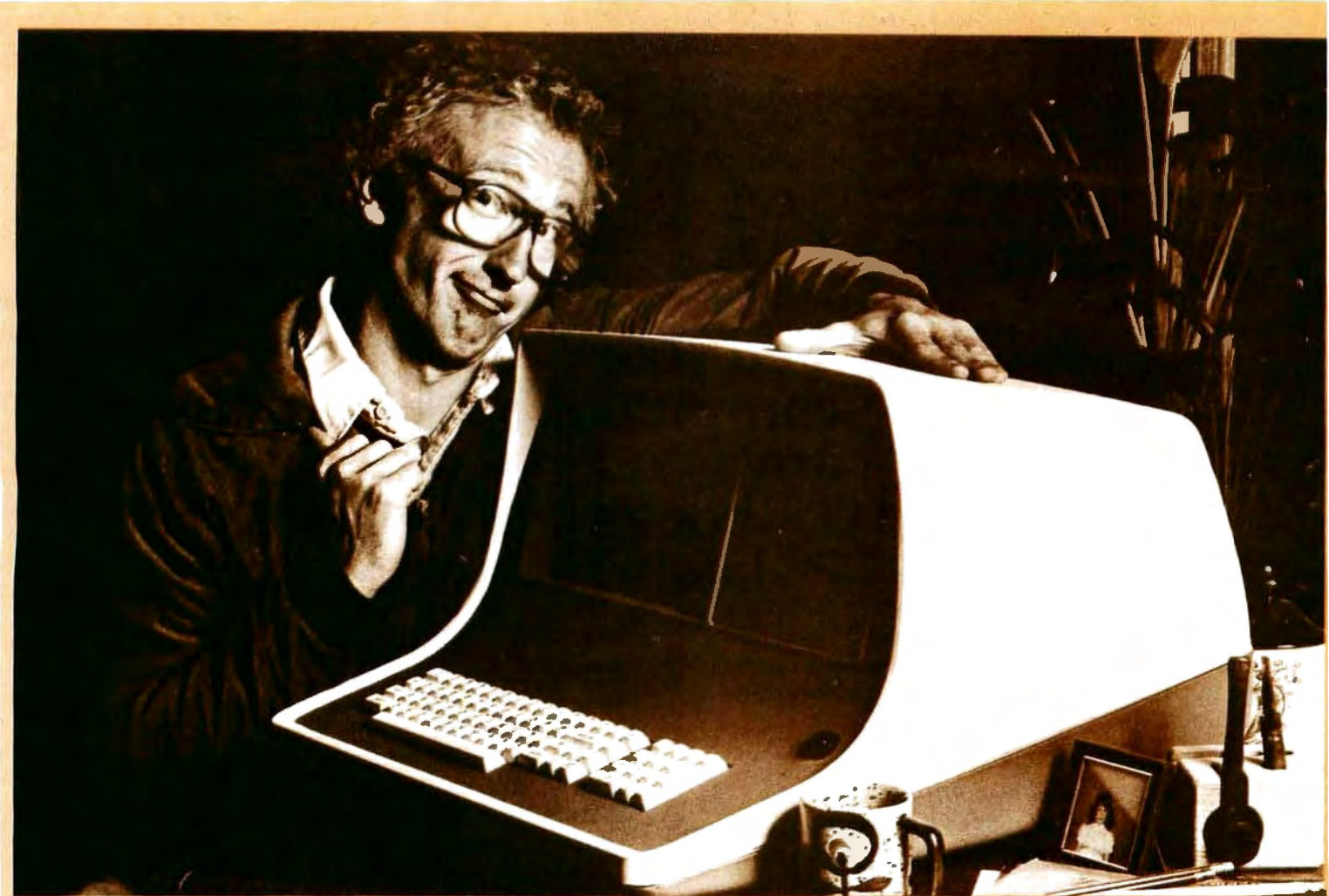

HOW BOB SCHMIDT AND HIS MICROSOFT BASIC COMPILER TURNED AN ORDINARY COMPUTER INTO A GENIUS.

Bob admits he thought his computer had reached the limit of its capabilities. Then he discovered the BASIC Compiler from Microsoft.

"It's incredibly fast," he boasts. "Nothing was as fast as my Microsoft BASIC interpreter—yet this new compiler is actually 3-10 times faster.

"And that's not all," he beamed. "My compiler has the same language features as Microsoft 5.0 BASIC and runs in my 40K CP/M system!"

Bob says, "When Microsoft comes out with a new product, I know it's got to be good. And this BASIC Compiler is the wizard I've been waiting for.

"At last, I can generate relocatable machine language modules from my Microsoft BASIC programs—machine code that's highly optimized. And because the Microsoft macro assembler and loader come with the BASIC Compiler, BASIC programs are easily linked to assembly language subroutines or Microsoft

FORTRAN and COBOL programs. Just like the pros," smiled Bob.

"What's more, the compiler generates a fully symbolic listing of the machine language that's generated—a great way for me to learn assembly code on my own."

Bob believes in giving credit where credit is due. "Microsoft turned my BASIC computer into a genius for \$395, but I was smart enough to recognize a good thing immediately."

If you want to get the most out of your computer and your BASIC programs, ask for more information on the Microsoft BASIC Compiler. We know you'll compliment yourself on a very smart move.

MICROSOFT



10800 N.E. Eighth Suite 819
Bellevue, Washington 98004
206/455-8080 Telex 328945

We set the standard.

Circle 56 on inquiry card.

If you haven't, we'd be surprised if you're using your computer at anywhere near its full potential. Because if it won't determine the most efficient assignment of resources and/or personnel, compute the yields of a bond over different periods, or calculate your income taxes, you might just as well have stuck with a pad and pencil.

The fact of the matter is that you just don't learn to program overnight. Which is precisely why Folio Books *Basic Software Library* (BSL) was developed. Using simple, straightforward BASIC language, the BSL leads you through every step necessary to input hundreds of useful and entertaining



Fed your computer any good books lately?

19 different BASICS. Or, to convert your favorite program to Fortran or

Over 116,000 volumes already sold... and two more editions have just arrived!

APL or just about any other language, the appendix in Volume II defines all the statements and parameters used in our programs.

Over 85% of the programs listed in the first five volumes can be

executed in most systems with 8K BASICS and 16K of free user RAM. If you only have 4K of BASIC, you can still input 60% of the first five volumes in only 8K of user RAM.

The *Basic Software Library* puts hundreds of reliable, complete and most of all USEFUL programs at your fingertips. So don't wait any longer. Feed your computer a good book and start using your system the way it was meant to be used. You won't be alone—over 116,000 volumes of the BSL are already in use. Just take a look at all the programs you could be feeding your system tonight—then CALL Folio Books at (800) 423-4864 (in California, call collect at (213) 795-5224) to order your own *Basic Software Library*.

It'll be the tastiest meal your system ever had.

There are hundreds of reliable, complete and most of all useful programs in the Basic Software Library

programs. Just punch it into your computer exactly as it appears in the BSL.

But just in case your BASIC may not use one of our functions, we've included an appendix in Volume V which gives conversion statements for

These are just some of the programs contained in the BSL!

Volume I: Business and Personal Bookkeeping Programs \$24.95

- Bond* • Computes price and interest for bond purchases.
- Building* • Analyzes the cost of building design proposals.
- Compound* • Computes effective compound interest rates.
- Decision 1* • Makes a lease/buy decision for you.
- Decision 2* • Makes the decision of whether to buy a component or make it.
- Depreciation* • Calculates depreciation by four different methods.
- Efficient* • Calculates the most efficient assignment of resources and/or personnel.
- Flow* • Predicts your yearly cash flow.
- Installment* • Performs monthly installment accounting.
- Interest* • Computes interest accruals monthly.
- Investments* • Computes annual rates of return on investments.
- Mortgage* • Makes a comparison of mortgage terms.
- Optimize* • Optimizes the layout for plant, shop, office, etc.
- Order* • Determines your economic order quantity for inventory items.
- Rate* • Computes true annual interest rates.
- Return 1* • Computes lessor's rate of

- return for uncertain assets.
- Return 2* • Computes a lessor's rate of return after taxes.
- Plus 16 games and 12 graphic programs!*

Volume II: Math and Engineering Programs \$24.95

- Conv.* • Calculates convolutions.
- Intensity* • Calculates and plots RF or Acoustic intensities.
- Lola* • Calculates longitude and latitude from interstellar fix or distance.
- Macro* • Simulates a language compiler.
- Max. Min.* • Calculates the maximum and minimum values of function over a specific interval.
- Navaid* • Calculates position from altitude and azimuth of celestial bodies.
- Planet* • Calculates sun and moon positions hourly.
- PSD* • Calculates Power Spectral Densities and FFT's.
- Rand 2* • Generates random integers between X and Y.
- Solve* • Solves polynomials by Bairstow's Method.
- Sphere Trian* • Solves any spherical triangle.
- Track* • Calculates course and distance and incremental vectors.
- Variable* • Finds all variables in BASIC

- programs.
- Vector* • Calculates final position; given start and motion vectors.
- Plotting and Statistics Programs*
- Binomial* • Calculates binomial probability distributions.
- Chi-Sq.* • Applies the Chi-Square test to samples.
- Coeff.* • Calculates coefficients of fourier series to approximate a function.
- Confidence 1* • Calculates confidence limits on linear regressions.
- Confidence 2* • Calculates confidence limits for a sample mean.
- Correlations* • Performs auto and cross correlations with plots.
- Exp-Distri* • Calculates exponential distribution for a sample.
- Paired* • Compares two groups of data using the rank test.
- Polynomial Fit* • Performs least squares polynomial fit.
- Stat 1* • Finds the mean, variance and standard deviation.
- Stat 2* • Computes various statistical measures for a variable.
- T-Distribution* • Calculates normal and T-distributions.
- Unpaired* • Compares two groups of unpaired data.
- Variance Z* • Analyzes a variance table of one-way random design.
- XY* • Plots functions of X and Y.

Appendix A: Basic Statement Definitions

Volume III: Advanced Business Programs \$39.95

- Billing* • Performs posting and billing of accounts.
- Inventory* • Maintains data for inventory records.
- Payroll* • Computes payrolls with a full set of deductions.
- Risk* • Performs a risk analysis on capital investments.
- Schedule 2* • Performs the most efficient scheduling of men and resources to location.
- Shipping* • Solves the problem of scheduling and assignments.
- Stocks* • Computes the value of stocks.
- Switch* • Calculates the effects of a bond switch.

Volume IV: General Purpose Programs \$9.95

- Bonds* • Computes the yields for a bond over different periods.
- Funds 1* • Calculates long-term predictions of funds.
- Funds 2* • Plots the results of the predictions above.
- Go-Moku* • Go-Moku: ancient Chinese game of chance.
- Life* • Life: truly a battle for survival, a real challenge.
- Loans* • Calculates annuities, loans

and mortgages.

Popul • Performs population projections for defined areas.

Profits • Determines the profitability of a firm's various departments.

Qubic • 3-Dimensional Tic-Tac-Toe

Rates • Calculates the effective annual interest rate for stated interest.

Savings • Computes savings plan profiles.

Volume V: *Experimenter's Programs* \$9.95

Baseball • Plays a full nine innings of baseball.

Compare • Compares two groups of data.

Confid 10 • Determines the confidence limits for normal population.

Differ • Compares the difference of the means for data of equal variance.

Fourier • Evaluates the fourier series.

Integers • Computes integers as the sum of other integers.

Logic • Determines conclusions from logic statements.

Primes • Factors numbers into their primes.

Quadrac • Solves quadratic equations.

Regression 2 • Calculates linear regressions.

Roulette • Computerized "wheel of fortune" plays roulette.

Stat 10 • Calculates quantities for two groups of paired data.

Stat 11 • Computes sample statistics.

Tap • Computes cost for surfacing road or driveway.

Vary • Performs analysis of a variance table; one-way random design.

Appendix B: *Statement Conversion Algorithms*

Volume VI: *A Complete Business Program* \$49.95

Ledger • Maintains ALL company accounts and generates financial reports. Includes routines for: Pyl, Inventory, Depreciation, Accounts Receivable, Accounts Payable.

Volume VII: *Professional Programs* \$39.95

Chess • Designed to challenge the average player.

Medbil • Complete patient billing system for doctors, dentists. Also permits the maintenance of a patient history record.

Wdproc • Wordprocessing for lawyers, publishers, writers, etc. Write, store and change from rough draft to final copy in a variety of formats.

Volume VIII: *Home Owners Program* \$19.95

1040-Tax • 1040 Taxpayer's return, itemized or standard deductions.

Balance • Reconciles bank statements.

Checkbook • Balances your checkbook.

Instlo 78 • Computes real cost on financed items.

Deprec 2 • Computes depreciation, four methods, any time period.

Appendix C: *Favorite Program Conversions*

NEW! Volume IX: *Programs for the Traveler* \$19.95

Auto • Expense and mileage (kilometers) calculations.

Cypher • Codes and decodes private messages.

Hurrtrac • Hurricane tracking and projection program.

ID • Vehicle identification program.

Lorana • Lorán "A" position program.

Navigate • Computes minimum time courses.

Omega • Omega position program.

Patterns • Generates computer pictures.

Radar • Vehicle tracking program.

RDF • Position location program.

NEW! Volume X: *A Comprehensive Business Program* \$69.95

The complete software program to deal with virtually any business problem. Contains the following programs:

- Accounts receivable.
- Accounts payable.
- Merchandise inventory.
- Check register.
- Fixed assets.
- Payroll.
- Balance and profit and loss sheets.
- Year-end reports.
- Building a data base.
- Sample data.
- ACBS 1 (use).
- Data sheets.
- Sample business forms.
- Tax updating.
- Basic statements
- Source listings.

Editorial continued from page 10:

what are the typical criteria expected in the modern personal computer? For one thing, systems software is required to use the rich hardware capabilities of the small system. The days of an integer subset of high-level language X with a disk operating system capable of only simple data transfer operations are gone. The modern personal computer user at a minimum requires an extended disk BASIC with files and strings and an operating system with all the appropriate filing, editing and utility amenities. Nearly all the widely advertised systems have this kind of capability.

In what I consider to be the ultimate in usefulness for current computers, we find the high-level language orientation of computers with *manufacturer-independent* Pascal, C, ANSI standard FORTRAN, and BASIC languages.

The particular case of the UCSD Pascal system is pioneering a machine independence never before seen in computing. Users are driving the mass-produced computer market, with no single company having dominance enough to dictate styles of languages. The success of UCSD Pascal over the past two years as a machine-independent package available from numerous manufacturers is one of the joys of present-day computing. I can edit, compile, and use the operating system on one machine in a manner identical with my interactions on another machine. I use three different computers with totally different hardware processor designs — yet, with UCSD Pascal, the operating systems are functionally identical, so I do not have to switch personalities constantly.

I have demonstrated with friends that it is possible to send object code produced by the UCSD Pascal compiler to other machines where it will execute and behave the same way. The manner of transportation at the hardware level is sometimes via disk media where compatibility exists, and, where different disk formats are involved, we have transferred files through the means of serial RS-232C compatible data connections.

This Pascal-based system is actively supported by a number of manufacturers, now prominently including personal computer manufacturers Apple and North Star as well as the integrated circuit manufacturer Western Digital. UCSD Pascal is available in versions for DEC PDP-11 minicomputer systems (upon which it was originally developed), CP/M-based 8080 and Z80 systems, Motorola 6800-based systems, and even the Radio Shack TRS-80. On all these diverse hardware configurations — with a working useful criterion of 500 K bytes mass storage, 50 K or more bytes of memory — the same operating system and compilers run, can pass files compatibly between each other, and achieve systems performance sometimes missing from the minicomputers and behemoth computers of today and yesterday.

So with this in mind as the ultimate in off-the-shelf technology, let's summarize: A desirable contemporary personal computer has 64 K bytes of memory, about 500 K bytes of mass storage on line, any old competently designed computer architecture, upper and lowercase video terminal, printer, and high-level languages such as that provided by the UCSD Pascal software system. This is the state of the art in small computing as it stands to date.

Order 3 or more volumes and receive a 10% discount; order 5 or more and we pay shipping and handling in addition to your 10% discount.

ORDERING INFORMATION: Call toll-free (800) 423-4864 M-F 11-5 p.m., Sat. 9-12 noon Pacific Time. Mail order: include name, address and telephone. M/C and Visa customers include: your name as it appears on your card, card #, expiration date. All orders add \$1.00/volume for shipping and handling. California residents add 6% sales tax. We ship UPS unless otherwise requested.

(800) 423-4864

In California call collect: **(213) 795-5224**

Folio Books

P.O. Box 4100-H, Los Angeles, California 90041

BSL Also Available at Leading Computer Stores Everywhere.

Circle 57 on Inquiry card.

New for the APPLE II & TRS-80*



the subLOGIC FS1 Flight Simulator!

Experience the excitement of a new era in computer simulation as you make your landing approach after a practice flight in your FS1. Then return to the skies where enemy fighters are waiting to intercept you.

The FS1 is a visual flight simulator that gives you realistically stable aircraft control. And its beautifully accurate graphics are produced by a high-performance driver capable of drawing 150 lines per second.

Please DO NOT confuse the FS1 with other software claiming to offer flight simulation. The FS1's sophistication, speed, and beauty are way beyond the ordinary.

See the FS1 package demonstrated at your dealer's, or order directly from subLOGIC. Either way, it's only \$25 plus 75¢ for UPS or \$1.50 for first class mail. VISA and MasterCard accepted.

*16K required. Specify your system: Apple II or TRS-80 Level I or Level II.

(217) 359-8482
subLOGIC
Box V, Savoy, IL 61874

The engineering and graphics experts
opening a new era in computer simulation.

A Particular System

The previous discussion of the glowing generalities of our entry into the 1980s with personal computing technologies is only part of the information you need when contemplating a purchase. To provide a concrete example of a particular case, I shall describe the new computer I just bought. First, why did I need a new one? The computer I have been using until recently (a Northwest Microcomputer Systems Model 85/P) executes the UCSD Pascal system, meets all the minimum requirements, and had served me well for nearly a year.

But no computer, however competently engineered, is immune to dumb users like yours truly. As an attempt to get around a relatively minor hardware problem, I managed to plug a terminal into the wrong socket and fry a power supply, possibly worse. After a month of withdrawal symptoms, my frustration level reached such a peak that I had to get another computer. . . . NOW! . . . INSTANTLY! Thus the genesis of this month's editorial celebrating the existence of off-the-shelf personal computers — when I had the need to get one, a computer was available from a local retailer, and purchased with cash over the counter.

To be sure, I had been contemplating a new computer for some time. I had also been looking into a possible small UCSD Pascal facility for a good friend of mine who desires a computer to handle his local political campaign data processing activities. Thus I had actually priced out a system that was available off the shelf at Bob McGuffie's Computerland store in Nashua, New Hampshire. The system was an Apple II with UCSD Pascal and assorted peripherals. Then, the frustration level rose to exceed my threshold of action during the weekend of the Philadelphia Personal Computing '79 show. On Saturday of that week, I called Bob at his store in New Hampshire to firm up an order for a slightly expanded system.

The order for the system was placed on October 6. I picked up the system on October 11, with all items except an extra set of read-only memories for a second pair of floppy disk drives. Here is what I am now using to write editorials, write various memos involved with my everyday work, explore miscellaneous uses of personal computing, etc:

Apple II Plus Computer with . . .
UCSD Pascal Option (64 K total memory),
Serial Communications Interface,
Four 5-inch floppy disk drives (2 controllers,
520 K bytes on line),
Parallel Printer Interface,
D C Hayes Micromodem II, and extra phone
line.

To this list of equipment should be added an Integral Data Systems Model 440 "Paper Tiger" printer which I had ordered a month earlier with the intention of using as a scratch printer. Also added to this list is a COPS-10 terminal which was manufactured by the Computer Peripheral Corp. of which several were already owned by BYTE. This set of equipment (including the printer but omitting the cost of the COPS-10 terminal) cost only \$6000 and, except for two read-only memory parts which arrived ten days later, was delivered off the shelf.

As the Apple Pascal comes delivered, it is oriented

SYNCHRO-SOUND

The ORIGINAL Computer People Who KNOW computers and offer EVERYTHING you need in Small Computer Systems

Compare PRICE, QUALITY, DELIVERY, SERVICE and you'll see why you don't have to look anywhere else!



TEXAS INSTRUMENTS
810 Multi-Copy Impact Printer
ONLY **\$1599.00**
SINGLE QUANTITY PRICE

We carry a full line of Texas Instruments products

SUPER SPECIAL!



LA 34
DECwriter IV Teleprinter
\$1095.00
SINGLE QUANTITY PRICE

TERMINALS

LEAR-SIEGLER ADM-3A.....
ADM-31.....
ADM-42.....

HAZELTINE 1400.....
1410.....
1500.....
Mod 1 Edit.....

CALL* for prices







COMPUTERS

NORTHSTAR Horizon II (kit)..... CALL* for price

DIGITAL SYSTEMS DSC-2.....
Dble Density Dual Drive Disk..... CALL* for prices

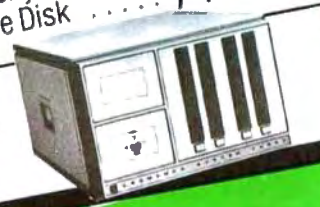
CROMEMCO System 3..... CALL* for price

PRINTERS

QUME Sprint—5/45 KSR
..... **\$2995.00**
..... Typewriter Quality Printer Terminal



TELETYPE

43..... CALL* for price



CENTRONICS

Micro.....
779-2.....
700-2.....
703-0.....

CALL* for prices



MORE SPECIALS

Okidata SL 125	\$2595.00	Livermore Acoustic Coupler	249.00
Javelin 9" Monitor	159.95	Centronics Micro Printer	395.00
Persci 277 Dble Density	1395.00	5" Scotch Diskette .. Box/	34.95
Imsai PCS 80/15	599.00	8" Scotch Diskette .. Box/	39.95
Televideo 912 920	CALL*		

* Our prices are too low to advertise. Please call or write.
We now carry a full line of Alpha-Micro Products

We have a full staff of Programmers and Computer Consultants to design, configure and deliver a Turnkey Computer System to meet your specific requirements.



SYNCHRO-SOUND

ENTERPRISES, INC.

The Computer People
193-25 Jamaica Avenue, Jamaica, New York 11423
TWX 710-582-5886

PHONE ORDERS, CALL:
NEW YORK — 212/468-7067
LOS ANGELES — 213/628-1808
CHICAGO — 312/641-3010
DALLAS — 214/742-6090

toward use of the Apple II video display, a 24-line by 40-character display built into the computer. Because of the short line width and uppercase only characteristics of the built-in Apple II display, I do not prefer to use it as a primary UCSD Pascal terminal. This is no great problem because the clever hardware design of the Apple Pascal option and the documentation which comes with the system make it fairly trivial to reconfigure the UCSD Pascal system for operation via any typical terminal. At bootstrap time, the Apple II Pascal system simply checks to see if a Serial Communications card is plugged into slot number 3 of the Apple peripheral bus. If so, it uses that card as the system terminal instead of the built-in Apple display. It of course makes default assumptions about the terminal, but these proved to be adequate to check some major points about the interface. The major technical problem was discovering that my terminal generated a default bit in the wrong state when parity was suppressed, and that its cursor addressing feature did not seem to work. The parity default problem was solved by changing a jumper option in the terminal. The cursor addressing problem was solved by a GOTOXY kludge.

Using the Apple II built-in display as a bootstrapping tool, I was able to run the UCSD system's SETUP program to create a SYSTEM.MISCINFO file for the COPS-10 terminal. This mode of operation also enabled me to write a custom Pascal "GOTOXY" procedure which is used by the UCSD Pascal system to do cursor addressing with the particular terminal involved. It turn-

ed out that, as a kludge, I had to do cursor addressing with a "home" followed by a sequence of "cursor down" and "cursor right" operations — a technical point I have not yet resolved. The problem that keeps me from using direct cursor addressing is either the inability of the terminal to understand its documented addressing sequences, or the inability of the compiled GOTOXY procedure to emit the cursor escape character. The kludge gets around the problem temporarily at the price of some cursor movement delays. Listing 1 shows the Pascal code which resulted. Since the program was edited and compiled before I had the terminal attached, it uses uppercase only. As I write these notes the cursor addressing kludge remains in the system, slowing down operation of the UCSD system's screen editor during deletions and cursor positioning.

After getting the terminal to work with default parameters I was able to write a Pascal procedure which is compiled and saved as SYSTEM.STARTUP. When

Listing 1: This GOTOXY procedure meets the requirements of cursor control for the UCSD Pascal system, given an Apple II driving a COPS-10 terminal. It uses an inelegant kludge for cursor positioning, one which requires a total of 105 character times to reach the worst case position. Sooner or later it will be replaced when direct cursor control's subtleties are mastered using my terminal. This listing (and listing 2) was produced on the Integral Data Systems Model 440 "Paper Tiger" printer that is attached to the Apple via a parallel printer port. A custom Pascal print utility program is used to transfer files to the printer in formatted form instead of using the system's Filer program.

SPECIAL INTRODUCTORY OFFER



ANADEX DP-8000 LINE PRINTER

LOGON offers you this excellent small reliable printer at a low introductory price. Every DP-8000 is complete with the latest features: - Adjustable tractors and 1K input buffer. Standard features include:

- RS232C, current loop and centronics parallel
- 80 columns - 112 char/sec
- 96 char set - 9 x 7 font — Bidirectional printing
- Top of form, skip over perf, out of paper, eight vertical tabs, etc.



Only **\$795**

Plus \$20.00 shipping and handling.
Terms - check with order -
Allow 3 weeks for delivery

Logon Inc.
2460 Lemoine Ave.
Fort Lee, N.J. 07024
201-224-6911
212-594-8202

```

PROGRAM GOXY;

PROCEDURE FGOTOXY(X,Y:INTEGER);

(* COPS 10 - GOTOXY *)

CONST
  HOME = 25;
  DOWN = 10;
  ACROSS = 12;

VAR
  SEND: PACKED ARRAY[0..0] OF 0..255;
  J,I : INTEGER;

BEGIN
  SEND[0] := HOME;
  UNITWRITE(2,SEND,1);
  IF X>79 THEN X:=79
  ELSE IF X<0 THEN X:=0;
  IF Y>23 THEN Y:=23
  ELSE IF Y<0 THEN Y:=0;
  IF Y<>0 THEN
    BEGIN
      SEND[0] := DOWN;
      FOR I := 0 TO Y-1 DO
        UNITWRITE(2,SEND,1)
      END;
    IF X<>0 THEN
      BEGIN
        SEND[0] := ACROSS;
        FOR I := 0 TO X-1 DO
          UNITWRITE(2,SEND,1)
        END
      END
    END;
  END;

BEGIN (* DUMMY MAIN *)
END.

```

CENTRONICS COVERS THE COURT

...with new, low-priced printers for small businesses

Now small businesses can have the advantage of Centronics performance. We have new models to meet the needs of small businesses — a selection that covers the court. And we've followed-through by pricing them lower than other printers that can't match Centronics' features and reliability.

TOP-RANKED TEAM We understand your small business needs — that's why Centronics has sold more printers to the small business market than anyone else. We have new, fully-featured models designed for small business applications. High throughput for inventory control. Full 132-column width for accounts receivable. Versatile forms handling capability

for invoicing, payroll, and statements. Plus excellent print quality for labels and listings. The bottom line: with Centronics, small businesses can have mainframe performance at micro prices.

READY FOR ANY TOUR These printers are designed to deliver maximum in-service time, a key consideration for a small business. And we have the largest worldwide service organization of any independent printer company.

DON'T WRITE — phone Bob Cascarino today at (603) 883-0111, extension 4032, or contact any of our 15 U.S.A. or 9 international sales offices. Centronics Data Computer Corporation, Hudson, New Hampshire 03051.



CENTRONICS® PRINTERS
...the advantage

Listing 2: This is a first cut at the program `SYSTEM.STARTUP`, which is executed every time UCSD Pascal wakes up on the Apple II with the COPS-10 terminal. It uses direct addressing of memory through a standard Pascal variant record technique isolated in the procedure "set_memory." The memory locations directly addressed from procedure "set_up_cops" are the addresses described for various parameters of the Apple II Serial Communications Interface card.

```

PROCEDURE set_up_cops;
CONST
  slot:=3;
  data_rate_address:=1144;
  stop_bits_address:=1272;
  parity_address:=1400;
  linewidth_address:=1784;
  data_bits_address:=1912;
  op_modes_address:=2040;

PROCEDURE set_memory (value,address:INTEGER);

TYPE
  ptr = ^CHAR;
  memory_access=(pointer,number);
  memory =
    RECORD
      CASE memory_access OF
        pointer : (a_pointer:ptr);
        number   : (a_number:INTEGER)
      END;
VAR
  anybyte : memory;

BEGIN (set_memory)
  anybyte.a_number := address+slot;
  anybyte.a_pointer := CHR(value)
END;

BEGIN (set_up_cops)
(

```

All constants for setting up the Apple-II serial terminal port are determined from information on pages 21 to 24 of the Serial Interface Card manual, #WP-A2L0008/030-0012 ... 3/79-10K RP. Reference is also made to the manual for the COPS-10 terminal)

```

( 19200 BPS = 1 )
set_memory(1,data_rate_address);

( COPS can use 2 stop bits )
set_memory(3,stop_bits_address);

( no parity, no checksum )
set_memory(6,parity_address);

( COPS has 80 character lines )
set_memory(80,linewidth_address);

( COPS generates 8 data + 1 start bits )
set_memory(9,data_bits_address);

( no linefeed,lower case,no delay,no television )
( 0 + 32 + 64 + 128 )
set_memory(224,op_modes_address)

END (set_up_cops);

BEGIN
set_up_cops;
Writeln('');
Writeln('');
Writeln('');
Writeln('COPS-10 terminal setup completed');
Writeln('');
Writeln('');
Writeln('');
Writeln('');
Writeln('APPLE-2 Pascal System at BYTE');
Writeln('');
Writeln('');
Writeln('');
Writeln('Remember to set the date using the Filer');
Writeln('');
END.

```

executed, this procedure manipulates the Apple II serial communications port through absolute memory addresses. `SYSTEM.STARTUP` changes defaults so that the terminal will run at 19,200 bps, its maximum rate. In listing 2, the procedure "set_memory" is used to place arbitrary information in arbitrary memory locations; the procedure "set_up_cops" references "set_memory" in order to set up the hardware specific control locations of the serial port in slot number 3 of the Apple. Reading and learning about these system configuration details took about a weekend of work.

As my deadline for this editorial approaches, I have yet to try out the D C Hayes Micromodem with the system, although I expect it will be quite controllable from Pascal programs — perhaps with a link to a short 6502 assembly-language program if I use the read-only memory routines of the modem card.

The printer quite obviously works, as seen by the sample listings. One of my first application tasks was typing in my 1025-line Pascal print utility program as I had used it on my previous UCSD-based system. Only two language related points worked differently on the UCSD version II.0 Apple as compared to the UCSD version I.5 booted through CP/M. First, I found that the intrinsic procedure `PAGE(OUTPUT)` did not work on my Apple, possibly due to some problem in my use of the `SETUP` utility to configure the system for my terminal. Second, I

received a syntax error for a statement which had compiled just fine in UCSD Pascal version I.5 and which the version II.0 documentation of Apple implies should work: `READ(KEYBOARD, anychar)` where "anychar" is a variable declared `CHAR`. I got around both these problems by using the UCSD-specific intrinsic procedure `UNITWRITE` and `UNITREAD`, respectively.

This Apple II system with UCSD Pascal demonstrates that the state of the art in small computers is powerful indeed. I was able to walk into a computer store and purchase a full-fledged machine with mass storage, lots of memory, a good high-level language, operating system, and printer. At \$6000 this fits the bill of being personally affordable yet possessed of those features which make for a complete computer system. Of course there are other computers which are functionally equivalent to this Apple II system. I use its purchase as an example of what the state of the art is at present — a concrete example of my "ideal" abstraction of a personal computer cast into a specific and eminently useful form as a mass-produced product. ■

Note:

You may have noticed that the familiar "In This BYTE" page is missing from this issue. We have integrated the information from that page into the "In The Queue" page so that readers do not have to repeatedly flip between these corresponding pages.

BYTE^{T.M.} is available in microform

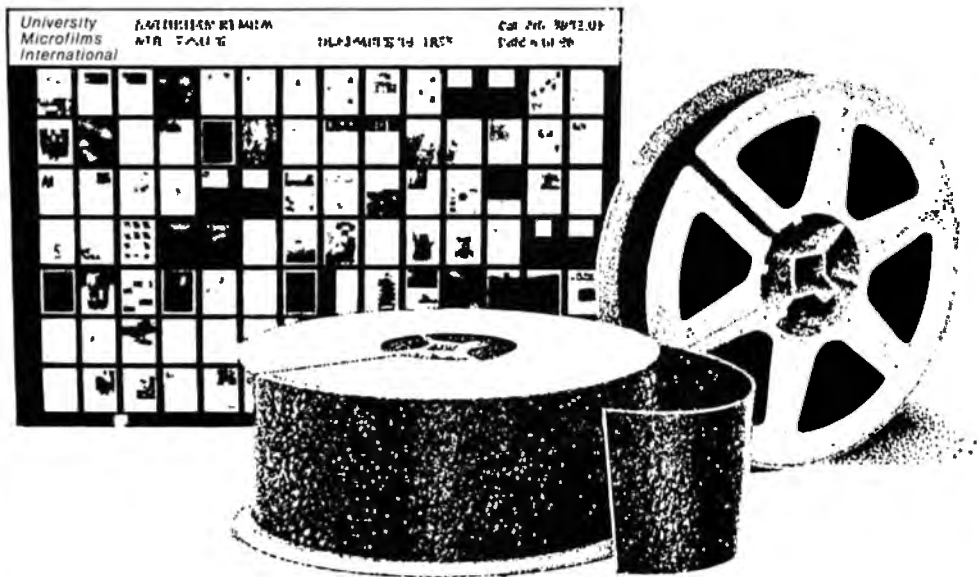

Please send me additional information.

Name _____

Institution _____

Street _____

City _____

State _____ Zip _____

University Microfilms International

300 North Zeeb Road
Dept. P.R.
Ann Arbor, MI 48106
U.S.A.

18 Bedford Row
Dept. P.R.
London, WC1R 4EJ
England

What Computers Cannot Do

T G Lewis
Computer Science Department
Oregon State University
Corvallis OR 97331

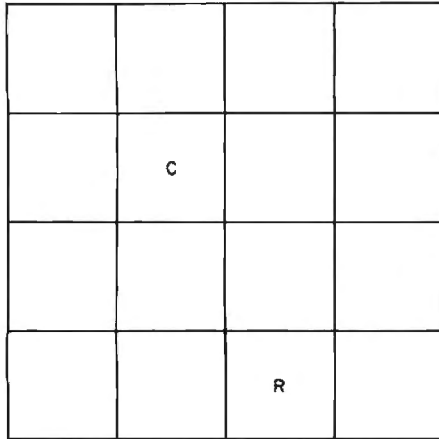

Figure 1: The game of Look is used to illustrate the concept of computability. A piece of cheese (C) is placed in any one of the squares, and a mechanical mouse robot (R) is placed in any other square. The object of the game is for R to find C.

Rapid advances in computing, resulting from the microcomputer revolution, are surprising even experienced computer professionals. A single integrated circuit microprocessor can perform the same number of computations per second as the expensive, large-scale computer of ten years ago. Yet, in a technical sense, both the type of computer and the things that computers are used for seem to have changed very little in the last ten years.

Ten years ago, BASIC was used in a manner similar to that of today, except that more people are now using it. Ten years ago computers had registers and memories to perform calculations; today register and memory costs have decreased fantastically. The cost of computing has declined, making it available to almost everyone. But has computing itself changed?

Can computers do any more today than they could ten years ago? Has there actually been any progress made in computing since Babbage's Analytic Engine, one hundred years ago?

What is meant by progress, and what is meant by computing? If progress is measured by the number of computers sold, the impact on society, or the size of the computer industry, then something has certainly increased and something else has decreased. What effect computers have had on our society is a moot question indeed, but one that I leave for another philosopher.

If computing is measured in terms of the number of machine cycles executed this year as compared to last year, or in terms of the number of programs written, then something has again increased and perhaps something else has decreased (like size or cost). But this kind of reasoning misses the point.

The essence of computing centers on two fundamental questions: (1) what exactly is computable, and (2) is it possible to compute more today than ten years ago? If these two questions can be answered, I believe that we can determine if progress has been made, whether this progress is due to microcomputers or their dinosaur ancestors, the maxicomputers.

Back to Games

Suppose a simple game called Look is played. Look is so trivial that it is easily played by any low intelligence animal. In fact, Look may be played by a simple machine.

A 4 by 4 grid of squares is arranged as shown in figure 1. A piece of cheese is placed in one of the squares and a mechanical mouse is placed in any other square. The mouse is a robot designated by "R"; the cheese is represented by "C." The objective is for robot R to find cheese C. The game immediately poses a problem for robot designers, for they must program R to find C without outside help. How is R instructed to locate C?

The first area of concern is the simplest program for R. If it is impossible to solve the robot programming problem in a simple manner, a sophisticated solution will probably fail.

Suppose R is designed to move one step in any of directions North, South, East and West. This is called a step action, and the direction is designated by writing STEP W for a single step in the western direction, for example.

Clearly, the robot must know when it has encountered a barrier (wall) and when it has found the cheese. Hence, mouse R is also empowered with a sensor that sets a condition code. Codes Barrier and Found are set by sensors on board R.

The STEP and condition code designs are a start toward a working mouse. They allow the robot to move

About the Author

Dr Lewis is an Associate Professor of Computer Science at Oregon State University, where he lectures on software engineering and personal computer systems. He is the author of *How to Profit from Your Personal Computer* and *The Mind Appliance: Home Computer Applications*.

DIGITAL RESEARCH

CP/M FLOPPY DISKETTE OPERATING SYSTEM — Packages supplied on diskette complete with 8080 assembler, text editor, 8080 debugger and various utilities plus full documentation. CP/M available configured for most popular computer/disk systems including North Star Single, Double or Quad density, Altair 8800 disks, Helios II, Exidy Sorcerer, Vector MZ, Heath H17 or H89T, TRS-80, iCOM 3712 and iCOM Micro Disk plus many other configurations available off the shelf. **\$145/\$225**

CP/M version 2 (not all formats available immediately) **\$170/\$225**

MP/M **\$300/\$500**

Lower prices!

MAC — 8080 Macro Assembler. Full Intel macro definitions. Pseudo Ops include RPL, IRP, REP, TITLE, PAGE, and MACLIB. Z-80 library included. Produces Intel absolute hex output plus symbols file for use by SID (see below). **\$85/\$115**

SID — 8080 symbolic debugger. Full trace, pass count and break-point program listing system with back-trace and histogram utilities. When used with MAC, provides full symbolic display of memory labels and equated values. **\$70/\$115**

ZSID — As above for Z-80. Requires Z-80 CPU. **\$95/\$115**

TEX — Text formatter to create paginated, page-numbered and justified copy from source text files, directable to disk or printer. **\$70/\$115**

DESPOOL — Program to permit simultaneous printing of data from disk while user executes another program from the console. **\$45/\$75**

NEW!

All Microsoft prices are discounted!

MICROSOFT

BASIC-80 — Disk Extended BASIC. ANSI compatible with long variable names, WHILE/WEND, chaining, variable length file records. **\$300/\$225**

BASIC COMPILER — Language compatible with BASIC-80 and 3-10 times faster execution. Produces standard Microsoft relocatable binary output. Includes Macro-80. Also linkable to FORTRAN-80 or COBOL-80 code modules. **\$350/\$225**

FORTRAN-80 — ANSI 76 (except for COMPLEX) plus many extensions. Includes relocatable object compiler, linking loader, library with manager. Also includes MACRO-80 (see below). **\$400/\$225**

COBOL-80 — ANSI 74 Relocatable object output. Format same as FORTRAN-80 and MACRO-80 modules. Complete ISAM, interactive ACEDIT, IDIA, COPY, EXTEND. **\$625/\$225**

MACRO-80 — 8080/8080 Macro Assembler. Intel and Z80 mnemonics supported. Relocatable linkable output. Loader, Library Manager and Cross Reference List utilities included. **\$149/\$115**

XMACRO86 — 8086 cross assembler. All Macro and utility features of MACRO-80 package. Mnemonics slightly modified for 8086. Compatibility data sheet available. **\$275/\$225**

EDIT-80 — Very fast random access text editor for text with or without line numbers. Global and in-line commands supported. File compare utility included. **\$89/\$115**

MICRO FOCUS

STANDARD CIS COBOL — ANSI 74 COBOL standard compiler fully validated by U.S. Navy tests to ANSI level 1. Supports many features to level 2 including dynamic loading of COBOL modules and a full ISAM file facility. Also, program segmentation, interactive debug and powerful interactive extensions to support protected and unprotected CRT screen formatting from COBOL programs used with any dumb terminal. **\$850/\$550**

FORMS 2 — CRT screen editor. Output is COBOL data descriptions for copying into CIS COBOL programs. Automatically creates a query and update program of indexed files using CRT protected and unprotected screen formats. No programming experience needed. Output program directly compiled by CIS COBOL (standard). **\$200/\$220**

EIDOS SYSTEMS

KISS — Keyed Index Sequential Search. Offers complete Multi-Keyed Index, Sequential and Direct Access file management. Includes built-in utility functions for 16 or 32 bit arithmetic, string/integer conversion and string compare. Delivered as a relocatable linkable module in Microsoft format for use with FORTRAN-80 or COBOL-80, etc. **\$325/\$225**

KBASIC — Microsoft Disk Extended BASIC with all KISS facilities, integrated by implementation of nine additional commands in language. Package includes KISS REL as described above, and a sample mail list program. **\$585/\$415**

to licensed users of Microsoft BASIC-80 (MAC-80) **\$435/\$415**

All Micropro prices are discounted!

MICROPRO

SUPER-SORT I — Sort, merge, extract utility as absolute essential program or linkable module in Microsoft format. Sorts fixed variable records with data in binary, BCD, Packed Decimal, EBCDIC, ASCII, floating, fixed point, exponential, field justified, etc. Even variable number of fields per record! **\$225/\$225**

SUPER-SORT II — Above available as absolute program only. **\$175/\$225**

SUPER-SORT III — As II without SELECT/EXCLUDE. **\$125/\$225**

WORD-STAR — Menu driven visual word processing system for use with standard terminals. Text formatting performed on screen. Facilities for text pagination, page number, justify, center and underscore. User can print one document while simultaneously editing a second. Edit facilities include global search and replace, read/write to other text files, block move, etc. Requires CRT terminal with addressable cursor positioning. **\$445/\$225**

WORD-MASTER Text Editor — In one mode has super-set of CP/M's ED commands including global searching and replacing, forward and backwards in file. In video mode, provides full screen editor for files with serial addressable-cursor terminal. **\$125/\$225**

SOFTWARE SYSTEMS

CBASIC-2 Disk Extended BASIC — Non-interactive BASIC with pseudo-code compiler and runtime interpreter. Supports full file control, chaining, integer and extended precision variables, etc. **\$100/\$115**

PASCALZ — Z-80 native code PASCAL compiler. Produces optimized ROMable re-entrant code. All interfacing to CP/M is through the support library. The package includes compiler, linker, macro-assembler and source for the library. Requires 56K and Z-80 CPU. Version 2 includes editor/Jensen/Wirth except variant records. **\$275/\$225**

Version 3 Upgrade with variant records and expected Z-80. **\$395/\$225**

PASCALMT — Subset of standard PASCAL. Generates ROMable 8080 machine code. Symbolic debugger included. Supports interrupt procedures and BCD arithmetic for real variables. CPU I/O and assembly language interface supported. Includes Sets, Enumeration and Record data types. Manual explains BASIC to PASCAL conversion. Requires 32K. **\$95/\$300**

Source for PASCALMT run time package Requires MAC (See under Digital Research). **\$50**

Structured systems prices are discounted!

STRUCTURED SYSTEMS GROUP

GENERAL LEDGER — Interactive and flexible system providing proof and report outputs. Customization of COA created interactively. Multiple branch accounting centers. Extensive checking performed. Data entry line proof, COA correctness, etc. Journal entries may be batched prior to posting. Closing procedure automatically backs up input files. All reports can be tailored as necessary. Requires CBASIC-2. **\$899/\$225**

ACCOUNTS RECEIVABLE — Open item system with output for internal aged reports and customer-oriented statement and billing purposes. On-Line Enquiry permits information for Customer Service and Credit departments. Interface to General Ledger provided if both systems used. Requires CBASIC-2. **\$699/\$225**

ACCOUNTS PAYABLE — Provides aged statements of accounts by vendor with check writing for selected invoices. Can be used alone or with General Ledger and/or with NAD. Requires CBASIC-2. **\$699/\$225**

ANALYST — Customized data entry and reporting system. User specifies up to 75 data items per record. Interactive data entry, retrieval and update facility makes information management easy. Sophisticated report generator provides customized reports using selected records with multiple level break-points for summarization. Requires CBASIC-2, 24 x 8 CRT, printer and 48K system. **\$225/\$115**

LETTERRIGHT — Program to create, edit and type letters or other documents. Has facilities to enter, display, delete and move text, with good video screen presentation. Designed to integrate with NAD for form letter mailings. Requires CBASIC-2. **\$179/\$225**

NAD Name and Address selection system — interactive mail list creation and maintenance program with output as full reports with reference data or restricted information for mail labels. Transfer system for extraction and transfer of selected records to create new files. Requires CBASIC-2. **\$79/\$220**

QSORT — Fast sort/merge program for files with fixed record length, variable field length information. Up to five ascending or descending keys. Full back-up of input files created. **\$95/\$220**

Graham-Dorian prices are discounted!

GRAHAM-DORIAN SOFTWARE SYSTEMS

GENERAL LEDGER — An on-line system; no batching is required. Entries to other GRAHAM-DORIAN accounting packages are automatically posted. User establishes customized C.O.A. Provides transaction register, record of journal entries, trial balances and monthly closings. Keeps 14 months history and provides comparison of current year with previous year. Requires CBASIC-2. Supplied in source. **\$495/\$335**

ACCOUNTS PAYABLE — Maintains vendor list and check register. Performs cash flow analysis. Flexible — writes checks to specific vendors for certain invoices or can make partial payments. Automatically posts to GRAHAM-DORIAN general ledger or runs as stand alone system. Requires CBASIC-2. Supplied in source. **\$495/\$335**

ACCOUNTS RECEIVABLE — Creates trial balance reports, prepares statements, ages accounts and records invoices. Provides complete information describing customer payment activity. Reports can be posted to different ledger accounts. Entries automatically update GRAHAM-DORIAN general ledger or runs as stand alone system. Requires CBASIC-2. Supplied in source. **\$495/\$335**

PAYROLL SYSTEM — Maintains employee master file. Computes payroll withholding for FICA, Federal and State taxes. Prints payroll register, checks, quarterly reports and W-2 forms. Can generate ad hoc reports and employee form letters with mail labels. Requires CBASIC. Supplied in source code. **\$495/\$335**

INVENTORY SYSTEM — Captures stock levels, costs, returns, sales, ages, turnover, markup, etc. Transaction information may be entered for reporting by salesman, type of sale, date of sale, etc. Reports available both for accounting and decision making. Requires CBASIC. Supplied in source code. **\$495/\$335**

JOB COSTING — Designed for general contractors. Can be used interactively with other GRAHAM-DORIAN accounting packages for tracking and analyzing expenses. User establishes customized cost categories and job phases. Reports comparison of actual versus estimated costs. Automatically updates GRAHAM-DORIAN general ledger or runs as stand alone system. Requires CBASIC-2. Supplied in source. **\$495/\$335**

APARTMENT MANAGEMENT SYSTEM — Financial management system for receipts and security deposits of apartment properties. Captures data on vacancies late rents, vacancy notices, vacancies, income lost through vacancies, etc. Requires CBASIC. Supplied in source code. **\$495/\$335**

CASH REGISTER — Maintains files on daily sales. Files data by sales person and item. Tracks sales, overruns, refunds, payouts and total net deposits. Requires CBASIC. Supplied in source code. **\$495/\$335**

tiny C — Interactive interpretive system for teaching structured programming techniques. Manual includes full source listings. **\$75/\$40**

BDS C COMPILER — Supports most major features of language, including Structures, Arrays, Pointers, recursive function evaluation, linkable with library to 8080 binary output. Lacks data initialization, long & float type and static & register class specifiers. Documentation includes "C Programming Language" book by Kernighan & Ritchie. **\$110/\$115**

WHITESMITHS' C COMPILER — The ultimate in systems software tools. Produces faster code than Pascal with more extensive facilities. Conforms to the full UNIX™ version of C language, described by Kernighan and Ritchie, and makes available over 75 functions for performing I/O, string manipulation and storage allocation. Linkable to Microsoft REL files. Requires 60K CP/M version. **\$630/\$330**

POLYVUE/80 — Full screen editor for any CRT with XY cursor positioning. Includes vertical and horizontal scrolling, interactive search and replace, automatic text wrap around for word processing, operations for manipulating blocks of text, and comprehensive 70 page manual. **\$135/\$115**

POLYTEXT/80 — Text formatter for word processing applications. Justifies and paginates source text files. Will generate form letters with custom labels and conditional processing. Support for Daisy Wheel printers includes variable pitch justification and motion optimization. **\$85/\$115**

ALGOL-60 — Powerful block-structured language compiler featuring economical run time dynamic allocation of memory. Very compact (24K total RAM) system implementing almost all Algol 60 report features plus many program extensions including string handling, direct disk address I/O etc. Requires Z80 CPU. **\$199/\$220**

Z80 DEVELOPMENT PACKAGE — Consists of: (1) disk file editor, with global inter-intra-line facilities; (2) Z80 relocating assembler. Global block mnemonics, conditional assembly and cross reference table capabilities; (3) linking loader producing absolute Intel hex disk file. **\$95/\$220**

ZDT — Z80 Debugger to trace, break and examine registers with standard Z80/Mosk memory dump. Displays by displays \$35 when ordered with Z80 Development Package. **\$50/\$110**

DISTEL — Disk based disassembler to Intel 8080 or TDX/LXian Z80 source code, listing and cross reference files. Intel or Z80/LXian pseudo ops optional. Runs on 8080. **\$65/\$110**

DISLOG — As DISTEL to Z80g Mosk memory dump. Runs on Z80 only. **\$65/\$110**

TEXTWRITER III — Text formatter to justify and paginate letters and other documents. Special features include insertion of text during execution from other disk files or console, permitting receipt documents to be created from linked fragments on other files. Has facilities for sorted index, table of contents and footnotes. Excellent for contracts, manuals, etc. **\$125/\$220**

POSTMASTER — A comprehensive package for mail list maintenance. Features include keyed record extraction and label production. A form letter program is included which provides neat letters on single sheet or continuous forms. Requires CBASIC-2. **\$160/\$225**

WHATSI?™ Interactive data-base system using associative tags to retrieve information by subject. Hashing and random access used for fast response. Requires CBASIC-2. **\$125/\$225**

XYBASIC Interactive Process Control BASIC — Full disk BASIC features plus unique commands to handle bytes, rotate and shift, and to test and set bits. Available in integer, extended and ROMable versions. Integer/Disk or Integer/ROMable. **\$295/\$225**

SMAL/80 Structured Macro Assembled Language — Package of powerful general purpose text macro processor and SMAL structured language compiler. SMAL is an assembler language with IF-THEN-ELSE, LOOP-REPEAT-WHILE, DO-END, BEGIN-END constructs. **\$75/\$115**

SELECTOR III-C2 — Data Base Processor to create and maintain mail Key data bases. Prints formatted, sorted reports with numeric summaries or mailing labels. Comes with sample applications including Sales Activity, Inventory, Payables, Receivables, Check Register, and Client/Patient Appointments, etc. Requires CBASIC Version 2. Supplied in source code. **\$295/\$220**

CPM/374X — Has full range of functions to create or rename an IBM 3741 volume, display directory information and edit the data set contents. Provides full file transfer facilities between 3741 volume data sets and CP/M files. **\$195/\$110**

BASIC UTILITY DISK — Consists of: (1) CRUNCH™ — Compacting utility to reduce the size and increase the speed of programs on disk. (2) DPFUN™ — Double precision subroutines for computing nineteen transcendental functions including square root, natural log, log base 10, sin, arc sin, hyperbolic sin, hyperbolic arc sin, etc. Furnished in source on diskette and documentation. **\$50/\$35**

THE STRING BIT — Fortran character string handling. Routines to find, fill, pack, move, separate, concatenate and compare character strings. This package completely eliminates the problems associated with character string handling in FORTRAN. Supplied with source. **\$45/\$115**

BSTAM — Utility to link one computer to another also equipped with BSTAM. Allows file transfers at full data speed (no compression), with CRC block control check for very fast error detection and automatic retry. We use IBM 3741 volume, display directory information to send *COM, etc. 250 baud with 300 baud with phone connection. Both ends need one. Standard and M versions can talk to one another. Compatible TRSDOS version also available. **\$150/\$85**

Floppy Disk Kit — Template and instructions to modify single sided 5 1/4" diskettes for use of second side in 800 sided disks. **\$12.50**

FLOPPY SAVER Protection for center holes of 5 1/4" floppy disks. Only 1 needed per disk. Contains centering post, pressure ring, 7-mil mylar reinforcing rings. Installation tools and rings for 25 diskettes. Re-orders of rings only. **\$14.95**

*CP/M is a trademark of Digital Research
 **Z80 is a trademark of Zilog, Inc.
 ***UNIX is a trademark of Bell Laboratories
 ****WHATSI? is a trademark of Computer Headware

CP/M for Heath, TRS-80 Model I and PolyMorphic 8813 are modified and must use specially compiled versions of system and applications software
 Modified version available for use with CP/M as implemented on Heath and TRS-80 Model I computers.

User license agreement for this product must be signed and returned to Lifeboat Associates before shipment may be made

SOFTWARE SUPERMARKET

Lifeboat Associates

Orders must specify disk systems and formats e.g. North Star single, double or quad density, IBM single or 2D/256, Altair, Helios II, Micropolis Mod I or II, 5 1/4" floppy sector (Micro ICOM/SD Systems Dynabyte), etc.

Prices F.O.B. New York. Shipping, handling and C.O.D. charges extra.

Manual cost applicable against price of subsequent software purchase

The sale of each proprietary software package conveys a license for use on one system only

Lifeboat Associates, 2248 Broadway, N.Y., N.Y. 10024 (212) 560-0082 Telex: 220501 (New number!)

TM

™The Software Supermarket is a trademark of Lifeboat Associates

one square in any compass direction, detect a barrier, or locate the cheese. Surely radar or any other sophisticated tool is not needed to solve the Look problem.

Sit back and watch R move one square at a time after each command it is given. Recall, however, that Look is a game played only by a mechanical mouse without human intervention; R is a robot. A robot can be defined as follows:

Robot: Any device that operates without direct human control.

By this definition, a wall clock is a robot because it keeps time independently of direct human instruction. An automobile, however, must have direct contact with a human in order to operate.

The Look mouse must be given a brain with enough intelligence to find its own way from one square to another. This is where the concept of computing arises.

The Concept of Computing

A robot that acts without direct human guidance must possess two types of control: (1) basic actions and (2) intrinsic control for sequencing basic actions. The following two sets are chosen in keeping with the simplest possible design:

ACTIONS: STEP X, set condition code, BARRIER, FOUND, NOT FOUND, and START, STOP, where X is N, W, E, S.

CONTROL: simple sequence of a collection of actions, looping of actions, decision (branch) capability.

These actions and control are programmed into R through some yet to be determined mechanism. A pseudolanguage will be used to illustrate the programs in this article, but it is important to remember that every programming language for every computer known to the author has at least the three control constructs listed above; that is, it is conjectured that the intelligence being given R is no more than the intelligence of very simple computers. This leads to the following hypothesis:

Hypothesis 1: Any robot mouse with the actions and control given to R can be programmed to solve the Look problem.

It is possible to go even further with this hypothesis and claim that the solution to the Look problem is indeed possible. Possible means that a path from the starting location of R to the square occupied by C exists and is computable:

Hypothesis 2: Any path leading to C from R is a *computation*, and furthermore, any machine with the properties of R is able to perform such a computation.

There is now a concept of computing. For the game of Look, a computation involves finding a path. A function is a set of operations that tries to calculate a computation

BATTERY-WRAP

WIRE WRAPPING TOOL

MODEL BW-2630

- POSITIVE INDEXING
- ANTI-OVERWRAPPING
- BITS AVAILABLE FOR AWG 26, 28 & 30
- BATTERY OPERATED
- LIGHT WEIGHT



\$19⁸⁵*

BATTERIES AND BIT NOT INCLUDED

U.S.A.
FOREIGN
PATENTS
PENDING



BW-2630	BATTERY-WRAP TOOL	\$19.85
BT-30	BIT FOR AWG 30	\$ 3.95
BT-2628	BIT FOR AWG 26 & 28	\$ 7.95
RB-20	TWO NI-CAD BATTERIES	\$10.75

OK MACHINE & TOOL CORPORATION

3455 CONNER STREET, BRONX, N.Y. 10475, U.S.A.

PHONE (212) 994-6600 • TELEX: 125091

*MINIMUM BILLING \$25.00 / ADD SHIPPING CHARGE \$2.00 / NEW YORK CITY / STATE RESIDENTS ADD APPLICABLE TAX.

MicronET

It's off and running. And delivering as promised.

What is MicroNET?

It is the personal computing service of CompuServe, Incorporated. CompuServe is a nationwide commercial time sharing computer network with large-scale mainframes. MicroNET allows the personal computer user access to CompuServe's large computers, software and disc storage during off-peak hours (from 6 PM to 5 AM weekdays, all day on Saturdays, Sundays and most holidays).

What do I get?

You can use our powerful processors with X-Basic, Fortran, Pascal, Macro-10, AID or APL. You get 128K bytes of storage free (just access it at least once a month). Software includes games—including networking multi-player games—personal, business and educational programs.

In addition, there is the MicroNET National Bulletin Board for community affairs,

for sale and wanted notices and the MicroNET Electronic Mail System for personal messages to other MicroNET users. You can even sell software via MicroNET.

NEW! MicroQUOTE, a security information system for corporate stocks and public debt.

NEW! MicroNET Software Exchange with dozens of new programs available for downloading to your personal computer at a specified charge.

NEW! Executive programs for TRS-80, Apple II and CP/M systems (so your machine and ours can talk to each other error-free). You can switch between terminal and local mode while on line.

What do I have to have to use MicroNET?

The standard 300 baud modem. MicroNET has local phone

service in most major cities (see below) and a reduced phone charge in over a hundred others.

What is the cost?

We've saved the best for last. There is a one-time hook-up charge of only \$9.00! Operating time—billed in minutes to your VISA or MasterCard card—is only \$5.00 an hour.

Want more information?

Good. Write to us at the address below. We'll send you a full packet of information about MicroNET.

CompuServe

Personal Computing Division
Dept. B
5000 Arlington Centre Blvd.
Columbus, Ohio 43220

MicroNET is available via local phone calls in the following cities: Akron, Atlanta, Boston, Canton, Chicago, Cincinnati, Cleveland, Columbus, Dallas, Dayton, Denver, Detroit, Houston, Indianapolis, Los Angeles, Louisville, Memphis, West Caldwell (NJ), New York, Philadelphia, Pittsburgh, San Francisco, Stamford (CT), St. Louis, Toledo, Tucson and Washington, D.C.

Access to the MicroNET service is available in 153 other cities for an additional charge of \$4.00 per hour.



"... but the really impressive stuff is in the back room."

(ie: a path from R to C). A function is *computable* if R can get to C, and a function is *undecidable* if there is a possibility that R will fail to reach C.

Programming a Function in Look

Now an attempt is made to build a robot R that finds its way to C. The first attempt is again a simple approach to the problem. Suppose R is instructed to go West until reaching a barrier, then another direction is chosen and it continues to travel in that direction until reaching a barrier, and so on. Such a program might look like the pseudolanguage program shown in listing 1.

Of course, this program does not solve the Look puzzle. It may correctly locate the cheese C if C is in a boundary square (see figure 2). The problem is that C may or may not be in a square along the circular path established by program CIRCLE. Hence, it is undecidable whether or not CIRCLE computes a path leading to C.

The intelligence of R must be increased in order to guarantee a computable path (as opposed to an undecidable path). Clearly, the problem with CIRCLE is that it fails to cover every possible square. How can no square be left uncovered?

A second simple program (see listing 2) is attempted that exhaustively scans every possible square until it locates C. Lines 200 thru 220 move R to a left side square. The program must cover every square, but since R may be initially placed anywhere within Look, a starting point must be established that guarantees an exhaustive scan of the sixteen squares. This is done in lines 230 thru 250.

CIRCLE:

```

10  START R ;
20  REPEAT LOOP
30  STEP W ; IF FOUND THEN STOP ;
40  UNTIL W BARRIER ;
50  REPEAT LOOP
60  STEP N ; IF FOUND THEN STOP ;
70  UNTIL N BARRIER ;
80  REPEAT LOOP
90  STEP E ; IF FOUND THEN STOP ;
100 UNTIL E BARRIER ;
110 REPEAT LOOP
120 STEP S ; IF FOUND THEN STOP ;
130 UNTIL S BARRIER ;
140 REPEAT LOOP
150 STEP W ; IF FOUND THEN STOP ;
160 UNTIL W BARRIER ;
170 STOP CIRCLE

```

Listing 1: Pseudolanguage program that calculates circular paths on the Look game board.

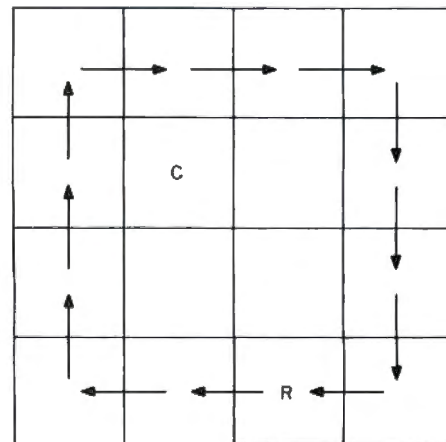

Figure 2: Path computed by the CIRCLE program (listing 1). CIRCLE creates circular paths for R on the game board, which may or may not intersect with C. It is therefore undecidable whether or not CIRCLE computes a path leading to C.

MAGSAM™ KEYED FILE MANAGEMENT SYSTEM

Sophisticated applications made simple.

Put data at your fingertips...easily accessed, displayed, and updated by key. MAGSAM™ allows your CBASIC programs to create and access sophisticated keyed file structures through simple CBASIC statements.

Powerful, affordable, and easy to use.

MAGSAM™ is now available in three versions offering an array of features and capabilities. Standard MAGSAM™ features include random by key, sequential by key, generic by key, randomly by record number, and physical sequential access techniques. Each MAGSAM™ Package includes the MAGSAM™ file manager, tutorial program, file dump utility, User Guide, Reference Card, and one year update service.

- **MAGSAM™** — Most advanced version. Secondary Indexing with any number of keys, and Record and Key Deletion with automatic reuse of freed space. \$145†
- **MAGSAM II™** — Single Key support with full Record and Key Delete capability. \$99†
- **MAGSAM I™** — Entry level version. Single Key support without Delete functions. \$75†
- **MAGSAM™ User Guide only** — comprehensive tutorial and reference manual. \$15

Available for 8" soft sector, Micropolis, and TRS-80 disk formats. Requires CP/M* or derivative and CBASIC. Distributed as CBASIC subroutines in source form.

Visa and Mastercard welcome. Dealer and OEM inquiries invited



MICRO APPLICATIONS GROUP
7300 CALDUS AVENUE
VAN NUYS, CA 91406

* Trademark of Digital Research † Single site license

EXHAUST:

```

200  REPEAT LOOP
210  STEP W ; IF FOUND THEN STOP
220  UNTIL W BARRIER ;
230  REPEAT LOOP
240  STEP S ; IF FOUND THEN STOP
250  UNTIL S BARRIER ;
260  REPEAT LOOP
270  REPEAT LOOP
280  STEP E ; IF FOUND THEN STOP
290  UNTIL E BARRIER ;
300  STEP N ; IF FOUND THEN STOP ;
310  REPEAT LOOP
320  STEP W ; IF FOUND THEN STOP ;
330  UNTIL W BARRIER ;
340  STEP N ; IF FOUND THEN STOP ;
350  UNTIL N BARRIER ;
360  STOP

```

Listing 2: Pseudolanguage program that makes an exhaustive sweep through every square on the Look board.

R is now in the proper lower left position to begin looking for C by systematically visiting every square. This is done by moving N after every E or W BARRIER is found as shown in figure 3.

This version of the program for R illustrates two conceptually important features. Indeed, this program is called an *algorithm* because (1) it will systematically carry out the basic actions in a deterministic (predictable) manner every time it is executed, and (2) it will reach a STOP statement every time it is run. The question remains, however: will this program (algorithm) find C every time?

Looking for C

The program for exhaustive search lacks a certain elegance. For example, the sophistication of R could be increased to add subroutine capability:

```

1000     SUBROUTINE MOVE: (X,Y)
1010     REPEAT LOOP
1020     STEP X; IF FOUND THEN STOP;
1030     UNTIL Y BARRIER;
1030     RETURN

```

This would reduce program size and complexity by using pieces of the program iteratively. Such an improvement may benefit a programmer or reduce the cost of building robots, but does nothing to improve the concept of computing.

The EXHAUST program becomes easier to understand and write when additional control is supplied. However, the addition of subroutines, interrupts, and other sophisticated features does nothing to increase the computational power of robots. This is an important fundamental concept:

Hypothesis 3: Every function that can be computed, can be computed by a robot with only three control operations: (1) sequence, (2) looping, (3) conditional branching.

If true, this means that every solution to the Look puzzle is possible with the simple machine designed here. There is no path through Look that cannot be computed with the power of robot R. Does this mean that every computation in Look is computable by R? In this specific game, the answer is yes. We have not proven the above hypotheses, but they can be supported by evidence.

What Are the Limits?

What is *not* computable, if such a simple machine (R) is able to compute every function in Look? (This corresponds to finding every path from R to C.) If internal barriers are added to Look as shown in figure 4, does R need more power? The answer is no. A larger, more sophisticated program may be required, but it can be constructed from the same simple building blocks as before.

Suppose that an attempt is made to fool robot R by removing C entirely (see figure 5). What becomes of algorithm EXHAUST? Reexamination of the algorithm shows that the program eventually halts when every square has been searched by R at least once. The STOP action executed when C is located is a different STOP than the one executed when C is missing from the game

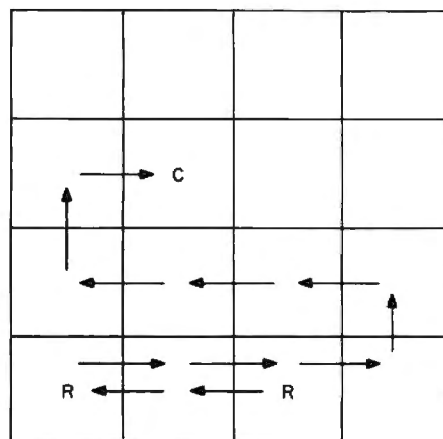

Figure 3: The exhaustive sweep solution is an inelegant but effective method that systematically visits every square on the board, looking for C.

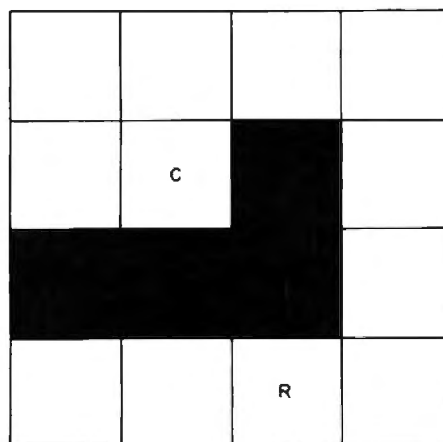

Figure 4: Adding an internal barrier to the Look game. R does not need any more computing power to solve such a layout, but the program may have to be more sophisticated.

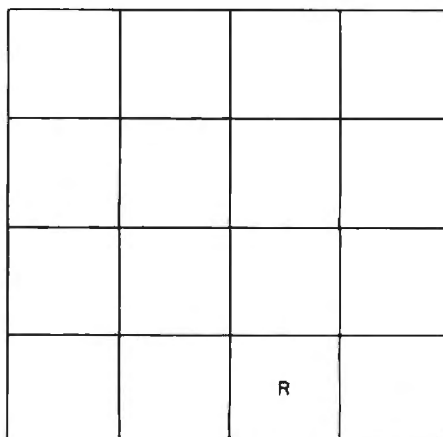

Figure 5: Removal of the target C from the game. Although R can no longer find C, the program will still halt, and through suitable adjustments, the program can tell whether or not C was found.

Heuristics

SpeechLink™

2000

Talk To Your Computer . . .

- Voice data entry to the Apple® computer
- Voice control of your Apple® system
- User variable vocabulary (64 words and up)
- Applesoft & Integer Basic compatible with or without disk operating system

Useful For . . .

- Collecting inventory data
- Running the Apple® as a terminal
- Controlling production test equipment (say "test 2")
- Menu selection of programs (say "stocks")
- Entering stock market data
- Educational programs for the kids (say "square")

See your computer dealer.
Model 2000 suggested retail price
\$259, model 20A \$189.

Heuristics
INC.

1285 HAMMERWOOD AVENUE
SUNNYVALE, CALIFORNIA 94086
408/734-8532

Apple® is a registered trademark of Apple Computer Corporation

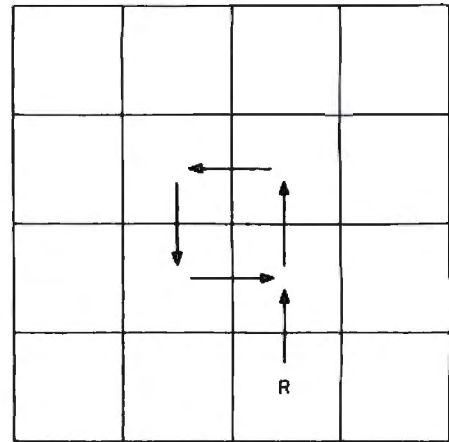

Figure 6: A heuristic technique for finding C. The programmer has assumed that C is more likely to be found in the center squares, and has thus accelerated the search at the expense of an occasional failure.

board. Can it be known which stop is executed when EXHAUST halts?

Suppose lines 210, 240, 280, 300, 320, 340, and 360 in listing 2 are modified to display the condition code setting when a STOP is executed. Then when the robot halts, the condition code can be examined to see if it says FOUND or NOT FOUND.

Indeed, R can be built cleverly enough so that it stops and informs you of its condition. This requires that R eventually stop. When it stops, it is asked whether or not it has found a path to C. This leads to another important concept in computing:

The Halting Problem: A robot that computes an algorithm must eventually halt. If a robot tries to compute a function (ie: find a path) that does not guarantee the termination of its search, the robot is computing an undecidable function.

Normally, undecidable functions are avoided in computing. Often, however, the risk of encountering a non-terminating search is not great, and thus the rules can be relaxed to speed up the robot. For example, suppose that the EXHAUST algorithm is replaced by a faster heuristic. That is, the search strategy is changed as follows: the exhaustive search procedure is too slow. Its speed can be increased by increasing the robot's speed (technological improvement in equipment), or by decreasing the search space (eliminating the number of squares considered). Perhaps the cheese is in the central squares most of the time. If so, a nearly perfect batting average can be obtained by searching the middle four squares only. Figure 6 suggests one possible heuristic for computing a path to C.

Perhaps the "four-square" heuristic will locate C, perhaps not. This approach may seem too casual, but interestingly enough, much of the software in contemporary systems is of this nature. That is, many programs are heuristic in nature rather than algorithmic, because they have reduced their search space to only the most probable paths. One way of defining a heuristic is as "a procedure for finding the solution *most* of the time."

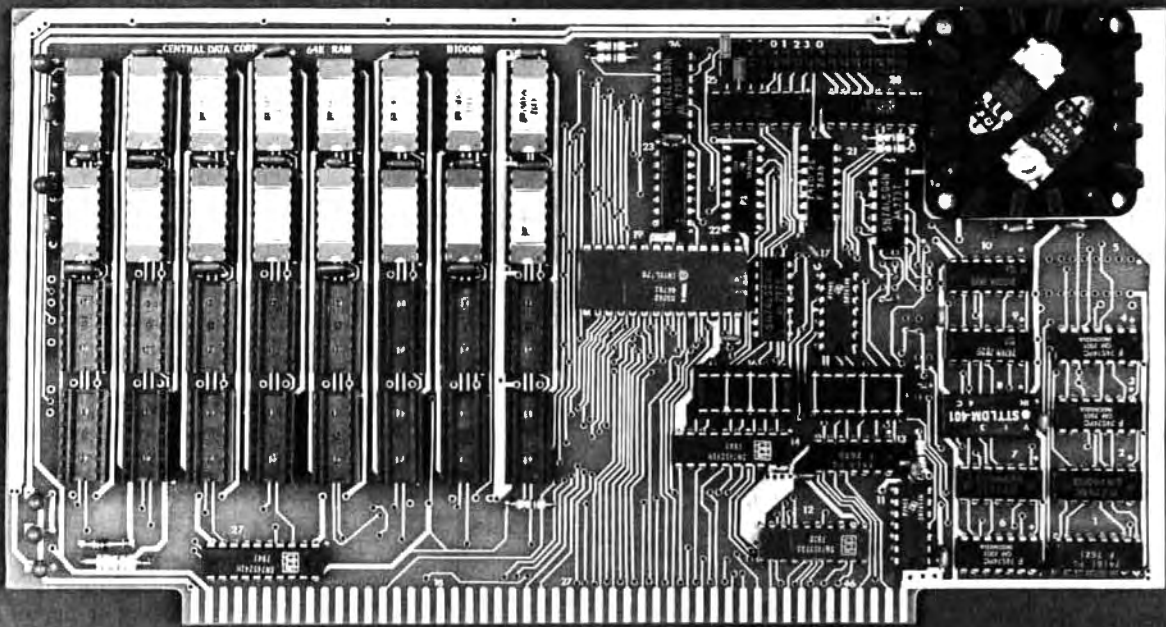

32K Board Pictured Above

Why Not the Best?

From The Dynamic RAM Company.

2MHz	4MHz
16K—\$249	\$259
32K—\$375	\$395
48K—\$500	\$530
64K—\$625	\$665

We have now been shipping our 2MHz dynamic RAM boards for over two years. Hundreds of 4MHz boards have been going out every month since early 1979. Our reliability is proven in the thousands of systems which contain our board. Many quality-minded systems houses across the country and overseas are using our boards for their equipment.

Our prices still beat all. Despite rising 16K memory chip prices (at least from reputable suppliers), Central Data continues to give you the best buy in memory today. Nobody offers a board with a capacity of 64K, assembled, tested, and guaranteed for a full year at the price we do.

Deselect around PROMs. Our boards have the important deselect feature which lets you overlap any fixed memory in your system with no interference.

Our features make the board easily used and expanded. You address our boards on 16K boundaries with mini-jumps (small shorting plugs that slide over wire-wrap pins) near the top of the board for easy access. If you want to expand your board after you have purchased it, all that you need to do is add memory. We can supply you with expansion packages (\$150-2MHz, \$160-4MHz) which include eight RAMs that you can depend on as well as two mini-jumps for addressing. And of course, our board **never** generates wait states.

Low power consumption keeps your computer running cool and reliable. The total power consumption of our 16K board is typically less than 4 watts (+8V @ 300ma, +16V @ 150ma and

–16V @ 20ma). Boards with additional memory typically increase power consumption only 1 watt per 16K!

Standard S-100 Interface. Our board is designed to interface with any standard S-100 CPU. All of the timing of the board is independent of the processor chip, and the board is set up for different processors by changing two plugs on the board.

Call or write us today. That will guarantee a fast response with more information on the board. Or make an order — you'll probably have the board in two weeks! **If you're interested, also ask for a catalog on our Z8000 16-bit processor board designed for the MULTIBUS.** All of these products are available to your local dealer, also.

Central Data Corporation, 713 Edgebrook Drive, PO Box 2530, Station A, Champaign, IL 61820. (217) 359-8010

Central Data

Hypothesis 4: Many computer programs are heuristic in nature because they do not satisfy the halting problem, or do not cover the search space of solutions.

More has been required of the little robot than is required of real computer programs. Thus, R is a good model of what machines can do. Still, there must be something R cannot compute. In fact, there is: R cannot tell if its program is an algorithm or merely a heuristic. This is one of the cornerstones of computing.

A More Powerful Robot: GR

Suppose a more powerful generalized robot, GR, is constructed. GR is basically like R, except GR solves a problem called DECIDE. This new game is played as follows: the instructions for a program written in robot R's language (eg: the EXHAUST problem) are given GR as its inputs. Thus, GR plays the DECIDE game on a program instead of a checkerboard. GR is smart enough to interpret the instructions directly and to determine the halting condition of R.

Let us assume that the EXHAUST program is given to GR. GR interprets EXHAUST and, when it reaches a STOP, announces that R has halted. Further, GR announces HALT NOT FOUND or HALT FOUND, depending on the condition code setting of R. In fact, GR is a general robot because it can interpret programs for other robots. In a sense, GR can simulate R because it can interpretively execute any program which can be written for R:

Hypothesis 5: Any machine GR that can simulate a robot of the power of R is a universal robot. A universal robot is limited in its power, being able to compute only computable functions.

Can a problem be found that is too difficult for GR? It would be interesting to discover if such an uncomputable function exists. GR is quite similar to real computers. For example, an Intel 8080 could be simulated on a Motorola 6800 to perform the functions of a universal robot. Thus, if problems too difficult for GR are discovered, they will also be too difficult for the Intel 8080, Motorola 6809, IBM 370, CDC 7600, or Cray-1!

The Halting Problem Revisited

It was stated earlier that the GR machine can interpret any program and decide whether or not it halts. To be more precise, however, a GR robot cannot in general decide whether an arbitrary program from R's library of programs will halt or run forever. Notice the emphasis on any arbitrary program. A specific program can be examined and it can be determined that it will halt. This was done for the EXHAUST program. However, a decide algorithm is being sought that can be written before any program from R is tried. Thus, the DECIDE program must be smart enough to handle any program it is given. This is where the problem appears. Suppose a program is written in the language suggested earlier for R. This language made R powerful enough to compute anything that robots can compute. Thus, the DECIDE algorithm can be written in this language. The DECIDE algorithm is loaded into a mouse just like R, and it becomes super-

mouse GR. Now GR can decide whether or not a given program halts and, if so, whether or not the arbitrary program being interpreted has found its solutions. If it is shown that at least one program exists for which GR fails, then the DECIDE algorithm is *undecidable* (ie: it is not an algorithm). In fact, there is such a program.

If the DECIDE program *itself* is input into GR, a paradox is created for GR. If it executes to a STOP action and announces a HALT FOUND termination, the DECIDE program has succeeded. If, on the other hand, GR reaches a STOP and announces HALT NOT FOUND, then GR must itself have reached a NOT FOUND condition. This, however, is impossible, because GR cannot reach a FOUND termination point within the loaded DECIDE algorithm at the same time it reaches a NOT FOUND termination point within the interpreted DECIDE algorithm. Therefore, the DECIDE problem is unsolvable and is, in short, a problem no computer can compute:

Hypothesis 6: The general halting problem is undecidable. This is an example of a problem computers cannot solve.

After that mind twister, it may be argued that such a problem is of no practical significance. Unfortunately, the halting problem is completely analogous to several important practical problems in computing. Here are a few:

Hypothesis 7: A robot GR that can test any other robot R to determine if R is malfunctioning is impossible to build.

Hypothesis 8: A robot GR that can examine any other robot and determine if R is secure (impenetrable by a team of spies) is impossible to build.

Hypothesis 9: A robot GR that can examine a programming language robot R and determine if it is without ambiguity is impossible to build.

In essence, it has been illustrated that computers have their limits regardless of their size, speed, number of registers, or sophisticated instruction sets. This notion is summarized in the next hypothesis:

Hypothesis 10: Progress in computing has led to microcomputers and circuits that still cannot solve the same problems that earlier computers could not solve.

In other words, computing has advanced in a technological sense only, and not in a conceptual sense. The limitations of computing remain the same: the power of computing is the same.

All computers do essentially the same thing. Some are easier to program because they have high-level instructions. Some are faster because their organizations are more efficient. However, the fundamental problems of computing remain.

Difficult Problems

Fable: An old man was about to send his son into the world to travel. He bent over and wheezed into his proud son's face, "Hear me well, son. The world has

Mainframe Owners...

Maybe TRS-80™ Model II Should be Your Next Hardware Investment!



Designed for business. Radio Shack's design concept for TRS-80 Model II was to build a business computer — not a hobby, "home" or personal computer that could be used by the businessman. Model II is compact, fast and powerful. It's ideal for a small business, and also "just right" for many time-consuming small jobs within larger businesses. For firms with large mainframe computers, Model II can handle the jobs that constantly interrupt the data processing schedule — or those too hot to wait for open time on the mainframe. Use it either as a stand-alone computer or an intelligent terminal.

Language. Model II's interpretive BASIC language is easy to use, and will soon be supplemented by other compiler languages. The built-in half-meg disk storage can be expanded to two megabytes. Vectored interrupts, direct memory access and a separate keyboard processor add to the throughput.

Availability. TRS-80 Model II is on display at 50 Radio Shack Computer Sales/Service Centers and 100 specialized Computer Departments in major area Radio Shack stores. It's being delivered through our 7300 retail outlets on a first-come, first-served basis. Visit your nearest Radio Shack store for details or write the address below.

**TRS-80 Model II 32K
1-Disk Systems from \$3450**

**TRS-80 Model II 64K
4-Disk System (shown) . . . \$6599**

Retail prices may vary at individual stores and dealers

TRS-80 Model II Features

- 32K or 64K RAM
- Built-in 8" Floppy (500K Bytes)
- Supports 4 Floppies (Up to 2 Megabytes)
- DMA and Vectored Interrupts for Faster Throughput
- Interpreter BASIC (Other Languages Available 2nd Quarter 1980)
- Z-80A Processor at 4 MHz
- Separate Keyboard Processor
- 2 RS-232C I/O Ports, 1 Centronics Parallel Port

Radio Shack®

The biggest name in little computers™

A Division of Tandy Corporation • Over 7000 Locations in 40 Countries

Free 24-Page TRS-80 Catalog

Write: Radio Shack, Dept. CMA-413,
1300 One Tandy Center,
Fort Worth, Texas 76102

many perplexities."

"Yes, father, I have heard," the young man replied.

"There are two kinds of difficulties that will befall you as you find your way. There are problems that you can solve, and problems that you cannot solve. Be wise and spend your energies only on the problems you can solve."

"I will remember, father."

The Look example can now be returned to, and energy can be applied to solving a problem that it is possible to solve. EXHAUST is a blunt approach to computing a path from R to C. It may be, however, that EXHAUST is the easiest way to compute the location of C.

An algorithm need be only as complex as the problem at hand. Therefore, if the complexity of the problem can be determined, a program can be designed that is no more complex than the problem. Is this possible?

The EXHAUST problem is actually rather uncomplicated. Suppose that initially the cheese is in any square. If there are S squares, the cheese can be in any one of (S-1) squares with probability 1/(S-1). The average number of steps for R to compute along the EXHAUST trail is the average of 1 + 2 + 3 + . . . + (S-1):

$$\frac{\text{AVERAGE \#STEPS}}{\text{STEPS} = 1} = \frac{\sum_{S-1} \text{STEPS}}{S-1} = \frac{S}{2}$$

Hence, the average number of steps to find C is half the total number of squares in Look.

The problem can be more difficult if C is located at the worst possible location (eg: at (S-1) steps from robot R). This is called the worst case complexity of Look, or SWORST = (S-1). In either the average or worst case condition, the EXHAUST algorithm will complete in a number of steps proportional to S. The complexity of Look is O(S). Since S is a straight line when plotted on graph paper, the Look puzzle is called *linear*:

Hypothesis 11: Linear problems are easy, polynomial problems are more involved, and exponential problems are difficult.

Suppose the Look problem is modified to a more realistic situation. Try to trace the roots of your family tree back to 1600 AD. A great-great . . . great-grandparent is given as a target (C). You must trace your father or mother first, then their father or mother, etc. If your ancestors never practiced incest, remarried, etc, you will have to compare at least 2^R ancestors to find the shortest path back to your roots, where R = number of generations.

The roots problem is difficult because of the exponential growth in the computation. Thus, an exponential problem is hard.

Let us examine another version of Look that poses a test for the power of microcomputers and maxicomputers

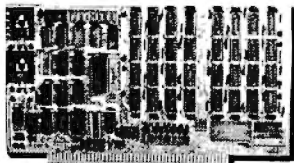

64K BYTE EXPANDABLE RAM
 DYNAMIC RAM WITH ON BOARD TRANSPARENT REFRESH GUARANTEED TO OPERATE IN NORTHSTAR, CROMEMCO VECTOR GRAPHICS, SOL. AND OTHER 8080 OR Z-80 BASED S100 SYSTEMS * 4MHZ Z-80 WITH NO WAIT STATES
 * SELECTABLE AND DESELECTABLE IN 4K INCREMENTS ON 4K ADDRESS BOUNDARIES
 * LOW POWER—8 WATTS MAXIMUM
 * 200NSEC 4116 RAMS
 * FULL DOCUMENTATION
 * ASSEMBLED AND TESTED BOARDS ARE GUARANTEED FOR ONE YEAR AND PURCHASE PRICE IS FULLY REFUNDABLE IF BOARD IS RETURNED UNDAMAGED WITHIN 14 DAYS

	ASSEMBLED / TESTED
64K RAM	\$595.00
48K RAM	\$529.00
32K RAM	\$459.00
16K RAM	\$389.00
WITHOUT RAM CHIPS	\$318.00



S100 MAINFRAME AND CARD CAGE

- * W/ SOLID FRONT PANEL \$239.00
- * W/ CUTOUTS FOR 2 MINI-FLOPPIES \$239.00
- * 30 AMP POWER SUPPLY \$119.00

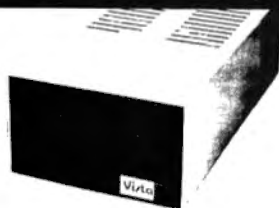

VISTA V-200 MINI-FLOPPY SYSTEM
 * S100 DOUBLE DENSITY CONTROLLER
 * 204 KBYTE CAPACITY FLOPPY DISK DRIVE WITH CASE & POWER SUPPLY
 * MODIFIED CPM OPERATING SYSTEM WITH EXTENDED BASIC
 \$695.00
 * EXTRA DRIVE, CASE & POWER SUPPLY \$395.00

16K X 1 DYNAMIC RAM
 THE MK4116-3 IS A 16,384 BIT HIGH SPEED NMOS. DYNAMIC RAM THEY ARE EQUIVALENT TO THE MOSTEK, TEXAS INSTRUMENTS, OR MOTOROLA 4116-3.
 * 200 NSEC ACCESS TIME, 375 NSEC CYCLE TIME
 * 16 PIN TTL COMPATIBLE
 * BURNED IN AND FULLY TESTED
 * PARTS REPLACEMENT GUARANTEED FOR ONE YEAR
 \$9.50 EACH IN QUANTITIES OF 8

BETA COMPUTER DEVICES
 P.O. BOX 3465
 ORANGE, CALIFORNIA 92665
 (714) 633-7280

CALIF RESIDENTS PLEASE ADD 6% SALES TAX. MASTERCHARGE & VISA ACCEPTED. PLEASE ALLOW 14 DAYS FOR CHECKS TO CLEAR BANK. PHONE ORDERS WELCOME.

KIM/SYM/AIM-65—32K EXPANDABLE RAM
 DYNAMIC RAM WITH ON BOARD TRANSPARENT REFRESH THAT IS COMPATIBLE WITH KIM/SYM/AIM-65 AND OTHER 6502 BASED MICROCOMPUTERS.

- * PLUG COMPATIBLE WITH KIM/SYM/AIM-65. MAY BE CONNECTED TO PET USING ADAPTOR CABLE. SS44-E BUS EDGE CONNECTOR.
- * USES +5V ONLY (SUPPLIED FROM HOST COMPUTER BUS) 4 WATTS MAXIMUM
- * BOARD ADDRESSABLE IN 4K BYTE BLOCKS WHICH CAN BE INDEPENDENTLY PLACED ON 4K BYTE BOUNDARIES ANYWHERE IN A 64K BYTE ADDRESS SPACE.
- * BUS BUFFERED WITH 1 LS TTL LOAD
- * 200NSEC 4116 RAMS
- * FULL DOCUMENTATION
- * ASSEMBLED AND TESTED BOARDS ARE GUARANTEED FOR ONE YEAR, AND PURCHASE PRICE IS FULLY REFUNDABLE IF BOARD IS RETURNED UNDAMAGED WITHIN 14 DAYS

	ASSEMBLED / TESTED
WITH 32K RAM	\$418.00
WITH 16K RAM	\$349.00
WITHOUT RAM CHIPS	\$279.00
HARD TO GET PARTS ONLY (NO RAMS)	\$109.00
BARE BOARD AND MANUAL	\$49.00

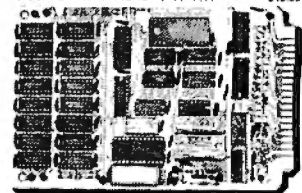

NEW FROM MOUNTAIN HARDWARE. THE APPLE CLOCK.

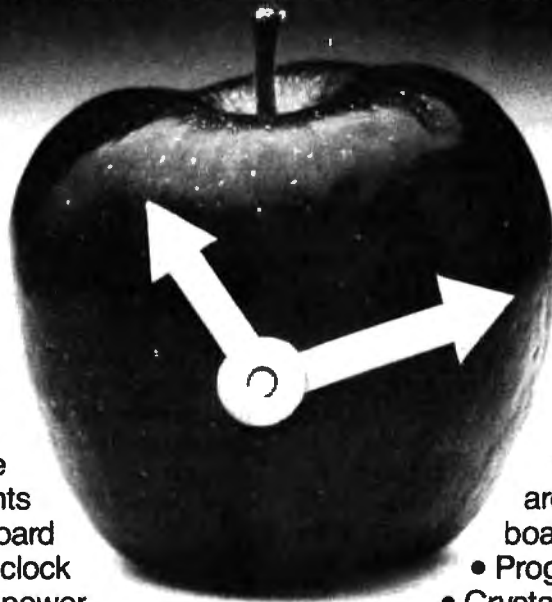

NEW UTILITY FOR YOUR COMPUTER.

Until now, there hasn't been a Real-Time Clock for the Apple II*. The Apple Clock from Mountain Hardware keeps time and date in 1mS increments for over one year. On-board battery backup keeps the clock running in the event of power outage. Software controlled interrupts are generated by the clock. That means you can call up schedules, time events, date printouts ...all in real time on a programmed schedule.

EASY TO USE.

The Apple Clock is easily accessed from BASIC using routines carried in on-board ROM. With it, you can read time and program time-dependent functions for virtually any interval. From milliseconds to days, months or a year.

PLUG IN AND GO.

Plug the Apple Clock into a peripheral slot on your Apple II and you're ready to go.

FEATURES.

- Time and date in 1mS increments for periods as long as one year.
- Software for calendar and clock routines, as well as an event timer are contained on on-board ROM.
- Program interrupts.
- Crystal controlled accuracy of $\pm .001\%$.
- On-board battery backup keeps your clock in operation even during power outage.

REAL TIME AT THE RIGHT PRICE.

At \$199 assembled and tested, it's the clock your Apple has been waiting for. And, it's available now through your Apple dealer. Drop in for a demonstration. Or return the coupon below.

A COMPLETE LINE.

Mountain Hardware also offers a complete line of peripheral products for many fine computers.

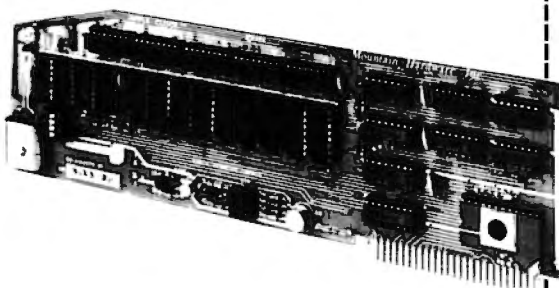

Mountain Hardware, Inc.

300 Harvey West Blvd., Santa Cruz, CA 95060
(408) 429-8600
Sounds great.

Send me everything I'll need to know about the Apple Clock.
 I've got a _____ computer. Send me information.

Name _____

Address _____

City _____ State _____ Zip _____

*Apple II is a trademark of Apple Computer, Inc.

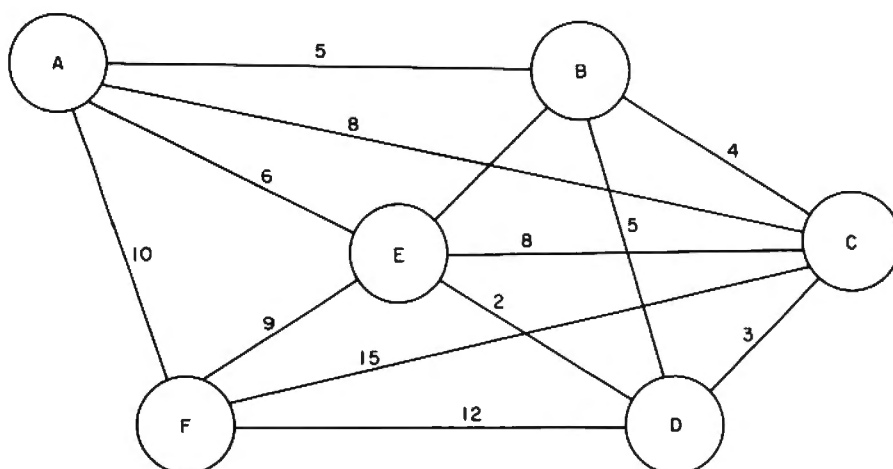

Figure 7: The traveling salesperson problem. A salesperson wishes to visit all six cities in a given district, once every month. The problem is to compute the shortest path that goes through each city only once.

alike. Suppose a die is tossed to decide which direction to take: N, W, E, or S. A random number generator is used to produce a random walk around the Look checkerboard. Will such an approach add to the complexity of computation? A random selection introduces chance into the EXHAUST algorithm. This is called a *nondeterministic* procedure (similar to a heuristic), because the exact path may not be reproducible due to the randomness. Eventually the path would be discovered, because there is a nonzero probability that every square will be visited by the meandering robot R.

A nondeterministic procedure may be more complex than a deterministic procedure, or surprisingly it may be less complex, because it reduces the search space statistically. For example, under certain constraining rules, the random walk through Look can produce an answer in $O(\sqrt{S})$ average steps. This is an improvement over the average for EXHAUST. (The maximum or worst case analysis can be much greater, however.)

The most difficult problems faced by computers are known as NP - complete problems. Their algorithms are nondeterministic in nature and perform in a time proportional to some power of the length of their input data. This class of problems can be illustrated by examining the traveling salesperson game.

Traveling Computer Salesperson

Suppose a computer salesperson is given a district with six cities. Each city must be visited once every month. The salesperson wants to compute the shortest path that goes through each city one time only.

A map is shown in figure 7 along with candidate paths between any two cities in the district. Each connecting line is labeled with the distance between cities. What is the shortest route that begins at A and returns to A after passing through every city? Does this problem have a solution? If one path exists, is it unique, or are there others of equal distance?

The complexity of this problem and others like it continues to be a conceptually difficult computation for computers. The difficulty of a number of important problems in computing is just being realized.

This raises some philosophical questions for the future. For example, is the functioning of brain cells a complex problem? If so, is the path established by a thought process representable as a computable function? Even if thought is a computable function, it might also belong to the class of NP - complete problems, and thereby be difficult for computers to handle.

Conclusion

In summary, we must be realistic about the power of computers. There are functions that no computer can compute, and there are functions that require impressive performance to manage. The current crop of microcomputers is no more able to compute a solution to problems than computers of a decade ago. Programmers may, however, have learned new ways to apply computing power in the interim.

On the optimistic side, many practical problems remain to be solved in our society. Computers can help solve them and, due to the microcomputer revolution, there is an opportunity to economically apply this technology to the real world. Along the way, do not forget the limits to computing. ■

BIBLIOGRAPHY

- Appl, K and W Haken, "The Solution of the Four-Color-Map Problem," *Scientific American*, volume 237, number 4, October 1977, page 108.
- Gardner, M, "Mathematical Games: In Which Joining Sets of Points by Lines Leads into Diverse (and Diverting) Paths," *Scientific American*, volume 237, number 5, November 1977, page 18.
- Additional discussion of the four-color problem appears in Martin Gardner's "Mathematical Games" column in the issues of *Scientific American* for September 1960, April 1975, and April 1976.
-

\$3,995

Million-Character Computer System One-Year Transferable Warranty

\$3,995

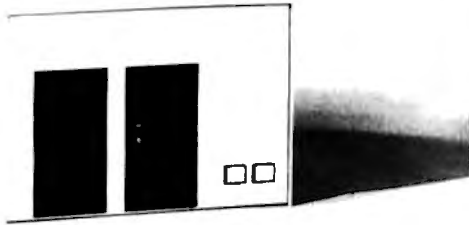

SEE System 6684 Unique Standard Features

- CPU integrated into Diskette Cabinet with peripheral ports in rear of cabinet
- 4 Full communications ports RS232 or 20 mA/60 mA CL; 75 to 19,200 bits/sec.

\$4,995



SEE System 6784 Unique Standard Features

- CPU integrated into video terminal cabinet with peripheral ports in rear
- Video has 16 programmable function keys, 128 high resolution characters with graphics, numeric keypad, reversed video, full editing, 24 x 80 display

Standard Features on All Systems

- Central Processing Unit with 12 slots; 2 MHz (expandable to 4MHz with pipelining architecture)
- 8 Free Slots for expansion; capacity for 442,368 characters of memory within standard chassis
- 49,152 characters of 200 ns random access memory; 150 ns memory optional
- 8 vectored interrupts; all input and output is interrupt driven
- 1.2 million characters, double sided, dual 8" diskettes. IBM 3740 compatible
- Printer controller; Centronics compatible
- Magnum BASIC. Extremely fast business BASIC with full editing capabilities, print using, sequential and random files, integer and floating point arithmetic with up to 16 digits precision; N-dimensional matrices and much more
- A superset of Microsoft 16K extended disk BASIC
- Interactive conversational macro assembler and editor for 6800 family microprocessors
- One-year transferable limited warranty on parts and labor for all SEE hardware
- Guaranteed 24-hour turn-around time on repairs

Optional Features on All Systems

- Up to 64 interconnected, intelligent terminals with no degradation of response time. Each is a stand alone CPU. True distributed processing
- Expandable to 12 MB of 150 ns RAM for each terminal
- Up to 64 RS232 ports with full communications. Talks to any peripheral or CPU with RS232 interface
- Expandable to 4 MB of diskette storage
- Up to 660 MB hard disk storage with removable modules
- ANSI standard 10.5 inch tapes (1600 BPI)
- 11 MB cartridge tape system
- Matrix and word processing printers from 55 CPS to 1400 LPM
- Choice of 6809 and/or 6512 CPU board with speed of up to 4 MHz with 150 ns memory
- Interactive relocatable macro assembler, development system and DOS for 6502 and 6512 microprocessors. Can assemble source programs up to 2 MB long
- PASCAL compiler
- FORTRAN compiler
- BASIC compiler
- COBOL compiler
- Powerful word processing software
- Comprehensive business software, incl. General Ledger, Accounts Receivable, Accounts Payable, Inventory, Payroll; Packages for Physicians, Publishers, Manufacturers, etc.

Quantity discounts to bona fide dealers, OEMS, and schools
Special configurations and modular shipment available
A few distributorships available in the United States and other countries



SYSTEMS ENGINEERING ENTERPRISES
1749 Rockville Pike, Rockville, Maryland 20852
(301) 468-1822



Beginner's Guide for the UCSD Pascal System

by Kenneth L. Bowles

A Structured Approach to Creative Programming

Language Series

The BYTE Book Of Pascal

Blaise W. Liffick, Editor

Take the mystery out of programming

with the latest from *BYTE Books™*

You Just Bought a Personal What?

by Thomas Dwyer and Margot Critchfield
Whether you are a novice programmer or an experienced computer user, this book is filled with practical ideas for using a personal computer at home or work. It will take you through the steps necessary to write your own computer programs, and then show you how to use structured design techniques to tackle a variety of larger projects. The book contains over 60 ready-to-use programs written in Radio Shack TRS-80 Level II BASIC in the areas of educational games, financial record keeping, business transactions, disk-based data file and word processing. \$11.95 pp. 256 ISBN 0-07-018492-5

The BYTE Book of Pascal

Edited by Blaise W. Liffick
Based on the growing popularity of Pascal as a programming language, numerous articles, language forums and letters from past issues of BYTE magazine have been compiled to provide this general introduction to Pascal. In addition, this book contains several important pieces of software including two versions of a Pascal compiler

- one written in BASIC and the other in 8080 assembly language; a p-code interpreter written in both Pascal and 8080 assembly languages; a chess playing program; and an APL interpreter written in Pascal. \$25.00 Hardcover pp. 342 ISBN 0-07-037823-1

Beginners Manual for the UCSD Pascal System

by Kenneth Bowles
Written by the originator of the UCSD

Pascal System, this highly informative book is designed as an orientation guide for learning to use the UCSD Pascal System. Once familiar with the system, you will find the guide an invaluable reference tool for creating advanced applications. This book features tutorial examples of programming tasks in the form of self-study quiz programs. \$11.95 pp. 184 ISBN 0-07-006745-7



"BOOKS OF INTEREST TO COMPUTER PEOPLE"

Please send _____ copies of You Just Bought a Personal What?
 _____ copies of Beginners' Guide for the UCSD Pascal System
 _____ copies of The BYTE Book of Pascal

Name _____ Title _____ Company _____

Street _____ City _____ State/Province _____ Code _____

Check enclosed in the amount of \$ _____

Bill Visa Bill Master Charge

Card No. _____ Exp. Date _____

Add 60¢ per book to cover postage and handling.

BYTE BOOKS Division • 70 Main Street
Peterborough, New Hampshire 03458



Circle 36 on inquiry card.

BYTE News . . .

INTEL 32-BIT MICROPROCESSOR RUMORED: As reported in this column last April, Intel was rumored to be working on a 32-bit microprocessor. The project is moving closer to reality as Intel has assigned a part number to the device. It will be called the 8800 (not to be confused with the Altair 8800 computer). The instruction set will not be compatible with Intel's 8-bit or 16-bit microprocessors. The device will be housed in the new 64-pin QUIP (quad-in-line package, see "BYTE News," June 1979) which is cheaper, smaller, and easier to test than dual-in-line packages. The 8800 is reportedly being developed at Intel's facility in Aloha OR. The first test prototypes are reported to have been produced.

TI RF MODULATOR FCC WAIVER GRANTED: The Federal Communications Commission (FCC) has granted Texas Instruments a waiver which permits TI to connect its personal computers to home color television receivers using a radio frequency (RF) modulator. TI originally petitioned the FCC for approval of the RF modulator system in February 1979. The petition was rejected since the regulations required that the complete system be submitted for approval: TI submitted only the RF modulator for approval. Subsequently, Texas Instruments applied for a waiver, provided that the modulator unit met the standards.

The FCC asked other personal computer system manufacturers to comment on the TI request. Radio Shack, Apple Computer, Commodore, Mattel, and Atari responded negatively to the request. Apple, Atari, and Mattel went to great expense to comply with the FCC regulations. The Radio Shack and Commodore systems, which contain integral displays and do not use RF modulators, do not come under the FCC regulations.

The FCC decision further waives testing by the FCC and merely requires that the manufacturer provide the FCC with test results showing compliance. In a related action, the FCC relaxed the standards on RF interference generated by commercial and personal computer systems.

Several personal computer manufacturers that compete with TI have already stated that this waiver will give TI a competitive advantage. Furthermore, several firms publicly questioned the FCC's rule-making methods in making its decision. The likelihood now is that the other personal computer makers will offer systems with RF modulators. It will probably take these manufacturers at least a year to bring out such competing systems.

ULTRA MINI-FLOPPY DRIVE INTRODUCED: Sanyo Seiki Manufacturing Co, Tokyo, Japan, has begun producing samples of an ultra-small floppy disk drive and controller. Called the FMC-100, it uses a 2-inch floppy disk that stores 8 K bytes on one track. It is intended for use in word-processing typewriters and personal computer systems.

THWARTING COMPUTER SOFTWARE PIRATING: A patent (number 4,168,396) has been issued to Robert M Best, Seattle WA, for a "microprocessor which prevents the piracy of computer programs." The device reportedly uses cryptography to protect the software. It is called a *cryptomicroprocessor* and stores software in cipher to prevent it from being copied, disassembled, or altered by unauthorized processes. Authorized users can decipher the software with special encryption keys. The patent states that the device is intended primarily for use in personal computer systems.

AC LINE TO TTL INTERFACE IC INTRODUCED: General Instrument Optoelectronics of Palo Alto CA has introduced a low-cost, 8-pin integrated circuit that can be used to directly monitor AC power line circuits and provide transistor-transistor logic (TTL) outputs. The device, therefore, can be used to interface your microprocessor inputs easily and directly to monitor AC power-line-operated devices such as motors, solenoids, relay contacts, and the like. It can also be used to detect power failure and other such applications.

FLAT PANEL TERMINAL DISPLAYS BECOMING AVAILABLE: Computer terminals using flat-screen video displays are getting close to the marketplace. The technology is based on the plasma panel developed by Owens-Illinois, Toledo OH, in the late 1960s. Currently, Interstate Electronics of Anaheim CA, IBM, and Fujitsu have these panels in production. Control Data and NCR are planning large-scale production. IBM now makes approximately 100,000 plasma panels annually, which

are all used in-house. Interstate Electronics currently sells a plasma display terminal that has a 512 by 512 matrix of dots and can display alphanumeric characters and graphics.

Plasma panel makers are working on getting the cost down to the point where these displays can compete with cathode-ray tube (CRT) displays. This is still expected to take several more years.

RANDOM RUMORS: IBM will soon unveil small business (Model 5105) and multiterminal (Model 5130) computers in their 5100 line of microcomputers. The 5105 computer will begin at \$4500 and the 5130 will range from \$21,500 to \$37,500. The basic 5105 will include 16 K bytes of program-mable memory, a 960-character video display screen, a magnetic tape cartridge, and a thermal or electrostatic printer. Increasing memory up to 96 K bytes, adding a 1920-character screen, floppy disks, and high-speed printer, and including software packages will raise the 5105 price up to \$20,000. It is expected that the 5105 will penetrate the personal computer market to some extent even though it is intended to be an entry-level business computer system . . . IBM is also rumored to have an intensive research and development effort trying to develop a low-cost alternative to the cathode-ray tube (CRT) screen display. Reportedly they are currently investigating 24 different alternatives. At this time, the most promising is the multiplexed liquid-crystal display . . . It is rumored that a Japanese electronics company will shortly introduce a \$600 personal computer system that is hardware and software compatible with the Radio Shack TRS-80 (Level-II BASIC, 16 K version) . . . By the end of 1979, over 2,500,000 floppy disk drives had been manufactured.

64 K EPROMS AVAILABLE BY MID-YEAR: Samples of 64 K bit erasable-programmable read-only memory (EPROM), organized as 8 K words by 8 bits, are currently being distributed to customers by Motorola, and production quantities are expected to be shipped by the end of the second quarter of 1980. Motorola has put their 64 K EPROM in a 24-pin package by multiplexing the program supply and chip-enable signals on the same pin. Intel and Texas Instruments, it is believed, will use 28-pin packages for their 64 K EPROMS.

In the meantime, the supply of 2708 EPROMS (1 K words by 8 bits) has caught up to demand and prices are now in the \$6 range. The demand for the 2716 EPROM (2 K words by 8 bits) is still very strong, and hence the devices are selling in the \$20 to \$24 range.

Texas Instruments is currently the largest manufacturer of EPROMs with about 38% of sales. Intel is second with 29%. Fujitsu and Hitachi share third place with 8% each.

AT&T RUNS INTO TROUBLE WITH UNIX: The Association of Data Processing Service Organizations (ADAPSO) has petitioned the US Department of Justice to take action against AT&T's sale of software products, particularly the UNIX operating system. UNIX is one of the most popular software systems for larger Digital Equipment Corp (DEC) PDP-11 machines. Most users feel that UNIX is better than DEC's software.

ADAPSO maintains that AT&T is in violation of a 1956 consent decree. In 1978 the Justice Department authorized an investigation after a similar petition by the Computer and Communications Industry Association (CCIA).

Developed at Bell Laboratories in 1969, UNIX was offered to non-Bell organizations starting in 1973, for \$20,000 per computer. In the first half of 1978, Bell reported \$580,000 revenues from about 800 non-Bell users.

Whitesmiths Ltd, a New York software house, is currently working on an LSI-11 version of UNIX.

IBM and MCA TO MARKET VIDEO DISK: IBM and MCA Inc have formed a joint venture, called Discovision Associates, to develop, manufacture, and market video disks and players. Until now, MCA has been the sole manufacturer of optical video disks. It is hoped that this will broaden the use of video disk technology in the home entertainment, industrial education, and information fields. The optical disk technology, which uses a laser to record and play back the recorded material, shows promise for use in the computer field. It could be used to store large amounts of read-only digital data in much more compact form than presently is possible on magnetic disks. North American Philips is also marketing a video disk player and RCA plans to introduce a system soon.

MAIL: I receive a large number of letters each month, as a result of this column. If you write to me and wish a response, please include a stamped, self-addressed envelope.

Sol Libes
Amateur Computer Group of New Jersey
(ACG-NJ)
1776 Raritan Rd
Scotch Plains NJ 07076

DELTA IS READY . . .

WITH SYSTEMS AND SOFTWARE!

. . . Feel Free to Mix and Match

SYSTEM 1



\$1750.00

Twin Mini W/32K



\$139.00

Leedex Monitor



\$110.00

Keyboard



\$499.00

Base 2

SYSTEM 2

MULTIUSER CAPABLE



\$1650.00

32K S-100 Mainframe



\$775.00

T/V 912 Terminal



\$1750.00

TI 810*



\$1350.00

**1 Megabyte
Double Density Storage**

SYSTEM 3

MULTIUSER CAPABLE



\$1950.00

64K S-100 Mainframe



\$985.00

T/V 920 Terminal



\$34.50

Diablo 1620



\$1850.00

**2 Megabyte
Quad Density Storage**

SYSTEM 4

MULTIUSER

t (Dealers Only)



Desk Enclosure



32 Megabyte Disk



AT&T Model 300

Software:

CPM 1.4 \$115.00
CPM 2.0 \$150.00
MPM MULTI-USER \$350.00

CBASIC \$115.00
MBASIC \$300.00
FORTRAN \$395.00
COBAL \$625.00
PASCAL \$265.00

WORDSTAR \$495.00
ACCTS. PAYABLE \$699.00
ACCTS. RECEIVABLE \$699.00
GENERAL LEDGER \$899.00
SUPERSORT \$225.00

DATABASE \$150.00
INVENTORY \$440.00
OSORT \$ 95.00
NAD \$ 79.00
LETTERRIGHT \$180.00

West:

DELTA PRODUCTS

1653 E. 28th Street
Long Beach, Calif. 90806
Tel: (213) 595-7505



East:

DELTA PRODUCTS

1254 South Cedar Road
New Lenox, Illinois 60451
Tel: (815) 485-9072

Telex: 182-126 DELTMAR SGHL

Indirect Addressing for the 6502

Kenneth Skier
25 Myrtle Ave
Cambridge MA 02138

One of the most attractive features of the 6502 processor—in fact, of the entire 6500 series—is the flexibility offered by its thirteen addressing modes. Unfortunately, these addressing modes are not always available when you want them. Indirect indexed addressing, for example, is available for load and store instructions (and a few others), but not for jump to subroutine (JSR).

A structured approach to programming leads one to write many programs as nested subroutines, and it is not always desirable for the programmer to specify the addresses of those subroutines in advance. For a given application, you may want the user to choose the address of the next subroutine that the processor will execute, or you may want software to calculate or look up that address, perhaps in response to sampled input conditions. In either case, you need indirect addressing for the jump to subroutine instruction.

In the 6502, the jump to subroutine instruction has only one addressing mode: absolute. So how can you get what the 6502 does not have?

One solution is to use the jump to subroutine instruction (JSR, hexadecimal 20) in your program, and follow it with two reserved bytes (ie: when you write the program, you do

not care what is in those two bytes). The rest of your program follows those two bytes. When your program runs, it will ask the user to specify the address of the next subroutine, or else it will look up or calculate that address according to some algorithm. It will then store that address in the two reserved bytes mentioned earlier (low byte first). When the 6502 processor executes the JSR instruction, it will use the next two bytes for the address of the subroutine it is supposed to execute.

This technique will work, but I avoid it for several reasons. First, it requires writing a program that modifies itself, and a simple error in such a program can cause it to self-destruct or subtly deface itself, not something I would look forward to debugging. Second, such a program may work fine in programmable memory, but it cannot work in read-only memory. The third reason is the clincher: this technique is unnecessary. You can have a program execute a subroutine and calculate or look up its address without requiring that it modify itself.

What is the solution? Use the zero page.

Set aside four consecutive bytes in the zero page of memory. The first part of your program, which presumably initializes I/O (input/-

output) ports, variables, flags, table pointers, etc, will write a hexadecimal 20 (JSR) into the first of these zero-page bytes, and a hexadecimal 60 (RTS) into the fourth of these zero-page bytes. (It need not do anything to the second and third bytes.) When it is time for your program to select the address of a subroutine and then perform a subroutine jump to that address, have your program calculate or look up the subroutine's address and then store it, low byte first, in the second and third zero-page bytes mentioned above.

Now your program can jump to a *fixed address*: the address of the first of these four zero-page bytes. Upon arrival at the zero page, the processor will perform a subroutine jump to a new address: the address it previously looked up or calculated. When it finishes executing *that* subroutine, it returns to the fourth of the zero-page bytes, which tells the processor to return to the program that called it. In practice your program jumps to a subroutine with a fixed address, whereupon it jumps to a subroutine with a calculated address. In effect, however, you get indirect addressing for the JSR instruction.

The effect can be impressive.

Using this technique, you can display an address, then let the user

OMNIX

A UNIX[®]-LIKE OPERATING SYSTEM FOR Z-80 MICROPROCESSORS

1. Multi-user & multi-process
 2. Input/output redirection using pipes, links, and forks
 3. User accessible spooler & event queue manager
 4. Powerful structured macro language for shell programming
 5. WHENEVER, UNTIL, IF-ELSE, & WHILE shell commands
 6. Mountable, hierarchical, password-protected file systems
 7. Global, group, & individual file permissions
 8. Memory support from 64k to 1M; disk support to 4000M
 9. Installed on Industrial Microsystems & Cromemco CS-3
 10. Compatible with software developed on CP/M[®]
 11. Now available from Yourdon
 12. Single CPU license: \$350, support: \$75/year
-
-

Available now from:

**YOURDON SOFTWARE
PRODUCTS GROUP**

UNIX[®] is a trademark of Bell Laboratories
CP/M[®] is a trademark of Digital Research Inc.

1133 Avenue of the Americas/New York, N. Y. 10036/(212) 730-5840

change that address or execute it as a subroutine. It is an effective way to give a GO function to a read-only memory monitor. I have discovered many other applications for this technique in system software and applications programs.

Using this technique, your program can jump to the Xth subroutine in a table: the table would simply be a list of the addresses of eligible subroutines. Assuming that the beginning of your program initialized the first and fourth of the zero-page bytes (to hexadecimal 20 and 60, respectively), your program might look like listing 2.

This technique works quite nicely, but why go to all of that trouble each time you want to call a subroutine? Listing 3 shows a subroutine named CALL SUBROUTINE (X). The programmer need only load the X register with the number of the desired subroutine, and call CALL SUBROUTINE (X). (See listing 4 for a program segment that does just that.)

In other words, you can call a subroutine by a name that you've given it, rather than by its explicit address. To relocate any such subroutine, you need only change its address in the table of subroutine addresses; the routines that call it need not be changed in any way.

Here is one last point. You do not *have* to put the four bytes (20, XX, XX, 60) in the zero page; you can put them anywhere in programmable memory. However, putting them in the zero page lets your program operate on the second and third of these bytes (that is, on the subroutine's address), with the zero-page addressing mode available on many other instructions. Thus, by putting those four bytes in the zero page, you can make your overall program shorter (and probably faster) than it would be if you put those bytes elsewhere in programmable memory.

Incidentally, this technique may be used for any instruction, not just for JSR. To achieve such indirect addressing for other instructions, do not write a hexadecimal 20 in the first byte; write the op code for the instruction you want to execute. (Be sure that your program follows that op code with the appropriate one or two byte operand, and that your program writes a return [RTS, hexadecimal 60] in the byte following that operand, or your program, like

Listing 1: A program to initialize the zero-page bytes.

```
LDA    #$20           Write JRS
STA    zero page byte #1 and
LDA    #$60           RTS into
STA    zero page byte #4 zero page
      .
      .
remainder of initialize routines
```

Listing 2: The indirect addressing method discussed can be used to jump to one subroutine in a table of subroutines. If the start of the program initializes the first and fourth byte of the zero-page reference to a jump to subroutine (JSR) command and a return (RTS) command, the coding for using the table might look as above. Note that "Zero Page Byte #3" does not mean address 0003; rather it means the address of the third of the zero-page bytes referred to in this article.

```
LDA    TABLE, X      Look up address
STA    zero page byte #2 of Xth subroutine
INX
LDA    TABLE, X      and copy that
STA    zero page byte #3 address into the
JSR    zero page byte #1 zero page
      .               Execute that
      .               subroutine
      .
remainder of program
```

Listing 3: Routine to create subroutine call using zero-page addresses.

```
LDA    TABLE,X      Look up address
STA    zero page byte #2 of Xth subroutine
INX
LDA    TABLE,X      and copy that
STA    zero page byte #3 address into the
JSR    zero page byte #1 zero page.
RTS                    Execute that subroutine.
                       Return to caller.
```

Listing 4: Shorter program segment to simulate an indirect subroutine jump.

```
LDX    subroutine #
JSR    CALL SUBROUTINE (X)
      .
      .
remainder of program
```

Charlie on the MTA [a legendary subway passenger...RSS], may never return.) In any case, the program that calls this function must do so by exe-

cuting a subroutine jump to the first of these zero-page bytes, even if those zero-page bytes do something other than call a subroutine. ■

4 PAPERBYTE 50.00

A Complete Library of M6800 System Software!

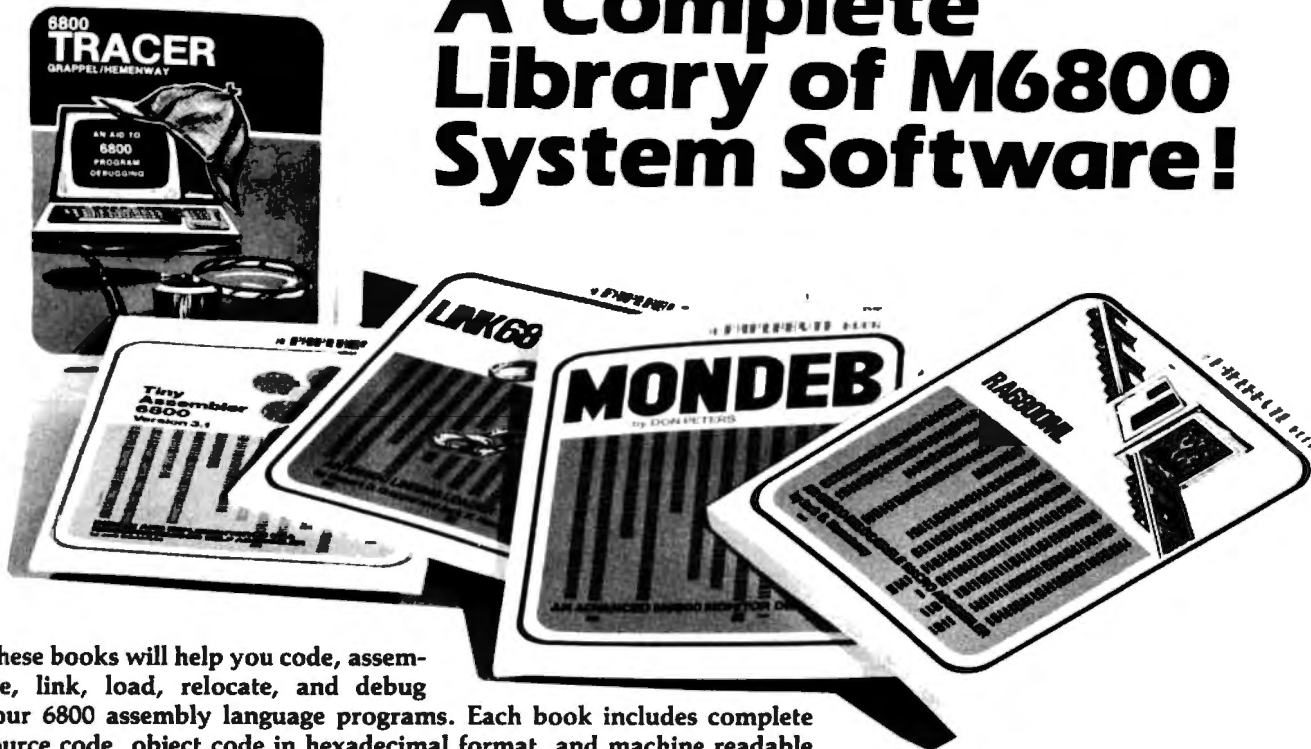

These books will help you code, assemble, link, load, relocate, and debug your 6800 assembly language programs. Each book includes complete source code, object code in hexadecimal format, and machine readable (PAPERBYTE[®]) bar code listings, to make entering and modifying the programs as easy as possible.

Tracer: A 6800 Debugging Program is for the programmer looking for good debugging software. Tracer features single step execution using dynamic break points, register examination and modification, and memory examination and modification. This book includes detailed Tracer program notes and a reprint of "Jack and the Machine Debug" (from the December 1977 issue of BYTE magazine).
 ISBN 0-931718-02-3 Pages: 24 Price: \$6
 Authors: Robert D. Grappel & Jack E. Hemenway

MONDEB: An Advanced M6800 Monitor-Debugger has all the general features of Motorola's MIKBUG monitor as well as numerous other capabilities. Some of the command capabilities of MONDEB include displaying and setting the contents of registers, setting interrupts for debugging, testing a programmable memory range for bad memory locations, changing the display and input base of numbers, displaying the contents of memory, searching for a specified string, copying a range of bytes from one location in memory to another, and defining the location to which control will transfer upon receipt of an interrupt.
 ISBN 0-931718-06-6 Author: Don Peters Pages: 88 Price: \$5

RA6800ML: An M6800 Relocatable Macro Assembler is a two pass assembler for the Motorola 6800 microprocessor. The Assembler can produce a program listing, a sorted Symbol Table listing and relocatable object code. The object code is loaded and linked with other assembled modules using the Linking Loader LINK68. There is a complete description of the 6800 Assembly language and its components. Each major routine of the Assembler is described in detail, complete with flow charts and a cross reference showing all calling and called-by routines, pointers, flags, and temporary variables. In addition, details on interfacing and using the Assembler and error messages generated by the Assembler are included. This book provides the necessary background for coding programs in the 6800 assembly language, and for understanding innermost operations of the Assembler.
 ISBN 0-931718-10-4
 Author: Jack E. Hemenway
 Pages: 184 Price: \$25

LINK68: An M6800 Linking Loader is a one pass linking loader which allows separately translated relocatable object modules to be loaded and linked together to form a single executable load module, and to relocate modules in memory. It produces a load map and a load module in Motorola MIKBUG loader format. This book provides everything necessary for the user to easily learn about the system, including a detailed description of the major routines of the Linking Loader, including flow charts. While implementing the system, the user has an opportunity to learn about the nature of linking loader design as well as simply acquiring a useful software tool.
 ISBN 0-931718-09-0
 Authors: Robert D. Grappel & Jack E. Hemenway
 Pages: 72 Price: \$8

Tiny Assembler 6800, Version 3.1 is a small (4 K) but sophisticated and useful assembler for a large subset of the Motorola 6800 assembly language. The book includes detailed notes on the design and implementation of Version 3.0 of the assembler, a complete description of the enhancements upgrading the Tiny Assembler to Version 3.1, an updated user's guide, and complete listings for both versions, making this book the most complete documentation possible for Jack Emmerich's Tiny Assembler.
 ISBN 0-931718-08-2 Pages: 80 Price: \$9
 Author: Jack Emmerichs

Please send

_____ copies of RA6800ML: An M6800 Relocatable Macro Assembler

_____ copies of LINK68: An M6800 Linking Loader

_____ copies of Tracer: A 6800 Debugging Program

_____ copies of MONDEB: An Advanced M6800 Monitor-Debugger

_____ copies of Tiny Assembler 6800, Version 3.1

Name _____ Title _____ Company _____

Street _____ City _____ State/Province _____ Code _____

Check enclosed in the amount of \$ _____

Bill Visa Bill Master Charge

Card No. _____ Exp. Date _____

Add 60¢ per book to cover postage and handling.

BYTE BOOKS 70 Main Street Peterborough NH 03458 **JK GROW**

Circle 35 on inquiry card.

Telephone Dialing by Computer

Edward Joyce
4603 Lyceum Dr
San Antonio TX 78229

How would you like to have your computer dial a seven-digit telephone number in about 3/4 of a second? For a small investment in hardware components and construction time, your personal computer can dial a telephone number faster than you can say that number. This article describes the construction and operation of a dual-tone multiple-frequency (Touch Tone) dialing device that interfaces with an ASCII computer terminal and can be used for automatic telephone dialing.

Many practical applications can be designed around an automatic dial feature, but the most obvious is a personal telephone directory. In such a system, a list of frequently dialed telephone numbers and associated names is displayed on the computer terminal. The user selects the number to be dialed by entering a single corresponding character on the computer keyboard (see table 1). A feature that could be incorporated is an option to redial the last number dialed, which would be useful for reaching busy numbers.

Assuming that you have a microprocessor and an ASCII terminal, the additional hardware that is required can be constructed for less than \$20. Furthermore, this Touch Tone interface does not require its own I/O (in-



Photo 1: Dialing the telephone is done by selecting from a menu displayed by the computer on the screen of the video terminal.

put/output) port, the telephone can be used both automatically and manually, the programming is relatively simple, and either a Touch Tone or rotary-dial telephone can be utilized. [Note that the telephone exchange to which the line is connected must be capable of interpreting Touch Tones. Some telephone systems (such as those in Peterborough NH) still cannot use Touch Tone dialing....RSS]

Touch Tone Interface

A block diagram of the hardware is shown in figure 1. Note that communication with the Touch Tone

device is established through the terminal. Specifically, the computer generates tones by sending certain characters to the terminal. Since most ASCII codes have predesignated meanings (for example, hexadecimal 30 is the digit 0, hexadecimal 41 is the letter A, etc), it is necessary to assign the Touch Tone controls to ASCII codes not used by your terminal. A logical choice for these assignments is among the thirty-two ASCII control codes (hexadecimal 00 thru hexadeci-

Touch Tone is a registered trademark of the Bell System for its dual-tone multiple-frequency signaling equipment.

About the Author

Ed Joyce attended the University of Pittsburgh and Trinity University where he completed a master's degree in Computing and Information Sciences. Since 1973 he has worked as a professional programmer with interests in multiprocessor microprocessor systems and speech recognition. Currently he is employed at Small Systems Engineering Dept, Data Point Corp in San Antonio TX. His recreational interests are backpacking and motorcycle touring.

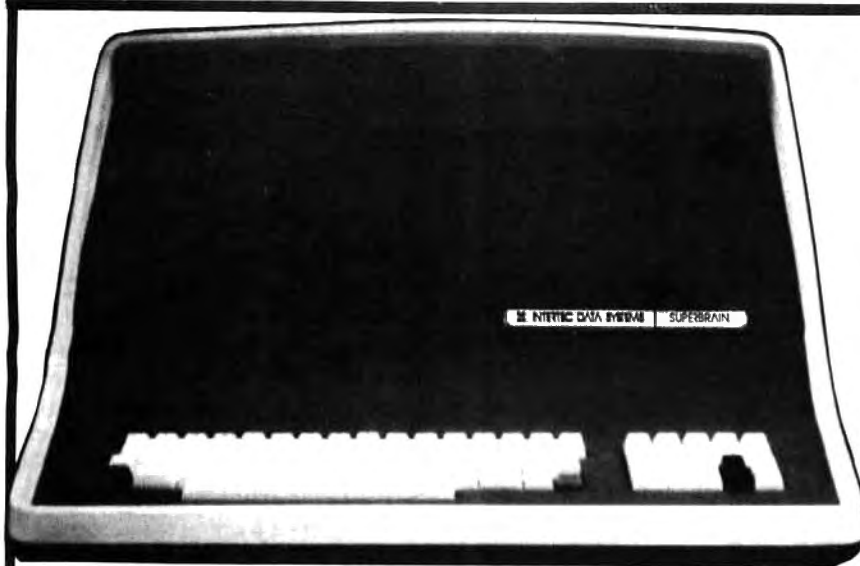

*Superbrain is a registered trademark of Intertec Data Systems.

SUPERBRAIN™

The Honor Graduate

OEM's . . .

End Users . . .

Computer Dealers . . .

\$2995!

SuperBrain users get exceptional performance for just a fraction of what they'd expect to pay. Standard system features include: two double density mini-floppies with 320K bytes of disk storage, 64K of RAM memory to handle even the most sophisticated programs, a CP/M Disk Operating System with a high powered text editor, assembler, debugger and a disk formator. And, with SuperBrain's S-100 bus adaptor, you can add all the programming power you will ever need . . . even a 10 megabyte disk!

SuperBrain's CP/M operating system boasts an overwhelming amount of available software in BASIC, FORTRAN, COBOL, and APL. Whatever your application . . . General Ledger, Accounts Receivable, Payroll, Inventory or Word Processing . . . SuperBrain is tops in its class. But best of all, SuperBrain tackles your toughest jobs for less than one-third the cost of other similar systems.

You'll appreciate the careful attention given to every engineering detail. Standard SuperBrain features include: a full ASCII keyboard with numeric pad and user-programmable function keys. A non-glare, dynamically focused, 12-inch CRT for sharp images everywhere on the screen. Twin Z80 microprocessors to insure efficient data transfer to auxiliary peripheral devices. A universal RS-232 communications port for serial data transmission. And, a single board design to make servicing a snap!

Performance and packaging have never been better matched. Your operators will appreciate SuperBrain's good looks. You'll appreciate SuperBrain's outstanding value. Twin Z80A processors, dual double density disk drives, and a high resolution CRT terminal. All in a single, smart looking, self-contained desktop unit. And, all for a price that's substantially less than the competition!

Make no mistake about it. The freshman students in the small systems business can't begin to compete with this year's honor graduate. The SuperBrain. The only system at the top of its class in price and performance.

System Specifications

CPU	
Microprocessors	Twin Z80A's with 4MHz Clock Frequency. One Z80A (the host processor) performs all processor and screen related functions. The second Z80A is "down-loaded" by the host to execute disk I/O. When not processing disk data, the second Z80 may be programmed by the host for other processor related functions.
Word Size	8 bits
Execution Time	10 microseconds register to register
Machine Instructions	158
Interrupt Mode	All interrupts are vectored
Floppy Disk	
Storage Capacity	320K total bytes formatted on two double density drives. Optional external 10-300 megabyte hard disk storage is available using optional S-100 bus adaptor.
Data Transfer Rate	250K bits/second
Average Access Time	250 milliseconds
Media	5 1/4 inch mini-disk
Disk Rotation	300 RPM
Internal Memory	
Dynamic RAM	64K bytes dynamic RAM
Static RAM	256 bytes of static RAM is provided in addition to the main processor RAM. This memory is used for program and I/O data storage for the auxiliary processor.
ROM Storage	1K bytes standard. Allows ROM "bootstrapping" of system at power-on. ROM storage is 2708 compatible and may be reprogrammed by the user for custom applications.
CRT	
Display Size	12-inch dynamically focused P4 phosphor
Display Format	25 lines x 80 characters per line
Character Font	8 x 8 character matrix on a 6 x 12 character field
Line Drawing Characters	Eleven special graphics symbols used for form generation.
Display Presentation	Light characters on a dark background. Reversible through keyboard program selection.
Bandwidth	20 MHz
Cursor	Reversed image (block cursor)
Communications	
Screen Data Transfer	Memory mapped at 3B kilobaud. Synchronous transmission of data at rates up to 9600 bps.
Auxiliary Interface	Universal RS-232 asynchronous. Synchronous interface optional.
Parallel Interface	Radio Shack TRS 80 compatible.
S-100 Bus	Printed circuit edge connector provided for connection of optional S-100 bus adaptor.
Transparent Mode	Enables display of all incoming and outgoing control codes.
Parity	Choice of even odd marking or spacing.
Transmission Mode	Half or Full Duplex. One or two stop bits.
Addressable Cursor	Direct positioning by either discrete or absolute addressing.
System Utilities	
Disk Operating System	CP/M
DOS Software	An 8080 disk assembler, debugger, text editor and file handling utilities.
Optional Software	
FORTRAN	ANSI standard. Relocatable, random and sequential disk access.
COBOL	ANSI standard. Relocatable, sequential, relative and indexed disk access.
BASIC	Sequential and random disk access. Full string manipulation, interpreter.
Application Packages	Extensive software development tools are available including software for the following applications: Payroll, Accounts Receivable, Accounts Payable, Inventory Control, General Ledger, and Word Processing.
Keyboard	
Alphanumeric Character	Generates all 128 upper and lower case ASCII characters.
Special Features	N-Key Rollover. Automatic repeat (at 15 CPS). Keyboard lock/unlock.
Numeric Pad	0-9, decimal point, comma, minus and four user-programmable function keys.
Special Functions Keys	Up to 64 user-defined two-key function sequences.
Cursor Control	Up, down, forward, backward and home.
Internal Construction	
Cabinetry	Structural foam.
Component Layout	Two board modular design. All processor related functions and hardware are on a single printed circuit board. All video and power related circuits on a separate single board. These two boards are interconnected via a single 22-pin ribbon cable.
Mounting	CRT and two circuit boards mounted to base CRT in a rigid steel frame. Disk Drive assembly mounted into upper cover for ease of servicing.
Environment	
Weight	Approximately 45 pounds.
Physical Dimensions	14 1/2" (H) x 21 1/2" (W) x 23 1/4" (D)
Environment	Operating 0 to 50 C Storage 0 to 85 C, 10 to 95% rel. humidity - non condensing.
Power Requirements	115 VAC, 60 HZ, 1 AMP (optional 230VAC 50HZ model available).

*Specifications subject to change without notice.

DEALER/OEM QUANTITIES AND SPECIAL PRICING AVAILABLE VIA MICROAMERICA DISTRIBUTING



NEECO

679 Highland Ave.
Needham, MA
02194

Mon-Fri 9:30-5:30
MasterCharge &
Visa Accepted

(617) 449-1760
Telex: 951021

MICROAMERICA DISTRIBUTING

"Nationwide distributors of Computer Equipment"

21 Putnam Street
Needham, MA
02194

(617) 449-4310

Access Code	Number	Description
1	381-9604	Parents
2	699-1626	Office
3	1-614-353-7795	Spouse's Parents
.		
.		
.		
9	828-3384	Weather
A	828-0553	Computer Shop
B	227-8341	Fire Dept
C	227-7201	Police Dept
D	824-5222	Dial-A-Prayer
.		
.		
.		
Z		Last Number Dialed

Table 1: Typical information displayed on the computer terminal in an automatic telephone dialing system that can be set up using the dialing device described in this article. The user types a single-character access code on the computer keyboard and the system dials the corresponding telephone number automatically.



Figure 1: Block diagram of connections in the system.

		High Group			
		Column 1 1209 Hz	Column 2 1336 Hz	Column 3 1477 Hz	Column 4 1633 Hz
Low Group	Row 1 697 Hz	1	2	3	A
	Row 2 770 Hz	4	5	6	B
	Row 3 852 Hz	7	8	9	C
	Row 4 941 Hz	*	0	#	D

Table 2: Row and column input lines on the integrated tone dialer device, associated tone frequencies, and corresponding digits or signaling codes derived from the combination of two tones of different frequency.

mal 2F). Most terminals use ten or twelve of these thirty-two codes for predesignated functions (such as line feed and carriage return). However, there are generally about twenty codes that can be used for other purposes. The Touch Tone device described here will use ten of these control characters.

How are the ASCII control characters sent to the Touch Tone device? By utilizing the decoding logic of the terminal. In units such as the Southwest Technical Products Company CT-64, all thirty-two control characters are decoded by the terminal. Some of the control characters are acted upon by the terminal (eg: line feed); however, those which are not used are brought out to labeled pads on the main circuit board for custom use and user-defined functions. For tone generation, simply choose ten of these user-defined control characters and connect the appropriate pins to the corresponding pins of the Touch Tone device.

Terminals which do not decode the unused ASCII control characters or do not present at least ten pins for user-defined functions require construction of a control-character decoder. The control-character decoder runs in parallel with the terminal and requires only two integrated circuits.

Touch Tone Generating Circuit

Now that the method of interfacing the terminal with the Touch Tone circuit has been described, the actual operation of the Touch Tone device will be discussed. Basically, it consists of two medium-scale integration (MSI) quad \bar{S} -R latches, a Mostek integrated tone dialer, and a relay for switching the Touch Tone device to the telephone.

The integrated tone dialer requires two inputs (a row input and a column input) to generate a tone. These input signals activate tones as shown in table 2. Activating row 1 and column 1 generates the tones for the digit 1; activating row 3 and column 2 generates the tones for the digit 8, etc.

IDS Announces S-100 Energy Management Module

The 100-EMM Energy Management Module provides temperature measurement at four separate locations indoors or out; monitors eight (8) doors, windows, or fire sensors; controls six external devices via relay or optoisolator; and provides an intrusion alarm with battery backup (alarm operates even during primary power outages). Put the 100-EMM to use in your home or business and claim a 30% tax credit for the cost of your S-100 computer system including the 100-EMM. (Purchasing the 100-EMM can actually save you several times its cost in tax credits. Full instructions for filing are included in the 100-EMM manual.)

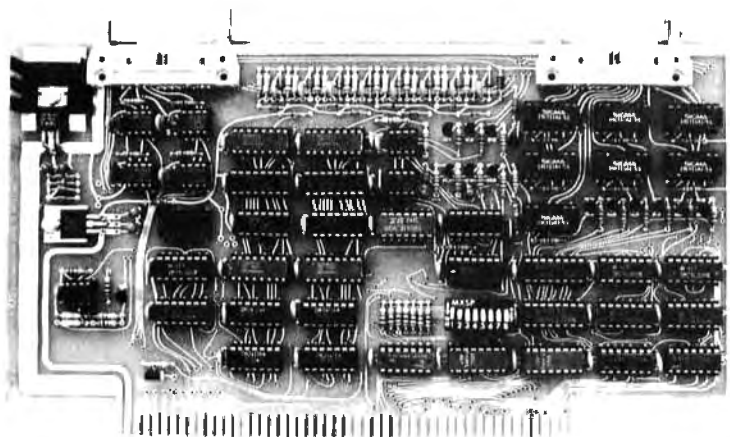

**BUY THIS S-100 BOARD
AND GET A 30% TAX
CREDIT BASED ON THE
COST OF YOUR
COMPUTER SYSTEM!**

**100-EMM Energy Management Module
Assembled and Tested \$395.00
Kit \$345.00**

Options for 100-EMM:

CP-52 Cable Panel - Terminates two 26-conductor flat cables in 26 screwplugs. Use it for convenient interconnection of the 100-EMM to the "outside world". **\$45.00**

CABL-26-STD 26-Conductor Flat Ribbon Cable - Four feet in length with connectors for 100-EMM and CP-52 above. **\$35.00** Other lengths available on special order. Add **\$1.00** per foot.

OTHER PRODUCTS FROM IDS. The most complete source of S-100 compatible modules for process control, data acquisition, energy management, and data communications.

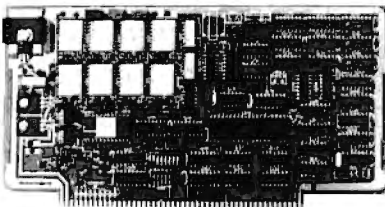

88-MODEM S-100 ORIGINATE/ANSWER MODEM WITH AUTO-DIALER. Software selectable baudrate provides any baudrate from 66-600 baud. Provides 1.5 stop bits when operated in 5-bit code mode. Auto-answer programs available for CROMEMCO CDOS, CP/M, North Star Horizon and MDS, and Alpha Micro.

Assembled and Tested \$395.00 Kit \$245.00

88-UFC UNIVERSAL FREQUENCY COUNTER

Four software selected inputs. Measure frequency from 0-650 MHz and period from .1µs to 1 Second. Extensive software included.

Assembled and Tested \$299.00 Kit \$199.00 Temperature-Compensated Crystal Oscillator option **\$145.00**

88-SAI SYNCHRONOUS/ASYNCHRONOUS INTERFACE

The most versatile serial interface on the market. Computer access/control of all data and handshake lines and provision for masked interrupts, inversion of any input or output signal, and onboard baudrate generation for 110, 134.5, 150, 300, 600, 1200, 2400, 4800, 9600, and many other baud rates. Many more features.

Assembled and Tested \$299.00 Kit \$199.00

88-SPM TIME OF DAY CLOCK with battery backup. Set the clock with three out instructions: no delays! Programs included in North Star BASIC, CBASIC, and 8080 assembly language.

Assembled and Tested with crystal option \$199.00 Kit less crystal option \$99.00 Crystal Option Kit **\$25.00**

88-RCB RELAY CONTROL BOARD

16 Relays on one board. Control appliances, production equipment, or even musical instruments (See BYTE Magazine Sept 1977 page 12)

Assembled and Tested \$299.00 Kit \$199.00

**INTERNATIONAL
DATA SYSTEMS, INC.**

Mailing Address:

Post Office Box 17269
Dulles International Airport
Washington, DC 20041
Telephone (703)661-8442

Shipping Address:

400 West Service Road, Suite 130
Dulles International Airport
Washington, DC 20041 USA
TELEX 901112 IDS CTLY

Figure 2: Schematic diagram of the dual-tone multiple-frequency (Touch Tone) telephone dialing circuit. Connections to the terminal apply to the Southwest Technical Products Corp CT-64 unit. Terminals which do not decode the entire ASCII character set may require additional decoding circuitry for use with the telephone interface. The isolating telephone coupler is required for connection to the telephone line of devices which have not been given approval by the Federal Communications Commission.

The tone combinations for the characters A, B, C, and D (column 4 of table 2) do not have corresponding keys on a normal telephone Touch Tone pad but are reserved for future use. Since you will be generating only the tones 0 thru 9, only inputs for columns 1 thru 3 and rows 1 thru 4 will be needed. Hence, seven ASCII control characters will be needed to activate the three columns and four rows. Use of the other three ASCII control characters (for a total of ten) is discussed later.

The purpose of the latches (IC1 and IC2) is to hold the output state of the logic decoder of the terminal. Since the terminal processes only one character at a time and the tone dialer requires the simultaneous presence of two input signals, the latch holds the first input from the terminal while the second input is being transmitted. There is a latch for each column and row of the integrated tone dialer. The latch IC2 is also used to control a relay for attaching the tone device to the telephone. A schematic of the complete Touch Tone generating circuit is shown in figure 2.

The output of the integrated tone dialer goes into an isolating coupler connected to a telephone. The coupler must be approved by the Federal Communications Commission, and it is required for user con-

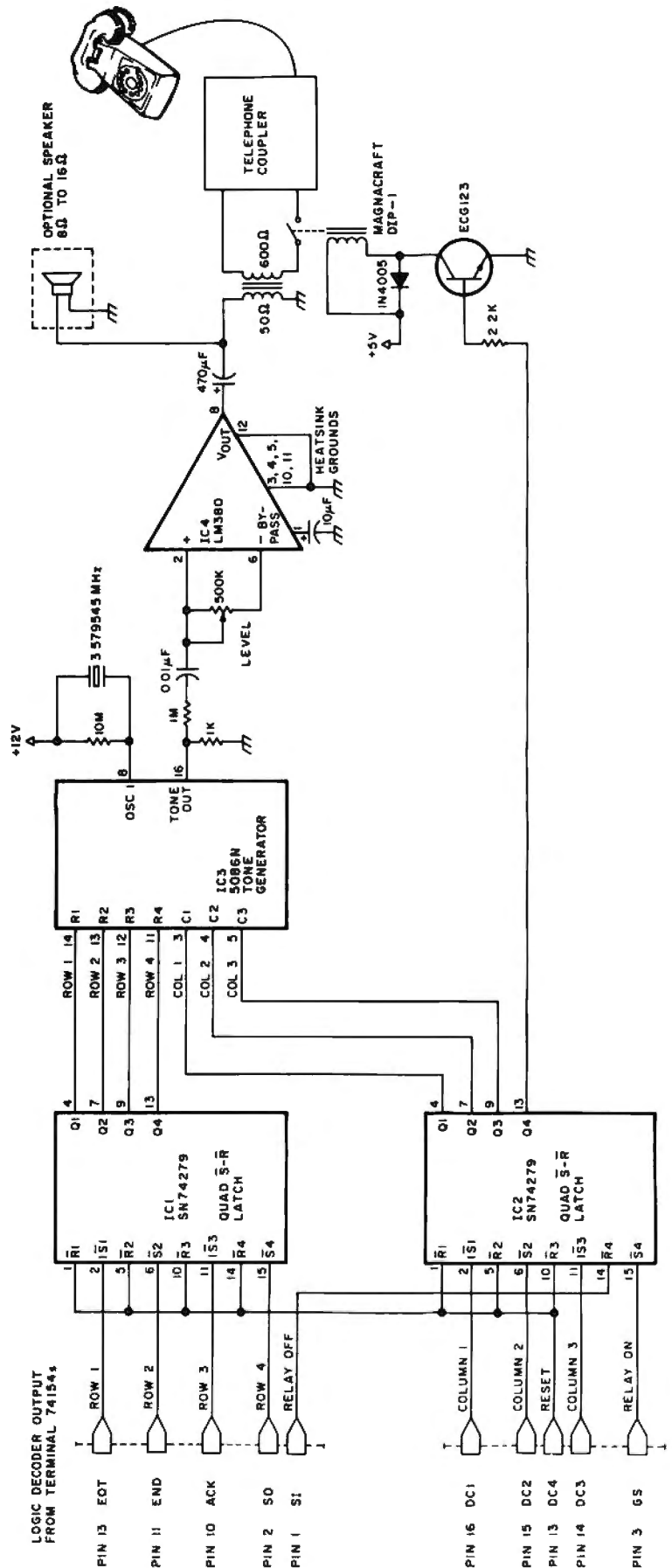

Number	Type	+5 V	GND	+12 V
IC1	74279	16	8	
IC2	74279	16	8	
IC3	5086N	6	1,7	
IC4	LM380	7	14	

Table 3: Power supply connections for integrated circuits in figure 2.



APPLE OWNERS — EXPAND YOUR SYSTEM WITH 8" FLOPPY DISK FROM *WIZARD!*

WIZARD 2+2

Many software programs are restricted by the 116 K available on the 5" drives now on the market. Some business programs require 12 or more diskettes, which can be both confusing and error inducing.

WIZARD offers three solutions:

"WIZARD 1 + 1" : single 8" drive system; 256K	\$ 1695.
"WIZARD 2 + 2" : two 8" drive system; 516K	\$ 2495.
"WIZARD PLUS" : two 8" drives, double sided; over 1 megabyte	\$ 3195.

All systems are ready to run, fully assembled and tested, and include:

SHUGART full size 8" floppy disk drive(s).

Controller Card for your Apple (48K RAM required)

All interface software, cables, connectors, cabinet and power supply.

ONE YEAR parts and labor warranty from defects in material and workmanship.

WATCH FOR NEW *WIZARD* PRODUCTS FROM D&T ELECTRONICS:

we are currently developing a 10 Megabyte disc, and other hardware/software.

ALL SYSTEMS AVAILABLE NOW (stock to two weeks).

SEE YOUR LOCAL APPLE DEALER, OR CONTACT THESE *WIZARD* DISTRIBUTORS:

MARCOMP

175 East Edgewood Drive
McMurray, PA 15317
(412) 941-5936

COMPUTER DISTRIBUTORS, INC.

PO BOX 9194
Austin, TX 78766
(512) 345-9729

DEALER INQUIRIES INVITED

SOFTWARE: We have software available to run on these expanded capacity systems; please send for our list.

If you are a software writer and have programs currently on 5" that would benefit from the expanded capacity of our 8" systems, we would like to hear from you.

WIZARD is a registered trademark of D&T Electronics, Inc.
Apple is a registered trademark of Apple Computer, Inc.

structed devices which attach to the telephone company's equipment. Approved couplers can be purchased for approximately \$5 from electronic supply houses, or they can be leased from the telephone company for \$2 to \$4 a month.

As previously mentioned, there are three more ASCII control characters required by the Touch Tone device. These perform the reset, relay on, and relay off functions. The reset control is used to turn a tone off after it has been turned on (the tone combination is turned on by activating a row/column combination). (That is, once a row and column have been turned on, they remain on until a reset is issued.) Reset is also used to clear the latches after powering up the circuit. Note that the control character used for reset (pin 13 of the terminal 74154) is connected to the reset pin of the latch for each row and column control (IC1 and IC2). A single reset operation clears all of the row and column latches. This is more convenient than clearing the row and column latches individually.

The relay on and relay off controls are used to make connection to and disconnect from the telephone. The Touch Tone device is connected to the telephone coupler immediately before dialing and is disconnected from the terminal immediately after dialing. This prevents random signals and noise (such as that generated at power on) from entering the telephone line from the terminal.

In my system, the power supply for the Touch Tone device was taken from the terminal's power supply. After the Touch Tone generating circuit has been constructed, the volume output from the integrated tone dialer should be adjusted with a VU meter so that it will be in the range of -6 to 0 dB. Output signals less than -6 dB in level will not be recognized by the telephone company equipment. Output levels greater than 0 dB cause cross-modulation into other phone lines. The general operation of the Touch Tone device can be tested off-line by entering the various control characters with the terminal in full duplex mode.

Dialing

Once the hardware is functioning correctly, dialing is simple. Basically, it consists of the following steps:

- Turn the line connection relay on (send the control character for *relay on* to the terminal).
 - Turn column on for Nth digit (send the control character for the column of digit N to the terminal).
 - Turn row on for Nth digit (send the control character for the row of digit N to the terminal).
 - Wait 40 ms.
 - Turn tone off (send the control character for *reset* to the terminal).
 - Wait 40 ms.
- The preceding steps are performed once for each digit of the telephone (for example, seven times for a local telephone number).
- Turn relay off (send the control character for *relay off* to the terminal).

Note that from the perspective of the microprocessor unit, generating Touch Tones is accomplished in the same manner as displaying characters on the terminal screen. The 40 ms delays are minimum times required by the telephone company equipment. A tone must stay on for at least 40 ms, and there must be at least a 40 ms delay between tones.

Summary

This Touch Tone interface, used in conjunction with a microprocessor and an ASCII terminal, is an example of a practical computer application in communications. I advise personal computing enthusiasts who construct their own Touch Tone devices to be most careful when debugging the software. Sending random sequences of digits through a Touch Tone interface can be a painful way to debug your program (although the pain may not be felt until the telephone bill arrives a few weeks later). ■

Acknowledgements

I am grateful to Dink Stockert, Dr David Crouch, and Carl Zettner for their assistance in the design and construction of the hardware. Lynn Mason, of Cimarron Information Systems Inc, was very generous in providing a computer system for preparation of the text of this manuscript.

Introducing...

MINI-FLEXTM

Designed Specifically to Protect 5" Diskettes



The Newest
Member of The
Advance Access
Diskette
Protection Family

For Further Information
CALL TOLL FREE
800 323-0254



ADVANCE ACCESS GROUP

10526 W. Cermak Westchester, IL 60153 312 562-5210

"Manufacturers of Information Processing Supplies"

Build your own microcomputer as you learn computer technology at home.

New from NRI! The Most Complete and Up-to-date Home Study Course Ever Offered

As the microprocessor revolutionizes the computer world and microcomputers appear almost everywhere, NRI brings you a new, convenient, and effective way to keep up with this expanding technology. It's NRI's Computer Technology Course, created and designed exclusively for learning at home in your spare time.

Featuring NRI's Exclusive Dual Language Microcomputer

NRI goes beyond book learning to give you practical, "hands-on" experience in designing circuitry, interfacing components, programming, and troubleshooting. As you learn, you actually assemble NRI's designed-for-learning microcomputer, incorporating the latest advances in the state of the art. It looks and operates like the finest of its kind, actually does more than many commercial units. But NRI engineers have designed components and planned assembly so it demonstrates important principles, gives you working experience in detecting and correcting problems. And it's yours to keep, put to work in your own home or business.

You also build and keep your own test instruments, including a transistorized volt-ohm meter and CMOS digital frequency counter. And NRI's Discovery Lab[®] broadens your horizons with specialized experiments and theory demonstrations.

The Proven Way to Learn at Home

You don't have to worry with travel, classes, or time lost from work when you learn the NRI way. As they have for more than 60



years of teaching technical subjects, NRI brings the material to you. You study in your spare time, at your convenience, using "bite-size" lessons that program material into logical segments for easier assimilation. You perform experiments and build equipment using kits we supply. And your personal NRI instructor is always available for consultation should you have questions or problems. Over a million students have already shown the effectiveness of NRI training.

Choice of Courses

Several courses are available, depending

upon your needs and background. NRI's Master Course in Computer Technology starts with the fundamentals, explores basic electronics and digital theory, the total computer world, and the microcomputer. The Advanced Course, for students already versed in electronics and general computers, concentrates on the microprocessor and microcomputer. In both courses, you build all instruments and your own computer.

Send for Free Catalog... No Salesman Will Call

Get the details on these exciting new courses in NRI's free, 100-page catalog. Shows all kits and equipment, lesson outlines, and full information, including facts on other electronics courses. Mail the coupon today and we'll rush your catalog. No salesman will ever call. Keep up with the latest technology as you learn on your own computer. If coupon has been removed, write to NRI Schools, Computer Department, 3939 Wisconsin Ave., Washington, D.C. 20016.



NRI Schools
McGraw-Hill Continuing
Education Center
3939 Wisconsin Avenue
Washington, D.C. 20016

NO SALESMAN WILL CALL
Please check for one free catalog only.



All career courses
approved under GI Bill.
 Check for details.

- Computer Electronics Including Microcomputers
- TV/Audio/Video Systems Servicing
- Complete Communications Electronics with CB • FCC Licenses • Aircraft, Mobile, Marine Electronics
- CB Specialists Course
- Amateur Radio • Basic and Advanced

- Digital Electronics • Electronic Technology • Basic Electronics
- Small Engine Repair
- Electrical Appliance Servicing
- Automotive Mechanics
- Auto Air Conditioning
- Air Conditioning, Refrigeration, & Heating Including Solar Technology

Name _____ (Please Print) Age _____

Street _____

City/State/Zip _____

Accredited by the Accrediting Commission of the National Home Study Council

170-010

Analysis of Polynomial Functions with the TI-59 Calculator

Part 2

Pierre Chancé
20 Rue de Longchamp
75116 Paris FRANCE

Consider the following polynomial:

$$P(x) = x^4 - 8x^2 + 7$$

For $P(x) = 0$ it is essential to study the characteristic elements, derived polynomials $P'(x)$ and $P''(x)$, and automatically plot the function curve. The procedure is as follows:

1. Read the magnetic card of the main program in groups 1 and 2.
2. Initialize by depressing key A.
3. Enter each of the coefficients with the keys. Start with the coefficient for x^4 by depressing key B each time. A 0 is entered for any term not having a power of x . Thus, you can perform the sequence 0 B, 0 B, 1 B, 0 B, -8 B, 0 B, 7 B.
4. Depress key C.

Depressing key C causes the processing of $P(x)$ to its conclusion with no other intervention.

When reading listing 1, the following are seen successively, separated by program spaces:

- the column of the seven given coefficients or the 0s which replace them
- the group of the lower boundary a and upper boundary b
- the group of interval $(b - a)$ and increment Δx
- the indication of the maximum error

After these appear the following results:

- the group of roots followed by the series 9. 999...? that indicates the end of determination of the roots
- the table of the thirty-nine values of x
- the table of the thirty-nine values of $P(x)$

If it is desired to retain the data for $P(x)$ to plot the function curve later, this is the time to record it in groups 3 and 4.

The procedure for the first derived polynomial is even simpler:

1. Depress key B' once; this causes all the coefficients of $P'(x)$ to be printed one after the other.
2. Depress key C.

The second derived polynomial is obtained in the same manner. The same applies for the derivatives of order n , provided the polynomial remains derivable. Notice that it is useless to reinitialize to change from one polynomial to the next.

Plotting the Function Curve

By convention, hereafter designate the data used in plotting the function curve as listing 2. It can be the table of values of $P(x)$ already recorded or any other that could be substituted for reasons that will be discussed. The plot itself will be designated figure 1.

Text continued on page 134

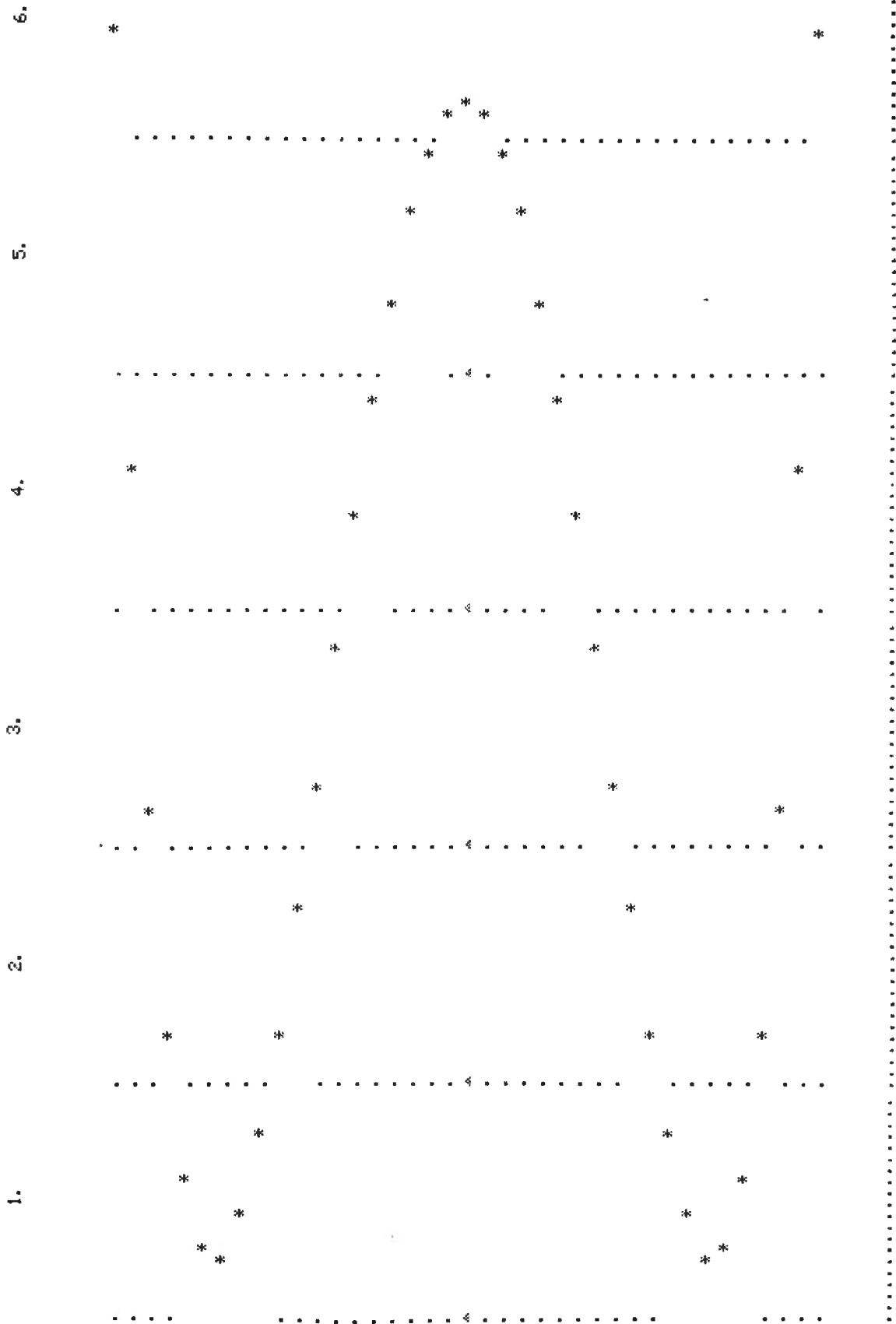

Figure 1: The six segments of output from the TI-59 that define the function curve.

NEECO PROUDLY
ANNOUNCES THE
COMPUTHINK

MINIMAX

"FULLY INTEGRATED COMPUTER SYSTEM"



MINIMAX SERIES COMPUTER



PRINTER NOT INCLUDED IN PRICE

THE MINIMAX SERIES WAS DESIGNED TO OFFER THE MARKET MINICOMPUTER CAPABILITIES AT MICROCOMPUTER PRICES. COMPARE THE CAPABILITIES & PRICE!

CONTACT NEECO FOR FULL SPECS - FREE MINIMAX MANUAL.

MEET THE MINIMAX COMPUTER

THE MINIMAX SERIES COMPUTER WAS DESIGNED BY INDUSTRY PROFESSIONALS. COMPARE THE PRICE AND FEATURES TO ANY OTHER COMPUTER IN ITS CLASS!



MINIMAX I - \$4495

• THE MINIMAX SERIES COMPUTER IS AN INTEGRATED, COMPACT UNIT CONTAINING THE CPU, DUAL DENSITY DISK STORAGE, 12 INCH CRT, AND FULL STYLE KEYBOARD, WITH SEPARATE NUMERIC ENTRY PAD. ALL KEYS (INCLUDING CURSOR) WITH FULL REPEAT • HYBRID 2 MEGAHERTZ 6502 CPU • 108K SYSTEM RAM (48K USER) • FASTEST FLOPPY DISK ACCESS (24K LOADS IN 4.2 SECONDS) • 16K ROM CONTAINS COMPUTHINK BASIC (AN EXTENDED MICROSOFT BASIC) WITH EXTENDED PRECISION, DOS INCLUDES COMPLETE FILE I/O WITH FULL RANDOM ACCESS, COMPLETE MONITOR WITH DEBUG & TRACE, AND TINY 6502 ASSEMBLER • COMPLETE HIGH RESOLUTION GRAPHICS WITH INDIVIDUAL DOT (240x512) POINT SCREEN ADDRESSABILITY • FULL SCREEN TEXT EDITING WITH OVERWRITE, INSERTION OR DELETION • SPLIT SCREEN/WINDOW MODES • INDIVIDUAL FIELD EDITING WITH FIELD PROTECT AND AUTO SKIP TO NEXT FIELD • DISK STORAGE SYSTEM TRANSFERS 6K PER SECOND WITH AUTO VERIFY AND PARITY CHECK • 12 INCH CRT-64 CHARACTERS BY 30 LINES. UP TO THREE PROGRAMMABLE CHARACTER FONTS FOR LANGUAGES OR SPECIAL CHARACTERS ••• SWITCHABLE 110 OR 220V OPERATION •••• HYBRID CPU IS MICROPROGRAMMABLE WITH 64 USER DEFINABLE OPCODES. CHOICE OF 800K OR 2.4 MEGABYTE DISK STORAGE • FULL SERIAL RS-232C PORT WITH PROGRAMMABLE BAUD RATES AND MODEM CONTROL SIGNAL • DEDICATED DISK PORT • PRINTER PORT SUPPORTS PARALLEL COMMERCIAL PRINTERS • 24 PIN I/O USER PORT • PAGEMATE DATABASE AVAILABLE • PLM COMPILER AVAILABLE • BUSINESS PACKAGES AVAILABLE • COMPLETE DIAGNOSTICS & SCHEMATICS INCLUDED • COMPLETE USER MANUAL INCLUDED

MINIMAX I - .8 MEGABYTE ON LINE MINIFLOPPY STORAGE

MINIMAX II - \$5995

MINIMAX II - 2.4 MEGABYTE ON LINE 8" FLOPPY STORAGE

THE MINIMAX WAS DESIGNED AND IS MANUFACTURED BY COMPUTHINK COMPUTER CORP. DISTRIBUTED IN EUROPE AND THE EASTERN U.S. BY NEECO.

COMPUTHINK .4 & .8 MEGABYTE DISK DRIVES FOR THE NEW 16/32K PETS!

DISK SYSTEMS INCLUDE DISKMON OPERATING SYSTEM IN ROM AND INTERFACE TO 16/32 PETS!



FOR 8K PETS (small keyboards)
4 Megabytes of Disk Storage for 8K PETS!
(Requires Expandamem)
400K-8S DISK SYSTEM INCLUDES RANDOM ACCESS IN DOS-LOADS 20K IN 4 SECONDS!
24K Expandamem Memory *525
32K Expandamem Memory *615

\$1295

- Dual Minifloppy Drives with 200K per diskette side for total 400K 800K on line
- 800K model accesses all 4 diskette sides via dual read and write arm system
- Dual Density Hardware and DOS loads 20K (with verification) in 4.2 seconds complete
- DISKMON (DOS) adds 17 commands to BASIC including Random Access and printer support
- System comes complete with plug in internal board containing 8K RAM DOS and Disk Controller Hardware • Board plugs directly onto internal memory expansion pins
- System does not utilize IEEE or USER Port system functions directly from memory port
- All DISKMON DOS commands reside interactively with BASIC disk directory command and format command do not interfere with program in RAM - DOS command were designed for simplicity of use System was manufactured for heavy commercial use
- System installs completely in less than ten minutes - immediately ready for use
- *525 and *615 prices include all hardware DOS complete user manual and demo utility diskette
- Available software includes PLM Compiler (*250), Relocatable Assembler (*70), Source-Editor Program (*70), Autolink Linking Loader (*70) and a complete Database system (Pagemate *495)
- Call or write for complete product information and specifications. User manual *10

(PRODUCT AVAILABILITY IS AUG/SEPT—CALL FOR INFO)

ALL 16/32K MODELS INCLUDE AN INTERNAL PLUG-IN INTERFACE	400K-16N	\$1295
BOARD CONTAINING DOS, 8K OF RAM, AND CONTROLLER	400K-32N	\$1295
	800K-16N	\$1695
	800K-32N	\$1695



Microcomputer Systems Division

NEW ENGLAND ELECTRONICS CO., INC.
679 HIGHLAND AVE., NEEDHAM, MA 02194
MON-FRI, 9:00-5:30, E.S.T.

(617) 449-1760



NEECO

Microcomputer Systems Division

**PROUDLY ANNOUNCES THE NEWEST
HARDWARE AND SOFTWARE FOR YOUR PET!**

The PET is now a truly sophisticated
Business System with the announcement
of these peripherals and software packages.

**FREE
SOFTWARE
& PET DUST
COVER!**
(Offer ends
2/28/80)



PRODUCT	DESCRIPTION	PRICE	AVAILABILITY
PET 2001—8KN (Large Keys)	8K RAM	\$ 795	IMMEDIATE
PET 2001—8K	8K RAM	\$ 795	IMMEDIATE
PET 2001—16KN (Large Keys)	16K RAM*	\$ 995	IMMEDIATE
PET 2001—32KN (Large Keys)	32K RAM	\$1295	IMMEDIATE
PET 2023 PRINTER	ROLL FEED	\$ 850	IMMEDIATE
PET 2022 PRINTER	TRACTOR/ROLL	\$ 995	IMMEDIATE
ROMRETRO KIT	UPDATED O/S	\$ 90	IMMEDIATE
PET 2040	DUAL FLOPPY*	\$1295	IMMEDIATE
PET C2N	2nd Cassette	\$ 100	IMMEDIATE

*The 16K/32K (large keyboard) units do not include a cassette drive. Order C2N Cassette. 2040 Floppy Drive requires a 16K or 32K unit. 8K RAM Retrofit available July.

ALL PETS ARE FULLY TESTED BY NEECO BEFORE SHIPMENT. NEECO IS A FULL CUSTOMER-ORIENTED COMPANY. CALL FOR OUR FREE CATALOG. ALL ORDERS OVER \$795 WILL RECEIVE A FREE NEECO PET DUST COVER AND \$100 OF SOFTWARE FROM OUR CATALOG IF YOU MENTION YOU SAW THIS AD.

PET-DISK BASED BUSINESS SOFTWARE

SOFTWARE/APPLICATION	REQUIRES	AUTHOR	AVAILABILITY	PRICE
WORDPRO II / WORD PROCESSING	2040 + 16K PET	PRO/MICRO	IMMEDIATE	\$100
WORDPRO III / WORD PROCESSING	2040 + 32K PET	"	JANUARY	\$200
GENERAL LEDGER	"	CMS SOFTWARE	IMMEDIATE	\$295*
ACCOUNTS PAYABLE	"	"	JANUARY	\$295*
ACCOUNTS RECEIVABLE	"	"	JANUARY	\$295*
MAILING LIST	"	"	IMMEDIATE	\$100
MICROLEDGER	"	COMPUMAX	"	\$140
MICROPAY	"	"	"	\$140
MICROREC	"	"	"	\$140
MICROINV	"	"	"	\$140
MICROPERS	"	"	"	\$140

*The CMS Software (G/L, A/R, A/P) are based on Osborne & Associates trial tested business basic software. Software is complete with full documentation and user instructions. All packages require a printer for output. Commodore recommends the NEC Spinwriter (available from NEECO) as the output printer for WORDPRO.

PRODUCTS ARE AVAILABLE TO DEALERS VIA MICROAMERICA DISTRIBUTING (617-449-4310)

**FOR WORD PROCESSING
NEC IS BEST!**

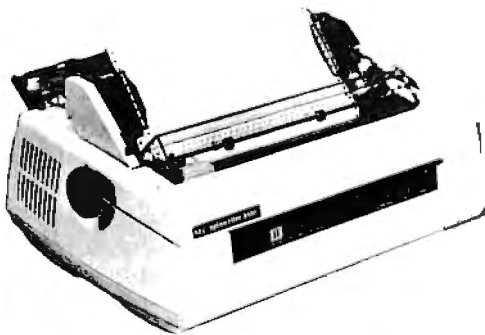

- * 55 characters per second output speed
- * Changeable thimble for different typstyles
- * Less than 1% warranty malfunction rate
- * IBM quality letter output
- * Dealer inquiries invited

\$2995

*Price includes IEEE interface to PET. IEEE Port is available for use with 2040 Dual Disk.

**THE NEC SPINWRITER
MODEL 5530-P** (Centronics I/O modified for PET)

*The NEC 5530-P is the output printer recommended by Commodore for their Word Processing System.

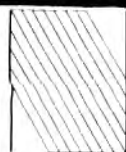

NEECO

679 Highland Ave.
Needham, MA
02194

Mon-Fri 9:30-5:30
MasterCharge &
Visa Accepted

(617) 449-1760
Telex: 951021

MICROAMERICA DISTRIBUTING

"Nationwide distributors of Computer Equipment"

21 Putnam Street
Needham, MA
02194

(617) 449-4310

Text continued:

The procedure is as follows in practice:

1. In groups 3 and 4 read listing 2 mentioned above.
2. In groups 1 and 2 read the magnetic card of the program for the function curve.
3. Initialize by depressing key A.
4. With the keys enter the two extremes envisaged for the curve starting with the lower and then each time depressing key B.
5. Depress key C.

Depressing key C initiates the entire process with no other intervention. The six strips obtained are separated by cutting with scissors, and are assembled with glue or adhesive tape. This is the standard automatic procedure, and nothing prevents the operator from applying it in every case using the data collected in listing 1.

However, you may desire to center the reproduction in a smaller field. When examining the table of values of $P(x)$ obtained, it is obvious that, for registers R_{21} thru R_{25} and R_{55} thru R_{59} , small variations in x cause considerable variations in $P(x)$. In other words, the curve ends with parabolic branches. In the same way a photographer takes a close-up of a subject, you can neglect the infinite range and concentrate on useful details.

For this purpose, you must disconnect automatic operation and gain control of the depth of field. This time, the procedure will be as follows:

1. Reread the card of the main program in groups 1 and 2.
2. Initialize by depressing key A.
3. Re-enter the initial coefficients of R_{16} to R_{10} by each time depressing key B as previously indicated.
4. Switch to programming mode LRN, and perform the few modifications required:

- Replace the neutral NOP instructions provided for this purpose at statements 087, 096 and 119 by R/S instructions.
- Replace the initial partition of the interval (a, b) at statements 120 thru 122 by as many NOP instructions.
- Replace all occurrences of ϵ with a deliberately excessive number, for example 999...

5. Return to the calculating mode, and depress key C. The rest of the program will be executed but will stop whenever useful to permit the entry of a data item of your choice:

- Boundary a with the first stop: here, it will be 3 in absolute value but the calculator will recognize it as negative 3.
- Boundary b with the second stop: it will again be 3.
- Partition of the interval (a, b) at the third stop: keep it at 20 on seeing the value of the interval the machine has just printed out after the boundaries.

Naturally, each data entry with the keys is followed by operation of the R/S key to restart the calculation.

What happens now? Without getting involved in a root calculation that is no longer of interest at this point, the

Listing 1: A listing containing the data and error specification for a six-degree polynomial, $P(x)$. Thirty-nine values of x are also printed along with the corresponding values of $P(x)$ calculated for each value of x .

0.	0.	0.	0.
0.	0.	0.	0.
1.	4.	0.	0.
0.	0.	0.	0.
-8.	-16.	3.	0.
0.	0.	0.	0.
7.	0.	-4.	0.
-3.828427125			
3.828427125	-3.	-2.154700538	
	3.	2.154700538	
7.656854249			
.3828427125	6.	4.309401077	
	0.3	.2154700538	
0.000001			
	0.000001	0.000001	
-2.6457516			
-1.9999998053	-2.000000095	-1.15470057	
1.000000232	.0000002725	1.154700295	
2.645751297	2.000000068	9.9999999 999	
9.9999999 999	9.9999999 999		
-3.637005769	21	-2.046965511	21
-3.445584412	22	-1.939230485	22
-3.254163056	23	-1.831495458	23
-3.0627417	24	-1.723760431	24
-2.871320344	25	-1.616025404	25
-2.679898987	26	-1.508290377	26
-2.488477631	27	-1.40055535	27
-2.297056275	28	-1.292820323	28
-2.105634919	29	-1.185085296	29
-1.914213562	30	-1.077350269	30
-1.722792206	31	-9696152423	31
-1.53137085	32	-8618802154	32
-1.339949494	33	-7541451884	33
-1.148528137	34	-6464101615	34
-.9571067812	35	-5386751346	35
-.7656854249	36	-4309401077	36
-.5742640687	37	-3232050808	37
-.3828427125	38	-2154700538	38
-.1914213562	39	-1077350269	39
	40	-8.9-12	40
.1914213562	41	.1077350269	41
.3828427125	42	.2154700538	42
.5742640687	43	.3232050808	43
.7656854249	44	.4309401077	44
.9571067812	45	.5386751346	45
1.148528137	46	.6464101615	46
1.339949494	47	.7541451884	47
1.53137085	48	.8618802153	48
1.722792206	49	.9696152423	49
1.914213562	50	1.077350269	50
2.105634919	51	1.185085296	51
2.297056275	52	1.292820323	52
2.488477631	53	1.40055535	53
2.679898987	54	1.508290377	54
2.871320344	55	1.616025404	55
3.0627417	56	1.723760431	56
3.254163056	57	1.831495458	57
3.445584412	58	1.939230485	58
3.637005769	59	2.046965511	59
76.15249512	21	-11.749125	21
52.96920178	22	-8.893	22
34.42252761	23	-6.381375	23
19.94856125	24	-4.224	24
9.015614845	25	-2.390625	25
1.124224037	26	-0.861	26
-4.192852014	27	0.385125	27
-7.370630645	28	1.368	28
-8.811905689	29	2.107875	29
-8.887247468	30	2.625	30
-7.935002802	31	2.939625	31
-6.261295001	32	3.072	32
-4.140023871	33	3.042375	33
-1.81266571	34	2.871	34
.5107266897	35	2.578125	35
2.853524043	36	2.184	36
4.470520569	37	1.708875	37
5.848933998	38	1.173	38
6.708205561	39	0.596625	39
	40	3.68-11	40
6.708205561	41	-0.596625	41
5.848933998	42	-1.173	42
4.470520569	43	-1.708875	43
2.853524043	44	-2.184	44
.5107266897	45	-2.578125	45
-1.81266571	46	-2.871	46
-4.140023871	47	-3.042375	47
-6.261295001	48	-3.072	48
-7.935002802	49	-2.939625	49
-8.887247468	50	-2.625	50
-8.811905689	51	-2.107875	51
-7.370630645	52	-1.368	52
-4.192852014	53	-0.385125	53
1.124224037	54	0.860999998	54
9.015614845	55	2.390625	55
19.94856125	56	4.224	56
34.42252761	57	6.381375	57
52.96920178	58	8.893	58
76.15249512	59	11.749125	59

Let your LSI-11* break the 28K barrier

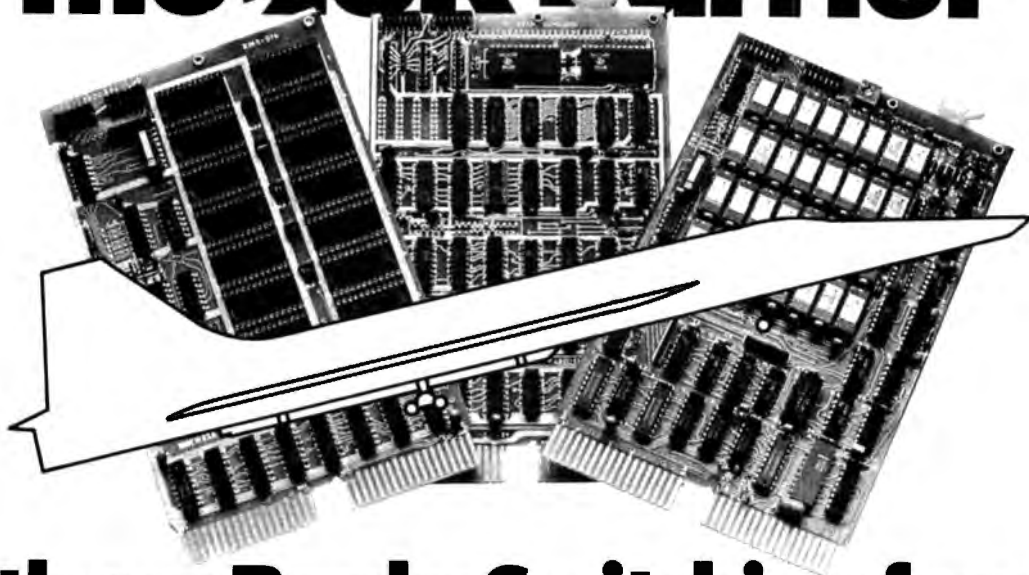

With our Bank-Switching family

In LOCAL mode our memory is functionally just like DEC memory. But when you run out of memory space you're not lost. Add an inexpensive Bank-Switch Controller (BSC-256) and you can go to **two megabytes**. Add another and go to **four megabytes**.

So don't get boxed in with other brands of LSI-11* memory. Break free. Join the family:

RMA-032	32K by 16 bit RAM. On-board refresh	\$1200 (Single qty.)
RMS-016	16K by 16 bit ROM. (Intel 2716)	\$300 (Single qty.)
BSC-256	The Bank-Switch Controller	\$300 (Single qty.)

Substantial quantity discounts are available. For a free copy of our Bank-Switching manual, call or write on your company letterhead.

*Digital Pathways Inc.
4151 Middlefield Road
Palo Alto, CA 94306
(415) 493-5544*

**Registered trademark of Digital Equipment Corporation*



DIGITAL PATHWAYS

Listing 2: Listing of a sample input of data used to plot the function curve.

0.		-0.9	34						
0.		-0.75	35	-8.4224	28				
1.		-0.6	36	-7.36799375	29				
0.		-0.45	37	-5.9375	30				
-8.		-0.3	38	-4.25849375	31				
0.		-0.15	39	-2.4464	32				
7.		0.	40	-0.60449375	33				
		0.15	41	1.1761	34				
		0.3	42	2.81640625	35				
-3.		0.45	43	4.2496	36				
3.		0.6	44	5.42100625	37				
		0.75	45	6.2881	38				
6.		0.9	46	6.82050625	39				
0.3		1.05	47	7.	40				
		1.2	48	6.82050625	41				
9999999.		1.35	49	6.2881	42				
		1.5	50	5.42100625	43				
		1.65	51	4.2496	44				
		1.8	52	2.81640625	45				
-2.55		1.95	53	1.1761	46				
9.9999999 999		2.1	54	-0.60449375	47				
		2.25	55	-2.4464	48				
-2.85	21	2.4	56	-4.25849375	49				
-2.7	22	2.55	57	-5.9375	50				
-2.55	23	2.7	58	-7.36799375	51				
-2.4	24	2.85	59	-8.4224	52				
-2.25	25			-8.96099375	53				
-2.1	26			-8.8319	54				
-1.95	27	7.99500625	21	-7.87109375	55				
-1.8	28	1.8241	22	-5.9024	56				
-1.65	29	-2.73749375	23	-2.73749375	57				
-1.5	30	-5.9024	24	1.8241	58				
-1.35	31	-7.87109375	25	7.99500625	59				
-1.2	32	-8.8319	26						
-1.05	33	-8.9609375	27						

calculator simply indicates the lowest root in approximate fashion and then rapidly prints out the tables of values of x and $P(x)$ at the assigned values of a and b (see listing 2).

All that remains is to use these values contained in

registers R_{21} to R_{59} for the plot by continuing with the known steps as follows:

6. In groups 1 and 2 read the card of the program for the function curve.
7. Initialize with key A.
8. With the keys punch in $-9 B$ then $8 B$ to enter the extremes which are obviously appropriate here.
9. Depress key C which delivers the six ideal strips after this mathematical "zooming" as can be seen from looking at the curve in detail (see figure 1).

Above all, the question is one of knowing if this plot is technically satisfactory.

For verification purposes, see if the coordinates of the minimums found by the calculation ($\pm 2, -9$) and the coordinates measured on the plot are consistent. More precisely, determine the abscissa of the minimums with an ordinate of -9 . From the small median triangular sign marking the 0 abscissa on the base line, you can easily count ± 13 intervals each having a value of 0.15, the increment of x . This gives $\pm 13 \times 0.15 = \pm 1.95$. This abscissa is very close to the value calculated (± 2), and it can be said that the plot is extremely accurate.

As for the points of inflection, their ordinate is found to be $-1.888...$ for $P(x)$ evaluated from the roots of $P''(x) = 0$, in other words abscissas of ± 1.154700 . The points of inflection whose abscissa is ± 1.15 in accordance with the calculation fall slightly before the eighth point on the base line at the abscissa ($8 \times 0.15 = 1.20$). This is also very close to the value calculated. These are the points where the curve crosses its tangent.

The zero ordinate can easily be deduced from a simple rule. Given that the difference between minimum and maximum is $9 + 8 = 17$ in absolute value and there are $4 \times 20 + 17 = 97$ elementary intervals between these points, each has a value of 0.175. From this the axis of the abscissas is at $9/0.175 = 51$ intervals from the minimum of the curve.

From the table of $P(x)$ it can be seen that the curve cancels between registers R_{34} and R_{33} , R_{46} and R_{47} , and that this effectively corresponds to the interval 6-7 of the base line. Without providing the precision of a professional plotter, the reproduction obtained is thus of suitable quality given the means employed.

Conclusion

When a procedure is used for a rather long calculation that requires only three keyboard operations:

- initialization by key A
- data entry by key B or B'
- complete execution by key C

the drawbacks of the relative slowness of calculation are considerably reduced.

The TI-59 cannot execute its program with great speed. However, most users can tolerate a delay of a few minutes with no hardship. Some will appreciate the option of allowing users to disable automatic operation to follow their own inspiration. ■



M.O.M.

MAIL ORDER MEDIA

100% GUARANTEED FLOPPY DISKS.

—MINI DISKS BOX OF 10 (SOFT, 10 AND 16 SECTOR)	\$29.50 + TAX
—MAXI DISKS BOX OF 10 (SOFT AND 32 SECTOR)	\$35.00 + TAX

ALSO SPECIALIZING IN:

- FLOPPY DISK STORAGE SYSTEMS
- FLOPPY DISK MAILING PACKAGES
- DATA CASSETTES AND CARTRIDGES

MASTER CHARGE & VISA WELCOME 10 DAY DELIVERY

DEAR M.O.M. — PLEASE SEND MORE INFORMATION TO

NAME _____

ADDRESS _____

STREET

CITY STATE ZIP

PHONE _____

MAIL ORDER MEDIA
473 MACARA #706
SUNNYVALE, CA. 94086
(408) 739-5215

Back-Up

'Security... for your S-100 hard disk data'

The availability of fast, reliable, high capacity hard disk storage for the S-100 computer market has created a wave of excitement. It has also underscored the somber necessity for a reliable means of backup. No serious application is practical without a dependable, economical method for backup and archiving of critical on-line data.

Now, CSSN breaks the barriers to hard disk applications by offering the complete solution for data security . . . a cartridge tape drive (13.4 megabyte capacity), fully S-100 interfaced, and software to make it work. - BACKUP IS NOW A REALITY!



*Put your valuable data on-line with a hard disk . . .
Save it off-line with our Back-Up Solution*

Circle 82 on Inquiry card.

CSSN

COMPUTER SERVICE SYSTEMS NETWORK

120 BOYLSTON STREET • FOURTH FLOOR • BOSTON, MASSACHUSETTS 02116 • (617) 482-2343 • TWX (710) 321-1913 INCORPORATED

The Plot Continues

Leslie B Walter
72 Central St
Farmington NH 03835

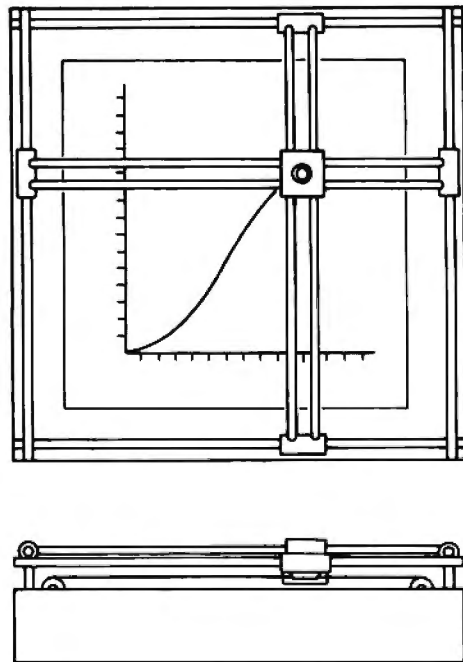

Figure 1: A sketch of the complete plotter mechanism.

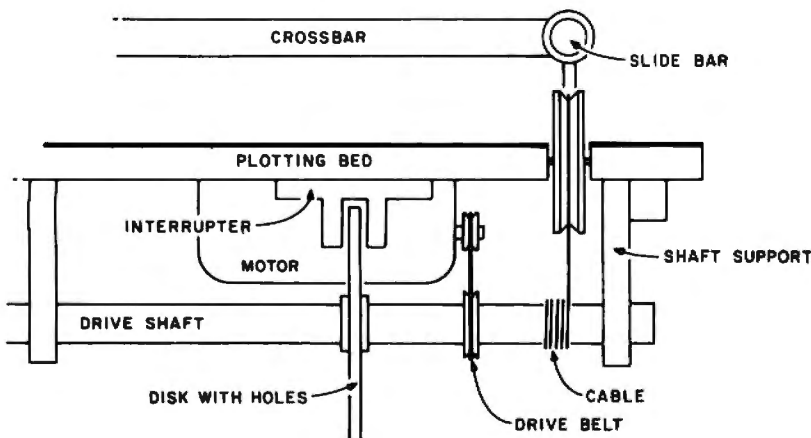

Figure 2: Cutaway showing details of drive mechanism. The motor drives the shaft, turning the disk. The interrupter sends a pulse to the controller each time a hole passes through it. A cable wrapped around the shaft comes up through the plotting bed and pulls the crossbar along the slide. There should be a cable at each end of the crossbar.

I had a dream the other night. A wondrous vision: I built an inexpensive, simple plotter and it worked. I remember that just before retiring, I was reading the March 1977 BYTE, specifically the article on building a plotter using model aircraft servomotors ("Give Your Micro Some Muscles," page 9).

The servomotor idea sounded great at first, but is quite complicated to run. For one thing, the plotting routine must constantly send out carefully timed pulses. Either that or you need a set of programmable clocks. Second, you must have a circuit that indicates when the plotter is finished with the current line segment or you would be plotting the next line before the first line is finished (unless you want to wait out the worst case every time). Third, there is that trigonometric routine. I don't even want to think about that. Fourth, there is the problem of wobble. With arms long enough to give a decent sized plotting area, the slightest bump or small snag on the paper and your beautiful plot begins to look like a Los Angeles seismograph record. Arms rigid enough to avoid this problem would be extremely difficult to build. There is also the problem of play. At the end of 10-inch arms, a small amount of play at the servomotors would be greatly magnified, possibly enough to miss the desired point by a fair margin.

I propose the following alternative design approach. The idea isn't perfect, but I think it will work.

Mechanical Description

The basis for the plotter (and the hardest part to build) is the crossbars (figures 1 and 2). These are two sets of perpendicular bars that slide on long rails set at the edge of the plotting bed. The pen mount with its solenoid sits on the intersection of the bars. It slides along in a fashion similar to the crossbars and their rails. By moving the crossbars to the proper X,Y coordinates the pen moves with the intersection to the desired point.

The bars are moved by cables wrapped around a drive shaft. Rotating the shaft in one direction moves the bar up (or down). The other bar is moved by a similar arrangement, right or left. In order to keep track of where the bars are, each drive shaft has a disk mounted on the end with holes evenly spaced around it. As the disk rotates

The COMPUTER FACTORY

TO ORDER CALL (212) 687-5000

SUPERBRAIN™

INTERTEC DATA SYSTEMS

32K ONLY \$2995

64K \$3245



More than an intelligent terminal, the SuperBrain outperforms many other systems costing three to five times as much. Endowed with a hefty amount of available software (BASIC, FORTRAN, COBOL), the SuperBrain is ready to take on your toughest assignment. You name it! General Ledger, Accounts Receivable, Payroll, Inventory or Word Processing... the SuperBrain handles all of them with ease.

Features Include:

- Two dual-density minifloppies with 320K bytes of disk storage
- 32K of RAM to handle even the most sophisticated programs
- a CPM Disk Operating System with a high-powered text editor, assembler and debugger

SPECIAL COMBINATION SALE!

Superbrain & Centronics 704 only \$4595

Available Software

- Accounts Receivable/Payable \$ 125
- General Ledger \$ 125
- Payroll with cost accounting \$ 125



NEW!

APPLE II PLUS ONLY \$1195

A complete self-contained computer system with APPLESOFT floating point BASIC in ROM, full ASCII keyboard in a light weight molded carrying case.

Features Include:

- auto-start ROM • Hi-Res graphics and 15 color video output.
- Expandable to 48K.

Supertalker.....	\$279	Micromodem.....	\$379
Disk.....	585	Programmer's Aid.....	50
Add-on Disk.....	495	SpeechLab.....	229
Pascal Card.....	495	Lightpen.....	250
Business Software.....	625	Communication Card.....	225
Monitor.....	159	Modem.....	200
Printer Card.....	180	EPRM Programmer.....	100

• 16-bit microprocessor
• 16K RAM
• 13" color monitor (24 lines of 32 chrs.)
• 28K ROM operating system (includes 14K BASIC)
• Sound - 3 tones, 5 octaves
• 16 colors: 192 x 256 res.
• Large TI library of ROM programs available.

only \$1150
Includes 13" Color Monitor!

FINALLY TEXAS INSTRUMENTS TI-99/4 Home Computer

Many Peripherals. Coming soon!

Over 1000 software tapes, books, disks on display. Come in and browse.



NEW! MINIMAX

The Minimax Series Computer is an integrated, compact unit containing the CPU, Disk Storage, 12 inch CRT, and Full Style Keyboard

- Features Include:
- 2 Megahertz 6502 CPU
 - 108K System RAM
 - High Res. Graphics (240x512)
 - Switchable 110 or 220V Operation
 - Choice of 800K or 2.4 Megabyte Disks
 - Business Packages Available \$395 ea
 - Serial and Parallel I/O
- MINIMAX I - .8 Megabyte on line minifloppy storage \$4495
MINIMAX II - 2.4 Megabyte on line 8" floppy storage \$5995

NEW! \$1895 List \$2500 CENTRONICS 704

- 180 cps Bi-Directional
- Upper/Lower Case
- 9 x 9 Matrix
- Tractor Feed
- Up to 15" Paper Width
- RS-252 Serial Interface



CENTRONICS 753

- New Word Processing Dot Matrix Printer
- 130-150 cps • Proportional Spacing
- Tractor Feed • N x 9 Matrix

\$2495

- \$ 1595 Complete!
- 16K model \$ 1895
- 32K model \$ 2195



Commodore Computer

These low cost Commodore PET Business Computers have virtually unlimited business capabilities: Accounts Receivable, Inventory Records, Payroll, and other accounting functions.

PET 16N & 32N COMPUTERS

- Full size keyboard
- 16 or 32,000 Bytes Memory
- Level III Operating System
- Full Screen Editor
- Upper/lower case & 64 graphic characters



PET DUAL FLOPPY DISK

- Stores 360,000 Bytes on-line
- Microprocessor controlled
- Uses single or dual sided floppies



HI-SPEED PRINTER

- 150 characters per second • Up to 4 copies 8 1/2" wide
- Microprocessor Controlled • Prints All Graphics
- Full Formatting Capability

PERIPHERALS FOR PET

- 24K Memory Expansion \$499
- 16K Memory Expansion 399
- PET to RS232 Serial 169
- 2 Way Serial/Communication 229
- Modem Board for PET 375
- Analog to Digital Board 275
- for 16 Devices 95
- Second Cassette Drive 95
- Parallel Printer Interface 169

CENTRONICS 730

Parallel \$895
Serial \$945

- 100 CPS - MICROPROCESSOR CONTROLLED!
- Tractor & Friction Feed • Uses Single Sheets, Roll, Fanfold • Upper & Lower Case • Light Weight



CompuColor II

COMPUCOLOR II Disk-Based Model 3 Advanced hardware and software technology gives you:

- 13" Color Display
- Advanced Color Graphics
- 51K Disk Built-In
- 16K ROM Operating System
- 8K RAM User Memory
- 4K RAM Refresh
- 8080A Microcomputer
- RS-232 I/O



ANDERSON JACOBSON

DAI I/O Terminal

Ideal for word processing and small businesses.

- ASC II Code
- 15 cps Printout
- High Quality Selective Printing
- Use Keyboard for PET
- Reliable heavy duty Mechanism
- Completely Refurbished by A.J.
- Service in 15 Major Cities
- Plus \$35 Freight-In Charge



NOW IN STOCK
Parallel \$1095
Serial \$1195

DATA GENERAL micro NOVA
The ultimate in small Business Computers when matched with COMPUFACTORY's minicomputer Software: Accounts Receivable/Payable, Inventory Control/ Order Entry, General Ledger, Payroll Systems, ... from \$12,140 for 64K computer with cabinet, printer terminal, video terminal, dual disk and multi-user operating system!

Data General
10 Megabyte System \$17,040

FREE
\$35 of Software with purchase of any computer on this page.

Master Charge
Min Credit Card Order \$75

Open Mon.-Fri. 10-6 Sat. 10-4

RADIO SHACK • PET • SORCERER • APPLE • COMPUCOLOR • ETC.
PRINTERS • PRINTERS • PRINTERS

The COMPUTER FACTORY'S extensive inventory and wide selection of computer printers assures you of finding the printer best suited for your needs and specifications. The following printers work well with all known personal computers

CENTRONICS 779 \$ 945
TRENDCOM 100 375
TRENDCOM 200 595
PAPER TIGER 440..... \$995
XYMEX 10000..... 2495
XEROX1740 2810

TO ORDER CALL (212) 687-5000 (46th St.)
The COMPUTER FACTORY 485 Lexington Avenue 750 Third Avenue New York, N.Y. 10017
Foreign order desk - Telex 640055

with the shaft, the holes pass through an optical interrupter (a U-shaped device with a light source on one side and a photo-transistor on the other). Each time a hole passes through the interrupter, a pulse passes to the control circuit, driving a counter up or down depending on the direction it's turning. By comparing the counter, which contains the current position of the bar, with the desired destination point, the control circuits can move the bar in the proper direction.

One small problem lies in the hardware department. The motors which drive the crossbars must be able to stop fairly fast, at least before the next hole comes up on the disk. If not, the plotter would signal the computer that it is finished even though the motors would have to reverse themselves to return to the origi-

nal point. If you are using motors that are geared down (ie: the motors are spinning fast, but the shaft is turning slowly) then this problem tends to disappear. The disadvantage to geared down motors is time, of course. The more gear reduction that is used, the longer it takes to draw a line segment, and the longer your processor is sitting idle. The ideal motor is one that turns the shaft as fast as the pen and paper can tolerate and which can stop quickly.

Controlling the Plotter

From here there are two ways in which you can control the plotter: software and hardware. My choice is hardware, although both methods have their advantages.

The hardware controller I came up with (figure 3) is simple. Set up three input/

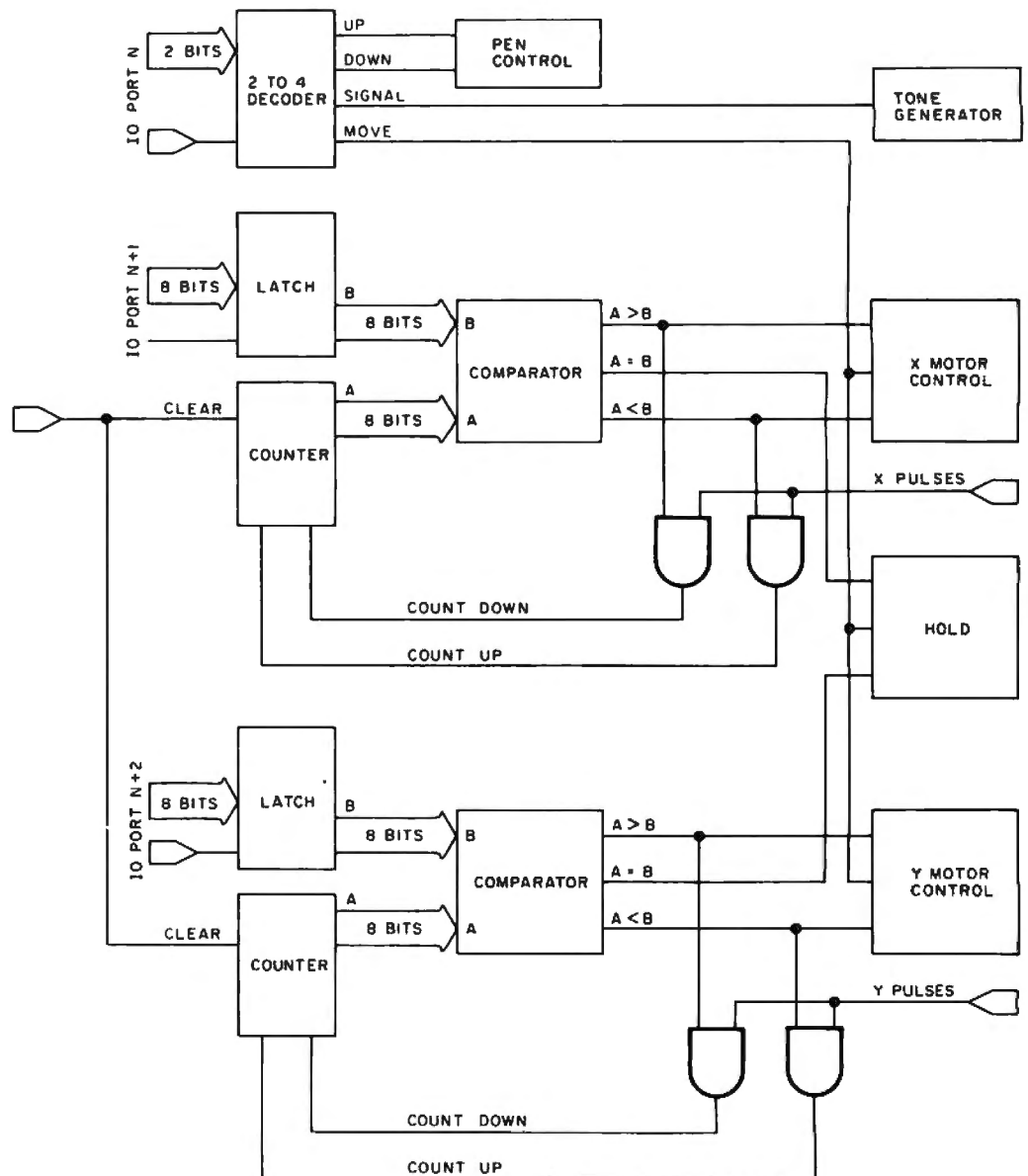

Figure 3: A block diagram of a hardware plotter controller.

**RADIO SHACK COMPUTER OWNERS
TRS-80 MODEL I AND MODEL II**

TRS-80TM MONTHLY NEWSLETTER

- PRACTICAL APPLICATIONS
- BUSINESS
- GAMBLING • GAMES
- EDUCATION
- PERSONAL FINANCE
- BEGINNER'S CORNER
- NEW PRODUCTS
- SOFTWARE EXCHANGE
- MARKET PLACE
- QUESTIONS AND ANSWERS
- PROGRAM PRINTOUTS
- AND MORE

PROGRAMS AND ARTICLES PUBLISHED IN OUR FIRST 12 ISSUES INCLUDE THE FOLLOWING:

- A COMPLETE INCOME TAX PROGRAM (LONG AND SHORT FORM)
- INVENTORY CONTROL
- STOCK MARKET ANALYSIS
- WORD PROCESSING PROGRAM (FOR DISK OR CASSETTE)
- LOWER CASE MODIFICATION FOR YOUR VIDEO MONITOR OR PRINTER
- PAYROLL (FEDERAL TAX WITHHOLDING PROGRAM)
- EXTEND 16-DIGIT ACCURACY TO TRS-80 FUNCTIONS (SUCH AS SQUARE ROOTS AND TRIGONOMETRIC FUNCTIONS)
- NEW DISK DRIVES FOR YOUR TRS-80
- PRINTER OPTIONS AVAILABLE FOR YOUR TRS-80
- A HORSE SELECTION SYSTEM***ARITHMETIC TEACHER
- COMPLETE MAILING LIST PROGRAMS (BOTH FOR DISK OR CASSETTE SEQUENTIAL AND RANDOM ACCESS)
- RANDOM SAMPLING***BAR GRAPH
- CHECKBOOK MAINTENANCE PROGRAM
- LEVEL II UPDATES***LEVEL II INDEX
- CREDIT CARD INFORMATION STORAGE FILE
- BEGINNER'S GUIDE TO MACHINE LANGUAGE AND ASSEMBLY LANGUAGE
- LINE RENUMBERING
- AND CASSETTE TIPS, PROGRAM HINTS, LATEST PRODUCTS COMING SOON (GENERAL LEDGER, ACCOUNTS PAYABLE AND RECEIVABLE, FORTRAN-80, FINANCIAL APPLICATIONS PACKAGE, PROGRAMS FOR HOMEOWNERS, MERGE TWO PROGRAMS, STATISTICAL AND MATHEMATICAL PROGRAMS (BOTH ELEMENTARY AND ADVANCED) . . . AND

FREE WORD PROCESSING PROGRAM (Cassette or Disk)
For writing letters, text, mailing lists, etc., with each new subscriptions or renewal.



LEVEL II RAM TEST -

Checks random access memory to ensure that all memory locations are working properly.

SEND FOR OUR 36 PAGE SOFTWARE CATALOG (INCLUDING LISTINGS OF HUNDREDS OF TRS-80 PROGRAMS AVAILABLE ON CASSETTE AND DISKETTE) \$2.00 OR FREE WITH EACH SUBSCRIPTION OR SAMPLE ISSUE.

COMPUTRONICS!
MATHEMATICAL APPLICATIONS SERVICE

Box 148 New City, New York 10956



24 HOUR ORDER LINE
(914) 425-1535



ONE YEAR SUBSCRIPTION \$24

TWO YEAR SUBSCRIPTION \$48

SAMPLE OF LATEST ISSUE \$ 4

START MY SUBSCRIPTION WITH ISSUE _____

(#1 - July 1978 • #7 - January 1979 • #12 - June 1979)

NEW SUBSCRIPTION _____ RENEWAL _____

CREDIT CARD NUMBER _____ EXP. DATE _____

SIGNATURE _____

NAME _____

ADDRESS _____

*** ADD \$6/YEAR (CANADA, MEXICO) - ADD \$12/YEAR AIR MAIL - OUTSIDE OF U.S.A., CANADA & MEXICO ***

Figure 4: A sketch of the 45° syndrome. The stepped lines indicate the type of line drawn by a software driven plotter. The lines with the single angle are the type drawn by the hardware controller. If the line segment to be drawn is less than a few plotter steps long, the difference is negligible.

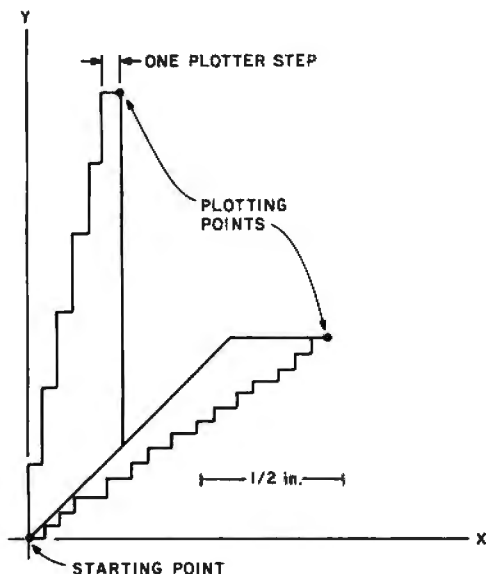

output (I/O) ports: one for commands and one each for the X and Y coordinates.

The command port accepts four commands: pen up, pen down, signal and move. The two pen commands are self-explanatory; the signal command generates an audible tone. This is an option I included for signalling the end of a plot or calling attention to a particular point in the plotting process.

The move command starts the motor circuits (otherwise they would start moving the plotter before both coordinates were in) and also generates a hold signal for the processor until the line segment is finished. When the move command is received, the motors drive the crossbars until the counters, which hold the current plotting position, match up with the eight-bit latches which contain the position that the plotter is to move to. When the coordinates match, the hold line is dropped, allowing the computer to output the next command.

The comparator circuits are also used to determine whether the pulses coming from the interrupters are used to drive the counters up or down.

The only other circuit needed is an initialization circuit that drives the pen to location (0,0) and clears the counters. This is used to synchronize the counters and pen when the plotter is first turned on.

As to the circuits which actually drive the motors and pen solenoid, these depend on the components themselves. If you wish to drive the plotter directly by software, the two coordinate I/O ports are used to read the current location of the pen. A software routine then decides how to move the crossbars, one step at a time, to get to the desired point. However, this requires more commands for the plotter, such as X up, X down, Y up, Y down.

With this hardware method you run into what I call the 45° syndrome. Since the motors turn at about the same speed, the pen will tend to move at an angle which is a multiple of 45°. For example, if the pen has farther to go in the X direction, the pen will reach the proper Y coordinate first, giving a line with two segments (figure 4). If the line you wish to draw is a multiple of 45°, drawing axes and such, then this presents no problem, but with lines at other

At Last! HIGH RESOLUTION S-100 GRAPHICS

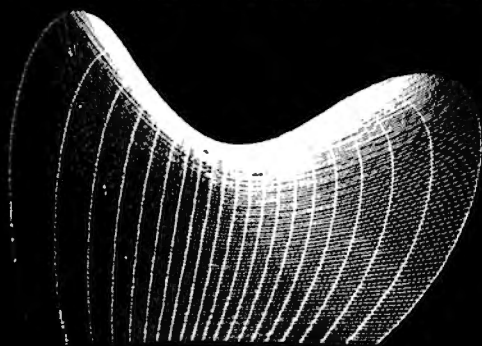

Unretouched photograph

\$925

Complete interface
Assembled and tested
On-board memory
Standard video output
Monitor extra
FOB Cambridge

- LIGHT PEN
- HIGH RESOLUTION
- 512 X 640 MATRIX
- S-100 PLUG-IN
- HIGH SPEED
- SOFTWARE

Send for brochure and data



CAMBRIDGE DEVELOPMENT LAB

44 Brattle Street, Cambridge, MA 021 38
Call (617) 547-3894

angles it will become apparent, especially if the lines are very long.

If, as in most plotting, the increments are very small, this problem is no more serious than the usual stepping phenomenon that occurs on most plotters. With the software driven plotter, the routine can smooth a long line out by adjusting the increments in the X and Y directions.

The decision of which method to use lies mostly in the use to which you will put the plotter. If you're drawing long straight lines, then by all means use the software driven method. If you are like me and plan to use it mostly for plotting functions, the hardware method is much simpler to use because the length of the line segments tends to be short.

Design Details

In designing a plotter for your own use, there are three factors to keep in mind. They are the desired resolution, the size of the plotting area and the number of bits used for the coordinates. Determining any two of these factors automatically sets the third.

For instance, in my design I used a resolution of 0.05 inches (0.13 cm) and an 8-bit coordinate system. This gave me a plotting

area of 12.8 inches (33 cm) square. That was big enough for me.

The drive shaft is what causes problems. In order to have an exactly evenly spaced set of holes on the disk, you have to have a shaft with a circumference that is a multiple of the resolution, in this case 0.05 inches (0.13 cm). This is not easy. Short of going to a machine shop and having them turn out special drive shafts, I decided to search for a standard diameter that would come close. One half inch works out fairly well.

With 31 holes in the disk, the formula:

$$RES = (\pi \times DIAM)/H$$

gives the true resolution. Here, π is 3.1415, DIAM is the drive shaft diameter (0.5 inches), H is the number of holes and RES is the true resolution, in this case 0.05067 inches, which was close enough to 0.05 to suit me.

What this formula means is that the holes divide the circumference of the drive shaft into 31 segments, each one 0.05067 inches long. Thus as the cable comes off the shaft, driving it one hole means that the crossbar will move 0.05067 inches.

The only other critical parts are the crossbar slides since the crossbars must glide smoothly. ■

Low Power 32K RAM for Heath® H8 computers

only \$479

DG-32D 32K RAM FEATURES:

- ✓ Plugs into Heath® H8 Computer
- ✓ Ready to use. Fully assembled, tested & burned in
- ✓ Operates with existing Heath memory
- ✓ Protected Memory Output Buffers in the event of Address error.
- ✓ Utilizes popular 4116 RAM devices
- ✓ Memory Address DIP switch changeable
- ✓ Arranged as 4 Independent 8K Blocks
- ✓ Low Power Consumption: Less than 6 watts, typical
- ✓ Transparent Refresh
- ✓ One year guarantee
- ✓ Compatible with all current H8 peripherals.

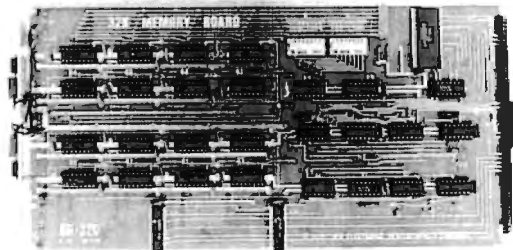

D•G Electronic Developments Co. brings you a totally compatible, fully assembled and tested 32K RAM for Heath® H8 computers. The DG-32D has less than 6 watts power consumption. This allows you to add a full 32K bytes of Random Access Memory without taxing or replacing your computer's power supply. Engineered to plug-in and run without any user modifications, the DG-32D can be used with or without existing H8 RAM without modification. Protection of the memory output buffers is provided in the event of assigning two blocks to the same address space. The DG-32D is the ideal answer to expansion of the Heath H8 computer . . . Low power consumption, low price, high capacity, total engineering and exacting production methods.

Ordering Information: DG-32D RAM available only from DG Electronic Developments Co., P.O. Box 1124, 1827 South Armstrong, Denison, Texas 75020. Check, money-order, VISA or Master Charge. Phone orders accepted on charge orders. NO COD's. Foreign orders add 30%. Texas residents add 5%. For VISA or Master Charge orders call 214-465-7805. \$479.00 freight prepaid.

32K RAM for HEATH® H8

Heath® and H8 are registered trademarks of the Heath Corporation, Benton Harbor, Michigan.

D•G ELECTRONIC DEVELOPMENTS CO.

Discover

the *most* organized (and inexpensive) way to keep up with what's new in computer techniques and management—

The Library of Computer and Information Sciences



(Publishers' Prices shown)

62620. MICROCOMPUTER HANDBOOK. Charles J. Sippl. Detailed reference to the technology and applications of microprocessors. **\$19.95**

79155. SOFTWARE INTERPRETERS FOR MICROCOMPUTERS. Thomas C. McIntire. How to design a reliable software interpreter for any microcomputer system. **\$18.95**

70093. PRIMER FOR SMALL SYSTEMS MANAGEMENT. Grady M. Easley. Spells out the supervisory skills needed in the day-to-day administration of a small computer complex. **\$18.95**

53704. HOW TO DESIGN, BUILD AND PROGRAM YOUR OWN WORKING COMPUTER SYSTEM. Robert P. Haviland. **\$12.95**

49600. THE FUTURE WITH MICROELECTRONICS. Barron and Curnow. Shows how future developments will transform every area of society from the factory to the home. **\$17.50**

42303. A DISCIPLINE OF PROGRAMMING. Edsger W. Dijkstra. Impressive new programming tools to solve problems that range from the everyday to the complex. **\$20.95**

55353. INFORMATION RETRIEVAL SYSTEMS: Characteristics, Testing, and Evaluation. F. Wilfred Lancaster. A comprehensive and practical introduction to information retrieval. **\$19.95**

40071-2. COMPUTER SYSTEMS PERFORMANCE EVALUATION. Domenico Ferrari. *Counts as 2 of your 3 books.* **\$29.95**

79167. SOFTWARE RELIABILITY GUIDE-BOOK. Robert L. Glass. Spells out all the technological and management techniques. **\$18.95**

59920. MANAGEMENT: Tasks, Responsibilities, Practices. Peter F. Drucker. The skills, techniques and tools a good executive needs to stay effective in modern management. **\$17.50**

39890-2. COMPUTER DATA-BASE ORGANIZATION. James Martin. An invaluable planning tool having over 200 diagrams. *Counts as 2 of your 3 books.* **\$26.50**

50551. GRANTS: How to Find Out About Them and What to Do Next. Virginia P. White. **\$19.50**

**Take any 3 books
(values to \$64.85)
for only \$1.00 each**

if you will join now for a trial period and agree to take 3 more books—at handsome discounts—over the next 12 months

62748. MINICOMPUTER SYSTEMS: Organization, Programming, and Applications. Eckhouse and Morris. **\$21.95**

41785. DEBUGGING SYSTEM 360/370 PROGRAMS USING OS AND VS STORAGE DUMPS. D. H. Rindfleisch. A superior guide to storage dump debugging. Illustrations, examples, sample dumps. **\$19.95**

40010. COMPUTER POWER FOR THE SMALL BUSINESS. Sippl and Dahl. A complete and practical guide to micro and mini computers that will meet the needs of your small business. **\$15.95**

87218. THE WIRED SOCIETY: A Challenge For Tomorrow. James Martin. How the modern revolution in telecommunications portends vast changes in the way we live and do business. **\$12.95**

39858. COMPUTER ARITHMETIC: Principles, Architecture, and Design. Kai Hwang. Covers algorithmic flow charts, arithmetic and Boolean equations, schematic logic circuit diagrams. 422 pages, with over 230 illustrations. **\$21.95**

32268. ADVANCED ANS COBOL WITH STRUCTURED PROGRAMMING. Gary D. Brown. **\$19.95**

45380. THE ENTREPRENEUR'S MANUAL: Business Start-Ups, Spin-Offs, and Innovative Management. Richard M. White, Jr. **\$16.95**

32485. ALGORITHMS + DATA STRUCTURES = PROGRAMS. Niklaus Wirth. **\$20.95**

39737-2. COMPACT NUMERICAL METHODS FOR COMPUTERS. J. C. Nash. Hundreds of ways to solve mathematical problems on small computers. *Counts as 2 of your 3 books.* **\$29.95**

**—EXTRAORDINARY—
VALUE!**

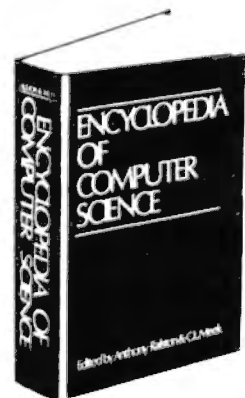

44900-3. ENCYCLOPEDIA OF COMPUTER SCIENCE. Edited by Anthony Ralston and Chester L. Meek. More than 1550 outside pages of information on every aspect of computer science—from algebra to automata theory, from basic terminology to string-processing languages. 470 articles by 208 experts. Over 700 charts, tables, graphs, and diagrams. *Counts as 3 of your 3 books.* **\$60.00**

If the reply card has been removed, please write to
The Library of Computer and
Information Sciences
Dept. 7-AA9, Riverside, N.J. 08370
to obtain membership information and application.

TSE

“TRS-80 USERS! Your Software Supermarket”

GAMES

Warfare I 4-game anthology, Level II, 16K \$7.95
Backgammon by Scott Adams. Level II, 16K \$7.95
X-Wing II by Chris Freund. Level II, 16K \$9.95
Talpin by Art Canfil. Level II, 16K \$9.95
Sargon Chess by Dan and Kathie Spracklen. Level II, 16K \$19.95
Cheese Companion by Michael Kelleher. Level II, 16K \$7.95
Three D Tic Tac Toe by Scott Adams. Level II, 16K \$7.95
Concentration by Lance Micklus. Level II, 16K \$7.95
Amazin' Mazes by Robert Wallace. Level II, 16K \$7.95
Time Bomb by David Bohike. Level II, 16K \$4.95

Life Two by Leo Christopherson. With sound - Level II, 16K \$14.95
Android Nim by Leo Christopherson. With sound - Level II, 16K \$14.95
Cubes by Leo Christopherson Level II, 16K \$9.95
Mastermind II by Lance Micklus \$7.95
Mastermind II - Source List - \$20.00
Robot/Breakaway Game duo by Lance Micklus. Level II, 4K \$7.95
Tycoon by David Bohike. Level II, 16K \$7.95
Slalom by Denso Hamlin. level II, 16K \$7.95
9 Games for Preschool Children by George Blank. Level II, 16K \$9.95
Ten Pin by Frank B. Rowlett, Jr. Level II, 16K \$7.95
Atlantic Balloon Crossing by Dean Powell. Level II, 16K \$9.95
Space Battles by Level IV, Level II, 16K Tape or 32K Disk, Tape -\$14.95, Disk - \$19.95

Star Trek III.3 by Lance Micklus Level II, 16K \$14.95
Dog Star Adventure by Lance Micklus. Level II, 16K \$9.95
Safari by David Bohike. Level II, 16K \$7.95
Treasure Hunt by Lance Micklus. Level II, 16K \$7.95
'Round the Horn by George Blank. Level II, 16K \$9.95
Pork Barrel by George Blank. Level II, 16K \$7.95
Kamikaze by Russell Starkey. Level II, 16K \$7.95
All Star Baseball by David Bohike. Level II, 16K \$7.95
Barricade by Small Systems Software. Machine Language -\$14.95
Journey To The Center Of The Earth by Greg Hassett. Level II, 16K Tape \$7.95
Pentominoes by James Garon. Level II, 16K \$7.95
Snake Eggs by Leo Christopherson. With sound Level II, 16K \$14.95



**Now
In Stock!**

SARGON was the BEST
SARGON II is MUCH
BETTER!

Seven levels of play . . .
faster, better end game . . .
randomized opening.

\$29.95

BOOKS

Sargon Handbook by Don & Kathie Spracklen. \$14.95 plus \$1.00 shipping and handling.
The Basic Handbook by Dr. David A. Lien. \$14.95 plus \$1
Z80 Instruction Handbook by Scelbi Publications. \$4.95
The Little Book Of BASIC Style by John Nevison. \$5.95 plus \$1
TRS-80 Assembly Language Programming by William Barden, Jr. \$3.95 plus \$1
Introduction to TRS-80 Graphics by Don Inman. \$7.95 plus \$1
Learning Level II by David A. Lien. \$15.95 plus \$1

Calculator by R. W. Robitaille, Sr. Level II, 4K \$2.95
Moving Signboard by Circle Enterprises. Level II. 4K \$9.95
Histogram/Scattergram by Gary S. Breschini. Level II, 16K \$9.95.
Simple Simon by George Blank. Level II. Written in BASIC. \$4.95
Math Drill by K. L. Brown. Level II, 16K \$4.95
RPN Calculator by Russell Starkey. Level II, 16K \$9.95
Ham Radio by Michael Kelleher. Level II, 16K \$9.95
Ham Radio ARS I.1 (32K disk) \$24.95
Electronics Assistant by John Adamson. Level II, 16K \$9.95
Preflight by Stephen Hebbler. Level II, 16K \$20.00
Basic Statistics by Steve Reisser. Level II, 16K \$20.00
Drill Masters by Computer Graphics - specify title desired. Level II, 16K \$7.95 each. German, Russian, Italian, Spanish, or Music Theory
Keyboard-80 by John Adamson. Level II, 16K \$9.95

NEW!!!

Understandable! Indexed library with 200
Assembly Language Routines.

Z80 Software Gourmet Guide And Cookbook

from Scelbi. \$14.95 + \$1 postage.

SPECIAL PURPOSE



Trial Offer!
0 SAMPLER \$5.95

1 ADVENTURELAND

2 PIRATE'S COVE

3 MISSION IMPOSSIBLE

4 VOODOO CASTLE

5 THE COUNT

6 STRANGE ODYSSEY

7 FUN HOUSE

8 BRAND NEW! PYRAMID OF DOOM

SCOTT ADAMS' ADVENTURES

Cassettes \$14.95
Combinations on disk:
2 for \$24.95
3 for \$39.95

ST-80D

by Lance Micklus

The STANDARD
in Smart Terminal
Programs for the TRS-80

(32K Disk)
\$79.95

IMPORTANT

No sales tax •

All C.O.D.'s or special •
delivery orders are a mini-
mum of \$5 for special
handling

When ordering Percom •
please add \$5 each,
packaging and handling fee.

PRICES DO NOT •
INCLUDE SHIPPING

BUSINESS

Inventory II.2 by M. Kelleher and R. W. Robitaille, Sr. 16K disk systems \$59.95

Inventory System II.3 by M. Kelleher. Improved version, \$79.95

Inventory 'S' by Roger W. Robitaille, Sr. Level II, 16K Tape -\$24.95; 32K Disk -\$39.95

Payroll by Stephen Hebbler. For disk systems. 32K \$59.95

Accounts Receivable II by S. Hebbler. 32K disk systems \$79.95

Appointment Log by Michael Kelleher. Level II, 16K \$9.95 Disk version, \$19.95

General Ledger I by M. Kelleher, requires 32K Disk, \$79.95

Mall List II by R. W. Robitaille, Sr. 32K disk systems \$99.95

Small Business Bookkeeping by R. W. Robitaille, Sr. Level II, 16K. With Journal -\$22.00; Without Journal - \$15.00

PERSONAL

Typing Tutor by Roger W. Robitaille, Sr. Level II, 16K \$19.95

Secrets of the Tarot by John T. Philipp. Level II, 16K \$9.95

Biorhythms by Frank B. Rowlett, Jr. Level II, 4K \$4.95

Personal Finance by Lance Micklus. Level II, 16K \$9.95

Advanced Personal Finance by Lance Micklus for 32K disk systems \$24.95

Home Financial Management by Michael Kelleher. Level II, 16K \$9.95

UTILITIES

NEWDOS by Apparat \$49.95

NEWDOS+ by Apparat \$99.95

Machine Language Monitor by Small Systems Software. Level II, 16K \$26.95

Three Monitors for Disk by Small Systems Software. Disk for 16 through 48K (all in one) \$29.95

KVP Extender by Lance Micklus. Tape - \$29.95; Disk - \$34.95

KVP 232 by Lance Micklus - KVP adapted for the TRS-232. Tape - \$29.95

ST80 Smart Terminal Level II, 16K \$49.95

ST80D Smarter Terminal for disk systems. \$79.95

Micro Text Editor by Don Coons. Level II, 4K or 16K \$9.95

Text-80 by Frank B. Rowlett, Jr. For 32K disk systems \$59.95

8080-Z80 Conversion Level II, 16K \$15.00

Renumber by Lance Micklus. Level II, available in 16 through 48K (specify when ordering) \$7.95

Renumber source listing \$20.00

Electric Pencil by Michael Shroyer. Powerful machine language word processing system. Level II, 16K tape - \$100; Disk version - \$150

Level III BASIC by Microsoft. \$49.95

Level I in Level II by Apparat. Level II, 16K \$15.00

Fortran by Microsoft. 32K - 2 Disks. New low price \$195.00

HARDWARE ACCESSORIES

Cassettes boxes of ten each. C-10 - \$8.50 plus \$1.00 shipping

C-20 - \$7.50 plus \$1.00 shipping

Diskettes Dysan, (premium quality) box of 5 -\$24.95 plus \$1.00 shipping; nationally known brand, box of 10 - \$34.95 plus \$1

Diskette Storage Box \$5.00

Floppy Armour™ Protective envelope for shipping floppy disks, 5-pack - \$4.95 plus \$1.00 shipping and handling

NEWDOS

Eliminate 90% of the hassle of a disk system by replacing your TRS-DOS with NEWDOS! faster, more reliable, many more features \$49.95.

or

Add Superzap, Directory checks, other utilities. NEWDOS+ \$99.95

PACKAGE PRICE \$150

SEPARATELY:
MACRO ASSEMBLER \$80.
FORTRAN \$80.

WANTED

Used TRS-80 equipment! We buy and sell used equipment. Call or write for details.

SAVE \$167.

TRS-80 expansion interface with our 16K RAM, single PERCOM disk drives with cable, and NEWDOS operating system. \$830.

TRS 232 by Small Systems Hardware - \$49.95

Percom Disk Drives Single or dual, for TRS-80's. Single drive -\$399.00; Dual drive - \$795.00; Cable required - \$29.95

ASK ABOUT OUR FREE HARDSIDE CATALOG

TO ORDER (9AM - 5:30 PM, EST)

TOLL-FREE 1-800-258-1790

The Software Exchange

6 South Street, Box 68, Milford, NH 03055 603-673-5144

* A trademark of Radio Shack and Tandy Corp.

Circle 90 on inquiry card.

CP/M[®]2

NOW BETTER THAN EVER

- Control Program for Microcomputers.
- Includes Editor, Assembler, Debugger, Utilities.
- Supports Floppy Disks and Hard Disks.
- For 8080, 8085, Z-80, MDS, Cromemco.
- **\$150**-Diskette and Documentation
- **\$25**-Documentation only

MP/M[™]

NEW INDUSTRY STANDARD

- Multi-terminal access.
- Multi-programming.
- CP/M-compatible.
- Real-time features.
- **\$300**-Diskette and Manual
- **\$25**-Manual only

DIGITAL RESEARCH

OPTIONAL SOFTWARE PACKAGES

MAC[™] MACRO ASSEMBLER:

- Compatible with new Intel macro standard.
- Complete guide to macro applications.
- **\$90**-Diskette and Manual.

SID[™] SYMBOLIC DEBUGGER:

- Symbolic memory reference.
- Built-in assembler/diassembler.
- **\$75**-Diskette and Manual.

TEX[™] TEXT FORMATTER:

- Powerful text formatting capabilities
- Text prepared using CP/M Editor.
- **\$75**-Diskette and Manual.

DESPOOL[™]

- Background print utility.
- Use with CP/M
- **\$50**-Diskette and Manual.

DIGITAL RESEARCH[™]

P.O. Box 579 • Pacific Grove, California 93950
(408) 649-3896

Technical Forum

Aids to the Direct Reception of Weather Satellite Photographs

William D Johnston, 1808 Pomona Dr, Las Cruces NM 88001

A recent note in "BYTE's Bits" (June 1979 BYTE, page 225) brought to the attention of BYTE readers the prospect of direct reception of weather satellite photographs by amateurs using home-built equipment. The purpose of this brief article is to expand on that note, and to direct the interested reader to a number of existing resources.

Applications of the home computer in this field are many and varied. They include such projects as orbital predictions, antenna tracking calculations, signal error analysis, generation of map overlays, and weather system modeling, to name just a few. Most of the mathematical calculations involved are quite simple, requiring the use of nothing more difficult than high school trigonometry. A computer enthusiast can derive a great deal of personal satisfaction from writing software to arrive at the correct solutions. Those who are hardware oriented will want to go a step further and use their computers to drive a tracking antenna in real time.

The 1968 report by Vermillion (NASA SP-5079) mentioned in BYTE's Bits was not the first to appear on the subject. A comprehensive article on building a home receiving station appeared in *QST* magazine as far back as 1965. Vermillion himself put out a number of other excellent NASA reports since the 1968 document, including SP-5080 and TN D-7994. *Scientific American* carried a construction article based on a design similar to the 1965 *QST* equipment.

The great majority of technical literature on the subject, however, has appeared in the various American and British amateur radio magazines over the past five or six years. A review of the annual indices (usually appearing in the December issues) of *Ham Radio*, *QST*, *Radio Communication*, and *Wireless World* will reveal a wealth of information. These articles are indexed under "Satellites," "Weather Satellites," "OSCAR," and "Facsimile." The subject matter runs the gamut from construction details for homebrew state-of-the-art receivers and recorders, to surplus equipment conversions, to computer software for orbital calculations and antenna tracking.

An excellent book on the subject has been written for amateurs by Ralph Taggart. Mr Taggart is the author of

IS YOUR Z80 HALF ASLEEP?

Don't settle for less than the total performance built into your Z80 Computer. Wake up its entire potential with an OASIS Operating System—the high-powered, professional software package that takes full advantage of Z80 power.

Utilizing optimized Z80 code, OASIS makes the system run faster. More and better tools let you develop software faster, too.

It's easy to use because all the tools you need are included: ISAM files, hard and floppy disk support, editor, user accounting with logon, password privilege level, and file security. Options: BASIC Compiler, spooler, text editor and output processor,

development package, and more.

The BASIC Compiler *is also an interpreter, complete with debugger.* It makes programs run faster, takes less memory, and provides software security. A first for micros, it's an OASIS exclusive.

FEATURES: Single- & Multi-User / User Accounting / Multi-Tasking / File & Record Security / Logon Password & Privilege Protection / Keyed (ISAM) Direct & Sequential Files / Hard & Floppy Disk Support / Extensive Documentation

OASIS PRODUCTS: Single-User Operating System / Multi-User Operating System / Macro Relocating Assembler / Debugger / Linker / Editor / Output Text Formatter / Spooler / Communications Package / Sort / Diagnostic & Maintenance Utilities / Interactive EXEC Language / Re-entrant BASIC Compiler

OASIS IS AVAILABLE FOR: Altos / Bitlings / Digital Microsystems / Digital Group / Cromemco / Vector Graphic / Micromation / Compucorp North Star / Onyx / Bell Controls TRS-80 Mod II / Verdex and others

Multi-User OASIS, available for most computer configurations, gets even more performance out of your system. It has all the Single-User features, *PLUS a re-entrant BASIC Compiler*, file and record locking, variable time-slicing, user-to-user communications, and extended memory addressing. All fully upward compatible with Single-User.

Documentation?...complete and extensive. And, of course, there's plenty of application software.

OASIS operating systems, languages, development packages, system utilities—all fully integrated, all from one source.

Ask your dealer or manufacturer. Or send the coupon direct, today.

MAKES MICROS RUN LIKE MINIS.

OASIS

Order OASIS direct from:
Phase One Systems, Inc.
 7700 Edgewater Drive, Suite 830
 Oakland, CA 94621

Telephone (415) 562-8085 TWX 910-366-7139

My computer configuration (specify make, disk system, etc.)

Name _____

Street Address (No Box #) _____

City _____ State _____ Zip _____

PLEASE
SEND ME:

OASIS (Includes Manual)	Manual Only	Amount
<input type="checkbox"/> Single-User System \$150	<input type="checkbox"/> \$17.50	
<input type="checkbox"/> BASIC Compiler \$100	<input type="checkbox"/> \$15	
<input type="checkbox"/> Multi-User System \$250	<input type="checkbox"/> \$17.50	
<input type="checkbox"/> Re-entrant BASIC Compiler \$145	<input type="checkbox"/> \$15	
SPECIAL WITH THIS COUPON: System AND BASIC Manual		
	<input type="checkbox"/> \$27.50	
Complete Information		
	<input type="checkbox"/> \$1	
Shipping		\$2
<input type="checkbox"/> Check Enclosed <input type="checkbox"/> VISA		\$1 for C.O.D.
<input type="checkbox"/> UPS C.O.D. <input type="checkbox"/> Mastercharge		California residents add sales tax
Card Number: _____		
Expiration Date: _____		
Signature: _____		
TOTAL		

EQ CROSSING AT 67 DEGS				
TIME	AZ	EL	RNG	
MINS	DG	DG	KM	
4	177	0	3483	
5	178	3	3093	
6	180	7	2706	
7	183	12	2327	
8	186	18	1961	
9	192	26	1618	
10	202	37	1319	
11	223	49	1102	
12	262	55	1022	
13	299	48	1108	
14	318	36	1328	
15	327	26	1628	
16	333	18	1971	
17	336	12	2336	
18	339	7	2715	
19	341	3	3100	
20	342	-1	3488	

EQ CROSSING AT 68 DEGS				
TIME	AZ	EL	RNG	
MINS	DG	DG	KM	
4	179	0	3479	
5	180	3	3092	
6	182	7	2708	
7	185	12	2333	
8	190	18	1971	
9	196	26	1636	
10	207	35	1347	
11	228	46	1141	
12	264	51	1070	
13	297	45	1158	
14	315	34	1375	
15	325	25	1670	
16	331	18	2008	
17	335	12	2370	
18	338	7	2745	
19	340	3	3127	
20	342	-1	3513	

Listing 1: A small portion of a typical satellite tracking printout generated on a home computer. The data can be calculated in real time, or a perpetual-prediction printout (about fifty pages long) can be prepared in advance. All calculations are based on the exact location of the ground station that is to use the print-out.

many of the articles that have appeared in the amateur radio magazines, including a very good introductory treatise for beginners.

BYTE has published material which is directly applicable to the subject. This was related to computer generation of map overlays for satellite photos. It is a very handy capability to have on occasions when your received pictures show nothing but cloud cover and you need a system of reference (see my article series "Computer Generated Maps," May 1979 BYTE, page 10; June 1979 BYTE, page 100).

Those who are concerned about the cost and complexity of such a project need not worry. It is entirely possible to assemble a station capable of receiving high-resolution photos (both visible light and infrared images) with an outlay of less than \$100. Excellent quality picture recorders, capable of recording images up to 19 inches (48 cm) square, are available on the surplus market for as little as \$50. Recorders that produce pictures about 4 by 6 inches (10 by 15 cm) can be found for as little as \$10. Advertisements in the amateur radio magazines and visits to ham radio swap meets provide the best leads to equipment buys. Many of the previously mentioned articles even show you how to build a recorder from scratch,

STATEMENT OF OWNERSHIP, MANAGEMENT, AND CIRCULATION

U.S. POSTAL SERVICE STATEMENT OF OWNERSHIP, MANAGEMENT AND CIRCULATION (Required by 39 U.S.C. 3685)			
1. TITLE OF PUBLICATION BYTE: The Small Systems Journal		2. DATE OF FILING 9/27/79	
3. FREQUENCY OF ISSUE Monthly		4. ANNUAL SUBSCRIPTION PRICE \$18/year	
5. LOCATION OF HEADQUARTERS OR GENERAL BUSINESS OFFICES OF THE PUBLISHERS (Not printer) 70 Main Street, Peterborough, NH 03458			
6. LOCATION OF THE HEADQUARTERS OR GENERAL BUSINESS OFFICES OF THE PUBLISHERS (Not printer) 1221 Avenue of the Americas New York, NY 10020			
7. NAMES AND COMPLETE ADDRESSES OF PUBLISHER, EDITOR, AND MANAGING EDITOR PUBLISHER (Name and Address) Virginia Londoner Vale Street Peterborough, NH 03458 EDITOR (Name and Address) Carl T Helmers, Jr. Carriage Hill Road Hancock, NH 03449 MANAGING EDITOR (Name and Address) Christopher P Morgan Hancock Road Dublin, NH 03444			
8. OWNER (If owned by a corporation, its name and address must be stated and also immediately thereunder the names and addresses of stockholders owning or holding 1 percent or more of total amount of stock. If not owned by a corporation, the names and addresses of the individual owners must be given. If owned by a partnership or other unincorporated firm, its name and address, as well as that of each individual must be given. If the publication is published by a nonprofit organization, its name and address must be stated.) NAME ADDRESS PLEASE SEE ATTACHED SHEET			
9. KNOWN BONDHOLDERS, MORTGAGEES, AND OTHER SECURITY HOLDERS OWNING OR HOLDING 1 PERCENT OR MORE OF TOTAL AMOUNT OF BONDS, MORTGAGES OR OTHER SECURITIES (If there are none, so state) NAME ADDRESS NONE			
10. FOR COMPLETION BY NONPROFIT ORGANIZATIONS AUTHORIZED TO MAIL AT SPECIAL RATES (Section 132.122, PSN) The purpose, function, and nonprofit status of this organization and the exempt status for Federal income tax purposes (Check one) <input type="checkbox"/> NOT APPLICABLE <input type="checkbox"/> HAVE CHANGED DURING PRECEDING 12 MONTHS <input type="checkbox"/> HAVE CHANGED DURING PRECEDING 12 MONTHS (If changed, publisher must submit explanation of change with this statement.)			
11. EXTENT AND NATURE OF CIRCULATION		12. AVERAGE NO. COPIES EACH ISSUE DURING PRECEDING 12 MONTHS	
A. TOTAL NO. COPIES PRINTED (Net Press Run)		157,817	
B. PAID CIRCULATION 1. SALES THROUGH DEALERS AND CARRIERS, STREET VENDORS AND COUNTER SALES		21,426	
2. MAIL SUBSCRIPTIONS		127,135	
C. TOTAL PAID CIRCULATION (Sum of B.1 and B.2)		148,561	
D. FREE DISTRIBUTION BY MAIL, CARRIER OR OTHER MEANS (Samples, complimentary, and other free copies)		3,323	
E. TOTAL DISTRIBUTION (Sum of C and D)		151,884	
F. COPIES NOT DISTRIBUTED 1. OFFICE USE, LEFT OVER, UNACCOUNTED, SPOILED AFTER PRINTING		4,656	
G. RETURNS FROM NEWS AGENTS		1,277	
H. TOTAL (Sum of E, F, and G—should equal net press run shown in A)		157,817	
I. ACTUAL NO. COPIES OF SINGLE ISSUE PUBLISHED NEAREST TO FILING DATE		161,310	
13. I certify that the statements made by me above are correct and complete. SIGNATURE AND TITLE OF EDITOR, PUBLISHER, BUSINESS MANAGER, OR OWNER Virginia Londoner			
14. FOR COMPLETION BY PUBLISHERS MAILING AT THE REGULAR RATE (Section 132.121, Postal Service Manual) 39 U.S.C. 3626 provides in pertinent part: "No person who would have been entitled to mail matter under former section 4306 of this title shall mail such matter at the rates provided under this subsection unless he files annually with the Postal Service a written request for permission to mail matter at such rates." In accordance with the provisions of this statute, I hereby request permission to mail the publication named in item 1 at the phased postage rates presently authorized by 39 U.S.C. 3626. SIGNATURE AND TITLE OF EDITOR, PUBLISHER, BUSINESS MANAGER, OR OWNER Virginia Londoner			

PS Form 3526 (Page 1)

(See instructions on reverse)

*7) The owner is McGraw-Hill Inc., 1221 Avenue of the Americas, New York, New York 10020. Stockholders holding 1% or more of stock are: Donald C. McGraw Jr.; Harold W. McGraw Jr.; John L. McGraw; William H. McGraw; June M. McBroom; Elizabeth McGraw Webster; all of 1221 Avenue of the Americas, New York, New York 10020; Occi and Company, c/o Occidental Life of California, P.O. Box 3635, Terminal Annex, Los Angeles, California 90054.



Patents Awarded to Apple

The US Patent Office has granted Apple Computer Inc, 10260 Bandlely Dr, Cupertino CA 95014, two patents for the switching power supply and color video-display designs used in the Apple II personal computer.

The AM-2 power supply is a 40 W, multiple-output

flyback switching device with a unique starting and restarting circuitry scheme and a secondary winding mechanism which counteract typical power supply problems of power dissipation and breakdown.

The video display includes a special timing reference mechanism and a recirculating shift register that resolves the difficulties involved in simultaneously generating horizontal, vertical, and color frequency signals. They also eliminate many of the components normally required in a video display. ■



Put the BYTE on the IRS with Aardvark

In an era when computers are an integral part of business and entertainment, and computer software is more and more sophisticated, Aardvark is yet another breed in advanced computer software. Aardvark's Micro Tax series is a true user-oriented Federal Income Tax package. Specifically developed by qualified tax professionals for use on personal home computers, this low-cost, time-saving Aardvark Micro Tax package accurately and efficiently computes your federal income tax liability. Aardvark will display and fill in facsimile Form 1040 and related schedules and, if connected to a Centronics printer, will print out these facsimile forms auto-

matically. Each program is designed to use the appropriate tax table or rate schedule. The more advanced Micro Tax II and III also calculate Income Averaging, Maximum Tax on Earned Income, Minimum Tax and Alternative Minimum Tax. The Aardvark package is compatible with Apple II and TRS-80 users and includes an indexed instruction manual and input forms for easy input of tax data. To see how Aardvark can be tax-deductible, check the instructions in the binder of the manual. You can also use the binder to store pertinent 1979 tax records. Cure your headaches this tax season, order today...and put the BYTE on the IRS with Aardvark!

MICRO TAX I \$25
 Form 1040
 Schedule A
 Schedule B
 Schedule TC
 (will not calculate Income Averaging, Max Tax or Alternative Minimum Tax)

MICRO TAX II \$35
 Form 1040
 Schedule A
 Schedule B
 Schedule G (Inc. Avg.)
 Schedule TC
 Form 4625 (Minimum Tax)
 Form 4726 (Max Tax)
 Form 6251 (Alt. Min. Tax)

MICRO TAX III \$50
 Program 2 plus
 Schedule C
 Schedule D
 Schedule E
 Schedule SE
 Form 2119 - Sale of Personal Residence

When Ordering Specify:
 TRS-80 16K Level II Basic
 Apple II 32K with Applesoft Basic
 Apple II 16K Micro with Applesoft ROM Card

Aardvark Software

Coming Soon - Micro Tax Package for PET and TI Systems.

P.O. Box 26505 Milwaukee, WI 53213



24 hrs.

Call TOLL FREE 1-800-558-8570.

7 days



In Wisconsin 1-414-289-9988

©Aardvark Software Inc. 1979

Circle 92 on inquiry card.

SYNCHRONOUS SATELLITE				SYNCHRONOUS SATELLITE				SYNCHRONOUS SATELLITE				SYNCHRONOUS SATELLITE			
LONG. DEG	AZ DEG	EL DEG	RANGE KM	LONG. DEG	AZ DEG	EL DEG	RANGE KM	LONG. DEG	AZ DEG	EL DEG	RANGE KM	LONG. DEG	AZ DEG	EL DEG	RANGE KM
0	103	4	41191												
1	103	5	41112	46 W	144	34	38273	91 W	207	37	38035	136 W	257	10	40976
2	104	6	41033	47 W	146	34	38234	92 W	208	37	38066	137 W	257	9	40653
3	105	7	40955	48 W	147	35	38197	93 W	209	36	38097	138 W	253	9	40729
4	105	7	40876	49 W	148	35	38161	94 W	211	36	38130	139 W	254	8	40807
5	106	8	40799	50 W	149	36	38127	95 W	212	35	38165	140 W	255	7	40884
6	107	9	40722	51 W	151	36	38094	96 W	213	35	38201	141 W	255	7	40962
7	108	10	40645	52 W	152	37	38063	97 W	214	34	38230	142 W	256	6	41041
8	108	10	40569	53 W	153	37	38032	98 W	216	34	38277	143 W	257	5	41120
9	109	11	40492	54 W	155	37	38004	99 W	217	34	38317	144 W	258	4	41199
10	110	12	40415	55 W	156	38	37977	100 W	218	33	38356	145 W	258	4	41278
11	111	12	40339	56 W	157	38	37951	101 W	219	33	38401	146 W	259	3	41358
12	111	13	40263	57 W	159	38	37927	102 W	220	32	38445	147 W	260	2	41438
13	112	14	40187	58 W	160	39	37904	103 W	221	31	38491	148 W	261	1	41518
14	113	14	40111	59 W	161	39	37883	104 W	223	31	38537	149 W	261	1	41598
15	114	15	40035	60 W	163	39	37864	105 W	224	30	38583	150 W	262	0	41679
16	115	16	39959	61 W	164	39	37846	106 W	225	30	38634	151 W	***	**	****
17	116	17	39906	62 W	166	40	37829	107 W	226	29	38685	152 W	***	**	****
18	116	17	39858	63 W	167	40	37815	108 W	227	29	38730	153 W	***	**	****
19	117	18	39809	64 W	168	40	37801	109 W	228	28	38783	154 W	***	**	****
20	118	19	39760	65 W	170	40	37789	110 W	229	28	38843	155 W	***	**	****
21	119	19	39712	66 W	171	40	37779	111 W	230	27	38906	156 W	***	**	****
22	120	20	39665	67 W	173	40	37771	112 W	231	26	38974	157 W	***	**	****
23	121	21	39619	68 W	174	40	37763	113 W	232	26	39011	158 W	***	**	****
24	122	21	39574	69 W	176	40	37758	114 W	233	25	39070	159 W	***	**	****
25	122	22	39530	70 W	177	40	37754	115 W	234	24	39129	160 W	***	**	****
26	123	23	39487	71 W	179	41	37752	116 W	235	24	39189	161 W	***	**	****
27	124	23	39445	72 W	180	41	37751	117 W	236	23	39251	162 W	***	**	****
28	125	24	39403	73 W	182	41	37752	118 W	237	23	39313	163 W	***	**	****
29	126	25	39362	74 W	183	40	37754	119 W	238	22	39377	164 W	***	**	****
30	127	25	39324	75 W	184	40	37758	120 W	239	21	39441	165 W	***	**	****
31	128	26	39286	76 W	186	40	37764	121 W	239	21	39506	166 W	***	**	****
32	129	26	39248	77 W	187	40	37771	122 W	240	20	39572	167 W	***	**	****
33	130	27	39212	78 W	189	40	37780	123 W	241	19	39639	168 W	***	**	****
34	131	28	39177	79 W	190	40	37790	124 W	242	19	39707	169 W	***	**	****
35	132	28	39144	80 W	192	40	37802	125 W	243	18	39775	170 W	***	**	****
36	133	29	39111	81 W	193	40	37816	126 W	244	17	39845	171 W	***	**	****
37	134	29	39079	82 W	195	39	37831	127 W	245	16	39915	172 W	***	**	****
38	135	30	39049	83 W	196	39	37848	128 W	245	16	39986	173 W	***	**	****
39	136	30	39020	84 W	197	39	37866	129 W	246	15	40057	174 W	***	**	****
40	137	31	38992	85 W	199	39	37885	130 W	247	14	40130	175 W	***	**	****
41	139	32	38965	86 W	200	39	37907	131 W	248	14	40203	176 W	***	**	****
42	140	32	38941	87 W	202	38	37929	132 W	249	13	40276	177 W	***	**	****
43	141	33	38917	88 W	203	38	37954	133 W	249	12	40350	178 W	***	**	****
44	142	33	38894	89 W	204	38	37979	134 W	250	12	40425	179 W	***	**	****
45	143	34	38873	90 W	206	37	38007	135 W	251	11	40500	180 W	***	**	****

*** MEANS THAT A GEOSYNCHRONOUS SATELLITE AT THE GIVEN POSITION IS NOT VISIBLE FROM THIS GROUND STATION.

Listing 2: Part of a geosynchronous satellite antenna-pointing chart created on a home computer. Knowing the station longitude of a particular satellite, one simply refers to that entry in the chart to find the antenna-pointing angles. The illustrated example was prepared for a ground station located in Peterborough NH, site of the offices of BYTE Publications.

using simple materials (eg: a kitchen rolling pin for a recording drum!), if you cannot find or do not want to buy a surplus recorder.

The necessary radio receiving equipment is also reasonably simple. If you already own a general coverage receiver, a converter can be built for as little as four or five dollars. In fact, many public-service band radios and scanners can receive the satellites directly (on 137.5 MHz), and all you need to add is an outdoor antenna.

Satellite tracking should be a snap for the average computer enthusiast. The published literature includes many articles on satellite tracking software. The only additional data you need is the time and longitude of the equator crossing of an occasional reference orbit (once every few weeks or so). Reference orbit information is transmitted daily via teletypewriter to most National Weather Service (NWS) offices on the TBUS circuit. The National Weather Service also carries the information on their high-frequency radio teletypewriter (RTTY) circuits. The American Radio Relay League station W1AW transmits the same information by both voice and radio teletypewriter. See any recent issue of QST for the W1AW transmission schedule. It is also possible to have

your name put on a mailing list maintained by the National Environmental Satellite Service, and receive this information by mail on a monthly basis.

Some weather satellites are in geosynchronous orbits; that is, their periods of revolution are the same as the rotational period of the earth (ie: 24 hours). Consequently, they remain stationary with respect to the earth's surface. This makes life really simple because you do not have to track them. It is only necessary to compute the antenna pointing angles once for each satellite. A recent article about locating geosynchronous satellites in QST gives the procedure for doing this on either a pocket calculator or a home computer.

Listings 1 and 2 show portions of the output from typical home-computer programs for polar orbiting and geosynchronous satellites, respectively. The programs that produced them are based on articles that have appeared in amateur radio magazines, and they require just a few seconds to execute.

As you can see, there are quite a few areas of opportunity for home computer projects in this exciting field. It is intriguing to receive real-time weather satellite photos right in your own home and to try to outguess the

weatherman! You can even use your computer to maintain weather records over long periods of time to aid in your forecasting.

I do not personally have additional advice to offer on construction details or equipment recommendations, other than to refer the reader to the many excellent articles already in print. I can, however, provide some assistance with tracking data. As an extension of a service I provide to amateur radio operators to assist in tracking the OSCAR communications satellites, I also provide perpetual orbital-prediction printouts for the current primary polar orbiting weather satellite, TIROS-N. (I have discontinued the printouts for all of the earlier weather satellites, but the service will be extended to include NOAA-6, which was launched in June 1979.) A printout showing antenna pointing data to all geosynchronous satellite locations, in one-degree increments, is also available.

All printouts are computed based on the exact station location, and can be used directly for tracking or as a check on the accuracy of programs you develop on your own. There is a nominal charge for the printouts (\$5.00 for the TIROS-N printout, and \$1.00 for the geosynchronous satellite printout) to help defray the cost of postage and materials. If you would like additional information about the printouts, be sure to enclose a self-addressed, stamped envelope with your letter. ■

REFERENCES

1. Anderson, Wendell G, "Amateur Reception of Weather Satellite Picture Transmissions," *QST*, November 1965, page 11.
2. Johnston, William D, "Computer Generated Maps," *BYTE*, May 1979, page 10 and June 1979, page 100.
3. Johnston, William D, "Locating Geosynchronous Satellites," *QST*, March 1978, page 23.
4. Ruperto, Eugene F, "Weather Satellite Pictures Are Picked Up in the Home," *Scientific American*, January 1974, page 114.
5. Taggart, Ralph E, "Amateur Weather Satellite Reception," 73, May 1976, page 52.
6. Taggart, Ralph E, *Weather Satellite Handbook*, 1976, 73 Inc.

An Improved Maze Program

David Lyons, 77 Elizabeth St S, Brampton Ontario, CANADA L6Y 1R3

I enjoyed "My Computer Runs Mazes," by David E Stanfield in the June 1979 *BYTE*, page 86. I agree that the form of the listing provided is easy to enter, but it could be difficult to modify the program for other systems. Therefore, I have compiled the following information which might help.

The maze matrix will not print properly on terminals with line lengths other than thirty-two characters or

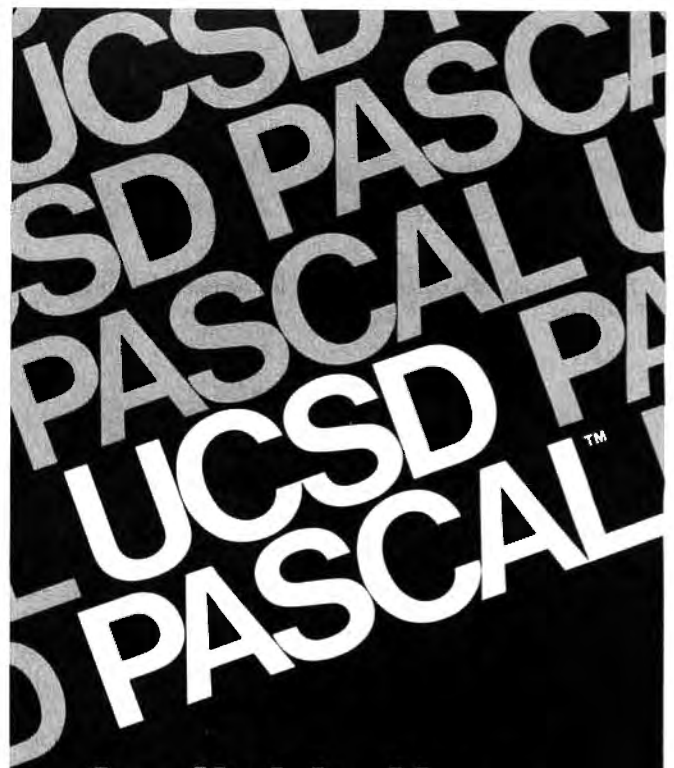

Available Now

The most widely used Pascal system. Compilers to complete development software. For most popular microcomputer systems. With full documentation and support. From one source.

SOFTech
MICROSYSTEMS
A SUBSIDIARY OF SOFTECH

9494 Black Mountain Road
San Diego, CA 92126 714/578-6105

UCSD Pascal is a trademark of the Regents of the University of California.

Find out more. Send this coupon.

- Please send UCSD Pascal description and order form.
- Please send distributor and volume license information.

Name _____

Title _____

Company _____

Address _____

City/State/Zip _____

Computer system _____

Send to: SofTech Microsystems
9494 Black Mountain Road
San Diego, CA 92126

Byte 1

Listing 1: Adding carriage return and line feed to maze display output.

Hexadecimal Address	Hexadecimal Code	Instruction Mnemonic	Operand
0283	26 EB	BNE	\$0270
0285	BD 02 5F	JSR	CRLF
0288	01	NOP	
0289	01	NOP	

without screen wraparound, since screen wraparound is relied upon for the carriage return and line feed after each row of alternating X and space characters. These missing characters can be added by a modification to the appropriate printing routine, as in listing 1.

Cursor-right and cursor-up characters do not always seem to be standard. The locations in which they occur are listed in table 1, if you need to alter them. Contrary to what is implied in the listing in the original article, the maze-running program is contained in two sections of memory, one from hexadecimal 003D to 0060, and the other from hexadecimal 0100 to 0784. Also, the display memory is located between hexadecimal 0800 and 09FF.

Now I shall suggest some possible enhancements. Provisions are made to open up corridors and set the goal, but not to replace a wall or remove the food except by redrawing the entire maze. By adding the patch in listing 2, the command table can be extended to allow the setting of an X at the current cursor location by pressing the X key.

If the goal is not accessible in the maze, the same branches can be searched repeatedly before the search ends. This seems due to the search strategy of eliminating only the end location of a branch each time a dead-end is reached, even though the entire branch back to the nearest node could be eliminated when backtracking is necessary. The strategy can be modified so that dead-end paths are searched only once by changing four conditional branch (BEQ) instructions as shown in table 2.

Listing 2: Command table extension.

Hexadecimal Address	Hexadecimal Code	Label	Instruction Mnemonic	Operand
02B3	BD 07 85		JSR	PATCH
0785	81 58	PATCH	CMP A	#X
0787	26 08		BNE	NFOUND
078A	BD 02 DD		JSR	BACKSPACE
078D	86 58		LDA A	#X
078F	A7 00		STA A	0,X
0791	39		RTS	
0792	7E 02 D3	NFOUND	JMP	RESTORECHAR

Move-Right Character

031B
0498
0520
0686

Move-Up Character

03AD
056F
069C

Table 1: Hexadecimal addresses of instructions using cursor-control characters.

Hexadecimal Location	Hexadecimal Branch Value
05C8	42
05FB	E9
0624	27
0643	E9

Table 2: Search strategy modification. Deposit the indicated branch values into the corresponding memory locations.

This change also has the added advantage of allowing the search to terminate on its own. You do not have to reset the computer if a loop is encountered in a maze. I hope that these comments will help others to enjoy this program. ■

How to Start and Run A Successful Business Hands-On-Techniques for:

- uncovering lucrative markets and products
- using the basic components involved in a business plan (and some innovative wrinkles which will help your plan attract capital)
- approaching venture capital groups
- money leveraging
- implementing management-by-objective, management-by-exception, and management-by-motivation systems which maximize growth
- accomplishing market penetration
- a list of the keys that venture capitalists look for
- a comprehensive list of venture capital groups that continually invest in new ideas
- use of profit center controls

For the businessman who wants to make a dime do a dollar's work, who wants marketing and sales boiled down to a commonsense discipline, and who wants to be able to perceive the major frontiers of American business in the next decade, there is no better book. This is the sort of instruction for which businessmen commonly pay consultants \$50 an hour. The first investment you should make. THE ENTREPRENEUR'S MANUAL can be one of the most profitable you'll make.

Satisfaction guaranteed

Send \$24.95 now to: **Rabinic**
P.O. BOX 942, N.Y., N.Y. 10004

add \$1.10 for C.O.D.

MICROSOFT CONSUMER PRODUCTS CONTINUING THE MICROSOFT TRADITION

Microsoft set the standard in microcomputer system software. We know more about the structure and capabilities of today's microcomputers than anyone else. And now we're using that power in a whole new way!

Announcing Microsoft Consumer Products. Distinctive software packages backed by the Microsoft name. Each is created by a top-notch programmer and comes to you fully documented, at a cost you can afford.

Microsoft Editor/Assembler-Plus.* Now get every feature of Radio Shack's Editor/Assembler and Z-Bug all in one package. PLUS—many "big computer" features to simplify your programming, editing and debugging. All in a low cost cassette package. Don't waste time creating both source and object tapes—Assembler-Plus assembles directly into memory. Supports macros and conditional assembly, too. Editor-Plus simplifies editing with extra commands like Substitute, Move, Copy and Extend. And Z-Bug;™ the most powerful debugger ever available for the TRS-80, has single step execution, direct execution in calculator mode and symbolic references. And, you can use up to 8 breakpoints at a time, with no need to remove a breakpoint before proceeding. For the 16K, Level II, cassette TRS-80. Priced at \$29.95.

Microsoft Adventure. Only Microsoft offers Adventure complete, as originally written for the DEC PDP-10, now implemented on personal computers. The ultimate fantasy/logic game, Adventure allows you to explore the depths of the "Colossal Cave," collecting treasures and magic, solving puzzles, avoiding hazards and adversaries—including the dreaded killer dwarves. Don't be fooled by imitation or incomplete versions. Only Microsoft has it all. Adventure fills an entire disk with everything you need for your exploration. Written by Gordon Letwin, of SOFTWIN, Associates. Adventure for the TRS-80 requires a single-disk, 32K system. For the Apple II,* a single-disk, 32K system with either the standard disk or language card system. For just \$29.95.

Microsoft Typing Tutor. There's no easier way to master your keyboard! Faster and more efficient than any other teaching method, Typing Tutor helps you if you're starting from scratch or simply building speed. The secret lies in Typing Tutor's exclusive TRM™ or "Time Response Monitoring" software. TRM monitors your keyboard 20 times per second so the computer can evaluate your skill. Your speed. Your errors. Your weakest keys. Typing Tutor tells you where you stand then automatically adjusts itself to help you improve. Written by Dick Ainsworth and Al Baker of the Image Producers, Inc. For the Apple II with 16K and Apple BASIC or the TRS-80 with 16K and Level II BASIC. Priced at \$14.95.

Microsoft Level III BASIC. Upgrade your Level II TRS-80 and increase your programming efficiency without additional hardware. Microsoft Level III loads from cassette tape on top of the Level II ROM. It gives you every feature of Disk BASIC except disk file commands. But that's not all—Level III's high-speed graphics turn your TRS-80* into a virtual electronic drawing board. And there's program renumbering, long error messages, quick shift-key entries, time-limit INPUT statements and many more features. System requirements: Level II BASIC and 16K. Occupies 5.2K RAM. Priced at \$49.95.

Where To Buy. Microsoft Consumer Products are sold by computer retailers nationwide. If your local computer store doesn't have them, call us. Phone (206) 454-1315. Or write Microsoft Consumer Products, 10800 Northeast Eighth, Suite 819, Bellevue, WA 98004.

*TRS-80 is a trademark of Radio Shack Corp. *Apple II is a trademark of Apple Computer, Inc.™ Editor/Assembler-Plus and Z-Bug are trademarks of Microsoft. TRM is a trademark of The Image Producers, Inc.



Alpha Lock for Your ASCII Keyboard

Terry Conboy
1231 Crestview Dr
San Carlos CA 94070

There are times when you need to hold the output of your keyboard in the uppercase mode for all alphabetic characters. A great deal of software is designed to accept only uppercase alphabetic American Standard Code for Information Interchange (ASCII) characters. The circuit given here is designed to be placed between the transistor-transistor logic (TTL) parallel output of the keyboard and the parallel input port on the computer (or the input to the parallel-to-serial converter in a serial data arrangement). The programmer will then be able to reduce the beautifully designed 128-character set to a 102-character set.

A quick glance at a table of ASCII characters will show that the alphabetic characters are easy to recognize. (Such a table appeared in "Complete ASCII" by David M Ciemiwicz in the February 1978 BYTE, page 19.) They all have a 1 in bit 6 (the most significant data bit not considering the parity bit). Lowercase characters have bit 5 equal to 1, and uppercase characters have bit 5 equal to 0. If the problem was as simple as this, the circuit shown in figure 1 would do the trick. (I was inspired to

ASCII Character	Binary 6543210	Bits 6,4,3 Octal	Bits 2,1,0 Octal
@	1000000	4	0
[1011011	7	3
\	1011100	7	4
]	1011101	7	5
^	1011110	7	6
_	1011111	7	7
·	1100000	4	0
;	1111011	7	3
,	1111100	7	4
'	1111101	7	5
~	1111110	7	6
Delete	1111111	7	7

Table 1: The 12 ASCII characters with a binary representation having bit 6 (the most significant data bit, not considering the parity bit) equal to 1 that should not be shifted by the uppercase alpha-lock function.

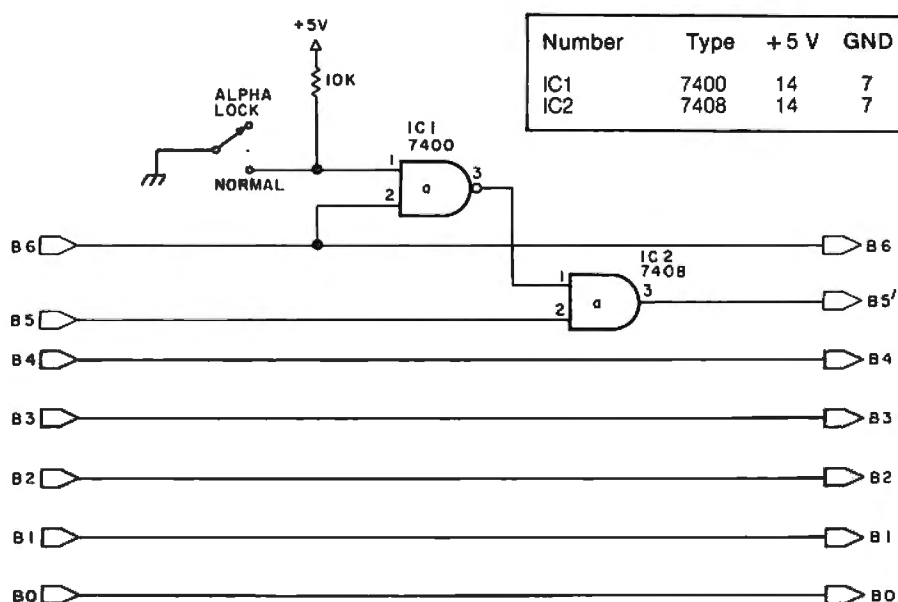

Figure 1: A simple circuit to provide alphabetic uppercase lock. It causes the undesired shift of 6 punctuation and control codes in addition to the alphabetic characters.

About the Author

Terry Conboy is employed as a staff engineer for microwave telecommunications development at GTE Lenkurt in San Carlos CA. Interested in computers and digital communication, he is an Extra class amateur radio operator and has published articles in several ham radio magazines.



You Just Bought a Personal What?

by Thomas Dwyer and Margot Critchfield

Whether you are a novice programmer or an experienced computer user, this book is filled with practical ideas for using a personal computer at home or work. It will take you through the steps necessary to write your own computer programs, and then show you how to use structured design techniques to tackle a variety of larger projects. The book contains over 60 ready-to-use programs written in Radio Shack TRS-80 Level II BASIC in the areas of educational games, financial record keeping, business transactions, disk-based data file and word processing. \$11.95 ISBN 0-07-018492-5

Please send _____ copies of You Just Bought a Personal What?

 Name Title Company

 Street City State/Province Code

Check enclosed in the amount of \$ _____
 Bill Visa Bill Master Charge
 Card No. _____ Exp. Date _____
 Add 60¢ per book to cover postage and handling.

BYTE BOOKS 70 Main Street
 Peterborough, New Hampshire 03458

J&S CROW
ENT

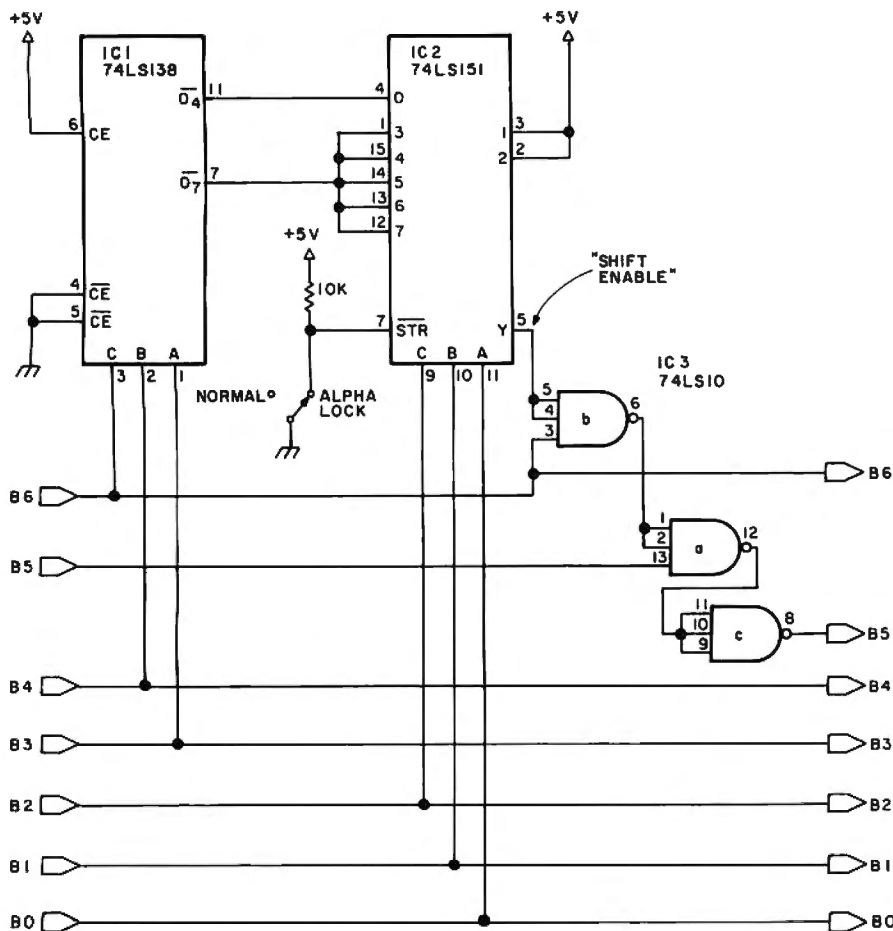

Number	Type	+ 5 V	GND
IC1	74LS138	16	8
IC2	74LS151	16	8
IC3	74LS10	14	7

Figure 2: An alphabetic uppercase lock circuit which shifts only the 26 alphabetic characters when enabled by the switch.

develop this circuit by an idea description "Recognize Uppercase Letters Only with a Simple 2-Gate Circuit," in *Electronic Design*, July 19 1977, page 106, written by Chacko Neroth.)

Of course there is a catch. There are 64 binary combinations in which bit 6 is 1, and only 52 of them are letters. The remaining combinations are punctuation marks, with the exception of the *delete* control code, as shown in table 1. If the keyboard omits these characters, the simple circuit of figure 1 will force bit 5 low when bit 6 is 1 and the circuit is enabled. However, if the keyboard does have these codes (and it probably has *delete*), remembering to unshift when necessary can be a headache.

To overcome this problem, it is necessary to detect the 12 non-alphabetic characters and inhibit the shift automatically. My first thought was to use a multitude of inverters

and 8-input NAND gates (such as the system described by Steve Ciarcia in "Build a Keyboard Function Decoder," July 1978 *BYTE*, page 98), but there had to be a better way. Use of a programmable read-only memory would be nice, but it seemed like overkill and perhaps more expensive than necessary.

The solution turned out much simpler than I expected. By forming the octal equivalent of the group of bits 6, 4, and 3 and of the group of bits 2, 1, and 0, as shown in the last columns of the table, the user can see that by detecting the coincidence of these combinations, the desired shift enabling line can be obtained. The lucky combination of octal numbers allows the use of a 3-to-8-line decoder (74LS138) to unscramble the 3 most significant bits of interest and an 8-line multiplexer/data selector (74LS151) driven by the 3 least significant bits. By selecting the pro-

per outputs from the decoder and data selector (those corresponding to the codes we wish to recognize), there can be case shifting at the proper times. The new circuit is shown in figure 2.

When the high-order bits are decoded, the corresponding output goes to 0. If the low-order bits select a 0 output from the decoder, the *shift enable* line will also go to 0. This allows bit 5 to pass through unchanged. If the alpha-lock function is not desired, allowing the active-low strobe input on the data selector to be pulled up to a 1 will force the shift enable line to 0 regardless of the data being sent.

The use of low-power Schottky TTL integrated circuits allows adding the alpha-lock function while typically increasing the load on the power supply by only 14 mA. The cost of the three integrated circuits will be easily under \$2■

**Have you ever
Practiced
Tape Deck
having
singin' in the
...with your
PET, Apple!**

Available at computer stores everywhere!



Or write to:
**Hayden Book
Company, Inc.**
50 Essex Street
Rochelle Park, N.J. 07662



A Computer Generated Reminder Message

E M Pass
President
Computer Systems Consultants Inc
1454 Latta Lane NW
Conyers GA 30207

Listing 1: The Tickler filing program written in MSI 14 K Disk BASIC.

```
0100 REM TICKLER MESSAGE SYSTEM
0200 STRING= 68
0300 DIGITS= 0
0400 LINE= 0
0600 DIM A(255)
0700 Z=0
0800 A8=0
0900 A9=0
1000 PRINT "TICKLER MESSAGE SYSTEM"
1100 INPUT "INSERT DATA DISK AND HIT RETURN",Z#
1150 IF Z#="NEW" GOSUB 6460
1200 OPEN #10,"TICKLRX" FOR UPDATE
1300 FIELD #10,N1=2,N2=3,N3=6,N4=6,M#=68
1400 GET #10
1420 IF LEFT$(M$,7)="TICKLER" GOTO 1500
1440 CLOSE #10
1460 GOSUB 6460
1480 GOTO 1200
1500 A1=N3
1600 A2=N4
1620 PRINT "ENTER PRINT CONTROL AS FOLLOWS:"
1640 INPUT " S=SELECTIVE,A=ALL,N=NONE,U=UPDATE ONLY ",Z#
1660 IF LEFT$(Z$,1)<"A" GOTO 1620
1680 IF LEFT$(Z$,1)>"U" GOTO 1620
1700 INPUT "ENTER CURRENT DATE (YYMMDD)",D9
1720 IF D9<>INT(D9) GOTO 1700
1740 D1=INT(D9/10000)
1760 D3=D9-D1*10000
1780 D2=INT(D3/100)
1800 D3=D3-D2*100
1820 IF ABS(D1-89)>11 GOTO 1700
1880 IF ABS(D2-6.5)>6 GOTO 1700
1900 IF ABS(D3-16)>15 GOTO 1700
1940 IF LEFT$(Z$,1)="N" GOTO 2320
1960 PRINT :PRINT:PRINT:PRINT
1980 IF A1<2 GOTO 2600
2000 FOR Q=2 TO A1
2020 GET #10
2040 IF N1<1 GOTO 2260
2060 IF LEFT$(Z$,1)="A" GOTO 2100
2080 IF N3>09 GOTO 2300
2090 IF LEFT$(Z$,1)="U" GOTO 2190
2100 IF Z>0 GOTO 2140
2120 PRINT "ENTRY TYPE DATE UPDATE MESSAGE":PRINT
2140 Z=Z+1
2145 I=68
2150 I=I-8
2154 IF I<20 GOTO 2160
2156 IF MID$(M$,I,8)=" " GOTO 2150
2160 PRINT " ";Q;TAB(8);N1;TAB(12);N3;" ";N4;TAB(32);"-";LEFT$(M$,I+8)
2180 IF LEFT$(Z$,1)="A" GOTO 2300
2190 IF N1=1 N1=0
2200 GOSUB 6000
2210 IF N1>1 N4=D9
2220 REWRITE #10
2240 IF N1>1 GOTO 2300
2260 IF A9<255 A9=A9+1
2280 A(A9)=Q
2300 NEXT Q
2310 PRINT :PRINT:PRINT:PRINT
2320 PRINT "ENTER ENTRY NUMBERS TO BE DELETED,";
```

Listing 1 continued on page 162

Most people and businesses share the common problem of being required to perform some actions at definite future dates. These actions may be of a one-time-only nature, or they may be periodic according to some rule.

The penalty for forgetting an event such as a birthday may be minor, but the penalty for neglecting to file an income-tax return may be more severe.

Solutions to the problem are numerous, and include the use of human memory alone, writing notes on a wall or desk calendar, or maintaining an ordered stack of notes and forms. The solution that I suggest here, called the Tickler filing system, involves the use of a computer to help perform this function. The program described here was written for a small maintenance service company which has, in addition to the normal requirements of small businesses, the necessity of keeping track of periodic preventative maintenance calls for its client companies.

The Tickler system enables a clerk to input a series of messages, each of which has a starting date and a code indicating the type of repetition desired for the message. Each time that the program is executed, it can check a file of messages and print and reschedule all messages for which the time limit has expired since the last printing. The clerk can then delete and add additional messages, as required. Since the program contains no features that are specific to the maintenance service company, it

THERE'S NO NEED TO COMPROMISE WITH COMPUPRO™

We don't compromise on our designs so you don't have to compromise on performance. Our expanded S-100 line is the answer to the needs of professional computer users — just ask the dealers who specify our components when making up systems for scientific, commercial, and industrial applications. Speaking of dealers, Godbout products (under the CompuPro™ name) are now available from more dealers than ever before . . . which makes it even easier for you to experience Godbout quality in person. Shop around, compare prices, and compare specs: we think we know whose products will earn a space in your computer.

MORE NEWS FROM THE MEMORY LEADER.

This month, we spotlight Econoram XIII A — an S-100 bank select board that's completely compatible with Alpha Micro, Cromemco, and similar systems (all 8 bits of the data word are available for bank select). Addressable on 4K boundaries. Available in 16K, 24K, or 32K configurations; see list below (which includes our other popular memories) for prices.

All Econoram* memories are fully static, run with 5 MHz (or slower) systems, include a 1 year limited warranty, and generally come in three different configurations to suit your needs — unkit, assembled and tested, or qualified under our high-reliability Certified System Component program (200 hour burn-in, immediate replacement in event of failure within 1 year of invoice date).

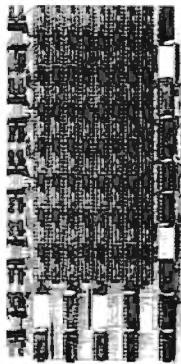

Name	Buss & Notes	Unkit	Assm	CSC
8K Econoram IIA	S-100	\$149	\$179	\$239
16K Econoram IV	S-100	\$269	\$329	\$429
16K Econoram VIIA-16	S-100	\$279	\$339	\$439
24K Econoram VIIA-24	S-100	\$398	\$485	\$605
16K Econoram IX-16	Dig Grp	\$319	\$379	n/a
32K Econoram IX-32	Dig Grp	\$559	\$639	n/a
32K Econoram X	S-100	\$529	\$649	\$789
32K Econoram XI	SBC/BLC	n/a	n/a	\$1050
16K Econoram XIII A-16	S-100 (1)	\$329	\$419	\$519
24K Econoram XIII A-24	S-100 (1)	\$429	\$539	\$649
32K Econoram XIII A-32	S-100 (1)	\$559	\$699	\$849
16K Econoram XIV	S-100 (2)	\$299	\$359	\$459
16K Econoram XV-16	H8 (3)	\$329	\$395	n/a
32K Econoram XV-32	H8 (3)	\$599	\$729	n/a
16K x 16 or 32K x 8 Econoram XVI — coming soon!				

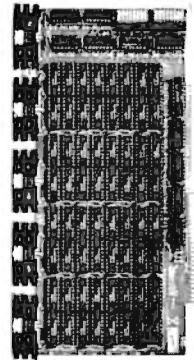

- (1) Bank select board addressable on 4K boundaries.
- (2) Extended addressing (24 address lines). Single block addressable on 4K boundaries
- (3) Bank select option for implementing memory systems greater than 64K.

Econoram is a trademark of Godbout Electronics.

THE GODBOUT COMPUTER BOX: \$259 desk top, \$299 rack mount (introductory price)

The ideal home for your computer. Includes dual AC outlets and fuseholder on rear, power switch, heavy-duty line filter, black anodized front panel (with textured vinyl painted cover for desk top version); pre-drilled base accepts our high-performance S-100 motherboards or types by Vector, California Digital, and others. Rack mount version includes slides for easy pull-out from rack for maintenance or board changing. You can even cut a hole in the front panel and put in a mini-floppy . . . all in all, this is a functional, versatile, and handsome enclosure that does justice to the finest computer systems.

2708 EROM BOARD \$85 unkit

4 independently addressable 4K blocks, with dipswitch selectable jump start built right into the board. Includes all support chips and manual, but does not include EROMs.

ACTIVE TERMINATOR BOARD \$34.50 kit

Plugs into any S-100 motherboard (although ours don't need it) to reduce ringing, crosstalk, noise, and other buss-related problems.

LIMITED QUANTITY SPECIAL: PASCAL/M™ MEMORY!

PASCAL can give a microcomputer with CP/M more power than many minis! And for a limited time only, you can buy an assembled 32K Econoram X, plus our totally standard Wirth PASCAL/M™ 8" diskette, for \$799 (regular combined price, \$999). Includes manual, plus Wirth's definitive book on PASCAL; specify Z80 or 8080/8085 version. Hurry — this is an introductory special. Diskette only without memory board: \$350.

S-100 MEMORY MANAGER BOARD \$59 kit, \$85 assm, \$100 CSC

Now you can add bank select and extended addressing to older S-100 machines like the Altair, IMSAI, Sol, Polymorphic, etc. Either use this board with our new extended addressing boards, or retrofit our high density Econorams (the ones with phantom or extra qualifier lines) for use with the Memory Manager to get up to 1/2 a megabyte of memory space for your computer.

DO YOU SPEAK TRS-80**?

We've been expanding the memory of Model I TRS-80** machines for over a year now with our low power, high speed memory expansion chip set (\$87.20). Now you can use the same chip to expand memory in Apple, newer PET, Exidy Sorcerer, and Heath H89 machines — as well as expand a 32K Model II TRS-80** to 48K or even 64K. And if that isn't enough memory for you, watch this space for news on our high-density, Model II compatible 64K board with bank select!
**TRS-80 is a trademark of the Tandy Corporation.

2S "Interfacer" S-100 I/O Board \$189 unkit, \$249 assm, \$324 CSC

Dual RS-232 ports with full handshake; EIA232C line drivers and receivers (1488, 1489) along with current loop (20 mA) and TTL signals on both ports. On-board crystal controlled timebase with independently selectable Baud rate generators for each port (up to 19.2 Kbaud). Hardware UARTs.

HIGH-PERFORMANCE MOTHERBOARDS

19 slot: \$174 unkit, \$214 assm
12 slot: \$129 unkit, \$169 assm
6 slot: \$ 89 unkit, \$129 assm

Unkits have edge connectors and termination resistors pre-soldered in place for easy assembly. These boards exceed the latest S-100 specs and will work with 5 to 10 MHz CPUs. Includes true active termination, grounded Faraday shield between all buss signal lines, and edge connectors for all slots.

3P PLUS S "Interfacer II" S-100 I/O Board \$189 unkit, \$249 assm, \$324 CSC

Incorporates 1 channel of serial I/O (with all the features of a port from the 2S "Interfacer"), along with 3 full duplex parallel ports. The parallel section uses LSTTL octal latches for latched input and output data with 24 mA drive current, attention/enable/strobe bits for each parallel port (with selectable polarity), interrupts for each input port, and separate 25 pin connectors with power for each channel along with a status port for interrupt mask and port status.

TERMS: Allow 5% for shipping excess refunded. Cal res add tax. VISA/Mastercharge* call our 24 hr. order desk at (415) 562-0636 COD OK with street address for UPS. Prices good through cover month of magazine.

CompuPro™ from

GODBOUT
ELECTRONICS

SEND FOR OUR
FREE CATALOGUE

725 Wright St., Oakland Airport, CA 94614 415-562-0636

should be of general use to other businesses and individuals needing a similar facility.

A sample series of executions of the program appears in this article. The program provides prompts for the user after the file has been established. The user must enter NEW to establish the file. The ability to enter messages, message types, and starting dates should provide sufficient flexibility for virtually any simple application.

Program Details

The program in listing 1 was written using a SwTPC 6800 running the MSI 14K Disk BASIC interpreter level 1.3. The hardware includes 32 K bytes of main memory, one MSI floppy disk drive, and one low-speed (thirty character per second) printing terminal. The interpreter and this program require about 24 K bytes of memory. Since it uses random access techniques, adapting the program to a cassette tape system would be difficult. Implementing it on another disk system or on a timesharing system should not be difficult.

A flowchart of the major portion of the system appears as figure 1.

Initialization

Line 200 of listing 1 sets the string length to 68 bytes. For those with SwTPC 8 K BASIC, this statement may be replaced with POKE (62, 68). Line 300 sets up the output routine to print numeric values with a floating, not fixed, decimal point. Line 400 causes the output routine to ignore right margin considerations on output.

Line 600 allocates an area of 255 variables to point to those records that have been deleted and may be reused. Line 1100 causes the computer to wait until the clerk indicates that the proper disk has been mounted, since the data disk is kept apart from the program disk. Line 1150 checks for the entry of the word NEW, which indicates that the data file does not yet exist and is to be constructed.

Line 1200 opens the data file in update mode; the MSI BASIC interpreter allows opening data files in Input, Output and Update modes. Line 1300 defines the format of the

Listing 1 continued:

```

2340 INPUT " FOLLOWED BY ZERO",Q
2350 IF ABS(Q)<>INT(Q) GOTO 2320
2400 IF Q>=1 GOTO 2320
2420 IF Q<1 GOTO 2600
2430 IF Q=1 GOTO 2320
2440 SET #10=Q
2460 GET #10
2480 IF N1<1 GOTO 2320
2500 M1=0
2520 IF A9<255 A9=A9+1
2540 A(A9)=0
2560 REWRITE #10
2570 PRINT " ;Q." DELETED"
2580 GOTO 2320
2600 INPUT "ENTER TYPE FOR NEW MESSAGE (0=QUIT,99=HELP)",M1
2620 IF ABS(M1)<>INT(M1) GOTO 2600
2640 IF M1=0 GOTO 3000
2660 IF M1<10 GOTO 3040
2700 PRINT
2720 PRINT "          TYPES ARE AS FOLLOWS "
2740 PRINT "          1=SPECIFIC DATE ONLY"
2760 PRINT "          2=WEEKLY"
2780 PRINT "          3=BIMONTHLY"
2800 PRINT "          4=MONTHLY"
2820 PRINT "          5=SEMIMONTHLY"
2840 PRINT "          6=QUARTERLY"
2860 PRINT "          7=SEMI-ANNUALLY"
2880 PRINT "          8=ANNUALLY"
2900 PRINT "          9=EVERY N DAYS"
2920 PRINT
2940 GOTO 2600
3010 INPUT "ENTER DATE FOR NEW MESSAGE (MM/DD)",M3
3050 IF M3<09 M3=09
3060 IF M3<>INT(M3) GOTO 3040
3070 D4=INT(M3/10000)
3080 D6=M3-D4*10000
3090 D5=INT(D6/100)
3100 D6=D6-D5*100
3180 IF ABS(D4-89)>11 GOTO 3040
3200 IF ABS(D5-5.5)>5 GOTO 3040
3220 IF ABS(D6-15)>15 GOTO 3040
3240 INPUT "ENTER MESSAGE",M#
3260 IF LEN(M#)<2 GOTO 3240
3280 M8=M8+1
3300 IF ABS(M8) GOTO 3360
3320 M7=M8\M#
3340 IF A7>1 GOTO 3390
3350 IF A1<1 A1=1
3360 A1=A1+1
3380 A7=M1
3390 IF A1>=A2 GOTO 3800
3400 SET #10=M7
3420 GET #10
3440 M1=M1 M2=0 M3=M3 M#=#
3460 N4=D9
3480 UN M1 GOTO 4000,2480,3520,3560,3600,3640,3680,2720,3760
3500 M2=7
3520 GOTO 4000
3540 M2=14
3560 GOTO 4000
3580 M2=1
3600 GOTO 4000
3620 M2=2
3640 GOTO 4000
3660 M2=3
3680 GOTO 4000
3700 M2=6
3720 GOTO 4000
3740 M2=12
3760 GOTO 4000
3780 INPUT "ENTER NUMBER OF DAYS",N2
3800 IF ABS(N2)<>INT(N2) GOTO 3760
3820 IF ABS(N2-500)>499 GOTO 3760
3840 GOTO 4000
4000 REWRITE #10
4020 GOTO 2600
6000 IF N1<2 RETURN
6020 I=INT(N3/10000)
6040 K=N3-I*10000
6060 J=INT(K/100)
6080 K=K-J*100
6100 IF I<1900 I=I+1900
6120 IF N1>3 GOTO 6300
6140 WOSUB 7000
6160 C=D+N2
6180 GOSUB 7200
6200 NS=(I-1900)*100+J)*100+K
6220 IF N3<D9 GOTO 6120
6240 RETURN
6260 IF M1=9 GOTO 6140
6280 J=J+N2
6300 IF J<13 GOTO 6400
6320 J=J-12
6340 I=I+1
6360 GOTO 6200

```

Listing 1 continued on page 164

Why Should I Help A Hospital In Memphis?



Because St. Jude Children's Research Hospital offers hope to stricken children wherever they may be.

1. St. Jude Children's Research Hospital is the *only* institution dedicated *solely* to conquering catastrophic diseases of childhood.

2. Since opening in 1962, St. Jude Children's Research Hospital has brought hope in some of these diseases where previously none existed.

3. St. Jude Children's Research Hospital's impressive studies of infantile malnutrition have become the basis for government programs to feed

poverty-level children.

4. Treatment procedures developed by St. Jude Children's Research Hospital are freely disseminated to doctors and hospitals all over the world and have been incorporated into the standard pediatric literature.

5. St. Jude Children's Research Hospital depends on public contributions to continue its life-saving work.

St. Jude Children's Research Hospital is unique. Under one roof, its basic and clinical doctors and scientists look for the answers that will save children in every community regardless of race, creed or religion. Children admitted to its research programs receive total medical care at no cost. Some live and some die, but from these patients comes the knowledge that may some day eliminate these dreadful diseases, giving hope to now hopeless children everywhere.

Why Help?

Why should you help? Because St. Jude Children's Research Hospital knows no boundaries. Its impact is everywhere. Because you care.



Danny Thomas, Founder

**ST. JUDE CHILDREN'S
RESEARCH HOSPITAL**

Listing 1 continued:

```

6450 INPUT "ENTER NEW TO CLEAR DISK",Z#
6480 IF Z#<>"NEW" RETURN
6500 OPEN #10,"TICKLER" FOR OUTPUT
6520 FIELD #10,N1=2,N2=3,N3=6,N4=6,M#=68
6540 INPUT "ENTER NUMBER OF MESSAGES TO BE HELD IN FILE",K
6550 IF ABS(K)>INT(K) GOTO 6540
6560 IF K<100 K=100
6570 K=INT((K+2)/3)*3
6580 N1=0:N2=0:N3=1:N4=K:M#="TICKLER MESSAGE SYSTEM"
6600 PUT #10
6620 N3=0:N4=0:M#=""
6640 FOR I=2 TO K
6650 PUT #10
6660 NEXT I
6690 CLOSE #10
6700 RETURN
7000 REM ASTRONOMICAL DAY (D) FROM YEAR (I),MONTH(J),DAY(K)
7020 T1=-INT((14-J)/12)
7040 T2=INT((1461*(I+4800+T1))/4)
7060 T3=INT((367*(J-2-T1*12))/12)
7080 T4=INT((3*INT((I+4900+T1)/100))/4)
7100 D=K-32075+T2+T3-T4
7120 RETURN
7200 REM YEAR(I),MONTH(J),DAY(K) FROM ASTRONOMICAL DAY(D)
7220 L=D+68569
7240 N=INT((4*L)/146097)
7260 I=INT((146097*N+3)/4)
7280 L=L-I
7300 I=INT((4000*(L+1))/1461001)
7320 J=INT((1461*I)/4)
7340 L=L-J+31
7360 J=INT((80*L)/2447)
7380 K=L-INT((2447*J)/80)
7400 L=INT(J/11)
7420 J=J+2-12*L
7440 I=100*(N-49)+I+L
7460 RETURN
8800 PRINT "FILE FULL OF MESSAGES NOW"
8900 A1=A2
9000 SET #10=1
9100 GET #10
9200 N1=0:N3=A1:N4=A2
9300 REWRITE #10
9400 CLOSE #10
9990 INPUT "INSERT PROGRAM DISK AND HIT RETURN",Z#
9999 END

```

data file record, shown in table 1. Since this defines an 85-byte record and each sector on the MSI disk (GSI 110) is 256 bytes in length, there will be three records per sector.

Lines 1400 through 1480 check the first record in the data file. If the message text is not TICKLER, the program assumes that the disk is not valid and asks the clerk if the disk should be cleared. Lines 1500 and 1600 retrieve the current and maximum end-of-file pointers from the first record in the file.

Control Options

Lines 1620 through 1680 request print-control for the current execution of the program. Options are explained in table 2. Lines 1700 through 1900 obtain the current date from the clerk and validate it. Line 1940 checks for run option of N (no printing) and, if it is N, skips the checking of the current messages.

Message Display

Lines 2000 through 2300 successively check every message in the file. Line 2020 reads the next record in the

THE MM-103 DATA MODEM AND COMMUNICATIONS ADAPTER

S-100 bus compatible

FCC APPROVED

Both the modem and telephone system interface are FCC approved, accomplishing all the required protective functions with a miniaturized, proprietary protective coupler.

WARRANTY

One year limited warranty. Ten-day unconditional return privilege. Minimal cost, 24-hour exchange policy for units not in warranty.

HIGH QUALITY

-50 dBm sensitivity. Auto answer. Auto originate. Auto dialer with computer-controlled dial rate. 61 to 300 baud (anywhere over the long-distance telephone network), rate selection under computer control. Flexible, software-controlled, maskable interrupt system.

ASSEMBLED & TESTED

Not a kit! (FCC registration prohibits kits)

LOW PRICE—\$359.95— For Modem AND Coupler

plus shipping & handling



Potomac Micro-Magic, Inc.

Write for brochure:
First Lincolnia Bldg., Suite B1
4810 Beauregard St.
Alexandria, Va. 22312

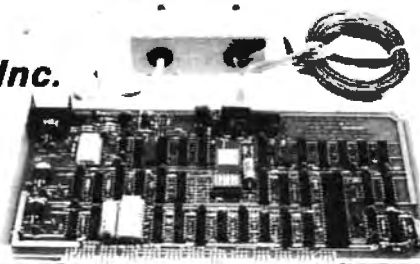

Call for further information:
VOICE: (703) 750-3727
MODEM: (703) 750-0930 (300 baud)



BUILDING BLOCKS OF THE FUTURE

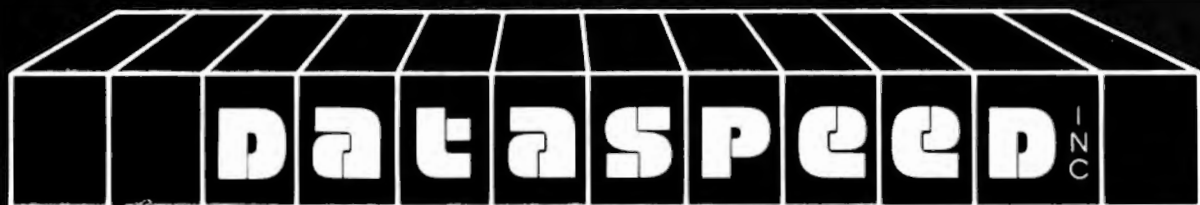

THE CONDUCTOR™

A versatile dual density floppy disk controller. Backed up with dual density CP/M™ (\$150) and available NOW!!!

\$325 assembled

VIDEO CONTROLLER

Memory mapped 80 x 24 with dual character sets (programmable!) user rom space and HARDWARE SCROLLING. Firmware available.

\$349 assembled

DISK SYSTEMS

All the hardware you need for a COMPLETE floppy disk system. PLUS—FREE Osborne Accounting software. Just add CP/M and a computer
Single disk \$1095—
Dual 1649

All DATASPEED products are fully assembled and tested and warranted.

DATASPEED, INC.,
1302 NOE ST.
SAN FRANCISCO
CA. 94131
(415) 282-5616

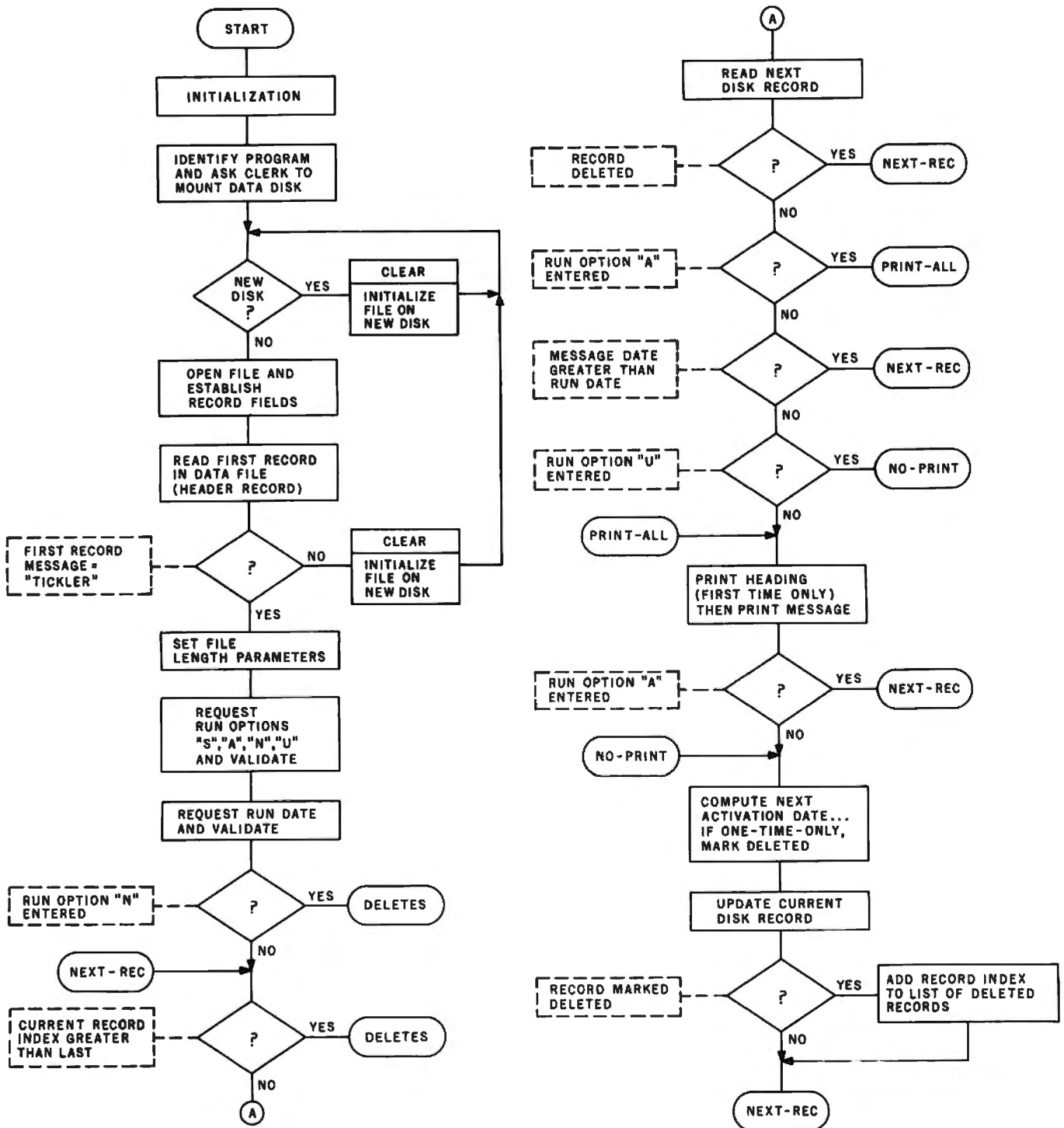

Figure 1: Flowchart of a portion of the Tickler program that initializes disk files, selects options, prints messages, and computes new time intervals for the next activation of periodic messages.

Variable	Description	External Length	Type
N1	Message type	2 bytes	Numeric
N2	Days	3 bytes	Numeric
N3	Message date	6 bytes	Numeric
N4	Date of last update	6 bytes	Numeric
M\$	Message text	68 bytes	Character

Table 1: Format of the data file record for opening data.

Option	Description
S	Selectively print and update messages
A	List all messages without updating dates
N	Only enter messages
U	Update message dates without listing

Table 2: Options for updating messages.

BITS gives you Access to Tools

Tools are only as useful as the user's skills.

Sharpen your computing skills with the latest microcomputer books from BITS.

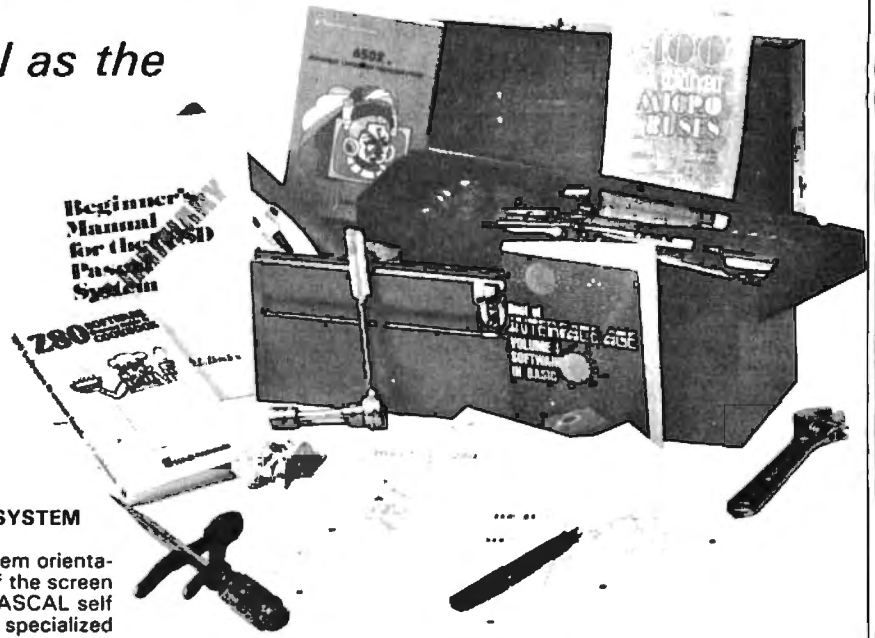

BEGINNER'S MANUAL FOR THE UCSD PASCAL SYSTEM by Kenneth L. Bowles

□ Here from the originator of UCSD PASCAL is a system orientation guide and reference manual. It explains the use of the screen editor, file manager, and compiler with quizzes for PASCAL self study and guides to use of disk files and libraries of specialized routines. Appendices with specific instructions for the Apple II, TRS-80, and Terak 8510A implementations are included. (If you're just learning PASCAL, the book *Microcomputer Problem Solving Using PASCAL* by Bowles is recommended as a companion text.) This book will have you running your PASCAL programs quickly, even if you have no computer experience. 229pp.

#249 \$11.95

Z80 SOFTWARE GOURMET GUIDE & COOKBOOK by Nat Wadsworth

□ From Scelbi Publications we have an appetizing and long awaited addition to their Gourmet Guide series. They've served up the Z80 instruction set with a buffet of useful assembly language routines par excellence! The menu: The Z80 instruction set, Utility routines, Stack operations, Input/output processing, Conversion routines, Search and sort routines, Decimal arithmetic routines, Floating point routines, Space capture, and Creative programming concepts. 322pp.

#250 \$14.95

NUMBERS IN THEORY AND PRACTICE Blaise W. Liffick, editor

□ This reference, Volume 3 in BYTE Books™ Programming Techniques series, is a mix of reprints of articles from BYTE Magazine and much new material. In an effort to equip the microcomputer user with a background in numbers and computational methods, it covers the number system, floating point numbers, numerical methods, random number generators, and the math behind computer graphics. Of value to both the novice and the experienced microcomputer programmer. 184pp.

#246 \$8.95

THE S-100 & OTHER MICRO BUSES by Elmer C. Poe and James C. Goodwin

□ This book is about microcomputer buses; the hardware paths through which the microcomputer's processor communicates with present and future system components. A general discussion of bus structure is followed by chapters on 11 of the most widely used bus systems, including the S-100, TRS-80, Apple II, Pet, and Kim buses. Also included are chapters on bus to bus interfacing. A valuable collection of microcomputer data. 144pp.

#247 \$5.95

BITS PROGRAMMER PAD™

Improve your assembly language programming skills with BITS PROGRAMMER PADS™. Available for the Z-80 8080A, 6502, 6800 or 1802 microprocessors. Punched for 3-ring notebooks, and printed on both sides (pictured above). 50 page pads, only \$2.50 each. (Shipping and handling: USA - 75¢ for 1 pad, \$1.25 for 2 or more; Foreign - \$1 per pad to a max. charge of \$4.)

BEST OF INTERFACE AGE: VOLUME I SOFTWARE IN BASIC Edited by Carl D. Warren

□ The first volume of this new series contains classic software; four microcomputer versions of BASIC: Lawrence Livermore Labs' 8080 BASIC, Dr. Wang's Palo Alto Tiny BASIC (8080), National's Tiny BASIC for SC/MP, and Robert Uiterwyk's 6800 4K BASIC. Each includes full assembly language listing and guides to aid in implementing and using the interpreters. More to come. 314pp.

#248 \$12.95

6502 ASSEMBLY LANGUAGE PROGRAMMING by Lance A. Leventhal

□ 6502 programmers Osborne and Associates have included the 6502 in their Assembly Language Programming series! They thoroughly cover the 6502 instruction set and include assembler conventions, code conversions, arithmetic problems, and program design, debugging, testing, and documentation. Over 80 program examples are included, the 6520 PIA and 6522 VIA are covered, and the 6502 interface system is explained. Comprehensive coverage! 606pp.

#226 \$12.95

MICROCOMPUTER PROBLEM SOLVING USING PASCAL by Kenneth L. Bowles

□ This book is designed both for introductory courses in computer problem solving at the freshman and sophomore college level, and for individual self-study. Graphics are stressed in this version of the book. A complete single-user software system based on PASCAL has been developed at the University of California at San Diego, where the author is a professor in the Department of Applied Physics and Information Science. This system embodies extensions to the standard PASCAL which include the necessary functions and procedures for handling graphics and strings. 563pp.

#077 \$9.80

BASIC BASIC, 2nd EDITION by James S. Coan

□ Basic BASIC gives you step-by-step instructions for using a terminal, writing programs, using loops and lists, solving mathematical problems, understanding matrices and more. The book contains a wealth of illustrations and example programs, and is suitable for beginners on many different levels. It makes a fine reference for the experienced programmer, too. 256pp.

#014 \$8.95

POSTAL CHARGES

U.S. - \$.75/book to a maximum of \$3.00; Foreign - \$1.00/book to a maximum of \$4.00 (surface rate); UPS (U.S. only) - \$1.75 1st book, \$.75 each additional book to a maximum of \$4.00; Foreign Air Mail - \$7.00/book.

BITS™ inc Books to erase the impossible

25 Route 101 West, PO Box 428, Peterborough, NH 03458.

1B010



DIAL YOUR BANK CARD ORDERS
TOLL FREE 800-258-5477



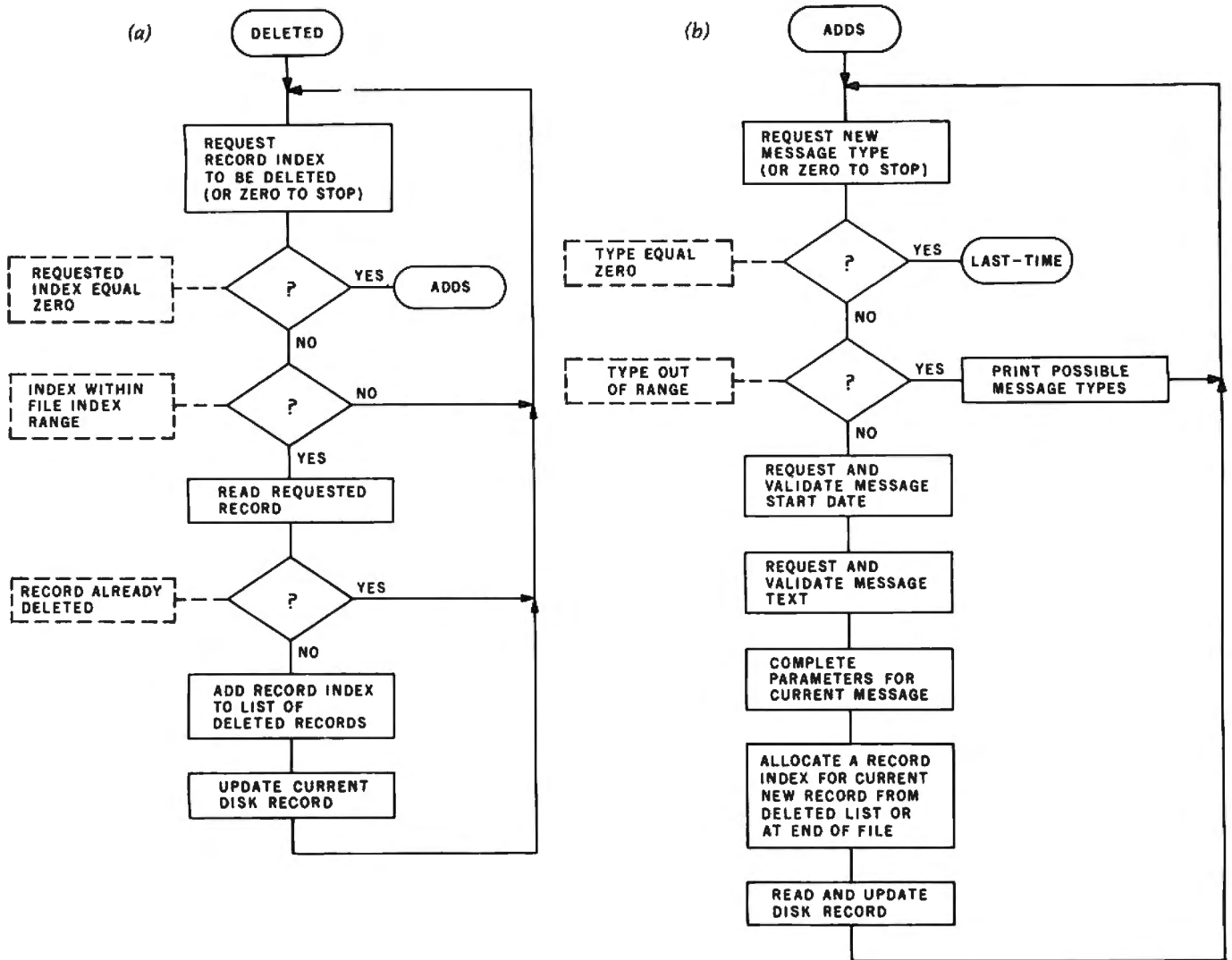

Figure 2: Flowchart of (2a) the routine that deletes messages and (2b) the routine that adds messages to the file.

file. Lines 2060 through 2090 check the print-control option and current date to determine if a given message is to be listed. Lines 2100 and 2120 print a heading before the first message. Lines 2145 through 2156 reduce the number of trailing blanks to be printed.

Line 2160 formats and prints the current message, along with entry number and type, expiration date, and date of last update. Line 2180 checks the print-control option for A (print all), and if it is A, bypasses updating the message date. Lines 2190 through 2220 update the message date and type, as required, on disk. Lines 2240 through 2280 add deleted record numbers to a table for later reuse.

Message Deletion

Lines 2320 through 2580 allow the clerk to delete additional lines from the file and add any deleted record

numbers to the table described above. Deleted lines are recognized by having a message type of zero. Figure 2a shows the deletion procedure.

Entering New Messages

The message addition procedure is shown in figure 2b.

Lines 2600 through 4020 allow the clerk to enter new messages into the file. Line 2600 requests that a message type be entered. Line 2620 ensures that an integer value was keyed. Line 2640 checks this value for zero and, if it is zero, prepares to exit the program. Line 2660 checks this value for validity and, if it is not valid, causes the information on lines 2700 through 2920 to be printed. These lines identify the message types, shown in table 3.

Line 3020 returns to request that a new message type be entered for an invalid type entry. Lines 3040

through 3220 request that a date be entered to be used as an initial message date. Lines 3240 through 3260 request the clerk to enter the message text and ensure that something was entered.

Lines 3280 through 3390 attempt to allocate a record number for the new entry from those just deleted or at the

Type	Description
0	Deleted
1	Specific date only
2	Weekly
3	Biweekly
4	Monthly
5	Bimonthly
6	Quarterly
7	Semi-annually
8	Annually
9	Every N days

Table 3: Message types available in the Tickler system. These values are contained in the M1 and N1 variables in the BASIC program.

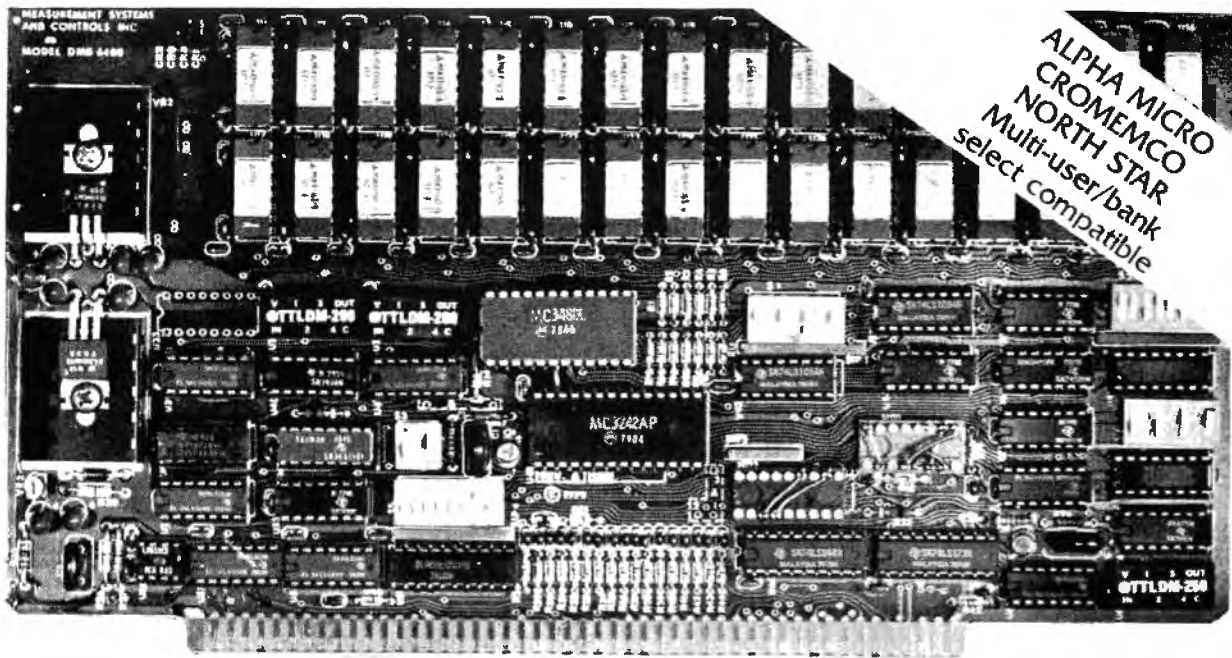

Model DMB-6400 Series dynamic 64k byte RAMS incorporate the features which are standard in the DM-6400 Series and adds bank select for multi-user-timesharing applications.

- ALPHA MICRO, CROMEMCO, and NORTH STAR output port bank select.
- Memory bank size can be incremented to 64k bytes in 16k increments.
- Four (4) 16k byte, functionally independent memory banks.
- Eight (8) 64k byte banks of memory per output port for expansion to 512k bytes for each output port.

Model DM-6400 Series dynamic 64k memory boards feature IEEE S-100 compatible timing and on board transparent refresh.

- Memory selectable and deselectable in 4k byte increments.
- 25 MHz on board crystal oscillator for independent timing.

DMB-6400 and DM-6400 Common Features:

- 4 MHz Z80 operation with no wait states.
- Low power- 8 watts maximum.
- Tested and burned-in.
- Reliable, expandable memories.

ONE YEAR GUARANTEE

THE FOLLOWING PRODUCTS ARE AVAILABLE

- | | | | |
|---|---|--|--|
| <input type="checkbox"/> DMB-6400/64K RAM | <input type="checkbox"/> DMB-3200/32K RAM | <input type="checkbox"/> DM-6400/64K RAM | <input type="checkbox"/> DM-3200/32K RAM |
| <input type="checkbox"/> DMB-4800/48K RAM | | <input type="checkbox"/> DM-4800/48K RAM | |

ATTRACTIVELY DISCOUNTED OEM AND DEALER QUANTITY PRICES AVAILABLE

U.K. & EUROPEAN REPRESENTATIVE:

ABACUS COMPUTERS LTD
82, NEW CAVENDISH STREET
LONDON, W1M 7LD U.K.
TEL: 01-580/8841 TELEX: 881-3085

AUSTRALIAN REPRESENTATIVE:

COMPUTERLAND OF MELBOURNE
555 COLLINS STREET
MELBOURNE, VIC3000
TEL 625581

MEASUREMENT
systems & controls
incorporated

867 North Main Street • Orange, CA 92668
Telephone: 714/633-4460

end of the current file. Lines 3400 through 3450 read the data at the allocated record number and overlay the record with more current data. Lines 3460 through 3820 continue this process by filling in parameters depending upon message type. Lines 3760 through 3800 request and validate the number of days for message type 9 (repeat every N days). Line 4000 updates the record on disk. Line 4020 returns to request additional message entries.

Message Repetition

Lines 6000 through 6400 compute the next message activation date for a message whose current-activation interval has elapsed. It does this using the message type and old expiration date. If the newly computed message date is still earlier in time than the current date, the new message date becomes the old date, and the new message date is recomputed.

Data File Initialization

Lines 6460 through 6700 prepare a new-disk data file for use by the program. Lines 6460 and 6480 validate the format request. Lines 6500 and

6520 open the file for output, creating a new file, and provide the format of each record, as described earlier. Lines 6540 through 6570 request and validate the maximum number of records to be placed into the data file. Lines 6580 through 6660 format the records in the file. Line 6680 closes the file to complete the last sector and directory entry.

This disk-clearing subroutine is shown in flowchart form as figure 3.

Date Conversion

Lines 7000 through 7460 provide Gregorian date to Julian day number (as used by astronomers, a system that counts consecutive days since January 1, 4713 BC) conversions to help facilitate the process of recomputing the message activation date for message types 1, 2, 3, and 9. To calculate the Gregorian date N days from another, the following steps are performed:

1. Convert Gregorian date to Julian day number.
2. Add N to Julian day number.
3. Convert Julian day number to Gregorian date.

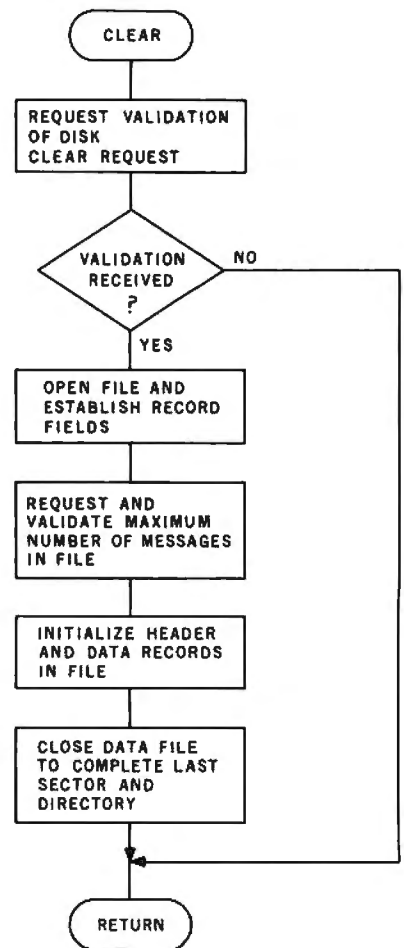

Figure 3: Flowchart of the subroutine that initializes a new disk file.

TRS-80* PERIPHERALS

DISK DRIVES 40 tracks, with power supply & case and cable VERBATIM DISKETTES \$3.00 DYSAN DISKETTES \$4.60	16k MEMORY KITS for TRS-80, APPLE, SORCERER w/jumpers and instructions ONE YEAR GUARANTEE!!!!	PRINTERS from CENTRONICS, INTEGRAL DATA, NEC SPINWRITER, TEXAS INSTRUMENTS. ALL AT GREAT SAVINGS!!
--	---	---

TRS-80 computers in stock!!

We also carry APPLE, SORCERER, PET, SD SALES products. WE WILL NOT BE UNDERSOLD.

GAMES	TRS-80 SOFTWARE UTILITIES	BUSINESS
ANDROID NIM \$14.00 nim robots that wink and respond. Excellent graphics and sound. STAR TREK III \$14.00 Travel through the galaxy on the Enterprise and destroy Klingons. New updated version. AIR RAID \$14.00 Real time shooting gallery. SARGON-CHESS \$19.00 Best chess for TRS-80 LIBRARY 100 \$49.00 100 games, utilities, and business programs in one package. Great value! ADVENTURE \$14.00 disk \$24.95	NEWDOS+ \$99.00 Enhanced DOS. Contains many improvements over TRSDOS. 7 useful utilities built in. For 40 track use also. NEWDOS \$49.00 Same as above without utilities. SYSTEM INTEGRATION TEST \$29.00 tests memory, disk drives, and printer. MICROSOFT FORTRAN \$325.00 CPM \$150.00 RENUMBER \$14.00 disk \$17.00 G2 LEVEL III \$49.00 FORTH by MMS \$65.00 GSF by RACET \$24.00	GL, AR, AP, PAYROLL INTERACTIVE \$350.00 reports include unbilled invoices, open/closed accounts, aging, Trial balance, income statement, balance sheet. Handles 200 accounts, 1750 transactions. Stand alone of each \$95 INVENTORY II \$99.00 activity listing, complete listing, selected listing, minimum quantity search, 1000 items per disk ALL ABOVE PROGRAMS BY SSSG ELECTRIC PENCIL \$99.00 by Michael Shroyer disk \$150.00 BEST word processor for the TRS-80

The above list is just a brief summary of some of our most popular software. We have a large selection of other software for many uses and for many computers. Documentation for any of our programs is available on request. If you have any questions, please call. We would like to hear from you.

TO ORDER, CALL OR WRITE:

C.O.D.

*TRS-80 is a Registered Trademark of Tandy Corp.

MIDWEST COMPUTER PERIPHERALS

PO BOX 437
 WILMETTE, IL 60091
 (312) 251-5028

NEW YEARS SPECIAL
 10% Discount on all Software orders over \$100

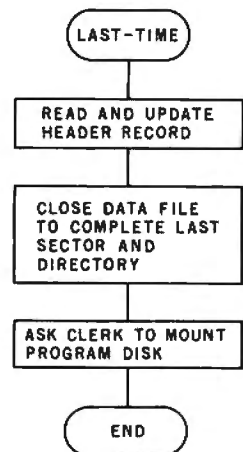

Figure 4: Flowchart of the routine that terminates execution of the Tickler system in an orderly manner.

Exit Procedures

A flowchart of the exit operations is shown as figure 4.

Lines 9000 through 9300 update the first record in the file, which contains

A BUSINESS PROPOSITION

from

INTERTEC DATA SYSTEMS

Dear Computer Enthusiast:

As a result of the phenomenal growth our company has experienced during the past year, there are now many excellent opportunities in our national dealership program. And as a result of this expansion in our dealership network, there are new employment opportunities in the marketing and technical divisions of our company. We'd like to talk about these opportunities for just a minute.

Our two major products, the InterTube II Video Terminal and the SuperBrain Video Computer are, to say the least, an overwhelming success. This widespread acceptance and demand for our products naturally requires the establishment and maintenance of a comprehensive dealer/service network. Many retailers and other microcomputer resellers have already joined our team. They are now realizing the true advantages our unsurpassed price/performance products can give them. How about you? Isn't it time you breathed a little new life into your operation? Dealership and OEM contracts are now being established in many areas. Call us today and discuss your requirements. You'll find us to be quite responsive.

Of course, our ability to successfully penetrate and maintain our position in this ever-increasingly competitive marketplace is due to the support of our many marketing, technical and service personnel. As our marketshare increases, so does our requirement for qualified personnel. We are presently recruiting marketing representatives to work closely with our dealers in the field. A sales/management background in this industry would qualify you for consideration for one of these positions. Also, we are in search of technical personnel to assist us here in South Carolina in supporting the varied applications our customers have for our products. At present, we are recruiting Basic, Fortran and Assembly language programmers as well as lab and production technicians.

Whatever your interests may be, dealership or employment, we urge you to carefully consider the advantages of association with our company. Pause for just a moment and give us a call at 803/798-9100. And if you don't believe us, ask the industry experts. They will tell you we're on the way to the top! So, why not join us now and enjoy the ride.

Best Regards,

The Marketing Department
INTERTEC DATA SYSTEMS CORPORATION

Dear Intertec,

Yes, I'm interested! Please call me with more information about the opportunities I've checked below.

- Dealership Programs
- OEM Arrangements
- Marketing positions presently available in my area.
- Technical Support positions available at the factory
- Other (specify) _____

If you're interested in dealership or OEM arrangements, please send us some detailed information on the nature of your present business including: 1) type of business; 2) length of time in business; 3) number of employees in sales, service and administrative positions; 4) products presently represented and/or manufactured, and 5) your application for our products.

If you're interested in employment, whether it be in a field marketing position or a technical factory position, please enclose a resume detailing your experience and salary requirements.

Don't delay! Give us your name and address below and return this advertisement to:



INTERTEC DATA SYSTEMS

The Marketing Department
2300 Broad River Road
Columbia, South Carolina 29210

If you're in a big hurry to reap the benefits of association with Intertec, skip the form and call us direct at 803-798-9100. Just ask for someone in the Marketing Department.

Your name _____

Company _____

Street _____

City, State & Zip _____

Telephone () _____

Listing 2: A sample series of executions of the Tickler program.

```
#?JN
TICKLER MESSAGE SYSTEM
INSERT DATA DISK AND HIT RETURN?
ENTER PRINT CONTROL AS FOLLOWS:
S=SELECTIVE,A=ALL,N=NONE,U=UPDATE ONLY ? N
ENTER CURRENT DATE (YYMMDD)? 790209
ENTER ENTRY NUMBERS TO BE DELETED, FOLLOWED BY ZERO? 0
ENTER TYPE FOR NEW MESSAGE (0=QUIT,99=HELP)? 99
```

```
TYPES ARE AS FOLLOWS:
1=SPECIFIC DATE ONLY
2=WEEKLY
3=BIWEEKLY
4=MONTHLY
5=BI-MONTHLY
6=QUARTERLY
7=SEMI-ANNUALLY
8=ANNUALLY
9=EVERY N DAYS
```

```
ENTER TYPE FOR NEW MESSAGE (0=QUIT,99=HELP)? 2
ENTER DATE FOR NEW MESSAGE (YYMMDD)? 79100210
ENTER MESSAGE? MESSAGE 1
ENTER TYPE FOR NEW MESSAGE (0=QUIT,99=HELP)? 3
ENTER DATE FOR NEW MESSAGE (YYMMDD)? 790220
ENTER MESSAGE? MESSAGE 2
ENTER TYPE FOR NEW MESSAGE (0=QUIT,99=HELP)? 4
ENTER DATE FOR NEW MESSAGE (YYMMDD)? 790301
ENTER MESSAGE? MESSAGE 3
ENTER TYPE FOR NEW MESSAGE (0=QUIT,99=HELP)? 5
ENTER DATE FOR NEW MESSAGE (YYMMDD)? 790215
ENTER MESSAGE? MESSAGE 4
ENTER TYPE FOR NEW MESSAGE (0=QUIT,99=HELP)? 6
ENTER DATE FOR NEW MESSAGE (YYMMDD)? 790305
ENTER MESSAGE? MESSAGE 5
ENTER TYPE FOR NEW MESSAGE (0=QUIT,99=HELP)? 7
ENTER DATE FOR NEW MESSAGE (YYMMDD)? 790401
ENTER MESSAGE? MESSAGE 6
ENTER TYPE FOR NEW MESSAGE (0=QUIT,99=HELP)? 8
ENTER DATE FOR NEW MESSAGE (YYMMDD)? 790601
ENTER MESSAGE? MESSAGE 7
ENTER TYPE FOR NEW MESSAGE (0=QUIT,99=HELP)? 9
ENTER DATE FOR NEW MESSAGE (YYMMDD)? 790209
ENTER MESSAGE? MESSAGE 8
ENTER NUMBER OF DAYS? 10
ENTER TYPE FOR NEW MESSAGE (0=QUIT,99=HELP)? 1
ENTER DATE FOR NEW MESSAGE (YYMMDD)? 790401
ENTER MESSAGE? MESSAGE 9
ENTER TYPE FOR NEW MESSAGE (0=QUIT,99=HELP)? 0
INSERT PROGRAM DISK AND HIT RETURN?
```

```
MSI READY
#?JN
TICKLER MESSAGE SYSTEM
INSERT DATA DISK AND HIT RETURN?
ENTER PRINT CONTROL AS FOLLOWS:
S=SELECTIVE,A=ALL,N=NONE,U=UPDATE ONLY ? A
ENTER CURRENT DATE (YYMMDD)? 790210
```

ENTRY	TYPE	DATE	UPDATE	MESSAGE
2	2	790210	790209	-MESSAGE 1
3	3	790220	790209	-MESSAGE 2
4	4	790301	790209	-MESSAGE 3
5	5	790215	790209	-MESSAGE 4
6	6	790305	790209	-MESSAGE 5
7	7	790401	790209	-MESSAGE 6
8	8	790601	790209	-MESSAGE 7
9	9	790209	790209	-MESSAGE 8
10	1	790401	790209	-MESSAGE 9

```
ENTER ENTRY NUMBERS TO BE DELETED, FOLLOWED BY ZERO? 0
ENTER TYPE FOR NEW MESSAGE (0=QUIT,99=HELP)? 9
ENTER DATE FOR NEW MESSAGE (YYMMDD)? 790401
ENTER MESSAGE? MESSAGE 10
ENTER NUMBER OF DAYS? 24
ENTER TYPE FOR NEW MESSAGE (0=QUIT,99=HELP)? 0
INSERT PROGRAM DISK AND HIT RETURN?
```

```
MSI READY
#RUN
TICKLER MESSAGE SYSTEM
INSERT DATA DISK AND HIT RETURN?
ENTER PRINT CONTROL AS FOLLOWS:
S=SELECTIVE,A=ALL,N=NONE,U=UPDATE ONLY ? S
ENTER CURRENT DATE (YYMMDD)? 790301
```

ENTRY	TYPE	DATE	UPDATE	MESSAGE
2	2	790210	790209	-MESSAGE 1
3	3	790220	790209	-MESSAGE 2
4	4	790301	790209	-MESSAGE 3
5	5	790215	790209	-MESSAGE 4
9	9	790209	790209	-MESSAGE 8

```
ENTER ENTRY NUMBERS TO BE DELETED, FOLLOWED BY ZERO? 9
9 DELETED
ENTER ENTRY NUMBERS TO BE DELETED, FOLLOWED BY ZERO? 0
ENTER TYPE FOR NEW MESSAGE (0=QUIT,99=HELP)? 0
INSERT PROGRAM DISK AND HIT RETURN?
```

```
MSI READY
#?JN
TICKLER MESSAGE SYSTEM
INSERT DATA DISK AND HIT RETURN?
ENTER PRINT CONTROL AS FOLLOWS:
S=SELECTIVE,A=ALL,N=NONE,U=UPDATE ONLY ? S
ENTER CURRENT DATE (YYMMDD)? 790501
```

ENTRY	TYPE	DATE	UPDATE	MESSAGE
2	2	790301	790301	-MESSAGE 1
3	3	790306	790301	-MESSAGE 2
4	4	790401	790301	-MESSAGE 3
5	5	790415	790301	-MESSAGE 4
6	6	790305	790209	-MESSAGE 5
7	7	790401	790209	-MESSAGE 6
10	1	790401	790209	-MESSAGE 9
11	9	790401	790210	-MESSAGE 10

```
ENTER ENTRY NUMBERS TO BE DELETED, FOLLOWED BY ZERO? 0
ENTER TYPE FOR NEW MESSAGE (0=QUIT,99=HELP)? 0
INSERT PROGRAM DISK AND HIT RETURN?
```

```
MSI READY
#RU
RU
↑ - ERROR # 03
```

```
MSI READY
#RUN
TICKLER MESSAGE SYSTEM
INSERT DATA DISK AND HIT RETURN?
ENTER PRINT CONTROL AS FOLLOWS:
S=SELECTIVE,A=ALL,N=NONE,U=UPDATE ONLY ? S
ENTER CURRENT DATE (YYMMDD)? 790502
```

ENTRY	TYPE	DATE	UPDATE	MESSAGE
3	3	790501	790501	-MESSAGE 2
4	4	790501	790501	-MESSAGE 3

```
ENTER ENTRY NUMBERS TO BE DELETED, FOLLOWED BY ZERO? 0
ENTER TYPE FOR NEW MESSAGE (0=QUIT,99=HELP)? 0
INSERT PROGRAM DISK AND HIT RETURN?
```

```
MSI READY
```

current and last record numbers. Line 9400 closes the file to update the first record and directory entry.

Line 9500 restores the input routine so that commas become string

delimiters once again. Line 9990 requests the clerk to insert the program disk and acknowledge this action.

If you or your business have the problem of needing one-time or per-

iodic reminders, then this program should be worth the effort it takes to key it in (and convert it, if necessary). There are rewards for using it and penalties for not using it. ■

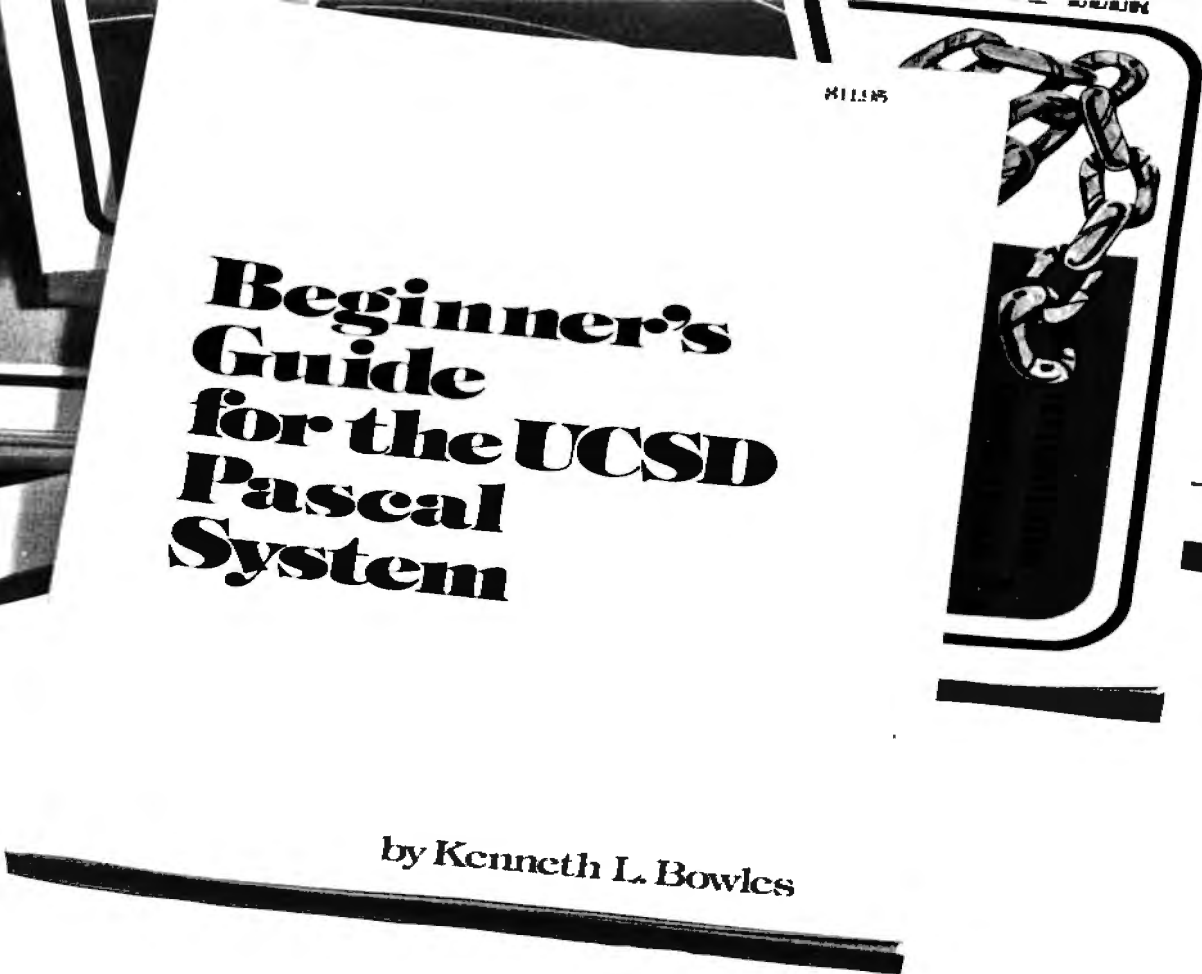

Beginner's Guide for the UCSD Pascal System

by Kenneth L. Bowles

MASTER UCSD Pascal

Written by the originator of the UCSD Pascal System, this highly informative book is designed as an orientation guide for learning to use the UCSD Pascal System. For the novice, this book steps through the System bringing the user to a sophisticated level of expertise. Once familiar with the System, you will find the guide an invaluable reference tool for creating advanced applications. This book features tutorial examples of programming tasks in the form of self-

study quiz programs. The UCSD Pascal Software Systems, available from SofTech Microsystems Inc, is a complete general purpose software

package for users of microcomputers and minicomputers. The package offers several interesting features including:

- Programs which may be run without alteration on the General Automation or DEC PDP-11 minicomputers, or on an 8080, 8085, Z80, 6502, 6800, or 9900 based microcomputers.
 - Ease of use on a small, single-user computer with display screen and one or more floppy disk drives.
- \$11.95 ISBN 0-07-006745-7**



70 Main Street, Peterborough, NH 03458

Please send _____ copies of *Beginner's Guide for the UCSD Pascal System*

Name _____ Title _____ Company _____
Street _____ City _____ State/Province _____ Code _____

Check enclosed
in the amount of \$ _____
 Bill Visa Bill Master Charge
Card No. _____
Exp. Date _____
Add 60¢ per book to
cover postage and handling.

A Pascal Checkbook Balancing Program

Carl T Helmers, Editorial Director, BYTE Publications

Probably the most hackneyed example of what one can do with a personal computer is the proverbial checkbook balancing program. Well, here I have gone and done it: I sat down and profaned Pascal by writing a simple little interactive checkbook balance figuring program (listing 1).

The interactive sequence at initialization reflects a hardware specific aspect of a system which has UCSD Pascal bootstrapped through the CP/M operating system's "BIOS" drivers. This is the use of the "<control> P" character from the keyboard to toggle a single bit flag which determines whether or not the printer is on. We assume the program is off upon entry, so that one

depression of the <control> P character will turn on the printer through the "BIOS" keyboard driver's action.

The general outline of the program, found in the last eight non-blank lines of listing 1, is fairly standard and applicable to a host of specific uses. For nearly every use of a computer, we start with a procedure called *initialization* which sets up the necessary initial conditions of processing. Then, we continue with a *repeat until done* loop construct which does the main logic of the process over and over again.

When the flag *done* becomes true during the main logic, the repeat loop discontinues and we fall through to the standard procedure *summarize* which does any final processing before the program is complete. Of course, in this particular example, *summarize* is a null operation, since I have no particular need to provide any reporting or file operations other than those encountered in the main loop. I have left the dummy procedure *summarize* in the listing to document this need for a possible summary procedure in a more elaborate version of the same program.

This program is run in UCSD Pascal, version 1.5. This same program should run identically on any computer with the UCSD Pascal software system. A sample run follows the listing. I have used the program now for several months; the interactive sequence used for all the detailed computations could be much improved, even though the present form has proved quite practical.

Listing 1: A Pascal listing of the checkbook balancing program.

```
PROGRAM checks;
{ A simple little program written March 26 1979 by Carl Helmers }
{ Time from inception to working program approximately 15 minutes }

VAR
done : BOOLEAN;
detail,balance : REAL;
anychar : CHAR;
count : INTEGER;

PROCEDURE initialize;
BEGIN
balance := 0;
count := 0;

{The following sequence turns on my printer if I type <ctrl P> }
PAGE(OUTPUT);
WRITELN('Checkbook balancer program');
WRITELN('Set printer to top of form, press <ctrl P>, then any key.');
```

READ(KEYBOARD,anychar);

```
{Premature end of program if I type <esc> now}
IF anychar = CHR(27) THEN done := TRUE
ELSE done := FALSE;

{A sequence to get the initial balance...}
IF NOT done THEN
BEGIN
anychar := 'N';
REPEAT
WRITELN('');
WRITELN('Enter Initial Balance');
READLN(balance);
WRITELN('Balance Starts at ',balance:10:2);
WRITELN('Is this correct?');
READ(KEYBOARD,anychar);
WRITELN(anychar)
UNTIL ((anychar='y') OR (anychar='Y'))
END;
END {initialize};

PROCEDURE process_one_check;
VAR
s : STRING[50];
```

Main/Frames from \$200

Main/Frames from \$200

- 14 Basic Models Available
- Assembled & Tested
- Power Supply:
 - 8v@15A, ± 16v@3A
- 15 Slot Motherboard (connectors optional)
- Card cage & guides
- Fan, line cord, fuse, power & reset switches, EMI filter
- 8v@30A, ± 16v@10A option on some models

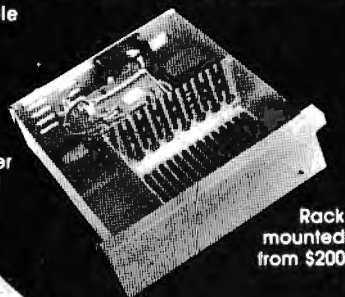

Rack mounted from \$200

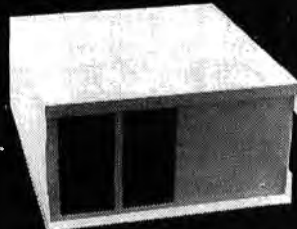

8" Floppy Main/Frame (includes power for drives and mainframe) from \$365

Write or call for our brochure which includes our application note:

'Building Cheap Computers'

INTEGRAND

8474 Ave. 296 • Visalla, CA 93277 • (209) 733-9288
We accept BankAmericard/Visa and MasterCard

```

PROCEDURE get_charge;
BEGIN
  anychar := 'N';
  REPEAT
    WRITELN('Enter amount of ',s,' ');
    READLN(detail);
    WRITELN('Is ',detail:10:2,' the correct value of the ',s,
      '? ');
    READ(KEYBOARD,anychar);
  UNTIL ((anychar='y') OR (anychar='Y'))
END {get_charge};

```

```

PROCEDURE display_balance;
BEGIN
  WRITELN('          Current Balance = ',balance:10:2)
END {display_balance};

```

```

BEGIN {process_one_check}
  WRITELN(' ');
  WRITELN('C? D? I? or <esc>');
  READ(KEYBOARD,anychar);
  WRITELN(anychar);
  IF anychar = CHR(27)
  THEN
    done := TRUE
  ELSE
    CASE anychar OF
      'C','c':
        BEGIN
          s := 'check';
          get_charge;
          balance := balance - detail;
          display_balance
        END;
      'D','d':
        BEGIN
          s := 'deposit';
          get_charge;
          balance := balance + detail;
          display_balance
        END;
      'I','i':
        BEGIN
          s := 'interest';
          get_charge;
          balance := balance + detail;
          display_balance
        END
    END
  END {CASE};

```

```

END {process_one_check};

```

```

PROCEDURE summarize;
BEGIN
  {Remarkable... this procedure doesn't do anything!}
END {summarize};

```

```

BEGIN {checks}
  {isn't this simple... all we do is }
  initialize;
  REPEAT
    process_one_check
  UNTIL done;
  summarize
END.

```

Listing 2: A sample run.

Checkbook balancer program
Set printer to top of form, press <ctrl P>, then any key.

```

Enter Initial Balance
3.1415927
Balance Starts at      3.14
Is this correct?
n

```

```

Enter Initial Balance
1000
Balance Starts at 1000.00
Is this correct?
y
C? D? I? or <esc>
c
Enter amount of check:
15
Is 15.00 the correct value of the check?
          Current Balance = 985.00
C? D? I? or <esc>
3
C? D? I? or <esc>
2
C? D? I? or <esc>
c
Enter amount of check:
32.98
Is 32.98 the correct value of the check?
          Current Balance = 952.02
C? D? I? or <esc>
i
Enter amount of interest:
2
Is 2.00 the correct value of the interest?
          Current Balance = 954.02
C? D? I? or <esc>
d
Enter amount of deposit:
1000
Is 1000.00 the correct value of the deposit?
          Current Balance = 1954.02
C? D? I? or <esc>
c
Enter amount of check:
270
Is 270.00 the correct value of the check?
          Current Balance = 1684.02
C? D? I? or <esc> █

```

Double your memory ... not the price!

COMPARE AT \$695 ...

\$525



**Remex RFD 4000/8''
Floppy Disc Drive
Double the storage!
Double sided ...
Double density!!**

Offers quality and features found in drives costing much more! Single or Double Density Double-Sided Drive Door Lock INCLUDED Write-Protect INCLUDED 180 Day Warranty Compatible with Shugart 850/851 Low Power Operation ensures LONGER LIFE!! Model RFD 4001 offers Data and Sector Separator

AVAILABLE OPTIONS/ACCESSORIES

Dual Drive Power Supply and Cabinet, \$139.95 Single Drive Power Supply and Cabinet, \$119.95
 RFD 4000 Manual, \$5.95 Interface Manual, \$2.95 Drive Cabinet, \$29.95

SIRIUS SYSTEMS, P O Box 9748, Knoxville, TN 37920

Phone orders accepted 9 AM-7 PM (E S T) 615/577-1072, please send the following

RFD 4000 \$525 RFD 4001, \$539 / Check Money Order C O D MC VISA AE

NAME _____ CARD # _____

ADDRESS _____ EXPIRATION DATE _____

CITY _____ STATE _____ ZIP _____ CARDHOLDERS SIGNATURE _____

Add \$7.00 per Drive for Shipping/Handling Tennessee residents add 6% sales tax Foreign orders add 10% (payment in U.S. currency only)

Book Reviews

Illustrating BASIC

Donald Alcock
Cambridge University
Press, 1977
134 pages, softcover with
ring binding \$4.95
hardcover \$14.95

If you are looking for a good introductory BASIC text containing informative illustrations, short programs, a fundamental approach to programming in BASIC, and if you enjoy reading a unique typeset format, then *Illustrating*

BASIC by Donald Alcock, is for you.

In order to set the general approach used throughout this book, the author presents a line drawing of the famous program "bug." This is but one of the many "biff! bam! pow!" Batman and Robin type inserts used to reinforce specific concepts

as they develop. This approach leads the reader through a convenient how-to-do-it explanation of BASIC programming.

The first chapter introduces the reader to what the author calls "Components of the Language." Immediately, the reader gets a taste of the unique presentation offered by this book; illustrations, short programs, and interesting problems abound. The fundamental concepts of most BASICs are introduced via a short note, an illustration, and a few program lines which allow the reader to see how the program should appear. Numeric variables (integer, real, and exponent form) and text variables (strings) are presented in a short but thorough exposition.

Chapter 2, entitled "Input and Output, Expressions and Functions," covers the statements: DATA; READ; RESTORE; INPUT; the functions SGN, ABS, SQR, INT, LOG, EXP, SIN, COS, TAN, and ATN; RND; DEF; PRINT; TAB; and PRINT USING. For each of these statements, a simple illustrative program is given. For example, an engineer may be interested in the short routine that calculates the spring properties of a diving board; the businessman will find the monthly repayment on a loan useful; the game player can use the die throwing routine; the mathematician has a routine that plots the graph of the cosine function; and everyone should enjoy the examples given for the PRINT USING statement.

After these concepts is Chapter 3, "Control." As in every chapter, the pertinent statements such as GOTO, IF... THEN, STOP, ON...GOTO, FOR...NEXT, GOSUB, and RETURN are introduced, illustrated, and programmed into short routines. Chapter

Big savings from AJ on TTYs, couplers, and modems.

Off-lease equipment, refurbished
by AJ at the factory.

ASR 33—\$725 (Qty. 1) Or lease for as low as \$49/month
(36-month lease), including service.

KSR 33—\$595 (Qty. 1) Or lease for as low as \$45/month
(36-month lease), including service.

- 30-day parts/labor warranty*
- Send and receive
- Paper tape punch
- Pedestal mounted
- Visa or Master Charge

AJ Couplers/Modems

- The Cadillacs of the industry
- Some models under \$100
- 30-day parts/labor warranty*
- Variety of models—up to 1200 bps
- Fast delivery
- Nationwide AJ service network
- Visa or Master Charge

Quantities limited and first-come, first-served.
So call toll-free now: (800) 538-9721.

California residents call (408) 263-8520.

Prices subject to change without notice.

*Details available on request.



ANDERSON
JACOBSON

STARFLEET ORION



A specially designed SF TACTICAL BATTLE GAME for your PET, TRS-80 or APPLE Computer.

The man called Sudden Smith watched the five blips on his screen spread out to meet the enemy. Two freighters converted into something like battlegagons, powerful but slow, and three real cruisers: the most powerful group of warships ever seen near the Promethean system — except for the Stellar Union fleet opposing them. Everyone was calling it Starfleet Orion, though it existed for only this day. It was life or death, and, after the object lesson on the planet Spring, everyone knew it.

STARFLEET ORION is a complete 2 player game system

- rule book
- battle manual
- cassette
- ship control sheets
- program listings

Includes 2 programs, 22 space ship types, and 12 playtested scenarios. Game mechanics are extremely simple, but play is exciting, challenging, and rich in detail. Specify PET (8K), TRS-80 (Level II, 16K), or APPLE II (16K & 32K) \$19.95.

Ask your local dealer or send your check to:

Automated Simulations
 Department Y
 P.O. Box 4232
 Mountain View, CA. 94040

California residents please add 6% sales tax

WE CARRY —

- CROMEMCO
- NORTH STAR
- VECTOR GRAPHICS
- THINKER TOYS
 - NEC
- CENTRONICS
- INTERTUBE
- SERENDIPITY
- PERKIN ELMER
- TEXAS INSTRUMENTS

Professional A/R, A/P, Ledger, Payroll, Medical Billing software with customization available. Send for our catalog — Send for quote.

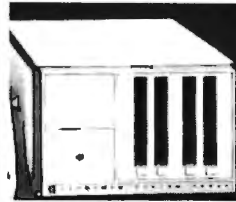

SARA-TECH
 COMPUTERS
 P. O. Box 692
 Venice, FL
 33595
 (813) 485-3559



SPECIALIZING IN QUALITY MICROCOMPUTER HARDWARE

INDUSTRIAL • EDUCATIONAL • SMALL BUSINESS • PERSONAL

BUILDING BLOCKS FOR MICROCOMPUTER SYSTEMS, CONTROL & TEST EQUIPMENT

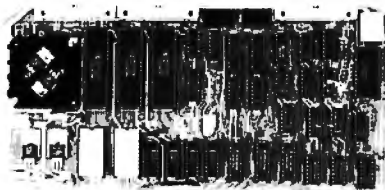

R² I/O
 2K ROM
 2K RAM
 3 Serial Ports
 1 Parallel Port
WIRED: \$295.00

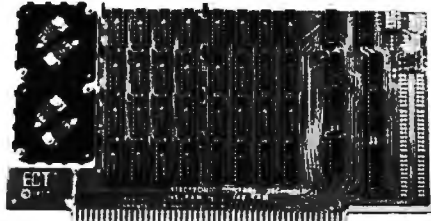

16 K RAM
 FULLY STATIC
 MEMORY
KIT: \$279.00
WIRED: \$310.00

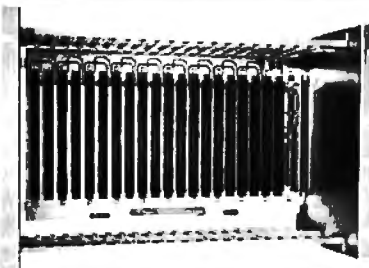

ECT-100-F
 RACKMOUNT
 CARD CAGES
KIT: \$200.00
WIRED: \$250.00



TT-10
 TABLE TOP
 MAINFRAMES
KIT: \$340.00
WIRED: \$395.00

POWER SUPPLIES, CPU's, MEMORY, OEM VARIATIONS

763 RAMSEY AVE.
 HILLSIDE, N.J. 07205

ELECTRONIC CONTROL TECHNOLOGY (201) 686-8080

3 does just that with the GOTO. Some of the programs include: solving a pair of simultaneous equations having any number of right-hand sides; area calculations for triangles, rectangles, and circles; and the game of Moo (quite similar to Bulls and Cows; ie: a number-based Mastermind).

A useful routine in Chapter 3 introduces the reader to stacks and to the concept of recursion via the GOSUB statement. This by-the-way approach of intro-

ducing and examining a relatively complex idea is done rather subtly and painlessly.

Arrays are covered quite well in Chapter 4, and matrix operations are presented in Chapter 5. The concepts in Chapter 4 concerning arrays are enhanced when the reader finishes examining the matrices in Chapter 5. The author explains and illustrates matrix functions, although not all BASIC systems have them. He then manipulates

matrices without the functions, using nested loops. Some of the more interesting matrix operations include: arithmetic operations upon arrays; transposing a matrix; initializing an array to all zeros or all ones; inverting a matrix; and input and output statements performed on arrays.

The array manipulating routines deal primarily with matrix algebra applications and could prove useful to the engineer or the mathematician.

Chapter 6, entitled "Complete Example Programs," contains only two programs. The first is a routine which converts Roman numerals to Hindu-Arabic (such as VII to 7). The other program is a critical-path analysis routine. Expecting a host of programs in this chapter, I was disappointed to find only two. They are good example programs which bring together most everything the reader has seen so far. Perhaps they could have been included as wrap-up programs in other chapters.

The remaining three chapters ("Commands and Signing On," "Files of Data," and "Syntax") explain how the typical BASIC interpreter handles the RUN, SAVE, UNSAVE, OLD, NEW, and CATALOG commands (the reader is cautioned as to the particulars of his or her personal BASIC); a typical sign-on session (see your owner's manual for this one); a short (unfortunately) discussion pertaining to sequential and direct-access files; and a modified Backus-Naur notation used to summarize the syntax of BASIC.

I ran most of the examples presented in the text on my Level II TRS-80. Since the author does not use any machine- or interpreter-dependent statements in his examples, there should be no problem in running the examples on other microcomputers. Some caution is expressed by the author, however, with regard to the lack of portability of BASIC. The reader should examine his or her BASIC manual for any differences between what the author labels "minimal BASIC" and the BASIC used in the reader's computer.

Overall, *Illustrating BASIC* is a good first book for the novice computerist. The author's Preface statement does ring true after reading this book: "You don't have to be a computer scientist to read this book: It is for students meeting computers for the first time; for those in industry (parti-

FORT//80™

FORTRAN

for the 8080 only \$99.95

- FORT//80 is a subset of Fortran IV with many powerful enhancements!
- FORT//80 is an advanced software development tool!
- FORT//80 is AFFORDABLE!!

FEATURES

- FORT//80 directly addresses 8080 ports as FORTRAN variables
- I/O drivers accessed via FORTRAN read/write statements
- FORT//80 accepts embedded in-line machine code
- 8080 condition codes are available as FORTRAN keywords and can be operated upon
- Multiple assignment operators accepted
- Intertwined listings and object code for quick debugging
- Symbolic names up to 31 char long simplify documentation
- Constants expressible to base 2, 8, 10, 16 or as char strings
- Compact: Needs only 25K for compiler and minimum workspace

- Fast: Runs up to 10 times as fast as PLM
- FORT//80 directives specify location of code in memory at run-time
- Interrupt and interrupt control
- FORT//80 control of interrupts and interrupt service lines
- All code runs on 8080, 8085 and Z80 (upward compatibility)
- FORT//80 is a true resident compiler and generates directly executable object code. No run time package needed
- FORT//80 is very fast. It compiles quickly and produces dense highly optimized code
- Single and double precision IBM format floating point arithmetic

PRICING

FORT//80 CPM version and manual on 8" diskette	\$99.95
FORT//80 Language manual separately	20.00
FORT//80 Implementation manual	20.00
Sample diskette validation program and data	5.00

Shipping charges to US and Canada postpaid, overseas add \$5.00. Please add appropriate state sales tax. Master Charge and Visa accepted.

1. FORT//80 is supplied on a single use basis, subject to the signing of a non-disclosure agreement.
2. FORT//80 can be implemented with other disc operating systems using the implementation manual or special versions available by quotation.
3. The purchase price of manuals and sample programs will be credited towards subsequent purchase of FORT//80.

ramsay electronics

BOX 4072, ROCHESTER, NY 14610
 PHONE ORDERS CALL 716-271-6487

Distributors:

- Digital Research of Texas, Box 401565, Garland, TX 75040, (214) 271-2461
- Electrolabs Inc., Box 6721, Stanford, CA 94305, (415) 321-5601
- Arkansas Systems Inc., 8901 Kanis Rd., Little Rock, KS 72205, (501) 227-8471
- Arkon Electronics Ltd., 409 Queen St. W., Toronto, ONT M5V 2A5, (416) 868-1315

Dealer inquiries invited.

™Akron Electronics Ltd.

cularly engineers) who never formally studied computing but would like to write simple computer programs; for managers who do not want to write programs but would like to know more about a field in which they often have to take decisions; and for those who can already write in BASIC but seek a broader view of portable programming and an introduction to a few programmers' techniques like state tables and list processing."

Len Gorney
Box 91 RD 5
Salisbury Rd
Clarks Summit PA 18411

Implementing Software for Non-Numeric Applications

William M Waite
Prentice-Hall, 1973
110 pages hardcover
\$21.00

Implementing Software for Non-Numeric Applications is a textbook on list and string processing languages. It covers the basics of lists and strings, and how to implement languages in order to deal with these data types. There are two major reasons why a computer hobbyist might want to read this book: to learn how such languages work and to learn how to implement them.

Most of the book is about lists. It begins with a discussion of what lists are, and then presents an ideal machine for processing them (cf Pascal p-code), a fairly simple list processing language called HELP, and then LISP. The discussion of LISP focuses fairly heavily on what LISP does internally and why. After more discussion of complex lists, the book proceeds to a discussion of strings; SNOBOL4 is introduced but not discussed in the detail that LISP is treated. The

final section is on implementation.

The author of the book favors implementation by abstract machine modeling; this is the way in which Pascal is implemented. It has the advantage that a compiler or interpreter, once written, can be implemented on new machines with much less effort than would otherwise be the case. The discussion of implementation is more than just theoretical; the appendices contain complete FORTRAN listings for an abstract machine model,

and for HELP language compiler and interpreter.

HELP is a language similar to LISP. The software may be directly implemented if you have a FORTRAN compiler; otherwise it has to be translated into assembler (or perhaps BASIC, if execution speed is not important). I cannot say how successful this would be; I already have LISP for my Z80 processor and so was not tempted to implement HELP.

In conclusion, this book is fairly heavy going. If you

want a thorough introduction to how list languages work, why they do what they do, and how to implement them, this is an excellent book. If you want an introduction to LISP, it would probably be better to first read an introductory text. Then read *Implementing Software for Non-Numeric Applications* to really understand the way things work.

John A Lehman
716 Hutchins #2
Ann Arbor MI 48103 ■

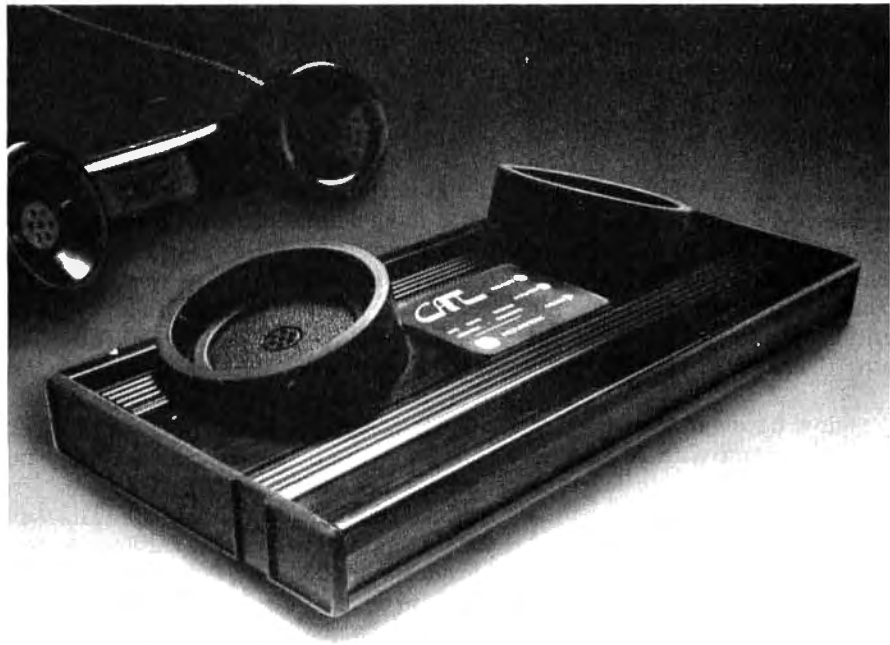

Basic Cat™

A Cat acoustic modem lets your computer talk face to face with any other compatible computer or terminal within reach of your phone. It takes the data you type into your terminal and sends it out over standard telephone lines. It's that simple.

Talk to your office computer from home. Send or receive data from anywhere. Swap programs in Basic, Pascal, Fortran, Cobol or whatever—it doesn't matter

to Cat. It's the accurate, reliable, affordable (under \$199) modem that talks your language.



Tie your computer into the world.

Call for details

(800) 423-5410

In California (213) 996-5060

Available at Hamilton/Avnet, Kierulff Electronics, Byte Shops, Computerland, and your local computer store.

Novation, Inc., 18664 Oxnard Street, Tarzana, California 91356

Relocating 8080 System Software

John G Lipham
Dept of Physics
University of North Carolina
at Charlotte
Charlotte NC 28223

Owners of both large and small computer systems often experience software problems when the time comes to upgrade the system. All old applications programs will have to be modified to run under the new system. However, the real problem occurs when you want to use some or all of the old system software. This was recently the situation at the University of North Carolina at Charlotte (UNCC) Physics Department.

The original hardware consisted of an IMSAI mainframe with 20 K bytes of memory interfaced with a Teletype and audio cassette. We added a floppy disk and Tektronix 4006-2 graphics terminal. To operate the disk, we acquired the CP/M operating system written by Digital Research and distributed by IMSAI.

The CP/M system has a disk-based version of BASIC called BASIC-E, which was written by Gordon Eubanks. This is an excellent version that allows up to 31 characters for variable names, nearly form-free entry of statements with line numbers required only for program transfer (eg: GOTO ..., GOSUB ..., etc), and numerous built-in functions, as well as file handling capabilities. However, it is unusual for BASIC

because programs are first created using an editor, compiled into an intermediate file (using BASIC-E), and finally run (using RUN-E). Our system is used primarily for instructional purposes and some of our students have had no previous programming experience. Hence, we felt that it was desirable to have an interactive version of BASIC for their use.

We already had an interactive BASIC with our old system. However, there was a catch. To run under the CP/M system, it was necessary to shift the origin of BASIC to the address hexadecimal 0100 from its original starting address of 0000. (The CP/M monitor uses the addresses hexadecimal 0000 thru 00FF.)

In principle, if you have an assembly-language listing and an assembler program, it is always possible to reassemble the assembly-language code to machine code with a new starting address. However, with our old version of BASIC, this listing consisted of 113 typed pages! Ignoring the difficulty of just entering this amount of code, a moment's reflection will show that the assembler and the code would never fit in 20 K bytes. (The machine code itself occupies about 9 K bytes.) Assembling the code in pieces that fit is a possibility. But, even with a cross-reference table of variable names, this would be an excruciating process. Hence, we were left with the only practicable alternative: relocating the machine code directly.

Thus it was with great interest that I read Leor Zolman's article in the July 1977 BYTE entitled "A Machine Code Relocator for the 8080." I have used the program written by Zolman

and have found that it works as advertised.

However, I have oversimplified my initial statement of the problems faced in modifying our old BASIC to run under CP/M. There were segments of the old software that had to be removed to be compatible with CP/M. Thus, to avoid a lot of NOPs, various relocations to lower-memory addresses had to be made. (Various additions and replacements also had to be made.) As pointed out by Zolman, his program works by moving blocks of code tail-to-tail. Hence, "relocating backward into lower memory fails if the difference between the source and destination address is not greater than the block length." Also, his suggested solution to this limitation of performing two relocations was impracticable because of our memory limitations.

I found that by making some modifications I could remove the limitation in Zolman's original program at the cost of 36 additional bytes of program code. This modified relocater program is presented in listing 1. As written, the program is designed to run with the CP/M system's Dynamic Debugging Tool (DDT), which is a type of monitor program for machine-code programs. I found this to be a useful procedure, since the Dynamic Debugging Tool allows the machine's memory to be reviewed and modified via a terminal keyboard. I also found the disassembler routine of this program to be invaluable. (The program can be modified to run without a monitor, or with another monitor, by changing memory location hexadecimal 2DCC.)

About the Author

John Lipham's first contact with programming was as a graduate student in physics at the University of North Carolina at Chapel Hill. There he discovered PL/1 and assembly language for the IBM 360. Recently he has been working with a colleague on a project using an IMSAI microcomputer system. The goal of the project is to develop software to aid in teaching physics, and to interface the system to scientific instruments for research purposes.

Mike's
announces

North Star Horizon Timesharing with Hard Disk Interface

In excess of 120 megabytes bulk storage capacity now possible. Several different hard disk units are available, interfaced to North Star DOS and BASIC.

Two to seven-user timesharing North Star Horizon integrated computer systems with: Dual density or quad capacity eight inch drives and/or hard disk units with your choice of a variety of printers.

A complete selection of innovative business application software is available for North Star* systems.

Foreign orders are our specialty. Dealerships are available. Call or write for descriptive literature, hard disk availability and/or dealer information package.

Micro Mike's, Incorporated

905 South Buchanan * Amarillo, Texas 79101 * USA
Telephone: 806-372-3633

making technology uncomplicated — for People

TRS-80 LEVEL II

\$750. COMPLETE SYSTEM

The world's most popular microcomputer, with 16K of memory and Level 11 basic for only \$750, complete with full 90 day Radio Shack warranty. We accept check, money order or phone orders with Visa or MasterCharge. (Shipping costs added to charge orders).

Disk drives, printers, peripherals, software and games . . . you name it, we've got it (Both Radio Shack & other brands). Write or call for our complete price list.



Shown is Level I. Level II includes Alphanumeric keypad.

C&S ELECTRONICS MART

Ltd.

AUTHORIZED DEALERSHIP **Radio Shack**

32 E. Main Street • Milan Michigan 48160 • (313) 439-1400

CP/M® 2.0 FOR THE MOD-II

The Latest CP/M Operating System up and running now on the TRS-80® MOD-II

THE PROBLEM...

Yes, the TRS-80 Mod-II is the most powerful computer you can buy for the money today. And yes, it is as good as computers selling for up to three (or more) times the price.

But just like the IBM 5110 Radio Shack compares it with, the new TRS-80 Mod-II suffers from a familiar problem...not enough systems software, not enough applications software.

SOLVED...

We've done it. Taken the world's most popular micro-operating system and matched it to the world's newest micro business computer. It's up and running today, and you can have it in your Mod-II *this week*. And we mean **STANDARD CP/M Version 2.0**. The latest and best. With all of its features. And some of our own.

Make no mistake. This is not just a promise, it's a powerful working system. Order C.O.D. Send \$25 down, pay \$225 + \$2.50 Shipping & Handling, or save C.O.D. and shipping by sending \$250 with your order. Master Charge and Visa also accepted. Air Shipment add \$2.00. California residents add 6% sales tax.

IN STOCK NOW. MANY APPLICATIONS PROGRAMS AVAILABLE NOW. BASIC, FORTRAN, COBOL, APPLICATIONS PACKAGES AVAILABLE FOR BUSINESS & PROFESSIONS! FOR INFORMATION CALL (415) 592-6633.

CP/M is a trademark of Digital Research Corp. TRS-80 is a trademark of Tandy Corp.

STANDARD CP/M 2.0 FEATURES

- Microprocessor Control Program
- Includes Editor, Assembler, Debugger, Utilities
- Supports Floppy and Hard Disks

PLUS SOME OF OUR OWN

- Reads single and double density diskettes
- Single drive copy and backup routines
- All routines optimized for TRS-80 Mod-II

WHAT YOU GET

- The complete CP/M diskette from Digital Research Corp.
- The MPU diskette with our additions and patches to make it work on the TRS-80 Mod-II
- Seven manuals from Digital Research Corp.
- One manual from MPU to explain our additions

**SEND FOR OUR
CATALOGS OF
TRS-80 MOD-I AND MOD-II
APPLICATIONS SOFTWARE**

MPU
POST OFFICE BOX 808
SAN CARLOS, CALIF 94070

While there are some differences in detail as to the operation of the modified relocater, this program is run in the same manner as Zolman's original program. For ease of reference I have retained Zolman's nomenclature. (nb: Using this nomenclature, you view the memory as though you were looking down into a barrel. Numerically smaller addresses are at the top and numerically larger ones are at the bottom.) The same pieces of information are required for a relocation and reference fix, as in Zolman's program. This required information is outlined in table 1, which, except for memory addresses, is the same as Zolman's.

The LXI Problem

As pointed out by Zolman, the load immediate (LXI) instruction is a potential source of problems in relocating machine-code programs. The main difficulty is that this instruction is frequently used for two different jobs: to load a constant into a register pair, and to load an address into a register pair. The relocater program cannot distinguish between these two uses. Hence, if a program constant happens to be equal to an address within the program block being moved, an erroneous reference fix will be made.

Unfortunately there seem to be no widely accepted conventions for the use of this instruction that produce easily relocatable machine code. Adoption of the following conventions is suggested for all those desiring to write relocatable code:

- (1) The LXI instruction shall be used only to load addresses into a register pair (eg: LXI H,3101H).
- (2) All program constants shall be loaded into a register pair using 2 move immediate instructions (eg: MVI H,31H MVI L,01H).

The cost of adopting these conventions is relatively modest in that it will take 4 bytes to load a 2-byte constant into a register pair, instead of the 3 bytes required using the LXI instruction. Furthermore, if you only want to zero out a register pair, the following sequence of instructions achieves the same result at no additional cost, without using the LXI instruction:

Listing 1: A relocater program for use on 8080 systems. This is a modified version of the relocater program written by Leor Zolman in the July 1977 BYTE. This relocater will move a source program to any location in memory and fix address references. Relocations of a source-program block to any address outside the source are performed without overwriting. The program is designed to run with the Dynamic Debugging Tool (DDT) of the CP/M software system. If need be, the program can be modified to run without a monitor or with another monitor by changing the contents of hexadecimal memory location 2DCC. While differing in some details with Zolman's relocater program, it requires the same information and is run in the same manner.

```

2D00          ORG      2D00H          ;SET ORIGIN
2D00 31162E  BEGIN:  LXI      SP,STACK+8 ;INITIALIZE STACK
2D03 2A032E          LHL      SBOT          ;BOTTOM OF SOURCE
2D06 EB          XCHG          ;D,E=SBOT=(B)
2D07 2A012E          LHL      SSTRT          ;H,L=SSTRT=(A)
2D0A 4D          MOV      C,L
2D0B 44          MOV      B,H          ;SAVE IN B,C
2D0C CDCD2D          CALL     COMPH          ;COMPLIMENT(A) & ADD 1
2D0F 19          DAD      D          ;H,L=(B)-(A)=BLOCKSIZE
2D10 E5          PUSH     H          ;SAVE ON STACK
2D11 2A052E          LHL      DTOP          ;TOP OF DESTINATION
2D14 EB          XCHG          ;D,E=DTOP=(C)
2D15 69          MOV      L,C
2D16 60          MOV      H,B          ;H,L=SSTRT
2D17 CDCD2D          CALL     COMPH
2D1A 19          DAD      D          ;H,L=(C)-(A)=DISPL
2D1B 220C2E          SHLD     DISPL          ;SAVE DISPLACEMENT
2D1E F5          PUSH     PSW          ;HAS SIGN OF DISPL
2D1F 3A0B2E          LDA      LDA FUNC          ;CHECK FOR MOVE
2D22 B7          ORA      A
2D23 CA602D          JZ       STEP2          ;IF 0 FIX REF. ONLY
2D26 F1          POP      PSW
2D27 DA3E2D          JC       DOWN          ;(C)>(A) IF CARRY SET
;IF COME HERE DESTINATION IS ABOVE SOURCE
;SO MOVE IS DONE HEAD-TO-HEAD
2D2A EB          UP:      XCHG          ;H,L=D,E=DTOP
2D2B D1          POP      D          ;D,E=BLKSIZE
2D2C 0A          XI:      LDAX     B          ;B,C=SSTRT=SOURCE PTR.
2D2D 77          MOV      M,A          ;MOVE TO NEW LOC.
2D2E 7A          MOV      A,D
2D2F B7          ORA      A
2D30 C2382D          JNZ     Y          ;CHECK IF THRU
2D33 7B          MOV      A,E
2D34 B7          ORA      A
2D35 CA582D          JZ       TEST          ;IF D,E=0 THEN MOVE DONE
2D38 23          Y:      INX      H          ;INCR DEST. PTR. TO NEXT
2D39 03          INX      B          ;INCR SOURCE PTR.
2D3A 1B          DCX     D          ;COUNT DOWN BLKSIZE
2D3B C32C2D          JMP      X          ;CONTINUE
;IF COME HERE DESTINATION IS BELOW SOURCE
;SO MOVE IS DONE TAIL-TO-TAIL
2D3E EB          DOWN:  XCHG          ;H,L=D,E=DTOP
2D3F D1          POP      D          ;D,E=BLKSIZE
2D40 D5          PUSH     D          ;SAVE ON STACK
2D41 19          DAD      D          ;H,L=SBOT=DTOP+BLKSIZE
2D42 EB          XCHG          ;D,E=SBOT;H,L=BLKSIZE
2D43 09          DAD      B          ;H,L=SSTRT+BLKSIZE=SBOT
2D44 EB          XCHG          ;D,E=SBOT;H,L=SBOT
2D45 C1          POP      B          ;B,C=BLKSIZE
2D46 1A          XX:      LDAX     D          ;D,E=SOURCE PTR.
2D47 77          MOV      M,A          ;MOVE TO NEW LOC.
2D48 78          MOV      A,B
2D49 B7          ORA      A
2D4A C2522D          JNZ     YY          ;CHECK IF THRU
2D4D 79          MOV      A,C
2D4E B7          ORA      A
2D4F 3A582D          JZ       TEST          ;B,C=0, MOVE DONE
2D52 2B          YY:      DCX     H          ;PT. TO NEXT DEST.
2D53 1B          DCX     D          ;PT. TO NEXT SOURCE
2D54 0B          DCX     B          ;COUNT DOWN BLKSIZE
2D55 C3462D          JMP      XX          ;CONTINUE
2D58 3A0B2E          TEST:  LDA      FUNC          ;=02 IF MOVE ONLY
2D5B FE02          CPI     02H
2D5D CACC2D          JZ       DONE
;COME HERE TO DO REFERENCE FIXING.
;NECESSARY ONLY FOR 3 BYTE OP CODES
2D60 01E72D          STEP2: LXI      B,TABL3          ;B,C= TABLE PTR
2D63 2A032E          LHL      SBOT          ;NEED TO ADD 1 TO SBOT
2D66 23          INX      H
2D67 22032E          SHLD     SBOT
2D6A 2A072E          LHL      START          ;D,E=MEMORY PTR.
2D6D EB          XCHG
2D6E 2A092E          CHEKF: LHL      SSTR          ;CHECK FOR END OF FILE
2D71 CDCD2D          CALL     COMPH          ;D,E=MEM. PTR.

```

Listing 1 continued on page 184

**For Business Systems Software
Programmers Only!!
Machine Language
ISAM**

**FOR
TRS-80* Models I and II
ACCESS TIME 1/2 SECOND!!**

This machine language ISAM ROUTINE provides file access sophistication required to implement complex business software, and is completely compatible with TRS-80* BASIC.

Specifications: based on 1000 record file, key length of 6, data length of 64

- Access time of 1/2 second
- Best add/delete time of 1 second
- Average add/delete time of 2 seconds
- Worst case add/delete time of 5 seconds
- Keys up to 25 characters
- Data up to 255
- Provides next highest key upon each file access.
- Preset range of allowable key values, set upon file creation up to 4 files held open concurrently.
- No special utilities needed to "Reclaim" used record space.
- Model I Routine occupies 5 K of user space (loads at top of user memory)
- Model II Routine occupies 6 K of user space (loads at top of user memory)
- EOF, file full, empty, key not found, INVALID key value and all TRS DOS* error codes supported.

TRS-80 Model I (32 K + 48 K only) \$160.00
TRS-80 Model II (64 K only) \$170.00

Includes: All necessary documentation, file creation program, file inspection program, machine language ISAM routine and loader.



SYSTEMS SPECIALISTS
415 MILLBURY STREET
WORCESTER, MA 01607
(617) 755-8134

*TRS-80 and TRS DOS are trademark of Tandy Corporation, which has no relationship to RCR Inc.

Z_S - SYSTEMS



64K RAM BOARD

The Z_S-SYSTEMS 64K RAM board is designed to operate in any Z80 based microcomputer having S-100 bus. It uses 16K dynamic RAM chips, & features:

- Board select
- Bank select
- Transparent on-board refresh
- 2 or 4MHz operation (w/ no wait state)
- Memory disable

Compatible with Cromemco and M/PM multiuser. Fully assembled, burned in, & tested. Available from stock to 60 days
As low as \$500.00 in quantities of 100

Price of one.....\$695.00

With 16K RAM.....\$359.00
Plus shipping charges

FLOPPY DISK CONTROLLER

Handles with no modification up to:

- * 4 standard 8" drives (Shugart or compatible) or
 - * 3 minidrives 5"
- Run with 2 or 4 MHz CPU

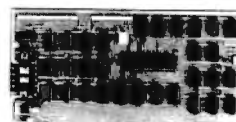

Use CP/M Disk Operating System Using the 1771 LSI controller
Price of one.....\$245.00
PC board only.....\$35.00

SEND FOR FREE INFORMATION
6 months warranty on our boards with normal use

Z_S-SYSTEMS
PO Box 1847, San Diego, CA 92112
(714) 447-3997

TRS MOD I and MOD II PROGRAMS FROM RACET COMPUTES

∞ BASIC for Level II and Disk Systems \$49.95

Full MATRIX Functions - 30 BASIC commands!!
Mathematical and common matrix functions. Change arrays in mid-program. Complete array handling. Tape array read and write, including strings. Common subroutine calls.

Over 50 more STRING Functions as BASIC commands!! String manipulation, translation, compression, copying, search, screen control, pointer manipulation and utility functions. Includes multikey multivariable machine language sorts. Load only machine language functions that you want! Where you want in memory! Relocating linking loader! More than you ever expected!!

∞ BUSINESS (Requires Infinite BASIC) \$29.95

20 Business oriented functions including:
Printer Automatic Pagination with headers and footers!
Packed Decimal Arithmetic (+, -, *, /) 127 digits!
Binary array searched and hash code generator!

COMPROC Command Processor for Disk Systems \$19.95

Auto your disk to perform any sequence of DOS commands, machine language loads, BASIC, memory size, run program, respond to input statements, etc. Single BASIC command file defines execution! Includes auto key-debounce, screen print and lower case software driver.

New Products Jan/Feb! We answer reader response inquiries!!

ATTN! System Houses - We license usage of our routines!
TRS Add-On OEM's - Direct BASIC commands tailored for your hardware.

REMODEL + PROLOAD Specify 16, 32, or 48K Memory \$34.95
RENUMBER any portion or all of BASIC program. Line references adjusted.

MOVE any portion of a BASIC program from one location to another.

DELETE lines or ranges of lines while using the utility.

MERGE all or any portion of a program from tape. (Load lines 300-500 from your tape to existing program at line 1000 with renumbering on the way in!)

SAVE combined/merged programs, or any portion to tape with **VERIFY**.

COPYSYS Copy Systems Tapes (Editor/Assembler Format) \$14.95

GSF (16, 32, or 48K) \$24.95

18 Machine language routines using 'USR' calls. Includes RACET sorts, array handling, and fast lines and scrolls.

DOSORT (Specify 32 or 48K - 2 disk minimum) \$34.95

Sort/Merge multi-diskette sequential files. Multiple keys and variables. Includes GSF - machine language sorts, comparators and string handling.

MOD II SUPPORT

RACET is supporting the MOD III!!
Call or write for current information! We have a MOD II Superzap and other assembly language tools!

Ask your dealer if he carries our products!
DEALERS! We will work with you directly or through our distributors.

RACET COMPUTES
702 Palmdale, Orange CA 92665

CHECK, VISA, M/C, C.O.D. • Calif. Residents add 6% • Telephone Orders Accepted (714) 637-5016
WHEN ORDERING PLEASE ADVISE PUBLICATION SOURCE

Listing 1 continued:

```

2D74 19          DAD      D          ;D,E-H,L=DIFF.
2D75 DACC2D     JC       DONE       ;DIFF.>=0,CARRY SET
2D76 1A          LDAX    D           ;LOAD MEM. USING D,E
2D77 67          MOV     H,A        ;SAVE IN R
2D7A AF         XRA     A          ;ZERO ACCUM.
2D7B 6F         MOV     L,A        ;SET UP CNTR.
2D7C 2C         COMP3: INR     L          ;BUMP CNTR
2D7D 7D         MOV     A,L       ;
2D7E FE1B      CPI     27D       ;CHECK FOR END OF TABLE
2D80 CAB32D     JZ     AGAIN      ;IF THRU,LOOK # 2 BYT OPS
2D83 0A         LDAX    B          ;LOAD TABLE ENTRY
2D84 94         SUB     H          ;COMP. WITH CURR. MEM.
2D85 CAA12D     JZ     MTCH3      ;JMP IF MATCH
2D88 03         INX     B          ;ELSE BUMP TABLE PTR.
2D89 C37C2D     JMP     COMP3     ;LOOK AGAIN
2D8C 01D52D     AGAIN: LXI    B,TABL2 ;NOW,LOOK AT 2 BYTE OPS
2D8F AF         XRA     A          ;ZERO ACCUM.
2D90 6F         MOV     L,A        ;SET CTR.
2D91 2C         COMP2: INR     L          ;BUMP CTR.
2D92 7D         MOV     A,L       ;
2D93 FE13      CPI     19D       ;CHECK FOR END TABLE
2D95 CAC52D     JZ     OUT1      ;NO MATCH 2 OR 3 BYTE OPS
2D98 0A         LDAX    B          ;LOAD TABLE ENTRY
2D99 94         SUB     H          ;COMP. WITH CURRENT MEM.
2D9A CAC42D     JZ     OUT2      ;JMP IF MATCH
2D9D 03         INX     B          ;ELSE BUMP TABLE PTR.
2D9E C3912D     JMP     COMP2     ;LOOK AGAIN
2DA1 2A032E     MTCH3: LHLD   SBOT    ;FOUND 3 BYTE OP CODE
2DA4 CDCD2D     CALL   COMPH     ;IS ADDR. IN RANGE?
2DA7 13         INX     D          ;GET LO ADDR. BYTE
2DA8 1A         LDAX    D          ;LOAD IN ACC.
2DA9 4F         MOV     C,A       ;STORE IN C
2DAA 13         INX     D          ;GET HI ADDR. BYTE
2DAB 1A         LDAX    D          ;LOAD ACC.
2DAC 47         MOV     B,A       ;PUT IN B
2DAD 09         DAD     B          ;H,L=MEM.ADDR.-SBOT
2DAE DAC52D     JC     OUT1      ;MEM.ADDR.>=SBOT+1,C SET
2DB1 2A012E     LHLD   SSTRT     ;LESS THAN (A)?
2DB4 CDCD2D     CALL   COMPH     ;
2DB7 09         DAD     B          ;H,L=MEM. ADDR.-SSTRT
2DB8 D2C52D     JNC    OUT1      ;MEM.ADDR. < SSTRT,C=0
2DBB 2A0C2E     FIXR:  LHLD   DISPL   ;IF COME HERE,IN RANGE.
2DBE 09         DAD     B          ;H,L=MEM.ADDR.+DISPL
2DBF 7C         MOV     A,H       ;
2DC0 12         STAX   D          ;STORE NEW HI ADDR.
2DC1 1B         DCX   D          ;PT. AT LO ADDR. BYTE
2DC2 7D         MOV     A,L       ;
2DC3 12         STAX   D          ;STORE NEW LO ADDR. BYTE
2DC4 13         OUT2: INX     D          ;
2DC5 13         OUT1: INX     D          ;ADV. PTR. TO NEXT OP
2DC6 01E72D     LXI    B,TABL3   ;RESET TABLE PTR.
2DC9 C36E2D     JMP     CHECKF    ;CONTINUE
2DCC FF         DONE:  RST     07    ;FINIS,RETURN TO DDT
;***** SUBROUTINE *****
2DCD 7C         COMPH: MOV     A,H       ;SUBROUTINE USED TO
2DCE 2F         CMA    ;FIND 2'S COMPLIMENT
2DCF 67         MOV     H,A       ;REPRESENTATION OF
2DD0 7D         MOV     A,L       ;H,L REGISTER PAIR
2DD1 2F         CMA    ;
2DD2 6F         MOV     L,A       ;
2DD3 23         INX     H          ;
2DD4 C9         RET

;***** TABLES AND CONSTANTS *****
2DD5 060E16     TABL2: DB 06H,0EH,16H   ;TABLE OF 2 BYTE
2DD8 1E262E     DB 1EH,26H,2EH   ;OP CODES
2DDB 363EC6     DB 36H,3EH,0C6H
2DDE CEDED6     DB 0CEH,0DEH,0D6H
2DE1 DBDEE6     DB 0DBH,0DEH,0E6H
2DE4 EEF6FE     DB 0EEH,0F6H,0FEH
2DE7 011121     TABL3: DB 01H,11H,21H   ;TABLE OF 3 BYTE
2DEA 222A31     DB 22H,2AH,31H   ;OP CODES
2DED 323AC2     DB 32H,3AH,0C2H
2DF0 C3C4CA     DB 0C3H,0C4H,0CAH
2DF3 CCCCDD2     DB 0CCH,0CDH,0D2H
2DF6 D4DADC     DB 0D4H,0DAH,0DCH
2DF9 E2E4EA     DB 0E2H,0E4H,0EAH
2DFC ECF2FA     DB 0ECH,0F2H,0FAH
2DFF FAFC     DB 0FAH,0FCH
2E01          SSTRT: DS 02H    ;SOURCE TOP(A)
2E03          SBOT:  DS 02H    ;SOURCE BOTTOM(B)
2E05          DTOP:  DS 02H    ;DESTINATION TOP(C)
2E07          START: DS 02H ;START OF REF. FIXING(D)
2E09          SSTP:  DS 02H    ;END OF REF. FIXING(E)
2E0B          FUNC:  DS 01H    ;00=REF. FIX ONLY (F)
;02=MOVE ONLY
;01=MOVE & FIX
2E0C          DISPL: DS 02H    ;DISPLACEMENT
2E0E          STACK: DS 08H    ;MEM. SPACE FOR STACK

```

Hexadecimal Code	Operator	Operand
AF	XRA	A
67	MOV	H,A
6F	MOV	L,A

Meanwhile, back in the real world, the LXI problem will usually be encountered by anyone relocating software. Going through a massive assembly listing and manually fixing references would be a tedious and time-consuming chore. Fortunately, the computer can be used to do the "grit" work.

A program that enables the computer to look through the machine code for LXI operation codes is presented in listing 2. I have called it FIXLXI, though corrections must still be made manually. However, the computer does the tedious job of finding LXI operation codes. Upon finding an LXI operation code, the computer outputs the address where the instruction is located, followed by the operation code (eg: 01 for LXI B), and finally the 2-byte hexadecimal constant that is loaded into the register pair. For compatibility with the terminal, all output is in the form of ASCII code. (The conversion from binary to ASCII is done by a simple table look-up procedure.)

For example, upon finding the machine code equivalent of LXI D,21AEH at hexadecimal address 24AB, the program will cause output of the following:

24AB 11 21AE.

Afterward, control passes to the monitor and the operator consults the listing to verify that the code is correct. If not, a manual fix must be performed. (Using CP/M's Dynamic Debugging Tool program as a monitor makes this an easy task. Simply typing in S24AB to the terminal invokes a routine that displays both the memory address (24AB) and the memory contents (01) of the designated location. It then waits for a change to be entered, a command to look at the next memory location, or a command to quit.) When the program is reentered, the search for LXI operation codes resumes at the next operation code following the previously found LXI operation code.

To operate FIXLXI you need only

BYTE BACK ISSUES FOR SALE

The following issues are available:
 1976: July, November
 1977: March, May thru December
 1978: February thru October, December
 1979: January thru December except March

Cover price for each issue through August 1977 is \$1.75 Domestic; \$2.75 Canada and Mexico; \$3.75 Foreign. September 1977 through October 1979 issues are \$2.50 Domestic; \$3.25 Canada and Mexico; \$4.00 Foreign. November 1979 to current is \$3.00 Domestic; \$3.75 Canada and Mexico; \$4.50 Foreign.

Send requests with payment to:

BYTE Magazine
 70 Main St, Peterborough NH 03458
 Attn: Back Issues



Use x, y Genesis Applesoft Subroutines for apple computer Graphs.

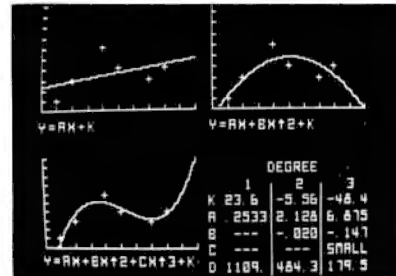

APPLICATIONS IN:
 Engineering Physics Mathematics
 Business Education Stock Market
\$74.95

For more information:

FUTUREWORLD

Department B1
 2514 UNIVERSITY DR.
 DURHAM, NC 27707
 (919) 489-7486

DATA TERMINAL EQUIPMENT — FROM MICROMAIL



LA34 DECwriter IV

\$1,199.00

- Upper/lower case, 9x7 dot matrix
- 10, 12, 13.2, 16.5 characters/inch
- 2, 3, 4, 6, 8 or 12 lines/inch
- 22"W x 7"H x 15 1/2"D, 25 lbs.
- 110 or 300 baud, RS 232C serial ASCII
- Friction feed, paper width to 15"

SOROC IQ 120 **\$795.00**

- RS 232C, upper/lower case, full ASCII
- Numeric keypad, protected fields
- Cursor keys plus addressable cursor
- Auxiliary extension port



SOROC IQ 140 **\$1,250.00**

- RS 232C and 20mA current loop
- Extensive editing features
- 25th line terminal status display
- 16 function keys (32 with shift)



New from DIABLO

DIABLO 1640 **\$2,690.00**

Receive-only **\$2,331.00**

High-quality daisywheel printing at 45 cps.

DIABLO 1650 **\$2,779.00**

Receive-only **\$2,419.00**

Metal daisywheel printing at 40 cps.

T.I. 810 printer **\$1,695.00**

- Includes upper/lower case
- 150 characters per second
- RS 232C serial interface
- Adjustable forms tractor

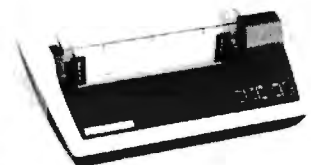

NEC Spinwriter

Call or write for prices

To Order: Send certified check (personal or company checks require two weeks to clear) including handling* and 6% sales tax if delivered within California.

*Handling: Less than \$2,000, add 2%; over \$2,000, add 1%. Everything shipped freight collect in factory cartons with manufacturer's warranty.

MICROMAIL

MICROMAIL • BOX 3297 • SANTA ANA, CA 92703
 (714) 731-4338

specify the starting address (SSTAR) and the ending address (SSTP) of the code to be examined. In listing 2 this information is entered at hexadecimal addresses 2E42 and 2E44.

Employing the FIXLXI program with a terminal operating at a data rate of 1200 bits per second (bps), I found that I could get through our BASIC listing in less than two hours. Similar results were obtained when I relocated another old assembler program.

Data Block Problems

It is not good programming practice to place program constants in the midst of executable code. Unfortunately, this and other kludges are frequently found. However, you will find in most cases that the program constants are at least huddled together in a contiguous block. If this is true, the data block can be moved, but no fixing of references should be performed within the data block. As indicated by Zolman, the procedure in this case is to perform the fixing of references in two stages. First, program references are fixed in the program block up to, but not including,

Table 1: These six pieces of information must be entered into the locations shown (beginning at hexadecimal location 2E01 for listing 1) before a relocation can be performed with the modified relocator program.

Label	Number of Bytes	Address	Comments
a	2	2E01, 2E02	First address of block to be relocated
b	2	2E03, 2E04	Last address of block to be relocated
c	2	2E05, 2E06	Destination address
d	2	2E07, 2E08	First address to have references fixed
e	2	2E09, 2E0A	Last address to have references fixed
f	1	2E0B	Function select: 00 = fix references only 01 = move block and fix references 02 = move block only

the data block. Then, skipping over the data block, program references after the data block are fixed for the remaining portion of the program block.

In addition to the usual data block problems that have been mentioned, there is another difficulty encountered when systems software is relocated. The data blocks in an applications program will normally

contain constants that are independent of the location of the program. In a systems software program like BASIC this is *not* true for all constants. This is so because of the design logic of an interpreter program. Essentially the interpreter works by comparing an input command or function to a table of *legal* commands or functions. If a match is found, con-

Text continued on page 190

New from Osborne/McGraw-Hill

Adam Osborne

foretells the Next Industrial Revolution

A revolution based on microelectronics. Will it prove to be a dream or a nightmare? In his new book, Dr. Osborne takes an honest look at the microelectronics boom; he scrutinizes what is happening today and predicts what will certainly be happening tomorrow.

Running Wild — The Next Industrial Revolution

by Adam Osborne

#28-4. \$3.95

Running WILD



PET™

Personal Computer Guide

by C. Donahue & J. Enger

NEW this Winter

Everything you always wanted to know about PET but Commodore didn't tell you. A practical guide to PET programming techniques, graphics, operation, and how to cope with those *&#! PET peculiarities. #30-6. \$15.00

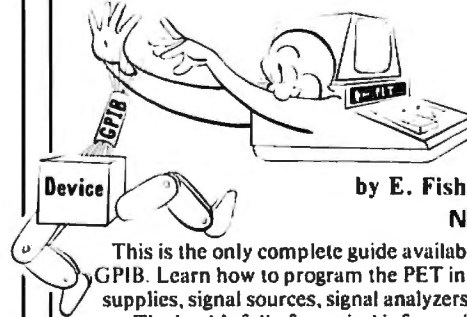

PET™ and the IEEE 488 (GPIB) Bus

by E. Fisher and C. W. Jensen

NEW this Winter

This is the only complete guide available on interfacing PET to GPIB. Learn how to program the PET interface to control power supplies, signal sources, signal analyzers and other instruments.

The book's full of practical information, as one of its authors assisted in the original design of the PET GPIB interface.

*PET is a registered trademark of Commodore Business Machines #31-4. \$15.00



OSBORNE/McGraw-Hill

630 Bancroft Way, Dept. B1, Berkeley, CA 94710

For credit card or phone order, call (415)548-2805



S1073

ANNOUNCING:

NEW!

MICROSTAT

A complete statistics package for business, scientific, education and research work. No other package has the features of MICROSTAT. For example:

- File oriented with COMPLETE editing
- A Data Management Subsystem for editing, sorting, ranking, lagging, data file transfers PLUS 11 data transformations (e.g., linear, reciprocal, exponential, etc.)
- Frequency distributions
- Simple and multiple regression
- Time series (including exponential smoothing)
- 11 Non-parametric tests
- Crosstabs/Chi-square
- Factorials (up to 1,000,000!), permutations, combinations
- 8 Probability distributions
- Scatterplots
- Hypothesis test (Mean, proportion)
- ANOVA (one and two-way)
- Correlation
- Plus many other unique features

Users manual: \$10.00 (credited towards purchase) and includes sample data and printouts. Uses NORTH STAR BASIC 32K of memory, one or two disk drives (2 recommended). Printer optional. Price: \$200.00



ECOSOFT

P.O. Box 68602
Indianapolis, IN 46268

Phone orders:
(317) 253-6828

CP/M 2.0

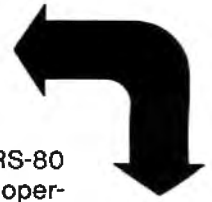

TRS-80 MOD II

Expand the horizons of your TRS-80 model II with the industry standard operating system, CP/M version 2.0, and get these advantages over TRSDOS:

- compatible with hundreds of existing software packages
- wide choice of programming languages: BASIC, PASCAL, FORTRAN, COBOL, C, ASSEMBLER, and others
- faster disk access
- more storage per diskette
- assembler, editor, file handler, and dynamic debugger included with the operating system

Introductory price: \$175 including manuals



For full details about how CP/M 2.0 can improve the performance of your TRS-80 model II, contact:

PICKLES & TROUT

P.O. BOX 1206, GOLETA, CA 93017, (805) 967-9563

CP/M is a trademark of Digital Research Inc. TRS-80 is a trademark of Tandy Corp.

Z-80/TRS-80™ Users BOOK YOU'VE WANTED NOW CAN BE YOURS THE Z-80: HOW IT WORKS (THE PROGRAMMERS PERSPECTIVE)

By Monte Corum

Best Most Complete Reference Yet
cpu Operation Explained

Addressing Modes Demystified

Register Functions Described

Instructions Defined

Interrupts Diagrammed

Cycles Outlined Formats Described

Execution Described in Text,

Notation and Diagrams

Meaningful Analysis of 698 Commands

in Formatted, Usable Tables

Simple, Consistent Notation and Formats

A Programmer's Book, Beginner or Experienced

Ideal Text for Class Instruction

Price: \$17.95 Plus Tax and Shipping

VISA & MSTRCHRG-NUMBER AND EXP. DATE

PREPAID WE SHIP

MICROWARE ASSOCIATES, INCORPORATED

9301 N. 58th St. DPT. AAA

SCOTTSDALE, AZ. 85253

DEALER INQUIRIES INVITED

™ TRS-80 IS A TRADEMARK OF TANDY CORP.

S-100, 6-PORT COMMUNICATIONS

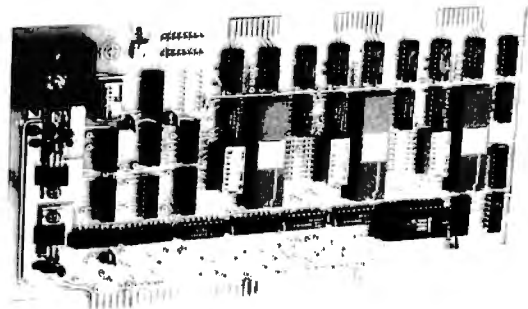

- INTERFACES MULTI TERMINALS, COMPUTERS, PRINTERS, MODEMS, ETC.
- 2, 4, OR 6 CHANNELS; 2 OPTIONAL RTC'S
- SELECTABLE I/O ADDRESS
- PROGRAMMABLE SYNC. CHARACTERS
- SYNC AND ASYNC
- HARDWARE ERROR CHECKING (CRC-16, CCITT)
- COMPLIES WITH: EIA RS-232C STANDARD; IEEE PROPOSED S-100 BUS STANDARD

FULL 6-PORT CONFIGURATION (ASSEMBLED AND TESTED) \$895.00

For information, contact: Dianne Polk (703) 893-4330 x 100

Inco, Inc.
7916 Westpark Drive □ McLean, Virginia 22102

New CRT SENSATION!

You have been reading about our astounding high performance microcomputer products. Our X-9000 Pascal MICROENGINE™ CPU that executes Pascal 13x faster than an LSI-11 and 3x faster than a PDP11-34. Our X-920 CRT matches the features of the SOROC IQ140. Our X-8000 16-bit CPU addresses 8M bytes of memory directly and is coming soon!

*Trademark Western Digital Corporation

DISPLAY/EDIT TERMINAL Model X-920



\$920

\$820 (Without 18 function keys)

STANDARD FEATURES (partial list)

- Microprocessor controlled
- Serial RS232C and 20 ma current loop
- 10 baud rates—75 to 19,200
- 24 lines x 80 characters
- 96 ASCII displayable characters
- Upper and lower case
- 12 x 10 character resolution
- Dual intensity display
- Clear full intensity data only
- Programmable reverse video
- Programmable underline
- 105 keys with alpha lock
- 14 key numeric pad with decimal
- 16 special function keys
- 8 edit function keys
- 2 block transmission keys
- Self test mode
- Protect mode
- Block mode
- 60 storable tabbing
- Insert/delete character and line
- Scrolling
- Addressable cursor
- A host of other features, including cursor controls and remote commands such as clear to nulls, spaces, end of line, end of screen; set hi,lo,zero intensity; set blink; etc.
- Optional screen print & 2nd page memory

For our system or for yours, in commercial, technical, educational or personal applications, the Computex X-920 is unmatched in its class.

All features of the Hazeltine 1400 and ADM-3A Plus: 128 ASCII characters... 7 x 10 matrix... Reverse video... Print key... Shiftlock... Transparent mode... Backspace... Tabbing... Integrated numeric pad.



\$799

List price \$956

PERKIN-ELMER (Model 550)

Off the shelf delivery now on the Model X-920 and P-E Model 550. Add 40 lb. shipping. **Customer satisfaction is guaranteed.** Full refund with the return of any product within 10 days. X-9000 CPU \$2995 Pascal MICROENGINE™ owners manual \$19.95; X-920 operators manual \$10, postpaid. **Cash prices.** 10% down guarantees priority. IL residents add 5% sales tax. **Master Charge and Visa** accepted.

Computex stands for competence. We **service what we sell.** Written hardware warranty. Nationwide service contracts. Custom software. We provide **expert technical support.**

(312) 684-3183
COMPUTEX
Microcomputer Systems
"The Computer Experts"
5710 Drexel Avenue
Chicago, IL 60637

Listing 2: An 8080 program to facilitate the examination and correction of load X immediate (LXI) instructions. (Because of the multiple uses of the LXI instruction, the relocater program of listing 1 can, in certain circumstances, mishandle the 2 bytes of information following the LXI code.) The program is designed to run with the Dynamic Debugging Tool (DDT) of the CP/M software. Given the starting and ending addresses of a source program block, this program finds LXI operation codes. It then displays the following information on the user's terminal: the memory address where the LXI instruction is located; the operation code; the 2 bytes following the operation code. Control is then passed to the monitor to allow the operator to make any needed corrections. Upon reentry the search for LXI operation codes is resumed at the next operation code following the LXI operation code previously found.

```

2D00          ORG      2D00H      JSET ORIGIN
2D00 01182E   START:  LXI      B,TABL3  JB,C=TABLE PTR
2D03 2A422E   LHL  S5STAR  JD,E=MEMORY PTR.
2D06 EB       XCHG
2D07 31AE2E   LXI      SP,STACK+8  JINITIALIZE STACK
2D0A CDEB2D   CALL    BUSY        JCHECK CRT STATUS
2D0D 3E0A     MVI      A,0AH      JLINE FEED
2D0F D30A     OUT     CRT         JTO CRT
2D11 CDEB2D   CALL    BUSY        JCHECK STATUS
2D14 3E0D     MVI      A,0DH      JCARR. RET
2D16 D30A     OUT     CRT         JTO CRT
2D18 3A452E   CHEXP:  LDA      S5STP+1 JCHECK FOR END OF FILE
2D1B 92       SUB
2D1C C2262D   JNZ     NEXT        JCONTINUE IF NOT
2D1F 3A442E   LDA      S5STP
2D22 93       SUB     E
2D23 CA9D2D   JZ      ENDF        JQUIT IF END
2D26 1A       NEXT:  LDAX   D           JLOAD MEM. CONTENTS USING PTR.
2D27 67       MOV     H,A         JSAVE IN H
2D28 AF       XRA    A           JZERO ACCUM.
2D29 6F       MOV     L,A         JSET UP CNTR.
2D2A 2C       COMP3: INR     L           JBUMP CNTR
2D2B 7D       MOV     A,L
2D2C FE1B     CPI    27D         JCHECK FOR END OF TABLE
2D2E CA3A2D   JZ      AGAIN      JJMP IF THRU
2D31 0A       LDAX   B           JLOAD TABLE ENTRY
2D32 9A       SUB     H           JCOMP. WITH CURR. MEM.
2D33 CA4F2D   JZ      MTCH3      JJMP IF MATCH
2D36 03       INX    B           JELSE BUMP TABLE PTR.
2D37 C32A2D   JMP     COMP3      JLOOK AGAIN
2D3A 01062E   AGAIN: LXI      B,TABL2 JPTR HAS ADDR 2 BYTE OPS
2D3D AF       XRA    A           JZERO ACCUM.
2D3E 6F       MOV     L,A         JSET CTR.
2D3F 2C       COMP2: INR     L           JBUMP CTR.
2D40 7D       MOV     A,L
2D41 FE13     CPI    19D         JCHECK FOR END TABLE
2D43 CA572D   JZ      NOMAT      JJMP IF THRU
2D46 0A       LDAX   B           JLOAD TABLE ENTRY
2D47 9A       SUB     H           JCOMP. WITH CURRENT MEM.
2D48 CA562D   JZ      MTCH2      JJMP IF MATCH
2D4B 03       INX    B           JELSE BUMP TABLE PTR.
2D4C C33F2D   JMP     COMP2      JLOOK AGAIN
2D4F 7D       MTCH3: MOV     A,L         JFOUND 3 BYTE OP CODE
2D50 FE05     CPI    05D         JLXI'S FIRST FOUR IN TABL3
2D52 DA5E2D   JC      FDLXI      JIF L<=4 OP IS LXI
2D55 13       NOLXI: INX    D         JNOT LXI IF HERE, SO
2D56 13       MTCH2: INX    D         JMOV MEM. PTR. TO NEXT LOC.
2D57 13       NOMAT: INX    D
2D58 01182E   LXI      B,TABL3   JRESET TABLE PTR.
2D5B C3182D   JMP     CHEXF      JCONTINUE SEARCH
2D5E 7A       FDLXI: MOV     A,D         JFOUND LXI,PREP FOR OUT
2D5F CDAD2D   ADDR:  CALL   BYTE1      JOUTPUT 1ST DIGIT:HI ADDR
2D62 7A       MOV     A,D
2D63 CDB52D   CALL   BYTE2      JOUTPUT 2ND DIGIT:HI ADDR
2D66 7B       MOV     A,E
2D67 CDAD2D   CALL   BYTE1      JOUTPUT 1ST DIGIT:LO ADDR
2D6A 7B       MOV     A,E
2D6B CDB52D   CALL   BYTE2      JOUTPUT 2ND DIGIT:LO ADDR
2D6E CDDC2D   CALL   SPACE      JINSERT TWO SPACES
2D71 1A       OPCODE: LDAX   D
2D72 CDAD2D   CALL   BYTE1      JOUTPUT OPCODE BYTES
2D75 1A       LDAX   D           JOF LXI INSTRUCTION
2D76 CDB52D   CALL   BYTE2
2D79 CDDC2D   CALL   SPACE      JINSERT TWO SPACES
2D7C 13       CONST: INX    D           JD,E POINTS TO 16 BIT
2D7D 13       INX    D           JCONSTANT FOLLOWING LXI OP
2D7E 1A       LDAX   D           JLOAD IT IN ACCUM.
2D7F CDAD2D   CALL   BYTE1      JOUTPUT 1ST DIGIT OF CONSTANT
2D82 1A       LDAX   D           JLOAD AGAIN(BYTE1 CLOBBERS)
2D83 CDB52D   CALL   BYTE2      JOUTPUT 2ND DIGIT(ASCII CODE)
2D86 1B       DCX   D           JPOINT TO 3RD&4TH DIGITS
2D87 1A       LDAX   D           JLOAD IN ACCUM.
2D88 CDAD2D   CALL   BYTE1      JOUTPUT 3RD DIGIT
2D8B 1A       LDAX   D           JLOAD AGAIN
2D8C CDB52D   CALL   BYTE2      JOUTPUT 4TH DIGIT
    
```

Listing 2 continued on page 190

VULCAN = DBMS

THE PROFESSIONAL DATABASE MANAGEMENT SYSTEM

For 8080/Z80 systems under CP/M or PTDOS

- VULCAN is a complete database management system that has 38 powerful, easy to learn, English-like commands to manipulate files, records, fields, and scratch-pad variables.
- VULCAN has a command repertoire which includes such commands as: SORT, REPORT, APPEND, INSERT, EDIT, COPY, REPLACE, LOCATE, DISPLAY, DO, LIST, and LOOP.
- VULCAN structured data records can be selectively chosen for processing using complex Boolean, string, or mathematical expressions.
- VULCAN can be used in interactive or program mode. The program mode uses modern structured command programs to combine powerful DBMS operations.
- VULCAN is written in assembly language for efficient information processing and requires 36K bytes CP/M system and one or more disk drives.
- VULCAN can accept or store data in standard ASCII files to be compatible with BASIC, FORTRAN, etc.

*VULCAN (CP/M or PTDOS) \$490
Manual only \$ 25

SCDP

Software Consultation Design and Production

6542 Greeley St.
Tujunga, CA 91042 (213) 352-7701

California residents add 6% sales tax.

Disc/3 MART, INC.

DO IT YOURSELF

LOW-LOW PRICES

ANADEx Printer, DP 8000 \$ 845.00
CENTRONIX 730 Matrix Printer 825.00
(with 4 free zip pack ribbons)
HAZELTINE 1520 1319.00
IMS 16K RAM Memory Board 350.00
SOROC IQ 120 TERMINAL Assembled .. 795.00

TI "SILENT 700" PORTABLE PRINTERS

TI 743 (RO) 1095.00
TI 743 (KSR) 1250.00
TI 994 Personal Computer 1150.00

CARTRIDGES • DISKETTES • MAG TAPE ACCESSORIES

ADDS, CENTRONICS, HAZELTINE, IMSAI, LEAR SIEGLER, TECHTRAN, TI, VECTOR GRAPHICS AND OTHERS

STORE HOURS: 9 A.M. - 5:30 P.M. Mon. through Fri.

Call or write for quotes or information.

Disc/3 MART, INC.

1840 LINCOLN BLVD.,
SANTA MONICA, CA 90404
(213) 450-5911

EXCITING MAIL ORDER DISCOUNTS



NOVATION CAT

ACOUSTIC MODEM

- ANSWER, ORIGINATE
- 300 BAUD
- BELL 103
- LOW PROFILE DESIGN

\$179⁰⁰

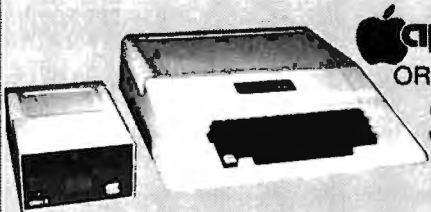

Apple II 16k
OR APPLE II PLUS

\$975

APPLE II 32K *1050
APPLE II 48K *1125

• COLOR • GRAPHICS • SOUND

• APPLE II ACCESSORIES •

APPLE SOFT BASIC CARD.....\$155	APPLE DISK II.....\$440
DC HAYES MICROMODEM.....\$335	WITH CONTROLLER CARD...\$495
ALF MUSIC SYNTHESIZER.....\$240	PASCAL LANGUAGE SYSTEM. \$450
CORVUS 10 MEGABYTE DRIVE \$4,850	INTEGER BASIC CARD.....\$155

SD EXPANDORAM

• 64K S-100 DYNAMIC RAM BOARD	WITHOUT MEMORY.....\$149 00
• WORKS WITH Z-80, 8080 & 8085	16K KIT.....215 00
• POWER CONSUMPTION 5 WATTS	32K KIT.....269 00
• BANK SELECT • PHANTOM REFRESH	48K KIT.....349 00
• NO WAIT STATES REQUIRED	64K KIT.....409 00

ADD \$50 FOR ASSEMBLED & TESTED

LEEDEX VIDEO 100

12" BLACK & WHITE MONITOR

- VIDEO BANDWIDTH 12 MHz ±3db
- COMPOSITE VIDEO INPUT

\$129⁰⁰



SOROC IQ 120

- SERIAL RS232C
- FULL ASCII UPPER/LOWER CASE
- NUMERIC KEYPAD CURSER KEYS
- SCREEN CONTROL & PROTECTED FIELDS

\$750⁰⁰

• ALSO AVAILABLE •

SOROC IQ 140 \$1,225.⁰⁰



AXIOM

Ex 801 MicroPrinter \$495
Ex 820 MicroPlotter \$795

WORKS DIRECTLY WITH APPLE TRS-80 PET

- SILENT NON-IMPACT OPERATION
- 160 CHARACTERS PER SECOND
- 80, 40 OR 20 COLUMNS PER LINE
- RS232C/20MA OR PARALLEL ASC II

EX820 MicroPlotter



• TO ORDER •

Phone orders invited, using credit cards. Or send cashiers check or money order that draws on a U.S. bank. Please add 3% (\$10 Minimum) for handling, shipping (air service) and insurance, or equipment will be shipped freight collect. California residents add 6% sales tax. All equipment is in factory cartons with the manufacturer's warranty. Equipment is subject to price change and availability without notice.



VISA



COMPUTER SPECIALTIES

1840 LINCOLN BLVD., SUITE 202,
SANTA MONICA, CA 90404 • (213) 450-5911

```

2D8F CDDC2D          CALL SPACE          ;INSERT TWO SPACES
2D92 13             THRU: INX D              ;ADVANCE MEM PTR
2D93 13             INX D              ;TO NEXT OP CODE
2D94 01422E        LXI B,SSSTAR        ;SAVE MEM PTR
2D97 7B             MOV A,E            ;TO NEXT LOC.
2D98 02             STAX B           ;SO CAN LOOK FOR
2D99 7A             MOV A,D            ;NEXT OP CODE
2D9A 03             INX B              ;UPON REENTRY
2D9B 02             STAX B           ;TO PROG.
2D9C FF             RST 07           ;GO MANUAL CONTROL
2D9D 01F12D        ENDF: LXI B,MESGE-1    ;FIND EOF MESSAGE
2DA0 03             LOOPO: INX B              ;LOAD IT,BYTE AT A TIME
2DA1 CDEB2D        CALL BUSY          ;CHECK STAT OF CRT
2DA4 0A             LDAX B           ;
2DA5 D304          OUT CRT           ;PUT IT OUT
2DA7 FE48          CPI "H"          ;TILL END
2DA9 C2A02D        JNZ LOOPO         ;GO TO MANUAL
2DAC FF             RST 07           ;CONTROL WHEN FINIS

;***** OUTPUT SUBROUTINES *****
2DAD E6F0          BYTE1: ANI 0F0H         ;MASK LEAST SIG. BITS
2DAF 47             MOV B,A          ;SAVE IT
2DB0 AF             XRA A           ;SET FLAG=0
2DB1 CDBE2D        CALL OUTT         ;OUTPUT TO CRT
2DB4 C9             RET              ;RETURN FOR NEXT
2DB5 E60F          BYTE2: ANI 0FH         ;MASK MOST SIG. BITS
2DB7 47             MOV B,A          ;SAVE
2DB8 AF             XRA A           ;A=0
2DB9 3C             INR A           ;SET FLAG=1
2DBA CDBE2D        CALL OUTT         ;OUTPUT TO CRT
2DBD C9             RET              ;MORE?
2DBE FE00          OUTT: CPI 00H         ;CHECK FLAG
2DC0 C2CB2D        JNZ RESTR        ;IF 01 BR AROUND
2DC3 78             MOV A,B          ;GET OUT BYTE
2DC4 1F             RAR             ;SHIFT INTO
2DC5 1F             RAR             ;LOWEST 4 BITS
2DC6 1F             RAR             ;PREP FOR CONV
2DC7 1F             RAR             ;TO ASCII
2DC8 C3CC2D        JMP TYPOT        ;CONVERT & OUTPUT
2DCB 78             RESTR: MOV A,B          ;GET OUT BYTE
2DCC 6F             TYPOT: MOV L,A      ;SET UP FOR CONV
2DCD AF             XRA A           ;
2DCE 67             MOV H,A         ;0 IN TOP 8 BITS
2DCF 01322E        LXI B,ASCTB      ;LOAD ADDR TABLE IN B,C
2DD2 09             DAD B           ;GET POS IN TABLE
2DD3 EB             XCHG          ;SAVE D,E
2DD4 CDEB2D        CALL BUSY          ;CHECK STAT OF CRT
2DD7 1A             LDAX D          ;LOAD CONV. VALUE
2DD8 D304          OUT CRT           ;PUT IT OUT
2DDA EB             XCHG          ;GET D,E BACK
2DDB C9             RET              ;RETURN FOR NEXT BYTE
2DDC CDEB2D        SPACE: CALL BUSY        ;CHECK CRT STAT
2DDF 3E20          MVI A," "       ;SPACE
2DE1 D304          OUT CRT           ;TO CRT
2DE3 CDEB2D        CALL BUSY          ;CHECK STAT
2DE6 3E20          MVI A," "       ;ANOTHER SPACE
2DE8 D304          OUT CRT           ;TO CRT
2DEA C9             RET

;***** STATUS CHECK OF OUTPUT PORT *****
2DEB DB05          BUSY: IN CRTS         ;CHECK IF READY
2DED 1F             RAR             ;
2DEE D2EB2D        JNC BUSY         ;
2DF1 C9             RET              ;RETURN IF READY
2DF2 0A0D          MESGE: DB 0AH,0DH
2DF4 454E44204F    DB "END OF FILE SEARCH"

;***** TABLES AND CONSTANTS *****
2E06 060E16        TABL2: DB 06H,0EH,16H    ;TABLE OF 2 BYTE
2E09 1E262E        DB 1EH,26H,2EH    ;OP CODES
2E0C 363EC6        DB 36H,3EH,0C6H
2E0F CEDED6        DB 0CEH,0DEH,0D6H
2E12 DBDEE6        DB 0DBH,0DEH,0E6H
2E15 EEF6FE        DB 0EEH,0F6H,0FEH
2E18 011121        TABL3: DB 01H,11H,21H    ;TABLE OF 3 BYTE
2E1B 312A22        DB 31H,2AH,22H    ;OP CODES.
2E1E 323AC2        DB 32H,3AH,0C2H    ;LXI INSTR. ARE FIRST
2E21 C3C4CA        DB 0C3H,0C4H,0CAH
2E24 CCCDD2        DB 0CCH,0CDH,0D2H
2E27 D4DADC        DB 0D4H,0DAH,0DCH
2E2A E2E4EA        DB 0E2H,0E4H,0EAH
2E2D ECF2F4        DB 0ECH,0F2H,0F4H
2E30 FAFC          DB 0FAH,0FCH
2E32 30313233      ASCTB: DB 30H,31H,32H,33H    ;TABLE OF ASCII
2E36 34353637      DB 34H,35H,36H,37H ;EQUIVALENTS OF
2E3A 38394142      DB 38H,39H,41H,42H ;NOS. 1-F HEX
2E3E 43444546      DB 43H,44H,45H,46H
2E42              DS 02H          ;START OF SOURCE
2E44              SSTP: DS 02H      ;END OF SOURCE
2E46              STACK: DS 08H     ;SPACE FOR STACK
0004 =            CRT EQU 04      ;CRT PORT
0005 =            CRTS EQU 05     ;CRT STATUS PORT

```

Text continued:

trol is passed to that routine within the BASIC code. This procedure is frequently implemented by storing the address of the desired routine immediately adjacent to the command (function). (Actually, since commands (functions) are not all the same length (RESTORE is larger than FOR), it is common practice to place a delimiter, such as 0, immediately after the command (function). The address of the proper routine then follows.)

Thus, after the system software has been relocated and program references fixed, the command and function table addresses must also be fixed. These areas will usually be clearly indicated in the program listing. Also, since the data that must be changed is reasonably small, a manual fix can be readily performed. The success of this process is dependent upon your knowing the new addresses of the command (function) routines. Consequently, if a number of shifts and/or additions must be made, I would strongly suggest that changes and fixes be made one at a time. While this procedure requires more work, it is preferable to making all changes at once, since it is easy to lose track of where everything is located.

Caveat Emptor

After carefully implementing the programs and following the procedures that have been outlined, you may still find that your relocated software has glitches. Excluding pilot error, the source of any problems can logically be only an improper reference fix. While there may be many ways for this to happen, I have found only two species of software bugs that create this problem.

The first, and potentially least troublesome, bug occurs when an isolated byte or two of data is buried in the middle of executable code. With this particular gem I also found a call to a subroutine whose sole function was to implement a jump over the data! (I'm not making this up. I really did find this super kludge.)

If you are extremely lucky, the isolated byte(s) will not just happen to be the same as one of the 2- or 3-byte operation codes. In this case the relocater program will assume incorrectly that it is a 1-byte operation and correctly continue to search for 3-byte operation codes. In the more

**NO FRILLS! NO GIMMICKS! JUST GREAT
DISCOUNTS
MAIL ORDER ONLY**

HAZELTINE

1400	} Call For Prices
1410	
1420	
1500	
1500(Kit)	

CENTRONICS

779-2	995.00
700-2	1350.00
703 tractor	2195.00
Micro Printer	395.00
730	975.00

NORTHSTAR

Horizon I assembled ..	1629.00
kit	1339.00
Horizon II assembled ..	1999.00
kit	1599.00

TELETYPE

Mod 43	995.00
--------------	--------

INTERTEC

Superbrain	2195.00
------------------	---------

DIGITAL SYSTEMS

Computer	\$ 4345.00
Double Density Dual Drive	2433.00

TELEVIDEO

912	} Call For Prices
920	

DEC

LA 34	1149.00
-------------	---------

CROMEMCO

System III \$1000 off ..	4990.00
--------------------------	---------

TEXAS INSTRUMENTS

810 Printer	1595.00
-------------------	---------

ATARI 800

795.00

ADDS Regent 25

CALL

Optima Cabinets (New) ..

99.95

5" Scotch Diskette

Box/29.95

8" Scotch Diskette

Box/34.95

Most items in stock for immediate delivery. Factory-fresh, sealed cartons.

DATA DISCOUNT CENTER

Box 100 135-53 Northern Blvd., Flushing, New York 11354, 212/465-6609

N.Y.S. residents add appropriate Sales Tax. Shipping FOB N.Y. BankAmericard, Master Charge add 3%. COD orders require 25% deposit.

**T.D.Q.
TAPE DATA QUERY**

**THE IDEAL SOLUTION FOR PERSONAL AND
VERY-SMALL BUSINESS DATA MANAGEMENT**

PET-8K

TRS-80-LVL II

* COMPLETE CASSETTE FILE MANAGEMENT SYSTEM

- ENGLISH-LIKE COMMAND LANGUAGE
- REPORT GENERATOR
- UTILITY PACKAGE
- NO PROGRAMMING KNOWLEDGE REQUIRED
- REQUIRES 2 CASSETTE RECORDERS

* T.D.Q. APPLICATION CASEBOOK

-COMPLETE DIRECTIONS TO MICRO-COMPUTERIZE:

- | | |
|-----------------------|--------------------------|
| ● INVENTORY CONTROL | ● CUSTOMER DIRECTORY |
| ● ACCOUNTS RECEIVABLE | ● APPOINTMENT SCHEDULING |
| ● ACCOUNTS PAYABLE | ● VENDOR MASTER FILE |
| ● ORDER PROCESSING | ● PAYROLL JOURNAL |
| ● LABEL PRINTING | ● CHECKBOOK JOURNAL |
| ● CHECK PRINTING | ● TELEPHONE BOOK |
| ● INVOICE PRINTING | ● RENT COLLECTION |

SPECIAL YEAR-END SALE PRICE - \$100.00

INCLUDES:

CASEBOOK; 2 CASSETTES; 3 USER'S MANUALS & REF. CARDS

ORDERS MUST BE RECEIVED BY JAN. 31, 1980

SEND CHECK OR MONEY-ORDER TO:

H. GELLER COMPUTER SYSTEMS

P.O. BOX 350

NEW YORK, N.Y. 10040

(N.Y. RESIDENTS ADD SALES TAX)

Baud News

Published by Datasouth Computer Corporation, 627-F Minuet Lane, Charlotte, NC 28210.

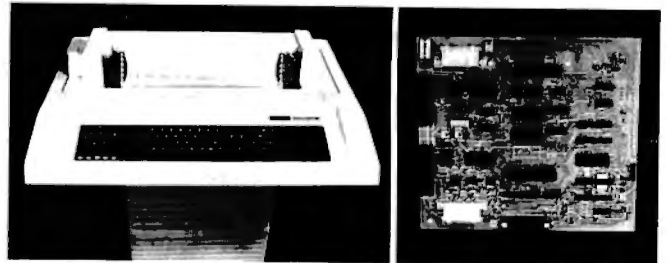

For LA36 Owners, 1200 Baud Breakthrough

CHARLOTTE A spokesman for Datasouth Computer Corp. confirmed reports of LA36 DECwriters® printing at blazing speed. With Datasouth's DS120 Terminal Controller, the LA36 prints bidirectionally at speeds up to 165 cps with true 1200 baud throughput. A 1000 character internal print buffer eliminates the need for fill characters.

is fully compatible with existing electronics.

Results Are In

As BAUD NEWS went to press, DS120's were providing enhanced speed and versatility for more than 3000 LA36 owners. The micro-processor-based electronics have proven very reliable, and service, when needed, has been prompt and efficient. Of course, the DS120 comes with a 90-day warranty on materials and workmanship.

Well-Endowed With Features

Versatile performance features include complete forms control and data formatting capability programmable from either the keyboard or data stream; plus both an EIA RS232-C and 20mA Current Loop interface.

Easy Installation

This blazing speed is accomplished by replacing the LA36 logic card with the DS120 unit—which

Delivered Nationwide

Datasouth reports a network of stocking distributors in major cities throughout the U.S. for prompt service and delivery. The spokesman added that he welcomes inquiries and will gladly give you all the details on the DS120. He can be called at 704/523-8500 or addressed at Datasouth's office, 627-F Minuet Lane, Charlotte, N.C. 28210.

DEC is a registered trademark of Digital Equipment Corporation. Installation of the DS-120 will void any DEC warranty or service contract.

usual case, the isolated byte will be identical to a 2- or 3-byte operation code. Then the possibility exists not only for an improper reference fix, but also for a mangling of the operation code(s). Fortunately, this mangling process is generally not self-propagating, so the damage is usually localized.

The second, and potentially most troublesome, bug involves the writing of relocatable code. While it may come as a surprise, yes there is such a thing as nonrelocatable code. To see that this is so, recall that the relocator program fixes references by operating only on the 2-byte hexadecimal constant following 3-byte operation codes. Implicit in this procedure is the logical assumption that all references to program addresses will be made via 3-byte operation codes. Certainly this is the easiest and most natural way to handle addresses. However, it is possible to use the 1- and 2-byte operation codes to manipulate addresses.

As a case study of this particular "buggy" (and bugging) practice, I submit the verbatim example from a listing of an assembler program in listing 3.

In this example the programmer needed to load the character following an operation code into the DE register pair without disturbing

the HL register pair. Without a detailed knowledge of other program constraints, it is difficult to specify a foolproof fix for this code. Assuming no stack problems, appropriate substitutions are suggested in listing 4.

Those wishing to write relocatable code will avoid use of the programming practice illustrated in listing 3. (This is not an onerous requirement, since code that violates this convention tends to be tortured and unnatural.) Those who, for proprietary or other reasons, wish to write nonrelocatable code will liberally sprinkle their code with such examples.

What To Do

At this point it is reasonable to ask what can be done if you encounter one of the exotic bugs I have discussed. Unfortunately, there is no quick fix that is generally applicable. However, the following guidelines and suggestions may be helpful.

First, the source of the bug needs to be isolated to an area less than the size of the whole program. To do this, study the actual operation of the program. For which commands or functions does the program fail? After this bit of detective work, examination of the command or function table of your listing will tell you where to begin looking for the bug(s).

If nothing turns up at this point, the bug may be in a subroutine called by the command (function) routine. Even worse, it may be in a subroutine called by the subroutine, etc.

Finally, if all else fails, it will be necessary to perform a step-by-step trace of the operation of the program. At best this is a tedious process. If, however, you have isolated the bug, it is possible to set up a breakpoint that is activated only upon entry to the program segment that is suspect. (A breakpoint works by causing program control to pass to the monitor when the breakpoint is encountered. Before the breakpoint is activated, program execution is performed at normal machine speed.) With the Dynamic Debugging Tool program of the CP/M system distributed by IMSAI, a single breakpoint can be set by temporarily replacing a byte of the suspect software with the RST 07 instruction (FF in machine code). After the monitor has control, you can use it to generate a detailed trace of the program's operation for the suspect area.

After this recounting of the perils of relocating systems software, I hope that the reader is not totally discouraged. For well-designed software, relocation can be easily managed using the relocator and FIXLXI programs. ■

Address	Hexadecimal Code	Instruction Mnemonic	Operand	Commentary
BDC4	3E F0	MVI	A,ABUFF and 0FFH	;LOAD LOW BUFFER ADDRESS
BDC6	80	ADD	B	;ADD LENGTH OF OP CODE
BDC7	5F	MOV	E,A	
BDC8	3E D4	MVI	A,(ABUFF and 0FF00H)/256	
BDCA	CE 00	ACI	0	;GET HIGH ORDER ADDRESS
BDCC	57	MOV	D,A	
BDCD	1A	LDAX	D	;FETCH CHARACTER AFTER OP CODE

Listing 3: An example of poor programming practice. In this example, the programmer has loaded the DE register pair without disturbing the HL register pair. However, because the reference to the address hexadecimal D4F0 is done via 1 and 2-byte op code, this machine is not machine relocatable.

Address	Hexadecimal Code	Instruction Mnemonic	Operand	Commentary
BDC4	11 F0 D4	LXI	D,D4F0	;LOAD BUFFER ADDRESS
BDC7	E5	PUSH	H	;SAVE H,L PAIR
BDC8	68	MOV	L,B	;GET LENGTH OF OP CODE
BDC9	26 00	MVI	H,00	;PAD WITH ZEROS
BDCB	19	DAD	D	;ADD LENGTH TO BUFFER
BDCC	EB	XCHG		;PUT RESULTS IN D,E
BDCD	E1	POP	H	;GET H,L BACK
BDCE	1A	LDAX	D	;FETCH CHARACTER AFTER OP CODE

Listing 4: Another method of performing the operation shown in listing 3. Here the reference to the address hexadecimal D4F0 is done using the LXI op code. This code is machine relocatable.

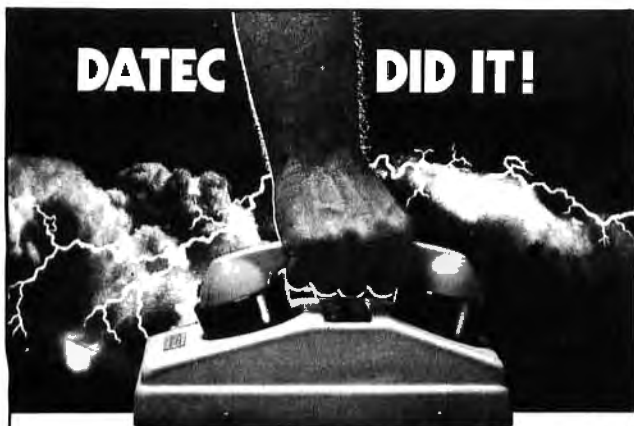

THE HEAVY DUTY COUPLER

Crystal control punches through rain-soaked, muddy lines to grab weakened signals.

Heavy duty rubber cups hold fast... knock out noise.

Torture testing boosts reliability above 99%. DATEC Heavy Duty couplers are guaranteed.

We're building our reputation on acoustic couplers. We've got to build them better.



DATEC

Datec Incorporated
300 E. Main Street
Carrboro, N.C. 27510
(919) 929-2135

DATEC 30 originate only. DATEC 32 originate and answer Full or half duplex switchable. 0-300 BPS.

CP/M SOFTWARE

Word Processing For CP/M

FMT Text Formatter \$75

Use FMT and your text editor to convert your CP/M system to a powerful word processor. FMT features include automatic page headings and footings, page numbering, centering, underscoring, external file merging, and in-line console input. FMT works with any video, CRT, or hardcopy terminal and printer combination. Added capabilities for daisy-wheel printers: superscripting, subscripting, and half-line spacing.

Run Cromemco Software Under CP/M

ADAPT Software Interface \$50

Now you can get Cromemco software to run on your CP/M system. ADAPT interfaces those powerful Cromemco packages (except for Multi-User BASIC) to any CP/M Version 1.4 system without patching. ADAPT works without changes for any memory size.

Fast RATFOR

RATFOR [RATIONAL FORtran] \$95

RATFOR lets you write structured code that translates to MicroSoft or Cromemco FORTRAN. TSW's RATFOR [RATIONAL FORtran] precompiler runs at more than 1000 statements per minute. Documentation includes "Software Tools" book by Kernighan and Plauger. (ADAPT and RATFOR packages combined \$125)



THE SOFTWARE WORKS
8369 Vickers
San Diego, CA 92111
(714) 569-1721

* CP/M is a trademark of Digital Research

WE ARE KNOWN FOR OUR PROMPT, COURTEOUS SERVICE

★ HAZELTINE CRT's ★★ NEW, LOW PRICES ★

1500 (assembled) \$885.
1510 \$980.
1520 \$1,210.
50 Hz option available for all models \$100.
German, French, Danish character sets \$30.

TELETYPE MODEL 43

4320 AAA (TTL interface) \$985.
4320 AAK (RS232 interface) \$1,085.
with transformer to operate on 50 Hz., 220 v.
installed inside cabinet \$75.

PAPER TIGER

..... \$950.
Graphics option, add \$199.
198 cps. 8 software selectable character sizes, adjustable tractor, plain paper, Impact, dot matrix printer. An outstanding value!

DECwriter 35/36 upgrade

Specs available.

INCREASE BAUD RATE TO 1200 \$750.

IMS 5000 and IMS 8000 Complete Z80 systems starting at \$2,050. 4 I/O ports, 1K EPROM bootstrap loader, double density drives, 5 1/4 or 8" disks. S-100 bus. 12 slot mainframe. A beautiful, high quality system. Runs CP/M.

INTERTEC SUPER BRAIN

..... \$2,885.
Dual Z80, dual double density floppies, 32K RAM (expandable) 4Mhz., CP/M, Contained in Intertube II.

INTERTUBE II

..... \$875.

SOROC IQ 120

..... \$865.

IMS 16K Fully static memory, 250 ns

..... \$285.

MARINCHIP SYSTEMS 9900 16 BIT CPU

Price includes DOS, BASIC, word processor, text editor, linking loader

Assembled \$700.
Kit \$550.

Complete systems configured from \$5,700.

DRIVES

SIEMENS 8" double density, Shugart compatible \$450.

PER SCI 277 \$1,200.

299B \$1,700.

INNOTRONICS 2 drives with cabinet and power \$1,565.
Shugart compatible. Extremely reliable.

CONTROLLERS:

Tarbell single density \$255.

double density \$380.

Konan S-100, hard disk controller \$1,550.

TEI Mainframes

..... completely tested and assembled

12 slot \$433.

22 slot \$609.

MODEM: "THE CAT" from Novation

..... \$190.
Originate/answer, 300 baud. Incredibly compact!

CENTRONICS, TEXAS INSTRUMENTS, PRINTERS, DIABLO, NEC SPINWATER, DEC LA 34, PET, TRS-80 ALSO AVAILABLE.

TO ORDER: We ship within 24 hours of receipt of certified check, bank check or money order. Credit cards add 4%.

Personal checks: allow ten days.

COD'S ACCEPTED AT NO EXTRA CHARGE.

Shipping charge: \$13. for terminal, \$4. for memory, modems.

N.Y. residents add sales tax. Prices and availability subject to change without notice.

DEALER INQUIRIES INVITED.

WE EXPORT TO ALL COUNTRIES

OVERSEAS CALLERS USE (212) 448-6298 OR

TWX: 710 588 2844 CABLE: OWENS ASSOC.

We have no reader inquiry number.

Please call or write. Product sheets available.

JOHN D. OWENS ASSOCIATES, INC.

12 SCHUBERT STREET

STATEN ISLAND, NEW YORK 10305

(212) 448-6283 (212) 448-6298

U.S. ROBOTICS, INC.

LA34 DECwriter IV \$1199.00



- Tabs
- 132 columns
- 10, 12, 13.2, 16.5 characters/inch
- 2, 3, 4, 6, 8 or 12 lines/inch
- Optional tractor feed
- 110 or 300 baud
- RS232C/ASCII
- Friction feed/up to 15" wide paper
- 9x7 dot matrix, impact printing
- Upper/lower case

Teletype Model 43 KSR \$1049.00

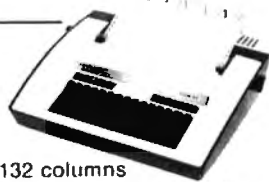

- 110 or 300 baud
- RS232C/ASCII
- Pin feed/8 1/2" H x 11" W paper is perfect for filing and copying
- 132 columns
- Upper/lower case, true descenders
- Dot matrix, impact printing



The 550 BANTAM from Perkin-Elmer \$799.00

All the features of the
Hazeltine 1400 &
LSI ADM-3A plus

- Shiftlock Key
- Print Key
- Integrated Numeric Pad
- Editing Functions
- Extremely Compact: 15" W x 19" D x 14" H
- Silent fan-free operation
- Upper/Lower Case
- 7x10 Character Matrix
- White or Black Characters
- Transparent Mode
- Addressable Cursor
- Tab Function
- Backspace Key

PENRIL 300/1200 MODEM Originate/Auto-Answer \$799.00



- RS232
- Full duplex over voice grade phone lines
- 1 year warranty
- Stand alone
- 0-300 or 1200 baud
- Bell 212A & 103/113 compatible
- FCC certified for direct connection to phone lines via RJ11C voice jack (standard extension phone jack)

USR-300 Series

USR-310 Originate



Acoustic Coupler \$159.00

- 0-300 Baud
- Bell 103/113 compatible
- Stand Alone
- RS232
- 1 Year Warranty
- Crystal Controlled
- State of the Art LSI circuitry
- 5 stage active filters

USR-330 Originate/ Auto-Answer



Modem \$339.00

FCC certified for direct connection to phone lines via standard extension phone jack.

USR-320 Auto-Answer Modem \$319.00

U.S. ROBOTICS, INC.

1035 W. LAKE ST.
CHICAGO, ILL. 60607

Sales
General Offices
Service

(312) 733-0497
(312) 733-0498
(312) 733-0499

Clubs and Newsletters

Hobby Computer Club of Holland (HCC)

The HCC now has over 3000 members in 12 local groups which meet on a monthly basis. They welcome information on all aspects of microcomputing and currently are in need of information on hardware and software for the Apple II. Contact the HCC, Christinalaan 171, Eindhoven, NETHERLANDS.

Home Software Exchange's Program of the Month Club

This club offers an opportunity for persons who own small computers to buy and sell cassette computer programs. Upon joining, each member receives a yearly catalog of all programs listed on the exchange and monthly newsletter updates. A \$2 royalty fee is given each time a member's program is purchased. Membership dues are \$6 per year. To join send the membership dues and the programs you wish to list on cassettes with a listing of the program and a short description.

Contact the Home Software Exchange, 1716 Dixie Dr, Jackson MS 39209.

Computerized Investments Club

The purpose of this club is to trade ideas, data, and programs related to the stock, option, and commodity markets. Club projects include the development of computerized trading and investment systems, and the development of a shared data base.

Write to Computerized Investments Club, R D 1 Box 138, Sicklerville NJ 08081.

Videodisc News

This monthly newsletter is designed for readers in communications, education, television, audio and visual production, information storage and retrieval, microcomputers, and home video entertainment. Articles will cover new developments in software and hardware, competitive comparisons, conferences and services, and more. A special subscription rate of \$95 per year is available to BYTE readers.

Contact Subscriber Services, Videodisc News, POB 5340, W Bloomfield MI 48033.

Medical Computer Journal

MCJ is a newsletter that is devoted to information about computers and their uses in the daily practice of private physicians. Issues will cover the most common illnesses and the use of computers in dealing with them, computer systems, laboratory test interpretation and analysis using computers, and ideas for the uses of computers in offices.

Subscriptions are \$15 per year. For information, contact Dr Aziz Ghaussy, editor of the MCJ, 42 E High St, E Hampton CT 06424.

Computer Newsletter for Engineers

Engineering Computer Applications Newsletter (ECAN) is being published monthly to inform and advise engineers on how to use advanced computer technology and increase productivity and profits. ECAN will contain articles on small

computers, peripheral equipment, engineering programs, combining large and small computers, graphics in engineering design, and many other topics. Subscriptions are \$36 per year. Contact *ECAN*, 5 Denver Tech Ctr, POB 3109, Englewood CO 80111.

Crescent City Computer Club

This club meets once a month in a general meeting and they also have monthly meetings for their specialized groups. Their meetings are held at 8 PM in room 2120 of the University of New Orleans Science Bldg, on the main campus. The club also publishes a newsletter that covers the events of the meetings.

Contact the Crescent City Computer Club, POB 1097, University of New Orleans LA 70122.

Arcadian Newsletter

This newsletter has articles concerning various aspects of computing. Programs, schedules of events, corrections of programs, and general information items appear. Ads are welcome, and the latest issue included an item from the editor looking for reviews of software programs.

Contact *Arcadian*, 3626 Morrie Dr, San Jose CA 95127.

Apple Canada Users Group

This new group has been meeting on the first Wednesday of every month at the Computerland/Toronto store, 2180 Yonge St, Toronto, Ontario Canada. The meetings begin at 7:30 PM.

Contact Apple-Can, 2180 Yonge St, Toronto, Ontario M4S 2B9 CANADA.

Heath Users Group (HUG) Newsletter

REMark is a HUG membership magazine published quarterly for members only. The newsletter contains articles on programming, expanding the capabilities of Heath computers and items of general interest. Subscriptions are \$14 a year and should be sent to the Heath Users' Group, Hilltop Rd, St Joseph MI 49085.

Sphere Newsletter

The Sphere Microcomputer Newsletter contains hardware and software features of interest to M6800 microcomputer owners and more specifically to Sphere owners. The newsletter is mailed 6 times a year. The subscription rate is \$12 and should be addressed to Jeffrey Brownstein, 2 Tor Rd, Wappingers NY 12590. Material for publication should be sent to coeditor Roger J Spott, 13975 Connecticut Ave, Wheaton MD 20906. ■



Like All Modern Vehicles — The Cost Goes Up

George, the programmable toy van from Beneficial Marketing, was listed in the November issue as costing \$24.95. This should read \$39.95. ■

DYNACOMP



Quality software for: Apple II Plus
TRS-80 (Level II)
North Star

All software is supplied with complete documentation which includes clear explanations and examples. Each program will run with standard terminals (32 characters or wider) and within 16K program memory space. Except where noted, all software is available on North Star diskette (North Star BASIC or Microsoft BASIC for those North Star systems running under CP/M), TRS-80 cassette (Level II) and Apple cassette (*Applesoft BASIC*). These programs are also available on *PAPER TAPE* (Microsoft *BASIC*).

FLIGHT SIMULATOR

(as described in *SIMULATION*, Volume II)

A realistic and extensive three-dimensional simulation of take-off, flight and landing. The program utilizes aerodynamic equations and the characteristics of a real airfoil. You can practice instrument approaches and navigation using radials and compass headings. The more advanced flyer can also perform loops, half-rolls and similar aerobatic maneuvers.

Price: \$17.95 postpaid
SIMULATION, Volume II (BYTE Publications): \$6.00

VALDEZ

A simulation of supertanker navigation in the Prince William Sound and Valdez Narrows. The program uses an extensive 256X256 element radar map and employs physical models of ship response and tidal patterns. Chart your own course through ship and iceberg traffic. Any standard terminal may be used for display.

Price \$14.95 postpaid

BRIDGE 2.0

An all-inclusive version of this most popular of card games. This program both *BIDS* and *PLAYS* either contract or duplicate bridge. Depending on the contract, your computer opponents will either play the offense OR defense. If you bid too high the computer will double your contract! *BRIDGE 2.0* provides challenging entertainment for advanced players and is an excellent learning tool for the bridge novice.

Price: \$17.95 postpaid

HEARTS 1.5

An exciting and entertaining computer version of this popular card game. Hearts is a trick-oriented game in which the purpose is not to take any hearts or the queen of spades. Play against two computer opponents who are armed with hard-to-beat playing strategies.

Price: \$14.95 postpaid

MAIL LIST I NEW

A many-featured mailing list program which sorts through your customer list by user-defined product code, customer name or Zip Code. Entries to the list can be conveniently added or deleted and the printout format allows the use of standard size address labels. Each diskette can hold approximately 900 entries.

Price: \$18.95 postpaid (available for North Star only)

TEXT EDITOR I (Letter Writer)

An easy to use, line-oriented text editor which provides variable line widths and simple paragraph indexing. This text editor is ideally suited for composing letters and is quite capable of handling much larger jobs.

Price: \$14.95 postpaid

COMPRESS

Make your BASIC programs run faster and use less memory! In many cases you can reduce the size of your programs by 30% or more, while improving execution speed by a comparable amount. Save money by storing more programs on each diskette or cassette.

Price: \$9.95 postpaid

GAMES PACK I NEW

Seven entertaining games for less than a dollar a kilobyte! Play *CATAPULT*, *CRAPS*, *SWITCH*, *HORSERACE*, *SLOT MACHINE*, *BLACKJACK* and *LUNAR LANDER*. This is an excellent way to introduce your children to computers.

Price: \$10.95 postpaid

All orders are processed within 48 hours. Please enclose payment with order. If paying by *MASTER CHARGE* or *VISA*, include all numbers on card. Foreign orders add 10% for shipping and handling.

Write for detailed descriptions of these and other programs available from DYNACOMP.



DYNACOMP

P.O. Box 162

Webster, New York, 14580

New York State residents please add 7% NYS sales tax.



SPRING 1980

10001010111010100000001000010111110100010101111

JAMES MARTIN SEMINAR

10001010111010100000001000010111110100010101111



Future Strategy, Management, & Design for:

- Distributed Processing
- Data Base
- Networks
- Corporate Strategy

Atlanta	Feb. 25-29
San Francisco	March 17-21
New York	March 17-21
Chicago	March 24-28

CALL OR WRITE: (213) 476-9747

**TECHNOLOGY
TRANSFER
INSTITUTE**

P.O. BOX 49765, LOS ANGELES, CA. 90049 (213) 476-9747

BYTE's Bits

A New System for Medical Data Processing

The Computer Center Inc, 433 Valley Ave, Birmingham AL 35209, is marketing the Doctors Office Computer System (DOCS). DOCS organizes precise methods to control cash flow and has the capability to handle all doctors' medical and financial bookkeeping needs in a single system. The present package processes charge and payment entry, patient statements, insurance billing, Medicare and Medicaid submittals, collection agency referrals, and the patient accounting system identifies unpaid charges by age, amount, and percentage of payment. Additionally, the patient accounting system handles patient admission updates, records, and appointments.

DOCS is designed to run on an Alpha Micro 100, with a minimum of 64 K memory and is currently being adapted for use on Texas Instruments and Hewlett-Packard systems. To install DOCS, a medical group can expect to invest from \$35,000 to \$70,000 for hardware and software.

Call for Papers

On August 27-28, the IEEE Computer Society will sponsor the Second Workshop on Picture Data Description and Management in Asilomar, California. This conference will address the problems of storage, retrieval and manipulation of pictures of great complexity and of large numbers of pictures. Papers on pictorial information systems, applications of pictorial data bases, picture syntax and semantics, combinatorial problems in image data structures, data structures for image data management, computer graphics of

complex images and animation, image stores, computer architecture for picture processing, and other topics are being solicited. To submit papers, please send four copies to Professor S K Chang, Program Chairman, 1980 PDDM Workshop, Dept of Information Engineering, University of Illinois at Chicago Circle, POB 4348, Chicago IL 60680.

Word Processor Cuts Hospital Paperwork Costs

Due to annual hospital cost increases and the escalating requirement for paperwork of government agencies, insurance companies and other groups, hospital paperwork is expanding constantly.

Burroughs Redactron word processing equipment has powerful text editing, formatting, file management and arithmetic capabilities to partially or completely automate the completion of Medicaid forms, patient records of all kinds, laboratory results and patient correspondence, as well as other hospital related documents; so that paperwork is handled quickly, accurately and at a lower cost.

Tufts-New England and the Presbyterian Hospital of Dallas, are using these systems to facilitate accurate and economic preparation of patient discharge summaries, for surgical reports, to update pharmaceutical inventories, controlling and printing tests and test results, and much more. The use of the system has resulted in more efficient and economical use of time and attention in hospitals and laboratories. For more information, contact Redactron Corp, 95 Horse Block Rd, Yaphank NY 11980.

Dial: 402-987-3771

HOTLINE

YOU NEED CRISP, HIGH CONTRAST BLACK-WHITE and VIVID COLOR ALPHA-NUMERICS/GRAPHICS CAPABILITIES FROM YOUR VIDEO MONITOR IF YOU WANT REALLY SUPER-LOOKING IMAGES FROM YOUR COMPUTER!!

AS SPECIALISTS IN VIDEO IMAGING...we think we have the right monitor or modulator for your system. Our product line includes the popular "Micro-Vortec" (OSI and Apple Inc. approved UHF color modulator), a variety of color and B-W monitors, color cameras, B-W cameras, Audio subcarrier kits and parts. FREE CATALOG UPON REQUEST. Dealers welcomed. Well established program with over 400 dealers.

GET FREE DETAILS VIA OUR HOTLINE!!!

ATV Research 13-B BROADWAY DAKOTA CITY, NE. 68731

Circle 140 on inquiry card.

FIELD ENGINEERS

Never sell yourself short!

If you fix computers and their peripherals, and it is time for a job change, let

FIELD SERVICE SEARCH

locate the best opportunities for you. Employer pays fees. Call collect (312) 398-5535.

Address:

FIELD SERVICE SEARCH

925 E. Rand Road
Arlington Heights, IL 60004
Private Employment Agency

Circle 141 on inquiry card.

SURPLUS ELECTRONICS

ASCII  ASCII

IBM SELECTRIC[®] BASED I/O TERMINAL WITH ASCII CONVERSION INSTALLED \$645.00

- Tape Drives • Cable
- Cassette Drives • Wire
- Power Supplies 12V15A, 12V25A, 5V35A Others. • Displays
- Cabinets • XFMRs • Heat Sinks • Printers • Components

Many other items. SEND \$1.00 FOR CATALOG REFUNDABLE FIRST ORDER WORLDWIDE ELECT, INC.
130 Northeastern Blvd.
Nashua, NH 03060

Phone orders accepted using VISA or MC
Call 603-889-7661

Circle 142 on inquiry card.

TEXAS INSTRUMENT COMI

TI 99 4 COMPUTA	\$ 995.
TI 810 BASIC PRINTER	\$1590.
TI 820 BASIC PRINTER	\$1990.
TI SOFTWARE	\$5AVE

CENTRONICS PRINTERS

279-2 TRAC. FD	\$949.
279-1 FRIC.FD	\$890.
230-1 NEW PRNTR	\$799.
230-3	\$849.
MICRO PI \$390. MICRO 51	\$425.

COMMODORE BUSINESS MACHINES

PET 2001-BK	\$675.
PET 2001-16N,P	\$829.
PET 2001-32N,H	\$1070.
PET 2040 DUAL FLOPPY	\$1090
PET 2022 TRAC.FD PRINTER	\$849.
PET 2023 FRIC.FD PRINTER	\$749.

NORTH STAR COMPUTERS

81G \$\$ SAVINGS

INTERTEC SUPERKAIN

THE HONOR GRADUATE COMUIER \$2990

DISPLAY TERMINALS

INTERTUSE 11	\$725
HAZELTINE 1400	\$690.
1410	\$785
1500	\$950.
1510	\$1149.

MULTI-BUSINESS COMPUTER SYSTEMS
28 MARLBOROUGH STREET
PORTLAND, CONN. 06480
(203) 342-2747

Circle 143 on inquiry card.

TRS-80 users

Learn FORTH

FORTH is a structured high level language that dramatically cuts program development time. You can expand the FORTH language by defining new operations and data types. FORTH programs are compiled to reduce memory space and speed execution.

tinyFORTH is a complete version of the powerful FORTH language tailored to the TRS-80. The tinyFORTH system includes FORTH, a text editor, an assembler, graphics, and cassette I/O.

Learn FORTH on your own computer. The tinyFORTH user's manual contains hundreds of examples to teach you FORTH in a hands-on style.

tinyFORTH for 16k level II TRS-80:
Cassette and full documentation \$29.95
Documentation only \$ 9.95

All orders are fully guaranteed. And \$1.50 for postage and handling. Order with check, money order, Visa, or Mastercharge.

Write for a FREE booklet describing FORTH.

The Software Farm
Box 2304 Dept. A14 Reston, VA 22090

Circle 144 on inquiry card.

New from Vantage Data Products

550 West 200 South
Suite 8
Provo, Utah 84601
(801) 377-6687



Communications/Control CPU Card

- CPU-Z80 1K RAM
16 bit interval timer and interrupt
EPROM* 2708 standard (2716 optional)
- Serial Communications-RS-232 interface,
UART Complete MODEM capability,
programmable baud rates, etc.
- Parallel I/O - 16 bits in (TTL), 16 bits Out (TTL)
- Power - on and external reset
*EPROM not included

\$195 assembled, tested, with warranty and documentation

Immediate delivery from stock!
All orders shipped prepaid
MC, VISA, phone orders welcome
Utah residents add 4% sales tax

Circle 145 on inquiry card.

CROMEMCO SYSTEMS DISCOUNTED

System 2 with 64k RAM—\$3195
System 3 with 32k RAM—\$4795
with 64k RAM—add \$ 595

Discounts up to 20% on most Cromemco hardware. We carry the full Cromemco line.

TORREY PINES BUSINESS SYSTEMS

14260 Garden Rd., Suite 8A
Poway, California 92064
(714) 486-3460

California residents add 6% sales tax

Circle 146 on inquiry card.

**\$ MINI FLOPPY AT \$
\$ STORE DISCOUNT \$**

SINGLE SIDED—\$225.00
DOUBLE SIDED—\$345.00

CABINETS-CABLES AND POWER SUPPLIES ARE ALSO AVAILABLE

INTERFACE, INC
20932 CANTARA ST
CANOGA PARK, CA 91304
(213) 341-7914

Circle 147 on inquiry card.

16 K RAMS & RAM CONTROLLERS

16 K X 1 DYNAMIC RAMS MK4118P2

- 200 NSEC ACCESS/375 NSEC CYCLE TIMES
- 16 PIN/TTL COMPATIBLE
- ALL CHIPS BURNED IN AND FULLY TESTED
- PRICE WITH DATA SHEET \$88.00 IN QTY OF 8/THAT'S \$9.50 EACH

6800/6502 64K BYTE RAM & CONTROLLER SET
MAKE 64K BYTE MEMORY FOR YOUR 6800 OR 6502 THIS SET INCLUDES

- 32 MK54116-3, 16K X 1, 200 NSEC RAMS
- 1 MC3480 MEMORY CONTROLLER
- 1 MC3242A MEMORY ADDRESS MULTIPLEXER AND COUNTER
- DATA & APPLICATION SHEETS PARTS TESTED AND GUARANTEED \$295.00 PER SET

DYNAMIC MEMORY CONTROLLER MC3480L

- GENERATES RAS/CAS & REFRESH TIMING FOR 16K TO 64K BYTE MEMORIES
- PRICE WITH DATE SHEET \$13.95 EACH

MEMORY ADDRESS MUX/COUNTER MC3242AP

- MUX ADDRESS & REFRESH COUNTER FOR 16K TO 64K BYTE MEMORIES
- PRICE WITH DATA SHEET \$12.50 EACH

QUANTITY DISCOUNTS AVAILABLE
ALL ORDERS POSTPAID U.S. FUNDS OR INTERNATIONAL
ORDERS CHECK OR MONEY ORDER VISA OR MC ALSO AC
CEPTED SEND ACCY NO. FOR INFORMATION DATA & INTERBANK
NO WITH SIGNED ORDER CALIF. RESIDENTS PLEASE ADD
6% SALES TAX PHONE ORDERS (714) 533-4466

MEASUREMENT SYSTEMS & CONTROLS, INC
MEMPHIS DEVICES DIVISION
867 NORTH MAIN ST. ORANGE CA 92668

Circle 148 on inquiry card.

Computer Chess Competition

Chess 4.9, the program written by David Slate and Larry Atkin of Northwestern University, regained the title of North American Computer Chess Champion in the tournament held during the convention of the Association for Computing Machinery (ACM) in Detroit, Michigan from October 28 to October 31, 1979.

Slate and Atkin's program (then called Chess 4.7) was upset in the 1978 championship by the program Belle, written by Ken Thompson of Bell Laboratories. Belle won the 1978 competition with a perfect score of four wins in the 4-round Swiss System tournament. (See "Computer Chess Report," May 1979 BYTE, page 174.)

In the 1979 Tenth Annual North American Computer Chess Championship, however, Belle suffered a setback in the third round of

Player	Chess 4.9	Belle	Duchess	Chaos	L'excentrique	Mychess	Blitz 6.9	Sargon 2.5	Ostrich 80	Awit	BS '66 '76	Rufus	Score
Chess 4.9		1/2	1				1	1					3 1/2
Belle	1/2			1/2	1			1					3
Duchess	0			1				1	1				3
Chaos		1/2	0				1				1		2 1/2
L'excentrique		0				1/2			1		1		2 1/2
Mychess					1/2			0	1	1			2 1/2
Blitz 6.9	0		0	0				1/2			1		1 1/2
Sargon 2.5		0	0			1	1/2						1 1/2
Ostrich 80	0			0					1/2	1			1 1/2
Awit			0		0				1/2		1		1 1/2
BS '66 '76						0	0			0	1		1
Rufus				0	0					0	0		0

Table 1: Cross-table of the results of games in the Tenth Annual North American Computer Chess Championship, held October 28 to October 31, 1979 in Detroit, Michigan. The table contains blank entries, since each program did not play every other program in the 4-round Swiss System event.

competition when the Chaos program (written by Mike Alexander, Fred Swartz, John O'Keefe, and Victor

Berman of the University of Michigan) fought Belle to a draw. The hopes of Belle's backers were further dashed

when Chess 4.9 also achieved a draw with Belle in the fourth and final round. With this final half-point, Chess 4.9 wrested a clear-cut victory in the tournament with a score of 3 1/2 out of 4 possible points.

Three programs of the twelve competing in the event were run on microcomputer systems. The program Mychess, written in Z80 assembler language by David Kittinger of Anchorage, Alaska, ran on a Cromemco Z-2D system with 64 K bytes of memory and gained a score of 2 1/2 points. Dan and Kathe Spracklen entered version 2.5 of Sargon, which ran on a 6502-based electronic chessboard processor; the program obtained a score of 1 1/2 points. The program Rufus, written by Charles Sullivan in 6502 assembler, did not fare so well. It lost all games and ended with a score of zero. Rufus ran on an Apple II computer in 48 K bytes of memory.

Besides these three programs that used microprocessors to calculate what moves to make, two programs that ran on large computers employed microprocessors to control electronic chessboards that indicate moves with light-emitting diodes and transmit opponent's moves automatically. Both Chess 4.9 and Blitz 6.9 (written by Robert Hyatt and Albert Gower of the University of Southern Mississippi) used these devices.

The tournament was organized by a committee comprising Monroe Newborn, Ben Mittman, Ira Purchis, and David Dahm. The tournament director was International Master David Levy (who was featured in "Chess 4.7 versus David Levy," by J R Douglas, December 1978 BYTE, page 84). In attendance as observers were one-time World Champion Max Euwe (oy - vuh), president of the Federation Internationale des Echecs (FIDE), and George Koltanowski, former presi-

TURN-ON!

Now have full computer control of up to 256 lights, appliances and even wall switches **without special wiring**. The SciTronics REMOTE CONTROLLER permits direct control of the inexpensive BSR remote line-carrier switches sold by Sears, Radio Shack and many others.

HOW IT WORKS: Writing 3 control words to the controller board sends one of 6 instructions over the a-c line to the desired switch. The instructions include any remote on, off, all off, any light bright, dim, or all on. Reading the board tells if busy.

FEATURES:

- ★ FULL S-100 COMPATIBILITY—all lines fully buffered, board address dip switch selectable to span 65K.
- ★ FULL TRS-80-1 COMPATIBILITY—board housed in attractive woodgrained case with power supply and connector cable allows direct connection to TRS-80-1 expansion port.
- ★ COMPATIBLE WITH OTHER SYSTEMS—combination of on-board select switches and complete connector wiring information allows ease of use with Apple II, PET, KIM, SYM, HEATH HB, plus others.
- ★ SYSTEM SELECT SWITCHES—choose active high or low inputs, addressed or I/O drive, parallel or serial entry, non S-100 inputs like VMA, clocking on any transition.
- ★ SIMPLE TO USE—sample software included for all systems listed, all IC's socketed.

APPLICATIONS:

- ★ Make your entire home, business or apartment "computer controlled"
- ★ Save energy by controlling lights and appliances
- ★ Control lights and alarms for security systems



REMOTE CONTROLLER BOARD \$159.

ENCASED SELF POWERED CONTROLLER FOR TRS-80-1 \$184.

remote switches not included

Send check or money order to:

SciTronics Inc.
523 S. Clewell St., P.O. Box 5344
Bethlehem, PA 18015
(215) 868-7220

Please list system with which you plan to use controller. Master Charge and Visa accepted. PA residents add sales tax.

dent of the United States Chess Federation (USCF) and noted player of blind-fold chess.

Stanford University professor John McCarthy presented the tournament awards and spoke at a ceremonial luncheon held on the final day of the ACM convention.

A cross-table of game results achieved by the twelve programs is reproduced here in table 1. According to Dr Newborn, the strength of play of all the programs in the 1979 competition was greater than in the previous tournaments.

An interesting experiment took place on the Saturday preceding the tournament. David Levy, with an ability rating of about 2390, played a single game against a team consisting of David Slate (USCF rating of about 2050) and his program, Chess 4.9 (also rated at about 2050). The purpose was to find out if cooperation between man and machine could produce better play than either man or machine playing alone.

According to rating statistics, a player rated 2050 should, in a 20-game match, win perhaps two games and draw perhaps five. It was expected that the Slate-Chess 4.9 team would have an effective rating of about 2150, with Levy favored to win.

True to expectation, Levy used his knowledge of the strong and weak areas of the opposing team and won the game. Nevertheless, development of the symbiotic relationship between the human player and a computer may yet extend the capabilities of both men and machines.

Microcomputers in Education

A nonthreatening first experience with microcomputers for kindergarten to 12th grade teachers has been developed by Dan Isaacson at the University of Oregon. He designed a self-instructional, laboratory-type course to help teachers

use computers without having to be programmers.

The course consists of programs and text that show how to turn on the computer, load programs, explore materials at various levels in fine arts, business, English, foreign languages, consumer economics, and more. The program will be released in the summer of 1980 for use by public schools and colleges of Education. For more information, contact Dan Isaacson, Computer Center, University of Oregon, Eugene OR 97403. ■

BYTE's Bugs

Reformatting Dollars and Cents

Mr J R Borden of Laguna Hills CA, has pointed out an error in my recent letter on formatting dollars and cents ("Good Cents," September 1979 BYTE, page 150). In trying to compact the procedure to one line, I erred in the roundoff, the results not being correct for \$1.995 and similar cases. A correct ver-

sion is given in line 30 of the adjacent listing.

```
20 IF X < 0 THEN X = ABS
(X); PRINT "—";
30 X = X + 0.005; PRINT
"$"; INT (X); " "; RIGHTS (
STR$ ( INT (100 * (X +
1)));2)
```

Mr Borden also considered the case of negative quantities. To handle these requires an additional line, line 20 in the listing.

I apologize for any inconvenience this error may have caused.

James D Childress
5108 Springlake Way
Baltimore MD 21212 ■

The AJ 630 data terminal. Low noise. Low price. High performance.

The AJ 630 thermal printing data terminal. Now you can get a lot of terminal for a little money.

Just look at its features:

- Exceptionally quiet thermal operation
- Desktop portability
- Proven reliability
- Selectable printing speeds up to 30 cps
- AJ-supplied thermal paper
- Standard ASCII and APL configurations

And look at its price:

- Just \$53 a month on a 36-month standard lease, including maintenance — and equally attractive payout lease.
- Just \$995 for outright purchase.

In short, you can have a full-fledged data terminal for about the price of a high-quality electric typewriter.

And to make it as easy as possible for you to have the AJ 630, you can even use your Visa or Master Charge cards.

The AJ 630 comes with our standard 30-day parts and labor limited warranty. And is backed by AJ's nationwide service network.

Act now. Write Anderson Jacobson, Inc., 521 Charcot Avenue, San Jose, California 95131. Or call your nearest AJ regional office: San Jose, CA (408) 946-2900; Rosemont, IL (312) 671-7155; Hackensack, NJ (201) 488-2525.

**NOW—
\$53 a month
lease!
\$995
purchase!**



**ANDERSON
JACOBSON**

Prices subject to change without notice

Event Queue

JANUARY 1980

Education Coordinators' Workshops 1980. Held throughout 1980, these workshops will cover costing, justifying costs, course design strategies, scheduling, record keeping and reporting to management. For information on when and where the workshops will be held, write to Deltak Inc, 1220 Kensington Rd, Oak Brook IL 60521, or call (312) 920-0700.

January 3-4

Hawaii International Conference on System Sciences, Honolulu HI. The conference will cover developments in theory and practice in software and

hardware, and advanced computer systems applications in selected areas, with emphasis on medical information processing and computer-based decision support-systems for upper level managers in organizations. For more information, contact Perry G Patteson, Office of Management Programs, University of Hawaii, 2404 Maile Way, Honolulu HI 96822.

January 5-8

International Winter Consumer Electronics Show, Las Vegas Convention Center, Grand Ballroom of the Las Vegas Hilton and the Jockey Club Hotel, Las Vegas NV. The show will have over 850 exhibitors covering markets including audio systems, software, television and

video tape and disk systems, home computers, calculators, and many more. Contact Consumer Electronics Shows, 2 Illinois Center, Suite 1607, 233 N Michigan, Chicago IL 60601.

January 5 and 12

Introduction to Computing and Personal Computers, Human Computing Resources, 10 St Mary St, Toronto Ontario M4Y 1P9 CANADA. This course will cover introductions to computers, programming, software and hardware, using computers in homes and offices, and buying and owning a personal computer.

January 8-24

Tuesdays and Thursdays, Introductory Programming in BASIC, Human Computing Resources, 10 St Mary St, Toronto Ontario M4Y 1P9 CANADA. Direct execution of commands, the writing of simple BASIC programs, system dialects, error handling and debugging, and programming methods and style will be covered in this course.

January 15

Invitational Computer Conference, Orange County CA. New developments in computer and peripheral technology such as Pascal systems, printers, and streaming tape drives will be featured in this conference directed to the quantity buyer. For more information, contact B J Johnson and Associates, 2503 Eastbluff Dr, Suite 203, Newport Beach CA 92660.

January 15-18

TV-Microelectronics and Microprocessing Exhibition, National Exhibition Centre, Birmingham, England. Manufacturers and suppliers of microprocessors, electronic and microcomputer games, video display units,

In order to gain optimum coverage of your organization's computer conferences, seminars, workshops, courses, etc, notice should reach our office at least three months in advance of the date of the event. Entries should be sent to: Event Queue, BYTE Publications, 70 Main St, Peterborough NH 03458. Each month we publish the current contents of the queue for the month of the cover date and the two following calendar months. Thus a given event may appear as many as three times in this section if it is sent to us far enough in advance.

video cameras and projection systems and digital consumer electronics are invited to participate. Over 9000 retailers, wholesalers, distributors and government buying authorities are expected to attend this show. For more information, contact TMAC, 680 Beach, Suite 428, San Francisco CA 94109.

January 17

Electronic Road Shows, Proud Bird Restaurant, Los Angeles Airport, Los Angeles CA. This traveling exhibition of components, materials and instruments is being produced by the Electronic Representatives Association (ERA). Over 80 ERA member firms will participate, and products from over 700 electronic companies will be displayed. For more information, contact the Southern California ERA office, 20969 Ventura Blvd, Suite 9, Woodland Hills CA 91364.

January 21-24

American Association of Physics Teachers and the American Physical Society, Chicago Marriott Hotel, Chicago IL. An introduction to microprocessors, a Pascal programming workshop, and a course on the use of personal computers in learning physics, plus more sessions on microprocessors will be presented.

Contact the American Association of Physics Teachers, Graduate Physics

AG REMOTE CONTROL
FROM YOUR COMPUTER

**TRS-80 PET S100
APPLE KIM AIM65**

INEXPENSIVE CONTROL SOLUTION FOR

HOME SECURITY • ENERGY CONSERVATION
GREENHOUSES • ENVIRONMENTAL CONTROL
INDUSTRIAL CONTROL • LABORATORIES

CmC's μ DAC system now includes an interface to the BSR X-10 remote control modules. These low-cost modules allow control over lamps, motors and appliances. With the CmC X-10 interface your computer can control 256 separate devices. Lamps can be turned on or off, dimmed or brightened. Alarms, kitchen appliances, hi-fis, TVs, motors, pumps, heaters and more can be put under your computer's control.

Direct plug-in and software for most computers.

Circle the reader service number, call or write for our latest catalog.



CONNECTICUT microCOMPUTER, Inc.
150 POCONO ROAD
BROOKFIELD, CONNECTICUT 06804
TEL: (203) 775-9659 TWX: 710-456-0052

MAXIMUM VALUE FOR YOUR DOLLAR

NORTH STAR COMPUTER PRODUCTS	
DOUBLE DENSITY	KIT ASM
HRZ-1-32K-D	\$1590. \$1850.
HRZ-2-32K-D	1910. 2200.
MDS-A-D	550. 640.
EXTRA DRIVE	330.
QUAD DENSITY	KIT ASM
HRZ-1-32K-Q	\$1750. \$2040.
HRZ-2-32K-Q	2230. 2560.
MDS-A-Q	720. 800.
EXTRA DRIVE	480.

All HORIZONS now come standard with 3 ports and all edge connectors and minimum 32K memory.

BOARDS-DISCS	
RAM-16K W/PARITY	\$300. \$345.
RAM-32K W/PARITY	475. 520.
FPB-A	205. 270.
VERBATIM DISCS, BOX OF 10	.. \$29. PP

We will try to beat any deal. Call:
A.E.I.
3851 HACKETT AVE.
LONG BEACH, CALIF. 90808
(213) 421-4815

Circle 153 on inquiry card.

**5VOLT 1 AMP
REGULATED POWER SUPPLY**
The 5VDC section is regulated and compatible with TTL and DTL decoder drivers and associated logic circuits. The 200VDC section is unregulated and makes an ideal supply source for all gas discharge type numerical readouts.

7 AMP
120V AC
117 V, 60 Hz

DC Output: (1) 200V @ 0.80 mA (unregulated)
(2) 5V @ 0-1A Regulated.

Current Limit: 1.5A Automatic restoration
Limited Offer

FACTORY CLOSOUT \$18.00 each

ALCO S.P.D.T. MINI TOGGLE
+8 pins @ 128 sec

22/44 EDGEBOARD CONNECTOR
TIN SOLDER TAIL. .156" x .200"

LARGE QUANTITIES AVAILABLE
\$1.35 each 10 for \$10.00
\$1.35 each 10 for \$12.50

1 1/2 AMP FULL WAVE BRIDGE RECTIFIER
400 PIV 2 for \$1.00

HOUSE MARKED DARLINGTON TRANSISTOR
18 Amps 80 Volts 150 Watts Similar to MJ4200 PNP Specify NPN or PNP \$1.50 each 10 for \$11.00

C-N D.P.D.T. PRINTED CIRCUIT MINI TOGGLE
+8 pins @ 128 sec + on-on 10 for \$12.50

ALL ELECTRONICS CORP.
905 S. Vermont Ave. • Los Angeles, Calif. 90006
DEPT. BY-1 (213) 380-8000

STORE & WAREHOUSE HOURS
Mon. - Fri. Saturday
9 AM - 5 PM 10 AM - 3 PM

TERMS
• Quantities Limited
• Min. Order \$10.00
• Add \$1.50 Shipping USA
• Calif. Res. Add 5% • Prompt Shipping

SEND FOR OUR FREE CATALOG

Circle 154 on inquiry card.

C-10 SHORT CASSETTES 50 FT.

Qty.	Price
1	\$1.00
10	\$0.75
50	\$0.65

Premium tape and cassettes acclaimed by thousands of repeat order microcomputer users. Price includes labels, cassette box and shipping in U.S.A. VISA and M/C orders accepted. California residents add sales tax. Phone (415) 968-1604.

MICROSETTE CO.
475 Ellis Street
Mt. View, CA 94043

Circle 155 on inquiry card.

FLOPPY DISK REPAIR



- PerSci and Shugart
- Quick turnaround
- Eight inch and minis



National Computer Service
1023 N. LaBrea
Hollywood, CA. 90038
213-851-2226

Circle 156 on inquiry card.

TERMINAL DATA CORPORATION

MODEL 1200 RS-232 DATA SPLITTER

available in kit form

Model 1200K gives the terminal or microprocessor user a second interface for a printer, plotter, cassette or tape drive. It operates at any speed & isolates the two output devices from each other, while providing 2 RS-232 interfaces from the terminal or microprocessor.

The kit consists of 3 RS-232 connectors, printed circuit board, all necessary components, enclosure, mounting hardware & assembly instructions. \$59

write or call

TERMINAL DATA CORP.
11878 Conkley Cir.
Rockville, MD 20852
(301) 881-7655

Circle 157 on inquiry card.

APPLE II

8" DISK CONTROLLER

APPLE DOS COMPATIBLE

- DOUBLES APPLE II™ STORAGE
 - SHUGART 800/801 COMPATIBLE
 - STANDARD IBM™ 3740 FORMAT
 - CP/M™, UCSD PASCAL™ CAPABILITY
- Available at your local APPLE Dealer. \$400.

SVA SORRENTO VALLEY ASSOCIATES
11722 SORRENTO VALLEY RD.
SAN DIEGO, CA 92121

Circle 158 on inquiry card.

CASSETTES

with
Agfa Premium Grade Tape



5-screw type

24 pack — \$21.00

Illinois Residents add 6% sales tax

includes Norelco-style boxes with Index cards, 48 labels, shipping.



Call or write today



Polyline Corp. 312/298-5300
1233 Rand Rd. Des Plaines, IL 60016

TRS-80 Model I and II quality software

DATA BASE MANAGER IBM-IV \$69
You can use it to maintain a data base & produce reports without any programming. Define file parameters & report formats on-line. Features key random access fast multi-key sort field with label generator audit log MOD-II version with more than 30 enhancements \$199

ACCOUNTS RECEIVABLE ACCT-III \$69
One or more drives. Order entry calculates sales tax shipping amount for multiple items. Credit checking aging sales analysis invoices statements and reports. As opposed to most other A/R cuts can be used by doctors store managers etc. MOD-II version \$149

WORD PROCESSOR 16K \$39 32K \$49 MOD-II \$49
Fast word processor specifically designed for the TRS-80 that uses disk storage for text. Written in BASIC. No special hardware and text limit. Use for letters manuals & reports. 32K version features upper/lower case without hardware change and multiple input text files.

MAILING LIST advanced MAIL V \$59
Fast sort by any field. Multiple labels and reports. 4-digit selection code. new zip code ext. screen input live keyboard. powerful report writer. MOD-II \$99

INVENTORY INV-V \$99
9-digit alphanumeric key for fast key random access. Reports include order info. performance summary etc. Calculate E.O.B. Powerful report writer. MOD-II \$149

All programs are on-line interactive. random access. virtually bug free. documented and delivered on disks. MOD-I requires 32K DOS. We challenge all software vendors to offer low cost manuals so you can compare and avoid those high-priced undocumented on-memory programs. Send \$5 for a MOD-I manual and \$10 for MOD-II.

MOD-II programs are extensively modified guaranteed to run with 1 year newsletter & updates 10% off for ordering more than 1 MOD-II programs.
MICRO ARCHITECT
96 Dothan St. Arlington, MA 02174

Circle 159 on inquiry card.

TRS SALE

ALL BRAND NEW 16K LEVEL 2 FULL WARRANTY \$699.00

- ALSO:
- 16K MEMORY UPGRADE \$59.
 - TRS80 3SPEED KIT UPGRADES
 - TRS80 TO FAST, SLOW AND NORMAL SPEEDS \$19.
 - 5V-EPROM 2716 \$35.
 - 2708 EPROMS \$7.
 - MICROTEK PRINTERS \$725.
 - SOFTWARE AND INTEGRATED CIRCUITS(TTL'S, MOS, CMOS)
- SEND FOR FREE CATALOG

DES-MAR ELECTRONICS
POST OFFICE BOX 4482
AGNEW STATION
SANTA CLARA, CA. 95054

©CALIF. ADD 6.5% TAX

— Tanaka Corporation

Circle 160 on inquiry card.

SAVE ON ADD-ON PRODUCTS FOR TRS-80

The largest family of disk drives from the largest supplier, drives come complete with power supply and cabinet.

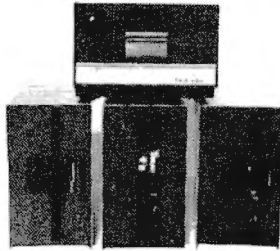

TF-Perfec FD200, 40 track, use both sides	\$382
TF-3 Shugart SA400, 35 track, same as handy	\$389
TF-5 MPI B51, 40 track,	\$379
TF-70 Micropolis, 77 track with 195K of storage	\$639
TDH-1 Dual sided drive, 35 track	\$499

* MAXI DISK *

Maxi Disk 1: 10 Megabyte Hard Disk with 5 fixed, 5 removable with controller	\$6299
Maxi Disk 2: 10 Megabyte (fixed) Winchester Technology	\$5349
77 tracks of Storage includes new DOS+	\$695

PRINTERS

DP800 Anadex, 80 column, 112cps	\$950
LP779 Centronics 779	\$1099
LP730 Centronics 730	\$950
LP700 Centronics 700-1	\$1495
LP701 Centronics 701-1	\$1759
LP702 Centronics 702-2	\$1995
SPW-1 Spinwriter-NEC	\$2495

NEW! LINE PRINTER BASE 2

Base 2 Printer 80, 132 col., graphics 60 LPM with tractors..... **\$599**

* DRIVES FOR ANY MICROCOMPUTER * Does not include power supply & cabinet. MOD II DISK DRIVES NOW AVAILABLE

Perfec FD200	\$282
Perfec FD250 (dual head)	\$399
Shugart SA400 (unused)	\$286
Shugart SA800	\$479
MPI B51	\$279
MPI B52	\$349

SOFTWARE

New DOS+ with over 200 modifications and corrections to TRS-DOS	\$99
New DOS+ 40 track	\$110
AJA Word Processor	\$75
AJA Business Program	\$250
Racet Infinite Basic	\$49.95
Disk Drive Alignment Program	\$109
Radix Data Base Program	\$99.95
Electric Pencil	\$150

ALL PRICES CASH DISCOUNTED. FREIGHT FOB/FACTORY

Circle 239 on inquiry card.



2080 South Grand Ave.
Santa Ana, CA 92705
(714) 979-9923



7310 E. Princeton Ave.
Denver, CO 80222
(303) 758-7275

Building, State University of New York at Stony Brook, Stony Brook NY 11794.

January 22-24

Designing, Installing and Managing An International Telecommunications Private User Network, Dallas TX. This course is intended for communication professionals interested in understanding and developing communication systems, services, and techniques. For more information, contact Telecom Systems Group, 579 Pompton Ave, Cedar Grove NJ 07009.

January 23-26

International Microcomputers Minicomputers Microprocessors (IMMM), Harumi Exhibition Centre, Tokyo Japan. This is a show for manufacturers, commercial and financial establishments, service industries and institutions, and design engineers interested in buying computer systems, components and services. For more information, contact Industrial and Scientific Conference Management Inc, 222 W Adams St, Chicago IL 60606.

January 28-30

Communication Networks '80, Sheraton Washington Hotel, Washington DC. The program will offer 50 conference sessions in areas such as fiber optics, satellite communications, systems networks, and innovations in electronic mail and office administrative networks.

For further information on registration, speaking opportunities or exhibit space, contact William Leitch, The Conference Company, 60 Austin St, Newton MA 02160.

January 28-30

Principles of Programming Languages, Las Vegas NV. This symposium concerns practical and theoretical aspects of principles and innovations in the design, definition, and implementation of programming languages. Some topics are

algorithms and complexity bounds for language processing tasks, specification languages, error detection and recovery, and unusual or special-purpose languages that raise issues of principle. Contact Professor John Werth, Dept of Mathematical Sciences, University of Nevada, Las Vegas NV 89154.

January 30-February 1

MIMI'80 Asilomar, Asilomar Conference Grounds, Pacific Grove CA. This symposium covers all aspects of mini and microcomputers including technology, hardware, software engineering, languages, education and more. Contact The Secretary, MIMI '80 Asilomar, POB 2481, Anaheim CA 92804.

FEBRUARY 1980

February 6

Invitational Computer Conference, Ft Lauderdale FL. This conference is directed to the quantity buyer and will feature the newest developments in computer and peripheral technology. Contact B J Johnson and Associates, 2503 Eastbluff Dr, Suite 203, Newport Beach CA 92660.

February 12-14

Data Communications Conference and Exhibition, Harbour Castle Hilton, Toronto Ontario, Canada. Panel sessions, presentations, workshops, and technical sessions related to the field of data communications will be featured. Network control, management, performance and architecture; communications hardware and software; fiber optics; distributed data processing; and international communications policies are some of the subject areas that will be discussed.

The exhibition at the convention center will feature over 100 exhibitors.

For more information, contact Whitsed Publishing

Ltd, Suite 2504, 2 Bloor St W, Toronto Ontario M4W 3E2 CANADA.

February 13-15

The IEEE International Solid State Circuits Conference, San Francisco CA. This conference is a forum for the presentation of advancements in all aspects of solid state circuits. It will cover design, performance, fabrication, testing, and applications in digital, analog, microwave, and other areas of new solid state circuits, device structures, phenomena and systems. For more information, contact Lewis Winner, 301 Almeria Ave, POB 343788, Coral Gables FL 33134.

February 18-21

European Information Management Exhibition and Conference, Wembley Conference Centre, London England. This show will exhibit microcomputer systems and peripheral items with demonstrations and applications focused on problem solving for the management executive. Contact, Expoconsul, 420 Lexington Ave, New York NY 10017.

February 22-23

Louisiana Computer Exposition, University of Southwestern Louisiana, Lafayette LA. This conference is entitled "Distributed Systems Based on Mini and Micro Computers." It will cover programming languages, operating systems, evaluation of distributed systems, design criteria for distributed systems, and other related topics. There will be exhibitions of equipment and papers will be read and discussed. For more information, contact the Computer Science Dept, University of Southwestern Louisiana, POB 44330, Lafayette LA 70504.

February 25-27

Communication Networks '80, Shoreham Americana Hotel, Washington DC. This

conference and exposition will cover business communications. For program information, contact the Director of Program Development, The Conference Company, 60 Austin St, Newton MA 02160. For exhibit information, contact the national sales manager, Communications Networks '80, POB 96, Haddon Heights NJ 08035.

February 25-28

Compcon 80, Jack Tar Hotel, San Francisco CA. The conference theme is "VLSI: New Architecture Horizons." It will be devoted to developing advanced technologies for computers. Contact Compcon Spring '80, POB 639, Silver Spring MD 20901.

February 26-28

Nepcon West '80, Anaheim Convention Center, Anaheim CA. The conference and exhibit will deal with the latest advances in electronics by covering such topics as wave soldering, etching, automated assembly, die attaching, hybrid circuit packaging, photo lithography, precious metal recovery, laser annealing, and much more. For further information, contact ISCM Inc, 222 W Adams St, Chicago IL 60606.

February 26-29

Office/Korea/80, Korea Exhibition Center, Seoul Korea. Exhibits at this exposition will include the range of products needed in offices from computers, word processing equipment and software to stationary, supplies, furniture and services. Information about the show may be obtained from Expoconsul, a division of Clapp and Poliak, 420 Lexington Ave, New York NY 10017.

MARCH 1980

March 3-5

Office Automation Conference, Georgia World

Guaranteed software from Data Access Corporation. . .

TRS-80 ISDMS INDEXED SEQUENTIAL DATA MANAGEMENT SYSTEM

Interactive Data Base Definition
Random Key Access To Any Record
Sequential Key Access To Any Record
Fast Assembler Sorting On Any Field
Complete Interactive File Maintenance
Fast In-Memory Directory Of All Records
Automatic Blocking & Unblocking Of Records
Loads It's Assembler Program from BASIC
BASIC & Assembler Source Included
Sample Data & Programs Included
Includes Assembler Disk Sort
INKEY\$ Data Entry Routine
Runs On 2, 3 or 4 Drives

IF YOU'VE GOT A TRS-80* DISK SYSTEM, WE'VE GOT A FAST, FEATURE PACKED SOFTWARE SYSTEM THAT'S READY TO GO TO WORK FOR YOU NOW! INTERACTIVELY DEFINE A DATA BASE AND BEGIN USING IT IN HOURS! BUILD YOUR APPLICATION WITH ISDMS, ITS A SOLID FOUNDATION!

PRICE: \$175.

ISDMS WITH REPORT GENERATOR

The complete ISDMS Package combined with a report definition and generation program. With ISDMS and the Report Generator you can create a complete file and report system without writing a line of code!

PRICE: \$225

TRS-80 BUSINESS PROGRAMS

TRS-80 Model II conversions available soon

Accounts Receivable, up to 1200 Accounts . . . \$500
On-Line Inventory, up to 1800 Items . . . \$600
Point Of Sale Inventory, up to 3000 Items . . . \$750
General Ledger w/Check Writer . . . \$500
Payroll, All Fed., State Taxes, Tips & EIC . . . \$500
Mailing List, up to 1800 names on 4 Disks . . . \$200

Licensed copies of Data Access TRS-80 programs are guaranteed to load and run on operational systems, and to be free from programming defects.

DEALER INQUIRIES INVITED

DATA ACCESS CORPORATION

4221 Ponce De Leon Blvd.
Coral Gables, FL 33146
Phone: (305) 446-0669

*TRS-80 is a registered trademark of Radio Shack

Congress Center, Atlanta GA. A combination conference and exhibition of office computer systems has been developed to help management understand the growing technology of business computer systems. For more information, contact H A Bruno and Associates Inc, 78 E 56th St, New York NY 10022.

March 10-12

1980 National Office Exhibition and Conference, Automotive Building, Exhibition Pl, Toronto Canada. Subject areas of the conference will include energy conservation, small business computers, micrographics, word processing, telecommunications, copiers, office landscaping, and many others. There will be approximately 100 exhibitors presenting their products and giving demonstrations.

For more information, contact Whitsed Publishing Ltd, Suite 2504, 2 Bloor St W, Toronto Ontario M4W

3E2 CANADA.

March 14-16

West Coast Computer Faire, Civic Auditorium and Brooks Hall, San Francisco CA. An expected 15,000 attendees, over 340 exhibits, and more than 100 conference speakers will highlight this year's program. Exhibitor and speaker information may be requested from the Computer Faire, 333 Swett Rd, Woodside CA 94062.

March 17-20

Interface '80, Miami Beach Convention Center, Miami Beach FL. This conference and exposition is devoted to data communications, distributed data processing, and networking. Approximately 1000 exhibitors are expected and attendance is expected to exceed 12,000. For information, contact Interface '80, 160 Speen St, Framingham MA 01701.

March 17-21

Applied Time Series Analysis, University of

California at Los Angeles CA. This course is designed for engineers, scientists, programmers, economists and other users of digital time series who require modern methods of data analysis using the fast Fourier transform, digital filtering, power spectral densities and correlation functions. The lectures cover topics relating to the Fourier transform, sampling linear systems, convolution, covariance, digital filtering, power and cross-spectral density functions, and introductions to new methods in spectral analysis and rotating machinery analysis. For more information, contact UCLA Extension, 10995 Le Conte Ave, Los Angeles CA 90024.

March 20

Electronic Road Shows, Castaways Restaurant, Burbank CA. See January 17 for details.

March 24-28

Fourth European Conference

on Electrotechnics, Stuttgart. This conference will review recent development trends and applications in the field of microelectronics. Microprocessors, computer communication, industrial electronics applications of microelectronics in the automobile and in medicine, and other topics will be covered. The conference language will be English. Contact Professor Dr W E Proebster, IBM Deutschland GmbH, Postfach 80 08 80, D-7000 Stuttgart 80 GERMANY (BRD).

March 26-28

Viewdata '80, Wembley Conference Centre, London England. Viewdata 80 is an international exhibition and conference on video-based systems and microcomputer industries. The British Post Office is presenting the Prestel Show, about electronic mail services.

Contact TMAC, 680 Beach St, Suite 428, San Francisco CA 94109. ■

GET YOURS FREE 1980

EAIA
ELECTRONICS, INC.

ADVANCED ELECTRONICS FOR THE '80's AND BEYOND

NEW IDEAS IN EAIA'S 1980 CATALOG

R-4700J COMPUTER BASED MODULAR SYNTHESIZER SYSTEM page 2

8700 CO... VIDEO

COMPUTER... SYNTHESIS... MORE

PROTEUS - PROGRAMMABLE PRESET LEAD SYNTHESIZER page 5

EXX - EXPONENTIAL MODULE CARDS page 8

PLEASE RUSH

MY FREE 1980 CATALOG

name: _____

address: _____

city: _____ state: _____ zip: _____

EAIA ELECTRONICS, Dept. 1-B 1020 W. Witshire, Oklahoma City, OK 73116

MICAH

OSBORNE BUSINESS SOFTWARE

in CBASIC2 or CROMEMCO 16K BASIC

*** features ***

- Four Complete Packages--
 - General Ledger
 - Accounts Receivable
 - Accounts Payable
 - Payroll with Cost Accounting
- Strong support from Osborne Manuals
- CBASIC2 runs under CP/M or under CDOS version 1.07 on Cromemco computers
- 16K BASIC runs on Cromemco computers
- Cursor addressing routines for Hazeltine, Lear Siegler and Cromemco (Beehive) Terminals
- Source Codes and Installation Instructions provided along with disks
- Automatic Command Start-up
- Easy to apply to all of your business and systems needs

*** hardware required ***

- One or more 8" or 5" Floppy Drives
- CRT with cursor addressing
- 132-Column Printer

\$95 per package

TELEORDER
Add \$5 for shipping
Call add'n-1-20 sales tax
CREDIT CARDS ACCEPTED

*** DEALER INQUIRIES INVITED ***

MICAH'S PRODUCTS OF DISTINCTION

• OSBORNE BUSINESS SOFTWARE (in CBASIC2 & 16K)	• DCP-1 (Disk Utilities for CP/M and CDOS)	• EXPAND (Run Cromemco Software on CP/M)
• CBASIC (CP/M for Cromemco Computers)	• DCP-2 (Disk Utilities for Cromemco)	• BLACKJACK (Tutorial Casino Action)
• MICROPHONE (Variable Printer Graphics)	• DCP-3 (DCP-2 Expanded)	• DRIVE (Customized Printer Drivers)
	• SPOOL (Cromemco Format Utilities)	• DBMS Conversion to NAII

• Call or Write for Free Catalogue and More Information •

*** We will Customize any of our programs at our Standard Consulting Rates ***

Ah! MICAH . . . Satisfyin' Software

That turns your system on!

MICRO Applications and Hardware

• CONSULTANTS and SOFTWARE DEVELOPERS •

MICAH Box 22212 San Francisco, California 94122 USA phone: 415/664-0778

TRS-80, PET, APPLE, SORCERER Hardware/Software Systems

Available now:

- HAM INTERFACE--including the most sophisticated RTTY systems money can buy.
- Baudot and ASCII printer interfaces.
- Electra Sketch[™], ANIMATION GRAPHICS Compiler

Write or call for free catalog

MACROTRONICS, inc.

P.O. Box 518 (A) Keyes, CA 95328
(209) 634-8888 / 667-2888 (R) (S)

We are experiencing telephone difficulties, please keep trying.

Circle 166 on inquiry card.

DISCOUNT PRICES

NORTH STAR
APPLE II
POLYMORPHIC
INTERACT
HAZELTINE
SOROC
CENTRONICS
MICROTEK
INTERTUBE
& Others

Call for Prices
(301) 694-8884

**FREDERICK COMPUTER
PRODUCTS**

Municipal Airport
Frederick, MD. 21701

Circle 167 on inquiry card.

CASSETTE DUPLICATION

TRS-80 (I & II), PET, APPLE, KIM, ATARI

Quality software duplication is more than copying cassettes. Microsette duplication uses a proprietary high speed duplicator designed specifically for computer program duplication. The finished products are of consistent quality, guaranteed to load. Minimum order is 100 with discounts for higher quantities. Call (415) 968-1604 for details.



MICROSETTE CO.
475 Ellis Street
Mt. View, CA 94043

Circle 168 on inquiry card.



SEARCHING THROUGH YOUR ENTIRE NORTH STAR BASIC PROGRAM LISTINGS.

WITH OUR NEW "SCAN" COMMAND YOU CAN INSTANTLY DISPLAY OR PRINT -

- ALL LINES THAT CONTAIN A SELECTED VARIABLE
- ALL OCCURRENCES OF GOSUB OR GOTO TO A PARTICULAR LINE NUMBER.
- ALL REFERENCES TO ANY LINE NUMBER
- ALL OCCURRENCES OF ANY CHARACTER, NUMBER, LINE NUMBER, GROUP OF CHARACTERS OR ANYTHING THAT IS CONTAINED IN ANY BASIC LINE

This is not one of those "funny programs written in BASIC." It is a machine language addition to BASIC that resides completely within NORTH STAR BASIC. It will not affect normal BASIC or DOS. It is self loading and can be loaded separately to operate with BASIC or saved along with BASIC as a copy of BASIC with the "Scan" command. Does not change memory available to BASIC. Easy to understand instructions.

- Available for version 6 as well as 14 digit basic
- State your version when ordering
- Dealer inquiries invited

PHONE ORDERS ACCEPTED **ONLY \$27.50** On disk
ORDER TODAY USE YOUR VISA OR MASTERCARD CARD (California only) (cash)

ELECTRONIC TECHNICIANS

SOFTWARE SERVICES
1072 CASITAS PASS RD
CARPINTERIA, CA 95013
805-684-6049



Circle 169 on inquiry card.

APPLE

- APPLE II or APPLE II PLUS \$995.00
- DC HAYES MODEMS 339.95
- FLOPPY DISK W/CONT. 529.95
- APPLE SOFT CARD 159.95
- PASCAL CARD 459.95
- ALF MUSIC SYNTHESIZER 249.95
- 10 MEGA-BYTE DISK DRIVE (for APPLE) 4695.00

UCATAN
COMPUTER STORE

access from Ramada Inn

PO Box 1000

Destin, Florida 32541

(904) 837-2022 or (904) 243-8565

Circle 170 on inquiry card.

Memorex Floppy Discs

Lowest prices. **WE WILL NOT BE UNDERSOLD!** Buy any quantity 1-1000. Visa, MasterCard accepted. Call free (800)235-4137 for prices and information. All orders sent postage paid.

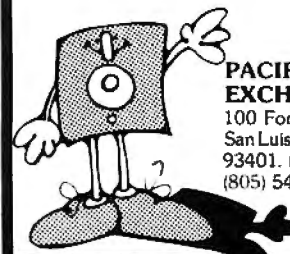

PACIFIC EXCHANGES
100 Foothill Blvd.
San Luis Obispo, CA
93401. (In Cal. call
(805) 543-1037.)

Circle 171 on inquiry card.

a TRS-80 basic renumbering program that does more

Renumber a program in any desired manner in one pass • renumbers even the longest programs in seconds • changes all line number references • rearranges program order • easily repeated use because commands are BASIC remarks • returns original BASIC program on errors • called from BASIC, returns to BASIC • specify 4 or 16K Level II or 32 or 48K DOS

Tested cassette/program both sides \$20

TRS-80 acting up? • check your RAM with our versatile RAM check • runs until interrupted • finds permanent and intermittent bad memory • memory size independent

Tested cassette program both sides \$10

MICROBIOTIC COMPUTING, INC.
6515 ROSS AVENUE S.E.
ALBUQUERQUE, NEW MEXICO 87108

Circle 172 on inquiry card.

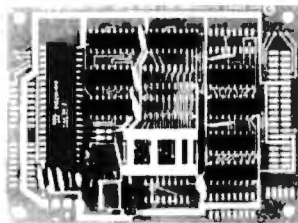

The AE-35 is a one-board microcomputer utilizing the 8035 geared toward stand-alone applications with:

- an 8-bit input, output, and bi-directional port
- fully programmable hand shake lines on each port
- crystal based timer
- 64 bytes RAM, expandable onboard to 1 K bytes
- provisions for program memory to 4 K bytes
- single supply capability (+5V)
- small size [5 inches x 3 1/4 inches]
- low cost [89.95 - singles plus shipping]

Contact factory for availability
money order, check, or C.O.D.

Adroit Electronics, Inc.
5 East Long Street, Suite 1012
Columbus, Ohio 43215
614-221-3060

Circle 173 on inquiry card.

H9 OWNERS!

Now you too can have graphic capabilities similar to those of the TRS-80 with GRAFIX. No modification to existing circuit boards is required. GRAFIX simply plugs into existing IC sockets.

Comes with complete instructions. Full 6 month warranty.

Kit \$59.95
Assembled and tested \$69.95

**Northwest Computer
Services, Inc.**
8503 N.E. 30th Avenue
Vancouver, WA 98665

Circle 174 on inquiry card.

CATCH THE S-100 INC. BUS!



	LIST PRICE	OUR SPECIAL CASH PRICE
Ithaca Audio Z-80 Processor, Assembled & Tested 2 MHZ	175.00	140.00
Godbout Econoram IIA, 4 MHZ 8K "Unkit"	149.00	125.00
Mullen TB-2 Extender Board with Probe-Kit	49.00	39.00
Morrow's Micro Stuff/Thinker Toys Switchboard Kit	199.00	165.00
North Star Horizon 2-32K-D Assembled & Tested	2765.00	2299.00
S.D. Systems Z-80 Starter Kit w/PIO	249.00	210.00

Subject to Available Quantities • Prices Quoted Include Cash Discounts. Shipping & Insurance Extra.

We carry all major lines such as S.D. Systems, Cromemco, IMSAI, Vector Graphics, North Star, Sanyo, ECT, TEI, Godbout, Thinker Toys, Hazelline, IMC. For a special cash price telephone us.

Bus... **S-100, inc.**
 Address... **7 White Place**
Clark, N.J. 07066
 Interface... **201-382-1318**

Programming Quickies

A French-English/English-French Dictionary

Dr Fred Levit, 251 E Chicago Ave, Chicago IL 60611

The program FRENGLSH turns a microcomputer into a foreign language dictionary. As written here, it will look up the French or English word entered and then print the translation. It does not translate phrases or sentences, but serves as a replacement for a paper dictionary.

FRENGLSH is written in CBASIC and uses two files which are stored on a disk. The first file, called DICTION, is a random access file each record of which contains pairs of words with the pairs separated by slashes. Each pair of words consists of a French word followed by a dollar sign and then the corresponding English word, or an English word followed by a colon and then the corresponding French word. As you can see in table 1, the word pairs are arranged in the record alphabetically by the left-hand word of each pair.

The second file used by FRENGLSH is called FRINDEX and is an index to the diction file. It contains a list of the first words in each record of the DICTION file, arranged alphabetically, with the corresponding line number in the DICTION file where that word is found. This file is read into an array in memory so that it can be searched rapidly when the program is running.

When a word is entered, FRENGLSH first searches the index to find the line number in DICTION where the wanted word pair will be found (lines 70 to 97 of listing 1). It then goes to that line in the file and searches the record for the wanted word plus the correct separator. Searching for the word with the separator appended avoids problems caused by similarly spelled words with different meanings which may be shared by French and English. When the correct left-hand member of the word pair has been found then the right-hand member of the pair is extracted (lines 99 thru 108, listing 1) and the entered word and its translation are printed. (See listing 2.)

The DICTION file contains about 1100 French words, which includes those most commonly used and needed by someone studying the language. Naturally not every word one might seek can be found, but, before giving up, FRENGLSH does one more thing. The infinitive form of most French verbs ends in -er or -oir, and that is the way the verbs are listed in a dictionary. But many verbs are most frequently encountered in the second person form,

Pascal / MT

from



8080 / Z80

- COMPILER & SYMBOLIC DEBUG!
- RUNS UNDER CP/M (S Derivatives)
- Generates Romable Machine Code
- Needs only 32K bytes
- Output is 10X faster than P-code
- Efficiently compiles a subset of Standard Pascal

Available for ALL CP/M Systems

\$99.95

Options include: real/business arithmetic multi tasking, interrupt procedures, etc.

Call/Write **Meta Tech**
 3308 Midway Drive
 Suite 289
 San Diego, CA 92110
 (714) 223-5566 X289

Dealer Inquiries Invited

Table 1: A portion of the file DICTION. Each record of 240 characters or less occupies about two and a half lines. Note that the words are in pairs, either French\$English or English:French. The list is alphabetized by the left-hand word in each pair.

```

"/A$TO/ABORD$APPROACH/ABOVE:AU-DESSUS(V)/ABOVE
ALL:SURTOUT/ABSENCE:ABSENCE(LA)/ABSENCE$ABSENCE/
ABSENT:ABSENT$ABSENT$ABSOLUMENT$ABSOLUTELY/
ABSOLUTELY:ABSOLUMENT/ACCEPT:ACCEPTER/"
"/ACCEPTER$ACCEPT(TO)/ACCIDENT$ACCIDENT/ACCIDENT:
ACCIDENT(LE)/ACCORD$AGREEMENT/ACCOUNT:COMPTE(LE)/
ACE:AS(LE)/ACHAT$PURCHASE/ACHERER$BUY(TO)/ACHEVER$
FINISH(TO)/ACIER$STEEL/ACQUAINTANCE:CONNAISSANCE(LA)/"
"/ACQUERIR$ACQUIRE/ACQUIRE:ACQUERIR/ACROSS:
TRAVERS/ACT:AGIR/ACTIF$ACTIVE/ACTION$ACTION OR
STOCK/ACTION:ACTION/ACTIVE:ACTIF/ACTUEL$PRESENT
TIME/ADD:AJOUTER/ADDITION$CHECK(RESTAURANT)"/"
"/ADDITIONAL:ADDITIONNEL/ADDITIONNEL$ADDITIONAL/
ADDRESSER$ADDRESS(TO)/ADIEU$GOODBYE/ADMETTRES
ADMIT(TO)/ADMIT:ADMETTRE/ADRESSE:ADRESSE(LA)/ADRESSE$
ADRESS/ADULT:ADULTE(LE)/ADULTE$ADULT"/"
"/ADVANCE(TO):AVANCER/ADVANTAGE:AVANTAGE(LE)/
ADVENIR$HAPPEN(TO)/ADVENTURE:AVENTURE(LA)/
ADVERTISEMENT:ANNONCE(LA)/AFFAIRES$BUSINESS/AFIN$SO
THAT/AFRICA:AFRIQUE(LA)/AFFIQUES$AFRICA/AFTER:APRES/"
"/AFTERNOON:APRES-MIDI(LE)/AFTERWARDS:ENSUITE/
AGAINST:CONTRE/AGIR$ACT(TO)/AGREEMENT:ACCORD(LE)/
AID$HELP/AIDERS$HELP(TO)/AILLEURS$ELSEWHERE/AIMABLE$
AMIALE/AIMERS$LIKE OR LOVE/AINSI$SO/AIR$AIR/"
"/AIR:A
B>
    
```

Listing 1: A listing of FRENGLSH. The program is written in CBASIC so that the line numbers at the left are not referenced by GOTO statements. Instead statement numbers are added by the programmer for statements which must be returned to. For example, line 61: GOTO 75 sends the program to line 48, which is statement 75.

```

11 REM          PROGRAM FRENGLSH IS COPYRIGHTED (1979) BY
21 REM          THE AUTHOR, FRED LEVIT M.D., AND ALL RIGHTS
31 REM          ARE RESERVED.
41
51          DIM WORDS(100),LINE,NUM(100)
61          PRINT "V 1.0"
71          PPINT " JUL 79"
81
91          PRINT:PRINT:PPINT
101
111
121          PRINT TAB(30):"PROGRAM FRENGLSH"
131          PRINT
141          PRINT TAB(22):"A FRENCH-ENGLISH-FRENCH DICTIONARY"
151
161
171          PRINT:PRINT
181          PRINT "STARTING MODE IS FRENCH-ENGLISH. TO REVERSE MODE"
191          PRINT "ENTER A 1 INSTEAD OF A WORD"
201          PRINT
211          PRINT "TO END THE PROGRAM ENTER A 9 INSTEAD OF A WORD"
221          PRINT:PRINT
231          PRINT "PLEASE WAIT 40 SECONDS WHILE WE LOAD"
241
251          PRINT:PRINT
261
271
281          OPEN "DICTION" RECL 204 AS 2
291          MODES="F"
301
311          REM          READ INDEX INTO MEMORY
321          OPEN "FINDEX" RECL 25 AS 1
331          IF END #1 THEN 50
341
351          H=1
361          WHILE -1
371              READ #1,N,WORDS(N),LINE,NUM(N)
381              N=N+1
391          WEND
401
411          50 CLOSE 1
421
431          PRINT "ENTER FRENCH WORD AFTER F# OR ENGLISH AFTER EN# "
441          PRINT:PRINT
451
461          REM          ENTER WORD TO BE SOUGHT
471
481          75 PRINT:PRINT
491          IF MODES="F" THEN (SEPARATOR$=" " ELSE (SEPARATOR$=":"
501          IF MODES="F" THEN PRINT "FR# " ELSE PRINT "EN# "
511
521          INPUT ENTERED.WORDS
531          55 WORDS(:DOUGHT$)=ENTERED.WORDS
541
551          IF WORDS(:DOUGHT$)="9" THEN :TOP
561          IF WORDS(:DOUGHT$)="1" AND MODES="F" THEN\
571              MODES ="E":\
581              GO TO 75
591          IF WORDS(:DOUGHT$)="1" AND MODES="E" THEN\
601              MODES="F":\
611              GO TO 75
621
631
641          REM          PAD WORDS(:DOUGHTS) TO 15 CHARACTERS
651
661          WHILE LEN(WORDS(:DOUGHTS))<15
    
```

Listing 1 continued on page 208

THE BEST MICRO COMPUTER

- Exporter -



Fast + Efficient

Our Foreign Customers Receive:

- Purchasing Agent's Service
- Wholesale Discounts
- 220 V/50 Hz Power

Products

- | | |
|-------------------|-------------------|
| NORTH STAR | TELEVIDEO |
| TEXAS INSTRUMENTS | BASE 2 |
| SOROC | KONAN CORPORATION |
| INDUSTRIAL MICRO | CENTRONICS |
| HAZELTINE | INTEGRAL DATA |
| EXIDY SORCERER | VERBATIM |
| MICRO PERIPHERALS | + More |

P.O. Box 1118 Scottsdale, Arizona 85252 U.S.A.
Tel: 602-994-3435 TELEX: 165745

DEC LSI-11 Components

Dependable service
at discount prices

Domestic
and Export

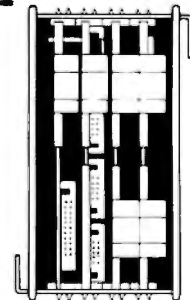

Mini Computer Suppliers, Inc.

25 Chatham Rd., Summit, N.J. 07901
Since 1973
(201) 277-6150 Telex 13-6476

©Mini Computer Suppliers, Inc.
1979

Listing 1 continued:

```

671      WORD,DOUGHTS=WORD,DOUGHTS+" "
681      WEND
691
701  PEM          BEGIN SEARCH OF INDEX
711
721      TOP.LINE = 1
731      BOTTOM.LINE = N-1
741
751  100  MIDLINE = INT((BOTTOM.LINE-TOP.LINE)/2)+TOP.LINE
761
771
781      IF WORD,DOUGHTS = WORDS+MIDLINE\
791      THEN LINE,DOUGHT=MIDLINE\
801      GO TO 500
811
821      IF WORD,DOUGHTS LT WORDS+MIDLINE\
831      THEN BOTTOM.LINE=MIDLINE
841
851      IF WORD,DOUGHTS GT WORDS+MIDLINE\
861      THEN TOP.LINE=MIDLINE
871
881      IF BOTTOM.LINE-TOP.LINE NE 1 THEN\
891      GO TO 100
901
911      IF WORD,DOUGHTS LT WORDS+BOTTOM.LINE\
921      THEN LINE,DOUGHT=TOP.LINE\
931      GO TO 500
941
951      IF WORD,DOUGHTS GE WORDS+BOTTOM.LINE\
961      THEN LINE,DOUGHT=BOTTOM.LINE\
971      GO TO 500
981
991  PEM          MATCH FOR WORD NEEDED
1001
1011  500  PERD #2+LINE,DOUGHTS\
1021
1031      LOC1= MATCH(ENTERED,WORDS+SEPARATORS+AS,1)
1041      IF LOC1 = 0 THEN GO TO 1000
1051      LOC2=MATCH(" "+AS,LOC1)
1061      LOC3= MATCH(SEPARATORS+AS,LOC1)
1071
1081      TRANSLATEDS=MIDS(AS,LOC3+1,LOC2-(LOC3+1))
1091
1101  PEM          PRINT TRANSLATED WORD
1111
1121      PRINT ENTERED,WORDS+" " + TRANSLATEDS
1131      GO TO 75
1141
1151  PEM          WORD NOT FOUND. CHECK FOR VERB ENDING
1161
1171  1000 PRINT ENTERED,WORDS+" NOT FOUND. "
1181      IF RIGHTS(ENTERED,WORDS+2) = "EZ" THEN\
1191      ENTERED,WORDS=LEFT(ENTERED,WORDS+LEN(ENTERED,WORDS)-2)+"ER"\
1201      GO TO 85
1211
1221      IF RIGHTS(ENTERED,WORDS+2) = "EP" THEN\
1231      ENTERED,WORDS=LEFT(ENTERED,WORDS+LEN(ENTERED,WORDS)-2)+"IP"\
1241      GO TO 85
1251
1261      PRINT "MA: YOUR WORD SPELLED CORRECTLY ?"
1271      GO TO 75
1281
1291
1301  END
1311
1321
1331
1341
1351
1361
1371
1381
1391
1401
1411
1421
1431
1441
1451
1461
1471
1481
1491
1501
1511
1521
1531
1541
1551
1561
1571
1581
1591
1601
1611
1621
1631
1641
1651
1661
1671
1681
1691
1701
1711
1721
1731
1741
1751
1761
1771
1781
1791
1801
1811
1821
1831
1841
1851
1861
1871
1881
1891
1901
1911
1921
1931
1941
1951
1961
1971
1981
1991
2001

```

Listing 2: In this run of FRENGLSH the first prompt FR=? was answered by typing "bonjour," and FRENGLSH found the corresponding English word "hello." In the third example, the word "voulez" is not the dictionary form of the verb. The -ez ending signifies it is second-person present tense. FRENGLSH did not therefore find "voulez," so it looked for the stem of the word with common infinitive endings, -er or -oir. "Vouloir," the correct infinitive form of the verb, was found and the corresponding English was printed.

```

PROGRAM FRENGLSH
A FRENCH-ENGLISH-FRENCH DICTIONARY

STARTING MODE IS FRENCH-ENGLISH. TO REVERSE MODE
ENTER A 1 INSTEAD OF A WORD

TO END THE PROGRAM ENTER A 9 INSTEAD OF A WORD

PLEASE WAIT 40 SECONDS WHILE WE LOAD

ENTER FRENCH WORD AFTER FR= OR ENGLISH AFTER EN=

FR= ? BONJOUR
BONJOUR = HELLO

FR= ? ATTERIR
ATTERIR = TO LAND (AIRPLANE)

FR= ? VOULEZ
VOULEZ NOT FOUND. VOULER NOT FOUND. VOULOIR = TO WANT

FR= ?

```

ending in -ez. For example, *vouloir* means "to want" while *voulez* means "you want." *Parler* means "to talk" and *parlez* means "you talk." If the word you give to FRENGLSH ends in -ez and is not found in the DICTION file, FRENGLSH will search for the root of the word with an -er ending, and, if that fails, for an -oir ending (lines 116 thru 128 in listing 1). Only if those additional two searches are unsuccessful does FRENGLSH report failure.

As can be seen, at 130 lines, including comments and blank lines, FRENGLSH is not a very long program. Of course, the real problem is in creating the DICTION file with its thousands of words. This was done by using several other programs. One program permitted the entry of word pairs, assigning the correct separator, and writing the list to a file which was then corrected using the system editor. These lists were concatenated as they

were created, and the completed list was split into twenty-six separate lists, each beginning with a different letter of the alphabet. These individual lists were then proofread, corrected, concatenated, and alphabetized to make a single long file. The final file was then read by a program which created the DICTION file by inserting slashes between the word pairs and assembling the pairs into records of 204 or less characters. Finally a small program was used to read the first word in each record in the DICTION file, together with its record number, to create FINDEX, the index file.

FRENGLSH is quite fast. Most of the time it is considerably faster than thumbing the pages of a paper dictionary, especially for people like me who have never really learned which letters follow which in the alphabet. ■

Z80 User Stack Emulation

Allen Gelder, Box 11721 Main Post Office,
San Francisco CA 94101

Passing arguments to subroutines via the Z80 hardware stack is complicated by the presence of the subroutine return address at the top of the stack. This artifact of the CALL instruction makes a cork-in-the-bottle effect that precludes just PUSHing the arguments onto the stack and later POPing them into the subroutine after the CALL. The problem is solved on the new Motorola 6809 by the addition of a *user stack* which does

not participate in the CALL housekeeping. Such a structure is easily emulated and can be integrated very naturally into the Z80 instruction set by the use of the restart instruction group.

Recall that the restart (RST) instructions are 1-byte calls to selected page 0 locations. For example, hexadecimal op code D7 is RST 10. When program flow encounters this instruction, the program counter (register PC) will be pushed onto the stack and control will be transferred to location 0010. Often this location contains a vector to the actual routine, which will typically be concluded by a return (RET). This is the arrangement here (see listing 2, page 210). It is easy to link this emulation; just initialize UPSTOR with a 2-byte user pointer to the desired top of the user stack, and then vector the restarts as indicated. (See listing 1, page 210.)

When program flow encounters a D7 op code (RST 10), the result will be a POPU DE, that is, the top of the user stack will be popped into DE, and the user pointer (UP) will be updated. Similarly, a DF op code (RST 18) will result in a PSHU DE onto the top of the user stack, etc (see table 1). This action is perfectly consistent with current hardware stack usage, right down to the near congruence of the POPU and PSHU instruction bytes.

The difference is that this stack is totally controlled by the user, at very little programming expense. In the configuration of table 1, the user stack access covers the primary register pairs BC, DE, HL and AF. An alternative assignment (see listing 3, page 210, and table 2) of restarts can include registers IX and IY. This is at the expense of register pairs DE and AF, but saves one byte over the corresponding PUSH or POP IX (or IY) instruction.

Interpretation of the restart group of instructions is varied. In the literature, the restart instructions are described as saving space, useful for interrupts, or as left-over 8080 instructions. In practice they are often usurped by the input/output (I/O) software, or perhaps page 0 is submerged in read-only memory. If this is the case in your Z80-based system, it is worth looking for a vector table in programmable memory or in some other way gaining access to the restart instructions. Because they are an embedded group of 1-byte, user-programmable instructions, they bestow a kind of microprogrammability on the Z80.

User Stack Instruction	Hardware Stack Instruction
POPU BC C7 (RST00)	POP BC C1
PSHU BC CF (RST08)	PUSH BC C5
POPU DE D7 (RST10)	POP DE D1
PSHU DE DF (RST18)	PUSH DE D5
POPU HL E7 (RST20)	POP HL E1
PSHU HL EF (RST28)	PUSH HL E5
POPU AF F7 (RST30)	POP AF F1
PSHU AF FF (RST38)	PUSH AF F5

Table 1: Restart (RST) instructions assigned to user stack in listing 1.

User-Stack Instruction	Hardware-Stack Instruction
POPU IX D7 (RST10)	POP IX DDE1
PSHU IX DF (RST18)	PUSH IX DDE5
POPU IY F7 (RST30)	POP IY FDE1
PSHU IY FF (RST38)	PUSH IY FDE5

Table 2: Restart (RST) instruction assignments made by modified user-stack emulation in listing 2.

In this user stack setup, the restart instructions are exploited as 1-byte PSHU and POPU instructions in service of an emulated processor architectural feature. They could as easily call an emulated addressing mode not available on the Z80. The point is that an appropriate use of the restart group is in calling instruction-like subroutines that represent the primitives serving the user's own fanciful structure. Thus you can design your own corner of the Z80. Let your curiosity PSHU into trying it.

9 new kits! ANALOG PERIPHERAL FUNCTIONS
... in touch with reality!

QK-100 Triple A - D Converter	\$36.95
QK-101 Dual Air Temperature Sensors	26.95
QK-102 Dual Ground Moisture Sensors	29.95
QK-103 Power Supply with Dual Sockets	29.95
QK-104 Dual Liquid Temperature Sensors	32.95
QK-105 Dual Photo Sensors	27.95
QK-106 Dual Water Level Sensors	34.95
QK-108 Dual Surface Temperature Sensors	30.95
QK-109 Dual Hall-Effect DC Magnetic Sensors	54.95
QK-110 Multiplier and Voltage-Controlled Amp	43.95
QK-112 Peak Sense and Hold/Sample and Hold	28.95
QK-115 8/16 Input Analog Multiplexer	38.95
QK-122 Dual Instrumentation Amplifier	24.95
QK-124 Log and Anti-Logarithmic Functions	40.95
QK-133 Multiple Audible Alarm	25.95
QK-134 Multiple Analog Comparators	39.95
QK-138 Dual "People" Sensors	34.95
QK-900 Socket and Mounting Board	8.95

sensors

Qkit AVAILABLE IN ASSEMBLED MODULES

(602) 299-9831 CALL Q-KIT

P.O. BOX 35879 WITH YOUR CUSTOM

TUCSON, SYSTEM REQUIREMENTS!

ARIZONA 85740 a division of j.r. conwell corporation

SOFTWARE BREAKTHROUGH!

A true breakthrough in 8080 development software has been achieved . . .

R-A-I-D

RAID stands for "Real-time Interactive Assembler Debug," but RAID is much more.

SIMULATOR - RAID is a true simulator and real-time debug in one! Simulation mode provides TOTAL CONTROL of test program. It's crash proof! Segments of memory may be write-protected, limits specified for stack, program counter, etc. Simulation mode is transparent and both modes may be used together for high speed simulations

SYMBOLIC DEBUG - RAID is a fully symbolic debug, including labels and operands! Also included are multiple radix, multiple breakpoints, memory search, 9 display formats, single-step, multi-step, display/alter registers or memory, programmable output, etc. Over 70 commands in all!

ASSEMBLY/DIS-ASSEMBLY - Memory may be displayed or altered in instruction mnemonic form complete with symbolic labels and operands. Exclusive feature permits "following" subroutines during dis-assembly

TRACING - Elaborate trace facilities have been included. Trace each instruction as executed, trace subroutines as entered and exited, trace by breakpoint dumps with user programmable dump data

FULL DISK ACCESS - In addition to loading/saving named files, RAID permits reading/writing on a specified track & sector basis

FLOATING POINT OPTION - Permits direct display or alteration of FPP (see below) numbers. 12 digit mantissa, exponent to ± 127,BCD format.

CP/M COMPATIBLE - RAID will run on any CP/M system of 24K or more. Works with both ASM and MAC assemblers fully symbolically

TO ORDER: Specify software desired and enclose check or money order (COD ok).

- A) RAID without floating point option \$150.00
- B) RAID with floating point option, and FPP source code \$250.00
- C) FPP Floating Point Processor only \$125.00
- D) RAID Documentation Only \$25.00
- E) ISIS to CPM Conversion Utilities \$125.00

All software supplied on CP/M compatible 8" diskette. ISIS versions also available.



**SOUTHERN
SYSTEMS
OF BIRMINGHAM**

Post Office Box 3373A
Birmingham, AL 35205
(205) 933-1659

Listing 1: Vectoring RST10.

```
0010 C310 50      00099 RST10      JP      FROM10      ; Now D7 calls FROM 10
```

Listing 2: Assembled program for Z80 user-stack emulation using restart (RST) instructions.

```
5000          00100          ORG      5000H
5000 00          00101 SPSTOR  NOP          ; SP saved here.
5001 00          00102          NOP
5002 00          00103 UPSTOR  NOP          ; UP saved here.
5003 00          00104          NOP
5004 E5          00105 FROM00  PUSH     HL          ; Vector C0 here.
5005 21C100      00106          L        HL,00C1H
5006 1828        00107          JR        USRSTK
500A E5          00108 FROM08  PUSH     HL          ; Vector C0 here.
500B 21C500      00109          LD        HL,00C5H
500E 1822        00110          JR        USRSTK
5010 E5          00111 FROM10  PUSH     HL          ; Vector D7 here.
5011 21D100      00112          LD        HL,00D1H
5014 181C        00113          JR        USRSTK
5016 E5          00114 FROM18  PUSH     HL          ; Vector DF here.
5017 21D500      00115          LD        HL,00D5H
501A 1816        00116          JR        USRSTK
501C E5          00117 FROM20  PUSH     HL          ; Vector E7 here.
501D 21E100      00118          LD        HL,00E1H
5020 1810        00119          JR        USRSTK
5022 E5          00120 FROM28  PUSH     HL          ; Vector EF here.
5023 21E500      00121          LD        HL,00E5H
5026 180A        00122          JR        USRSTK
5028 E5          00123 FROM30  PUSH     HL          ; Vector F7 here.
5029 21F100      00124          LD        HL,00F1H
502C 1804        00125          JR        USRSTK
502E E5          00126 FROM38  PUSH     HL          ; Vector FF here.
502F 21F500      00127          LD        HL,00F5H
5032 223E50      00128 USRSTK  LD        (OPSTOR),HL ; Place in OPSTOR.
5035 E1          00129          POP      HL
5036 ED730050    00130          LD        (SPSTOR),SP ; Save the SP.
503A ED7B0250    00131          LD        SP,(UPSTOR) ; Initialize User Stack.
503E 00          00132 OPSTOR  NOP          ; Event happens here.
503F 00          00133          NOP
5040 ED730250    00134          LD        (UPSTOR),SP ; Save the UP.
5044 ED7B0050    00135          LD        SP,(SPSTOR) ; Restore the SP.
5048 C9          00136          RET          ; Back to program.
```

Listing 3: Alternate assembled listing to include index registers IX and IY. These two sections of code are directly substituted for the code in listing 2.

```
.
.
.
5010 E5          00111 FROM10  PUSH     HL          ; Vector D7 here.
5011 21DDE1      00112          LD        HL,E1DDH
5014 181C        00113          JR        USRSTK
5016 E5          00114 FROM18  PUSH     HL          ; Vector DF here.
5017 21DDE5      00115          LD        HL,E5DDH
501A 1816        00116          JR        USRSTK
.
.
.
5028 E5          00123 FROM30  PUSH     HL          ; Vector F7 here.
5029 21FDE1      00124          LD        HL,E1FDH
502C 1804        00125          JR        USRSTK
502E E5          00126 FROM38  PUSH     HL          ; Vector FF here.
502F 21FDE5      00127          LD        HL,E5FDH
5032 223E50      00128 USRSTK  LD        (OPSTOR),HL ; Place in OPSTOR.
```



16K STATIC MEMORY (RAM)

250 nsec Access Time, Assembled, tested, and Guaranteed. \$300.00

Fully Static - TMS 4044
S-100 Bus - Buffered lines, Dip Sw address in 2, BK blocks 4K incr., Write Protect, Phantom disable, Battery backup, fully Socketed.
Bank Select - Port 40H (Cromemco Software Comp.), 80H or COH.
Guarantee - One full year. To order, call for Visa, M.C., or C.O.D. (\$4 fee.) Personal check o.k. M.O. speeds shipping. Stock to 72 hour delivery. Illinois residents add 5 1/4% tax.

S. C. DIGITAL

P.O. Box 906, Aurora, IL 60507
Phone: (312) 897-7749

Circle 181 on inquiry card.

H-8 OWNERS AD-8/4 H

Analog/Digital Subsystem

- 8 Analog Input Channels
- 100 μ s A/D Conversion Time
- 4 Analog Output Channels—
Each with Sample and Hold
- Full 8 Bit Resolution
- Uses Single Card Slot
- Fully Assembled and Tested
- Full Documentation Provided
- VISA and M.C. Accepted

\$125.00

CCM, Inc.

P.O. Box 2308
Reston, VA 22091

Circle 182 on inquiry card.

THE AMSAT-GOLEM 80 PROJECT

Front Panel Hardware

Boards \$45.00
Kits \$245.00
Assembled and Tested \$349.00

AMS80 Software

Documentation (178 pages) \$15.00
Source code 8" CP/M* disc \$30.00
Source code 5" Northstar* (CP/M*) \$30.00
Object Code 5" Northstar* \$10.00

Write for information on other S-100 cards and software optimized for Amateur Radio communications, control and logging.

SNOW MICRO SYSTEMS INC.
P.O. Box 1704
Silver Spring, MD 20902

* CP/M and Northstar are registered trademarks.

Circle 183 on Inquiry card.

BYTE's New Toll-free Subscriber W.A.T.S. Line (800) 258-5485

To further improve service to our customers we have installed a toll-free WATS line in our Peterborough, New Hampshire office. If you would like to order a subscription to BYTE, or if you have a question related to a BYTE subscription, you are invited to call (800) 258-5485 between 8:30 AM and 4:30 PM Eastern Time. This applies to calls from within the continental US only.

We thank you and look forward to serving you

STATISTICAL DATA

DATABANK programs contain 10 years of monthly statistical data on ten related subjects. Information is the most current available. Each cassette is date stamped. Includes graphs, tables, trends, comparisons, update routine, and external input.

Programs available for **TRS-80** L2, 16K

- General Economy
- Manufacturing & Trade
- Industrial Production
- Money & Credit
- Money Rates & Yields
- Commodity Spot Prices
- Mortgage Terms & Yields
- Foreign Exchange Rates
- Energy Production
- Petroleum Production

\$29.95 each 3 for \$84.95
Cassette storage album included with order for six or more programs.



DATABANK POB 9285
Ft Lauderdale, FL 33310

Circle 184 on inquiry card.

Radio Shack DEALER COMPUTER CENTER

MICRO MANAGEMENT SYSTEMS



**Up To 15% Discount
on
TRS-80's**

WE HAVE THE HIGHLY
RELIABLE LOBO DISK DRIVE
IN STOCK!

MINI MALL—DOWNTOWN SHOPPING CENTER
CAIRO, GEORGIA 31728
912-377-7120

Circle 185 on inquiry card.

GAME DESIGN

Leading Coin-op Amusement Game company will consider use of YOUR pinball, video or other game idea on a royalty, commission or other basis. **WRITE FOR DISCLOSURE FORM BEFORE SUBMITTING GAME IDEA.**

Department BMA
P.O. Box 236
Bensenville, IL 60106

Circle 186 on inquiry card.

Save More Than 20%
North Star—Intertube
Thinker Toys—Microtek
The Smartest Computers at the Smartest Price
Quad & Double Density

	List	Only
Horizon-1-32K-D Kit	\$1999	\$1585
Horizon-2-32K-D Kit	2399	1905
Assembled & Tested	2765	2185
Horizon-2-32K Kit Quad	2799	2225
Assembled & Tested	3215	2555
Pascal for North Star on Disk		49
Powerful North Star BASIC		FREE
ZTEI PT 212 Computer 5 mHz	8000	6250
Thinker Toys Discus 2D A&T	1149	949
Duacus 2+2 1 2 Megabytes A&T	1549	1299
Measurement system memory		640
A&T 4mHz 64 K		
Godbout Memory		Call for price
Intertube II Smart Terminal	995	745
Microtek Printer	750	675
Anadex Printer	995	875
Florida Data Printer 800 CPS 4300		Call for price
Maryellen Word Processor	Your Best Buy	38
Textwriter III		125
EZ-80 Tutorial Learn Machine Language		25
PDS For North Star Better Than CP/M		99
Compiler for Horizon Secret Superfast Code		100
10% Off Software Prices With Computers		
Verbatim the Best Diskettes Box of 10		99
Which Computers Are Best? Brochure . . .	FREE	
North Star Documentation Refundable		20
W/HRZ		

American Square Computers
Kivett Dr • Jamanstown NC 27868
(919)-863-1105

Circle 187 on inquiry card.

RS 232C Computer Compatible Paper Tape Readers Available from Stock



Addmaster Corporation announces that the Model 612 Stand Alone Paper Tape Readers is now available from stock and is shipped in 1 to 3 working days after receipt of order. The Model 612 has greater capacity than earlier models. The ability to read 5 to 8-level tape and to transmit 7 to 11 frames per character at 90 to 9600 baud are among the new features. Others include starting and stopping on character at all speeds, choice of manual control or X-on, X-off, 90 to 260 volt, 50 to 60 Hz power and even, odd or no parity. RS 232, current loop or parallel outputs are available as is choice of desk top or rack mounting. Single unit price of the new Model 612 is \$656.00 to \$779.00

Addmaster Corporation

416 Junipero Serra Drive
San Gabriel CA 91776
(213) 285-1121

Circle 188 on inquiry card.

Eighteen with a Die

A Learning Game Player

Russell R Yost Jr
1825 E Palo Verde Dr
Phoenix AZ 85016

The simulation of human intellect by a machine of human invention has fascinated mankind for centuries. Unfortunately, the attainment of such a goal still seems to be distant. The advances in machines that might achieve such a goal seem to be continually offset by additions to our knowledge of the complexity of the human intellectual process. Simple game-playing machines, however, are feasible, and their popularity probably stems from the above mentioned human yearning, even though these games represent only a narrow slice of human intellect.

Game-playing programs are of great value to the personal computer owner, since results of great interest to spouse and neighbors can be produced with only a small investment in memory and software. Rarely do such programs involve more than logic plus simple integer arithmetic, and they are so short that hand assembly of machine-language programs is entirely feasible.

Many games are well adapted to interaction with the human player through the same I/O (input/output) channel used for programming. I am sure that the first program tried by most buyers of the Southwest Technical Products Corp 6800 computer system (after some memory check programs) is the Tic-Tac-Toe program whose listing is supplied with the computer kit.

Although such beginner games soon become boring, game-playing programs of real and continuing challenge are now becoming feasible for all amateur computer owners. Meanwhile, simple game players such as the one described here continue to intrigue computer enthusiasts.

Game Categories

Thus far I have been using the term "game player" loosely, and indeed the term is loosely used in many articles. Three distinct categories are easy to define: puzzles, gambling machines, and man versus machine game players.

It seems to me that a game like Shooting Stars (by Willard I Nico, May 1976 BYTE, page 42) is really a puzzle that the human tries to solve in as few moves as possible. Star Trek-type games might be considered examples of a gambling program. Through the use of random number generators, the human's moves produce random results following prescribed odds; luck is involved in the result.

Tic-Tac-Toe is an example of a man versus machine game. The machine plays the role of an adversary, playing by the same rules that apply to the human.

This last category comes the closest to the simulation of human intellect, which is why I feel it is of great interest to the computer owner. However,

all three types of games are interesting to players, and many games combine elements of all three in their architecture.

Game Learning Program

A natural extension of the third category is the game learning and playing program. In this type, the machine is given the rules of the game, but initially does not possess any strategy for selecting its moves. Through playing a series of games with the human, it learns a strategy for increasing its chances of winning. This type comes even closer to the simulation of human intellect.

The design of such machines has been one of my hobbies for over thirty-five years. I recently purchased a computer because my ambitions outgrew what could be built using relays and stepping switches, or even

About the Author

Russell Yost studied physics at the California Institute of Technology before World War II diverted him into working on defense electronic systems. Since 1952 he has worked for Motorola; he is now the chief engineer for radar systems in the Government Electronics Division. When he saw the rising tide of microprocessor electronics, he bought a Southwest Technical Products 6800 computer system to gain experience in the new field. He uses the 6800 system to design logic circuits at home; at work he writes FORTRAN programs for simulation on a Sigma 5 computer. He is active in amateur radio and photography.

small-scale integration logic elements. Software generation for such machines is now my current hobby.

The learning process can be implemented in various ways. One way is the "reward or punishment" approach exemplified by the game Hexapawn, which was described by Martin Gardner and based on a learning machine developed by Donald Michie. (See "Mathematical Games," *Scientific American*, volume 206, number 3, March 1962, page 138.)

The computer's response to each game situation is selected at random from a set of legal moves whose individual selection probabilities are the result of a previous experience. After each game in which the computer wins, the moves that it used are enhanced in probability. After each game it loses, the moves that it used are reduced in probability.

Gardner presented a simple model of such a game in which each response was the label of a box containing a certain number of beads. Losing moves were penalized by the removal of beads; winning moves had beads added to their boxes. The probability of selecting a given move in future games was related to the number of beads contained by its box. Robert Weir described a simpler process in which the various response probabilities were either 0 or 1 ("Hexapawn: A Beginning Project in Artificial Intelligence," November 1975 *BYTE*, page 36).

Win Table

Another learning process is the construction of a table of winning moves for each position or situation of the game. Many games are characterized by the existence of such a table. Each player tries to move to prevent the other player from getting to a winning situation in the table. Such a table is sometimes referred to as a *game tree* because of the multiple branches that lead to a single final winning position represented by the trunk of the tree.

For learning, the machine can initially be given the table of all possible moves for each game situation, with winning moves unidentified. For each situation the machine plays from, it fills in the winning moves by determining which of its permitted moves prevent the player from reaching a winning situation. Furthermore, after making its move, the machine may

.....
In a game-learning program, the machine is given the rules of the game, but initially possesses no strategy for selecting its moves.
.....

again analyze the new situation, before allowing the player to take his or her turn.

For the early games in a sequence of games, when most of the winning moves are unidentified, this process produces many errors. However, when the end of the game can be reached from the situation being analyzed, this process correctly identifies winning moves.

In subsequent games of a series, the correct entries appearing close to the end of the game permit the correction of earlier errors. To do this, the computer designates as *losing* moves those resulting in a situation from

which the player can, with a legal move, attain a winning situation.

The net result is that during a series of games, the win table, which originally identified none of the winning moves, is gradually improved until it contains no significant errors and a sufficient number of winning moves to enable the machine to play faultlessly. Thereafter, one of the two players has no chance to win unless the other errs. Naturally, the game must be arranged so that the losing player is the human player; otherwise the learning process would not be apparent.

The above process of computer learning is quite similar to the way a human would learn to play such a game. At the start of the early games, play would be more or less random. Near the end of each game the beginning player would consider the opponent's legal responses to each of the permitted moves, and would try to select one that prevented a win by the opponent. In subsequent games the player would remember the situations from which he or she was able to win,

HARD DISC SYSTEM

KB10

SUPER PRICE/PERFORMANCE

- Complete Sub-System: DRIVE, CONTROLLER, and CABLES for \$100 computers
- Uses the most popular drive for small business systems
- 10 Megabyte formatted capacity ■ 5MB fixed platter plus ■ 5MB 5440 removable cartridge for FAST BACK-UP and UNLIMITED off line STORAGE
- Look Ahead buffer for maximum performance ■ expandable to 40 MB
- Supported by CP/M 2.0, MP/M, Oasis, Famos, Fordos, Tempos Operating Systems
- Beautiful teak finish table top (shown) enhances any office decor
- Rack mount also available ■ Dealers/OEMs contact John Costello.

XCOMP

XCOMP, INC., 9915-A Businesspark Ave., San Diego, CA 92131 • (714) 271-8730

CP/M® SOFTWARE TOOLS

NEW ED-80 TEXT EDITOR

ED-80 offers a refreshing new approach for the creation and editing of program and data files conversationally—and it saves you money. Its powerful editing capabilities will satisfy the most demanding professional—yet it can still be used by the inexperienced beginner.

Look at These Outstanding Features:

- FULL SCREEN window displays with forward and backward scrolling for editing your data a page-at-a-time, rather than line-by-line.
- Provides you with all the features found on the large mainframe and minicomputer editors, such as IBM, UNIVAC, CDC, and DEC.
- Commands include forward or backward LOCATE, CHANGE, and FIND; and INSERT, DELETE, REPLACE, APPEND, SAVE, PRINT, WINDOW, MACRO, TABSET, SCALE, DUMP, and others.
- Compatible with existing CP/M edit and text formatted files, with CBASIC, and with Microsoft's MBASIC, FORTRAN, COBOL, and ASSEMBLER.
- CHANGE commands allow you to make conditional changes and to use variable length strings.
- Designed for CP/M and derivative operating systems, including LIFEBOAT, CDOS, IMDOS, DOS-A, ADOS, etc.
- GET and PUT commands for concatenating, moving, duplicating, and merging your edit files on the same or different diskettes.
- Provides you with fast memory-to-memory COPY commands, and an intermediate buffer for copying lines over-and-over.
- Saves your last LOCATE, CHANGE, FIND, and APPEND command for easy re-execution.
- Simple line-oriented commands for character string editing.
- Safeguards to prevent catastrophic user errors that result in the loss of your edit file.
- INLINE command for your character-oriented editing.
- Designed for today's CRT's, video monitors, and teletypewriter terminals.
- Thoroughly field tested and documented with a comprehensive User's Manual and self-instructional tutorial.

And remember — in today's interactive programming environment — your most important software tool is your text editor. ED-80 is already working in industry, government, universities, and in personal computing to significantly cut program development time and to reduce high labor costs. Why not let ED-80 begin solving your text editing problems today? ED-80 is protected by copyright and furnished under a paid-up license for use on a single computer system. Single Density Diskette and Manual: \$99.00, or the Manual alone: \$20.00 (credited with purchase of the Diskette). Specify Disk make/model, 5" or 8", hard or soft sectored. ORDER NOW and we'll pay the postage!

SOFTWARE DEVELOPMENT & TRAINING, INC.
 Post Office Box 4511 — Huntsville, Alabama 35802



Dealer Inquiries Welcomed
 © CP/M is a trademark of Digital Research



GENERAL LEDGER PAYROLL ACCOUNTS RECEIVABLE & PAYABLE

Flexible and sophisticated business software that is among the highest quality on the market. Originally developed by OSBORNE & ASSOCIATES and rapidly becoming a standard. Our service is support. We will send you these programs with the proper I/O and CRT specific subroutines for your hardware configuration. Get back to business and leave the programming to us. Include hardware description with order.

- Accounts Receivable and Payable 145.00
- Payroll (California) 145.00
- Non California state tax calculations
 (please inquire) 15-250.00
- General Ledger 145.00
- Multiple profit center option for G/L 25.00
- Manuals (each) 15.00

All programs in CBASIC under CP/M (Includes source)

UTILITIES

- DOS MOVER for NORTH STAR. Moves DOS and BASIC anywhere you want it. (i.e., from 2A00 to 0000) 35.00
- ALS-8 MOVER on North Star Disk 35.00

Synergetic Computer Products

3885 Magnolia Drive • Palo Alto, CA 94306
 (415) 856-6049

Visa • Mastercharge • COD • Certified Check
 CP/M is a trademark of Digital Research

and would attempt to attain those positions earlier in the game.

There is another interesting parallel to human behavior in a machine that learns by this scheme. The machine's rate of learning (ie: the rate at which it corrects errors in the win table) is dependent on the skill of the human opponent. Since the human cannot win when the win table is error-free, the only way the new player can win early in a series of games is to take advantage of the errors, by playing to reach those situations for which the win table is erroneous. If this is done, the machine has an opportunity to analyze the results of moves from, and correct the errors for, that situation. On the other hand, if the human plays poorly and does not take advantage of the machine's errors, the machine does not correct the errors for early game situations, but wins in the end game.

A final, and most provocative parallel to the learning process of living systems is the need for random trials to discover winning moves that have been erroneously erased or never discovered. In analyzing a given situation, the machine sometimes cannot find a winning move because of an error in a situation closer to the end of the game. I found that no fixed preprogrammed move strategy would guarantee that the machine would correct such an error.

It was absolutely essential for the machine to try moves at random each time it analyzed that situation until it "accidentally" made the correct move, played to the erroneous situation, and then corrected the error residing there. This is a striking analogy to the random attempts of the smallest insect (or for that matter, a human baby) to manipulate its environment.

A Suitable Game

As implied above, it is essential to find a simple game to demonstrate learning by filling in the win table. At the same time, the game must be challenging enough to maintain the interest of its human player. Eighteen with a Die is such a game.

I discovered a variant of the game in a book by Geoffrey Mott-Smith a number of years ago (Geoffrey Mott-Smith, *Mathematical Puzzles for Beginners and Enthusiasts*, The Blakistone Co, Philadelphia PA, 1946). As described, the game was

played with a die (half of a pair of dice). One player makes a random roll for his first play. Thereafter each player, in turn, turns one of the four vertical faces of the die upward by rotating it 90 degrees in a direction of the player's choice. A running total of all the plays is kept, and the object is to make the total hit a given target value on the move. Mott-Smith used the goal number of thirty-one.

I have shortened the game to the goal number of eighteen, and have allowed the first player a free choice for the first move, rather than making it random. Mott-Smith described an algorithm by which, given the current total and the last player's move, a winning play could be derived. However, it was not infallible, particularly near the end of the game. Thus the idea of the win table evolved as the approach to a learning machine.

Since the opposite faces of a die sum to seven, the rules for Eighteen with a Die become the following:

.....
The machine's rate of learning is dependent on the skill of the human opponent.
.....

after the first play, each player may play a number from one to six inclusive, but it may not be the number just played by his opponent nor its complement with respect to seven. Thus, if the total is seventeen, one is a winning play if the opponent has not just played one or six. Sixteen is always a winning situation for the player whose turn it is. The player can win by playing two, or if that is not legal, by playing one, which prevents the opponent from hitting eighteen exactly on his turn.

Electromechanical Game Player

In 1959 I designed and constructed a relay and stepping-switch machine that demonstrated this learning game.

I called it GLIM, for Game Learning Intelligent Machine. Photo 1 shows GLIM and the author (quite a bit younger then). Each memory bit was implemented as a pair of neon lamps sharing a common dropping resistor.

One of the lamps of each pair was used internally as part of the memory readout system. The other was included in a random display on the front panel which was shaped somewhat like a human brain. Though randomly arranged (to prevent utilization by the human player), the lamps that would be lit when the win table was error-free were located in the upper part of the brain display. Thus the degree to which the machine had become "highly" educated could be estimated.

The memory was read out by a motor-driven scanner containing six photocells, one for each of the six plays that the machine might make. A servo-mechanism positioned the scanner over a 6 by 18 array of neon lamps so that the photocells could

Photo 1: The author with Game Learning Intelligent Machine (GLIM) in 1959. GLIM was a machine built with hard-wired logic in the form of relays and stepping switches that played the game Eighteen with a Die. It was a forerunner of the general-purpose computer of today that uses software to play the same game. GLIM contained eighteen 6-bit words of memory consisting of pairs of neon lamps, one pair for each bit. Each lamp pair had a common, current-controlling dropping resistor.

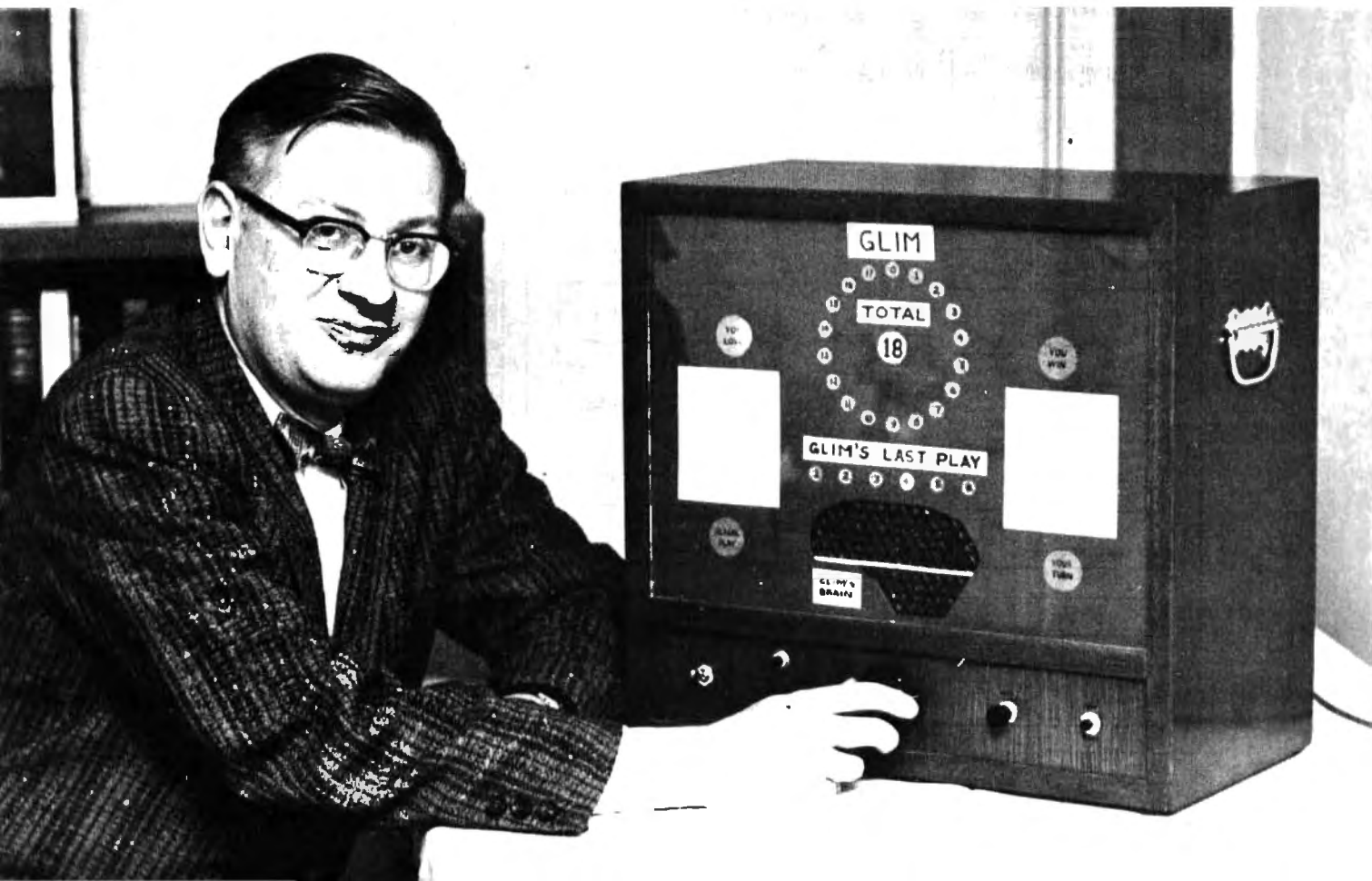
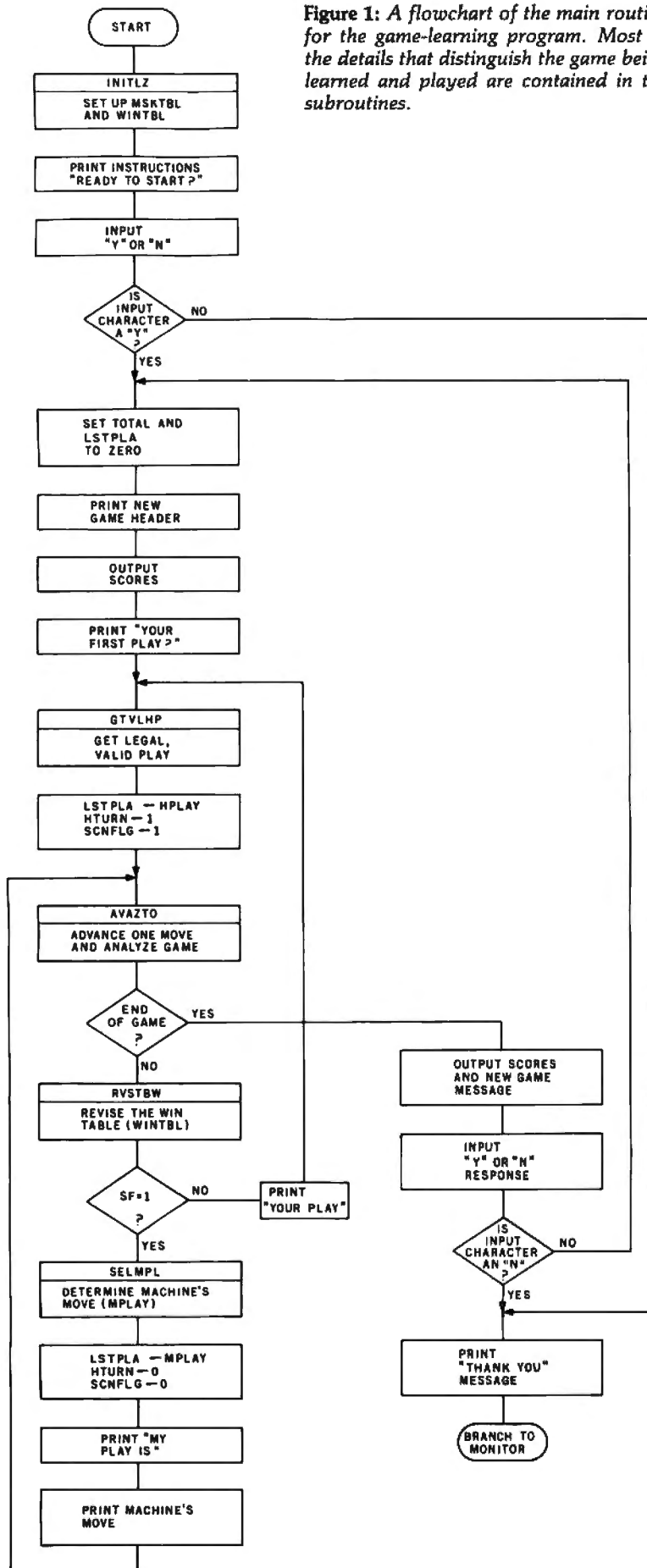

Figure 1: A flowchart of the main routine for the game-learning program. Most of the details that distinguish the game being learned and played are contained in the subroutines.



scan ahead in the memory, looking for lighted memory cells through a "legal play" mask mounted on the scanner. Plexiglas light collectors formed an optical OR function, while the mask formed an AND with each neon cell.

For example, the photocell that looked at the row of memory corresponding to the current total plus a move of one was masked so that it could see only the neon lamps in columns 2, 3, 4, and 5 of the memory array. These are the human's legal responses to a play of one. The next photocell could see only columns 1, 3, 4 and 6. Similar logic is embodied in the program described in this article.

As described above, the machine would play faultlessly after its win table was error-free. With the goal number of eighteen, the first player (the human) has no winning play and is doomed to lose every game after the machine has learned the game. To make the game more interesting, the logic was designed to cause the machine to "goof" occasionally. It skipped the procedure of picking out a winning move and merely selected a random legal play. In the program given here this is available as a software option. If selected, the goofs occur at random (controlled by a pseudo-random number generator) about once every eight machine plays.

Software Game Player

Figure 1 shows the flowchart of the main program for Eighteen with a Die. As can be seen, it is quite general. Most of the details that characterize it for this particular learning game are contained in the subroutines which are described below. The storing of human play (HPLAY) and machine play (MPLAY) in lastplay (LSTPLA) is an exception. Another exception is the setting of scan flag (SCNFLG) to allow the win table (WINTBL) to be updated both before and after the machine's play is added to the total.

The initialization subroutine (INITLZ) is flowcharted in figure 2. Mask table (MSKTBL) is initialized with a pattern of ones that correspond to legal responses to plays represented by the row indices. The least significant bit (LSB) represents a response of one.

Next, win table (WINTBL) is ini-

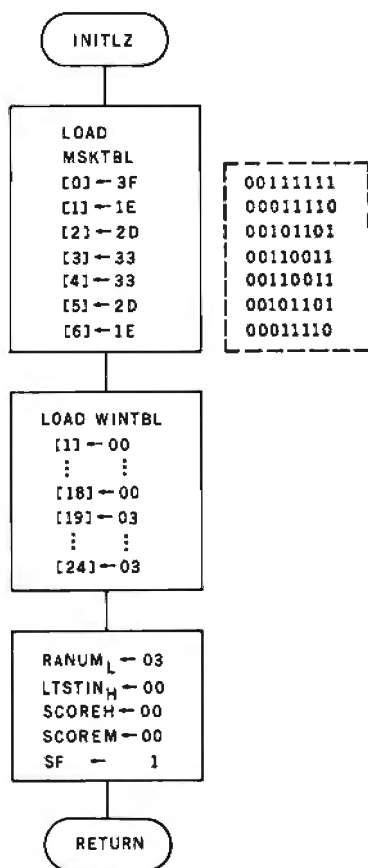

Figure 2: Flowchart of the initialization subroutine (INITLZ). The bit pattern set into mask table (MSKTBL) signifies legal responses to plays denoted by the row numbers. Win table (WINTBL) is loaded with blanks until the six rows after the game end. These rows are loaded to cause correct winning plays to be found during game playing.

tialized. Rows 1 through 18 are cleared, signifying no winning moves. However, rows 19 through 24 (those reachable by attempted plays from 18) are loaded with ones in both the 1 and 2 columns. One or both will represent a legal, winning human response, and will cause correct win or lose move information to be recorded in one or more of the columns of win table rows 13 through 18, when individual games have progressed that far. RANUM must be initialized to any nonzero value for the pseudorandom number generator.

LTSTIN is a 2-byte variable that is the operand for the legal test (LGLTST) subroutine. The low-order byte could be loaded and utilized before a double-precision load and test is made, so the high-order byte

Input Character	Hexadecimal ASCII	CT1024 Terminal Response	SwTPC Peripheral Response
Control-P	10	Cursor home up	Same
Control-U	15	Erase to end of line	Same
Control-V	16	Erase to end of page	Same

Table 1: Use of cursor and cassette tape control characters assumed in this program, compared with uses recommended by Southwest Technical Products Corp.

must be initialized to zero. SCOREH and SCOREM are used to accumulate the human's and machine's scores, and must start from zero for each series of games.

After initialization, the main program prints the game instructions, ending with the question, "READY TO PLAY?" All such messages and formats are stored as strings of ASCII characters, terminated by hexadecimal 04 (Control-D, or EOT).

After loading the microprocessor's X register with the starting address of the string, the string is output by a subroutine starting at hexadecimal E07E in the MIKBUG monitor. It tests

for hexadecimal 04, outputs the character to the terminal, increments the X register, and recycles. Detection of a hexadecimal 04 causes a return to the user program. If you do not have MIKBUG or a similar monitor, you can easily write this subroutine.

Next, a human response to the question at the end of the instructions is sought, a Y, or N, signifying yes or no. Again, a MIKBUG subroutine IN-EEE (location E1AC) is used for this process. The ASCII character representing the human's response ends up in the A accumulator. After the human's response to this question, one of two messages is printed.



our prices are LOWER

than Sears Roebuck catalog!

*Wish Book for the 1979 Holiday Season (page 656-661)

PLUS... WE PAY POSTAGE!



\$279.95

VOICE CHESS CHALLENGER®



\$89.95

BACKGAMMON
CHESS '79™

fds

FACTORY DIRECT SALES
Dept. 57
1317 E. Colorado St.
Glendale, CA 91205
Phone: (213) 245-1417

ORDER TODAY

Retail Store Hours Tues - Fri 10AM to 6PM
Sat 9AM to 5PM Closed Sunday & Monday

20% deposit required on C.O.D. orders

Check Money Order VISA Master Charge
 CA residents add 6% sales tax (No C.O.D. outside continental U.S.A.)

FREE SHIPPING on all prepaid orders!



\$279.95

CHECKER CHALLENGER®



\$59.95

BRIDGE CHALLENGER®

SATISFACTION GUARANTEED
OR YOUR MONEY BACK!

Price subject to change without notice. Refunds guaranteed. Quality Made in U.S.A. Copyright © 1979 Factory Direct Sales

Both begin by erasing the instructions.

For a Y response, the message then comprises the new game header, while the "thanks for playing" message occurs for any other response. Instruction erasure is performed by ASCII control characters at the start of each of these two messages that activate cursor-home and erase-to-end-of-page (EOF). The ASCII codes I have used for such terminal controls are shown in table 1. The codes are compatible with those recommended by SwTPC.

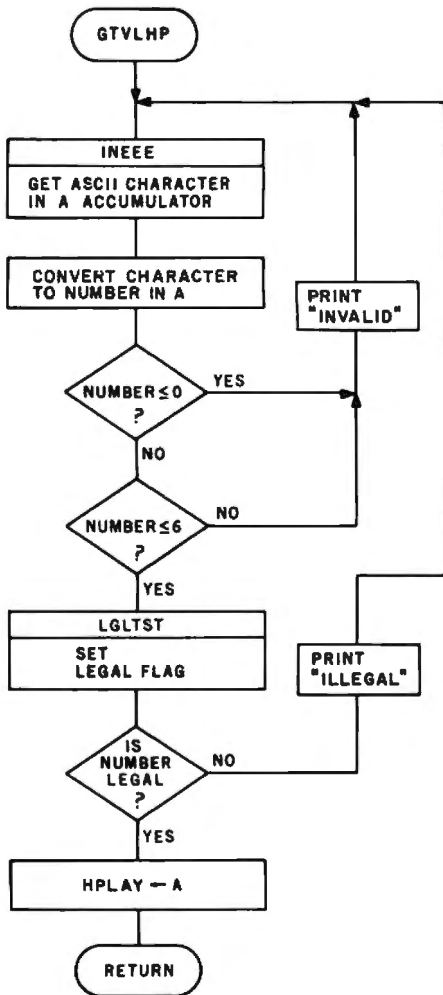

Figure 3: Flowchart of subroutine to get a valid, legal human's play (GTVLHP). A MIKBUG subroutine (INEEE) is used to input a move. After verifying that the play is in the valid range 1 through 6, LGLTST is called to see if the move is legal.

The "goof" feature causes the computer to make an occasional mistake.

Figure 3 shows the flowchart for the subroutine get valid legal human play (GTVLHP). This begins by looking for an ASCII character from the keyboard to be loaded into accumulator A, which is accomplished by using the MIKBUG INEEE subroutine. Subtracting hexadecimal 30 converts the ASCII code to a binary number, which is tested to determine if it is in the range 0 through 6. If the number is not in this range, an "invalid" message is printed. It is then subjected to the legal test (LGLTST) subroutine, figure 4, where it is compared with last play (LSTPLA) according to the rules governing legal plays. Legal plays are then loaded into HPLAY. Illegal plays are denoted by setting the zero flag bit in the M6800's condition register to one.

Figure 5 shows the flowchart for the subroutine advance and analyze total (AVAZTO). Two totals are actually calculated. One is TOTBCD, a binary-coded-decimal version of the total that is output to the terminal. Each time it is augmented by adding LSTPLA to it, the 6800 decimal adjust instruction (DAA) is employed to restore the number to binary-coded-decimal form. TOTAL is the total in hexadecimal notation and is used in the program for detecting the end of the game, advancing the win table index, etc. If the total equals or exceeds hexadecimal 12 (decimal 18), the flag, ENDGAM, is set, and the win or lose logic decides who won and increments the scores accordingly. The scores are used only for display, and are stored in binary-coded-decimal form.

The next subroutine used is revise win table (RVSTBW), shown in figure 6. This process is accomplished in two steps. First, the rows of the win table corresponding to trial machine plays of 1 through 6 are ANDed with corresponding rows of mask table, which contain the legal responses to those plays. The results are stored in a 6-byte table of winning human response flags (WHRF).

Next, machine trial play pattern

(MPTPAT) is initialized to hexadecimal 20, which sets bit 5 to 1. The index register, X, is initialized to a corresponding value of six. Starting with six and decrementing facilitates subsequent use of the 6800's stack pointer.

In the second phase of this subroutine, each row of the WHRF table is tested to see if any winning human responses were found in the first phase for the play held in the X register. If no winning human response was found, MPTPAT is ORed into the win table row cor-

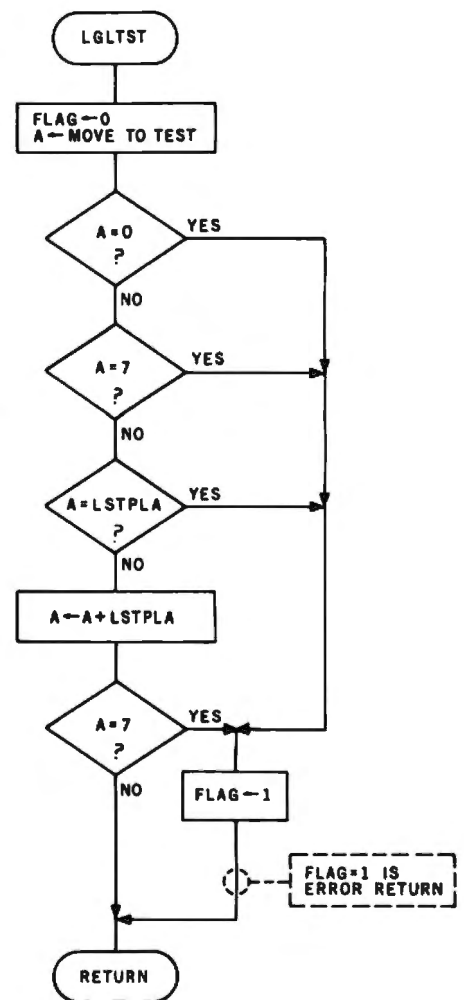
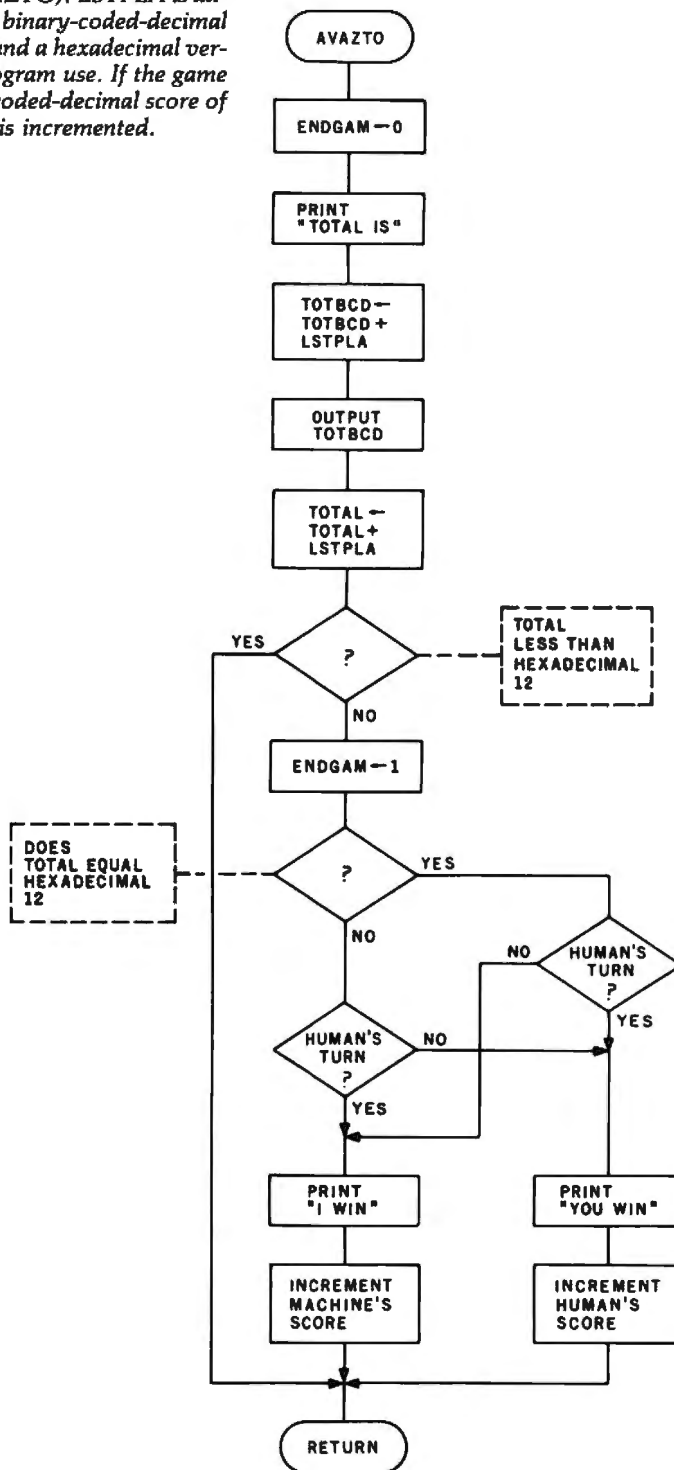

Figure 4: Flowchart of the legality testing subroutine (LGLTST). The legal-move flag is first cleared to indicate an acceptable move. The computer-generated random plays of 0 and 7 are rejected. A trial play is then compared with the last play (LSTPLA) and with a value of 7+LSTPLA to implement the rules. If the flag returns from this routine with a value of 1, the move is not legal.

Figure 5: Flowchart of the subroutine for game analysis (AVAZTO). LSTPLA is added to two totals, a binary-coded-decimal version for display and a hexadecimal version for internal program use. If the game is over, the binary-coded-decimal score of the winning player is incremented.



responding to the current total, to add an apparent winning move to the row. If any winning human response was found, the Xth column of the win table row corresponding to the current total is zeroed, by being ANDed with the one's complement of MPTPAT, thus deleting any erroneous winning play indication.

In the first case, X represents an

apparent winning play for the machine, so it is tested to determine if it is a legal play. If so, it is stored in machine play, winning (MPLAW). X is then decremented and MPTPAT is shifted right by one place, to correspond to a play of five, and the second phase is repeated. At the conclusion, MPLAW holds the smallest winning play discovered, and the win table



WANT TO BE KING OF THE HILL?

Treat Yourself Royally with GIMIX Unique and Incomparable Boards and Systems... DIP-switch Versatility for use with both SS50 (6800) and SS50C (6809) Systems (SWTP, etc.)

32K STATIC RAM BOARD

- SS50C Extended Addressing (can be disabled)
- 4 separate 8K blocks
- Low Power 2114L RAMS (2 AMP TYP. for 32K)
- Write Protect
- Fully Socketed for 32K
- Gold Bus Connectors

NEW!

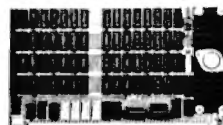

16K . . \$328.12
24K . . \$438.14
32K . . \$548.15

16 & 24K Versions are socketed for 32K and require only additional 2114S for expansion.

All GIMIX Memory Boards are assembled, burned-in, and tested at 2MHz.

FACTORY PRIME STATIC RAMS

2114L 450 ns . . . \$5.90 200 ns . . . \$6.90
4044 450 ns . . . \$5.90 250 ns . . . \$6.90
Add \$5.00 Handling on Orders Under \$200.00

THE UNIQUE GIMIX 80 x 24 VIDEO BOARD

- ★ Upper and Lower Case with Descenders
- ★ Contiguous 8x10 Character Cells
- ★ Hardware Scrolling
- ★ X-Y Addressable Hardware Cursor

It is the **ONLY Video Board** that gives you **Software Control** of:

- A programmable RAM Character Generator plus 2 EPROM Character Generators (128 char. ea.)
- Selecting 256 Displayable Characters from 384 available.
- Normal or inverse video, full or reduced intensity, or combinations of these by **both** ASCII Code and Bit 8.
- GHOSTability — multiple boards at the same address.

Fully decoded, occupies only 2K of address space
Fully socketed — Gold bus connectors.
Assembled, Burned-in, and Tested at 2MHz.

Deluxe Version \$458.76
Without RAM Character Generator . . \$398.24
Other Video Boards from \$198.71

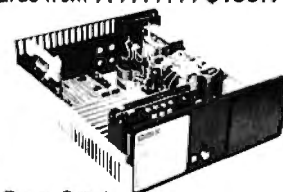

THE CLASSY CHASSIS

- Ferro-resonant Power Supply
- Heavyweight Aluminum Cabinet with fan and provisions for two 5" disk drives.
- 6800/6809 Mother Board, fifteen 50 pin and 8 DIP-switch addressable 30 pin slots — Gold Plated Pins. Fully decoded. \$798.19

With Baud Rate Generator on Mother Board . . \$828.19

32K SYSTEM Incomparable Features, at a Comparable Price! \$1,594.59
Includes: Chassis, 6800 CPU, 32K RAM Board, Choice of I/O Card.

16K Version of above \$1,374.49

Phone, write, or see your dealer for details and prices on our broad range of Boards and Systems for the SS50/SS50C bus and our AC Power Control Products for all computers.

GIMIX inc.

1337 W. 37th Place • Chicago, IL 60609
(312) 927-5510 • TWX 910-221-4055

The Company that delivers.
Quality Electronic products since 1975.

GIMIX[®] and GHOST[™] are Registered Trademarks of GIMIX Inc.



row for the current total has been updated, based on examining the next six rows of the win table.

Making the Machine Fallible

The subroutine select machine play (SELMPL) shown in figure 7 is needed because sometimes no machine winning plays are found, in which case the machine must choose a legal play at random. If the "goof" feature is desired, the program's current winning move (MPLAW) will be ignored, and a random play will be selected.

The generate random play (GNRNPL) subroutine actually generates numbers from 0 thru 7. The occurrence of a zero causes the computer to make a random move if the "goof" option is active. Next, MPLAW is tested to determine if it has changed from its initial value of zero. If it is no longer zero, its value is loaded into MPLAY as the machine's play. If MPLAW is zero, another random number from 0 thru 7 is generated and tested for legality. Numbers are generated again and again until a legal one is found for use as MPLAY, the machine's move.

The GNRNPL subroutine (figure 8, page 229) uses logic feedback around a shift register to generate a pseudo-random sequence. Two bytes plus the carry bit comprise a 17-stage register. Since seventeen is a prime number, coding theory assures us that every unique feedback arrangement will generate a sequence that will not repeat until after $2^{17} - 1$ (or 131,071) shifts. The three least significant bits are masked off to generate numbers from 0 thru 7.

Three shifts are used to generate each play, to assure that all three bits are randomly changed. I could have used a shorter shift register, but I found that with a shorter register, a given play was followed by only a few of the theoretically possible values. A few additional instructions are required to implement the 17-stage register, in which any given play will be followed with nearly equal probability by *all* of the values 0 thru 7.

The feedback comprises the Exclusive-OR of the zero and third order bits. This is accomplished by ANDing the low-order byte with hexadecimal 09. The carry bit is set to one if the result is one or eight and to zero if the result is zero or nine. The carry bit is

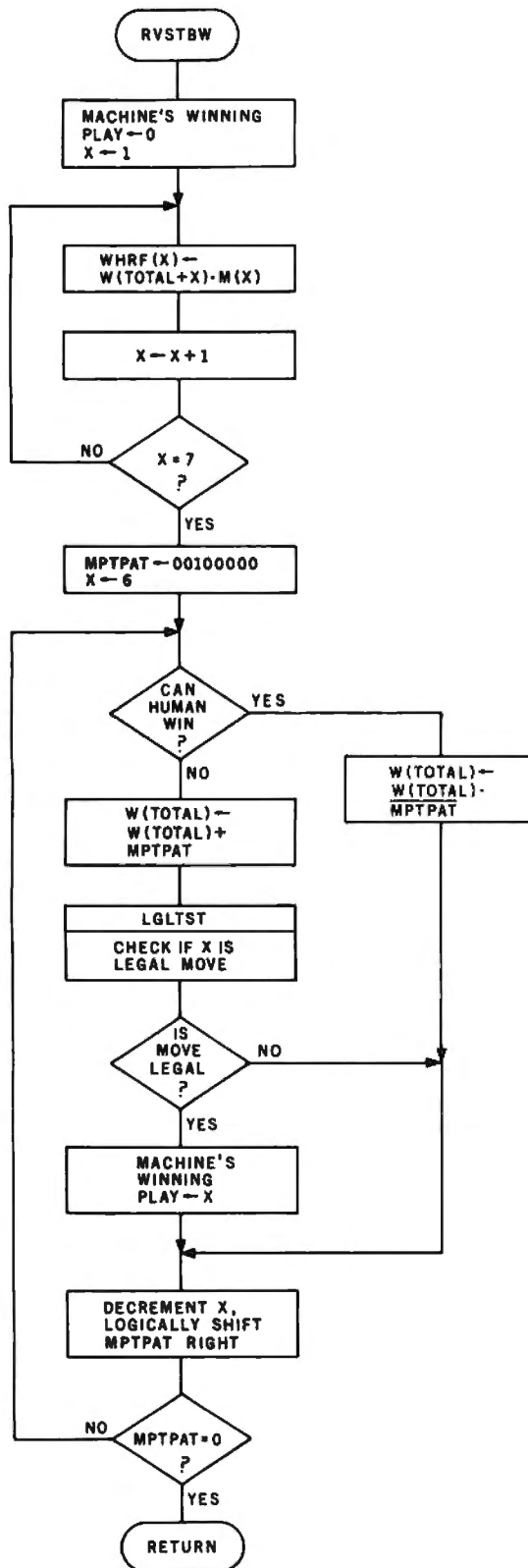

Figure 6: Flowchart of the subroutine that revises the win table (RVSTBW). The win table row corresponding to the total before and after the computer's play is revised by trying all possible computer plays, and by selecting those plays that block the human from a legal winning response. The smallest apparent winning computer play is saved in MPLAW. The following logical notation is used: "." is logical AND, "+" is logical OR.

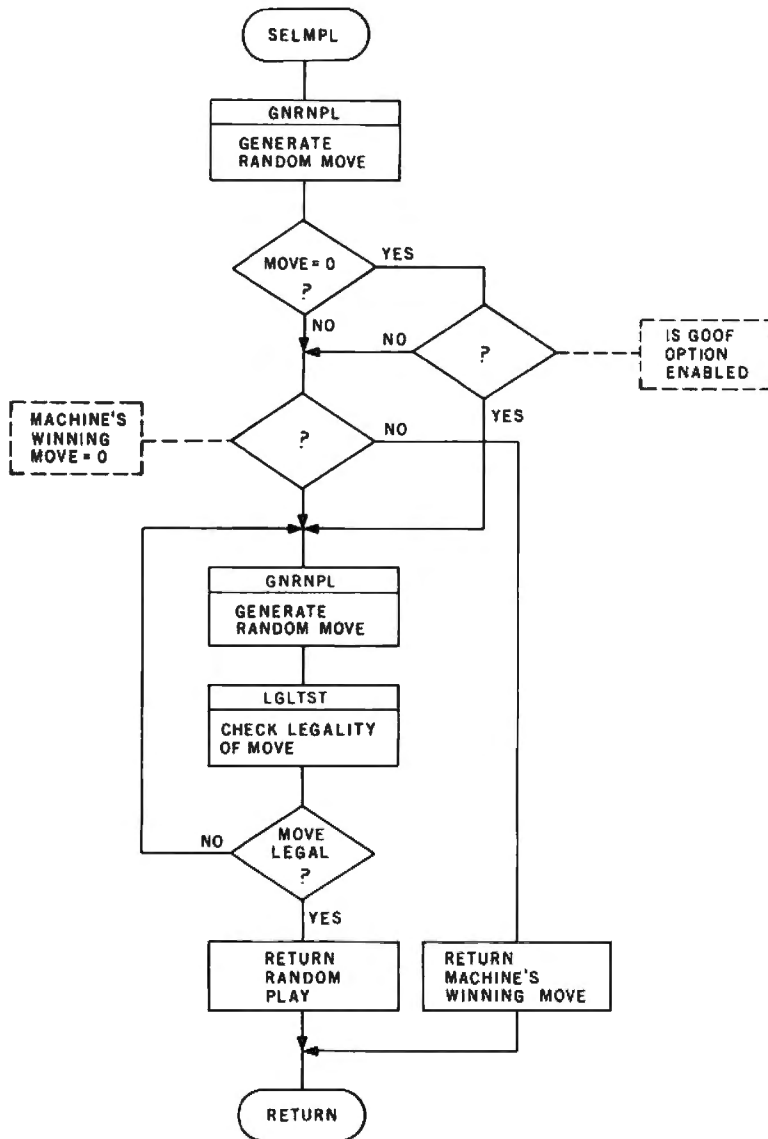

Figure 7: Flowchart of the subroutine that determines the machine's play (SELMPL). If the goof option is selected, the odds are one in eight that the computer will make a random legal play, instead of playing the apparent winning play discovered while revising the win table. If no winning play is found, a random play is made.

then shifted into the most significant bit of the high-order byte. The least significant bit is shifted into the carry and then into the most significant bit of the low-order byte. The latter's least significant bit is discarded.

During initialization, at least one of the shift register bits must be set to one, otherwise only zeros would circulate endlessly. The full 17-bit word cannot take the value zero, but the three least significant bits can take this value.

Other Random Methods

The above scheme has the disadvantage that the sequence is fixed by

the initialization constant, so that each new series of games set up by loading the program start out with the same sequence of random plays. If the human should play the identical sequence of moves for a whole series of games, the machine's responses to those moves would not vary.

I have employed a way around this in other machines using the player's response time, measured in sufficiently small units, to generate random numbers. For example, three asynchronous free-running flip-flops at frequencies of 100, 141, and 173 Hz can be allowed to run during the time the computer is waiting for the

human to respond. When stopped by the response, they will represent a random binary number from 0 thru 7 that depends on the human's response time measured in hundredths of seconds, modulo 7. Using frequencies related by ratios close to $\sqrt{2}$ and $\sqrt{3}$ assures that the flip-flops will generate a relatively long sequence (of order 100) before repeating.

This approach was not feasible, however, when using a MIKBUG subroutine to get the human's response.

Listing 1 is the program listing in assembler format for the SwTPC 6800. MIKBUG subroutines were freely used for input and output. All constants and variables are stored on page one of memory, starting at hexadecimal address 0020. The initialization subroutine is also stored here. The main program begins at hexadecimal 0100. Messages start at hexadecimal 02D0 and extend to hexadecimal 057F. About 1380 (decimal) bytes are needed. Addresses from 0000 to 001F were not used, in compliance with SwTPC's suggestion that these be reserved for a disk operating system.

You may wish to revise message formats. Revisions of starting addresses will require revisions of the load index register (LDX #) instructions in the main programs and subroutines wherever the messages are printed.

How to Play Against the Machine

The human player has several options for competing with the machine. With the goof feature disabled, try to see how many games you can win, starting with the win table empty, before the machine is winning every game. Your strategy should be to induce the machine to load as many errors as possible into the win table, then play to inhibit the machine from correcting those errors.

When you have memorized all of the winning plays for each total, you will do better. This knowledge can be acquired through experience, or by examining the win table after the machine has thoroughly learned the game. Unless the goof feature is used, some winning moves may not be found by the machine, but it will find enough that one or more will be legal

Text continued on page 229

How to Use the Program Listing

The program in listing 1 was assembled using Jack Emmerichs's Tiny Assembler for the 6800 processor. Since this assembler operates using only one pass through the source code, it must handle forward references in a special way.

A forward reference occurs during assembly when some instruction in the program references a symbol that appears after it in the source code. (A symbol is a label for an instruction or for data.) Since the assembler has not yet come to the referenced symbol and does not know what its address is, the assembler cannot initially generate the proper object code.

If you have your own assembler, you will face no difficulty in using Eighteen with a Die (since you will probably wish to reassemble it on your own system). If you do not have an assembler in your 6800 system and want to enter the object code directly from listing 1, you must be aware of the behavior

of the Tiny Assembler in its treatment of forward references.

As the Tiny Assembler scans the source code, it maintains a forward-reference table in memory. When it comes to a forward reference, such as:

```
JSR TXTOUT
```

(which appears at hexadecimal location 0109 in listing 1) that has not been encountered and is therefore not yet defined in the symbol table, the Tiny Assembler generates "dummy" code (consisting of zeros) in the locations where the address of TXTOUT should be. Data identifying TXTOUT and keeping track of where the dummy code was generated is placed in the forward-reference table.

When the Tiny Assembler gets to the definition of TXTOUT in the source listing, it resolves all previous forward references to TXTOUT at once. At the place in listing 1 where the symbol

TXTOUT appears, we see the source code:

```
TXTOUT JMP PDATA1
```

At this point the following object code is generated:

```
018E 7E E0 7E
010A 01 8E
0117 76
0126 67
0137 56
018B 02
015D 30
017F 0E
```

The resolution of hexadecimal location 010A uses the extended addressing mode; other resolutions shown use the relative addressing mode. After the address of the symbol TXTOUT is found, the reference to TXTOUT is deleted from the forward-reference table.

When the output of the assembler is loaded into memory by the loader program, the forward-reference resolution data is written over the dummy values (zeros) that were originally generated. If loading the object code by hand, they should be written over the dummy values in the same way.

You can, if you wish, look at the symbol table shown at the end of the listing at any time to find out what values were obtained for all symbols during the assembly. The Tiny Assembler uses only four characters (the first three and the last one) of a symbol, and the symbol table uses these condensed symbols, not the full spellings found in the program.

Complete documentation about the Tiny Assembler appeared in the following BYTE articles by Jack Emmerichs: "Designing the Tiny Assembler: Defining the Problem," April 1977, page 60; "Implementing the Tiny Assembler," May 1977, page 84; "Expanding the Tiny Assembler," September 1977, page 44.

Reprints of these magazine articles plus PAPERBYTE® bar codes for optical scanning are available in book form under the title Tiny Assembler 6800, Version 3.1, by Jack Emmerichs. You may obtain this book for \$9.60 (including postage) from BYTE Books, 70 Main St, Peterborough NH 03458.

S-100 INTELLIGENT COLOR GRAPHICS BOARD CGS-808



The CGS-808 is an intelligent color graphics board for the S-100 bus. The CGS-808 is simple to use: just plug it in and run. It requires no memory space and little software overhead.

Features:

- MC6847 video display generator, on-board 8085 microprocessor.
- Eight colors—green, yellow, blue, red, buff, cyan, magenta, orange.
- 11 programmable modes ranging from 64x64 to 256x192 in 4 and 1 colors.
- I/O mapped for true S-100 compatibility.

Software:

- Firmware Pack I—clear screen, change mode, plot point, draw line, alphanumeric/semigraphic, read/write screen.
- Firmware Pack II—relative and absolute modes, ellipses, alphanumerics (two sizes), 3D hidden dot.
- Firmware Pack III—shaped ellipses, shaded polygons, chain lines, move point, move line, bar graph, expansion port driver.

CGS-808B (Bare "Kit")	\$125.00
(Includes PC board, documentation, MC6847, MC1372, 8085 and 2708 with Firmware Pack I)	
CGS-808A (Assembled and Tested)	\$399.00
Firmware Pack II	\$ 60.00
Firmware Pack III	\$ 99.00
SubLogic 2D Graphics Driver	\$ 35.00
SubLogic 3D Graphics Driver	\$ 30.00

Phone Orders Welcome — Visa/Mastercharge — Add \$3.00 for Shipping & Handling
California Residents Add 6% Sales Tax — Call or write for your free brochure.



BIOTECH ELECTRONICS
P.O. Box 485, Ben Lomond, CA 95005
(408) 338-2686

Listing 1: Complete assembler listing Eighteen with a Die as coded for the 6800 microprocessor in a system equipped with a MIKBUG (or MIKBUG-compatible) monitor.

```

0000 >*****
0000 >*
0000 >*          18 WITH A DIE          *
0000 >*          VSN 2.0                *
0000 >*
0000 >*          R. YOST          79-07-18 *
0000 >*
0000 >*****
0000 >
0000 >
0000 >*          EQUATES
0000 >
0000 >INEEE EQU $E1AC MIKBUG SR: GET ASCII CHAR. IN 'A' REG
0000 >CONTR EQU $E0E3 MIKBUG MON. RET. POINT
0000 >OUT2HS EQU $E0CA MKBG SR : PRINT 2 HEX CHR'S + SPACE.
0000 >OUTHTR EQU $E06B MKBG SR: PRINT RIGHT NYBBLE OF 'A' REG.
0000 >PDATA1 EQU $E07E MKBG SR: STRING PRINTER, TERM'D BY $04
0000 >
0000 >*          VARIABLES AND TABLES
0000 >
0000 >          ORG $20
0020 >MSKTBL RMB 7          LEGAL RESPONSES MASKS
0027 >WINTBL RMB 18        TABLE OF WINNING PLAY BIT PATTERNS
0039 >          RMB 7          SPACE FOR END GAME MARKERS
0040 >MPAT RMB 1           M. TRIAL PLAY PATTERN
0041 >SCOREH RMB 1         H. AND M. BCD SCORES
0042 >SCOREM RMB 1
0043 >TOTAL RMB 1         BINARY TOTAL OF ALL PLAYS
0044 >TOTBCD RMB 1        DITTO, BCD
0045 >HPLAY RMB 1         VALID, LEGAL, H. PLAY
0046 >LSTPLA RMB 1        OPPONENT'S PREV. PLAY
0047 >HTURN RMB 1         H. TURN FLAG
0048 >SCNFLG RMB 1       SCAN WIN TABLE FLAG. 1 MEANS
0049 >*          BEFORE M'S PLAY;
0049 >*          0 MEANS AFTER M'S PLAY.
0049 >ENDGAM RMB 1        END GAME FLAG. SET IF TOTAL > 17.
004A >LTSTIN RMB 2        DUMMY INPUT VARIABLE FOR LEGAL TEST
004C >*          2 BYTES ACCOMODATE X REG.
004C >WHRF RMB 6          TABLE STORES WINNING HUMAN RESPONSES
0052 >*          TO TRIAL M PLAYS.
0052 >MPLAY RMB 1         TRIAL M PLAY.
0053 >MPLAW RMB 1         WINNING M PLAY DETECTED IN REVISING
0054 >*          WIN TABLE.
0054 >SSTO RMB 2          TEMP. STK. PNTR STORAGE.
0056 >WTBLRP RMB 2        WINTABLE ROW POINTER
0058 >RANUM RMB 2         RANDOM NUMBER SHIFT REGISTERS.
005A >
005A >*          SUBROUTINE INITIALIZE - INITLZ
005A >
005A >          ORG $5D
005D CE 00 20 >INITLZ LDX #MSKTBL INITIALIZE MASK TABLE WITH
0060 86 3F >          LDAA #3F          LEGAL RESPONSE PATTERNS
0062 A7 00 >          STAA 0,X          IN 6 LEAST SIG. BITS.
0064 86 1E >          LDAA #1E
0066 A7 01 >          STAA 1,X
0068 A7 06 >          STAA 6,X
006A 86 2D >          LDAA #2D
006C A7 02 >          STAA 2,X
006E A7 05 >          STAA 5,X
0070 86 33 >          LDAA #33
0072 A7 03 >          STAA 3,X

```

```

0074 A7 04 >          STAA 4,X
0076 4F >          CLRA          CLEAR WIN TABLE BEFORE
0077 CE 00 01 >          LDX #1          FIRST GAME.
007A A7 26 >I1 >          STAA WINTBL-1,X
007C 08 >          INX
007D 8C 00 13 >          CPX #13
0080 26 FB >          BNE I1
0082 86 03 >          LDAA #3          STORE DUMMY H WIN PLAY
0084 A7 26 >I2 >          STAA WINTBL-1,X BITS BEYOND END OF WINTABLE
0086 08 >          INX          SO MACHINE CAN SEE END OF
0087 8C 00 19 >          CPX #19          GAME COMING.
008A 26 FB >          BNE I2
008C 97 59 >          STAA RANUM+1 INITIALIZE RANDOM NUMBER GENERATOR
008E 4F >          CLRA          SEED.
008F 97 4A >          STAA LTSTIN CLEAR HIGH BYTE OF L. TEST; ALSO
0091 97 41 >          STAA SCOREH DUMMY VAR. AND SCORES.
0093 97 42 >          STAA SCOREM
0095 39 >          RTS
0096 >
0096 >*          MAIN PROGRAM
0096 >
0100 >          ORG $100
0100 8E A0 47 >          LDS #A047 PRESERVE STRT ADDR @ $A048,9.
0103 BD 00 5D >          JSR INITLZ
0106 CE 00 00 >          LDX #MES1 PRINT INSTRUCTIONS AND
0109 BD 00 00 >          JSR TXTOUT ASK "READY TO PLAY".
010C BD E1 AC >          JSR INEEE GET RESPONSE;
010F 81 59 >          CMPA #'Y IF NOT 'Y' THEN
0111 27 00 >          BEQ M2
0113 >
0113 CE 00 00 >M1 >          LDX #MES5 PRINT "THANKS, GOODBY",
0116 8D 00 >          BSR TXTOUT
0118 7E E0 E3 >          JMP CONTRL AND EXIT TO MIKBUG.
011B >
011B 4F >M2 >          CLRA          ELSE, INITIALIZE VARS. FOR
0112 08 >
011C 97 43 >          STAA TOTAL NEW GAME.
011E 97 44 >          STAA TOTBCD
0120 97 46 >          STAA LSTPLA
0122 CE 00 00 >          LDX #MES2 PRINT NEW GAME HEADER.
0125 8D 00 >          BSR TXTOUT
0127 CE 00 41 >          LDX #SCOREH PRINT SCORES.
012A BD E0 CA >          JSR OUT2HS
012D CE 00 42 >          LDX #SCOREM
0130 BD E0 CA >          JSR OUT2HS
0133 CE 00 00 >          LDX #MES3 PRINT "YOUR 1ST PLAY?".
0136 8D 00 >          BSR TXTOUT
0138 BD 00 00 >M3 >          JSR GTVLHP GET VALID LEGAL H. PLAY.
013B 96 45 >          LDAA HPLAY PUT IN HPLAY AND LAST PLAY.
013D 97 46 >          STAA LSTPLA
013F 86 01 >          LDAA #1
0141 97 47 >          STAA HTURN SET H. TURN FLAG,
0143 97 48 >          STAA SCNFLG AND SCAN FLAG, TO DENOTE WIN TABLE
0145 BD 00 00 >M4 >          JSR AVAZ TO REVISION BEFORE M. PLAY. ADD PLAY
0148 >*          TO TOTALS. SET END GAME FLG. IF
0148 >*          TOTAL > 17, AND CALC. SCORES.
0148 7D 00 49 >          TST ENDGAM
014D CE 00 41 >          BEQ M5
0150 BD E0 CA >          LDX #SCOREH IF GAME OVER, PRINT SCORES.
0153 CE 00 42 >          JSR OUT2HS
0156 BD E0 CA >          LDX #SCOREM
0159 CE 00 00 >          JSR OUT2HS
015C 8D 00 >          LDX #MES4 PRINT "NEW GAME?".
015E BD E1 AC >          BSR TXTOUT
0161 81 4E >          JSR INEEE
0163 >*          CMPA #'N IF RESPONSE = 'N', PRINT THANKS,ETC, &
          ETC, AND EXIT.

```

Listing 1 continued:

```

0163 27 AE > BEQ M1
0165 20 B4 > BRA M2 ELSE, SET UP NEW GAME.
0167 >
0167 BD 00 00 >M5 JSR RVST3W IF GAME NOT OVER, LOOK AHEAD FOR
014C IA >
016A >* H RESPONSES TO M TRIAL PLAYS
016A >* AND REVISE WIN TABLE.
016A 7D 00 48 > TST SCNFLG IF SCAN FLAG CLEAR, THEN
016D 27 00 > BEQ M6 GET NEXT H. PLAY.
016F BD 00 00 > JSR SELMPL ELSE, SELECT M. PLAY.
0172 96 52 > LDAA MPLAY
0174 97 46 > STAA LSTPLA
0176 4F > CLRA CLEAR SCAN FLAG TO REVISE WIN TABLE BY
0177 >* LOOKING AHEAD AFTER M'S PLAY.
0177 97 48 > STAA SCNFLG
0179 97 47 > STAA HTURN CLEAR H. TURN FLAG.
017B CE 00 00 > LDX #MES6 ANNOUNCE M'S PLAY,
017E 8D 00 > BSR TXTOUT
0180 96 52 > LDAA MPLAY
0182 BD E0 6B > JSR OUTHR
0185 20 BE > BRA M4 AND PROCESS IT.
0187 >
0187 >
0187 CE 00 00 >M6 LDX #MES7 IF SCAN FLAG WAS RESET, REQUEST
018E 18 >
018A 8D 00 > BSR TXTOUT NEXT H. PLAY,
018C 20 AA > BRA M3 AND GET IT.
018E >
018E 7E E0 7E >TXTOUT JMP PDATA1 BSR TARGET FOR MIKBUG STRING PRINT
010A 01 8E >
0117 76 >
0126 67 >
0137 56 >
018B 02 >
015D 30 >
017F 0E >
0191 >
0191 >* SUBROUTINE GTVLHP - GET VALID LEGAL H. PLAY.
0191 >
01A0 >
01A0 >
01A0 >
01A0 BD E1 AC >GTVLHP JSR INEEE GET H. KEYBOARD INPUT;
0139 01 A0 >
01A3 80 30 > SUBA #30 CONVERT TO HEX.
01A5 2F 00 > BLE G1 IF LESS THAN 1,
01A7 81 06 > CMPA #6
01A9 2F 00 > BLE G2 OR GREATER THAN 6.
01AB >
01AB CE 00 00 >G1 LDX #MES8 PRINT "INVALID"
01A6 04 >
01AE 8D DE > BSR TXTOUT
01B0 20 EE > BRA GTVLHP AND TRY AGAIN.
01B2 >
01B2 97 4B >G2 STAA LTSTIN+1 CHECK H. PLAY FOR LEGALITY.
01AA 07 >
01B4 BD 00 00 > JSR LGLTST ZERO (Z) BIT OF C REG.=0 IF
01B7 26 00 > BNE G3 PLAY IS LEGAL.
01B9 CE 00 00 > LDX #MES9 IF NOT, PRINT "ILLEGAL"
019C 8D D0 > BSR TXTOUT
01BE 20 E0 > BRA GTVLHP AND TRY AGAIN.
01C0 >
01C0 96 4B >G3 LDAA LTSTIN+1 STORE VALID LEGAL H PLAY.
01B8 07 >
01C2 97 45 > STAA HPLAY
01C4 39 > RTS
01C5 >
01C5 >* LEGAL TEST S.R., LGLTST
01C5 >

```

```

01C8 > ORG $1C8
01C8 96 4B >LGLTST LDAA LTSTIN+1 0 AND 7 INPUTS
01B5 01 C8 >
01CA 27 00 > BEQ L1 FROM RAND. NO. GEN. ARE TREATED AS
01CC 81 07 > CMPA #7 ILLEGAL.
01CE 27 00 > BEQ L1
01D0 91 46 > CMPA LSTPLA IF TEST PLAY = LAST PLAY,
01D2 27 00 > BEQ L1
01D4 9B 46 > ADDA LSTPLA OR IF SUM = 7, THEN
01D6 81 07 > CMPA #7 TEST PLAY IS ILLEGAL.
01D8 39 >L1 RTS 'Z' BIT OF COND'N (C) REG. RETURNS
01CB 0C >
01CF 08 >
01D3 04 >
01D9 >* RESULT OF TEST.
01D9 >
01D9 >
01D9 >FP
01D9 >*****
01D9 >* 18 WITH A DIE, VSN 2.0, CONTINUED *
01D9 >*
01D9 >* R. YOST 79-07-18 *
01D9 >*
01D9 >*****
01D9 >
01D9 >* S.R. ADVANCE AND ANALYZE TOTAL AVAZIO
01D9 >
01E0 >
01E0 > ORG $1E0
01E0 7F 00 49 >AVAZIO CLR ENDGAM INILZ END GAME FLAG
0146 01 E0 >
01E3 CE 00 00 > LDX #MESA PRINT "TOTAL IS "
01E6 8D A6 > BSR TXTOUT
01E8 96 46 > LDAA LSTPLA GET LAST PLAY
01EA D6 47 > LDAB HTURN AND H TURN FLAG
01EC >* IN 'A' AND 'B' REGS.
01EC 9B 44 > ADDA TOTBCD ADD LAST PLAY TO BCD TOTAL.
01EE 19 > DAA
01EF 97 44 > STAA TOTBCD
01F1 CE 00 44 > LDX #TOTBCD SET 'X' AS PNTR FOR MKBG S.R.
01F4 BD E0 CA > JSR OUT2HS PRINT TOTAL.
01F7 96 46 > LDAA LSTPLA NOW, ADD LAST PLAY TO
01F9 9B 43 > ADDA TOTAL BINARY TOTAL.
01FB 97 43 > STAA TOTAL
01FD 80 12 > SUBA #18 IF TOTAL < 18, THEN RETURN.
01FF 2D 00 > BLT A2
0201 7C 00 49 > INC ENDGAM ELSE, SET END GAME FLAG.
0204 4D > TSTA IF TOTAL NOT 18,
0205 27 00 > BEQ A4
0207 5D > TSTB AND IF H'S TURN, THEN
0208 27 00 > BEQ A3
020A CE 00 00 >A1 LDX #MESS PRINT "I WIN",
020D BD 01 8E > JSR TXTOUT
0210 86 01 > LDAA #1 AND INCREMENT M'S SCORE IN BCD.
0212 9B 42 > ADDA SCOREM
0214 19 > DAA
0215 97 42 > STAA SCOREM
0217 39 >A2 RTS
0200 16 >
0218 >
0218 CE 00 00 >A3 LDX #MESC IF TOTAL NOT 18, AND IF M'S TURN
0209 0E >
021B BD 01 8E > JSR TXTOUT PRINT "YOU WIN"
021E 86 01 > LDAA #1 AND INCREMENT H'S SCORE IN BCD.
0220 9B 41 > ADDA SCOREH
0222 19 > DAA
0223 97 41 > STAA SCOREH
0225 39 > RTS

```

```

0226      >
0226 5D   >A4      TSTB          ELSE, IF TOTAL = 18,
0206 1F
0227      >*&          AND IF M'S TURN, THEN
0227 27 E1 >      BEQ   A1          AWARD WIN TO MACHINE.
0229 20 ED >      BRA   A3          ELSE, IF H'S TURN, AWARD
022B      >*&          WIN TO HUMAN.
022B      >
022B      >*&          SUBROUTINE REVISE WINTABLE - RVSTBW
022B      >
0230      >          ORG   $230
0230 4F   >RVSTBW CLRA
0168 02 30 >
0231 97 53 >          STAA  MPLAW  RESET WINNING PLAY REG. TO 'NONE' STATE.
0233 97 56 >          STAA  WTBLRP  CLEAR W.TBLE PTR. HIGH
0235      >*&          BYTE FOR PAGE 0 USE.
0235 9F 54 >          STS   SSTO   SAVE STACK POINTER.
0237 CE 00 01 >          LDX   #1      LOAD TABLE POINTER WITH TRIAL
023A      >*&          PLAY OF 1.
023A 86 26 >          LDAA  #WINTBL-1 INLZ W TBLE PNTR LOW BYTE TO
023C 9B 43 >          ADDA  TOTAL  CORRESPOND TO CURRENT TOTAL.
023E 97 57 >          STAA  WTBLRP+1
0240 9E 56 >          LDS   WTBLRP  SET STK PTR TO NEXT ROW OF W. TABLE.
0242 32     >R1      PULA          GET W. TABLE ROW (BYTE) IN 'A'.
0243      >*&          ( THIS IS THE ROW CORRESPONDING TO
0243      >*&          THE CURRENT TOTAL PLUS THE TRIAL
0243      >*&          MACHINE PLAY.)
0243 A4 20 >          ANDA  MSKTBL,X MASK WITH LEGAL RESPONSES
0245      >*&          TO M'S TRIAL PLAY.
0245 A7 4B >          STAA  WHRF-1,X STORE RESULT IN TBL. OF WINNING
0247      >*&          H RESPONSES TO M TRIAL PLAYS.
0247 08     >*&          INX          GET NEXT TRIAL M PLAY;
0248 8C 00 07 >          CPX   #7      IF < 7, REPEAT SCAN FOR LEGAL WINNING
024B 26 F5 >          BNE   R1          H RESPONSES.
024D      >
024D      >*&          NOW, ADD WINNING M PLAYS FOUND ABOVE TO THE WIN TABLE
024D      >*&          IN THE ROW CORRESPONDING TO THE CURRENT TOTAL. LIKE-
024D      >*&          WISE, DELETE ANY PREVIOUSLY INCORRECTLY DEFINED WIN-
024D      >*&          ING PLAYS FROM THE SAME ROW.
024D      >
024D 86 20 >          LDAA  #$20   SET 6TH BIT OF M TRIAL PLAY PATTERN.
024F 97 40 >          STAA  MPTPAT
0251 CE 00 06 >          LDX   #6      SELECT M TRIAL PLAY OF 6.
0254      >*&          (BY COUNTING DOWN, GET SMALLEST
0254      >*&          WINNING PLAY IN MPLAW.)
0254 9E 56 >R2      LDS   WTBLRP  SET STK PTR TO CURRENT
0256 34     >          DES   TOTAL  ROW (BYTE) OF W. TABLE.
0257 6D 4B >          TST   WHRF-1,X DID PREVIOUS SCAN DETECT ANY WINNING
0259      >*&          LEGAL H RESPONSES TO TRIAL M PLAY?
0259 26 00 >          BNE   R3          IF NOT, TRIAL M PLAY IS A WINNING PLAY,
025B 32     >          PULA          SO 'OR' THE TRIAL BIT PATTERN INTO THE
025C 9A 40 >          ORAA  MPTPAT  CURRENT TOTAL ROW OF THE W. TABLE.
025E 36     >          PSHA
025F DF 4A >          STX   LSTIIN  TEST TRIAL PLAY FOR LEGALITY,
0261 9E 54 >          LDS   SSTO   AFTER RESTORING STACK POINTER.
0263 BD 01 C8 >          JSR   LGLTST
0266 27 00 >          BEQ   R4          IF LEGAL, STORE TRIAL PLAY IN
0268 96 4B >          LDAA  LSTIIN+1 MPLAW, OVER ANY PREVIOUS LARGER PLAYS.
026A 97 53 >          STAA  MPLAW
026C 20 00 >          BRA   R4          SELECT NEXT TRIAL PLAY.
026E      >
026E 73 00 40 >R3     COM   MPTPAT  IF LEGAL WINNING H RESPONSES TO TRIAL
025A 13     >          PULA          PLAY WERE DETECTED IN PREVIOUS SCAN,
0271 32     >
0272 94 40 >          ANDA  MPTPAT  CLEAR THE BIT (IN CURRENT W. TABLE
0274 36     >          PSHA          ROW) CORRESPONDING TO M TRIAL PLAY.
0275 73 00 40 >          COM   MPTPAT
0278 09     >R4      DEX          SELECT NEXT (LOWER) M. TRIAL PLAY
0267 10     >
026D 0A     >
0279 74 00 40 >          LSR   MPTPAT  MOVE TRIAL PLAY PATTERN BIT TO
027C      >*&          CORRESPOND TO NEXT M. TRIAL PLAY.
027C 26 D6 >          BNE   R2          IF PATTERN NOT NULL, REPEAT
027E      >*&          W. TABLE REVISION FOR NEXT M. TRIAL PLAY.
027E 9E 54 >          LDS   SSTO   RESTORE STACK POINTER.
0280 39     >          RTS
0281      >
0281      >*&          SUBROUTINE SELECT M. PLAY - SELMPL
0281      >
0281      >          ORG   $290
0290      >          JSR   GNRNPL  GET RANDOM NUMBER 0 THRU 7,
0290 BD 00 00 >SELMPL  FOR GOOF DECISION.
0170 02 90 >          IF = 0, GOOF. (WITH SP1, THIS IS
0293      >*&          TURNED OFF. USE SP2 HERE TO TURN ON.)
0293 27 00 >          BEQ   SP1
0295      >*&
0295      >          LDAA  MPLAW  IF NOT GOOFING, GET WINNING M PLAY.
0295 96 53 >SP1      LDAA  MPLAW  IF NOT GOOFING, GET WINNING M PLAY.
0294 00     >
0297 27 00 >          BEQ   SP2   IF THERE WAS NONE, GET RANDOM PLAY
0299 20 00 >          BRA   SP3   AND STORE IN M PLAY REG.
029B      >
029B BD 00 00 >SP2      JSR   GNRNPL  GET RANDOM PLAY, 0 THRU 7.
0298 02     >
029E 97 4B >          STAA  LSTIIN+1 TEST SELECTED PLAY FOR LEGALITY.
02A0 BD 01 C8 >          JSR   LGLTST
02A3 27 F6 >          BEQ   SP2   IF ILLEGAL, TRY ANOTHER.
02A5 96 4B >          LDAA  LSTIIN+1 ELSE, TRANSFER THE SELECTED PLAY
02A7 97 52 >SP3      STAA  MPLAW  TO THE M PLAY REG.
029A 0C     >
02A9 39     >          RTS
02AA      >
02AA      >*&          SURROUTINE GENERATE RANDOM PLAY - GNRNPL
02AA      >
02AA      >          ORG   $2B0
02B0      >
02B0 CE 00 03 >GNRNPL  LDX   #3      COUNT 3 SHIFTS, SO 3 'NEW' BITS WILL
0291 02 B0 >          BE GENERATED.
029C 02 B0 >          LDAB  #9      MASK BIT PATTERN TO IMPLEMENT
02B3      >*&          BIT-3 EXOR BIT-0 = 1?
02B3 C6 09 >GR1      LDAB  #9      MASK BIT PATTERN TO IMPLEMENT
02B5      >*&
02B5 D4 59 >          ANDB  RANUM+1 APPLY MASK TO LOW BYTE OF R.N.
02B7 C1 01 >          CMPB  #1      TEST TRUE, SO SET CARRY.
02B9 27 00 >          BEQ   GR2
02BB C1 08 >          CMPB  #8      TEST FALSE, SO CLEAR CARRY.
02BD 0C     >          CLC
02BE 26 00 >          BNE   GR3
02C0 0D     >GR2      SEC
02BA 05     >
02C1 76 00 58 >GR3      ROR   RANUM  ROTATE CARRY INTO MSB OF 2 BYTE R.N.
02BF 01     >
02C4 76 00 59 >          ROR   RANUM+1
02C7 09     >          DEX          DECREMENT SHIFT COUNTER.
02C8 26 E9 >          BNE   GR1
02CA 96 59 >          LDAA  RANUM+1 STORE 3 LSB'S OF R.N. IN 'A', AS
02CC 84 07 >          ANDA  #7      RANDOM NUMBER 0 THRU 7.
02CE 39     >          RTS
02CF      >
02CF      >FP

```

Listing 1 continued on page 226

Listing 1 continued:

```

02CF >*****
02CF >*
02CF >*      18 WITH A DIE, VSN 2.0, MESSAGES      *
02CF >*
02CF >*      R. YOST,          79-07-18              *
02CF >*
02CF >*****
02CF >
02CF >*      CURSOR / SCREEN ERASE / CONSTANTS
02CF >
02CF >CHMEOF EQU $1016 CURSOR HOME, ERASE SCREEN
0D0A >CRLF EQU $D0A CARRIAGE RETURN, LINE FEED
0004 >ENDST EQU 4 STRING END SYMBOL FOR MIKBUG PDATA1
0010 >CRHM EQU $10 CURSOR HOME
000A >LNFD EQU $A LINE FEED
0A0A >LNFD$ EQU $A0A TWO LINE FEEDS
0015 >EOL EQU $15 ERASE TO END OF LINE
0016 >EOF EQU $16 ERASE FROM CURSOR TO END OF SCREEN
00D0 >CRET EQU $D CARRIAGE RETURN
02CF >
02CF >*      INSTRUCTIONS - MES1
02CF >
02D0 >      ORG $2D0
02D0 10 16 >MES1 FDB CHMEOF
0107 02 D0
02D2 00 00 >      FDB 0
02D4 00 >      FCB 0
02D5 48 49 21 >      FCC 31,WII LET'S PLAY "18 WITH A DIE"!
02D8 20 4C 45
02DB 54 27 53
02DE 20 50 4C
02E1 41 59 20
02E4 22 31 38
02E7 20 57 49
02EA 54 48 20
02ED 41 20 44
02F0 49 45 22
02F3 21
02F4 0D 0A >      FDB CRLF
02F6 59 4F 55 >      FCC 31,YOU START; CHOOSE ANY NUMBER, 1
02F9 20 53 54
02FC 41 52 54
02FF 3B 20 43
0302 48 4F 4F
0305 53 45 20
0308 41 4E 59
030B 20 4E 55
030E 4D 42 45
0311 52 2C 20
0314 31
0315 0D 0A >      FDB CRLF
0317 54 48 52 >      FCC 29,THRU 6. I DO LIKewise, BUT WE
031A 55 20 36
031D 2E 20 49
0320 20 44 4F
0323 20 4C 49
0326 4B 45 57
0329 49 53 45
032C 2C 20 42
032F 55 54 20
0332 57 45
0334 0D 0A >      FDB CRLF
0336 43 41 4E >      FCC 31,CAN'T PLAY THE NUMBER THE OTHER
0339 27 54 20
033C 50 4C 41
033F 59 20 54
0342 48 45 20
0345 4E 55 4D
0348 42 45 52
034B 20 54 48
034E 45 20 4F
0351 54 48 45
0354 52
0355 0D 0A >      FDB CRLF
0357 4A 55 53 >      FCC 31,JUST PLAYED, NOR ITS DIFFERENCE
035A 54 20 50
035D 4C 41 59
0360 45 44 2C
0363 20 4E 4F
0366 52 20 49
0369 54 53 20
036C 44 49 46
036F 46 45 52
0372 45 4E 43
0375 45
0376 0D 0A >      FDB CRLF
0378 46 52 4F >      FCC 29,FROM 7. TRY TO MAKE THE TOTAL
037B 4D 20 37
037E 2E 20 54
0381 52 59 20
0384 54 4F 20
0387 4D 41 4B
038A 45 20 54
038D 48 45 20
0390 54 4F 54
0393 41 4C
0395 0D 0A >      FDB CRLF
0397 4F 46 20 >      FCC 26,OF ALL OUR PLAYS HIT 18 ON
039A 41 4C 4C
039D 20 4F 55
03A0 52 20 50
03A3 4C 41 59
03A6 53 20 48
03A9 49 54 20
03AC 31 38 20
03AF 4F 4E
03B1 0D 0A >      FDB CRLF
03B3 59 4F 55 >      FCC 10,YOUR PLAY.
03B6 52 20 50
03B9 4C 41 59
03BC 2E
03BD 0D 0A >      FDB CRLF
03BF 0A >      FCB LNFD
03C0 52 45 41 >      FCC 31,READY TO START? (TYPE Y OR N.)
03C3 44 59 20
03C6 54 4F 20
03C9 53 54 41
03CC 52 54 3F
03CF 20 28 54
03D2 59 50 45
03D5 20 59 20
03D8 4F 52 20
03DB 4E 2E 29
03DE 20
03DF 04 >      FCB ENDST
03E0 >
03E0 >*      NEW GAME HEADER - MES2
03E0 >
03F0 >      ORG $3F0
03F0 10 16 >MES2 FDB CHMEOF
0123 03 F0
03F2 00 00 >      FDB 0
03F4 20 20 20 >      FCC 25,          EIGHTEEN WITH A DIE

```

```

03F7 20 20 20
03FA 45 49 47
03FD 48 54 45
0400 45 4E 20
0403 57 49 54
0406 48 20 41
0409 20 44 49
040C 45
040D 0D 0A > FDB CRLF
040F 0A > FCB LNFD
0410 20 20 20 > FCC 29, GAMES WON
0413 20 20 20
0416 20 20 20
0419 20 20 20
041C 20 20 20
041F 20 20 20
0422 20 20 47
0425 41 4D 45
0428 53 20 57
042B 4F 4E
042D 0D 0A > FDB CRLF
042F 20 20 20 > FCC 28, YOU ME
0432 20 20 20
0435 20 20 20
0438 20 20 20
043B 20 20 20
043E 20 20 20
0441 20 20 20
0444 20 59 4F
0447 55 20 4D
044A 45
044B 0D 0A > FDB CRLF
044D 54 4F 54 > FCC 23,TOTAL IS 00.
0450 41 4C 20
0453 49 53 20
0456 30 30 2E
0459 20 20 20
045C 20 20 20
045F 20 20 20
0462 20 20
0464 04 > FCB ENDST
0465 >
0465 >* YOUR FIRST PLAY? - MES3
0465 >
0465 > ORG $465
0465 0D 0A >MES3 FDB CRLF
0134 04 65
0467 0A > FCB LNFD
0468 20 20 20 > FCC 25, YOUR FIRST PLAY?
046B 20 20 20
046E 20 20 59
0471 4F 55 52
0474 20 46 49
0477 52 53 54
047A 20 50 4C
047D 41 59 3F
0480 20
0481 04 > FCB ENDST
0482 >
0482 >* ILLEGAL PLAY - MES9
0482 >
0482 > ORG $482
0482 0D 0A >MES9 FDB CRLF
01BA 04 82
0484 00 00 >
0486 49 4C 4C > FDB 0
0489 45 47 41 > FCC 27,ILLEGAL PLAY! TRY ANOTHER.
048C 4C 20 50

```

```

048F 4C 41 59
0492 21 20 54
0495 52 59 20
0498 41 4E 4F
049B 54 48 45
049E 52 2E 20
04A1 04 > FCB ENDST
04A2 >
04A2 >* INVALID PLAY - MES8
04A2 >
04A2 > ORG $4A2
04A2 0D 0A >MES8 FDB CRLF
01AC 04 A2
04A4 00 > FCB 0
04A5 49 4E 56 > FCC 31,INVALID PLAY! PLAY 1 THRU 6. ?
04A8 41 4C 49
04AB 44 20 50
04AE 4C 41 59
04B1 21 20 50
04B4 4C 41 59
04B7 20 31 20
04BA 54 48 52
04BD 55 20 36
04C0 2E 20 3F
04C3 20
04C4 04 > FCB ENDST
04C5 >
04C5 >* TOTAL IS - MESA
04C5 >
04CE > ORG $4CE
04CE 10 >MESA FCB CRHM
01E4 04 CE
04CF 0A 0A > FDB LNFD
04D1 0A 0A > FDB LNFD
04D3 54 4F 54 > FCC 9,TOTAL IS
04D6 41 4C 20
04D9 49 53 20
04DC 04 > FCB ENDST
04DD >
04DD >* YOU WIN! - MESC
04DD >
04DD > ORG $4DD
04DD 2E 20 59 >MES8 FCC 11,. YOU WIN!
04E0 4F 55 20
04E3 57 49 4E
04E6 21 20
0219 04 DD
04E8 04 > FCB ENDST
04E9 >
04E9 >* I WIN! - MESB
04E9 >
04EA > ORG $4EA
04EA 2E 20 20 >MESB FCC 11,. I WIN!
04ED 49 20 20
04F0 57 49 4E
04F3 21 20
020B 04 EA
04F5 04 > FCB ENDST
04F6 >
04F6 >* NEW GAME? - MES4
04F6 >
04F6 > ORG $4F6
04F6 0A >MES4 FCB LNFD
015A 04 F6
04F7 0D 0A > FDB CRLF

```

Listing 1 continued:

```

04F9 15 > FCB EOL
04FA 4E 45 57 > FCC 23,NEW GAME? ("Y" OR "N")
04FD 20 47 41
0500 4D 45 3F
0503 20 28 22
0506 59 22 20
0509 4F 52 20
050C 22 4E 22
050F 29 20
0511 04 > FCB ENDS T
0512 >
0512 >* THANKS, ETC. - MES5
0512 >
0512 > ORG 5512
0512 0D >MES5 FCB CRET
0514 05 12
0513 54 48 41 > FCC 28, THANKS FOR PLAYING, HOPE YOU
0516 4E 4E 53
0519 20 46 4F
051C 52 20 50
051F 4C 41 59
0522 49 4E 47
0525 2E 20 48
0528 4F 50 45
052B 20 59 4F
052E 55
052F 0D 0A > FDB CRLF
0531 45 4E 4A > FCC 24, ENJOYED IT AS MUCH AS I.
0534 4F 59 45
0537 44 20 49
053A 54 20 41
053D 53 20 4D
0540 55 43 48
0543 20 41 53
0546 20 49 2E
0549 0D 0A > FDB CRLF
054B 53 45 45 > FCC 14, SEE YOU LATER!
054E 20 59 4F
0551 55 20 4C

```

```

0554 41 54 45
0557 52 21
0559 04 > FCB ENDS T
055A >
055A >* MY PLAY IS - MES6
055A >
055A > ORG 555A
055A 0A >MES6 FCB LNFDS
055B 0D 0A > FDB CRLF
055D 16 > FCB EOF
055E 00 00 > FDB 0
0560 00 00 > FDB 0
0562 4D 59 20 > FCC 11, MY PLAY IS
0565 50 4C 41
0568 59 20 49
0569 53 20
056D 04 > FCB ENDS T
056E >
056E >* YOUR PLAY? - MES7
056E >
056E > ORG 556E
056E 2E >MES7 FCC 1,,
056F 0A 0A > FDB LNFDS
0571 20 20 59 > FCC 13, YOUR PLAY?
0574 4F 55 52
0577 20 50 4C
057A 41 59 3F
057D 20
057E 04 > FCB ENDS T
057F >
057F >
057F > END

```

<<< UNRESOLVED ITEMS >>>

THE ESSENCE of output quality

- Any IBM SELECTRIC® can be converted to produce high quality output at an affordable price!
- Interfaces directly to S100, Parallel, RS-232 or IEEE-488.
- Compatible with TRS-80, Sorcerer, Pet, Apple, Horizon, etc.
- Why be printer bound? Prices from \$496 to \$575.

Call
today.



Backspace and Tab
Available NOW!



Escon Products, Inc.
171 Mayhew Way, Suite 204
Pleasant Hill, Ca., 94523
(415) 935-4590

At last... the mechanical interface

Turn your electric typewriter into a low cost, high quality hard copy printer.

30 Day Delivery

User list
\$469⁰⁰

Dealer Inquiries
Invited.



Now available with
interfaces for most
personal computers:
TRS-80, Apple, GPIB, etc.

The all new
I/O Pak from
Rochester Data,
Inc. interfaces the keyboard
of any commercially available
electric typewriter with any
computer. The result: low cost, high
quality hard copy.
Write today for more information.

ROCHESTER DATA

Incorporated

3100 Monroe Avenue, Rochester, New York 14618

Table 2: Symbols for the Eighteen with a Die learning program (written for the Motorola M6800 processor) shown in listing 1.

A1 020A	A2 0217	A3 0218	A4 0226	AVA0 01E0
CHMF 1016	CONL E0E3	CRET 000D	CRHM 0010	CRLF 0DCA
ENDM 0049	ENDT 0004	EOF 0016	EOL 0015	G1 01AB
G2 01B2	G3 01C0	GNRL 02B0	GR1 02B3	GR2 02C0
GR3 02C1	GTUP 01A0	HPLY 0045	HTUN 0047	I1 007A
I2 0084	INEE E1AC	INIZ 005D	L1 010E	LGLT 01CE
LNFD 000A	LNFS 0A0A	LSTA 0046	LTSN 004A	M1 0113
M2 011B	M3 0138	M4 0145	M5 0167	M6 0187
MES1 02D0	MES2 03F0	MES3 0465	MES4 04F6	MES5 0512
MES6 055A	MES7 056E	MES8 04A2	MES9 0482	MESA 04CE
MESB 04EA	MESC 04DD	MPLW 0053	MPLY 0052	MPTT 0040
MSKL 0020	OUTR E06B	OUTS E0CA	PDA1 E07E	R1 0242
R2 0254	R3 026E	R4 0278	RANM 0058	RVSW 0230
SCNG 0048	SCOH 0041	SCOM 0042	SELL 0290	SP1 0295
SP2 029B	SP3 02A7	SSTO 0054	TOTD 0044	TOTL 0043
TXIT 018E	WHR F 004C	WINL 0027	WIBP 0056	C

Text continued from page 221:

for every total having winning moves. (Some totals, including zero, have none.)

Using the goof feature, and if the human does not err and seizes every opportunity to win, the game becomes a game of luck. The random plays made by the machine may be winning plays, and a sequence of winning plays found at random is not impossible. With the goof feature activated, the machine will sometimes surprise you by playing the very first game of a series faultlessly.

The game can readily be extended to a goal total greater than eighteen. Multiples of nine assure that no winning play is available to the first player. Longer games will slow the learning process; not only will each game be longer, but the propagation of "good" information from the end of the win table to its beginning will require many more games. Another elaboration could be a "brain" display similar to the one that I implemented in my mechanical machine, GLIM. ■

REFERENCES

1. Gardner, Martin, "Mathematical Games," *Scientific American*, Volume 206, Number 3, March 1962, page 138.
2. Gardner, Martin, *The Unexpected Hanging*, Simon and Schuster, New York, 1969.
3. Mott-Smith, Geoffrey, *Mathematical Puzzles for Beginners and Enthusiasts* The Blakistone Co, Philadelphia, 1946.
4. Nico, Willard I, "Shooting Stars," *BYTE*, Volume 1, Number 9, May 1976, page 42.
5. Wier, Robert R, "Hexpawn: A Beginning Project in Artificial Intelligence," *BYTE*, Volume 1, Number 3, November 1975, page 36.

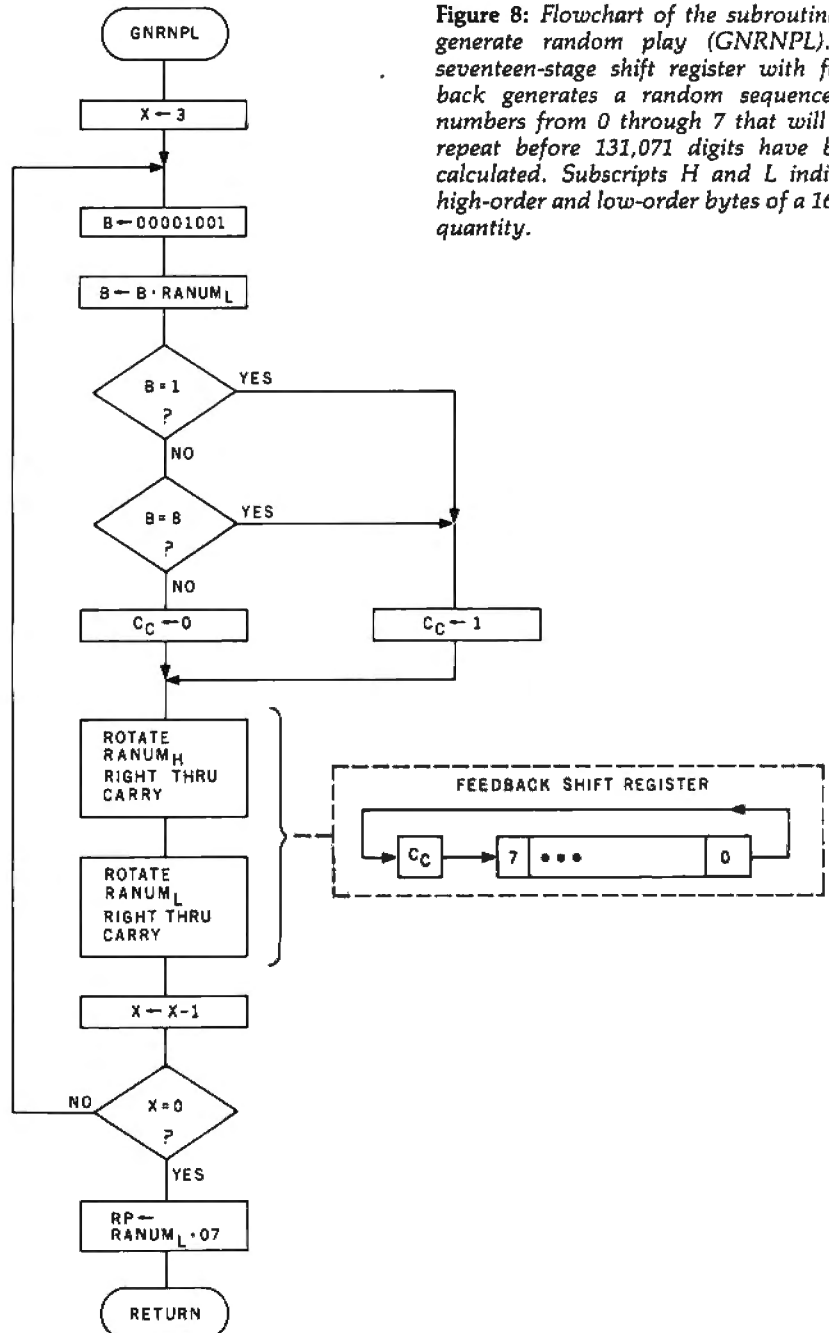

Figure 8: Flowchart of the subroutine to generate random play (GNRNPL). A seventeen-stage shift register with feedback generates a random sequence of numbers from 0 through 7 that will not repeat before 131,071 digits have been calculated. Subscripts H and L indicate high-order and low-order bytes of a 16-bit quantity.

What's New?

SOFTWARE

Apple Writer — A Low-Cost Text Editor for Apple II Users

Using the Apple Writer, a document needs to be typed into the computer only once; corrections, text additions and the rearrangement of text can be accomplished easily and quickly. Automatic search and replacement for specified words or phrases, justification of text, and uppercase and lowercase type are some of the other features of Apple Writer. The 48 K byte storage capacity of the Apple II permits storage of at least 12 pages of text in each on-line file.

The package consists of two master 5-inch floppy disks and an operating manual. The floppy disks include an interactive tutorial which the user can call to the screen for quick learning or review of the Apple Writer system. The cost for the system is \$75. Contact Apple Computer Inc, 10260 Bandy Dr, Cupertino CA 95014.

Circle 562 on inquiry card.

Program Simulates Solar Home

The Sunsim-1 program calculates the sun's energy in hourly intervals at any specified location on earth, and demonstrates its use for domestic space heating, cooling, and hot water heating.

Cumulative energy and temperature values are displayed, including solar energy collected and used, backup energy used, thermal and hot water storage temperatures, and more. Users can input their requirements for size of home, volume of thermal storage, and area and angle of solar collector. Written in Level II BASIC for TRS-80 this program requires 16 K bytes of storage. Sunsim 1 is available on cassette for \$49 from Solartek, POB 298, Guilderland NY 12084.

Circle 563 on inquiry card.

Dental Office Management Package

Dental System I performs patient registration and inquiry, manages accounts receivable, including aging, and provides delinquency reports. Itemized statements and insurance forms can be printed, finance charges on past due amounts can be included for any patient, or the entire practice. The system produces a daily journal of charges, receipts and adjustments, a payment journal summarized by payment method, a report summarizing charges generated by each doctor or

Pascal Compiler for the 6800

Dynasoft Pascal is a subset of standard Pascal intended for cassette-based microcomputers that cannot support full-scale implementations such as UCSD Pascal. It includes the control structures of standard Pascal and supports most of the data types. Language extensions include EXTERN, PROCEDURES and FUNCTIONS, LINK to other Pascal programs, an optional OTHERWISE clause on the CASE statement and absolute memory addressing.

The one-pass compiler produces pseudo-code which requires only a 1.3 K byte interpreter to execute, making it possible to run programs in as little as 2 K bytes. The system, including the compiler, interpreter, a line-oriented

C Compiler for 8080 and Z80 Microprocessors

The BDS C Compiler is the implementation of a subset of the C Programming Language. It is designed for 8080 and Z80 microcomputer systems running under the CP/M 1 operating system. The practical minimum memory size necessary to run BDS C is 32 K bytes, although many modestly sized programs may compile in as little as a 24 K byte system. A larger memory size allows for larger sized source files, since BDS C loads the entire source file into memory at one time. Separately compiled functions can always be linked together, so a C source file which is too lengthy for compilation in one group may be broken up into pieces, compiled separately, and then linked together for execution.

The C Compiler and a copy of *The C Programming Language*, by Ritchie and Kernighan, are available from Lifeboat Associates, 2248 Broadway, New York NY 10024, for \$110. The manual is \$15.

Circle 565 on inquiry card.

hygienist, recall and reminder lists, and more.

Minimum hardware requirements are a 64 K byte computer, two double-density 8-inch floppy disk drives, a video terminal and a 132-column printer. This system can support a practice with up to 4000 patients and the addition of a hard disk would make it possible to handle a larger number of patients.

The price for the Dental System I is \$1995. For further information, contact STR Corp, 5455 Buford Hwy, Suite B-123, Atlanta GA 30340.

Circle 567 on inquiry card.

editor, and system supervisor, occupies little more than 7 K bytes of memory and compiles a 2000-character source program in 12 K bytes of memory.

Price for the basic cassette version, with manual, is \$35, from Dynasoft Systems, POB 51, Windsor Junction, North Saskatchewan B0N 2V0 CANADA.

Circle 564 on inquiry card.

LISP Interpreter for Apple II

This new LISP system features a built-in prettyprinter and LISP editor, both written in LISP, along with prompts that make it clear that LISP is taking in an expression and returning its value. Errors are trapped by the interpreter, and a full trace-back can be printed. Owl LISP has eliminated the PROG pseudofunction, yet defines local variables by using an extended syntax which allows for optional and local variables with default values. Owl LISP also provides a LOOP, WHILE, and UNTIL construction to allow for iterative programming. PEEK, POKE and CALL are provided to access Apple graphics and other functions. String processing can be carried out using IM-PLODE and EXPLODE which convert between character strings and lists.

The system consists of about 6 K bytes of code, 300 bytes of garbage collector work space and 4 K bytes of predefined LISP work space. LISP costs £40 from Owl Computers, 41 Stortford Hall Park, Bishops Stortford, Hertfordshire, CM23 5AJ ENGLAND.

Circle 566 on inquiry card.

Where Do New Products Items Come From?

The information printed in the new products pages of BYTE is obtained from "new product" or "press release" copy sent by the promoters of new products. If in our judgement the information might be of interest to the personal computing experimenters and homebrewers who read BYTE, we print it in some form. We openly solicit releases and photos from manufacturers and suppliers to this marketplace. The information is printed more or less as a first in our queue, subject to occasional priority modifications. While we would not knowingly print untrue or inaccurate data, or data from unreliable companies, our capacity to evaluate the products and companies appearing in the "What's New?" feature is necessarily limited. We therefore cannot be responsible for product quality or company performance.



TRS-80® BUSINESS SOFTWARE for Model I & Model II

CP/M® and CBASIC® based software oriented toward business applications.

FEATURING

- Model I CP/M (rel. 1.5)..... \$150.00
- Model II CP/M (rel. 2.0)..... 250.00
- APH (Automated Patient History)..... 175.00
- DOWNLOAD** program..... 95.00
- RESIDENTIAL PROPERTY ANALYSIS** system..... 300.00

The Genuine Article:

- Osborne & Assoc. CBASIC source programs—
- O&A **Payroll** w/Cost Accounting..... \$250.00
- O&A **Accts. Rec./Accts. Payable**... 250.00
- O&A **General Ledger** w/Cash Journal. 250.00
- O&A CBASIC books for above (each).... 15.00

Send 30¢ SASE for CP/M Users Group software list & free "CP/M Primer".

* TRS-80 is a registered trademark of Radio Shack, a Tandy company
 * CP/M is a registered trademark of Digital Research
 * CBASIC is a registered trademark of Software Systems

CYBERNETICS (714) 848-1922
 8041 NEWMAN AVENUE • SUITE 208 • HUNTINGTON BEACH, CALIFORNIA 92647

"BSTAM"

Byrom Software Telecommunications Access Method

The missing link between any CP/M or TRSDOS computers!

A commercially oriented telecommunications facility for transmitting and receiving CP/M* and TRSDOS** files, BSTAM has BIG computer features for your micro:

- links computers directly at 9600 baud with UARTS, or via phone lines using modems
- full speed data transfer without hex conversion overhead
- full wildcard expansions to send *.COM, etc.
- reliable error detection and automatic retry with console messages for status and errors

It's Terrific!
 We use it ourselves!

\$150 PER COMPUTER \$5 MANUAL ALONE

*CP/M is a trademark of Digital Research

**TRSDOS is a trademark of Tandy Corporation

Lifeboat Associates

2248 Broadway New York, N.Y. 10024 (212)580-0082 Telex:220501

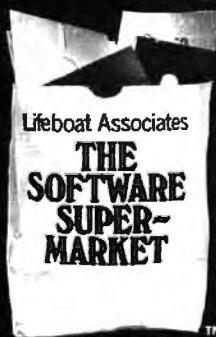

on computers, peripherals, software and other Radio Shack® products.

Offered Exclusively By

Pan American Electronics, Inc. A **Radio Shack** Authorized Sales Center

1117 CONWAY MISSION, TEXAS 78572

Toll Free 800/531-7466
 In Texas 512/581-2765



NO TAXES on out-of-state shipments.
 FREE delivery available on minimum orders.
 WARRANTIES honored by Radio Shack®.



What's New?

SOFTWARE

Music System for Apple II

Micro Music Inc, University Plaza, Suite 8, 309 W Beaufort, Normal IL 61761, has released Micro Composer, an Apple II compatible music-system that allows the user to enter, display, edit, and play music with up to four voices in a 4-octave range. The program allows the user to see all four voices as music is played; enter music by a coding system which keeps track of rhythmic durations, program pitch, rhythm and timbre; choose from seven tone colors for each voice or create tone colors; and has seven preset timbres. Micro Composer comes with a manual, software, and a music card for the Apple II extension slot and is connected to an 8 ohm speaker. Memory requirements are 32 K bytes for the cassette-based system and 48 K bytes for the disk-based system. The price for the package is \$220.

Circle 568 on inquiry card.

MMSForth for the TRS-80

Forth is a structured language similar to Pascal except that, in Forth, the programmer defines additional commands as they are needed. The MMSForth System Diskette supplies reliable disk I/O, virtual memory, double precision integer math, in-line editing, string handling and arrays, and user called disk and tape I/O. MMSForth includes full source code for the majority of MMSForth which is written in Forth. Speed is approximately half that of assembler code, while development is usually much less than half.

This system costs \$64.95 from Miller Microcomputer Services, 61 Lake Shore Rd, Natick MA 01760.

Circle 569 on inquiry card.

Radio Shack Has Variety of Software for TRS-80 Systems

Radio Shack's programs come on cassette and 5-inch floppy disks for the TRS-80 systems. Among the new programs available are a General Ledger I, an Inventory Control System, Statistical Analysis, Real Estate, a Level-I BASIC course that teaches the user how to program, and several advanced programming aids. Radio Shack also has a number of computer games and novelty programs for the TRS-80. For further information on Radio Shack TRS-80 software or products, contact the Radio Shack Computer Customer Service, 205 NW 7th St, Ft Worth TX 76106.

Circle 570 on inquiry card.

Hard Copy Graphics Program for the PET, Apple II, and TRS-80



West Coast Consultants software provides users with full graphics capability for Houston Instrument's Hiplot plotter. Programs that drive the plotter through an RS-232 interface are currently available on tape cassette for the PET, Apple II, and TRS-80. The programs are written in BASIC and require a minimum of 16 K bytes of memory. For further information, contact West Coast Consultants, 1775 Lincoln Blvd, Tracy CA 95376. The prices are \$50 and \$75 for the programs.

Circle 571 on inquiry card.

Pascal Software Compiler for the 1802 Microprocessor

The new GR-Pascal compiler runs with a minimum of 20 K bytes of programmable memory plus a floppy disk system and utilities. Minimum target systems can be from 2 K bytes upwards of program code, including full 16-bit arithmetic package for signed integer variables. The compiler is written in Pascal and features a provision for assembler code, hexadecimal numbers, byte variables, interrupt procedures and

Data Base Management System for Microcomputers

This data base management system (DBMS) runs on 8 to 16 K bytes of read-only memory for Z80, 8080, and 6502 systems. This system provides a full network capability and generalizes some features of the CODASYL approach. The Data Definition Language Analyzer/Editor and Data Manipulation Language permit many-to-many-set relationships. Full data base security is maintained by providing read and write access levels for all record types, items,

Adaptable Operating System for 6809 Microprocessor

Percom Data Company has developed a 6809 operating system for the company's new SS-50 bus-compatible 6809 control computer and other 6809 microprocessing systems. The 1 K byte operating system, called PSYMON, includes eight monitor-type commands and fifteen callable utilities. Hardware adaptability is easy because interfacing is accomplished with simple, specific device driver routines that reference a table of parameters called a Device Control Block (DCB) which is independent of the operating system. Command expansion or modification is facilitated by a feature that allows user-written routines in read-only memory to alter PSYMON pointers and enhance or modify the basic PSYMON command repertoire.

The erasable-programmable read-only memory version for the Percom SBC/9 sells for \$39.95 and the versions for the other systems sell for \$69.95 including a users manual. For information, contact Percom Data Company, 211 N Kirby, Garland TX 75042.

Circle 572 on inquiry card.

disk input/output (I/O) facilities. A typical 200-line Pascal program will compile into 3 K bytes of programmable memory, and processing speed is increased by a factor of 3 to 4 by restricting variables to signed integers with 16-bit accuracy.

The compiler comes on an 1802 circuit in 2 K bytes of read-only memory on-board with 64 K bytes of programmable memory and sells for £40. For more information, contact The Golden River Co Ltd, Telford Rd, Bicester, Oxfordshire, OX6 0UL ENGLAND.

Circle 573 on inquiry card.

and set relationships. A common data base is maintained in order that no data need be duplicated in different files, and different applications can be supported in the one data base. Routines are callable from host languages and have input/output (I/O) and host language interface routines isolated for adaption to North Star, CP/M, and TRS-80 operating systems.

The user's manual and sample application programs are included in the package which costs about \$800. For more information, contact Micro Data Base Systems Inc, POB 248, Lafayette IN 47902.

Circle 574 on inquiry card.

EPROM PROGRAMMERS

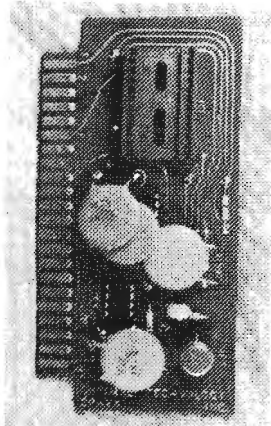

EP-2A SERIES

- PROGRAMS 2708 and 2716 EPROMS
- Price \$59.95 Assembled and Tested
- Kit price \$49.95
- Includes Connector

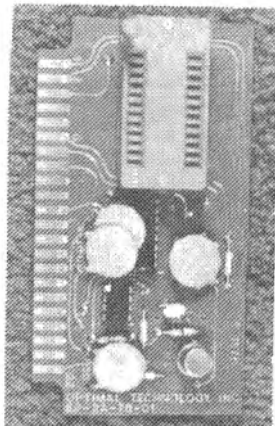

EP-2A-78 SERIES

- PROGRAMS 2708, 2716, 2758, TMS 2716 and TMS 2532 EPROMS
- TEXTTOOL ZERO FORCE SOCKET
- Price \$79.95 Assembled and Tested
- Includes Connector

Software available for the Rockwell AIM-65, MOS Technology KIM-1, Synertek SYM-1, Motorola D2, RCA VIP and many other single board computers that use the 6502, 6800, 8080/85, Z-80, 1802, F-8 and 2650 CPU's. Stock. Specify one set of software.

Optimal Technology Inc.
Blue Wood 127
Earlsville, VA 22936 U.S.A.
Phone (804) 973-5482

What you 'C' is what you get!

C Compiler for CP/M*

New, and available now! An easily affordable compiler incorporating most of the features of the full C language.

BD SOFTWARE

System requirements: CP/M and at least 24K of RAM

Variable Types: char, int, unsigned

Composite Types: arrays, structures, unions

Pointers: to variables, structures, unions and functions

Features: is a structured language, all functions (Programs) recursive; more powerful expression operators than any other von Neumann type language; allows free-formatted source; close enough to UNIX** C to make conversions feasible.

Speed: On 2 Mhz 8080, the statement
for (i = 1; i < 30000; i++) x = 5;
takes about 4 seconds to execute.

Package contains: compiler, linker, library manager; standard function library; sample source files include games, a terminal emulator with disk I/O plus the source for many standard library functions; BDS C User's Guide; Book—*The C Programming Language* by Dennis Ritchie and Brian Kernighan of Bell Labs. **Price: \$110**

Recipient of the Computer Lib Seal of Approval

*CP/M is a trademark of Digital Research Corp

**UNIX is a trademark of Bell Laboratories

Lifeboat Associates

2248 Broadway, New York, N.Y. 10024 (212) 580-0082 Telex 668585

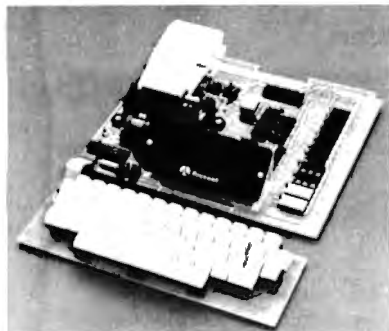

AIM 65

AIM 65 is fully assembled, tested and warranted. With the addition of a low cost, readily available power supply, it's ready to start working for you. It has an addressing capability up to 65K bytes, and comes with a user-dedicated 1K or 4K RAM.

- Thermal Printer
- Full-Size Alphanumeric Keyboard
- True Alphanumeric Display
- Proven R6500 Microcomputer System Devices
- Built-In Expansion Capability
- TTY and Audio Cassette Interfaces
- ROM Resident Advanced Interactive Monitor
- Advanced Interactive Monitor Commands

PRICE: \$375.00(1K RAM)

Plus \$4.00 UPS (shipped in U.S. must give *street* address), \$10 parcel post to APO's, FPO's, Alaska, Hawaii, Canada, \$25 air mail to all other countries

We manufacture a complete line of high quality expansion boards. Use reader service card to be added to our mailing list, or U.S. residents send \$1.00 (International send \$3.00 U.S.) for airmail delivery of our complete catalog.

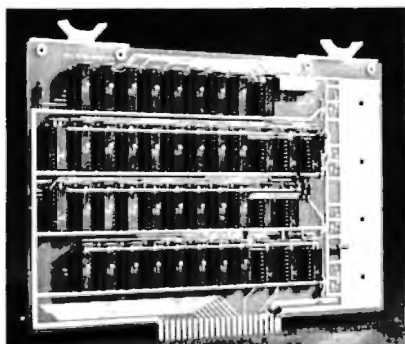

VAK-4 DUAL 8K-RAM \$379.00
VAK-2 8K-RAM (1/2 populated) \$239.00

VAK-4 16K STATIC RAM BOARD

- Designed specifically for use with the AIM-65, SYM-1, and KIM-1 microcomputers
- Two separately addressable 8K-blocks with write protect.
- Designed for use with the VAK-1 or KIM-4* motherboards
- Has provisions for mounting regulators for use with an unregulated power supply
- Made with 1st quality 2114 static ram chips
- All IC's are socketed
- Completely assembled, burned-in, and tested

We manufacture a complete line of high quality expansion boards. Use reader service card to be added to our mailing list, or U.S. residents send \$1.00 (International send \$3.00 U.S.) for airmail delivery of our complete catalog.

*Product of MOS Technology



2967 W. Fairmount Avenue • Phoenix, AZ 85017 • (602) 265-7564

What's New?

SYSTEMS



Inexpensive Word Processor Capable of Powerful Formatting and Text Editing

The SDS 420 consists of a video display, keyboard, floppy disk storage that will store 1.2 M bytes of memory, computer, and printer. In addition to standard formatting, the SDS 420 word processor has instructions for right justification, underline, bold text, include a file, indent, extend, columns, decimal alignment, headings, footings, subscripts and superscripts. The 12-inch screen will display 25 lines of 80 characters per line with variable speed scrolling. The printer will print up to 96 standard characters at 45 characters per second.

The system retails for under \$12,000 from Scientific Data Systems, 12640 Beatrice St, Los Angeles CA 90066.

Circle 590 on inquiry card.

AMD Delivers the AmZ8000 System

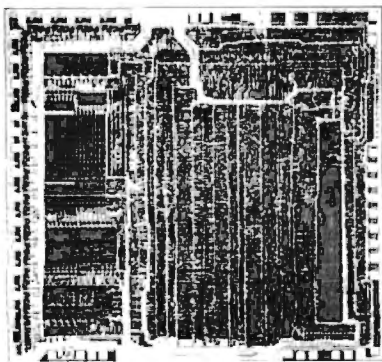

The AmSYS 8/8 floppy disk-based system, designed to support the AmZ8000 processor in both hardware

and software, supports the 8080, 8085 and Z80 microprocessors also. Its basic configuration contains 32 K bytes of memory, two floppy disk drives, and multiple serial and parallel input/output (I/O) ports. Software support includes a disk operating system; macroassembler for the AmZ8000; translators from 8080, 8085 and Z80 code to AmZ8000 code; Pascal compiler for the AmZ8000 and a variety of software packages. Prices start at \$7450. AMD also has the AMC 96/4016 Evaluation Board, which incorporates the AmZ8002, 8 K bytes of programmable memory, twenty-four parallel I/O lines, two RS-232 serial I/O ports, 12 K bytes of erasable-programmable read-only memory sockets, system clock and resident monitor for \$975.

Contact Advanced Micro Devices Inc, 901 Thompson Pl, Sunnyvale CA 94086.

Circle 591 on inquiry card.

Separate BASIC Computer for S-100 Systems



The DLX-10 is a single-board computer that executes BASIC directly in high-speed hardware from 5 to 10 times faster than 8080 systems or 2 to 5 times faster than Z80 systems. It does not replace the microprocessor but functions as a separate BASIC computer. It can boost an S-100 bus microcomputer system into the performance range of a minicomputer.

The DLX-10 runs independently of the main processor and accesses memory as a direct memory access (DMA) device. It runs in parallel to the existing processor, has a stack architecture, and utilizes on-board programmable memory to hold intermediate computations.

BASIC source language programs are translated by software to relocatable BASIC stack-machine object code and are then executed by the DLX-10.

The DLX-10 comes with software to run Northstar BASIC or CBASIC for \$1250 from Alasda Computer Systems, 12759 Poway Rd, Poway CA 92064.

Circle 593 on inquiry card.

Multiprocessor S-100 CP/M Compatible Computer

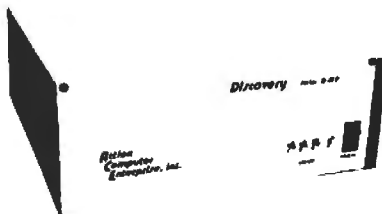

The Discovery Computer System MP Series A, from Action Computer Enterprise Inc, 75 W Green St, Pasadena CA 91105, features an 8080 microprocessor with 32 K bytes of programmable memory (expandable to 64 K bytes), two serial and two parallel input/output

(I/O) ports per processor, a separate S-100 bus for each processor, dual 8-inch floppy disk drives, a video terminal with 24 lines by 80 columns display, 128 upper and lowercase ASCII characters, and an optional printer. Up to 4-user processors can be configured within a single chassis with the ability to expand through auxiliary mainframes and processors.

The Distributed Processing Operating System (DPOS) contains CP/M and supervises reading and updating of files, provides write protection on a disk basis, and prevents incorrect interleaving of file updates. CBASIC-II is provided as the standard user language.

Single-user systems, expandable to multiuser capabilities, start at \$3000. A complete four-user computer can be purchased for \$11,000. Kits are also available.

Circle 592 on inquiry card.

What's New?

SYSTEMS

Microcomputer Kit with 8086 Processor

The Intel SDK-86 is a complete 8086 microcomputer system on a board with memory and I/O (input/output) systems in kit form. This stand-alone 16-bit microcomputer allows designers to obtain hands-on experience with Intel's 8086 16-bit HMOS microprocessor, which offers ten times the processing power of the 8080 processor.

Included in the kit is an 8086 processor; 8 K bytes of 2316 or 2716-type read-only memory; 2 K bytes (expandable to 4 K bytes) of 2142-type programmable memory; 48 parallel I/O lines (implemented through two 8255A programmable peripheral interface devices); an RS-232 or current loop serial I/O structure (implemented via an 8251A universal synchronous/asynchronous receiver-transmitter); selectable data rate from 110 to 4800 bits per second (bps); TTL-compatible bus signals and parallel I/O signals; 24-key hexadecimal data and control keyboard; 8-digit hexadecimal display and control (using an 8279 programmable keyboard and display controller); and 256 vectored interrupts.

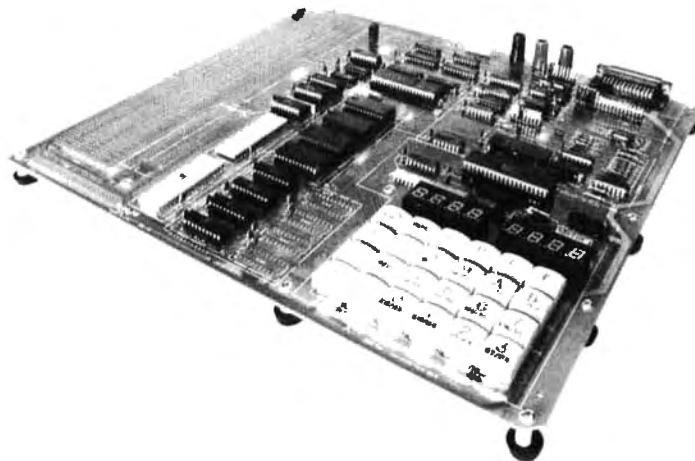

The 2 K bytes of 2142-type programmable memory can be doubled by implementing additional devices in the positions provided. There is room for 8 K bytes of program instructions using either or both of the keyboard and terminal software monitors included in the kit. There is a fully buffered system bus. Programs and data may be entered three ways: from the built-in keyboard; through a built-in serial communications interface; or via cable (SDK-C86) from

any Intel Microcomputer Development System.

A complete design library is provided with the kit. This library includes both the assembly and user manual, plus an MCS-86 user manual and 8086 assembly language reference manual. The SDK-86 microcomputer kit is priced at \$780. For further information, contact Intel Corp., 3065 Bowers Ave, Santa Clara CA 95051.

Circle 594 on inquiry card.

Personal Computer Introduced by Texas Instruments

Texas Instruments has introduced a personal computer featuring easy-to-use computing power for personal finance, home management, family entertainment

and education. Designated the Model TI-99/4, the system consists of a console with 16 K bytes of programmable memory, a wide range of sound effects, sixteen colors for graphic display, a powerful extended BASIC programming language, and a 13-inch color video monitor.

At the heart of the TI-99/4 is a library of Texas Instruments Solid State Software command modules. These command modules allow users instant program accessibility. Solid State Software command module titles include: Demonstration, Diagnostic, Early Learning Fun, Beginning Grammar, Number Magic, Video Graphs, Home Financial Decisions, Household Budget Management, Video Chess, Football, Physical Fitness, Speech Construction, Investment Analysis, Personal Record Keeping, Statistics, Early Reading, and Tax and Investment Record Keeping.

Among peripheral accessories offered is a Solid State Speech synthesizer with a price of \$150. By building a basic vocabulary into the language system, home programmers can place audible messages in their programs. The speech synthesizer module has a 200-word vocabulary and plugs into the console. Speech can be written into programs using BASIC programming language. Future command modules will call up

spoken words automatically.

TI BASIC is a full floating point, 13-digit expanded version of BASIC that is fully compatible with ASCII and the BASIC specification of the American National Standards Institute. TI BASIC includes a full complement of 24 BASIC statements, 14 commands, color graphics, and sound and music over four full octaves. A *Beginner's BASIC Guide* for self-teaching comes with the TI-99/4. For users knowledgeable about programming, McGraw-Hill has published *Programming BASIC With the TI Home Computer*, a book by Herbert Peckham.

Remote controls are offered as accessories to the TI-99/4. Two of these controls may be connected to the computer at the same time. Each includes a multiposition (360°) rotary lever with a side-mounted pushbutton. Other accessories offered by Texas Instruments include: a printer, disk storage, and an RS-232 interface device for connecting the computer to other electronic devices.

The price for the TI-99/4 system is \$1150. Solid State Software command modules carry prices ranging from \$19.95 to \$69.95 each. For further information, contact Texas Instruments Inc, Consumer Relations, Attn TI-99/4, POB 53, Lubbock TX 79408.

Circle 595 on inquiry card.



What's New?

PERIPHERALS

New Motherboard for the KIM-1, SYM-1, and AIM-65

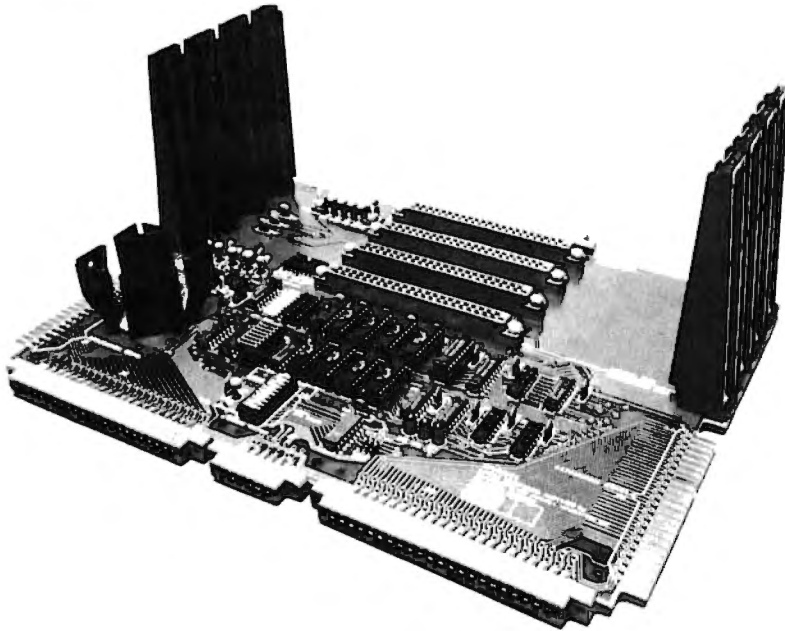

The Little Buffered Mother motherboard incorporates 4 K bytes of programmable memory on the motherboard itself, which, when used with either the SYM-1 or AIM-65, gives the user a total of 8 K bytes of contiguous programmable memory (5 K contiguous on the KIM-1). The motherboard also has regulators for the on-board logic and has the power required for all three microprocessor boards, except the +24 V for the AIM printer.

The unit is available for \$139 without programmable memory or for \$189 with 4 K bytes of programmable memory. Optional boards for the Little Buffered Mother include programmable memory and a programmer, parallel input/output (I/O), and disk controller.

For more information, contact Seawell Marketing, 315 NW 85th St, Seattle WA 98117.

Circle 596 on Inquiry card.

High-Capacity Hard Disk Drive for S-100 Systems

MicroAge has introduced the Fujitsu M2201 Drive with S-100 bus controller for North Star Horizon systems. This system allows accessing up to 40 M bytes of disk storage per drive with the capability of adding up to 4 drives per system. The M2201 was developed with the advent of a new type of direct memory access (DMA) disk controller board capable of very high-speed data transfer. A 2400 RPM rotation combined with a quick seek time and relatively low latency time give the M2201 an average access time of 30 ms.

The system is available for \$9995. For more information, contact MicroAge Wholesale, 1425 W 12th Pl, Tempe AZ 85281.

Circle 597 on inquiry card.

Low-Cost Peripheral Accepts Hand-Printed Characters

With the PrestoDigitizer tablet, users can communicate with their computers through ordinary hand-printed characters. Stroke direction and sequence are the parameters which are transmitted to the computer that allow it to recognize the user's style of hand-printed characters. The learning and recognition algorithms fit in approximately 2 K bytes of memory. Versions of the tablet are available for several popular computers. The tablets can recognize the entire uppercase alphabet, numerals, and many punctuation marks. The PrestoDigitizer retails for \$48.50, including software, from Innovation, POB 1317, Los Altos CA 94022.

Circle 598 on inquiry card.

8-Inch Fixed Disk Drive Series Offers Low Cost Per Megabyte

An 8-inch Winchester fixed disk drive series that offers 5 and 10 M bytes at a low cost has been introduced by Shugart, 435 Oakmead Pky, Sunnyvale CA 94086. Specifications include a capacity of 5.33 M bytes per drive for the SA1002 and 10.67 M bytes for the SA1004; formatted capacity is 4.2 and 8.4 bytes, respectively. Transfer rate for each type is 4.34 M bits per second. Average access time is 70 ms. The Winchester drives offer the same environmental specifications as the standard 8-inch floppy disk drive. Mean time between failure (MTBF) is 8000 power-on hours of typical usage. Optional data separator and controller printed circuit boards are available.

Price for the SA1002 in single quantities is \$1600 and \$1980 for the SA1004.

Circle 599 on inquiry card.

MCD Consulting Introduces the Bionic Voice

Designed around a Computalker Consultants CT-1 Speech Synthesizer, the Bionic Voice uses English language design. Knowledge of phonemes or phonetic alphabet is not required. Predefined dictionaries are provided, and custom dictionary entries may be added. Rapid conversations are possible, because of the English language design. The Bionic Voice can be operated like a conventional language or spelling board. All numerals, letters of the alphabet, and any words or phrases defined on the keyboard may be vocalized instantly as the keys are depressed. There are no commands or codes to memorize nor is knowledge of computers necessary.

To upgrade to a version of the Bionic Voice that has more capability, a simple change of keyboard and computer program can be made.

The Bionic Voice may be used as a voice response for nonvocal or non-verbal individuals; for educational and instructional applications in speech pathology and linguistics; and as a foreign language translator. The Bionic Voice is not limited to voice synthesis. It may be applied to other computer functions. The price ranges between \$2700 and \$3500 depending on necessary modifications.

For further information about the Bionic Voice, contact MCD Consulting, 8306 Selleck, 600 N 15th St, Lincoln NE 68508.

Circle 600 on inquiry card.

What's New?

PERIPHERALS

Video Digitizer Allows Display and Storage of Computer Generated Images

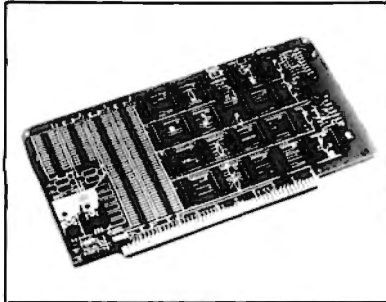

This fast-scan video digitizer can be utilized in consumer environments and in medical, security and other special-

purpose applications requiring image storage and analysis.

This device, for S-100 bus computers, converts output from the video camera (or other source of composite video) into 8-bit gray scale digital information. Maximum horizontal resolution is approximately 700 points per line and vertical resolution is 480 lines per image. Data can be transferred via software to either a memory mapped high-resolution video board or to main memory. A driver program, implementing sixteen shades of gray, is included for controlling the board, displaying images on a high-resolution video board, storing images on disk and printing images on a matrix printer.

The price for the video digitizer is \$175, and it is available from Vector Graphic Inc, 31364 Via Colinas, Westlake Village CA 91361.

Circle 601 on inquiry card.

Digital Controller for Touch Screen Digitizer

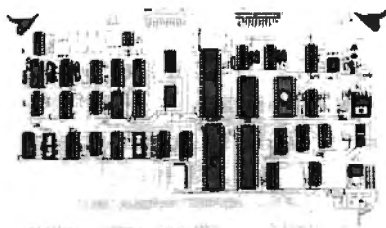

The TSD Touch Screen Digitizer enables untrained personnel to gain access to a data base by simply touching

the screen with a finger. The controller provides an interface between the touch screen and other computer equipment. The controller provides all timing signals required by the screen; measures the time delay between the transmitted signal and the reflected signal from an object touching the glass, which allows the resulting data to be adjusted to overlay the display behind the touch screen; processes and filters the echo times to produce clean X,Y position data; and formats the X,Y data into either parallel or serial form.

It is available from TSD Display Products Inc, 35 Orville Dr, Bohemia NY 11716, for \$2000.

Circle 602 on inquiry card.

The Microtek MT-80 Printer



The MT-80 series printer supports the full uppercase and lowercase 96-character ASCII set in three software selectable fonts on original plus three copies. The printer contains a

240-character buffer, with optional data buffers to 4 K available in 1 K increments. A self-diagnostic program is automatically run on power up. Life expectancy of the print head is 100 million characters and mean time between failures (MTBF) is 1 million lines.

The pin feed system can accept fan-fold forms from 4.5 inches (11.5 cm) to 9.5 inches (24 cm) wide. The unit features top of form control and up to 10 vertical tab settings. Form length is software programmable in one-line increments.

The unit weighs 22 pounds and measures 7.3 by 17.7 by 14.8 inches (18 by 45 by 37 cm). The Centronics-compatible parallel interface version is priced at \$750 and the serial (RS-232) version is priced at \$835. The MT-80G, with an IEEE-488 interface, is also available. Contact Microtek Inc, 7844 Convoy Ct, San Diego CA 92111.

Circle 603 on inquiry card.

Versatile Printer from Malibu Design Group



The Model 165 printer can be operated as a high-speed dot matrix printer at 165 characters per second (cps); a reduced speed, letter-quality dot matrix printer at 90 cps; or a full graphics matrix printer. The 165 printer can do computer portraits, custom character sets such as Japanese, music symbols, high-density characters for word processing, and more.

Underlining, expanded characters, programmable horizontal and vertical tabs, selectable left margin, user adjustable platen and a feature that shuts off the fan when the printer is idle (which reduces noise and power consumption) are some of the features of this printer.

Price for the basic Model 165 is \$2395 from Malibu Design Group Inc, 8900 Eton Ave, Suite G, Canoga Park CA 91304.

Circle 604 on inquiry card.

Pocket Computer for General-Purpose Use



Using easily loaded electronic applications modules, the Nixdorf LK-3000 personal computer can be freely programmed to be used as a personal date book or telephone directory, or it can function as a data collection system capable of communication with other data processing systems. The unit also functions as a hand-held language dictionary to translate German, English, French, Greek, Italian, Spanish, Polish and Swedish words and idioms. The unit is produced by Nixdorf Computer Corp, 168 Middlesex Tpke, Burlington MA 01803, and is priced at \$140.

Circle 605 on inquiry card.

What's New?

PERIPHERALS

Inexpensive and Compact Printer

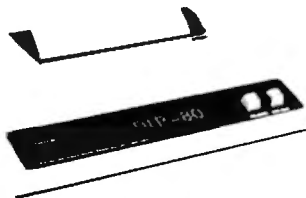

The low-profile DIP-80 features 7 by 7 or 14 by 14 dot matrix printing, upper and lowercase character set, 100

character per second (cps) bidirectional printout, roll or fanfold paper, a full 96-character ASCII set, upper and lowercase printing at either 80 or 96 characters per line on 8.5 inch wide paper, and a 2-line buffer. Paper feed, at the rate of 1 line per second, is accomplished through a friction roller. Interface options include Centronics-compatible parallel, RS-232C serial or 20 mA current loop. The printer measures 15.75 by 9 by 3.5 inches (40 by 23 by 8.8 cm) and is available from DIP Inc, 210 Lincoln St, Boston MA 02111, for \$625.

Circle 606 on inquiry card.

Telecommunications Facility for Transmitting and Receiving CP/M

The Byrom Software Telecommunications Access Method (BSTAM) allows transmission of program or data files between any two computers and is compatible with all 8080/Z80 systems using CP/M operating systems or a derivative, including Heath and TRS-80 adaptations. Transmissions are made over a normal voice-grade telephone line at 300 bits per second (bps) and over direct wire interconnections at 9600 bps. Error checking, cyclic redundancy check (CRC) error checking, protocol informa-

tion, and group file transmission are featured but no data expansion is performed, resulting in fast transfers. BSTAM can precisely transfer data over poor circuits, with retry provisions and perfect reporting in the event of hard errors. The user interface allows a long sequence of files to be sent, with the file names automatically announced to the receiving computer. Sample drivers for 8250, 8251, 6850 and other Universal Asynchronous Receiver Transmitters (UARTs) are provided.

BSTAM comes on floppy disk for \$150. Documentation is \$5. Contact Lifeboat Associates, 2248 Broadway, New York NY 10024.

Circle 607 on inquiry card.

Apple Serial and Parallel Interface

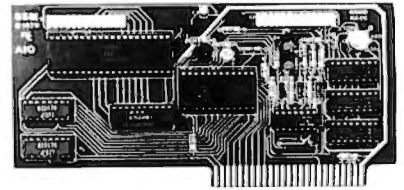

The A10 interface allows maximum flexibility for interfacing an Apple II with peripherals such as printers, plotters, terminals, modems and other computers. The software-programmable serial interface uses the RS-232 standard and includes three handshaking lines. A switch selects nine standard data transmission rates. On-board firmware provides a powerful driver routine that eliminates the need to write any software to utilize the interface. The A10's parallel interface features software programmable I/O ports with enough lines to handle two printers simultaneously with handshaking control.

The A10 comes with serial interface firmware, two cable assemblies and a manual with easy to follow application notes. It is priced at \$175 assembled, and \$135 in the kit form, from SSM (Solid State Music), 2116 Walsh Ave, Santa Clara CA 95050.

Circle 608 on inquiry card.

Single Chip Real-Time Signal Processor



Intel Corp has developed a single chip real-time analog input/output (I/O) microcomputer, the 2920 Signal Pro-

cessor, and the SP20 hardware and software support package. The 2920 converts analog input signals to digital information, processes this information in its computer, and produces analog outputs in a real-time mode. The SP20 support package, a 2920 software simulator assembler and 2920 erasable-programmable read-only memory (EPROM) board, run on the Intellec Microcomputer Development System. The 2920 interfaces directly with analog signals using the on-chip circuitry and can handle multiple signals using I/O multiplexers, enabling thousands of complex analog systems to be formulated from one standard integrated circuit. The device can implement functions such as filters, limiters, oscillators, modulators and demodulators, nonlinear conversions, and perform logical operations all under program control.

The 2920 can be used in phase lock loops, complex filters, test and instrumentation circuits, speech processing, medical electronics, and many other applications. The 2920 device costs about \$300 and the support package costs \$3400. Contact Intel Corp, 3065 Bowers Ave, Santa Clara CA 95051.

Circle 609 on inquiry card.

What's New?

PUBLICATIONS

Bubble Memory Design Handbook

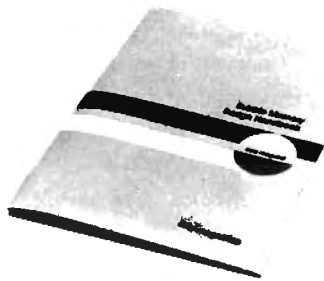

A 64-page catalog presenting the features, descriptions and functional characteristics of the 7110 1 M bit bubble memory and its support device family is now available from Intel Magnetics Inc. Included in the handbook are specifications, diagrams, and tables for the 7110 magnetic bubble memory, the 7220 controller, 7230 current pulse generator, 7242 dual formatter/sense amplifier, 7250 coil predriver, 7254 quad VMOS drive transistors, and IMB-100 development board.

Contact Intel Literature Dept, 3065 Bowers Ave, Santa Clara CA 95051, for free copies of the guide.

Circle 610 on inquiry card.

Quarterly Review of Software for TRS-80

80 Software Critique is a collection of reviews of TRS-80 cassette software. Program reviews are included only if they have been run several times; weak points and bugs in programs are documented. Program reviews include games, simulations, educational programs, music programs, and others. Business software is not included. Names and addresses of software vendors are provided and software prices are included. A one year (4 issues) subscription is \$24 and the price of a single issue is \$7. Write to *80 Software Critique*, POB 134 Waukegan IL 60085.

Circle 611 on inquiry card.

New Heathkit Catalog Available Free

A new 96-page catalog describing nearly 400 electronic kits designed for the hobbyist is available from Heath Co, Dept 350-880, Benton Harbor MI 49022. New products in this catalog include the H89 computer, a 3.5 digit auto ranging multimeter, a low-priced DC to 5 MHz single-trace oscilloscope, and more.

Circle 612 on inquiry card.

Wall Chart and Book on the Z80

The Working Programmer Press, 5080 Shady Ave, San Jose CA 95129, has the Z80 processor pins and elements on a wall-chart poster and work-sheet that measures 18 by 24 inches (46 by 60 cm). It retails for \$7.95 by mail.

The drawings are from the book *The Z80, How It Works, A Programmers Perspective*, published by Microware Associates Inc, Scottsdale AZ. The book describes the working and programmable elements for the Z80. Sections on instruction cycles with detailed register interactions are included.

Circle 613 on inquiry card.

New Language for the 6502 User

XPLO is a simplified Pascal-type language available for 6502 systems with less than 32 K bytes of memory. It is a fast, structured compiler, so users can talk to their computers in their own language. Versions for 20 K Apple II, KIM, TIM, and SYM systems are available for under \$70. For further information on XPLO and other languages, assemblers, and games, plus a free catalog, write to The 6502 Program Exchange, 2920 Moana, Reno NV 89509.

Circle 614 on inquiry card.

Bugbook IV, Microcomputer Interfacing with the 8255 PPI Chip

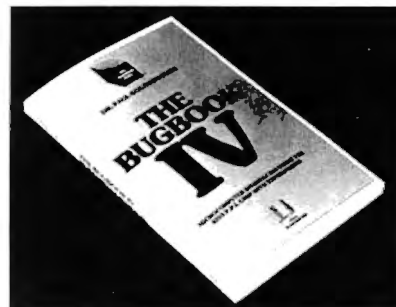

This new book details microcomputer input/output (I/O) techniques and their implementation with the 8255 Programmable Peripheral Interface (PPI) integrated circuit. Techniques and experiments are presented in such a way that the principles can be applied to other PPI chips by students, scientists and engineers. All of the modes of operation are detailed, and a clear explanation of data transfer processes, flag sensing, bit testing, and similar topics are included. The price is \$8.50. For more information, contact E and L Instruments Inc, 61 First St, Derby CT 06418.

Circle 616 on inquiry card.

Educational Software Catalog for Personal Computers

A new mail order catalog devoted exclusively to educational software is being published by Queue, 5 Chapel Hill Dr, Fairfield CT 06432. The catalog will contain listings from numerous publishers. Software listings will be separated by educational level and field, and by computer. Listings for all popular personal computers will be included, and all software can be ordered directly from Queue.

Circle 615 on inquiry card.

Analog Dialogue



This publication includes application articles on very high-speed data acquisition, statistics methods using RMS to DC, checking converter linearity, a 300 kHz continuous 12-bit conversion system, and more. Product descriptions include voltage to current (V/I) converters for process control, a 14-bit

sample/hold amplifier, CMOS switches, three power supplies, and several data converters. The booklet is available for free from Analog Devices, Rt 1 Industrial Park, POB 280, Norwood MA 02062.

Circle 617 on inquiry card.

Connecticut microComputer Catalog

This catalog presents the Data Acquisition Modules Systems (DAM), including the AIM 16 analog to digital (A/D) converter. The publication also includes program reviews and a list of dealers for the company's products. Contact Connecticut microComputer Inc, 150 Pocono Rd, Brookfield CT 06804.

Circle 618 on inquiry card.

What's New?

MISCELLANEOUS

Parallel Input/Output and Timer Board

A parallel input and output (I/O) board has been developed by Tecmar Inc, 23414 Greenlawn Ave, Cleveland OH 44122, for interprocessor communications. It has two 16-bit parallel input ports and two 16-bit parallel output ports, status word for polled operation, interrupts for vectored interrupt operation, and is individually maskable from software.

Tecmar also has a 16-bit timer with 8-bit prescaler, intervals up to 8.4 seconds with resolution of 128 microseconds, status byte for polled operation, interrupt for vectored interrupt operation, and is compatible with conventional S-100 8080 and Z80 systems.

The cost for the entire board is \$350.

Circle 619 on inquiry card.

A Single Board Computer System

The VP Single Board Computer System provides the functions needed for business, process control or software development systems. No other boards of any type are required. Incorporating on-board voltage regulators, it will even operate from a 12 V battery. The multiple serial and parallel input and output (I/O) ports allow the VP to interface with transducers, modems, couplers, terminals, printers, plotters, digitizers, temperature, pressure, voltage monitors and many other devices with an electrical output. The typical configuration includes a Z80 processor, Centronics printer port, 8-bit parallel input port, RS-232C serial port, disk controller for eight drives, and 32 K bytes of programmable memory. The software library includes operating systems,

BASIC, CBASIC, FORTRAN, COBOL, and business accounting, payroll, and word processing packages. The board is available from Data World Inc, 7541 Ravensridge Dr, St Louis MO 63119, for \$900.

Circle 620 on inquiry card.

Computer Games Telephone Network

GameMaster is a computer gaming information network that is available for PET, Apple II, TRS-80, and any other personal computer that is outfitted with a modem. The system offers games, information, educational programs and other items of interest for computer users in the Midwest. For more information, contact GameMaster, 205 W Wacker Dr, Suite 1517, Chicago IL 60606.

Circle 621 on inquiry card.

Smoke Signal's New 6809 Chieftain Computer

Smoke Signal Broadcasting has developed a new integrated computer system utilizing the Motorola 6809 processor, and configured around the new

Chieftain microcomputer with programmable read-only memory (PROM) or erasable-programmable read-only memory (EPROM) storage, and a minimum of 32 K bytes of programmable memory.

The system also includes expansion

capability to at least 256 K bytes — and perhaps up to 1 megabyte — requiring larger memory cards than the current 16 K byte board. In addition, the new motherboard will handle as many as sixteen serial or parallel ports in its 30-pin input/output (I/O) section. Nearly unlimited I/O capability is possible if the user wishes to use any of the 50-pin positions.

Smoke Signal has also developed a new disk controller allowing either single- or double-density recording techniques to be employed. Along with the ability to handle double-sided disks, users can store up to 1 megabyte on each 8-inch floppy disk (320 K bytes on a 5-inch floppy disk). Current users of any SS-50 bus disk system compatible with the Smoke Signal system can purchase the controller board separately or as part of the new Chieftain.

The new controller allows instant access and immediate response to an interruption request at any time during disk operation or other multiuser applications. The unit can be expanded for multiuser operation.

The Smoke Signal disk operating system has been converted to run on the 6809, as well as the text editor and text word processor. All higher-level languages are available for the 6809 including UCSD Pascal.

A hard disk capability on the order of 15 megabytes of fixed storage and 15 megabytes of removable storage is available, expandable to 80 megabytes of fixed storage.

For more information, contact Smoke Signal Broadcasting, 31336 Via Colinas, Westlake Village CA 91361, or call (213) 889-9340.

Circle 622 on Inquiry card.



SAVE 10% * ON ANY PREPAID ORDER OVER \$100⁰⁰

FROM OUR 52 PAGE DETACHABLE

1980 ENGINEERING SELECTION GUIDE BEGINNING ON PAGE 80



JUST ATTACH THIS COUPON TO YOUR ORDER OR
MENTION WHEN PLACING YOUR ORDER BY PHONE

1
PRIORITY ONE ELECTRONICS®

16723 Roscoe Blvd. Sepulveda, CA 91343

10% FROM OUR 1980
ENGINEERING
SELECTION GUIDE
DISCOUNT COUPON

VALID ON PREPAID ORDERS
RECEIVED BEFORE FEBRUARY 15, 1980

*Sorry Discount Not Valid On
ROCKWELL, AIM, MICROPOLIS,
SHUGART, SIEMANS,
AND SHIPPING CHARGES

What's New?

MISCELLANEOUS

Fiber Optic Evaluation Kit for Systems Engineers



Motorola has introduced a fiber optic evaluation kit, developed to give designers experience with the latest fiber optic components. The kit is called The Link, and refers to the optical link between the transmitter and receiver of any system with all of the optical portions needed. The kit includes an MFOE103FB fiber optic infrared light-emitting diode (LED) source, an MFOD402FB integrated detector/preamplifier, a 1 meter length of fiber optic glass cable with matching AMP connectors, design considerations, applications and circuit ideas.

Price for the kit is \$99. Additional ferrule semiconductors and components are available. Contact Motorola, POB 20912, Phoenix AZ 85036.

Circle 629 on inquiry card.

Joystick for Apple II



ISC Inc, 2224-C Old Middlefield Way, Mountain View CA 94043, has introduced the Model VS20/APL Videostick X/Y controller for the Apple II. The unit features a large push (firing) button and a linear joystick designed specifically for applications such as plotting graphics or playing games. The controller plugs directly into the Apple II and can be hand-held or table positioned.

The Videostick is priced at \$39.95, and is available from Computer Plus Inc, 1324 S Mary, Sunnyvale CA 94087.

Circle 632 on inquiry card.

The BASIC Programmer's Toolkit

The Toolkit is a collection of machine language firmware aids designed to enhance the writing, debugging and polishing of BASIC programs for the PET. This 2 K byte read-only memory chip offers additional read-only memory storage, avoiding any need to load tapes or give up valuable programmable

storage. The Toolkit contains 10 powerful commands to help programmers with their PET. The board attaches to the memory expansion port of any 8 K byte PET. The Toolkit costs \$79.95 and the version for the 16 K or 32 K byte PET retails for \$49.95. For more information, contact Palo Alto ICs, 430 Sherman Ave, Palo Alto CA 94306.

Circle 630 on inquiry card.

Low-Cost Transmitter/Receiver Integrated Circuit Pair for Radio Control

National Semiconductor Corp has developed a low-cost transmitter/receiver pair of integrated circuits that allow for the design of lightweight and compact remote control systems. The LM1871 and 1872 make use of an unusual pulse code modulation technique that allows the chip set to handle analog and digital control signal information. The chip set is adaptable for use in toys, such as model cars, airplanes and trucks with simple on/off digital control to sophisticated units with several channels of proportional analog control.

The LM1871 and 1872 feature two digital and two analog channels for control, operation in the 27 MHz and 49 MHz unlicensed bands or in the 72 MHz licensed band, 50 meter outdoor control range, and an internal voltage regulator which keeps radiated power constant even if the supply voltage changes. The chips have built-in flip-flops which eliminate the need for bulky timing components.

The devices come in 18-pin dual in-line packages and operate on 9 V or less. They are priced at approximately \$12 for the set. For more information, contact National Semiconductor Corp, 2900 Semiconductor Dr, Santa Clara CA 95051.

Circle 631 on inquiry card.

Floppy Disk Mailer

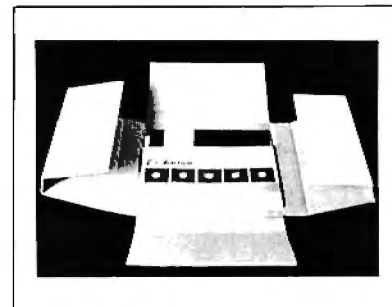

Inmac, 2465 Augustine Dr, POB 4780, Santa Clara CA 95051, has designed a floppy disk mailer that protects up to five standard floppy disks or five 5-inch floppy disks against bending, curling or cupping in transit. The disks are placed in the center of the new Inmac mailer, then the mailer is folded according to the instructions printed on the mailer itself, assuring safety in mailing. Consisting of 10 mailers, a package costs \$10. When purchased simultaneously, three or more packages cost \$8.50 per package.

Circle 633 on inquiry card.

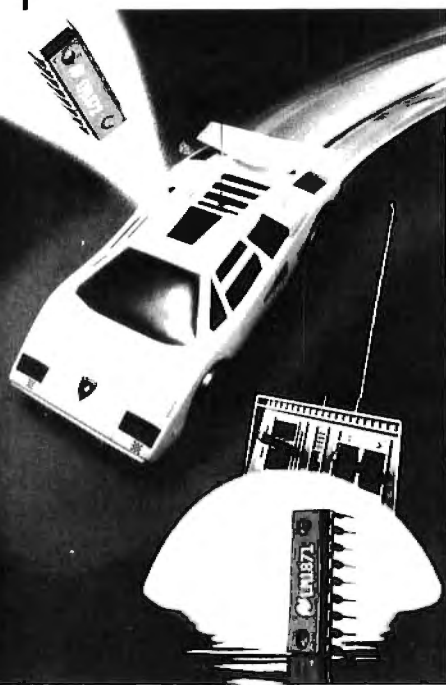

MATCHMAKER TECHNOLOGY

TURNKEY DISK SUBSYSTEMS

DISK IS IN!!!

For those who wish to avoid the aggravation, fussing, irritation, annoyance etc., of assembling your own subsystem, plug in and GO!!!

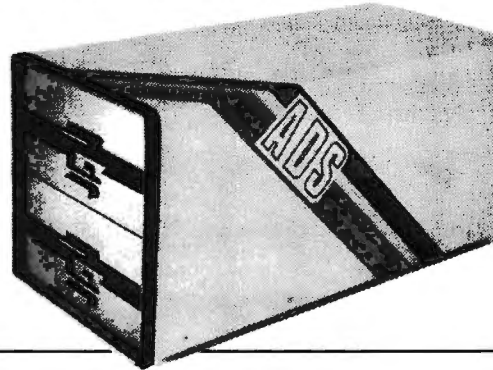

✓ SORCERER

✓ TRS-80

✓ APPLE

✓ HPIB

✓ PET

APPLE

FEATURES:

- 2 8" Floppy DISK DRIVES (Single Sided)
- Color Coordinated Cabinet with Power Supply
- Expanded version of APPLE-DOS
- Single Density Disk Controller
- Full Cabling, Connectors + Documentation
- Assembled and Tested
- Plug In and GO!!! **\$1695.00**

OPTIONS:

- 2 8" Double Sided Drives (In place of Single Sided) **\$2395.00**
- 16K Internal Memory Expansion Kit **69.00**

PET

Prices and specifications same as for APPLE except PET Operates via PET-DOS

TRS-80

Prices and specifications same as for SORCERER with following exceptions:

- Expansion Interface necessary
- Space for up to 48K plug-in dynamic memory on Controller Card
- Software package as above **\$ 995.00**

SORCERER

FEATURES:

- 2 8" Single Sided Floppy Disk Drives
- Single and/or Double Density
- Color Coordinated Cabinet with Power Supply
- Full RS-232 Interface
- OS-1 Disk Operating System (Fully CP/M compatible) CP/M is a registered trademark of Digital Research
- Full Cabling, Connectors + Documentation
- Assembled and Tested
- One S-100 Slot available for Memory Expansion
- Plug In and GO!!! **\$2195.00**

OPTIONS:

- 2 8" Double Sided Drives (In place of Single Sided) **\$2845.00**
- 32K Dynamic RAM Memory Board, Assembled and Tested **\$ 299.00**
- 16K Dynamic RAM Internal Memory Expansion Kit **\$ 69.00**
- Deluxe Business Software package includes:
 - C BASIC
 - WORD PROCESSING SOFTWARE
 - INTERACTIVE "Big 4":
 - General Ledger, Accts. Payable, Accts. Rec. and Payroll **\$ 695.00**
- 10 MBY Removeable Hard Disk - Call for Details

ANOTHER Fine Product brought to you exclusively by the folks at:

In California: 415-321-5601
Outside Cal: 800-227-8266

Electrolabs

POB 6721, Stanford, Ca. 94305

Worldwide:
TLX: 345567 Electrolabs PLA

What's New?

MISCELLANEOUS

Scotchflex Brand Breadboard System from 3M

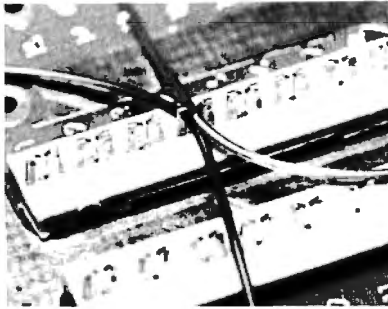

3M has developed a breadboard system that eliminates stripping, soldering and crimping of wires. Connections are made with continuous, 30 AWG

solid insulated wire which is easily inserted into the "U"-contact with a hand-tool supplied by 3M, saving time and labor. Multiple bussing is simplified by putting 2 wires into each contact which provides 4 connections. The contacts are only about one-third the height of wrap posts so prototype circuit boards can be mounted in the same space occupied by production boards. Wires can be removed without unwrapping or cutting, and dual sockets and plug strips can be removed with an inexpensive hand-tool, simplifying reuse of the board and components.

Kits with 8 contact solder strips, plug strips, 16 position dual sockets and Scotchflex "U"-contacts cost \$97.50. Separate components are also available. Contact 3M Co, POB 33600, St Paul MN 55133, Dept EP9-9.

Circle 638 on inquiry card.

Heathkit H8 Extender Board Kit



The H8 Extender Board allows Heathkit owners to troubleshoot their machine easily because each board is up above the computer for access to all circuits and components. Jumper links in power lines make power measurement simple. The links can be replaced with fine copper wire, which protects the traces or the motherboard from damage due to excessive current during testing.

The kit features a double-sided printed circuit board, with plated through holes, and a Molex, 25-pin edge connector, with formed leads.

The kit is available from Mullen Computer Products Inc, POB 6214, Hayward CA 94545, for \$39.

Circle 640 on inquiry card.

Microcomputer Users Provided Access to Commodity Futures Data Base

A commodity futures data base, used by professionals in the field, is being made available to personal computer owners. The MJK data base provides daily information on 38 major commodities including interest rate futures and foreign currencies, as well as agricultural commodities with cash and price information on many. The data becomes available at 2:15 PM (PST) each trading day. In addition to providing daily price, volume and open in-

terest data, MJK makes available a series of programs for calculating moving averages, spread charts, bar graphs, etc. POISE is a special program for testing trading systems in the history of the data base.

A minimum of \$25 per month is charged after a subscriber set-up fee of \$25. Additional charges for the service are \$16 per hour for connect time and 14¢ a second for processor usage. Included is the cost of TYMNET, providing telephone connection at local message-unit rates from most US population centers. For further information, contact Krause and Co, Central Tower Building, San Francisco CA 94103. Circle 639 on inquiry card.

Talking Language Translator Is Introduced by Texas Instruments



A talking Language Translator, utilizing speech synthesis and offering solid state electronic modules for English, French, German and Spanish, has been introduced by Texas Instruments Inc,

POB 53, Lubbock TX 79408. Designed for world travelers as an aid in communicating in a foreign country and for language students in learning to pronounce a foreign language, the handheld device is programmed with a vocabulary of words and phrases selected for everyday use, and can be used as a basic vocabulary for learning a language.

The Language Translator has the ability to form thousands of spoken phrases by linking together its spoken vocabulary words. Each module contains about 1000 words of which half will be spoken and displayed, while half will be displayed only. Components include a speech synthesizer integrated circuit, a controller, and four read-only memories. An earplug is provided for quiet use.

There are five basic functions for users:

- Common phrases - allows user to key-

in a numerical code to access one of 25 preprogrammed phrases.

- Partial phrases - users may form thousands of their own phrases by linking preprogrammed partial phrases with words from the word memory.
- Translate mode - translates 1000 words from input language to output language.
- Memory learn mode - drills user on pronunciation and translation of user-selected words.
- In the learn mode - a programmed drill assists the user to learn.

The Language Translator is priced at approximately \$250.

English, Spanish, French and German modules are available. Japanese and Chinese will be ready in the first quarter of 1980. The approximate price of each is \$50.

Circle 641 on inquiry card.

SAVE THE WHALE

The Fin Whale is the world's greatest long-distance communicator.

Scientists believe that loud, deep-tone, low-frequency sounds made by Fin Whales (frequencies around 20 hertz, or cycles per second) actually travel underwater for distances of at least 500 miles, and under optimum conditions might carry for a radius of over 4,000 miles, potentially reaching an area greater than the entire Atlantic Ocean.

Drawing by
Don Swett

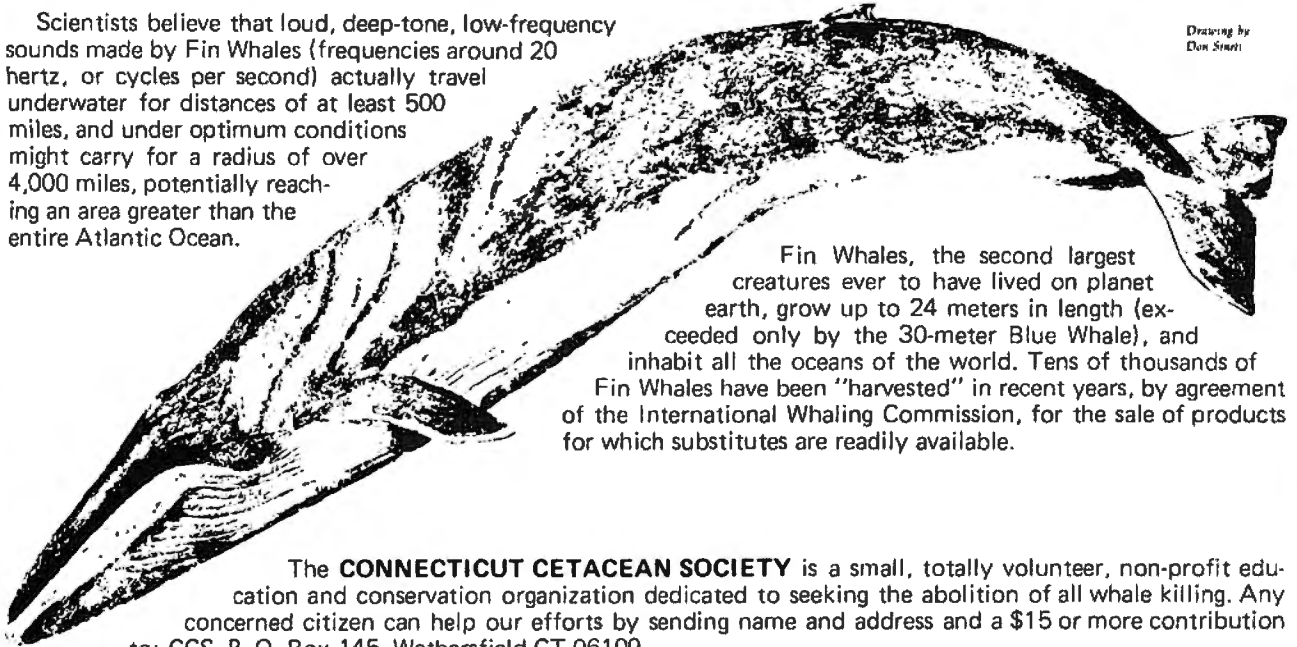

Fin Whales, the second largest creatures ever to have lived on planet earth, grow up to 24 meters in length (exceeded only by the 30-meter Blue Whale), and inhabit all the oceans of the world. Tens of thousands of Fin Whales have been "harvested" in recent years, by agreement of the International Whaling Commission, for the sale of products for which substitutes are readily available.

The **CONNECTICUT CETACEAN SOCIETY** is a small, totally volunteer, non-profit education and conservation organization dedicated to seeking the abolition of all whale killing. Any concerned citizen can help our efforts by sending name and address and a \$15 or more contribution to: CCS, P. O. Box 145, Wethersfield CT 06109.

UP TO 25% OFF

YOUR OWN TRS-80 SYSTEM AT TREMENDOUS SAVINGS

① TRS-80 Complete System

Includes: CPU/Keyboard, Power Supply, Video Monitor, Cassette Recorder, Manual, and Game Cassette.

② Line Printer

③ Mini Disk System

④ C-10 Cassettes

⑤ Verbatim Diskettes



DISK DRIVES IN STOCK!

ITEM	REG. PRICE	OUR PRICE
Level II—4k	\$619.00	\$575.70
Level II—16k	\$849.00	\$789.60
Expansion Interface	\$299.00	\$278.10
Mini Disk Drive	\$ 495.00	\$ 385.00
Centronics 730 Printer	\$ 995.00	\$ 850.00
Centronics 101 Printer	\$1595.00	\$1400.00
Anadex DP-8000 Printer	\$ 895.00	\$ 995.00
Memory Kit (16K) FREE INSTALLATION	\$ 149.00	\$ 98.00
Verbatim Diskettes ea	\$ 5.95	\$ 4.95
3	\$ 17.89	\$ 12.00
10	\$ 59.00	\$ 37.00
C-10 Cassettes	\$ 4.95	\$ 4.50
25	\$ 24.75	\$ 18.75
Paper (9 1/2 x 11 fanfold, 3500 sheets)	\$ 35.00	\$ 29.95

SALE

Centronics 779 \$995.00
Same as Line Printer I (Tractor)

TRS-80 MODEL II \$3626.00
• 64K RAM
• 1/2 MEG DISK

ADDITIONAL DISK DRIVE (1ST) \$1069.50
ADDITIONAL DISK DRIVE (2ND + 3RD) \$ 558.00

MINI DISK DRIVES NOW \$385
Over \$100 less than Radio Shack's!



There are new developments every day—write or call for the latest information.

VRData corp.
777 Henderson Boulevard N-6
Folcroft Industrial Park
Folcroft PA 19032
(215) 461-5300



TOLL FREE
1-(800) 345-8102 *Orders only!

FOREIGN and DOMESTIC DISTRIBUTORSHIPS AVAILABLE . . .

FLOPPY SYSTEMS

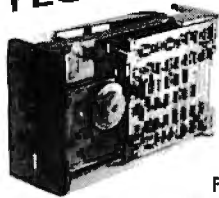

8" Siemens FDD120-8D
All Siemens options included in this drive may be configured hard or soft and single or double density. We find this to be an extremely reliable drive. **\$430.00**

Fully Shugart compatible.



5 1/4" BASF Magical Miniature Mini drive only 2/3 the size of others is reliable and durable and quickly gaining in popularity with our customers. Single or dual density fast access times **\$259.00**



Tarbell Controller may be re-configured to control 5 1/4" drives and includes short cable for one drive. **KIT \$179.00, ASM \$265,** but only **\$219** with purch. of 2 drives.



Cable Kits For 8" Drives with 10' 50 cond. cable and connectors. Also power cable and connectors. Flat cable assem if you wish. For one drive **27.50**, two **33.95**, three **38.95**

Cable Kits for 5 1/4" Drives as above, but 34 cond. For one drive **24.95**, two **29.95**.



"Power One" Model CP206 Power Supply adequate for at least two drives. 2.8A/24V 2.5A/5V, 0.5A/-5V beautiful quality. **\$99.00**

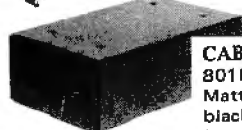

CABINETS for FDD120 and 801R drives, or CP206 supply. Matte finish in mar resistant black epoxy paint and stacking design **29.95**

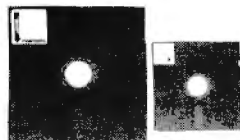

DISKETTES (3M, MRX, BASF, Georgia Magnetics, & Victor Borge)
8" **\$39.95/10**
5 1/4" **\$29.95/10**

32K - \$490.00 16K - \$290.00

NEW!! - CHRISLIN 64K Dynamic RAM \$750.00 (Showing Amazing Similarity to Tarbell's unit) (16K Shown in photo)

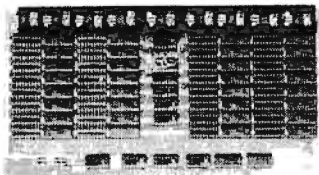

32K - \$549.00 16K - \$349.00

"BACK TO SCHOOL" KEYBOARD SPECIAL

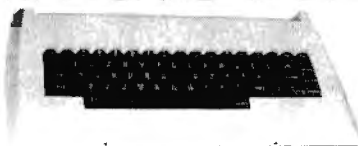

CHERRY "PRO" Keyboard \$119.00
Streamlined Custom Enclosure \$34.95
BOTH ONLY \$124.95 !!!!!!!

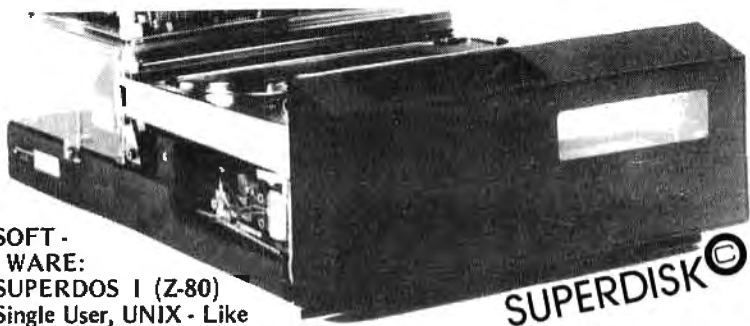

10MBy DRIVE \$3300

S - 100 DMA CONTROL

POWER UNIT \$395.00

SOFTWARE: SUPERDOS I (Z-80) Single User, UNIX - Like File System, AND Totally Upward Compatable From "XX/X" (What did you say, Digital Research??)

PS: SUPERDOS-I runs on the TRS-80, and can transform it from a toy computer to a real business machine !!!

For the first time in something like 10 years, a new STANDARD in removable media has evolved. Selected by Datapoint, and others who have not yet announced, this drive is beautifully simple and easy, if not trivial to maintain. 920kBy/sec, transfer rate, 3600 RPM 39 lbs and only 125 Watts.

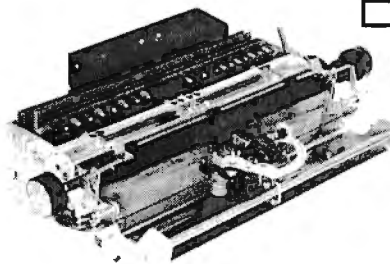

Daisy Wheel Printers Gume Sprint 3\45

PRINTER (factory warr.) \$1199.00
POWER SUPPLY (Boschert) \$349.00 (shown mounted on rear of printer)
COMBINATION SPECIAL \$1699.00

DATA DISPLAY MONITORS

Used 12" Sylvania monitors. Composite Video, 15 MHz, 120VAC. Rebuilt with NEW P39 anti-glare tube **\$119.00**
New P4, **109.00**, used P4 **79.00**.
U-fix model, **10/\$300.00**

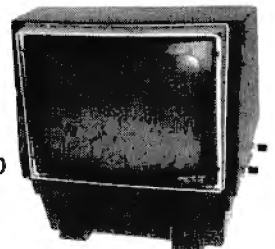

"OEM STYLE" as above, will fit any case. (Both versions serviced by qualified tech). Identical to above but subtract **\$12.00**

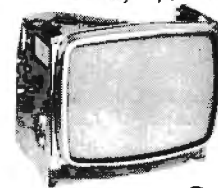

Dopler Motion Sensor Intrusion Detector

Extremely effective microwave motion detector for detecting unwanted visitors. Ignores mice and other non-larcenous creatures. Operates on 12VDC or from small transformer supplied. Output is relay closure for alarm control interface, or to switch on lights annunciators. Will operate THROUGH door of closet or thin wall. Best application seems to be to turn on outside lights to help invited guests, and to intimidate unwanted ones. **\$159.00**
Water Repellent Cover **\$24.95**

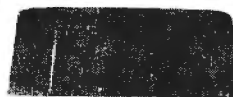

New!

Electrolabs

POB 6721, Stanford, CA 94305
415-321-5601 800-227-8266
Telex: 345567 (Electrolab Pla)
Visa MC Am. Exp.

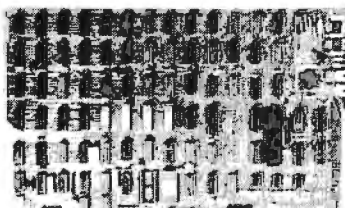

ESAT 200B

BI-LINGUAL 80x24 COMMUNICATING TERMINAL

Scrolling, full cursor, bell, 8x8 matrix, 110 - 19,200 baud, Dual Font Applications. Arabic & Hebrew, Multilingual Data Entry Forms Drawing, Music, & Switchyards. **\$349.00**

SOCKET SPECIAL



"Won't Let Go"

Low Profile

Solder Tail

1 CENT/ Pin !! (0.75/1000's)

8 14 16 18 20 22 24 28 40

RECOMMENDED FOR USE WITH: 8080, 8085, 8088, 8088A, 8088B, 8088C, 8088D, 8088E, 8088F, 8088G, 8088H, 8088I, 8088J, 8088K, 8088L, 8088M, 8088N, 8088O, 8088P, 8088Q, 8088R, 8088S, 8088T, 8088U, 8088V, 8088W, 8088X, 8088Y, 8088Z, 8088AA, 8088AB, 8088AC, 8088AD, 8088AE, 8088AF, 8088AG, 8088AH, 8088AI, 8088AJ, 8088AK, 8088AL, 8088AM, 8088AN, 8088AO, 8088AP, 8088AQ, 8088AR, 8088AS, 8088AT, 8088AU, 8088AV, 8088AW, 8088AX, 8088AY, 8088AZ, 8088BA, 8088BB, 8088BC, 8088BD, 8088BE, 8088BF, 8088BG, 8088BH, 8088BI, 8088BJ, 8088BK, 8088BL, 8088BM, 8088BN, 8088BO, 8088BP, 8088BQ, 8088BR, 8088BS, 8088BT, 8088BU, 8088BV, 8088BW, 8088BX, 8088BY, 8088BZ, 8088CA, 8088CB, 8088CC, 8088CD, 8088CE, 8088CF, 8088CG, 8088CH, 8088CI, 8088CJ, 8088CK, 8088CL, 8088CM, 8088CN, 8088CO, 8088CP, 8088CQ, 8088CR, 8088CS, 8088CT, 8088CU, 8088CV, 8088CW, 8088CX, 8088CY, 8088CZ, 8088DA, 8088DB, 8088DC, 8088DD, 8088DE, 8088DF, 8088DG, 8088DH, 8088DI, 8088DJ, 8088DK, 8088DL, 8088DM, 8088DN, 8088DO, 8088DP, 8088DQ, 8088DR, 8088DS, 8088DT, 8088DU, 8088DV, 8088DW, 8088DX, 8088DY, 8088DZ, 8088EA, 8088EB, 8088EC, 8088ED, 8088EE, 8088EF, 8088EG, 8088EH, 8088EI, 8088EJ, 8088EK, 8088EL, 8088EM, 8088EN, 8088EO, 8088EP, 8088EQ, 8088ER, 8088ES, 8088ET, 8088EU, 8088EV, 8088EW, 8088EX, 8088EY, 8088EZ, 8088FA, 8088FB, 8088FC, 8088FD, 8088FE, 8088FF, 8088FG, 8088FH, 8088FI, 8088FJ, 8088FK, 8088FL, 8088FM, 8088FN, 8088FO, 8088FP, 8088FQ, 8088FR, 8088FS, 8088FT, 8088FU, 8088FV, 8088FW, 8088FX, 8088FY, 8088FZ, 8088GA, 8088GB, 8088GC, 8088GD, 8088GE, 8088GF, 8088GG, 8088GH, 8088GI, 8088GJ, 8088GK, 8088GL, 8088GM, 8088GN, 8088GO, 8088GP, 8088GQ, 8088GR, 8088GS, 8088GT, 8088GU, 8088GV, 8088GW, 8088GX, 8088GY, 8088GZ, 8088HA, 8088HB, 8088HC, 8088HD, 8088HE, 8088HF, 8088HG, 8088HH, 8088HI, 8088HJ, 8088HK, 8088HL, 8088HM, 8088HN, 8088HO, 8088HP, 8088HQ, 8088HR, 8088HS, 8088HT, 8088HU, 8088HV, 8088HW, 8088HX, 8088HY, 8088HZ, 8088IA, 8088IB, 8088IC, 8088ID, 8088IE, 8088IF, 8088IG, 8088IH, 8088II, 8088IJ, 8088IK, 8088IL, 8088IM, 8088IN, 8088IO, 8088IP, 8088IQ, 8088IR, 8088IS, 8088IT, 8088IU, 8088IV, 8088IW, 8088IX, 8088IY, 8088IZ, 8088JA, 8088JB, 8088JC, 8088JD, 8088JE, 8088JF, 8088JG, 8088JH, 8088JI, 8088JJ, 8088JK, 8088JL, 8088JM, 8088JN, 8088JO, 8088JP, 8088JQ, 8088JR, 8088JS, 8088JT, 8088JU, 8088JV, 8088JW, 8088JX, 8088JY, 8088JZ, 8088KA, 8088KB, 8088KC, 8088KD, 8088KE, 8088KF, 8088KG, 8088KH, 8088KI, 8088KJ, 8088KL, 8088KM, 8088KN, 8088KO, 8088KP, 8088KQ, 8088KR, 8088KS, 8088KT, 8088KU, 8088KV, 8088KW, 8088KX, 8088KY, 8088KZ, 8088LA, 8088LB, 8088LC, 8088LD, 8088LE, 8088LF, 8088LG, 8088LH, 8088LI, 8088LJ, 8088LK, 8088LL, 8088LM, 8088LN, 8088LO, 8088LP, 8088LQ, 8088LR, 8088LS, 8088LT, 8088LU, 8088LV, 8088LW, 8088LX, 8088LY, 8088LZ, 8088MA, 8088MB, 8088MC, 8088MD, 8088ME, 8088MF, 8088MG, 8088MH, 8088MI, 8088MJ, 8088MK, 8088ML, 8088MM, 8088MN, 8088MO, 8088MP, 8088MQ, 8088MR, 8088MS, 8088MT, 8088MU, 8088MV, 8088MW, 8088MX, 8088MY, 8088MZ, 8088NA, 8088NB, 8088NC, 8088ND, 8088NE, 8088NF, 8088NG, 8088NH, 8088NI, 8088NJ, 8088NK, 8088NL, 8088NM, 8088NN, 8088NO, 8088NP, 8088NQ, 8088NR, 8088NS, 8088NT, 8088NU, 8088NV, 8088NW, 8088NX, 8088NY, 8088NZ, 8088OA, 8088OB, 8088OC, 8088OD, 8088OE, 8088OF, 8088OG, 8088OH, 8088OI, 8088OJ, 8088OK, 8088OL, 8088OM, 8088ON, 8088OO, 8088OP, 8088OQ, 8088OR, 8088OS, 8088OT, 8088OU, 8088OV, 8088OW, 8088OX, 8088OY, 8088OZ, 8088PA, 8088PB, 8088PC, 8088PD, 8088PE, 8088PF, 8088PG, 8088PH, 8088PI, 8088PJ, 8088PK, 8088PL, 8088PM, 8088PN, 8088PO, 8088PP, 8088PQ, 8088PR, 8088PS, 8088PT, 8088PU, 8088PV, 8088PW, 8088PX, 8088PY, 8088PZ, 8088QA, 8088QB, 8088QC, 8088QD, 8088QE, 8088QF, 8088QG, 8088QH, 8088QI, 8088QJ, 8088QK, 8088QL, 8088QM, 8088QN, 8088QO, 8088QP, 8088QQ, 8088QR, 8088QS, 8088QT, 8088QU, 8088QV, 8088QW, 8088QX, 8088QY, 8088QZ, 8088RA, 8088RB, 8088RC, 8088RD, 8088RE, 8088RF, 8088RG, 8088RH, 8088RI, 8088RJ, 8088RK, 8088RL, 8088RM, 8088RN, 8088RO, 8088RP, 8088RQ, 8088RR, 8088RS, 8088RT, 8088RU, 8088RV, 8088RW, 8088RX, 8088RY, 8088RZ, 8088SA, 8088SB, 8088SC, 8088SD, 8088SE, 8088SF, 8088SG, 8088SH, 8088SI, 8088SJ, 8088SK, 8088SL, 8088SM, 8088SN, 8088SO, 8088SP, 8088SQ, 8088SR, 8088SS, 8088ST, 8088SU, 8088SV, 8088SW, 8088SX, 8088SY, 8088SZ, 8088TA, 8088TB, 8088TC, 8088TD, 8088TE, 8088TF, 8088TG, 8088TH, 8088TI, 8088TJ, 8088TK, 8088TL, 8088TM, 8088TN, 8088TO, 8088TP, 8088TQ, 8088TR, 8088TS, 8088TT, 8088TU, 8088TV, 8088TW, 8088TX, 8088TY, 8088TZ, 8088UA, 8088UB, 8088UC, 8088UD, 8088UE, 8088UF, 8088UG, 8088UH, 8088UI, 8088UJ, 8088UK, 8088UL, 8088UM, 8088UN, 8088UO, 8088UP, 8088UQ, 8088UR, 8088US, 8088UT, 8088UU, 8088UV, 8088UW, 8088UX, 8088UY, 8088UZ, 8088VA, 8088VB, 8088VC, 8088VD, 8088VE, 8088VF, 8088VG, 8088VH, 8088VI, 8088VJ, 8088VK, 8088VL, 8088VM, 8088VN, 8088VO, 8088VP, 8088VQ, 8088VR, 8088VS, 8088VT, 8088VU, 8088VV, 8088VW, 8088VX, 8088VY, 8088VZ, 8088WA, 8088WB, 8088WC, 8088WD, 8088WE, 8088WF, 8088WG, 8088WH, 8088WI, 8088WJ, 8088WK, 8088WL, 8088WM, 8088WN, 8088WO, 8088WP, 8088WQ, 8088WR, 8088WS, 8088WT, 8088WU, 8088WV, 8088WW, 8088WX, 8088WY, 8088WZ, 8088XA, 8088XB, 8088XC, 8088XD, 8088XE, 8088XF, 8088XG, 8088XH, 8088XI, 8088XJ, 8088XK, 8088XL, 8088XM, 8088XN, 8088XO, 8088XP, 8088XQ, 8088XR, 8088XS, 8088XT, 8088XU, 8088XV, 8088XW, 8088XX, 8088XY, 8088XZ, 8088YA, 8088YB, 8088YC, 8088YD, 8088YE, 8088YF, 8088YG, 8088YH, 8088YI, 8088YJ, 8088YK, 8088YL, 8088YM, 8088YN, 8088YO, 8088YP, 8088YQ, 8088YR, 8088YS, 8088YT, 8088YU, 8088YV, 8088YW, 8088YX, 8088YY, 8088YZ, 8088ZA, 8088ZB, 8088ZC, 8088ZD, 8088ZE, 8088ZF, 8088ZG, 8088ZH, 8088ZI, 8088ZJ, 8088ZK, 8088ZL, 8088ZM, 8088ZN, 8088ZO, 8088ZP, 8088ZQ, 8088ZR, 8088ZS, 8088ZT, 8088ZU, 8088ZV, 8088ZW, 8088ZX, 8088ZY, 8088ZZ

CP/M* Source Code - FREE! when you purchase "OS-1"
 Electrolabs' new operating system for the Z-80 designed to have exactly the appearance of UNIX**, including virtual I/O, "set TTY", a tree and a shell, filters and pipes PLUS total compatability with CP/M software!

OS-1 FEATURES

(Because OS-1 is truly a comprehensive "OS", and not merely a file handling "DOS", we have changed the name from "Superdos" to "OS-1")

- VIRTUAL I/O** - copy with a single command between floppy and hard disk, or from TTY to printer to tape to disk... etc., etc. No messy I/O routines to write, & no awkward transfers.
- SECURITY** - 9 modes of file protection, user and login protection.
- MULTI-USER** - up to 256 passwords. (non-simultaneous users)
- 16MB FILE SIZE** - but no limit to no. of directories per device, thus allowing EASY implementation of gigantic storage devices.
- "SET TTY"** - for printer or crt: tabs, page width, buffer, cursor, UC/LC, fonts, formfeed, arbitrary control characters etc., etc.
- "LOGIN"** - automatically executes user selected programs and "set TTY".
- OCCUPIES 12KBy** - only 50% larger than CP/M, but 500% more features.
- CP/M & CDOS COMPATIBLE** - your library is guaranteed to run!

* (Naturally, we are not giving away the version of CP/M written by Digital Research, Please pardon our pun, but they might object. What we ARE giving you is a greatly enhanced version of CP/M which resides on OS-1, and allows the user of OS-1 to run any and all of his programs, packages or system utilities which are already running on CP/M. We give you the source code at no charge so that you may modify any part of the CP/M to suit your own system requirements. At no charge, you also receive the enhancement allowing 4MBy files instead of 256K.)

OS-1 (with debugger, linker and screen oriented editor)	\$199.00
Update service, per year	29.00
Symbolic Debugger	150.00
MACRO-Assembler (Creates relocatable code)	150.00
"C" Compiler	660.00
FORTRAN Compiler	100.00
BASIC Compiler (very fast)	350.00

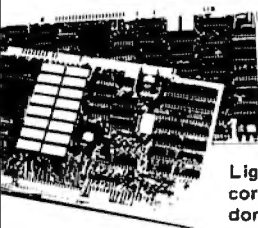

Graphics

High Resolution 480 x 512
 for B&W and Color Imaging and Graphics

Light pen, A-D, D-A, TV synchro (needs no time base correction or adjustment with anything between random interface & NTSC commercial standard), T, V, single frame grabber ("snapshot"). Up to 1 Byte of attributions per pixel.

LSI-100 & S-100 applied to:

Graphic Presentation - such as computer generated animation & other graphic displays up to 256 colors & up to 256 b&w gray scales. **Image Analysis** - using built-in FRAME GRABBER, for medical image enhancement, contour analysis, & pattern recognition. **Commercial TV Tilting & Advertising** - using synchronization capability. **Interactive graphics** - using light pen accessory.

BASIC CONFIGURATION -

LSI-11 \$1995. S-100 \$1265.
 For TRS-80/Exldy Add \$595.00
 Includes: Data Board - 32K (480 x 512 x 1 pixel) D-A 16 level video generator. Video Synchronization Circuitry. Address Control & Timing Board.

FEATURES - High speed, DMA or 2KBy window memory mapped interface. Full NTSC commercial color capability. Low power consumption. Excellent Software **Options - Accessories - Software**
 Options include: light pen, auxiliary outputs, text mode, memory and much more. **Accessories** include: b&w and color cameras and monitors. **Software:** "Plot" 2D or 3D, "Tilting", "Contour", "Image Enhancement", "Vector Curve Generation".

Call for price and details

*CPM and **UNIX

trademarks of Digital Research and Western Electric respectively.

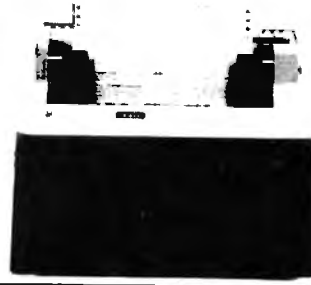
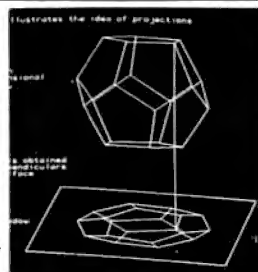
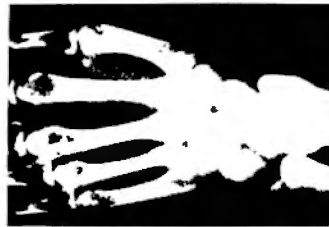

PAPER TIGER

IDS MODEL 440

- 8 Software Selectable Character Sizes
- Parallel & Serial Interface
- 98 ASCII Character set, upper & Lower case
- Forms length control
- Tractor Feed \$995.00
- Graphics option with 2K CRT screen buffer add \$199.00

DYNAMIC DEVICES MODEM

- Acoustically coupled modem assembly set
- Asynchronous 0-300 Baud
- Switchable originate or answer modes
- Operates full or half duplex mode
- 15 minute assembly \$149.95



NEW YEAR'S IC SPECTACULAR

(While Supply Lasts)	7001 (pull outs)	2.00	TMS2716	19.00
	4116 (set of 8, 16K)		2732	95.00
MEMORY & EPROM		69.00	CPU	
2114-	\$ 3.00 5204		1802CD	\$19.95
2114-2	6.99 2708	4.95	6502	6.25
Pd411	2.50 2516	8.95	Z-80	9.95
2107 (pull outs)	2.00 2716	35.00	Z-80A	12.95
		35.00	8080A	8.99
			8085	22.00
			8741	79.00

ELECTROLABS

POB 6721 Stanford, CA 94305
 415-321-5601 800-227-8266
 Telex: 345567 (Electrolab Pla)

FLOPPY CONTROLLERS

1771	\$26.95
1791	37.95
Pd372	39.00

MISCELLANEOUS (CALL US!!)

Electrolab's System Switcher Model SP04



Tames

RAW POWER



for the

LSI-11/23 ★

And Hard Disks

FEATURES:

- * Brown-Out Proof
- Line Frequency Indifferent
- Very Low EMi
- U.L. Approved
- 20 KHz
- High Efficiency
- Soft Start
- Extremely Lightweight
- Open Frame Design
- Short Circuit and
- OV Protection
- 20,000 Hour MTBF (MIL 217B)
- Adaptable to Un-Interruptable Power applications, and
- Low Cost!! (just look at DEC's price)



Electrolabs



COMPUCRUISE

Put a computer in your car, which gives you the most effective and functional cruise control ever designed, plus complete trip computing, fuel management systems, and a remarkable accurate quartz crystal time system.

So simple a child can operate, the new CompuCruise combines latest computer technology with state-of-the-art reliability in a package which will not likely be available on new cars for years to come • Cruise Control • Time, E.T., Lap Timer, Alarm • Time, Distance, Fuel to Arrival • Time, Distance, Fuel to Empty • Time, Distance and Fuel on Trip • Current or Average MPG, GPH • Fuel Used, Distance since Fillup • Current and Average-Vehicle Speed • Inside, Outside or Coolant Temperature • Battery Voltage • English or Metric Display. \$169.95, without cruise control \$129.95.



FLOPPY DISK STORAGE BINDER

This black vinyl three-ring binder comes with ten transparent plastic sleeves which accommodate either twenty, five-inch or ten, eight-inch floppy disks. The plastic sleeves may be ordered separately and added as needed. A contents file is included with each sleeve for easy identification and organizing. Binder & 10 holders \$14.95 Part No. B800; Extra holders 95¢ each. Part No. 800



OPTO-ISOLATED PARALLEL INPUT BOARD FOR APPLE II

There are 8 inputs that can be driven from TTL logic or any 5 volt source. The circuit board can be plugged into any of the 8 sockets of your Apple II. It has a 16 pin socket for standard dip ribbon cable connection.

Board only \$15.00. Part No. 120, with parts \$69.95. Part No. 120A.

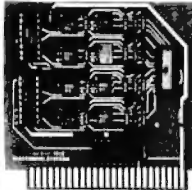

TIDMA

• Tape Interface Direct Memory Access • Record and play programs without bootstrap loader (no prom) has FSK encoder/decoder for direct connections to low cost recorder at 1200 baud rate, and direct connections for inputs and outputs to a digital recorder at any baud rate • S-100 bus compatible • Board only \$35.00 Part No. 112, with parts \$110 Part No. 112A



SYSTEM MONITOR

8080, 8085, or Z-80 System monitor for use with the TIDMA board. There is no need for the front panel. Complete with documentation \$12.95.

16K EPROM

Uses 2708 EPROMS, memory speed selection provided, addressable anywhere in 65K of memory, can be shadowed in 4K increments. Board only \$24.95 part no. 7902, with parts less EPROMs \$49.95 part no. 7902A.



ASCII KEYBOARD

TTL & DTL compatible • Full 67 key array • Full 128 character ASCII output • Positive logic with outputs resting low • Data Strobe • Five user-definable spare keys • Standard 22 pin dual card edge connector • Requires +5VDC, 325 mA. Assembled & Tested. Cherry Pro Part No. P70-05AB. \$119.95.



ASCII KEYBOARD

53 Keys popular ASR-33 format • Rugged G-10 P.C. Board • Tri-mode MOS encoding • Two-Key Rollover • MOS/DTL/TTL Compatible • Upper Case lockout • Data and Strobe inversion option • Three User Definable Keys • Low contact bounce • Selectable Parity • Custom Keycaps • George Risk Model 753. Requires +5, -12 volts. \$59.95 Kit.

ASCII TO CORRESPONDENCE CODE CONVERTER

This bidirectional board is a direct replacement for the board inside the Trendata 1000 terminal. The on board connector provides RS-232 serial in and out. Sold only as an assembled and tested unit for \$229.95. Part No. TA 1000C

DISK JACKET™

Made from heavy duty .0095 matte plastic with reinforced grommets. The mini-diskette version holds two 5-1/4 inch diskettes and will fit any standard three ring binder. The pockets to the left of the diskette can be used for listing the contents of the disk. Please order only in multitudes of ten. \$9.95/10 Pack.

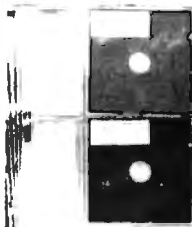

ATARI 800

Computer with 8K \$995.00, disk drive \$549.00, printer \$599.99

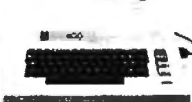

VIDEO TERMINAL

16 lines, 64 columns • Upper and lower case • 5x7 dot matrix • Serial RS-232 in and out with TTL parallel keyboard input • On board baud rate generator 75, 110, 150, 300, 600, & 1200 jumper selectable • Memory 1024 characters (7-21L02) • Video processor chip SFF96364 by Neculonic • Control characters (CR, LF, →, ←, ↑, ↓, non destructive cursor, CS, home, CL • White characters on black background or vice-versa • With the addition of a keyboard, video monitor or TV set with TV interface (part no. 107A) and power supply this is a complete stand alone terminal • also S-100 compatible • requires +16, & -16 VDC at 100mA, and 8VDC at 1A. Part No. 1000A \$199.95 kit.



RS-232/20mA INTERFACE

This board has two passive, opto-isolated circuits. One converts RS-232 to 20mA, the other converts 20mA to RS-232. All connections go to a 10 pin edge connector. Requires +12 and -12 volts. Board only \$9.95, part no. 7901, with parts \$14.95 Part No. 7901A.



COMPUCOLOR II

Model 3, 8K \$13.95, Model 4, 16K \$15.95, Model 5, 32K \$18.95. Prices include color monitor, computer, and one disk drive.



PET COMPUTER

With 32K & monitor - \$1195. Dual Disk Drive - \$1195.



APPLE II OR APPLE II PLUS

16K - \$995, 32K - \$1059, 48K - \$1123. Disk & cont. \$589



CASSETTE TAPE ERASER



REMOVES RECORDINGS IN ONE SECOND! The process eliminates static positive / negative ions and maintains original tone quality with minimal tape hiss • To improve tone quality • To reduce hissing • For quick and easy to erase • No battery or liquid required • Powerful and effective action • Unconditional 2 year guarantee. ERASER-8 \$19.95.

16K RAMS

For the Apple, TRS-80 or Pet \$8 each Part No. 4116/2117.

APPLE II HOBBY/PROTOTYPING CARD

\$14.95 Part No. 7907

T.V. INTERFACE

• Converts video to AM modulated RF, Channels 2 or 3. So powerful almost no tuning is required. On board regulated power supply makes this extremely stable. Rated very highly in Doctor Dobbs' Journal. Recommended by Apple • Power required is 12 volts AC C.T., or +5 volts DC • Board only \$7.60 part No. 107, with parts \$13.50 Part No. 107A



PARALLEL TRIAC OUTPUT BOARD FOR APPLE II

This board has 8 triacs capable of switching 110 volt 6 amp loads (660 watts per channel) or a total of 5280 watts. Board only \$15.00 Part No. 210, with parts \$119.95 Part No. 210A.

To Order:

Mention part no. description, and price. In USA shipping paid by us for orders accompanied by check or money order. We accept C.O.D. orders in the U.S. only, or a VISA or Master Charge no., expiration date, signature, phone no., shipping charges will be added. CA residents add 6.5% for tax. Outside USA add 10% for air mail postage and handling. Payment must be in U.S. dollars. Dealer inquiries invited. 24 hour order line (408) 448-0800



Send for FREE Catalog . . . a big self-addressed envelope with 41¢ postage gets it fastest!

ELECTRONIC SYSTEMS Dept. B, P. O. Box 21638, San Jose, CA USA 95151

TRS-80 E.S. SERIAL I/O

- Can input into basic
- Can use LLIST and LPRINT to output, or output continuously
- RS-232 compatible
- Can be used with or without the expansion bus
- On board switch selectable baud rates of 110, 150, 300, 600, 1200, 2400, parity or no parity odd or even, 5 to 8 data bits, and 1 or 2 stop bits. D.T.R. line
- Requires +5, -12 VDC
- Board only \$19.95 Part No. 8010, with parts \$59.95 Part No. 8010A, assembled \$79.95 Part No. 8010C. No connectors provided, see below.



EIA/RS-232 connector Part No. DB25P \$6.00 with 8 conductor cable \$10.95 Part No. DB25PP



3 ribbon cable with attached connectors for TRS-80 and our serial board \$19.95 Part No. 3CAB4D

MODEM

- Type 103
- Full or half duplex
- Works up to 300 baud
- Originate or Answer
- No coils, only low cost components
- TTL input and output-serial
- Connect 8 Ω speaker and crystal mic. directly to board
- Uses XR FSK demodulator
- Requires +5 volts
- Board only \$7.60 Part No. 109, with parts \$27.50 Part No. 109A



DISKETTES



Box of 10, 5" \$29.95, 8" \$39.95. Plastic box, holds 10 diskettes, 5" - \$4.50, 8" - \$6.50.

RS-232/ TTL INTERFACE

- Converts TTL to RS-232, and converts RS-232 to TTL
- Two separate circuits
- Requires -12 and +12 volts
- All connections go to a 10 pin gold plated edge connector; kit \$ 9.95 Part No. 232A 10 Pin edge connector \$3.00 Part No. 10P.

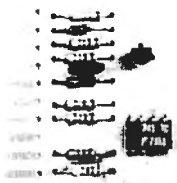

RS-232/TTY INTERFACE

This board has two active circuits, one converts RS-232 to 20mA, and the other converts 20mA to RS-232. Requires +12 and -12 volts. \$9.95 Part No. 600A Kit.



PART NO 600

S-100 BUS ACTIVE TERMINATOR

Board only \$14.95 Part No. 900, with parts \$24.95 Part No. 900A



APPLE II SERIAL I/O INTERFACE

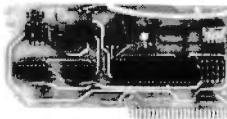

Baud rate is continuously adjustable from 0 to 30,000

- Plugs into any peripheral connector
- Low current drain. RS-232 input and output
- On board switch selectable 5 to 8 data bits, 1 or 2 stop bits, and parity or no parity either odd or even
- Jumper selectable address
- SOFTWARE
- Input and Output routine from monitor or BASIC to teletype or other serial printer
- Program for using an Apple II for a video or an intelligent terminal. Also can output in correspondence code to interface with some electrics.
- Also watches DTR
- Board only \$15.00 Part No. 2, with parts \$42.00 Part No. 2A, assembled \$62.00 Part No. 2C

8K EPROM PIICEON

Saves programs on PROM permanently (until erased via UV light) up to 8K bytes. Programs may be directly run from the program saver such as fixed routines or assemblers.

- S-100 bus compatible
- Room for 8K bytes of EPROM non-volatile memory (2708's).
- On-board PROM programming
- Address relocation of each 4K of memory to any 4K boundary within 64K
- Power on jump and reset jump option for "turnkey" systems and computers without a front panel
- Program saver software available
- Solder mask both sides
- Full silkscreen for easy assembly. Program saver software in 1 2708 EPROM \$25, Bare board \$35 including custom coil, board with parts but no EPROMS \$139, with 4 EPROMS \$179, with 8 EPROMS \$219.

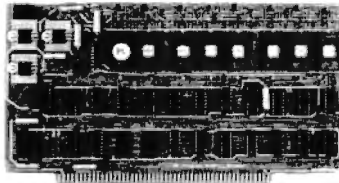

WAMECO PRODUCTS WITH

ELECTRONIC SYSTEMS PARTS

FDC-1 FLOPPY CONTROLLER BOARD will drive shugart, pertek, remex 5" & 8" drives up to 8 drives, on board PROM with power boot up, will operate with CPM (not included). PCBD \$42.95

FPB-1 Front Panel. (Finally) IMSAI size hex displays. Byte or instruction single step. PCBD \$42.95

MEM-1A 8Kx8 fully buffered, S-100, uses 2102 type RAMS. PCBD \$24.95, \$168 Kit

GMB-12 MOTHER BOARD, 13 slot, terminated, S-100 board only \$34.95 \$89.95 Kit

CPU-1 8080A Processor board S-100 with 8 level vector interrupt PCBD \$25.95 \$89.95 Kit

RTC-1 Realtime clock board. Two independent interrupts. Software programmable. PCBD \$25.95, \$60.95 Kit

EPM-1 1702A 4K EPROM card PCBD \$25.95 \$49.95 with parts less EPROMS

EPM-2 2708/2716 16K/32K EPROM card PCBD \$24.95 \$49.95 with parts less EPROMS

GMB-9 MOTHER BOARD. Short Version of GMB-12. 9 Slots PCBD \$30.95 \$67.95 Kit

MEM-2 16Kx8 Fully Buffered 2114 Board PCBD \$25.95, \$269.95 Kit

T.V. TYPEWRITER

- Stand alone TVT
- 32 char/line, 16 lines, modifications for 64 char/line included
- Parallel ASCII (TTL) input
- Video output
- 1K on board memory
- Output for computer controlled cursor
- Auto scroll
- Non-destructive cursor
- Cursor inputs: up, down, left, right, home, EOL, EOS
- Scroll up, down
- Requires +5 volts at 1.5 amps, and -12 volts at 30 mA
- All 7400, TTL chips
- Char. gen 2513
- Upper case only
- Board only \$39.00 Part No. 106, with parts \$145.00 Part No. 106A



UART & BAUD RATE GENERATOR

- Converts serial to parallel and parallel to serial
- Low cost on board baud rate generator
- Baud rates: 110, 150, 300, 600, 1200, and 2400
- Low power drain +5 volts and -12 volts required
- TTL compatible
- All characters contain a start bit, 5 to 8 data bits, 1 or 2 stop bits, and either odd or even parity.
- All connections go to a 44 pin gold plated edge connector
- Board only \$12.00 Part No. 101, with parts \$35.00 Part No. 101A, 44 pin edge connector \$4.00 Part No. 44P



TAPE INTERFACE

- Play and record Kansas City Standard tapes
- Converts a low cost tape recorder to a digital recorder
- Works up to 1200 baud
- Digital in and out are TTL-serial
- Output of board connects to mic. in of recorder
- Earphone of recorder connects to input on board
- No coils
- Requires +5 volts, low power drain
- Board only \$7.60 Part No. 111, with parts \$27.50 Part No. 111A



HEX ENCODED KEYBOARD

E.S. This HEX keyboard has 19 keys, 16 encoded with 3 user definable. The encoded TTL outputs, B-4-2-1 and STROBE are debounced and available in true and complement form. Four onboard LEDs indicate the HEX code generated for each key depression. The board requires a single +5 volt supply. Board only \$15.00 Part No. HEX-3, with parts \$49.95 Part No. HEX-3A. 44 pin edge connector \$4.00 Part No. 44P.

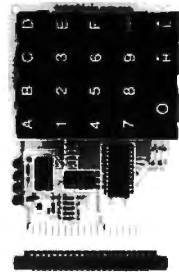

DC POWER SUPPLY

- Board supplies a regulated +5 volts at 3 amps., +12, -12, and -5 volts at 1 amp.
- Power required is 8 volts AC at 3 amps., and 24 volts AC C.T. at 1.5 amps.
- Board only \$12.50 Part No. 6085, with parts excluding transformers \$42.50 Part No. 6085A



To Order: Mention part no., description, and price. In USA shipping paid by us for orders accompanied by check or money order. We accept C.O.D. orders in the U.S. only, or a VISA or Master Charge no., expiration date, signature, phone no., shipping charges will be added. CA residents add 6.5% for tax. Outside USA add 10% for air mail postage and handling. Payment must be in U.S. dollars. Dealer inquiries invited. 24 hour order line (408) 448-0800



Send for FREE Catalog . . . a big self-addressed envelope with 41¢ postage gets it fastest!

ELECTRONIC SYSTEMS Dept. B, P. O. Box 21638, San Jose, CA USA 95151

JADE Computer Products

74LS CHIPS 15% OFF !!!

MEMORY PRICES REDUCED !!!

S D SYSTEMS SALE !!!

S D SYSTEMS EXPANDORAM

EXPANDABLE TO 64K USING 4116 RAMS

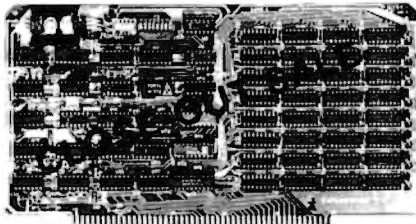

Interfaces with most popular S-100 boards
Bank selectable; PHANTOM provision
Draws only 5 watts fully populated
Designed to work with Z-80, 8080, and 8085 systems
No wait states required
16K boundaries & protect via dip switches
Kits come with sockets for full 64K
Invisible refresh

MEM-16130K (16K KIT)	\$199.00
MEM-16130A (16K A&T)	\$249.00
MEM-32131K (32K KIT)	\$265.00
MEM-32131A (32K A&T)	\$315.00
MEM-48132K (48K KIT)	\$339.00
MEM-48132A (48K A&T)	\$389.00
MEM-64133K (64K KIT)	\$394.00
MEM-64133A (64K A&T)	\$444.00

S D SYSTEMS PROM-100

VERSATILE EPROM PROGRAMMER

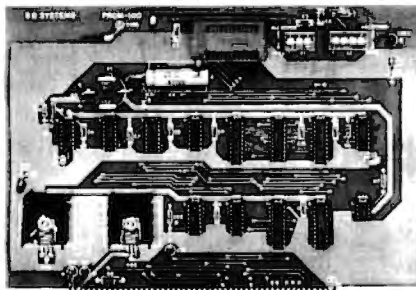

S-100 bus compatible (note: board height 7")
Dip switch selects 2708, 2716, 2732, 2758, or 2516's
25 VDC programming pulse generated on board
Programming time only 100 seconds for 16K bits
Support-software listing provided in manual
Program and erasure verification
Software provides for reading of object file from
CP/M and programming into EPROM
MEM-99520K (KIT)

MEM-99520K (KIT)	\$145.00
MEM-99520A (A&T)	\$215.00

S D SYSTEMS EXPANDOPROM

EXPANDABLE TO 32K USING 2716 EPROMS

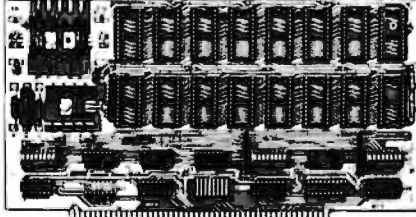

S-100 bus compatible, uses 2708 or 2716 EPROMs
Dip switches allow selection of: each EPROM, 16K
or 32K boundary, wait states

MEM-32220K (KIT)	\$135.00
MEM-32220A (A&T)	\$199.00

GET THE INSIDE TRACK JADE DOUBLE-D DOUBLE DENSITY DISK CONTROLLER

Read/write single or double density, 8" or 5 1/4" drives
On board Z-80 insures reliable operation
CP/M compatible in either single or double density
Density is software selectable
Up to 4 single or double sided, single or double
density drives may be mixed on the same system
EIA level serial printer interface on board-up to 9600
baud (perfect for despooling operations)
All the hard work of disk access is done by the on
board Z-80A and 2K memory, leaving your host
CPU free for its normal duties

Uses IBM standard formats for proven reliability
THIS BOARD REALLY WORKS !!!!!
IOD-1200K (DOUBLE-D KIT)

IOD-1200K (DOUBLE-D KIT)	\$285.00
IOD-1200A (DOUBLE-D A&T)	\$349.00
IOD-1200D (MANUAL ONLY)	\$15.00

S D SYSTEMS VERSAFLOPPY II DOUBLE DENSITY DISK CONTROLLER

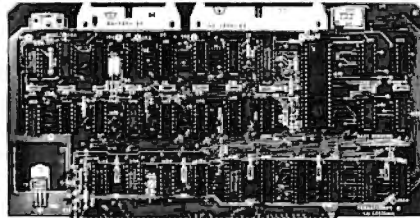

Single or double density floppy disk controller
965600 bytes on 8" double sided diskettes
259840 bytes on double sided 5 1/4" diskettes
S-100 bus (IEEE) standard compatible
IBM 3740 format in single density
8" and 5 1/4" drives controlled simultaneously
Operates with Z-80, 8080, and 8085 CPU's
Controls up to 4 drives

Vectored interrupt operation optional
IOD-1160K (KIT)

IOD-1160K (KIT)	\$305.00
IOD-1169A (A&T)	\$399.00

S D SYSTEMS VERSAFLOPPY VERSATILE FLOPPY DISK CONTROLLER

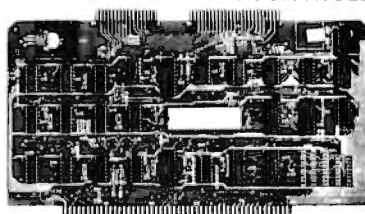

IBM 3740 soft sectored format
S-100 Z-80 or 8080 compatible
Controls up to 4 single or double sided drives
Compatible with all popular disk drives
CP/M compatible
Listings for control software included

IOD-1150K (KIT)	\$139.00
IOD-1150A (A&T)	\$229.00

NEW 2 OR 4 MHz REV. C BOARD THE JADE BIG Z

Z-80 CPU BOARD WITH SERIAL I/O PORT

2 or 4 MHz switchable, on-board 2708, 2716, or 2732
EPROM useable in SHADOW mode (full 64K RAM)
Automatic MWRITE generation if no front panel
On-board USART for sync or async RS232

CPU-30201K (KIT)	\$159.00
CPU-30201A (A & T)	\$209.00

S D SYSTEMS EXPANDORAM II 4 MHz RAM BOARD EXPANDABLE TO 256K

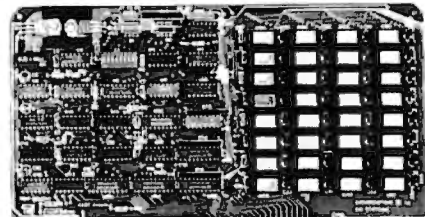

S-100 bus compatible, up to 4 MHz operation
Expandable memory from 16K to 256K
Dip switch selectable boundaries
Page-mode allows up to 8 boards on the same bus
Invisible refresh; PHANTOM output disable
Designed to operate in Z-80 based systems

MEM-16631K (16K KIT)	\$275.00
MEM-16631A (16K A&T)	\$325.00
MEM-32632K (32K KIT)	\$359.00
MEM-32632A (32K A&T)	\$410.00
MEM-48632K (48K KIT)	\$445.00
MEM-48632A (48K A&T)	\$495.00
MEM-64632K (64K KIT)	\$529.00
MEM-64632A (64K A&T)	\$579.00

S D SYSTEMS VDB-8024

80 X 24 I/O MAPPED VIDEO BOARD

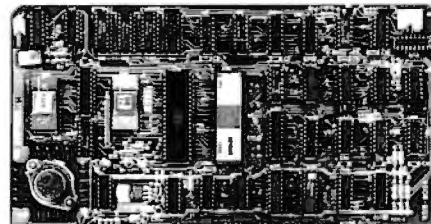

80 character by 24 line display, 7 X 10 dot matrix
Composite or separate TTL video outputs
On-board keyboard interface with power
On-board Z-80 and 2K RAM

Blink, underline, reverse, protect, up/down scroll
Upper/lower case characters, 32 special characters
Optional 128 user-programmable characters
IOV-1020K (KIT)

IOV-1020K (KIT)	\$295.00
IOV-1020A (A&T)	\$459.00

S D SYSTEMS SBC-100/200

2 OR 4 MHz SINGLE BOARD COMPUTER

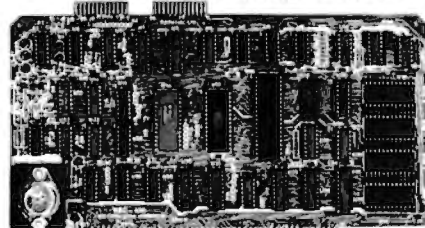

S-100 bus compatible Z-80 CPU
1K of on-board RAM
4 EPROM sockets accomodates 2708, 2716, or 2732
One parallel and one serial I/O port
4-channel counter timer chip (Z-80 CTC)
Software programmable serial baud rates
CPC-30100K (2 MHz KIT)

CPC-30100K (2 MHz KIT)	\$215.00
CPC-30100A (2 MHz A&T)	\$345.00
CPC-30200K (4 MHz KIT)	\$255.00
CPC-30200A (4 MHz A&T)	\$365.00

PRICES SLASHED FOR JANUARY !!!!

CALL TOLL-FREE AND SAVE

800-421-5809 CONTINENTAL U.S.

800-262-1710 INSIDE CALIFORNIA

S D SYSTEMS Z-80 STARTER KIT COMPLETE Z-80 MICROCOMPUTER

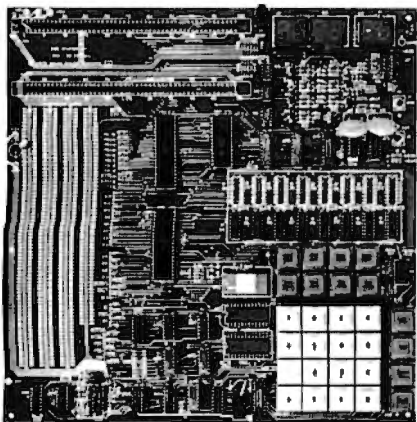

On-board keyboard, display, EPROM programmer, and cassette interface
On-board S-100 interface
Wire-wrap area and room for 2 S-100 connectors
Two 8-bit parallel I/O ports, 4-channel CTC, 5 programmable breakpoints
Examine and change memory, I/O ports, or register
CPS-30010K (KIT) \$219.00
CPS-30010A (A&T) \$365.00

CP/M 2.0

Digital Research has done it again! This new release of their industry standard disk operating system is bound to be an even bigger hit than the original version. All of the fundamental file-size restrictions of release 1 have been eliminated, while maintaining full compatibility with the earlier versions. This new release can be field-configured by the user for a single mini-disk up through a multiple drive hard-disk system with 128 megabyte capacity. Field configuration can be accomplished easily through use of the Macro Library (DISKDEF) provided with CP/M 2.0.

A powerful operating system for only ... \$150.00

JADE'S NEW MOTHERBOARDS THE ISO-BUS

WE'RE PROUD OF OUR MOTHER!

6-SLOT

BARE BOARD \$24.95
KIT \$49.95
ASSEMBLED & TESTED \$59.95

12-SLOT

BARE BOARD \$39.95
KIT \$89.95
ASSEMBLED & TESTED \$99.95

18-SLOT

BARE BOARD \$59.95
KIT \$129.95
ASSEMBLED & TESTED \$149.95

SPECIAL PACKAGE PRICE ROCKWELL AIM-65 THE HEAD-START IN MICROCOMPUTERS

KIM-1 compatible
On-board printer
Full ACSII keyboard

AIM-65 w/1K RAM..\$375.00
AIM-65 w/4K RAM..\$450.00
8K BASIC ROM..\$100.00
POWER SUPPLY..\$59.95
CASE for AIM-65..\$49.95

4K Assembler/Editor..\$80.00
Special Package Price \$599.00
4K AIM-65, 8K BASIC ROM, Power Supply, and Case.



JADE MEMORY EXPANSION KITS FOR

TRS-80 APPLE EXIDY

Everything you need to add 16K of memory to your computer. Your kit comes neatly packaged with easy to follow instructions. In just minutes your computer is ready to tackle more advanced software.

\$75.00

AVAILABLE IN FEBRUARY NEW JADE P/S I/O

PARALLEL/SERIAL/INTERRUPT BOARD

Z-80 SIO/PIO, 2 CTCs, expands to 2 SIOs, 4 CTCs
4 serial ports (async, sync, bisync, SDLC/HDLC)
2 parallel ports with full handshake

Software baud rate generators, interval timers, counters, and generates 32 vectored interrupts
Designed especially for MP/M multi-user multi-tasking operating systems. For use with Z-80 only
IOI-1045B (BARE BOARD) \$45.00
IOI-1045K (KIT) \$169.95
IOI-1045A (A & T) \$224.95

MICROPROCESSORS

F8 \$16.95
Z80 (2MHz) \$10.95
Z80A (4MHz) \$14.95
CDP1802CD \$24.95
6502 \$11.95
6800 \$12.50
6802 \$20.00
8008-1 \$15.95
8035 \$24.00
8025-B \$24.00
8080-A \$10.00
8085 \$23.00
TMS9900TL \$49.95

8080A SUPPORT DEVICES

8212 \$5.00
8214 \$4.65
8216 \$2.95
8224 (2MHz) \$4.30
8226 \$2.75
8228 \$6.40
8238 \$6.40
8243 \$8.00
8251 \$7.50
8253 \$20.00
8255 \$6.40
8257 \$19.95
8259 \$19.95
8275 \$69.95
8279 \$17.70

USRT

S2350 \$10.95

UARTS

AY5-1013A \$5.25
AY5-1014A \$8.25
TR1602B \$5.25
TMS6011 \$5.95
IM6403 \$9.00
BAUD RATE GENERATORS
MC14411 \$10.00

6800 PRODUCT

6821P \$5.25
6828P \$12.00
6834P \$16.95
6850P \$4.80
6852P \$7.50
6860P \$9.25
6862P \$12.00
6875L \$7.30
6880P \$2.50

CHARACTER GENERATORS

2513 Upper \$7.95
2513 Lower \$6.75
2513 Upper (5 volt) 9.75
2513 Lower (5 volt) \$13.00
MCM6571 up scan \$13.00
MCM6571A down scan \$10.95

PROMS

1702A \$5.00
2708 \$8.85
2716 \$39.95
2716 (5v) \$39.85
2758 (5v) \$30.00

DYNAMIC RAMS

4116/416D 8 for \$74.95
2104/4096 \$4.75
2107B-4 \$3.95
TMS4027/4096 \$4.75

STATIC RAMS

21L02 (450ns) \$1.50
21L02 (250ns) \$1.75
2101-1 \$2.95
2111-1 \$3.25
2112-1 \$2.95
2114L (450ns) \$5.75
2114L (300ns) \$5.95
TMS4044 (450ns) \$8.00
TMS4044 (300ns) \$9.95
410D (200ns) \$9.95
4200A (200ns) \$9.95

INTEGRAL DATA SYSTEMS THE PAPER TIGER

132 COLUMN DOT MATRIX PRINTER

Up to 198 CPS
1.75 to 9.5 inch adjustable tractor and friction feed.
Parallel and serial interface.

98 character ASCII set.
80 to 132 columns.
6 or 8 lines per inch.
Eight software selectable character sizes.

110, 300, 600, or 1200 baud.
PRM-33440 \$995.00
PRM-33441(with graphics & 2K buffer) .. \$1195.00

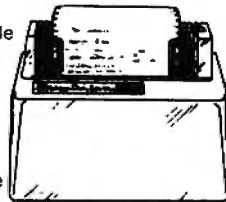

DISKETTE SPECIAL

5.25" SOFT, 10, OR 16 SECTOR

10 for \$29.95

8" SOFT SECTOR IBM COMPATIBLE

10 for \$34.95

S-100 CONNECTOR SALE



100 PIN IMSAI TYPE SOLDER-TAIL CONNECTOR

6 for \$17.50 12 for \$30.00

SPST DIP SWITCHES



PART NUMBER	NUMBER OF SWITCHES	PRICE
SWD-103	3	\$1.00 \$1.18
SWD-104	4	\$1.05 \$1.20
SWD-105	5	\$1.10 \$1.24
SWD-106	6	\$1.15 \$1.28
SWD-107	7	\$1.20 \$1.30
SWD-108	8	\$1.25 \$1.34
SWD-109	9	\$1.30 \$1.36
SWD-110	10	\$1.35 \$1.38

SALE



TEXT TOOL ZIP* DIP II SOCKETS

16 PIN ZIP* DIP II \$5.50
24 PIN ZIP* DIP II \$7.50
40 PIN ZIP* DIP II 10.25

* ZERO INSERTION PRESSURE

SPECIAL HOLIDAY PRICE! NOVATION CAT ACOUSTIC COUPLER/MODEM

\$175.00



Let your computer talk to other computers!
Bell Systems 103 compatible
300 baud, answer or originate
IOM-5200A (SALE PRICED)

JADE Computer Products

4901 W ROSECRANS, HAWTHORNE, CA 90250
213-879-3313

PLACE ORDERS TOLL FREE

800-262-1710 800-421-5809
INSIDE CALIFORNIA CONTINENTAL U.S.

WRITE FOR OUR FREE 1978 CATALOG
FOR CUSTOMER SERVICE OR TECHNICAL INQUIRIES
CALL 213-879-3317

TERMS OF SALE: Cash, checks, money orders, and credit cards accepted. Minimum order \$10.00. California residents add 6% sales tax. Minimum shipping and handling charge \$2.50. Prices are for U.S. and Canadian delivery only and are subject to change without notice. For export prices and information send for a JADE INTERNATIONAL CATALOG.



HICKOK 3 1/2 Digit Mini-Multimeter
MODEL LX 303 \$69.50

Sinclair PDM35 digital Multimeter
Reg. \$69.95 \$49.95

ESG PRECISION 3 1/2-Digit Portable DMM
• Overhead Projection • Battery or AC operation • 3 High LED Displays • Auto Zeroing Model 2800 comes complete with test leads, operating manual and spare fuse

NLS 15 MHz Mini Oscilloscope
Model MS 15
Reg. \$318.00 \$269.95

ESG Logic Probe
Model LP 1 \$44.95

30MHz Dual Trace with Delay Line
Reg. \$1100.00 \$892.50

Function Generator
Reg. \$127.50

GOULD 15 MHz Dual Trace
• Triggers in excess of 25 MHz
Model OS255 \$795 including probes

Weller Controlled Output Soldering Station
Reg. \$77.50 \$49.95

Weller Xcelite
Reg. \$139.00 \$69.50

Service Master Attache Style Tool Kit Tool Cases
Model 995M \$47.50
Model TC 100 ST \$279.95
Model 999P \$19.95

Miniature High Fidelity Stereo Speaker System
3-Way
Reg. \$139.00 \$69.50

Magnifier LAMP
Model MG 10A \$49.50

Chess Challenger
Model GCC \$74.95

SENCORE TV-VTR-MATV and Video Analyzer
Model VA48 \$945.75

ESG CONTINENTAL SPECIALTIES
100 MHz 8-Digit Counter \$127.50
• 20 Hz - 100 MHz Range • G. F. LED Displays • Fully Automatic Reg. \$150.00
• In-Loop - 100 IFC (100 lead input cable manual)

ESG PS500 500MHZ Prescaler \$59.95

BK PRECISION Digital Capacitance Meter
Model 820 \$249.95

CODE-A-PHONE Telephone Answering Devices
Model 1400 \$199.95

Wahl NEW ISO-TIP "Quick Charge"
Model 7500 Cordless Soldering Iron \$17.95
Model 5800 Thermal Solder Circuit Tester \$29.95

Logic Monitor
Model LM 1 \$59.95

ESG SYSTEM X-10MM Remote Control for Lights & Appliances
4 Piece Starter Kit Reg. \$87.95 \$79.50

HICKOK Function Generator
Model 270 \$181.90

Bearcat Scanner
Model 250 \$299.95

Touch K100 Scanner
Reg. \$269 \$199.95

BSR Changer Accessories
Model BSR 129 \$29.95

Microflame Deluxe Gas Torch Kit
Model 4400 Reg. \$39.95 \$29.95

In-Dash AM/FM 8 Track Stereo
C-777 \$52.50

AM/FM Cassette Stereo
CAS 888 \$57.50

Stereo Power Booster
POW-40 \$24.95

FREE 1979 Catalog

Call TOLL FREE (800) 645-9518

"We Will Beat Any Advertised Price"

FORDHAM
BSR Conklin St. Farmingdale, N.Y. 11735

HOBBY WORLD ELECTRONICS

America's Largest Mail-Order Computer Store



YOUR #1 SOURCE

CALL TOLL FREE: (800) 423-5387 USA

IN CALIF: (800) 382-3651

LOCAL & OUTSIDE USA (213) 886-9200

74LS

Order by Cat No. 999 and type

TYPE NO.	PRICE	TYPE NO.	PRICE
74LS 00	.28	74LS157	1.45
74LS 01	.19	74LS158	.49
74LS 02	.29	74LS160	.99
74LS 03	.19	74LS161	1.10
74LS 04	.89	74LS162	.99
74LS 05	.35	74LS163	.99
74LS 06	.29	74LS164	1.25
74LS 09	.25	74LS165	.89
74LS 10	.29	74LS168	.99
74LS 11	.59	74LS169	.49
74LS 12	.29	74LS170	1.69
74LS 13	.59	74LS173	1.29
74LS 14	1.25	74LS174	.99
74LS 15	.39	74LS175	.99
74LS 20	.29	74LS181	2.25
74LS 21	.29	74LS190	1.10
74LS 22	.29	74LS191	1.10
74LS 26	.25	74LS192	1.10
74LS 27	.25	74LS193	1.10
74LS 28	.39	74LS194	1.10
74LS 30	.29	74LS195	1.10
74LS 32	.39	74LS196	.89
74LS 33	.39	74LS197	1.65
74LS 37	.39	74LS221	1.25
74LS 38	.32	74LS240	4.50
74LS 40	.25	74LS241	2.40
74LS 42	.89	74LS242	1.50
74LS 47	.89	74LS243	2.50
74LS 48	.79	74LS244	2.60
74LS 51	.29	74LS247	1.10
74LS 54	.29	74LS248	1.10
74LS 55	.29	74LS251	1.99
74LS 73	.44	74LS253	.99
74LS 74	.59	74LS257	.99
74LS 75	.49	74LS258	.99
74LS 76	.45	74LS259	1.99
74LS 83	.89	74LS260	.69
74LS 85	1.25	74LS261	1.75
74LS 86	.45	74LS266	.49
74LS 90	.49	74LS273	1.50
74LS 92	.75	74LS275	4.50
74LS 93	.59	74LS279	.75
74LS 95	.99	74LS283	.79
74LS 96	1.15	74LS293	1.95
74LS 107	.29	74LS295	.99
74LS 109	.45	74LS298	.79
74LS 112	.29	74LS365	.85
74LS 113	.29	74LS366	.79
74LS 114	.29	74LS367	.85
74LS 122	.49	74LS368	.85
74LS 123	.99	74LS373	3.05
74LS 124	1.35	74LS374	1.95
74LS 125	.89	74LS377	3.90
74LS 126	.29	74LS378	1.25
74LS 132	.79	74LS386	.65
74LS 138	.88	74LS393	1.45
74LS 139	.88	74LS395	1.45
74LS 145	1.25	74LS399	2.95
74LS 151	.67	74LS424	1.95
74LS 153	.79	74LS668	1.25
74LS 154	1.79	74LS670	2.49
74LS 155	.89	81LS 96	1.45
74LS 156	.69	81LS 97	1.55

CMOS

Order by Cat No. 999 and type

TYPE NO.	PRICE	TYPE NO.	PRICE
CD 4000	.19	CD 4028	.85
CD 4001	.23	CD 4030	.45
CD 4002	.23	CD 4035	.99
CD 4006	1.09	CD 4040	1.10
CD 4007	.25	CD 4044	.79
CD 4008	.28	CD 4045	.89
CD 4009	.45	CD 4046	1.19
CD 4010	.39	CD 4049	.45
CD 4011	.38	CD 4050	.45
CD 4012	.25	CD 4051	1.15
CD 4013	.36	CD 4052	.69
CD 4014	.99	CD 4053	1.19
CD 4015	.99	CD 4066	.85
CD 4016	.45	CD 4069	.49
CD 4017	1.30	CD 4071	.26
CD 4018	.99	CD 4081	.29
CD 4019	.42	CD 4082	.29
CD 4020	1.10	CD 4510	.99
CD 4021	1.25	CD 4516	.79
CD 4022	1.10	CD 4519	.59
CD 4023	.39	CD 4522	1.25
CD 4024	.75	CD 4526	1.25
CD 4025	.26	CD 4528	.99
CD 4026	1.45	CD 4529	.49
CD 4027	.49		

MICROPROCESSORS

Order by Cat No. 999 and type

TYPE NO.	PRICE
780 A	12.75
1802	16.50
6502	14.50
6800	6.50
8015	11.75
8080 A	6.60
8085	15.95
TMS 9900	49.00

HAZELTINE TERMINALS

Standard interfacing to most systems!

Cat No.	Model	Description	Price
2167*	1400	51 key, 80 x 24 display, drrmb	\$840
2168*	1500	Intelligent, 74 key, 80 x 24	\$1195
2169*	1520	Intelligent, 81 key, 95 char.	\$1588

ATARI THE AFFORDABLE COMPUTER

The perfect computer for both home and business!

Sophisticated, yet simple. Designed by the expert in home computer based accessories. It won't become obsolete, because it has an expandable memory, advanced peripheral components, and comprehensive array of software modules. Whether you've had programming experience or not, you'll find yourself operating your Atari in no time at all! Features of the Model 400 include: 57 key keyboard, high-resolution color graphics, built-in TV modulator for direct connection with any standard color TV, 8K RAM, 8K BASIC ROM, plus more and more! The model 800 has all the features of the 400 plus two channel digital recorder, 8K RAM, (expandable to 48K) and 16K ROM, (expandable to 32K).

Cat No.	Description	Price
2172	Atari 400 Per-sonal Computer	\$550.00
2176	Digital recorder for 400	90.00
2173	Atari 800 Per-sonal Computer	995.00
2174	Minidisk Drive for 800	750.00
2175	Line Printer for 800	600.00

HOW TO ORDER
Pay by check, Mastercharge, Visa, or COD. Charge orders please include expiration date. Foreign pay in U.S. funds. Order by phone or mail, or at our retail. **MINIMUM ORDER \$10.** please include phone number and magazine/issue you are ordering from. Prices valid thru last day of cover date. **SHIPPING: USA:** add \$2.00 for the first 2 lbs. For ground add 35¢ for add'l lb. For air add 75¢ for add'l lb. **FOREIGN:** surface: add \$3.00 for first 2 lbs, 60¢ per add'l lb. Air: add \$11.00 for first 2 lbs, \$5 for each add'l lb. **CODs \$1 add'l!** Guaranteed satisfaction for 30 days or your money back! Not responsible for typographical errors. Some items subject to prior sale. We reserve the right to limit quantities.

SEND FOR FREE CATALOG
FEATURING:
Computers and accessories, disk drives, printers, integrated circuits, LEDs, semiconductor, books, software, connectors, plus more and more! The widest selection at the lowest prices! Circle our reader service number or phone/write today for your copy!

19511 Business Center Dr. Dept. B1 Northridge, Ca. 91324



Radio Hut

201 LOCHWOOD MALL • DALLAS, TEXAS 75218
ORDER BY PHONE—214-324-5509

PLEASE WRITE FOR CATALOG OR
WHILE IN DALLAS, VISIT OUR RETAIL
STORE AT 201 LOCHWOOD MALL,
DALLAS, TEXAS 75218
(GARLAND ROAD AT JUPITER).

ORDERING INFORMATION & TERMS: Orders under \$15.00
add 75¢ handling. No C.O.D. We accept Visa, MasterCard,
and American Express cards. Tex. Res. add 5% tax. Foreign
orders (except Canada) add 20% P&H. 90 Day Money Back
Guarantee on all items. Add 5% P&H, maximum \$5.00.
ORDER BY PHONE — (214) 324-5509

The EXPANDORAM is available in versions
from 16K up to 64K, so for a minimum invest-
ment you can have a memory system that will
grow with your needs. This is a dynamic mem-
ory with the invisible on-board refresh, and IT
WORKS!

- Bank Selectable
- Phantom
- Power 8VDC, +16VDC, 5 Watts
- Lowest Cost Per Bit
- Uses Major Brand 16K RAMS
- PC Board is doubled solder masked and has silk-screened parts layout
- Extensive documentation clearly written

SD EXPANDORAM

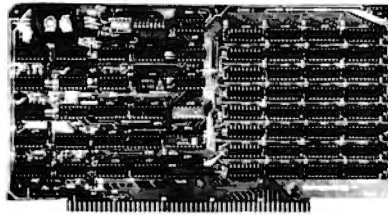

- Complete kit includes all Sockets for 64K
- Memory access time: 375ns, Cycle time: 500ns.
- No wait states required
- 16K boundaries and Protection, via Dip Switches
- Designed to work with Z-80, 8080, 8085 CPU's

EXPANDORAM 64K Kit (16K Ram)

WITHOUT MEMORY	\$139.00
16K	209.00
32K	275.00
48K	340.00
64K	405.00

SD'S PROM 100 PROM Programmer Board
The PROM-100 Programmer is a development tool for S-100 Bus computer systems. The Zero Insertion Force Programming Socket extends above the card cage height for easy access to PROM devices. Software verifies PROM erasure, verifies program loading and provides for reading of object file from Disk or PROM and programming into PROM/EPROM. Features include: On-board generated 25vdc Programming pulse, TTL compatible, maximum programming time for 16,389 bits is 100 seconds. Programs: 2708, Intel 2758, 2716, 2732 and TI 2516. DIP Selectable EPROM type.

PROM-100 Board Kit \$149.95

SD'S MPB-100 Z80 CPU BOARD KIT

The MPB-100 provides, a Z80 microprocessor based CPU for S-100 Bus systems. Front panel usage is optional, making the MPB-100 suitable for upgrading existing systems to Z80 level. A PROM socket is provided on-board which makes the MPB-100 adaptable to process control applications. Features include: Power-on Jump to 4K boundaries, 2 Megahertz or 4 Megahertz operation, optional wait states, on-board PROM socket.

MPB-100 KIT \$199.00



SD'S VERSAFLOPPY II
• IBM 3740 Compatible Soft Sector'd Format for Single Density Drives • Operates with Single and Dual Sided Drives, Single or Double Density Drives and 5" & 8" Drives — in any combination of four simultaneously • Drive Select and Side Select Circuitry • S-100 Bus Compatible • Vectored Interrupt Operation Optional • Phase Locked Loop Data Recovery Circuit • Operates with Z80 CPU's • Uses FD1791-1 Controller Chip • The Versafloppy II incorporates all the possible features of a flexible disk drive controller into one board. Capable of handling four drives simultaneously, combinations of any variety are possible, such as 5" single sided, 8" dual density dual sided, 5" dual density single sided. Most popular drives are controlled directly with the Versafloppy II. The operating system for the Versafloppy II is the extremely powerful SDO5 available for SD Systems. Diagnostic and control software available to complete your disk system.

\$290 KIT, \$385.00 ASSEMBLED & TESTED



SD'S VDB-8024 VIDEO DISPLAY BOARD

The VDB-8024 features its own on-board Z80 microprocessor. This gives the capability of using software (included in ROM) to control functions and enhancements without interference with the computer's CPU. Included in the special features: 80 characters by 24 lines display, keyboard power and interface, composite and separate video output, 2K on-board RAM, a total of 256 available characters, full cursor control, forward and reverse scrolling, underlining, field reverse, field protect enhancements, programmable characters.

VDB-8024 KIT \$289.00

SD'S "VERSAFLOPPY I" KIT

FEATURES: IBM 3740 soft sector'd compatible, S-100 BNS Compatible for Z-80 or 8080. Controls up to 4 drives (single or double sided). Directly controls the following drives: Sugart SA400/450 Mini Floppy • Shugart SA800/850 Standard Floppy • PERSCI 70 and 277 • MFE 700/750 • CDC 9404/9406

\$135.00



SD'S SBC-100 SINGLE BOARD COMPUTER

The SBC-100 provides a complete micro-computer on a single board! The Z80 microprocessor is used as the heart of the SBC-100. The SBC-100 meets all the requirements of a Z80 CPU board with the added features of I/O ports, counter/timer channels, on board RAM, provisions for PROM/ROM and a software programmable baud rate generator. S-100 Bus compatible, the SBC-100 features are: 8K bytes of available PROM, 1024 bytes on-board RAM, Serial I/O with both synchronous and asynchronous operation, Parallel I/O ports, Operational Vectored Interrupts, and Four Counter/Timer Channels. SD Monitor available for RS-232 and Video Terminals. Disk based system software also available.

SBC-100 KIT \$209.00

TARBELL FLOPPY DISK INTERFACE
Compatible with Z80 & 8080. S-100 Bus. Uses CPM operating system. Plugs directly into your IMSAI or ALTAIR • Fastest transfer rate
KIT \$190.00 Assembled & Tested \$260.00

TARBELL CASSETTE INTERFACE
Plugs directly into your IMSAI or ALTAIR • Fastest transfer rate • Extremely reliable • Phase encoded • 4 extra status & control lines
KIT \$99.95

COMPUTER CORNER CPU'S

Z80	\$10.99
RELATED CHIPS	
2114 (300ns)	\$5.99
Z80 PIO	\$9.95
2708	\$7.99
4115	8/\$34.95
4116	8/\$80.00
DISC CONTROLLER	
1771	\$29.95
1791	\$37.95

IC SOCKETS

SOLDER TIN		LOW PROFILE	
PIN		PIN	
8	.12	16	.17
14	.15	18	.24
24	.32	40	.54
28	.39	20	.26

Z80 STARTER KIT

Kit: \$219.95 Assembled & Tested \$369.95
SD System's Z80 Starter Kit enables the novice to build a complete microcomputer on a single board. Featuring the powerful Z80 microprocessor, the Z80 Starter Kit features • Keyboard and Display • Audio Interface • PROM Programmer • Expansion and Wire Wrap Area • On Board RAM • 4 Channel Counter/Timer • Z-BUG Monitor in PROM • I/O Ports.

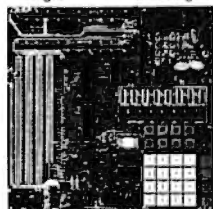

DIP SWITCHES

3 Pos.	\$1.10
4 Pos.	\$1.12
5 Pos.	\$1.16
6 Pos.	\$1.20
7 Pos.	\$1.22
8 Pos.	\$1.26
9 Pos.	\$1.36
10 Pos.	\$1.30

LEDS AND READOUT

Jumbo Red LED's	8/1.00
Jumbo Green LED's	4/.95
Jumbo Yellow LED's	4/.95
Jumbo Amber LED's	4/.95
MV Red	10/1.00
FND 70CC	.50
DL 707	.95
DL 747CA	.65
DL 728CC	1.19
FND 800CC	1.50
Red Filter 4" Bezel	2.50
Green Filter 4" Bezel	2.50
Amber Filter 4" Bezel	2.50
4N25	1.60
4N26	1.25
4N27	1.10
4N28	.95
4N31	1.20

S-100 CONNECTORS High-Quality Gold Pins \$2.99 EACH

FLOPPY DISK SPECIAL
5.25" SOFT, 10 OR 16 SECTOR
10 FOR \$29.95
8" SOFT SECTORED IBM COMPATIBLE
10 FOR \$34.95

- S-100 Bus Compatible
- Up to 4Mhz Operation
- Expandable Memory from 16K to 256K
- DIP Switch Selectable Boundaries
- Uses 16K (4116) or 64K (4164) Memory Devices
- Page Mode Operation Allows up to 8 Memory Boards on Bus
- Operates with Z80 CPU's
- Phantom Output Disable
- Invisible Refresh (Synchronized with Wait States)

Circle 212 on inquiry card.

SD'S EXPANDORAM II The Random Access Memory

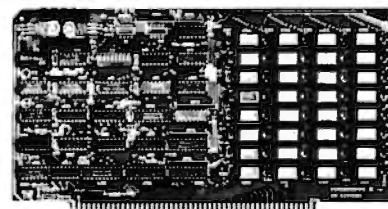

SD Systems' ExpandoRAM II is a dynamic RAM board with capacities from 16K bytes (4116) to 256K bytes (4164). It operates on the industry S-100 Bus. The design allows 8 boards to operate from the same S-100 Bus. The ExpandoRAM II is compatible with most S-100 CPU's based on the Z80 microprocessor.

EXPANDORAM II KIT

W/O	\$195.00
16K	285.00
32K	375.00
48K	465.00
64K	555.00

page

Precut Wire Wrap Wire

PRECUT WIRE SAVES TIME AND COSTS LESS THAN WIRE ON SPOOLS

Kynar precut wire. All lengths are overall, including 1" strip on each end. Colors and lengths cannot be mixed for quantity pricing. All sizes listed are in stock for immediate shipment. Other lengths available. Choose from colors: Red, Blue, Yellow, Orange, Black, White, Green and Violet. One inch tubes are available at 50¢. State second choice on colors when possible.

Length	100	500	1,000	Length	100	500	1,000
2.5 inches	1.04	2.98	5.16	6.5 inches	1.60	5.37	9.84
3	1.08	3.22	5.65	7	1.66	5.63	10.37
3.5	1.13	3.46	6.14	7.5	1.73	5.89	10.91
4	1.18	3.70	6.62	8	1.78	6.15	11.44
4.5	1.23	3.95	7.12	8.5	1.82	6.41	11.97
5	1.28	4.20	7.61	9	1.87	6.76	12.51
5.5	1.32	4.48	8.10	9.5	1.92	6.93	13.04
6	1.37	4.72	8.59	10	1.99	7.26	13.57

Kit #1	\$7.95	Kit #2	\$19.95	Kit #3	\$24.95	Kit #4	\$44.95	#30 Spools
Less than 2.7¢/ft. (#30)		Less than 2¢/ft. (#30)		Less than 1.7¢/ft. (#30)		Less than 1.6¢/ft. (#30)		1-4 5-9 10+
250 3"	100 4"	250 2½"	250 5"	500 2½"	500 4½"	1000 2½"	1000 4½"	50 ft. 1.75 1.60 1.40
250 3"	100 5"	500 3"	100 5½"	500 3"	500 5"	1000 3"	1000 5"	100 ft. 3.00 2.75 2.50
100 4"	100 6"	500 3½"	250 6"	500 3½"	500 5½"	1000 3½"	1000 5"	250 ft. 4.75 4.50 4.25
		500 4"	100 6½"	500 4"	500 6"	1000 4"	1000 6"	500 ft. 8.50 8.00 7.50
		250 4½"	100 7"					1000 ft. 14.50 12.50 10.50

Wire Wrap Tool

BATTERY HOBBY TOOL*

- Auto Indexing
- Anti-Overwrapping
- Modified Wrap

BW2630	Tool	\$19.85
BT30	#30 Bit	2.95
BT2628	#26 Bit	7.95
BC1	Batteries & Charger...	11.00

*Requires 2 "C" Nicad Batteries



JANUARY SALES!

Solderless Breadboarding

SK10 2/\$25.00 ~~\$18.50~~
The SK10's unique matrix configuration is embedded in a high temperature plastic molding. It gives you 64 pairs of 5 common spring contacts for principle circuit construction and a series of common buss strips (8) of 25 connections each.
Dimensions: .33"h x 2.2"w x 6.5"l

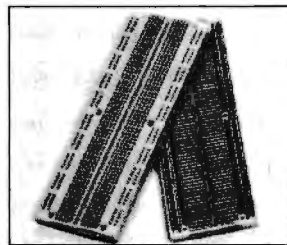

TI Edge Card Connectors

44 pin ST	(.156" centers)	1.95
100 pin ST	(.125" centers)	2.50
100 pin WW	(.125" centers)	2.95

All connectors gold plated.

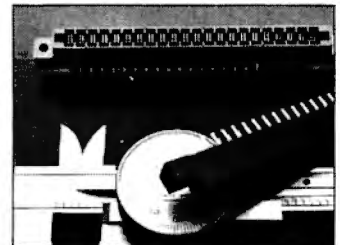

RNIC Sockets

RN HIGH RELIABILITY eliminates trouble. "Side-wipe" contacts make 100% greater surface contact with the wide, flat sides of your IC leads for positive electrical connections.

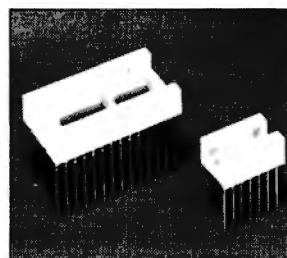

WIRE WRAP SOCKETS	Size	Quant./Tube	Price Ea.	Price/Tube
3-level Gold	08 pin WW	52	.31	\$16.12
Closed Entry Design	14 pin	60	.32	\$19.20
	16 pin	52	.34	\$17.68
All prices include Gold	18 pin	23	.50	\$11.50
2-level Sockets	20 pin	21	.65	\$13.65
Also Available	22 pin	19	.70	\$13.30
	24 pin	10	.70	\$7.00
Sockets sold at these prices by the tube only.	28 pin	10	.95	\$9.50
	40 pin	7	1.20	\$8.40

ORDERING INFORMATION

- Orders under \$25, add \$2 handling
- Blue Label or First Class, add \$1 (up to 3 lbs.)
- CODs, VISA & MC orders will be charged shipping
- Most orders shipped next day

AVAILABLE AT SELECTED LOCAL DISTRIBUTORS

page 135 E. Chestnut Street 5A, Monrovia, California 91016 Phone (213) 357-5005

California Digital

Post Office Box 3097 B • Torrance, California 90503

FREE Paper Tiger

With Purchase of The INTEGRAL DATA 440

Your Choice, \$200 Value

- 1) Graphics Option Package
 - 2) Interface for APPLE II
 - 3) TRS-80 Printer Interface
- California Digital has recently researched the complete low cost printer market. It is our opinion that the IDS-440 Paper Tiger is, without doubt, the most versatile and offers the best value of any printer costing under \$1,000.

This quality dot matrix printer incorporates such features as software selectable character size to allow print densities upto 132 characters per line. Full forms handling capabilities and tractor feed mechanism adjustable to 8.5". The Paper Tiger is engineered to accept either parallel or RS232 serial ASCII. 110/220V.50/60Hz. \$295.00 plus shipping

CONNECTORS

your choice
DB25P male plug & hood
or
DB25S female

\$3.25

Qty. fe. male hd.	
10	3.05 1.95 1.15
25	2.95 1.79 1.05
100	2.65 1.67 .95
500	2.25 1.60 .85
1K	1.97 1.37 .73

Edge Connectors

GOLD 100 PIN
MSAI/ALTAIR

Imsal solder, 125 x 250 \$2.95 3/4 7.50
Imsal w/w, 125 centers \$4.95 3/4 13.00
Altair solder/alt, 140 row \$5.95 3/4 15.00

SPECIALS
22/44 Kim socket, 156" \$1.95 3/4 5.00
25/50 solder tab, 156" \$1.09 3/4 3.00
36/72 wide post w/w, 156 \$1.95 3/4 5.00

S-100 Mother Board

Quiet Buss

\$2995
8803-18
18 slot
MSAI

The Quiet Buss from California Industrial is quality engineered. No short cuts have been taken to produce this mother board. Active termination circuitry prevents noise and crosstalk. Manufactured from extra heavy FR-4 epoxy glass.

TELETYPE MODEL 43

4320 KEYBOARD

TTL AAA \$1050
RS232 AAK 1150
Friction ... AAE 1100 plus shipping
103 Modem AAB 1575



Minidisk Drive for TRS-80

your choice
Lobo or Vista

\$388.
Includes Interface Cable

FREE PLASTIC LIBRARY CASE

with purchase of each box of ...
Verbatim mini-diskettes, \$5 value.

\$24.95
BOX of 10
DISKETTES

Authorized Distributor

Scotch Data Products

740-0	IBM soft format.	\$39.00	\$3.50
710-3	Double side soft	85.00	8.00
741-0	Double density	33.00	3.10
743-0	Double/Double	70.00	6.60
740-32	8" Hard sector	35.00	3.30
734-(0X)10(18)5	1 1/4" mini	35.00	3.30

Library case for any above: Add \$3.00
831A Data Cassette 5.50
DC100 Mini Cartridge 15.00
DC300 Data Cartridge 20.00
9201 Disk Cartridge 39.30

Shugart Associates

SA800-R Floppy Disk Drive

The most cost effective way to store data processing information, when random recall is a prime factor. The SA800 is fully compatible with the IBM 3740 format. Write protect circuitry, low maintenance & Shugart quality.

\$449.50

\$85 KEYBOARD
ASCII ENCODED

KEYTRONIC ASCII & ASCII complement.
Ten key data pad
Cursor controls
Six user switches
Alpha Lock
Auto repeat
Single 5 volt.
Glass read.

NEW

MEMORY

TRS-80 \$65
APPLE II 65
16k memory (8) 4116's

Installation is simple. Anyone who has ever changed a spark plug should be able to up-grade his microcomputer.

How can California Digital offer these memory up-grade sets at 25% below our competition? Simple, we buy in volume, wholesale to dealers and sell the balance directly to owners of personal micro-systems. These 16K dynamic memory circuits are factory prime and unconditionally guaranteed for one full year. NOW, before you change your mind, pick up the telephone and order your up-grade memory from California Digital. Add \$3 for TRS80 jumpers.

STATIC	1-31	32-99	100-5C	-999	1K+	
211.02	450nS.	1.19	.99	.95	.80	.85
211.02	250nS.	1.49	1.39	1.25	*	*
2114	1Kx4 450	5.95	5.50	5.25	4.75	4.50
2114	1Kx4 300	8.95	8.50	8.00	*	*
4044	4Kx1 450	5.95	5.30	5.25	*	*
4044	4Kx1 250	9.95	9.30	9.00	*	*
4045	1Kx4 450	8.95	8.30	8.00	*	*
4045	1Kx4 250	9.95	9.30	9.00	*	*
5257	low pow.	5.95	5.50	5.00	4.80	4.60

SPECIAL CIRCUITS

Z80A 4MHz.	24.95	AYS-1013A UART	4.95
8088A CPU	9.95	Floppy Drive Controllers	
8085	22.50	WD 1771 single D	39.95
8088 Intel 16 bits	85.00	WD 1781 Double D	65.00
FMS8000 18 bits	49.95	WD 1791 1X D 3740	*

E PROMS

1702A	2K	4.95	4.50	4.00
2708	8K	9.95	9.50	9.00
2716 5v 16K		39.95	35.00	*
2716 T 1		24.88	20.00	*
2532		85.00	4.00	*

Buying a CRT Terminal?

Hazeltine • Soroc • Lear Siegler

\$850

Well if you really insist upon purchasing one of the above terminals, sure, we'll sell it to you. But when the keyboard starts to double bounce, the screen fades and the power supply just craps out don't call us, complain to the manufacturer.

Regent 25
from
APPLIED DIGITAL DATA SYSTEMS

The alternative, take a serious look at the ADDS Regent 25. We have, and concluded that this terminal offers, the best value in today's market. Through years of research the ADDS Company has evolved a low maintenance, extremely durable CRT terminal capable of withstanding an abusive 24 hour duty cycle. The Regent 25 features Intel 8085 microprocessor controlled circuitry along with the Cherry Switch long-life capacitance keyboard.

\$139.50

PORTABLE DATA ENTRY SYSTEM

These used data terminals were originally designed for chain store inventory control and order entry systems. The operator enters the inventory control number, merchandise on hand and the unit price. After all pertinent data has been entered into the recorder, the data is transcribed in telephone, the handset is placed in the accurate reader and all the recorded information is transmitted back to the master computer. With a little on location and use of these portable entry system, you should be able to exchange programs and our paper information with associate across the country. All units were removed from service in working condition. Original cost \$2,500. Each system comes complete with:

- Portable Computer Drive Unit
- Removable Entry Keyboard with E.E. Display
- Free Card "IF" Software
- Removable Computer
- Electric Charger
- 4022 Cable
- Shuntload Battery
- Full Documentation

MINIATURE SWITCHES

your choice

10	50	100	1k
\$98	\$88	\$81	\$73.66

SPDT Miniature Toggle

7101 C&K ON-NONE-ON
7107 jbt ON OFF (mt. ON)
7108 C&K ON (moment ON)
7103 C&K ON OFF ON
Rotary 3P-4-Pos.
Rotary 3P-6-Pos.
Push B (N.O.) \$39ea. 4/\$1

DIP Switch

10	25	100	1k
\$129	\$119	\$99	\$83

specify 4 or 6 pos.

DISCOUNT Wire Wrap Center

IC SOCKETS

pin	wire wrap ea. 25	low profile 50				
6		17	16	15		
14	37	36	35	18	17	16
16	38	37	36	19	18	17
24	99	93	85	36	35	34
40	169	155	139	63	60	58

50%
\$98

KYNAR WIRE WRAP

500	1000	11,000
\$8.	\$15.	\$105.

\$2995
BW 630
OK HOBBY WRAP-JO wire wrap & strip tool
\$545

(213) 679-9001

All merchandise sold by California Digital is premium grade. Sorry, no COD's. Orders are shipped the same day received. California residents add 6%. Foreign orders add 10%. Orders over \$25, when accompanied by payment, are shipped at our expense. Otherwise, please add \$2.



Circle 216 on Inquiry card.

7400 TTL

SN7400N	15	SN7400	29
SN7401N	18	SN7401	35
SN7402N	18	SN7402	35
SN7403N	18	SN7403	35
SN7404N	18	SN7404	35
SN7405N	20	SN7405	35
SN7406N	20	SN7406	35
SN7407N	29	SN7407	35
SN7408N	20	SN7408	35
SN7409N	20	SN7409	35
SN7410N	18	SN7410	35
SN7411N	25	SN7411	35
SN7412N	25	SN7412	35
SN7413N	40	SN7413	35
SN7414N	20	SN7414	35
SN7415N	25	SN7415	35
SN7416N	25	SN7416	35
SN7417N	25	SN7417	35
SN7418N	25	SN7418	35
SN7419N	25	SN7419	35
SN7420N	25	SN7420	35
SN7421N	25	SN7421	35
SN7422N	39	SN7422	35
SN7423N	35	SN7423	35
SN7424N	35	SN7424	35
SN7425N	39	SN7425	35
SN7426N	35	SN7426	35
SN7427N	35	SN7427	35
SN7428N	35	SN7428	35
SN7429N	39	SN7429	35
SN7430N	39	SN7430	35
SN7431N	35	SN7431	35
SN7432N	35	SN7432	35
SN7433N	35	SN7433	35
SN7434N	35	SN7434	35
SN7435N	35	SN7435	35
SN7436N	35	SN7436	35
SN7437N	35	SN7437	35
SN7438N	35	SN7438	35
SN7439N	35	SN7439	35
SN7440N	35	SN7440	35
SN7441N	35	SN7441	35
SN7442N	35	SN7442	35
SN7443N	35	SN7443	35
SN7444N	35	SN7444	35
SN7445N	35	SN7445	35
SN7446N	35	SN7446	35
SN7447N	35	SN7447	35
SN7448N	35	SN7448	35
SN7449N	35	SN7449	35
SN7450N	35	SN7450	35
SN7451N	35	SN7451	35
SN7452N	35	SN7452	35
SN7453N	35	SN7453	35
SN7454N	35	SN7454	35
SN7455N	35	SN7455	35
SN7456N	35	SN7456	35

Cromemco Incorporated

TU-ART Digital Interface

Cromemco's TU-ART digital interface is a convenient interface for CRT terminals, line printers, modems, and other devices. Has 2 parallel I/O ports, and is independent programmable interval timer. Baud rates are 50 to 9600 characters per minute (110, 300, 600, 1200, 2400, 4800, 9600). Has vectored prioritized interrupts so it is able to support the powerful vectored interrupt structure of a microprocessor. It also has interval timers w/real-time capability.

General Information:
 TU-ART Type 8501
 Power requirements: 5V to 10V
 10V @ 80mA
 Operating environment: 5-50°C

General Information:
 TU-ART Type 8501
 Power requirements: 5V to 10V
 10V @ 80mA
 Operating environment: 5-50°C

TRT-W (Assembled) ... \$295.00

TELEPHONE/KEYBOARD CHIPS

AV-5-9100	Push Button Telephone Dialer	\$14.95
AV-5-9200	Repository Dialer	14.95
AV-5-9500	CMOS Clock Generator	4.95
AV-5-9575	Keyboard Encoder (86 keys)	14.95
HD1005	Keyboard Encoder (16 keys)	7.95
HC322	Keyboard Encoder (36 keys)	7.95
HC323	Keyboard Encoder (86 keys)	6.25

ICM CHIPS

ICM4705	CMOS Precision CMOS LED Stopwatch/Timer	24.95
ICM7200	Oscillator Controller	7.50
ICM7207	Seven Decade Counter	19.95
ICM7209	Clock Generator	6.95

NMOS READ ONLY MEMORIES

MCM6571	128 X 9 X 7 ASCII Shifted with Greek	13.50
MCM6574	128 X 9 X 7 Math Symbols & Pictures	13.50
MCM6575	128 X 9 X 7 Alpha Control Char Gen	13.50

MISCELLANEOUS

TL074CN	Quad Low Noise Bi-fer Op Amp	2.49
TL494CN	Switching Regulator	4.49
TL495CP	Single Switching Regulator	1.75
11C90	Divide 10/11 Prescaler	19.95
11C90	High-Speed Divide 10/11 Prescaler	11.95
4N33	Photo-Darlington Opto-Isolator	3.95
4N35	Top Gate Freq. Divider	3.95
DM0206CH	SMZ 2-phase CMOS clock driver	3.75
71L308	27-nd nm display w/integ logic chip	10.95
MM5320	TV Camera Sync Generator	14.95
MM5330	1/2 Digit DPML Logic Block (Special)	1.95
LD110111	3 1/2 Digit CMOS clock driver	25.00/dt
MC1433P	4 1/2 Digit A/D Converter	13.95

LITRONIX ISO-LIT 1

Photo Transistor Opto Isolator
 (Same as MCT 2 or 4N25)

49¢ each

SN 76477 SOUND GENERATOR

Generates Complex Sounds
 Low Power - Programmable
\$3.95 each

TV GAME CHIP AND CRYSTAL

AV-5-8500-1 and 2.01 MHz Crystal (Chip & Crystal)
 Includes score display, 6 games and select angles, etc. **7.95/set**

EXAR

XR205	58.40	XR2242CP	1.50
XR210	4.40	XR2264	4.25
XR215	4.40	XR2265	2.99
XR220	1.55	XR2267	2.99
XR-1555	1.50	XR3403	1.25
XR555	.39	XR4130	1.25
XR556	.89	XR4131	1.25
XR567CT	.89	XR4132	1.25
XR567CT	1.25	XR4133	1.25
XR1310P	1.95	XR4202	3.80
XR1468CN	3.95	XR4203	2.05
XR1468CN	1.95	XR4204	2.05
XR1489	1.95	XR4205	1.15
		XR4211	1.47

DIODES

TYPE	VOLTS V	PRICE	TYPE	VOLTS V	PRICE
1N4001	500	1.00	1N4002	1000	1.00
1N4002	1000	1.00	1N4003	2000	1.00
1N4003	2000	1.00	1N4004	4000	1.00
1N4004	4000	1.00	1N4005	6000	1.00
1N4005	6000	1.00	1N4006	8000	1.00
1N4006	8000	1.00	1N4007	10000	1.00
1N4007	10000	1.00	1N4008	15000	1.00
1N4008	15000	1.00	1N4009	20000	1.00
1N4009	20000	1.00	1N4010	30000	1.00
1N4010	30000	1.00	1N4011	40000	1.00
1N4011	40000	1.00	1N4012	50000	1.00
1N4012	50000	1.00	1N4013	60000	1.00
1N4013	60000	1.00	1N4014	70000	1.00
1N4014	70000	1.00	1N4015	80000	1.00
1N4015	80000	1.00	1N4016	90000	1.00
1N4016	90000	1.00	1N4017	100000	1.00
1N4017	100000	1.00	1N4018	150000	1.00
1N4018	150000	1.00	1N4019	200000	1.00
1N4019	200000	1.00	1N4020	300000	1.00
1N4020	300000	1.00	1N4021	400000	1.00
1N4021	400000	1.00	1N4022	500000	1.00
1N4022	500000	1.00	1N4023	600000	1.00
1N4023	600000	1.00	1N4024	700000	1.00
1N4024	700000	1.00	1N4025	800000	1.00
1N4025	800000	1.00	1N4026	900000	1.00
1N4026	900000	1.00	1N4027	1000000	1.00
1N4027	1000000	1.00			

SCR AND FW BRIDGE RECTIFIERS

C360	15A @ 400V	SCR(N1849)	\$1.95
C36M	25A @ 600V	SCR	1.95
2N280	1.6A @ 300V	SCR	50
MDA 980-1	12A @ 50V	FW BRIDGE RECT.	1.85
MDA 980-3	12A @ 200V	FW BRIDGE RECT.	1.93

TRANSISTORS

C10681	90	2N3904	41.00
2N3904	90	2N3905	41.00
2N3905	90	2N3906	41.00
2N3906	90	2N3907	41.00
2N3907	90	2N3908	41.00
2N3908	90	2N3909	41.00
2N3909	90	2N3910	41.00
2N3910	90	2N3911	41.00
2N3911	90	2N3912	41.00
2N3912	90	2N3913	41.00
2N3913	90	2N3914	41.00
2N3914	90	2N3915	41.00
2N3915	90	2N3916	41.00
2N3916	90	2N3917	41.00
2N3917	90	2N3918	41.00
2N3918	90	2N3919	41.00
2N3919	90	2N3920	41.00
2N3920	90	2N3921	41.00
2N3921	90	2N3922	41.00
2N3922	90	2N3923	41.00
2N3923	90	2N3924	41.00
2N3924	90	2N3925	41.00
2N3925	90	2N3926	41.00
2N3926	90	2N3927	41.00
2N3927	90	2N3928	41.00
2N3928	90	2N3929	41.00
2N3929	90	2N3930	41.00
2N3930	90	2N3931	41.00
2N3931	90	2N3932	41.00
2N3932	90	2N3933	41.00
2N3933	90	2N3934	41.00
2N3934	90	2N3935	41.00
2N3935	90	2N3936	41.00
2N3936	90	2N3937	41.00
2N3937	90	2N3938	41.00
2N3938	90	2N3939	41.00
2N3939	90	2N3940	41.00
2N3940	90	2N3941	41.00
2N3941	90	2N3942	41.00
2N3942	90	2N3943	41.00
2N3943	90	2N3944	41.00
2N3944	90	2N3945	41.00
2N3945	90	2N3946	41.00
2N3946	90	2N3947	41.00
2N3947	90	2N3948	41.00
2N3948	90	2N3949	41.00
2N3949	90	2N3950	41.00

C/MOS

CD4000	23	CD4070	1.65
CD4001	23	CD4071	1.65
CD4002	23	CD4072	1.65
CD4003	23	CD4073	1.65
CD4004	23	CD4074	1.65
CD4005	23	CD4075	1.65
CD4006	23	CD4076	1.65
CD4007	23	CD4077	1.65
CD4008	23	CD4078	1.65
CD4009	23	CD4079	1.65
CD4010	23	CD4080	1.65
CD4011	23	CD4081	1.65
CD4012	23	CD4082	1.65
CD4013	23	CD4083	1.65
CD4014	23	CD4084	1.65
CD4015	23	CD4085	1.65
CD4016	23	CD4086	1.65
CD4017	23	CD4087	1.65
CD4018	23	CD4088	1.65
CD4019	23	CD4089	1.65
CD4020	23	CD4090	1.65
CD4021	23	CD4091	1.65
CD4022	23	CD4092	1.65
CD4023	23	CD4093	1.65
CD4024	23	CD4094	1.65
CD4025	23	CD4095	1.65
CD4026	23	CD4096	1.65
CD4027	23	CD4097	1.65

74C00

74C00	39	74C163	2.49
74C01	39	74C164	2.49
74C02	39	74C165	2.49
74C03	39	74C166	2.49
74C04	39	74C167	2.49
74C05	39	74C168	2.49
74C06	39	74C169	2.49
74C07	39	74C170	2.49
74C08	39	74C171	2.49
74C09	39	74C172	2.49
74C10	39	74C173	2.49
74C11	39	74C174	2.49
74C12	39	74C175	2.49
74C13	39	74C176	2.49
74C14	39	74C177	2.49
74C15	39	74C178	2.49
74C16	39	74C179	2.49
74C17	39	74C180	2.49
74C18	39	74C181	2.49
74C19	39	74C182	2.49
74C20	39	74C183	2.49
74C21	39	74C184	2.49
74C22	39	74C185	2.49
74C23	39	74C186	2.49
74C24	39	74C187	2.49
74C25	39	74C188	2.49
74C26	39	74C189	2.49
74C27	39	74C190	2.49
74C28	39	74C191	2.49
74C29	39	74C192	2.49
74C30	39	74C193	2.49
74C31	39	74C194	2.49
74C32	39	74C195	2.49
74C33	39	74C196	2.49
74C34	39	74C197	2.49
74C35	39	74C198	2.49
74C36	39	74C199	2.49
74C37	39	74C200	2.49
74C38	39	74C201	2.49
74C39	39	74C202	2.49
74C40	39	74C203	2.49
74C41	39	74C204	2.49
74C42	39	74C205	2.49
74C43	39	74C206	2.49
74C44	39	74C207	2.49
74C45	39	74C208	2.49
74C46	39	74C209	2.49
74C47	39	74C210	2.49
74C48	39	74C211	2.49
74C49	39	74C212	2.49
74C50	39	74C213	2.49
74C51	39		

Continuity Tester and Flashlight



Convenient versatile tool for quickly checking continuity of dead circuits, switches, appliances, cords, fuses, motors, control equipment, coils and panel boards. Also tests circuits for low-resistance shorts and helps identify wires in multi-wire cables. Dozens of other uses. Plus the added convenience of a handy, durable flashlight. Uses two AA size penlight batteries (not furnished). Insulated clip prevents accidental shorting to case. Alligator clip has 48" lead with plug.

RT300 \$7.95

Custom Cables & Jumpers



DB 25 Series Cables

Part No.	Cable Length	Connectors	Price
DB25P-4-P	4 Ft.	2-DP25S	\$15.95 ea.
DB25P-4-S	4 Ft.	1-DP25P/1-25S	\$16.95 ea.
DB25S-4-S	4 Ft.	2-DP25S	\$17.95 ea.

Dip Jumpers

DJ14-1	1 ft.	1-14 Pin	\$1.59 ea.
DJ16-1	1 ft.	1-16 Pin	1.79 ea.
DJ24-1	1 ft.	1-24 Pin	2.79 ea.
DJ14-1-14	1 ft.	2-14 Pin	2.79 ea.
DJ16-1-16	1 ft.	2-16 Pin	3.19 ea.
DJ24-1-24	1 ft.	2-24 Pin	4.95 ea.

For Custom Cables & Jumpers, See JAMECO 1980 Catalog for Pricing

25 PIN-D SUBMINIATURE CONNECTORS

(Meets RS232C)

PART NO.	DESCRIPTION	PRICE
DB25P	PLUG (as pictured)	\$2.95
DB25S	SOCKET	3.50
DBS1226-1	CABLE COVER for DB25P or DB25S	1.75
DB25P-431	PLUG - Right Angle - P.C. Mount	4.95
DB25S-431	SOCKET - Right Angle - P.C. Mount	5.25

Printed Circuit Connectors

156 Spacing-Tin-Double Read-Out Bifurcated Contacts Fits .054 to .070 P.C. Boards

PART NO.	DESCRIPTION	PRICE
15/30 SE	15/30 Contacts - solder eyelet	\$1.95
16/36 SE	16/36 Contacts - solder eyelet	2.40
22/44 SE	22/44 Contacts - solder eyelet	2.95
22/44 WW	22/44 Contacts - wire wrap	3.95
50/100 WW	50/100 Contacts - wire wrap (R881-1)	6.95

Jumbo 6-Digit Clock Kit

Four .630"ht. and two .300"ht. common anode displays
Uses MM5314 clock chip
Switches for hours, minutes and hold functions
Hours easily viewable to 30 feet
Simulated walnut case
115 VAC operation
12 or 24 hour operation
Includes all components, case and wall transformer
Size: 6 1/2" x 3 1/4" x 1 1/4"

JE747 \$29.95

JE701

Bright .300 ht. comm. cathode display
Uses MM5314 clock chip
Switches for hours, minutes and hold modes
Hours easily viewable to 20 ft.
Simulated walnut case
115 VAC operation
12 or 24 hr. operation
Incl. all components, case & wall transformer
Size: 6 1/2" x 3 1/8" x 1 3/8"

6-Digit Clock Kit \$19.95

Regulated Power Supply

Uses LM309K. Heat sink provided. PC board construction. Provides a solid 1 amp @ 5 volts. Can supply up to ±5V, ±9V and ±12V with JE205 Adapter. Includes components, hardware and instructions. Size: 3 1/2" x 5" x 2 1/4"

JE200 \$14.95

ADAPTER BOARD

Adapts to JE200 - ±5V, ±9V and ±12V

DC/DC converter with +5V input. Toroidal hi-speed switching XMFR. Short circuit protection. PC board construction. Piggy-back to JE 200 board. Size: 3 1/2" x 2" x 9/16" H

JE205 \$12.95

MICROPROCESSOR COMPONENTS

8088/8086 SUPPORT DEVICES		MICROPROCESSOR MANUALS	
8083A CPU	\$ 7.95	MS-280 User Manual	\$7.50
8212 8-bit Input/Output	2.25	MC-CDP1802 User Manual	7.50
8214 Priority Interrupt Control	2.95	MC-2850 User Manual	5.00
8216 Bi-Directional Bus Driver	3.95		
8224 Clock Generator/Driver	3.85		
8226 Bus Driver	4.95		
8228 System Controller/Bus Driver	5.95		
8238 System Controller	5.95		
8251 Prog. Comm. 1 (USART)	7.95		
8253 Prog. Interval Timer	14.95		
8255 Prog. Paralle. 16 (PPI)	9.95		
8257 Prog. DMA Control	19.95		
8259 Prog. Interrupt Control	19.95		
8088/8086 SUPPORT DEVICES		ROM'S	
MC6800 MPU	\$14.95	1301 Static	\$1.49
MC6802CP MPU with Clock and Ram	24.95	1103 1024X1	9.99
MC6810API 128KB Static Ram	5.99	2101 (8010) 256X4	30.95
MC6821 Paralle. Interf. Adapt (MC6820)	7.49	2102 (1024X) Static	1.75
MC6828 Paralle. Interrupt Controller	12.99	3132 1024X1 Static	1.95
MC6830B 1024KB Bit ROM (MC6830-B)	14.99	3118 (1611) 256X4	3.95
MC6850 Asynchronous Comm. Adapter	1.95	2141 1024X4 Static MOS	4.95
MC6852 Synchronous Serial Data Adapt	9.95	2142 1024X4 Static 4500s	7.95
MC6850 0-600 bps Digital MODEM	12.99	2143 1024X4 Static 3000s low power	10.95
MC6862 7400 Logic Adapter	14.95	2143-3 1024X4 Static 3000s low power	11.95
MC6880A Quad 3-State Bus Trans (MC6870)	12.95	5101 256X4 Static	7.95
MICROPROCESSOR CHIPS - MISCELLANEOUS		5200X107 4096X1 Dynamic	4.95
28017003 CPU	\$14.95	7469 18X4 Static	1.75
28047760-11 CPU	16.95	74200 256X1 Static Tri-state	4.95
CDP1802 CPU	19.95	9321 256X1 Static	2.95
2850 MPU	19.95	UPD414 4K Dynamic 16 pin	4.95
6507 CPU	11.95	(M68427) 16K Dynamic 16 pin 250ns	9.95
8035 8-Bit MPU w/clock RAM, I/O lines	19.95	T8S4044 4K Static	14.95
P6085 CPU	16.95	45M1 1024X4 Static	14.95
TMS1990QL 16-Bit MPU w/hardware, multiply & divide	49.95	T2S4045 16,384X1 Dynamic	41.00
SHIFT REGISTERS		PROM'S	
MMS500N MPU	\$ 5.00	MMS262 20K1	Dynamic
MMS503H Dual 50 Bit Dynamic	50	1702A 2048	FRAMOS
MMS504H Dual 16 Bit Static	50	218HT16L 16K*	EPROM
MMS505H Dual 100 Bit Static	50	M28515 18K*	EPROM
MMS101H Dual 64 Bit Accumulator	50	*Requires single +5V power supply	89.95
MMS102H 500,512 Bit Dynamic	80	4508 EPROM	10.95
25047 1024 Dynamic	3.99	2716 18K*	EPROM
2516 1024 Static	4.99	74S332 4008	14.95
2522 Dual 132 Bit Static	2.24	2708 8K	3.49
2524 512 Static	90	2716 T 1 18K*	2.95
2525 1024 Dynamic	2.95		
2527 Dual 256 Bit Static	2.95		
2530 Dual 250 Static	4.00		
2529 Dual 240 Bit Static	4.00		
2532 Dual 80 Bit Static	2.95		
3341 Flip	6.95		
74LS870 424 Register File (Tri-State)	2.49		
		74186 512 TTL Open Collector	9.95
		74189 256 TTL Open Collector	3.95
		74S287 1024 Static	2.95
A-Y-5-1013 30A BAUD	5.95		

JE600 HEXADECIMAL ENCODER KIT

FEATURES:
• Full 8 bit latched output for micro-processor use.
• 3 User Define keys with one being bi-stable operation.
• Debounce circuit provided for all 19 keys.
• LED readout to verify entries.
• Easy interfacing with standard 16 pin IC connector.
• Only +5VDC required for operation.

Full 8 Bit Latched Output - 19 Keyboard

The JE600 Keyboard provides two separate independent outputs produced from sequential key entries to allow direct programming for 8 bit microprocessors or 8 bit memory arrays. There are (3) additional keys provided for user operation with one having a bistable output available. The outputs are latched and monitored with LED readouts. Also included is a key entry strobe.

JE600 \$59.95
Hexadecimal Keypad only \$14.95

62-Key ASCII Encoder Keyboard Kit

FEATURES:
• 60 Keys generate the full 128 characters, upper and lower case ASCII set.
• Fully buffered.
• 2 user-define keys provided for other applications.
• Caps lock for upper case only alpha characters.
• Utilizes a 2376 (40 pin) encoder read only memory chip.
• Outputs directly compatible with TTL logic or MOS logic arrays.
• Easy interfacing with a 16-pin dip or 18-pin edge connector.

JE610 \$79.95
62-Key Keypad only . . . \$34.95

HICKOK LX303 Portable LCD Digital Multimeter

• 8 1/2" high 3 1/2" Digital Liquid Crystal Display • 200 Hours of operation with a 9V battery
• Automatic zero, polarity and overrange indicators • 100mV DC F.S. in ohm only • Basic accuracy ±1% range and functions • Supplied complete from a 2 1/2" x 3 1/2" x 1 1/2" case with lead wire.
• Full year warranty.

SPECIFICATIONS: DC volts 3 ranges 100mV, 10V, 100V Accuracy 100% 100mV, 10% 10V, 1% 100V. AC volts 3 ranges 100mV, 10V, 100V Accuracy 10% 100mV, 10% 10V, 1% 100V. Max. range 600V. Resistance 10 ranges 100Ω to 10MΩ Accuracy 1% 100Ω, 1% 10V, 1% 100V, 1% 1000Ω, 1% 10K, 1% 100K, 1% 1M. Diode Test 100mV. Continuity and buzzer. Dimensions and Weight 8 1/2" x 3 1/2" x 1 1/2". Price: \$79.95. Power: 9V battery (not included). Model: LX303. 11/20/79

LX303 Digital Multimeter \$74.95

\$10.00 Min. Order - U.S. Funds Only
Calif. Residents Add 8% Sales Tax
Postage - Add 5% plus \$1 Insurance (if desired)

Spec Sheets - 25¢
1980 Catalog Available - Send 41¢ stamp

Jameco ELECTRONICS

PHONE ORDERS WELCOME (415) 592-8097

MAIL ORDER ELECTRONICS - WORLDWIDE
1355 SHOREWAY ROAD, BELMONT, CA 94002
ADVERTISED PRICES GOOD THRU JANUARY

The Incredible "Pennywhistle 103"



\$139.95 Kit Only

The Pennywhistle 103 is capable of recording data to and from audio tape without critical speed requirements for the recorder and it is able to communicate directly with another modern terminal for telephone "hamming" and communications. In addition, it is free of critical adjustments and is built with non-precision, readily available parts.

Data Transmission Method: Frequency Shift Keying, half-duplex (half-duplex selectable)
Maximum Data Rate: 300 Baud
Data Format: Asynchronous Serial (return to mark level required between each character)
Receive Channel Frequencies: 2025 Hz for space, 2225 Hz for mark
Transmit Channel Frequencies: Switch selectable Low (normal) = 1070 space, 1270 mark, High = 025 space, 2225 mark
46 dbm acoustically coupled

Receive Sensitivity: 15 dbm nominal Adjustable from -8 dbm to -20 dbm
Transmit Level: Frequency reference automatically adjusts to allow for operation between 1800 Hz and 2400 Hz
EIA RS-232C or 20 mA current loop (receiver is optoisolated and non-polar)

Power Requirements: 120 VAC, single phase, 10 Watts
Physical: All components mount on a single 5 1/2" x 9" printed circuit board. All components included.

Requires a VOM, Audio Oscillator, Frequency Counter and/or Oscilloscope to align.

TRS-80 16K Conversion Kit

Expand your 4K TRS-80 System to 16K.
Kit comes complete with:
• 8 each UPD416-1 (16K Dynamic Rams) 250NS
• Documentation for Conversion

TRS-16K \$75.00

JUST WRAP



• 30 AWG wire
• Daisy chain or point-to-point
• Includes 50 ft. wire
• No stripping or cutting required - just wrap

• .026" square posts
• Built-in cut off
• Includes 50 ft. wire
• No stripping or cutting required - just wrap

Part No.	Wire Color	Price
JW-1-B	Blue	\$14.95
JW-1-W	White	14.95
JW-1-Y	Yellow	14.95
JW-1-R	Red	14.95

JUST WRAP Replacement Wire

Part No.	Color	50 ft. roll	Price
R-JW-B	Blue	50 ft. roll	\$2.99
R-JW-W	White	50 ft. roll	2.99
R-JW-Y	Yellow	50 ft. roll	2.99
R-JW-R	Red	50 ft. roll	2.99

JUST WRAP Unwrap Tool \$3.49

JUST WRAP Kit

• 50 ft. ea.: blue, white, red, yellow wire
• JUST WRAP Tool
• Unwrapping Tool

JWK-6 \$24.95

Vacuum Vise

Vacuum-based light-duty vise for small components and assemblies. ABS construction. 1 1/2" jaws, 1 1/4" travel. Can be permanently installed.

VV-1 \$3.49

EPROM Erasing Lamp

• Erases 2708, 2716, 1702A, 5203G, 5204G, etc.
• Erases up to 4 chips within 20 minutes.
• Maintains constant exposure distance of one inch.
• Special conductive foam liner eliminates static build-up.
• Built-in safety lock to prevent UV exposure.
• Compact - only 7-5/8" x 2-7/8" x 2"
• Complete with holding tray for 4 chips

UVS-1E \$69.95

Micro-Miniature Joystick

• 2 each 100K pots (Linear Taper)
• Printed Circuit Board Mount
• Size: 1" x 1-3/16" x 1-3/16"

Micro-Miniature Joystick ... \$4.95



CALIFORNIA COMPUTER SYSTEMS

16K RAM BOARD Fully buffered addressable in 4K blocks IEEE standard for bank addressing 2114's PCB \$26.95
 Kit 450 NSEC \$259.95
PT-1 PROTO BOARD Over 2,600 holes 4" regulators All S-100 buss functions labeled, gold fingers PCB \$25.95
PT-2 PROTO BOARD Similar to PT-1 except set-up to handle solder tail sockets PCB \$25.95



FORMERLY CYBERCOM/SOLID STATE MUSIC

PB-1 2708 & 2716 Programming Board with provisions for 4K or 8K EPROM No external supplies require test socket sockets Kit \$124.95
CB-1A 8080 Processor Board, 2K of PROM 256 BYTE RAM power on/rest Vector Jump Parallel port with status. Kit TBD PCB \$30.95
MB-6B Basic 8Kx8 ram uses 2102 type rams S-100 buss Kit 450 NSEC \$139.95 PCB \$26.95
MB-7 16Kx8 Static RAM uses μP410 Protection fully buffered Kit \$299.95
MB-8A 2708 EROM Board S-100, 8Kx8 or 16Kx8 kit without PROMS \$75.00 PCB \$28.95
VB-3 80x55 VIDEO BOARD Graphic included TBD
IO-2 S-100 8 bit parallel I/O port 2/3 of boards is for kludging. Kit \$46.00 PCB \$26.95
IO-4 Two serial I/O ports with full handshaking 20/60 ma current loop Two parallel I/O ports. Kit \$130.00 PCB \$26.95
VB-1B 64 x 16 video board, upper lower case Greek, composite and parallel video with software, S-100. Kit \$125.00 PCB \$26.95
Altair Compatible Mother Board, 11 x 11 1/2 x 1/8". Board only \$39.95 With 15 connectors \$94.95
Extended Board full size. Board only \$ 9.49
 With connector \$13.45
SB-1 Synthesizer Board S-100 PCB \$42.95 KIT \$135.95

WMC inc. WAMECO INC.

FDC-1 FLOPPY CONTROLLER BOARD will drive shugart peritek, remic 5" & 8" drives up to 8 drives. on board PROM with power boot up will operate with CPM™ (not included) PCB \$42.95

FPB-1 Front Panel IMSAI size hex displays Byte or instruction single step PCB \$47.50

MEM-1A 8Kx8 fully buffered, S-100, uses 2102 type rams PCB \$25.95

OM-12 MOTHER BOARD, 13 slot. terminated. S-100 board only \$38.75

CPU-1 8080A Processor board S-100 with 8 level vector interrupt PCB \$26.95

RTC-1 Realtime clock board. Two independent interrupts Software programmable. PCB \$23.95

EPM-1 1702A 4K Eprom card PCB \$25.95

EPM-2 2708/2716 16K/32K EPROM CARD PCB \$25.95

QM-9 MOTHER BOARD, Short Version of QM-12. 9 Slots PCB \$30.95

MEM-2 16K x 8 Fully Buffered 2114 Board PCB \$26.95

PTB-1 POWER SUPPLY AND TERMINATOR BOARD PCB \$25.95

8080A \$9.95 2708 \$8.99

8212 2.49 2114 (450 NS) low pwr 5.99

8214 4.49 2114 (250 NS) low pwr 6.99

8224 3.49 2102A-4L 1.20



(415) 592-1800

P. O. Box 424 • San Carlos, California 94070

Please send for IC, Xistor and Computer parts list

JAN. SPECIAL SALE ON PREPAID ORDERS
 (Charge cards not included on this offer)

FPB-1 with MIKOS #14
 Front Panel Kit\$119.95
8Kx8 Ram 450 NSEC fully buffered, 2,5 amps typical\$99.99

MIKOS PARTS ASSORTMENT WITH WAMECO AND CYBERCOM PCBDS

MEM-2 with MIKOS #7 16K ram with L2114 450 NSEC \$249.95
MEM-2 with MIKOS #13 16K ram with L2114 250 NSEC \$279.95
MEM-1 with MIKOS #1 450 NSEC 8K RAM \$119.95
CPU-1 with MIKOS #2 8080A CPU \$94.95
MEM-1 with MIKOS #3 250 NSEC 8K RAM \$144.95
QM-12 with MIKOS #4 13 slot mother board \$89.95
RTC-1 with MIKOS #5 real time clock \$54.95
EMP-1 with MIKOS #10 4K 1702 less EPROMS \$49.95
EPM-2 with MIKOS #11 16-32K EPROMS less EPROMS \$59.95
QM-9 with MIKOS #12 9 slot mother board \$79.95
FPB-1 with MIKOS #14 all parts for front panel \$134.95

MIKOS PARTS ASSORTMENTS ARE ALL FACTORY PRIME PARTS KITS INCLUDE ALL PARTS LISTED AS REQUIRED FOR THE COMPLETE KIT LESS PARTS LISTED ALL SOCKETS INCLUDED.

VISA or MASTERCARD Send account number, interbank number, expiration date and sign your order. Approx. postage will be added. Check or money order will be sent post paid in U.S. If you are not a regular customer, please use charge, cashier's check or postal money order. Otherwise there will be a two-week delay for checks to clear. Call residents add 6% tax. Money back 30 day guarantee. We cannot accept returned IC's that have been soldered to. Prices subject to change without notice. \$10 minimum order. \$1.50 service charge on orders less than \$10.00.

WAMECO

THE COMPLETE PC BOARD HOUSE EVERYTHING FOR THE S-100 BUSS

- * **FPB-1 FRONT PANEL BOARD**. Hex Displays, IMSAI Replaceable. PCB \$54.95
- * **FDC-1 FLOPPY DISC CONTROLLER BOARD** Controls up to 8 Discs. PCB \$45.00
- * **MEM-1A 8K BYTE 2102 RAM BOARD** PCB \$31.95
KIT 450 NSEC \$141.95
- * **MEM-2 16K BYTE 2114 RAM BOARD** PCB \$31.95
KIT 450 NSEC \$299.95
- * **CPU-1 8080A CPU BOARD** with Vector Interrupt. PCB \$31.95
KIT \$124.95
- * **EPM-1 4K BYTE 1702A EPROM** PCB \$29.95
KIT LESS PROMS \$59.95

- * **EPM-2 16K or 32K BYTE EPROM 2708 or 2176** Interchangeable. PCB \$30.00
KIT LESS PROMS \$74.95
- * **QMB-9 9 SLOT MOTHER BOARD** Terminated. PCB \$35.00
KIT \$89.95
- * **QMB-12 12 SLOT MOTHER BOARD** Terminated. PCB \$45.00
KIT \$115.95
- * **RTC-1 REALTIME CLOCK** Programmable Interrupts \$27.95
KIT \$79.95
- * **PTB-1 POWER SUPPLY BOARD** PCB \$30.95
KIT LESS REGULATORS \$55.95

FUTURE PRODUCTS: 80 CHARACTER VIDEO BOARD, IO BOARD WITH CASSETTE INTERFACE.

DEALER INQUIRIES INVITED, UNIVERSITY DISCOUNTS AVAILABLE AT YOUR LOCAL DEALER



WAMECO INC. 111 GLENN WAY #8, BELMONT, CA 94002 (415) 592-6141

DIGITAL RESEARCH COMPUTERS

(214) 494-1505

16K EPROM CARD-S 100 BUSS

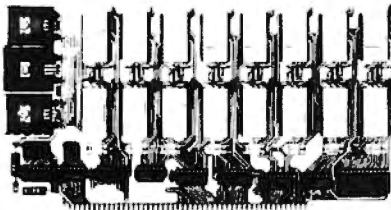

\$59.95
KIT

FIRST TIME OFFERED!
BLANK PC BOARD - \$28

USES 2708's!

Thousands of personal and business systems around the world use this board with complete satisfaction. Puts 16K of software on line at **ALL TIMES!** Kit features a top quality soldermasked and silk-screened PC board and first run parts and sockets. Any number of EPROM locations may be disabled to avoid any memory conflicts. Fully buffered and has WAIT STATE capabilities.

OUR 450 NS 2708'S
ARE \$8.95 EA. WITH
PURCHASE OF KIT

ASSEMBLED
AND FULLY TESTED
ADD \$25

8K LOW POWER RAM KIT-S 100 BUSS SALE

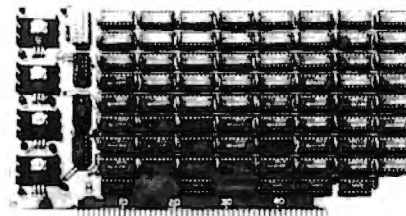

PRICE
CUT!

\$119.50
KIT

21L02
(450 NS RAMS!)

Thousands of computer systems rely on this rugged, work horse, RAM board. Designed for error-free, NO HASSLE, systems use.

Blank PC Board w/Documentation
\$29.95

Low Profile Socket Set...13.50
Support IC's (TTL & Regulators)
\$9.75

Bypass CAP's (Disc & Tantalums)
\$4.50

ASSEMBLED AND FULLY
BURNED IN ADD \$30

ALL ASSEMBLED BOARDS
ARE TESTED AT 4MHZ.

16K STATIC RAM KIT-S 100 BUSS

PRICE CUT!

\$259 KIT

FOR 4MHZ
ADD \$25

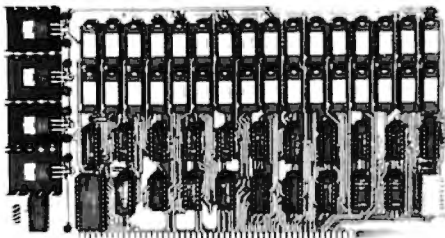

KIT FEATURES:

- 1 Addressable as four separate 4K Blocks
- 2 ON BOARD BANK SELECT circuitry (Cromemco Standard) Allows up to 512K on line!
- 3 Uses 2114 (450NS) 4K Static Rams
- 4 ON BOARD SELECTABLE WAIT STATES.
- 5 Double sided PC Board, with solder mask and silk screened layout. Gold plated contact fingers
- 6 All address and data lines fully buffered
- 7 Kit includes ALL parts and sockets
- 8 PHANTOM is jumpered to PIN 67
- 9 LOW POWER under 1.5 amps TYPICAL from the +8 Volt Buss
- 10 Blank PC Board can be populated as any multiple of 4K

BLANK PC BOARD W/DATA-\$33
LOW PROFILE SOCKET SET-\$12
SUPPORT IC'S & CAPS-\$19.95
ASSEMBLED & TESTED-ADD \$30

OUR #1 SELLING
RAM BOARD!

16K STATIC RAM SS-50 BUSS

PRICE CUT!

\$249 KIT

FULLY STATIC
AT DYNAMIC
PRICES

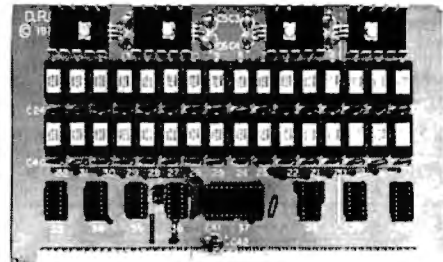

FOR SWTPC
6800 BUSS!

ASSEMBLED AND
TESTED - \$30

KIT FEATURES

- 1 Addressable on 16K Boundaries
- 2 Uses 2114 Static Ram
- 3 Runs at Full Speed
- 4 Double sided PC Board Solder mask and silk screened layout. Gold fingers
- 5 All Parts and Sockets included
- 6 Low Power Under 1.5 Amps Typical

BLANK PC BOARD-\$26 COMPLETE SOCKET SET-\$12
SUPPORT IC'S AND CAPS-\$19.95

PROC. TECH. QUILTS THE MICROPROCESSOR BUSINESS!
FACTORY CLOSE OUT - SPECIAL PURCHASE!
#16KRA

16K S-100 Dynamic Ram Board \$149.95

We purchased the remaining inventory of PT's popular 16K Ram Board when they recently closed their plant. Don't miss the boat! These are brand new, fully tested, ASSEMBLED and ready to go. All are sold with our standard 90 day limited warranty!!
Orig. \$429 each! 72 Page Full Manual, Included Free!

Z-80 PROGRAMMING MANUAL

By MOSTEK, or ZILOG. The most detailed explanation ever on the working of the Z-80 CPU CHIPS. At least one full page on each of the 158 Z-80 instructions. A must reference manual for any user of the Z-80. 300 pages.
\$12.95

SALE! LOW POWER - 250NS 8 FOR \$55
2114 RAM SALE! \$55

4K STATIC RAM'S. MAJOR BRAND, NEW PARTS.
These are the most sought after 2114's. LOW POWER and 250NS FAST
SPECIAL SALE: \$7.50 ea. or 8 For \$55

Perfect for
OEM's

S-100 Z80 CPU CARD

\$159.95

WIRED!
NOT A KIT!

4 MHZ

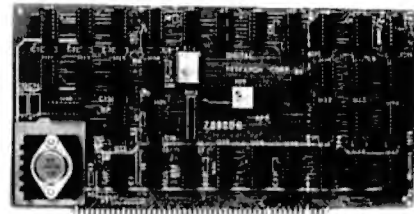

ASSEMBLED AND TESTED! READY TO USE! Over 3 years of design efforts were required to produce a TRUE S-100 Z80 CPU at a genuinely bargain price!

BRAND NEW!

FEATURES

- * 2 or 4 MHZ Operation. * Generates MWRITE, so no front panel required
- * Jump on reset capability * 8080 Signals emulated for S-100 compatibility
- * Top Quality PCB Silk Screened Solder Masked Gold Plated Contact Fingers

NEW! G.I. COMPUTER SOUND CHIP

AY3-8910 As featured in July, 1979 BYTE! A fantastically powerful Sound & Music Generator. Perfect for use with any 8 Bit Microprocessor. Contains: 3 Tone Channels, Noise Generator, 3 Channels of Amplitude Control, 16 Bit Envelope Period Control, 2-B But Parallel /O. 3 D to A Converters, plus much more! All in one 40 Pin DIP. Super easy to interface to the S-100 or other busses
SPECIAL OFFER: \$14.95 each Add \$3 for 64 page Data Manual

TERMS: Add 1.00 postage, we pay balance. Orders under \$15 add 75c handling No C.O.D. We accept Visa and MasterCharge Te Res add 5% Tax Foreign orders (except Canada) add 20% P & H 90 Day Money Back Guarantee on all items

Digital Research Computers
(OF TEXAS)

P.O. BOX 401565 • GARLAND, TEXAS 75040 • (214) 494-1505

NOT ASSOCIATED WITH DIGITAL RESEARCH OF CALIFORNIA, THE SUPPLIERS OF CPM SOFTWARE.



MICRO BUSINESS WORLD

MAIL ORDER

Immediate response to your orders (verbal or written). Phone (213) 371-1660

ATARI 800 Personal Computer System
Packed with: Computer Console, Basic Language Card, Education System Master Cartridge, Cassette Recorder, TV Modulator, 8K Memory (expandable to 48K), Power Supply & all Books and Manuals **\$849.99**

ATARI 400 Personal Computer System for less
Packed with: Computer Console, Basic Language Cartridge, Power Supply, TV Modulator, and all Books and Manuals **\$469.99**

ATARI Program Recorder **\$69.99**
ATARI Software, Romms, Cassettes 25% off list price
ATARI Expansion Memory:
8K Module **\$99.99**
16K Module **\$199.99**

CRAIG, M100
Electronic Language Translator
\$179.95

HELLO-BENJAMIN
FRENCH
SPANISH
ITALIAN
GERMAN
JAPANESE
Language Modules **\$22.95**

APPLESTICK • MORE FUN AND GAMES! 2 in 1: a Joystick and Game Paddles all in one box **\$49.50**



MICRO BUSINESS WORLD
15818 Hawthorne Boulevard
Lawndale, California 90260 (213) 371-1660
Circle 222 on inquiry card.



Apple II personal computer.

16K Regular or Plus **\$920.**

Disk II with controller **\$495.**
Disk II without controller **\$425.**
PASCAL Language Card **\$399.**

ALL Apple made boards
25% off list price
European Apple models available



commodore pet

A truly professional computer system

16K **\$849.** 32K **\$1095.**

Dual Floppy Disk

Model 2040 **\$1095.**

Single Disk Drive **\$795.**

Tractor Feed Printer Model 2022* **\$849.**

Friction Feed Printer Model 2023* **\$749.**

* need a IEEE to PET cable 45.00
or an IEEE to IEEE cable 35.00

DYSAN DISKETTES

THE CADILLAC OF THE FLOPPY DISKS

AT LOW LOW PRICES

8" (BOX OF 10)

3740/1 sgl side/sgl density **4.00 ea**

3740/1D sgl side/dbl density **6.50 ea**

5" (BOX OF 5)

104/1 soft sector **4.00 ea**

107/1 10 sectors **4.00 ea**

105/1 16 sectors **4.00 ea**

For each 2 boxes of 8" or 4 boxes of 5" you get one plastic storage case, but hurry — supply is limited.

EPSON (A SEIKO COMPANY)

TX-80 Printer with Graphics Capabilities. 7x6 dotmatrix.

Parallel (Centronics) standard 80 cols. Tractor Feed Model **\$695.**

Friction Feed Model **\$595.**

Popular Computer Interfaces available for only **\$79.**

(including cables)

Prices subject to change without notice. VISA and MASTER CHARGE WELCOME. Allow 2 weeks for cashiers check to clear, 4 weeks for personal checks. Add 2% for shipping and handling. Calif. residents add 6% sales tax. U.S. and International dealer inquiries invited.

HEATH DATA SYSTEMS

Smart Video Terminal WH-19 Has a Z80 micro processor numeric keypad **\$795.00**



WORLD FAMOUS SONY TRINITRON
Sharpest picture color television—15" Diag. now comes with direct input video. Get your "COLOR MONITOR" for the Apple II or Atari for only **\$495.00**

Plastic Floppy Disk Holder (up to 10) 8" **\$3.95**

Plastic Floppy Disk Holder (up to 10) 5" **\$3.25**

16K RAM set of 8 4116's 200 ns or better **\$65.00**

asap
computer products, inc.

11542-1 KNOTT ST.
GARDEN GROVE,
CA 92641
(800) 854-6411
(714) 891-2663

4116's (250NS)

ADD-ON MEMORY FOR APPLE, TRS 80, HEATH

8 for \$64.00

16 for \$120.00

FULLY GUARANTEED

IMSAI CONNECTORS

100 PIN • SOLDER TAIL

\$3.00 each

OR

10 for \$2.75 each

WRITE TO US FOR OUR NEW CATALOG

MICROBYTE 16K RAM BOARD

- FULLY S-100 COMPATIBLE
 - USES LOW-PWR 4Kx1 MM 5257 STATIC RAM
 - 2MHZ OR 4MHZ
 - 4K BANK ADDRESSABLE
 - EXTENDED MEMORY MANAGEMENT
 - NO DMA RESTRICTIONS
 - ASSEMBLED & TESTED
- 2MHZ **\$250.00**
4MHZ **\$265.00**

MICROBYTE 32K RAM BOARD

- FULLY S-100 COMPATIBLE
 - USES LO-PWR 4Kx1 MM5257 STATIC RAM
 - 2MHZ OR 4MHZ
 - BANK ADDRESSABLE
 - EXTENDED MEMORY MANAGEMENT
 - 8-BIT OUTPUT PORT
 - NO DMA RESTRICTIONS
- 2MHZ **\$525.00**
4MHZ **\$540.00**

2708's

450NS.

8.00 each

OR

8 for \$60.00

SPECIAL

.1 @ 12 VOLTS

CERAMIC CAPS

10¢ each

OR

100/\$9.00

LO-PRO SOCKETS

	1-24	25-99	100 Up
14PIN	.15	.14	.13
16PIN	.16	.15	.14
18PIN	.19	.17	.15
20PIN	.27	.25	.23
24PIN	.35	.31	.27
28PIN	.40	.33	.29
40PIN	.50	.46	.41

REGULATORS

320T-5...	(.80)
320T-12...	(.80)
340T-5...	(.75)
340T-12...	(.75)
78H05...	(5.00)
78L12....	(.35)

MISC. COMPONENTS

LM324	.75	2104	1.50
LM348	1.05	4108	3.00
LM377	1.25	MCM 6574 CHARACTER GENERATOR	
LM380	.75	\$7.00 ea.	
LM556	.75		
LM3900	.50		

SA800 DISK DRIVE

INSTALLED IN DUAL CABINET W/PWR SUPPLY ASSEMBLED & TESTED

(1) DRIVE INSTALLED **\$695.00**

(2) DRIVES INSTALLED **\$1125.00**

2716's

5 VOLT ONLY 450NS.

\$35.00 ea.

8/\$250.00

8251

4MHZ/U-ART

\$5.00 ea.

2732's

(4K) E-PROM 5 VOLTS

\$95.00 ea.

ORDERING INFO
NAME, ADDRESS, PHONE SHIP BY: UPS OR MAIL SHIPPING CHRG: ADD \$2.50 UP TO (5) LBS.

TERMS
WE ACCEPT CASH, CHECK, MONEY ORDER VISA & MASTER CHRG (U.S. FUNDS ONLY) TAX: 6% CALIF. ONLY

ComputerCity

When the people
behind the products count!

(Formerly the CPU Shop)

As the CPU Shop, we have been dedicated to meeting the needs of the microcomputer user. The success of the CPU Shop has led to ComputerCity—the merging of our manufacturing, wholesale and mail order divisions with our rapidly expanding retail outlets to provide the increased products and services the microcomputer consumers of today and tomorrow want—and need. We remain dedicated to providing the same service, technical assistance and fair pricing you've come to expect from the CPU Shop.

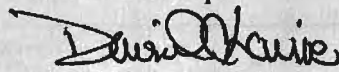

David C. Lourie, President

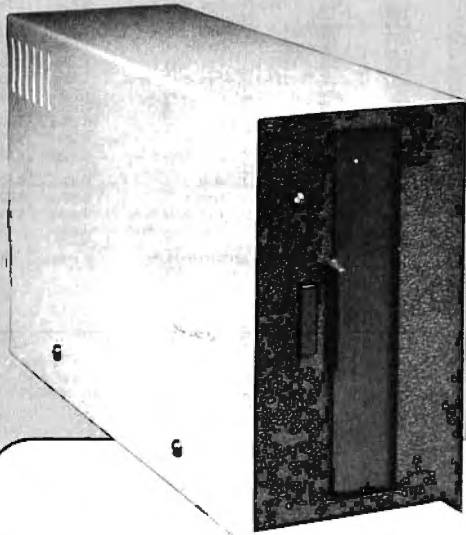

ComputerCity Sampler Disk Drives

When you're ready to add disk storage to your TRS-80*, we're here to help. Our CCI-100™ and -200™ drives offer more capacity than Radio Shack 35-Track (85K Bytes) drives. These drives are fully assembled, tested and ready to plug-in the moment you receive them. They can be intermixed with each other and Radio Shack drives on the same cable. 90 day warranty.

CCI-100™ 40 Track (102K Bytes) \$399.00 CCI-200™ 77 Track (197K Bytes) \$675.00

Printers

Letter Quality High Speed Printer

NEC Spinwriter: Includes TRS-80* interface software, quick change print fonts, 55 CPS, bidirectional, high resolution plotting, graphing, proportional spacing and tractor feed assembly. 90 day warranty **\$2979.00**
Also: Centronics, Paper Tiger, HI Plot Digital Plotter



16K Memory Up-grade Kits
Fast and ultrareliable **\$99.00**

DISK OPERATING SYSTEMS
NEWDOS by Apparat† **\$49.95**
NEWDOS "PLUS" by Apparat† **\$99.95**
DOS 3.0 by the original author of 2.1 **\$49.95**

DISKETTE TRS-80*

BUSINESS SOFTWARE BY SBSG

Free enhancements and upgrades to registered owners for the cost of media and mailing. 30 day free telephone support. User reference on request.

Fully Interactive Accounting Package: General Ledger, Accounts Payable, Accounts Receivable and Payroll. Report generating.

Complete Package (requires 3 or 4 drives) **\$475.00**
Individual Modules (requires 2 or 3 drives) **\$125.00**

Inventory II: (requires 2 or 3 drives) **\$ 99.00**

Mailing List Name & Address II (requires 2 drives) **\$129.00**

Intelligent Terminal System ST-80 III: **\$150.00**

The Electric Pencil from Michael Shroyer **\$150.00**

File Management System: **\$ 49.00**

Budget Control Program II by CSA **\$ 49.95**

Cash Register System II by CSA **\$ 99.00**

ComputerCity

A division of CPU Industries, Inc.
175 Main Street, Dept B-1 Charlestown, MA 02129

Hours: 10AM - 6PM (EST) Monday - Saturday
For detailed information, call 617/242-3350
Massachusetts residents add 5% Sales Tax

™CCI-100 and -200 are ComputerCity Inc. trademarks

* Tandy Corporation Trademark †Requires Radio Shack TRSDOS*

TO ORDER CALL TOLL FREE 1-800-343-6522

Massachusetts residents call 617/242-3350

Retail Store Locations:

175 Main Street, Charlestown, MA
K Mart Plaza, Manchester, NH
50 Worcester Road (Rt. 9), Framingham, MA
165 Angell Street, Providence, RI

Visa and Master Charge accepted

Franchise and dealer inquiries invited

BECKIAN ENTERPRISES

ALL PRIME QUALITY — NEW PARTS ONLY
SATISFACTION GUARANTEED.

EDGE CARD CONNECTORS: GOLD PLATED:

Abbreviations: S/E Solder Eye . S/E Sold Tail: W/W Wire Wrap.

PART # DESCRIPTION.	Row Sp.	1-Pcs.	10-24pcs.	25pcs. Up.
BRAND: TEXAS INST.				
4070 50/100 Imsei/Crom.	.250	\$3.95ea.	\$3.55ea.	\$3.15ea.
4090 50/100 Imsei W/W	.250	4.30ea.	3.85ea.	3.45ea.
BRAND: SULLINS: U.I. Reg.				
129905 50/100 Solder Eye	.140	6.80ea.	8.10ea.	5.45ea.
129875 50/100 S/T Imsei	.250	4.50ea.	4.10ea.	3.70
129875 50/100 W/W Imsei	.250	5.25	4.75	4.20
129895 50/100 S/T Altair	.140	4.95	4.45	3.95
129990 50/100 S/T Cromem.	.250	4.75	4.25	3.80

OTHER .125" CONTACT CTR CONNECTORS:				
12305 22/44 S/E No Ears	.140	4.15	3.75	3.35
12759 36/72 S/T	.140	5.40	4.85	4.35
12790 40/80 W/W	.250	6.30	5.65	5.00

.100" CONTACT CTR CONNECTORS:				
10048 13/26 S/E No Ears	.140	3.40	3.05	2.15
10020 25/50 S/E TRS 80	.140	4.50	4.05	3.80
10175 20/40 S/E TRS 80	.140	5.95	5.35	4.75
10180 20/40 W/W TRS 80	.200	3.30	3.00	2.15
10190 20/40 S/T TRS 80	.140	3.20	2.90	2.55
10485 36/72 S/E Vector	.140	5.60	4.90	4.40
10490 36/72 W/E Vector	.200	5.80	5.25	4.65
10500 36/72 S/T Vector	.140	5.70	4.20	4.80
10535 40/80 S/E PET	.140	5.95	5.35	4.75
10540 40/80 W/W PET	.200	6.00	5.40	4.80
10550 40/80 S/T PET	.140	5.80	5.25	4.65
10585 43/86 S/E COS/ELF	.140	6.35	5.25	5.55
10805 43/86 S/T COS/ELF	.140	6.80	5.95	5.30
10895 43/86 W/W COS/ELF	.200	6.90	6.20	5.95
10915 43/86 S/T COS/ELF	.200	6.80	6.10	5.40

.158" CONTACT CENTER CONNECTORS.				
PART # DESCRIPTION.	Row Sp.	1-Pcs.	10-24pcs.	25pcs. Up.
15105 6/12 S/E PET/MSC	.140	\$1.80	\$1.65	\$1.45
15110 6/12 S/T PET/MSC	.140	1.85	1.65	1.50
15137 6/12 S/T PET/MSC	.200	1.80	1.54	1.45
15175 8/ S/E Sgle Row	-	1.70	1.50	1.30
15270 10/20 S/E	.140	2.15	1.85	1.70
15275 10/20 S/T	.140	2.00	1.85	1.60
15435 12/24 S/E PET	.140	2.60	2.35	2.10
15440 12/24 S/T PET	.140	2.65	2.40	2.15
15445 12/24 S/T PET	.200	2.75	2.50	2.20
15505 15/30 S/E GRI Key	.140	2.50	2.25	2.00
15510 15/30 S/T GRI Key	.140	2.40	2.15	2.05
15515 15/30 W/W GRI Key	.200	2.60	2.35	2.10
15600 18/36 S/E	.140	3.35	3.05	2.70
15610 18/36 S/T	.140	3.00	2.70	2.40
15615 18/36 W/W	.200	3.60	3.20	2.90
15700 22/44 S/E KIM/VEC	.140	2.98	2.80	2.75
15705 22/44 S/T KIM/VEC	.140	3.98	3.30	3.00
15710 22/44 W/W KIM/VEC	.200	3.49	3.20	2.95
15875 25/50 S/E	.140	4.65	4.20	3.75
15880 25/50 S/T	.140	4.55	4.10	3.65
15885 25/50 W/W	.200	4.85	4.35	3.90
16115 36/72 S/E	.140	6.50	5.65	5.20
16120 36/72 S/T	.140	6.55	5.90	5.25
16125 36/72 W/W	.200	6.75	6.10	5.40
16145 36/72 S/T	.200	6.50	5.85	5.20
16235 43/86 S/T Mot 8800	.140	6.90	5.95	5.30
16240 43/86 W/W Mot 8800	.200	7.30	7.05	6.25
16250 43/86 S/T Mot 8800	.200	6.90	5.95	5.20
16725 43/86 S/E Mot 8800	.140	7.20	6.50	5.75

D' TYPE SUBMINIATURE CONNECTORS.				
PART NUMBER	DESCRIPTION.	1-Pcs.	10-24pcs.	25-99pcs.
DE 8P	Male	\$1.80ea.	\$1.40ea.	\$1.30ea.
DE 9S	Female	2.25ea.	2.00ea.	1.80ea.
DE 110983-1	2 pc. Grey Hood.	1.50ea.	1.35ea.	1.20ea.
DA 15P	Male	2.35ea.	2.15ea.	2.00ea.
DA 15S	Female	3.25ea.	3.10ea.	2.90ea.
DA 51211-1	1 pc. Grey Hood	1.40ea.	1.20ea.	1.15ea.
DA 51220-1	2 pc. Black Hood	2.50ea.	2.25ea.	2.00ea.
DA 110983-2	2 pc. Grey Hood	1.80ea.	1.35ea.	1.30ea.
DB 26P	Male	2.80ea.	2.60ea.	2.40ea.
DB 26S	Female	3.80ea.	3.40ea.	3.20ea.
DB 51212-1	1 pc. Grey Hood	1.50ea.	1.30ea.	1.15ea.
DB 51220-1	2 pc. Black Hood	1.90ea.	1.65ea.	1.45ea.
DB 110983-3	2 pc. Grey Hood	1.75ea.	1.50ea.	1.35ea.
DC 37P	Male	4.20ea.	4.00ea.	3.70ea.
DC 37S	Female	6.00ea.	5.75ea.	5.50ea.
DC 110983-4	2 pc. Grey Hood	2.25ea.	2.00ea.	1.75ea.
DD 50P	Male	5.50ea.	5.10ea.	4.75ea.
DD 50S	Female	9.40ea.	8.80ea.	8.00ea.
DD 51210-1	1 pc. Grey Hood	2.40ea.	2.20ea.	2.00ea.
DD 110983-5	2 pc. Grey Hood	2.80ea.	2.40ea.	2.10ea.
D 20418-2	Hardware Set (1 Hood Set)	.90ea.	.80ea.	.70ea.

I.C. SOCKETS GOLD. W/WRAP 3 TURN	
14 pin	\$0.40 ea.
18 pin	0.64 ea.
8080A PRIME.	
\$6.00 ea.	
EIA 8 CONDUCTOR CABLES 8ft. Long. CLASS #1 Type Cables.	
1 to 4 pcs.	\$23.00
5 to 8 pcs.	20.00

I.C. SOCKETS TIN.	
14 pin	\$0.15 ea.
18 pin	0.17 ea.
CONNECTORS FOR CENTRONICS 700 SERIES. Amphenol 57-3038U	
1 to 4 pcs.	\$9.00 ea.
5 to 8 pcs.	7.00 ea.

COOLING FANS. Extra Quiet.	
1 to 4	\$18.00 ea.
5 to 9	17.00 ea.

TERMS: MINIMUM ORDER: \$15.00 ADD \$1.35 For Handling & Shipping. Orders over \$30.00 in the U.S.A. We Pay the Shipping. CALIF. RESIDENTS: Please Add 6% Sales Tax.
NOTE: NO C.O.D. OR CREDIT CARD ORDERS WILL BE ACCEPTED.

BECKIAN ENTERPRISES
P.O. BOX #3089
SIMI VALLEY, CA 93063

MAIL ORDERS TO:

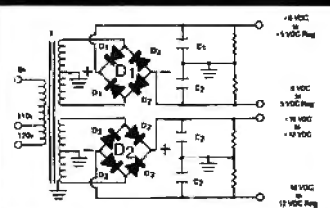

BUILD YOUR OWN LOW COST MICRO-COMPUTER POWER SUPPLIES FOR S-100 BUS, FLOPPY DISCS, ETC.

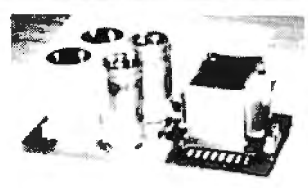

POWER TRANSFORMERS (WITH MOUNTING BRACKETS)							
ITEM NO.	USED IN KIT NO.	PRI. WINDING TAPS	SECONDARY WINDING OUTPUTS			SIZE W x D x H	UNIT PRICE
			2x8 Vac	2x14 Vac	2x24 Vac		
T ₁	1	0V, 110V, 120V	2x7.5A	2x2.5A	—	3 3/4" x 3 3/8" x 3 1/8"	21.95
T ₂	2	0V, 110V, 120V	2x12.5A	2x3.5A	—	3 3/4" x 4 3/8" x 3 1/8"	27.95
T ₃	3	0V, 110V, 120V	2x9A	2x2.5A	2x2.5A	3 3/4" x 4 3/8" x 3 1/8"	29.95
T ₄	4	0V, 110V, 120V	2x4A	—	2x3A	3 3/4" x 3 3/8" x 3 1/8"	21.95

POWER SUPPLY KITS (OPEN FRAME WITH BASE PLATE, 3 HRS. ASSY. TIME)								
ITEM	USED FOR	@+8 Vdc	@-8 Vdc	@+16 Vdc	@-16 Vdc	@+28 Vdc	SIZE WxDxH	UNIT PRICE
KIT 1	15 CARDS SOURCE	15A	—	2.5A	2.5A	—	12" x 6" x 4 7/8"	51.95
KIT 2	SYSTEM SOURCE	25A	—	3A	3A	—	12" x 6" x 4 7/8"	58.95
KIT 3	DISC SYSTEM	15A	1A	2A	2A	—	14" x 6" x 4 7/8"	66.95
KIT 4	DISC SOURCE	8A	1A	—	—	5A	10" x 6" x 4 7/8"	49.95

EACH KIT INCLUDES: TRANSFORMER, CAPACITORS, RESIS., BRIDGE RECTIFIERS, FUSE & HOLDER, TERMINAL BLOCK, BASE PLATE, MOUNTING PARTS AND INSTRUCTIONS.
DISC DRIVE POWER SUPPLY "R3" ASSY. & TESTED, OPEN FRAME, SIZE: 9" (W) x 5" (D) x 5" (H) 59.95
 SPECS: +5V @ 5A REGULATED, -5V @ 1A REG., +24V @ 5A REG., SHORTS PROTECT.
 IDEAL FOR 2 SHUGART 801/851 OR SIEMANS FDD 100-8/200-8 DISK DRIVES & ROCKWELL AIM-65.
 SHIPPING FOR EACH TRANSFORMER: \$4.75. FOR EACH POWER SUPPLY: \$5.00 IN CALIF. \$7.00 IN OTHER STATES. CALIF. RESIDENTS ADD 6% SALES TAX. OEM WELCOME.

MAIL ORDER:
P.O. BOX 4296
TORRANCE, CA 90510

SUNNY INTERNATIONAL
(TRANSFORMERS MANUFACTURER)
Telephone: (213) 633-8327

STORE:
7245 E. ALONDRA BLVD.
PARAMOUNT, CA 90723
STORE HOURS: 9 AM - 6 PM



NEW PRODUCTS!

Super Color S-100 Video Kit \$99.95
Expandable to 256 x 192 high resolution color graphics. 6847 with all display modes computer controlled. Memory mapped, 1K RAM expandable to 6K. S-100 bus 1802, 8080, 8085, 280 etc.

Gramlin Color Video Kit \$59.95
32 x 16 alpha/numerics and graphics; up to 8 colors with 6847 chip; 1K RAM at 8000. Plugs into Super Elf 44 pin bus. Not expandable to high resolution Graphics.

Elf II Adapter Kit \$24.50
Plugs into Elf II providing Super Elf 44 and 50 pin bus plus S-100 bus expansion (With Super Expansion). High and low address displays, state and mode LED's optional \$18.00.

1802 16K Dynamic RAM Kit \$149.00
1802/S-100 expandable to 32K. Hidden refresh w/clocks up to 4 MHz w/no wait states. Addr. 16K RAM \$79.00.

Quest Super Basic

Quest, the leader in inexpensive 1802 systems announces another first. Quest is the first company worldwide to ship a full size Basic for 1802 systems. A complete function Super Basic by Ron Center including floating point capability with scientific notation (number range $\pm 17E^{\pm 4}$), 32 bit integer ± 2 billion; multi dim arrays; String arrays; String manipulation; Cassette I/O. Save and load, Basic, Data and machine language programs; and over 75 Statements, Functions and Operators.

Easily adaptable on most 1802 systems. Requires 12K RAM minimum for Basic and user

programs. Cassette version in stock now. ROM versions coming soon with exchange privilege allowing some credit for cassette version.

Super Basic on Cassette \$40.00

Tom Pittman's 1802 Tiny Basic Source Listing now available. Find out how Tom Pittman wrote Tiny Basic and how to get the most out of it. Never offered before. \$19.00

S-100 4-Slot Expansion \$95.00

Super Monitor V.I Source Listing \$15.00

Coming Soon: Assamler, Editor, Disassembler, DA/AD, Super Sound/Music, EPROM programmer.



RCA Cosmac Super Elf Computer \$106.95

Compare features before you decide to buy any other computer. There is no other computer on the market today that has all the desirable benefits of the Super Elf for so little money. The Super Elf is a small single board computer that does many big things. It is an excellent computer for training and for learning programming with its machine language and yet it is easily expanded with additional memory, Full Basic, ASCII Keyboards, video character generation, etc.

Before you buy another small computer, see if it includes the following features: ROM monitor; State and Mode displays; Single step; Optional address displays; Power Supply; Audio Amplifier and Speaker; Fully socketed for all IC's; Real cost of in warranty repairs; Full documentation.

The Super Elf includes a ROM monitor for program loading, editing and execution with SINGLE STEP for program debugging which is not included in others at the same price. With SINGLE STEP you can see the microprocessor chip operating with the unique Quest address and data bus displays before, during and after executing instructions. Also, CPU mode and instruction cycle are decoded and displayed on 8 LED indicators.

An RCA 1861 video graphics chip allows you to connect to your own TV with an inexpensive video modulator to do graphics and games. There is a speaker system included for writing your own music or using many music programs already written. The speaker amplifier may also be used to drive relays for control purposes.

Super Expansion Board with Cassette Interface \$89.95

This is truly an astounding value! This board has been designed to allow you to decide how you want it optioned. The Super Expansion Board comes with 4K of low power RAM fully addressable anywhere in 64K with built-in memory protect and a cassette interface. Provisions have been made for all other options on the same board and it fits neatly into the hardwood cabinet alongside the Super Elf. The board includes slots for up to 6K of EPROM (2708, 2758, 2716 or T1 2716) and is fully socketed. EPROM can be used for the monitor and Tiny Basic or other purposes.

A 1K Super ROM Monitor \$19.95 is available as an on board option in 2708 EPROM which has been preprogrammed with a program loader/editor and error checking multi file cassette read/write software, (relocatable cassette file) another exclusive from Quest. It includes register save and readout, block mode capability and video graphics driver with blinking cursor. Break points can be used with the register save feature to isolate program bugs quickly, then follow with single step. The Super Monitor is written with

A 24 key HEX keyboard which includes 16 HEX keys plus load, reset, run, wait, input, memory protect, monitor select and single step. Large, on board displays provide output and optional high and low address. There is a 44 pin standard connector slot for PC cards and a 50 pin connector slot for the Quest Super Expansion Board. Power supply and sockets for all IC's are included in the price plus a detailed 127 pg. instruction manual which now includes over 40 pgs. of software info, including a series of lessons to help get you started and a music program and graphics target game.

Many schools and universities are using the Super Elf as a course of study. OEM's use it for training and research and development.

Remember, other computers only offer Super Elf features at additional cost or not at all. Compare before you buy. Super Elf Kit \$106.95, High address option \$8.95, Low address option \$9.95. Custom Cabinet with drilled and labeled plexiglass front panel \$24.95. Expansion Cabinet with room for 4 S-100 boards \$41.00. NiCad Battery Memory Saver Kit \$6.95. All kits and options also completely assembled and tested.

Questdata, a 12 page monthly software publication for 1802 computer users is available by subscription for \$12.00 per year.

Tiny Basic Cassette \$10.00, on ROM \$38.00, original Elf kit board \$14.95. 1802 software; Moews Video Graphics \$3.50. Games and Music \$3.00, Chip 8 Interpreter \$8.50.

subroutines allowing users to take advantage of monitor functions simply by calling them up. Improvements and revisions are easily done with the monitor. If you have the Super Expansion Board and Super Monitor the monitor is up and running at the push of a button.

Other on board options include Parallel Input and Output Ports with full handshake. They allow easy connection of an ASCII keyboard to the input port. RS 232 and 20 mA Current Loop for teletype or other device are on board and if you need more memory there are two S-100 slots for static RAM or video boards. Also a 1K Super Monitor version 2 with video driver for full capability display with Tiny Basic and a video interface board. Parallel I/O Ports \$9.85, RS 232 \$4.50, TTY 20 mA I/F \$1.95, S-100 \$4.50. A 50 pin connector set with ribbon cable is available at \$15.50 for easy connection between the Super Elf and the Super Expansion Board.

Power Supply Kit for the complete system (see Multi-volt Power Supply).

TERMS: \$5.00 min. order U.S. Funds. Calif residents add 6% tax. BankAmericard and Master Charge accepted. Shipping charges will be added on charge cards.

Same day shipment. First line parts only. Factory tested. Guaranteed money back. Quality IC's and other components at factory prices.

INTEGRATED CIRCUITS

74007TL	17	LM3238-5	5.95	CD4021	1.25
74024	18	LM3238-12	1.10	CD4022	1.10
74028	18	LM3238-15	5.00	CD4023	28
74030	19	LM3238-5	1.00	CD4024	2.00
74031	19	LM3238-8	6.00	CD4025	2.00
74124	20	LM3238-12	1.50	CD4026	2.00
74124	20	LM3238-15	1.50	CD4027	6.00
74124	20	LM3244	1.15	CD4028	4.5
74228	28	LM3238	1.55	CD4029	1.02
74230	28	LM3238-8	1.55	CD4030	1.02
74424	20	LM3240K-8	1.35	CD4035	1.02
74424	20	LM3240K-12	1.35	CD4040	1.02
74424	20	LM3240K-15	1.35	CD4042	1.02
74424	20	LM3240K-24	1.35	CD4043	8.5
74424	20	LM3240K-12	1.35	CD4044	8.5
74424	20	LM3240K-15	1.35	CD4045	8.5
74424	20	LM3240K-24	1.35	CD4046	8.5
74424	20	LM3240K-12	1.35	CD4047	8.5
74424	20	LM3240K-15	1.35	CD4048	8.5
74424	20	LM3240K-24	1.35	CD4049	8.5
74424	20	LM3240K-12	1.35	CD4050	8.5
74424	20	LM3240K-15	1.35	CD4051	8.5
74424	20	LM3240K-24	1.35	CD4052	8.5
74424	20	LM3240K-12	1.35	CD4053	8.5
74424	20	LM3240K-15	1.35	CD4054	8.5
74424	20	LM3240K-24	1.35	CD4055	8.5
74424	20	LM3240K-12	1.35	CD4056	8.5
74424	20	LM3240K-15	1.35	CD4057	8.5
74424	20	LM3240K-24	1.35	CD4058	8.5
74424	20	LM3240K-12	1.35	CD4059	8.5
74424	20	LM3240K-15	1.35	CD4060	8.5
74424	20	LM3240K-24	1.35	CD4061	8.5
74424	20	LM3240K-12	1.35	CD4062	8.5
74424	20	LM3240K-15	1.35	CD4063	8.5
74424	20	LM3240K-24	1.35	CD4064	8.5
74424	20	LM3240K-12	1.35	CD4065	8.5
74424	20	LM3240K-15	1.35	CD4066	8.5
74424	20	LM3240K-24	1.35	CD4067	8.5
74424	20	LM3240K-12	1.35	CD4068	8.5
74424	20	LM3240K-15	1.35	CD4069	8.5
74424	20	LM3240K-24	1.35	CD4070	8.5
74424	20	LM3240K-12	1.35	CD4071	8.5
74424	20	LM3240K-15	1.35	CD4072	8.5
74424	20	LM3240K-24	1.35	CD4073	8.5
74424	20	LM3240K-12	1.35	CD4074	8.5
74424	20	LM3240K-15	1.35	CD4075	8.5
74424	20	LM3240K-24	1.35	CD4076	8.5
74424	20	LM3240K-12	1.35	CD4077	8.5
74424	20	LM3240K-15	1.35	CD4078	8.5
74424	20	LM3240K-24	1.35	CD4079	8.5
74424	20	LM3240K-12	1.35	CD4080	8.5
74424	20	LM3240K-15	1.35	CD4081	8.5
74424	20	LM3240K-24	1.35	CD4082	8.5
74424	20	LM3240K-12	1.35	CD4083	8.5
74424	20	LM3240K-15	1.35	CD4084	8.5
74424	20	LM3240K-24	1.35	CD4085	8.5
74424	20	LM3240K-12	1.35	CD4086	8.5
74424	20	LM3240K-15	1.35	CD4087	8.5
74424	20	LM3240K-24	1.35	CD4088	8.5
74424	20	LM3240K-12	1.35	CD4089	8.5
74424	20	LM3240K-15	1.35	CD4090	8.5
74424	20	LM3240K-24	1.35	CD4091	8.5
74424	20	LM3240K-12	1.35	CD4092	8.5
74424	20	LM3240K-15	1.35	CD4093	8.5
74424	20	LM3240K-24	1.35	CD4094	8.5
74424	20	LM3240K-12	1.35	CD4095	8.5
74424	20	LM3240K-15	1.35	CD4096	8.5
74424	20	LM3240K-24	1.35	CD4097	8.5
74424	20	LM3240K-12	1.35	CD4098	8.5
74424	20	LM3240K-15	1.35	CD4099	8.5
74424	20	LM3240K-24	1.35	CD4100	8.5

21102-1	1.15
21102-2	1.25
21102-3	1.25
21102-4	1.25
21102-5	1.25
21102-6	1.25
21102-7	1.25
21102-8	1.25
21102-9	1.25
21102-10	1.25
21102-11	1.25
21102-12	1.25
21102-13	1.25
21102-14	1.25
21102-15	1.25
21102-16	1.25
21102-17	1.25
21102-18	1.25
21102-19	1.25
21102-20	1.25
21102-21	1.25
21102-22	1.25
21102-23	1.25
21102-24	1.25
21102-25	1.25
21102-26	1.25
21102-27	1.25
21102-28	1.25
21102-29	1.25
21102-30	1.25
21102-31	1.25
21102-32	1.25
21102-33	1.25
21102-34	1.25
21102-35	1.25
21102-36	1.25
21102-37	1.25
21102-38	1.25
21102-39	1.25
21102-40	1.25

8080A	1.50
8085A	1.50
8085B	1.50
8085C	1.50
8085D	1.50
8085E	1.50
8085F	1.50
8085G	1.50
8085H	1.50
8085I	1.50
8085J	1.50
8085K	1.50
8085L	1.50
8085M	1.50
8085N	1.50
8085O	1.50
8085P	1.50
8085Q	1.50
8085R	1.50
8085S	1.50
8085T	1.50
8085U	1.50
8085V	1.50
8085W	1.50
8085X	1.50
8085Y	1.50
8085Z	1.50

8080A	1.50
8085A	1.50
8085B	1.50
8085C	1.50
8085D	1.50
8085E	1.50
8085F	1.50
8085G	1.50
8085H	1.50
8085I	1.50
8085J	1.50
8085K	1.50
8085L	1.50
8085M	1.50
8085N	1.50
8085O	1.50
8085P	1.50
8085Q	1.50
8085R	1.50
8085S	1.50
8085T	1.50
8085U	1.50
8085V	1.50
8085W	1.50
8085X	1.50
8085Y	1.50
8085Z	1.50

8080A	1.50
8085A	1.50
8085B	1.50
8085C	1.50
8085D	1.50
8085E	1.50
8085F	1.50
8085G	1.50
8085H	1.50
8085I	1.50
8085J	1.50
8085K	1.50
8085L	1.50
8085M	1.50
8085N	1.50
8085O	1.50
8085P	1.50
8085Q	1.50
8085R	1.50
8085S	1.50
8085T	1.50
8085U	1.50
8085V	1.50
8085W	1.50
8085X	1.50
8085Y	1.50
8085Z	1.50

8080A	1.50
8085A	1.50
8085B	1.50
8085C	1.50
8085D	1.50
8085E	1.50
8085F	1.50
8085G	1.50
8085H	1.50
8085I	1.50
8085J	1.50
8085K	1.50
8085L	1.50
8085M	1.50

The DATA-TRANS 1000

A completely refurbished
IBM Selectric Terminal with
built-in ASCII Interface.

\$1495

Features:

- 300 Baud
- 14.9 characters per second printout
- Reliable heavy duty Selectric mechanism
- RS-232C Interface
- Documentation included
- 60 day warranty- parts and labor
- High quality Selectric printing
- Off-line use as typewriter
- Optional tractor feed available
- 15 inch carriage width



HOW TO ORDER DATA-TRANS 1000

1. We accept Visa, Master Charge. Make cashiers checks or personal check payable to:
DATA-TRANS
2. All orders are shipped F.O.B. San Jose, CA
3. Deliveries are immediate

For orders and information
DATA-TRANS
2154 O'Toole St.
Unit E
San Jose, CA 95131
Phone: (408) 263-9246

SERIAL I/O

Four Serial I/O RS-232 ports, S-100 Bus. Software or jumper selectable baud rates (110, 300, 600, 1200, 2400, 4800, 9600, 19.2K), on board Xtal baud rate generator. Addressing, switch selectable, Parity or no parity (odd or even) switch selectable, 1 or 2 stop bits, 5 to 8 bits/character. Board only \$29.95, Part No. 7908. With parts (kit) \$199.95, Part No. 7908A.



MICRO-PROCESSOR INTERFACING TECHNIQUES

Microprocessor interfacing is no longer an art. It is a set of techniques, and in some cases just a set of components. This comprehensive book introduces the basic interfacing concepts and techniques, then presents in detail the implementation details, from hardware to software. It covers all the essential peripherals, from keyboard to floppy disk, as well as the standard buses (S100 to IEEE 488) and introduces the basic troubleshooting techniques. (2nd Expanded Edition). By Austin Lesea and R. Zaks. Ref. C207 SYBEX. \$11.95

PROGRAMMING THE 6502 PROGRAMMING THE Z80 PROGRAMMING THE 8080*

It covers all essential aspects of programming, as well as the advantages and disadvantages of the 6502 and should bring the reader to the point where he can start writing complete applications programs. For the reader who wishes more, a companion volume is available: The 6502 Applications Book. By R. Zaks. 6502: Ref. C202; Z80: Ref. C280; 8080: Ref. C208, SYBEX. Each \$10.95



44 BUS MOTHER BOARD

Has provisions for ten 44 pin (.156) connectors, spaced 3/4 of an inch apart. Pin 20 is connected to X, and 22 is connected to Z for power and ground. All the other pins are connected in parallel. This board also has provisions for bypass capacitors. Board cost \$15.00 Part No. 102. Connectors \$3.00 each Part No. 44WP.



GAME PADDLES & SOUND

For Your TRS 80 (Level II or Disk)

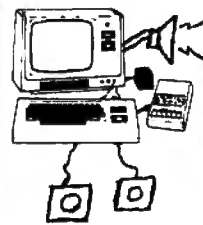

Includes: 2 game paddles, interface, software, speaker, power supply, full documentation including: schematics, theory of operation, and user guide; plus 2 games on cassette (Pong and Starship War). \$79.95 Complete Part No. 7922C

LEEDEX MONITOR



12" Black and White • 12 MHz Bandwidth • Handsome Plastic Case • \$139.00

DIGITAL CASSETTE



5 min. each side. Box of 10 \$9.95.

To Order: Mention part no., description, and price. In USA shipping paid by us for orders accompanied by check or money order. We accept C.O.D. orders in the U.S. only, or a VISA or Master Charge no., expiration date, signature, phone no., shipping charges will be added. CA residents add 6.5% for tax. Outside USA add 10% for air mail postage and handling. Payment must be in U.S. dollars. Dealer inquiries invited. 24 hour order line (408) 448-0800



Send for FREE Catalog . . . a big self-addressed envelope with 41¢ postage gets it fastest!

ELECTRONIC SYSTEMS Dept. B P. O. Box 21638, San Jose, CA USA 95151

10-DAY FREE TRIAL

Send for our
FREE Catalog



\$100 FREE ACCESSORIES WITH 16K or 32K PET

When you buy a 16K or 32K PET, apply \$100 toward PET accessories, FREE. Just indicate on your order that you have reduced the cost of your accessories by \$100.

FREE
SAVE
\$98

Terminal Package with 8K PETs
See Special Below

PET ACCESSORIES

8K-Keyboard N.....	\$795
16K-Keyboard B.....	\$995
16K-Keyboard N.....	\$995
32K-Keyboard C.....	1,295
32K-Keyboard B.....	\$1,295
32K-Keyboard N.....	\$1,295

C—calculator keyboard (only version with tape deck)
B—large keyboard (graphics not on keys)
N—large keyboard with graphics symbols

Commodore Dual Floppy Disk Drive	\$1,100
Computhink 800K Disk Drive	\$1,295
Commodore Printer (tractor feed)	\$849
Commodore Printer (friction feed)	\$995.00
Second Cassette-From Commodore	\$95.00
Commodore PET Service Kit	\$30.00
Beeper-Tells when tape is loaded	\$24.95
Petunia-Play music from PET	\$29.95
Video Buffer-Attach another CRT	\$29.95
Combo-Petunia and Video Buffer	\$49.95
New Serial Printer Interface for PET	\$79.95
KIM 1 (A Single Board Computer from Commodore)	\$179.00



Hazeltine 1400

Immediate Delivery—
2-Year Factory Warranty

LIST **SALE**
~~\$860~~ **\$649**

Hazeltine 1410 — \$835	Hazeltine 1510 — \$1195
Hazeltine 1500 — \$1069	Hazeltine 1520 — \$1499

Lear Siegler's ADM-3A

Back Again at Our Lowest Price Ever

The ADM-3A is industry's favorite dumb terminal for some very smart reasons:

- 12 in diagonal screen
- Full or half duplex operation at 11 selectable data rates
- 1920 easy-to-read characters in 24 rows of 80 letters
- Typewriter-style keyboard
- RS-232 C interface extension port
- Direct cursor addressing

Our Low Sale Price \$795

SAVE \$195
COMMODORE DISK DRIVES

Reg. \$1,295 Sale \$1,100



apple II plus

\$200 FREE ACCESSORIES

The new Apple II with Applesoft BASIC built-in! Eliminates the need for a \$200 Firmware Card and includes new Autostart ROM for easy operation. This combined with the FREE accessories from NCE could save you up to \$400 on a 48K Apple II system!

16K Apple II Plus—\$1195 (take \$100 in free accessories)
32K Apple II Plus—\$1345 (take \$150 in free accessories)
48K Apple II Plus—\$1495 (take \$200 in free accessories)

Apple II Accessories	
General Business	\$625
PASCAL	\$495
Integer BASIC ROM Card	\$200
VISI-Calc	\$99
Centronics Printer Interface	\$225
Disk and Controller	\$595
Parallel Printer Card	\$180
Communications Card	\$225
Hi-Speed Serial Card	\$195
Firmware Card	\$200

IN STOCK NOW!

EVERY ITEM IN THIS ADVERTISEMENT IS IN STOCK AND READY TO SHIP, EXCEPT WHERE NOTED.

PAPER TIGER 440SPE

The Graphics Printer for Apple II

Now you can print illustrations, block letters, charts, graphs, and more—all under software control. And with the expanded buffer, the Paper Tiger can hold the text from an entire 24-line-by-80-column CRT screen.
\$1194.00

SPECIAL

PET OWNERS ...

REMOTE TERMINAL for only \$98

A self-contained module and program cassette enables your PET to function as a 300 baud terminal. Supports Upper/Lower case, Rubout, Escape & all control functions. Output is TTL.

FREE WITH PET PURCHASE



CAT COUPLER

New 300 baud Originate, Answer Acoustic Coupler Looks good, works great
priced at \$189

NEW from Heath Data Systems

The All-In-One Computer

Dual Z-80 Processors • Built-In 102K Floppy Disk • 16K to 48K RAM • 25 x 80 Character Display • Upper/Lower Case and Line Graphics • 80 Character Keyboard with Keypad • 8 User-definable Keys • Two BASIC's and Auto-Scribe Word Processing available • Can support CP/M

Heath's third generation of computers is a compact, hi-style desktop unit which includes a complete terminal, a computer and a disk All-In-One! System includes Bootstrap in ROM, other programs available separately HDOS operating system includes Heath's BASIC, an assembler and text editor along with important disk utilities. Microsoft language requires HDOS.

WH89 with 16K RAM	\$2,295
WH89 with 32K RAM	\$2,445
WH89 with 48K RAM	\$2,595
WH17 Second Disk Drive	\$550
Dual-port Serial Interface	\$85
HDOS Operating System	\$100
Microsoft BASIC	\$100
Word Processing	\$395

ZENITH COLOR VIDEO MONITOR

Zenith's first color video display designed specifically for computers.

This 13-inch monitor is Zenith's first color video display designed specifically for computers. Features include automatic color level, color processing and degaussing circuits.

Zenith Color Monitor \$499.00

FREE Just Released

Compumart's New

Fall/Winter 1979 Catalog.

We've just published our catalog and it's packed with new products and money saving specials. Our illustrated 32-page book features microcomputers and microcomputer systems from Apple, Commodore PET, Heath, and Exidy Sorcerer. Also covered are the Commodore's KIM and Rockwell's AIM. A broad selection of terminals, books, software and peripherals are presented in detail. The text is thorough and provides a wealth of technical information. To get your FREE copy write to our address below. Please include the dept. number to speed handling.

CENTRONIC'S 779-2 PRINTER

TRACTOR FEED

- Parallel interface
- Continuous variable printing density 80-132 characters per line
- 5x7 dot matrix

SALE PRICE \$1095

- Form thickness control
- Horizontal and vertical form positioning
- Used with controller (Apple general business software)

SANYO MONITOR

\$169

\$279

9-inch ~~\$240~~ 15-inch ~~\$400~~



NCE/CompuMart SINCE 1971

DEPT. BY10,

270 THIRD ST., CAMBRIDGE, MA 02142

To Order: **1 (800) 343-5504**

In Mass.: **1 (617) 491-2700**



Member:
Computer Dealers
Association

IMPORTANT ORDERING INFORMATION

All orders must include 4% shipping and handling. Mass. residents add 5% sales tax; Mich. residents 4%, for sales tax.

Phones open from 8:30 a.m. to 5:30 p.m. EST Mon.-Fri. • P.O.'s accepted from D&B rated companies — shipment contingent upon receipt of signed purchase order • Sorry no C.O.D.'s • All prices are subject to change without notice • Most items in stock for immediate shipment — call for delivery quotation • In the Ann Arbor area? Our retail store is open 11:00 a.m. to 7:00 p.m. Tues.-Fri., 10:00 a.m. to 5:00 p.m. Saturdays (closed Sun. and Mon.)

If not satisfied, return your purchase with-in 10 days for full refund of purchase price!

APPLE II PLUS**

(limited offer) **\$990.00**
16K only

Disk I	475.00	Firmware Card	175.00
Disk II w/Controller	575.00	Proto Card	22.00
Pascal Card	475.00	M & R Modulator	29.95
Parallel Printer Card	165.00	Sanyo Cassette	54.95
Communications Card	210.00	16K Upgrade Kit	74.95
Business Software Pkg.	625.00	Apple Radio Car	159.00
10 Megabyte Hard Disk	895.00	8" Floppy Controller	350.00
D.C. Hayes Modem	349.95	Heuristics Speechlab	179.95



ADVANCED COMPUTER PRODUCTS

FLOPPY DISK DRIVES

MPI 851-6 1/4", 40 tracks	279.00	PERSCI Model 277 Dual	1195.00
Shugart SA400-5 1/4", 35 tracks.	295.00	WANGO/SIEMENS 5 1/4" Drive.	290.00
Siemens/GSI FDD120-8 8"	375.00	MPI B52 5 1/4" Dual	395.00
Shugart 800/801R 8"	495.00	WANGO/SIEMENS 282 Dual 5 1/4"	395.00

ENTER InterSystems



\$1150

- ★ Front Panel
- ★ Z80 CPU
- ★ IEEE S-100
- ★ 22 Cards
- ★ Modular Supply

TRS-80/APPLE MEMORY EXPANSION KITS

4116's
16K (200/250 ns.)
8 pcs. for **\$74.95**
w/instructions & jumpers.

HICKOK LX303

\$74.95



.5%, 3 1/2 digit 19 Range DVM, 1/2" LCD displays runs 200 hrs on 1 battery. 10 Meg Ohm Input. 1 yr. guarantee, made in U.S.A., test leads included.

Available Accessories

RC-3 115V AC Adapter	\$7.50
CC-3 Deluxe Padded Vinyl Carrying Case	\$7.50
VP-10 X10 DCV Probe Adaptor/ Protector 10 Kv	\$14.95
VP-40 40 Kv DC Probe	\$35.00
CS-1 10 Amp Current Shunt	\$14.95

Z80 Starter Kit

\$249

A Complete Microcomputer on a Board

- ★ Z80 Central Processing Unit with 158 Instructions.
- ★ On-Board Keyboard and Display.
- ★ Kansas City Standard Cassette Interface.
- ★ PROM Programmer Built on-board.
- ★ Expansion provision for two S-100 Connectors.
- ★ Wire Wrap area for custom circuitry.

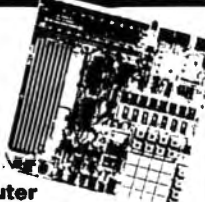

EXIDY SORCERER ONLY \$799.00



\$799 w/8K
\$1099 w/16K
\$1249 w/32K
\$1449 w/48K

User programmable or use cartridges. Combines the desirable features of the PET, APPLE and TRS-80 into a complete expandable computer system.
★ IO expansion kit

- ★ New Word Processing Pac
- ★ INCLUDES: Keyboard & enclosure
90 day Warranty
MICROSOFT BASIC
Video & Cassette Cable
Complete Documentation
★ \$100 Expansion Module
- ★ Cassette recorder
- ★ Sanyo 9" Monitor

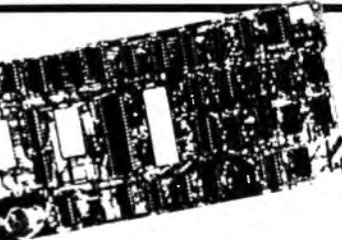

VDB-8024 Video Display Board

\$319 KIT
With On-Board Z80 Microprocessor
★ Full 80 Characters by 24 lines display.
★ Characters displayed by High Resolution 7 x 10 Matrix.
★ Keyboard Power and Interface.
★ Composite Video Output.
★ Separate TTL Level Synchronization and Video Outputs.
★ 2K Bytes Independent On-Board Memory.
★ On-Board Z80 Microprocessor.
★ Glitch Free Display.

SOL-20 WITH CP/M



We are proud to offer the SOL-20 with a dual floppy subsystem all operating under CP/M. Now you can use the SOL-20 and take advantage of the unlimited CP/M based software that is available.

A. MINI-DISK SYSTEM

- INCLUDES:
- SOL-20 w/32K
 - VISTA V-200 controller
 - (2) double density drives
 - CP/M w/documentation
 - Assembled & tested

\$2995.00

B. STANDARD FLOPPY SYSTEM

- INCLUDES:
- SOL-20 w/24K
 - VISTA controller
 - (2) 8" disk drives
 - CP/M w/documentation
 - Assembled & tested

\$3295.00

SOL nKRA (expandable to 65K) RAM boards. Assembled and socketed w/o memory, data delay and proms.
Only

Sol-20 Keyboards..... Only \$139.95

... and it's COLOR "The Compucolor II"

... a personal colorgraphics system for the modern computer man

- ★ Color Graphics 13" Color CRT
- ★ Proven 8080A CPU System
- ★ 16K Extended Disk Basic
- ★ Up to 117" Key Keyboard
- ★ Up to 32K RAM
- ★ Mindisk Drive 61.2K Bytes/Side



Model 3 w/8K, 72 Key Keyboard, RS232	SALE TAKE OFF	\$1495.00
Model 4 w/16K, 72 Key Keyboard, RS232		\$1695.00
Model 5 w/32K, 72 Key Keyboard, RS232		\$2295.00
Options: 101 Key Keyboard	ADD	\$150.00
117 Key Keyboard	ADD	\$225.00
Formatted Diskettes	2/\$	\$19.95
Programmed Diskettes		\$19.95
Diskette Library Inc. Hangman, Orhelo, Math, Chess, Startrak, Blackjack, Cubic Tac Tac Toe, Finance Vol. I, Finance Vol. II, Bonds and Securities, Assembler, Text Editor, Personal Data Base		

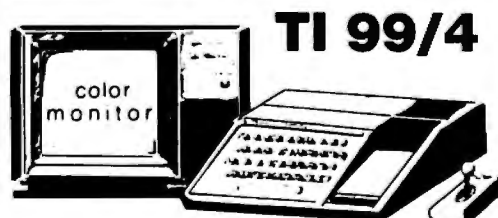

Finally! We've heard so much about it and we are proud to offer:
• Color • Up to 72K • 16 Color Graphics • Music • Sound • Solid State Software

LIMITED QTY: **\$1150.00**

KIM-1

Now only **\$179.00**

- ★ Power Supply
- ★ Cassette Recorder
- ★ Sanyo 9" Monitor
- Add enclosure \$29.95.

AIM 65

\$375.00

- ★ On Board 20 column alphanumeric printer
- w/1K RAM
- w/4K RAM
- Assembler ROM
- BASIC IN ROM
- Power Supply
- Enclosure

SYM-1 IN STOCK

Reg. \$269.00
Now **\$219.00**

- KIM-1 Compatible
- 4K ROM Monitor
- 1K Bytes 21 1/4 RAM
- 65K Memory Expansion
- User EPROM 2716
- Power Supply
- Cassette Recorder
- Sanyo 9" Monitor
- SVI Enclosure
- School & group discounts available

Buy now and receive \$100.00 worth of discount coupons.

- SRM-1 1K Static RAM exp. disc \$32.00
- PEK-1 I/O Port
- SVI BAS-1 Basic ROM (Microsoft) reg. \$159.00
- MK-2 CRT/TV Keyboard, reg. \$349.00

SBC-100

Z-80 based singleboard computer by SD Systems

- ★ 1K RAM
- ★ RS232 port
- ★ 4 channel counter/timer

KII

Assembled

TK80A

- ★ 8080A
- ★ Monitor ROM
- ★ DMA Display
- ★ 25 Key Keyboard
- ★ Cassette I/O

\$299.00

RCA COSMAC VIP

NEW LOW PRICE **\$249.00**
Assembled. Regular price

w/Sanyo 9" Monitor

Widen the ability of your TRS-80

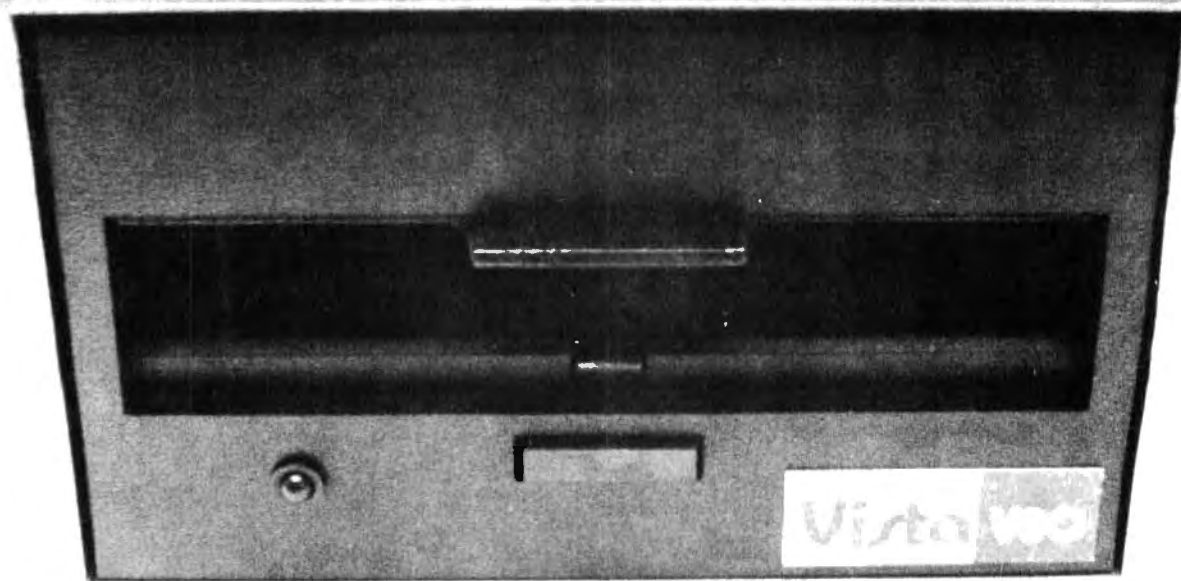

The Vista V80: \$395

The Vista V80 Mini Disk System is the perfect way to widen the capabilities of your TRS-80* Micro-computer. Quickly and inexpensively. Our \$395 price tag is about \$100 less than the Radio Shack equivalent. Our delivery time is immediate (24 hour turn-around from our Santa Ana, Ca. factory). And our system is fully interchangeable. That's just the start.

It will give you 23% more storage capacity by increasing useable storage from 55,000 to 65,000 bytes per drive with our new software patch.

It can work 8 times faster than the TRS-80 Mini-Disk system, because track-to-track access is 5ms versus 40ms for the TRS-80. You can realize this added speed

once the new double disk expansion interface is available without expensive modification of the existing unit.

It has a better warranty than any comparable unit warranty available – a full 120 days on all parts and service. When you consider how much more goes into the Vista V80, that shows a lot of faith in our product.

A full 3 amp power supply means you have 2½ times the power necessary to operate the V80, and full ventilation insures that there will be no problems due to overheating.

The Vista V80 Mini Disk System requires Level II Basic with 16K RAM Expansion interface (it operates from the Radio Shack interface system. It

comes complete with a dependable MPI Minifloppy disk drive, power supply, regulator board and vented case. It's shipped to you ready to run – simply take it out of the box and plug it in. You're in business. From the company that means business – Vista Computer Company.



The Vista Computer Company.
Manufacturers of Quality
Computer Systems
and Software.
714/953-0523
1401 Borchard
Santa Ana, Ca. 92705

Unclassified Ads

FOR SALE: The first sixteen issues of BYTE in mint condition. Best offer over \$100. Pat Gerstle, 1460 Oak Cir, Boulder CO 80302.

FOR SALE: SwTPC 6800 computer with 12 K memory, SWTBUG, serial and parallel input/output (I/O); CT-1024 terminal with scrolling mod in Enclosure Dynamics case; AC-30 cassette interface; GT6144 graphics board with joystick, each housed in separate cases; all interconnecting cables, full documentation, and large variety of software (SwTPC 4 K and 8 K BASIC, Microsoft BASIC, Assembler, games); \$650. R Maryanski, 424 Grant Av, Eatontown NJ 07724, (201) 542-4735.

FOR SALE: PERTEC iCOM FDOS-II dual drive/single density floppy disk drive with Intel interface card. Almost new. Paid \$3300, will take best offer received one month after offer appears. Gary Miner, POB 1177, Santa Cruz CA 95061, (408) 429-1331.

FOR SALE: An S-100 bus system comprised of the following: TDL Z80 processor board. TDL system monitor board with two serial ports and one parallel port, cassette interface, and read-only memory monitor. TDL video display board with 1920 characters and graphics. Keyboard. Morrow 16 K memory board. All housed in Vector Graphics box with 18 A power supply. Best offer. Richard Blum, 3 Mohawk Dr, Westboro MA 01581, (617) 366-9734.

FOR SALE: IMSAI 8080 with Micropolis double density floppy disk, 32 K bytes static programmable memory (250 ns), 8 K Bytesaver board with 16 K read-only memories, additional 16 K programmable-memory board without chips, SIO-2, PIO-4, Tarbell cassette board, Mountain Hardware clock board, OAE paper-tape reader, Hazelline 1500, 80-column printer, modem, and ultraviolet read-only memory eraser. All boards fully socketed, up and running. All brand new. Write for more details, give phone number. Jim Bartkus, 6519 S Kostner Av, Chicago IL 60629.

FOR SALE: Monroe 326 scientific calculator with cassette drive model 392, programmable 120 steps and twelve data registers, with nicads and charger, software included for financial analysis. Asking \$600 or best offer. Stanley Katz, 208 Hamden #305, Marshall MN 56258, (507) 537-1136.

FOR SALE: BYTE and *Kilobaud* magazines in good condition. Complete sets, volume 1 number 1 thru present date. Make offer for either or both sets. Mel Hart, 936 Dontaos Dr, St Louis MO 63131, (314) 966-4263.

FOR SALE: TRS-80, Level 2 BASIC, 16 K complete with video monitor, power supply, keyboard, cassette unit. Level 1 and 2 manuals, game software, all in perfect condition, I pay shipping; \$750. Robert E Stahl, 18273 Gum Tree Ln, Huntington Beach CA 92646, (714) 842-5832.

FOR SALE: Computer Automation Alpha/LSI-2 computer with 8 K 16-bit words of core memory, front panel, and 8-port serial input/output (I/O) board. \$1000. Phil Hughes, POB 2847, Olympia WA 98507, (206) 357-4415 days or (206) 352-9637 evenings.

FOR SALE: S-100 boards, Processor Technology cassette user tapes system interface with CUTER, Extended Cassette BASIC and ALS-8, \$160; VDM-1, \$150; BASE 2 16 K fast static programmable memory, \$325; Digital Micro System 16 K static programmable memory, \$290; IMSAI 8080 processor board, \$80; Advanced Computer Products LOGO I 8 K static programmable memory, \$180. All assembled and tested. Teletypewriter paper, Canary, \$3. T Tai, POB 142, Eagleville PA 19408.

FOR SALE: First two volumes of BYTE, excellent condition, complete. Please submit bids for both complete sets or individual issues. Magazines will go to highest bidder(s). K Watson, 600 Arapahoe #7, Boulder CO 80302.

FOR SALE: Solid State Music IO-4, 2P + 2S, input/output (I/O) board, S-100, documentation. Best offer. Stuart Sheedy, 1 Schoolhouse Ln, Syosset NY 11791, (516) 921-4321.

FOR SALE: Termet 300 keyboard printer. Excellent condition. Friction-feed Model B, RS-232, 10/15/30 cps (switch selectable), upper/lower case, 118 column, ASCII terminal. Full set of documentation included. Best reasonable offer. F P Godici, Rd #2 POB 135, Oswego NY 13126, (315) 343-3314.

FOR SALE OR TRADE: SwTPC 6800/2 with 24 K total memory; CT-64 terminal; AC-30 cassette interface; NP-N calculator interface. All equipment unassembled. In original cartons with all manuals and documentation. Sell for cash, or trade for TRS-80 expansion interface with memory, mini disk system, printer, etc. Gary Blanken, 1804 Ladd St, Silver Spring MD 20902.

FOR SALE: Teletype ASR33. Excellent condition. Wired for motor control, with pedestal, and one box of new paper tape; \$850. DSI paper-tape winder for Teletype 33; \$50. United Data 20 mA to RS-232C converter; \$125. R Groome, 1701 E 12th St Apt 9W West Tower, Cleveland OH 44114, (216) 621-4129.

FOR SALE: Assembled Heathkit H8, H9, and cassette recorder. Hardware includes 24 K memory and cassette interface. Software is Heath Extended BASIC, Assembler, Game Set 1, Biorhythm, and Space War. Included are reference manual and most of *REMARKS* (HUG magazine) to date. Would cost nearly \$1800 as a kit. The first check or money order for \$1440 gets it. G Council, 1258 33 Av, San Francisco CA 94122, (415) 664-4508.

FOR SALE: Two IMSAI 4 K static programmable-memory boards with individual 1 K write protect. \$85 each. One Polymorphics Video-Graphics board with 16 by 64 character display and 48 by 128 graphics display. 1 K of on board programmable memory and a parallel port for keyboard. \$150. All for S-100 bus. Everything assembled. Frederick Stark, 859 Standish, Pacifica CA 94044.

FOR SALE: TDL ZPU Z80 processor card and TDL Z16 memory card with 8 K bytes. Includes TDL Z80 macro-assembler, TDL 8 K BASIC, TDL 1 K monitor, and memory test software on paper tape. Documentation included: *macroassembler user manual*, *Z80 processor technical manual*, *Z16 manual*, and *8 K BASIC user manual*. All for \$500 or best offer within thirty days. Art Wetzel, 1123 Walnut St, Pittsburgh PA 15221, (412) 624-5208 or (412) 241-3578.

FOR TRADE: Are you interested in swapping software? If you send me an original game program in any version of TDL BASIC or either version of CBASIC, I will send you a game program in the appropriate language. Along with the program include a SASE, and two extra copies of your program, if possible. Your program must be typed or printed by computer. Michael Schiff, 184 Foch Av, Lawrenceville NJ 08648.

FOR SALE: Tarbell tape interface board, assembled and working, \$80 or best offer. Also, Memorex model 650 floppy disk drive, 8 inch, hard-secured, with documentation, \$200 or best offer. Frank Tuccio, 80 N Railroad Av, Mahwah NJ 07430.

Unclassified Policy

Readers who are soliciting or giving advice, or who have equipment to buy, sell or swap should send in a clearly typed notice to that effect. To be considered for publication, an advertisement must be clearly noncommercial, typed double spaced on plain white paper, contain 75 words or less, and include complete name and address information.

These notices are free of charge and will be printed one time only on a space available basis. Notices can be accepted from individuals or bona fide computer users clubs only. We can engage in no correspondence on these and your confirmation of placement is appearance in an issue of BYTE.

Please note that it may take three or four months for an ad to appear in the magazine.

WANTED: CAI programs wanted. Teachers, do you have any original TRS-80, PET, or Apple CAI programs for trade with other teachers? Bob Purser, POB 466, El Dorado CA 95623.

FOR SALE: Complete set of BYTE magazine from first issue to 1979. Make offer. Benjamin Clark, Rt 3 POB 800, Moncks Corner SC 29461.

FOR SALE: Static-memory boards assembled with original documentation. Godbout 4 K, paid \$130, asking \$50; SD Sales 4 K lowpower, paid \$95, asking \$65; MITS Altair 8800 1 K, \$25. All three boards for only \$125 and I pay insurance and postage. Also, I have an ASR33 teletypewriter with built-in 101C data set and phone dialer. Asking \$875 or best offer. Barry Woo, 949 Erica Dr, Sunnyvale CA 94086, (408) 737-2935.

FOR SALE: PDP-8/L computer; \$1000. James Foy, (609) 646-2132 after 6:00 PM.

BUY, SELL OR TRADE: Digital Group equipment. Have input/output (I/O), video display, Z80 processor, dual Phi-Deck system, keyboards, monitors, cabinets, etc. Need memories and TVC 96, real-world interface, etc. Jack Buster, POB 8062, Anchorage AK 99508, (907) 349-3324.

FOR SALE: Data General Nova 1220 minicomputer with 32 K bytes programmable memory, Auto-Program-Load, paper-tape reader and Teletype Interfaces, manuals, logic diagrams, and paper tapes. All in mint condition. \$1500 plus shipping. R C Meyer, 618 13th St NE, Owatonna MN 55060, (507) 451-6911 evenings.

FOR SALE: Input/output (I/O) board, S-100, Morrow Speakeasy, one parallel, one serial, cassette with control for three machines, 512 bytes programmable memory, read-only memory with bootstrap and cassette routines on board. Assembled and tested, with cable. Best offer over \$110. Rusty Brytton, 78 Clinton Pl, Bronx NY 10453, (212) 367-0663.

FOR SALE: Altair computer, two 4 K dynamic memories, ACR, PIO. \$500 or best offer. Also complete backlog of BYTE, best offer. Dan Starr, 58 Spruce St, Princeton NJ 08540.

FOR SALE: I am selling parts and spares from my old computer to pay for my new computer. All parts made by Intel. 13 K bytes P2102A-4; \$150 each, 4 K bytes C1702a; \$4 each, 24 D8212; \$2 each, 3 C8080A; \$7 each, 3 D8224; \$3 each, 8 P8226; \$2 each, 2 P8214; \$4 each, 20 unused d3601 read-only memory like 825126; \$3 each. Please add \$1 for UPS. Send cashier's check or money order. Frank Worrell, Lakeshore Dr RD4, Colchester VT 05446.

Reader Service

To get further information on the products advertised in BYTE, fill out the reader service card with your name and address. Then circle the appropriate numbers for the advertisers you select from the list. Add a 15-cent stamp to the card, then drop it in the mail. Not only do you gain information, but our advertisers are encouraged to use the marketplace provided by BYTE. This helps us bring you a bigger BYTE. *Correspond directly with company.

Inquiry No.	Page No.	Inquiry No.	Page No.	Inquiry No.	Page No.	Inquiry No.	Page No.
92	Aardvark Software 151	20	Digital Technology Inc 35	155	Microsette 201	94	Rabininc 154
213	AB Computers 254	32	Digitus Corp 57	168	Microsette 205	119	RACET Computes 183
52	Ackerman Digital Systems 86	129	Disc 3 189	56	Microsoft 91	212	Radio Hut 253
188	Addmaster Corp. 211	221	Digital Research: Computers 261	95	Microsoft (Consumer Prod Div) 155	69	Radio Shack 109
173	Adroit Electronics 205	138	Dynacomp 195	40	Microlek 71	112	Ramsey Electronics 178
77	Advanced Access Group 128	124	Ecosoft 187	120	Microware 187	*	Reliable Cash Register (Systems Specialists) 183
231	Advanced Computer Prod 268, 269	207	Electrolabs 243, 246, 247	41	The Micro Works 72	204	RNB Enterprises 233
154	All Electronics Corp 201	111	Electronic Control Technology 177	3	Micro World 8	187	Rochester Data 228
12	Allos 19	208	Electronic Systems 248, 249, 266	103	Midwest Computer Peripherals 170	175	S-100 206
187	American Square Computers 211	169	Electronic Technicians 205	219	Mikos 260	110	Sara Tech 177
108	Anderson Jacobson 176	196	Escon 228	81	MOM 136	181	S C Digital 211
151	Anderson Jacobson 199	193	Factory Direct Sales 217	178	Mini Computer Suppliers 207	128	SCDP 189
162	Apparal 202	141	Field Service Search 197	39	Morrow/Thinker Toys 69	150	SciTronics 198
31	Apple Computer 55	57	Folio Books 92, 93	10	Mountain Hardware 16	21	Seattle Computer Products 37
223	ASAP Computer Products 262	210	Fordham Radio Supply 252	70	Mountain Hardware 111	*	Shugart 6, 7
19	Atari Personal Computers 31	167	Frederick Computer 205	51	MPI 85	177	Sigma International 207
140	ATV Research 197	121	Futureworld 185	116	MPU 181	107	Sirius Systems 175
109	Automated Simulations 177	132	H Geller 191	176	MT Microsys (Formerly Metatech) 206	22	Smoke Sig Broadcasting (Dealers) 39
153	Avionic Enterprises (A.E.I.) 201	194	Gimix 219	143	Multi Business Computer Sys 197	63	Smoke Signal Broadcasting 39
225	Beckian 264	98	Godbout Electronics 161	156	National Computer Service 201	183	Snow Micro Systems Inc 211
195	Beta Computer Devices 110	84	H & E Comptronics 141	83	NEECO 123	5	Softagon Inc 10
*	Biotech Electronics 222	97	Hayden Book Co 159	79	NEECO 132	*	Softech Micro Systems 153
*	Bits, Inc. 167	11	Heath Company 17	237	NEECO 133	89	Softside 146
*	BYTE Back Issues 185	17	Heath Company 26, 27	215	Netronics 255	191	Software Dev & Training 214
35	BYTE Books 114, 121, 157, 173	67	Heuristics 106	238	Netronics 255	91	The Software Exchange 147
*	BYTE WATS 211	211	Hobby World 252	174	Northwest Computer Serv Inc 205	144	The Software Farm 197
115	C & S Electronics Mart 181	38	Houston Instruments 67	113	Novation 179	24	The Soft Warehouse 42
216	California Digital 257	102	Inco Inc 187	*	NRI Schools 129	135	The Software Works 193
85	Cambridge Development Labs 142	86	Infinity Micro 143	235	Ohio Scientific Instrument CIV	214	Solid State Sales 254
182	CCM Inc. 211	18	Infosoft Systems Inc 29	7	Ohio Scientific Instrument 12, 13	158	Sorrento Valley Associates 201
68	Central Data 107	36	inmac 62	27	OK Machine and Tool 47	180	Southern Sys of Birmingham 216
61	Centronics 97	14	Integral Data 23	64	OK Machine & Tool 102	233	Southern Tech Products Corp CII
37	Compucolor Corp 63	106	Integrand 174	28	Olivetti 51	6	SSM 11
230	CompuMart 267	147	Interface Inc 197	202	onComputing 33	58	SubLOGIC 94
65	CompuServe (Micronet) 103	75	International Data Systems 125	49	Optimal Technology 233	226	Sunny International 264
224	Computer City 263	9	Intertec Data Systems 15	123	Oregon Software 83	34	Supersoft 59
76	Computer Distributors 127	104	Intertec Data Systems 171	136	Osborne/McGraw-Hill 186	240	Sybox 61
*	The Computer Factory 139	4	Ithaca Intersystems 9	171	Owens Associates 193	59	Synchro Sound 95
50	Computer Furniture & Acc 84	8	Ithaca Intersystems 14	217	Pacific Exchanges 205	192	Synergistic Computer Products 214
*	Computer Headware 18	209	Jade Co 250, 251	164	Page Digital 256	78	System Engineering Enterprises 113
33	Computer Mart of NJ 58	218	Jameco 258, 259	217	PAIA 204	42	Tarbell Electronics 73
130	Computer Specialties 189	15	JJR Data Research 24	200	Pan Am Electronics (A Radio Shack Auth. Sales Cir.) 231	55	Technical Systems Cons (TSC) 89
44	Computer Room 76	43	Konan Corp 75	234	Per Com Data C III	139	Technology Transfer 196
156	Computer Service Center 201	60	Lifefloat Associates 101, 231, 233	25	Per Com Data 43	157	Terminal Data Corp 201
82	Computer Serv Sys Ntwk (CSSN) 137	88	Logon Inc (Technical Marketing) 96	26	Per Com Data 44	13	3/M Computer 21
127	Computex 188	166	MacMillan Book Club 145	241	Per Com Data 44	146	Torry Pines 197
54	CTC 88	*	Macrotronics 205	242	Per Com Data 44	170	Ucatan Computer Store 205
152	CT Micro Computer 200	*	McGraw-Hill Book Company 64, 65	243	Per Com Data 45	*	University Micro Films 99
16	Corvus Systems 25	165	Measurement Sys & Cont 169, 197	244	Per Com Data 45	137	US Robotics 194
1	Cromemco 1, 2	74	Micro Appl & Hardware (MICAH) 204	245	Per Com Data 45	145	Vantage Data Products 197
199	Cybernetics Inc 231	66	Microamerica 123	246	Per Com Data 45	23	Vector Electronics 40
163	Data Access Corp 203	159	Micro Applications Group 104	46	Personal Software 79	232	Vista Computer Company 270
184	DataBank 211	172	Micro Architect 201	47	Personal Software 81	206	VR Data 245
131	Data Discount Center 191	222	Microbiotic Computing 205	*	Phase One Systems 149	220	Wameco 260
133	Data South Computer 191	239	Micro Business World 262	125	Pickles & Trout 187	*	Whales 245
100	Data Speed 165	239	Microcomputer Technology Inc 202	99	Potomac Micro Magic 164	142	Worldwide Electronics 197
228	Data Trans 266	45	MicroDaSys 77	*	Polyline Corp 201	190	X-Comp 213
134	Datec 193	29	Micro Data Base Systems 53	30	Power One 54	71	Yourdon Software Prod Group Inc 119
72	Delta Products 117	2	Micro Diversions 5	53	Prodigy 87	118	Z _s Systems 183
160	DES-MAR Electronics 201	122	Micromail 185	*	Priority One (Insert)		
87	DG Electronics 144	185	Micro Management Systems 211	248	Priority One 241		
48	Digital Marketing 82	114	Micro Mikes 181	179	The Q Kit (Div JR Conwell Corp) 209		
80	Digital Pathways 135	*	Micro Pro International 49	227	Quest Electronics 265		
90	Digital Research Corp (CA) 148						

BOMB — BYTE's Ongoing Monitor Box

Article No.	ARTICLE	Page
1	Grogono: Making Color Slides with an Intecolor Microcomputer	20
2	Ciarcia: Computerize a Home	28
3	Gibson: A Computer-Controlled Light Dimmer	56
4	Wierenga: A Furnace Watchdog	74
5	Lewis: What Computers Cannot Do	100
6	Skier: Indirect Addressing for the 6502	118
7	Joyce: Telephone Dialing by Computer	122
8	Chance: Analysis of Polynomial Functions with the TI-59 Calculator, Part 2	129
9	Walter: The Plot Continues	136
10	Conboy: Alpha Lock for Your ASCII Keyboard	156
11	Pass: A Computer-Generated Reminder Message	160
12	Lipham: Relocating 8080 System Software	180
13	Yost: Eighteen with a Die, A Learning Game Player	212

October BOMB
 "Picking Up The Pieces" (page 76) by Alfred S Baker won first place in the October 1979 BOMB. Second place was taken by Fred R Ruckdeschel's "Curve Fitting With Your Computer" (page 150). "Self-Refreshing LED Graphics Display" (page 58), by Steve Ciarcia, placed third. ■

From PERCOM

One-Drive System:
\$399. (40-track) & \$675. (77-track)
Two-Drive System:
\$795. (40-track drives) & \$1350. (77-track drives)
Three-Drive System:
\$1195. (40-track drives) & \$2025. (77-track drives)
Requires Expansion Interface, Level II BASIC & 16K RAM.

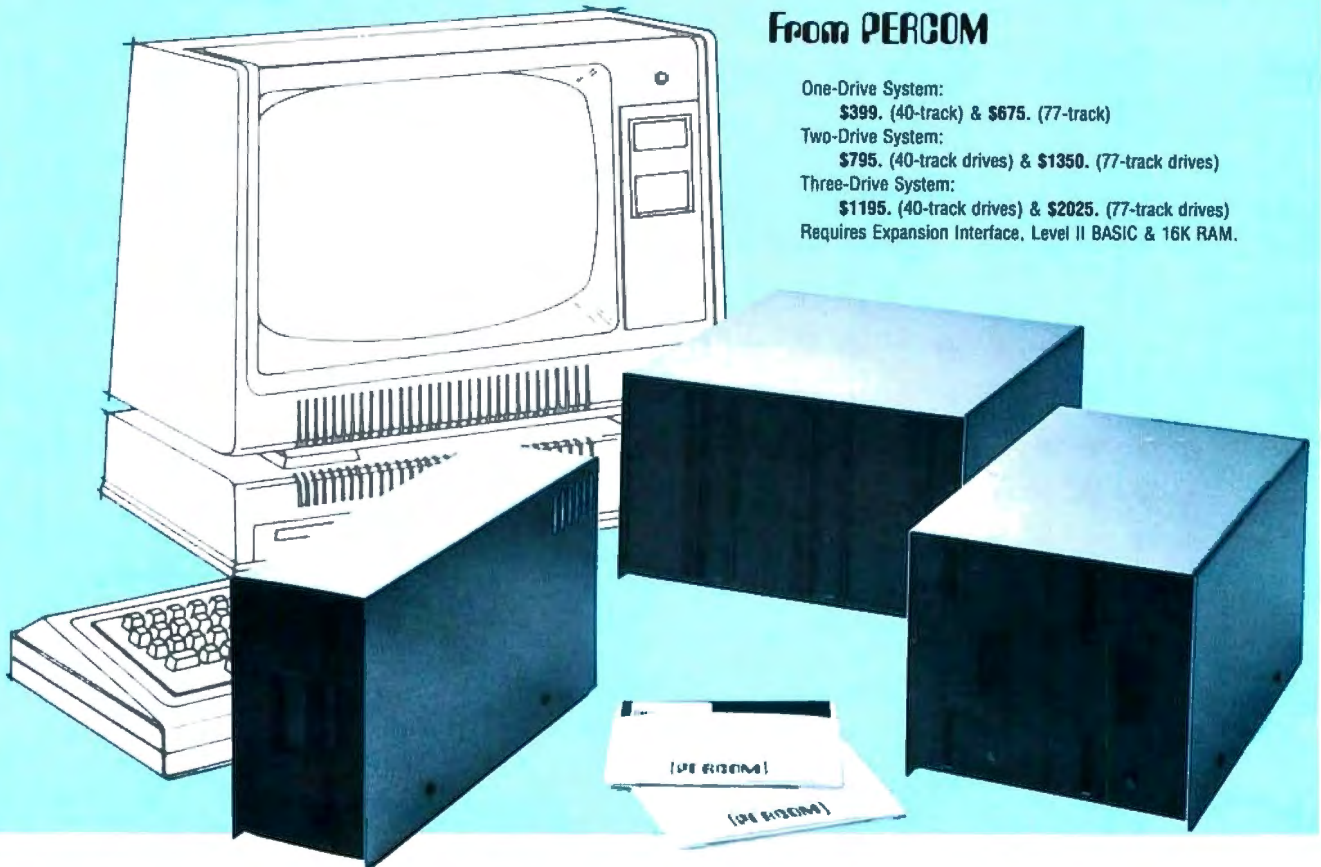

Low Cost Add-On Storage for Your TRS-80*. In the Size You Want.

When you're ready for add-on disk storage, we're ready for you.
Ready with six mini-disk storage systems — 102K bytes to 591K bytes of
additional *on-line* storage for your TRS-80*.

- Choose either 40-track TFD-100™ drives or 77-track TFD-200™ drives.
- One-, two- and three-drive systems immediately available.
- Systems include Percom PATCH PAK #1™, on disk, at no extra charge. PATCH PAK #1™ de-glitches and upgrades TRSDOS* for 40- and 77-track operation.
- TFD-100™ drives accommodate "flippy disks." Store 205K bytes per mini-disk.
- Low prices. A single-drive TFD-100™ costs just \$399. Price includes PATCH PAK #1™ disk.
- Enclosures are finished in system-compatible "Tandy-silver" enamel.

Whether you need a single, 40-track TFD-100™ add-on or a three-drive add-on with 77-track TFD-200™s, you get more data storage for less money from Percom.

Our TFD-100™ drive, for example, lets you store 102.4K bytes of data on one side of a disk — compared to 80K bytes on a TRS-80* mini-disk drive — and 102.4K bytes on the other side, too. Something you can't do with a TRS-80* drive. That's almost 205K bytes per mini-disk.

And the TFD-200™ drives provide 197K bytes of on-line storage per drive

— 197K, 394K and 591K bytes for one-, two and three-drive systems.

PATCH PAK #1™, our upgrade program for your TRSDOS*, not only extends TRSDOS* to accommodate 40- and 77-track drives, it enhances TRSDOS* in other ways as well. PATCH PAK #1™ is supplied with each drive system at no additional charge.

The reason you get more for less from Percom is simple. Peripherals are not a sideline at Percom. Selling disk systems and other peripherals is our main business — the reason you get more engineering, more reliability and more back up support for less money.

In the Product Development Queue . . . a *printer interface* for using your TRS-80* with any serial printer, and . . . the *Electric Crayon*™ to map your computer memory onto your color TV screen — for games, animated shows, business displays, graphs, etc. Coming PDQ!

™ TFD-100, TFD-200, PATCH PAK and Electric Crayon are trademarks of PERCOM DATA COMPANY.
*TRS-80 and TRSDOS are trademarks of Tandy Corporation and Radio Shack which have no relationship to PERCOM DATA COMPANY.

PERCOM

PERCOM DATA COMPANY, INC.
211 N. KIRBY • GARLAND, TX. • 75042

To order add-on mini-disk storage for your TRS-80*, or request additional literature, call Percom's toll-free number: 1-800-527-1592. For detailed Technical information call (214) 272-3421.

Orders may be paid by check or money order, or charged to Visa or Master Charge credit accounts. Texas residents must add 5% sales tax.

Percom 'peripherals for personal computing'

Step up to your next computer.



STEP UP TO A C4P FROM OHIO SCIENTIFIC

You know about computers. In fact, you probably own one now. One that you might be thinking of expanding. We have a better idea. Take a giant step into the personal computing future with an amazing, new C4P from Ohio Scientific.

SPEED SEPARATES THE COMPUTERS FROM THE TOYS

The C4P MF has execution speed that is twice as fast as Apple II or Commodore PET and over THREE times as fast as TRS-80. They are many times faster than the recently introduced flock of video game type computers. And, as if that weren't fast enough, the C4P nearly doubles its speed when equipped with the GT option.

Just look at the back panel of the C4P MF.



All the I/O you'll ever need!

Apple II, Commodore PET, TRS-80, and Atari 800 are registered trade names of Apple Computer Inc., Commodore Business Machines Ltd., Radio Shack, Atari, respectively.

SOUND

- 1—programmable tone generator 200—20KHz
- 1—8 bit companding digital to analog converter for music and voice output.

HUMAN INPUT EXPANSION

- 2—8 axis joystick interfaces
- 2—10 key pad interfaces

HOME INTERFACE

- 1—AC-12 AC remote control interface

DISPLAY

- 32 x 64 with upper and lower case 2048 Characters.
- 256 x 512 effective Graphic Points
- 16 Colors

SOFTWARE

Ohio Scientific offers a comprehensive library of both systems and applications software for the C4P.

The C4P is an outstanding premium computer — years ahead of the market. We know because there's nothing quite like it for the price, anywhere. And probably won't be for a very long time.

C4P \$698

8K BASIC-in-ROM, 8K of static RAM and audio cassette interface. Can be directly expanded to 32K static RAM and two mini-floppy disks.

C4P MF \$1695

All the features of the C4P plus real time clock, home security system interface, modem interface, printer interface, 16 parallel lines and an accessory BUS. The C4P MF starts with 24K RAM and a single mini-floppy and can be directly expanded to 48K and two mini-floppies. Over 45 diskettes now available including games, personal, business, educational and home control applications programs as well as a real time operating system, word processor and a data base management system.

Computers come with keyboards and floppies where specified. Other equipment shown is optional.

For literature and the name of your local dealer, CALL 1-800-321-8850 TOLL FREE.

OHIO SCIENTIFIC

1333 SOUTH CHILLICOTHE ROAD
AURORA, OH 44202 • (216) 562-3101

Circle 235 on inquiry card.