

# BYTE<sup>®</sup>

the small systems

AUGUST 1981 Vol. 6, No. 8  
\$2.50 in USA/\$2.95 in Canada

A McGraw-Hill Publication





SOUTHWEST TECHNICAL PRODUCTS CORPORATION  
219 W. RHAPSODY  
SAN ANTONIO, TEXAS 78216

(512) 344-0241

Circle 357 on inquiry card.

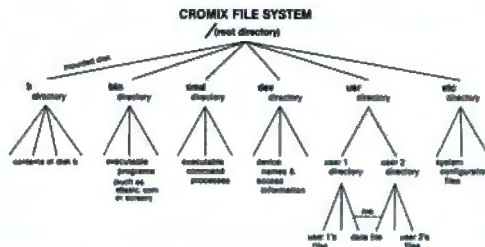

## CROMIX\* — Cromemco's outstanding UNIX<sup>†</sup> — like operating system

CROMIX is just the kind of major development you've come to expect from Cromemco. After all, we're already well-known for the most respected software in the microcomputer field.

And now we've come up with the industry's first UNIX-lookalike for microcomputers. It's a tried and proven operating system. It's available on both 5" and 8" diskettes for Cromemco systems with 128K or more of memory.

Here are just some of the features you get in this powerful Cromemco system:

- Multi-user and multi-tasking capability
- Hierarchical directories
- Completely compatible file, device, and interprocess I/O
- Extensive subsystem support

### FILE SYSTEM

One of the important features of our CROMIX is its file system comprised of hierarchical directories. It's a tree structure of three types of files: data files,

\*CROMIX is a trademark of Cromemco, Inc.  
†UNIX is a trademark of Bell Telephone Laboratories

directories, and device files. File, device, and interprocess I/O are compatible among these file types (input and output may be redirected interchangeably from and to any source or destination).

The tree structure allows different directories to be maintained for different users or functions with no chance of conflict.

### PROTECTED FILES

Because of the hierarchical structure of the file system, CROMIX maintains separate ownership of every file and directory. All files can thus be protected from access by other users of the system. In fact, each file is protected by **four separate access privileges** in each of the three user categories.

### TREMENDOUS ADDRESS SPACE, FAST ACCESS

The flexible file system and generalized disk structure of CROMIX give a disk address space in excess of one gigabyte per volume — file size is limited only by available disk capacity.

Speed of access to disk files has also been optimized. Average access speeds far surpass any yet implemented on microcomputers.

### 'C' COMPILER AVAILABLE, TOO

Cromemco offers a wide range of languages that operate under CROMIX. These include a high-level command process language and extensive subsystem support such as COBOL, FORTRAN IV, RATFOR, LISP, and 32K and 16K BASICS.

There is even our highly-acclaimed 'C' compiler which allows a programmer fingertip access to CROMIX system calls.

### THE STANDARD O-S FOR THE FUTURE

The power and breadth of its features make CROMIX the standard for the next generation of microcomputer operating systems.

And yet it is available for a surprisingly low \$595.

The thing to do is to get all this capability working for you now. Get in touch with your Cromemco rep today.



**Cromemco**™  
i n c o r p o r a t e d

280 BERNARDO AVE., MOUNTAIN VIEW, CA 94040 • (415) 964-7400  
Tomorrow's computers today

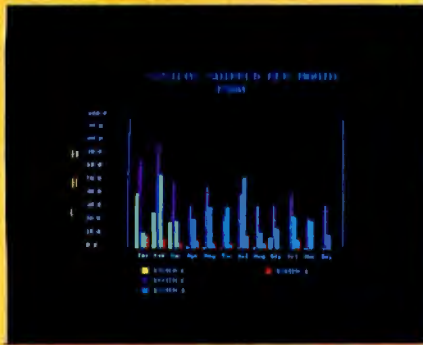

Management Information Display

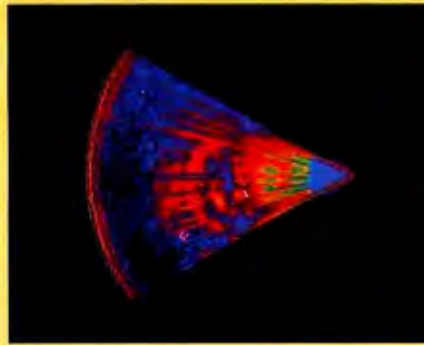

Ultrasonic heart sector scan



Process Control

## Get the professional color display that has BASIC/FORTRAN simplicity

### LOW-PRICED, TOO

Here's a color display that has everything: professional-level resolution, enormous color range, easy software, NTSC conformance, and low price.

Basically, this new Cromemco Model SDI\* is a two-board interface that plugs into any Cromemco computer.

The SDI then maps computer display memory content onto a convenient color monitor to give high-quality, high-resolution displays (756 H x 482 V pixels).

When we say the SDI results in a high-quality professional display, we mean you can't get higher resolution than this system offers in an NTSC-conforming display.

The resolution surpasses that of a color TV picture.

### BASIC/FORTRAN programming

Besides its high resolution and low price, the new SDI lets you control with optional Cromemco software packages that use simple BASIC- and FORTRAN-like commands.

Pick any of 16 colors (from a 4096-color palette) with instructions like DEFCLR (c, R, G, B). Or obtain a circle of specified size, location, and color with XCIRC (x, y, r, c).

\*U.S. Pat. No. 4121283

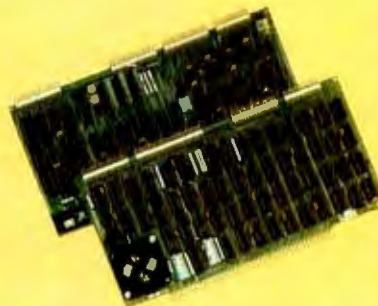

Model SDI High-Resolution Color Graphics Interface

### HIGH RESOLUTION

The SDI's high resolution gives a professional-quality display that strictly meets NTSC requirements. You get 756 pixels on every visible line of the NTSC standard display of 482 image lines. Vertical line spacing is 1 pixel.

To achieve the high-quality display, a separate output signal is produced for each of the three component colors (red, green, blue). This yields a sharper image than is possible using an NTSC-composite video signal and color TV set. Full image quality is readily realized with our high-quality RGB Monitor or any conventional red/green/blue monitor common in TV work.



Model SDI plugs into Z-2H 11-megabyte hard disk computer or any Cromemco computer

### DISPLAY MEMORY

Along with the SDI we also offer an optional fast and novel two-port memory that gives independent high-speed access to the computer memory. The two-port memory stores one full display, permitting fast computer operation even during display.

### CONTACT YOUR REP NOW

The Model SDI has been used in scientific work, engineering, business, TV, color graphics, and other areas. It's a good example of how Cromemco keeps computers in the field up to date, since it turns any Cromemco computer into an up-to-date color display computer.

The SDI has still more features that you should be informed about. So contact your Cromemco representative now and see all that the SDI will do for you.

**Cromemco**  
Incorporated  
280 BERNARDO AVE., MOUNTAIN VIEW, CA 94040 • (415) 964-7400  
Tomorrow's computers today

Circle 96 on inquiry card.

## Features

**14** **Introducing the Smalltalk-80 System** by Adele Goldberg / A readers' guide to the Smalltalk articles in this issue.

**36** **The Smalltalk-80 System** by the Xerox Learning Research Group / How message-sending objects are used in the Smalltalk-80 system.

**50** **Build a Z8-Based Control Computer with BASIC, Part 2** by Steve Ciarcia / Steve continues his description of the Z8-BASIC Microcomputer and suggests two applications.

**74** **Object-Oriented Software Systems** by David Robson / Object-oriented software systems provide the underlying design of Smalltalk.

**90** **The Smalltalk Environment** by Larry Tesler / Programming and debugging in Smalltalk are always interactive activities.

**147** **User-Oriented Descriptions of Smalltalk Systems** by Trygve M H Reenskaug / A Smalltalk application program will limit the user's access to the language.

**168** **The Smalltalk Graphics Kernel** by Daniel H H Ingalls / The Graphics Kernel provides the interface through which all text and graphics are displayed.

**200** **The Japanese Computer Invasion** by Stan Miastkowski / Like it or not, the Japanese small computers are on their way.

**230** **Building Data Structures In the Smalltalk-80 System** by James C Althoff Jr / Many kinds of data structures can be added easily to the Smalltalk-80 system.

**286** **Design Principles Behind Smalltalk** by Daniel H H Ingalls / The design principles of a language strongly affect its power and usability.

**300** **The Smalltalk-80 Virtual Machine** by Glenn Krasner / The use of a Smalltalk-80 Virtual Machine allows the system to be transported easily among different 16-bit microprocessors.

**322** **Building Control Structures In the Smalltalk-80 System** by L Peter Deutsch / Design of complicated control structures is easy in the Smalltalk-80 language.

**348** **Is the Smalltalk-80 System for Children?** by Adele Goldberg and Joan Ross / Although Smalltalk-80 is not meant to be used by children, application programs can be written that will allow them to be creative and, at the same time, learn about programming.

**369** **ToolBox: A Smalltalk Illustration System** by William Bowman and Bob Flegal / The versatile Smalltalk-80 language can create an environment for graphics design that can be used by non technically oriented people.

**378** **Virtual Memory for an Object-Oriented Language** by Ted Kaehler / Virtual memory techniques must be used when the active memory space needed by a language is much larger than the amount of available memory.

## Reviews

**398** **Microsoft Editor/Assembler Plus** by Keith Carlson

**401** **BOSS: A Debugging Utility for the TRS-80 Model I** by Scott Mitchell

## Nucleus

**6** Editorial: Smalltalk: A Language for the 1980s

**30** Letters

**197** BYTE's Bits

**224** BYTELINES

**392** BYTE's Bugs

**388** Ask BYTE

**391** Books Received

**391** Software Received

**392** Clubs and Newsletters

**394** Event Queue

**402, 413** System Notes: Indirect I/O Addressing on the 8080; Aim-65 16-bit Hexadecimal to Decimal Conversion

**404, 408, 414, 417, 418** Programming Quickies: A Disk Catalog for the Eighties; Alpha-Beta Tree Search Converted to Assembler; Fast Line-Drawing Techniques; Word Ujbnmarle; Binary-to-BCD Converter Program for the 8080

**421** What's New?

**478** Unclassified Ads

**479** Reader Service

**480** BOMB, BOMB Results

## BYTE



Page 14

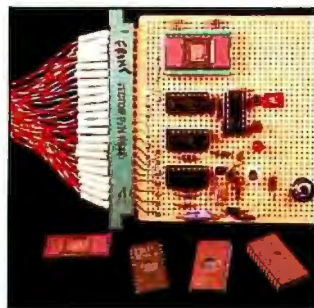

Page 50



Page 90

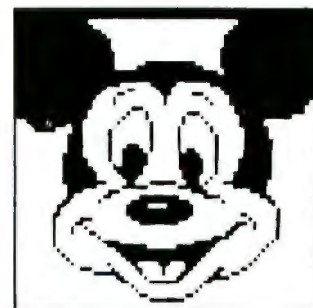

Page 168



**Editor in Chief**  
**Christopher Morgan**

**Managing Editor**  
Mark Haas

**Technical Editors**  
Gregg Williams, Senior Editor;  
Richard S Shuford; Curtis P Feigel;  
George Stewart; Stan Miastkowski;  
Charles Frelberg, New Products Editor;  
Steve Ciarcia, Mark Dahmke,  
Consulting Editors;  
Jon Swanson, Draftsman

**Copy Editors**  
Beverly Cronin, Chief; Faith Hanson;  
Warren Williamson; Anthony J Lockwood;  
Ann Graves

**Assistants**  
Faith Ferry; Debe Wheeler;  
Karen A Cilley

**Production**  
Nancy Estle, Director; Christine Destrempes,  
Asst Director; Wai Chiu Li;  
Deborah Porter; Jonathan M Graves;  
Patrice Scribner; Sherry McCarthy;  
Chief Typographer; Debi Fredericks;  
Donna Sweeney; Valerie Horn

**Advertising**  
Thomas Harvey, Director;  
Marion Gagnon; Rob Hannings;  
Marilyn Williams; Jacqueline Earnshaw,  
Reader Service Coordinator

**Circulation**  
Gregory Spitzfaden, Manager;  
Andrew Jackson, Asst Manager;  
Agnes E Perry; Barbara Varnum;  
Louise Menegus; Bill Watson;  
James Bingham, Dealer Sales

**Controller's Office**  
Daniel Rodrigues, Controller;  
Mary E Fluhr, Acct. & D/P Mgr; Karen Burgess;  
Jeanne Cilley; Mary Beth Ireland; Linda Fluhr

**Traffic**  
N Scott Gagnon

**Receptionist**  
Joanne Colburn

**Publishers**  
Virginia Londoner; Gordon R Williamson;  
John E Hayes, Associate Publisher;  
Cheryl A Hurd, Publisher's Assistant

Officers of McGraw-Hill Publications Company: Paul F McPherson, President; Executive Vice Presidents: James E Boddorf, Gene W Simpson; Group Vice President: Daniel A McMillan; Senior Vice President-Editorial: Ralph R Schulz; Vice Presidents: Kemp Anderson, Business Systems Development; Robert B Doll, Circulation; James E Hackett, Controller; Eric B Herr, Planning and Development; H John Sweger, Marketing.

Officers of the Corporation: Harold W McGraw Jr, President, Chief Executive Officer and Chairman of the Board; Robert F Landes, Senior Vice President and Secretary; Ralph J Webb, Treasurer.

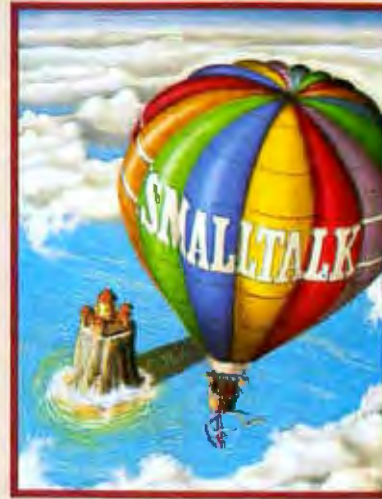

## In This Issue

Smalltalk isn't small talk any more. Three years ago, the cover of BYTE depicted the island kingdom of Smalltalk as a place where great and magical things happen, though its "craggy aloofness" kept it out of the mainstream of the computer programming community. During the past three years the Xerox Learning Research Group has continued developing Smalltalk, and this month we present the culmination of its work — the debut of the Smalltalk-80 system.

Because of the special nature of this issue, we have added a special introduction by Adele Goldberg, manager of the Xerox Learning Research Group based in Palo Alto, California. Adele guides you gently through the array of articles describing the Smalltalk-80 system and related topics.

In addition to our regular features, we also have the concluding part of Steve Ciarcia's article, "Build a Z8-Based Control Computer with BASIC." And Stan Miastkowski presents an in-depth report on what we can expect from Japan in his article, "The Japanese Computer Invasion."

BYTE is published monthly by BYTE Publications Inc. 70 Main St, Peterborough NH 03458, phone (603) 924-9281, a wholly-owned subsidiary of McGraw-Hill, Inc. Address subscriptions, change of address, USPS Form 3579, and fulfillment questions to BYTE Subscriptions, POB 590, Martinsville NJ 08836. Controlled circulation postage paid at Waseca, Minnesota 56093 - USPS Publication No. 528890 [ISSN 0360-5280]. Canadian second class registration number 9321. Subscriptions are \$19 for one year, \$34 for two years, and \$49 for three years in the USA and its possessions. In Canada and Mexico, \$21 for one year, \$38 for two years, \$55 for three years. \$43 for one year air delivery to Europe. \$35 surface delivery elsewhere. Air delivery to selected areas at additional rates upon request. Single copy price is \$2.50 in the USA and its possessions, \$2.95 in Canada and Mexico, \$4.00 in Europe, and \$4.50 elsewhere. Foreign subscriptions and sales should be remitted in United States funds drawn on a US bank. Printed in United States of America.

Address all editorial correspondence to the editor at BYTE, POB 372, Hancock NH 03449. Unacceptable manuscripts will be returned if accompanied by sufficient first class postage. Not responsible for lost manuscripts or photos. Opinions expressed by the authors are not necessarily those of BYTE. Entire contents copyright © 1981 by BYTE Publications Inc. All rights reserved. Where necessary, permission is granted by the copyright owner for libraries and others registered with the Copyright Clearance Center (CCC) to photocopy any article herein for the base fee of \$1.00 per copy of the article or item plus 25 cents per page. Payment should be sent directly to the CCC, 21 Congress St, Salem MA 01970. Copying done for other than personal or internal reference use without the permission of McGraw-Hill is prohibited. Requests for special permission or bulk orders should be addressed to the publisher.

BYTE® is available in microform from University Microfilms International, 300 N Zeeb Rd, Dept PR, Ann Arbor MI 48106 USA or 18 Bedford Row, Dept PR, London WC1R 4EJ England.



Subscription WATS Line: (800) 258-5485

Office hours: Mon-Thur 8:30 AM - 4:30 PM, Friday 8:30 AM - Noon, Eastern Time

### NATIONAL ADVERTISING SALES REPRESENTATIVES:

**NORTHEAST (617) 444-3946**  
Hajar Associates  
280 Hillside Ave  
Needham Heights MA 02194

**MIDWEST (312) 966-0160**  
Hajar Associates  
5225 Old Orchard Dr  
Skokie IL 60076

**MID ATLANTIC (212) 682-5844**  
Hajar Associates  
521 Fifth Ave  
New York NY 10017

**NORTHWEST (415) 964-0706**  
Hajar Associates  
1000 Elwell Ct, Suite 227  
Palo Alto CA 94303

**SOUTHWEST (714) 540-3554**  
Hajar Associates  
3303 Harbor Blvd  
Suite K-4  
Costa Mesa CA 92626

**SOUTHEAST (305) 886-7210**  
Hajar Associates  
1220 Prairie Lane  
Apopka FL 32703

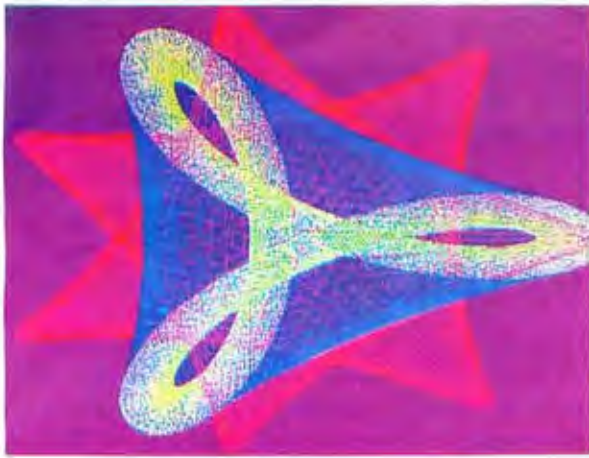

"...stands well above other S-100 graphics displays in its price and performance range."

BYTE, Product Review



"...better monochromatic display..."

ELECTRONIC DESIGN, 1981 Technology Forecast

# MICROANGELO

HIGH RESOLUTION GRAPHICS SINGLE BOARD COMPUTER

512 x 480 resolution black and white and vivid color displays

RS-170 composite or direct drive output

Local or external sync generation

4 Mhz Z80 microprocessor

60 hertz real-time clock

8 level interrupt tie-in

IEEE S100 bus compatible

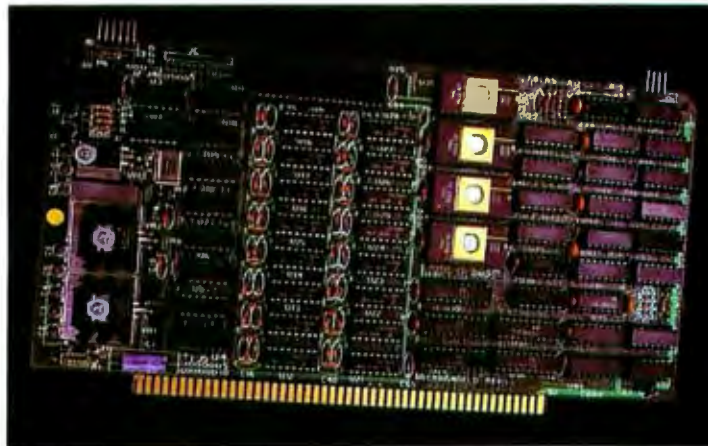

Light pen interface

Time multiplexed refresh

4K resident Screenware™ Pak I operating system

32K RAM isolated from host address space

High speed communications over parallel bus ports

## Screenware™ Pak I

A 4K byte operating system resident in PROM on MicroAngelo™. Pak I emulates an 85 character by 40 line graphics terminal and provides over 40 graphics commands. Provisions exist for user defined character sets and directly callable user extensions to Screenware™ Pak I.

## Screenware™ Pak II

An optional software superset of Pak I which adds circle generation, polygon flood, programmable split screen for separate graphics and terminal I/O, relative coordinates, faster vector and character plotting, a macro facility, full UCSD Pascal compatibility, and more.

## And now... COLOR!!

The new MicroAngelo™ Palette board treats from 2 to 8 MicroAngelos as "bit planes" at a full 512 x 480 resolution. Up to 256 colors may be chosen from 16.8 million through the programmable color lookup table. Overlays, bit plane precedence, fade-in, fade-out, gray levels, blinking bit plane, and a highly visual color editor are standard.

# SCION

8455-D Tyco Road • Vienna, Virginia 22180 • TWX: 710-831-9087 • (703) 827-0888

Circle 339 on inquiry card.

# PLAN80™

A financial modeling system that runs on a desk top computer, is easy to use yet powerful enough to replace most timesharing applications.

PLAN80 is a financial modeling system that runs on a desk top computer. It's easy to use yet powerful enough to replace most timesharing applications.

PLAN80 lets you tackle any numeric problem that can be defined in worksheet format. It performs complex calculations quickly and precisely and lets you examine "What If?" questions so you can evaluate more planning alternatives in greater detail.

With PLAN80 you get more than your calculated results. You know **how** you get them, because you define rows and columns with familiar names such as UNITS, PRICE and JANUARY and express calculations in terms such as SALES=UNITS \* PRICE. It's easy to review your assumptions and methods with people who have never seen PLAN80.

At any point in the PLAN80 model you may display or print results on your screen, printer or disk, save all or part of the results for use by another model, or play "What If?" by inputting new values, recalcu- lating and displaying or printing results.

Best of all, you can incorporate PLAN80 results into any report that requires a financial model -using your word processor to create professional results.

Anyone can use PLAN80 to create budgets, project sales or analyze costs - or even build a complex system of interrelated plans.

PLAN80 requires 56K RAM and CP/M. Also available for CP/M-86. Specify Z80, 8080/85, CDOS or 8086. Formats: 8" single density IBM soft-sectored, Cromemco CDOS, 5 1/4" NorthStar DD, Microp- olls Mod II, Superbrain 3.0. Price is \$295. Manual alone - \$30. Add \$7.00 for shipping and handling. Dealer inquiries invited.

SOFTWARE  
SOFTWARE  
DIGITAL MARKETING  
DIGITAL MARKETING

2670 CHERRY LANE  
WALNUT CREEK • CA 94596  
(415) 938-2880

CPM trademark Digital Research

## Editorial

# Smalltalk: A Language for the 1980s

by Chris Morgan, Editor in Chief

Welcome to the fifth annual BYTE language issue. Over the past four years we have devoted our August issues to discussions of APL, Pascal, LISP, and FORTH, respectively. This year we are pleased to present the Smalltalk-80 language, the culmination of ten years of research by the Xerox Learning Research Group located at the Xerox Palo Alto Research Center (PARC) in California.

During the past few months the BYTE staff has been acquainting itself with Smalltalk. I spent some time this spring working with the Smalltalk systems at Xerox PARC and being briefed by Adele Goldberg and Dave Robson. I came away excited by this revolutionary language. I hope the articles in this issue convey some of that excitement.

Smalltalk is an *object-oriented* language, as opposed to *procedure-oriented* languages such as BASIC, Pascal, and FORTRAN. Because of this, programming in Smalltalk is similar to the process of human interaction. An analogy might help to clarify this point. Suppose a person wishes to invest in a good mutual fund. He sends a telegram to his broker. The broker analyzes the current state of the market and picks what he considers to be the best mutual fund for his client. That in a very small nutshell describes the basic activity inherent in all Smalltalk programs: a message is sent to a receiver to invoke some response. In our analogy, the telegram is the message and the broker is the receiver. The telegram has two parts, called the *selector* and the *argument*. Here the selector is "buy" and the argument is "best mutual fund." The broker belongs to a *class* which contains the description of the *method* he uses to pick the best mutual fund. Because of this, the client does not have to tell the broker how to do his job.

Of course, my analogy skims only the thinnest surface of the deep waters of the Smalltalk-80 system, as you'll see when you read the articles in this issue.

When I first worked at a Smalltalk-80 computer terminal, I noticed an interesting phenomenon: I did very little typing, although a full keyboard was available to me. This is because of the window menu format and the presence of the "mouse," a small mechanical box with wheels that lets you quickly move the cursor around the screen. (Stoney Ballard of Digital Equipment Corporation, who has been doing research work lately with the Smalltalk-80 system, points out that he was able to do a significant amount of programming with his experimental system over several weeks even though his keyboard was not working.) Choosing a particular item in a list from a window causes another window to appear on the screen. Additional levels of nested windows can be accessed by continuing to reposition the cursor and pressing the appropriate key on the mouse.

This makes for *fast* programming. Those who saw the remarkable demonstration of the Xerox Star terminal (Xerox's new \$16,000 office terminal) at the National Computer Conference (NCC) this past spring got a taste of what a programming environment can do for productivity.

Smalltalk allows the user to solve more problems without becoming a computer expert. Larry Tesler from Apple (who wrote "The Smalltalk Environ-

Smalltalk-80 is a trademark of Xerox Corporation.



Percom Mini-Disk Drive Systems for TRS-80\* Computers...

## Now! Add-On and Add-In Mini-Disk Storage for your Model III.



The industry leader in microcomputer peripherals, Percom not only gives you better design, better quality and first-rate service, but you pay less to boot.

### Still #1 for Model I

As if greater storage capacities, exceptional quality control measures and lower prices aren't reasons enough to make Percom your first choice for Model I add-on drives, all Percom Model I drives are also rated for double-density operation.

Add our innovative DOUBLER™ adapter to your Model I Expansion Interface, and with Percom drive systems you can enjoy the same double-density storage capability as Model III owners.

The DOUBLER includes a TRSDOS\*-like double-density disk operating system called DBLDOS™

We also offer a double-density Model I version of OS-80 as well as DOUBLEZAP programs for modifying NEWDOS/80 and VTOS 4.0+ for DOUBLER compatibility.

Of course you don't have to upgrade your computer for double-density operation to use Percom mini-disk drive systems. In single-density operation, our TRS-80\* Model I compatible 40-track drives store 102 Kbytes of formatted data on one side of a diskette, and our 80-track drives store 205 Kbytes. By comparison, Tandy's standard drive for the Model I stores just 86 Kbytes.

And like our Model III drives, Model I add-on drives are optionally available with "flippy" storage capability.

### System Requirements:

**Model III:** 16-Kbyte system (min) and Model III BASIC. The second internal drive may be installed after the first internal drive kit is installed, and external drives #2, #3 and #4 may be added if either an internal or external first-drive kit has been installed. External drives #3 and #4 require an optional interconnecting cable.

**Model I:** 16-Kbyte system (min), Level II BASIC, Expansion Interface, disk operating system and an interconnecting cable. For double-density storage, a Percom DOUBLER must be installed in the Expansion Interface and DBLDOS (comes with the DOUBLER) or other double-density DOS must be used. For single-density operation, a Percom SEPARATOR™ adapter, installed in the Expansion Interface, will virtually eliminate "CRC ERROR — TRACK LOCKED OUT" read errors. Prices and specifications subject to change without notice.

### New for the TRS-80\* Model III

Patterned after our fast-selling TFD Model I drives. And subjected to the same reliability controls. These new TFD mini-disk systems for the Model III provide more features than Tandy drives, yet cost far less.

- **Flippy Capability:** Both internal (add-in) and external (add-on) drives permit recording on either side of a diskette.
- **Greater Storage Capacity:** Available with either 40- or 80-track drive mechanisms, Percom TFD mini-disk systems store more. A 40-track drive stores up to 180 Kbytes — formatted — on one side of a 5-inch diskette. An 80-track drive stores a whopping 364 Kbytes.
- **1.5 Mbyte On-line:** The Percom drive controller (included with the initial drive) handles up to four drives. With four 80-track mini-disk drives you can access over 1.5 million bytes of on-line file data.

Moreover, the initial drive may be either an internal add-in drive or an external add-on drive. And whichever configuration you get, the initial drive kit comes complete with our advanced 4-drive controller, interconnecting cables, power supplies, installation hardware, a DOS and of course the drive mechanism itself.

- **First Drive Includes DOS:** OS-80™, Percom's fast extendable BASIC-language disk operating system, is included on diskette when you purchase an initial drive kit. Originally called MicroDOS, OS-80 was favorably reviewed in the June 1980 issue of Creative Computing magazine.
- **Works with Model III TRSDOS:** Besides being fully hardware compatible, Percom's Model III 40-track drive systems may be operated with Tandy's Model III TRSDOS — without any modifications whatsoever. And, TRSDOS may be easily upgraded with simple software patches for operating 80-track drives.

Percom TFD add-on drives start at only \$399. Model III Drive kits start at only \$749.95.

Quality Percom products are available at authorized dealers. Call toll free 1-800-527-1592 for the address of your nearest dealer or to order direct from Percom.

**PERCOM**

PERCOM DATA COMPANY, INC.  
211 N. KIRBY GARLAND, TEXAS 75042  
(214) 272-3421

\*Trademark of Tandy Radio Shack Corporation which has no relationship to Percom Data Company.  
™DOUBLER, DBLDOS, OS-80 and SEPARATOR are trademarks of Percom Data Company, Inc.  
†Trademark of Virtual Technology Corporation.



FOR ANY  $\epsilon$   
THERE IS A  $\delta^*$

WHY LET ONE MAINFRAME DEFINE

OUR WELL-DIFFERENTIATED  
ARE CALCULATED  
SYSTEMS INTEGRATION

### A simple algorithm

We work with the serious systems integrator... on terms that make sense to you. That means giving you a set of products which expand your limits, not reduce them.

We manufacture the most complete family of high quality IEEE/696 S-100 mainframes on the market. Choices include three mainframes in rack-mount or table-top packages with complete board sets, to serve as the building blocks for your 8 or 16 bit system. We also provide other options ranging from complete floppy disk systems right up to our proven Pascal development system.

### The $\int$ factor: one source.

No matter which option you choose, you get the benefit of working with completely integrated products... fully assembled and tested... under one warranty and one price structure... leaving you free to concentrate on value-added application development and sales.

### Choose from mainframe options...

Select from three packaging options: Rack-mount, table-top or front panel models. All three feature our 20 slot S-100 motherboard with 25 amp power supply and are delivered fully assembled and tested with our Series II™ board sets. Any board configuration you choose works with any DPS-1 version, allowing you to vary your package offering, or develop on one version and market another.

- ◆ Front Panel model — a powerful development and diagnostic tool for Z-80† systems, which can be used for prototyping, servicing, debugging, and software or hardware development. Use its features to set breakpoints, trigger scopes, single step, slow step and more.

- ◆ Front Panelless desk top model—a lower cost option for OEM or other turnkey operations which do not require the extra capability of our Front Panel.

- ◆ Rack Mount version — features a heavy gauge frame designed to fit into standard 19" racks. CVT power supply for brown out immunity is standard.

\*In Calculus, a fundamental statement in the definition of limit; interpreted here to imply: "For your integration problem, Intersystems has a solution."

† Registered trademark of Zilog, Inc.

YOUR LIMITS?

OPTIONS  
TO SOLVE YOUR  
PROBLEMS.

- 6 SI/O — six individually software-controllable serial I/O ports with optional interrupts. Each can run RS 232 at up to 19,200 BAUD, as can our VI/O board.
- VI/O—has two serial ports; two 8-bit parallel output and two 8-bit parallel input ports plus 8 individually controllable command lines and 16 levels of vectored interrupts.
- FDC II—can DMA up to a full track into 16 Megabytes of memory. Optionally generates interrupts and handles up to four 8" floppies.
- MPU-8000 — available with the non-segmented Z-8002<sup>†</sup>, which directly addresses 64K, or the segmented Z-8001<sup>†</sup>, which can directly address 8 Megabytes.

#### Extended systems options...



Interfacing disk drives is not a trivial matter, so when your objectives and resources dictate you spend your energy elsewhere, use our resources to perform the service for you. We can add our disk drive package to any Z-80 or Z-8000 configuration we provide ... again, fully assembled and tested and covered under one warranty.

#### Or our complete Pascal Development System.

We use it for our own hardware and software development. It includes either table-top mainframe, two 8" floppy disks, 128K RAM, CP/M<sup>®</sup>, and Intersystems Pascal/Z<sup>™</sup> compiler and Cache BIOS<sup>™</sup>. THIS SYSTEM IS FAST! Why? Because our ultra-fast Cache BIOS automatically buffers whole tracks, eliminating most disk accesses. This delivers up to three times the throughput of any other floppy-based system we know and is equal to many small hard disk systems.

The system is versatile, too. SET program allows you to change many BIOS parameters and specify control characters to enable special features such as diagnostic output to trace program execution. It can also provide remote I/O to link your system to almost any other computer, large or small.



And it's reliable. The Cache BIOS System runs continuous memory tests when idle, and verifies with a Read after Write and Read after Read.

And the system also includes our Pascal/Z, a true native compiler producing ROMable and Re-entrant code. It features a minimum of extensions chosen for the development of your scientific and business applications. And it's compatible with our native code Pascal for Z-8000, providing a graceful upward path to 16 bit applications. So what you write now is right later.

#### One choice you won't have to make...

We don't believe you should ever have to sacrifice good technical support to find a good product. We'll back you to the hilt with services like free technical consultation, board-swapping, diagnostic packages, and documentation that gives you all you need to integrate, operate and maintain your system ... right down to schematics of the boards.

#### Your solution should be clear.

Whether you're integrating for scientific, governmental or commercial applications, Intersystems can provide a Delta for your Epsilon.

#### Talk to us today.

Ithaca Intersystems Inc.,  
Dept. B  
1650 Hanshaw Road,  
P.O. Box 91  
Ithaca, NY 14850

Phone  
(607) 257-0190



#### Board level options...

Intersystems mainframe packages, equipped with Series II boards, are operational in both 8 and 16 bit settings and support extended addressing in both I/O and memory space, recognizing 16 bit I/O addresses and 24 bit memory addresses. Just look at these individual features:



- MPU-80—uses a Z-80, 8 vectored interrupt lines and two 4K windows to address up to 1 Megabyte of RAM without bank select.
- 64KDR—sophisticated refresh circuitry allows unlimited DMA and absolutely reliable operation without wait states.

**InterSystems<sup>™</sup>**  
Ithaca Intersystems Inc.  
**Micros for bigger ideas.**

Circle 180 on inquiry card.

# High Technology

We make our competition obsolete

with Information Master,<sup>TM</sup> Data Master,<sup>TM</sup> and Transit.<sup>TM</sup>

Information Master is clearly the best information management software available for your Apple II,\* and it's the easiest to use.

Here are two very useful companions that add even more power to Information Master.

- Data Master — Alter the file layout of existing Information Master files without re-entering data. Add, omit, change fields, subdivide and append files selectively.
- Transit — Convert VisiCalc\* files (and almost any other files you may have) into Information Master files.

See your computer dealer today for all the details.

\* VisiCalc is a trademark of Personal Software, Inc.  
Apple II is a trademark of Apple Computer, Inc.



**High Technology, Inc.**  
Software Products Division  
P.O. Box B-14665  
8001 N. Classen Blvd.  
Oklahoma City, Okla. 73113  
405 840-9900

\*Apple II is a trade name of Apple Computer, Inc.

## Editorial

ment" on page 90) spoke about the efficiency of the language at the NCC. For example, suppose a user is running a complex program that churns away for nearly an hour—then a bug appears in the output routine. All is not lost. Since the Smalltalk-80 language is "modeless" (a concept Tesler discusses in his article), the user can debug the output routine and continue with the main routine without having to start from the beginning. This is only one of the advantages of the Smalltalk-80 system.

### Where to Start

The order in which you read the Smalltalk-80 articles in this issue makes a difference. The first stopping point should be Adele Goldberg's article "Introducing the Smalltalk-80 System" on page 14, in which she provides a guided tour of the issue. I also recommend Dave Robson's "Object-Oriented Software Systems" on page 74 as a good overview of the Smalltalk-80 philosophy. The glossary on page 48 will be helpful as you begin to absorb the rather extensive (and sometimes overwhelming) vocabulary used to describe the language. I found that, once the terms become familiar, the concepts begin to make elegant sense.

### When Can I Buy It?

There are currently no personal computer implementations of the Smalltalk-80 language. Because of this, I'm sure we'll be criticized by some for introducing the language too early and frustrating our readers. Nevertheless, I feel that the time to begin exposing people to object-oriented language is *now*. Only by challenging and enticing the personal computer community can we stimulate the industry to create the machines we all dream of.

As far as future hardware hopes are concerned, it is interesting to note that four of the speakers at the recent NCC Smalltalk-80 symposium were from Digital Equipment Corporation, Apple Computer Company, Tektronix, and Hewlett-Packard. All four research representatives were quick to point out that their companies are not necessarily working on Smalltalk products, but are rather exploring the language's potential. Despite the disclaimers, though, I would be very surprised if we do not see a computer with the Smalltalk-80 system built in sometime in the next few years—perhaps sooner. I hope this issue brings that dream closer. ■

### Acknowledgments

*I wish to express my appreciation to Adele Goldberg and Dave Robson at Xerox PARC for their invaluable help in preparing this special issue—and especially to Adele for coordinating the many authors who contributed their expertise. I'd also like to thank Gregg Williams for his editorial skills in preparing this issue . . . CM*

# Make the Apple II\* a powerful IEEE-488 Controller in a snap.

**Just plug the SSM A488 board into any Apple II\* expansion slot for a low-cost, full-featured instrumentation interface.** SSM gives the Apple II the power and versatility of a \$9,000 IEEE-488 controller. At a fraction of the price. Our board converts the Apple II into a truly sophisticated controller that programs and controls up to 15 different instruments connected together on the 488 bus.

**We make programming easy.** The 68488 chip, designed by Motorola, forms the heart of our A488. We back this chip with powerful on-board firmware to give you system control via simple string commands. The only software you need is easy-to-program Applesoft\* Basic. To develop special purpose firmware, simply replace our PROM with a RAM. With the A488, bus communications operate at top speed—without depending on software loops for timing. And like the more expensive IEEE-488 controllers, this system interfaces with more than 1200 instruments and peripherals.

**Suitable for OEMs as well as end users.** Whether you make test/measurement systems for resale, or simply for yourself, the SSM/Apple combo gives you top performance. As it cuts your costs. Call your local dealer or SSM today for complete details.

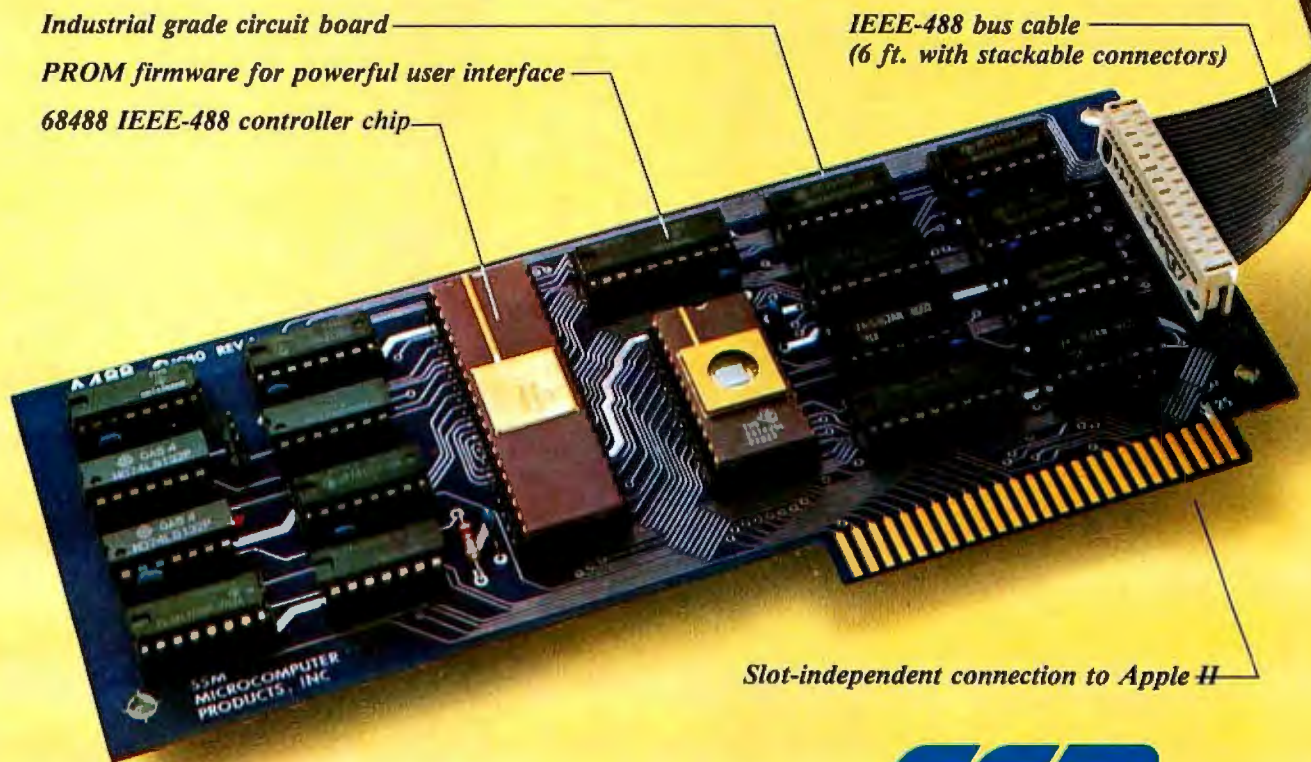

*SSM's A488 board expands the Apple II to a high-performance IEEE-488 controller.*

\*Registered trademarks of Apple Computer Inc.



**SSM Microcomputer Products, Inc.**  
2190 Paragon Drive  
San Jose, CA 95131  
(408) 946-7400 Telex: 171171  
TWX: 910-338-2077

**Reddy Chirra improves his vision with an Apple.**

**Reddy is an optical engineer who's used to working for big companies and using big mainframes.**

**But when he started his own consulting business, he soon learned how costly mainframe time can be. So he bought himself a 48K Apple II Personal Computer.**

**And, like thousands of other engineers**



**and scientists, quickly learned the pleasures of cutting down on shared time and having his own tamper-proof data base.**

**His Apple can handle formulas with up to 80 variables and test parameters on 250 different optical glasses.**

**He can even use BASIC, FORTRAN, Pascal and Assembly languages.**

**And Apple's HI-RES graphics come in handy for design.**

**Reddy looked at other microcomputers, but chose Apple for its in-depth documentation, reliability and expandability.**

**You can get up to 64K RAM in an Apple II. Up to 128K RAM in our new Apple III. And there's a whole family of compatible peripherals, including an IEEE-488 bus for laboratory instrument control.**

**Visit your authorized Apple dealer to find out how far an Apple can go with scientific/technical applications.**

**It'll change the way you see things.**



**The personal computer.**  **apple**

# Introducing the Smalltalk-80 System

---

Adele Goldberg  
Manager, Learning Research Group  
Xerox Palo Alto Research Center  
3333 Coyote Hill Rd  
Palo Alto CA 94304

---

*It is rare when one can indulge in one's prejudices with relative impunity, poking a bit of good humored fun to make a point.*

With this statement, Carl Helmers opened his remarks in the "About the Cover" section of the August 1978 issue of *BYTE*. The issue was a special on the language Pascal, so Helmers took the opportunity to present Pascal's triangle as drawn by artist Robert Tinney. The primary allegory of the cover was the inversion of the Bermuda Triangle myth to show smooth waters within the area labeled "Pascal's Triangle." In explaining the allegory, Helmers guided the traveler through the FORTRAN Ocean, the BASIC Sea, around the Isle of BAL, and up to the Land of Smalltalk.

*Traveling upward (in the picture) through heavy seas we come to the pinnacle, a snow white island rising like an ivory tower out of the surrounding shark infested waters. Here we find the fantastic kingdom of Smalltalk, where great and magical things happen. But alas . . . the craggy aloofness of the kingdom of Smalltalk keeps it out of the mainstream of things.*

It is rare when one can indulge in one's fantasies to respond to so pointed a remark as that provided by the

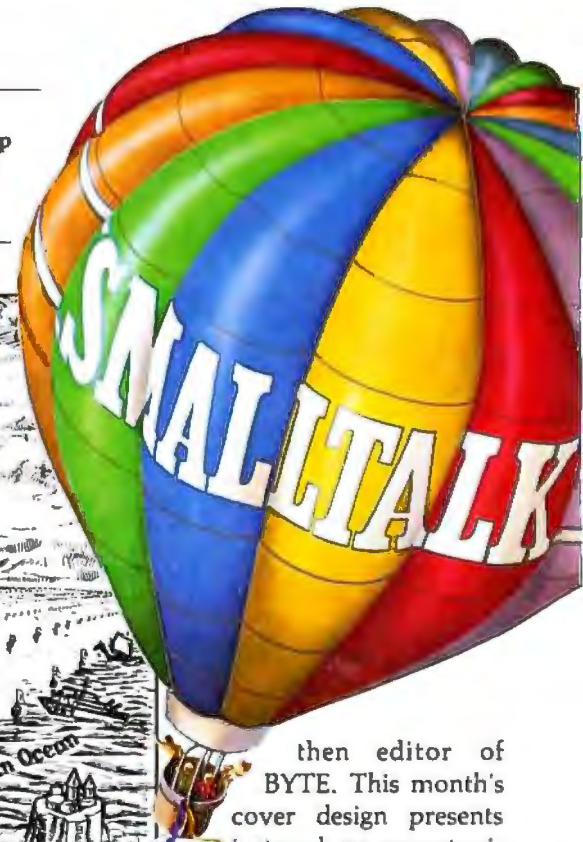

then editor of *BYTE*. This month's cover design presents just such an opportunity. It depicts the clouds clearing from around the kingdom of Smalltalk, and, with banners streaming, the Smalltalk system is taking flight into the mainstream of the computer programming community. This cover was also executed by Robert Tinney, to the delight of

the Learning Research Group (LRG) of the Xerox Palo Alto Research Center. LRG is the group that has designed, implemented, and evaluated several generations of Smalltalk over the past ten years.

The balloon on the cover symbolizes the Smalltalk-80 system that is being released this year for more general access. The release is in the form of publications and a file containing the Smalltalk-80 programming system. Twelve articles describing the system appear in this issue of *BYTE*. Through such publication, LRG's research will become generally accessible, dispelling the clouds.

Smalltalk is the name LRG assigned to the software



# TRS-80\* COMPUTING EDITION

©1981 Percom Data Co., Inc.

The Percom Peripheral

35 cents

## Percom's DOUBLER II™ tolerates wide variations in media, drives

GARLAND, TEXAS — May 22, 1981 — Harold Mauch, president of Percom Data Company, announced here today that an improved version of the Company's innovative DOUBLER™ adapter, a double-density plug-in module for TRS-80\* Model I computers, is now available.

Reflecting design refinements based on both theoretical analyses and field testing, the DOUBLER II™, so named, permits even greater tolerance in variations among media and drives than the previous design.

Like the original DOUBLER, the DOUBLER II plugs into the drive controller IC socket of a TRS-80 Model I Expansion Interface and permits a user to run either single- or double-density diskettes on a Model I.

With a DOUBLER II installed, over four times more formatted data — as much as 364 Kbytes — can be stored on one side of a five-inch diskette than can be stored using a standard Tandy Model I drive system.

Moreover, a DOUBLER II equips a Model I with the hardware required to run Model III diskettes.

(Ed. Note: See "OS-80™: Bridging the TRS-80\* software compatibility gap" elsewhere on this page.)

The critical clock-data separation circuitry of the DOUBLER II is a proprietary design called a ROM-programmed digital phase-lock loop data separator.

According to Mauch, this design is more tolerant of differences from diskette to diskette and drive to drive, and also provides immunity to performance degradation caused by circuit component aging.

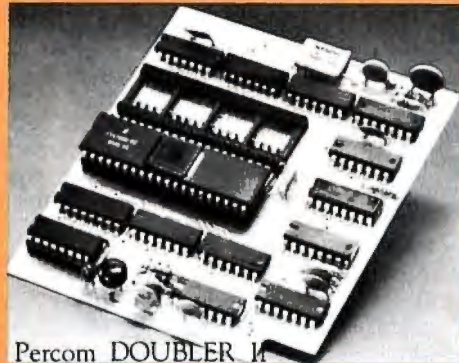

Percom DOUBLER II

Mauch said "A DOUBLER II will operate just as reliably two years after it is installed as it will two days after installation."

The digital phase-lock loop also eliminates the need for trimmer adjustments typical of analog phase-lock loop circuits.

"You plug in a Percom DOUBLER II and then forget it," he said.

The DOUBLER II also features a refined Write Precompensation circuit that more effectively minimizes the phenomena of bit-and-peak-shifting, a reliability-impairing characteristic of magnetic data recording.

The DOUBLER II, which is fully software compatible with the previous DOUBLER, is supplied with DBLDOS™, a TRSDOS\*-compatible disk operating system.

The DOUBLER II sells for \$29.95, including the DBLDOS diskette.

~~\$29.95~~  
Now \$16.95!

Owners of original DOUBLERs may purchase a DOUBLER II upgrade kit, without the disk controller IC, for \$30.00. Proof of purchase of an original DOUBLER is required, and each DOUBLER owner may purchase only one DOUBLER II at the \$30.00 price.

The Percom DOUBLER II is available from authorized Percom retailers, or may be ordered direct from the factory. The factory toll-free order number is 1-800-527-1592.

Ed. note: Opening the TRS-80 Expansion Interface may void the Tandy limited 90-day warranty. Circle 306 on Inquiry card.

## All that glitters is not gold OS-80™ Bridging the TRS-80\* software compatibility gap

Compatibility between TRS-80\* Model I diskettes and the new Model III is about as genuine as a gold-plated lead Krugerrand.

True, Model I TRSDOS\* diskettes can be read on a Model III. But first they must be converted and re-recorded for Model III operation.

And you cannot write to a Model I TRSDOS\* diskette. Not with a Model III. You cannot add a file. Delete a file. Or in any way modify a Model I TRSDOS diskette with a Model III computer.

Furthermore, your converted TRSDOS diskettes cannot be converted back for Model I operation.

TRSDOS is a one-way street. And there's no retreating. A point to consider before switching the company's payroll to your new Model III.

Real software compatibility should allow the direct, immediate interchangeability of Model I and Model III diskettes. No read-only limitations, no conversion/re-recording steps and no chance to be left high and dry with Model III diskettes that can't be run on a Model I.

What's the answer? The answer is Percom's OS-80™ family of TRS-80 disk operating systems.

OS-80 programs allow direct, immediate interchangeability of Model I and Model III diskettes.

You can run Model I single-density diskettes on a Model III; install Percom's plug-in DOUBLER™ adapter in your Model I, and you can run double-density Model III diskettes on a Model I.

There's no conversion, no re-recording. Slip an OS-80 diskette out of your Model I and insert it directly in a Model III.

And vice-versa. Just have the correct OS-80 disk operating system — OS-80, OS-80D or OS-80/III — in each computer.

Moreover, with OS-80 systems, you can add, delete, and update files. You can read and write diskettes regardless of the system of origin.

OS-80 is the original Percom TRS-80 DOS for BASIC programmers.

Even OS-80 utilities are written in BASIC. OS-80 is the Percom system about which a user wrote, in Creative Computing magazine, "... the best \$30.00 you will ever spend."

Requiring only seven Kbytes of memory, OS-80 disk operating systems reside completely in RAM. There's no need to dedicate a drive exclusively for a system diskette.

And, unlike TRSDOS, you can work at the track sector level, defining and controlling data formats — in BASIC — to create simple or complex data structures that execute more quickly than TRSDOS files.

The Percom OS-80 DOS supports single-density operation of the Model I computer — price is \$29.95; the OS-80D supports double-density operation of Model I computers equipped with a DOUBLER or DOUBLER II; and, OS-80/III — for the Model III of course — supports both single- and double-density operation. OS-80D and OS-80/III each sell for \$49.95.

## Circuit misapplication causes diskette read, format problems. High resolution key to reliable data separation

GARLAND, TEXAS — The Percom SEPARATOR™ does very well for the Radio Shack TRS-80\* Model I computer what the Tandy disk controller does poorly at best: reliably separates clock and data signals during disk-read operations.

Unreliable data-clock separation causes format verification failures and repeated read retries.

### CRC ERROR—TRACK LOCKED OUT

The problem is most severe on high-number (high-density) inner file tracks.

As reported earlier, the clock-data separation problem was traced by Percom to misapplication of the internal separator of the 1771 drive controller IC used in the Model I.

The Percom Separator substitutes a high-resolution digital data separator circuit, one which operates at 16 megahertz, for the low-resolution one-megahertz circuit of the Tandy design.

Separator circuits that operate at lower frequencies — for example, two- or four-

megahertz — were found by Percom to provide only marginally improved performance over the original Tandy circuit.

The Percom solution is a simple adapter that plugs into the drive controller of the Expansion Interface (EI).

Not a kit — some vendors supply an untested separator kit of resistors, ICs and other paraphernalia that may be installed by modifying the computer — the Percom SEPARATOR is a fully assembled, fully tested plug-in module.

Installation involves merely plugging the SEPARATOR into the Model I EI disk controller chip socket, and plugging the controller chip into a socket on the SEPARATOR.

The SEPARATOR, which sells for only \$29.95, may be purchased from authorized Percom retailers or ordered directly from the factory. The factory toll-free order number is 1-800-527-1592.

Ed. note: Opening the TRS-80 Expansion Interface may void the Tandy limited 90-day warranty. Circle 307 on Inquiry card.

PRICES AND SPECIFICATIONS SUBJECT TO CHANGE WITHOUT NOTICE.

PRICES DO NOT INCLUDE HANDLING AND SHIPPING.

PERCOM DATA COMPANY, INC. 211 N. Kirby Street Garland, Texas 75042 (214) 272-3421

\*Trademark of Percom Data Company, Inc. \*TRS-80 and TRSDOS are trademarks of Tandy Corporation which has no relationship to Percom Data Company. †Creative Computing Magazine, June, 1980, page 26.

# TWELVE STRONG HEATH/ZENITH YOUR

## Pick a strong partner

A computer purchase is the beginning of a long term partnership between you and the people you buy from. Your ongoing need for software and accessories requires a partner who will stand by you with a growing line of products. And nowhere will you find a more complete line of hardware, software and accessories than at your Heathkit Electronic Center. Here are twelve strong reasons to make Heath/Zenith your partner.

### 1. The All-In-One Computer

The heart of the Heath/Zenith line is the stand-alone *89 Computer*. It's a complete system with built-in 5¼-inch floppy disk drive, professional keyboard and keypad, smart video terminal, two Z80 microprocessors, and two RS-232C serial I/O ports. It comes with 16K RAM, expandable to 64K.

### 2. Peripherals

These include the popular *Heath/Zenith 19 Smart Video Terminal*, loaded with professional features. And the *14 Line Printer*, priced as low as \$495. Other printer brands are on display, including high-speed, typewriter-quality printers.



### 3. Software

*Word processing*, includes reliable, easy-to-use Zenith Electronic Typing and powerful, full-featured WORDSTAR.

*Small Business Programs*, feature General Ledger and Inventory Control.

*HUG, Heath Users' Group*, offers members a library of over 500 low-cost programs for home, work or play.

### 4. Programming Languages



For your own custom programs, Microsoft languages are available in BASIC (compiler and interpreter), FORTRAN and COBOL.

### 5. Operating Systems

Three versatile systems give you the capability to perform your specific tasks.

*CP/M by Digital Research* makes your system compatible with thousands of popular CP/M programs.

*UCSD P-System with Pascal* is a complete program development and execution environment.

*HDOS, Heath Disk Operating System* gives you a sophisticated, flexible environment for program construction, storage and editing.

### 6. Utility Software

Expand the performance range of your computer with a broad selection of utility tools, including the best of *Digital Research* and the complete line of innovative *Softstuff* products.

### 7. Disk Systems

The 8-inch *Heath/Zenith 47 Dual Disk System* adds over 2 megabytes of storage to your



89 Computer. Diskettes are standard IBM 3740 format, double-sided, double-density.

The 5¼-inch *87 Dual Disk System* adds 200K bytes of storage to your 89. Both disk systems feature read/write protection and easy plug-in adaptability.



### 8. Self-Study Courses

Learn at your own pace with *Programming Courses* that teach you to write and run your own programs in Assembly, BASIC, Pascal or COBOL.

A course on *Computer Concepts for Small Business* gives you the understanding to evaluate the ways a computer can benefit your business.

*Personal Computing* is a complete introduction to the fundamentals for the novice. Every Heathkit/Zenith course is professionally designed for easy, step-by-step learning.

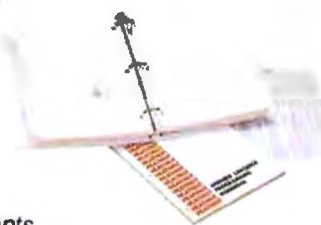

All Heath/Zenith Computer Products are available completely assembled and tested for commercial use. Or in easy-to-build, money-saving kits.

# REASONS TO MAKE COMPUTER PARTNER

## 9. Expansion Options

Communicate with the outside world through a *Three-port EIA RS-232C Serial Interface*.

Expand RAM to 64K with easy-to-install *expansion chips*.

## 10. Accessories



Your Heathkit Electronic Center has the latest in modems, black-and-white and color video monitors, computer furniture and a full line of supplies, accessories, books and parts.

## 11. Service

No one stands by you like Heath/Zenith. We help you get your system up and running smoothly. Service is available from trained technicians, over the phone or at one of 56 Heathkit Electronic Centers.



## 12. Value

Your money buys you more because Heath/Zenith prices are among the industry's most competitive. Make your own comparison and find out how much you can save.

Complete, integrated computer hardware and software, designed to serve you and to grow with you — that's what to look for in a strong partner. And with Heath/Zenith you get it all under one roof.

## All at your Heathkit Electronic Center

Pick the store nearest you from the list at right. And stop in today for a demonstration of the Heath/Zenith 89 Computer System. If you can't get to a store, send \$1.00 for the latest Heathkit® Catalog and the new Zenith Data Systems Catalog of assembled commercial computers. Write to Heath Co., Dept. 334-804, Benton Harbor, MI 49022.

## Visit Your Heathkit Electronic Center\*

where Heath/Zenith Products are displayed, sold and serviced.

- |  |  |   |
|--|--|---|
| <b>PHOENIX, AZ</b><br>2727 W. Indian School Rd.<br>602-279-6247  | <b>MISSION, KS</b><br>5960 Lamar Ave.<br>913-362-4486            | <b>CLEVELAND, OH</b><br>28100 Chagrin Blvd.<br>216-292-7553           |
| <b>ANAHEIM, CA</b><br>330 E. Ball Rd.<br>714-776-9420            | <b>LOUISVILLE, KY</b><br>12401 Shelbyville Rd.<br>502-245-7811   | <b>COLUMBUS, OH</b><br>2500 Morse Rd.<br>614-475-7200                 |
| <b>CAMPBELL, CA</b><br>2350 S. Bascom Ave.<br>408-377-8920       | <b>KENNER, LA</b><br>1900 Veterans Memorial Hwy.<br>504-467-6321 | <b>TOLEDO, OH</b><br>48 S. Byrne Rd.<br>419-537-1887                  |
| <b>EL CERRITO, CA</b><br>6000 Potrero Ave.<br>415-236-8870       | <b>BALTIMORE, MD</b><br>1713 E. Joppa Rd.<br>301-661-4446        | <b>WOODLAWN, OH</b><br>10133 Springfield Pike<br>513-771-8850         |
| <b>LA MESA, CA</b><br>8363 Center Dr.<br>714-461-0110            | <b>ROCKVILLE, MD</b><br>5542 Nicholson Lane<br>301-881-5420      | <b>OKLAHOMA CITY, OK</b><br>2727 Northwest Expressway<br>405-848-7593 |
| <b>LOS ANGELES, CA</b><br>2309 S. Flower St.<br>213-749-0261     | <b>PEABODY, MA</b><br>242 Andover St.<br>617-531-9330            | <b>FRAZER, PA</b><br>630 Lancaster Pike<br>(Rt. 30)<br>215-647-5555   |
| <b>POMONA, CA</b><br>1555 N. Orange Grove Ave.<br>714-232-3543   | <b>WELLESLEY, MA</b><br>165 Worcester Ave.<br>617-237-1510       | <b>PHILADELPHIA, PA</b><br>6318 Roosevelt Blvd.<br>215-288-0180       |
| <b>REDWOOD CITY, CA</b><br>2001 Middlefield Rd.<br>415-365-8155  | <b>DETROIT, MI</b><br>18645 W. Eight Mile Rd.<br>313-535-6480    | <b>PITTSBURGH, PA</b><br>3482 Wm. Penn Hwy.<br>412-824-3564           |
| <b>SACRAMENTO, CA</b><br>1860 Fulton Ave.<br>916-486-1575        | <b>E. DETROIT, MI</b><br>18149 E. Eight Mile Rd.<br>313-772-0416 | <b>WARWICK, RI</b><br>558 Greenwich Ave.<br>401-738-5150              |
| <b>WOODLAND HILLS, CA</b><br>22504 Ventura Blvd.<br>818-883-0531 | <b>HOPKINS, MN</b><br>101 Shady Oak Rd.<br>612-938-6371          | <b>DALLAS, TX</b><br>2715 Ross Ave.<br>214-826-4053                   |
| <b>DENVER, CO</b><br>5940 W. 38th Ave.<br>303-422-3408           | <b>ST. PAUL, MN</b><br>1645 White Bear Ave.<br>612-778-1211      | <b>HOUSTON, TX</b><br>1704 W. Loop N.<br>713-869-5263                 |
| <b>AVON, CT</b><br>395 W. Main St. (Rt. 44)<br>203-678-0323      | <b>BRIDGETON, MD</b><br>3794 McKelvey Rd.<br>314-291-1850        | <b>SAN ANTONIO, TX</b><br>7111 Blanco Road<br>512-341-8876            |
| <b>HIALEAH, FL</b><br>4705 W. 16th Ave.<br>305-823-2280          | <b>OMAHA, NE</b><br>9207 Maple St.<br>402-391-2071               | <b>MIDVALE, UT</b><br>58 East 7200 South<br>801-566-4626              |
| <b>PLANTATION, FL</b><br>7173 W. Broward Blvd.<br>305-791-7300   | <b>ASBURY PARK, NJ</b><br>1013 State Hwy. 35<br>201-775-1231     | <b>ALEXANDRIA, VA</b><br>6201 Richmond Hwy.<br>703-765-5515           |
| <b>TAMPA, FL</b><br>4019 W. Hillsborough Ave.<br>813-886-2541    | <b>FAIR LAWN, NJ</b><br>35-07 Broadway (Rt. 4)<br>201-791-6935   | <b>VIRGINIA BEACH, VA</b><br>1055 Independence Blvd.<br>804-460-0997  |
| <b>ATLANTA, GA</b><br>5285 Roswell Rd.<br>404-252-4341           | <b>AMHERST, NY</b><br>3476 Sheridan Dr.<br>716-835-3090          | <b>SEATTLE, WA</b><br>505 8th Ave. N.<br>206-682-2172                 |
| <b>CHICAGO, IL</b><br>3462-66 W. Devon Ave.<br>312-583-3920      | <b>JERICHO, L.I. NY</b><br>15 Jericho Turnpike<br>516-334-8181   | <b>TUKWILA, WA</b><br>15439 53rd Ave. S.<br>206-246-5358              |
| <b>DOWNERS GROVE, IL</b><br>224 Ogden Ave.<br>312-852-1304       | <b>ROCHESTER, NY</b><br>937 Jefferson Rd.<br>716-424-2560        | <b>MILWAUKEE, WI</b><br>5215 W. Fond du Lac<br>414-873-8250           |
| <b>INDIANAPOLIS, IN</b><br>2112 E. 62nd St.<br>317-257-4321      | <b>N. WHITE PLAINS, NY</b><br>7 Reservoir Rd.<br>914-761-7690    | *Units of Veritechnology<br>Electronics Corporation in<br>the U.S.    |

Prices and specifications subject to change without notice.

## HEATH/ZENITH

### Your strong partner

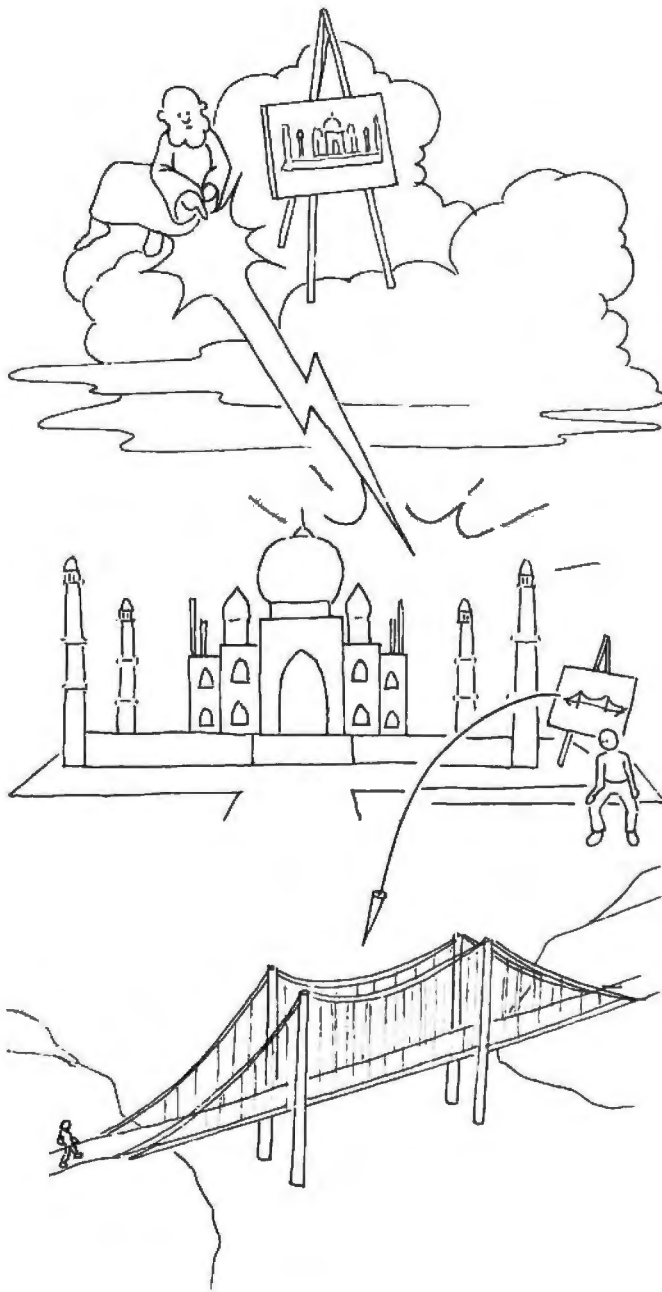

Figure 1

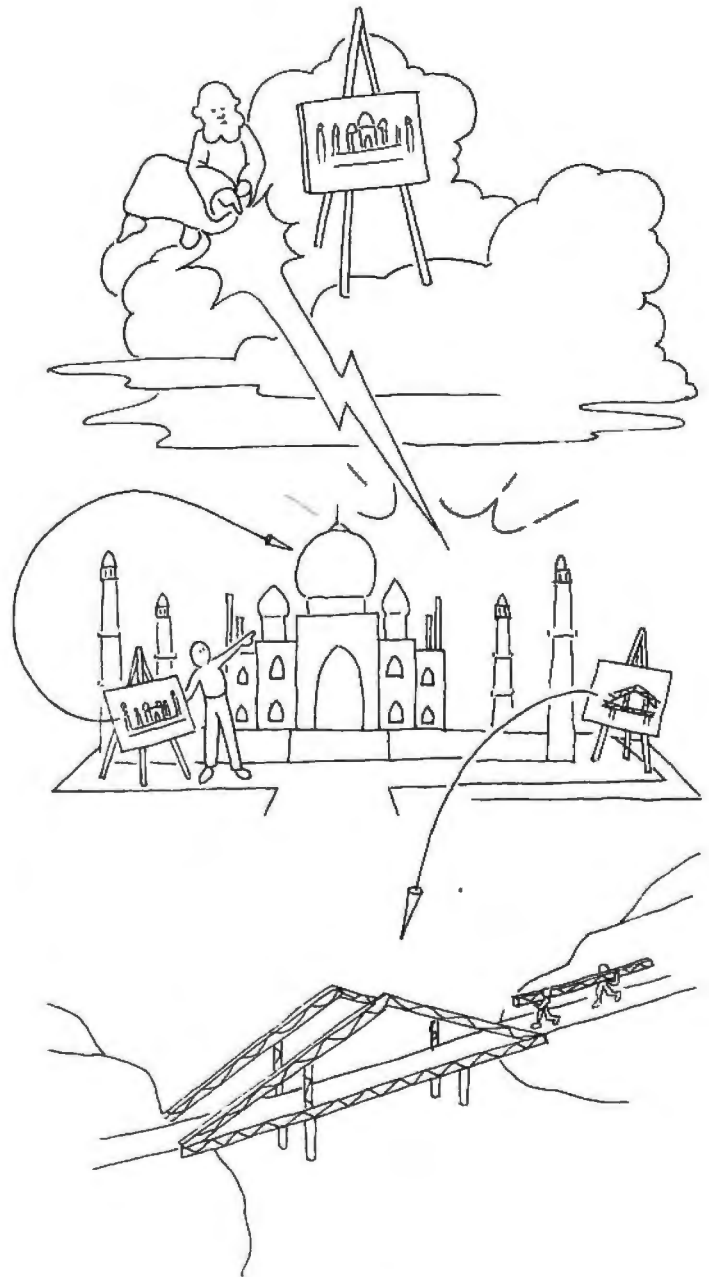

Figure 2

part of Alan Kay's personal computing vision, the Dynabook. The vision is a hand-held, high-performance computer with a high-resolution display, input and output devices supporting visual and audio communication paths, and network connections to shared information resources. LRC's goal is to support an individual's ability to use the Dynabook creatively. This requires an understanding of the interactions among language, knowledge, and communication. To this end, LRC does research on the design and implementation of programming languages, programming systems, data bases, virtual memories, and user interfaces.

The ivory tower on the island of Smalltalk is an exciting, creative place in which to work on these ideas. A

sense of LRC's long-range goals is aptly portrayed in the illustrations designed by Ted Kaehler.

In figure 1, we see a view of the conventional software development environment: a wizard sitting on his own computational cloud creating his notion of a Taj Mahal in which programmers can indulge in building applications for nonprogramming users. The Taj Mahal represents a complete programming environment, which includes the tools for developing programs as well as the language in which the programs are written. The users must walk whatever bridge the programmer builds.

A goal in the design of the Smalltalk system was to create the Taj Mahal so that programmers can modify it by building *application kits*, which are specialized exten-

# Mountain Computer put it all together for you.

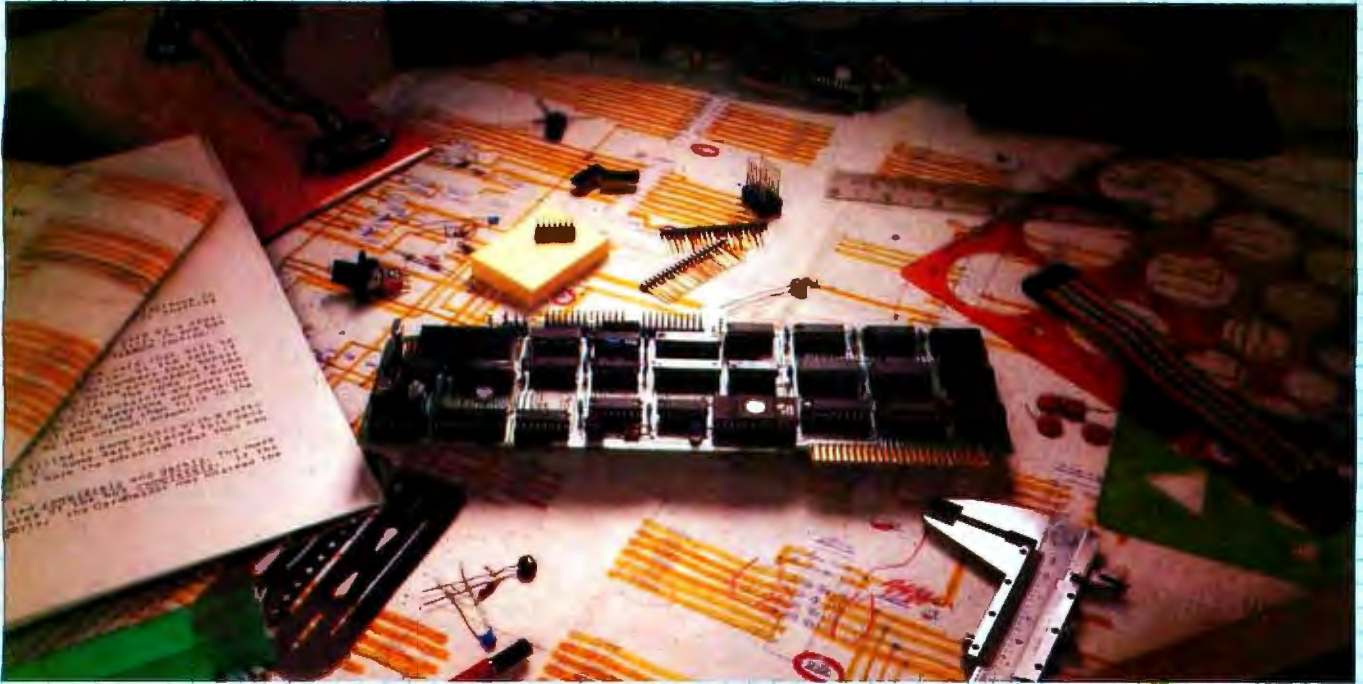

## The CPS MultiFunction Card

Three cards in one! The Mountain Computer CPS MultiFunction Card provides all the capabilities of a serial interface, parallel output interface and real-time clock/calendar—all on one card—occupying only one slot in your Apple II®. Serial and Parallel output may be used simultaneously from CPS. CPS is configured from a set-up program on diskette which sets the parameters (such as baud rate, etc.) for all functions contained on the card and is stored in CMOS RAM on the card. Once you have configured your card, you need never set it up again. You may also change parameters from the keyboard with control commands. All function set-ups stored on-board are battery powered for up to two years. "Phantom slot" capability permits assigning each of the functions of CPS to different slots in your Apple without the card actually being in those slots! For example, insert CPS in slot #4 and set it up so that it simulates a parallel interface in slot #1 and a clock in slot #7 and leave the serial port assigned to slot #4. CPS's on-board intelligence lets it function in a wide variety of configurations, thereby providing software compatibility with most existing programs. "We've put it all together for you"—for these reasons and many more! Drop by your Apple dealer and see for yourself how our CPS MultiFunction Card can expand the capabilities of your Apple and save you a great deal of money as well!

### Calendar/Clock

- One second to 99 years
- Battery backed-up (2 years)
- Two AA standard alkaline batteries for back-up (provided)
- Compatible with MCI Apple Clock™ time access programs

### Parallel Output

- Features auto-line feed, Apple tabbing, line length, delay after carriage return, lower to upper case conversion
- Centronics standard—reconfigurable to other standards
- Status bit handshaking

### Serial Interface

- Features auto-line feed, transparent terminal mode, Apple tabbing, line length, delay after carriage return, local echo of output characters, simultaneous serial/parallel output, lower to upper case conversion, discarding of extraneous LFs from serial input
- Uses the powerful 2651 serial PCI chip.
- 16 selectable internal baud rates—50 to 19.2Kbaud
- Half/Full duplex terminal operation
- I/O interface conforms to RS-232C
- Asynchronous/Synchronous operation



**Mountain Computer**  
INCORPORATED

300 El Pueblo Scotts Valley, CA 95066  
(408) 438-6650 TWX: 910 598-4504  
Circle 255 on inquiry card.

Special  
Introductory  
Price

**\$239**

\*Apple Clock was the trademark of Mountain Computer Inc.

\*Apple and Apple II are registered trademarks of Apple Computer Inc.

# APPLE OPTIONS.

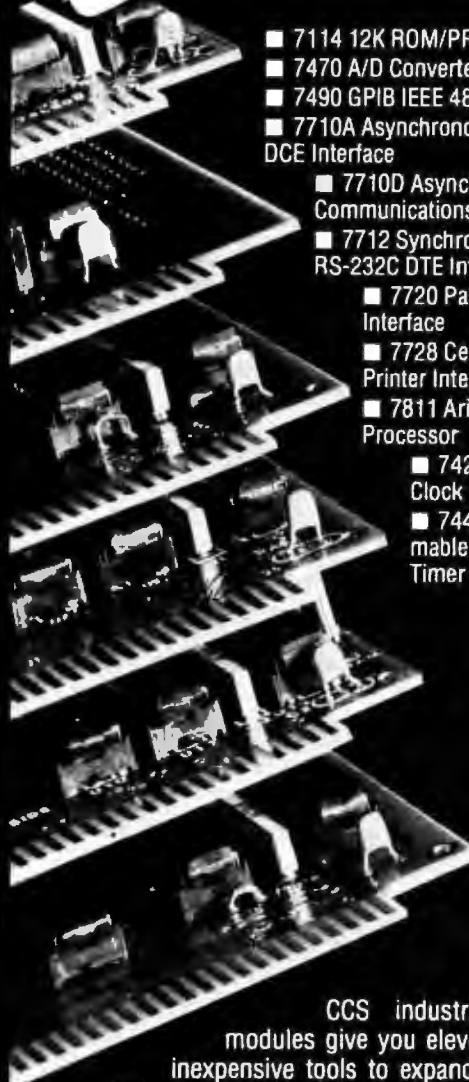

- 7114 12K ROM/PROM
- 7470 A/D Converter
- 7490 GPIB IEEE 488 Interface
- 7710A Asynchronous RS-232C DCE Interface
- 7710D Asynchronous Communications Interface
- 7712 Synchronous RS-232C DTE Interface
- 7720 Parallel Interface
- 7728 Centronics Printer Interface
- 7811 Arithmetic Processor
- 7424 Calendar/Clock
- 7440 Programmable Interval Timer

CCS industrial quality modules give you eleven reliable, inexpensive tools to expand the capabilities of Apple II computers. Available through 921 computer retailers nationally. There's one near you.

Apple, Apple II are trademarks of Apple Computer Corporation.



**California Computer Systems**

250 Caribbean Drive  
Sunnyvale, California 94086  
(408) 734-5811  
Telex 171959 CCS SUVL

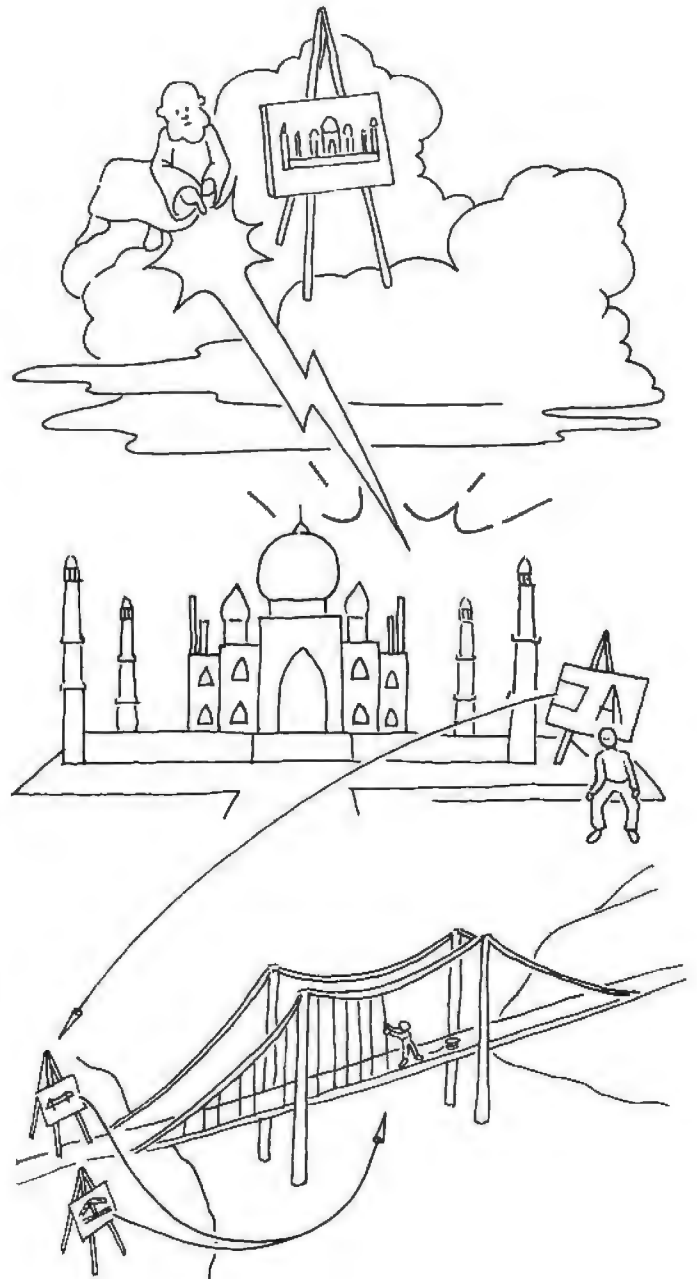

Figure 3

sions and/or subsets of the system whose parts can be used by a nonprogrammer to build a customized version of the application. Applications that can be created from a kit are related in a fundamental way: the programmer may, for example, create it for building bridges, but it is the user who pieces together the parts to create a customized bridge (see figure 2).

One of LRG's current research goals is to provide system parts to aid the programmer in creating kits. Although Smalltalk itself is conceptually sufficient for this task, it needs better support to help the programmer piece together the graphical display and the control for an interactive user interface. This is the "kit maker," as shown in figure 3.



# PUSH IN. PUSH ON.

## CCS. MAKING MINIS OUT OF MICROS.

Here's the CCS line of board-level computers for system builders on the move. **Push In** the CCS board. And **push on** with your application. CCS board-level systems go together easily, come up quickly, and run reliably, with a proven return rate of less than 1%.

CCS board-level computers offer systems builders the optimal combination of low development cost, low manufacturing cost, and high reliability from proven, tested modules.

**A headstart on reliability.** CCS modules are designed to industrial performance standards, manufactured to industrial quality standards, fully burned in and tested. You spend more time and energy on your application when you rely on CCS modules instead of reinventing (and rebuilding) standard computer functions.

**A full selection of S-100 board-level computers.** Whether you want to add capability to another S-100 based system, or build a system from scratch, chances are you'll find solu-

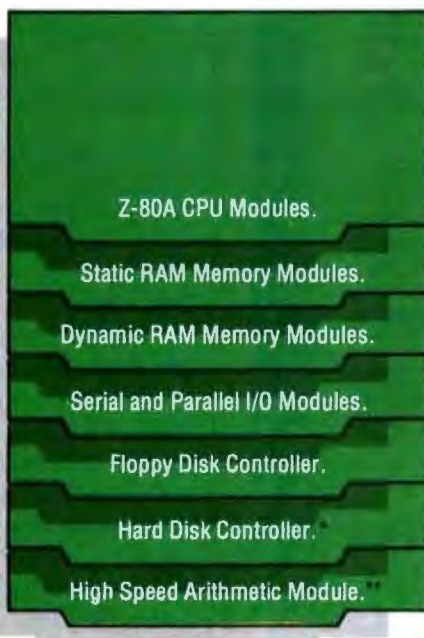

ons for all your system needs in the CCS product line. CCS manufactures a comprehensive selection, so you can tailor a system to your needs with a minimum of components. You buy exactly what you need. But you can easily expand later.

We'd like to tell you more about the CCS line of board-level computers, OEM systems, and computer systems. There's a lot more to tell. Send in the coupon for more information, contact your local computer dealer, or call.

- Please have a sales representative call me.
- Please send more information on CCS Board-Level Computer Modules.

Name \_\_\_\_\_  
 Company \_\_\_\_\_  
 Address \_\_\_\_\_  
 City/State/Zip \_\_\_\_\_  
 Phone (     ) \_\_\_\_\_



California Computer Systems  
 250 Caribbean Drive  
 Sunnyvale, California 94086  
 (408) 734-5811

• Available Quarter 2, 1981  
 • For use with CCS System Models 200, 300, 400.



## TAKE A STEP TOWARD TOMORROW

At MSI our small company environment encourages big ideas. If you've been thinking about a high technology career in micro-computers that offers high visibility, then why not think about MSI, the leader in Hand-Held Source Data Entry Systems. For Software Professionals, the following positions are now available.

### PROJECT GROUP LEADERS

Needed to direct a small team of technical professionals in:

#### High Level Languages

Background in HLL, i.e., PASCAL, ALGOL, etc., needed for development of Automatic Program Generator Systems using BASIC compiler and other languages. Assembly language required.

#### Operating Systems

Assembly language and/or interpreter experience required. Hardware interface experience desirable. Must have strong documentation and design skills. Knowledge of FORTH and PASCAL preferred.

### SENIOR ENGINEERING PROGRAMMERS

#### Test and Integration

Background in test planning and evaluation. Will be responsible for forming new group of specialists to develop test programs, implement test procedures and integrate software products.

#### Communications Development

Requires extensive experience in systems and programming. Knowledge of BSC protocols desirable and Hardware interface background in assembly language required. Familiarity with FORTH or PASCAL preferred.

#### Operating Systems Development

Senior and Intermediate Engineering Programmers. Assembly language programming experience on micro and mini-computers needed to create application solution systems for our new Route Accounting, Program Management Group. Experience in HIGH LEVEL LANGUAGE and FORTH would be a plus.

### SOFTWARE TECHNICAL WRITER

Responsible for development and design of software documentation manuals, including writing maintenance documents, operating instructions and design specifications. Degree plus 3 years' software documentation experience in Assembly and HIGH LEVEL LANGUAGE. Background in FORTH would be a plus.

We offer a complete benefits portfolio including paid medical, dental and life insurance, 100% tuition reimbursement, and retirement benefits. Please contact or call collect:

**Joan Ramstedt**

**MSI Data Corporation**  
340 Fischer Avenue, Costa Mesa, CA 92626  
(714) 549-6125

An Equal Opportunity Employer M/F/H



Figure 4

As part of the Dynabook vision, the system should help the programmer build a personal computational cloud (see figure 4). Two research projects, ThingLab by Alan Borning and PIE by Ira Goldstein and Danny Bobrow, took advantage of Smalltalk's support for creating new metaphors.

We are often asked: "What makes Smalltalk different from other languages?" The articles in this issue attempt to answer that question. Look for an emphasis on interactive graphics, on modular development of programs, and on integrated approaches to accessing program development tools. Also, look for the distinction between a programming language and a programming system, and consider the difference in providing a system in which the user can feel individual mastery over complexity. Although each article can be read independently of the

*Text continued on page 26*



# Take a look at our EPROM blaster for your Apple™ or TRS-80™



Apparat announces the most versatile EPROM burner available today for your TRS-80 model I and III or Apple computer . . . the Apparatus PROM Blasting system (A.P.B.). Most EPROM burners will program only one type of EPROM. The A.P.B. system will program all commonly used 24 pin EPROMs by using special personality modules that adapt the unit to the EPROM. The following EPROMs are programmable: 2704, 2708, 2716, (3-volt) & (5-volt), 2732, 2508, 2516 and 2532.

The versatility and power of the A.P.B. system means you're getting a PROM burning package with extensive capabilities. The price, \$149.00, insures you're getting the most cost-effective PROM burner on the market today.

With a unique combination of personality modules and

sophisticated software, A.P.B. will perform many operations impossible with conventional PROM burners. Here's a brief list of some of A.P.B.'s capabilities:

- Verify ROM is erased
- Read ROM
- Copy ROM
- Copy between different ROM types
- Program ROM
- Partial programming and copies
- Verify programming
- Read or save ROM data on disk or cassette (Apple only)
- Program directly from computer memory
- Examine and/or modify working memory
- Preset working memory

The A.P.B. system is the most flexible PROM burner available. The A.P.B. system package consists of an interface card that plugs directly into an expansion slot\*, a complete set

of personality modules, software on disk and a detailed instruction manual. The software will run under NEWDOS/80, or TRSDOS™ for the TRS-80, and APPLE DOS™ or APEX for the Apple.

If you're looking for a powerful, versatile and cost efficient EPROM burner, call APPARAT today. Dealer inquiries welcome.

**(303) 741-1778**

\*TRS-80 version requires the TRS-80 bus extender (Cat. # 1-025) or a separate user provided power supply and cable. TRS-80, and Apple are trademarks of Tandy Corp. and Apple Computer.



 **Apparat, Inc.**

4401 So. Tamarac Parkway, Denver, CO 80257 (303) 741-1778

**"ON GOING SUPPORT FOR MICROCOMPUTERS"**

Circle 21 on Inquiry card.

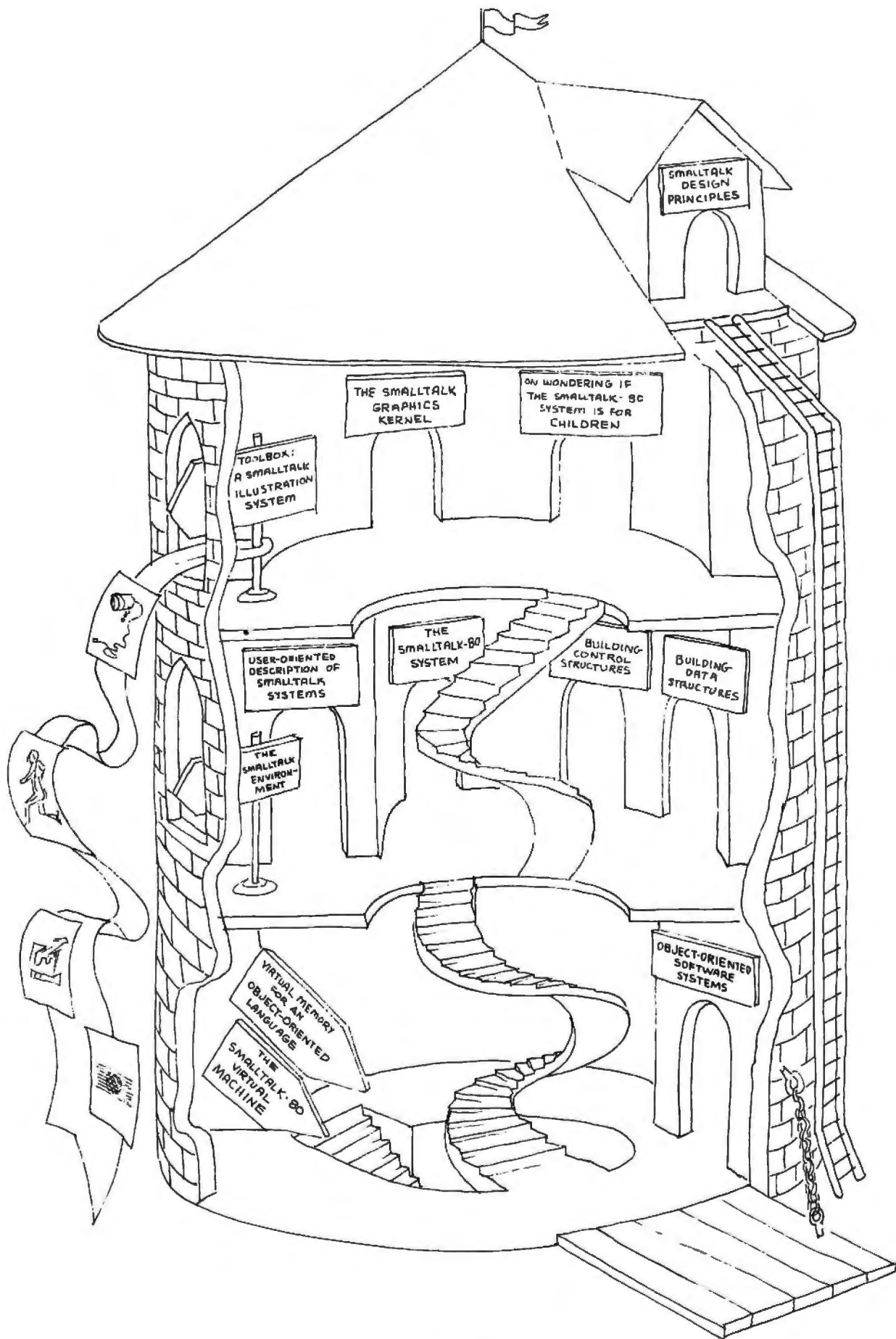

Figure 5



μ-SCI

## MICRO-SCI SQUEEZES MORE OUT OF YOUR COMPUTER, NOT YOUR POCKET

If you own an Apple II\* or plan to buy one, consider this:

The Disk II\* subsystem made for your Apple II provides only 35 tracks of storage. But Micro-Sci subsystems made for your Apple II provide up to 70 tracks, without reduced versatility or compatibility.

### MORE CAPACITY FOR LESS MONEY

Our A40 system features 40 tracks, whereas our A70 provides 70 tracks and exactly twice the byte capacity of Disk II.

With either Micro-Sci system, you pay a lot less per byte. And with the A40, you could even end up paying considerably less per drive.

### COMPATIBILITY TO SPARE

Micro-Sci has achieved this extra storage while maintaining compatibility with your existing Apple formatted diskettes.

Our subsystems operate with DOS 3.2 and 3.3, Pascal, and the Z80 SoftCard.

### VERSATILITY PLUS

You can even mix Apple Disk II's, A40's and A70's on the same computer. Micro-Sci's controller supports one or two A40's, one or two A70's or one of each.

Single or dual A40 drive subsystems give you more capacity (20,000 to 40,000 bytes) than Disk II drives, for less money.

Micro-Sci's A40/A70 subsystem combines the diskette level compatibility and interchangeability of the A40 with the superior storage capacity of the A70.

Dual A70's provide over half-a-megabyte of storage, at 5¼" floppy prices!

No matter which Micro-Sci subsystem you choose, you'll have more capacity, compatibility and versatility for your computer—and more money in your pocket. Contact us today for more information and the name of your nearest Micro-Sci Dealer.

\*"Disk II" is a registered trademark of Apple Computer, Inc., Cupertino, CA

\*\*SoftCard is a registered trademark of Micro-Soft Consumer Products.

μ-SCI

MICRO-SCI

17742 Irvine Boulevard, Suite 205, Tustin, California 92680 / Phone: 714/731-9461 / Telex: 910-346-6739

MICRO-SCI IS A DIVISION OF STANDUN CONTROLS, INC

others, knowledge of the Smalltalk-80 system and its design philosophy is a prerequisite to understanding many of them. The map in figure 5 is presented to help the reader find a course through this hitherto uncharted ivory tower.

You can begin at the drawbridge by reading Dave Robson's introduction to object-oriented programming (page 74) and then proceed by reading the description of the Smalltalk-80 language (page 36). The two examples of programming in Smalltalk-80 are likely next steps: one, by Jim Althoff, tells you how to build data structures (page 230); the other, by Peter Deutsch, describes how to build control structures (page 322). Or, you can follow a hallway to the user interface window and read Larry Tesler's description of the Smalltalk programming environment (page 90). Trygve Reenskaug offers further perspectives on providing a programming interface to a Smalltalk system (page 147).

At any time, you can take the side stairs to read Dan Ingalls' presentation of the design principles behind Smalltalk (page 286). Those readers who are interested in implementation details can head for the cellar and read Glenn Krasner's article on the Smalltalk virtual machine (page 300), or Ted Kaehler's article on a Smalltalk virtual memory (page 378).

The walls of the tower are covered with visual images that will please any graphics enthusiast. Many were created by the ToolBox painting component of Smalltalk, as described in Bill Bowman and Bob Flegal's article (page 369). Greater detail about the Smalltalk graphics kernel is provided by Dan Ingalls (page 168).

Ivory towers are often associated with educational enterprises. So it is not surprising that field studies of the various versions of Smalltalk have been carried out mostly in educational settings; elementary, junior, and senior high school students as well as university students have helped us test our ideas. Joan Ross and I provide some of the history in an article exploring whether the Smalltalk-80 system is for children (page 348).

Many people have helped to build our ivory tower, to surround it with protective clouds, and then to blow some of the clouds away. All the people, past and present, of the Xerox Palo Alto Research Center contributed a brick or two. George Pake, vice president of Corporate Research, assembled the bricklayers. We especially herald the person who is responsible for laying the foundation, Alan Kay, and current members of LRG not named as article scribes: Peggy Asprey, Alan Borning, Laura Gould, Bruce Horn, Neil Jacobstein, Kim McCall, Diana Merry, Steve Putz, and Steve Weyer. Special thanks to Bert Sutherland who did the "preflight check." ■

# BAR CODE FOR YOUR SMALL COMPUTER.



New in-depth report tells you how-at savings of up to \$40,000

"Contemporary Applications of Optical Bar Code Technology" is a new, comprehensive report from North American Technology that can save you thousands of dollars in research and development

time when programming and equipping your small computer for bar code.

Written by the originators of *Byte Magazine's* experiments with publication of software in printed form, Walter Banks and Carl Helmers, this report is the **only complete** presentation of materials on keyless data entry using modern bar code technology. It will enable you to:

- Read HP-41C calculator formats into your Apple, or other suitable computer.
- Prepare and deliver machine readable printed software to your customers.
- Read a UPC code into your personal computer.
- Print Code 39 manufacturing inventory tags with your formed character or dot matrix printer.

Here, in clear, concise, understandable language is all you need to know about bar code history, software engineering requirements, complete machine independent Pascal software in source listing and machine-readable bar code

forms. There is also description of software to generate and read all major formats from Code 39 to HP-41C, and UPC to the new NATI text software publication format. You get information you can use to program your small computer for bar code without detail processing by a human operator. This method speeds the operation, eliminates translation and entry errors and, where desirable, permits the use of unskilled personnel for the entry function. You save thousands of dollars as a result. The \$500 purchase price of the report includes license for the commercial modification and use of all software contained therein.

For detailed information, send for our brochure. There is no cost or obligation. Mail the coupon today.



## NORTH AMERICAN TECHNOLOGY, INC.

Strand Building  
174 Concord St.  
Peterborough, NH 03458  
(603) 924-6048

Please send me your **FREE** brochure on "Contemporary Applications of Optical Bar Code Technology."

NAME \_\_\_\_\_  
 ADDRESS \_\_\_\_\_  
 CITY \_\_\_\_\_  
 STATE \_\_\_\_\_ ZIP \_\_\_\_\_

Getting "STATIC" from our competition? . . . if so, you're paying too much!

Try Ours  
\$179

64K Static \$895  
assembled

16K Static \$179  
assembled



- STATIC RAMS • FULLY ASSEMBLED • FULLY TESTED • BURNED-IN • FULLY SOCKETED • INCREDIBLE VERSATILITY • BANK SELECTABLE
- EXTENDED ADDRESSING • DELIVERY FROM STOCK • SAVE HUNDREDS OF DOLLARS • INTRODUCTORY PRICE - ORDER TODAY

**The Memory Merchant Story**

Why hasn't memory come down in price like it should? Here's what is being done for you.

**High Performance and Low Price 16K Static Board**

You want the most cost-effective, high performance memory boards that technology will allow. With that in mind we commissioned one of the top memory designers in the country. We told him to design the board with the user in mind. It had to sell for less than \$200. It had to run cool and have low-power consumption. It had to have both extended addressing capabilities and bank select capabilities at no additional cost. You had to be able to de-select 1K blocks so the memory could accommodate memory-mapped video displays or controller cards. The board had to be fast so a user could run his processor at full speed. Finally, the board had to be reliable and easy to install. He came up with all this and more. Here's a high

**16K Ram, Model MM16K14 Specifications:**

- Four independent 4Kx8 byte segments
- One 4K segment equipped with 1K windows
- Compatible with both existing bank select type hardware and IEEE 696/S100 extended address protocol
- Operation guaranteed to 4 MHz with Z-80 and to 5 MHz with 8085 processors
- Low power consumption, typically 1.3 amps
- Uses low power 300 ns 2114 (1Kx4)

**64K Ram, Model MM65K16S Specifications:**

- Operation guaranteed to 8 MHz
- Compatible with both existing bank select type hardware and IEEE 696 extended address protocol
- Fully loaded board (64K) draws 400ma. while max. current is 550 ma.
- Four independently addressable 16K submodules on one board organized as 2 pair of independent 32K banks or as 1 64K extended address page. Each 32K bank responds independently to phantom. Bank select logic is compatible with either Cromemco Cromix\* or standard bank select software.
- 2716 (5V) EPROM compatibility: Programmed 2716 EPROMs may replace any or all of the Ram components on the board.
- New 16K (2Kx8) Static Roms which combine extreme low power (40ma. ON; 5ma. OFF) with high speed (200ns max. access time).
- Also available partially populated to 48K or 32K.

\*Cromix is a trademark of Cromemco.

Circle 215 on inquiry card.

performance, fully assembled, tested and burned-in, guaranteed 16K board that we are introducing for only \$179. Runs on any S-100 8080, 4 MHz Z-80, or 5 MHz 8085 system.

**The Most Advanced 64K Static Board**

The end user wants State-of-the Art when he buys a 64K board. So we had our super designer put together the 64K board of the future with tomorrow's high speed processors in mind. This board had to work with all S-100 systems, with current processors and future (up to 8 MHz) processors. It had to be ultra-low power. It had to be designed so the advanced user could populate the board with programmed EPROMs for special applications. This board, too, had to have both bank select and extended addressing at no extra cost. The board was also designed to be used as a 32K or 48K board and we are selling it that way, too. Put in additional chips when you want to increase the capacity!

OEM and dealer inquiries invited.

**No Risk Free Trial**

After you purchase one of our boards you may return it (intact) for any reason within 15 days after shipment and receive a full refund.

**Free Six Months Memory Insurance**

We will replace any board purchased from Memory Merchant that becomes defective through normal use for up to six months.

Yes! Please send me the items listed below. I understand that if I'm not fully satisfied with the product, I can get a full refund within 15 days after shipment. (Send check, money order, or use your credit card.)  
Note to credit card buyers: For extra fast service phone (415) 483-1008

| QUANTITY                         | DESCRIPTION | UNIT PRICE | TOTAL | SEND TO:  |
|----------------------------------|-------------|------------|-------|---|
|                                  | 64K         | \$895.00   |       | MEMORY MERCHANT (B1)<br>14666 Doolittle Dr.<br>San Leandro, CA 94577<br>(NO C.O.D.'s) |
|                                  | 48K         | 749.00     |       |   |
|                                  | 32K         | 569.00     |       |   |
|                                  | 16K         | 179.00     |       |   |
| SHIPPING & HANDLING \$5.00/Board |             |            |       | <input type="checkbox"/> CHECK  |
| TOTAL                            |             |            |       | <input type="checkbox"/> MONEY ORDER  |
| California Residents             |             |            |       | <input type="checkbox"/> VISA   |
| Add 6% Tax                       |             |            |       | <input type="checkbox"/> MASTERCHARGE<br>(Must also have ICAB)                        |

CARD NO. \_\_\_\_\_ EXP. DATE \_\_\_\_\_

ICA NO. \_\_\_\_\_ SIGNATURE \_\_\_\_\_

NAME \_\_\_\_\_

ADDRESS \_\_\_\_\_

Street City State Zip

Prices, terms, specifications subject to change without notice.

14666 DOOLITTLE DR.  
SAN LEANDRO,  
CA 94577  
(415) 483-1008



# ANNOUNCING

## A Major Breakthrough

The

# SYSTEM 2800

The System 2800 is the next logical step in the continuing line of innovative products from the Systems Group.

### Unbeatable S-100 Memory Boards

First was the development of the DMB6400 series of S-100 Memory boards featuring the innovative Bank Select switching technique. This enables users to software select up to four totally independent memory banks per board.



### The 2nd Generation

Then came the 2nd Generation of IEEE S-100 COMPATIBLE Z80 PROCESSORS, FLOPPY DISK CONTROLLERS and SERIAL I/O BOARDS. Each has been designed for single user, multi-user or

network operating systems such as CP/M®, MP/M™, CP/Net™ and OASIS™.



### The Next Logical Step ...

We challenged our design team to create an innovative yet competitive system utilizing our existing line of field proven, dependable S-100 boards. The result: a highly reliable, quality built, state of the art microcomputer that gives you the cost/performance edge you need to be a leader in your field.

The System 2800 comes with a choice of operating systems: CP/M with an enhanced CBIOS for single user systems and either MP/M or OASIS for multi-user, multi-tasking systems. MP/M is available with either a standard or

CP/M MP/M and CP/Net are trademarks of Digital Research  
OASIS is a trademark of Phase One Systems

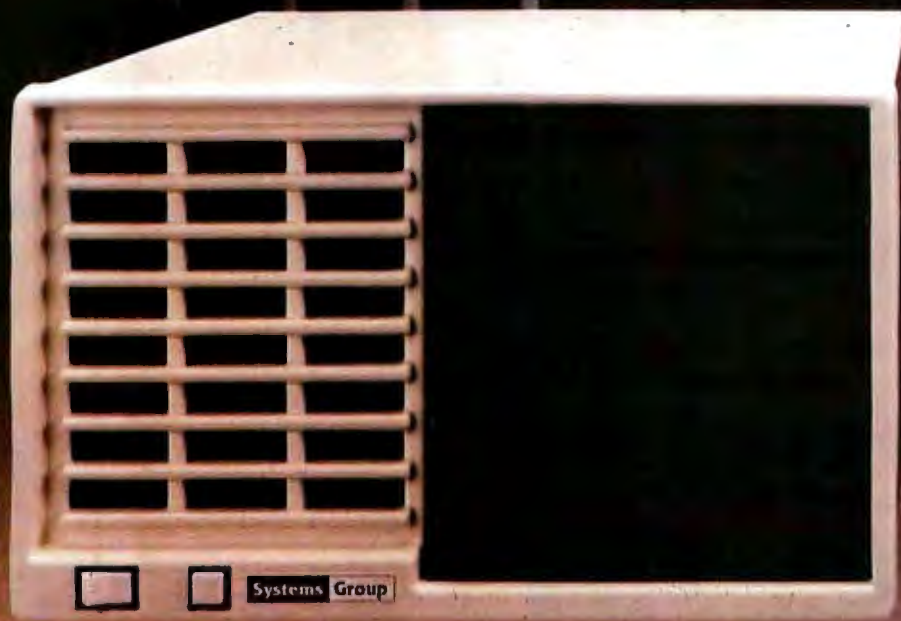

enhanced XIOS. The CP/M based System 2800 provides improved diagnostic reporting capability and increased sector sizes of 1024 bytes, yielding disk performance throughput increases up to 400% over standard unblocked systems.

The enhanced multi-user, multi-tasking MP/M based System 2800 provides the same advanced features as CP/M. In addition, this interrupt driven implementation can offer performance throughput increases up to 2000% thru extensive disk buffering for applications requiring a large number of disk accesses.

Also available is the OASIS operating system with ISAM files, automatic record locking and multiple-user print spooling.

All operating systems are available in either floppy or hard disk configurations. The disk drive selection includes single or double sided, double density 8-inch floppies with up to 2.52 megabytes of formatted storage per system, expandable to 5.04 megabytes, and an 8-inch 10 megabyte winchester hard disk.

### **Cost Effective Reliability**

Dealers, OEM's and System Integrators share many common needs. Not the least of these is dependable products. That's why we back our System 2800 with our established reputation for high quality products, superior support, prompt and courteous service, and a one-year warranty.

Take the next logical step. See your nearest computer dealer, or contact us for the complete story on our S-100 family of board products and enhanced systems.

## **Systems Group**

A Division of MEASUREMENT systems & controls  
incorporated

1601 Orangewood Ave.  
Orange, Calif. USA 92668  
(714) 633-4460 TWX/TELEX: 678 401 TAB IRIN

For International Sales Inquiries contact: SIGMA INTERNATIONAL, INC., P.O.  
Box 1118, Scottsdale, AZ 85252 USA (602) 994-3435 / Telex 165 745 Sigma

# Letters

## Advertisements, Etc

An advertisement in the May 1981 BYTE could cause readers to mistakenly conclude that certain products of Computer Corporation of America are available through Computers, Etc.

Computer Corporation of America's products and services are available only through the Computer Corporation of America. Additionally, the name "Computer Corporation of America" is the exclusive property of Computer Corporation of America, a corporation organized under the laws of the Commonwealth of Massachusetts.

Thank you, BYTE, for this opportunity to eliminate any confusion concerning the use of our name or availability of our products and services.

Joseph Jarzembowski  
General Counsel  
Computer Corporation of America  
575 Technology Sq  
Cambridge MA 02139

## Noise from the Past

I was pleased to see BYTE's ongoing reporting of new semiconductor devices with April's "What's New?" mention of LOUD Electronics's 3N120DB NED (noise-emitting diode).

BYTE seems to be in error, however, when it says that the device is a "new development in indiscreet electronics." As I remember, BYTE reported the development of an earlier version of this device five years ago, in 1976. At that time, the device was only available in high-voltage versions and had a much shorter lifetime than the current component has.

In the 1976, BYTE said:

*When connected across a +1000 V supply, it makes a loud noise (once). The NED was discovered by Igor Pravaganda, whom, you'll recall, worked many years trying to filter AC with polarized electrolytic capacitors. He'll always be remembered as the father of the confetti generator.*

At that time, the schematic diagram of the device was also slightly different. I assume the drawing of the NED has been standardized to the current version in the past five years.

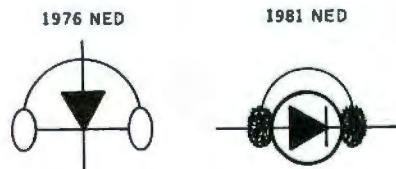

While I am pleased to learn of the continued development of this device, I do feel that, in the future, BYTE should be more careful in reporting of "new" semiconductors.

David J Lindbergh  
49 Beechmont St  
Worcester MA 01609

*We have been following the development of the NED (which appeared for the first time on page 41 of the February 1976 BYTE) very closely. Also at that time, we reported on the invention of two other devices: the Shiftless Register and the Fuzz-Locked Loop. We believe that these three devices will form the basis for data-communications systems in the future. Watch upcoming issues for a report on the Fast-Fourier Stepdown Transformer. . . . CPF*

## April's Foolers

The hasty printing of data concerning our Black-Hole Diode is not only an invasion of our corporate security, but is not in the national interest. (See the April 1981 BYTE, page 363.)

Our device, which is covered by US patents and is classified by the National Security Council as "Top Secret," should not be pandered about in a general-circulation magazine for all to see, especially when those not friendly to our nation may learn details of this device.

Furthermore, how BYTE learned of the existence of our device is unknown to us, but be advised that stricter security has been imposed to forestall any further lapses.

Be also advised that the company BYTE lists as being responsible for creating the



## Z8000

### System 3 \$7053

This 16-bit Multibus™ computer system includes:

- Z8001 CPU and 256K RAM
- 8 serial I/O ports
- 15-slot backplane
- Dual floppy disk drives
- Multiuser Operating System

Field upgrade to 16MB RAM, 268MB of hard disk, 32 users. Pascal, BASIC, C, COBOL and FORTRAN languages.

(312) 684-3183

## Dialogue™ 80

### AMPEX Terminal \$1045

- Full ASCII detached keyboard
- Separate edit/numeric keypads
- 25th status line
- 20 programmable function keys
- 2 pages memory (4 optional)
- 11 line drawing graphics characters
- 10 modes: block, protect, program. . .
- Monitor mode displays control codes



**COMPUTEX**  
MICROCOMPUTER SYSTEMS  
5710 Drexel, Chicago, IL 60637





## The next generation of business software

### WHAT'S IN A NAME?

We've changed the name of our product line. Originally, we called our products "Phoenix" because we saw the phoenix as an appropriate symbol of quality. Unfortunately, a lot of other companies chose Phoenix as well, and there was some concern that the market place would become confused.

Our new name, PALANTIR™ (pronounced *pal'anteeer*), is not a new name for us since it's our corporate name. It comes from J.R.R. Tolkien's *The Lord of the Rings* and describes a black crystal ball, a "seeing stone", used to see things at a distance.

Whatever the name on the package, the software in the package hasn't changed. It is still the highest quality business software you can buy for your microcomputer.

### WORD PROCESSING

We know word processing. A year-and-a-half ago the owners of Designer Software™ wrote a well-known word processor for another company. In the last 18 months we've learned about other features you want in a word processing package. PALANTIR™ Word Processing reflects our experience. It is more powerful than other word processing packages you can buy and can compete, feature for feature, with expensive dedicated word processors.

Many people have remarked that the user's manual we wrote earlier was the best ever for microcomputer software. Even so, we felt that we could have made it more accessible to the non-technical user. With PALANTIR™

Word Processing we have a separate Training Manual with beginning, intermediate and advanced levels. By allowing you to work at your own level, we have made the learning process easier and less intimidating.

### ACCOUNTING

All five PALANTIR™ general accounting packages (General Ledger, Accounts Receivable and Payable, Payroll and Inventory) were designed by CPAs based on similar packages from mini and mainframe computers. The programs are COBOL with an integral assembly-language data base. They are integrated to allow automated posting to the General Ledger. An internal screen handler permits full-screen data entry for speed and ease of use. Although we made cosmetic enhancements prior to distribution, the basic programs have been user-tested for at least eighteen months.

PALANTIR™ Accounting also includes a growing number of specific application packages. We have completed or scheduled for completion Fixed Assets, Tenant Processing, Mail Management, Financial Projections and Time/Billing. Each package stands alone, but many also work in conjunction with other PALANTIR™ packages. For example, Mail Management will work very well by itself, but we also designed it to fit in easily with the merging capabilities of Word Processing.

With all PALANTIR™ Accounting we have given special attention to documentation. Not being content to describe which buttons to push, we have taken the time to explain the accounting principles behind the programs and how each package helps to automate your office.

**Designer Software™**

HOUSTON

If you want to know what PALANTIR™ Word Processing and accounting can do for your business, call, write, telex or use The Source to request more information.

**3400 Montrose Blvd • Suite 718 • Houston, Texas 77006  
(713) 520-8221 • Telex 790510 • Source TCU671**

Designer Software and Palantir are trademarks of Palantir, Inc.

Tomorrow's  
Software...  
Today!

# UCSD\*

## P-SYSTEM



### PORTABLE POWERFUL PROFESSIONAL

#### FOR PROGRAMMERS

- Operating system with interpreter, screen and character editors, filler, assemblers, utilities and compilers.
- PFAS™ — Keyed - ISAM in 8K user memory

#### FOR ENGINEERS, CONTRACTORS

- Milestone™ — Organic Software's answer to PERT. Critical path modeling
- FORTRAN — ANSI '77 Subset

#### FOR DOCTORS, CLINICS

- MEDOFFICE™ — The complete office system for the professional.
- DATE BOOK™ — Appointment scheduling for your micro.

#### FOR SMALL BUSINESS

- GL, AR, AP, Payroll Packages
- Word Processing

#### FOR EDUCATORS, RESEARCHERS

- INTELLECTFUL™ — A full range LISP interpreter for A. I. applications
- mINDEX™ — Text database system for bibliographies, contracts, abstracts, etc.

And Much More —  
READY TO RUN ON  
DEC LSI-11‡  
TRS-80 Model II§

**PCD SYSTEMS**  
P. O. Box 143  
Penn Yan, NY 14527  
315-536-3734

‡TM Digital Equipment  
§TM of Tandy Corp.  
¶TM U. of California

## Letters

Black-Hole Device, Spatial Regression Ltd, will shortly receive summons from our legal department.

Any repetition or further disregard for national security regarding this device or its uses in particle-beam research will bring about swift and final action.

J W Kelty  
Chief Executive Officer  
Code-7 Electronics  
POB 1505  
Modesto CA 95353

*Each year, the BYTE staff enjoys slipping a few joke items into the April issue for our readers to find; some are subtle, some are outrageous. Response to this year's foolishness was greater than in any year past. In case you missed it, look for*

*"Lost Dutchman's Bug" (photo),  
page 302*

*"Black-Hole Diode" (new product),  
page 363*

*"Noise-Emitting Diode" (new product),  
page 364*

*"Slightly Used Cray-1" (unclassified  
ad), page 414*

*So you see, there's no need for "swift and final action" (gulp!)—we were just kidding! By the way, where should we return the sample device that was included with your letter? . . . CPF*

### Unpublished Apple Logo

With some hesitation, I'm writing this letter to inform BYTE readers of an unfortunate situation concerning the distribution of the MIT Apple Logo programming language. I've been writing Apple Logo at the Logo laboratory for the last two years as an undergraduate project. I've labored under the understanding that Apple Logo was to be placed in the public domain or licensed to software-development companies or dealers for distribution. However, for the past eight months, MIT has withheld the language from the public.

I would like to explain why. The original intent of my project was to implement a small subset of the Logo interpreter on the Apple computer. The final product actually evolved into a full-scale implementation, with features surpassing the Texas Instruments (TI) version, which also was developed at the Logo laboratory. When TI heard about this and the Apple Logo project, it reacted angrily; it fears that a

Logo for the Apple would adversely affect sales of its Logo system. In fact, TI may be quite justified in its fears, for there are many people who think that Apple Logo is superior to TI Logo as an educational tool. It's rumored that Texas Instruments is depending on TI Logo to redeem the TI-99/4 home computer, which is not selling as well as expected.

Texas Instruments is a very generous friend of MIT, and some people here are embarrassed about a situation that might threaten one of its sales programs. So, in an effort to appease its corporate friend, MIT has been stalling the distribution of Apple Logo. There was a version ready for distribution at the end of last year with many improvements over the version reviewed in the June BYTE (see "Logo for Personal Computers," page 36), and since then it has been expanded and improved. But I'm extremely frustrated that MIT chooses to avoid angering Texas Instruments by compromising the efforts of one of its undergraduate students. This frustration is compounded by the fact that I feel, as do many here at the lab, that the TI-99/4 has many serious deficiencies and that the public will be cheated if forced to buy it because it is the only machine on which Logo is available.

Apple Logo is one of the finest programs that can be used on the Apple, and I would like to see it widely distributed as early as possible. Two years of my efforts went into it, as well as those of several others, and it's sad that MIT does not recognize the injustice that it is doing to myself, the Logo laboratory, and the many Apple users who would benefit from Apple Logo. If TI is afraid that its sales will be hurt, then it should fix the deficiencies in its machine and stop trying to suppress this program. I urge BYTE readers to write the Office of the Provost at MIT and request that Apple Logo be made public or licensed for distribution without delay. Thank you.

Stephen Hain  
MIT Logo Laboratory  
545 Technology Sq  
Cambridge MA 02139

### Love's Labors Lost

Whilst enjoying very much the Shakespearean research endeavours of Andrew Kalnik, it is obvious that he has missed the point. (See "Micro-Shakespeare," April 1980 BYTE, page 104 and "MicroShakespeare Revisited," April



# The guy on the left doesn't stand a chance.

The guy on the left has two file folders, a news magazine, and a sandwich.

The guy on the right has the OSBORNE 1<sup>®</sup>, a fully functional computer system in a portable package the size of a briefcase. Also in the case are the equivalent of over 1600 typed pages, stored on floppy diskettes.

The owner of the OSBORNE 1 is going to get more work done—and *better* work done—in less time, and with less effort.

**Unfold it, plug it in, and go to work like you've never worked before. . . .**

Go to work with WORDSTAR<sup>®</sup> word processing, so your correspondence, reports, and memos take less time to produce, and say more of what you wanted to say. And with MAILMERGE<sup>®</sup>—the mailing system that turns out personalized mass mailings in the time you'd spend on a rough draft.

Go to work with SUPERCALC<sup>®</sup>, the electronic spreadsheet package that handles complex projections, financial planning, statistics, and "what if" questions instantly. For the more technically minded, SUPERCALC will process scientific data and calculate results.

Go to work with powerful BASIC language tools—the CBASIC-2<sup>®</sup> business BASIC, or the Microsoft BASIC<sup>®</sup> interpreter.

That's standard equipment.

Options include about a thousand different software packages from a host of vendors designed to run on the CP/M<sup>®</sup> computer system.

**Go to work at the office, at home, or in the field.**

Or anywhere. Optional battery packs and telephone

transmission couplers mean you need never work without the capabilities of the OSBORNE 1. That's good, because you won't want to work again without it.

**All for \$1795. It's inevitable.**

The OSBORNE 1 is the productivity machine that's changing the way people work. Put simply, the machine delivers a significant productivity edge—day in and day out—to virtually anyone who deals with words or numbers. Or both.

Since the entire system is only \$1795, it won't be too long before the guy on the left has an OSBORNE 1 of his own. The same probably goes for the person reading this ad. In fact, we think it's inevitable.

The OSBORNE 1 includes a Z80A<sup>®</sup> CPU, 64K bytes of RAM memory, two 100 kilobyte floppy disk drives, a business keyboard, built-in monitor, IEEE 488 and RS232 interfaces for printers and other things that get connected to computers, plus CP/M, CBASIC-2, Microsoft BASIC, WORDSTAR, and SUPERCALC. The system is available from computer retailers nationally.

**\$1795. It's inevitable.**



**OSBORNE**  
COMPUTER CORPORATION

2650B Corporate Avenue Hayward, California 94545  
Phone (415) 887-8080 TWX (910) 383-2021

## Letters

1981 BYTE, page 98.)

Careful scrutiny of the works of the Bard of Programmers reveals that some discarded program segments have become garbled into the text, probably as the result of bad file merges.

Take, for example, the statement

If it were done when 'tis done then 'twere well it were done quickly

or, parsing

IF I(T) WERE D(ONE) WHEN T IS

D(ONE) THEN T WERE W(L) I(T) WERE D(ONE) QUICKLY

which, written as we understand it, and using X for ', gives

```
IF I(T) = D(1)
  WHILE T(X) = D(1)
    T(X) = W(L)
    I(T) = D(1)
  QUICKLY
```

The WEND statement is missing, but it may be that QUICKLY denotes a machine-code subroutine that could have some terminating function. (Mistress

Quickly is a comical character in *The Merry Wives of Windsor*—an example, perhaps, of a subroutine label being confused with a file name?)

Further research has revealed, hidden in the depths of the surviving listings, an incomplete command syntax of a lost high-level language.

Typical examples of this are

| Lost Language | Modern Parlance |
|---------------|-----------------|
| Armour        | Chain           |
| Billet        | Log             |
| Breach        | Input           |
| Burden        | Load            |
| Count         | Cont            |
| Curtail       | Edit            |
| Espy          | Peek            |
| Fellow        | Cos             |
| Folio         | Print           |
| Hail          | Call            |
| Inquisition   | Exam            |
| Buffet        | Poke            |
| Missives      | Data            |
| Near          | Close           |
| Peasant       | Common          |
| Scotch        | Erase           |
| Scribe        | Write           |
| Set           | Put             |
| Tally         | List            |
| Unbesmirch    | Clear           |

There are some commands still in use today: GOTO, END, EXIT, ERROR, RESTORE, RUN are typical, whilst the use of functions such as SIN, HEX, DIM, and FIX show the arithmetical properties of the language. It can safely be assumed that commands such as READ and AUTO were not generally implemented at this time.

Research continues, but so far it looks as if Sir Francis Drake made the first recorded visit to Silicon Valley, during which, presumably, the natives acquired the principles of his on-board navigational computer.

**Ross Henderson**  
Systems Manager  
Digital Devices Ltd  
134 London Rd  
Southborough, Kent,  
TN4 0PL, England

*It is obvious that, despite improvements in hardware, some aspects of programming never change—Shakespeare, in his time, may have suffered the "slings and arrows of outrageous fortune" just as modern programmers do. What personal-computer user has not, after seeing an advertisement for software, purchased same from The Software Merchant of*

*Letters continued on page 282*



## Waiting On Delivery of A DEC LA120?

### Avoid the hassle by upgrading your LA36 for 1200 baud operation with a DS120 Terminal Controller.

The Datasouth DS120 gives your DECwriter® II the high speed printing and versatile performance features of the DECwriter® III at only a fraction of the cost. The DS120 is a plug compatible replacement for your LA36 logic board which can be installed in minutes. Standard features include:

- 165 cps bidirectional printing
- Horizontal & Vertical Tabs
- Page Length Selection
- 110-4800 baud operation
- 1000 character print buffer
- X-on, X-off protocol
- Self Test
- RS232 interface
- 20 mA Current Loop Interface
- Top of Form
- Adjustable Margins
- Double wide characters
- Parity selection
- Optional APL character set

Over 4000 DS120 units are now being used by customers ranging from the Fortune 500 to personal computing enthusiasts. In numerous installations, entire networks of terminals have been upgraded to take advantage of today's higher speed data communications services. LSI microprocessor electronics and strict quality control ensure dependable performance for years to come. When service is required, we will respond promptly and effectively. Best of all, we can deliver immediately through our nationwide network of distributors. Just give us a call for all the details.

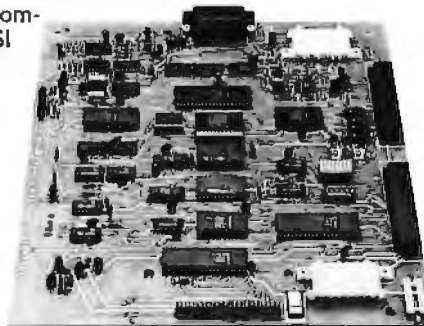

## DATASOUTH COMPUTER CORPORATION

4740 Dwight Evans Road • Charlotte, North Carolina 28210 • 704/523-8500

# STOP STEALING FROM YOUR OWN BUSINESS



Here's the white collar crime of 1981: Let your people labor away for hours at jobs a properly trained computer can do in seconds.

You pay for all those wasted hours.

And you're missing opportunities, because the hours could be spent on new, productive, profitable projects.

We can help you.

If you have a CP/M®-based microcomputer, SSG's Business Productivity Packages will scoop up all those hours you're losing and give you back more productivity, more time, more information, and more success.

**ANALYST. \$250.** An information storage and retrieval (data base) system that will replace piles of files with information you can USE.

**MAGIC WORKSHEET. \$250.** SSG's answer to the world's demand for electronic spreadsheet calculation and "what-if" capabilities on CP/M systems. (Available quarter two 1981.)

**NAD Name and Address. \$100.** A mailing

and addressing system to do all the typing and clerical work on lists—from ten names to ten thousand.

**LETTERRIGHT. \$200.** A correspondence processing package that speeds letter writing AND merges your letters with names selected from your NAD list.

It takes very few hours at today's salary levels to repay the cost of any of these systems. They'll do you far better than that. SSG's Productivity Software Packages will contribute immediately to the growth and success of your business.

Please act now. **Tear out this page.** This coupon or a phone call will get you immediate relief from the white collar crime of 1981. We'll send you complete information. Or better still, answer your questions immediately.

Time's a-wasting.  
That's a crime.



- Please rush me information on the SSG Business Productivity Packages for CP/M-based computers.
- Please call me right away.

Name \_\_\_\_\_  
 Company \_\_\_\_\_  
 Address \_\_\_\_\_  
 City State Zip \_\_\_\_\_  
 Telephone (    ) \_\_\_\_\_

CP/M is a registered trademark of Digital Research. NAD, Magic Worksheet are trademarks of SSG.

## Structured Systems Group

5204 Claremont, Oakland, California 94618 (415) 547 1567

INCORPORATED

# The Smalltalk-80 System

The Xerox Learning Research Group  
Xerox Palo Alto Research Center  
3333 Coyote Hill Rd  
Palo Alto CA 94304

The Smalltalk-80 system represents the current state of the object-oriented point of view as it has been reduced to practice by the Xerox Learning Research Group. The Smalltalk-80 system is composed of objects that interact only by sending and receiving messages. The programmer implements a system by describing messages to be sent and describing what happens when messages are received.

*The Smalltalk-80 system is the latest in a series of programming environments that have applied the object-oriented point of view more and more uniformly to the design and production of software systems. The fundamental ideas of objects, messages, and classes came from SIMULA. (See reference 1.) SIMULA allows users to create object-oriented systems, but uses the standard data/procedure-oriented ALGOL language to provide numbers, booleans, basic data structures, and control structures. The Flex system, the Smalltalk-72, Smalltalk-74, and Smalltalk-76 (see references 5, 2, and 4, respectively) systems extended the object-oriented point of view to an increasing number of the elements of a programming environment. For example, in Smalltalk-72, arithmetic, list structures, and control structures were represented as objects and messages, but classes were not. In Smalltalk-74, class descriptions as objects were introduced. The Smalltalk-76 system added the capability to express relationships between classes, and extended the object-oriented point of view to the programmer's interface.*

*This article presents the central semantic features and most of the syntactic features of the Smalltalk-80 system. It was prepared by Dave Robson and Adele Goldberg as scribes for the group effort of designing and implementing the system. Two forthcoming books (see reference 3) provide the full specification of the Smalltalk-80 system; in particular, the books describe the implementation of the interpreter and storage manager, and the graphical user interface.*

## Sending Messages—Expressions

Messages are described by *expressions*, which are sequences of characters that conform to the syntax of the Smalltalk-80 programming language. A message-sending expression describes the *receiver*, *selector*, and *arguments* of the message. When an expression is *evaluated*, the message it describes is transmitted to its receiver. Here are several examples of expressions describing a message to an object. (Note: color has been added to help identify the receivers, selectors, and arguments in the following examples.)

1. 

|       |        |
|-------|--------|
| frame | center |
|-------|--------|
  2. 

|        |   |        |
|--------|---|--------|
| origin | + | offset |
|--------|---|--------|
  3. 

|       |         |             |
|-------|---------|-------------|
| frame | moveTo: | newLocation |
|-------|---------|-------------|
  4. 

|      |     |       |      |         |
|------|-----|-------|------|---------|
| list | at: | index | put: | element |
|------|-----|-------|------|---------|
- Key:  Receiver  
 Selector  
 Argument

Each expression begins with a description of the receiver of the message. The receivers in these examples are described by *variable names*: frame, origin, frame, and list, respectively. Generally, at least one space must separate the parts of an expression.

Messages without arguments are called *unary messages*. A unary message consists of a single identifier called a unary selector. The first example is a unary message whose selector is center.

A *binary message* has a single argument and a selector that is one of a set of special single or double characters called *binary selectors*. For example, the common arithmetic symbols (+, -, \*, and /) are binary selectors; some comparison operations are represented as double characters (eg: == for equivalence, ~ = for not equal). The second example is a binary message whose argument is offset.

A *keyword message* has one or more arguments and a selector that is made up of a series of *keywords*, one preceding each argument. A keyword is an identifier with

a trailing colon. The third example is a single-argument keyword message whose selector is `moveTo:` and whose argument is `newLocation`. The fourth example is a two-argument keyword message whose selector is made up of the keywords `at:` and `put:` and whose arguments are `index` and `element`. To talk about the selector of a multiple-argument keyword message, the keywords are concatenated. So, the selector of the fourth example is `at:put:`.

The message receivers and arguments in the examples are described by variable names. In addition, they can also be described with *literals*. The two most common kinds of literals are integers and strings. An *integer literal* is a sequence of digits that may be preceded by a minus sign (eg: 0, 1, 156, -3, or 13772). A *string literal* is a sequence of characters between single quotes (eg: 'hi', 'John', or 'the Smalltalk-80 system'). A binary message with an integer literal as its receiver is

```
45 + count
```

A keyword message with a string literal as its argument is

```
printer display: 'Monthly Payroll'
```

When a message is sent, it invokes a method determined by the class of the receiver. The invoked method will always return a result (an object). The result of a message can be used as a receiver or argument for another message. An example of a unary message describing the receiver of another unary message is

```
window frame center
```

Unary messages are parsed left to right. The first message in this example is the unary selector `frame` sent to the object named `window`. The unary message `center` is then sent to the result of the expression `window frame` (ie: the object returned from `window`'s response to `frame`).

Binary messages are also parsed left to right. An example of a binary message describing the receiver of another binary message is

```
index + offset * 2
```

The result of sending the binary message `+ offset` to the object named `index` is the receiver for the binary message `*2`. All binary selectors have the same precedence; only the order in which they are written matters. Parentheses can be used to change the order of evaluation. A message within parentheses is sent before any messages outside the parentheses. If the previous example were written

```
index + (offset * 2)
```

the result of the binary message `* 2` to `offset` would be

used as the argument of a binary message with receiver `index` and selector `+`.

Unary messages take precedence over binary messages. If unary messages and binary messages appear together, the unary messages will be sent first. In the example

```
frame center + window offset - index
```

the result of the unary message `center to frame` is the receiver of the binary message whose selector is `+` and whose argument is the result of the unary message `offset to window`. The result of the `+` message is, in turn, the receiver of the binary message `- index`. Parentheses can be used to explicitly show the order of evaluation, eg: `((frame center) + (window offset)) - index`. Parentheses can also be used to alter the order of evaluation. In the example

```
(center + offset) x
```

the binary message `+ offset` would be sent before the unary message `x`.

Whenever keywords appear in an unparenthesized message, they compose a single selector. The example

```
window showText: 'Title' inFont: helvetica  
indented: 15
```

is a single message whose selector is `showText:inFont:indented:`. Because of this concatenation, there is no left-to-right parsing rule for keyword messages. If a keyword message is to be used as a receiver or argument of another keyword message, it must be parenthesized. The expression

```
frame scale: (factor max: 5)
```

describes two keyword messages. The result of the expression `factor max: 5` is the argument for the `scale: message to frame`.

Binary messages take precedence over keyword messages. When unary, binary, and keyword messages appear in the same expression without parentheses, the unary messages are sent first, the binary messages next, and the keyword messages last. The example

```
bigFrame height: smallFrame height * 2
```

is evaluated as if it were parenthesized as follows:

```
bigFrame height: ((smallFrame height) * 2)
```

A *cascaded message expression* describes a sequence of messages to be sent to the same object. A simple message expression is a description of the receiver (ie: a variable name, literal, or expression) followed by a message (ie: a unary selector, a binary selector and argument, or a set of keywords and arguments). A cascaded message expres-

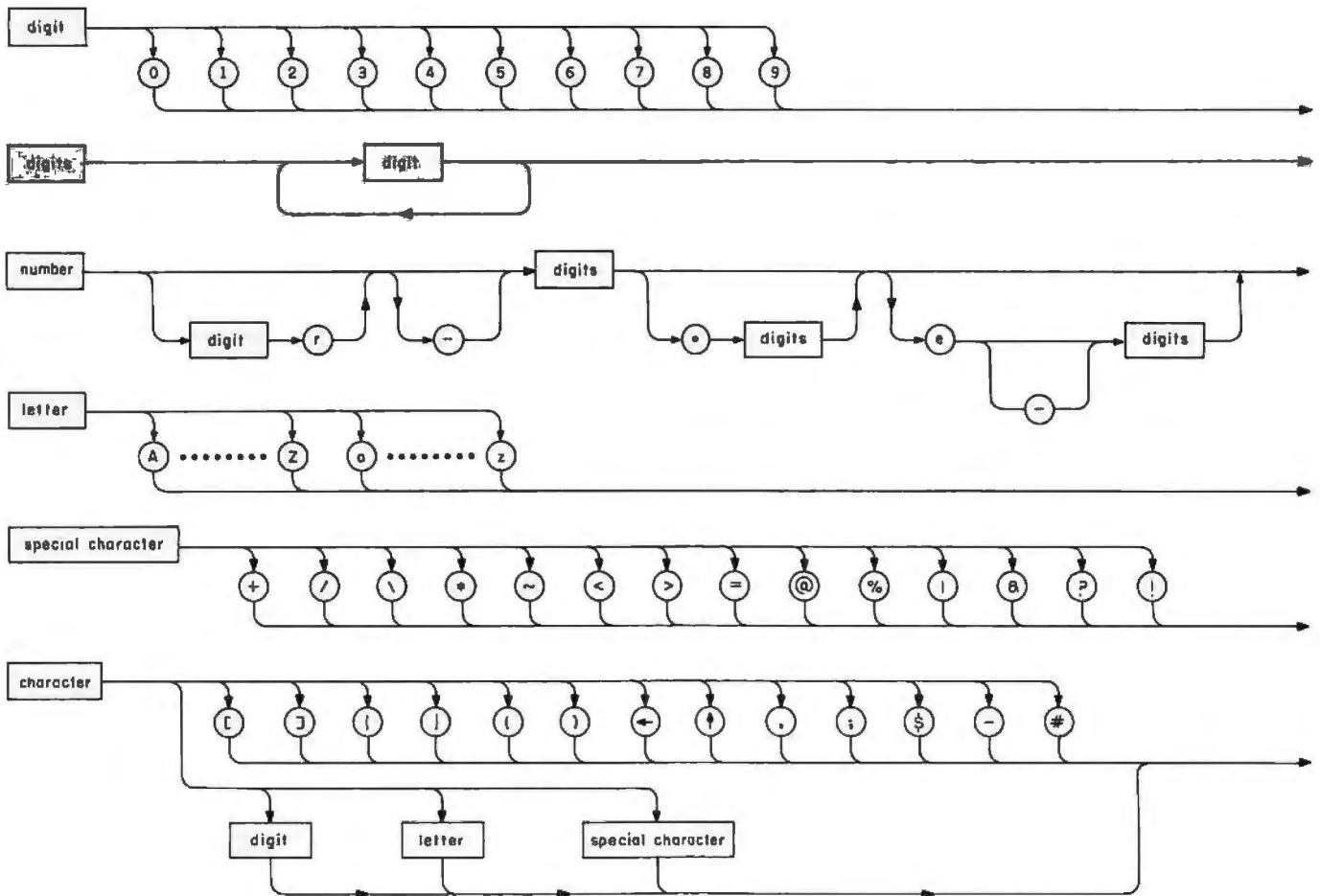

Figure 1: Syntax diagrams for the Smalltalk-80 language.

sion is a single description of a receiver followed by several messages separated by semicolons. For example, in the expression

```
printer newLine; print: reportTitle; space;
print: Date today.
```

four messages are sent to the object named printer. The selectors of the four messages are newLine, print:, space, and print:. In the expression

```
window frame center: pointer location;
width: border + contents; clear
```

three messages are sent to the object returned from the frame message to window. The selectors of the three messages are center:, width:, and clear. Without cascading, this would have been three expressions

```
window frame center: pointer location.
window frame width: border + contents.
window frame clear
```

### Assigning Variables

The value of a variable can be used as the receiver or

argument of a message by including its name in an expression. The value of a variable can be changed with an *assignment expression*. An assignment expression consists of a variable name followed by a left arrow (←) followed by the description of an object. When an assignment expression is evaluated, the variable named to the left of the arrow assumes the value of the object described to the right of the arrow. The new value can be described by a variable name, a literal, or a message-sending expression. Examples of assignments are

```
center ← origin
index ← 0
index ← index + 1
index ← index + 1 max: limit
```

In the last example, the message + 1 is sent to the value of the variable index, the message max: limit is sent to the result of the + 1 message, and the result of the max: limit message becomes the new value of the variable index.

A number of variables can be assigned in the same expression by including several variable names with left arrows. The expression

```
start ← index ← 0
```

makes the value of both start and index be 0.



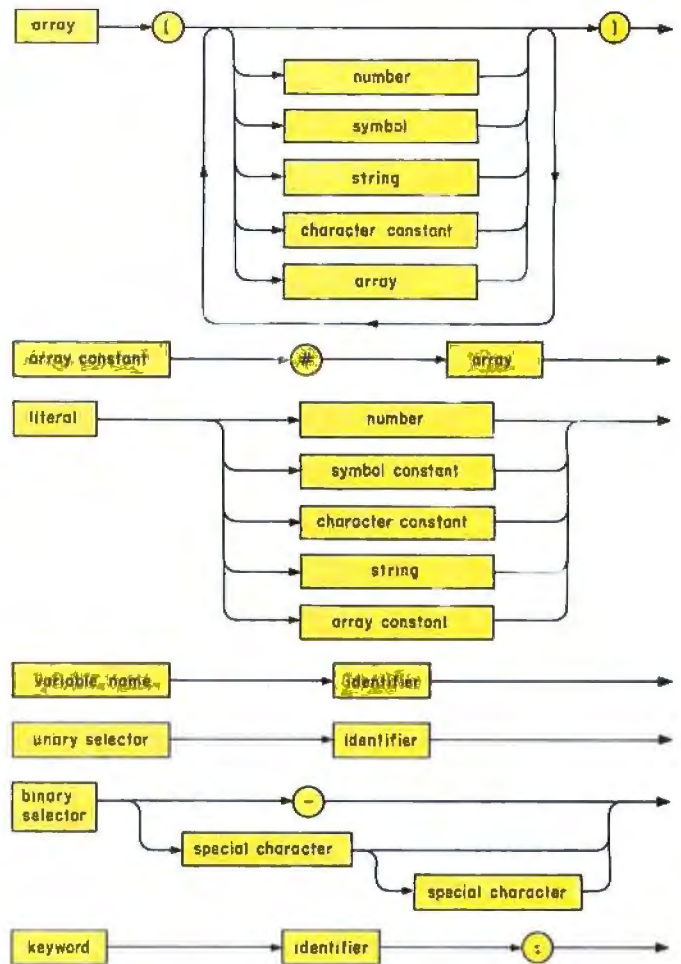
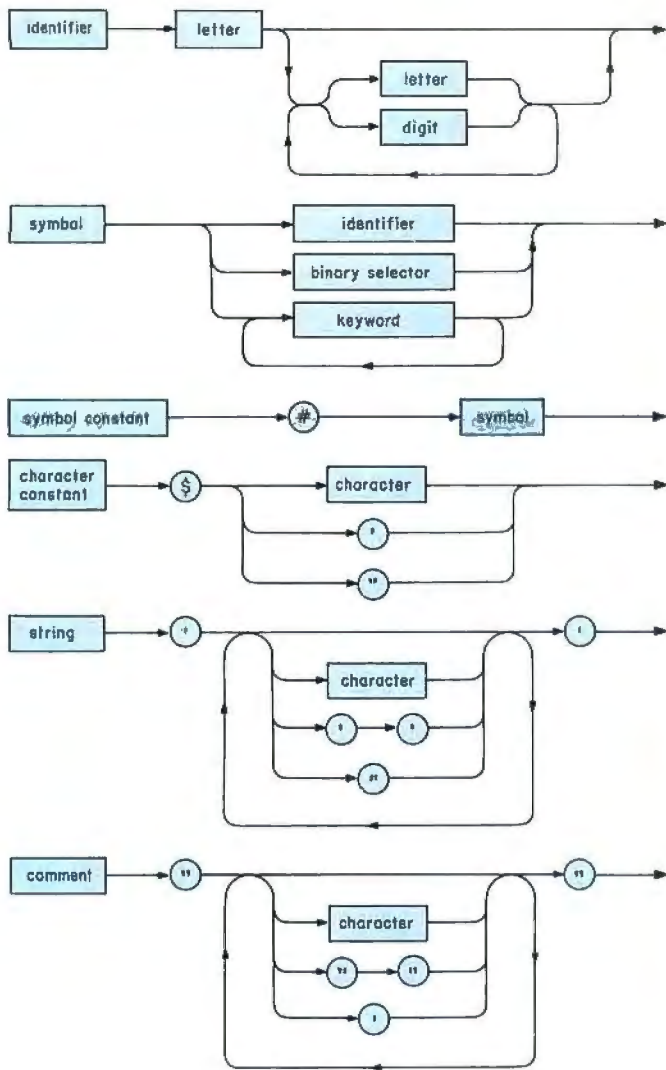

Figure 1 continued on page 40

The syntax table in figure 1 is a diagram for parsing well-formed Smalltalk-80 expressions. This table does not specify how *spaces* are treated. Spaces must not appear between digits and characters that make up a single token, nor within the specification of a number. Spaces must appear

- between a sequence of identifiers used as variables or unary selectors
- between the elements of an array in an array constant
- on either side of a keyword in a keyword expression

Spaces may optionally be included between any other elements in an expression. A carriage return or tab has the same syntactic function as a space.

### Receiving Messages—Classes

A *class* describes a set of objects called its *instances*. Each instance has a set of *instance variables*. The class provides a set of names that are used to refer to these variables. A class also provides a set of *methods* that describe what happens when its instances receive mes-

sages. A method describes a sequence of actions to be taken when a message with a particular selector is received by an instance of a particular class. These actions consist of sending other messages, assigning variables, and returning a value to the original message.

To create a new application, modify an existing application, or to modify the Smalltalk-80 system itself, a programmer creates and modifies classes that describe objects. The most profitable way to manipulate a class is with an interactive system. Much of the development of the Smalltalk-80 system has been the creation of appropriate software-development tools. (See Larry Tesler's article "The Smalltalk Environment," on page 90.) Unfortunately, to describe a system on paper, a noninteractive linear mode of presentation is needed. To this end, a *basic class template* is provided as a simple textual representation of a class. The basic class template in table 1 shows the name of the class, the names of the instance variables, and the set of methods used for responding to messages.

In table 1, the italicized elements will be replaced by the specific identifiers or methods appropriate to the

Figure 1 continued:

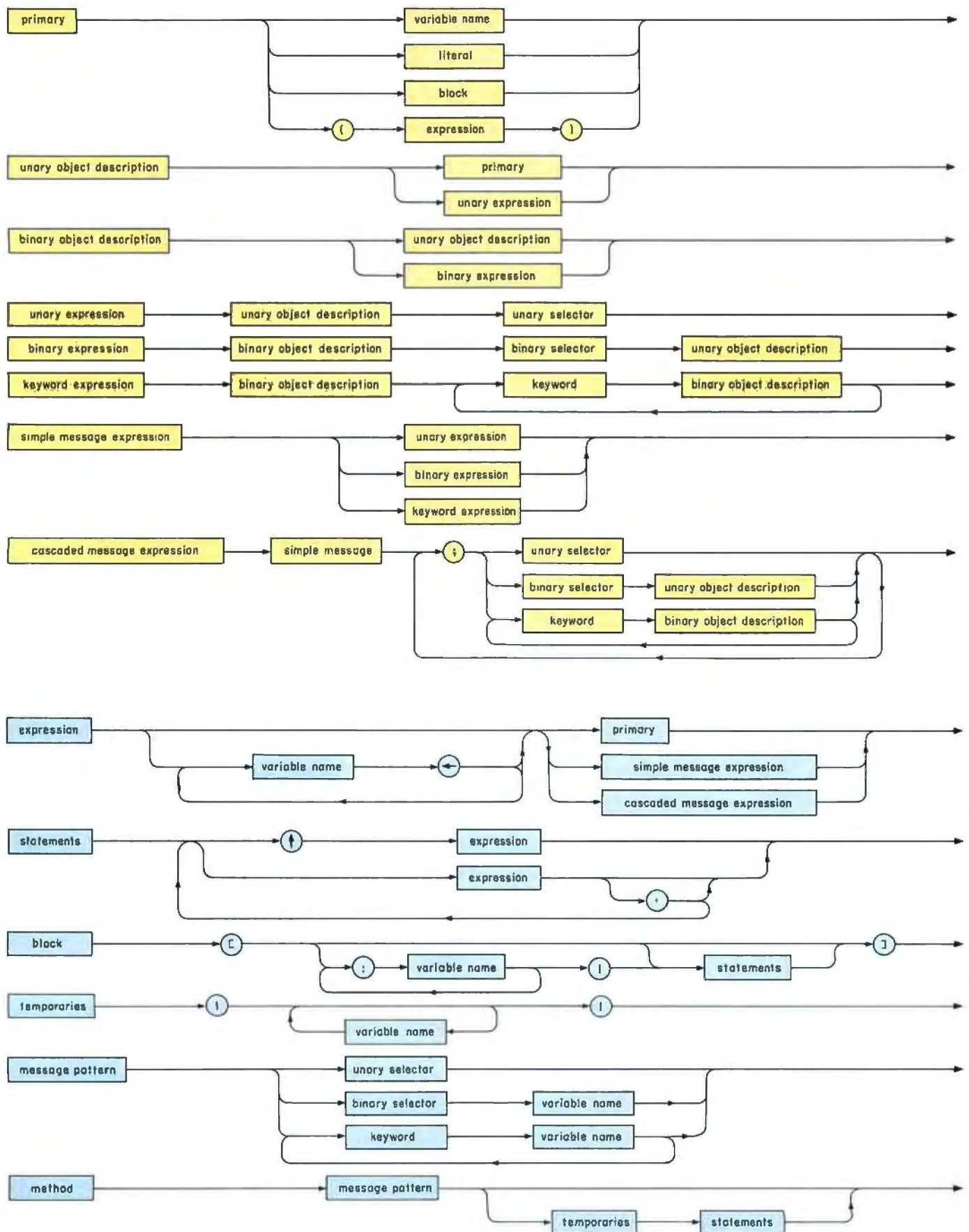

|                         |   |
|-------------------------|---|
| class name              | <i>identifier</i>                       |
| instance variable names | <i>identifier identifier identifier</i> |
| methods                 |   |
|                         | <i>method</i>                           |
|                         | <i>method</i>                           |
|                         | <i>method</i>                           |

Table 1: The basic class template.

class. Names of classes begin with an uppercase letter, and names of variables begin with a lowercase letter. As an example, figure 2 shows the basic template form of a class named *Point* whose instances represent points in a two-dimensional coordinate system. Each instance has an instance variable named *x* that represents its horizontal coordinate and an instance variable named *y* that represents its vertical coordinate. Each instance can respond to messages that initialize its two instance variables, request the value of either variable, and perform simple

arithmetic. The details of methods (in particular, the use of '|', '.' and '!') are the subject of our next discussion.

**Methods**

A method has three parts:

- a *message pattern*
- some *temporary variable names*
- some *expressions*

The three parts of a method are separated by vertical bars (|). The message pattern consists of a selector and names for the arguments. The expressions are separated by periods (.) and the last one may be preceded by an up arrow (!). In the method for selector + in figure 2, the message pattern is + aPoint, the temporary variable names are sumX and sumY, and there are three expressions, the last one preceded by an !.

Line breaks have no significance in *methods*; formatting is used only for purposes of aesthetics. The vertical bars and periods are delimiters of significance.

As stated earlier, each message pattern contains a selector. When a message is received by an instance, the method whose message pattern contains the same selector will be executed. For example, suppose that *offset* were an

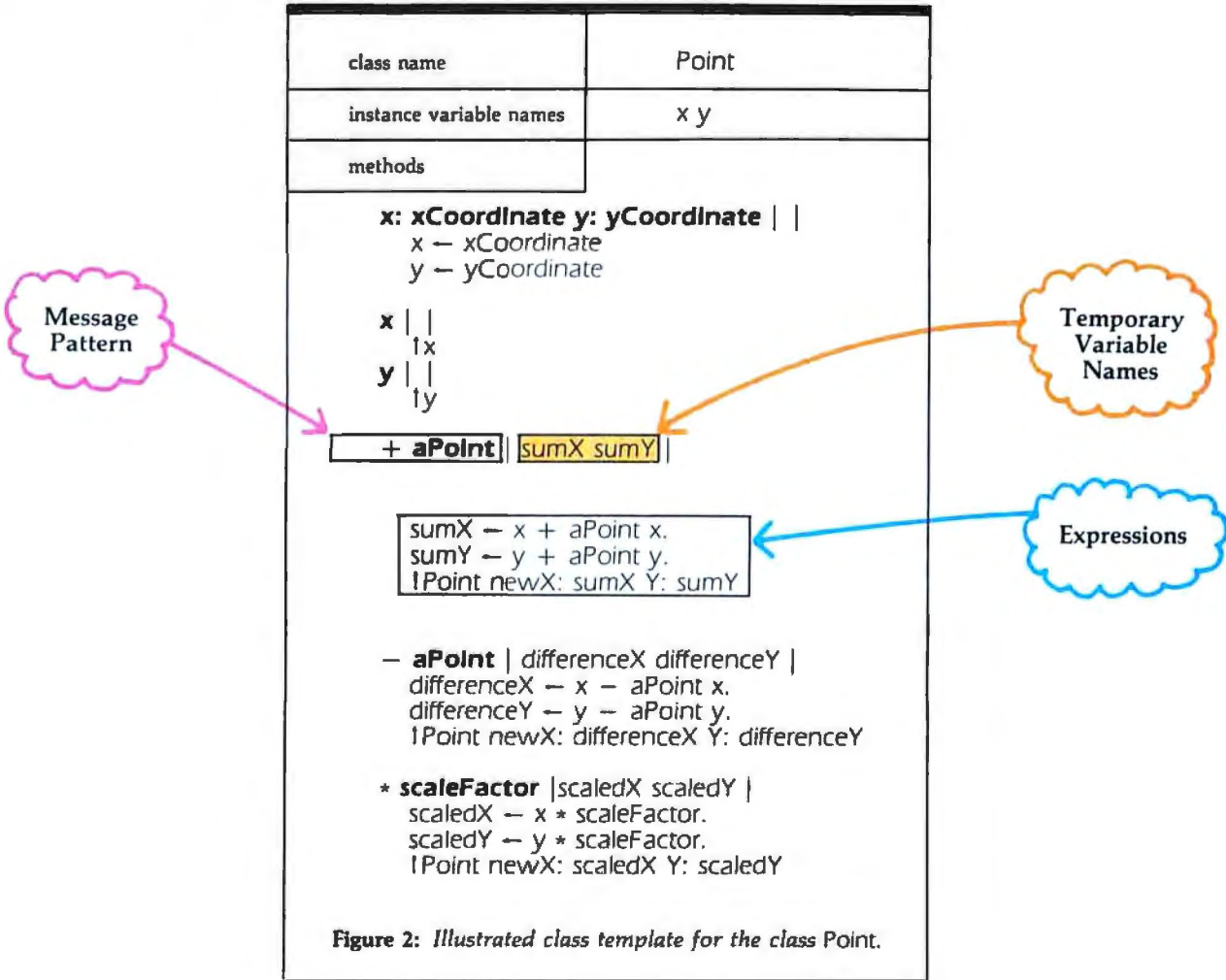

|                         |   |
|-------------------------|---|
| class name              | DepositRecord   |
| superclass              | Object  |
| instance variable names | date amount   |
| methods                 | <pre> <b>of: depositAmount on: depositDate    </b>     date ← depositDate.     amount ← depositAmount  <b>amount    </b>     ↑ amount  <b>balanceChange    </b>     ↑ amount </pre> |

**Table 2:** Class template for class DepositRecord.

|                         |  |
|-------------------------|--|
| class name              | CheckRecord  |
| superclass              | DepositRecord  |
| instance variable names | number   |
| methods                 | <pre> <b>number: checkNumber for: checkAmount on:</b> <b>checkDate    </b>     number ← checkNumber.     date ← checkDate.     amount ← checkAmount  <b>of: anAmount on: aDate    </b>     self error:     'Check records are initialized with     number:for:on:'  <b>balanceChange     0 ← amount</b> </pre> |

**Table 3:** Class template for class CheckRecord.

instance of Point in the expression

offset + frame center

The method whose message pattern is + aPoint would be executed in response. For selectors that take arguments, the message pattern also contains *argument names* wherever arguments would appear in a message. When a method is invoked by a message, the argument names in the method are used to refer to the actual arguments of that message. In the above example, aPoint would refer to the result of frame center.

|                               |  |
|-------------------------------|--|
| class name                    | <i>identifier</i>  |
| superclass                    | <i>identifier</i>  |
| instance variable names       | <i>identifier identifier identifier</i>                  |
| class variable names          | <i>identifier identifier identifier</i>                  |
| class messages and methods    | <pre> <i>method</i>  <i>method</i>  <i>method</i> </pre> |
| instance messages and methods | <pre> <i>method</i>  <i>method</i>  <i>method</i> </pre> |

**Table 4:** The full class template.

Following the message pattern, a method can contain some *temporary variable names* between vertical bars. When a method is executed, a set of variables is created that can be accessed by the temporary variable names. These temporary variables exist only while the method is in the process of execution.

Following the second vertical bar, a method contains a sequence of expressions separated by periods. When a method is executed, these expressions are evaluated sequentially.

So, there are three steps in receiving a message, corresponding to the three parts of the method. Smalltalk will

1. Find the method whose message pattern has the same selector as the message and create a set of variables for the argument values.
2. Create a set of temporary variables corresponding to the names between the vertical bars.
3. Evaluate the expressions in the method sequentially.

Six kinds of variables can be used in a method's expressions:

- the instance variables of the receiver
- the pseudo-variable *self*
- the message arguments
- temporary variables
- class variables
- global variables

The instance variables are named in the message receiver's class. In the example, x and y refer to the values of the instance variables of offset.

There is an important *pseudo-variable* available in every method, which is named *self*. *self* refers to the

receiver of the message that invoked the method. It is called a pseudo-variable because its value can be accessed like a variable, but its value cannot be changed using an assignment expression. In the example, *self* refers to the same object as *offset* during the execution of the method associated with +.

Arguments and temporary variables are similar, in that the names for both are declared in the method itself and they both exist only during the method's execution. However, unlike arguments, temporary variables are not automatically initialized. The values of temporary variables can be changed with an assignment expression.

*Class variables* are shared by all instances and the class itself. Names for the class variables are shown in the full class template in an entry called "class variable names" (see table 4). Although they are variables and their values can be changed, they are typically treated as constants, initialized when the class is created, and then simply used by the instances. For example, if the class of floating-point numbers wanted to provide trigonometric functions, it might want to define a variable called *pi* to be used in any of its methods.

*Global variables* are shared by all objects. A global dictionary, called *Smalltalk*, holds the names and values of these variables. The classes in the system, for example, are the values of global variables whose names are the class names. With the exception of variables used to reference system resources, few global variables exist in the Smalltalk-80 system. Programming style that depends on user-defined globals is generally discouraged.

If the last expression in a method is preceded by an *!*, the message that invoked the method takes on the value of this expression. If an *!* does not precede the last expression, the value of the message is simply the receiver of the message. For example, the *x:y:* message to a *Point* (see figure 2) behaves as if it had been written

```
x: xCoordinate y: yCoordinate | |
  x ← xCoordinate.
  y ← yCoordinate.
  ! self
```

Methods can contain comments anywhere. A *comment* is a sequence of characters delimited by double quotes. Two consecutive double quotes are used to embed a double quote within a comment. The methods in class *Point* were purposely written in a verbose style to provide examples. The messages for + could have been written

```
+ aPoint | |
  ! Point newX: x + aPoint x Y: y + aPoint y
```

The basic class template presents only the most important attributes of a class. The complete description of a class is provided by the *full class template*, described in the next section.

## Inheritance

The basic template allows a class to be described in-

dependently of other classes. It ignores inheritance among classes. The full class template, however, takes inheritance into account. (See table 4.) With it, a class can be described as a modification of another class called its *superclass*. All classes that modify a particular class are called its *subclasses*. A subclass inherits the instance variable names and methods of its superclass. A subclass can also add instance variable names and methods to those it inherits. The instance variable names added by the subclass must differ from the instance variable names of the superclass. The subclass can *override* a method in the superclass by adding a message with the same selector. Instances of the subclass will execute the method found in the subclass rather than the method inherited from the superclass.

To assemble the complete description of a class, it is necessary to look at its superclass, its superclass's superclass, and so on, until a class with no superclass is encountered. There is only one such class in the system (ie: without a superclass), and its class name is *Object*. All classes ultimately inherit methods from *Object*. *Object* has no instance variables. The set of classes linked through the superclass relation is called a *superclass chain*. The full class template has an entry called "superclass" that specifies the initial link on the class's superclass chain.

As an example, we might describe a class, *DepositRecord*, whose instances are records of bank account deposits. Each instance has two instance variables representing the date and amount of the deposit. The class template is shown in table 2.

|                               |   |
|-------------------------------|---|
| class name                    | CheckRecord   |
| superclass                    | DepositRecord   |
| instance variable names       | number  |
| class messages and methods    | <pre>number: checkNumber for: checkAmount on:   checkDate       ! self new number: checkNumber     for: checkAmount     on: checkDate</pre>   |
| instance messages and methods | <pre>number: checkNumber for: checkAmount on:   checkDate       super of: checkAmount on: checkDate.   number ← checkNumber  of: anAmount on: aDate       self error: 'Check records are initialized with   number:for:on:'  balanceChange     ! 0 ← amount</pre> |

Table 5: Full class template for class *CheckRecord*.

A class, *CheckRecord*, whose instances are records of checks written on an account is a subclass of *DepositRecord*; this new class adds an instance variable that represents the check number. The class template is shown in table 3.

An instance of *CheckRecord* has three instance variables. It inherits the *amount* message, adds the *number:for:on:* message, and overrides the *balanceChange* and *of:on:* messages. The *of:on:* method contains a single expression in which the message error: 'Check records are initialized with number:for:on:' is sent to the pseudo-variable *self*. The method for error: is found in the superclass of *DepositRecord*, which is the class *Object*; the response is to stop execution and to display the string literal argument to the user.

An additional pseudo-variable available in a method's

|                               |   |
|-------------------------------|---|
| class name                    | Point   |
| superclass                    | Object  |
| instance variable names       | x y   |
| class variable names          | pi  |
| class messages and methods    | <p><i>instance creation</i><br/> <b>newX: xValue Y: yValue</b>    <br/>           ↑ self new x: xValue<br/>           y: yValue<br/> <b>newRadius: radius Angle: angle</b>    <br/>           ↑ self new x: radius * angle sin<br/>           y: radius * angle cos</p> <p><i>class initialization</i><br/> <b>setPI</b>     pi — 3.14159</p>   |
| instance messages and methods | <p><i>accessing</i><br/> <b>x: xCoordinate y: yCoordinate</b>    <br/>           x — xCoordinate.<br/>           y — yCoordinate<br/> <b>x</b>       x<br/> <b>y</b>       y<br/> <b>radius</b>       ((x * x) + (y * y)) squareRoot<br/> <b>angle</b>       (x/y) arctan</p> <p><i>arithmetic</i><br/> <b>+ aPoint</b>       Point newX: x + aPoint x<br/>           Y: y + aPoint y<br/> <b>- aPoint</b>       Point newX: x - aPoint x<br/>           Y: y - aPoint y<br/> <b>* scaleFactor</b>       Point newX: x * scaleFactor<br/>           Y: y * scaleFactor</p> <p><b>circleArea</b>   r  <br/>           r — self radius.<br/>           ↑ pi * r * r</p> |

Table 6: Full class template for class Point.

expressions is *super*. It allows a subclass to access the methods in its superclass that have been overridden in the subclass description. The use of *super* as the receiver of a message has the same effect as the use of *self*, except that the search for the appropriate message starts in the superclass, not the class, of the receiver.

For example, the method associated with *number:for:on* in *CheckRecord* might have been defined as

```
number: checkNumber for: checkAmount on:
checkDate | |
super of: checkAmount on: checkDate.
number — checkNumber
```

### Metaclasses

Since a class is an object, there is a different class that describes it. A class that describes a class is called a *metaclass*. Thus, a class has its own instance variables that represent the description of its instances; it responds to messages that provide for the initialization and modification of this description. In particular, a class responds to a message that creates a new instance. The unary message *new* creates a new instance whose instance variables are uninitialized. The object *nil* indicates an uninitialized value.

The classes in the system might all be instances of the same class. However, each class typically uses a slightly different message protocol to create initialized instances. For example, the last expression in the method associated with *+* in class *Point* (see figure 2) was

```
Point newX: sumX Y: sumY
```

*newX:Y:* is a message to *Point*, asking it to create a new instance with *sumX* and *sumY* as the values of the new instance's instance variables. The *newX:Y:* message would not mean anything to another class, such as *DepositRecord* or *CheckRecord*. So, these three classes can't be instances of the same class. All classes have a lot in common, so their classes are all subclasses of the same class. This class is named *Class*. The subclasses of *Class* are called *metaclasses*.

The *newX:Y:* message in *Point*'s metaclass might be implemented as

```
newX: xValue Y: yValue | |
↑ self new x: xValue y: yValue
```

The *new* message was inherited by *Point*'s metaclass from *Class*. One reason for having metaclasses is to have a special set of methods for each class, primarily messages for initializing class variables and new instances. These methods are displayed in the full class-template form shown in table 4; they are distinguished from the methods for messages to the instances of the class. The two categories are "class messages and methods" and "instance messages and methods," respectively. Methods in

the category "class messages and methods" are associated with the metaclass; those in "instance messages and methods" are associated with the class.

If there are no class variables for the class, the "class variable name" entry is omitted. So, *CheckRecord* might be described as shown in table 5.

It is often desirable to create subcategories within the categories "class messages and methods" and "instance messages and methods." Moreover, the order in which the categories or subcategories are listed is of no significance. (The notion of categories is simply a pretty printing" technique; it has no semantic significance.)

Returning to the example of class *Point*, if the instance methods of class *Point* include subcategories *accessing* and *arithmetic*, the template for *Point* might appear as shown in table 6.

When the class *Point* is defined, the expression

```
Point setPi
```

should be evaluated in order to set the value of the single class variable.

A *Point* might be created and given a name by evaluating the expression

```
testPoint ← Point newX: 420 Y: 26
```

The new *Point*, *testPoint*, can then be sent the message *circleArea*:

```
testPoint circleArea
```

or used in a more complex expression:

```
(testPoint * 2) circleArea
```

### Primitive Routines

The response to some messages in the system may be performed by a *primitive routine* (written in the implementation language of the machine) rather than by evaluating the expressions in a method. The methods for these messages indicate the presence of such a primitive routine by including *<primitive>* before the first expression in the method. A major use of primitive methods is to interact with the machine's input/output devices.

An example of a primitive method is the *new* message to classes, which returns a new instance of the receiver.

```
new | | <primitive>
```

This particular primitive routine always produces a result. If there are situations in which a primitive routine cannot produce a result, the method will also contain some expressions. If the primitive routine is successful in responding to the message, it will return a value and the expressions in the method will not be evaluated. If the primitive routine encounters difficulty, the expressions will be evaluated as though the primitive routine had not been specified.

Another example of a message with a primitive response is a message with the selector *+* sent to a *SmallInteger*

```
+ aNumber | | <primitive>
self error: 'SmallInteger addition has failed'
```

One reason this primitive might fail to produce a result is that the argument is not a *SmallInteger*. In the example, this would produce an error report. In the actual *Smalltalk-80* system, an attempt is made to check and see if the argument were another kind of number for which a result could be produced.

### Indexed Instance Variables

An object's instance variables are usually given names by its class. The names are used in methods of the class to refer to the values of the instance variables. Some objects also have a set of instance variables that have no names and can only be accessed by messages. The instance variables are referred to by an integral *index*. Indexable objects are used to implement the classes in the system that represent collections of other objects, such as arrays and strings.

The messages to access indexed instance variables have

|  |                   |
|--|-------------------|
| class name   | Array             |
| superclass   | IndexedCollection |
| indexable instance variables   |                   |
| class messages and methods   |                   |
| <i>instance creation</i><br><b>with: anElement    </b><br>  (self new: 1) at: 1 put: anElement<br><b>with: firstElement with: secondElement</b><br>  anArray  <br>anArray ← self new: 2.<br>anArray at: 1 put: firstElement.<br>anArray at: 2 put: secondElement.<br>  anArray |                   |
| instance messages and methods  |                   |
| <i>accessing</i><br><b>at: anInteger    </b><br><primitive><br>self error: 'index out of range'<br><br><b>at: anInteger put: anElement    </b><br><primitive><br>self error: 'index out of range'<br><br><i>funny stuff</i><br><b>embed    </b><br> Array with: self           |                   |

Table 7: Full class template for class *Array*.

selectors `at:` and `at:put:`. For example

```
list at: 1
```

returns the first indexed instance variable of `list`. The example

```
list at: 4 put: element
```

stores `element` as the value of the fourth indexed instance variable of `list`. The `at:` and `at:put:` messages invoke primitive routines to load or store the value of the indicated variable. The legal indices run from one to the number of indexable variables in the instance. The `at:` and `at:put:` messages are defined in class `Object` and, therefore, can be understood by all objects; however, only certain classes will create instances with indexable instance variables. These classes will have an additional line in the class template indicating that the instances contain *indexable instance variables*. As an example, we show a part of the template for class `Array` in table 7.

Each instance of a class that allows indexable instance variables may have a different number of them; such instances are created using the `new:` message to a class, whose argument tells the number of indexable variables. The number of indexable instance variables an instance has can be found by sending it the message `size`. A class whose instances have indexable instance variables can also have named instance variables. All instances of any class will have the same number of named instance variables.

## Control Structures and Blocks

The two control structures in the Smalltalk-80 system described so far are

- the sequential execution of expressions in a method
- the sending of messages that invoke other methods that eventually return values

All other control structures are based on objects called *blocks*. Like a method, a block is a sequence of expressions, the last of which can be preceded by an up arrow (`!`). The expressions are delimited by periods; they may be preceded by one or more identifiers with leading colons. These identifiers are the *block arguments*. Block arguments are separated from expressions by a vertical bar.

Whenever square brackets are encountered in a method, a block is created. Evaluation of the expressions inside the square brackets is deferred until the block is sent the message `value` or a message whose selector is a concatenation of one or more occurrences of the keyword `value:`. Control structures are implemented as messages with receivers or arguments that are blocks. The methods for carrying out these control-structure messages involve sending the blocks patterns of `value` messages.

In the Smalltalk-80 system, there are two types of

primitive control messages: conditional selection of blocks, `ifTrue:ifFalse:`, and conditional iteration of blocks, `whileTrue:` and `whileFalse:`.

The representation of conditions in the Smalltalk-80 system uses distinguished boolean objects named `false` and `true`. The first type of primitive control message provides for conditional selection of a block to be executed. This is similar to the `IF . . . THEN . . . ELSE` of ALGOL-like languages. The expression

```
queue isEmpty ifTrue: [index ← 0]
                ifFalse: [index ← queue next]
```

evaluates the expressions in the first block if the receiver is `true` and evaluates the expressions in the second block if the receiver is `false`. Two other forms of conditional selection provide only one alternative

```
queue isEmpty ifTrue: [index ← 0].
queue isEmpty ifFalse: [index ← queue next].
```

When `ifTrue:` is sent to `false`, it returns immediately without executing the block. When `ifFalse:` is sent to `true`, the block is not executed.

The second type of primitive control message repeatedly evaluates the expressions in a block as long as some condition holds. This is similar to the `WHILE` and `UNTIL` statements in ALGOL-like languages. This type of control message is a message to a block; the receiver, the block, evaluates the expressions it contains and determines whether or not to continue on the basis of the value of the last expression. The first form of this control message has selector `whileTrue:`. The method for `whileTrue:` repeatedly executes the argument block as long as the receiver's value is `true`. For example,

```
[index <= limit] whileTrue: [self process: list at: index.
                             index ← index + 1]
```

The binary message `<=` is understood by objects representing magnitudes. The value returned is the result of comparing whether the receiver is less than or equal to (`<=`) the argument.

The second conditional iteration message has selector `whileFalse:`. The method for `whileFalse:` repeatedly executes the argument block as long as the receiver's value is `false`. For example,

```
[queue isEmpty] whileFalse: [self process: queue next]
```

The messages `whileTrue` and `whileFalse` to a block provide a shorthand notation for messages of the form `whileTrue: aBlock` and `whileFalse: aBlock`, if the argument `aBlock` is an empty block.

Block arguments allow one or more of the variables inside the block to be given new values each time the block is executed. Instead of sending the block the message `value`, messages with selectors `value:` or `value:value:`, and



so on, are sent to the block. The arguments of the value: messages are assigned to the block arguments (in order) before the block expressions are evaluated.

As an example, classes with indexed instance variables could implement a message with selector `do:` that takes a block as an argument and executes it once for every indexed variable. The block has a single block argument; the value of the appropriate indexed variable is passed to it for each execution. An example of the use of such a message is

```
list do: [:element | self process: element]
```

The message might be implemented as

```
do: aBlock | index |
  index ← 1.
  [index < = self size] whileTrue:
    [aBlock value: (self at: index).
     index ← index + 1]
```

Similar control messages can be implemented for any class. As an example, a simple repetition could be provided by a `timesRepeat: aBlock` message to instances of class `Integer`

```
timesRepeat: aBlock | index |
  index ← 1.
  [index < = self] whileTrue:
    [aBlock value.
     index ← index + 1]
```

Examples of implementing other control messages are given in L Peter Deutsch's article "Building Control Structures in the Smalltalk-80 System," on page 322.

### The Smalltalk-80 System: Basic Classes

The Smalltalk-80 language provides a uniform syntax for retrieving objects, sending messages, and defining classes. The Smalltalk-80 system is a complete programming environment that includes many actual classes and instances. In support of the uniform syntax, this system includes class descriptions for `Object`, `Class`, `Message`, `CompiledMethod`, and `Context`, whose subclasses are `BlockContext` and `MethodContext`. Multiple independent processes are provided by classes `ProcessorScheduler`, `Process`, and `Semaphore`. The special object `nil` is the only instance of class `UndefinedObject`. These classes comprise the kernel Smalltalk-80 system.

The system also includes class descriptions to support basic data structures; these are numerical and collection classes. The class `Number` specifies the protocol appropriate for all numerical objects. Its subclasses provide specific representations of numbers. The subclasses are `Float`, `Fraction`, and `Integer`. For a variety of reasons, there are both `SmallIntegers` and `LargeIntegers`; of these, there are `LargePositiveIntegers` and `LargeNegativeIntegers`.

Class `Collection` specifies protocol appropriate to objects representing collections of objects. These include `Bag`, `Set`, `OrderedCollection`, `LinkedList`, `MappedCollection`, `SortedCollection`, and `IndexedCollection`. The latter provides protocol for objects with indexable instance variables. It has subclasses `String` and `Array`. Elements of a string are instances of class `Character`; bytes are stored in instances of `ByteArray`. A subclass of `String` is `Symbol`; a subclass of `Set` is `Dictionary` (a set of Associations).

`Interval` is a subclass of `Collection` with elements representing an arithmetic progression. Intervals can be created by sending the message `to:` or `to:by:` to `Integer`. So, the expressions `1 to: 5 by: 1` and `1 to: 5` each create a new `Interval` representing 1, 2, 3, 4, 5. As a `Collection`, `Interval` responds to the enumeration message `do:`. For example, in

```
(1 to: 5) do: [:index | anArray at: index put: index * 2]
```

the block argument `index` takes on successive values 1, 2, 3, 4, 5.

For programmer convenience, an `Integer` also responds to the messages `to:do:` and `to:by:do:`, allowing the parentheses in interval enumeration expressions to be omitted.

The ability to stream over indexed or ordered collections is provided by a hierarchy based on class `Stream`, including `ReadStream`, `WriteStream`, and `ReadAndWriteStream`. A file system, local or remote, is then implementable as a subclass of these kinds of Streams.

Since instances of the system classes described above are used in the implementation of all applications, an understanding of their message protocol is as necessary to understanding an implementation as an understanding of the language syntax. These system classes are fully described in the forthcoming Smalltalk books.

In addition to the basic data-structure classes, the Smalltalk-80 system includes class descriptions to support interactive graphics (forms and images and image editors, text and text editors), networking, standard files, and hard-copy printing. A complete Smalltalk-80 system contains about sixty class definitions, not including a variety of windows or views, menus, scrollbars, and the metaclasses. Many of these are discussed in companion articles in this issue. (See Daniel H H Ingalls's "The Design Principles Behind Smalltalk," page 286, and Larry Tesler's "The Smalltalk Environment," page 90.)

The important thing to note is that each of these class descriptions is implemented in the Smalltalk-80 language itself. Each can be examined and modified by the programmer. Some of the class descriptions contain methods that reference primitive methods; only these methods are implemented in the machine language of the implementation machine. It is a fundamental part of the philosophy of the system design that the programmer have such complete access. In this way, system designers, such as members of the Xerox Learning Research Group, are able to build the next Smalltalk in the complete context of Smalltalk itself. ■

## References

1. Birtwistle, Graham; Ole-Johan Dahl; Bjorn Myhrhaug; and Kristen Nygaard. *Simula Begln*. Philadelphia: Auerbach, 1973.
2. Goldberg, Adele and Alan Kay, editors. *Smalltalk-72 Instructional Manual*. Xerox PARC technical report, March 1976 (out of print).
3. Goldberg, Adele; David Robson; and Daniel H H Ingalls. *Smalltalk-80: The Language and Its Implementation* and *Smalltalk-80: The Interactive Programming Environment*, 1981 (books forthcoming).
4. Ingalls, Daniel H H. "The Smalltalk-76 Programming System: Design and Implementation." In *Proceedings of the Principles of Programming Languages Symposium*, January 1978.
5. Kay, Alan. *The Reactive Engine*. Ph.D. Thesis, University of Utah, September, 1969 (University Microfilms).

## Glossary

**Editor's Note:** This glossary provides concise definitions for many of the keywords and concepts related to *Smalltalk-80*. These definitions will be most useful if you first read the introductory *Smalltalk* articles. . . . GW

### General Terminology

|                          |  |
|--------------------------|--|
| <i>object</i>            | <i>a package of information and descriptions of its manipulation</i>   |
| <i>message</i>           | <i>a specification of one of an object's manipulations</i>   |
| <i>method</i>            | <i>a procedure-like entity; the description of a sequence of actions to be taken when a message is received by an object</i> |
| <i>class</i>             | <i>a description of one or more similar objects</i>  |
| <i>instance</i>          | <i>an object described by a particular class</i>   |
| <i>method dictionary</i> | <i>a set of associations between message selectors and methods; included in each class description</i>                       |
| <i>metaclass</i>         | <i>a class whose (single) instance is itself a class</i>   |
| <i>subclass</i>          | <i>a class that is created by sharing the description of another class, often modifying some aspects of that description</i> |

### Syntax Terminology

|                         |   |
|-------------------------|---|
| <i>message receiver</i> | <i>the object to be manipulated, according to a message</i>   |
| <i>message sender</i>   | <i>the object requesting a manipulation</i>   |
| <i>message selector</i> | <i>a symbolic name that describes a desired manipulation of an object</i>   |
| <i>message argument</i> | <i>one of the objects specified in a message that provides information needed so that a message receiver can be manipulated appropriately</i>       |
| <i>unary message</i>    | <i>a message without arguments</i>  |
| <i>binary message</i>   | <i>a message with a single argument and a selector that is one of a set of special single or double characters</i>                                  |
| <i>keyword message</i>  | <i>a message that has one or more arguments and a selector made up of a series of identifiers with trailing colons, one preceding each argument</i> |

|              |   |
|--------------|---|
| <i>block</i> | <i>a literal method; an object representing a sequence of actions to be taken at a later time, upon receiving an "evaluation" message (such as one with selector value or value:)</i> |
|--------------|---|

### Semantics

|                                |  |
|--------------------------------|--|
| <i>instance variable</i>       | <i>a variable that is information used to distinguish an instance from other instances of the same class</i>   |
| <i>class variable</i>          | <i>a variable shared by all instances of a class and the class itself</i>  |
| <i>named variable</i>          | <i>an instance variable that is given a name in the class of the instance; the name is used in methods of the class</i>  |
| <i>indexed variable</i>        | <i>an instance variable with no name, accessed by message only; referred to by an integer (an index)</i>   |
| <i>global or pool variable</i> | <i>a variable shared by instances of several classes; a system example is Smalltalk, a dictionary that includes references to all the defined classes</i>                        |
| <i>temporary variable</i>      | <i>a variable that exists only while the method in which it is declared is in the process of execution</i>   |
| <i>pseudo-variable</i>         | <i>a variable available in every method without special declaration, but whose value cannot be changed using an assignment. System examples are self, super and thisContext.</i> |
| <i>nil</i>                     | <i>a special object, the only instance of class UndefinedObject</i>  |

### Implementation Terminology

|                        |  |
|------------------------|--|
| <i>field</i>           | <i>the memory space in which the value of an object's variable is stored</i>                         |
| <i>bytecode</i>        | <i>a machine instruction for the virtual machine</i>   |
| <i>object pointer</i>  | <i>a reference to an object</i>  |
| <i>reference count</i> | <i>of an object, is the number of objects that point to it (ie: that contain its object pointer)</i> |

**Robots:**  
*the future arrives...*

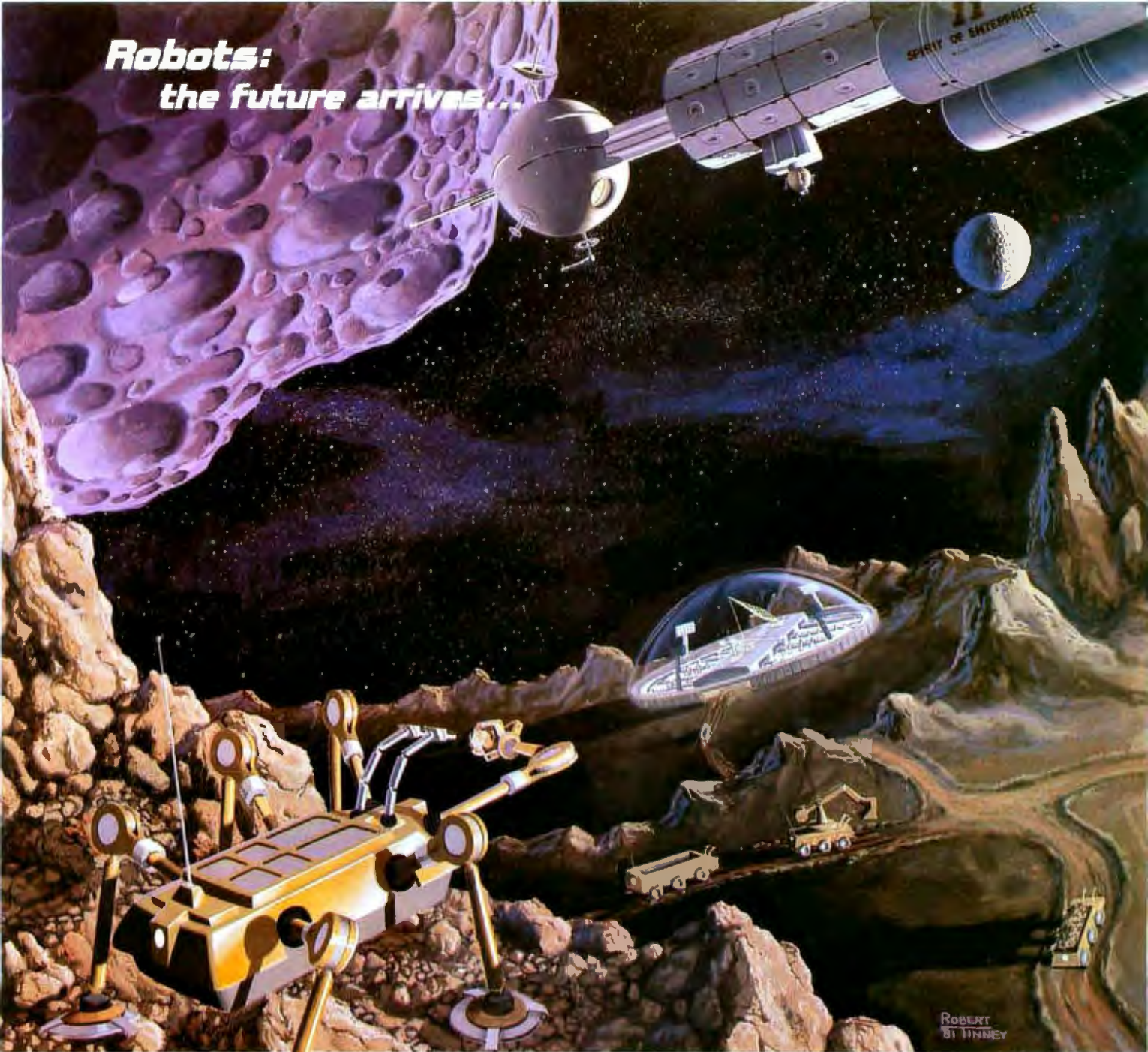

ROBERT  
ST. TINNEY

**Scene:** *An asteroid mining team of the 21st century. Not a human team, but a team of self-replicating intelligent robots.*

1961 Enter the first industrial robot—blind and unable to respond to its environment—capable only of unvarying, repetitive tasks.

1975 Robots with touch sensing begin to do precision assembly

1981 Robots are no longer blind—silhouette vision arrives.

1982 Robots feel with an artificial skin.

1986 Robots adapt to the unstructured human environment.

1987 Reasoning robots hear and speak human speech.

1990 Walking robots explore the surface of Mars.

1996 Orbiting robot factories construct solar power stations.

2000 and beyond: Self-replicating robots terraform the cosmos.

This future is unfolding today exclusively in the pages of *Robotics Age*. Every two months we bring you the latest state-of-the-art robotic technology—from artificial intelligence to automated robotic factories, to personal robots. Join us in the robotics age.



**The advances that make this a picture of our future are happening today.**

Robotics Age Magazine, Post Office Box 423, Tujunga, California 91042

## Build a Z8-Based Control Computer with BASIC, Part 2

Steve Ciarcia  
POB 582  
Glastonbury CT 06033

The Z8-BASIC Microcomputer system described in this two-part article is unlike any computer presently available for dedicated control applications. Based on a single-chip Zilog Z8 microcomputer with an on-board tiny-BASIC interpreter, this unit offers an extraordinary amount of power in a very small package. It is no longer necessary to use expensive program-development systems. Computer control can now be applied to many areas where it was not previously cost-effective.

The Z8-BASIC Microcomputer is intended for use as an intelligent controller, easy to program and inexpensive enough to dedicate to specific control tasks. It can also serve as a low-cost tiny-BASIC computer for general interest. Technical specifications for the unit are shown in the "At a Glance" box on page 52.

Last month I described the design of the Z8-BASIC Microcomputer hardware and the architectures of the Z8671 microcomputer component and Z6132 32 K-bit Quasi-Static Memory. This month I'd like to continue the description of the tiny-BASIC interpreter, discuss how the BASIC program is stored in memory, and demonstrate a few simple applications.

### Process-Control BASIC

The BASIC interpreter contained in

ROM (read-only memory) within the Z8671 is officially called the Zilog BASIC/Debug monitor. It is essentially a 2 K-byte integer BASIC which has been optimized for speed and flexibility in process-control applications.

There are 15 keywords: GOTO, GO@, USR, GOSUB, IF...THEN, INPUT, IN, LET, LIST, NEW, REM, RUN, RETURN, STOP, PRINT (and PRINT HEX). Twenty-six numeric variables (A through Z) are supported; and numbers can be ex-



Photo 1: Z8-BASIC Microcomputer. With the two "RAM" jumpers installed, it is configured to operate programs residing in the Z6132 Quasi-Static Memory. A four-position DIP (dual-inline pin) switch (at upper right) sets the serial data rate for communication with a user terminal connected to the DB-25S RS-232C connector on the top center. The reset button is on the top left.

# NEVER UNDER\$OLD.

That's right. If you can find a lower price in this magazine **WE WILL BEAT IT!** Period.\*

## S-100 HARDWARE

|                     |        |
|---------------------|--------|
| SD SYSTEMS          |        |
| Versa Floppy I kit  | \$259  |
| Versa Floppy II kit | \$349  |
| ExpandoRam II kit   | \$249  |
| ITHICA INTERSYSTEMS | \$CALL |
| ALTOS               | \$CALL |
| NORTHSTAR           | \$CALL |

## SUPPLIES

|                             |         |
|-----------------------------|---------|
| Verbatim Datalife Diskettes |         |
| MD525-01, 10, 16            | \$26.50 |
| FD34-9000                   | \$30.00 |
| FD34-8000                   | \$44.00 |

|                     |         |
|---------------------|---------|
| Avery Tabulables    |         |
| 5,000 3 1/2 X 15/16 | \$18.75 |
| 3,000 3 1/2 X 15/16 | \$14.25 |
| 1,000 3 1/2 X 15/16 | \$8.15  |

|                                   |         |
|-----------------------------------|---------|
| UARCO Paper (prices are FOB S.P.) |         |
| 9 1/2 X 11, 15 or 18 Lb.          | \$25.95 |
| 14 7/8 X 11, 15 or 18 Lb.         | \$35.00 |

## SOFTWARE

|                          |       |
|--------------------------|-------|
| Microsoft Basic-80       | \$299 |
| Microsoft Basic Compiler | \$319 |
| Microsoft Fortran-80     | \$399 |
| Magic Wand               | \$275 |
| Apple Visicalc           | \$113 |
| Pickles and Trout CP/M®  | \$175 |

## APPLE HARDWARE

|                         |       |
|-------------------------|-------|
| Microsoft Z-80 Softcard | \$259 |
| Microsoft Ramcard       | \$170 |
| SSM AIO A&T             | \$165 |
| SYMTEC Apple Light Pen  | \$219 |

## MOUNTAIN HARDWARE:

|                       |        |
|-----------------------|--------|
| Super Talker          | \$270  |
| ROMWRITER             | \$157  |
| INTROL/X-10           | \$180  |
| ROMPLUS+              | \$162  |
| MUSICSYSTEM           | \$499  |
| Apple Clock           | \$252  |
| Lobo Drive            | \$CALL |
| Videx 80 x 24         | \$299  |
| Andromeda             | \$170  |
| M & R Sup-R-Term      | \$299  |
| Enhancer              | \$100  |
| NEC Green Monitor     | \$240  |
| Sanyo Green Monitor   | \$240  |
| D.C. Hayes Micromodem | \$299  |

## CALIFORNIA COMPUTER SYSTEMS

See our full page ad in this magazine.

## PRINTERS

|                           |        |
|---------------------------|--------|
| EPSON MX-80               | CALL   |
| MX-80 Graphics ROM        | CALL   |
| NEW EPSON MX-80 TF        | CALL   |
| Okidata Microline 80      | \$415  |
| Okidata Microline 82      | \$625  |
| Okidata Microline 83      | \$899  |
| IDS Paper Tiger 4600      | \$1050 |
| Anadex DP-9000, 1         | \$1195 |
| Anadex DP-9500, 1         | \$1295 |
| Centronics 737            | \$689  |
| NEC Spinwriter            | \$CALL |
| NEC w/ Sellum Option      | \$CALL |
| C. Itoh Starwriter 25 cps | \$1440 |
| C. Itoh Starwriter 45 cps | \$1770 |
| Diablo 630                | \$2195 |
| Malibu 165                | \$1995 |
| Malibu 200                | \$CALL |
| MPI 88G                   | \$495  |

## TRS-80 HARDWARE

|                     |        |
|---------------------|--------|
| TRS-80's            | \$CALL |
| Micropolis 77 track | \$399  |
| Percom Doubler      | \$199  |
| Percom Separator    | \$27   |
| Orchestra 80        | \$79   |



**ALPHA  
BYTE  
STORES**

**5115 Douglas Fir Road • Suite B • Calabasas, CA 91302**

\*Include \$8.00 shipping and handling on all orders. Visa and Master Card accepted. Never undersold offer applies only to items currently deliverable from other retail vendors at advertised price. All never undersold offers good as supply lasts. Please add \$8.00 for all COD orders. Please call for items not listed. We gladly answer any questions on all of our hardware, software, and supply needs. Quantity discounts available. School purchase orders accepted. Please remember to figure competitors shipping and handling charges when arriving at never undersold price.

**(213) 883-8594**



pressed in either decimal or hexadecimal format. BASIC/Debug can directly address the Z8's internal registers and all external memory. Byte references, which use the "@" character followed by an address, may be used to modify a single register in the processor, an I/O port, or a memory location. For example, @4096 specifies decimal memory location 4096, and @%F6 specifies the port-2 mode-control register at decimal location 246. (The percent symbol indicates that the characters following it are to be interpreted as a hexadecimal numeral.) To place the value 45 in memory location 4096, the command is simply, @4096=45 (or @%1000=%2D).

Command abbreviations are standard with most tiny-BASIC interpreters, but this interpreter allows some extremes if you want to limit program space. For example:

```
IF 1>X THEN GOTO 1000
      can be abbreviated
IF 1>X 1000

PRINT"THE VALUE IS ";S
```

can be abbreviated  
"THE VALUE IS ";S

```
IF X=Y THEN IF Y=Z
THEN PRINT "X=Z"
      can be abbreviated
IF X=Y IF Y=Z "X=Z"
```

One important difference between most versions of BASIC and Zilog's BASIC/Debug is that the latter allows variables to contain statement numbers for branching, and variable storage is not cleared before a program is run. Statements such as GOSUB X or GOTO A\*E-Z are valid. It is also possible to pass values from one program to another. These variations serve to extend the capabilities of BASIC/Debug.

In my opinion, the main feature that separates this BASIC from others is the extent of documentation supplied with the Z8671. Frequently, a computer user will ask me how he can obtain the source-code listing for the BASIC interpreter he is using. Most often, I have to reply that it is not available. Software manufacturers that have invested many man-years

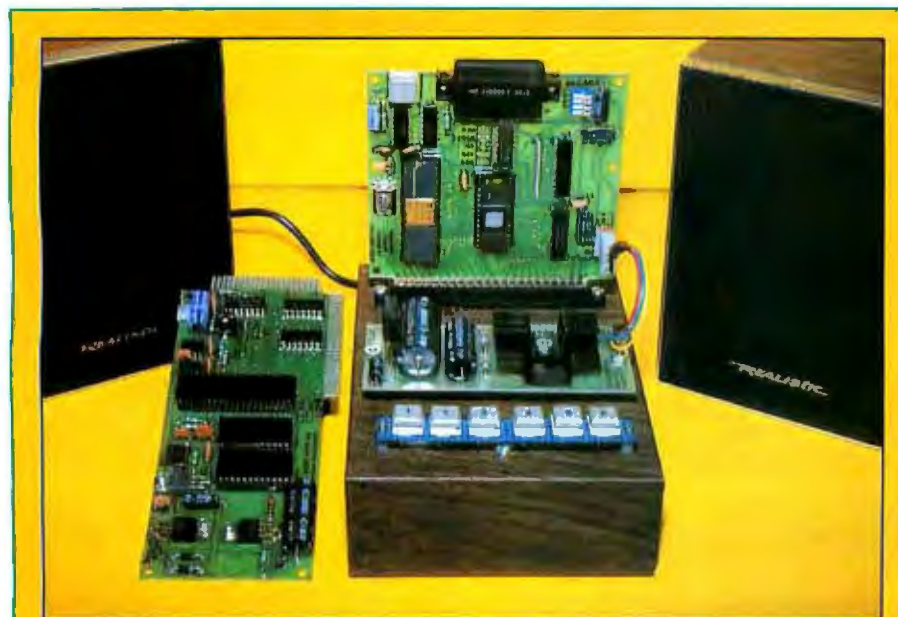

**Photo 2:** The Z8/Micromouth demonstrator. A Z8-BASIC Microcomputer is configured to run a ROM-resident program that exercises the Micromouth speech synthesizer presented in the June Circuit Cellar article. A Micromouth board similar to that shown on the left is mounted inside the enclosure. Six pushbutton switches, connected to a parallel input port on the Z8 board, select various speech-demonstration sequences. The Micromouth board is driven from a second parallel port on the Z8 board.

## At a Glance

**Name**  
Z8-BASIC Microcomputer

**Processor**  
Zilog Z8-family Z8671 8-bit microcomputer with programmable (read/write) memory, read-only memory, and I/O in a single package. The Z8671 includes a 2 K-byte tiny-BASIC/Debug resident interpreter in ROM, 144 internal 8-bit registers, and 32 I/O lines. System uses 7.3728 MHz crystal to establish clock rate. Two internal and four external interrupts.

**Memory**  
Uses Z6132 4 K-byte Quasi-Static Memory (pin-compatible with 2716 and 2732 EPROMs); 2 K-byte ROM in Z8671. Memory externally expandable to 62 K bytes of program memory and 62 K bytes of data memory.

**Input/Output**  
Serial port: RS-232C-compatible and switch-selectable to 110, 150, 300, 1200, 2400, 4800, and 9600 bps. Parallel I/O: two parallel ports; one dedicated to input, the other bit-programmable as input or output; programmable interrupt and handshaking lines; LSTTL-compatible. External I/O: 16-bit address and 8-bit bidirectional data bus brought out to expansion connector.

**BASIC Keywords**  
GOTO, GO@, USR, GOSUB, IF...THEN, INPUT, LET, LIST, NEW, REM, RETURN, RUN, STOP, IN, PRINT, PRINT HEX. Integer arithmetic/logic operators: +, -, /, \*, and AND; BASIC can call machine-language subroutines for increased execution speed; allows complete memory and register interrogation and modification.

**Power-Supply Requirements**  
+5 V  $\pm$ 5% at 250 mA  
+12 V  $\pm$ 10% at 30 mA  
-12 V  $\pm$ 10% at 30 mA  
(The 12 V supplies are required only for RS-232C operation.)

**Dimensions and Connections**  
4- by 4½-inch board; dual 22-pin (0.156-inch) edge connector. 25-pin RS-232C female D-subminiature (DB-25S) connector; 4-pole DIP-switch data-rate selector.

**Operating Conditions**  
Temperature: 0 to 50°C (32 to 122°F)  
Humidity: 10 to 90% relative humidity (noncondensing)

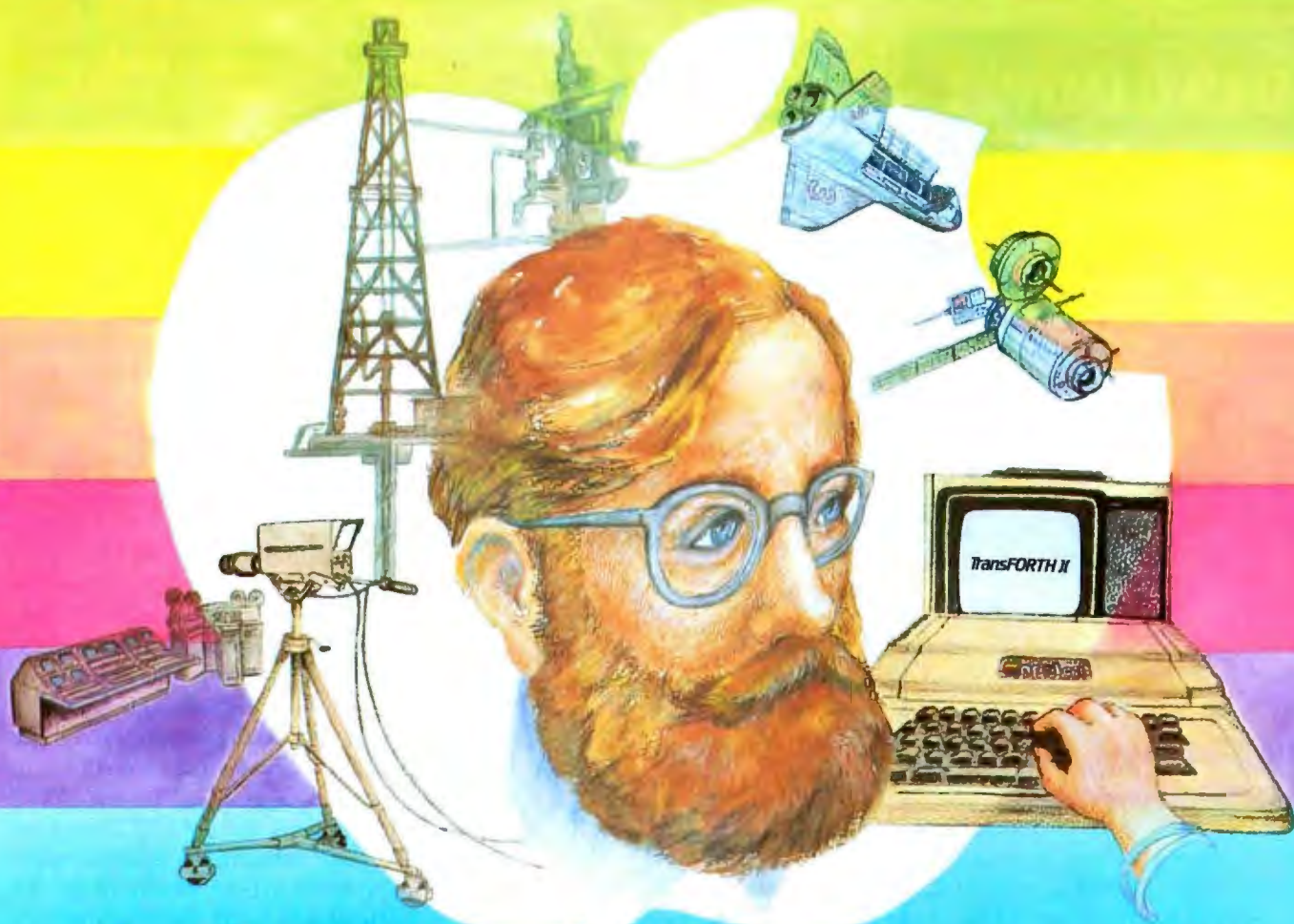

# In Language Lies The Future.

Paul Lutus creates language. Language for the future. From him we have Apple Writer, Apple World and MusiComp. His software was used by the Viking Mars Lander team and other advanced space programs.

For the past three years he has applied himself to the development of more efficient and powerful computer languages to help him with his work. These new languages of the future are now available for your use exclusively from Insoft.

See the new world of programming from Insoft at your Apple dealer.

**insoft**

The languages of the future. The tools of today.

259 Barnett Rd. / Unit 3 / Medford, Or 97501 / (503) 779-2465



Apple is a registered trademark of Apple Computer, Inc.

## TransFORTH II

The final "word" in Apple programming. A brilliant extension of FORTH.

- Fully compiled
- Floating point
- Transcendental functions
- Strings and arrays
- Hires, Lores and Turtlegraphics
- Music

Far more compact and approachable than Pascal, TransFORTH II is both recursive and structured and easier to use than BASIC.

Over three years in development, this high level language enables you to program in English with far greater speed and convenience than ever before possible.

TransFORTH II. A transformation in computer programming. Available today.

## ALD System II

The Assembly Language Development System. Already the preferred assembler for professional software developers.

- Object files to 18K
- Source files to 37K
- Cursor based screen editor
- Upper and lower case text entry
- Nested macro instructions
- Local, global and universal labels
- Comprehensive error trapping

The enormous file capacity of ALD System II assures you of the ability to develop virtually any imaginable software system. And you can do so with ease since ALD System II edits with the simplicity of a word processor.

ALD System II. Powerful yet convenient. The first choice of professionals.

The best comes last. Both new programs are available for the Apple II or Apple III.

# DISCOUNT LINE

1-800-528-8960

1-602-861-3181 Arizona

TWX #910-950-1194

## ANADIX

9500-\$1275 9501-\$1275

## ATARI

400-\$435 800-\$740

## CENTRONICS

730-\$600 737-\$750

## DATASOUTH

DS120-\$595 DS180-\$1375

## DIABLO

630-\$2150 1640-\$2575

## EPSON

MX70-\$395 MX80-\$470

## HAZELTINE

1421-\$755 1520-\$1350

1500-\$995 Esprit-\$650

## IDS1

#60 Breakout 'Blue Box'-\$250

## LOBO

Drive/Controller-\$490

Drive-\$390

## MODEMS

Cat-\$155 Hays-\$325

## MONITORS

Leedex-\$135 Sanyo-\$165

## MPI

88G-\$595 99G-\$725

## NEC

5510-\$2540 5520-\$2900

## OKIDATE

M80-\$385 SL125-\$3150

M82-\$550 SL160-\$3150

M83-\$825 SL250-\$4200

## TELEVIDEO

912-\$725 950-\$995

## TI

810-\$1475 820-\$1795

## SOROC

1Q120-\$730 1Q135-\$800

## SSM

A10-\$160

## ZENITH

Z89-\$2150

Add - 3% Charge Cards  
2% Shipping

# EXPOTEK CORPORATION

2231R W. Shangri La Rd.  
Phoenix, AZ 85029

in a BASIC interpreter are not easily persuaded to give away its secrets.

In most cases, however, a user merely wants to know the location of the GOSUB...RETURN address stack or the format and location of stored program variables. While the source code for BASIC/Debug is also not available (because the object code is mask-programmed into the ROM, you couldn't change it anyway), the locations of all variables, pointers, stacks, etc. are fixed, and their storage formats are defined and described in detail. The 60-page BASIC/Debug user's manual contains this information and is included in the 200 pages

of documentation supplied with the Z8-BASIC Microcomputer board. (The documentation is also available separately.)

## Memory Allocation

Z8-family microcomputers distinguish between four kinds of memory: internal registers, internal ROM, external ROM, and external read/write memory. (A slightly different distinction can also be made between program memory and data memory, but in this project this distinction is unnecessary.) The register file resides in memory-address space in hexadecimal locations 0 through FF (decimal 0 through 255). The 144 registers include four I/O- (input/output) port registers, 124 general-purpose registers, and 16 status and control registers. (No registers are implemented in hexadecimal addresses 80 through EF [decimal addresses 128 through 239]).

The 2 K-byte ROM on the Z8671 chip contains the BASIC/Debug interpreter, residing in address space from address 0 to hexadecimal 7FF (decimal 0 to 2047). External memory starts at hexadecimal address 800 (decimal 2048). A memory map of the Z8-BASIC Microcomputer system is shown in figure 1.

When the system is first turned on, BASIC/Debug determines how much external read/write memory is available, initializes memory pointers, and checks for the existence of an auto-start-up program. In a system with external read/write memory, the top page is used for the line buffer, program-variable storage, and the GOSUB...RETURN address stack. Program execution begins at hexadecimal location 800 (decimal 2048).

When BASIC/Debug finds no external read/write memory, the internal registers are used to store the variables, line buffer, and GOSUB...RETURN stack. This limits the depth of the stack and the number of variables that can be used simultaneously, but the restriction is not too severe in most control applications. In a system without external memory, automatic program execution begins at hexadecimal location 1020 (decimal 4128).

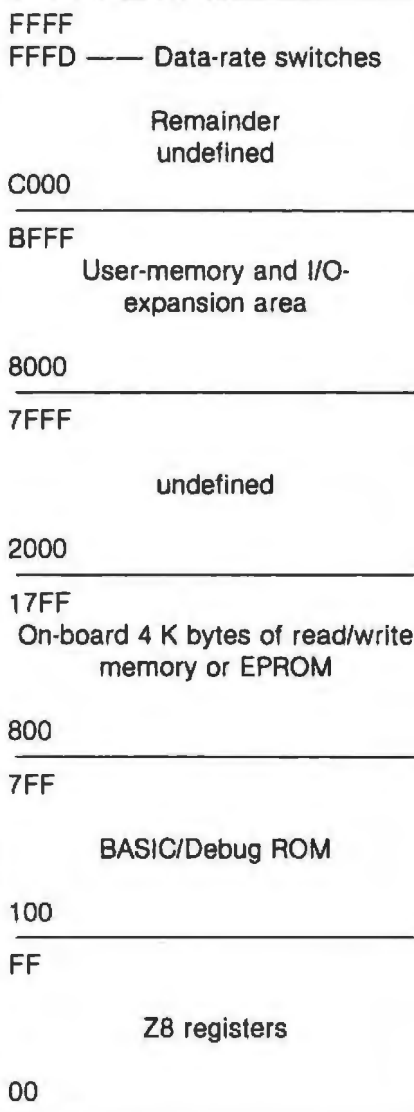

Figure 1: A simplified hexadecimal memory map of the Z8-BASIC Microcomputer.



# GUARANTEED RELIABLE FOR 2 FULL YEARS.

Unprecedented product reliability deserves an unprecedented warranty. IMS International provides its dealers with both.

## Our commitment is real.

We are so confident that our products are the industry standard in reliability, we stand behind them for *two full years* from date-of-sale to the end user. All IMS manufactured products are covered.

The success of our dealers will insure our continued growth. That's why IMS International

is committed to providing every IMS dealer with these distinct advantages in today's marketplace:

- 2 year warranty
- Low retail cost
- Best margins in the industry
- Protected territories
- Full factory technical support
- Complete system delivery in 30 days
- Comprehensive advertising and promotional support

For more information about IMS International's "Reliables" and our unique dealer plan, call 714/978-6966 or write us:

**IMS** 2800 Lockheed Way  
INTERNATIONAL Carson City, NV 89701  
Telex: 910-395-6051



In a system that uses an external 2 K-byte EPROM (type 2716), wrap-around addressing occurs, because the state of the twelfth address line on the address bus (A11) is ignored. (A 4 K-byte type-2732 EPROM device does use A11.) A 2716 EPROM device inserted in the Z6132's memory socket will read from the same mem-

ory cells in response to accesses to both logical hexadecimal addresses 800 and 1000. Similarly, hexadecimal addresses 820 and 1020 will be treated as equivalent by the 2716 EPROM. Therefore, when a 2 K-byte 2716 EPROM is being used, the auto-start address, normally operating at hexadecimal 1020, will begin execution of

any program beginning at hexadecimal location 820. For the purposes of this discussion, you may assume that programs stored in EPROM use type-2716 devices and that references to hexadecimal address 820 also apply to hexadecimal address 1020.

### Program Storage

The program-storage format for BASIC/Debug programs is the same in both types of memory. Each BASIC statement begins with a line number and ends with a delimiter. If you were to connect a video terminal or teletypewriter to the RS-232C serial port and type the following line:

```
100 PRINT "TEST"
```

it would be stored in memory beginning at hexadecimal location 800 as shown in listing 1.

The first 2 bytes of any BASIC statement contain the binary equivalent of the line number (100 decimal equals 64 hexadecimal). Next are bytes containing the ASCII (American Standard Code for Information Interchange) values of characters in the statement, followed by a delimiter byte (containing 00) which indicates the end of the line. The last statement in the program (in this case the only one) is followed by 2 bytes containing the hexadecimal value FFFF, which designates line number 65535.

The multiple-line program in listing 2 further illustrates this storage format.

One final example of this is illustrated in listing 3 on page 58. Here is a program written to examine itself. Essentially, it is a memory-dump routine which lists the contents of memory in hexadecimal. As shown, the 15-line program takes 355 bytes and occupies hexadecimal locations 800 through 963 (decimal 2048 through 2499). I have dumped the first and last lines of the program to further demonstrate the storage technique.

I have a reason for explaining the internal program format. One of the useful features of this computer is its ability to function with programs residing solely in EPROM. However,

Listing 1: Simple illustration of BASIC program storage in the Z8-BASIC Microcomputer.

|     |       |    |    |    |    |    |    |       |
|-----|-------|----|----|----|----|----|----|-------|
|     | 100   | P  | R  | I  | N  | T  | "  | T     |
| 800 | 00 64 | 50 | 52 | 49 | 4E | 54 | 20 | 22 54 |
|     | E     | S  | T  | "  |    |    |    |       |
| 80A | 45 53 | 54 | 22 | 00 | FF | FF |    |       |

Listing 2: A multiple-line illustration of BASIC program storage.

|     |       |      |    |    |    |     |    |       |
|-----|-------|------|----|----|----|-----|----|-------|
|     | 100   | A    | =  | 5  |    | 200 | B  | =     |
| 800 | 00 64 | 41   | 3D | 35 | 00 | 00  | C8 | 42 3D |
|     | 6     | 3005 | "  | A  | *  | B   | =  | "     |
| 80A | 36 00 | 0B   | BD | 22 | 41 | 2A  | 42 | 3D 22 |
|     | :     | A    | *  | B  |    |     |    |       |
| 814 | 3B 41 | 2A   | 42 | 00 | FF | FF  |    |       |

**GO!...**

**GET YOUR SHARE OF THE MICRO MARKET!  
IF A NUDGE IS ALL YOU NEED, READ ON....**

**HARDWARE** — Boards, systems and support at the right price, featuring CCS, Televideo and others.

**SOFTWARE** — Many industry-standard packages and some unique surprises, such as:

- AUTOGEN** — Interactively reconfigure your CP/M\* BIOS. Bring new peripherals on-line quickly.
- READER** — Analyze your English prose. Measure how easy or hard it is to read.
- TL** — Do discrete-event simulation on a micro. Write parallel programs, schedule resources, much more.

**INTERESTED? GET OUR CATALOG FOR THE FULL STORY!  
CALL OR WRITE NOW!**

**MAI** MICROCOMPUTER APPLICATIONS, INC.  
11124 HOLLYVILLE ROAD, AUSTIN, TX 78756  
(512) 345-5264

# NO MORE WAITING.

**CIS COBOL™ software with FORMS-2™ for Apple II® computers is here. Now. From Micro Focus.**

Apple II users . . . the wait is over. And your patience has paid off. Now you can create serious business programs with the world's most popular professional programming language—COBOL. And, run them on the industry standard operating system—CP/M™.

**COBOL—the only standard language designed exclusively for business programming.**

COBOL gives you programs that are easy to write, easy to read, easy to maintain and easy to learn.

**A complete program in 20 minutes.**

FORMS-2, a COBOL source-code generator, lets you begin with a blank screen . . . and end with a fully-operational program. FORMS-2 generates standard COBOL code. You can use it as is. Or build on it to create even more sophisticated programs.

**Business computer compatibility.**

CIS COBOL on Apple II is standard COBOL. (ANSI X3.23-1974) With it, you have the broadest applications flexibility available today. And the most reliable.

**Powerful file handling.**

You can grow with CIS COBOL. It provides you with all the power of ANSI COBOL file handling. Underlying B-tree technology takes care of large ISAM files . . . fast.

Circle 189 on inquiry card.

**Quick, convenient program development.**

With CIS COBOL and FORMS-2, you have your very own low-cost tools that allow you to get work done faster and less expensively than ever before. Features include interactive debug, fast compile-and-go, interactive screen creation and dynamic loading of modules.

**GSA approved.**

CIS COBOL is certified on Apple II by the General Services Administration. Which means it's been tested, re-tested and tested again . . . all under the most demanding conditions. No wonder it's been chosen for use by over 25 of the world's leading computer manufacturers.

**See your Apple dealer for a demonstration.**

Don't wait any longer. Get all the details about

CIS COBOL and FORMS-2 today. For further information, visit your nearest Apple dealer. Or call us at (408) 248-3982 for a FREE fact-filled brochure.



CIS COBOL and FORMS-2 are trademarks of Micro Focus, Inc. Apple II is a registered trademark of Apple Computer Inc. CP/M is a trademark of Digital Research.

 **MICRO FOCUS™**  
The COBOL Company

Micro Focus, Inc.  
1601 Civic Center Dr., Santa Clara, CA 95050  
Tel: (408) 248-3982  
Telex: 171135 MISSION SNTA

Micro Focus LTD.  
58 Acacia Rd., London N.W. 8, ENGLAND  
Tel: (01) 722-8843/4/5/6/7  
Telex: 28536 MICROF G

the EPROMs must be programmed externally. While I will explain how to serially transmit the contents of the program memory to an EPROM programmer, some of you may have only a manual EPROM programmer or one with no communication facility. But if you are willing to spend the

time, it is easy to print out the contents of memory and manually load the program into an EPROM device.

### Dedicated-Controller Use

The Z8-BASIC Microcomputer can be easily set up for use in intelligent control applications. After being

tested and debugged using a terminal, the control program can be written into an EPROM. When power is applied to the microcomputer, execution of the program will begin automatically.

The first application I had for the unit was as a demonstration driver for the Micromouth speech-processor board I presented two months ago in the June issue of *BYTE*. (See "Build a Low-Cost Speech-Synthesizer Interface," in the June 1981 *BYTE*, page 46, for a description of this project, which uses National Semiconductor's Digitalker chip set.) It's hard to discuss a synthesized-speech interface without demonstrating it, and I didn't want to carry around my big computer system to control the Micromouth board during the demonstration. Instead, I quickly programmed a Z8-BASIC Microcomputer to perform that task. While I was at it, I set it up to demonstrate itself as well.

The result (see photo 2 on page 52) has three basic functional components. On top of the box is a Z8-BASIC Microcomputer (hereinafter called the "Z8 board") with a 2716 EPROM installed in the memory integrated-circuit socket, the Z8-board power supply (the wall-plug transformer module is out of view), and six pushbutton switches. Inside the box is a prototype version of the Micromouth speech-processor board (a final-version Micromouth board is shown on the left).

The Micromouth board is jumper-programmed for parallel-port operation (8 parallel bits of data and a data-ready strobe signal) and connected to I/O port 2 on the Z8 board. The Micromouth BUSY line and the six pushbuttons are attached to 7 input bits of the Z8 board's input port mapped into memory-address space at hexadecimal address FFFD (decimal 65533).

The most significant 3 bits of port FFFD are normally reserved for the data-rate-selector switches, but with no serial communication required, the data rate is immaterial and the switches are left in the open position. This makes the 8 bits of port FFFD, which are brought out to the edge

**Listing 3:** A program (listing 3a) that examines itself by dumping the contents of memory in printed hexadecimal form. Listing 3b shows the first and last lines of the program as dumped during execution.

```
(3a)
100 PRINT "ENTER START ADDRESS FOR HEX DUMP " ; INPUT X
102 PRINT "THE LIST IS HOW MANY BYTES LONG " ; INPUT C
103 PRINT
105 B=X+8 ; A=X+C
107 PRINT "ADDRESS                DATA":PRINT
110 PRINT HEX (X) ; "          " ;
120 GOSUB 300
130 X=X+1
140 IF X=B THEN GOTO 180
150 GOTO 120
180 IF X>=A THEN 250
200 PRINT:PRINT:B=X+8:GOTO 110
250 PRINT:STOP
300 PRINT HEX (@X) ; : PRINT "  " ;
310 RETURN
:
```

(3b)

```
:RUN
ENTER START ADDRESS FOR HEX DUMP ? 2048
THE LIST IS HOW MANY BYTES LONG ? 30

ADDRESS                DATA

          100          P    R    I    N    T    "
800          0    64    50    52    49    4E    54    22
          E    N    T    E    R    sp    S    T
808          45    4E    54    45    52    20    53    54
          A    R    T    sp    A    D    D    R
810          41    52    54    20    41    44    44    52
          E    S    S    sp    F    O    R    sp
818          45    53    53    20    46    4F    52    20
:
:
:RUN
```

```
ENTER START ADDRESS FOR HEX DUMP ? 2360
THE LIST IS HOW MANY BYTES LONG ? 45

ADDRESS                DATA

          O    P          300          P    R    I
938          4F    50    0    1    2C    50    52    49
          N    T    sp    H    E    X    sp    (
940          4E    54    20    48    45    58    20    28
          @    X    )    ;    :    sp    P    R
948          40    58    29    3B    3A    20    50    52
          I    N    T    "    sp    sp    "    ;
950          49    4E    54    22    20    20    22    3B
          310          R    E    T    U    R
958          0    1    36    52    45    54    55    52
          N          65535
960          4E    0    FF    FF    0    0    0    0
```

# SYBEX DOES PASCAL...

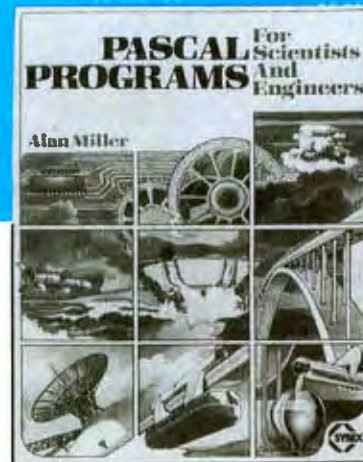
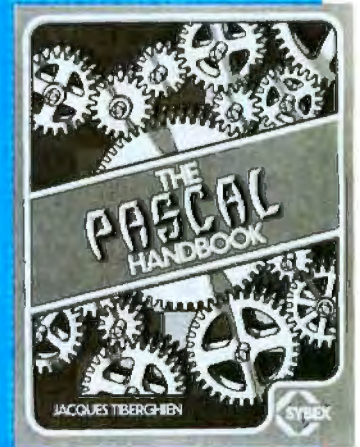

## □ INTRODUCTION TO PASCAL

by *Rodney Zaks* is a simple yet comprehensive guide to standard and UCSD Pascals: step-by-step presentation with exercises for beginners, complex concepts and extensive appendices for experienced programmers. An indispensable book for everyone who wants to learn Pascal programming.

320 pp., 100 illustr., Ref. P310, \$14.95

## □ THE PASCAL HANDBOOK

by *Jacques Tiberghien* is an easy-to-read, easy-to-use dictionary containing all the features for most existing versions of Pascal (Standard, Jensen-Wirth, OMSI, UCSD, HP1000, Pascal/Z). Over 180 entries, arranged alphabetically; each includes definition, description, syntax diagram, details of implementation, variations and examples. The perfect reference tool for any Pascal user.

500 pp., 150 illustr., Ref. P320, \$14.95

## □ PASCAL PROGRAMS FOR SCIENTISTS AND ENGINEERS

by *Alan Miller* is a comprehensive collection of frequently used algorithms for scientific and technical applications programmed in PASCAL. This time saving book includes programs for curve fitting, approximations, random number generation, integrals, statistical techniques and more.

250 pp., 80 illustr., Ref. P340 \$16.95 paper, \$25.00 cloth

**SYBEX**  
 MAIL TO:  
 SYBEX DEPT. B81  
 2344 SIXTH STREET  
 BERKELEY, CA 94710  
 PHONE ORDERS:  
 INSIDE CA 415/848-8233  
 TOLL FREE OUTSIDE CA 800-277-2346

NAME \_\_\_\_\_ SEND ME YOUR FREE CATALOG  
 ADDRESS \_\_\_\_\_  
 CITY \_\_\_\_\_ STATE \_\_\_\_\_ ZIP \_\_\_\_\_  
 ADD \$1.50/book UPS or 75¢/book 4th class mail or \$8/book overseas airmail  
 (CA add tax) Total amt. Enclosed \_\_\_\_\_ OR CHARGE MY VISA MC AM EX.  
 CARD NO. \_\_\_\_\_ EXP. DATE \_\_\_\_\_  
 SIGNATURE \_\_\_\_\_

connector, available for external inputs. In this case, pressing one of the six pushbuttons selects one of six canned speech sequences.

Coherent sentences are created by properly timing the transmission of word codes to the speech-processor board. This requires nothing more than a single handshaking arrange-

ment and a table-lookup routine (but try it without a computer sometime). The program is shown in listing 4a.

The first thing to do is to configure the port-2 and port-3 mode-control registers (hexadecimal F6 and F7, or decimal 246 and 247). Port 2 is bit-programmable. For instance, to configure it for 4 bits input and 4 bits out-

put, you would load F0 into register F6 (246). In this case, I wanted it configured as 8 output bits, so I typed in the BASIC/Debug command @246=0 (set decimal location 246 to 0).

The data-ready strobe is produced using one of the options on the Z8's port 3. A Z8 microcomputer has data-available and input-ready handshaking on each of its 4 ports. To set the proper handshaking protocol and use port 2 as I have described, a code of hexadecimal 71 (decimal 113) is placed into the port-2 mode-control register. The BASIC/Debug command is @247= 113. The RDY2 and DAV2 lines on the Z8671 are connected together to produce the data-available strobe signal.

Lines 1000 through 1030 in listing 4a have nothing to do with demonstrating the Micromouth board. They form a memory-dump routine that illustrates how the program is stored in memory. You notice from the memory dump of listing 4b that the first byte of the program, as stored in the ROM, begins at hexadecimal location 820 (actually at 1020, you remember) rather than 800 as usual. This is to help automatic start-up. The program could actually begin anywhere, but you would have to change the program-pointer registers (registers 8 and 9) to reflect the new address. The 32 bytes between 800 and 820 are reserved for vectored addresses to optional user-supplied I/O drivers and interrupt routines.

**Listing 4:** A program (listing 4a) that demonstrates the functions of the Micromouth speech synthesizer, operating from a type-2716 EPROM. The simple I/O-address decoding of the Z8 board allows use of the round-figure address of 65000. The program uses a table of vocabulary pointers that has been previously stored in the EPROM by hand. Listing 4b shows a dump of the memory region occupied by the program, proving that storage of the BASIC source code starts at hexadecimal location 820.

(4a)

```

100 @246=0:@247=113
110 X=@65000 :A=%1400
120 IF X=254 THEN @2=0
130 IF X=253 THEN GOTO 500
140 IF X=251 THEN A=A+32 :GOTO 500
150 IF X=247 THEN A=A+64 :GOTO 500
160 IF X=239 THEN A=A+96 :GOTO 500
170 IF X=223 THEN A=A+128 :GOTO 500
180 IF X=222 THEN N=0 :GOTO 300
200 GOTO 110
300 @2=N :N=N+1 :IF N=143 THEN 110
310 IF @65000<129 THEN 310
320 GOTO 300
500 @2=@A :A=A+1
510 IF @65000<129 THEN 510
520 IF @A=255 THEN GOTO 110
530 GOTO 500
1000 Q=2048
1005 W=0
1010 PRINT HEX(@Q),:Q=Q+1
1015 W=W+1 :IF W=8 THEN PRINT" ":GOTO 1005
1020 IF Q=4095 THEN STOP
1030 GOTO 1010
:

```

(4b)

```

:goto 1000
FF      FF      FF      FF      FF      FF      FF      FF
FF      FF      FF      FF      FF      FF      FF      FF
FF      FF      FF      FF      FF      FF      FF      FF
FF      FF      FF      FF      FF      FF      FF      FF
0       64      40       32       34       36       3D       30
3A      40      32       34       37       3D       31       31
33      0       0        6E      58       3D       40       36
35      30      30       30       20       3A       41       3D
25      31      34       30       30       0        0        78
49      46      20       58      3D       32      35       34
20      54      48       45      4E       20
0! AT 1015
:

```

### Programming the EPROM

The first EPROM-based program I ran on the Z8-BASIC Microcomputer was manually loaded. I simply

NEW

# IT'S MAGIC<sup>®</sup>



The System/48 is the outstanding office automation computing system for the 80's — it's so productive we call it MAGIC<sup>®</sup>. Look at these features:

- One to eight interactive users per node
- Data management system
- Report generator
- Query processor
- Screen format generator
- Automatic interface code generator
- Up to ½ Mbytes of user memory
- Winchester disk with 18-million bytes (formatted capacity)
- 15-minute mean-time-to-repair
- Built-in protection from line-voltage spikes, noise, and brownouts

And, it features MAGIC<sup>®</sup>, the Operating System that gets things done faster than you can say abracadabra because of its multi-keyed Indexed-Sequential Access Method and flexible file-organization. MAGIC<sup>®</sup> also offers high security, with password protection. MAGIC<sup>®</sup> supports global or local printers for as many users as desired.

MAGIC<sup>®</sup> also includes DataMagic II — TEI's red-hot database manager. DataMagic II has even more tricks up its sleeve — like automatic or manual record-lock protection and automatic transaction backout to protect the database. And it runs application software written for CP/M 2.X.

Take a MAGIC<sup>®</sup> leap into the future!

Arrange to attend one of our regularly scheduled System/48 workshops (RSVP).

OEM and Dealer Inquiries Invited



5075 S. LOOP EAST, HOUSTON, TX. 77033  
(713) 738-2300 TWX. 910-881-3639



If you have anything to do with small computers, you should be reading the Carl Helmers **PERSONAL COMPUTER LETTER** every month!

You won't want to miss a single issue of the new Personal Computer Letter... a monthly publication of comprehensive studies on issues affecting design, implementation, and applications of small computer systems. The Personal Computer Letter is a journal compiled and edited by Carl Helmers, co-founder and first editor of *Byte Magazine*. Here is valuable information in professionally prepared format about small computers, software, peripherals, trends in the industry, and new ideas. We accept no advertising, and the information provided is available nowhere else. Written for executives, decision-makers, market strategists, product designers and authors in the small computer field, each 12 to 16-page issue contains analysis and design studies by many of the personal computer industry's foremost experts. For example, the current issue covers: **Intelligent Serial Line Filters: Exploring a family of application oriented product ideas.**

Subscribe today. Mail the coupon with your check for \$200 for the next 12 monthly issues. Sample issues at \$25 per copy, applicable to a full year's subscription.



**NORTH AMERICAN TECHNOLOGY, INC.**

Strand Building  
174 Concord St.,  
Peterborough, NH 03458  
(603) 924-6048

- Enclosed is my \$200 check or money order for the next 12 issues of the Personal Computer Letter.
- Enclosed is my \$25 check or money order for a sample issue, applicable to subscription price.

NAME \_\_\_\_\_  
ADDRESS \_\_\_\_\_  
CITY \_\_\_\_\_  
STATE \_\_\_\_\_ ZIP \_\_\_\_\_

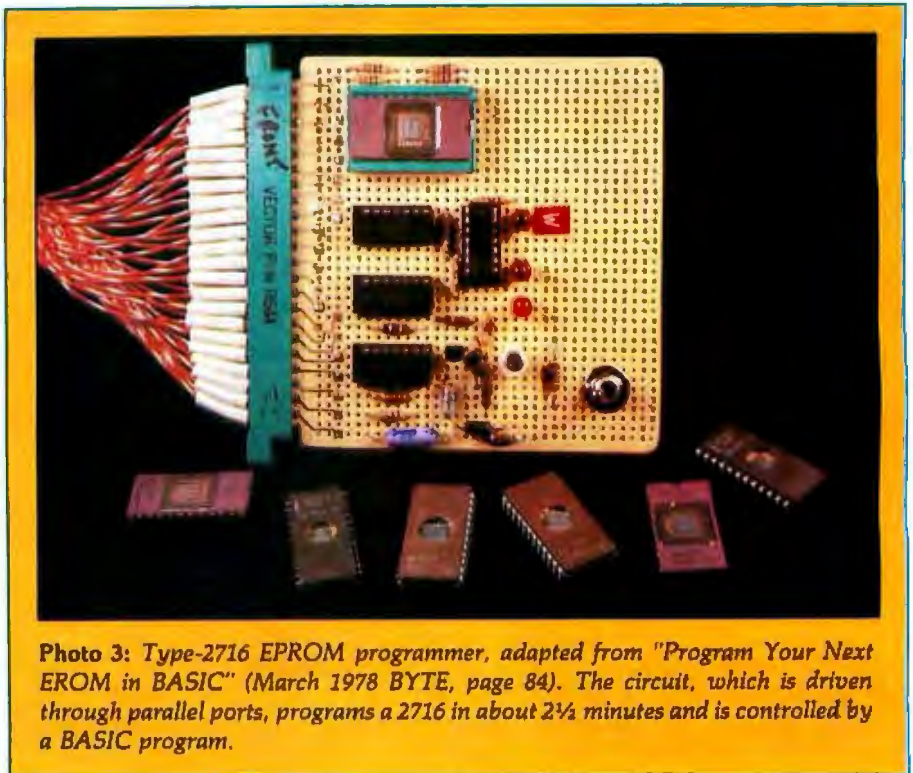

Photo 3: Type-2716 EPROM programmer, adapted from "Program Your Next EPROM in BASIC" (March 1978 *BYTE*, page 84). The circuit, which is driven through parallel ports, programs a 2716 in about 2½ minutes and is controlled by a BASIC program.

printed out the contents of the Z6132 memory using the program of listing 3 and entered the values by hand into the EPROM programmer. This is fine once or twice, but you certainly wouldn't want to make a habit of it. Fortunately, there are better alternatives if you have the equipment.

Many EPROM programmers are peripheral devices on larger computer systems. In such cases, it is possible to take advantage of the systems' capabilities by downloading the Z8 program directly to the programmer.

The programmer shown in photo 3 is a revised version of the unit I described in a previous article, "Program Your Next EPROM in BASIC" (March 1978 *BYTE*, page 84). It was designed for type-2708 EPROMs, but I have since modified it to program 2716s instead. All I had to do was lengthen the programming pulse to 50 ms and redefine the connections to four pins on the EPROM socket. It still is controlled by a BASIC program and takes less than 2½ minutes to program a type-2716 EPROM device. Refer to the original article for the basic design.

Normally, the LIST function or memory-dump routine cannot be

used to transmit data to the EPROM programmer because the listing is filled with extraneous spaces and carriage returns. It is necessary to write a program that transmits the contents of memory without the extra characters required for display formatting. The only data received by the EPROM programmer should be the object code to load into the EPROM.

In writing this program we can take advantage of the Z8's capability of executing machine-language programs directly through the `USR` and `GO@` commands. The serial-input and serial-output subroutines in the BASIC/Debug ROM can be executed independently using these commands. The serial-input driver starts at hexadecimal location 54, and the serial-output driver starts at hexadecimal location 61. Transmitting a single character is simply done by the BASIC statement

`GO@ %61,C`

where C contains the value to be transmitted. A serial character can be received by

`C=USR (%54)`



C  
O  
U  
G  
A  
R

TRS-80\*

Model I  
Model III

*Products that set Precedents.*

# OMIKRON™

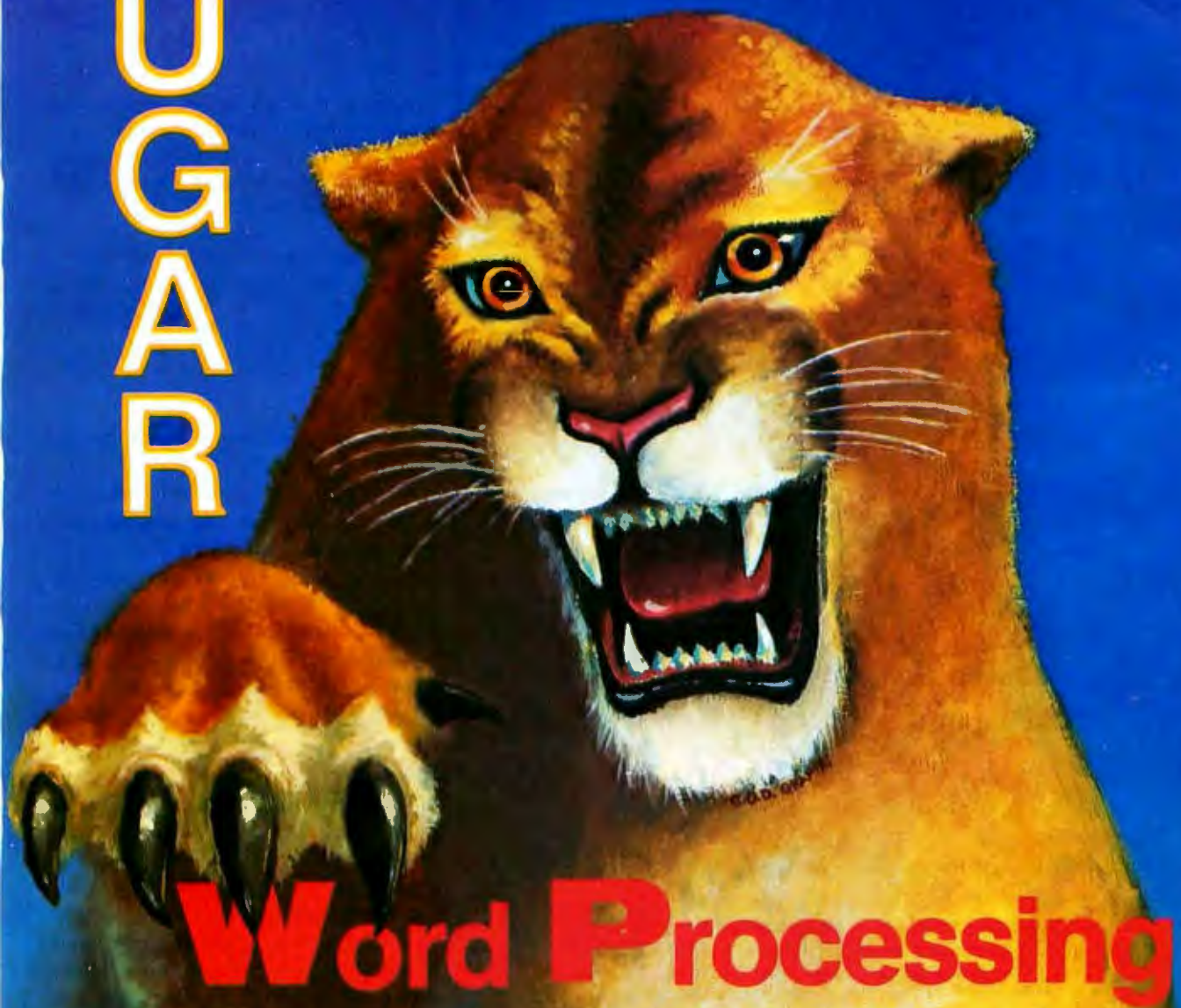

## Word Processing

**MAPPER** CP/M Adaptor  
**CBASIC II\*\*\*** CP/M \*\* AND  
THE BEST **WORD PROCESSOR**  
\$1000.00 VALUE ONLY **\$ 299**



**UNPRECEDENTED SAVINGS**

are available on selected CP/M programs through COUGAR, Omikron's official users group.

# OMIKRON

1127 Hearst St.  
Berkeley, CA 94702  
(415) 845-8010

TRADEMARKS:  
\*TRS-80/Radio Shack/Tandy Corp.  
\*\*CP/M/Digital Research  
\*\*\*CBASIC II/Compiler Systems  
\*\*\*\*PHOENIX/Palantir Inc.

# What can you honestly expect from an interactive data terminal that costs only \$369?\*



Well, to begin with, color graphics.

RCA's VP-3301 has unique color-locking circuitry that gives you sharp, jitter-free color graphics and rainbow-free characters.

Plus much more: Microprocessor control. Resident and programmable character set. Reverse video. State-of-the-art LSI video control. 20 and 40 character formats. RS232C and 20 mA current loop. Six baud rates. Eight data formats. ASCII encoding. Light-touch flexible-membrane key switches for reliability and long life. CMOS circuitry and a spill-proof, dust-proof keyboard for hostile environments.

The VP-3301 can be used with a 525-line color or monochrome monitor or a standard TV set through an RF modulator.\*\* It serves a wide variety of industrial, educational, business and individual applications including communication with time sharing and data base networks such as those provided by Dow Jones News/Retrieval Service, CompuServe and Source.

All this—for the low price of \$369. And it's made by RCA. So get the whole story about the surprising VP-3301 today. Write RCA MicroComputer Marketing, New Holland Avenue, Lancaster, PA 17604. Order toll-free: 800-233-0094.

\*\* Model VP-3303 with built-in RF modulator—\$389.  
\*Suggested user price. Monitor and modem not included.

# RCA

Circle 334 on inquiry card.

**Listing 5:** BASIC statements that print out the entire contents of the 4 K bytes of user memory, for use with a communicating EPROM programmer.

```
1000 X=%800 :REM BEGINNING OF
      USER MEMORY
1010 GO@ %61,@X :REM TRANSMIT
      CONTENTS OF LOCATION X
1020 X=X+1 :IF X=%1801 THEN
      STOP
1030 GOTO 1010
```

**Listing 6:** A simple BASIC program segment to demonstrate the concept of the "black box" method of modifying data being transmitted through the Z8-BASIC Microcomputer.

```
100 @246=0:@247=113 :REM SET PORT
      2 TO BE OUTPUT
110 @2=X :REM X EQUALS THE DATA
      TO BE TRANSMITTED
```

where the variable C returns the value of the received data.

To dump the entire contents of the Z6132 memory to the programmer, the statements in listing 5 should be included at the end of your program.

Execution begins when you type GOTO 1000 as an immediate-mode command and ends when all 4 K bytes have been dumped. The transmission rate (110 to 9600 bps) is that selected on the data-rate-selector switches.

Conceivably, this technique could also be used to create a cassette-storage capability for the Z8 board. In theory, a 3- or 4-line BASIC program can be entered in high memory (you can set the pointer to put the program there) to read in serial data and load it in lower memory. Changing the program pointer back to hexadecimal 800 allows the newly loaded program to be executed. Since the Z8-BASIC Microcomputer already has a serial I/O port, any FSK (frequency-shift keyed) modem and cassette-tape recorder can be used for cassette data storage.

## I/O for Data Acquisition

Data acquisition for process control is the most likely application for the Z8-BASIC Microcomputer. Low-

# Customizable

*The Unique Difference that Sets  
VEDIT Apart in Full Screen Editors*

Total user customizability is a predominate reason that over a thousand users find VEDIT the easiest to use full screen editor. It makes VEDIT the only editing package which allows you to determine your own keyboard layout and use the cursor and special function keys on any terminal having them. And only VEDIT fully supports all of the newly available terminals. It may come as a surprise to you, that with any other editor or word processor, you will have to memorize obscure control characters or multi-character sequences, while your terminal's extra keys and editing functions go unused. The customization extends to setting the default tab positions, scrolling methods and much more. It's almost like designing your own editor for your system, applications and preferences. And all of this is easily done with the setup program which requires no programming knowledge or 'patches', but simply prompts you to press a key or enter a parameter.

## *Unequaled Hardware Support*

The CRT version supports all terminals by allowing you to select during setup which terminal VEDIT will run on. Features such as line insert and delete, reverse scroll, status line and reverse video are used on 'smart' terminals. All screen sizes are supported, including large ones such as the 60 X 80 format on the Ann Arbor Ambassador terminal. Special function keys on terminals such as the Heath H19, Televideo 920C and IBM 3101, and keyboards producing 8 bit codes are all supported. The memory mapped version is extremely flexible and supports bank select and hardware cursors such as on the SSM VB3. With this level of customizability and hardware support, you will feel for the first time that the software was optimally designed for your system.

## *Fully Compatible Replacement for Ed*

Since VEDIT creates and edits standard text files of up to one diskette in length, it serves as a replacement for the CP/M

standard editor ED. Of course, you benefit from the fastest and easiest to use 'What you see is what you get' type full screen editing available, fast disk access and an editor which takes up only 12K of your valuable memory space. With VEDIT you will never again need or want to use the slow and tedious ED.

## *Special Features*

VEDIT is more than just a full screen editing replacement for ED, it gives you many new editing capabilities, such as a scratchpad buffer for moving and rearranging sections of text, complete file handling on multiple drives and iteration macros. Among its special features you will find automatic indenting for use with structured programming languages such as Pascal and PL/I, and other special facilities for Assembler and COBOL. A real time saver is the ability to insert a specified line range of another file anywhere in the text. Unlike most software, VEDIT will even tolerate your mistakes. For example, one key will 'Undo' the changes you mistakenly made to a screen line, and the disk write error recovery lets you delete files or insert another disk should you run out of disk space.

## *Ordering*

Many dealers carry VEDIT, or you may contact us for fast delivery. Specify the CRT version, your video board or microcomputer, the 8080, Z80 or 8086 code version, and disk format required.

VEDIT for 8080 or Z80: Disk and manual .....\$130  
VEDIT for CP/M-86: Disk and manual *(NEW)* .....\$185  
Manual: Price refunded with software purchase .....\$15

VISA or MASTERCARD Welcomed

CP/M and MP/M are registered trademarks of Digital Research, Inc. Apple II is a registered trademark of Apple Computer, Inc. SoftCard is a trademark of Microsoft. TRS-80 is a trademark of Tandy Corp.

• North Star • Cromemco • Heath H8/H89 • SuperBrain • Apple II Softcard • TRS-80 Model II & Model I  
Most other CP/M Systems with CRT or Memory Mapped Displays • MP/M • CP/M-86



## CompuView Products Inc.

618 Louise, Ann Arbor, Michigan 48103 • Telephone (313) 996-1299

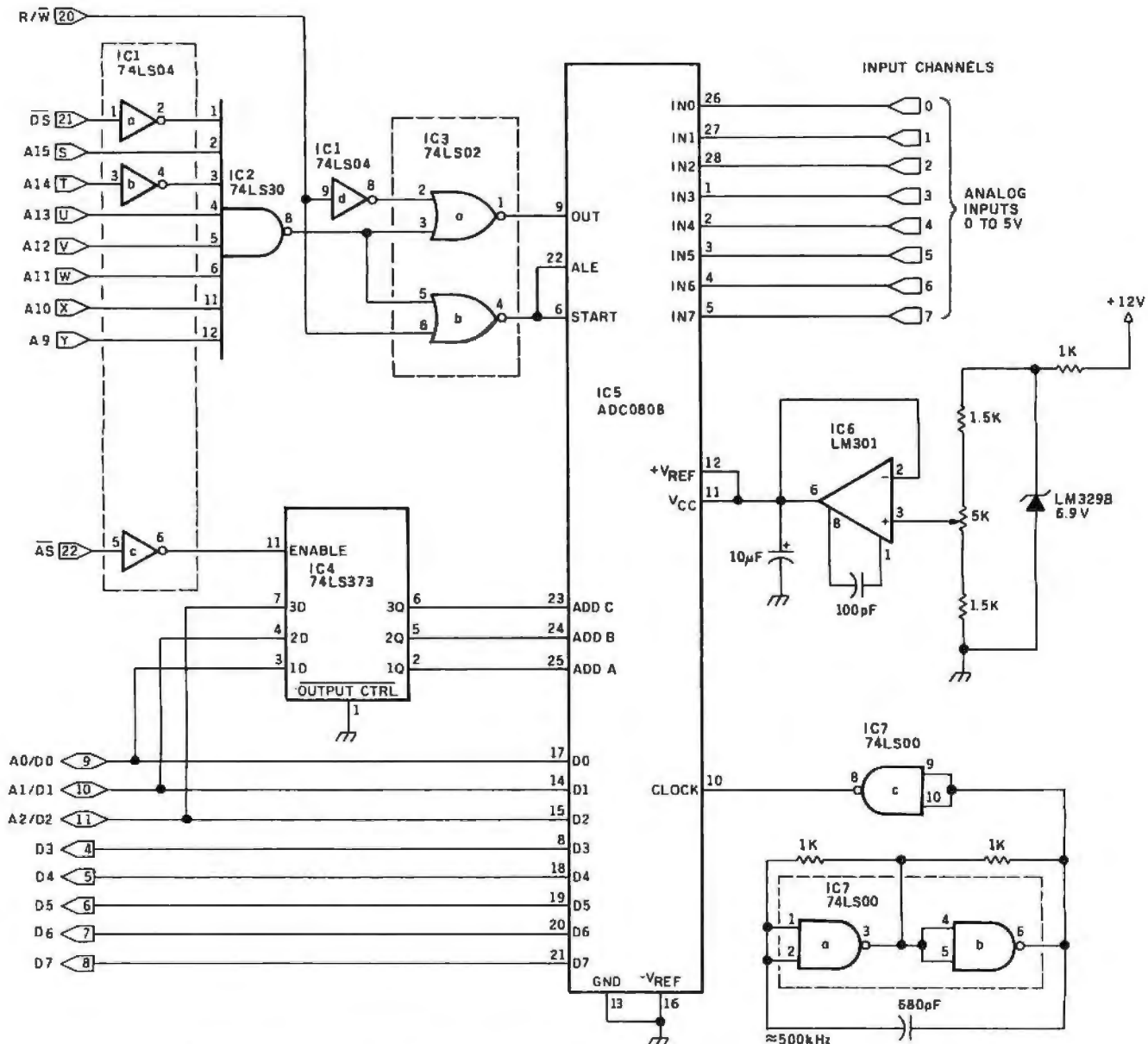

| Number | Type    | +5V                   | GND | +12V |
|--------|---------|-----------------------|-----|------|
| IC1    | 74LS04  | 14                    | 7   |      |
| IC2    | 74LS30  | 14                    | 7   |      |
| IC3    | 74LS02  | 14                    | 7   |      |
| IC4    | 74LS373 | 20                    | 10  |      |
| IC5    | ADC0808 | see schematic diagram |     |      |
| IC6    | LM301   | 4                     | 7   |      |
| IC7    | 74LS00  | 14                    | 7   |      |

**Figure 2:** Schematic diagram of an A/D converter. This 8-bit, eight-channel unit has a unipolar input range of 0 to +5 V, with the eight output channels addressed as I/O ports mapped into memory-address space at hexadecimal addresses BF00 through BF07.

cost distributed control is practical, substituting for central control performed by a large computer system. Analog and digital sensors can be read by a Z8-BASIC Microcomputer, which then can digest the data and reduce the amount of information (experiment results or control parameters) stored or transmitted to a central point. Control decisions can be

made by the Z8-BASIC Microcomputer at the process locality.

The Z8 board can be used for analog data acquisition, perhaps using an A/D (analog-to-digital) converter such as that shown in figure 2. This 8-bit, eight-channel A/D converter has a unipolar input range of 0 to +5 V (although the A/D integrated circuit can be wired for

bipolar operation), with the eight output channels addressed as I/O ports mapped into memory-address space at hexadecimal addresses BF00 through BF07 (decimal 48896 through 48903). When the Z8671 performs an output operation to the channel address, the channel is initialized for acquiring data, while data is read from the channel when the Z8671 performs

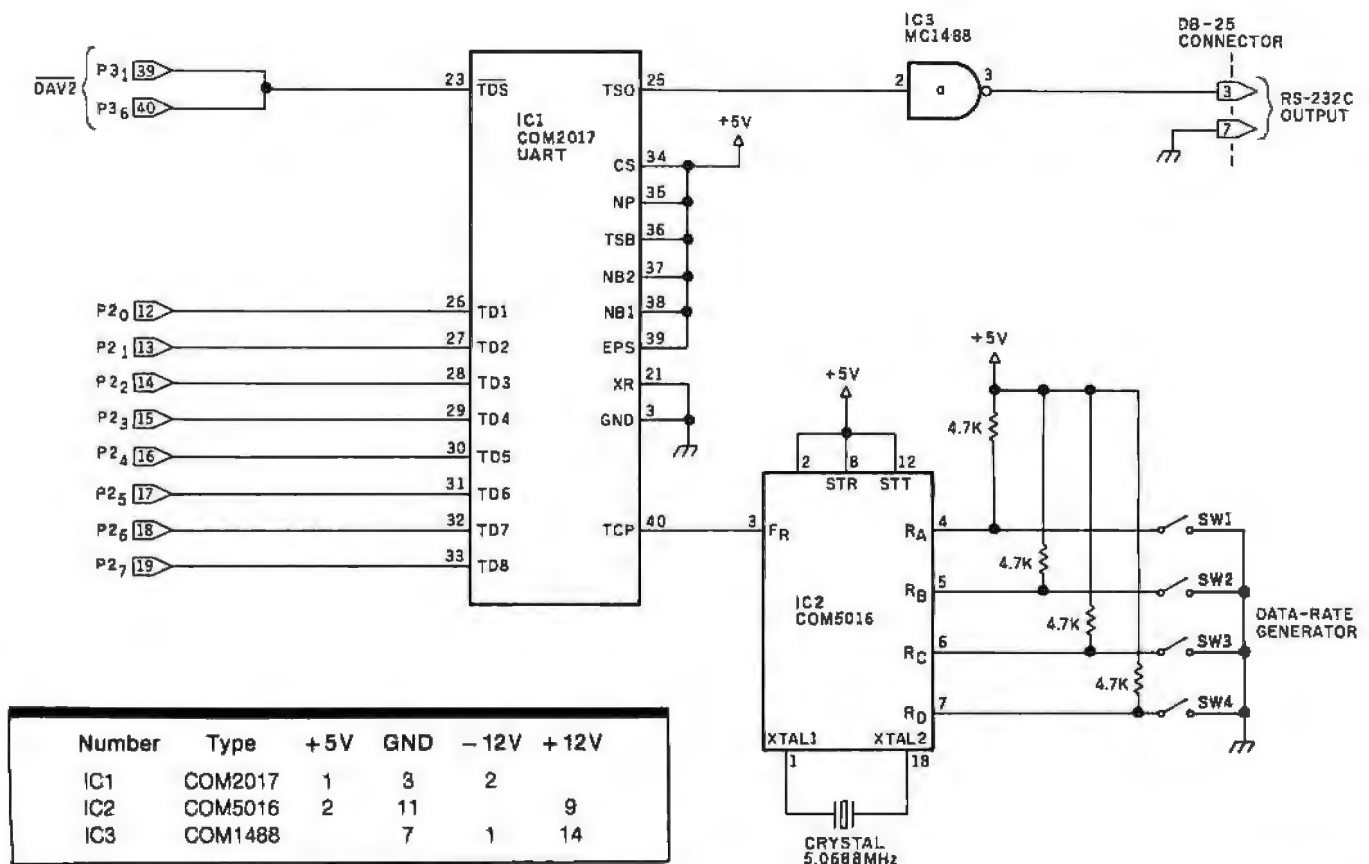

Figure 3: Schematic diagram of an RS-232C serial output port for the "black box" communication application of the Z8-BASIC Microcomputer. The Z8671 must be configured by software to provide the proper signals: one such signal, DAV2, is derived from two bits of I/O port 3 on the Z8671. The pin numbers shown in the schematic diagram for P3<sub>1</sub> and P3<sub>6</sub> are pins on the Z8671 device itself, not pins or sections on the card-edge connector, as are P2<sub>0</sub> through P2<sub>7</sub>.

an input operation on the channel's address.

### Intelligent Communication

Another possible use for the Z8-BASIC Microcomputer is as an intelligent "black box" for performing predetermined modification on data being transmitted over a serial com-

munication line. The black box has two DB-25 RS-232C connectors, one for receiving data and the other for retransmitting it. The intelligence of the Z8-BASIC Microcomputer, acting as the black box, can perform practically any type of filtering, condensing, or translating of the data going through.

Perhaps you have an application where continuous raw data is transmitted, but you would rather just keep a running average or flag deviations from preset limits at the central monitoring point rather than contend with everything. The Z8 board can be programmed to digest all the raw data coming down the line and pass

# THE 488+3

IEEE 488 TO S-100 INTERFACE

IEEE-488

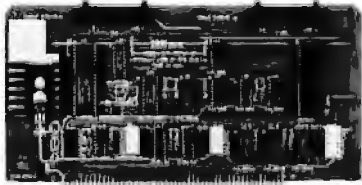

S-100

- Handles all IEEE-488 1975/78 functions
- IEEE 696 (S-100) compatible
- MBASIC subroutines supplied; no BIOS mods required
- 3 parallel ports (8255A-5)
- Industrial quality; burned in and tested
- \$375

(Dealer inquiries invited)

**D&W DIGITAL**  
1524 REDWOOD DRIVE  
LOS ALTOS, CA 95030 (415) 966-1460

# MTM! MORRIS STAFFE!

goes



© 2000

It's amazing! It's colossal! Awesome Apple at last joins forces with world-famous WordStar. And together they easily conquer the most beastly word processing! If you're an Apple owner, this is one double feature you won't want to miss!

WordStar, after all, is the most powerful and versatile word processing software ever developed for microcomputers. And now it's available for Apple—thanks to the SoftCard from Microsoft, a Z-80-based circuit card that converts Apple to CP/M. And thanks to a new edition of WordStar formatted especially for Apple.

You'll be glad to know our Apple edition contains all the features that have made WordStar the top banana in word processing:

**What you see is what you get.** With WordStar the screen shows exactly what will get printed—including all format variables like page breaks, justification, and hyphenation. As soon as you type a change, it's onscreen.

**User friendly?** Our menus give you so much help that most of the time you can leave your manual sitting on the shelf. Choose from four levels of help according to the job and your own experience.

**WordStar has more talent than you may ever need.** Its flexibility is simply awesome. From text typing to the most complex word processing you can imagine—WordStar lets you sail through it all with ease and efficiency.

In fact, WordStar is so powerful and so friendly, we challenge

Available in 40 & 80 column screen versions; and 13 & 16 sector media.

CP/M is a registered trademark of Digital Research.

Apple Computer is a registered trademark of Apple Computer, Inc.

© 1981 MicroPro International Corporation



comparison—feature for feature—against dedicated word processing systems costing thousands more than a WordStar-based system.

So, if you love your Apple but wish it could do more, that's where we come in. First, with WordStar. And next—since we don't monkey around when it comes to software—with Apple editions of our whole software family, all designed to work together:

**SpellStar™**, a new WordStar option, will find your spelling and typing mistakes for you. **MailMerge™**, another WordStar option, makes it easy to combine files to produce personalized form letters. **SuperSort™** takes on the biggest sorting, merging, and selecting jobs. And **DataStar™** handles data entry, retrieval, and update with tremendous power and precision.

Innovative excellence—that's what has made WordStar such a smash among micro users. And that's what you'll find in MicroPro's entire family of business software—now available in Apple editions.

Want more information about our Apple software? Clip the coupon. Or, if you've really gone ape by now, just phone us for the name of your nearest dealer.

Circle 230 on Inquiry card.

**MicroPro™**  
INTERNATIONAL CORPORATION

1299 Fourth Street  
San Rafael, California 94901  
(415) 457-8990  
Telex 340-388

**YES,**

I've gone ape!  
Please rush me information on MicroPro's family of business software solutions, and the name of my local MicroPro dealer.

Name \_\_\_\_\_  
Title \_\_\_\_\_  
Company \_\_\_\_\_  
Address \_\_\_\_\_  
City \_\_\_\_\_ State \_\_\_\_\_ Zip \_\_\_\_\_

# DISCOUNT HARDWARE

IEEE 696/S-100 Standard Boards  
Assembled, tested, warranted

**CompuPro™** from **GODBOUT**  
ELECTRONICS

## STATE OF THE ART CPU BOARDS

DUAL CPU 8/16 bit..... \$349  
Z-80 CPU..... \$249

## FAST RELIABLE STATIC MEMORY

16K.....\$299    32K.....\$549  
48K.....\$799    64K.....\$999

## SYSTEM AUGMENTATION BOARDS

I/O-I 2 RS232 Serial Ports..... \$199  
I/O-II 3 Parallel, 1 Serial Ports..... \$199  
I/O-III 8-Port..... \$549  
DISK-1 DMA Disk Cont..... \$399  
MPX Multiplex Channel..... \$399  
SUPPORT-1 Multifunction..... \$299  
    Port, clock, interrupts  
    timers, battery back-up  
    7 Boards in one

## DISCOUNT HARDWARE

Division of System Interface Consultants, Inc.  
17440 Revello Drive  
Pacific Palisades, CA 90272

Enclosed is \$\_\_\_\_\_

Please express the following assembled,  
tested, and warranted IEEE 696/S-100  
boards:

Name \_\_\_\_\_

Address \_\_\_\_\_

Phone (    ) \_\_\_\_\_

Add \$25 to each order for express shipping, handling  
and insurance. California residents add 6% tax. Allow  
2 weeks for personal checks. Prices subject to change  
without notice.

**CALL FOR INFORMATION AND PRICES ON  
Mainframes, terminals, printers, and complete  
integrated and tested systems to meet  
YOUR UNIQUE REQUIREMENTS.**

# (213) 454-2100

## DISCOUNT HARDWARE

Division of System Interface Consultants, Inc.  
Computer Specialists                      Established 1969

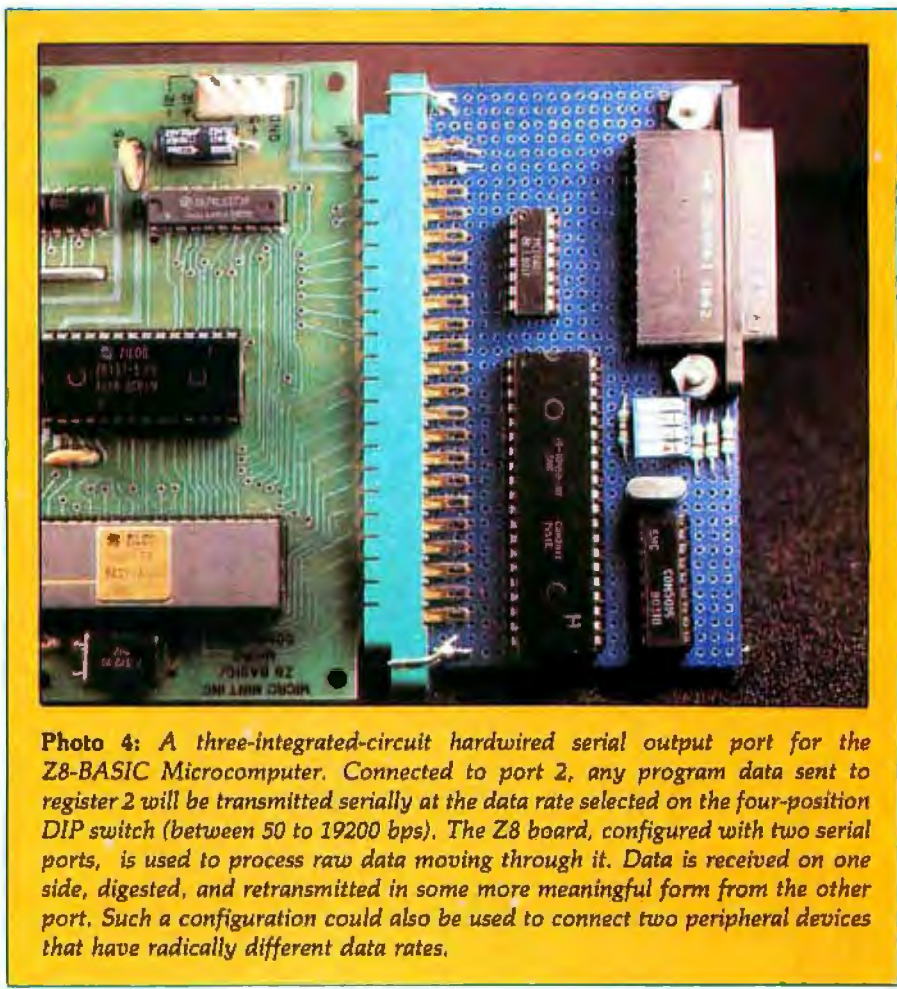

*Photo 4: A three-integrated-circuit hardwired serial output port for the Z8-BASIC Microcomputer. Connected to port 2, any program data sent to register 2 will be transmitted serially at the data rate selected on the four-position DIP switch (between 50 to 19200 bps). The Z8 board, configured with two serial ports, is used to process raw data moving through it. Data is received on one side, digested, and retransmitted in some more meaningful form from the other port. Such a configuration could also be used to connect two peripheral devices that have radically different data rates.*

on only what's pertinent.

Another such black-box application is to use the Z8 board as a printer buffer. Photo 4 shows the interface hardware of one specific application, which I used to attach a high-speed computer to a very slow printer. The host computer transmitted data to the Z8 board at 4800 bps. Since the receiving serial port used had to be bidirectional to handshake with the host computer, I added another serial output to the Z8 board for transmitting characters to the printer. Only three integrated circuits were required to add a serial output port. A schematic diagram is shown in figure 3 on page 67. The UART (universal asynchronous receiver/transmitter, shown as IC1) is driven directly from port 2 on the Z8 board (port 2 could also be used to directly drive a parallel-interface printer), and IC2 supplies the clock signal for the desired data rate. Of course, the UART could have been attached to the data and address

buses directly, but this was easier.

Transmitting a character out of this serial port requires setting the port-2 and port-3 mode-control registers as before. After that, any character sent to port 2 will be serially transmitted. The minimum program to perform this is shown in listing 6 on page 64. This circuit can also be used for downloading programs to the EPROM programmer.

### In Conclusion

It is impossible to describe the full potential of the Z8-BASIC Microcomputer in so few pages. For this reason, considerable effort has been taken to fully document its characteristics. I have merely tried to give an introduction here.

I intend to use the Z8-BASIC Microcomputer in future projects. I am interested in any applications you might have, so let me know about them, and we can gain experience together.



# We know just how good G&L Microcomputers are. Because we use them in our own PC's and CNC's.

And now we can fill all your needs with reliable industrial grade modules.

---

## GL 868 MODULES

- CPU-FPA PROCESSOR
- RAM-CMOS-EPROM
- ANALOG MODULES
- VIDEO MODULES
- SERVO MODULES

---

## NESTS-POWER SUPPLIES

- HALF NEST
- FULL NEST
- MASTER RACK
- POWER SUPPLIES

---

## PERIPHERALS

---

## SOFTWARE PACKAGES

---

## DEVELOPMENT SYSTEMS

---

## RELIABILITY

- 130°F AMBIENT RATED
- 95% RELATIVE HUMIDITY
- PRE-TESTED CHIPS WITH 125°C, 168 HOUR BURN-IN
- MODULE BURN-IN AND TEST AT 130°F FOR 40 HOURS



### GET THE FACTS

Ask for the fact-packed GL868 booklet. Giddings & Lewis Electronics Co., P.O. Box 1658, 666 S. Military Road, Fond du Lac, WI 54935, U.S.A. Telephone (414) 921-9400.

 **Electronics Division  
Giddings & Lewis**

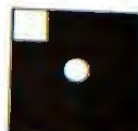
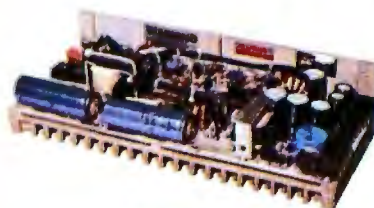
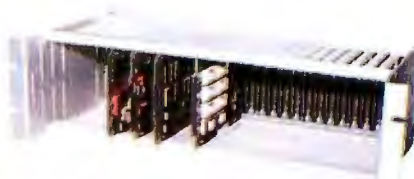
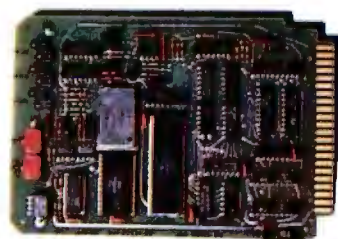

**Next Month: Build a phonetic voice synthesizer based on the Votrax SC-01 synthesizer chip. ■**

Special thanks to Steve Walters and Peter Brown of Zilog Inc for their aid in producing these articles.

BASIC/Debug is a trademark of Zilog Inc.

**Editor's Note:** Steve often refers to previous Circuit Cellar articles as reference material for the articles he presents each month. These articles are available in reprint books from BYTE Books, 70 Main St, Peterborough NH 03458. Ciarcia's Circuit Cellar covers articles appearing in BYTE from September 1977 through November 1978. Ciarcia's Circuit Cellar, Volume II presents articles from December 1978 through June 1980.

To receive a complete list of Circuit Cellar articles available from The MicroMint, circle 100 on the inquiry card.

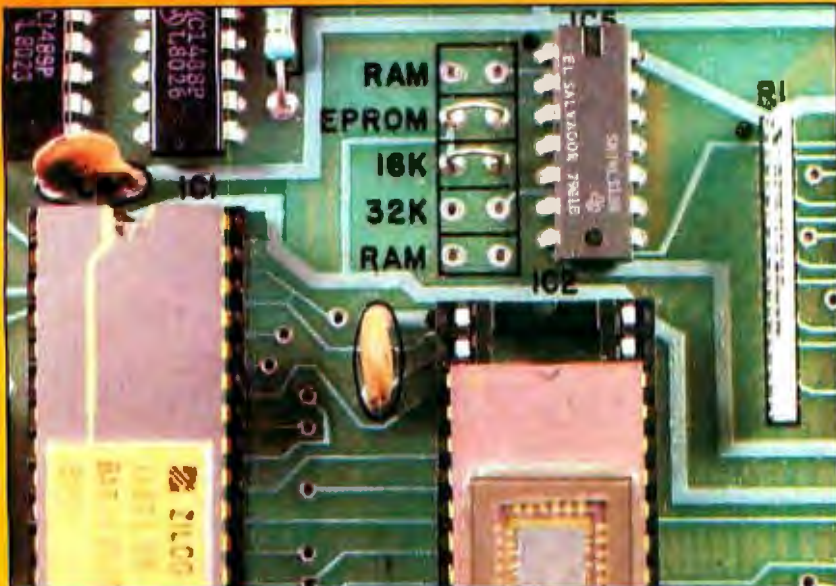

**Photo 5:** When the Z8-BASIC Microcomputer is used with a ROM-resident program, the two jumpers used with the Z6132 are removed, and the EPROM jumper is installed instead. When using a type-2716 16 K-bit (2 K-byte) EPROM device, the "16 K" jumper is installed. If a type-2732 32 K-bit (4 K-byte) EPROM is used instead, the "32 K" jumper is installed. The EPROM is inserted in the lower 24 pins of the 28-pin Z6132 socket (IC2) as shown.

The following items are available postpaid in the United States from:  
**The MicroMint Inc**  
 917 Midway  
 Woodmere NY 11598  
 Telephone:  
 (800) 645-3479 (for orders)  
 (516) 374-6793 (for technical information)

**Z8-BASIC Microcomputer**  
 (Documentation includes:  
 Z8 Technical Manual  
 Z8 Product Specification  
 Z6132 Product Specification  
 BASIC/Debug Manual  
 Z8-BASIC Microcomputer Construction/Operator's Manual)  
 Assembled and tested....\$170  
 Kit....\$140

**Z8-BASIC Microcomputer power supply**  
 (Size: 2½ by 4½ inches)  
 Provides: +5 V, 300 mA  
 +12 V, 50 mA  
 -12 V, 50 mA  
 Assembled and tested....\$35

These prices are in effect until September 15, 1981; call for prices after that date.  
 All printed-circuit boards are solder-masked and silk-screened. The documentation supplied with the Z8 board includes approximately 200 pages of materials. It is available separately for \$25. This charge will be credited toward any subsequent purchase of the Z8 board.  
 Please include \$2 for shipping and handling. New York residents please include 7% sales tax.

## TRS-80™ Computers

Now Available with 5 Megabytes fixed and 5 Megabytes removable storage.

Complete Hardware System including, 64K TRS-80 Model II.....**\$10,935.00**  
 220V Systems available for our European customers, including 64K TRS-80 Model II.....**\$12,995.00**

### ALL 2000 COMPUTER SYSTEMS

Via-Dell'Alloro, 22 R.A.  
 50123 Firenze, Italy  
 Telephone 28 37 72  
 Telex 572507

TRS-80 is a Trademark of Tandy Corp.

**PAN AMERICAN ELECTRONICS**  
 Dept. 200 • 1117 Conway Avenue  
 Mission, Texas 78572 U.S.A.  
**TOLL FREE ORDER 800/531-7466**  
 Texas & Principal No. 512/581-2766  
 Telex 767339



Circle 298 on inquiry card.

# COMPUSTAR™

**INTERTEC'S INCREDIBLE 255 USER SMALL BUSINESS COMPUTER**

At last, there's a multi-user micro-computer system designed and built the way it should be. The CompuStar™. Our new, low-cost "shared-disk" multi-user system with mainframe performance.

Unlike any other system, our new CompuStar offers what we believe to be the most practical approach to almost any multi-user application. Data entry. Distributed processing. Small business. Scientific. Whatever! And never before has such powerful performance been available at such modest cost. Here's how we did it . . .

The system architecture of the CompuStar is based on four types of video display terminals, each of which can be connected into an auxiliary hard disk storage system. Up to 255 terminals can be connected into a single network! Each terminal (called a Video Processing Unit) contains its own microprocessor and 64K of dynamic RAM. The result? Lightning fast program execution! Even when all users are on-line performing different tasks! A special "multiplexor" in the CompuStar Disk Storage System ties all external users together to "share" the system's disk resources. So, no single user ever need wait on another. An exciting concept . . . with some awesome application possibilities!

CompuStar™ user stations can be configured in almost as many ways as you can imagine. The wide variety of terminals offered gives you the flexibility and versatility you've always wanted (but never had) in a multi-user system. The CompuStar Model 10 is a programmable, intelligent terminal with 64K of RAM. It's a real workhorse if your requirement is a data entry

or inquiry/response application. And if your terminal needs are more sophisticated, select either the CompuStar Model 20, 30 or 40. Each can be used as either a stand-alone workstation or tied into a multi-user network. The Model 20 incorporates all of the features of the Model 10 with the addition of two, double-density mini-floppies built right in. And it boasts over 350,000 bytes of local, off-line user storage. The Model 30 also features a dual drive system but offers over 700,000 bytes of disk storage. And, the Model 40 boasts nearly 1½ million bytes of dual disk storage. But no matter which model you select, you'll enjoy unparalleled versatility in configuring your multi-user network.

Add as many terminals as you like - at prices starting at less than \$2500. Now that's truly incredible!

No matter what your application, the CompuStar can handle it! Three disk storage options are available. A tabletop 10 megabyte 8" winchester-type drive complete with power supply and our special controller and multiplexor costs just \$4995. Or, if your disk storage needs are more demanding, select either a 32 or 96 megabyte Control Data CMD drive with a 16 megabyte removable, top loading cartridge. Plus, there's no fuss in getting a CompuStar system up and running. Just plug in a Video Processing Unit and you're ready to go . . . with up to 254 more terminals in the network by simply connecting them together in a "daisy-chain" fashion. CompuStar's special parallel interface allows for system cable lengths of up to one mile . . . with data transfer rates of 1.6 million BPS!

Software costs are low, too. CompuStar's disk operating system is the industry standard CP/M\*. With an impressive array of application software already available and several communication packages offered, the CompuStar can tackle even your most difficult programming tasks.

Compare for yourself. Of all the microcomputer-based multi-user systems available today, we know of only one which offers exactly what you need and should expect. Exceptional value and upward growth capability. The CompuStar™. A true price and performance leader!

**INTERTEC  
DATA  
SYSTEMS®**

2300 Broad River Rd. Columbia SC 29210  
(803) 798-9100 TWX: 810-666-2115

Circle 177 on inquiry card.



# Object-Oriented Software Systems

---

David Robson  
Learning Research Group  
Xerox Palo Alto Research Center  
3333 Coyote Hill Rd  
Palo Alto CA 94304

---

*This article describes a general class of tools for manipulating information called object-oriented software systems. It defines a series of terms, including software system and object-oriented. The description is greatly influenced by a series of object-oriented programming environments developed in the last ten years by the Learning Research Group of Xerox's Palo Alto Research Center, the latest being the Smalltalk-80 system. The article describes object-oriented software systems in general, instead of the Smalltalk-80 system in particular, in order to focus attention on the fundamental property that sets the Smalltalk-80 system apart from most other programming environments. The words "object-oriented" mean different things to different people. Although the definition given in this article may exclude systems that should rightfully be called object-oriented, it is a useful abstraction of the idea behind many software systems.*

Many people who have no idea how a computer works find the idea of object-oriented systems quite natural. In contrast, many people who have experience with computers initially think there is something strange about object-oriented systems. (I don't mean to imply that computer-naive users can create complex systems in an object-oriented environment more easily than experienced programmers can. Creating complex systems involves many techniques more familiar to the programmer than the novice, regardless of whether or not an object-oriented environment is used. But the basic idea about how to create a software system in an object-oriented fashion comes more naturally to those without a preconception about the nature of software systems.) I had had some programming experience when I first encountered an object-oriented system and the idea certainly seemed strange to me. I am assuming that most of you also have some experience with software systems and their creation. So instead of introducing the object-oriented point of view as if it were completely natural, I'll try to explain what makes it seem strange compared to the point of view found in other programming systems.

## Software Systems

A software system is a tool for manipulating informa-

tion. For the purposes of this article, I'm using a very broad definition of information.

**Information:** *A representation or description of something.*

There are many types of information that describe different things in different ways. One of the great insights in computer science was the fact that information can (among other things) describe the manipulation of information. This type of information is called *software*.

**Software:** *Information describing the manipulation of information.*

Software has the interesting recursive property of describing how to manipulate things like itself. Software is used to describe a particular type of information-manipulation tool called a *software system*.

**Software system:** *An information-manipulation tool in which the manipulation is described by software.*

A distinction is made in information-manipulation tools between *hardware* systems and *software* systems. A hardware system is a physical device like a typewriter, pen, copier, or television set. The type of manipulation performed by a hardware system is built in and can only be changed by physical modification. The type of manipulation performed by a software system is not built in—it is determined by information, which can be manipulated.

The virtue of software systems is that the mechanism developed for manipulating information can be used to manipulate the mechanism itself. Software systems that actually manipulate other software systems are called *programming environments*.

**Programming environment:** *A software system that manipulates software systems. An environment for the design, production, and use of software systems.*

"Our goal at The Denver Software Company is to translate the advances in high technology—symbolized by the Space Shuttle triumph—into practical, problem-solving microcomputer programs for small business and home use."

*Wally Schina*

## Microcomputers Are The Door To The Future.

### We Have The Key.

Finally, there's an accounting package available for most microcomputers—from the least expensive to the top-of-the-line—that works the moment the machine is switched on. Language, programs, everything needed for accurate bookkeeping is built into the software, eliminating the need for programming skills or expensive equipment add-ons.

#### The FINANCIAL PARTNER™

is a comprehensive financial package that takes the headache out of bookkeeping. With general ledger, cash receipts, accounts payable, and check-printing capability, this system also provides standard financial reports. In addition, the FINANCIAL PARTNER™ comes with a detailed user's manual containing basic bookkeeping instruction. By automatically sorting and posting accounts, the FINANCIAL PARTNER™ saves you valuable time and is a complete guide to money management for your home or very small business. At \$175, it's worth its weight in gold.



#### Also from The Denver Software Company:

**The PASCAL TUTOR™**, a computer assisted course in UCSD Pascal\*. This complete software package uses the microcomputer to teach this powerful new programming language, \$125 for this fast, easy way to learn versatile UCSD Pascal\*.

**The PASCAL PROGRAMMER™** is a software breakthrough for those knowledgeable about UCSD Pascal\*. Pre-tested modules drastically shorten the time spent coding, testing, and debugging programs—by as much as 70%. For \$125, saves money as well as time.

\*UCSD Pascal is a trademark of the Regents of the University of California.

Products available from your local dealer.

**THE DENVER SOFTWARE COMPANY**

MANUFACTURERS OF MICROCOMPUTER SOFTWARE



14100 E. Jewell Ave., Suite 13 • Aurora, CO 80012  
Dealer inquiries welcome. 303-321-4511

Thus, a programming environment is also recursive: it is what it manipulates. The fact that software systems can be manipulated is both good news and bad news. Since a text editor is a software system, it is not "cast in concrete" and you can change it to conform to your style of interacting with text more closely than it does now (using a programming environment). However, you also may reduce it to the proverbial "pile of bits" (not a text editor at all).

### Data/Procedure-Oriented Software

The traditional view of software systems is that they are composed of a collection of *data* that represents some information and a set of *procedures* that manipulates the data.

**Data:** *The information manipulated by software.*

**Procedure:** *A unit of software.*

Things happen in the system by invoking a procedure and giving it some data to manipulate.

As an example of a software system, consider a system for managing windows that occupy rectangular areas on a display screen. The windows contain text and have titles. They can be moved around the screen, sometimes overlapping each other. (The details of this system are

not important. Its main purpose is to point out the differences between the structure of a data/procedure system and an object-oriented system.)

A window-management system implemented as a data/procedure system would include data representing the location, size, text contents, and title of each window on the screen. It would also include procedures that move a window, create a window, tell whether a window overlaps another window, replace the text or title of a window, and perform other manipulations of windows on a display. To move a window, a programmer would call the procedure that moves windows and pass to it the data representing the window and its new location.

A problem with the data/procedure point of view is that data and procedures are treated as if they were independent when, in fact, they are not. All procedures make assumptions about the form of the data they manipulate. The procedure to move a window should be presented with data representing a window to be moved and its new location. If the procedure were presented with data representing the text contents of a window, the system would behave strangely.

In a properly functioning system, the appropriate choice of procedure and data is always made. However, in an improperly functioning system (eg: one in the process of being developed or encountering an untested situation), the data being manipulated by a procedure may be of an entirely different form from that expected. Even in a properly functioning system, the choice of the appropriate procedure and data must always be made by the programmer.

These two problems have been addressed in the context of the data/procedure point of view by adding several features to programming systems. Data typing has been added to languages to let the programmer know that the appropriate choice of data has been made for a particular procedure. In a typed system, the programmer is notified when a procedure call is written using the wrong type of data. Variant records allow the system to choose the appropriate procedure and data in some situations.

### Object-Oriented Software

Instead of two types of entity that represent information and its manipulation independently, an object-oriented system has a single type of entity, the *object*, that represents both. Like pieces of data, objects can be manipulated. However, like procedures, objects describe manipulation as well. Information is manipulated by sending a *message* to the object representing the information.

**Object:** *A package of information and descriptions of its manipulation.*

**Message:** *A specification of one of an object's manipulations.*

When an object receives a message, it determines how

**DISKETTE  
COPY SERVICE**

**Allenbach  
Industries**

**LANIER · TRS-80 · ATARI  
APPLE · AND OTHERS**

For  
Information  
Outside California Call  
(800) 854-1515 or (800) 854-1516  
In California Call Collect (714) 436-4351

Allenbach Industries  
4322 Manchester Ave. Olivenhain, CA 92024

# MORROW DESIGNS

## Cost effective answers to floppy disk problems.

**DMA answers.** Standard, accumulator transfer floppy disk controllers can stall your microcomputer system's CPU for as long as 160 milliseconds. Just to access and transfer a sector of data to main memory. If CPU processing speed and system performance are critical, you need something better. That's where Morrow Designs' new intelligent Disk Jockey DMA™ controller comes in. This new breed of peripheral handles both 5¼" and 8" drives and can read almost any format in existence. Speed? Your CPU runs at full tilt while the DMA controller seeks and gathers a sector of data. How? Information transfers to and from main memory occur as "cycle steals" from the system bus. And the missing memory cycles are transparent to the CPU totaling only two milliseconds instead of the usual 80.

**Build a buffer.** Give the Disk Jockey DMA a little extra memory and your system's performance gets even better. The extra storage is used as a track buffer. So, whenever a sector on a new track is read, the track buffer is automatically filled with the other sec-



tors on the track. The result? Additional data on the track is immediately available. Without the 80 millisecond rotational latency normally encountered. And similar efficiencies occur with disk writes. Sectors in the track buffer are conditionally written on the disk only if a new track is accessed. And only one revolution of the disk is required.

**Now, prices.\*** All systems listed are supplied with a floppy disk drive, Disk Jockey Direct Memory Access Controller, CP/M\*\* 2.2 operating system, power supply, fan, cables, cabinet and Microsoft 5.2 BASIC.

**Even lower prices.** Morrow Designs' floppy disk systems with Disk Jockey™ 2D controllers offer the same high quality at even lower prices. Now without memory mapping!

**Fast answers.** See Morrow Designs' family of cost effective floppy disk systems at

your computer dealer. For a somewhat more leisurely answer, circle the reader service number below. For immediate answers, phone us at (415) 524-2101.

**LOOK TO MORROW FOR ANSWERS.**

### 5¼ Inch Systems (formatted data)

|   |        |
|---|--------|
| 400,000 Bytes (1) Dual Sided 48 TPI Drive   | \$1110 |
| 800,000 Bytes (2) Dual Sided 48 TPI Drive   | \$1899 |
| 800,000 Bytes (1) Dual Sided 96 TPI Drive   | \$1499 |
| 1,600,000 Bytes (2) Dual Sided 96 TPI Drive | \$2599 |

OEM pricing available

### 8 Inch Systems (formatted data)

|  |        |
|--|--------|
| 500,000 Bytes (1) Single Sided Drive   | \$1199 |
| 1,000,000 Bytes (2) Single Sided Drive | \$1975 |
| 1,000,000 Bytes (1) Dual Sided Drive   | \$1595 |
| 2,200,000 Bytes (2) Dual Sided Drive   | \$2675 |

OEM pricing available

\*Prices subject to change without notice.  
Disk Jockey DMA and Disk Jockey 2D  
are trademarks of Morrow Designs  
\*\*CP/M is a trademark of Digital Research.

## MORROW DESIGNS

5221 Central Avenue, Richmond, CA 94804  
(415) 524-2101



to manipulate itself. The object to be manipulated is called the *receiver* of the message. A message includes a symbolic name that describes the type of manipulation desired. This name is called the message *selector*. The crucial feature of messages is that the selector is only a *name* for the desired manipulation; it describes *what* the programmer wants to happen, not *how* it should happen. The message receiver contains the description of how the actual manipulation should be performed. The programmer of an object-oriented system sends a message to invoke a manipulation, instead of calling a procedure. A message names the manipulation; a procedure describes the details of the manipulation.

Of course, procedures have names as well, and their names are used in procedure calls. However, there is only one procedure for a name, so a procedure name specifies the exact procedure to be called and exactly what should happen. A message, however, may be interpreted in dif-

ferent ways by different receivers. So, a message does not determine exactly what will happen; the receiver of the message does.

If the earlier example of the window-management system were implemented as an object-oriented system, it would contain a set of objects representing windows. Each object would describe a window on the screen. Each object would also describe the manipulations of the window it represents—for example, how to move it, how to determine whether it overlaps another window, or how to display it. Each of these manipulations would correspond to a selector of a message. The selectors could include *move*, *overlap*, *display*, *delete*, *width*, or *height*. (In this article, an alternate typeface is used for words that refer to specific elements in example systems.)

In addition to a selector, a message may contain other objects that take part in the manipulation. These are called the message *arguments*. For example, to move a

Circle 354 on inquiry card.

# The Powerful New Alternative To VisiCalc™

*For CP/M based microcomputers, SuperCalc is the superior new "electronic worksheet" for businessmen. Complex calculations, alternative recalculations, and numerical forecasting are easy. Just type in your numbers - SuperCalc does the rest. SuperCalc pays for itself almost immediately, and eventually it will save enough in time and money to pay for your computer as well! Dealer and distributor inquiries welcome. SORCIM Corporation, 405 Aldo Ave., Santa Clara, CA 95050, (408) 727-7636*

*"What was needed for the OSBORNE 1 was an easy-to-understand CP/M based alternative to VisiCalc from a qualified, reliable company. SuperCalc by SORCIM is all that . . . and more."*

**Adam Osborne**  
Developer of the OSBORNE 1



Powerful Software Tools

# SuperCalc™ by SORCIM

VisiCalc is a trademark of Personal Software Inc., SuperCalc is a trademark of SORCIM Corp.



# MORROW DESIGNS

## Leading edge technology in hard disk systems.

**Complete systems.** Morrow Designs hard disk subsystems are delivered complete with hard disk, controller, cabinet, power supply, fan, cables and CP/M\* 2.2 operating system.

**Widest range.** Morrow Designs offers the widest range of hard disk systems available from a single supplier. 5¼," 8," 14." Five to over 100 megabytes of formatted hard disk storage. \$2,995 to \$19,980. Cost effective systems that work. And keep working.

**S-100 and more.** Morrow Designs hard disk systems are designed for use with the CP/M operating system. Available software packages allow our systems to run on any IEEE696/S-100 Standard system with no hardware modification.

Plus, Cromemco,† North Star,\*\* Vector Graphics, Godbout, Dynabyte, Exidy,†† IMSAI, Micro-mation, Processor Technology and California Computer Systems.

**Reliable systems.** Morrow Designs is committed to hard disk system reliability. Not simply with a 90-day warranty, but with a money back guarantee. If our system fails to perform to specification, send it back. We'll send back your money.

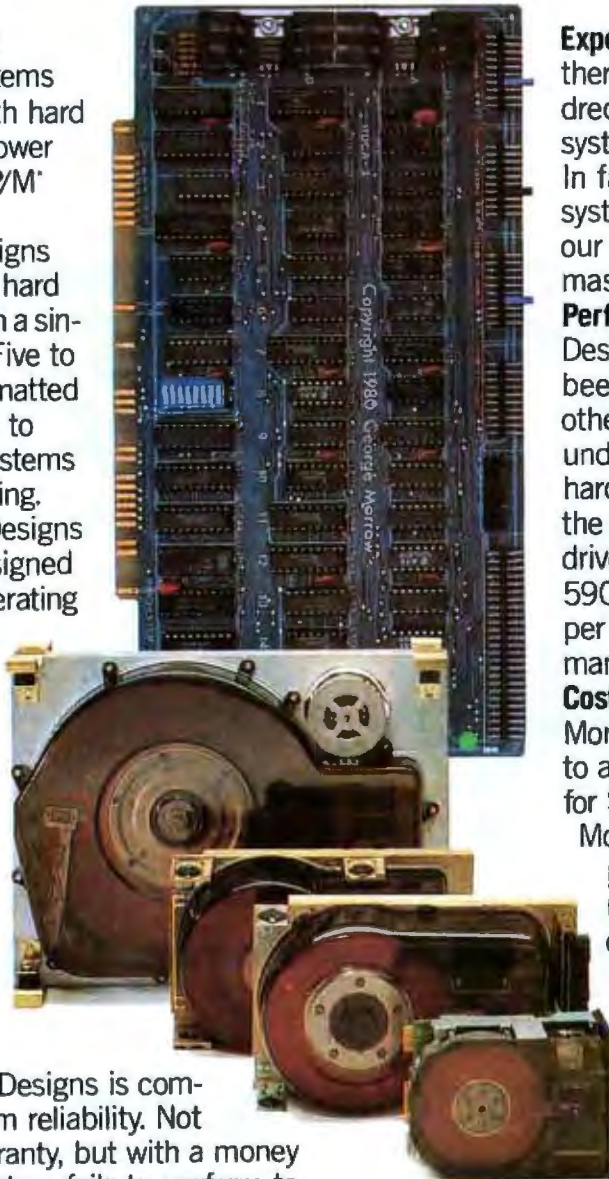

**Experience.** As of April, 1981, there were over fifteen hundred Morrow Designs hard disk systems successfully installed. In fact, over 200 independent systems integrators now use our hard disks to solve their mass storage problems.

**Performance answers.** Morrow Designs hard disk systems have been benchmarked against all other systems. None is faster under CP/M. Morrow Designs hard disks operate at 10 times the speed of a floppy disk drive. Transfer rates range from 590,000 bytes to 900,000 bytes per second. That kind of performance can become addictive.

**Cost effective answers.** Compare Morrow prices and performance to anything presently available for S-100 systems. You'll find

Morrow's price/megabyte/performance ratio to be unmatched. Leadership in disk systems technology earned us leadership in price/performance. And that may have earned us a call from you. Circle the Reader Service Number for our full line data sheets. Can't wait? Call us at

(415) 524-2101. And yes, OEM quantity prices are available. **LOOK TO MORROW FOR ANSWERS.**

## MORROW DESIGNS

5221 Central Avenue, Richmond, CA 94804  
(415) 524-2101



\*CP/M is a trademark of Digital Research.

\*\*Northstar is a trademark of North Star Computers, Inc.

†Cromemco is a trademark of Cromemco, Inc.

††Exidy is a trademark of Exidy Corporation.

window, the programmer might send the object representing the window a message with the selector move. The message would also contain an argument representing the new location. Since this is an object-oriented system, the selector and argument are objects: the selector representing a symbolic name and the argument representing a location or point.

The description of a single type of manipulation of an object's information (the response to a single type of message) is a procedure-like entity called a *method*. A method, like a procedure, is the description of a sequence of actions to be performed by a processor. However, unlike a procedure, a method cannot directly call another method. Instead, it must send a message. *The important thing is that methods cannot be separated from objects.* When a message is sent, the receiver determines the method to execute on the basis of the message selector. A different kind of window could be added to the system

with a different representation and different methods to respond to the messages move, overlap, display, delete, width, and height. Places where messages are sent to windows do not have to be changed in order to refer to the new kind of window; whichever window receives the message will use the method appropriate to its representation.

Objects look different from the outside than they do from the inside. By the outside of an object, I mean what it looks like to other objects with which it interacts (eg: what rectangles look like to other rectangles or to windows). From the outside, you can only ask an object to do something (send it a message). By the inside of an object, I mean what it looks like to the programmer implementing its behavior. From the inside, you can tell an object how to do something (in a method). For example, a window can respond to messages having the selectors move, overlap, display, delete, width, or height.

### IMPORTS



#### EPSON MX-80

Price Breakthrough - Call

|                    |        |
|--------------------|--------|
| Okidata M-80 ..... | \$399* |
| Okidata M-82 ..... | \$549  |
| Okidata M-83 ..... | \$849  |

### PAPER TIGERS



|            |        |
|------------|--------|
| 445G ..... | \$749  |
| 460G ..... | \$1119 |
| 560G ..... | \$1395 |

### HIGH SPEED



|                           |           |
|---------------------------|-----------|
| Anodex<br>9500/9501 ..... | \$1274.00 |
| Datasouth<br>DS-180 ..... | \$1349.00 |
| TI 810 Basic .....        | \$1499.00 |

### MORE PRINTERS

|                      |           |                            |           |
|----------------------|-----------|----------------------------|-----------|
| Centronics 737 ..... | \$719.00  | • NEC 5510 .....           | \$2689.00 |
| DEC LA 34AA .....    | \$1049.00 | • Diablo 630 .....         | \$2295.00 |
| MPI 88G .....        | \$619.00  | • C. Itoh Starwriter ..... | \$1495.00 |
| MPI 99G .....        | \$719.00  | • NEC 5520 .....           | \$3089.00 |

\*Tractors Included In price

### COMPUTERS



#### NORTHSTAR

Burned and tested - backed by fast warranty service. Find out why our prices, availability and service make us the #1 source for the #1 S-100 system. Free games disk.

|                         |           |
|-------------------------|-----------|
| Horizon II 64K DD ..... | \$2895.00 |
| Horizon II 64K Qd ..... | \$3295.00 |

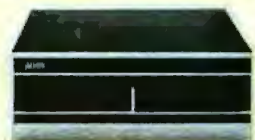

#### ALTD5

NOW MORE FOR LESS

ACS-8000-15 has 208K RAM, 1 Mg. on floppys, 6 serial and 2 parallel ports. Upgrade w/Winchester hard-disk drives and tape back-up. Multi-user at single user prices.

|                  |        |
|------------------|--------|
| ACS8000-15 ..... | \$4795 |
|------------------|--------|



#### ATARI

Atari 800 w/32K  
\$775

while they last  
plus 410 \$59 - Star R \$27  
Joysticks \$14 - 810 \$449



#### ZENITH

The all-in-one computer that's backed by your local Zenith/Health service center. Green Phosphor screen and CP/M included.

|                         |        |
|-------------------------|--------|
| Z89 w/48K 2 SIO's ..... | \$2249 |
|-------------------------|--------|

### ADDS



The new leader! Detachable keyboard, extra port, 3 function keys, numeric keypad, 24x80, RS-232, built and backed by ADDS.

|                      |       |
|----------------------|-------|
| ADDS Viewpoint ..... | \$569 |
|----------------------|-------|

### TELEVIDEO



|           |       |
|-----------|-------|
| 910 ..... | Call  |
| 912 ..... | \$729 |
| 920 ..... | \$759 |
| 950 ..... | \$969 |

### TERMINALS



|                      |       |
|----------------------|-------|
| Zenith Z-19 .....    | \$789 |
| Soroc IQ 120 .....   | \$729 |
| Soroc IQ 135 .....   | \$799 |
| Hazeltine 1421 ..... | \$779 |

### ORDERING

#### MAIL ORDER ONLY

2% cash discount included / charge cards add 2%. Prices subject to change, product subject to availability. Arizona residents add 5%. F.O.B. point of shipment Scottsdale. 0-20% restocking fee for returned merchandise. Warranties included on all products.

We participate in arbitration for business and customers through the Better Business Bureau of Maricopa County.



## Scottsdale Systems Ltd.

6730 E. McDowell Road, Suite 110, Scottsdale, Arizona 85257



(602) 941-5856



Call 8-5 Mon.-Fri.

(We Export) TWX 910-950-0082 (IMEC SCOT)



# I'll probably come down the hall to see you.

"I like to tell anyone who has done a good job that I know it and appreciate it. As far as I'm concerned, being the President doesn't mean a big office with a closed door. It's not private dining rooms and splendid isolation.

"You see, I know success at ITT DCD is its people. Our most important asset is our people; the computers, the facilities—whatever else we have or buy—nothing works right without the right people. And when you find them you have to challenge them, then reward them when they meet the challenges.

"People work for recognition. OK, I know what you're going to say. It's the money they're after and the praise is only icing on the cake. But believe me, you can't buy loyalty. You can pay people for their talent... but you can't buy them.

"I really appreciate a special effort. And if you do something innovative, notable, different—I'm going to get up, go and see you, tell you what I feel. We've put millions into independent research this year, because we believe you should back original thought. As far as I'm concerned, today's bright idea is tomorrow's profit. You can't get any simpler than that! Corporate success is a collective success, and it's my job to build a better team.

"For me it was always ITT. It was my first significant exposure to industry. I guess I'm a good example of the fact that staying can work for you. From a Project Engineer to President in 14 years. Yes, you're looking for a long term commitment and what it can do for you.

"And it looks like I'm here to stay—who would leave a life like this. I've got a wonderful house in Morris County, NJ. There I am, just 1 hour from Broadway, and I still have wild deer wandering across my lawn. A great place to bring up children—that wonderful mix of rural fantasy and Big Apple culture.

"Success? You could call it that. But success is setting a goal and reaching it. Satisfaction is finding yourself exactly where you want to be."

---

If you want to align your career with a company that looks for ideas and backs them all the way to reality, consider ITT DCD.

We have openings for degreed engineering/scientific professionals at all levels of experience in the following areas:

**COMMAND & CONTROL COMMUNICATIONS  
MESSAGE / CIRCUIT SWITCHING  
VOICE / SIGNAL PROCESSING**

- Hardware Systems Design
- Software Systems Design
- Systems Analysis • Programming

ITT DCD offers excellent salaries and a comprehensive benefits package that would be difficult to duplicate. Beyond medical, dental and life, we offer a superior system of educational support which encourages acquisition of credits and advanced degrees on our time at our expense. Relocation is another area of extraordinary effort on ITT DCD's part. We ease your move by coordinating all phases through our in-house relocation specialist. Please call or send resume to our Director of Professional Placement.

**Where engineers never stop learning**



An equal opportunity employer M/F

(800) 526-6292, (201) 284-2551

492 River Road, Nutley, New Jersey 07110

Software/Hardware Professionals:

# WHY KEEP YOUR CAREER WAITING?

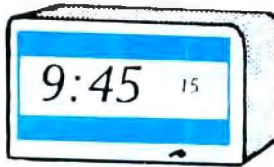

Timing is key to successful career change. But to make sure you're prepared to seize the right opportunity at the right time, you need professional assistance. Over the past twelve years, R.M. Norton and Company has offered the research and planning necessary for successful career change.

Drawing on more than a decade's resources, our consultants provide expert resume preparation and knowledgeable career path advice. And since we represent some of the country's premier companies, we

enjoy access to the choicest openings in a broad range of positions.

Current New England openings for the professional with state-of-the-art experience include: Software Design and Development, Computer Sciences, Assembly or Higher Level Language Programming, Data Base Design, Compiler and/or Operating Systems Design, Digital Logic Design, Interface Design, Microprocessor Utilization, Computer Architecture, Logic/Circuit Design, Power Supplies, Terminals Development and Distributed Systems Firmware.

If you can't keep your career waiting, contact us. At R.M. Norton, you'll find the expertise that comes with twelve years of experience and service. And as you'd expect, client companies assume all fees.

(617) 861-7800

271 Lincoln Street, Lexington, MA 02173



## R. M. NORTON & COMPANY, INC.

Professional Placement Consultants

### HARDWARE SOFTWARE professionals

|                        |        |
|------------------------|--------|
| Signal Process'g Engrs | to 40k |
| Project Engineers      | to 30k |
| Analog Design Engrs    | to 45k |
| Digital Design Engrs   | to 45k |
| Test Eqpmnt Designers  | to 35k |
| Test Engineers         | to 32k |
| Software Engineers     | to 30k |
| Diagnostic Engineers   | to 37k |
| Sftwr Systems Analysts | to 38k |
| ....                   |        |

Search & Recruitment by:  
David Barros

Call or send résumé

*Career Associates, inc.*

P.O. BOX 86, NO DARTMOUTH MA 02747

617-997-3311

### COVERING NEW ENGLAND AND THE U.S. SINCE 1964

We've been placing engineers in challenging more rewarding positions since 1964. We know the market and the people to contact here in New England. And through the National Personnel Consultants Network we are on top of openings in every area of the country. When you deal with E.P. Reardon you'll save yourself time and money and you'll be represented by a staff of experienced placement consultants that can do it all for you.

We have openings in all of the areas listed below from entry level to management. Salaries range from 22-55K per year.

|                                     |                          |
|-------------------------------------|--------------------------|
| Telecommunications                  | Circuit and Logic Design |
| Command, Control and Communications | Robotics/Automation      |
| Automatic Test Equipment            | Guidance and Control     |
| Microwave Devices & Systems         | Navigation Systems       |
| Radar Systems                       | RF Design                |
| CAD/CAM                             | Data Communications      |
| Instrumentation                     | Mechanical Packaging     |
| Optics & Electro Optics             | Process Control          |
|                                     | Mechanism Design         |
|                                     | Reliability              |

If you are qualified by education and experience in any of these or related fields put Bob McNamara to work for you today. Call him collect at (617) 329-2680 or contact him at the address below.



*E.P. Reardon Associates*

888 Washington Street, P.O. Box 228, Dedham, MA 02026 Clients are EOE.

FREE OFFER!

## If you read a lot of computer printouts— Rest your tired eyes on us.

Today's high technology engineers and technical management people—qualified professionals just like yourself—must work closely with computers to stay on the leading edge of the state-of-the-art.

However, this also means that you must read many computer printout sheets, each containing wide lines of characters and/or numbers.

GRADUATING ENGINEER, McGraw-Hill's magazine for senior-level engineering students, understands this because its readers and their professors are confronted with the same problem in the classroom.

To help ease their eyestrain we have made available to the professors a 15 inch (or 38 centimeters on the other edge) clear plastic ruler.

It features a yellow highlight bar down the center which can be used to zero in on that important, and always elusive, line of information.

Because we realize that industry also burns the midnight oil, GRADUATING ENGINEER is pleased to extend this offer to high technology professionals too.

So, why don't you rest your tired eyes on us? To request your free computer printout reading guide, just write to us on your company or personal letterhead to the address below.

Willie Williams,  
Editorial Associate  
**GRADUATING ENGINEER**  
McGraw-Hill Publications  
1221 Avenue of the Americas/Room 345  
New York, New York 10020



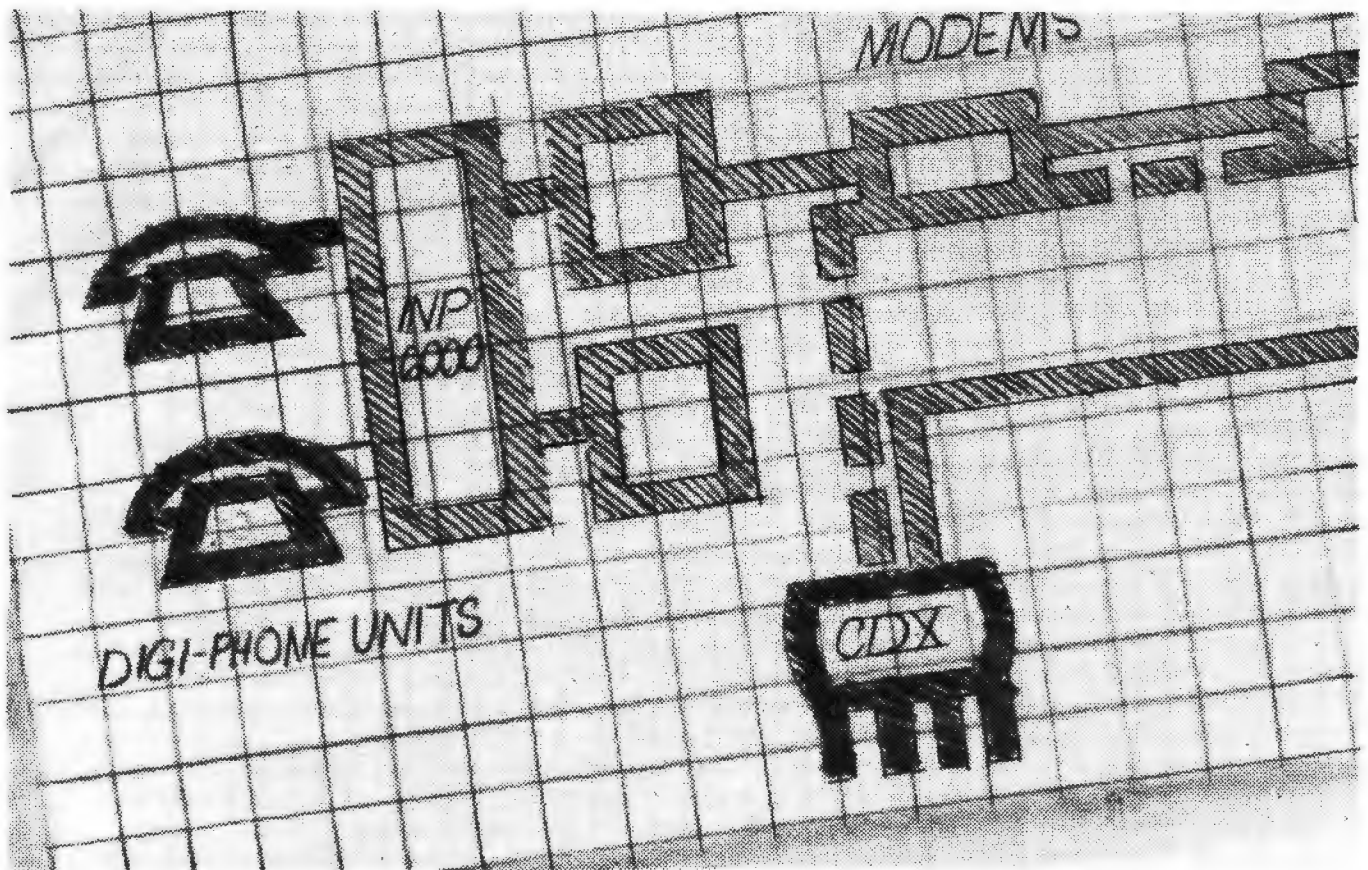

# Our Systems Speak for Themselves.

At Codex, we produce high-speed state-of-the-art data communications equipment. And our systems are known as the best in the industry.

If you know where the future in electronics is, those facts should speak for themselves.

Being the leader in data communications means we're part of one of the fastest-growing fields today. Our clients are Fortune 1000 firms. And we're shaping tomorrow's information networks to make them more efficient, and more productive.

What's in it for you? Just this. That kind of growth means you can go places with us. We promote extensively from within. And we make a conscious effort to enable our people



to do more—technically and professionally—than they ever thought possible.

Our technology helps the world communicate. Maybe it's saying something to you.

Codex offers competitive salaries and a comprehensive benefits package including dental insurance and profit sharing.

Interested candidates should forward a resume including salary history, in confidence, to J.T. Dombrowski, CODEX CORPORATION, 20 Cabot Boulevard, Mansfield, MA 02048.

## Senior Systems Engineer

Will be responsible for the design of custom software interfaces, product enhancements and product support for data communications systems. Requires a BS or MS in electrical engineering or computer science and a minimum of 4 years software design with some exposure to telecommunications and Assembly language programming.

## Senior Software Engineer

Responsibility will be for the definition and implementation of operating systems in multi-microprocessor environment for data communications systems. Requires a BS or MS in Computer Science or a related field and a minimum of 4 years of software development including implementation of operating systems software. Will utilize the knowledge of a variety of operating systems approaches in real-time multiprocessing environment e.g. UNIX.

## Senior Hardware Engineer

This position involves designing hardware to customer specifications for data communications systems. A BSEE is required plus a minimum of 4 years experience in digital design of microprocessor-based systems. Knowledge of data communication systems and some analog experience is a plus.

# WHAT DOES IT ALL MEAN?

You can call anybody a programmer analyst, given a few basic elements. At Keane, our titles mean more than an impressive name on your business card.

---

## Keane Prō·grām·mer Ān·a·lyst:

1. (n.) One who is responsible for working under minimal supervision for a leading computer consulting firm. May be called on to perform technical tasks ranging from business systems design to program development. 2. (v.) Interacts with clients, works on variety of challenging assignments. Plans, organizes and leads others. 3. (adj.) Highly motivated. Aggressive, strong in interpersonal skills. Interested in getting ahead. 4. (adj.) Experienced. Minimum of 2 or more years Commercial/COBOL. Knowledge of CICS, DB/DC, DL/1, IMS/TP, IDS or IDMS is a plus. 5. (Synonym) None. There is no one quite like a Keane Programmer Analyst.

In addition to Programmer Analysts, we are also looking for Project Managers and Programmers for our nine branch offices throughout New England. We offer competitive salaries and benefits that include health, dental, bonuses, merit raises and much more.

Call Dick Pippin, New England Recruiting Manager, at (617) 482-3321, or send your resume to him at Keane, Inc., 30 Federal Street, Boston, MA 02110. We are an equal opportunity employer, M/F.

---

## KEANE

---

# Engineering

## THE PRIME DIFFERENCE

One of the key elements of our success in the marketplace is the total commitment of our Research & Development organization to keep us on the leading edge of computer technology. This commitment manifests itself through highly visible engineering opportunities where achievement is recognized and rewarded. If you agree that the challenge of technical excellence should be enhanced by growth instead of being frustrated by it, the Prime difference might be right for you. Listed below is a brief synopsis of our major disciplines with a list of positions we are currently staffing.

### HARDWARE

Principal activities in this area include the design and development of fully compatible 32 bit processors and associated peripherals. We are also engaged in a major new emphasis on in-house LSI technology and sophisticated CAD tools for both electrical and mechanical applications.

- Processor Development
- Memory Systems
- Power Systems
- Hardware Programs and Planning
- Special Systems/Hardware
- Microelectronics
  - Design Engineering
  - Process Engineering
  - Application Programming
- Peripheral Development
  - Disc Controller and Subsystems
  - I/O Subsystems
  - Terminal Development
- Mechanical Design
  - Sr. Technical Contributors/Advanced Packaging
  - Sr. Mechanical Engineers
- Computer-Aided Design
- Mechanical CAD/CAM
  - Manager/Mechanical CAD Systems
  - Software Engineers
- Electrical CAD Systems
  - Software Engineers
  - CAD Instructor
- Communications

For the above areas, contact Martha Polachi at 879-2960, Ext. 3266.

### SOFTWARE

Our "Software First" philosophy combined with our diverse product offerings provide constant challenges for our software engineers. Continued excellence is dependent upon filling key future development positions now. If you have untapped talents in the following areas, we invite you to see what well managed innovation can offer.

- Translator and Compiler Development
  - COBOL
  - Microprocessors
  - Translators
- Software System Performance Evaluation
- Office Automation
- Data Management

For the above areas, contact Glenn Tines at 879-2960, Ext. 4019.

### RESEARCH & ADVANCED SYSTEMS

Expanded and innovative efforts in the areas of Reliability, Availability and Serviceability, combined with state-of-the-art systems architecture and networking, put this group on the leading edge of Prime's Advanced Development effort.

- Advanced Development Manager
- Reliability, Availability, Serviceability
- Human Factors Research
- Database Research

For the above areas, contact Charlie Cohen at 879-2960, Ext. 3288.

To learn more about a career with PRIME, contact the appropriate recruiter named above or forward your resume to their attention at PRIME COMPUTER, Dept. MH6, 500 Old Connecticut Path, Framingham, MA 01760. (617) 879-2960. Prime is an Affirmative Action Employer, seeking outstanding individuals.

# PRIME Computer

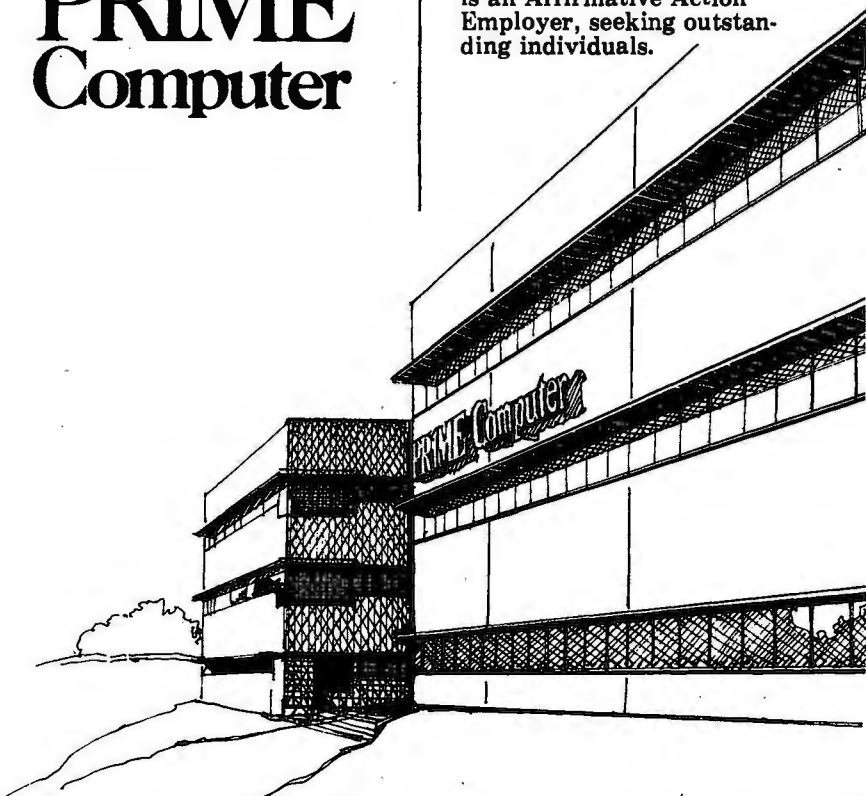

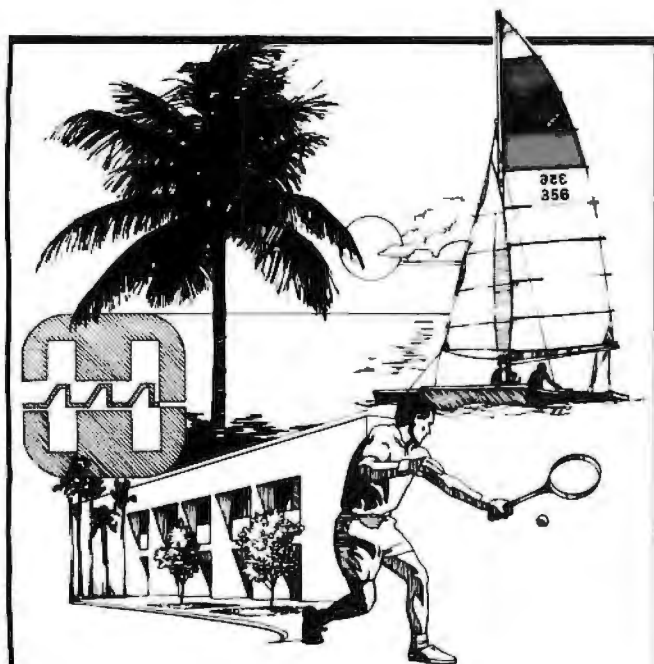

## UNABASHED SUCCESS AND WE'RE READY TO SHARE IT!

We've entered a crowded market and pushed the competition aside. Today, HARRIS COMPUTER SYSTEMS DIVISION is growing at a compound annual rate of nearly 30%. This expansion will continue to accelerate as emphasis on CAD/CAM, energy and systems create a greater demand for the Harris super mini-computer.

Now we're developing improved architecture, even greater performance and an expanded range of applications. These developments will lead to opportunity for the skilled SOFTWARE or HARDWARE ENGINEER looking for a place to step out of the crowd. If you have a BSCS or BSEE, 3-5 years of experience and a great deal of promise, let's talk about unabashed success!

A high salary, great benefits and fine working environment are only part of what awaits you when you join Florida's largest industrial employer. We're offering you a way of life in the sunny, income tax free state where off hours can be spent at almost every conceivable form of recreation and relaxing. But find out why high performance on the job can lead to better performance all around. For details, call Jan Kelley, toll free, at 1-800-327-4986 or send your resume including salary history to: HARRIS COMPUTER SYSTEMS DIVISION, 2101 West Cypress Creek Road, Ft. Lauderdale, Florida 33309.



**HARRIS**  
COMMUNICATION AND  
INFORMATION PROCESSING

An Equal Opportunity Employer M/F

## THE TIME IS NOW. THE COMPANY IS DRC.

At DRC you'll find an environment that encourages personal growth through high visibility, project mobility and technical recognition, both internally and through direct customer contact. You'll be part of a small team of highly skilled technical professionals performing Systems Analysis and Engineering Studies for DOD program managers. With the increased emphasis on Defense Systems, the time is now to grow with a leader in the industry.

We are specifically interested in people with a BSEE, MS preferred, with 5 to 10 plus years systems level experience in these topical areas.

- Automatic Test Equipment for use on military avionic systems
- Military Aircraft Displays and Instruments
- Fire Control Systems and Airborne Computers
- State-of-the-art Radar and ECM Systems
- IMU Component Reliability Analysis
- Military Digital Computers and associated Automatic Test Equipment
- Inertial Component Test
- Creative Design (Analog/Digital) of laboratory test equipment
- F-16 Avionics Intermediate Shop Management—Management Information Systems
- Signal Processing for Electronic Warfare, ECM, ECCM
- Life Cycle Cost Analysis
- Operations Research for airborne and ground based electronic systems
- Logistics Support Analysis for weapons systems applications

To learn more about these exciting opportunities, please forward your resume, including salary information, to Don Shanley, Dept. MH6 Dynamics Research Corporation, 60 Concord Street, Wilmington, MA 01887.

An equal opportunity employer, M/F.



**DYNAMICS RESEARCH CORPORATION**



ENGINEERS/SCIENTISTS

# SPACE

# FOR YOUR IDEAS



## ELECTRONIC ENGINEERS

If you're the kind of engineer who enjoys the challenge of new technological problems, investigate the professional positions available with **The Aerospace Corporation**. We seek scientists and engineers with Ph.D or M.S. in EE or Physics with background in one of these areas:

### **Laser Communication Engineer**

Perform analysis, design and development of laser communications systems for a variety of space programs, as well as other applications. In addition to a background in communications systems, you should be knowledgeable in the various laser transmitter technologies including solid state and gas, as well as laser receiver and optical components.

### **RF Systems Design**

Antenna design studies, RF link calculations for communications satellites, propagation studies to determine link margins. A broad RF background, and the ability to perform systems trade analysis for terrestrial communications networks involving large antenna and microwave subsystems are desirable.

### **Communications Systems Analysis**

Statistical analysis of communications systems. The ability to perform coding systems studies, link calculations for communications satellites, modulation and spread spectrum studies and systems trade analysis for communications networks is desirable.

### **Optical and Electro-Optical Systems Analysis**

Analysis and laboratory evaluation of optical and electro-optical components and systems such as CCD imaging and signal processing devices, lasers, laser modulators, fiber and integrated optics, and coherent optical processing. Image analysis, diffraction effects, optical systems design and specifications.

### **Space Power Systems**

Analysis of the design, processing, assembly and testing of solar cells and arrays, procurement and testing of batteries, and electrical integration of solar arrays and batteries into power systems.

For a more rewarding career please forward your resume to:

**The Aerospace Corporation**  
Professional Placement Dept. KK  
2350 E. El Segundo Blvd.  
El Segundo, CA 90245



# The Aerospace Corporation

Where There's Space For Your Ideas

An Affirmative Action Employer • U.S. Citizenship Required

# The Challenge of a Thought

MITRE accepts that challenge every day. Throughout the projects we undertake as General Systems Engineer to the U.S. Air Force's Electronic Systems Division, we have the same goal in mind: turning a good idea into an operational reality.

This is a great simplification of our work in C<sup>3</sup> (Command, Control and Communications), but essentially it comes down to these basics:

Isolate the need. Figure out what we think might work. Try it out and make sure it will work. And finally — bring it to fruition as a real capability in the field.

Our elite group of systems engineers has an unusual opportunity to provide technical leadership in concept development, design, demonstration and evaluation — and the satisfaction of seeing their thoughts come to tangible completion. And with the project-to-project mobility that is intrinsic in MITRE's structure, they know there will be another challenge waiting after this one.

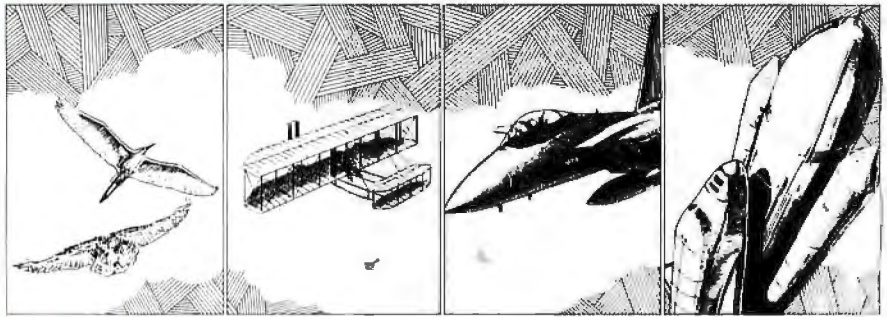

## Is to Make It a Reality.

If you have a degree and background in any of the following aspects of C<sup>3</sup>, you should consider the challenge of MITRE. This is a thought that could make your career an entirely different reality.

COMPUTER SYSTEMS  
RADAR SYSTEMS

SYSTEM SOFTWARE  
COMMUNICATIONS  
COMMAND AND CONTROL  
SYSTEMS ARCHITECTURE

Send your resume including current or required salary to David L. Finnegan, 4506 Middlesex Turnpike, Bedford, MA 01730. U.S. Citizenship or resident alien registration required.

MITRE is an equal opportunity employer actively seeking applications under its affirmative action program.

MAKE YOUR COMMITMENT TO EXCELLENCE.

# MITRE

## FOR THOSE WITH THE TECHNICAL "MIDAS TOUCH"

The next two decades may be the most challenging—the most rewarding! IT DEPENDS ON WHERE YOU ARE!

Grumman Aerospace is dedicated people combining their skills and resources to find realistic solutions to many of today's most urgent problems. It takes the best talents and efforts of many kinds of people, working together, to produce the high-performance systems and vehicles demanded of today's aerospace industry. Grumman pursues excellence in the design and development of a wide range of advanced aerospace products as well as other exciting projects.

We will need more of the best and most innovative minds to continue meeting these challenges of the future.

Immediate openings now exist in the following areas for degreed engineers (or equivalent experience)

- **Systems design, analysis and integration (EW, ECM)**
  - **Guidance and control • Software development**
  - Field representatives**
- (U.S. Navy aircraft carrier deployment)

If you would like to apply your talents to forward-looking programs send a comprehensive resume and salary requirements in strictest confidence to Kaye B. Perry, Manager, Employment Development, Grumman Aerospace Corporation, Plant 28, South Oyster Bay Road, Bethpage, NY 11714.

U.S. Citizenship Required/An Equal Opportunity Employer



**STAFF DESIGN ENGINEERING PROFESSIONALS**  
\$25,000 to \$60,000

**PUT YOUR IDEAS ON OUR DRAWING BOARD**

### Large Scale Computer System Development

Our client, a prestigious leader in the computer industry, has outstanding opportunities to work and live in the scenic rural environment of New York State's beautiful Hudson Valley. Positions are presently available in the following disciplines:

#### Digital Logic Designers

You will be involved in digital logic design utilizing state-of-the-art devices and technologies.

#### Advanced Semiconductor Device Engineers

You will be involved in designing high speed microprocessor and memory products.

#### Software Architects

You will be designing and integrating high level languages with large scale systems.

All of these positions require a B.S./M.S. Electrical or Computer Science Engineering Degree and a minimum of 18 months work experience in one of the above disciplines. An ability to conceive and develop innovative ideas is also necessary.

You will enjoy an excellent starting salary and an outstanding comprehensive benefits package. For confidential consideration, send your resume, a letter of interest, or call: (914) 471-3700.

THE HUDSON GROUP

Mr. Eugene Olan  
59 Academy Street  
Poughkeepsie, N.Y. 12601

Our client is an equal opportunity employer and assumes all fees.

Technical Division of Ethan Allen Personnel

# Engineers

Our products range in size from

devices to supersystems. Our technological range invites more striking comparisons — mini- and micro-computers, distributed processing, high density packaging, electro-optics, automation, and C<sup>3</sup>I systems to cite a few.

# Grow

We employ about 300 engineers and are the only RCA plant in New England. This means individual achievers get high visibility in our informal structure, yet we can call upon RCA's worldwide corporate resources. Last year, we upgraded or promoted over 25% of our engineers.

# With

We have openings for engineers who can design software, test systems, high density packages, maintainability and reliability programs, and complex computer-based systems.

Our sales have tripled and our employment doubled in the past five years. Our growth plan for the next five years shows even brighter prospects for the future. Become a part of

# RCA!

this Tradition on the Move, contact Roger Bishop, Employment Manager,

RCA Automated Systems, P.O. Box 588, Burlington, MA 01803, (617) 272-4000.

**RCA**



A TRADITION ON THE MOVE!



## DON'T WAIT FOR TOMORROW... CREATE IT.

When creative ideas are needed for new and unprecedented software systems, the people to see are at SofTech. We take new techniques and old approaches and combine them to find the best possible solution to any given problem.

At SofTech, you will have the opportunity to apply your abilities to exciting, real-world problems in such diverse areas as:

- Language design and compiler development
- Communications
- Software engineering facilities
- Data base systems
- Requirements analysis
- Signal processing applications
- Operating systems and executives
- Computer-aided design and computer-aided manufacturing.
- Sale and enhancement of microprocessor software products — sole world-wide distributor of the UCSD p-System.

If you have the talent and vision to add to our international reputation for excellence in the development and application of new systems and software technology, your best position is waiting at SofTech.

We offer opportunities for professional growth inherent in a 300 person environment, coupled with excellent starting salaries and outstanding benefits. Please send your resume and salary requirements to Judith M. Forsythe, Dept. 525, SofTech, Inc., 460 Totten Pond Road, Waltham, MA 02154; or call toll-free 1-800-225-8854.

an affirmative action/equal opportunity employer

# SOFTech

THE SOFTWARE TECHNOLOGY COMPANY

## Move Up To STC . . . And COLORADO!

Storage Technology Corporation is the world's largest manufacturer of high performance tape and disk storage equipment and a major producer of high speed line printers. A Fortune 500 company, we're located at the base of the magnificent Rocky Mountains and just minutes away from Denver. We offer you exciting career opportunities and the kinds of challenges that stimulate the most innovative of minds. Our current openings for qualified professionals include:

- Manufacturing Engineering Managers
- Development Engineers
- Mechanical Engineers
- Test Engineers
- Power Systems Engineers
- Software Test Engineers
- Test Design Engineers
- VLSI Design Engineers
- Senior Systems Programmers
- Quality Engineers
- Senior Product Specialist
- Marketing Product Line Planner

If you like to see your ideas impact the industry, we'd like to hear from you. We provide an excellent compensation package that includes health, dental and life insurance benefits, stock purchase plan, competitive relocation assistance and more. For consideration, please send your detailed resume in absolute confidence to STORAGE TECHNOLOGY CORPORATION, Dept. MID, 2270 South 88th St., MD #29, Louisville, CO 80027. We are an equal opportunity employer.



# We'll Give You Something to **THINK** About

GTE Systems' Strategic Systems Division boasts the largest group of engineering professionals dedicated to C<sup>3</sup> in this part of the country. Professionals dedicated to such projects as: a radio communications system that incorporates over 600 VLF, MF, VHF, UHF and SHF radios; the world's largest fiber optics cable network, over 15,000 kilometers; a hierarchy of over 5000 computers; and one of the largest software communications networks ever developed.

In the past year alone, over 600 engineers made Strategic Systems Division their first choice.

They came from major high-technology centers all over the United States...from England and Canada. Engineering professionals at all levels of experience. Over 600 of them chose to make their move to GTE Systems' Strategic Systems Division (SSD). All with the realization that our tremendous success and the incredible sophistication of our technology make SSD the best place to be for C<sup>3</sup> (command, control and communications).

Our proven C<sup>3</sup> expertise has been dramatically illustrated in such state-of-the-art, long-term programs as the MX and Minuteman. In addition, our Power Systems Organization is recognized as a leader in the design, development and manufacture of high energy Lithium Battery power sources. Right now, we're continuing our successful mode as we actively pursue new and more advanced programs in the C<sup>3</sup> and power systems industries.

Perhaps another consideration that has given SSD an edge is our advantageous location. Here, in Eastern Massachusetts, GTE professionals enjoy the cultural and educational riches of this prized New England environment, the intellectual stimulation of our famed Route 128 electronics belt and the recreational advantages of our distinctive seasons so enhanced by easy access to winters in New Hampshire and Vermont and spectacular summers on the sandy beaches of Cape Cod. All this in an area that claims the extraordinary benefits of easily affordable homes, both in suburban and rural areas.

## Hardware Engineering

- Distributed Processing
- Modems
- Data and Voice Multiplexing
- Switching
- Microprocessor Hardware and Firmware Design
- Power Supply Design (High-Efficiency, Switching)
- Analog Design
- Frequency Synthesizers
- Digital Radio
- Digital Signal Processing
- Fiber Optics Interfaces
- Electronic Surge Arrestors
- Display and Control
- Telephone Switching
- I/O Controller Design
- Antenna Design: VLF-SHF
- Equipment Integration
- COMSEC Interface
- Servo Design
- C<sup>3</sup> Simulator Design
- EMC/Tempest Design

## Systems Engineering

- Communications Systems
- COMSEC Systems
- Systems Software Operability
- Maintenance Systems

## Software Engineering

- Real-Time Command and Control
- Telecommunications/Computer Networking
- Real-Time Simulation
- Diagnostics/ATE
- Operating Systems and Compilers
- Microprocessor Development
- Data Base Management
- Telephony
- Systems Programming
- Support Software

## Test Engineering

- Test Planning and Analysis
- Unit Test
- Subsystems Test
- Systems Test
- Site Test

## Power Systems

- Research and Development Engineering
- Chemical Engineering
- Process/Production Engineering
- Program Management
- Quality Control
- Mechanical Packaging Engineering
- Industrial Engineering

## We will contact you.

Simply check off the area(s) of interest, complete the following information and forward this page to Bill U. Ahalt, GTE's Sylvania Systems Group, Strategic Systems Division, 189 "B" Street, Needham, MA 02194.

Name \_\_\_\_\_  
 Phone \_\_\_\_\_  
 Address \_\_\_\_\_  
 State \_\_\_\_\_ Zip \_\_\_\_\_  
 Degree \_\_\_\_\_ Yrs. of Exp. \_\_\_\_\_

an equal opportunity employer M/F



Systems

# Reach for Excellence

Share in the excitement of our outstanding achievements. Be part of Honeywell's Small Systems and Terminals Division (SS&TD) at our Billerica facility. And gain satisfying rewards in an environment governed by no less than excellence.

Since 1969, Billerica has been one of Honeywell's foremost engineering organizations with a history of significant technical accomplishments.

As headquarters for SS&TD, Billerica continues in this vein. Most recently, with the acclaimed introduction of Honeywell's DPS-6 family of small computers...and the WP-6 word processing system, just the first of many advanced products to be announced for Honeywell's new office automation line.

Throughout the coming year, and in years to come, our Billerica operation will continue to advance Honeywell's state of the art. Our engineers will continuously strive to find innovative answers in the field of LSI and VLSI, Terminals, Design Automation, Office Automation, Networking and Communications, Distributed Data Processing and more.

Join us in our quest for excellence. In computer technologies. In communications technologies. And in each and every thing we do.

---

**Honeywell**  
Small Systems and Terminals Division  
300 Concord Road  
Billerica, MA 01821

---

An Equal Opportunity Employer M/F/H

*Positions are available  
at most levels in:*

Terminals Software  
Development  
Product Planning &  
Specification  
Product Test  
Programming &  
Systems Analysis  
New Terminal Products  
Development

#### CAD/CAM Design

Systems Design  
Custom Software Development  
Terminals Hardware Development  
Firmware & Maintainability Systems  
Engineering  
Analog Design  
Custom Terminals Hardware Engineering  
Mechanical Design & Engineering Support  
Design Automation  
Semiconductor Design  
VLSI & LSI Design  
Disk Controller Design  
Components & Materials Engineering  
Maintainability & Systems Design  
Hardware & Systems Test  
Peripheral Subsystem Design  
Hardware & Software Technical Writers &  
Editors

*To investigate the above positions, please  
forward your resume to Don B. Batsford.*

**25 years**  
**in Computers**  
**25 years in**  
**Massachusetts**

## Honeywell

---

---

---

People,  
Our Competitive  
Edge

# The Landlord™



## Apartment Management Software

Keeping track of apartment availabilities, rent payments, security deposits, leases, and other administrative functions consumes a great deal of time and attention for apartment owners and managers. You and your staff probably spend countless hours dealing with the paperwork necessary to manage your property.

With the Landlord™ apartment management software and an Apple II\* computer, file cabinets full of paperwork and the frustrations of cumbersome bookkeeping procedures can be eliminated. The clerical work for your apartments can be accomplished with greater accuracy in a fraction of the time you presently spend. The Landlord™ will keep up-to-date files on apartments and residents as well as detailed records of property income and expenses.

You'll be able to enter, change, or delete information by following the simple English instructions that appear on the screen of the Apple II\*. The Landlord™ will automatically organize and store your data and make it available for your review at any time. With the Landlord™, your resident manager can instantly determine where apartment vacancies exist and when additional units will become available for rental. The Landlord™ also keeps track of resident payments, letting

you see at a glance who is behind on rent or other payments. Property and tax analysis reports are printed automatically each month and allow you to monitor the profitability of your apartments.

The Landlord™ apartment management software and the necessary Apple II\* equipment are available for less than the cost of a new sub-compact car. If you own or manage an apartment property with no more than 400 units, visit your nearest computer dealer for a demonstration.

BY881

Please return this coupon for more information about the Landlord™ and the name of the dealer nearest you.

Name \_\_\_\_\_

Company \_\_\_\_\_

Address \_\_\_\_\_

City/State \_\_\_\_\_ Zip \_\_\_\_\_



MIN MICROCOMPUTER SOFTWARE, INC.  
5835-A Peachtree Corners East  
Norcross, Ga. 30092

\*Apple II is a registered trademark of Apple Computer, Inc.  
The Landlord is a trademark of MIN Microcomputer Software, Inc.

However, nothing is known outside the window about how it responds to these messages. (It is known that a window will move when asked to, but it is not known how it accomplishes the move.)

The set of messages an object can respond to is called its *protocol*. The external view of an object is nothing more than its protocol; the internal view of an object is something like a data/procedure system. An object has a set of variables that refers to other objects. These are called its *private variables*. It also has a set of methods that describes what to do when a message is received. The values of the private variables play the role of data and the methods play the role of procedures. This distinction between data and procedures is strictly localized to the inside of the object.

Methods, like other procedures, must know about the form of the data they directly manipulate. Part of the data a method can manipulate are the values of its object's private variables. For example, we might imagine three ways that a window represents its location and size (internally). The private variables might contain:

- four numbers representing the *x* and *y* location of the center, the width, and the height
- two points representing opposite corners of the window
- a single rectangle whose location and size are the same as the window's

The method that moves a window (the response to

messages with the selector *move*) assumes that a particular representation is used. If the representation were changed, the method would also have to be changed. Only the methods in the object whose representation changed need be changed. All other methods must manipulate the window by sending it messages.

A message must be sent to an object to find out anything about it (ie: our concept of manipulation includes inquiring about information, as well as changing information). This is needed because we don't want the form of an object's inside known outside of it. The response to a message may return a value. For example, a window's response to the message *width* returns an object that represents its width on the display (a number). The method for determining what to return depends on the form of the window's private variables. If they are represented as the first alternative listed above (four numbers), the response would simply return the value of the appropriate private variable. If the second alternative is used (two points), the method would have to determine the width from the *x* coordinates of the two corners. If the third alternative is used (one rectangle), the *width* message would simply be passed on to the rectangle and the rectangle's response would become the window's response.

## Classes and Instances

Most object-oriented systems make a distinction between the description of an object and the object itself. Many similar objects can be described by the same general description. The description of an object is called a *class* since the class can describe a whole set of related objects. Each object described by a class is called an *instance* of that class.

**Class:** A description of one or more similar objects.

**Instance:** An object described by a particular class.

Every object is an instance of a class. The class describes all the similarities of its instances. Each instance contains the information that distinguishes it from the other instances. This information is a subset of its private variables called *instance variables*. All instances of a class have the same *number* of instance variables. The *values* of the instance variables are different from instance to instance. An object's software (ie: the methods that describe its response to messages) is found in its class. All instances of a class use the same method to respond to a particular type of message (ie: a message with a particular selector). The difference in response by two different instances is a result of their different instance variables. The methods in a class use a set of names to refer to the set of instance variables. When a message is sent, those names in the invoked method refer to the instance variables of the message receiver. Some of an object's private



Some things are just naturally right.

**tiny**  
**c**

tiny-c is a structured programming language designed to allow you to focus attention on the problems you want to solve — rather than the language you're using to solve it. With tiny-c you can expand your horizons far beyond the limits of BASIC. tiny-c ONE (interpreter), \$100 - includes Owner's Manual plus wide choice of media, source code. It's still the best structured programming trainer. tiny-c TWO (compiler), \$250 - includes Owner's Manual, CP/M® disk, source code. This version puts UNIX® pleasure into your CP/M.

tiny.c associates, P.O. Box 269, Holmdel, NJ 07733  
(201) 671-2296

**tiny**  
**c**

You'll quickly discover tiny-c is naturally right for your language needs.

New Jersey residents include 5% sales tax. Visa or Master Charge accepted. Include charge plate number with order.

- CP/M is a trademark of Digital Research, Inc.
- UNIX is a trademark of Bell Labs, Inc.
- tiny-c is a trademark of tiny.c associates



# SuperSoft's Gallery of CP/M Masterworks

|                              |                  |
|------------------------------|------------------|
| <b>Programming Languages</b> | Disk/Manual Only |
| "C"                          | \$200/20         |
| FORTH                        | \$200/25         |
| FORTRAN IV                   | \$250/25         |
| RATFOR                       | \$100/NA         |
| BASIC                        | \$200/25         |
| 'TINY' PASCAL                | \$ 85/10         |
| <b>System Maintenance</b>    |                  |
| Diagnostics II               | \$100/15         |
| Diagnostics I                | \$ 75/15         |
| DISK DOCTOR                  | \$100/15         |
| <b>Utilities</b>             |                  |
| Utility Pack #1              | \$ 60/NA         |
| Utility Pack #2              | \$ 60/NA         |
| <b>Text Processing</b>       |                  |
| TFS                          | \$ 85/15         |
| Super-M-List                 | \$ 75/10         |
| <b>Software Security</b>     |                  |
| Encode/Decode II             | \$100/20         |
| Encode/Decode I              | \$ 50/20         |
| <b>Intercommunications</b>   |                  |
| TERM                         | \$150/15         |
| TERM II                      | \$200/15         |
| <b>Entertainment</b>         |                  |
| ANALIZA                      | \$ 35/NA         |
| NEMESIS                      | \$ 40/NA         |
| Dungeon Master               | \$ 35/NA         |
| (For use with Nemesis)       |                  |
| <b>Miscellaneous</b>         |                  |
| Z8000 Cross-Assembler        | \$500/25         |
| "C" Cross-Compiler           | \$500/25         |
| (Z8000 Target)               |                  |

Many programs include SuperSoft's online "HELP" system!

## SUPERDISKS FOR SALE!

### SuperSoft Has Great Prices on Blank Discettes

SuperSoft sought out and found a discette that met our high standards. In the software distribution business we needed a discette that was reliable, sturdy, durable, and inexpensive. We wanted no data errors on any discette that we shipped.

- **Guaranteed**
- **Data density in excess of 3200 b.p.i.**
- **Approved by Shugart, Persci, Qume, Remex, others**
- **Operating temperature: 50-120 degrees Fahrenheit**

| Discette type | price per box |
|---------------|---------------|
|---------------|---------------|

#### Single Sided Single Density:

|                                  |         |
|----------------------------------|---------|
| Soft sectored IBM compatible 8": | \$30.00 |
| 10 hard sectors 5 1/4":          | \$30.00 |
| 16 hard sectors 5 1/4":          | \$30.00 |

#### Single Sided Double Density:

|                                  |         |
|----------------------------------|---------|
| Soft sectored IBM compatible 8": | \$35.00 |
| 10 hard sector 5 1/4":           | \$35.00 |
| 16 hard sector 5 1/4":           | \$35.00 |

- \*Add \$15.00 for Double Sided Discettes
- Illinois residents add 5%
- Add \$1.00 shipping per box

All SUPERDISKS are sold only in lots of 10. Each comes with jackets and box. All orders must be prepaid or C.O.D. Generally we ship from stock, with arrival times running about 8-10 days.

## TERM

### A Complete Networking/Intercommunications Package

TERM allows the CP/M user to communicate with other CP/M based systems or with remote timesharing computers. TERM supports file transfers between both timesharing systems and between CP/M systems.

TERM equals or exceeds comparable programs in power and flexibility, but costs less, delivers more and *source code* is provided on discette!

With TERM you can send and receive ASCII, HEX and COM files. You also have a conversational mode, and a timesharing terminal emulator. Below is a partial list of features:

- Engage/disengage printer
- auto error checking with re-try
- conversational mode
- send files
- terminal emulator
- receive files

requires 32K CP/M and a minimal knowledge of assembly language programming.

TERM is supplied with source and user manual: \$150.00  
Manual only: \$15.00

TERM

For complete information on these and all other SuperSoft products, please write for our free catalogue.

All software can be supplied on the following media:

CP/M formats . . . 8" sft sectored, 5" Northstar, 5" Micropolis Mod II, Vector MZ, Superbrain DD/QD, Apple II+



All Orders and General Information:  
SUPERSOFT ASSOCIATES  
P.O. BOX 1628  
CHAMPAIGN, IL 61820  
(217) 359-2112

Technical Hot Line: (217) 359-2691  
(answered only when technician is available)

\*CP/M REGISTERED TRADEMARK DIGITAL RESEARCH  
SSS FORTRAN is the copyright of Small Systems Services, Urbana, Illinois

24 hour express service available!

*SuperSoft*  
First in Software Technology

Prices subject to change without notice

# Epson Printers

**PRINTERS,  
MONITORS,  
DISKS**

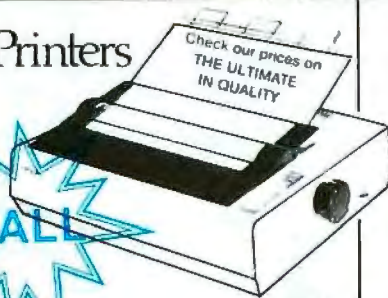

|                                    |      |
|------------------------------------|------|
| Amdek Color Monitor .....          | 369  |
| Amdek Green Screen .....           | 159  |
| Amdek/Leedex B/W 12" Monitor ..... | 129  |
| Centronics 737 .....               | 737  |
| Daisey Wheel Printer .....         | 1750 |
| Epson MX70 .....                   | CALL |
| Epson MX80 FT .....                | CALL |
| Epson MX80 .....                   | CALL |
| NEC Spinwriter #5510 .....         | 2590 |
| Paper Tiger 445G .....             | 725  |
| Paper Tiger 460G .....             | 1175 |
| Paper Tiger 560 .....              | 1495 |
| Silentype w/interface .....        | 529  |
| Sanyo 9" B/W Monitor .....         | 169  |
| Sanyo 12" B/W Monitor .....        | 255  |
| Sanyo Green Screen .....           | 309  |
| NEC Green Screen .....             | 239  |
| Televideo 912C .....               | 669  |
| Televideo 920C .....               | 749  |
| Dysan Disks (pkg. 10) .....        | 50   |
| Memorex Disks (pkg. 10) .....      | 40   |
| Opus Disks (pkg. 10) .....         | 30   |
| Verbatim "Gold" (pkg. 10) .....    | 35   |



**ATARI 800**  
PERSONAL COMPUTER SYSTEM

**\$789**

IF  
**ATARI**  
MAKES  
IT, WE  
SELL IT

|                                  |     |
|----------------------------------|-----|
| Assembler/Editor .....           | 45  |
| Atari 800 .....                  | 789 |
| Atari 400 8K .....               | 419 |
| Atari 820 Printer .....          | 429 |
| Atari 810 Disk Drive .....       | 499 |
| Atari 410 Program Recorder ..... | 69  |
| Atari 825 Printer .....          | 695 |
| Atari 850 Interface .....        | 169 |
| Atari Joystick .....             | 18  |
| Atari Paddles .....              | 18  |
| Le Stick .....                   | 35  |
| 16k RAM Microtek .....           | 99  |
| Microtek 32K RAM .....           | 189 |
| Visicalc .....                   | 180 |
| Basketball .....                 | 30  |
| Video Easel .....                | 30  |
| Super Breakout .....             | 30  |
| Music Composer .....             | 45  |
| Computer Chess .....             | 30  |
| Star Raiders .....               | 45  |
| 3-D Tic-Tac-Toe .....            | 30  |
| Invitation to Programing .....   | 17  |

**LEEDEX VIDEO 100**  
**12" Black & White \$139**

**\* MONTHLY \*  
SPECIALS**

**CENTRONICS 737**  
cable extra **\$737**

25 CPS  
**\$1750**  
DAISY-WHEEL PRINTER  
**Starwriter**

- Print speed — 25 CPS
- Paper width — 381mm (15") max.
- Backed by C. Itoh's 1 yr. limited warranty
- Interface — standard parallel or RS232-C compatible
- Ready-to-use, requiring no changes in hardware or software
- Compatible with sheet feeders & uses industry standard ribbon cartridges

AVAILABLE FOR IMMEDIATE SHIPMENT



- Excellent letter-quality printing on 3 sharp copies



TO ORDER: Phone orders invited using Visa, Mastercard or bank wire transfers. Visa and MC service charge of 2%. Mail orders may send charge card number (include expiration date), cashiers check, money order or personal check (allow ten business days for personal or company checks to clear) Include 3% (\$5 minimum) for UPS shipping, handling, and insurance. Calif. residents add 6% sales tax. Please include phone number.

No COD or PO accepted. APO and FPO include 5% for postage. FOREIGN ORDERS include 1% handling — shipped air FREIGHT COLLECT only Credit cards not accepted on foreign orders. All equipment is in factory cartons with manufacturers warranty. Opened products not returnable Restocking fee for returned merchandise. Equipment subject to price change and availability Retail store prices differ from mail order prices. WE SHIP THE SAME DAY ON MOST ORDERS!



**(714) 579-0330 • MAIL TO: 1251 BROADWAY, EL CAJON, CA. 92021**

AUTHORIZED  
APPLE  
SALES &  
SERVICE

**COMPUTER**



**SPECIALTIES**

DIV OF  
COMPUTER  
METRICS  
INC

**EXCITING DISCOUNTS**

**apple II**  
**16K computer**

**DISK with CONTROLLER**  
**NEW DOS 3.3 \$529**  
 without . . . \$445  
**Nearly Everything**  
**for Apple**

**\$1045**



**APPLE II 48K**  
**\$1095**

**WE WILL MEET OR BEAT**  
**ANY ADVERTISED PRICES**  
**ON MOST ITEMS IF MERCHANDISE**  
**IN STOCK**

**APPLE SOFTWARE**

|   |     |  |      |
|---|-----|--|------|
| Adventure by Microsoft . . . . .        | 27  | Hi Res Football . . . . .              | 33   |
| ABM by Muse . . . . .                   | 22  | Head-on . . . . .                      | 25   |
| Alien Rain by Broderbund . . . . .      | 22  | Integer Basic Cassette Demos . . . . . | 29   |
| Applebug Debugger . . . . .             | 29  | Pascal Language System . . . . .       | 459  |
| Apple PIE . . . . .                     | 129 | Peachtree Bus Pkgs . . . . .           | CALL |
| Apple Pilot . . . . .                   | 129 | Personal Filing System . . . . .       | 84   |
| Apple Plot System . . . . .             | 59  | Phantoms Five . . . . .                | 39   |
| Applepost Mailing List System . . . . . | 44  | Raster Blaster by Budge Co . . . . .   | 24   |
| Applesoft Cassette Demos . . . . .      | 29  | Sargon II Chess Game disk . . . . .    | 32   |
| Apple Game Paddles . . . . .            | 26  | Single Disk Copy Routines . . . . .    | 35   |
| Applesoft Utility Programs . . . . .    | 29  | Space Game Album by B Budge . . . . .  | 39   |
| Appewriter Word Processor . . . . .     | 65  | Space Eggs . . . . .                   | 25   |
| Ascii Express . . . . .                 | 65  | Star Cruiser . . . . .                 | 24   |
| Asteroid Field by Cabaler . . . . .     | 19  | Stellar Trek . . . . .                 | 23   |
| Autostart ROM Pkg . . . . .             | 59  | Sub-Logic FS-1 Flt Sim disk . . . . .  | 34   |
| Controller Bus. Pkg. . . . .            | 514 | Supertext II by Muse . . . . .         | 129  |
| Cosmos Mission/Space Invaders . . . . . | 24  | 3-D Graphics Tool by B Budge . . . . . | 39   |
| CCA Data Mgmt . . . . .                 | 84  | Tranquility Base . . . . .             | 24   |
| 3-D Animation Pack . . . . .            | 55  | Trilogy by Bill Budge . . . . .        | 24   |
| Data Factory by Microlab . . . . .      | 129 | Visicaic II . . . . .                  | 169  |
| Desktop Plan II . . . . .               | 169 | Visilist . . . . .                     | CALL |
| DB Master by Stoneware . . . . .        | 209 | Wizard and the Princess . . . . .      | 32   |
| DOS Tool Kit . . . . .                  | 65  | Zork . . . . .                         | 34   |
| DOS 3.3 Upgrade . . . . .               | 49  |  |      |
| Dow Jones Portfolio Evaluator . . . . . | 45  |  |      |
| Forth II by Softape . . . . .           | 45  |  |      |
| Fortran for Language Sys . . . . .      | 159 |  |      |
| Galaxian by Broderbund . . . . .        | 23  |  |      |

**LARGE SELECTION OF**  
**SOFTWARE IN STOCK —**  
**CALL FOR FREE BROCHURE —**

**APPLE COMPUTER**  
**INTERFACE CARDS**

|   |     |
|---|-----|
| ALS Smartterm . . . . .                                     | 324 |
| Apple Clock/Calendar Card<br>by Mtn. Comp. . . . .          | 225 |
| Applesoft II Firmware Cd. . . . .                           | 149 |
| CCS Asynchronous 7710A . . . . .                            | 145 |
| CCS Parallel Print Cd. 7720A . . . . .                      | 155 |
| Centronics Interface Cd. . . . .                            | 179 |
| Comm. Cd. & DB25 Cable . . . . .                            | 179 |
| CPS Multifunction by Mtn. Comp. . . . .                     | 259 |
| Expansion Chassis by Mtn. Comp. . . . .                     | 649 |
| HiSpeed Serial Int. Cd. . . . .                             | 155 |
| Integer Basic Firmware Cd. . . . .                          | 149 |
| ROMPLUS (keyboard filter extra) . . . . .                   | 135 |
| Serial Interface Card . . . . .                             | 139 |
| SSM AIO Serial/Parallel I/O<br>Assembled & Tested . . . . . | 189 |

**ACCESSORIES**

|  |     |
|--|-----|
| A/D D/A Board by Mtn. Comp. . . . .                | 319 |
| Andromeda 16k Ramcard . . . . .                    | 179 |
| Arith. Processor 7811 A or B . . . . .             | 339 |
| COPYROM by Mtn. Comp . . . . .                     | 51  |
| Dan Paymar L.C. Kit 1 or 2 . . . . .               | 55  |
| Extender Board . . . . .                           | 27  |
| GPIB by CCS model 7490A . . . . .                  | 259 |
| Graphics Input Tablet . . . . .                    | 649 |
| Hayes Micromodem* . . . . .                        | 319 |
| Introl X-10 Remote Control Sys. . . . .            | 239 |
| K & D Joystick for the Apple . . . . .             | 47  |
| Keyboard Filter ROM chip . . . . .                 | 49  |
| M & R Sup-R-Term 80 column board . . . . .         | 319 |
| Music System by Mtn. Comp. . . . .                 | 479 |
| Programmable Timer CCS 7440A . . . . .             | 159 |
| Prototyping Hobby Card . . . . .                   | 22  |
| ROMWRITER by Mtn. Comp. . . . .                    | 149 |
| SuperTalker Speech Synthesizer . . . . .           | 239 |
| Symtec Light Pen . . . . .                         | 214 |
| Versa-Writer Digitizer<br>Drawing System . . . . . | 209 |
| Videx Keyboard Enhancer . . . . .                  | 115 |
| Videx Videoterm . . . . .                          | 319 |
| Z-80 Soft Card Microsoft . . . . .                 | 295 |

**MEMBER CHAMBER OF COMMERCE**



**CALL 1-800-854-2833**  
**PHONE ORDERS**  
**MON. - SAT. 8 to 6 P.S.T.**

Circle 76 on Inquiry card.

**AUTHORIZED**  
**APPLE**  
**SALES &**  
**SERVICE**

**COMPUTER**



**SPECIALTIES**

**DIV OF**  
**COMPUTER**  
**METRICS**  
**INC**

variables are shared by all other instances of its class. These variables are called *class variables* and are part of the class.

The programmer developing a new system creates the classes that describe the objects that make up the system. The programmer of the window-management system would create a class that contained methods corresponding to the message selectors *move*, *display*, *delete*, *width*, and *height*. This class would also include the names of the instance variables referred to in those methods. These names might be *frame*, *text*, and *title*, where:

*frame* is a rectangle defining the area on the screen,  
*text* is the string of characters displayed in the window, and  
*title* is the string of characters representing the window's name

The classes representing rectangles and strings of characters are included in most systems, so they don't need to be defined.

In a system that is uniformly object-oriented, a class is an object itself. A class serves several purposes. In a running system, it provides the description of how objects behave in response to messages. The processor running an object-oriented system looks at the receiver's class when a message is sent to determine the appropriate

method to execute. For this use of classes, it is not necessary that they be represented as objects since the processor does not interact with them through messages (preventing a nasty recursion). In a system under development, a class provides an interface for the programmer to interact with the definition of objects. For this use of classes, it is extremely useful for them to be objects, so they can be manipulated in the same way as all other descriptions. Classes also are the source of new objects in a running system. Here again, it is useful for the class to be an object, so object creation can be accomplished with a simple message. For example, the message *new* might be sent to a class to create a new instance.

### Inheritance

Another mechanism used for implicit sharing in object-oriented systems is called *inheritance*. One object inherits the attributes of another object, changing any attributes that distinguish the two. Some object-oriented systems provide for inheritance between all objects, but most provide it only between classes. A class may be modified to create another class. In such a relationship, the first class is called the *superclass* and the second is called the *subclass*. A subclass inherits everything about its superclass. The following modifications can be made to a subclass:

- adding instance variables
- providing new methods for some of the messages understood by the superclass
- providing methods for new messages (messages not understood by the superclass)
- adding class variables

As an example, the window-management system might contain windows that have a minimum size. These would be instances of a subclass of the ordinary class of windows that added an instance variable to represent the minimum size and provided a new method for the message that changes a window's size.

### Conclusion

The realization that information can describe the manipulation of information is largely responsible for the great utility of computers today. However, that discovery is also partially responsible for the failure of computers to reach the utility of some predictions made in earlier times. On the one hand, it can be seen as a unification between the manipulator and the manipulated. However, in practice, it has been seen as a distinction between software and the information it manipulates. For small systems, this distinction is harmless. But for large systems, the distinction becomes a major source of complexity. The object-oriented point of view is a way to reduce the complexity of large systems without placing additional overhead on the construction of small systems. ■

**REFORMATTER™**

IBM DEC

CP/M

REFORMATTER

MicroTech Exports 1480

## GETS FILES ACROSS!

With **REFORMATTER** disk utilities you can read and write IBM 3740 and DEC RT-11 single density formatted diskettes on your CP/M™ system.

**REFORMATTER** enables you to access large system databases, improve data exchange with other organizations, increase program development capabilities, and use your micro in distributed processing.

**REFORMATTER** programs feature bi-directional data transfer and full directory manipulation. ASCII/EBCDIC conversion provided with CP/M ↔ IBM. *MP/M is now fully supported.*

Program Data Sheets, Application Guides, and Machine Compatibility Guides available.

Each program \$195.00 from stock. Specify CP/M ↔ IBM or CP/M ↔ DEC. Order from MicroTech Exports, Inc., 467 Hamilton Ave., Suite 2, Palo Alto, CA 94301 □ Tel: 415/324-9114 □ TWX: 910-370-7457 MUH-AITOS □ Dealer and OEM discounts available.

IBM

CP/M is a registered trademark of Digital Research

# NO.1 AGAIN

## This time in Switchers

Long the recognized leader in quality open-frame linears, Power-One is now setting the pace in switching power supplies.

Our fast growing line of efficient high-performance switchers offer a combination of features not found in others at these low prices. Features such as fully regulated outputs, 115/230 VAC input capabilities, superior hold-up time, and totally enclosed packaging for enhanced safety. Additionally, these models incorporate many other innovative ideas that set our switchers apart... while reflecting the same simplicity of design that has kept our open-frame linears the most cost-effective in the industry.

Best of all, Power-One switchers are 100% American built by Power-One personnel, at

Power-One facilities, and under tough Power-One quality control standards. Adding up to total dependability at typical Power-One low prices.

So check us out. See why we're leading the way again. This time in switchers.

Send for our new '81 Catalog. Better yet, contact your local Power-One representative for immediate action.

| VOLTS | AMPS  | MODEL     |
|-------|-------|-----------|
| 5V    | 40A   | SK5-40    |
| 12V   | 16.8A | SK12-16.8 |
| 15V   | 13.4A | SK15-13.4 |
| 24V   | 8.4A  | SK24-8.4  |
| 28V   | 7.2A  | SK28-7.2  |

SIZE: 2"H X 4.88"W X 13"L

**\$250**  
200 WATTS



**\$115**  
50 WATTS

| VOLTS | AMPS | MODEL    |
|-------|------|----------|
| 5V    | 10A  | SD5-10   |
| 12V   | 4.2A | SD12-4.2 |
| 15V   | 3.4A | SD15-3.4 |
| 24V   | 2.1A | SD24-2.1 |
| 28V   | 1.8A | SD28-1.8 |

SIZE: 2"H X 4.88"W X 6.25"L



| OUTPUT | VOLTS  | AMPS |
|--------|--|------|
| #1     | 5V   | 20A  |
| #2     | 12V  | 5A   |
| #3     | -12V   | 3A   |
| #4     | 5V, 12V,<br>15V, or 24V.<br>USER<br>SELECTABLE | 3.5A |

SIZE: 2"H X 4.88"W X 14"L

MAX OUTPUT POWER: 150 WATTS  
CONTINUOUS, SUM OF ALL OUTPUTS

150 WATTS - 4 OUTPUTS  
THE UNIVERSAL SHQ-150W

**\$295**

**NEW**



**\$170**  
100 WATTS

| VOLTS | AMPS | MODEL    |
|-------|------|----------|
| 5V    | 20A  | SF5-20   |
| 12V   | 8.4A | SF12-8.4 |
| 15V   | 6.7A | SF15-6.7 |
| 24V   | 4.2A | SF24-4.2 |
| 28V   | 3.6A | SF28-3.6 |

SIZE: 2"H X 4.88"W X 10"L

FREE! NEW 1981 CATALOG  
AND POWER-ONE  
TOUR GUIDE

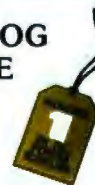

**POWER-ONE** D.C. POWER SUPPLIES

POWER-ONE INC. • POWER ONE DRIVE • CAMARILLO, CA 93010  
PHONE: (805) 484-2806 • (805) 987-3891 • TWX: 910-336-1297

Circle 312 on Inquiry card.

SEE EEM OR GOLDBOOK FOR OUR COMPLETE PRODUCT LISTING  
AND LOCATION OF YOUR NEAREST POWER-ONE REPRESENTATIVE.



# BUMPER CROP

**8-inch Winchester Multi-User Systems. Now In Volume- \$8,500.**

Altos is delivering the cream of the crop with their new 8-inch multi-user Winchester disk systems. They're freshly packed with the quality features you expect from Altos, and at a price you expect from Altos, too—just \$8,500.

Pick from two fully integrated systems, each packaged in our new compact, stylish cabinet suitable for either rack mount or table top applications. You get 10 MBytes of reliable on-line storage in our 8-inch Winchester drives. Then for system back-up storage, you can select from

either 8-inch, single or double-sided floppy drives (ACS8000-10 and -10D) or a 1/4-inch magnetic tape drive (ACS8000-10/MTU). And for powerful performance, all of these Z80A\*based systems come complete with 208K of RAM and 6 programmable serial ports, ready to support four users.

Here's the most bountiful selection of systems and capacities in the field from the company that knows how to deliver quality systems in the volumes that OEMs need to stay competitive.

And Altos supports these systems with a broad software selection including the three industry standard operating systems—CP/M, multi-user MP/M\*\* and OASIS†. These operating systems support seven high level programming languages: BASIC, FORTRAN, COBOL, PASCAL, APL, PL/1 and C. Also available are comprehensive communications packages: ASYNC—Altos-to-Altos, BISYNC—Altos-to-mainframe and full networking with CP/NET. All are designed to run on a high speed 800 Kilobaud networking channel—standard with every system.

The ACS8000-10 Winchester systems join our growing family of field-proven products. In just three years, more than 8,000 systems have been shipped to an OEM customer-base.

Get to market fast. Harvest your 8-inch Winchester system direct from the heart of Silicon Valley. Call or write today for specific product information and OEM pricing. Altos Computer Systems, 2360 Bering Drive, San Jose, CA 95131, (408) 946-6700, Telex 171562 ALTOS SNJ.

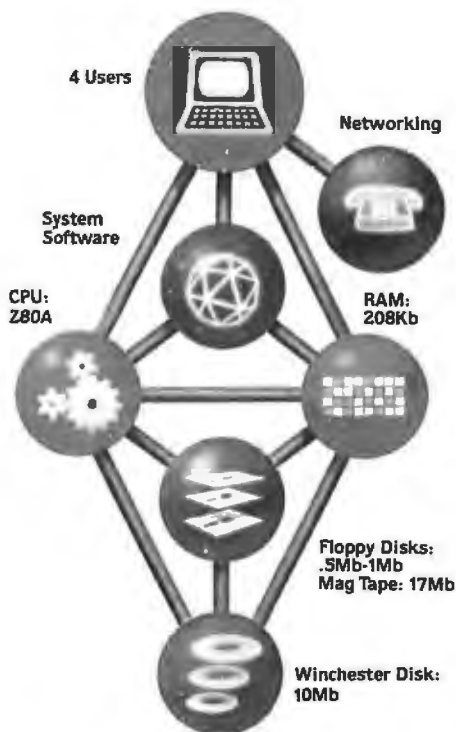

SYSTEMS PICTURED:  
 ACS8000-10 (10Mb HD + 1 floppy) \$ 8,500  
 ACS8000-10/MTU (10Mb HD + DEI Mag Tape) \$10,990



**Packed with Fresh Ideas**



\*Z80A is a registered trademark of Zilog, Inc.  
 \*\*CP/M and MP/M are registered trademarks of Digital Research, Inc.  
 †OASIS is a registered trademark of Phase One Systems, Inc.  
 ‡datapro is a registered trademark of Datapro Research Corp.  
 © 1981 Altos Computer Systems

# The Smalltalk Environment

---

Larry Tesler  
Apple Computer Inc  
10260 Bandley Dr  
Cupertino CA 95014

---

As I write this article, I am wearing a T-shirt (photo 1) given to me by a friend. Emblazoned across the chest is the loud plea:

DON'T  
MODE  
ME IN

Surrounding the caption is a ring of barbed wire that symbolizes the trapped feeling I often experience when my computer is "in a mode."

In small print around the shirt are the names of some modes I have known and deplored since the early 1960s when I came out of the darkness of punched cards into the dawn of interactive terminals. My rogues' gallery of inhuman factors includes command modes like INSERT, REPLACE, DELETE, and SEARCH, as well as that inescapable prompt, "FILE NAME?" The color of the silk screen is, appropriately enough, very blue.

My friend gave me the shirt to make fun of a near-fanatical campaign I have waged for several years, a campaign to eliminate modes from the face of the earth—or at least from the face of my computer's display screen. It started in 1973 when I began work at the Xerox Palo Alto Research Center (PARC) on the design of interactive systems to be used by office workers for document preparation. My observations of secretaries learning to use the text editors of that era soon convinced me that my beloved computers were, in fact, unfriendly monsters, and that their sharpest fangs were the ever-present modes. The most common question asked by new users,

at least as often as "How do I do this?," was "How do I get out of this mode?" Other researchers have also condemned the prevalence of modes in interactive systems for novice users (reference 1).

Novices are not the only victims of modes. Experts often type commands used in one mode when they are in another, leading to undesired and distressing consequences. In many systems, typing the letter "D" can have meanings as diverse as "replace the selected character by D," "insert a D before the selected character," or "delete the selected character." How many times have you heard or said, "Oops, I was in the wrong mode"?

## Preemption

Even when you remember what mode you are in, you can still fall into a trap. If you are running a data-plotting program, the only commands you can use are the ones provided in that program. You can't use any of the useful capabilities of your computer that the author of the program didn't consider, such as obtaining a list of the files on the disk. On the other hand, if you're using a program that lets you list files, you probably can't use the text editor to change their names. Also, if you are using a text editor, you probably can't plot a graph from the numbers that appear in the document.

If you stop any program and start another, data displayed by the first program is probably erased from the screen and irretrievably lost from view. In general, "running a program" in most systems puts you into a mode where the facilities of other programs are unavailable to you. Dan Swinehart calls this the *dilemma of preemption* (reference 2).

Many systems feature hierarchies of modes. A portion of a typical mode hierarchy is shown in figure 1. If you are in the editor and want to copy text from a file, you issue the *copy-from* command and it gives the prompt "from what file?" You then type a file name. What if you can't remember the spelling? No problem. Leave *from-what-file* mode, leave *copy-from* mode, *save* the edited text, *exit* from the editor to the executive, call up *file management* from the executive, issue the *list-files* command, look for the name you want (Hey, that went by too fast. Sorry, you can't scroll backwards in that mode.), *terminate* the list command, *exit* from file management to the executive, reenter the *editor*, issue the *copy-from* command, and when it prompts you with "from-what-file?," simply type the name (you haven't



Photo 1: The "DON'T MODE ME IN" T-shirt.





# DYNABYTE SYSTEMS+

*NORSEA offers the most professional, cost effective and high performance microcomputer systems and peripherals for USA, Canada and the World. Quantity discounts start at quantity 2 level.*

## COMPLETE SYSTEMS

(including software)

### Professional Word

#### Processing System

Dynabyte 5200 - Dual 5 1/4"  
Televideo 950  
Starwriter I  
WordStar  
List \$9,710

Net \$6,312

### Full Business

#### Accounting System

Dynabyte 5300 - Dual 8"  
Televideo 950  
DataSouth 180  
Business Manager  
List \$12,520

Net \$8,130

### 11 MB Hard Disk Full Business Accounting and Word Processing System

Dynabyte 5615 - 11 MB  
2-Televideo 950  
Starwriter I  
DataSouth 180  
Business Manager  
WordStar  
List \$24,075

Net \$15,650

### 45 MB Hard Disk High Performance Business Accounting and Word Processing System

Dynabyte 5700 - 45 MB  
4-Televideo 950  
Starwriter II  
Dataproducts 340CPS  
Business Manager  
WordStar  
List \$35,930

Net \$23,360

Many other configurations available, with or without software.

## REMAX FLOPPY DISK DRIVES

The highest quality in 1MB  
8" floppy drives  
RFD4000

\$699

Other REMEX products available.

## PERIPHERALS

Volker-Craig VC414H  
(Hazeltine 1510 compatible -  
amber screen)  
Televideo 950  
Starwriter I  
Starwriter II  
DataSouth DS-180  
Tally T-1705  
Dataproducts M-200

\$ 899

\$ 999

\$1,599

\$1,799

\$1,399

\$1,799

\$2,099

## HARD DISK SUBSYSTEMS

(Can be daisy chained for  
up to 104 MB of storage)  
Formatted with S-100 Controller,  
PSU and Cabinet  
M10-10MB-8"  
M20-20M-8"  
M26-26MB-14"

\$2,995

\$3,830

\$3,995

Subsystems also available in OEM  
stripped down versions.

## DYNABYTE MICROCOMPUTERS

This fast growing and truly professional  
range of microcomputers is now  
available at best prices through NORSEA,  
with a wide choice of quality peripherals  
and software.

## EXPORTS

NORSEA specializes in the export of  
Dynabyte microcomputers and a selected  
range of high quality peripherals.  
We are experienced in international  
trading and we pride ourselves on fast  
and courteous service at the  
lowest prices possible.

## FOREIGN SYSTEMS MANUFACTURERS

NORSEA offers you a unique purchasing  
service, procuring U.S., Canadian, and  
Japanese made computer subsystems and  
peripherals for your requirement at the  
most attractive prices and deliveries.  
Send us your shopping list including  
quantity and delivery requirements.

## TRADEMARKS

Business Manager by Dynabyte  
Starwriter by C. Itoh  
WordStar by MicroPro

To Order: Call (203) 775-0438  
(203) 775-4465  
Telex 969638



Prices subject to change without notice.

# 999 NORSEA

DATA CORPORATION  
U.S. Route 7, Brookfield  
Connecticut 06804 U.S.A.

# The COMPUTER FACTORY

TO ORDER CALL (212) 687-5000

## SUPERBRAIN™

**INTERTEC DATA SYSTEMS 64K ONLY \$2995**



More than an intelligent terminal, the SuperBrain outperforms many other systems costing three to five times as much. Endowed with a hefty amount of available software (BASIC, FORTRAN, COBOL), the SuperBrain is ready to take on your toughest assignment. You name it! General Ledger, Accounts Receivable, Payroll, Inventory or Word Processing. The SuperBrain handles all of them with ease.

**FEATURES INCLUDE:**

- 2 dual-density minifloppies with 360K bytes of disk storage
- A CP/M Disk Operating System with a high-powered text editor, assembler and debugger

|   |  |
|---|--|
| <b>Model QD</b><br>720K Bytes disk storage and 64K RAM<br><b>\$3495</b> | <b>SUPER BRAIN HARD DISKS</b>          |
| 10 Megabyte<br>List \$4995<br><b>\$4495</b>                             | 16 Fixed-16 Removable<br><b>\$9995</b> |



**NEW 96K 80 Column Commodore CBM Basic 4.0 Operating System**

- 80 column by 25 line display
- 12" CRT
- New screen editor
- Split screen processing
- Super fast string handling
- 15 additional basic commands
- Supports relative record processing

**Model 8032 32K memory \$1495**  
**NEW! Model 8096 \$1795**

**8050 DUAL DISK \$1795**  
1 million bytes on-line storage and DOS 2.0 operating system  
**NEW 2031 SINGLE DISK \$695**

## Commodore Computer

These low cost Commodore PET Business Computers have virtually unlimited business capabilities. Accounts Receivable, Inventory Records, Payroll, and other accounting functions.

- PET 16N & 32N COMPUTERS**
- Full size keyboard
  - 16 or 32K Bytes Memory
  - Level III Operating System
  - Full Screen Editor
  - Upper lower case & 64 graphic characters



- PET DUAL FLOPPY DISK**
- Stores 360,000 Bytes on-line
  - Microprocessor controlled
  - Uses single or dual sided floppies
- HI-SPEED PRINTER**
- 150 characters per second • Up to 4 copies 8" wide
  - Microprocessor Controlled • Prints All Graphics • Full Formatting Capability



**NEW CORVUS 5 MEG ONLY \$3750**

**APPLE II PLUS for price**

A complete self-contained computer system with APPLESOFT floating point BASIC in ROM, full ASCII keyboard in a light weight molded carrying case.

### Features Include:

- auto-start ROM
  - Hi-Res graphics and 15 color video output
  - Expandable to 48K
- |                         |       |                           |       |
|-------------------------|-------|---------------------------|-------|
| Supertalker .....       | \$279 | Micromodem .....          | \$379 |
| Disk .....              | 645   | Superterm (24 x 80) ..... | 395   |
| Add-on Disk .....       | 525   | Speechlab .....           | 229   |
| Pascal Card .....       | 495   | Communication Card .....  | 225   |
| Business Software ..... | 625   | Modem .....               | 200   |
| Monitor .....           | 159   | Graphics Printer .....    | 595   |
| Printer Card .....      | 180   | Graphics Tablet .....     | 795   |

**apple III IS FINALLY HERE 128K RAM!!**



FOR BEST DELIVERY AND SUPPORT SEE IT AT THE COMPUTER FACTORY

## PRINTERS

### EPSON

- MX-70
  - MX-80
  - MX-80FT
  - MX-100FT
- Call for Prices



**Qume NEW SPRINT 9 Only \$2295**  
• 45 cps

### CENTRONICS

**700-9 \$1195**

**704 \$1695**

- 180 cps Bi-Directional • Up to 15" Paper Width • 9 x 9 Matrix
- Upper/Lower Case
- Tractor Feed
- RS-232 Serial Interface
- 60 cps • Up to 15" paper width
- Tractor Feed • Parallel Interface for Apple & TRS-80 • 2 channel vertical forms • Top of Form!



### ANDERSON JACOBSON

- 841 I/O Terminal Ideal for word processing and small businesses.
- ASCII Code
  - 15 CPS Printout
  - High Quality Electric Printing
  - Reliable heavy duty mechanism
  - Completely Refurbished by A.J.
  - Delivered FREE to nearest service center
- Serial \$895**

### MONITORS

|                        |       |
|------------------------|-------|
| SANYO 12" GREEN .....  | \$325 |
| BMC 12" GREEN .....    | 295   |
| LEEDEX 13" COLOR ..... | 449   |
| ZENITH 13" COLOR ..... | 395   |
| LEEDEX 12" GREEN ..... | 179   |

## HAZELTINE ESPIRIT

**NEW!**

- 24 x 80
- Green Screen
- 7 x 11 Matrix
- Full Format Editing Controls



**INCREDIBLY ONLY \$695**

**DEALER INQUIRIES INVITED ON DIABLO, CENTRONICS, SUPERBRAIN**



**DIABLO 630 Special \$2495**

- On Site Warranty
- List \$2755
- VISA
- Master Charge

**Min. Credit Card Order \$75**  
N.Y. residents add 8% sales tax  
• Same day shipment on prepaid and credit card orders

## NEW STORES Grand Opening Specials

- LONG ISLAND, NY** 1301 Franklin Ave., Garden City, Opposite Saks (516) 248-6700
- FOREST HILLS, NY** 100-17 Queens Blvd. At 67th Road (212) 896-0700
- YONKERS, NY** 2361 Central Ave., Opposite Caldors (914) 783-1300

TO ORDER CALL (212) 687-5000 Mon-Fri. 10-6 Sat. 11-5

**The COMPUTER FACTORY** 485 Lexington Ave., New York, NY 10017 (46th St. Lobby)  
Foreign order desk — Telex 640055

INTRODUCING  
A NEW ERA IN COMPUTING



# ONYX COMES EAST

**THE COMPUTER FACTORY NOW STOCKS  
THE MOST POWERFUL AND COST-EFFECTIVE  
COMPUTER ON THE MARKET!**

**WINCHESTER DISK & TAPE BACK-UP—FLOPPIES ARE NOW OBSOLETE!**

- By using extremely advanced Winchester Disk Technology the ONYX system can now support up to **8 users simultaneously!**
- Disk capacities available in increments of 6.1, 10, 20, 40 megabytes—up to 4 disks per system (**160 megabyte total!**)
- Choice of 2 systems:  
**Z80A/OASIS® Z8002/UNIX®**
- Memory from 64K to **1 megabyte!**
- Languages available include:  
COBOL, BASIC, PASCAL, & FORTRAN
- A choice of very sophisticated software that formerly was only available to larger machine users! (ACCOUNTING, RELATIONAL DATABASES, WORD PROCESSING, INSURANCE, CONSTRUCTION, ETC.)
- Systems start at under \$ 9500

Come to the Computer Factory and our experts will demonstrate the **ONYX** system which best suits your business needs.

*DEALER INQUIRIES INVITED*

**The COMPUTER FACTORY®** TO ORDER CALL (212) 687-5000 Open Mon-Fri. 10-6 Sat. 11-5  
485 Lexington Ave., New York, NY 10017 (46th St. Lobby)  
Foreign order desk — Telex 640055

forgotten it, have you?).

You don't have to be a user-sympathizer to join the campaign against modes. The most coldhearted programmer is a victim as well. Say you have programmed a new video game for your personal computer and have encountered a bug. An obscure error message appears on the screen mixed in with spacecraft and alien forms. To see the latest version of the program on the screen, you have to wipe out the very evidence you need to solve the problem. Why? Because the system forces you to choose between edit mode and execute mode. You can't have both.

### Enter the Integrated Environment

Soon after I began battling the mode monster, I became associated with Alan Kay, who had just founded the Learning Research Group (LRG) at the Xerox PARC. Kay shared my disdain for modes and had devised a user-interface paradigm (reference 3) that eliminated one kind of mode, the kind causing the preemption dilemma. The paradigm he advocated was called "overlapping windows."

Most people who have used computer displays are familiar with windows. They are rectangular divisions of the screen, each displaying a different information set. In some windowing systems, you can have several tasks in progress, each represented in a different window, and can switch freely between tasks by switching between windows.

The trouble with most windowing systems is that the windows compete with each other for screen space—if you make one window bigger, another window gets smaller. Kay's idea was to allow the windows to overlap. The screen is portrayed as the surface of a desk, and the windows as overlapping sheets of paper (photo 2). Partly covered sheets peek out from behind sheets that obscure them. With the aid of a pointing device that moves a cursor around the screen, you can move the cursor over a partly covered sheet and press a button on the pointing device to uncover that sheet.

The advantages of the overlapping-window paradigm are:

- the displays associated with several user tasks can be viewed simultaneously
- switching between tasks is done with the press of a button
- no information is lost switching between tasks
- screen space is used economically

Of course, windows are, in a sense, modes in sheep's clothing. They are more friendly than modes because you can't slip into a window unknowingly when you are not looking at the screen, and because you can get in and out of any window at any time you choose by the push of a button.

Kay saw his paradigm as the basis for what he called an "integrated environment." When you have an integrated environment, the distinction between operating system and application fades. Every capability of your personal computer is always available to you to apply to any information you want. With minimal effort, you can move among such diverse activities as debugging programs, editing prose, drawing pictures, playing music, and running simulations. Information generated by one activity can be fed to other activities, either by direct user interaction or under program control.

When Kay invented the Smalltalk language in 1972, he designed it with the ability to support an integrated en-

What is a

# CLOCALPEEP?

Another name for the CCB-II, which is:

- a clock  
hour, minute, second
- a calendar  
day, day of week, month, year
- an audio alarm

All on one board for your



## TRS-80 Model II

It includes a pacemaker battery which will give over 8 years of continuous timekeeping.

From the folks who brought you the best CP/M® for the Model II.  
\$175 plus shipping  
Prepaid, COD, Mastercharge or Visa orders accepted. California residents add 6% sales tax.

TRS-80 is a trademark of Tandy Corp.  
CP/M is a registered trademark of Digital Research Inc.



### PICKLES & TROUT

P.O. BOX 1206, GOLETA, CA 93116, (805) 967-9563

Warning: Installation requires opening the Model II, which may void its warranty. We suggest that you wait until the warranty period has expired before installing the CCB-II.

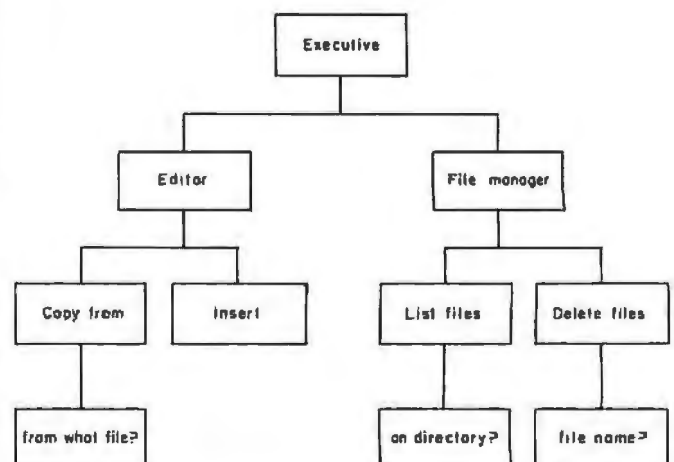

Figure 1: A portion of a typical mode hierarchy.

# HOOK 3 WINNERS



DOLPHIN

**\$139.00**

WINNER #1



**\$159.00**

WINNER #2



**\$179.00**

WINNER #3



**WATCH  
THIS SPACE  
FOR  
COLOR  
WINNER**

By  **TECO**

**DEMAND THESE  
UNITS FROM YOUR  
DEALER!**

Data-Ed  
18 Bridge Street  
Salem, NH 03079  
603-893-2047 (collect)

- \_\_\_ TM-12GX Monitors at \$179.00 plus 2.75 shipping
- \_\_\_ TM-12G Monitors at \$159.00 plus 2.75 shipping
- \_\_\_ TM-12 Monitors at \$139.00 plus 2.75 shipping

Please send OEM information about your low cost custom fit smart printers.

- Check or Money Order enclosed
- C.O.D. Orders Accepted
- Bill my-  VISA-  Mastercharge

Card No. \_\_\_\_\_

Exp. Date \_\_\_\_\_ Bank No. \_\_\_\_\_

Signature \_\_\_\_\_

VISA\*

master charge

Name \_\_\_\_\_

Address \_\_\_\_\_

City, State, Zip \_\_\_\_\_

vironment. The implementations of Smalltalk produced by Dan Ingalls and the other members of the Learning Research Group have achieved ever-increasing integration. The file system, process-management system, graphics capability, and compiler are implemented almost entirely in Smalltalk. They are accessible from any program, as well as by direct user interaction.

In recent years, the idea of an integrated environment has spread outside the Learning Research Group and even to non-Smalltalk systems. The window-per-program paradigm is now commonplace, and many system designers have adopted the overlapping-sheet model of the screen.

In summary, the term *environment* is used to refer to everything in a computer that a person can directly access and utilize in a unified and coordinated manner. In an *integrated environment*, a person can interweave activities without losing accumulated information and without giving up capabilities.

### Strengths of Smalltalk

Before delving further into the *nature* of the Smalltalk environment, we should first discuss its *purpose*.

Many general-purpose programming languages are more suitable for certain jobs than others. BASIC is easy to learn and is ideal for small dialogue-oriented programs. FORTRAN is well suited to numerical applications. COBOL is tailored to business data processing. Pascal is good for teaching structured programming.

LISP is wonderful for processing symbolic information. APL excels at manipulating vectors and matrices. C is great for systems programming. SIMULA shines at discrete simulations. FORTH lets people quickly develop efficient modular programs on very small computers.

All these languages have been used for numerous purposes in addition to those mentioned. You can write almost any program better in a language you know well than in one you know poorly. But if languages are compared from a viewpoint broader than that of a narrow expert, each language stands out above the others when used for the purpose for which it was designed.

Although Smalltalk has been used for many different applications, it excels at a certain style of software development on a certain type of machine. The machine that best matches Smalltalk's strengths is a personal computer with a high-resolution display, a keyboard, and a pointing device such as a *mouse* or graphics tablet (photo 3a). A cursor on the screen tracks mouse movements on the table so you can point to objects on the screen. The mouse (reference 4) has one or more buttons on its top side (photo 3b). One button is used as a *selection button*. If there are more buttons, they are normally used as *menu buttons*.

If the machine has a high-performance disk drive, you can use a virtual-memory version of Smalltalk and have as little as 80 K bytes of main memory, not counting display-refresh memory. Otherwise, you should have at least 256 K bytes of memory. This much memory is required because the whole integrated environment lives in one address space. It includes not only the usual run-time language support, but window-oriented graphics, the

# Clipper™



## LINE VOLTAGE TRANSIENT CLIPPING

Features Parallel Operation      5000 Hits/Second

|   |  |
|---|--|
| <p><b>PROTECTS:</b></p> <ul style="list-style-type: none"> <li>•Computers</li> <li>•Micro-Computer Systems</li> <li>•Word Processors</li> <li>•Cash Registers</li> <li>•Power Supplies</li> </ul> | <p><b>PROTECTS AGAINST:</b></p> <ul style="list-style-type: none"> <li>•High Energy Voltage Transients</li> <li>•On-Off Switching</li> <li>•Lightning Induced Transients</li> <li>•Inrush of On/Off Power</li> </ul> |
|---|--|

### DYMARC

INDUSTRIES, INC.



678F  
TRANSIENT VOLTAGE  
SURGE SUPPRESSOR LISTED

Dealer Inquiries Invited.

7133 Rutherford Rd. Baltimore, Md. 21207  
(301) 298-3130

800-638-9098

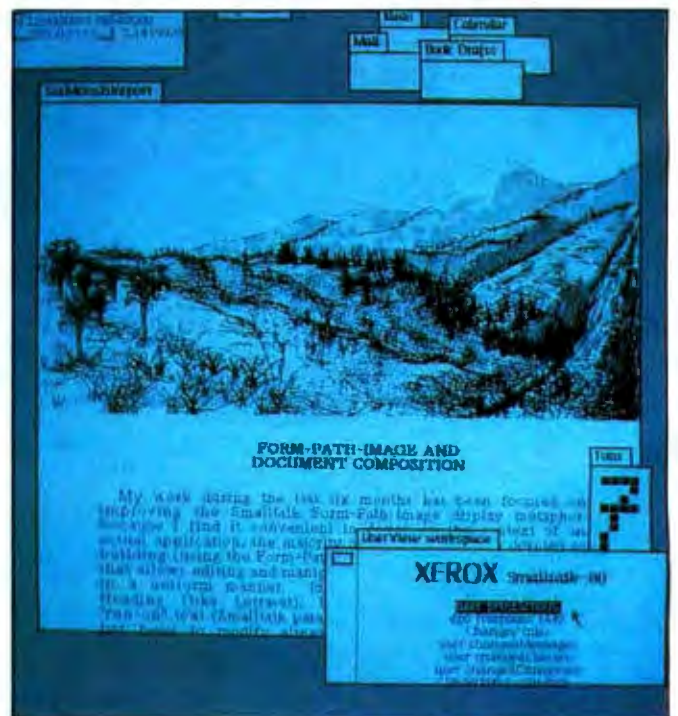

Photo 2: A typical Smalltalk display. The various "windows" look and behave like overlapping sheets of paper.

STATCOM wages

# WAR ON BUGS

with  
**CRTFORM™**

CRTFORM™, a software package, creates bug-free forms. Insurance forms, order forms, inventory forms—CRTFORM makes all types of forms for all kinds of people.

CRTFORM is a programmer productivity aid which makes it easy to create, test, modify, and use forms. The forms provide an interface between programmers and end-users, such as secretaries, executives, and CPAs. CRTFORM assures that the programmer will receive correct information while providing end-users information on how to enter data. If end-users make a mistake, they receive a message in plain English which tells them what went wrong and how to fix it.

The CRTFORM system consists of a form file manager, an input-field-oriented screen editor, and

precompiled run-time modules. The system contains a code generation section which is available to interface the program to the Pascal, FORTRAN, BASIC, and COBOL languages. In addition, the system can be configured without modification to run on over 95% of the terminals currently on the market. CRTFORM is currently available to run under the CP/M\*, UCSD\*, and Apple\* Pascal systems.

Statcom™ is a corporation specializing in software development tools and techniques. In addition to CRTFORM, Statcom will soon

be releasing a business report generation, file management, and data entry system which eliminate the need for a programmer.

For the name and address of your nearest CRTFORM dealer, call (512) 451-0221, or write to Statcom, 5766 Balcones, Suite 202, Austin, Texas 78731.



Programs that write programs.

**STATCOM™**  
CORPORATION

5766 BALCONES STE 202 AUSTIN TEXAS 78731

# FREE Computer Forms Catalog

with 32 pages of  
continuous  
business forms for  
small computer  
systems

Send today for our NEW full color 32 page catalog with programming guides, prices and order forms for continuous checks, invoices, statements, envelopes, stock paper and labels.

- Quality products at low prices
- Available in small quantities
- Fast Service
- Money Back Guarantee
- Convenient TOLL-FREE ordering

Fast Service by mail or . . .PHONE TOLL FREE

1 + 800-225-9550

Mass. residents 1 + 800-922-8580

8:30 a.m. to 5:00 p.m. Eastern Time Monday — Friday

Please rush a new computer forms catalog to:

CODE 20480

Name \_\_\_\_\_

Company \_\_\_\_\_

Street \_\_\_\_\_

City, State and Zip \_\_\_\_\_

Phone \_\_\_\_\_

Computer make & model \_\_\_\_\_



**Nebs  
Computer Forms**

78 Hollis Street, Groton, Mass. 01471  
A division of New England Business Service, Inc.

editor, the compiler, and other software-development aids. The programs you write tend to be small because they can build on existing facilities; no system facilities are hidden from the user. Users of LISP and FORTH will be familiar with this idea.

Smalltalk supports its preferred hardware by incorporating software packages that provide:

- output to the user through overlapping windows
- input from a keyboard, a pointing device, and menus
- uniform treatment of textual, graphical, symbolic, and numeric information

These interactive facilities are utilized heavily by the built-in programming aids and are available to all user-written applications.

The style of software development to which Smalltalk is oriented is *exploratory*. In exploratory development, it should be fast to create and test prototypes, and it should be easy to change them without costly repercussions. Smalltalk is helpful because:

- The language is more concise than most, so less time is spent at the keyboard.

(3a)



(3b)



Photo 3: A typical Smalltalk system (photo 3a) and a close-up of the "mouse" (photo 3b), a device that allows you to move an on-screen cursor and select certain options.



# COMPUTER WAREHOUSE

**CALL TOLL FREE 1-800-528-1054**

International Dealer & Personal Inquiries Invited, Prices May Vary. Tlx (0) 668382 (MCB)

## ATARI

|                               |              |
|-------------------------------|--------------|
| <b>Special 32K 800 System</b> |              |
| 800 w/32K, recorder           |              |
| star raiders, joysticks.....  | <b>\$860</b> |
| Above w/48K .....             | <b>\$925</b> |
| <b>800 (32K) .....</b>        | <b>\$744</b> |
| <b>810 Disk Drive .....</b>   | <b>\$440</b> |
| <b>825 Printer .....</b>      | <b>\$575</b> |
| <b>850 Interface .....</b>    | <b>\$155</b> |
| <b>410 Recorder .....</b>     | <b>\$70</b>  |
| <b>830 Modem .....</b>        | <b>\$140</b> |

|                         |              |
|-------------------------|--------------|
| <b>16K Memory .....</b> | <b>\$ 75</b> |
| <b>32K Memory .....</b> | <b>\$150</b> |

## DISK DRIVES

|                       |              |
|-----------------------|--------------|
| <b>Lobo</b>           |              |
| Apple 1st Drive ..... | <b>\$490</b> |
| Apple 2nd Drive ..... | <b>\$410</b> |

## MODEMS

|                   |              |
|-------------------|--------------|
| <b>Novation</b>   |              |
| CAT .....         | <b>\$155</b> |
| D-CAT .....       | <b>\$155</b> |
| AppleCat II ..... | <b>Call</b>  |
| AutoCat .....     | <b>Call</b>  |

## VIDEO TERMINALS

|                 |             |
|-----------------|-------------|
| <b>Adds</b>     |             |
| Viewpoint ..... | <b>Call</b> |

|              |             |
|--------------|-------------|
| <b>Soroc</b> |             |
| IQ 120 ..... | <b>Call</b> |
| IQ 130 ..... | <b>Call</b> |
| IQ 135 ..... | <b>Call</b> |
| IQ 140 ..... | <b>Call</b> |

|                       |              |
|-----------------------|--------------|
| <b>Televideo</b>      |              |
| 912 C .....           | <b>\$699</b> |
| 920 C .....           | <b>\$749</b> |
| 950 .....             | <b>Call</b>  |
| Zenith - Z - 19 ..... | <b>Call</b>  |

## PRINTERS

|                  |               |
|------------------|---------------|
| <b>C. Itoh</b>   |               |
| Starwriter ..... | <b>\$1380</b> |

|                  |               |
|------------------|---------------|
| <b>Datasouth</b> |               |
| DS180 .....      | <b>\$1299</b> |

|                     |             |
|---------------------|-------------|
| <b>Diablo .....</b> | <b>Call</b> |
|---------------------|-------------|

|                                |              |
|--------------------------------|--------------|
| <b>Epson</b>                   |              |
| MX-80 .....                    | <b>Call</b>  |
| MX-80 F/T .....                | <b>Call</b>  |
| MX-100 .....                   | <b>Call</b>  |
| Fric Feed Opt. for MX-80 ..... | <b>\$ 50</b> |

|            |  |
|------------|--|
| <b>NEC</b> |  |
| Okidata    |  |

|                    |              |
|--------------------|--------------|
| Microline 80 ..... | <b>\$399</b> |
| Microline 82 ..... | <b>\$515</b> |
| Microline 83 ..... | <b>\$755</b> |

|                   |             |
|-------------------|-------------|
| <b>Qume .....</b> | <b>Call</b> |
|-------------------|-------------|

|                |               |
|----------------|---------------|
| <b>Qantex</b>  |               |
| Serial .....   | <b>\$1198</b> |
| Parallel ..... | <b>\$1160</b> |

|                          |               |
|--------------------------|---------------|
| <b>Texas Instruments</b> |               |
| 810 Basic .....          | <b>\$1480</b> |
| 810 Loaded .....         | <b>\$1739</b> |

## COMPUTERS

|                        |             |
|------------------------|-------------|
| <b>Altos .....</b>     | <b>Call</b> |
| <b>Northstar .....</b> | <b>Call</b> |
| <b>Zenith</b>          |             |
| Z-89 48K .....         | <b>Call</b> |

## SOFTWARE

|                                 |             |
|---------------------------------|-------------|
| <b>CBASIC .....</b>             | <b>Call</b> |
| <b>CP/M .....</b>               | <b>Call</b> |
| <b>MP/M for NorthStar .....</b> | <b>Call</b> |

## DISKETTES

|                                   |              |
|-----------------------------------|--------------|
| <b>Scotch</b>                     |              |
| 5 1/4"-0, 10, 16 Sector (Qty 100) | <b>\$250</b> |
| 8"-0, 32 Sector (Qty 100)         | <b>\$260</b> |

## MONITORS

|                                 |              |
|---------------------------------|--------------|
| <b>Sanyo - 9" Monitor .....</b> | <b>\$165</b> |
|---------------------------------|--------------|

## We Buy and Sell Used Equipment

### Experienced Equipment

|                                |             |
|--------------------------------|-------------|
| <b>Diablo, NEC, Qume .....</b> | <b>Call</b> |
|--------------------------------|-------------|

|                                |               |
|--------------------------------|---------------|
| <b>Centronics 779 .....</b>    | <b>\$450</b>  |
| <b>Hazeltine 1420 .....</b>    | <b>\$600</b>  |
| <b>Atari 820 printer .....</b> | <b>\$250</b>  |
| <b>Soroc IQ 120 .....</b>      | <b>\$475</b>  |
| <b>TI 810 Basic .....</b>      | <b>\$1100</b> |



**ATARI®**



**3M**

**EPSON**  
EPSON AMERICA, INC

**OKIDATA**



**ZENITH**  
data systems

**NorthStar**

**TeleVideo™**

**TEXAS INSTRUMENTS**

**MPC**

**MICROTEK PERIPHERALS CORP.**



2222 E. Indian School Rd. Phoenix, Arizona 85016  
(602) 954-6109 1-800-528-1054

Store Hours: Tues.-Friday 10-5 MST Saturday 10-4 MST



Personal checks will delay shipping two weeks Prices & availability subject to change without notice

Prices reflect 3% cash discount. Product shipped in factory cartons with manufactures warranty. Add 2%, a minimum of \$5, for shipping and handling.

- The text editor is simple, modeless, and requires a minimum of keystrokes.
- The user can move among programming, compiling, testing, and debugging activities with the push of a button.
- Any desired information about the program or its execution is accessible in seconds with minimal effort.
- The compiler can translate and relink a single change into the environment in a few seconds, so the time usually wasted waiting for recompilation after a small program modification is avoided.
- Smalltalk programs grow gracefully. In most environments, a system gets more difficult to change as it grows. If you add 2 megabytes of virtual memory to the Smalltalk environment, you can fill the second megabyte with useful capabilities as fast as you can fill the first.
- The class structure of the language prevents objects from making too many assumptions about the internal behavior of other objects (see David Robson's article, "Object-Oriented Software Systems," on page 74 of this issue). The programmer can augment or change the methods used in one part of a program without having to reprogram other parts.

### The Anatomy of a Window

Over the years, members of the Learning Research Group have embellished Kay's original window concept. Let us look at a Smalltalk window in more detail (figure 2).

The window is shown as a *framed* rectangular area with a *title tab* attached to its top edge. The program associated with the window must confine its output to the framed area.

Every window has a *window menu* (photo 4a). The window menu includes commands to reframe the window in a new size and location, to close the window, to print the contents of the window on a hard-copy device, and to retrieve windows hidden under it.

A window is tiled by one or more *panes*, each with its own *pane menu* (photo 4b). The pane menu includes commands appropriate to the contents of that pane. In

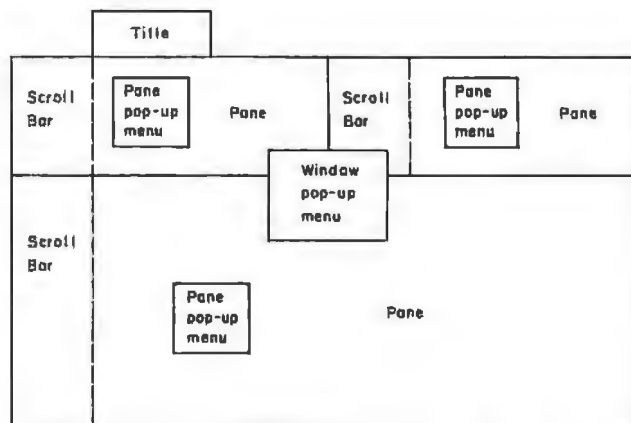

Figure 2: Anatomy of a window.

## CAT-100 FULL COLOR GRAPHICS

Complete line of color imaging systems with high resolution real time video **FRAME GRABBER** for the S-100 bus.

Capture and digitize a video frame in 1/60th of a second. Store up to 2 million bits of image data in on-board buffer. By software, select the best resolution for your application from 256 to 1280 pixels per TV line. Display your digitized image or your computer processed image with up to 256 gray levels or 65,536 simultaneous colors on standard B/W, NTSC or RGB color TV monitors.



480x512 Contoured digitized image



240x256 Digitized image, 16 levels

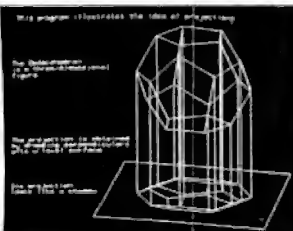

480x512 Computer-generated

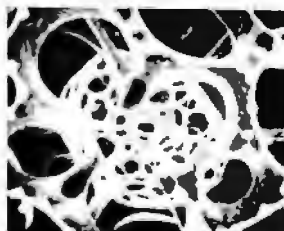

240x256 Digitized image, 16 levels

ROBOTICS-AUTOMATED COUNTING AND MEASURING-QUALITY CONTROL MONITORING-PATTERN RECOGNITION-IMAGE PROCESSING-MEDICAL AND SCIENTIFIC RESEARCH

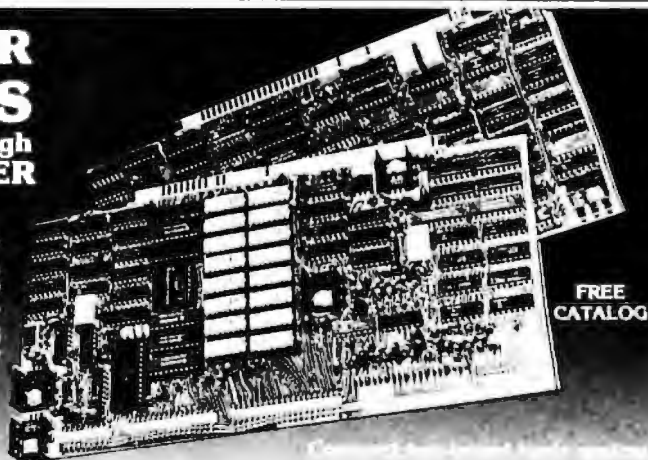

FREE CATALOG

### Features:

- Highest quality 480x512x8 digital video image
- Input capability from TV cameras or other sources
- Variety of synchronization choices
- 2 selectable video A/D conversion circuits
- Choice of 1, 2, 4, 8, 16 or 24 bits per pixel
- 32K-byte image memory on the basic system
- 64K, 128K, 192K and 256K-byte system capacity
- High resolution lightpen input
- Photographic trigger control input
- Software selectable system parameters
- Stand-alone intelligent graphics unit with universal interface

### Accessories:

- RGB color monitor
- High performance lightpen
- Hard copy printer/plotter
- Software packages available



835 Industrial Avenue  
Palo Alto, CA 94303  
(415) 856-2500

# MDBS... true data base management for small systems!

**Harvey M. Weiss,**  
an independent  
software reviewer,  
has this to say  
about our system:

"MDBS is truly a data base management system... , not a file management system."

"MDBS... offers the data manipulation, query, and report-writer capabilities of a DBMS found on much larger and more complex computer systems."

"MDBS has come to the rescue with... products whose ability to reduce development time and implement processes not available elsewhere make them invaluable to integrators and developers of  $\mu$ c-based systems."

For the complete Weiss review, see "Downscaling DBMS to the Microworld," *Mini-Micro Systems*, April, 1981, pp. 187-195.

**Check these  
advanced features  
for yourself:**

Flexible, powerful data structuring capabilities: network and hierarchical data structures, including many-to-many relationships (not available elsewhere).

Genuine data base management capabilities: far surpasses file management in data independence, automatic maintenance of relationships, and complete lack of data redundancy.

English-like, nonprocedural query language interface: ad hoc queries result in the automatic generation of desired reports, tables, files, and relations.

Host language interfaces, including various BASICS, COBOLS, PASCALS, FORTRAN, PL/I, C, and several assemblers.

Extensive built-in data access security (256 levels).

Automatic transaction logging and data base recovery.

Dynamic data base restructuring.

Plus many other advanced data base management features.

**Is MDBS right  
for your system?**

MDBS is written in Z-80, 6502, 8080 and 8086 machine language and run under CP/M (and similar derivatives) with CBASIC2, PL/1, PASCAL Z, PASCAL M, PASCAL MT+, BDS C, CIS COBOL, and Microsoft COBOL, FORTRAN, or BASIC; under North Star DOS and North Star BASIC; under TRSDOS or NEWDOS with TRS DISK BASIC; with Apple DOS and Applesoft BASIC; and with 86-DOS.

MDBS requires only 18K to 20K bytes for the Z-80 version, 22K for the 8080, and 30K for the 6502.

MDBS is independent of the types and sizes of disk drives.

**To learn more**

- For free literature about serious data base management on a microcomputer, please fill out and mail the coupon.
- For a practical introduction to true data base management for small computers, please send \$20 (Indiana residents, add 80¢ tax) for PRIMER/GUIDE manuals.
- For a comprehensive DOCUMENTATION PACKAGE consisting of THE PRIMER plus user manuals covering the MDBS, QRS, RTL, and DRS, please forward \$60 (+ \$2.40 Ind. tax).

Setting standards of excellence for data base  
software... worldwide.

**Micro  
Data Base  
Systems, inc.**

Box 248  
Lafayette, Indiana 47902  
317-448-1616/TWX 810-342-1881

Dealer/distributor/OEM inquiries invited.



**YES, please send me more information on the  
remarkably flexible MDBS Data Base System.**

Name \_\_\_\_\_ Title \_\_\_\_\_  
(Please print)

Company \_\_\_\_\_

Address \_\_\_\_\_

City \_\_\_\_\_ (State) \_\_\_\_\_ (Zip) \_\_\_\_\_

Phone \_\_\_\_\_

**MAIL TO: Micro Data Base Systems, Inc.  
P.O. Box 248-Y  
Lafayette, IN 47902**

addition, a pane has a *scroll bar* on its left side used to scroll the contents of the pane when more information exists than fits in the frame at one time.

Although you can see many windows and panes at once, you can interact with only one pane at a time. That pane and its window are said to be awake or *active*. To awaken a different pane of the same window, move the cursor over the new pane (photo 4c). To awaken a different window, move the cursor over the new window and press the *selection button* on the pointing device (photo 4d). When a window wakes up, its title tab and all

its panes are displayed, and it is no longer covered up by other windows.

The scroll bar of the active pane is called the *active scroll bar*. Its menu and the menu of its window are called the *active menus*. In order to reduce screen clutter and maximize utilization of precious screen space, no inactive scroll bars or menus are displayed. On machines that use a pointing device with three buttons, some versions of Smalltalk even hide the active menus until one of two *menu buttons* is pressed, at which time the associated menu *pops up* and stays up until the button is released. If the button is released when the cursor is over a command in the menu, that command is executed (photo 4e).

(4a)

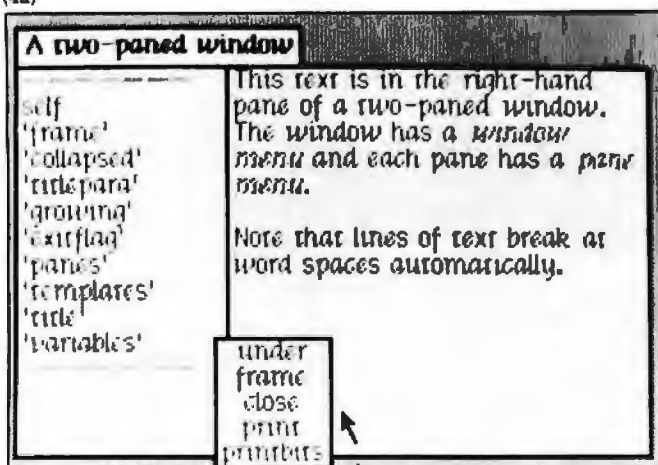

(4b)

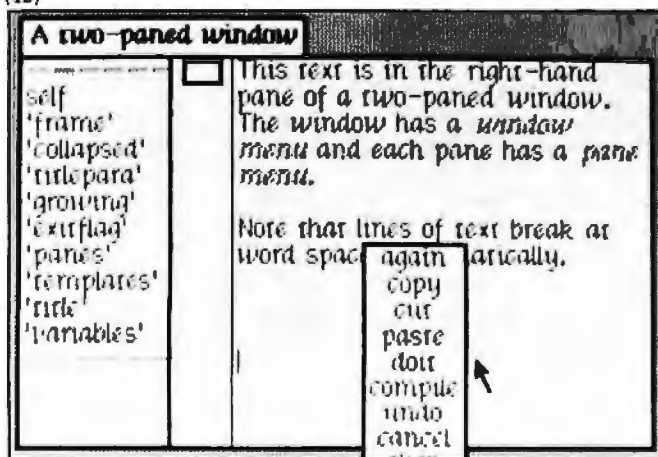

(4c)

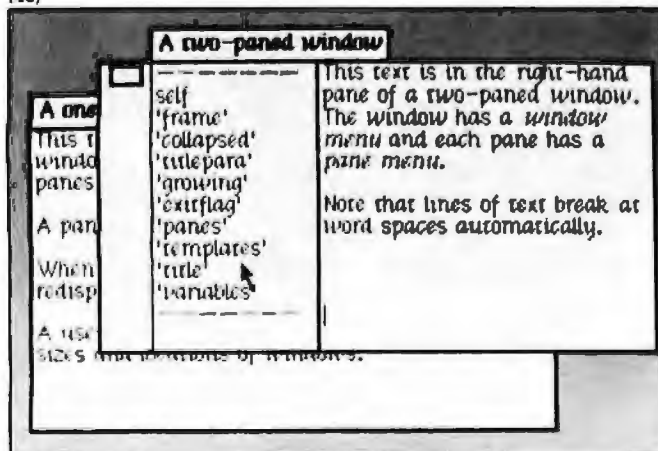

### Modeless Editing

The overlapping-window paradigm helps eliminate preemption. It can also reduce the need for certain prompts and their associated modes. For example, you never have to type the name of a procedure you want to examine. At worst, you point to its name in a list; at best, the desired procedure is already in a window on the screen, and you activate that window.

Unfortunately, overlapping windows do not eliminate command modes like "insert" and "replace" by themselves. Between 1973 and 1975, I worked at PARC with various collaborators, including Dan Swinehart and Timothy Mott, to banish command modes from interac-

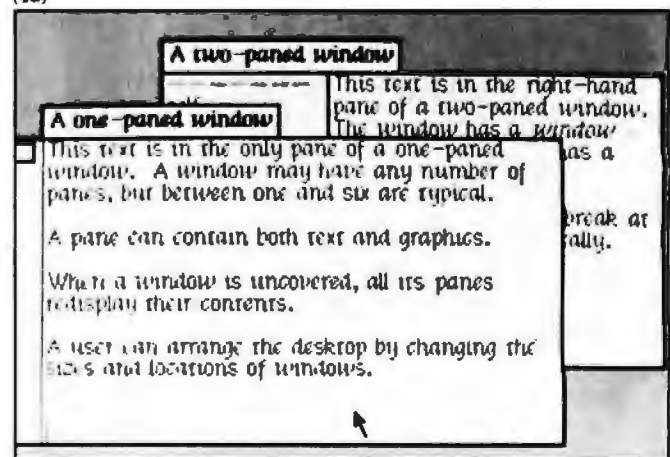

(4e)

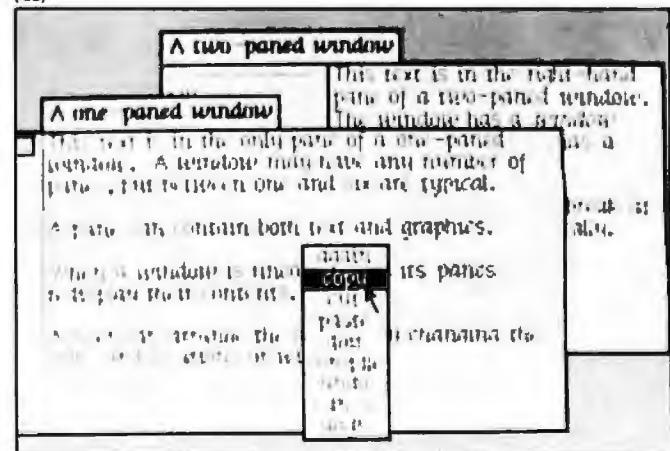

Photo 4: Windows and their behavior.

# 54 dB. Put up or shut up.

## The Gauntlet Is Down

Can any dot matrix computer printer match the INFOSCRIBE 1000? Its sound level in normal, continuous operation is only 54 dBA. By independent sound laboratory test.\*

That's right, 54 dBA. Like a group office where paper shuffling and throat clearing are making most of the noise.

As far as we're concerned, INFOSCRIBE 1000 is the quietest serial matrix impact printer on the market.

Compare with the typical matrix printer that can sound like a blender full of ball bearings, and you have the Number One reason why your next printer will be an INFOSCRIBE 1000

Even printers advertised at 56dB are a full 2 dB higher than ours. (Remember, every 3 dB up doubles the noise.)

## A New Generation Printer

If INFOSCRIBE 1000's purr were its only benefit, you should still buy it for the sanity of your office staff. But it happens that INFOSCRIBE 1000 is also the most feature-packed, the most beautiful, and the most economical printer in its class.

## Graphics Galore

INFOSCRIBE 1000 doesn't print characters only. Under software control it produces charts, diagrams, graphs, signs, anything within a vertical and horizontal resolution of 70 dots per inch. Now we're talking about a capability that can enhance management presentations, sales reports, even technical documents.

## Format Flexibility

INFOSCRIBE 1000 can produce data processing quality characters at 10, 12, or 16.5 characters per inch, or correspondence quality characters at 10. You also get subscripts and superscripts in any selected pitch, double-wide printing, true lower case descenders, and true underlining.

In addition to two different character sets stored in the printer, a third character set can be downloaded from the host computer. This offers a total of 288 different characters that can be selected on a character-by-character basis.

## Gratifying Throughput

There's more to INFOSCRIBE 1000's speed than a nominal 180 characters per second. High-speed paper movement with vertical and horizontal tabbing, plus bidirectional printing with logic seeking in both directions gets a lot of work out of the machine. And that's equivalent to having a faster computer.

## Unmatched Elegance

It's almost unfair that INFOSCRIBE 1000 is also the industry's best looking matrix printer. Slim, sleek, graceful, it makes those machines with the visible viscera look like remnants of early experimental days at Menlo Park. INFOSCRIBE 1000 is completely enclosed, sealing dirt out while sealing noise in. Its controls use membrane switches, so not even knobs or buttons break its sculptured exterior.

## Demand the INFOSCRIBE 1000

Is there a single reason why you should have any printer but the INFOSCRIBE 1000? At \$1,825 in singletons (substantially less in OEM quantities), INFOSCRIBE 1000 becomes mandatory for your system.

Insist on it from your system specialists. And if you are buying a first-time computer, no matter what make, ask for the printer that is setting a new standard: INFOSCRIBE 1000.

Get full details from your nearest Infoscrite distributor/representative. Or talk to your computer dealer. If he doesn't handle Infoscrite yet, he will.

\*Contact Infoscrite for an abstract of the independent testing laboratory report.



**INFOSCRIBE™**  
QUIETLY AUTHORITATIVE

Corporate Headquarters and Factory: Infoscrite, Inc., 2720 S. Croddy Way, Santa Ana, California 92704. Distributor/Representatives: CA, HI (714) 964-4722 or (415) 948-8961; CO, UT, WY (303) 371-4140 or (801) 292-8145; WA, OR, MT, ID, AK (206) 455-4822; IA, IL, IN, WI (312) 298-4830 or (414) 351-6123; TX, OK, AR, LA (214) 661-9633, (713) 681-0200, (918) 252-9646 or (512) 454-3579; MA, VT, ME, CT, RI, NH (617) 729-5770, (413) 737-6624 or (203) 624-7800; MN, ND, SD (612) 822-7011; DC, VA, MD (301) 424-4161; NY (315) 898-2651, (716) 223-4490; France 334-30-20, United Kingdom (063-33) 69162; Australia (61-2) 29-3753.

Overseas Distributor Inquiries Welcome

tive systems. Despite initial skepticism, nearly all users of our prototypes grew to appreciate the absence of modes. The following techniques were devised by us to eliminate modes from text editing. They are analogous to the techniques used to keep Polish-notation calculators relatively mode-free. Similar techniques can be applied to page layout, graphics creation, and other interactive tasks.

*Selection precedes command:*

- Every command is executed immediately when you issue it. You are not asked to confirm it. You can issue an *undo* command to reverse the effects of the last issued command. Although the main purpose of "undo" is to compensate for the lack of command confirmation, it can also be used to change your mind after issuing a command.
- For a command like "close the active window" that requires no additional parameters, you simply issue the command.
- For a command like "delete text" that requires one parameter, you first select the parameter using the pointing device and then issue the command. Until you issue the command, you can change your mind and make a different selection, or even choose a different command.
- For a command like "send electronic mail" that requires several parameters (recipient, subject, content), you first fill the parameters into a form using modeless text editing

and then issue the command. You are not in a mode while filling out the form. If you want to copy something into the form from another place, you can. If you want to do something else instead, just do it; you may even return to the form later and finish filling it out.

*Typing text always replaces the selected characters:*

- Pressing a text key on the keyboard never issues a command. It always replaces the current selection by the typed character and automatically selects the gap following that character.
- To replace a passage of text, first select it (photo 5a) and then type the replacement. The first keystroke deletes the original text (photo 5b).
- To insert between characters, you first select the gap between those characters (photo 6a) and then type the insertion (photo 6b). Essentially, you are replacing nothing with something.
- The destructive backspace function always deletes the character preceding the selection, even if that character was there before the selection was made.
- The "undo" command (photos 6c and 6d) can be used to reverse the effects of all your typing and backspacing since you last made a selection with the pointing device.

Thus, the usual insert, append, and replace modes are folded into one mode—replace mode—and one mode is no mode at all.

**ECT™**

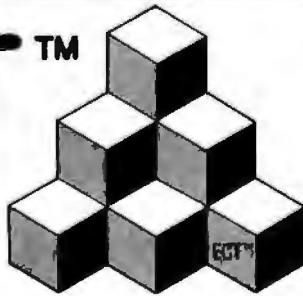

**Building Blocks for  
Microcomputer Systems,  
Dedicated Controllers  
and Test Equipment.**

**R<sup>2</sup>/O  
S-100 ROM,  
RAM & I/O  
BOARD**

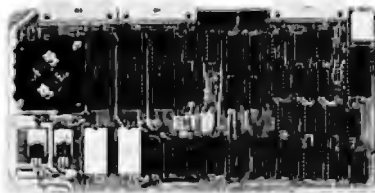

ECT's R<sup>2</sup>/O is an S-100 Bus I/O Board with 3 Serial I/O Ports (UART's), 1 Parallel I/O Port, 4 Status Ports, 2K of ROM with the 8080 Apple Monitor Program and 2K of Static RAM.

**\$295.00**

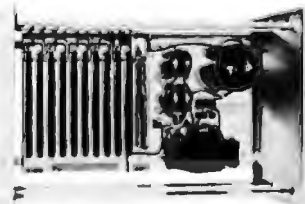

**RM-10  
S-100  
RACK MOUNT  
CARD CAGE**

ECT's RM-10 is a rack mount 10 slot Card Cage with Power Supply, consisting of an ECT-100 rack mount Card Cage (19"W x 12.25"H x 8"D), the MB-10 Mother Board (with ground plane and termination) all 10 connectors and guides and the PS-15A Power Supply (15A @ 8V, 1.5A @ ± 16V).

**\$295.00**

*Specializing in Quality Microcomputer Hardware  
Industrial • Educational • Small Business • Personal  
Card Cages, Power Supplies, Mainframes, CPU's, Memory, I/O, OEM Variations*

**ECT™ ELECTRONIC CONTROL TECHNOLOGY (201) 686-8080**

763 Ramsey Ave., Hillside, NJ 07205

# Tiny BASIC MICROCOMPUTER

## K-8073

The Engineer's Product Development Board Level Computer

**LOW COST  
POWERFUL/VERSATILE  
ENGLISH-LIKE PROGRAMMING**



1K Byte Local RAM  
Ext. Expandable To 9K

ART/RC Master, For Single  
Wire Data I/O Of 128 Slave Units

Real Time Clock  
W/Ext. Battery Backup  
Yr, Mo, Wk, Day, Hour, Sec.

RS-232 For CRT  
110-4800 Baud

**\$388**  
SINGLE UNIT

K-8073

STD (MOD) BUS 4.5 x 6.5 in.  
5 Volt Only—Cassette  
Tape In/Out—2 Sense—  
3 Flags

INS8073 Microinterpreter  
Tiny BASIC Processor

Autostart EPROM 2K Byte

Utilities Firmware, For  
Software Dev., EPROM 2K

EPROM—2K Byte

EPROM Programmer, 2K  
Byte Prm. Decoded—Req.  
Ext. 25V Only

PPI, Programmable I/O,  
24 Lines

PPI Interface Ribbon  
Connector

### THIS IS AN ENGINEER'S COMPUTER.

Simply attach a CRT, connect 5 volts, and you have yourself one each powerful, versatile microcomputer that YOU can program.

If you're fed-up with board level computers that require expensive development systems plus the skills of an Assembly language programmer, then you need the K-8073. With an on-chip microinterpreter and the extra control devices we designed into the board, you can do your own programming in the most simple English-like language available—Tiny BASIC. Sophisticated application designs can be implemented in hours instead of days or weeks because you have eliminated expensive and time consuming hardware and software costs.

**IN ADDITION TO ALL THIS**, the K-8073 offers advantages unheard of in other board level computers. Among these are an on-board EPROM Programmer, A Real Time Clock, Autostart, 1K Byte local RAM for variables, 8K Byte EPROM, ART/RC and PPI W/24 line I/O.

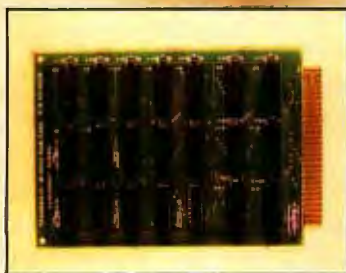

8K Byte RAM \$232.00



Development Station \$195.00

### THE K-8073 IS FOR OEM'S AS WELL AS END USERS.

Whether you manufacture Industrial Process Control, Environmental or Test/Measurement systems, or simply for your own use, you can count on top quality performance. The K-8073 comes complete with all socketed devices including the powerful F-2 Utilities Firmware and a Hardware/Software manual.

In Industry, Education, or New Product Development, the K-8073 provides you with State-of-the-Art technology for microprocessor efficiency and ease. With a full line of support products, the TransWave line takes care of your every need at the most reasonable prices.

To order your K-8073 or for further information, write or call TRANSWAVE CORPORATION, Cedar Valley Building, Vanderbilt, PA 15486, (412) 628-6370.

**TRANSWAVE**  
COMPUTER DIVISION OF UTSC

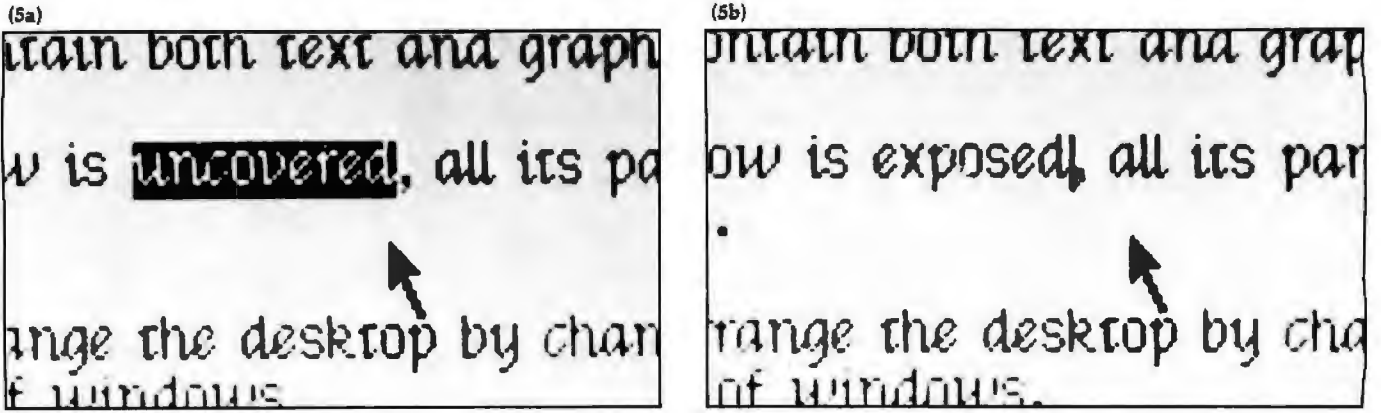

Photo 5: Replacing text in Smalltalk.

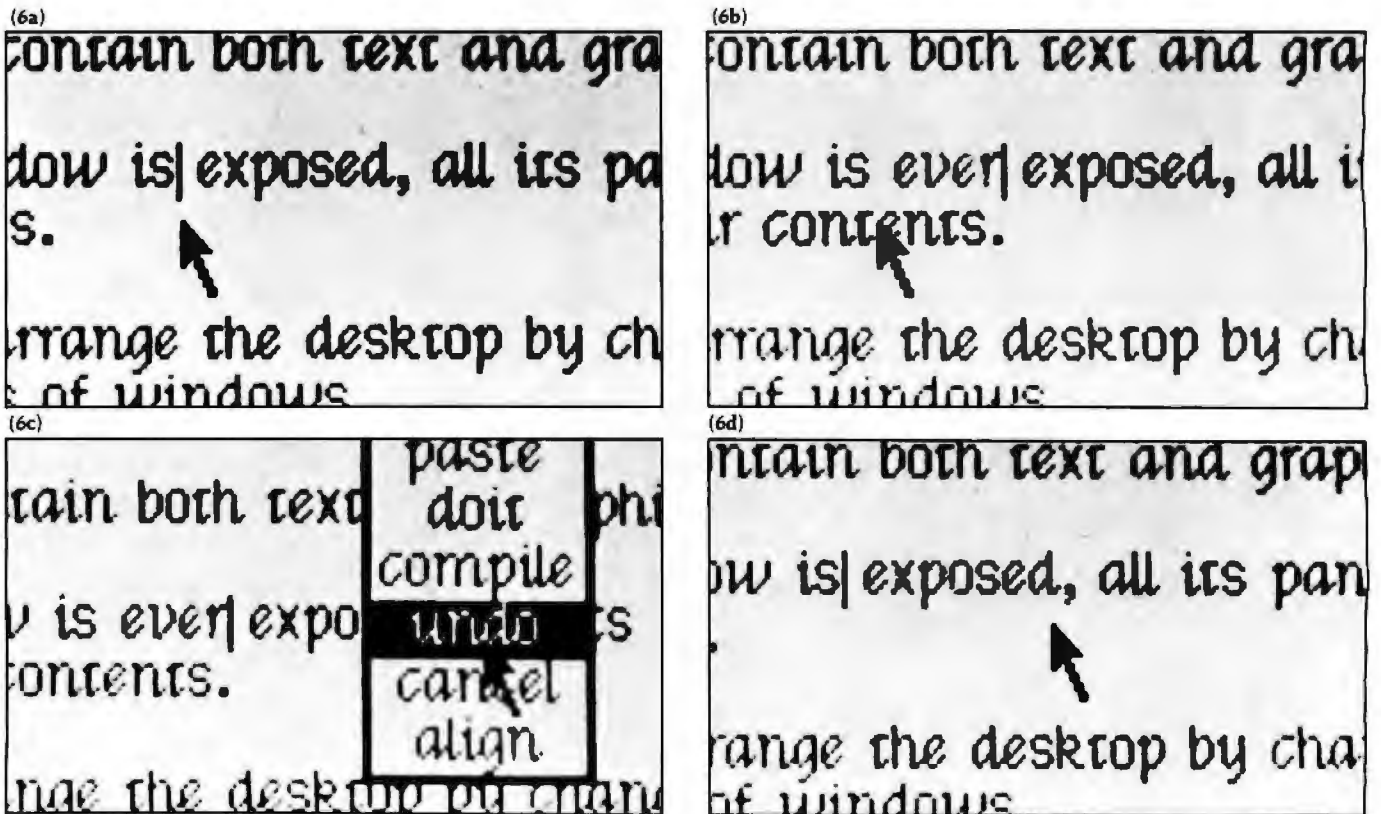

Photo 6: Inserting text in Smalltalk.

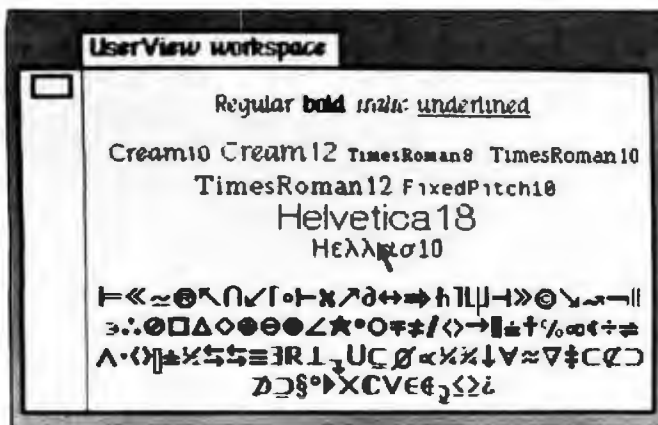

Photo 7: Multiple typefaces can be used in any window.

The "shift lock" key and analogous commands like "bold shift" and "underline shift" cause modes for the interpretation of subsequently typed characters. However, shifts are familiar to people and are relatively harmless. The worst they do is change a "d" to a "D," "d," or "d"—never to a Delete command.

The bit-map display can show boldface characters, as well as italics, underlining, and a variety of styles and sizes of printer's type (photo 7). Thus, as you enter text in bold shift, the screen shows what the text will look like when it is printed. A command like bold shift can also be applied to existing text to change it to boldface.

In 1976, Dan Ingalls devised a user interface for Smalltalk that incorporated most of the mode-avoidance techniques discussed earlier. Consequently, it is rare in



# Westico Software... What good hardware deserves.

The professional wants good software, wants it fast and backed by expert service — There's one answer — Westico, the Software Express Service that really delivers.



Call (203) 853-6880 for overnight delivery or when you need expert service.

## — Quality Software!

Westico constantly improves its quality software in a wide range of categories including: Accounting, Professional Time Accounting, Text Processing, Planning and Analysis, Telecommunications, Data Management, Development Tools, Language Processors.

## — Your Program Overnight!

Westico knows that the speed in which you receive a program is often a key consideration in your selection. That's why Westico is the only software company to offer overnight delivery.

## — Our 24-Hour Computer Hotline!

For detailed program information or for quick access ordering, just dial-up the Westico computer (300 baud) (203) 853-0816.

## — The Software for a wide variety of CP/M™ and other computer systems:

TRS-80 Model II, Apple, Vector Graphic, ICom, Cromemco, North Star, Micropolis, Ohio Scientific, Altos, Dynabyte, SuperBrain and more.

## — Professional Service

Westico is staffed by experts who understand your software and the equipment on which it runs. It's nice to know when you need service or advice, a Westico expert is standing by.

Send for our **NEW FREE** Catalog.

## — Professional Software

Current Westico products with **new prices** for complete systems and documentation alone:

**Accounting:** ACCOUNTS PAYABLE 495/60 • ACCOUNTS RECEIVABLE 495/60 • CLIENT WRITE-UP 895/60 • GENERAL LEDGER 495/60 • INVENTORY CONTROL 595/60 • PAS-3 DENTAL 990/40 • PAS-3 MEDICAL 990/40 • PAYROLL 495/60 • PROPERTY MANAGEMENT 895/60.

**Professional Time Accounting:** DATEBOOK™ II 295/25 • ESQ-1 Legal 1495/50 • ESQ-1 Legal Demo 75/50 • PTA 595/40 • PTA Demo 75/40.

**Text Processing:** MAIL-MERGE™ 125/25 • MINCE 175/25 • SPELL-GUARD™ 295/25 • TEXTWRITER 125/20 • WORDMASTER™ 145/40 • WORDSEARCH™ 195/40 • WORDSTAR™ 450/60.

**Planning & Analysis:** MILESTONE™ 295/25 • MINIMODEL 495/50 • STAT-PAK 500/40 • TARGET 195/25.

**Telecommunications:** ASCOM 175/20.



Dial-up our 24-hour Computer Hotline (300 baud) (203) 853-0816 for program information or orders.

**Data Management:** CBS 395/50 • CBS Demo 75/50 • CBS LABEL OPTION 80/10 • HDBS 300/35 • MAILING ADDRESS 395/60 • MAGSAM III 145/25 • MAGSAM IV 295/25 • MDBS 900/35 • MDBS DRS 300/5 • MDBS RTL 300/5 • MDBS QRS 300/5 • PRISM/ADS 795/55 • PRISM/IMS 495/55 • SELECTOR IV 550/35 • DATASTAR™ 350/60.

**Development Tools:** GENERAL SUB-ROUTINE PAK 295/30 • APPLICATION UTILITIES 495/30 • STRING BIT™ 65/15 • STRING/80™ 95/15 • STRING/80 SOURCE 295/-.

**Language Processors:** LYNX Overlay loader 250/25 • BASIC COMPILER 395/25 • BASIC-80 350/25 • CBASIC-2 120/15 • NEVADA COBOL 150/25 • PASCAL/M 225/25 • PASCAL/MT+ 425/30 • PL/I-80™ 475/35 • S-BASIC™ 295/35.

**Miscellaneous:** SUPERSORT I 225/40 • SURVEYOR 550/60 • ULTRASORT II™ 165/15.

## New from Westico

### MILESTONE: Tough Planning Jobs Made Easy

MILESTONE is a powerful new tool for managers and planners, which organizes complex projects and identifies job schedules essential to on-time completion.

MILESTONE finds the critical path through hundreds of interrelated tasks and determines where slack time can be eliminated.

Equally significant, MILESTONE computes manpower requirements and costs, allocating them to proper schedule periods and up to nine manpower skill/cost levels can be allocated to each task.

With MILESTONE, projects can be measured in hours, days, weeks, months, quarters or fiscal quarters; with provision to specify working hours, holidays, vacations and other non-productive time periods for up to 8,196 years.

Reschedule or complete tasks, revise prerequisites, play "What If" games. MILESTONE immediately displays the results on your screen or printer — either as a table or graph!

MILESTONE is easy to use and requires no programming!

System with full documentation — \$295. Documentation alone — \$25.

Versions for CP/M, APPLE PASCAL and CDOS.

## 4 WAYS TO ORDER

WES-31

- Write Westico, Inc., 25 Van Zant Street, Norwalk, CT 06855.
- Call (203) 853-6880
- Telex 643-788
- Dial-up our 24-hour computer (300 baud) (203) 853-0816

MasterCard and VISA accepted

Prices do not include shipping and are subject to change. In CT add 7½% sales tax.

Manual price may be credited toward purchase of software

Dealer Inquiries Invited. Copyright © 1981 Westico, Inc.

# WESTICO

## The Software Express Service

25 Van Zant Street • Norwalk, Connecticut 06855  
(203) 853-6880 • Telex 643-788

the present Smalltalk environment to encounter a mode.

### Making a Selection

In the Smalltalk-76 user interface, text is selected using the pointing device and a single button. First, the cursor is moved to one end of the passage to be selected (photo 8a). The selection button is pressed and held down while the cursor is moved to the other end of the passage. This operation is called "draw-through," though it is not necessary to traverse intermediate characters en route to the destination. When the cursor reaches the other end of the passage, the button is released. The selected passage is then shown in inverse video (photo 8d).

The feedback given to the user during selection is as follows. When the button is depressed, a vertical bar appears in the nearest intercharacter gap (photo 8b). (At the

(8a)

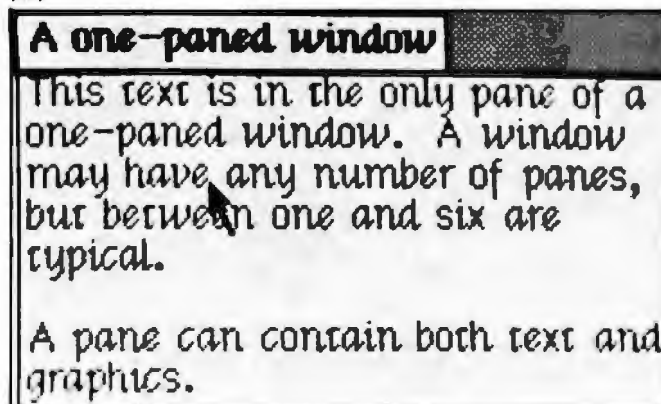

(8b)

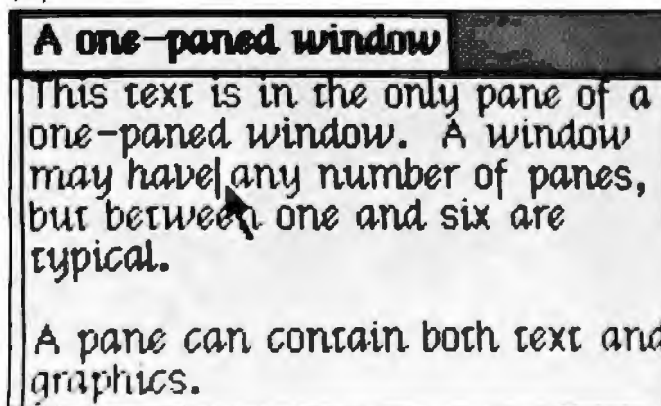

(8c)

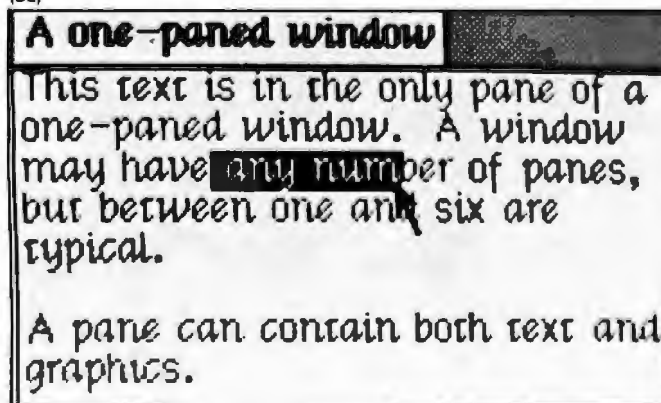

left end of a line of text, the bar appears to the left of the first character. At the right end of a line, the bar appears to the left of the final space character.)

If the button is released without moving the cursor, the bar remains, indicating that a zero-width selection has been made. This method—clicking once between characters—is the one to use before you insert new text.

If the button is held down while the cursor is moved, the system supplies continuous feedback by highlighting in inverse video all characters between the initial bar and the gap nearest to the cursor (photo 8c). When the button is released, the selected characters remain highlighted (photo 8d). This method—drawing through a passage—is the one to use before you copy, move, delete, or replace text, or before you change it to boldface or otherwise alter its appearance.

Clicking the button twice with the cursor in the same spot within a word selects that whole word and highlights it (photo 8e). This special mechanism is provided because it is very common to select a word. Informal experiments lead us to believe that double clicking is much easier than drawing through a word for beginners and experts alike. It is also faster. It takes the average user about 2.6 seconds to select a word anywhere on the screen using draw-through, but it takes only 1.5 seconds using the double click (reference 5).

There is only one selection in the active pane. It is called the *active selection*.

(8d)

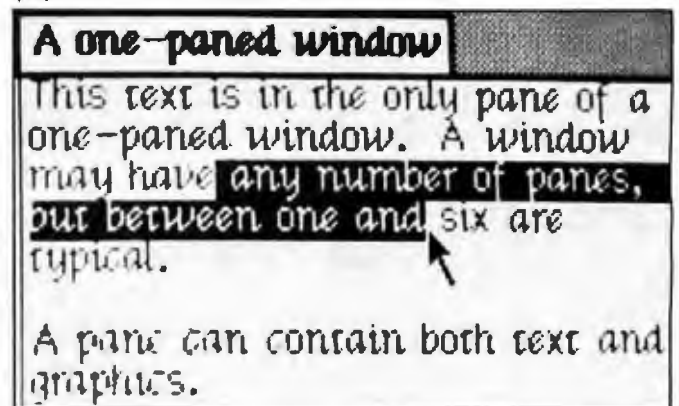

(8e)

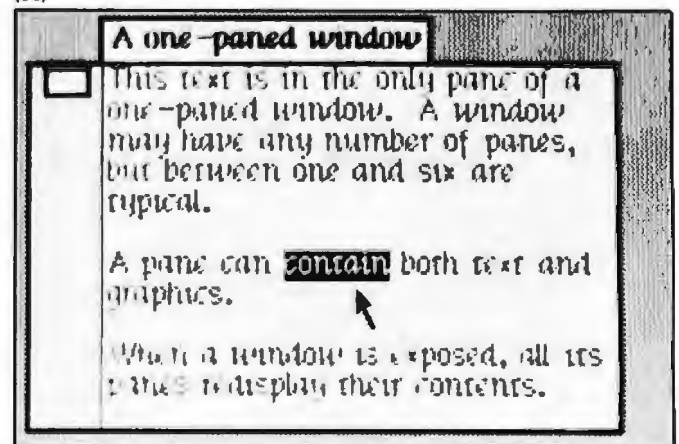

Photo 8: Selecting text using the mouse and the cursor.



**THE NEW**  
**FLIP/FLOPPY™ DISK**  
 with twice the byte

OMNI is pleased to bring you a **reversible** 5¼" mini diskette...the FLIP/FLOPPY DISK. Now you can record on both sides for twice the storage capacity of a single sided disk. And you'll be able to do it far more economically, too!

Each OMNI FLIP/FLOPPY DISK incorporates all of the quality features you'd expect from the very best single sided disk.



- Two recording surfaces
- Two sets of WRITE ENABLE notches
- Two index holes
- Reinforced Hub Rings
- Certified error-free operation at more than twice the error threshold of disk drives
- Over 12 million rated passes without disk related errors or significant wear, for extra long life operation
- Compatible with most 5¼" disk drives including APPLE, TRS-80, PET, OHIO SCIENTIFIC, and many more.

**OMNI Resources**

4 Oak Pond Avenue • Millbury, MA 01527 • 617-799-0197

Call TOLL-FREE: In Mass. 1-800-252-8770  
 Nationwide 1-800-343-7620

**INTRODUCTORY OFFER**

Order the OMNI FLIP/FLOPPY DISK at this special introductory price:

**Five Pack...\$21.00**

Equivalent to ten single-sided disks.

**Ten Pack....\$40.00**

Equivalent to twenty single-sided disks.

OFFER EXPIRES OCTOBER 15, 1981

Please send me the following OMNI FLIP/FLOPPY DISK(s)

\_\_\_\_\_ Five Packs(s) @ \$21.00 each = \$ \_\_\_\_\_  
 \_\_\_\_\_ Ten Pack(s) @ \$40.00 each = \$ \_\_\_\_\_  
 Shipping and handling \$ 1.50  
 Massachusetts residents add 5% sales tax \$ \_\_\_\_\_  
 TOTAL \$ \_\_\_\_\_

- Check made payable to OMNI RESOURCES     C.O.D.  
 Mastercard  
 Account Number \_\_\_\_\_  
 VISA/BankAmericard  
 Account Number \_\_\_\_\_  
 Credit Card Expiration Date \_\_\_\_ / \_\_\_\_

Name \_\_\_\_\_

Address \_\_\_\_\_

City \_\_\_\_\_

State \_\_\_\_\_ Zip \_\_\_\_\_

Phone Number ( \_\_\_\_\_ ) \_\_\_\_\_

Authorized Signature \_\_\_\_\_

(Please allow approximately three weeks for delivery)  
 Money back guarantee if not completely satisfied

# SOFTWARE for the ATARI 800\* and ATARI 400\* from QUALITY SOFTWARE



## STARBASE HYPERION™

By Don Ursem

Become absorbed in this intriguing, original space simulation of war in the far future. Use strategy to defend a front line Star Fortress against invasion forces of an alien empire. You create, deploy, and command a fleet of various classes of space ships, while managing limited resources including power generators, shields and probes. Real time responses are sometimes required to take advantage of special tactical opportunities. Use of color, sound, and special graphics

add to the enjoyment of this program. At least 24K of RAM is required.  
On Cassette — \$19.95      On Diskette — \$22.95

## NAME THAT SONG

By Jerry White

Here is great entertainment for everyone! Two players listen while the Atari starts playing a tune. As soon as a player thinks he knows the name of the song, he presses his assigned key or joystick button. There are two ways to play. The first way requires you to type in the name of the song. Optionally, you can play multiple choice, where the computer asks you to select the title from four possibilities. The standard version requires 24K of RAM (32K on diskette) and has over 150 songs on it. You also get a 16K version that has more than 85 songs. The instructions explain how you can add songs to the program, if you wish. Written in BASIC

On Cassette — \$14.95      On Diskette — \$17.95



## QS FORTH

By James Albanese

Want to go beyond BASIC? The remarkably efficient FORTH programming language may be just for you. We have taken the popular fig-FORTH model from the FORTH Interest Group and expanded it for use with the Atari Personal Computer. Best of all we have written substantial documentation, packaged in a three ring binder, that includes a tutorial introduction to FORTH and numerous examples. QS FORTH is a disk based system that requires at least 24K of RAM and at least one disk drive. Five modules that may be loaded separately from disk are the fig-FORTH kernel, extensions to standard fig-FORTH, an on-screen editor, an I/O module that accesses Atari's operating system, and a FORTH assembler

Diskette and Manual — \$79.95      Manual Only — \$39.95

FOR OUR COMPLETE LINE OF ATARI SOFTWARE  
PLEASE WRITE FOR OUR CATALOG



# QUALITY SOFTWARE

6660 Reseda Blvd., Suite 105, Reseda, CA 91335  
(213) 344-6599

ASK FOR QUALITY SOFTWARE products at your favorite computer store. If necessary you may order directly from us. MasterCard and Visa cardholders may place orders by calling us at (213) 344-6599. Or mail your check or bankcard number to the address above. California residents add 6% sales tax. Shipping Charges: Within North America orders must include \$1.50 for shipping and handling. Outside North America the charge for airmail shipping and handling is \$5.00. Pay in U.S. currency.

\*Indicates trademarks of Atari.

## Issuing a Command

When you issue a command in Smalltalk, you are sending a message to an object. There are two ways to send a message from Ingalls's user interface. You can send certain commonly sent messages to the active pane or window by choosing them from menus; you can send any message to any object by direct execution of a Smalltalk statement.

(9a)

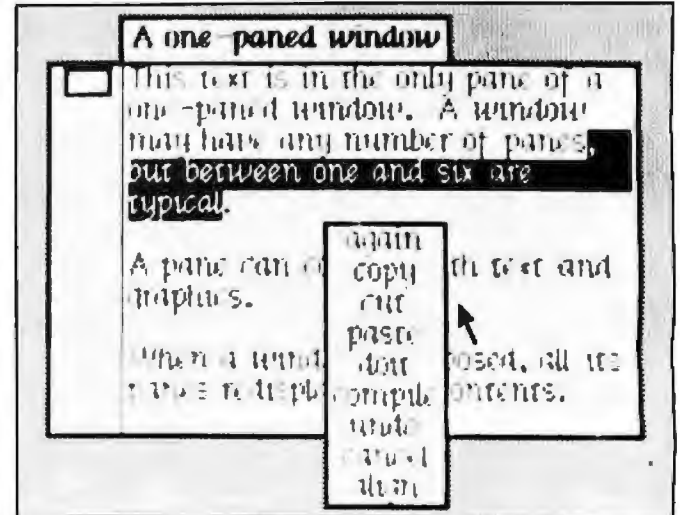

(9b)

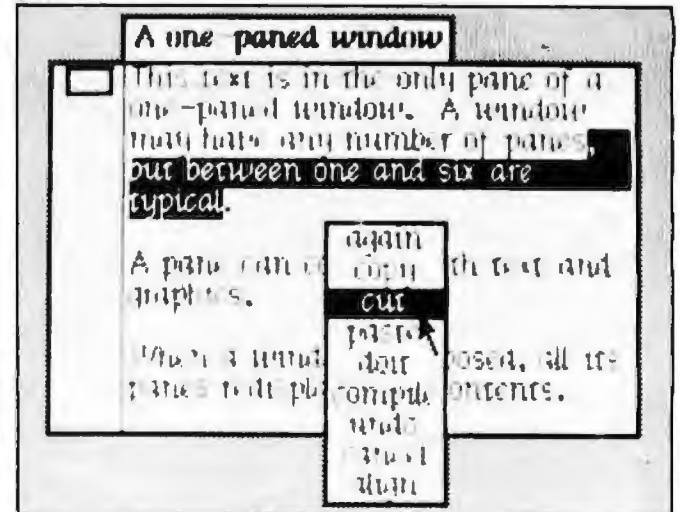

(9c)

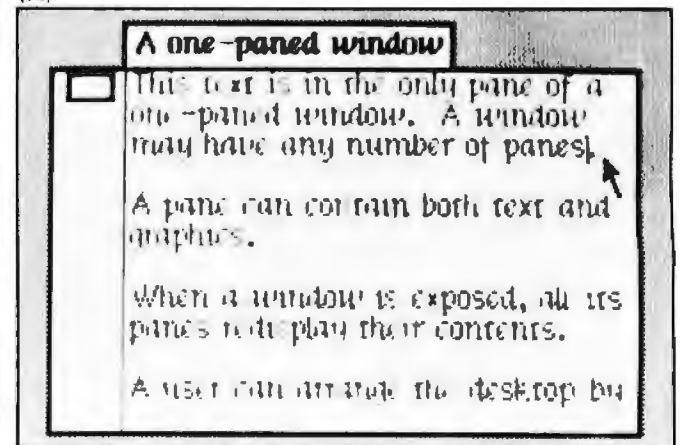

Photo 9: "Cutting" text in Smalltalk.



## Turn your Apple into the world's most versatile personal computer.

**The SoftCard™ Solution.** SoftCard turns your Apple into two computers. A Z-80 and a 6502. By adding a Z-80 microprocessor and CP/M to your Apple, SoftCard turns your Apple into a CP/M based machine. That means you can access the single largest body of microcomputer software in existence. Two computers in one. And, the advantages of both.

**Plug and go.** The SoftCard system starts with a Z-80 based circuit card. Just plug it into any slot (except 0) of your Apple. No modifications required. SoftCard supports most of your Apple peripherals, and, in 6502-mode, your Apple is still your Apple.

**CP/M for your Apple.** You get CP/M on disk with the SoftCard package. It's a powerful and simple-to-use operating system. It supports more software than any other microcomputer operating system. And that's the key to the versatility of the SoftCard/Apple.

**BASIC included.** A powerful tool, BASIC-80 is included in the SoftCard package. Running under CP/M, ANSI Standard BASIC-80 is the most powerful microcomputer BASIC available. It includes extensive disk I/O statements, error trapping, integer variables, 16-digit precision, extensive EDIT commands and string functions, high and low-res Apple graphics, PRINT USING, CHAIN and COMMON, plus many additional commands. And, it's a BASIC you can compile with Microsoft's BASIC Compiler.

**More languages.** With SoftCard and CP/M, you can add Microsoft's ANSI Standard COBOL, and FORTRAN, or

Basic Compiler and Assembly Language Development System. All, more powerful tools for your Apple.

**Seeing is believing.** See the SoftCard in operation at your Microsoft or Apple dealer. We think you'll agree that the SoftCard turns your Apple into the world's most versatile personal computer.

**Complete information?** It's at your dealer's now. Or, we'll send it to you and include a dealer list. Write us. Call us. Or, circle the reader service card number below.

SoftCard is a trademark of Microsoft. Apple II and Apple II Plus are registered trademarks of Apple Computer. Z-80 is a registered trademark of Zilog, Inc. CP/M is a registered trademark of Digital Research, Inc.

# MICROSOFT

CONSUMER PRODUCTS

Microsoft Consumer Products, 400 108th Ave. N.E.,  
Bellevue, WA 98004. (206) 454-1315

Circle 240 on inquiry card.

# 6809 SOFTWARE POWER TOOLS

BY MICROWARE®

## OS-9™ MULTIPROGRAMMING OPERATING SYSTEM

**A** true multitasking, real time operating system for timesharing, software development, database, process control, and other general applications. This versatile OS runs on almost any 6809-based computer.

- UNIX™-like file system with hierarchical directories, byte-addressable random-access files, and full file security. Versatile, easy-to-use input/output system is hardware independent and expandable.

- Powerful "shell" command interpreter features: I/O redirection, multiple job stream processing, and more. Includes a complete set of utility commands.

- OS-9 Level Two uses hardware memory management and can address over one megabyte of memory. Also includes pipes and filters for inter-process data transfers.

- OS-9 Level One runs on systems without memory management hardware having up to 56K memory.

OS-9 Level Two \$495\*    Level One \$195

## BASIC09™ PROGRAMMING LANGUAGE SYSTEM

**E**xtended BASIC language compiler/interpreter with integrated text editor and debug package. Runs standard BASIC programs or minimally-modified PASCAL programs.

- Permits multiple named program modules having local variables and identifiers. Modules are reentrant, position independent and ROMable.

- Additional control statements for structured programming: IF ... THEN ... ELSE, FOR ... NEXT, REPEAT ... UNTIL, WHILE ... DO, LOOP ... ENDLOOP, EXITIF ... ENDEXIT.

- Allows user-defined data types and complex data structures. Five built-in data types: byte, integer, 9 digit floating-point, string and boolean.

■ Runs under OS-9™ Level One or Level Two.  \$195\*

## OTHER OS-9™ FAMILY SOFTWARE

- Stylograph™ Screen-Oriented Word Processor
- Interactive Assembler   ■ Macro Text Editor
- Interactive Debugger

BASIC09 and OS-9 are trademarks of Microware® and Motorola. UNIX is a trademark of Bell Laboratories.\* Most software is available on ROM or diskette in versions for many popular 6809 computers. Contact Microware® for specific availability.

For compatible hardware see GIMIX ad page 128.



**MICROWARE**  
Microware Systems Corp., Dept. B2  
5835 Grand Avenue, Des Moines, Iowa 50304  
(515) 279-8844 • TWX 910-520-2535

Smalltalk-76 provides pop-up menus for the most commonly used commands, like "cut," which deletes the selected text. To issue the "cut" command, you pop up the active-pane menu with one of the menu buttons on the mouse (photo 9a), keep that button down while moving the cursor to the command name (photo 9b), and then release the button (photo 9c). A command in the pane menu can have only one parameter, the active selection. A command in the window menu can have no parameters.

To issue a command that is not available in a menu, you select any place you can insert text, and type the whole command as a statement in the Smalltalk language (photo 10a). Then you select that statement and issue the

(10a)

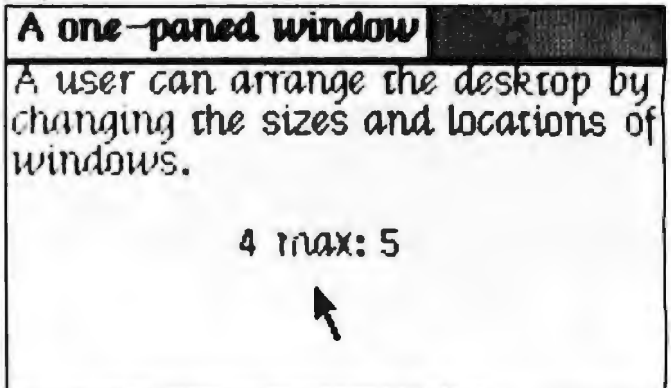

(10b)

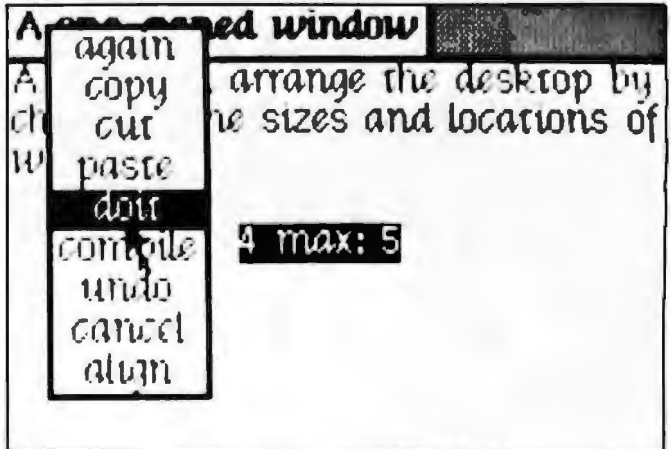

(10c)

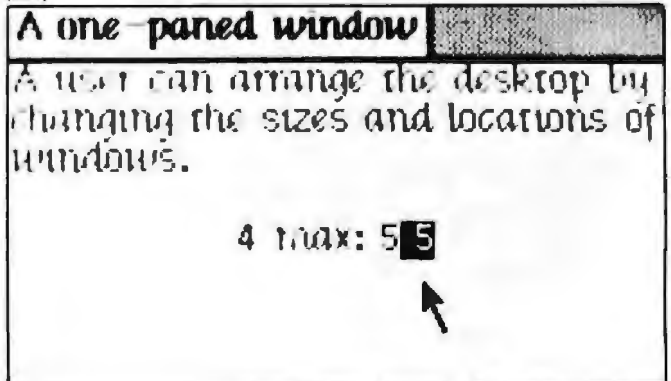

Photo 10: Executing text using the "doit" message.

# Price breakthrough: \$499.

For a CMOS microprocessor development system.

Our new CDP18S693 costs less than any other 1802 microprocessor development system on the market. And the development system can even become your final target system.

**The incredibly low \$499\* price includes:**

- CDP18S601 computer Microboard.
- ROM/audio cassette controller Microboard.
- Five-card chassis and case.
- Detachable 5-volt power supply.
- Audio cassette tape I/O drive for mass storage.

**You get these capabilities:**

- Extended BASIC resident in ROM with full floating-point arithmetic.
- 2K-byte monitor program with

extensive memory manipulation.

- RS232C or 20 mA terminal interface, up to 1200 baud.

**Or, for \$799,\* you can get the CDP18S694.** It has all the capability of the 693, plus:

- ROM-based 1802 Assembler/Editor.
- PROM Programmer board.
- A second cassette tape I/O drive.

**System expansion:**

- Expand your Microboard system capability, choosing from over 40 expansion boards and hardware accessories.
- Memory expandable to full 65K bytes.
- Virtually unlimited I/O expansion capability using any combination of analog and digital I/O boards.

- Run-time BASIC 3 firmware for final system configuration.

**Develop software for any 1802-based component design,** or for any Microboard system in BASIC or assembly language.

At these prices you can't afford not to get into CMOS.

For more information, contact any RCA Solid State sales office, sales representative or distributor.

Or contact RCA Solid State headquarters in Somerville, N.J. Brussels, Belgium. Sao Paulo, Brazil. Hong Kong.

**Or call Microsystems Marketing toll-free (800) 526-3862.**

\* U.S. optional distributor resale, single unit price.



Add a terminal, and you're ready to develop your software.

Another reason to switch to CMOS.

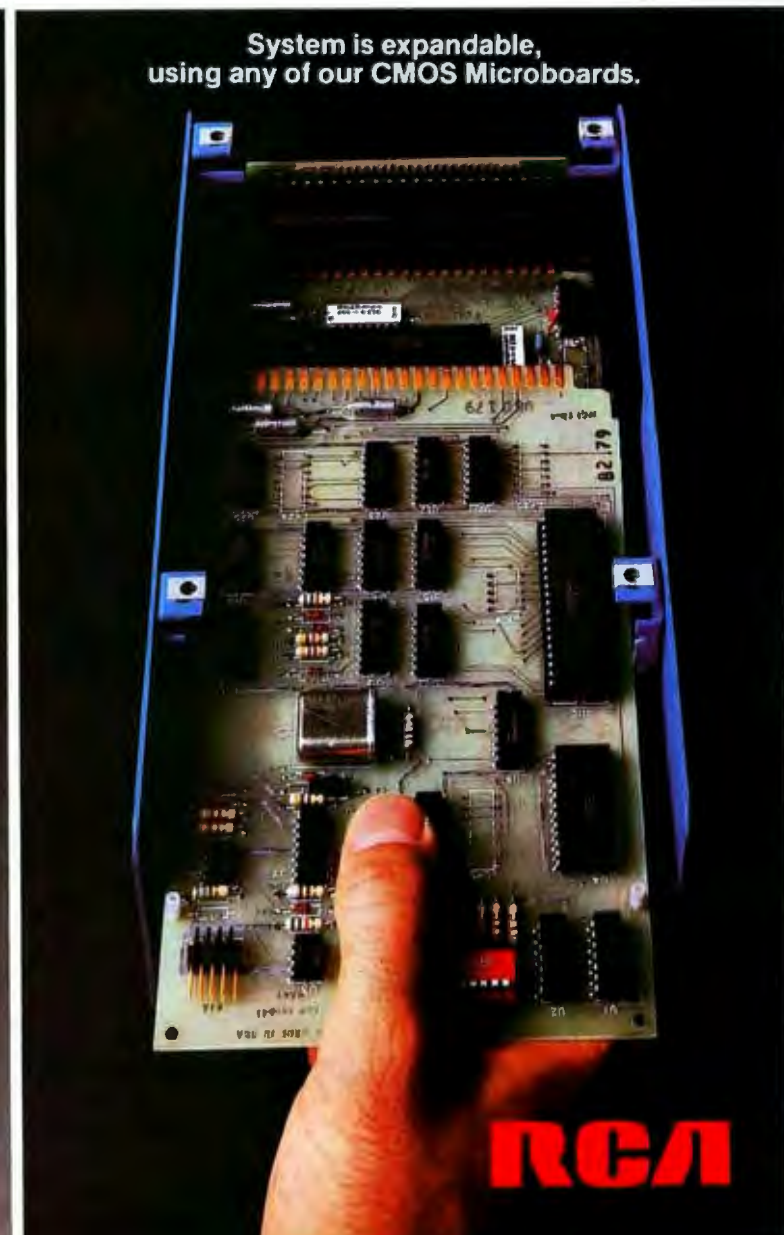

System is expandable, using any of our CMOS Microboards.

**RCA**

single-parameter command "do it" (photo 10b) to obtain the result (photo 10c). The "do it" command provides immediate execution of any Smalltalk statement or group of statements. This method of command issuance uses the previous method: you are sending the message *doit* to the pane, with the Smalltalk statement as its parameter.

It is standard practice to keep a "work-space" window around the screen in which to type your nonmenu commands. When you want to reissue a nonmenu command issued earlier, simply select the command in the work-space window and "do it." You may, of course, edit some of the parameters of the old command before you select it and "do it." In a sense, you are filling out a form when you edit parameters of an immediate statement.

Unfortunately, the common commands "move text from here to there" and "copy text from here to there" cannot be issued by a single menu command because they require two parameters, the source selection and the destination selection. Sometimes, they even involve messages to more than one pane, the source pane and the destination pane. In a modeless system, a move or copy command is done in two steps:

(11a)

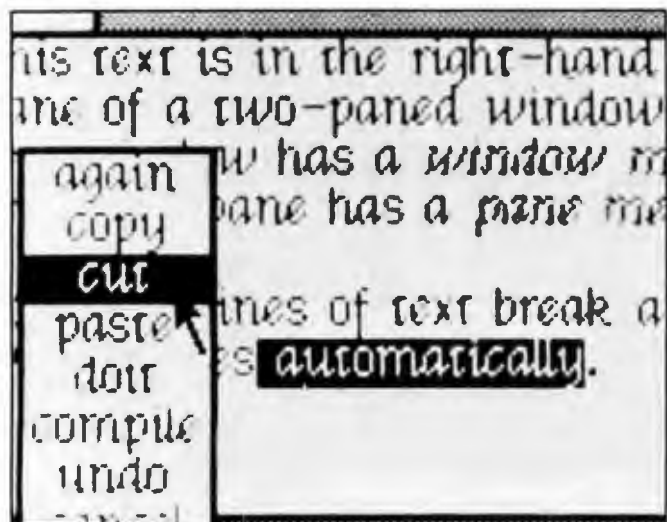

(11c)

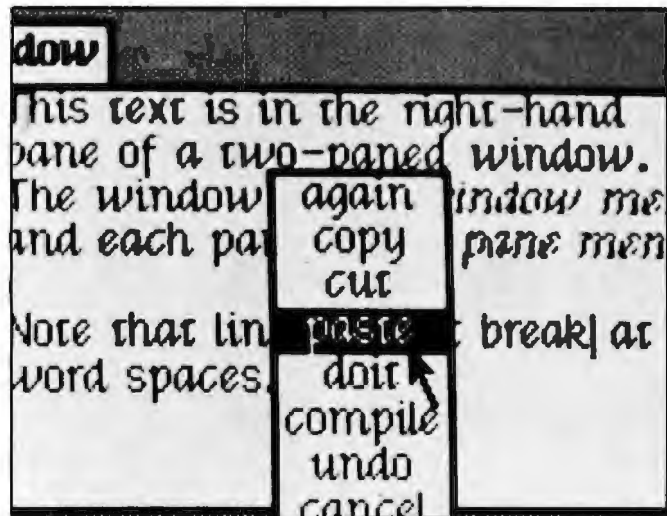

- A move is done by *cut and paste*. First, you select the source text and issue the "cut" command (photo 11a). The "cut" command deletes the selected text (photo 11b), but leaves it in a special place where it can be retrieved by "paste." Then you select the destination and issue the "paste" command (photo 11c) to complete the move (photo 11d).

- A copy is done by *copy and paste*, which is completely analogous to cut and paste, but does not delete the original text.

Remember the "copy-from-file" example (the one where you had to go in and out of many layers of modes)? In the Smalltalk-76 user interface, you can accomplish this with six pushed buttons, no mode exits, and no typing: (1) activate the source window that displays the file you are copying from; (2) select the desired text; (3) issue the "copy" command in the menu; (4) activate the destination window; (5) select the destination point, and (6) issue the "paste" command in the menu. The job requires little more effort than copying within the same document. If the window is not already

(11b)

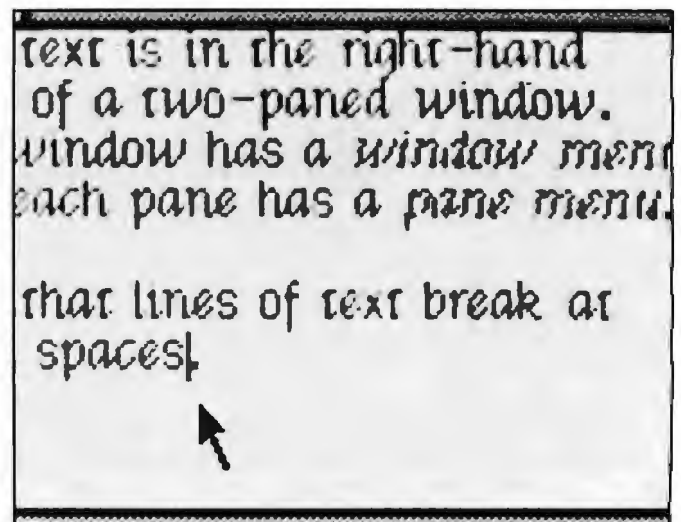

(11d)

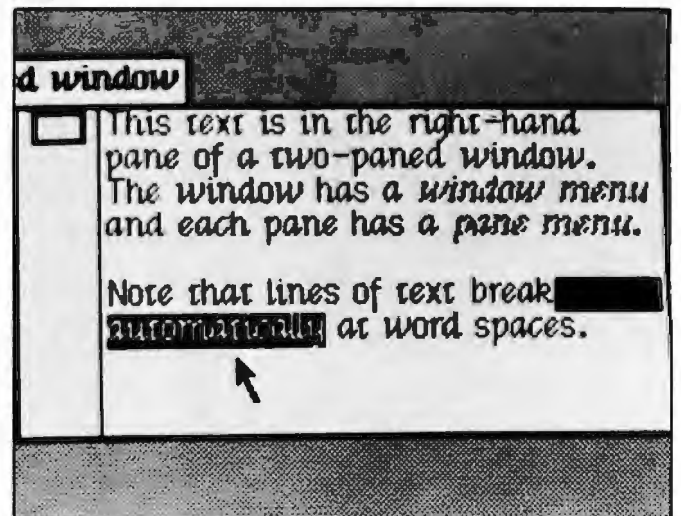
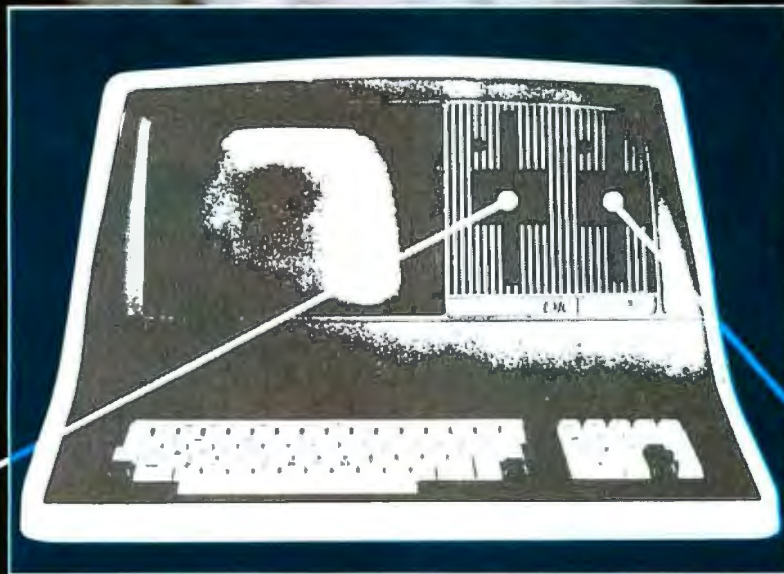

Photo 11: Moving text in Smalltalk.



*The perfect marriage of  
Superbrain™ and Winchester.™*

# **SUPERFIVE™**



700 K or 350 K  
floppy storage

5 Megabytes  
hard disk storage

**Finally, a price-performance breakthrough for mass storage in a one-piece,  
handsomely styled desk-top computer.**

## **SUPERFIVE™**

A product of CMC International

- 5¼" Micro-Winchester™ 5 Mbyte (formatted) hard disk
- 700K or 350K floppy disk back up
- Dual Z-80 processors with 64K RAM
- Dual RS232 ports
- Complete and ready to run with CP/M™ 2.2
- Also available 10 Mbyte hard disk, 5 MB removable
- 10 Mbyte hard disk SuperTen™

**DEALER & OEM INQUIRIES INVITED**  
**Telephone (206) 453-9777**

### **CMC INTERNATIONAL**

A Division of Computer Marketing Corporation  
11058 Main, Suite 125, Bellevue, WA 98004

on the screen and you can't remember the file name, you can go to another window and scroll through a list of files without having to exit any modes, invoke any programs, save any edits, lose sight of the destination file, or lose any time.

The Smalltalk-76 text-editing facilities not only relieve you of the burden of modes, they also require very few keystrokes and are easy to learn.

### Software-Development Aids

One of my summer projects in 1977 was to increase the speed and friendliness of the Smalltalk software-development environment by adding *inspect windows*, *browse windows*, and *notify windows* to the user interface. These and other enhancements made by the Learning Research Group are described below. In recent months, the team has further enhanced the Smalltalk-80 environment. Although it conforms to the same principles as before, its details are different from what is described in this article.

### Inspecting Data Structures

Suppose someone has given you a Smalltalk program to implement a "regular polygon" class (table 1) and you want to learn more about it. It would be helpful to see an actual instance of a regular polygon.

If the variable *triangle* refers to a regular polygon, you type the following statement into your work-space window:

```
triangle inspect
```

and then issue the "do it" command in the pane menu (photo 12a). In a few seconds, a two-paned "inspect window" appears on the screen. Its title tab tells you the class of the inspected object, in this case, *RegularPolygon*. The window is divided into two panes. The left or *variable pane* lists the parts of a regular polygon, *sides*, *center*, *radius*, and *plotter*. The right or *value pane* is blank.

You point to the word *sides* in the variable pane and click the selection button on the mouse. The word *sides* is highlighted, and in the value pane, the value of the variable *sides* appears (photo 12b), in this case, 3. You point to the word *center* and click. In the value pane appears the value of *center* (photo 12c), in this case, the point 526@302. The value pane is *dependent* on the variable pane because its contents are determined by what you select in the variable pane. The arrow in figure 3 symbolizes this dependency.

Let's inspect the value of *center*. In the variable pane, where *center* is selected, pop up the pane menu and issue



Figure 3: Principal dependencies among panes of an inspect window.

# EPSON PRODUCTS

## MX80/70 FRICTION FEED KIT by Orange Micro

HERE AT LAST! A friction feed kit for your EPSON MX80/70. The kit allows the user to convert his Epson printer to a friction feed and pin feed mechanism.

The friction feed will accept single sheets of your letterhead, or multiple copy forms such as invoices with up to 4 part carbon copies.

The pin feed replaces the adjustable sprocket mechanism. It allows use of 9½" wide continuous fan-fold paper which is an industry standard size.

No drilling required. Installation takes about 15 minutes. All parts are included with easy to follow instructions.



**\$75.00**

DEALER INQUIRIES  
INVITED

## EPSON MX80



- 9 x 9 dot matrix • Lower case descenders • 80 CPS • Bidirectional, Logic seeking • 40, 66, 80, 132 columns per line • 64 special graphic characters: TRS-80 Compatible • Forms handling • Multi-pass printing • Adjustable tractors.

MX80 ..... (List \$645) \$ CALL  
MX80 Dot Graphics Upgrade..... (List \$100) \$ CALL

## EPSON MX70



- Super low-priced dot resolution graphics • 5 x 7 dot matrix • User replaceable printhead • Top of Form.

MX70 ..... (List \$495) \$ CALL

## EPSON MX80 FT



- Same basic features as the MX80 • PLUS friction feed for single sheets • and adjustable tractors.

MX80 FT ..... (List \$745) \$ CALL

## APPLE INTERFACE For Epson

The Grappler™ interface card is the first to provide on-board firmware for Apple high resolution dot graphics. No longer does the user need to load clumsy software routines to dump screen graphics — it's all in a chip. Actually, it's our E-PROM, and it is replaceable to accommodate the Anadex, Epson MX80 & MX70, IDS Paper Tigers, Contronics 739, and future graphics printers. The Grappler™ accepts 17 software commands including Hi-Res inverse, 90° rotation, double size, and much more.



**\$165.00**

Includes Cable  
DEALER INQUIRIES  
INVITED

# Orange Micro

**"THE COMPUTER PRINTER SPECIALISTS"**

**UP TO 25% DISCOUNTS! — SAME DAY SHIPMENT!**

**NEW**

## CENTRONICS 739 (RADIO SHACK LINE PRINTER IV)

*With Graphics and Word Processing Print Quality*



- 18 x 9 dot matrix; suitable for word processing • Underlining • proportional spacing • right margin justification • serif typeface • 80/100 CPS • 9½" Pin Feed/Friction feed • Reverse Platen • 80/132 columns • Top of form

CENTRONICS 739-1 (Parallel)..... (List \$995) \$ Call  
CENTRONICS 739-3 (Serial) ..... (List \$1045) \$ Call

## VISTA — C. ITOH

*Daisy Wheel Letter Quality*



- 25 CPS (Optional 45 CPS) • Typewriter quality • Centronics parallel • RS 232 Serial (Optional) • Proportional spacing • Bidirectional • Programmable VFU • Self test • Diablo compatible • Friction feed (Optional tractors) • 136 printable columns • Manufactured by C. ITOH.

VISTA V300 (C. ITOH) ..... (List \$1895) \$ Call

## ANADEX

*Dot Graphics, Wide Carriage*



- 11 x 9 dot matrix; lower case descenders • Dot resolution graphics • Bi-directional, logic seeking • Up to 200 CPS • RS 232 Serial & Parallel • Forms control • X-ON/X-OFF • Up to 6 part copy.

ANADEX 9501 ..... (List \$1650) \$1350

## ANACOM

*Low Cost, High Speed, Wide Carriage*

- 9 x 9 dot matrix • Lower case descenders • Wide carriage • Adjustable tractors to 18" • 150 CPS, Bidirectional, Logic Seeking

ANACOM 150 ..... (List \$1350) \$ Call

## MALIBU 165

*The Small Business Printer; Letter Quality & Speed.*

- 10 x 9 dot matrix • Letter quality print; Lower case descenders • High speed; 165 CPS, Bidirectional, Logic seeking • Wide carriage • Vertical forms control • User programmable character set • Dot Resolution Graphics.

## NEC SPINWRITER

*High Speed Letter Quality*

- 55 CPS • Typewriter quality • Bidirectional • Plotting • proportional spacing.

5510-5 RO, Serial, w/tractors ..... (List \$2995) \$2650  
5530-5 RO, Parallel, w/tractors..... (List \$2970) \$2825

## AXIOM

*Dot Graphics, Low Price*



- Dot addressable graphics • 70 CPS • 12 characters per inch • 80 columns • adjustable tractors • 3 part copies • Manufactured by Sieko • Parallel, RS232 serial, IEEE-488 interfaces available.

AXIOM GP-80M ..... (List \$399) \$349

## TELEVIDEO CRT'S

**AT DISCOUNT PRICES!**



TVI 912C } Please Call Toll Free  
TVI 920C } Prices are too low to  
TVI 950 } advertise

QUANTITY PRICING AVAILABLE

## IDS PAPER TIGERS

*Dot Resolution Graphics, quality print, speed*



- 7 wire printhead (445); 9 wire printhead (480) with lower case descenders • Over 150 CPS • bi-directional, logic seeking (480) • 8 character sizes; 80-132 columns • Adjustable tractors • High-resolution dot graphics • Proportional spacing & text justification (480).

IDS 445G 7 wire printhead, graphics ..... (List \$895) \$ 750  
IDS 480G 9 wire printhead, graphics ..... (List \$1394) \$1150  
IDS 560G 9 wire, wide carriage, graphics ..... (List \$1794) \$1590

## PRINTERS

MALIBU 165 wide carriage, graphics, letter quality .. (List \$2495) \$ 1975  
QUME 5/45 typewriter quality ..... (List \$2905) \$ 2559

## INTERFACE EQUIPMENT

CCS APPLE PARALLEL interface & cable ..... \$ 150  
ORANGE INTERFACE for Apple II parallel interface board & cable ..... \$ 110  
MICROTRONICS Atari parallel interface ..... \$ 89  
ATARI 850 interface module, serial/parallel ..... \$ 189  
TRS-80 CABLES to keyboard or Exp. interface ..... \$ Call  
NOVATION D-CAT direct connect modem..... \$ Call

**CALL FOR FREE CATALOG**

**(800) 854-8275**  
**CA, AK, HI (714) 630-3322**

*At Orange Micro, we try to fit the right printer to your application. Call our printer specialists for free consultation.*

TELEPHONE ORDERS: Mon.-Fri. 8:30 - 5:00  
The Orange Micro Printer Store (Retail):  
Mon.-Fri. 10:00 - 6:00, Sat. til 4:00

Phone orders WELCOME; same day shipment. Free use of VISA & MASTERCARD. Personal checks require 2 weeks to clear. Manufacturer's warranty included on all equipment. Prices subject to revision.

**Orange Micro, Inc.**  
3150 E. La Palma, Suite I  
Anaheim, CA 92806

The following template contains a description of a regular polygon with the following attributes:

- sides            Number of sides (3 for a triangle, 5 for a pentagon, etc.).
- center          If the regular polygon were inscribed in a circle, this would be its center point.
- radius          If the regular polygon were inscribed in a circle, this would be its radius.
- plotter         A pen that can draw an image of the polygon on the screen or on paper.

The following expressions provide an example of creating and using an instance of RegularPolygon .

triangle — RegularPolygon sides: 3 radius: 50.

triangle translateBy -90 @ 60.  
triangle plot: black.

triangle translateBy: 165 @ 20.  
triangle scale: 0.6.  
triangle plot: gray            "where gray denotes an ink color"

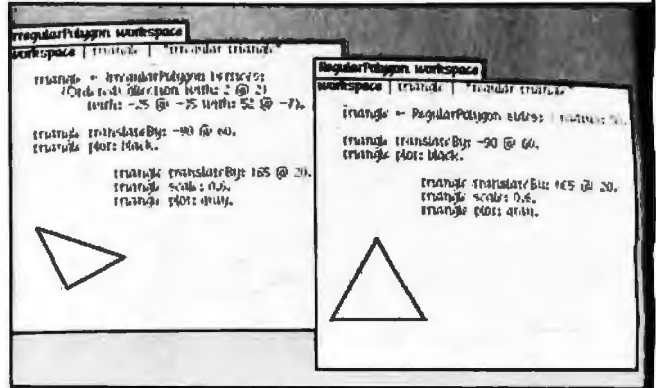

|                            |                             |
|----------------------------|-----------------------------|
| class name                 | RegularPolygon              |
| superclass                 | Object                      |
| instance variable names    | sides center radius plotter |
| class messages and methods |                             |

**initialization**

**sides: s radius: r | |**

"Create an instance of RegularPolygon whose center is located at the center of the currently active window on the display screen. Screen is a global variable that refers to the hardware display screen"

↑ self new sides: s radius: r center: (Screen activeWindow frame center)

**instance messages and methods**

**initialization**

**sides: s radius: r center: c | |**

"Initialize all attributes. Class Pen is provided in the system as one way of side effecting the display screen"

- sides — s.
- center — c.
- radius — r.
- plotter — Pen width: 2

**analysis**

**center | |**

↑center

"Answer the center coordinate of the polygon."

**sides | |**

↑sides

"Answer the polygon's number of sides"

**display**

**plot: Ink | |**

- plotter penup.            "Draw an image of the polygon using the specified ink color"
- plotter goto: self center   "lift the pen to disable drawing"
- plotter up.                "position the pen at the center"
- plotter go: radius.        "face the top of the screen"
- plotter turn: 180 - (self cornerAngle/2)   "position at a corner"
- plotter color: ink.        "turn to face along a side"
- plotter pendn.            "select the ink color"
- ↑ to: sides do:            "lower the pen to enable drawing"
- [:] | plotter go: self sideLength.    "for each side of the polygon"
- plotter turn. 180-self cornerAngle]   "plot that side"
- "turn to face along the next side"

**transformation**

**scale: factor | |**

"Scale the polygon radius by the specified factor"

radius — radius \* factor

**translateBy: deltaXY | |**

"Change the polygon's location by the specified amount (a Point)"

center — center + deltaXY

**private instance methods**

**cornerAngle | |** "Answer the interior angle of any vertex, in degrees"

↑ 180 - (360 / sides)

**sideLength | |** "Answer the length of any one of the equal sides"

↑ 2 \* radius \* (self cornerAngle / 2) degreesToRadians cos

**Table 1: Description and class template for class RegularPolygon.**



## Take Your Cue From Vista . . .

When it comes to Apples, take your cue from Vista's A800 Eight-Inch Floppy Disk Controller. The A800 offers a cost-efficient approach to software compatible disk memory expansion for your Apple II® computer. The A800 Controller enables Apple II users to access up to five megabytes of online storage through conventional disk operating (DOS) commands.

The Control and DMA Logic provides high speed (1 microsecond per byte) transfer of data from the disk drive directly to the Apple II memory without processor intervention. Plus, the Phase-Locked Loop Data Separator provides the ultimate in data reliability.

### AND THERE'S MORE.

The controller is compatible with the most popular disk operating systems for the

**It's a  
Sure  
Shot.**

Apple II computer. It also interfaces to all Shugart/ANSI Standard Eight-Inch Floppy Disk Drives. The A800 provides complete IBM format compatibility in both single and double-density modes.

### THE HOT SHOT AT A COOL PRICE.

The A800 is reasonably priced at \$595. A price you can't beat when you compare its quality and performance.

### CALL YOUR SHOTS.

Vista offers you a complete line of peripheral equipment to maximize the capabilities of your Apple system including: High capacity Mini-floppy Disk Drives, the Vista Music Machine 9 and the Vista Model 150 Type Ahead Buffer. In addition, Vista offers a line of advanced components fully compatible with the TRS-80\* and S-100 based computers.

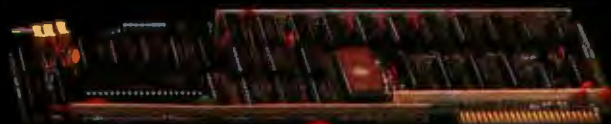

**Vista** Computer  
Company  
1317 E. Edinger Avenue  
Santa Ana, CA 92705  
(714) 953-0523

Call Toll Free 800-854-8017

© Apple II is a registered trademark of Apple Computers, Inc.  
\* TRS-80 is a trademark of Radio Shack, A Tandy Co.

the "inspect" command (photo 12d). On the screen appears another inspect window showing that center is an instance of class Point (photo 12e). You can now ex-

amine that point's variables, x and y, reactivate the original inspect window, close either or both windows, or work in any other window. You are not in a mode.

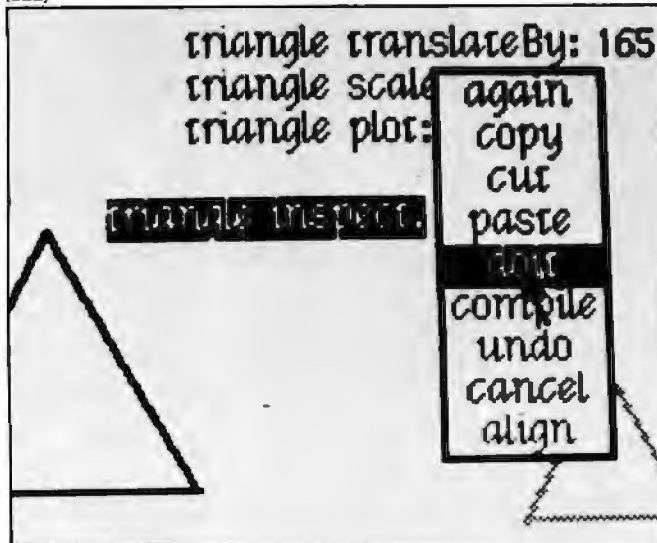

(12a)

### Browsing Through Existing Definitions

Now that you have inspected a sample regular polygon, you might want to find out what methods have been defined in its class. One way to do this is to activate a window called a "browse window" or "browser." Most Smalltalk programmers leave a browser or two on the screen at all times with the work-space window.

The title tab of the browser (photo 13a) says "Classes" because the standard browser lets you examine and change the definitions of all Smalltalk classes—classes supplied by the system, as well as classes supplied by yourself. It is easy to create a more restricted browser that protects the system from ill-conceived modification. But on a personal computer, you are just going to hurt yourself.

The browser has five panes. The principal dependen-

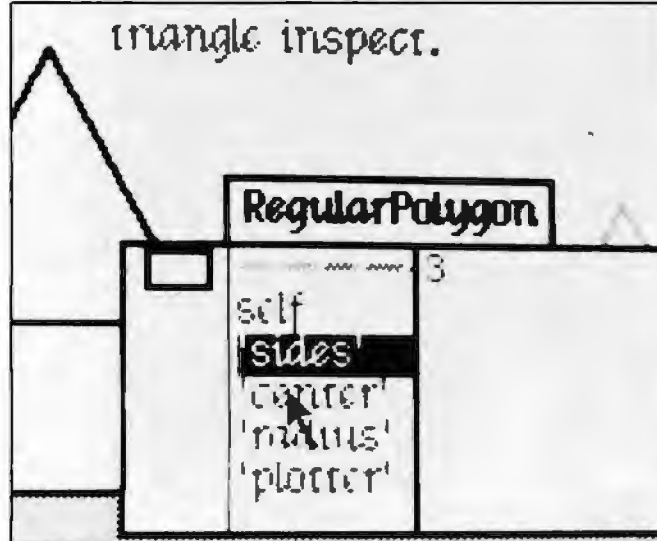

(12b)

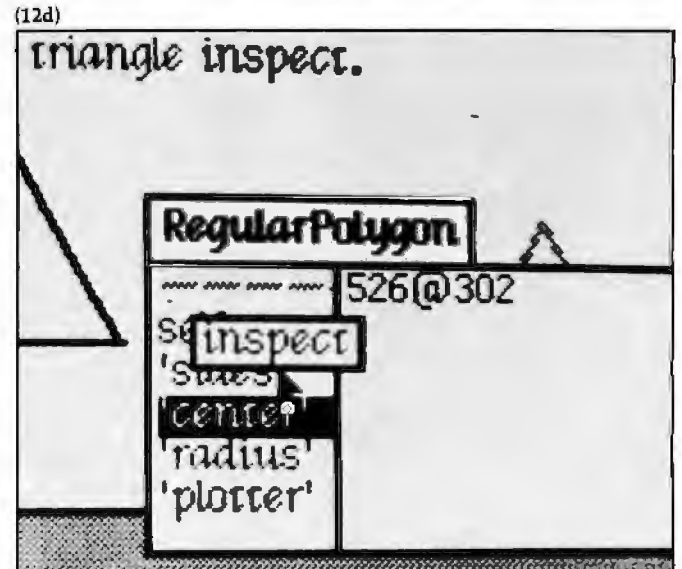

(12c)

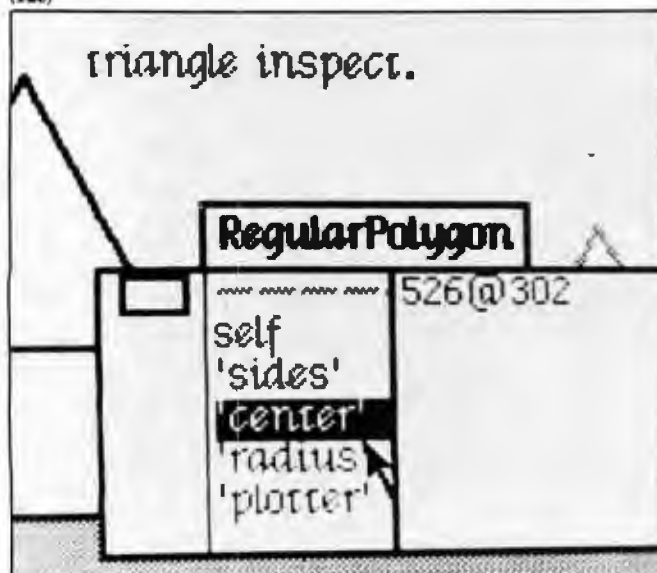

(12d)

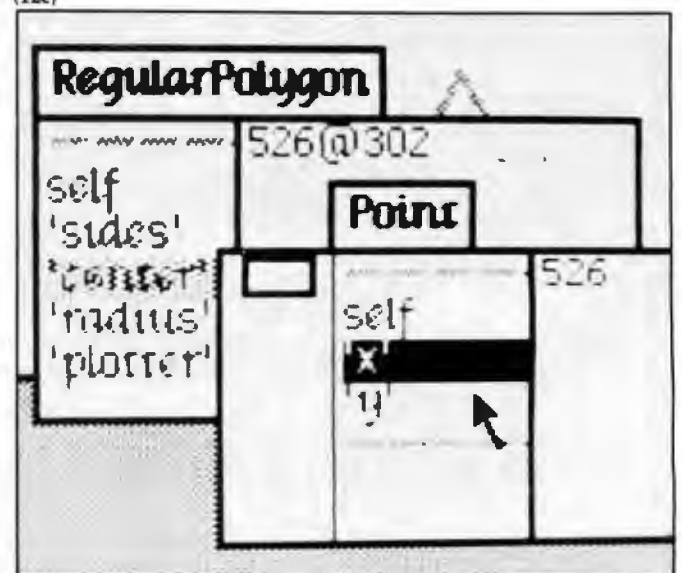

(12e)

Photo 12: Inspecting data structures in Smalltalk.



## **“Together we’re working to better serve mankind.”**

“Speaking on behalf of Vector computers, I’m pleased to announce that TRW Customer Service Division will provide a nationwide, nine-month on-site service warranty that you, the end-user, will receive absolutely free.\*

“I’d also like to add that this is a unique program. It’s actually the first time a microcomputer has had this kind of comprehensive nationwide on-site service — especially from a company of experts like TRW.

“Now you have even more security when you buy a Vector. In addition to increasing your personal productivity, helping you make faster decisions, and improving your business, we offer a network that will service us right in your office if we ever need it. At no expense to you.

“Right now, you can get quick, dependable service in Los Angeles, New York City, Denver, Dallas, Chicago, San Francisco, Northern New Jersey, Philadelphia, Atlanta, and Boston. With more cities on the way.

For more information and your nearest Dealer, call us at 800-423-5857. In California, call 800-382-3367. Or write to us at 31364 Via Colinas, Westlake Village, CA 91362.

“TRW and Vector. Now that we’re helping each other, there’s no telling how much we can accomplish for you.”

**VECTOR**  
Vector Graphic Inc.

**COMPUTERS FOR THE ADVANCEMENT OF SOCIETY.**

# ADD EXCITING MUSIC TO YOUR APPLE®!

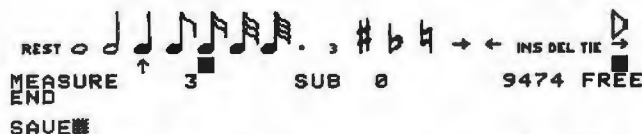

## A L F's 9-voice Music Card MC1 is only \$195.

### Here's what our customers have said:

(Excerpts from unsolicited letters. Copies of original letters available on request.)

#### About the A L F system:

It's a rare enough occurrence when hardware/software lives up to one's expectations. For something to exceed one's wildest hopes — as the ALF synthesizer certainly does — is a real treat. My congratulations to all concerned.

—Dhahran, Saudi Arabia

I myself have told several people that next to a disk, I consider the [ALF] synthesizer to be the most important peripheral they could purchase for their system. Very excellent job! Keep up the good work.

—Oak Ridge, Tennessee

I recently purchased 2 of your Apple music boards. Out of the peripherals I have for my Apple, I enjoy them the most. It has to be the most enjoyable thing that has ever been invented. I hope you continue to develop products as clever and enjoyable as this one. The Entry program has to be one of the most sophisticated programs I have ever seen. It proves that a hardware manufacturer DOES have the ability to also produce quality software. It is almost worth the price of the boards just for the Entry program.

—Burbank, California

#### About ease of use:

I have had my Music Card MC1 for a little more than a week now and I have almost completed entering "The Maple Leaf Rag". I found it to be a lot simpler than I thought and so I am very, very pleased. My family isn't because I sit up to all ends of the night playing with the blasted thing!

—Cypress, Texas

ALF has opened up my head and ears and enabled me to do things musically which I would like to be able to do on [conventional] instruments. As much as I love the instruments I try to play, I just don't have the talent and technique to play what is in my head. By golly, the ALF board doesn't know about my limitations, though. I can play hell out of that thing, playing notes and tempos which previously have existed only in my head. Many thanks from a frustrated musician and satisfied ALF "player".

—Demopolis, Alabama

#### About documentation:

I don't know much about hardware, but I have been a programmer for 15 years and I have never seen a better piece of software documentation than your user manual. It is a joy to study!

—Lancaster, California

#### About the competition:

Recently, I purchased an [ALF] 9-voice board and a couple of music albums. . . all I can say is that I wish I had listened and played with it before I purchased the Mtn. Hardware board. It sounds about the same and is vastly superior in software, ease of use, and price. The Entry program is a joy to use and it's easier than Mtn. Hardware's, but then, I guess you guys know that already. (Oh yes, you wouldn't happen to know of anyone that wants to buy a Mtn. Hardware system? \$450 or best offer?)

—Kirkland, Washington

I would like to tell you that after having used the system ONLY ONE DAY, that I am absolutely delighted with it. In addition, I purchased the three boards although I ALREADY own Mountain Hardware's music system. Now that I have seen and own your system, I am putting my "old" one up for sale. I think that your software makes it far easier to enter music, and that the software routines allow for far greater flexibility. Again, I extend my compliments to you. As I said, I have owned another music system, and consider myself therefore, qualified to make a judgement between the use of the two. Yours is the clear choice!

—Levittown, New York

See your local Apple® dealer or write:



**ALF Products Inc.**  
1448 Estes Denver, CO 80215

Apple is a trademark of Apple Computer Inc.

cies between panes are symbolized by arrows in figure 4. The top row has four panes called the *class-category pane*, *class pane*, *method-category pane*, and *method pane*. The large lower pane is called the *editing pane*. (After you have used the system for a few minutes, the significance of each pane becomes apparent, and it is not necessary to memorize their technical names.)

In photo 13a, the browser shows a method definition in the editing pane. You can tell that the method is class RegularPolygon's version of scale: because RegularPolygon is highlighted in the class pane and scale: is highlighted in the method pane.

The method-category pane lists several groups of methods within class RegularPolygon: **initialization**, **analysis**, **display**, **transformation**, **testing**, and **private methods**. You can tell that scale: is a transformation message in class RegularPolygon because that category is highlighted.

The class-category pane lists several groups of classes, including **numbers**, **files**, and **graphical objects**. You can tell that class RegularPolygon is in the **graphical objects** group because that category is highlighted.

Suppose you want to look at a different method, translateBy:. Click its name in the method pane and its definition is immediately displayed in that pane's dependent, the editing pane (photo 13b). If the method you want to see is in the method category **analysis**, first click that category name. Immediately after you do that, its dependent, the method pane, lists the methods in that category. Now you can click the name of the desired method (photo 13c).

If you want to know things about the class as a whole, like its superclass and field names, click "Class Definition" in the method-category pane and the definition appears in the editing pane (photo 13d).

Suppose you want to look at a different class, say IrregularPolygon. Click its name in the class pane and its method categories are immediately displayed in the next pane (photo 13e). If the class you want to see is in the class category **windows**, first click that category name. Immediately after you do that, the class pane lists the classes in that category. Now you can click the name of

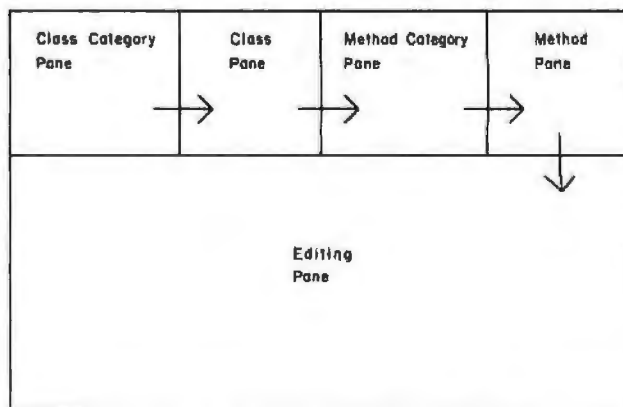

Figure 4: Principal dependencies among panes of a browse window.



# IF YOU CAN RECOGNIZE VALUE YOU CAN SAVE **\$500<sup>00</sup>**

## TRS-80<sup>®</sup> MOD III\*

FIRST...

We lowered the prices of  
the Model III from \$2499\* to

# \$1998

\*We have taken the basic 16K Model III expanded  
the memory to 48K and added our MTI Double  
Density, Dual Disk Drive system. System is fully  
compatible with Radio Shack DOS and peripherals.

### MOD III/EXPANDED

Same as above but has double storage capacity  
(708K storage). Your choice of 2 dual headed 40  
track drives or 2 single headed 80 track disk drives.  
Includes Microsystems DOS plus 3.3.

# \$2499



### MOD III/280

Our largest MOD III, approximately 1.5 mega bytes  
of storage, utilizes 2 dual headed 80 track, double  
density disk drives. Complete with manuals and  
professional operating system, Microsystems DOS  
plus 3.3 (40 & 80 track capability).

# \$2799

MTI has a complete line of **COMPUTER** add ons:

|   |                         |   |           |
|---|-------------------------|---|-----------|
| <b>INTERNAL DISK KIT 40 OR 80 TRACK</b> |                         | <b>EXTERNAL DISK KIT 40 OR 80 TRACK</b> |           |
| Drive Kit #1 from \$699                 | Drive Kit #3 from \$379 | TRS DOS & Manual \$21.95                |           |
| Drive Kit #2 from \$279                 | Drive Kit #4 from \$359 | DOS PLUS                                | from \$99 |

### MTI MOD III SALES, PARTS & SERVICE CENTERS - INDEPENDENT DEALERS

|                               |                                  |                                |
|-------------------------------|----------------------------------|--------------------------------|
| ARIZONA ..... (602) 839-0546  | NEW YORK ..... (212) 728-5252    | SAN DIEGO ..... (714) 281-0285 |
| SAN JOSE ..... (408) 427-0836 | CALL NORTH TIER.. (701) 594-5674 | TEXAS ..... (214) 247-6679     |
| MIDWEST ..... (618) 345-5068  |                                  | GEORGIA ..... (404) 449-8982   |



### MICROCOMPUTER TECHNOLOGY INC.

3304 W. MACARTHUR, SANTA ANA, CA 92704

• (714) 979-9923 • TELEX 6780401 TABIRIN •

• TRS-80 IS A REG. TRADEMARK OF TANDY CORP. \*Uses MTI Memory Disk Drives & Components



PRICES  
F.O.B. SANTA ANA

the desired class (photo 13f).

Categorization is used at both the class and method level to help the programmer organize his or her program and to provide fewer choices in each pane. If a list is longer than what can fit in a pane, it can be scrolled by pressing a mouse button with the cursor in the scroll bar.

If you just want to browse around reading class and method definitions, you can do so by lazily clicking the selection button with the cursor over each name, never touching the keyboard. That is why the window is called a browser. Browsers are further discussed in references 6 and 7.

Astute readers may have noticed that the class template (see "The Smalltalk-80 System" by the Learning Research Group on page 36 of this issue) presents the methods of a class apart from the methods of its in-

stances, while the browser does not. This discrepancy stems from differences between the Smalltalk-80 and Smalltalk-76 languages.

### Revising Definitions

If you are looking at a method definition or class definition in the editing pane, you can revise it using the standard text-editing facilities (select, type, cut, paste, copy).

If you like, you can copy information into the definition from other windows—including other browse windows—because you are not in any mode while browsing. You can even interrupt your editing to run another program, list your disk files, draw a picture, or do whatever you like. You can later reactivate the browser and continue editing.

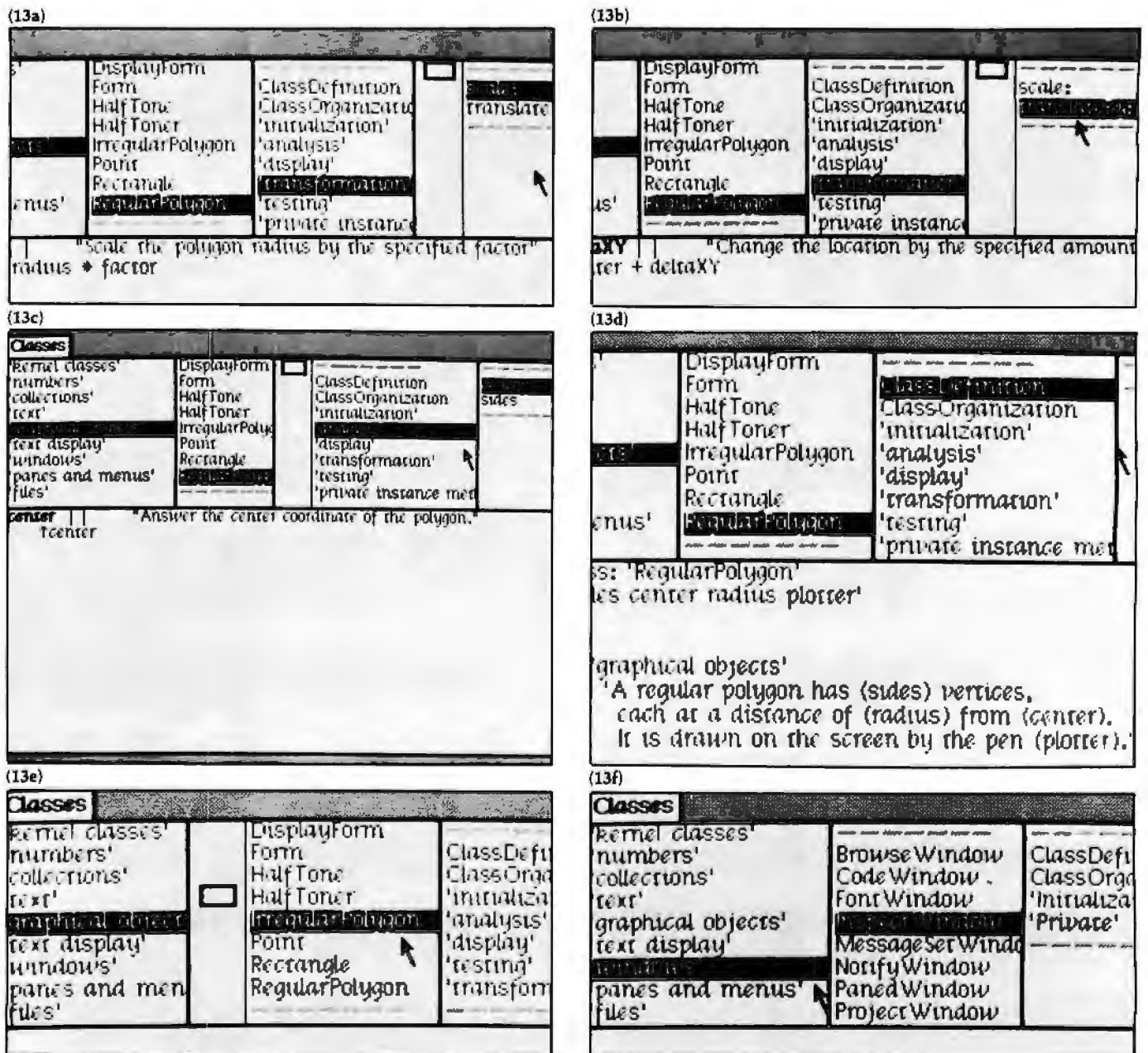

Photo 13: Browsing through existing definitions in Smalltalk.



**PERT/CPM TIMESAVER**

As a project manager, you know the value of careful planning. Oversights and miscalculations can cost you crucial time and money.

MILESTONE is a powerful "Critical Path" Program that can be used for planning and analyzing virtually any project, from the opening of a retail store, to charting the progress of a police investigation; from drawing up a cost estimate for a construction project to scheduling the development (and involved expenses) of a new computer; from keeping track of rental equipment to allowing a winery to chart the evolution of a vintage Chardonnay from harvest to bottling. The applications are endless.

What's more, MILESTONE is one of the easiest software packages to use. Once



the working days, skill categories, wages or salaries and time increments are defined, then MILESTONE is ready to do the work for you. Change, for instance, the estimated completion date of a particular time-critical task, and you'll instantly see it's effect on the entire project. All scheduling, manpower costs, associated reports, etc. are immediately re-tabulated. A calendar display allows you to visually follow the activities (200 per project with 64K RAM, 100 with 56K RAM). Examples are included on the disk.

TIME IS MONEY. SAVE BOTH WITH MILESTONE.

Price is \$295. Manual alone—\$30.

SOFTWARE  
SOFTWARE  
DIGITAL MARKETING  
DIGITAL MARKETING

2670 Cherry Lane • Walnut Creek, CA 94596  
(415) 938-2880

Dealer Inquiries invited.  
Dealers outside California call (501) 442-0864.  
Inside California call (415) 938-2883.

# MILESTONE™ WHEN TIME IS MONEY.

A PROJECT MANAGEMENT  
AND TIME SCHEDULING  
PROGRAM.

Circle 115 on inquiry card.

Milestone is a trademark of Organic Software.  
CPM is a trademark of Digital Research.  
MILESTONE requires 56K RAM and  
CP/M. Also available for CP/M-86, Apple  
Pascal and UCSD Pascal. Specify 8080,  
Z80, CDOS, 8086, UCSD Pascal or Apple  
Pascal. Formats: 8" single density IBM  
soft-sectored, 5 1/4" NorthStar DD,  
Micropolis Mod II, Superbrain 3.0, Apple II.

The following template contains a description of an irregular polygon with the following attributes:

- vertices            An OrderedCollection of Points.
- plotter            A pen that can draw an image of the polygon on the screen or on paper.

The following expressions provide an example of creating and using an instance of IrregularPolygon.

```
triangle — IrregularPolygon vertices.
              (OrderedCollection with: 2 @ 21
              with: -25 @ -35
              with: 52 @ -7).
```

```
triangle translateBy: -90 @ 60.
triangle plot: black.
```

```
triangle translateBy: 165 @ 20.
triangle scale: 0.6.
triangle plot: gray. "where gray denotes an ink color"
```

|                               |  |
|-------------------------------|--|
| class name                    | IrregularPolygon   |
| superclass                    | Object   |
| instance variable names       | vertices plotter   |
| class messages and methods    |  |
|                               | <pre> <b>initialization</b> <b>vertices: aCollection    </b> "Create an instance of IrregularPolygon whose center is located at the center of the currently active window on the display screen Screen is a global variable that refers to the hardware display screen." 1 self new vertices: aCollection center: (Screen activeWindow frame center) </pre>  |
| instance messages and methods |  |
|                               | <pre> <b>initialization</b> <b>vertices: aCollection center: c    </b> "Initialize all attributes. Class Pen is provided in the system as one way of side effecting the display screen " vertices — aCollection. plotter — Pen width: 2. self translateBy: c - self center  <b>analysis</b> <b>center   sum  </b> sum — 0@0. vertices do: [ :pt   sum — sum + pt]. 1 sum / self sides  <b>sides    </b> 1 vertices size  <b>display</b> <b>plot: Ink    </b> plotter penup. plotter goto: vertices last. plotter color: ink. plotter pendn. vertices do:   [ :pt   plotter goto: pt]  <b>transformation</b> <b>scale: factor   center  </b> "Scale the polygon by the specified factor " center — self center vertices — vertices collect:   [ :pt   (pt - center)*factor + center]  <b>translateBy: deltaXY    </b> "Change the polygon's location by the specified amount (a Point) " vertices — vertices collect: [:vertex   vertex + deltaXY] </pre> |

Table 2: Description and class template for class IrregularPolygon.

# THE HARD EDGE

AND STILL THE LEADING EDGE . . .  
IN SYSTEM PERFORMANCE



## Hard Disk and Streaming Tape

*reliability and versatility that can't be beat*

### OEM CONTROLLERS

- Multibus
- General Purpose
- S100



**S33**

- 31 or 62 MByte formatted
- Lowest cost/MByte from any manufacturer
- CP/M\* compatible "drop in" BIOS
- Single S100 card controller
- Fully expandable up to four drives, 8" or 14"
- Reliable high performance Prim Winchester Disks
- Immediate delivery



**S10**

- 10.5 or 32 MByte formatted



**SYSTEM 8**

- 8" Winchester 10 or 32 MByte formatted
- Integrated streaming cartridge backup
- Streaming backup at 5 MB/min
- Selective file backup under CP/M
- Versatile parallel I/O or DMA interface

# ADES

ADAPTIVE DATA & ENERGY SYSTEMS

2627 Pomona Boulevard • Pomona, CA 91768

Phone: (714) 594-5858

When you are done editing, pop up the active-pane menu and issue the "compile" command (photo 14a). Compilation takes a few seconds or less because it is incremental—that is, you can compile one method at a time. The compiler reports a syntax error to you by inserting a message at the point where the error was

detected and automatically selecting that error message (photo 14b). You can then cut out or overtyp the message, make the correction, and immediately reissue the "compile" command.

If you start to revise a definition and change your mind about it, you can pop up the pane menu and issue the

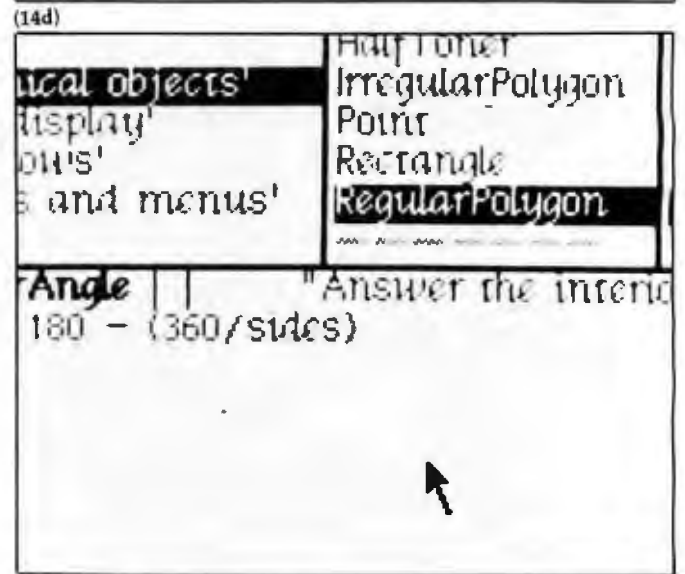
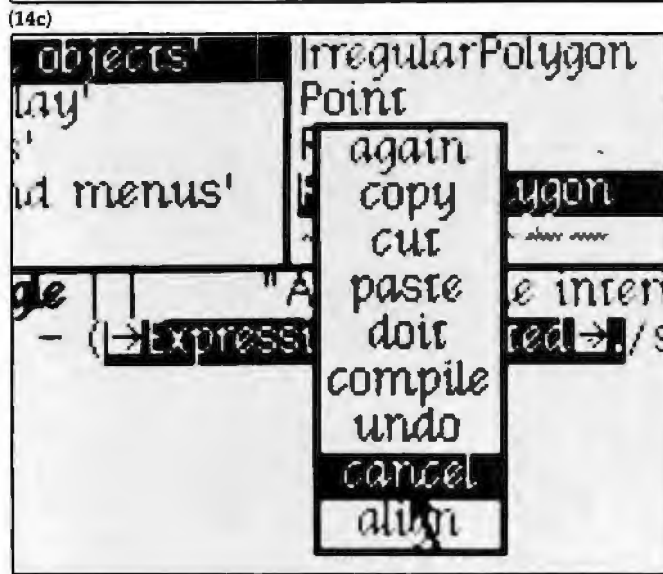
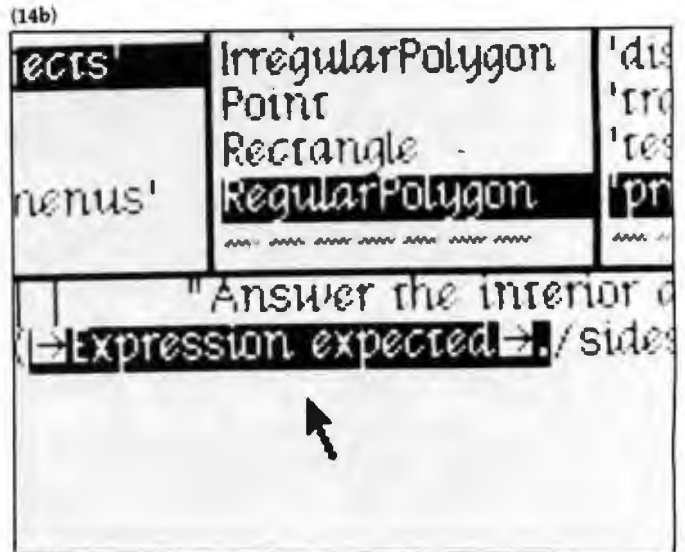
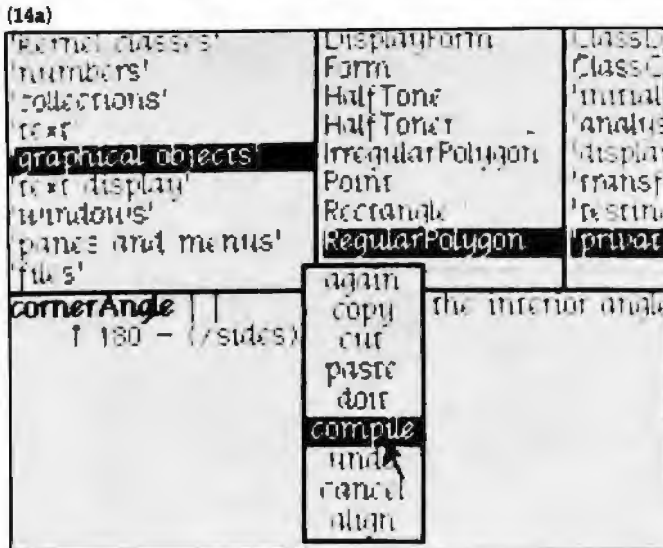

Photo 14: Options during method compilation.

**6809 SYSTEMS** ☺ **6809 SYSTEMS** ☺ **6809 SYSTEMS** ☺ **6809 SYSTEMS** ☺

Featuring the GIMIX mainframe with 30 amp C.V. ferro-resonant power supply; fifteen 50 pin and eight 30 pin slot Mother Board; 2 Mhz CPU with time of day clock & battery back-up, 1K RAM, 6840 programmable timer, provisions for 9511A or 9512 Arithmetic processors, and 4 PROM/ROM/RAM sockets that can hold up to 32KB of monitor or user software.

**VARIETY:** you can have 32KB, 56KB, 128KB and up of static RAM. You can use 5" and/or 8" disk drives, single or double density, single or double sided, and single or double tracking with GIMIX disk controllers. You have a wide choice of serial or parallel I/O cards.

**EXPANDABILITY:** You can add memory, I/Os, Video or Graphics cards, Arithmetic processors, additional drive capacity, and other hardware now or in the future to this SS50 bus structured system from GIMIX or other SS50 bus compatible manufacturers.

**SOFTWARE VERSATILITY:** GIMIX systems can use TSC's FLEX or UNIFLEX and MICROWARE'S OS-9 operating systems. A wide variety of software and languages is available for these systems.

**QUALITY:** All boards are assembled, burned-in, and tested and feature **GOLD PLATED BUS CONNECTORS**. Only top quality components are used and all boards are fully buffered for maximum system expansion. All boards come complete with bus connectors and all necessary instruction and documentation.

GIMIX designs, manufactures and tests, in-house, their complete line of products. Complete systems are available to fill your needs. Please contact the factory if you have any special requirements.

For further information, pricing and brochures, contact:

**GIMIX inc.**  
The Company that delivers Quality Electronic products since 1975.  
1337 WEST 37th PLACE, CHICAGO, IL 60609  
(312) 927-5610 • TWX 910-221-4055

GIMIX® and GHOST® are registered trademarks of GIMIX Inc.

Flex and Uniflex are trademarks of Technical Systems Consultants Inc. OS9 is a trademark of Microware Inc. See their ads for other GIMIX compatible software.

For GIMIX compatible software see Technical Systems Consultants ad page 183 and Microware ad page 112.

# MULTIUSER



COMPUTER  
ON S-100 BUS  
DESIGNED TO  
SATISFY A WIDE  
VARIETY OF  
APPLICATIONS.

STANDARD FEATURES  
INCLUDE: CP/M 2.2  
OPERATING SYSTEM, 64K  
EXPANDABLE, BANKSE-  
LECTABLE MEMORY, 4MHZ  
Z80A CPU WITH 4 SERIAL  
AND 3 PARALLEL PORTS,  
RELIABLE 8" FLOPPY DISK  
DRIVES IN A STURDY ALL  
METAL CABINET.

\$ 4900

MP/M OPTIONAL.

CP/M AND MP/M REGISTERED TRADE MARKS OF DIGITAL RESEARCH

**ZOBEX**<sup>®</sup>

P.O. BOX 1847 SAN DIEGO, CA. 92112

7343-J RONSON RD, SAN DIEGO, CA. 92111

(714) 571-6971

# We're #1 to the world.





# For two good reasons.

**M**ore people fly on Pan Am from America to places overseas than on any other airline.

Because Pan Am provides more of what demanding travelers demand.

Comfort and convenience.

For example, take comfort. To the Pan Am passenger, that may mean the unabashed luxury of First Class.

With its spacious cabin and Sleeperette seats.

(A Pan Am first, we might add.)

Or comfort could be Clipper® Class. Our separate section especially for business travelers. In Clipper Class, no one sits in the middle. No matter where in the world one is flying.

Sleeperette service® and Clipper Class are available on most of our widebodies. And we've got more widebodies than any other airline.

But offering more widebodies is just the beginning of our convenience story. For another chapter, consider this:

Pan Am can take passengers from more of the U.S. to more of the world than any other airline. From 25 U.S. cities to 47 cities around the world.

All with one ticket. One baggage check-in. On one airline.

If all this isn't reason enough to get you to fly us, we've got more coming. More ways to make your trip even more comfortable. Even more convenient.

Because at Pan Am, we intend to keep on giving you reasons for making us your number one choice.

**Say hello to  
Pan Am.**

#### United States

Detroit  
Fl. Lauderdale /  
Hollywood  
Fort Myers  
Honolulu  
Houston  
Jacksonville  
Las Vegas  
Los Angeles  
Melbourne  
Miami  
Mobile  
Newark  
New Orleans  
New York  
Norfolk  
Orlando  
Pensacola  
Phoenix  
San Diego  
San Francisco  
Sarasota / Bradenton  
Seattle / Tacoma  
Tampa / St. Pete  
Washington, D.C.  
West Palm Beach

#### Caribbean

San Juan

#### Central and South America

Buenos Aires  
Caracas  
Guatemala City  
Maracaibo  
Mexico City  
Montevideo  
Panama City  
Rio de Janeiro  
San José  
Santiago de Chile\*  
São Paulo

#### Europe

Berlin  
Frankfurt  
Hamburg  
London  
Munich  
Nuremberg  
Paris  
Rome  
Stuttgart  
Warsaw

#### The Middle East and Africa

Abidjan  
Accra  
Ankara  
Bahrain  
Dakar  
Dhahran  
Istanbul  
Lagos  
Monrovia  
Nairobi

#### The Far East and Pacific

Auckland  
Bangkok  
Beijing (Peking)  
Bombay  
Delhi  
Guam  
Hong Kong  
Karachi  
Manila  
Melbourne  
Osaka  
Shanghai  
Singapore  
Sydney  
Tokyo

\* Subject to government approval

**PAN AM**

"cancel" command (photo 14c). The "cancel" command *redisplay*s the last successfully compiled version of the method (photo 14d). If you cancel by accident, just issue the "undo" command to return the revised version.

### Adding New Definitions

To add a new method definition, select a method category. In the editing pane, a *template* appears for defining a new method (photo 15a). The template reminds you of the required syntax of a method.

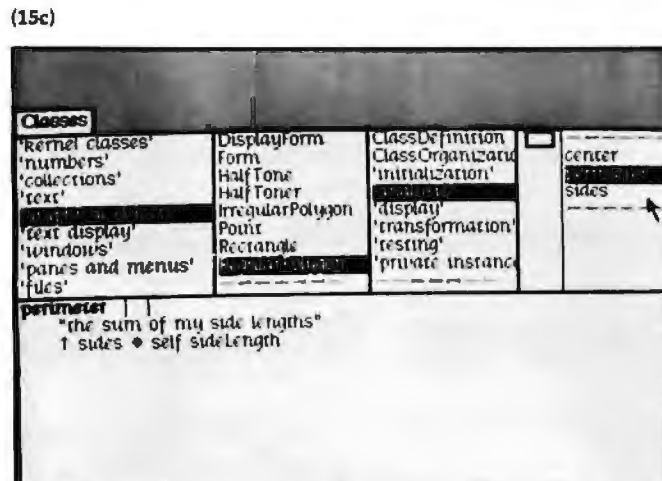
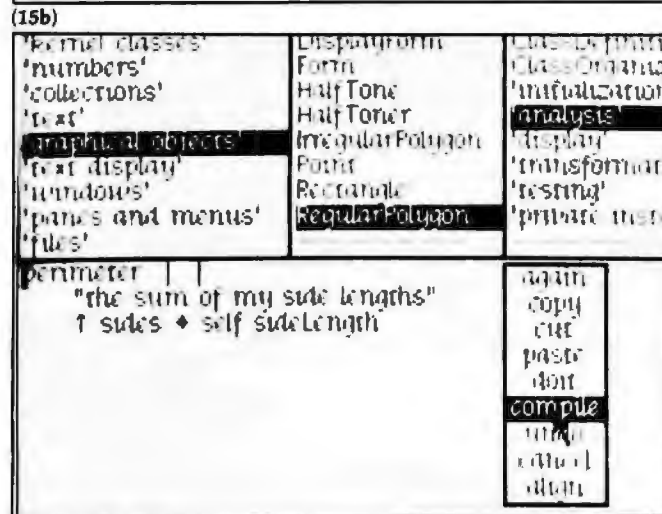
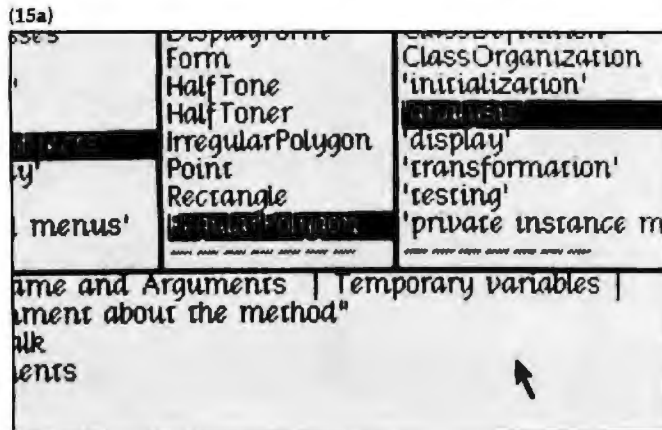

Use standard editing facilities to supply the message pattern, variable list, and body of the method. When the definition is ready, issue the "compile" command (photo 15b).

Once compilation succeeds, the selector of the new method is automatically added to the alphabetized list in the method pane, and the message pattern is automatically changed to boldface in the editing pane (photo 15c).

A new class definition is added in an analogous manner. Start by selecting a class category (photo 15d), then fill in a template for defining a new class and compile it (photo 15e). New categories can be added and old categories can be renamed and reorganized.

### Program Testing

Let us purposely add a bug to a method and see how it can be tracked down and fixed.

Browse to the method *cornerAngle* in class *RegularPolygon*, cut out the characters "180 —" (photo 16a), and recompile it. In the *RegularPolygon* work-space window, select the test program and issue the "do it" command (photo 16b). Instead of the desired triangle, an open three-sided figure is drawn because of the bug introduced into the angle calculation.

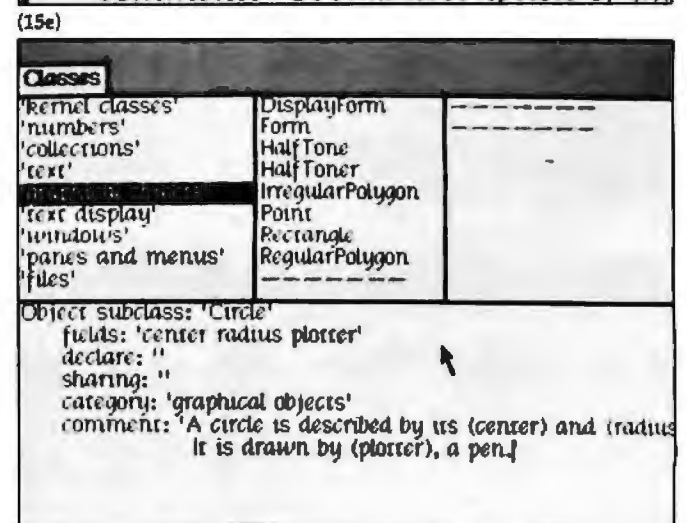
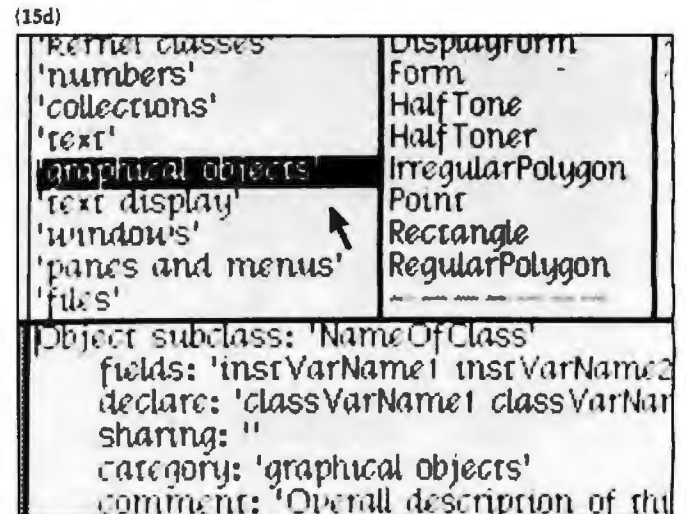

Photo 15: Adding new definitions in Smalltalk.

# C ~~AND~~ Pascal

## Efficiency ~~AND~~ Portability

## Flexibility ~~AND~~ Strong Typing

**Now you don't have to compromise!**

Whitesmiths Ltd. now offers portable language development systems for four families of computers. Approximately one thousand installations use our software.

We support complete versions of both C and Pascal, as compilers and cross-compilers. You get C automatically when you license Pascal, and you get native support with each cross-compiler. Test the software on your VAX before burning PROMs for your 68000 or 8080.

Whitesmiths Ltd. offers a variety of licensing arrangements, the simplest being a binary license for use on a single CPU. The full source code is available with internal documentation. Maintenance, training and sublicensing rights may also be obtained.

Call or write for more information.

| Source Operating Systems  | Target Machines             |                           |                           |                             |
|---|-----------------------------|---------------------------|---------------------------|-----------------------------|
|   | 8080 / Z80                  | LSI-11 / PDP-11           | VAX-11                    | M68000                      |
| <b>8080 / Z80</b><br>CP/M   | C: \$750<br>Pascal: \$950   | *                         | *                         | *                           |
| <b>LSI-11 / PDP-11:</b><br>Idris, Unix, RT11,<br>RSX-11/M,<br>RSTS/E, IAS | C: \$1350<br>Pascal: \$1550 | C: \$750<br>Pascal: \$950 | *                         | C: \$1350<br>Pascal: \$1550 |
| <b>VAX-11</b><br>Unix / V32<br>VMS  | C: \$1350<br>Pascal: \$1550 | *                         | C: \$750<br>Pascal: \$950 | C: \$1350<br>Pascal: \$1550 |
| <b>M68000</b><br>VERSAdos   | *                           | *                         | *                         | C: \$750<br>Pascal: \$950   |

Idris is a trademark of Whitesmiths, Ltd. ■ Unix is a trademark of Bell Laboratories ■ CP/M is a trademark of Digital Research Company ■ VMS, RSX-11/M, RSTS/E, LSI-11, VAX, are trademarks of Digital Equipment Corporation ■ VERSAdos is a trademark of Motorola Corporation

\*Special Order

Protect your software investment.

# Whitesmiths, Ltd.

P.O. Box 1132 Ansonia Station New York, N.Y. 10023 (212) 799-1200 Telex 645 592

Distributors: **Australia**

Fawcay Pty Ltd.  
Brighton-Le-Sands  
522 5574

**Japan**

Advance Industries  
Chiyoda-ku, Tokyo  
03-258-0839

**United Kingdom**

Real Time Systems  
Newcastle upon Tyne  
0632 733131

## Breakpoints

To track down the bug, let us set a breakpoint in the method `cornerAngle`. Using standard editing facilities, add the statement:

```
self notify: 'about to calculate angle'.
```

before the return statement (photo 16c). Now rerun the

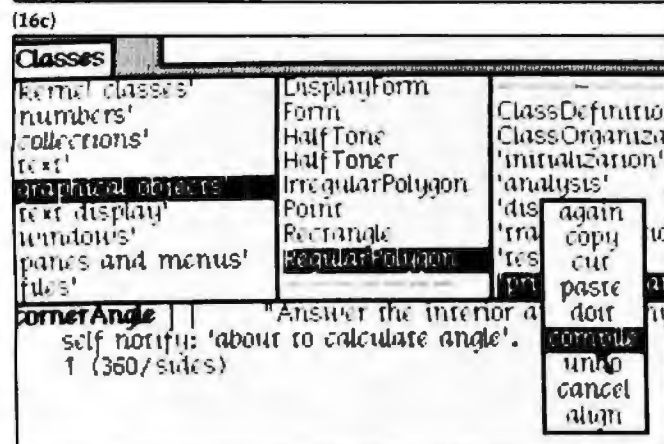
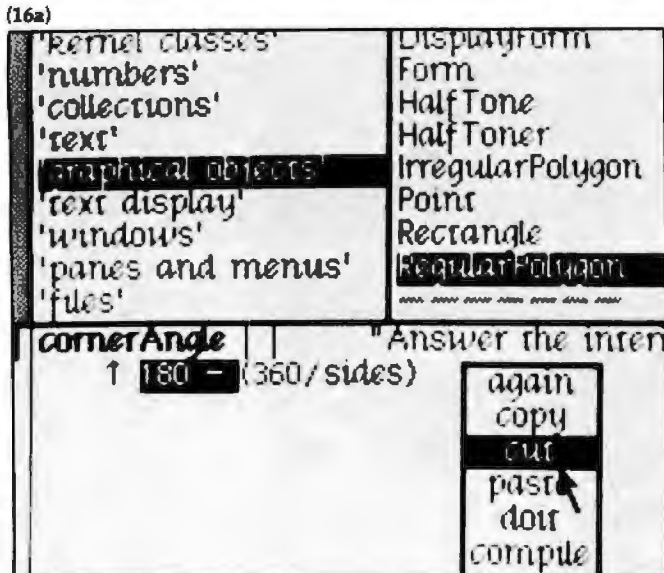

test case. When the computer encounters the breakpoint, a new window appears in midscreen. It is called a "notify window" (photo 16d). The title tab of the notify window says "about to calculate angle".

The notify window has one pane, the *stack pane*. It shows `RegularPolygon >> cornerAngle` (ie: the class and method in which the breakpoint was encountered). The pop-up menu of that pane offers several commands, including "stack" and "proceed" (photo 16e).

The "proceed" command closes the notify window and continues execution from the breakpoint. If we issue a "proceed" in our example, the same breakpoint will be encountered again immediately because the `cornerAngle` method is used several times during the execution of the test program.

## What a Notify Window Can Display

The "stack" command expands the contents of the pane to include messages that have been sent, but have not yet received replies (photo 17a). It reveals that the sender of the message `cornerAngle` was `RegularPolygon >> plot:`.

The pop-up menu of the notify window offers the usual repertoire, including the "close" and "frame" commands (photo 17b). If "close" were issued, the notify window would disappear from the screen and execution of the

*Text continued on page 138*

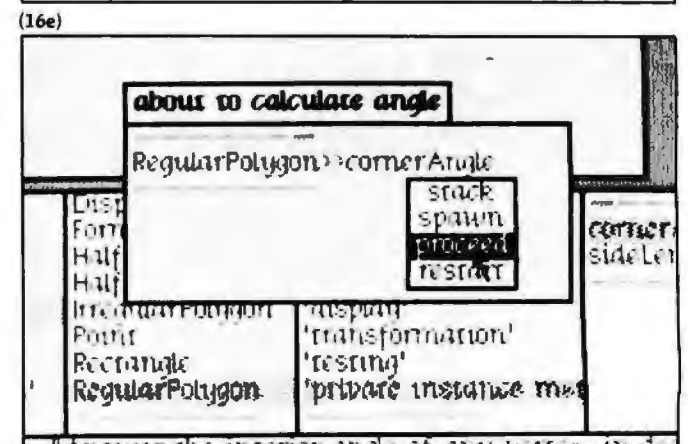
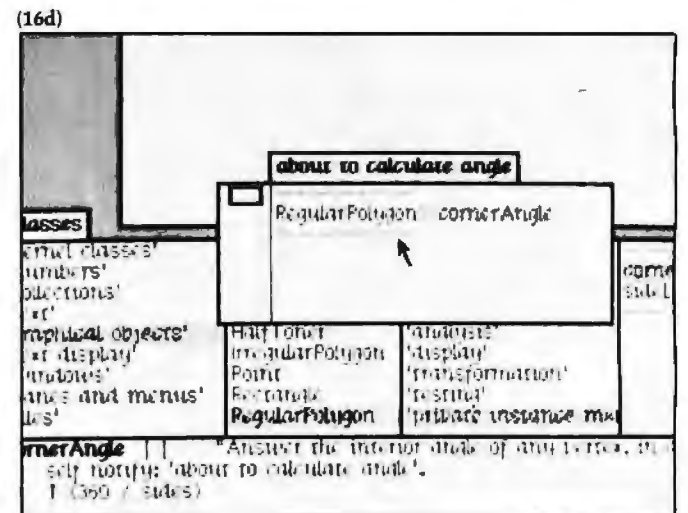

Photo 16: Creating a faulty method for purposes of illustration.

With the Hayes direct-connect Micromodem II,<sup>™</sup> your Apple II can communicate by phone with the outside world. You can access information networks like The Source for a variety of business and personal applications, exchange programs with friends anywhere in North America, and even use your Apple II when you're away from your home or office.

**Dependable.** The Micromodem II is so dependable it comes with a two-year limited

warranty. That's another reason why it's the largest selling direct-connect modem for Apple II computers.



**Programmable.** Automatic dialing and answering? Of course! We include programs on disk that dial phone numbers for you, send messages while you're away, and much more!

**Complete.** You get everything you need to communicate with other Bell 103 compatible modems at 110 or 300 baud. The serial interface

is built-in, and we even include our FCC-approved Microcoupler<sup>™</sup> that plugs directly into any modular telephone jack in the U.S. — you don't even need the phone!

**S-100, too.** The Hayes Micromodem 100 gives S-100 microcomputers all the advantages of our Micromodem II!

Put the outside world *inside* your computer with a data communications system from Hayes. Available at computer stores nationwide — call or write for the location nearest you. And don't settle for anything less than Hayes.



**Hayes**

## The Hayes Micromodem II opens up your Apple II to the outside world.



**Hayes Microcomputer Products Inc.** 5835 Peachtree Corners East, Norcross, Georgia 30092 (404) 449-8781

Micromodem II, Micromodem 100 and Microcoupler are trademarks of Hayes Microcomputer Products Inc.

<sup>™</sup> Apple Computer Inc. Micromodem II can also be used with the Bell & Howell computer. © 1981 Hayes Microcomputer Products Inc.

# PRINTERS

## EPSON MX-80 Now in stock!

The MX-80 dot matrix printer. Unequaled Epson reliability. Has all the features of the MX-70 plus more power and extra functions.

**CALL US**

**C-ITOH STARWRITER: LETTER QUALITY PRINTING FOR UNDER \$2000!** This daisywheel printer gives high quality at a low price. 25 cps. Parallel and serial interfaces available.

**CALL**

## NEC SPINWRITER FROM THE FIRST NAME IN LETTER QUALITY PRINTERS/Compumart offers beautiful print quality with NEC Spinwriter Terminals. We carry all models from RO THRU KSR WITH NUMERIC KEYPAD—5510-5530. All versions give unsurpassed hard copy output!

**CALL FOR PRICES**

## NEW INTEGRAL DATA'S 560

**PRINTER/**All the exciting features of the 400 series plus 14 1/2" paper capacity. 132 col. graphics printer. **IDS 445.** Priced lower than the 440 and equipped with a better print head. With & w/o graphics. **IDS 460.** Features include correspondence quality printing, high resolution graphics.

**CALL FOR PRICES**

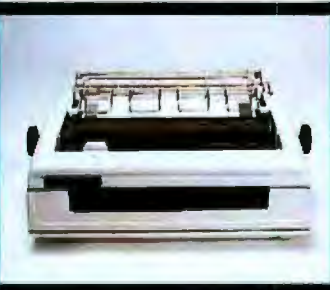

## CENTRONICS PRINTERS

### 3 SERIAL MODEL 737

The closest thing to letter quality print for under \$1000.

List \$1045 **SPECIAL \$795.**

**737-1** Parallel Interface

List \$995 **SALE PRICE \$695.**

**PLUS EXCITING REBATE OFFER ON CENTRONICS PRINTERS.**

## OMNI 810 PRINTER FROM TEXAS INSTRUMENTS **CALL US**

The 820 RO PACKAGE includes machine mounted paper tray and cable. A compressed print option and device forms control are standard features.

The 820 KSR PACKAGE includes fully ASCII Keyboard plus all of the features of the RO.

**CALL FOR PRICES**

# MONITORS TERMINALS

## CLEARANCE ZENITH COLOR VIDEO MONITOR \$349

**SUPER SELLING TERMINALS FROM LEAR SIGLER/**We have the following Lear Siegler terminals in stock at prices too low to print! Call for quotes.

**ADM-3A/**Industry's favorite dumb terminal for some very smart reasons/ADM-3A + NEW from Lear Siegler. **CALL!**

**IT IS HERE!** It is the new Intermediate Terminal from Lear Siegler. **CALL FOR DETAILS**

**SANYO MONITORS AT LOW COMPUMART PRICES/**Sanyo's new line of CRT data display monitors are designed for the display of alphanumeric or graphic data.

**9" SANYO B/W \$169. CALL**

**12" SANYO B/W CALL**

**12" SANYO W/ GREEN SCREEN CALL**

**13" SANYO COLOR CALL**



## NEC COLOR MONITOR/RECEIVER

**HIGH RESOLUTION/** Composite video using BNC connectors. 8-Pin connector for VCR/VTR video loop In/Out and television reception. **CALL US!**

Visit our giant

## ANN ARBOR STORE

1250 North Main Street  
Ann Arbor, Michigan

## FREE CATALOGS

### MICRO

Our complete line of micro-computers, accessories and peripherals.

### DEC LSI-11

Systems configured and integrated with other manufacturers compatibles.

**Send for them!**

# CALCULATORS MISC

## HP-41C CALCULATORS

**MEMORY MODULES** for storing programs of up to 2000 lines of program memory.

**"EXTRA SMART" CARD READER.** Records programs and data back onto blank magcards.

**THE PRINTER.** Upper and lower case. High resolution plotting. Portable thermal operation.

**APPLICATION MODULES**  
**CALL FOR PRICES ON ALL**

**NEW SUPER 41-CV SYSTEMS** with Quad RAMS built-in. Maximum memory on-board leaves slots open for Application Pacs and peripherals

+ **CARD READER**  
+ **CARD READER + PRINTER**  
QUAD RAMS equivalent to four Memory Modules all packed into one. **CALL ON ALL**

**MATROX PRODUCTS/**Compumart stocks the complete line. **CALL ON SPECS**

**DEC LSI-11/**Compumart now offers the entire product line **CALL FOR PRICES AND DELIVERY**

**NOVATION CATACOUSTIC MODEM** Answer Original. **CALL**

**NEW! D-CAT** Direct Connect Modem from Novation. **CALL**



## NEW! GILTRONIX RS 232 SWITCH/

The ultimate in flexibility. You can connect three peripherals to one computer or three computers to one peripheral. Switches the eight most important RS 232 signals.

**CALL ON PRICE**

**DYSAN DISKETTES/**Single side, single density. Hard or Soft Sector **\$5. ea.**

**MEMOREX 3401's/**5 1/4 disks **\$3.25**  
/with hub ring for Apple **\$3.50**

**MEMORY INTEGRATED CIRCUITS/**Call for quantity discounts when ordering over 50 units. **CALL**

**MOTOROLA 4116 (200 Nano-second Plastic)** **\$4.50**

# SYSTEMS SOFTWARE

## ROM EXPANSION ACCESSORIES

**FOR AIM—**  
**CALL SPECS AND PRICES**

**APPLE III IS IN STOCK/**Apple III Information Analyst Package—128K Apple III, Black and White Monitor 12", and information analyst software. **CALL**

## TOP SOFTWARE PACKAGES FROM COMPUMART

**VISICALC/**FOR APPLE/FOR HP/ FOR COMMODORE/FOR ATARI

**SOFTWARE FROM APPLE/**Apple Plot (the perfect graphic complement for Visicalc/Dow Jones News & Quotes/Apple Fortrom/Apple Writer/Pascal Language System/ Controller Business System **CALL**

**PERSONAL SOFTWARE/**Visidex/ VisiTrend/VisiPlot/VisiTerm **CALL**  
**MUSE/**Super Text **CALL**



## MOUNTAIN COMPUTER/

Expansion accessories for Apple/ Super Talker/The Music System/ ROM plus board with Keyboard Filter/ROM Writer/Clock Calendar/Atod and Dto A Converter/ Clock for Apple/CPS Multifunction Board **CALL**

**VIDEX/**Video Term (80 col. x 24 line, 7x9 Matrix plug in compatible board for Apple II) w/wo graphics EPROM/SSM Serial & Parallel, Apple Interface/ABT's Numeric Key Plan/California Microcomputer Keyboard **CALL**

**NEW!**

## VIC 20 PERSONAL COMPUTER FROM COMMODORE

**\$299**

## IMPORTANT ORDERING INFORMATION

**CALL 800 343-5504**, in Massachusetts (617) 491-2700, phones open from 8:30 a.m. to 7:00 p.m. Mon-Fri, 10:00 a.m. to 4:00 p.m. Sat.

**PO's:** Accepted from Dun & Bradstreet rated companies—shipment

contingent upon receipts of signed purchase order.

**SALE PRICES:** Valid for month of magazine date only—all prices subject to change without notice. Our Ann Arbor retail store is open 10:00 a.m. to 7:00 p.m. Tues-Fri, 10:00 a.m. to 5:00 p.m. on Saturdays.

# SYSTEMS APPLE II STARTER

## \$1895.

SAVE OVER \$200 ON OUR BEST SELLING APPLE SYSTEM/ System includes a 48K Apple II, Apple Disk, DOS 3.3 and Controller and a Sup R MOD RF Modulator.

List \$2209.

**EXCLUSIVE FOR THE APPLE:** Magic Wand, Videx, Z-80 softcard (Requires 48K Apple and disk). **COMPLETE SYSTEM \$925.**

### APPLE ACCESSORIES

**CHOOSE FROM:** Silentype Printer w/x face/Light Pen/Easy Writer (80 col. need a Videx)/Clock for Apple.

**FROM MICROSOFT:** 16K RAM Board/FORTRAN.

**FROM COMPUTER STATION:** Hi-Res Dump for 460 Printer.



OUR APPLE INVENTORY IS COMPLETE. WE'VE GOT IT ALL—CALL US FOR PRICES

# SYSTEMS COMMODORE WORD PRO

## \$4695.

CRISP LETTER QUALITY OUTPUT UNSURPASSED EASE OF OPERATION

This Compumart/Commodore system includes a COMMODORE 8032 32K CPU, a 4040 DUAL DISK, a C-I/OH PRINTER and x/face and WORDCRAFT 80 (all cables included). List \$5385.

**CALL FOR DETAILS AND LOW PRICES**

**A COMPLETE SYSTEM:** includes a DUAL DISK DRIVE/TRACTOR PRINTER and an 80 COLUMN 32K CPU. No interfaces needed. Cables included. List \$3685.

**COMPUMART \$3335.**

**SAVE \$200 ON COMMODORE ACCESSORIES WITH PURCHASE OF A 32K PET—SAVE \$100 WITH A 16K PET.**

**CHOOSE FROM:**

Visicalc/Word Pro 4/Wordcraft 80/Ozz the Information Wizard/Dow Jones Portfolio Mgmt System/Assembler Development Package.



# SYSTEMS HP 83 BASIC

## \$4249.

This Basic System from Hewlett-Packard includes HP-83/ROM DRAWER/MASS STORAGE ROM/5 1/4" SINGLE MASTER FLEXIBLE DISK DRIVE/HP-1B INTERFACE MODULE/2 METER HP-1B CABLE.

**SAVE \$400 ON HP-85 SERIES ACCESSORIES WITH THE PURCHASE OF AN HP-86**

**CHOOSE FROM:** PERIPHERALS; Disk Drives to Graphics Plotters ENHANCEMENTS; Basic Training/General Statistics/Financial Decision/Math/Linear Programming (\$95 EA.) ACCESSORIES; Enhancement ROM's/ ROM drawer/Overhead Transparency Kit SUPPLIES; Plotter Pens/Tape Cartridges INTERFACE MODULES: HP-1B Interconnect Cables/Serial (RS-232C) Interface Module.



WE CARRY EVERY PERIPHERAL MADE FOR THE HP-85. CALL US FOR PRICES

# SYSTEMS AIM 65 STARTER

## \$795.

**FROM ROCKWELL**

Our AIM Starter System for Educational & Laboratory use includes 4K AIM/BASIC & ROM/ASSEMBLER & ROM/POWER SUPPLY EGI ENCLOSURE/CRAIG TAPE RECORDER.

**ACCESSORIES FOR AIM STARTER:** PL 65 High Level Language/Paper for the Aim (roll)/Rockwell's 4 slot Motherboard/

CALL



WE ALSO CARRY RM EXPANSION ACCESSORIES FOR THE AIM-65. CALL FOR SPECS AND PRICES



Systems  
*Customized*

# 800-343-5504

IN MASS CALL 617-491-2700

# COMPUMART

65 Bent Street, Dept 108  
PO Box 568, Cambridge, MA 02139

From THE LEADER...

We just might be the largest independent small systems dealer in the country. Here's why: COMPUMART has been serving the computer needs of industry since 1971.

We stock, for immediate shipment, only those products from the finest micro-computer manufacturers.

And any product, except software, can be returned within 10 days for a full refund—even if you just change your mind. We also honor all manufacturers' warranties. Our expert technicians will service any product we sell.

Call us for more information on products, product configuration and service. Our phones are open Monday thru Friday, 8:30 a.m. to 7:00 p.m. and Saturday 11:00 a.m. to 4:00 p.m.

We have a staff of highly knowledgeable sales people waiting to hear from you, and to help. Because service is what we're all about.

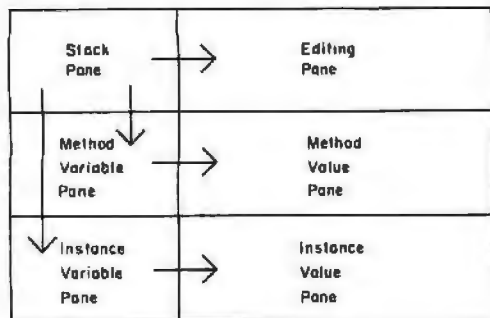

Figure 5: Principal dependencies among panes of a notify window.

Text continued from page 134:

program under test would be aborted. Let us issue the "frame" command instead. The notify window grows larger and acquires a total of six panes (photo 17c). Their interdependencies are diagrammed in figure 5.

The upper left pane is the stack pane retained from before. The upper right pane is an editing pane. If you select `RegularPolygon >> plot:` in the stack pane, its method definition appears in the editing pane. You can scroll through the definition and even edit it there and recompile as in the browser.

The middle two panes are the "context variable" and

"context value" panes. They are analogous to the two panes of an inspect window, but, in this case, the variables you can examine are the arguments and local variables of the method selected in the stack pane. Click ink in the variable pane to see its value in the value pane.

The bottom two panes are the "instance variable" and "instance value" panes. They also are analogous to the panes of an inspect window. They let you examine the instance variables of the receiver of the message selected in the stack pane. Click center to see its value appear in the value pane.

You can type statements into the value panes and execute them using "do it" (photo 17d). They will be executed in the context of the method selected in the stack pane—that is, they may refer to arguments and local variables of the method and to instance variables.

### Debugging

You could step through the execution of the method in the editing pane. You would select one statement at a time in the editing pane and issue the "do it" command. To close in on the planted bug, we can evaluate `self cornerAngle`, an expression on the last line of the method. Select that expression and issue the "do it" command (photo 18a). The answer, 120, appears to the right of the question (photo 18b). Since the interior angle of a regular

(17a)

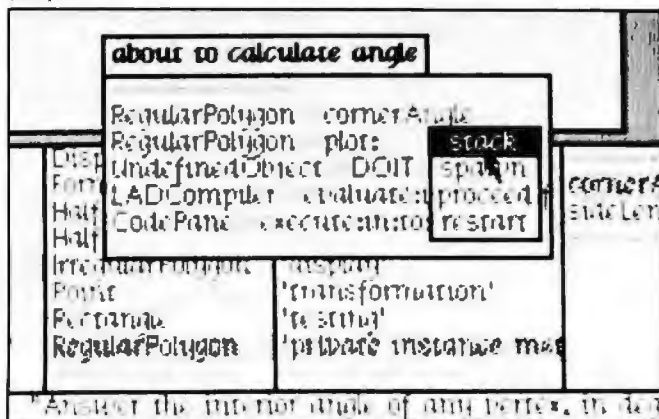

(17c)

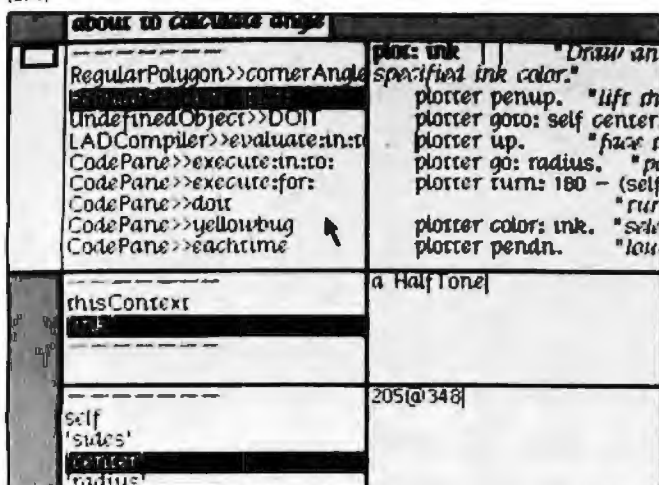

(17b)

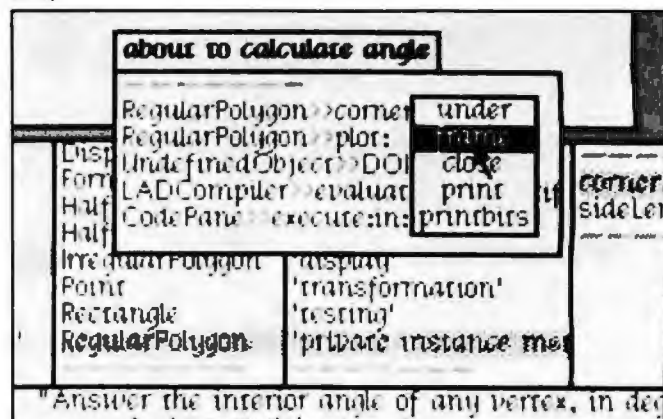

(17d)

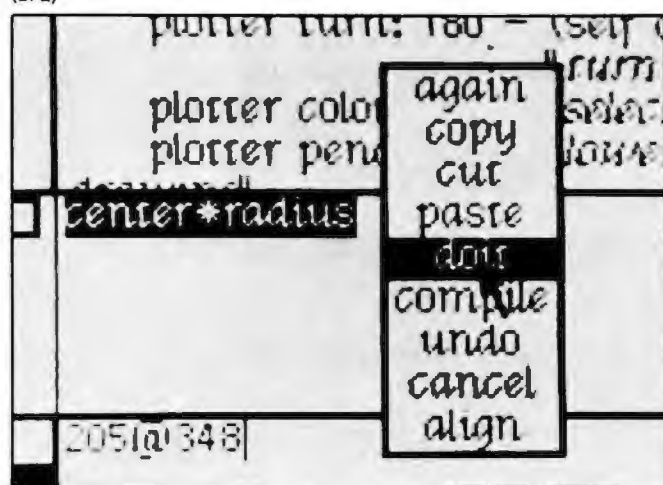

Photo 17: Use of the "notify" window.



## MEMORY

# Blackout!

## A PROBLEM FOR YOUR PRESENT RAM?

**Don't Curse the darkness. Get our non-volatile memory and watch elephants turn green with envy!**

Are you looking for a reliable non-volatile memory on a rugged industrial-standard IEEE-696 S-100 card? Your search is over. Our CMOS memory modules have a battery backup that is guaranteed to keep programs and data intact for a year. We didn't sacrifice performance for non-volatility in the design of our CMEM module, so you get all the card you're looking for . . . we even supply the battery.

- 32K on a single board, 8 or 16-bit cpu compatible.
- Switch selectable addressing on 4K boundaries.
- Extended memory addressing through 24-bit lines.

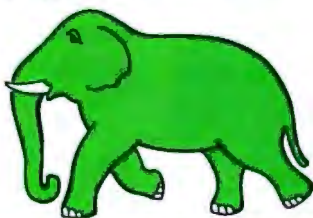

- 250 nanosec access time, no wait states required.
- Runs at 4 MHz for both 8 and 16-bit S-100 systems.
- Programs developed & stored w/out disks or tapes.
- Power fail interrupts.
- Software programmable write-protect window.
- 8K bytes-\$695, 16K bytes-\$895, 32K bytes-\$1095.

**The DUAL 77 Data Acquisition and Control System** is a turnkey system built to industrial standards and it comes ready to perform. As with all our systems and modules, our computer was designed with the wicked environment of the real world in mind. BASIC language makes programming easy and the built-in interface simplifies access to hundreds of sensors. The enormous expandability of the system allows its growth to meet your increasing needs, even if you enjoy learning new languages. The DUAL 77 is economical; \$9995 or higher with options.



**DUAL SYSTEMS CONTROL CORPORATION**  
1825 Eastshore Highway, Berkeley, CA 94710  
Phone (415) 549-3854 or (415) 549-3890



## A/D CONVERTER

This S-100 based module is designed to withstand the rugged environment of the laboratory or in industry for general use in converting analog signals to digital information.

- 32-channel single-ended, 16-channel differential.
- 12-bit resolution and accuracy.
- 30-microsecond conversion time.
- Instrumentation amplifier on board.
- BASIC program for use provided.
- \$695 or \$785 w/1-1000 gain transducer amplifier.



## NON-STOP CLOCK

Now you can keep time even with the main power off. Our industrial level clock module utilizes a backup battery circuit for a full year.

- Day, date, hours, minutes and seconds.
- Features new LSI CMOS chip.
  - Vectored interrupt capability.
  - Dip switch selectable port address.
  - Simple BASIC or Assembly language program.
  - Precision quartz crystal clock.  \$250

## D/A CONVERTER

The AOM-12 analog output module is an industrial level digital-to-analog (D/A) converter which converts digital commands from the computer into analog voltages.

- 12-bit  $\pm 1/2$  LSB accuracy over full 0-70°C temperature range.
- Voltage outputs of 0-10 volts,  $\pm 5$  volts, or  $\pm 10$  volts.
- Short circuit protection on all voltage outputs.
- Switch-programmable port base address for multiple boards.
- \$575



**Dual Systems Control Corporation**  
Department B, 1825 Eastshore Highway  
Berkeley, CA 94710 • (415) 549-3854

- Please send your brochure with complete details on modules.
- Please provide information on the DUAL 77 System.

Name \_\_\_\_\_ Title \_\_\_\_\_  
 Company \_\_\_\_\_  
 Street \_\_\_\_\_  
 City \_\_\_\_\_ State \_\_\_\_\_ Zip \_\_\_\_\_

**DEALER AND OEM INQUIRIES INVITED**

Circle 122 on Inquiry card.

(18a)

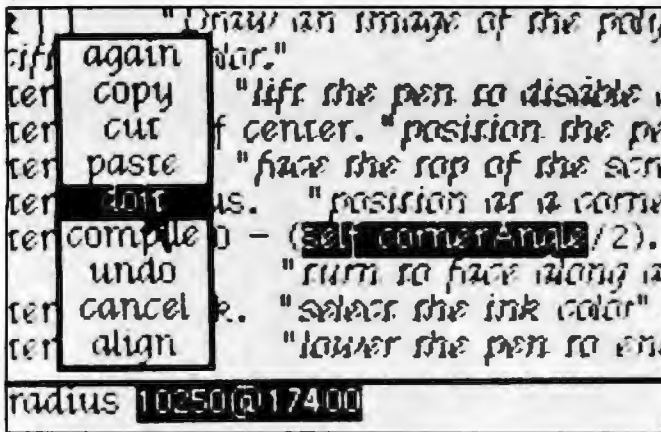

(18b)

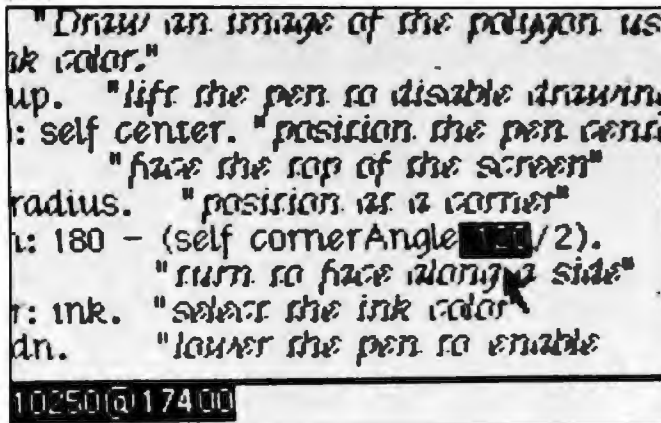

(18c)

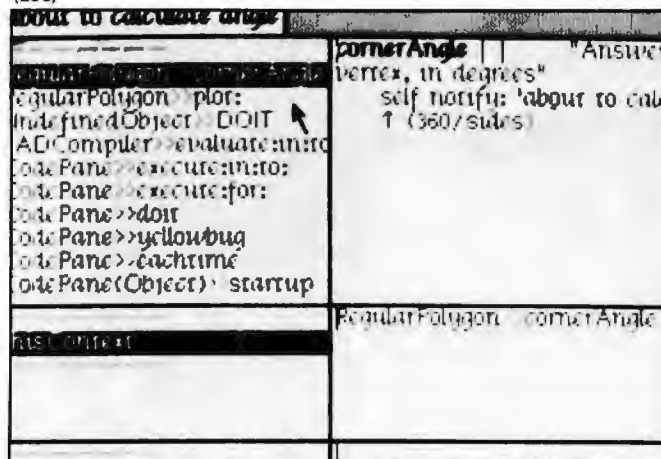

(18d)

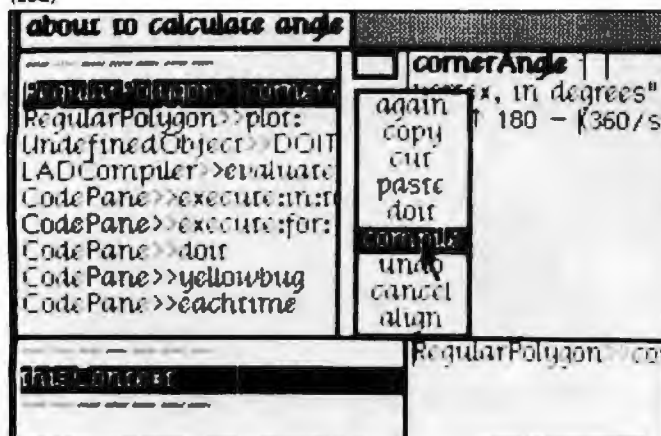

Photo 18: Debugging a faulty method.

triangle is 60 degrees, we have found the planted bug.

Now select `RegularPolygon>>cornerAngle` in the stack pane. Its method definition, including the breakpoint we set, appears in the editing pane (photo 18c). Use standard editing to remove the breakpoint, correct the error, and recompile the editing pane (photo 18d).

You can randomly access any level in the stack by clicking it in the stack pane.

### Resumption

After recompiling a method, you can resume execution from the beginning of any method on the stack using the "restart" command in the stack-pane menu (photo 19a). This lets the test proceed (photo 19b) without having to start over from the work-space window. Resumption of execution after a correction is a handy capability when a program that has been running well encounters a minor bug.

The entire stack of the process under test was saved in the notify window. When a notify window appears, the rest of the system is not preempted. You are not required to deal with the notify window when it appears. You can

(19a)

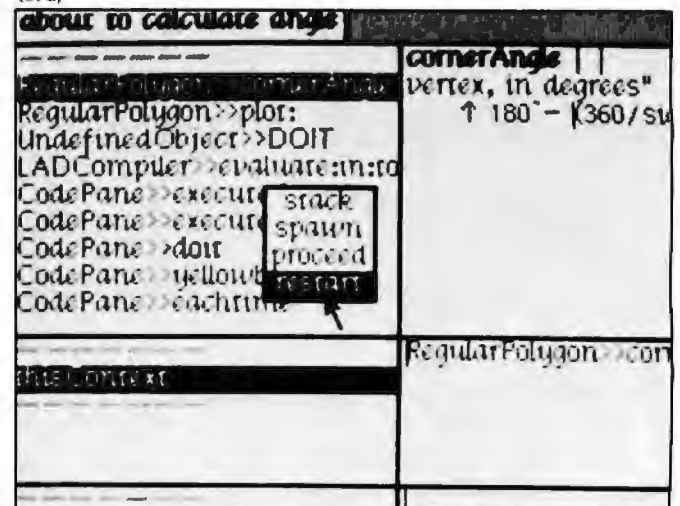

(19b)

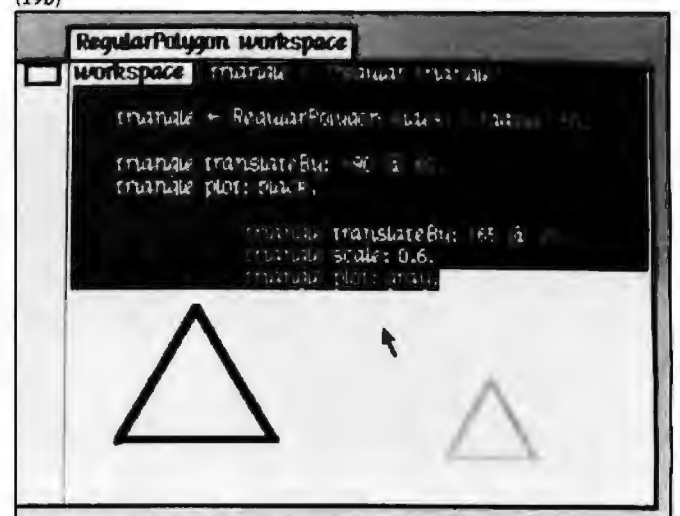

Photo 19: Compilation of a faulty method can be continued without restarting, once the error has been corrected.

New Products From Orange Micro

# Mix APPLES and ORANGES?

... And you get GRAPHICS!

**NEW**

## THE GRAPPLER™ Apple Interface and Cable

FROM ORANGE MICRO

The Grappler™ Interface is the first universal parallel interface card to provide on-board firmware for Apple high resolution dot graphics. No longer does the user need to load clumsy software routines to dump screen graphic - it's all in a chip. Actually, it's our E-PROM, and there are versions to accommodate the Anadex, Epson MX80 & MX70, IDS Paper Tigers, Centronics 739, and future graphics printers. The Grappler™ accepts 18 software commands including Hi-Res Inverse, 90° rotation, double size, and much more.

### GRAPPLER INTERFACE FEATURES

#### TEXT FEATURES:

- Printer Bell on/off
- High Bit on/off
- Left Margin
- Right Margin
- Var. Line Length
- Var. Page Length (skip over perf.)
- Video on/off
- Alternate Command Chars.

#### Text Screen Dump

#### HI-RES GRAPHICS FEATURES:

- Print Hi-Res Page 1 or 2
- Print Inverse
- Rotate Picture 90°
- Single/Double Size
- Variable Left Margin
- Chart Recorder Mode

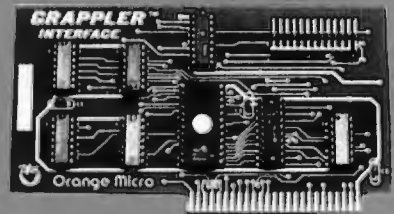

**\$165.00** Includes Cable

Dealer/Distributor  
Inquiries Invited

**NEW**

## MX80/MX70 FRICTION FEED

FROM ORANGE MICRO

HERE AT LAST! A friction feed kit for your EPSON MX80/70. The kit allows the user to convert his Epson printer to a friction feed and pin feed mechanism.

The friction feed will accept single sheets of your letterhead, or multiple copy forms such as invoices with up to 4 part carbon copies.

The pin feed replaces the adjustable sprocket mechanism. It allows use of 9½" wide continuous fanfold paper which is an industry standard size.

No drilling required. Installation takes about 15 minutes. All parts are included with easy to follow instructions.



**\$75.00**

Dealer/Distributor  
Inquiries Invited

CALL FOR FREE CATALOG

**(800) 854-8275**

**CA, AK, HI (714) 630-3322**

RETAIL PRINTER STORES:  
3150 E. La Palma, #1, Anaheim, CA  
13604 Ventura Bl., Sherman Oaks, CA.  
Store Hours: M-F 10-8 Sat. 10-4

Phone orders WELCOME; same day shipment. Free use of VISA & MASTERCARD. Personal checks require 2 weeks to clear. Manufacturer's warranty included on all equipment. Prices subject to revision.

**Orange  
Micro, Inc.**  
3150 E. La Palma, Suite I  
Anaheim, CA 92806

work in other windows and come back to it later, cause other notify windows to be created, or work a little in the notify window and then do something else. There are no modes.

### Error Notifications

Error messages are no different from breakpoints, ex-

(20a)

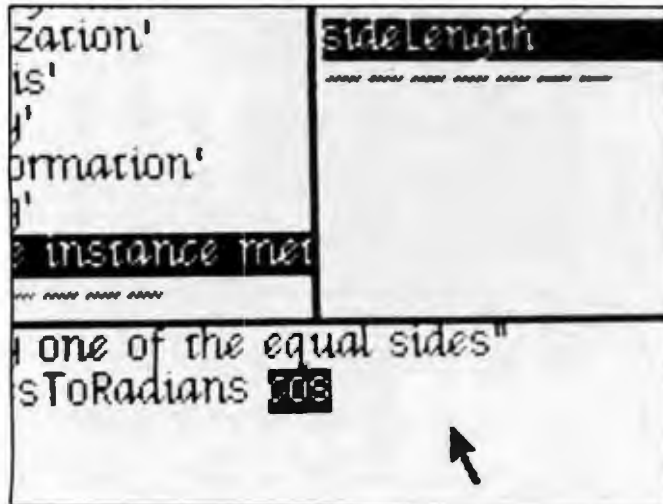

(20b)

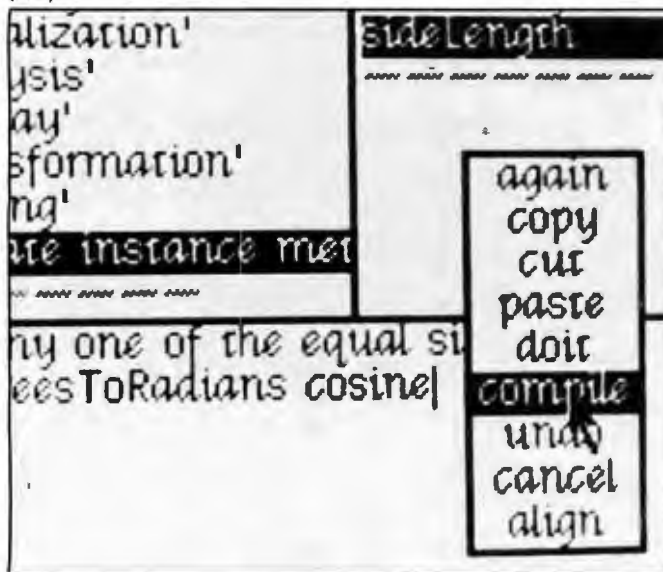

(20c)

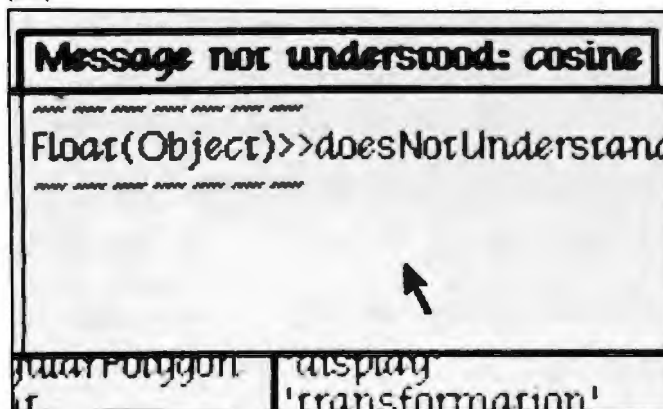

Photo 20: Displaying an error in a faulty method.

cept that if they are supposed to be "unrecoverable" they are programmed as:

```
self error: 'error whatever'.
```

If the user "proceeds" out of the notify window after an error, the process under test is terminated.

The most frequently encountered Smalltalk error is "Message not understood." It occurs when a method is sent to an object and neither that object's class nor any of its superclasses defines a method to receive that message. Let us edit the method `sideLength` (photo 20a) to send the message `cosine` instead of `cos`. After recompiling that method (photo 20b) and reexecuting the test program, a notify window appears (photo 20c) to announce that class `Real` and its superclasses do not define `cosine`.

In most programming systems, equivalent error conditions such as "undeclared procedure" and "wrong number of arguments" are issued at compile time. Smalltalk cannot detect these conditions until run time because variables are not declared as to type. At run time, the object sent the message `cosine` could be an instance of a class that did define a method of that name.

### Type Checking

When we program in languages like Pascal, we depend on type checking to catch procedure-call errors early in the software-development process. In return, we have to take extra time maintaining type declarations, and we lose the very powerful ability to define "generic" or "polymorphic" procedures with the same name but with parameters of varying types.

Type checking is important in most systems for four reasons, none of which is very important in Smalltalk:

- Without type checking, a program in most languages can "crash" in mysterious ways at run time. Even with type checking, most programming systems can crash due to uninitialized variables, dangling references, etc. Languages with this feature are sometimes called "unsafe." Examples of unsafe languages are Pascal, PL/1, and C. Examples of fairly safe languages are BASIC and LISP. Smalltalk is a safe language. It cannot be wiped out by normal programming. In particular, it never crashes when there are "type mismatches." It just reports a "Message not understood" error and helps the programmer quickly find and fix the problem through the notify window.

- In most systems, the edit-compile-debug cycle is so tedious that early error detection is indispensable. In Smalltalk, type errors are found early in testing, along with value-range errors and other bugs.

- Type declarations help to document programs. This is true, but well-chosen variable names and pertinent comments provide more specific information than do type declarations. A poor documenter can convey as little information in a strongly typed program as in an untyped program.

**This  
Single  
Board...**

**...is the Heart  
of the  
Microprocessor  
World's  
Best Multi-User  
System ...**

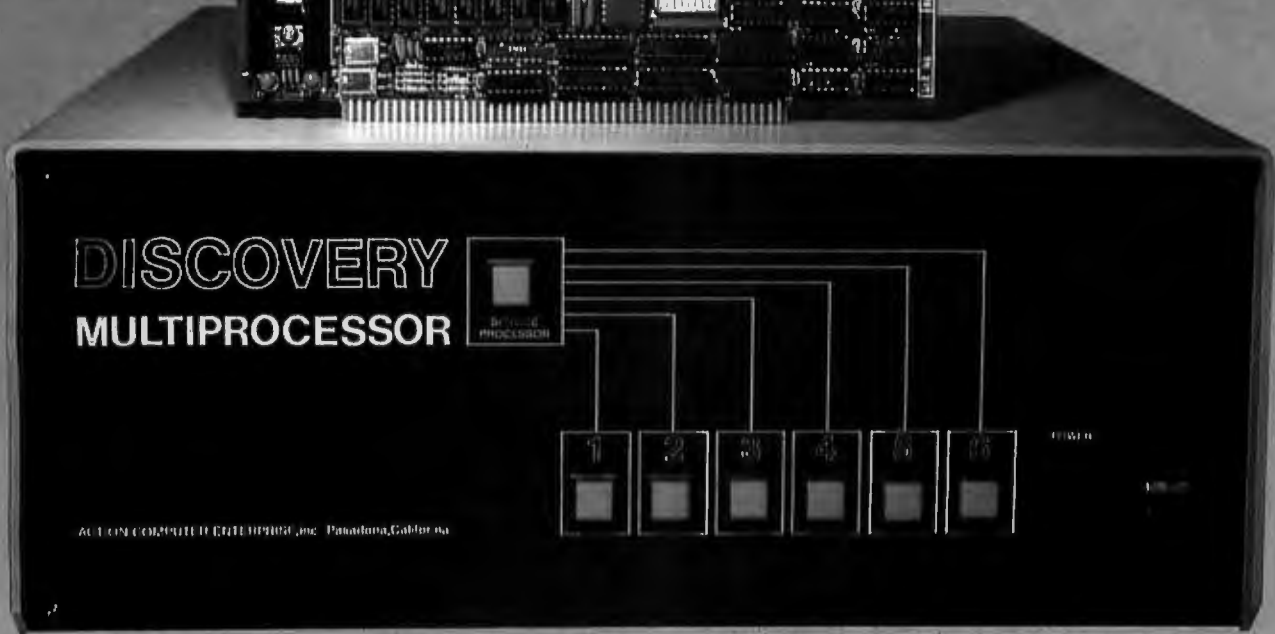

## THE DISCOVERY MULTIPROCESSOR

The dedicated power of this complete single board computer is provided to each user, making the DISCOVERY MULTIPROCESSOR unique among multi-user systems. With the power and expandability of distributed processing • With the economy of shared peripherals • With the flexibility of shared and public files • And all of this with full CP/M\* and S-100 compatibility.

### Multiprocessing Software      Multiprocessing Hardware

Our Distributed Processing Operating System, **dpc/os**®, resides in the Service Processor, establishing a CP/M environment for each user and managing access to the shared system resources. Multiuser facilities are provided for print spooling, for interprocessor communication and for private, public and shared-update files. Several processors can be employed concurrently by a single user via the enhanced batch submit facilities. And with **DISCOVERY** all CP/M compatible programs will execute without modification, thus protecting your software investment.

The ACE 64K Distributed Processing Single Board Computer, the **dpc-180**™ gives the **DISCOVERY MULTIPROCESSOR** its own unique architecture. One DPC is dedicated to each user providing exclusive use of the onboard Z-80, 64K ram and serial I/O. Access to the shared resources is provided by an expanded DPC used as a Service Processor. Additional users can be added at any time by simply inserting additional DPC's into the standard S-100 bus — up to a total of sixteen user processors in a single chassis!

\*CP/M is a registered TM of Digital Research, Inc.

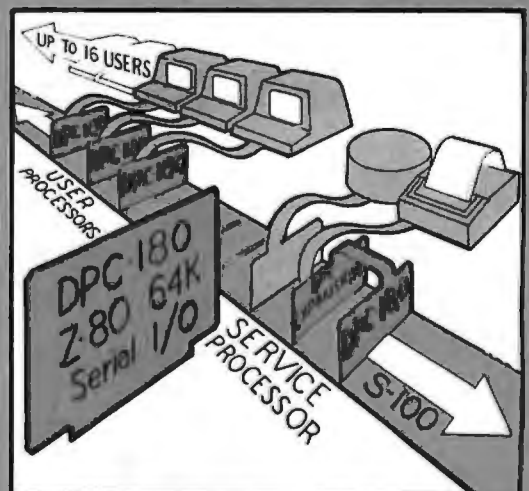

The ACE **DISCOVERY MULTIPROCESSOR** dedicates a complete 64K Z-80 Distributed Processing single board Computer, the **dpc-180**™ to each user. An expanded DPC coordinates all of the system activities.

Multiuser mainframes with 192K ram start at under \$6000. The 64K **dpc-180**™ is priced at \$1395. Immediate delivery. A complete line of standard peripherals including a 26M byte hard disk subsystem can be supplied on request. Dealer and OEM inquiries are invited.

**DISCOVERY** has been proven in installations throughout the World. If you need the Power of Multiprocessing... it's time you discovered us!

**Action Computer Enterprise, Inc.**  
The Multiprocessing Company

55 West Del Mar Boulevard, Pasadena, California 91105 USA • Cable ACEPAS Pasadena • (213) 793-2440

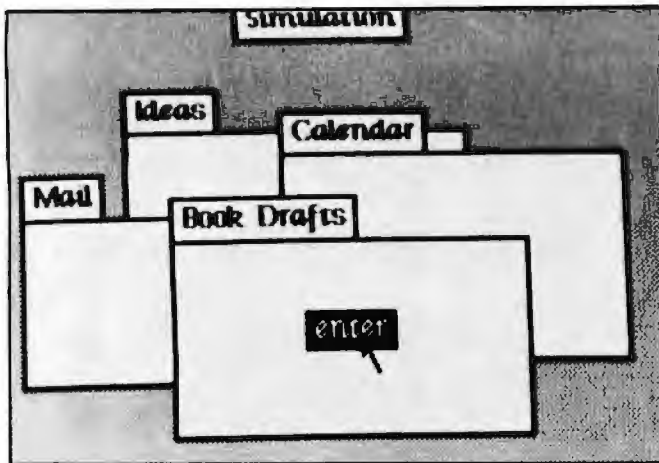
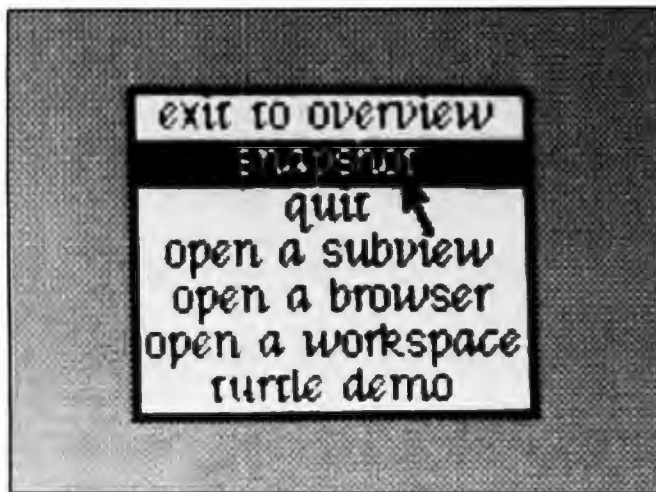

Photo 21: Project windows in Smalltalk. Each window, when selected, makes available all the windows associated with that project.

(22a)



(22b)

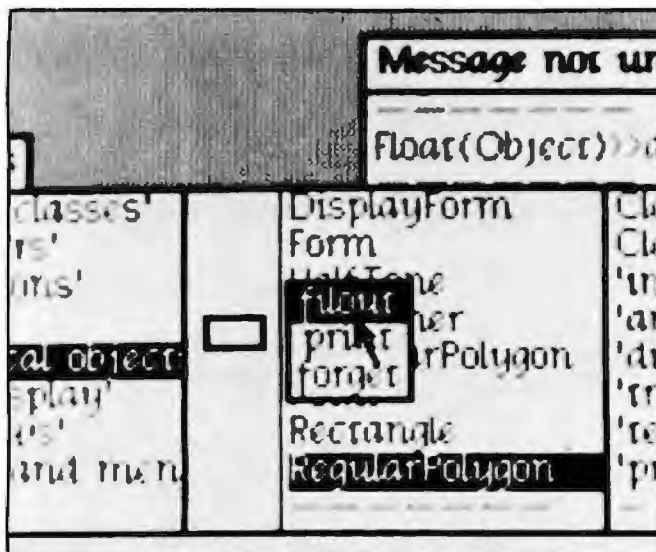

Photo 22: Recording results in Smalltalk. The current state of the Smalltalk system can be saved with "snapshot." Smalltalk code can be saved to a text file by using "filout" and restored by using "filin."

Most compilers can generate more efficient object code if types are declared. Existing implementations of Smalltalk cannot take advantage of type declarations. We expect that future versions will have that ability. At that time, type declarations may be added to the language. They probably will be supplied by the system rather than the user, using a program-analysis technique called "type inference."

### Project Windows

Although overlapping windows enable you to keep the state of several tasks on the screen at the same time, you may sometimes be working on several entirely different projects, each involving several tasks. Smalltalk lets you have a different "desk top" for each project. On each desk top are windows for the tasks involved in that project. To help you travel from one desk top to another, a desk top can have one or more project windows that show you other available desk tops and let you switch to one of them (photo 21).

### Saving Programs

In unintegrated systems, you create a program using standard text-editing facilities. Then, using standard utility programs, you can obtain a program listing on paper, back up the program on other media, and transmit the program to other people. In an integrated system, equivalent capabilities must be provided within the system itself. Some of the program-saving capabilities of Smalltalk are described briefly below.

One important facility is the *snapshot* (photo 22a). The entire state of the Smalltalk environment—including class and method definitions, data objects, suspended processes, windows on the screen, and project desk tops—can be momentarily frozen and saved on secondary storage. The snapshot can be restored later and resumed. People familiar with the *sysout* in InterLISP or the *workspace* concept in APL will understand the benefit of this facility.

Another facility allows definitions of one or more methods or classes to be listed on a printer. A related facility is *filin/filout*. The *filout* message (photo 22b) writes an ASCII representation of one or more definitions onto a conventional text file. The definitions can then be transfused into another Smalltalk environment by using the *filin* message in that environment.

Often, during a programming session, the user changes a number of method definitions that are scattered throughout many classes and cannot recall which ones were changed. The *changes* facility automatically keeps a record of what definitions changed in each project, and makes it easy for the user to *filout* those definitions at the end of the session.

### Implementation of the Environment

Because Smalltalk is an integrated environment, all the facilities described in this article are implemented in the

Text continued on page 147



# Meet the Tiger with a bigger bite.

Introducing the remarkable 132-column Paper Tiger™ 560. The first full-width matrix printer to give you fully formed characters for a low \$1695.\*

The new 560 features a staggered nine-wire ballistic type print head that overlaps dots in both horizontal and vertical planes. It bi-directionally prints up to 150 dense, text quality characters per second.

The 560 also features a reliable cartridge ribbon that lasts up to four times as long

**presents a breakthrough in matrix printing, offering the user excellent print quality with the look of a matrix printer. Employing a unique "red column" head manufactured by Integral Data Systems, Inc., the 560 creates high quality printouts by overlapping dots in both horizontal and vertical planes.**

Paper Tiger 560 Print Sample

as spool and cassette ribbons, separate heavy-duty stepper motors to drive the print head and advance the paper, plus true tractor feed.

And famous Paper Tiger performance comes with every new 560. Like fixed or proportionately spaced text, programmable tabbing and business forms control, automatic text justification, print formats to 220

columns, parallel and serial interfaces, self-diagnostics, and more. All inside the most compact printer of its kind.

Need more stripes? Dotplot™, our high-resolution raster graphics package, is standard on every 560.

For data processing, word processing and small business applications, this is your Tiger. The business-sized Paper Tiger™ 560.

It's a Tiger you can count on.

Call TOLL FREE 800-258-1386 (In New Hampshire, Alaska and Hawaii, call 603-673-9100.) Or write: Integral Data Systems, Inc., Milford, NH 03055.



## Paper Tiger 560

 Integral Data Systems, Inc.

See us at Comdex '81 in Las Vegas, Booth #774.

# The BOS M System: The Universal Donor

Type "O" Positive

The BOS M Card is the heart of the M System. It is designed to be IEEE S-100 bus compatible for universal system use. Virtually all elements of a computer mainframe now reside on one S-100 card — Z-80A CPU, 64k of 200ns RAM (no wait states), 4k 250ns EPROM, Winchester Disk I/O port, two RS-232 serial ports, system port, floating point processor, and parallel I/O. The same M Card can be used in single-user, multi-user, or even multi-processor systems.

**Second Generation Multi-Processor.** With the BOS M Card, multi-processing is finally free of the Master/Slave and hand-shaking parameters so prevalent in first generation multiprocessors. Inter-system communications are FIFO buffered; the old "Master" is now a slave to the user, and the system functions without "S-100 bus overrun" or system generated wait states.

**The Universal Processor is now a reality!** As a single-user system, the BOS M is unmatched in performance (up to ten times the speed of other microcomputers). As a multi-user system, this power can be translated into a low cost multi-terminal capability. As a multi-processor, the system leaves the realm of "microcomputer" and competes in performance with a minicomputer! You can start with a single-user computer and expand to a multi-user/multi-processor computer system when needed.



**The Universal Product.** BOS has what you need — anything from a single M Card to a complete turnkey computer system. Diskette, rigid disk, tape and telecommunications sub-systems are all available. Compatible software includes CP/M\*, MP/M\*, CP/NET\*, BOS/TURBODOS, complete monitor, languages, application packages, and more!

**Dealer and OEM Inquiries Welcome**

# BOS

Business Operating Systems, Inc.  
2835 East Platte Avenue  
Colorado Springs, Colorado 80909  
In Colorado Call: (303) 634-1541  
Toll Free Number: 1-800-525-8898

Registered Trademark  
of Digital Equipment  
TURBODOS is  
a product of  
Software 2000

The BOS M System does what a Universal Donor must do — it provides high performance for all system types; single-user, multi-user, and multi-processor. M Systems start at less than \$5,000.00 for a single-user computer with dual 8" double density diskette drives.



Text continued from page 144:

high-level language, including modeless editing, windows, the compiler, and the notify mechanism. This was possible because Smalltalk represents everything, including the dynamic state of its own processes, as objects that remember their own state and that can be sent messages by other objects. Using the browser, you can examine and (carefully) change the definitions of the software-development aids.

In the implementation of Smalltalk-76, classes *InspectWindow*, *BrowseWindow*, and *NotifyWindow* are all tiny subclasses of class *PaneWindow*, which defines their common behavior. Similarly, classes *StackPane*, *VariablePane*, *ValuePane*, and so on, are all tiny subclasses of class *ListPane*. The superclass defines common behavior such as scrolling and selecting entries.

If someone shows you a system claimed to be "Smalltalk," find out whether the software-development aids exist and whether they are programmed as class definitions in the high-level language. If not, the system is not bona fide.

## Conclusions

The Smalltalk programming environment is *reactive*. That is, the user tells it what to do and it reacts, instead of the other way around. To enable the user to switch between tasks, the state of the tasks is preserved in instantly accessible windows that overlap on desk tops. To give the user the maximum freedom of choice at every moment, modes rarely occur in the user interface. The result of this organization is that tasks, including software-development tasks, can be accomplished with greater speed and less frustration than is usually encountered in computer systems. ■

## References

1. Sneeringer, J. "User-Interface Design for Text Editing: A Case Study." *Software—Practice and Experience* 8, pages 543 thru 557, 1978.
2. Swinehart, D C (thesis). "Coplot: A Multiple Process Approach to Interactive Programming Systems." *Stanford Artificial Intelligence Laboratory Memo AIM-230*, Stanford University, July 1974.
3. Kay, A and A Goldberg. "Personal Dynamic Media." *Computer*, March 1977 (originally published as *Xerox PARC Technical Report SSL-76-1*, March 1976, out of print).
4. English, W, D Engelbart, and M Berman. "Display-Selection Techniques for Text Manipulation." *IEEE Transactions on Human Factors in Electronics*, volume 8, number 1, pages 21 thru 31, 1977.
5. Card, S, T Moran, and A Newell. "The Keystroke-Level Model for User Performance Time with Interactive Systems." *Communications of the ACM*, volume 23, number 7, July 1980.
6. Goldberg, A and D Robson. "A Metaphor for User-Interface Design." *Proceedings of the Twelfth Hawaii International Conference on System Sciences*, volume 6, number 1, pages 148 thru 157, 1979.
7. Borning, A. "ThingLab—A Constraint-Oriented Simulation Laboratory." To appear in *ACM Transactions on Programming Languages and Systems* (originally published as *Stanford Computer Science Report STAN-CS-79-746* and *Xerox PARC Technical Report SSL-79-3*, July 1979, out of print).

# INNOVATIVE PRODUCTS

## COMPLETE CATALOG OF COMPUTER EQUIPMENT AT DISCOUNT PRICES.

### 65K \$-100 DYNAMIC MEMORY BY FAMOUS NAME MANUFACTURER

unbelievable price: **\$299**

**FEATURES:** Fully Compatible with IEEE-696 Assembled, tested and fully populated with 65K of 200 ns. brand name memory Bank selectable, 4Mhz operation, extended addressing, invisible refresh 8/16 bit operation (per IEEE-696) and many other features One year warranty, manual included.. Hurry, limited quantities!

#### TELEVIDEO TERMINALS:

Model 912C ..... 695 00  
Model 920C ..... 720 00  
New! Model 950 ..... 995 00

#### EPSON PRINTERS:

Model MX-70 ..... \$CALL  
Model MX-80 ..... \$CALL

### Q.I. COMPUTER SYSTEMS:

| MODEL     | DESCRIPTION (ALL ASSEMBLED & TESTED)              | PRICE    |
|-----------|---|----------|
| MF+DD12A  | ..25 A Mainframe, 12 Slot S100, Dual 8" Drive     | \$625 00 |
| MF+18A    | ..25 A Tabletop Mainframe, 18 Slot S100           | 450 00   |
| MF+12A    | ..25 A Mainframe, 12 Slot S100, Dual 5" Drive     | 450 00   |
| Z+80A     | ..... Single Board Z-80 Computer 2/4 Mhz S-100    | 185 00   |
| Z+80A/22  | ..... Monitor Program for Z+80A & Tarbell or VF-1 | 30 00    |
| RAM 32    | .....32K Static RAM Board, Low Power, S-100       | 499 00   |
| OTC10A    | .....2 Serial & 4 Parallel Port I/O S-100         | 339 00   |
| OTCCCSA   | .....Clock Calendar Board, S-100                  | 125 00   |
| OTCCCAA   | .....Clock Calendar Board, for Apple              | 125 00   |
| OTCCTRS80 | .....Clock Calendar Module for TRS-80             | 125 00   |

### VISTA COMPUTER COMPANY:

| MODEL   | DESCRIPTION (ALL ASSEMBLED & TESTED)                 | PRICE     |
|---------|--|-----------|
| V300/25 | ..Letter Quality Printer 25 CPS                      | \$1895 00 |
| V300/45 | ..Letter Quality Printer, 45 CPS                     | 2195 00   |
| V-DRIVE | ..Dual 8" Disk Cabinet, Power Supply, Rack Mountable | 375 00    |

### COMPUTER SYSTEM RESOURCES:

| MODEL   | DESCRIPTION (ALL ASSEMBLED & TESTED)               | PRICE    |
|---------|--|----------|
| RAM 16  | ..16K Static RAM S-100                             | \$189 00 |
| RAM 16C | ..Low Power (CMOS) Version of RAM 16 1/3 Watt      | 259 00   |
| RAM 65  | ..16K Static RAM I/O Port Bank Select S-100        | 199 00   |
| RAM 65C | ..Low Power (CMOS) Version of RAM 65 1/4 Watt      | 279 00   |
| RAM 32  | ..32K Low Power 8/16 Bit Static RAM Fully IEEE 696 | 499 00   |
| RAM 256 | ..256K 8/16 Bit Dynamic RAM Fully IEEE 696         | 1295 00  |
| I/O-8   | .....8 Port Serial I/O Fully IEEE up to 200K BAUD. | 395 00   |

### ORDERING INFORMATION:

Minimum Order is \$15 00 Prices quoted do not include shipping and handling Foreign orders require prepayment by MICR or Money Order in US funds Purchase Orders accepted from US Government & firms with published A1 Rating from Dun & Bradstreet All other orders require prepayment, charge card, or COD shipment

### TOLL-FREE PHONE NUMBER:

Call Toll-Free 1-800-555-1212, and ask the operator for our New, Toll-Free (800) Number in Alaska, California, and Hawaii, call us collect at (213) 883-3244

### TO RECEIVE OUR FREE CATALOG:

Call our Toll-Free (800) number or circle Reader Service #

7131 OWENSMOUTH AVE. / #21D  
CANOGA PARK, CALIFORNIA 91303  
213 / 883-3244

# INNOVATIVE PRODUCTS

# User-Oriented Descriptions of Smalltalk Systems

---

Trygve M H Reenskaug  
Central Institute for Industrial Research  
Blindern, Oslo 3  
Norway

---

For many people, the workings of a computer remain a mystery. Just exactly what the computer does and how it does it is locked within the code of a computer language. The computer and the user understand two completely different languages. It is well known that only a few systems are designed and written so that they can be understood by the user. More than twenty years of experience has shown that a bad system design can never be hidden from the user, even by a masterfully devised user interface. A quality system, therefore, must be based on sound design that can be described in terms with which the user is familiar.

The Smalltalk system has been designed to handle a great variety of problems and solutions. It, therefore, provides the greatest possible flexibility for writing any kind of system a programmer may desire. While this flexibility is essential for experimenting, there is the potential for disastrous results if restrictions are not put on the system structures that are available to the application programmer.

This article shows how the basic metaphors of Smalltalk can be used to describe complex systems. Since this magazine is not yet distributed in a form readable by Smalltalk, we have to restrict ourselves to traditional written documentation. (Let it be a challenge to Smalltalk ex-

perimenters to convert this presentation into a graphic and dynamic one.)

The Smalltalk system user will most likely employ his system to organize the large amount of information that will be available to him,

---

**More than twenty years of experience has shown us that a bad system design can never be hidden from the user, even by a masterfully devised user interface.**

---

such as reference materials in the form of market information, news services, and weather forecasts. Some data, such as travel information and bank transactions, may flow both to and from the owner. Other information, such as personal notes or material that is not yet ready for distribution, can remain private.

An individual's total information needs are very large and complex. His Smalltalk system, therefore, is also likely to be large and complex. The challenge to the Smalltalk experimenter is to find ways to structure systems so the user will not only understand how to use them, but also get an intuitive feel for their inner workings. In this way, the user can really be the master and the systems

his faithful slaves.

An important part of any system is the software that controls the user's interaction with the information. Mastering the software is crucial to handling the information. With Smalltalk, software is just a special kind of information and is treated as any other information within the total system. It is available to the user in the usual manner.

A traditional way of describing software is through written documentation. Smalltalk provides more dynamic interfaces through the use of two-dimensional graphics and animation on the computer screen. Devising such interfaces is probably the greatest challenge in personal computing today, and it provides a rich field of endeavor for the interested experimenter.

## System Descriptions

We can describe any application system in three different ways: *how it is used*, *its system structure*, and *its implementation*:

• *How it is used*—This is the least satisfactory type of description. The user operates the system through rote command sequences such as: *switch on the machine, type your password, hit button A, listen to your system saluting you by playing "Hail to the Chief."* Since 80% of all user manuals for electronic data processing systems

are of this kind, we will not discuss them further here.

This level of understanding has been likened to walking around in a strange city following directions such as: "Go outside, turn right, walk straight ahead for four blocks, turn left . . ." It is easy to get lost under such circumstances.

● *System structure*—With this type of description, the user has an intuition about the kinds of building blocks that make up the system, how they behave, and how they interact to form the complete system. We show that the basic Smalltalk metaphors of *objects* and *messages* are well suited to function as building blocks. The metaphors are simple and easy to understand; yet they permit construction of immensely powerful systems.

---

**A basic system will have several thousand objects, and typical applications would contain many more.**

---

Any Smalltalk system contains a large number of objects. A basic system will have several thousand objects, and typical applications would contain many more. The common software engineering device of *layering* becomes essential in making the whole thing manageable. In the description of a layer, essential function on that level is highlighted and inconsequential detail is relegated to lower levels. There is one absolute requirement of these simplified descriptions appearing on the different layers: *what is shown should be correct and complete as far as it goes*. This means that the structure of the description has to be a pure tree structure: the function of each module has to be limited to that module with *no hidden side effects upon the other modules*.

This level of understanding corresponds to the user having a street map of the system. He knows the major landmarks and the most important streets. This gives the user an intuition about the total structure and permits him to find his way any-

where. It is almost impossible to get totally lost under these circumstances.

● *Implementation*—Descriptions at this level of understanding explain to the user how each individual object is built so that it behaves in the manner prescribed on the system structure level. Here he will find the third basic metaphor of Smalltalk, the *method*. A method is similar to a subroutine in other languages; it prescribes the actions to be taken by an object when it receives a message.

On all layers but the lowest, the behavior of an object is fairly complex, and we can think of it as composed of a number of *sub-objects* that are used to implement it. The purpose of the method is to enlist the aid of the sub-objects to implement the desired behavior. The user thus finds that the typical object is structured in much the same manner as his total system, and it consists of a number of sub-objects that send messages to each other. The description tool is recursive in that the same tool is used on all levels. This recursion description is probably the most powerful feature of Smalltalk. Once the user masters the few very general concepts, he can learn more and more about his system by simply using these concepts to dig deeper and deeper into the system layers. In addition, the user can modify and expand the system on any level by collecting new components out of the building blocks provided by the next level below it.

The user at this level now has an intuition of the overall layout of the city. He also has sub-maps of all the details and he knows how to read them. Depending on his personality, he may use these maps only when absolutely necessary, or he may use them to explore unknown territory. In contrast to the tourist, the Smalltalk user can even make modifications and new extensions to the city. The tools are there. The user decides if, when, and how he wants to use them.

**Example of a System Description**

*The problem:* Consider a small manufacturing company that has two



**The Converter that transforms your electronic typewriter into a computer printer.**

- No modifications to the typewriter
- Does not affect normal typewriter functions
- All typewriter functions accessible by computer
- RS232C, IEEE and parallel interfaces available
- KSR version turns typewriter into a computer terminal
- Fully assembled, tested and burned in

---

**NEW! NOW AVAILABLE**

---

**OLIVETTI PRAXIS 35  
TYPEWRITER  
+  
CONVERTER TP35 =  
DAISY WHEEL PRINTER  
FOR LESS THAN \$1000.**

---

Prices start as low as \$275.  
CONTACT YOUR LOCAL  
OFFICE EQUIPMENT DEALER  
OR  
VERTICAL DATA SYSTEMS INC.  
FOR FURTHER DETAILS.



Vertical Data Systems Inc.  
1215 Meyerside Dr., Unit 2A,  
Mississauga, Ontario,  
Canada L5T 1H3  
(416) 671-1752

---

**Dealer inquiries invited**

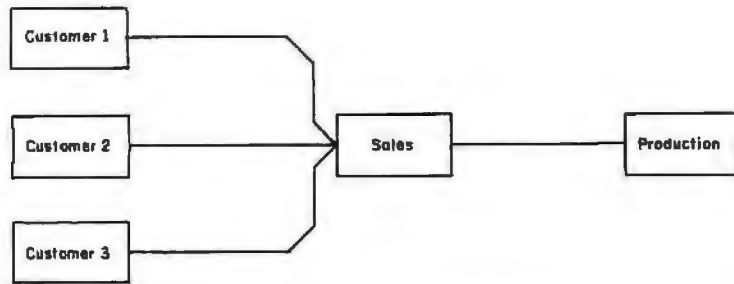

Figure 1: A job-shop manufacturing company with its customers.

departments: sales and production. The responsibility of the sales department is to find customers for any product the company can make, to contact the production department to find out when the product can be delivered, and to sign a contract with the customer. The responsibility of the production department is to manufacture each product as cheaply as possible at a specified level of quality and to have it finished on the promised date. When the production department has manufactured the product, it is dispatched to the customer through the sales department.

*The system:* A natural way to map this into a Smalltalk system would be to represent each department as an object. The function of the Sales object would be to keep track of the state of each sale in the following sequence:

1. Fill in and send proposals
2. Reserve the necessary resources in production for the product
3. Send contracts and packing notes to the customer

The function of the Production object would be to:

1. Keep track of commitments
2. Schedule the manufacture of products
3. Help keep the product quality
4. Control the manufacturing process to get the products completed on time

It also seems reasonable to include a third kind of object in our system: Customer objects. The purpose of these objects would be to act as a

receptacle for the messages being passed from the company to the customer and from the customer to the company. The various objects with a set of reasonable communication channels is shown in figure 1.

*The overall processing of an order:* The Smalltalk system would be programmed to reflect everything of importance that takes place during the processing of an order and to support its user on every step. The process that takes place inside the Smalltalk system would, therefore, closely resemble the actual processing of an order. Let us assume the following real-life process, which is depicted in figure 2. A customer submits an intention to buy, a request for offer, to the company. The sales department books resources from the production department and returns an offer with the cost and delivery date to the customer. The customer answers with a purchase order. This is transcribed and passed from sales to production as a requisition. The product is manufactured in production, and a ready-note is sent to sales, which arranges for transport and sends packing notes to the customer.

In the Smalltalk system, the Sales object would help the user of the system in corresponding with the customer, in keeping track of progress, and in sending the required forms to the production department. The Production object would help the user in the planning and control of the manufacturing process.

In order to highlight the principles, we have made this a very simple system. The reader will have no difficulty in expanding it, for example, by adding an object for the accounting department that takes care of bill-

## VISIT THE MicroAge. STORE IN YOUR AREA!

9530 Viscount  
El Paso, Texas  
(915) 591-3349

2525 N. Scottsdale Road  
Scottsdale, Arizona  
(602) 941-8794

611 Rockville Pike  
Rockville, Maryland  
(301) 762-7585

1490 W. Spring Valley Rd.  
Richardson, Texas  
(214) 234-5955

5742 E. Broadway  
Tucson, Arizona  
(602) 790-8959

83 South 10th Street  
Minneapolis, Minnesota  
(612) 338-1777

2760-S South Havana  
Aurora, Colorado  
(303) 696-6950

4550-50 E. Cactus  
Phoenix, Arizona  
(602) 996-2910

1707 Monroe Avenue  
Rochester, New York  
(716) 244-9000

24 W. Camelback  
Phoenix, Arizona  
(602) 265-0065

1220 Melbourne Drive  
Hurst, Texas  
(817) 284-3413

2591 Hamilton Road  
Columbus, Ohio  
(614) 868-1550

2675 Mayfair Road  
Milwaukee, Wisconsin  
(414) 257-1100

8615 Allisonville Road  
Indianapolis, Indiana  
(317) 849-5161

2065 El Camino Real West  
Mountain View, California  
(415) 964-7063

1517 N.E. 122nd Avenue  
Portland, Oregon  
(503) 256-4713

79 Main Street  
Norwalk, Connecticut  
(203) 846-0851

### COMING SOON TO:

Salt Lake City, Utah  
St. Louis, Missouri  
San Diego, California  
Omaha, Nebraska  
Albuquerque, New Mexico  
Spokane, Washington  
Toronto, Canada  
Boston, Massachusetts  
Pompano Beach, Florida  
Palm Beach, Florida  
Houston, Texas  
Wilmington, Delaware  
Chicago, Illinois  
Walnut Creek, California  
Panama City, Panama  
Anchorage, Alaska

**FOR FRANCHISE  
OPPORTUNITY  
INFORMATION CALL  
(602) 968-3168**

# CASH FLOW PROBLEMS?



## IT'S NICE TO KNOW SOMEONE WHO HAS THE SOLUTION.



MicroAge is your Solution Store . . . that means at MicroAge Computer Stores we have a wide selection of time-saving computerized business systems designed specifically to solve the daily cash flow problems every businessman faces.

MicroAge has computerized business systems that quickly and affordably allow you to regain control of your critical accounts receivable . . . at last making it possible for you to carry out effective collection procedures on a consistent basis. MicroAge has accounts receivable program packages to automatically display and update account information; prepare trial balance including a balance-due and delinquency aging

report, and take care of dozens of other tasks that eat into your time and profit!

Computerized business systems from the MicroAge Computer Store are available in the \$5,000 to \$15,000 range, to suit the individual budget of your small business or professional practice. MicroAge backs up every system with personalized service, warranty service and repair, installation, systems consulting, even customer training. Visit the MicroAge Computer Store in your area soon with your business problems, and let us help you with the solution.

**MicroAge.**  
**COMPUTER STORE**

*"The Solution Store" SM*

Circle 219 on inquiry card.

# Big sale on K's!

16K... \$149.95

32K... \$199.95

48K... \$249.95

64K... \$299.95

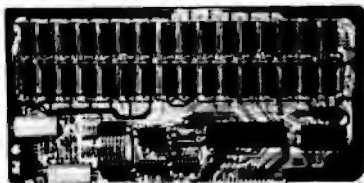

## New JAWS-IB

### The Ultrabyte Memory Board

Due to the tremendous success of our JAWS I, we were able to make a special purchase of first-quality components at below-cost prices for JAWS-IB. And we are sharing our cost saving with you. But don't be surprised if the next time you see this ad the prices have gone up substantially. Better yet, order now, and get the best memory on the market at the best price on the market.

#### ONE CHIP DOES IT ALL

Jaws-IB is the Rolls-Royce of all the S100 dynamic boards. Its heart is Intel's single chip 64K dynamic RAM controller. Eliminates high-current logic parts... delay lines... massive heat sinks... unreliable trick circuits. JAWS-IB solves all these problems.

#### LOOK WHAT JAWS-IB OFFERS YOU

Hidden refresh... fast performance... low power consumption... latched data outputs... 200 NS 4126 RAM's... on-board crystal... RAM Jumper selectable on 6K boundaries... fully socketed... solder mask on both sides of board... phantom line... designed for 8080, 8085, and Z80 bus signals... works in Explorer, Sol, Horizon, as well as all other well-designed S100 computers.

**10-DAY MONEY-BACK TRIAL:** Try a fully wired and tested board for 10 days — then either keep it, return it for full, or simply return it in working condition.

Continental U.S.A. Credit Card Buyers Outside Connecticut:  
**TO ORDER CALL TOLL FREE 800-243-7428**  
 From Connecticut Or For Assistance:  
 (203) 354-9375

Please send the items checked below:

#### JAWS-IB kit:

- 16K ..... \$149.95\*
- 32K ..... \$199.95\*
- 48K ..... \$249.95\*
- 64K ..... \$299.95\*

#### JAWS-IB Fully Assembled, Wired & Tested:

- 16K ..... \$179.95\*
- 32K ..... \$239.95\*
- 48K ..... \$299.95\*
- 64K ..... \$359.95\*

EXPANSION KIT, 16K RAM Module, to expand JAWS-IB in 16K blocks up to 64K. \$59.95

\*All prices plus \$2 postage and insurance (\$4.00 Canada). Connecticut residents add sales tax.

Total enclosed: \$ \_\_\_\_\_

- Personal Check       Money Order or Cashier's Check
- VISA                       Master Card (Bank No. \_\_\_\_\_)

Acct. No. \_\_\_\_\_ Exp. Date \_\_\_\_\_

Signature \_\_\_\_\_  
 Print Name \_\_\_\_\_

Address \_\_\_\_\_

City \_\_\_\_\_

State \_\_\_\_\_ Zip \_\_\_\_\_

**NETRONICS R&D Ltd.**  
 333 Litchfield Road, New Milford, CT 06776

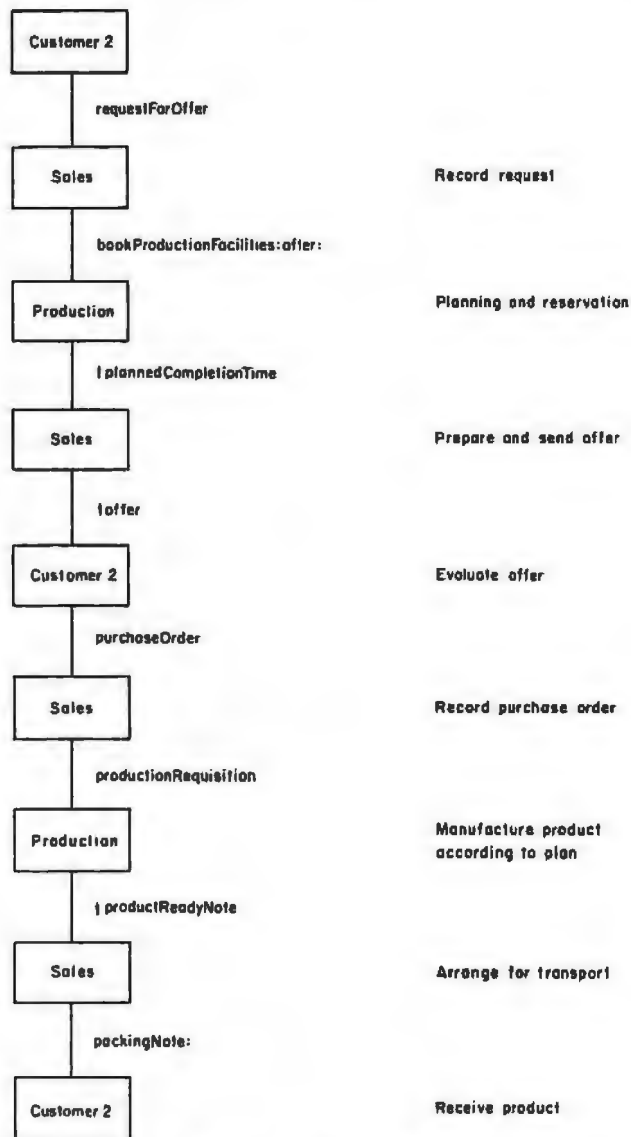

Figure 2: The processing of an order. The Smalltalk system supports this processing through interaction with its owner in real-time.

ing, an object for the warehouse that may or may not have the required product in stock, and so on. Also, figure 2 could probably be better documented on a Smalltalk computer by animating figure 1.

### An Implementation Description

Let us inspect the Production object of figure 1 and see how it processes the message `bookProductionFacilities:after:`. When this message is received by the Production object, it consults its message dictionary to find the corresponding method. If the products were simple and the workshop small, the object could contain the current production plan directly and the method could go something like that

shown in listing 1.

One of the instance variables of the Production object is the table `productDuration` which contains the time it takes to manufacture various products. Looking at this table, we find the duration for a product. In this simple example, there is only one resource, and we find the first available time slot for the product by sending self the message `findFreePeriod:after:`. This corresponds to calling a local subroutine in other systems. We then reserve the resource for our product in that period. (These two steps could have been combined into one, but the separation gives us more flexibility in varying the planning algorithm if we wish to do so later.)

# TRANSFER YOUR DATA INTO HARDCACHE™

## THE HARDCACHE SUBSYSTEM:

- ◆ **30 Megabytes [Formatted] Winchester Disk**  
Average access time 48 milliseconds
- ◆ **Cartridge tape drive provides:**  
Complete backup in under 10 minutes  
File save/reload  
Software distribution
- ◆ **S-100 Bus Intelligent Interface Card**  
DMA or programmed I/O data transfer  
Disk throughput optimizer  
Bootstrap ROM - switch selectable  
Time of day clock - battery powered
- ◆ **Compatible with**  
**CROMEMCO**  
**VECTOR GRAPHICS**  
**NORTH STAR** and other  
**S-100 based computer systems**
- ◆ **Installs on any CP/M or**  
**MP/M system\***



\*CP/M and MP/M are registered trademarks of Digital Research.



**EXECUTIVE SYSTEMS, INC.**

15300 Ventura Boulevard  
Sherman Oaks, California 91403  
(213) 990-3457

**NEW STATE-OF-THE-ART**  
**SS16K/IEEE**  
**16K STATIC RAM BOARD**  
**ONLY \$179<sup>95</sup>**

Expand your system beyond 64K — add universal bank select option for only \$20.00

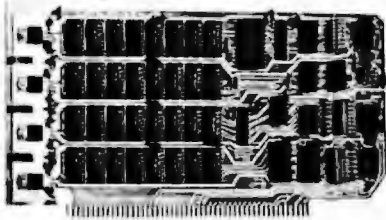

**New: SS16K/IEEE RAM**

It's everything you need in a 16K static RAM board — at the lowest price you've ever seen. The SS16K/IEEE comes with all the high performance features listed below. And unlike obsolete-design RAM's (without bank select) you can add-on our universal software bank-selector system anytime, now just \$20.00. This makes the SS16K/IEEE capable of addressing 2,048 different banks. You can add memory beyond the 64K limit. You can expand to a multi-terminal system.

**FEATURES OF SS16K/IEEE :**

- Low-power 2114's
- All inputs and outputs meet the proposed IEEE standards for the S100 bus.
- 4.0 MHz operation.
- Schmitt trigger buffer on all signals for maximum noise reduction.
- Addressable on 16K boundaries, 0-64K, dip switch selectable.
- Phantom option, dip switch selectable.
- PWR/MWRITE option, dip switch selectable.
- Glass epoxy PC board with gold-plated contacts and double-sided solder mask.
- Fully socketed.
- Four separate regulators, for maximum stability.

**WITH BANK SELECT OPTION (now just \$20.00) YOU ADD THIS:**

- Software bank selector featuring a universal decoder works with Cromenco, Alpha Micro, Netronics, most other systems, or your design. On-board dip switches: Bank Select Enable, Reset Enable, Reset Disable, Port Address, Port Data.
- LED Indicator to display status.

**10-DAY MONEY-BACK TRIAL:** Try a fully wired and tested board for 10 days — then either keep it, return it for kit, or simply return it in working condition.

Continental U.S.A. Credit Card Buyers Outside Connecticut:

**TO ORDER CALL TOLL FREE 800-243-7428**  
 From Connecticut or For Assistance:  
 (203) 354-9375

Please send the items checked below:

- SS16K/IEEE without bank select:
- Kit ..... \$179.95\*
- Fully assembled, wire & tested ..... \$199.95\*
- SS16K/IEEE with bank select:
- Kit ..... \$199.95\*
- Fully assembled, wired & tested ..... \$229.95\*
- SS16K/IEEE bank select option ..... \$20.00\*

\*Plus \$2 postage & insurance (\$5.00 Canada). Connecticut residents add sales tax.

Total enclosed: \$ \_\_\_\_\_

- Personal Check       Money Order or Cashier's Check
- VISA                       Master Card (Bank No. \_\_\_\_\_)

Acct. No. \_\_\_\_\_ Exp. Date \_\_\_\_\_

Signature \_\_\_\_\_

Print Name \_\_\_\_\_

Address \_\_\_\_\_

City \_\_\_\_\_

State \_\_\_\_\_ Zip \_\_\_\_\_

NETRONICS R&D Ltd.

333 Litchfield Road, New Milford, CT 06776

Listing 1: Smalltalk method for the message bookProductionFacilities:after:.

**bookProductionFacilities: productType after: earliestStartTime**

"Reserves production facilities for a new product of given type as soon as possible after the specified earliest starting time. Returns the planned completion time for the product."

```

| duration plannedStartTime |
duration ← productDuration at: productType.
plannedStartTime ← self findFreePeriod: duration after: earliestStartTime,
self reservePeriod: duration from: plannedStartTime.
↑ (plannedStartTime + duration)
    
```

Listing 2: Alternate Smalltalk method for the message bookProductionFacilities:after:.

**bookProductionFacilities: productType after: earliestStartTime**

"Reserves production facilities for a new product of given type as soon as possible after the specified earliest starting time. Returns the planned completion time for the product."

```

| productIdentification |
productIdentification ← jobManager defineProduct: productType.
jobManager schedule: productIdentification after: earliestStartTime.
↑ (jobManager plannedCompletionTime: productIdentification).
    
```

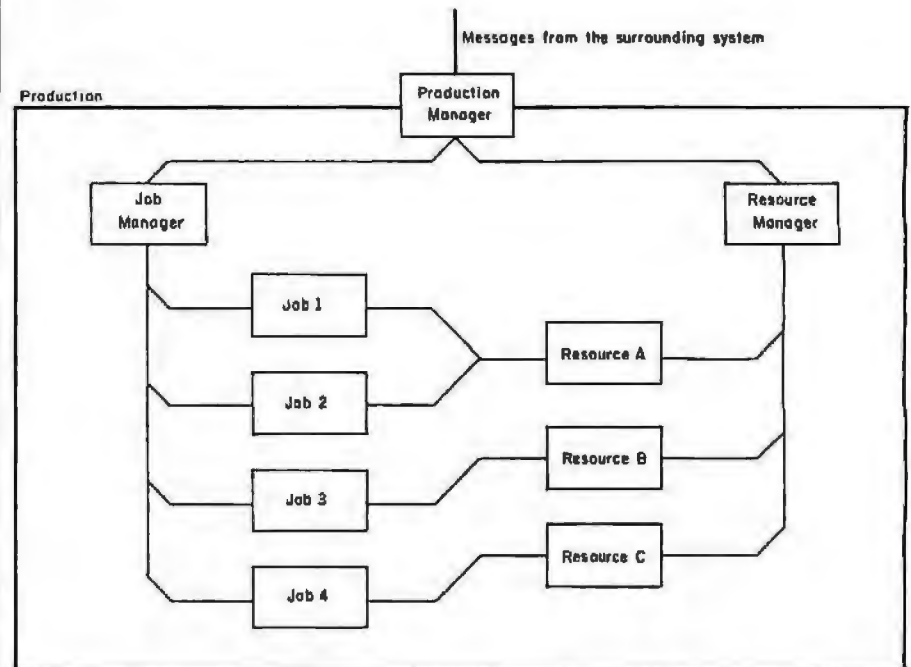

Figure 3: The internals of the Production object.

The planned completion time is returned to the sender, in this case the Sales object.

**Lower-Level System Description**

If the user wants more advanced aids for production control, the Production object would call upon the services of a subsystem of interconnected objects. A possible subsystem is shown in figure 3.

The entrance to the internals of the Production objects is through a Production Manager object; it is con-

nected to a Job Manager object and a Resource Manager object.

The manufacturing of a product is split into a number of jobs. The available production facilities (people and machines) are split into a number of resources. Each job is to be performed by a single resource. A natural way to map this into a Smalltalk system is to represent each job by a Job object and each resource by a Resource object.

In this scheme, each Job object ensures that the job is performed by its



## Wild Hare Software Systems Multiply the Capabilities of Data General's

**RDOS  
INFOS®  
ICOS  
DOS**

Wild Hare gives Data General users a choice when upgrading to a multi-user environment and eliminates the need to use AOS. Wild Hare makes it easy for you. It creates a true multi-lingual, multi-user environment for your current system. No user software modifications are necessary. There is no need to install a new operating system. And, no expensive hardware upgrade is required.

### Features

- Each user is totally independent of all other users.
- Each user may run all standard Data General software.
- Each user may independently edit, compile, execute and debug programs written in any language supported by RDOS, INFOS®, ICOS and DOS.
- Standard languages supported include: Fortran IV, Fortran V, COBOL, ALGOL, RPG, DG/L™, BASIC, PASCAL, MAC, etc.
- All NOVA's® and ECLIPSE's® are supported.
- Wild Hare guarantees its software systems on a money back basis.

**Wild Hare's Software  
Gives Data General Users  
A Choice!**

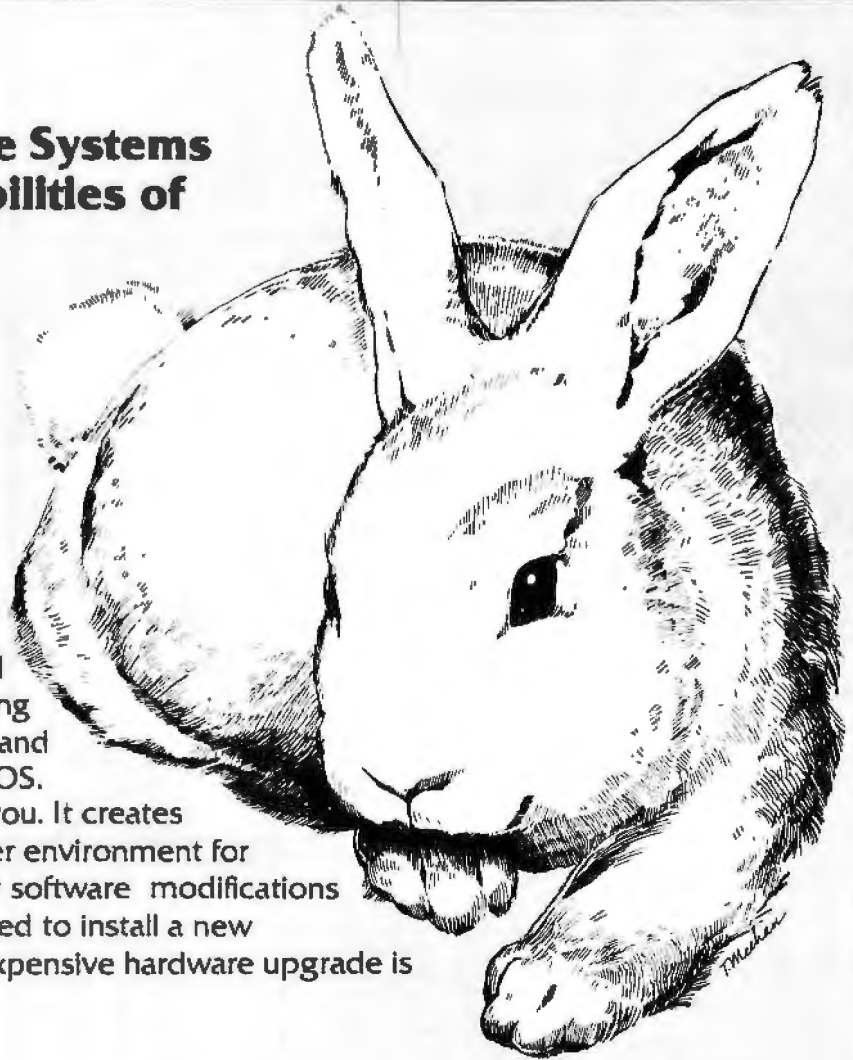

**WILD HARE** COMPUTER  
SYSTEMS INC.

P.O. Box 3581, Boulder, Colorado 80307  
(303) 494-0221

NOVA, ECLIPSE, and INFOS are registered trademarks of Data General Corporation.

CPU'S & SUPPORT CHIPS

Table listing various CPU and support chips with part numbers and prices, including models like 8030A, 8030B, and 8032.

RAM's ROM's

Table listing RAM and ROM chips with part numbers and prices, including 2114L-3, 4116-16, and 2102-4.

INTERFACE SHIFTS & DRIVERS REGISTERS

Table listing interface and driver chips with part numbers and prices, including 1488, 1489, and 1490.

PRINTED CIRCUIT BOARD

Text describing printed circuit board specifications, including 4" x 6" double sided epoxy board.

EPOXY GLASS VECTOR BOARD

Text describing epoxy glass vector board specifications, including thickness and spacing.

DAT'L'S DAC-08EO

Text describing DAC-08EO specifications, including bit depth and price.

INTERNAL LOGIC DRIVERS

Text describing internal logic drivers specifications, including bit count and price.

7 WATT LD 65 LASER DIODE IR \$8.95

Text describing 7Watt LD 65 laser diode specifications and price.

2N3820 P FET

Text describing 2N3820 P FET specifications and price.

2N5457 N FET

Text describing 2N5457 N FET specifications and price.

2N2946 UJT

Text describing 2N2946 UJT specifications and price.

ER 900 TRIGGER DIODES

Text describing ER 900 trigger diodes specifications and price.

2N 6028 PROG. UJT

Text describing 2N 6028 programmable UJT specifications and price.

DISC CAPACITORS

Table listing disc capacitor values and prices, including 1UF 16V, 10UF 16V, etc.

TANTALUM CAPACITORS

Table listing tantalum capacitor values and prices, including 47UF 35V, 10UF 10V, etc.

SANKEN AUDIO POWER AMPS

Text describing sanken audio power amp specifications and prices.

RS232 CONNECTORS

Text describing RS232 connector specifications and prices.

POSTAGE RATES

Text describing postage rates for orders under \$20.00 and above \$50.00.

C/MOS

Table listing C/MOS chips with part numbers and prices, including 4001, 4002, 4003, etc.

SPECIALS

- List of special offers including 10% discount on all SCR's and TRIACS, and prices for 4 ea. 2716 ROM's, etc.

CRYSTALS \$3.45 ea.

Text describing crystal specifications and prices.

WE SHIP OVER 95% OF OUR ORDERS WITHIN 24 HOURS OF RECEIPT

Text describing shipping and handling policies.

MINIATURE MULTI-TURN TRIM POTS

Text describing miniature multi-turn trim pots specifications and prices.

NO. 30 WIRE WRAP WIRE SINGLE STRAND

Text describing wire wrap wire specifications and price.

ALCO MINIATURE TOGGLE SWITCHES

Text describing Alco miniature toggle switches specifications and prices.

SCR's TRIAC's

Table listing SCR and TRIAC specifications and prices.

FP 100 PHOTO TRANS

Text describing FP 100 photo transistor specifications and price.

FAST RECOVERY DIODE (35ns)

Text describing fast recovery diode specifications and price.

SILICON POWER RECTIFIERS

Table listing silicon power rectifier specifications and prices.

IN 4148 (IN914)

Text describing IN 4148 diode specifications and price.

.5V at 800ma SOLAR CELLS

Text describing .5V solar cell specifications and price.

7 SEGMENT DISPLAYS

Text describing 7-segment display specifications and prices.

REGULATORS

Text describing voltage regulator specifications and prices.

TRANSISTOR SPECIALS

Table listing transistor special offers with part numbers and prices.

TTLIC SERIES

Table listing TTLIC series chips with part numbers and prices.

FULL WAVE BRIDGE

Table listing full wave bridge components with part numbers and prices.

DIP SOCKETS

Table listing DIP socket specifications and prices.

74LS SERIES

Table listing 74LS series chips with part numbers and prices.

LINEAR CIRCUITS

Table listing linear circuit components with part numbers and prices.

REGULATORS

Table listing voltage regulator specifications and prices.

resource within the available time. Similarly, each Resource object ensures that its resource is used in an efficient manner, that there is sufficient time available for preventive maintenance, and that there are no unacceptable overloads.

One of the instance variables of the Production Manager object is a pointer to the Job Manager object. By using that pointer as a communication channel, the Production Manager object passes most of the work on to the Job Manager object. First, the Job Manager is asked to define the new product. The Job Manager creates the Job objects (see figure 3), links them to the proper Resource objects, and returns an identification that is to be used for future references to the product.

Definition of New Objects

The first task of the Job Manager object is to define the new object. It receives message defineProduct: when this is to be done. The corresponding method could be something like that shown in listing 3. We are referencing two instance variables of the Job Manager object in this method: productDescriptions and productionManager. productDescriptions is an ordered collection with one member for each product type. Each of these members contains a sequence of small objects with the class, duration, and resource type for each of the jobs that go into the manufacture of such a product. productionManager contains a pointer to the Production Manager object. The result of the product creation is put in a third instance variable, the productDic-



SOLID STATE SALES P.O. BOX 74B SOMERVILLE, MASS. 02143

TEL. (617) 547 7053 WE SHIP OVER 95% OF OUR ORDERS WITHIN 24 HOURS OF RECEIPT TOLL FREE 1-800-343-5230



**MMSFORTH VERSION 2.0:  
MORE FOR YOUR RADIO SHACK  
TRS-80 MODEL I OR MODEL III !**

- ★ **MORE SPEED**  
10-20 times faster than Level II BASIC.
- ★ **MORE ROOM**  
Very compact compiled code plus VIRTUAL MEMORY makes your RAM act larger. Variable number of block buffers. 31-char. unique word-names use only 4 bytes in header!
- ★ **MORE INSTRUCTIONS**  
Add YOUR commands to the 78-STANDARD-plus instruction set!  
Far more complete than most Forths: single & double precision, arrays, string-handling, clock, more.
- ★ **MORE EASE**  
Excellent full-screen Editor, structured & modular programming  
Word search utility  
NOTEPADS Letter writer  
Optimized for your TRS-80 with keyboard repeats, upper/lower case display driver, full ASCII, single- & double-width graphics, etc.
- ★ **MORE POWER**  
Forth operating system  
Interpreter AND compiler  
8080 Assembler  
(Z80 Assembler also available)  
Intermix 35-10 80-track disk drives  
Model III System can read, write & run Model I diskettes!  
VIRTUAL I/O for video and printer, disk and tape (10-Megabyte hard disk available)



**THE PROFESSIONAL FORTH FOR TRS-80**

(Over 1,500 systems in use)

Prices:  
MMSFORTH Disk System V2.0 (requires 1 disk drive & 16K RAM, 32K for Model III) ..... \$129.95\*  
MMSFORTH Cassette System V2.0 (requires Level II BASIC & 16K RAM) ..... \$69.95\*

**AND MMS GIVES IT PROFESSIONAL SUPPORT**

Source code provided  
MMSFORTH Newsletter  
Many demo programs aboard  
MMSFORTH User Groups  
Inexpensive upgrades to latest version  
Programming staff can provide advice, modifications and custom programs, to fit YOUR needs

MMSFORTH UTILITIES DISKETTE: includes FLOATING POINT MATH (L2 BASIC ROM routines plus Complex numbers, Rectangular-Polar coordinate conversions, Degrees mode, more), plus a full Forth-style Z80 ASSEMBLER, plus a powerful CROSS-REFERENCER to list Forth words by block and line. All on one diskette (requires MMSFORTH V2.0, 1 drive & 32K RAM) ..... \$39.95\*

FORTHCOM: communications package provides RS-232 driver, dumb terminal mode, transfer of FORTH blocks, and host mode to operate a remote TRS-80 (requires MMSFORTH V2.0, 1 drive & 32K RAM) ..... \$39.95\*

THE DATAHANDLER V1.2: a very sophisticated database management system operable by non-programmers (requires MMSFORTH V2.0, 1 drive & 32K RAM) ..... \$69.95\*

MMSFORTH GAMES DISKETTE: real-time graphics & board games which include BREAKFORTH, CRASHFORTH, FREEWAY, OTHELLO & TICTACFORTH (requires MMSFORTH V2.0, 1 drive & 32K RAM) \$39.95\*

Other MMSFORTH products under development

**FORTH BOOKS AVAILABLE**

MicroFORTH PRIMER - comes with MMSFORTH separately ..... \$15.00\*  
USING FORTH - more detailed and advanced than above ..... \$25.00\*  
INVITATION TO FORTH - detailed beginner book on FORTH ..... \$17.50\*  
THREADED INTERPRETIVE LANGUAGES - advanced, excellent analysis of MMSFORTH-like language ..... \$19.95\*  
PROGRAM DESIGN & CONSTRUCTION - intro. to structured program, good for Forth ..... \$9.95\*  
FORTH '78 STANDARD MANUAL - official reference to 78-STANDARD word set, etc. .... \$10.00\*  
CALTECH FORTH MANUAL - good on Forth internal structure, etc. .... \$10.00\*  
FORTH SPECIAL ISSUE, BYTE Magazine (Aug. 1980) - we stock this collector's item for Forth users and beginners ..... \$4.00\*

\* - ORDERING INFORMATION: Software prices include manuals and require signing of a single system, single-user license. SPECIFY for Model I or Model III! Add \$2.00 S/H plus \$1.00 per additional book. Mass. orders add 5% tax. Foreign orders add 20% UPS COD, VISA & M/C accepted; no unpaid purchase orders, please

Send SASE for free MMSFORTH information  
Good dealers sought

Get MMSFORTH products from your computer dealer or

**MILLER MICROCOMPUTER SERVICES (88)**

81 Lake Shore Road, Natick, MA 01760  
(617) 653-6138

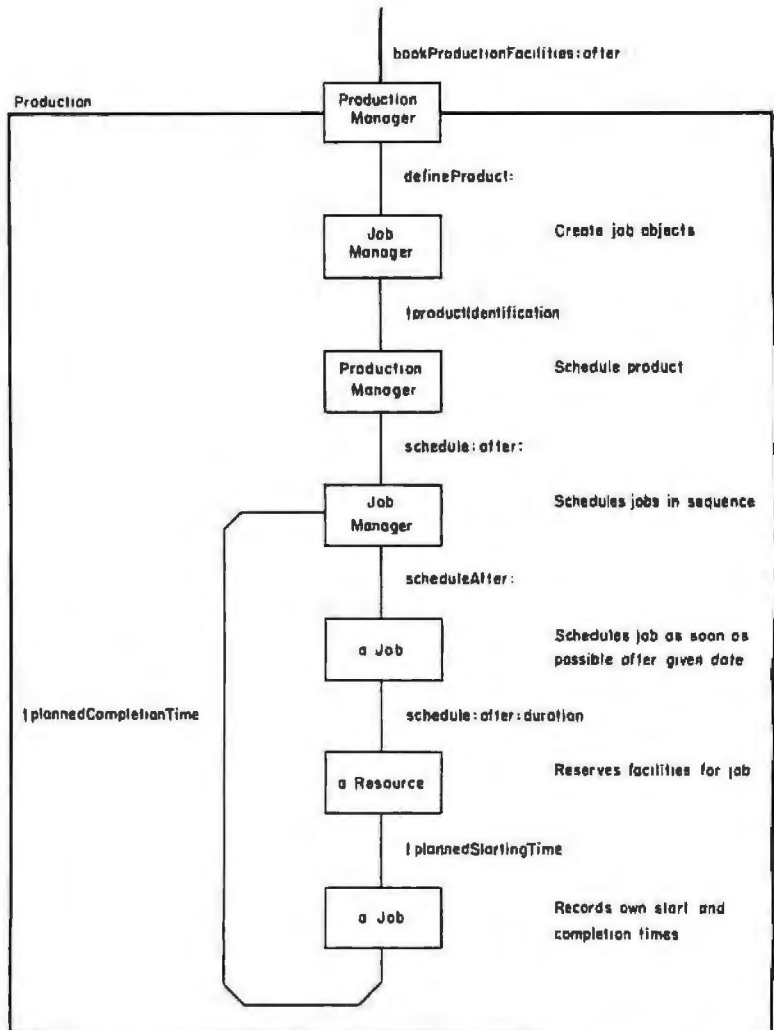

Figure 4: A simple planning algorithm implemented in a Smalltalk system.

Listing 3: Smalltalk method for the message defineProduct:.

**defineProduct: productType**

"To create a new product of given type. The corresponding Job objects are created and linked to their resource objects."

```

[productIdentification jobDescriptions job jobList resourceObject |
productIdentification ← self nextProductIdentification.
jobDescriptions ← productDescriptions at: productType.
jobList ← jobDescriptions collect:
[ :description |
job ← (description class) new.
job duration: (description duration).
resourceObject ← productionManager getResource: (description
resourceType).
job resource: resourceObject].
productDictionary at: productIdentification put: jobList.
↑ productIdentification.
  
```

tionary. In this dictionary, each key is a product identification; the corresponding entry is the sequence of job objects for that product.

The first line of code gets a new, unique identification for the new product. Next, the list of job descriptions

is retrieved from the productSpecification collection. We then build the sequence of Job objects by going systematically through the job descriptions. For each description, we create a new Job object of the given class, feed it its duration, and let it

# datasouth announces... **THE TOTAL PRINTER PACKAGE!**

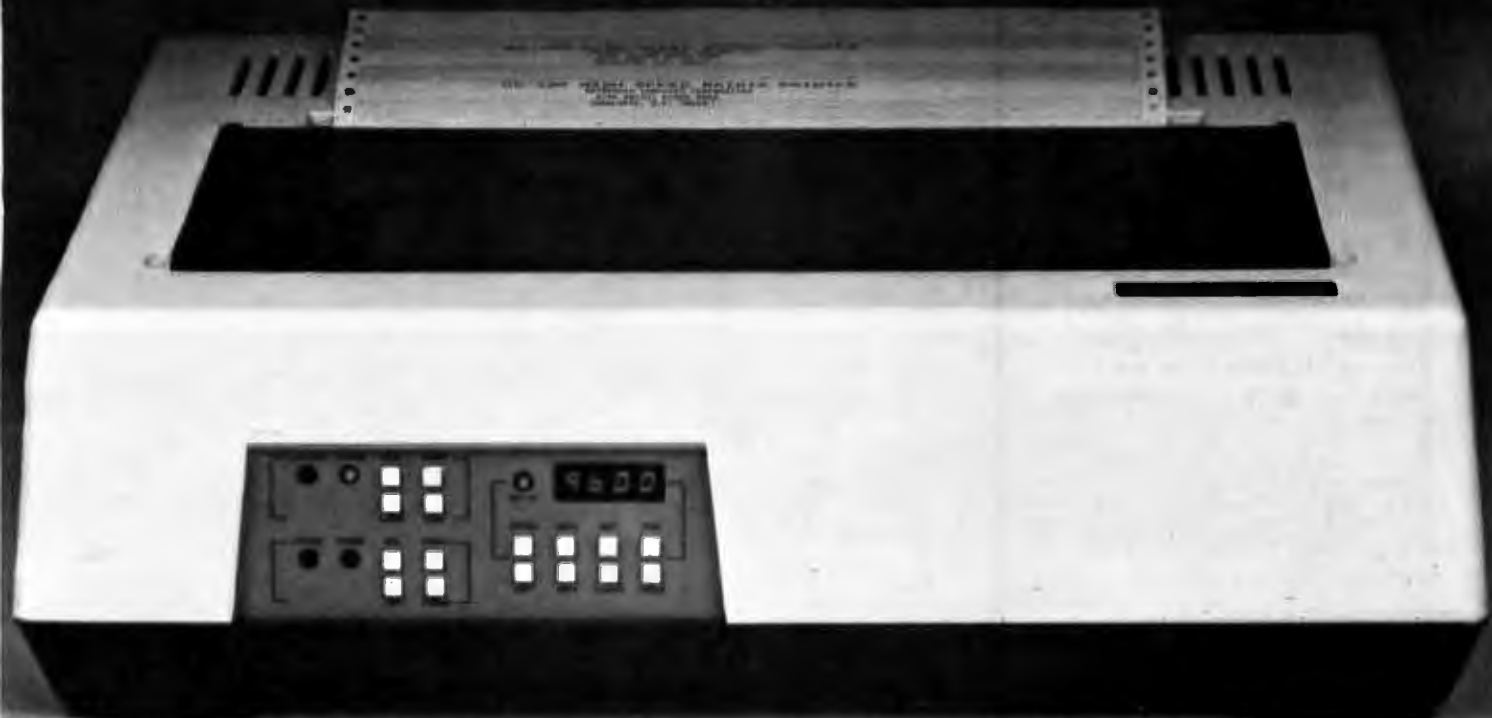

With so many matrix printers on the market today, it may seem tough to find exactly the right one for your application. Some models may offer the speed you need, others the communications flexibility and still others the forms handling capability. But no printer offers all the features you need...until now.

The DS180 matrix printer provides the total package of performance features and reliability required for applications such as CRT slave copy, remote terminal networks and small to mid-range systems. Not a "hobby-grade" printer, the DS180 is a real work-horse designed to handle your most demanding printer requirements. And pricing on the DS180 is hundreds of dollars below competitive units.

**High Speed Printing**—Bidirectional, logic-seeking printing at 180 cps offers throughput of over 200 lpm on average text. A 9-wire printhead life-tested at 650 million characters generates a 9x7 matrix with true lower case descenders and underlining.

**Non-volatile Format Retention**—a unique programming keypad featuring a non-volatile memory allows the user to configure the DS180 for virtually any application. Top of form, horizontal and vertical tabs, perforation skipover, communications parameters

and many other features may be programmed and stored from the keypad. When your system is powered down, the format is retained in memory. The DS180 even remembers the line where you stopped printing. There is no need to reset the top of form, margins, baud rate, etc... It's all stored in the memory. If you need to reconfigure for another application, simply load a new format into the memory.

**Communications Versatility**—The DS180 offers three interfaces including RS232, current loop and 8-bit parallel. Baud rates from 110-9600 may be selected. A 1K buffer and X-on, X-off handshaking ensure optimum throughput.

**Forms Handling Flexibility**—Adjustable tractors accommodate forms from 3"-15". The adjustable head can print 6-part forms crisply and clearly making the DS180 ideal for printing multipart invoices and shipping documents. Forms can be fed from the front or the bottom.

If you would like more information on how the DS180's low-cost total printer package can fill your application, give us a call at Datasouth. The DS180 is available for 30-day delivery from our sales/service distributors throughout the U.S.

**datasouth**  
**computer corporation**

# SOFTWARE DEVELOPMENT TOOLS FOR INDUSTRY

## CP/M CROSS-ASSEMBLERS

Fast, comprehensive cross-assemblers to run under CP/M.\* Extensive pseudo-ops include full listing control, nested conditionals, mnemonic synonyms, and inclusion of external source files. Generate object file, assembly listing, and symbol table from source code for nine popular microprocessor families.

|              |           |
|--------------|-----------|
| XASM05.....  | 6805      |
| XASM09.....  | 6809      |
| XASM18.....  | 1802      |
| XASM48.....  | 8048      |
| XASM51.....  | 8051      |
| XASM65.....  | 6502      |
| XASM68.....  | 6800/6801 |
| XASMF8.....  | F8/3870   |
| XASM400..... | COPS400   |

Assemblers .... \$200.00 each  
Manual only .... \$25.00

## 8048 DEVELOPMENT PACKAGE

Now you can use the 8048 family of single-chip microcomputers without buying expensive equipment. Develop 8048 software with the XASM48 cross-assembler. Then plug our EPR-48 board into your S-100 system to program the 8748 EPROM version. (Similar packages for 8051 and TMS9940E coming soon.)

8048 Development Package ... \$574.00  
EPR-48 alone ..... \$449.00

## PROM EMULATOR BOARD

Debug dedicated systems quickly. Our PSB-100 PROM Emulator is an S-100 board with up to 8K of RAM. Cable with 24-pin plug replaces PROM(s) in your target system for instant program testing.

PSB-100 PROM Emulator .. \$445.00 w/  
2K RAM



**avocet  
systems  
inc.**

\*Trademark of Digital Research

804 south state st.  
dover, delaware/19901/302-734-0151

Visa and Mastercharge accepted. We ship on 8" single-density. Ask us about other formats.  
OEM AND DEALER INQUIRIES INVITED.

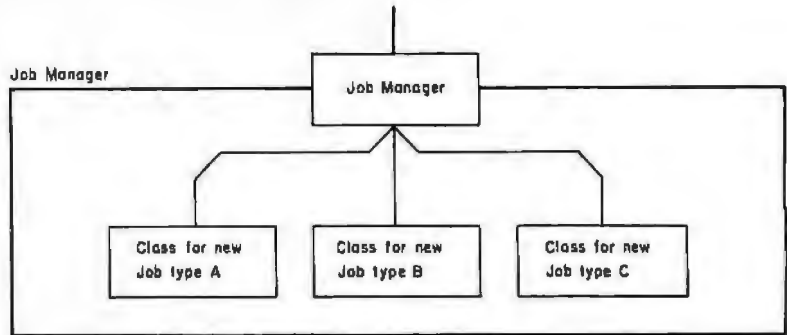

Figure 5: Sub-objects in the Job Manager actually create the new Job objects.

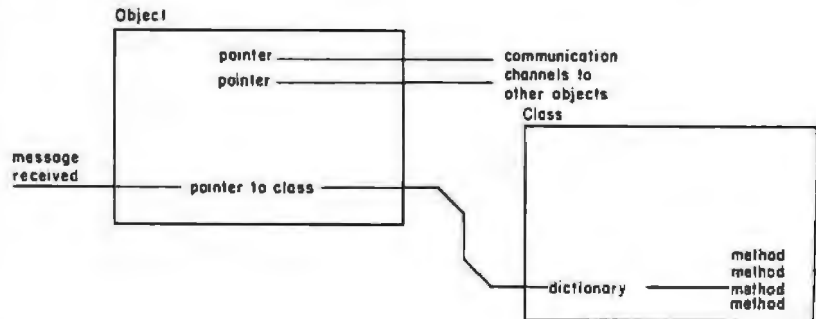

Figure 6: All objects contain a pointer to a Class object that contains their message dictionary and methods.

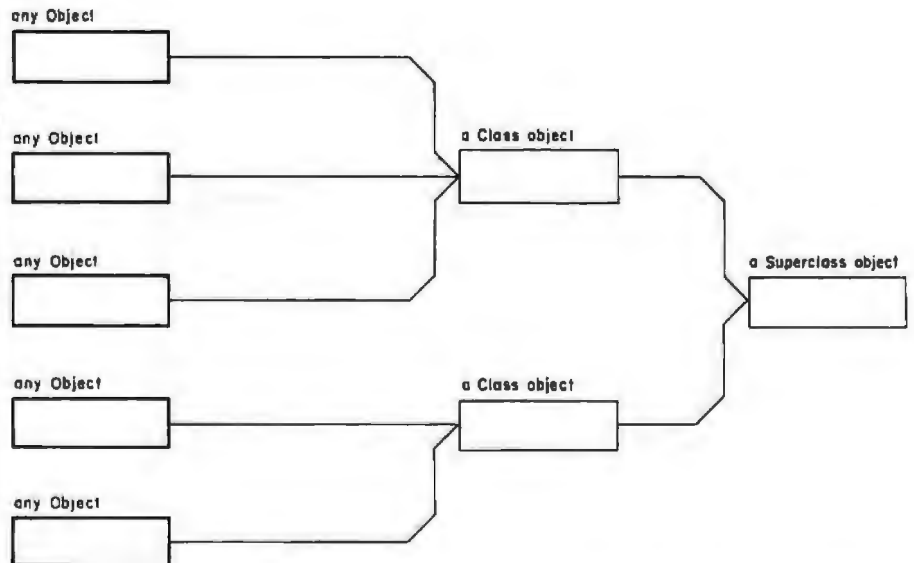

Figure 7: The superclass-subclass chains of pointers. The user does not meet them unless he wants to become a real Smalltalk expert.

connect itself to its Resource object. From figure 3, we see that there is no direct connection between the Job Manager object and the resources. We therefore have to go via the Production Manager object to get the pointer to the Resource object that we give to the new Job object.

We finally insert the new list of jobs into the productDictionary in the Production Manager object and return the product identification.

The Job Manager is built so that Job objects may belong to several different classes. The different Job objects created would all understand the

# The One Printer Solution for the Two Printer Problem.



## HIGH SPEED DATA PROCESSING

The new Dual-Mode 200 brings speed and uncompromising print quality to business and professional applications.

Financial statements, inventory reports, labels and more are printed at data processing speeds from 165 cps to 250 cps.

Fully adjustable tractors and a friction feed platen provide precise forms handling for pin-feed and single sheet paper.

Complete "Dot Control" graphics is standard with resolution to 120 x 144 dots per inch.

Interfacing is easy with both E.I.A. RS-232C serial and an ASCII parallel port.

## LETTER QUALITY WORD PROCESSING

The Dual-Mode 200 also features letter perfect print you will be proud to use for business letters and reports. Letter Mode speeds range from 42 cps to 60 cps.

The standard Titan 10 pitch font is complemented by an array of optional fonts including Elite 12 pitch, italics, proportionally spaced, OCR-A, scientific and foreign character sets.

Up to 12 font selections may be stored in the printer and interchanged while printing.

The Dual-Mode 200 accepts standard daisy-wheel print commands for word processing system compatibility.

It's the perfect solution for the two printer problem.

## The Dual-Mode 200 Printer for the one printer office.

*Call or write today for complete specifications*

2301 Townsgate Road, Westlake Village, CA 91361, (805) 496-1990

a subsidiary of Datacube Corporation

**malibu**  
Electronics Corporation

**DOTS DO IT BETTER™**

Thousands of SoftwareHows™ users agree — SoftwareHows products set a new standard of excellence for solution-oriented software. Instant installation for your system, powerful "word processing-like" editing facilities and consistent operating features make this SolutionWare™ the only serious choice for your needs.

## Why settle for a piece when you can have the whole pie?!

At last! An integrated system of business software ideal for you!

How often have you purchased software only to be **disappointed by its features** or frustrated by the **inability of the different programs to work together**? Are you tired of entering the same data into your **Purchase Ordering System** when a part is ordered, into **Inventory** when it arrives, **Payables** when it's invoiced and **General Ledger** when it's paid for? Can you easily link your **Accounting Data Base** with your word processing software to create **personalized letters, reports, notices and announcements**?\* Does your **Point of Sale, Order Entry** software also save a **keyed file** which may later be **Sorted** for over 60 customer characteristics and used to generate **personalized sales literature**?

If you don't like your answers to these questions, **your accounting software is costing you money!**

The Data Base Integration™ System from **SoftwareHows™** does **this and much more!** This newest software product offers the perfect blend of **performance, price and flexibility**. Every **single transaction** feeds your **master records**. This common data base approach organizes **all** your business information so that every module is **fully interactive**. The result of this vast and easy to use data base is **unique**. You'll be amazed at how much better **you'll understand the operation and cash flow of your business!** And better understanding means **better planning — and higher profits for you!**

The Data Base Integration System is built around the basic four accounting tools: **General Ledger** provides those all important **balance sheets and income statements**, **Accounts Receivable** and **Payable** take care of **invoice control** in a jiffy, while **Payroll** with **Cost Accounting** does **your payroll** and provides **cost effectiveness data**. All packages fully interact and are self-checking. The amazing **Order-Right™ order entry system** and **MicroDaSys Inventory**, give you one of the most complete **sales management and material requirements systems available**. Output is processed with lightning speed and meticulous accuracy: invoices, shipping labels, charge slips and COD tags. Orders **automatically** interact with **Inventory** and **Receivables**. If your **stock is too low**, **Inventory** recommends the **best source of supply** and **approximate prices** to pay. Upon authorization, a **purchase order** is generated. The receiving department verifies receipt and the invoice is transferred to **Accounts Payable**.

The Data Base Integration Business System is \$2500. And that's for all seven packages! Now there's a deal too good to pass up! It includes over 1500 pages of user documentation, and a supply of computer forms. With our unique DBI Installation Program, getting the complete package up and running on **your** system is a **breeze**. Best of all, complete **CBASIC source code** is included with every CBASIC package. Current disk formats include 8" soft-sectored, 5" hard- and soft-sectored.

**Call or Write for the SolutionWare™ to meet your software needs — today!**

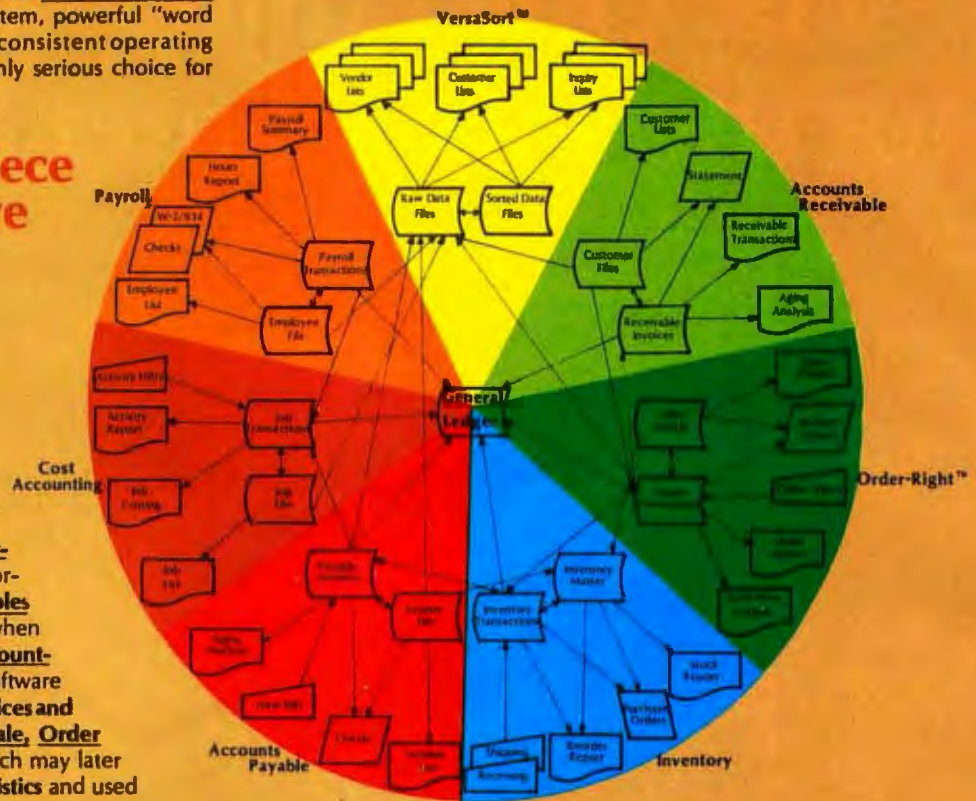

- Ask your dealer why our business software is the best!
- A Complete 200 page Overview of all SoftwareHows SolutionWare is yours for just \$75, refundable with purchase.

**SOFTWARE HOWS™**  
a division of MicroDaSys

PO Box 36275 Los Angeles, CA 90038  
(213)731-0876 TWX:310-321-2378



same message protocols, but they would differ in their implementation. For example, a job might be: *wait for 24 hours while a resin glue is curing.* This does not need any resources, and the planning of such a job would be very simple—wait 24 hours. Another kind of job, such as pouring concrete, should not span a weekend, since joining old and new concrete could give weak spots in the product.

As is the case with Job objects, we often find that several objects share the same message protocols and process the messages with the same methods. Their only difference is that they appear in different places in the total system and that their instance

**The Smalltalk user should be able to "open up" the application object on the screen to see its component parts and to find out how they work together.**

variables point to different objects (their states are different). Such objects are created by the same class object and are said to belong to the same class.

It would be very inefficient if each object of a class stored a replica of the message dictionary and all methods, and it would be extremely tiresome if we actually had to program each object by itself. We, therefore, use the concept of layering to let each and every object enlist the services of its class object in order to decode an incoming message and to select the proper method to process it. This mechanism is illustrated in figure 6. As in so many other parts of Smalltalk, we find a recursive argument.

Many classes are very similar; they differ only in the handling of a few messages. The different kinds of Job objects are a case in point. It seems reasonable to let a class object enlist the services of a superclass object whenever it is called upon to execute methods it shares with other classes.

# DISK DOCTOR

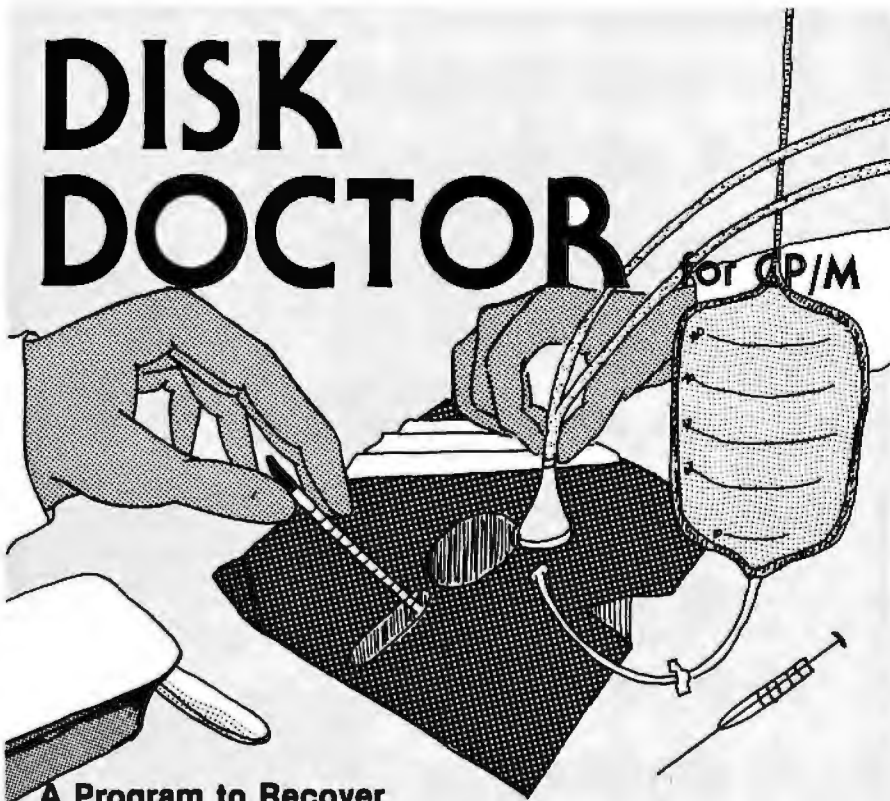

## A Program to Recover "Crashed" Discettes AUTOMATICALLY!

Maybe it was a lightning storm, static from the rug, or just too late at night to be working. Whatever the cause, when a discette "crashes" and valuable data or programs are destroyed, the loss is enormous, both in time and money.

DISK DOCTOR is a program which automatically recovers bad discettes. Best of all DISK DOCTOR does not require any knowledge of CP/M file structure! If you can operate CP/M, then you can use DISK DOCTOR. The entire system is menu driven with key information displayed.

DISK DOCTOR is comprised of five "wards", each capable of performing a specific discette recovery operation.

- **Ward A:** Verifies discettes and locks out bad sectors without touching the good files that remain.
- **Ward B:** Copies whatever can be read from a "crashed" file and places it into a good file under user control.
- **Ward C:** Copies discettes without stopping for bad sectors. Bad sectors are replaced by spaces.
- **Ward D:** "Un-erases" files. That is, Ward D will recover accidentally erased disk files.
- **Ward E:** Displays directory of recoverable erased files.

DISK DOCTOR will pay for itself the first time it is used.

Best of all, DISK DOCTOR operates almost complete automatically. The small amount of user interaction is explained in the manual as well as prompted by DISK DOCTOR.

Requires: 48K CP/M, two drives needed for complete operation.

DISK DOCTOR: \$100.00  
Manual Alone: \$ 10.00

CP/M Formats: 8" soft sectored, 5" Northstar, 5" Micropolis Mod II, Vector MZ, Superbrain DD/QD, Apple II +



All Orders and General Information:  
SUPERSOFT ASSOCIATES  
P.O. BOX 1628  
CHAMPAIGN, IL 61820  
(217) 359-2112  
Technical Hot Line: (217) 359-2691  
(answered only when technician is available)

**SuperSoft**  
First in Software Technology

CP/M REGISTERED TRADEMARK DIGITAL RESEARCH

# consumer computers mail order

*This is just a sample of our everyday low prices.*

## APPLE II PLUS

**16K**  
for only

**\$1025**



**48K**  
for only

**\$1129**

- Apple Disk II Drive w/controller . . . . . **\$519**
- Disk II Drive, Add-On . . . . . **\$439**
- Silentype Printer . . . . . **\$349**
- Hayes Micromodem II . . . . . **\$299**
- Epson MX-80 w/apple card . . . . . **\$599**

Videx  
Videoterm  
**\$269**

**FREE!**

**1982 Catalog**

In order to keep our phone lines clear for your orders,  
please mail this coupon to receive a free catalog

NAME \_\_\_\_\_

ADDRESS \_\_\_\_\_

CITY \_\_\_\_\_ STATE \_\_\_\_\_ ZIP \_\_\_\_\_

Microsoft  
Z-80  
Softcard  
**\$269**

**TOLL FREE ORDER LINE 800-854-6654**  
*in California or outside the continental U.S.* **(714) 698-8088**

*See pages 474-475 for more discount prices and order information.*

# ANNOUNCING A NEW ERA OF LOWER PRICES

*We're in the business of saving you money.*

Let's Face It. When you order anything through the mails you never really know who you are dealing with. We at Consumer Computers realize this every time we talk to you or receive a letter from you. We do our darndest to see that you not only get the information and help you need to intelligently place your order, but also that the price we give you is the best you can get anywhere.

We've been around. Consumer Computers has been actively serving people's computer needs in the San Diego area for 5 years now. We will still be here tomorrow, and the next day, too. So when you deal with Consumer Comput-

ers, you can rest assured that you're dealing with people that are thoroughly familiar with the business of selling computers. We pledge to see that any order placed with us is handled with the utmost efficiency and care, from the time the order is placed until it arrives at your doorstep. And if you have a problem, we think you will find that the expertise of our Service Department is unmatched for the quality of their work, and the speed that they have your equipment back into your hands where it belongs.

That's our promise. That's Consumer Computers.

**consumer  
computers** *mail order*

*See our advertisement on previous page*

Many classes will then share the same superclass; we get a tree-shaped class structure as shown in figure 7. Note that the purpose of this structure is convenience in programming and efficiency in implementation; it belongs on the lowest levels of the system hierarchy and is not part of the structure of the application system.

### Future Experiments

When personal computing becomes sufficiently entertaining and interesting to become a widespread

tool, the new user of a Smalltalk system is likely to begin by using its ready-made application systems for writing and illustrating documents, for designing aircraft wings, for doing homework, for searching through old court decisions, for composing music, or whatever. After a while, he may become curious as to how his system works. He should then be able to "open up" the application object on the screen to see its component parts and to find out how they work together. He could, for example, see

something like figure 1 together with his usual user interface. By exercising the application commands, the computing process could be illustrated on the system diagram. Using Smalltalk to document itself in this manner should make it possible to make some novel and extremely powerful system description tools.

The next thing the user might want to do is to build new systems similar to the one he has been using. A kit of graphical building blocks would let the user compose a new system by editing the system diagram on the screen. While the Trip system (as described in reference 2) is not a proper kit, it could be a good source of ideas to the experimenter on building such systems.

Finally, the expert user would want to make his own kits. Even here, it is important that he sees only what he needs and that all unimportant details are suppressed. Since what is important in one context might be unimportant in another, and vice versa, the concepts of *filters* (see reference 1) will be an essential ingredient for the experimenter when he develops tools for these expert users.

Much experimenting needs to be done before we learn how to make systems that are self-documenting on any level and that provide a smooth and stumble-free transition from one level to the next. It is hoped that the availability of Smalltalk will lead to great activity in this field, to the benefit of all future computer users. ■

*And You Thought You Didn't Have A Choice*

Now you can provide your customers with another of those little extras that makes them feel good about the sale . . .

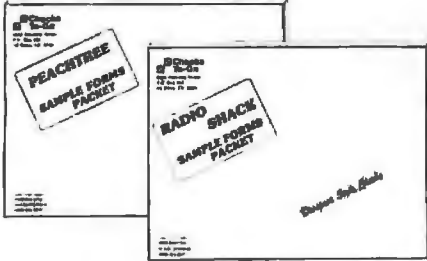

. . . a complete packet of the most attractive stock forms on the market. From the people whose only business is you and your customer.

- OVER 200 STOCK FORMS TO CHOOSE FROM
- 7-WORKING DAY GUARANTEED RUSH SHIPMENT
- PERSONALIZED SERVICE AND QUALITY YOU WILL LEARN TO COUNT ON

**CALL NOW TOLL FREE**  
For free packets for the following systems:

• Systems Plus • TCS • Structured Systems Group •  
• Vector • Peachtree • Radio Shack • Osborne •  
• Alpha Micro • Durango • Warex • Cado •  
**VECTOR** • BPI • Honey • Harvate  
• Many More

**CALL TODAY FOR FREE SAMPLE PACKETS**

NATIONWIDE  
800-854-2750



**Checks To-Go**

IN CALIFORNIA  
800-552-8817

*Offer Your Customers The Alternative They Deserve*

### References

1. Goldberg, Adele and David Robson. "A Metaphor for User Interface Design." *Proceedings of the University of Hawaii Systems Science Symposium*, January 1979, Honolulu.
2. Gould, Laura and William Finzer. "A Study of TRIP: A Computer System for Animating Time-Rate-Distance Problems." *Proceedings of the IFIP World Conference on Computers in Education (WCCE-81)*, Lausanne, Switzerland, July 1981.
3. Ingalls, Daniel H H. "The Smalltalk-76 Programming System. Design and Implementation." *Conference Record of the Fifth Annual ACM Symposium on Principles of Programming Languages*, Tucson, Arizona, January 1978.

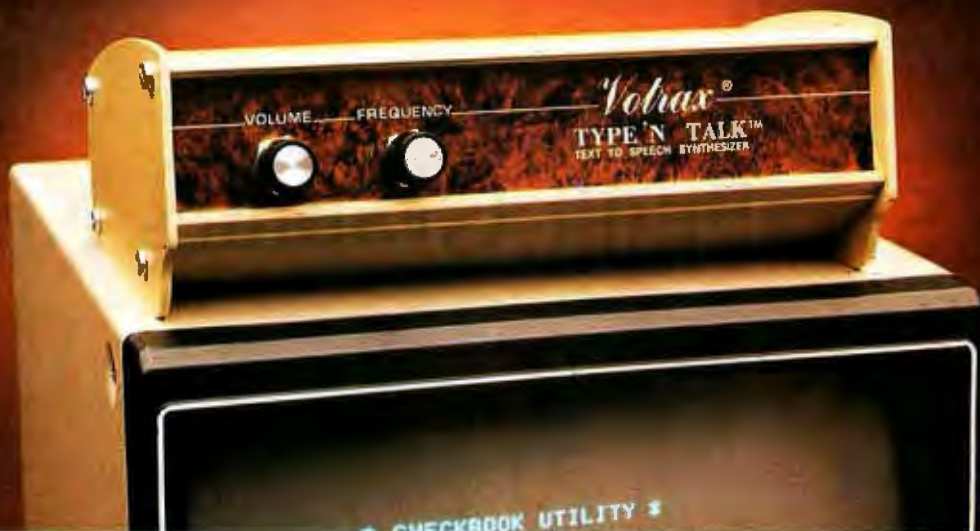

# TYPE-'N-TALK™ IS T.N.T.

## The exciting text-to-speech synthesizer that has every computer talking.

- **Unlimited vocabulary**
- **Built-in text-to-speech algorithm**
- **70 to 100 bits-per-second speech synthesizer**

Type-'N-Talk™, an important technological advance from Votrax, enables your computer to talk to you simply and clearly — with an unlimited vocabulary. You can enjoy the many features of Type-'N-Talk™, the new text-to-speech synthesizer, for just \$375.00.

You operate Type-'N-Talk™ by simply typing English text and a talk command. Your typewritten words are automatically translated into electronic speech by the system's microprocessor-based text-to-speech algorithm.

### The endless uses of speech synthesis.

Type-'N-Talk™ adds a whole new world of speaking roles to your computer. You can program verbal reminders to prompt you through a complex routine and make your computer announce events. In teaching, the computer with Type-'N-Talk™ can actually tell students when they're right or wrong — even praise a correct answer. And of course, Type-'N-Talk™ is great fun for computer games. Your games come to life with spoken threats of danger, reminders, and praise. Now all computers can speak. Make yours one of the first.

### Text-to-speech is easy.

English text is automatically translated into electronically synthesized speech with Type-'N-Talk™. ASCII code from your computer's keyboard is fed to Type-'N-Talk™ through an RS 232C interface to generate synthesized speech. Just enter English text and hear the verbal

response (electronic speech) through your audio loud speaker. For example: simply type the ASCII characters representing "h-e-l-l-o" to generate the spoken word "hello."

### TYPE-'N-TALK™ has its own memory.

Type-'N-Talk™ has its own built-in microprocessor and a 750 character buffer to hold the words you've typed. Even the smallest computer can execute programs and speak simultaneously. Type-'N-Talk™ doesn't have to use your host computer's memory, or tie it up with time-consuming text translation.

### Data switching capability allows for ONLINE usage.

Place Type-'N-Talk™ between a computer or modem and a terminal. Type-'N-Talk™ can speak all data sent to the terminal while online with a computer. Information randomly accessed from a data base can be verbalized. Using the Type-'N-Talk™ data switching capability, the unit can be "de-selected" while data is sent to the terminal and vice-versa — permitting speech and visual data to be independently sent on a single data channel.

### Selectable features make interfacing versatile.

Type-'N-Talk™ can be interfaced in several ways using special control characters. Connect it directly to a computer's serial interface. Then a terminal, line printer, or additional Type-'N-Talk™ units can be connected to the first Type-'N-Talk™, eliminating the need for additional RS-232C ports on your computer.

Using unit assignment codes, multiple Type-'N-Talk™ units can be daisy-chained. Unit addressing codes allow independent control of Type-'N-Talk™ units and your printer.

### Look what you get for \$375.00. TYPE-'N-TALK™ comes with:

- Text-to-speech algorithm
- A one-watt audio amplifier
- SC-01 speech synthesizer chip (data rate: 70 to 100 bits per second)
- 750 character buffer
- Data switching capability
- Selectable data modes for versatile interfacing
- Baud rate (75-9600)
- Data echo of ASCII characters
- Phoneme access modes
- RS 232C interface
- Complete programming and installation instructions

The Votrax Type-'N-Talk™ is one of the easiest-to-program speech synthesizers on the market. It uses the least amount of memory and it gives you the most flexible vocabulary available anywhere.

### Order now. Toll free.

Call the toll-free number below to order or request additional information. MasterCard or Visa accepted. Charge to your credit card or send a check for \$375.00 plus \$4.00 delivery. Add 4% sales tax in Michigan.

**1-800-521-1350.**

Dealer Inquiries Invited

*Votrax*

Circle 398 on Inquiry card.

Distributed by Votrax  
A Votrax Company — Dept. RT  
900 Stephenson Highway, Troy, MI 48064  
(313) 569-0341

Type-'N-Talk™ is covered by a limited warranty. Write Votrax for a free copy.

# The Smalltalk Graphics Kernel

Daniel H H Ingalls  
Learning Research Group  
Xerox Palo Alto Research Center  
3333 Coyote Hill Rd  
Palo Alto CA 94304

Graphics are essential to the quality of an interactive programming system and to the interactive applications that go along with such a system. Qualitatively, people think with images, and any system that is incapable of manipulating images is incapable of augmenting such thought. Quantitatively, a person can visually absorb information equivalent to millions of characters a second, while the normal rate for reading text is less than 100 characters a second.

For the graphical interaction cycle to be complete, a computer system must provide a channel for input in the visual domain as well. While the projection of images from the realm of thought into the space of electronic information seems an impossible task, a well-designed pointing device can effectively harness the computer's graphical output capability to express graphical input from the user. Given such a pointing device, the process of selecting from graphical objects, such as text displayed on the screen, is natural and rapid. By tracking the pointer with a program that simulates a pen or paintbrush, the visual input channel can be extended to include line drawing and freehand sketches.

The purpose of graphics in the Smalltalk system is to support the *reactive principle*:

*Any object accessible to the user should be able to present itself in a meaningful way for observation and manipulation.*

Meaningful presentation of any object in the system demands maximum control over the display medium, and

many technologies fall short in this respect. One approach that provides the necessary flexibility is to allow the brightness of every discernible point in the displayed image to be independently controlled. The simplest implementation of this approach is a contiguous block of storage in which the setting of each *bit* (1 or 0) is *mapped* into dark or light illumina-



Photo 1: An example of a Smalltalk-80 video display. Note the multiple windows, the combinations of text and graphics, and the pointer in the window marked "UserView workspace."

tion of the corresponding picture element, or *pixel*, when displaying or combining with other images. The block of storage is thus referred to as a *bitmap*, and this type of display is called a *bitmap display*. The simplest form of bitmap allows only two brightness levels, white and black. The Smalltalk-80 graphics system is built around this model.

Photo 1 shows a typical view of the Smalltalk-80 system, and it illustrates the wide range of graphical idiom

implied by the reactive principle. Rectangular areas of arbitrary size are filled with white, black, and various halftone patterns. Text, in various typefaces, is placed on the screen from stored images of the individual characters. Halftone shades are "brushed" by the user to create freehand paintings. Moreover, although not shown on the printed page, images on the display may be moved or sequenced in time to provide animation.

## Graphical Storage—Forms

Simple images are represented by instances of class *Form*. A *Form* has height and width and a bitmap that indicates the white and black regions of the particular image being represented. Consider, for example, the arrow-shaped *Form* that appears in the lower-right window of the screen image in photo 1. The internal representation of this *Form* is depicted in figure 1. Its height is 16, its width is 8, and its appearance is described by the pattern of ones and zeros (shown as light and dark squares) in its bitmap. The height and width of the *Form* serve to impose the

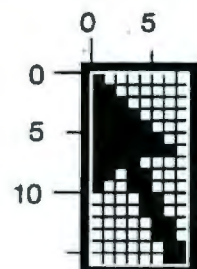
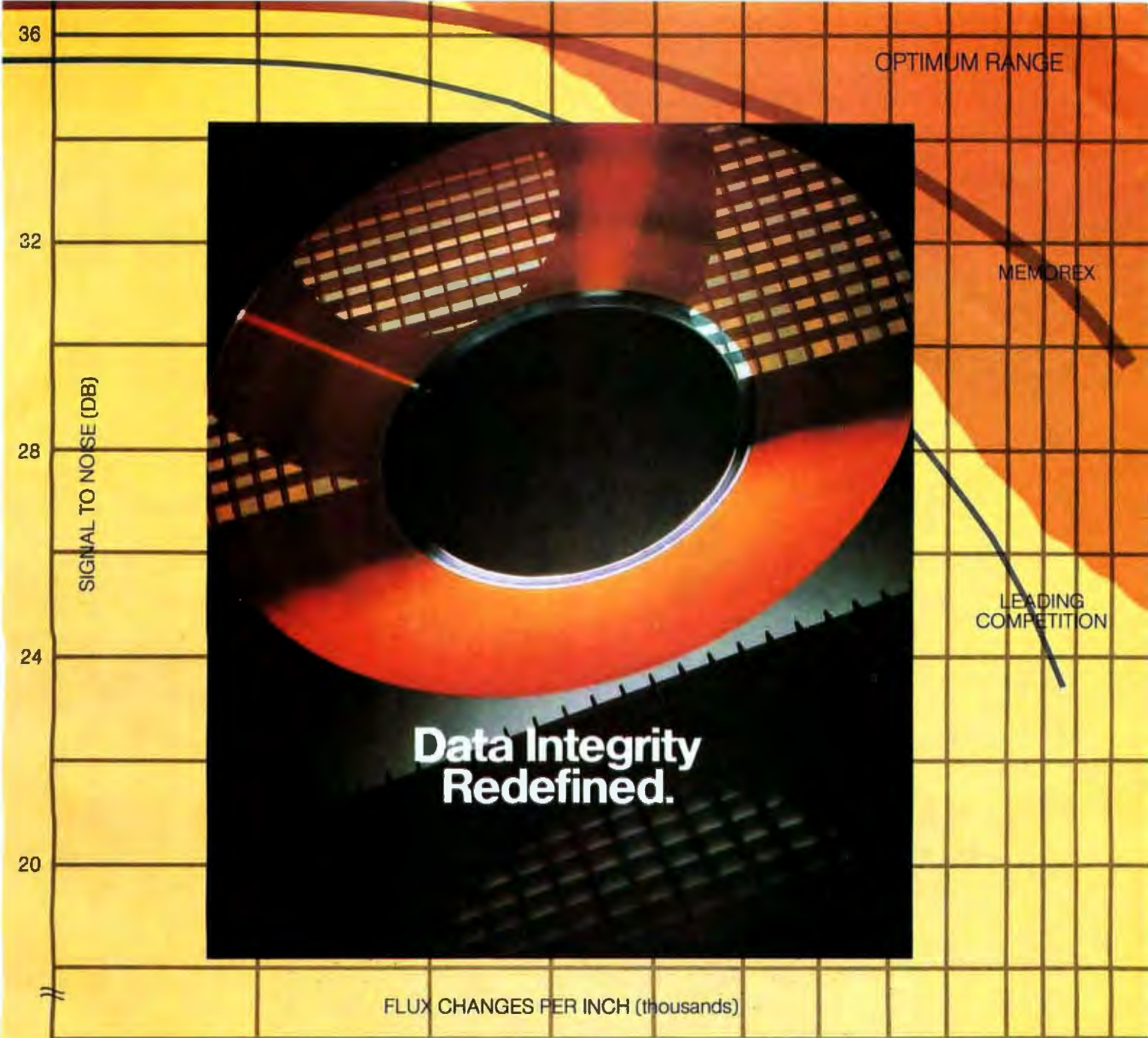

Figure 1: A simple *Form* representing the cursor in photo 1.



The new Memorex® M Formula magnetic coating has been widely accepted by major OEM drive manufacturers. Now M Formula is redefining performance and reliability standards for removable rigid disc products on all existing and new generation drives as well. M Formula, containing our exclusive Hi/Oxide™ formulation, offers the highest signal to noise ratio—up to 30 dB at 10,000 flux changes per inch—of any rigid media in the industry. With higher performance margins and protection against random errors, you're assured greater data integrity.

Our revolutionary Hi/Oxide coating provides higher coercivity, which allows

stronger and more consistent magnetic properties. Hi/Oxide coating also forms a uniformly smooth, hard surface that sets new standards for durability.

It all adds up to virtually trouble-free data handling. But most importantly, the new M Formula helps ensure the highest levels of data integrity in disc packs or cartridges.

To help you compare and evaluate rigid media, send for a free copy of the booklet, "Critical Factors in Purchasing Rigid Media." Write to Debi Garringer, Memorex Rigid Media and Components Division, 1125 Memorex Drive, Santa Clara, CA 95052 or call (800) 538-8028; in California (408) 987-2064.



**MEMOREX**

*For twenty years, the expression of excellence.*

© 1981 MEMOREX CORPORATION MEMOREX IS A REGISTERED TRADEMARK OF MEMOREX CORPORATION

Circle 214 on Inquiry card.

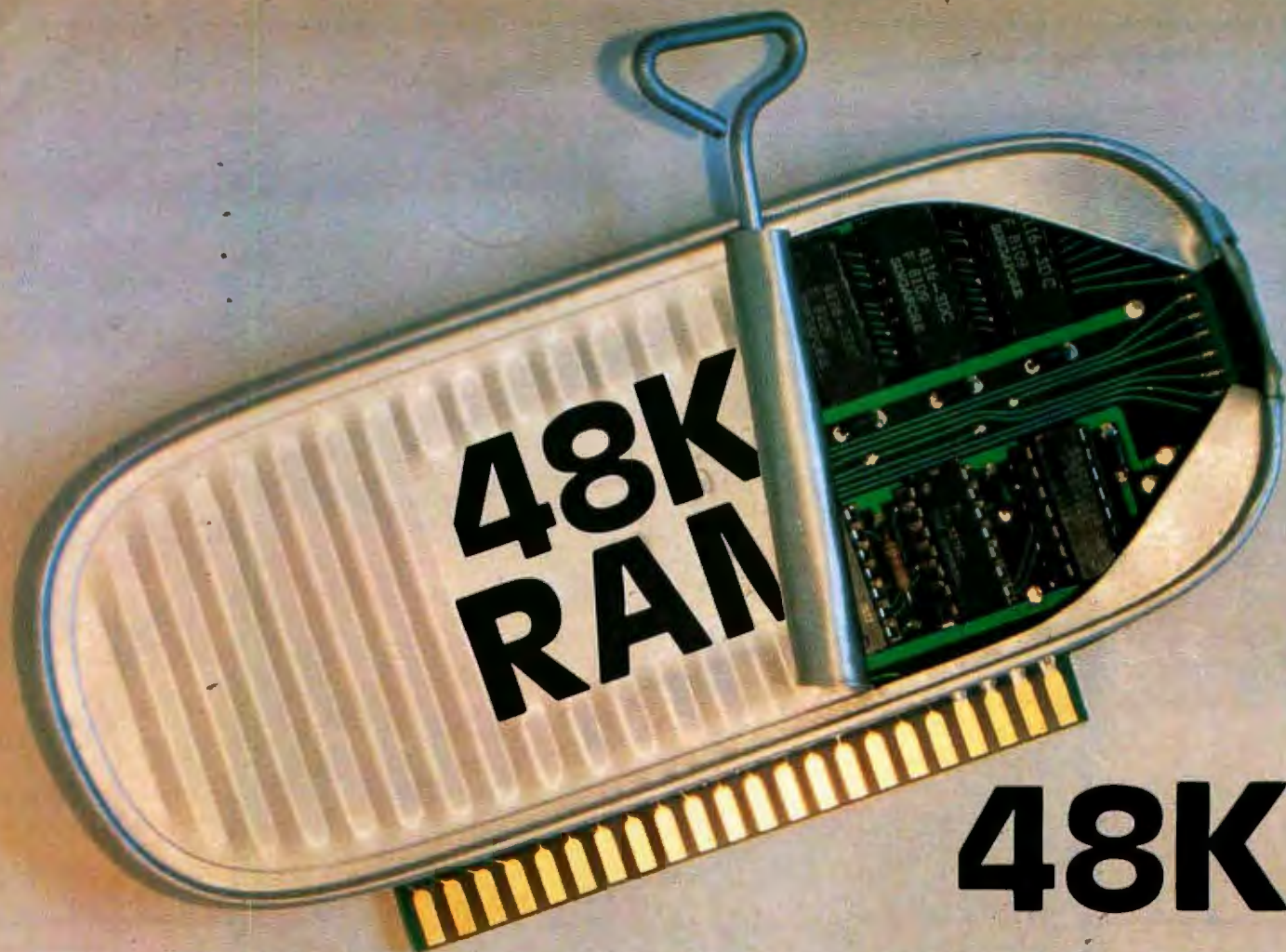

# 48K RAM FOR ATARI

Get the most from your ATARI 400. Memory expansion to a full 48K is now possible with our 48K board. Expand your ATARI 800 with our 32K board.

**Available now - see your local  
computer dealer.**

**48K Board  
\$299.<sup>00</sup>**

**32K Board  
\$199.<sup>00</sup>**

***I*NTEC**

3387 Del Rosa Avenue North Suite No. 111  
San Bernardino, CA 92404 Telephone (714) 864-5269

ATARI is the trademark of ATARI, INC.

Circle 171 on inquiry card.



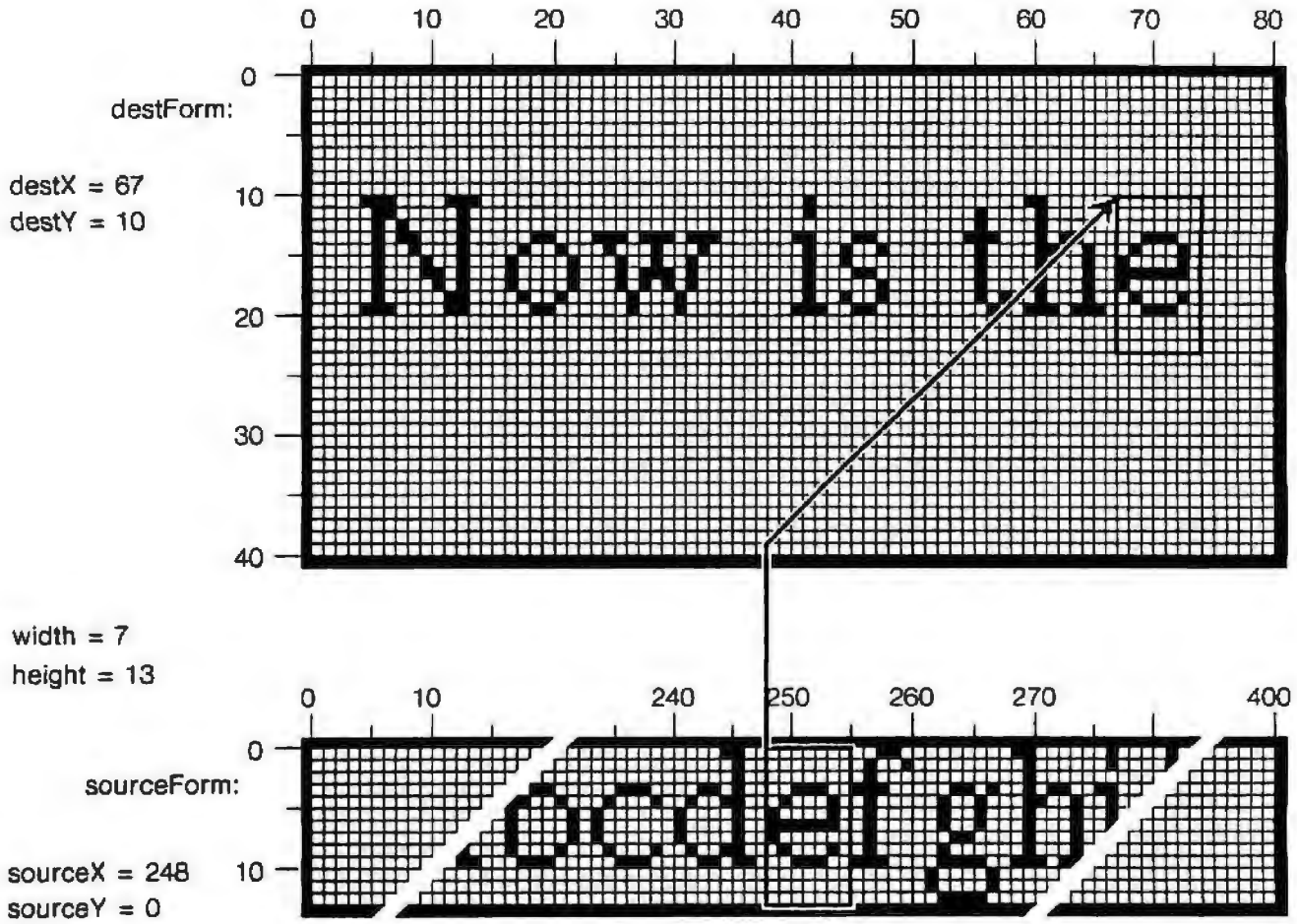

Figure 2: Copying a character of text from a source Form (bottom) to a destination Form (top).

appropriate two-dimensional ordering on the otherwise unstructured data in the bitmap. We will return to the representation of Forms in more detail later in this article.

A complex image can be represented in either of two ways: by a very large Form, or by a structure that includes many Forms and rules for combining and repeating them in

order to produce the desired image. The freehand drawing in the center of photo 1 is an example of the former, and the text below it is an example of the latter.

The large unstructured Form has an additional use of great importance: it can be presented to the display hardware as a buffer in memory of the actual data to be shown on the

display terminal. We refer to the Form which is so used as the displayForm. Since the interface to the hardware is through a Form, there is no difference between combining images internally and displaying them on the screen. Animation can be done simply in this manner: one Form serves as the displayForm while the next image to be displayed is



## Now! An Acoustic Coupler for \$125.

The Omnitec Model 715 (originate only) has the necessary features, needed to expand any business or home computer systems capability: 0-450 baud data rate, RS232 compatibility and carrier detect at a low factory-direct price of \$125. Or, select the Model 770 at \$179.00 for originate or answer communications. Both models carry a one year warranty.

**OMNITEC DATA**  
 2405 South 20th Street • Phoenix, Arizona 85034  
 PRICES INCLUDE SHIPPING & HANDLING WHEN PRE-PAID

ORDER TOLL-FREE 800-528-8423

AVAILABLE FACTORY-DIRECT ONLY!

Model 715: \_\_\_\_\_ Model 770: \_\_\_\_\_

Send Me: \_\_\_\_\_

Enclosed is \$ \_\_\_\_\_

NAME \_\_\_\_\_

ADDRESS \_\_\_\_\_

CITY \_\_\_\_\_

STATE \_\_\_\_\_

ZIP \_\_\_\_\_

CHECK OR MONEY ORDER

# GOOD IDEA!

You can save buying wholesale through our firm. As your agent we will buy computers on the wholesale market for you. Our fee is one fourth of what we save you off list price. Access to over 500 manufacturers. Minimum fee of \$75 per order. Call for other prices.

|                          | Whse.    | Fee     |
|--------------------------|----------|---------|
| <b>COMPUTERS</b>         |          |         |
| Alpha Micro 10MEG        | \$11,204 | \$1,243 |
| Altos 8000-10            | 5,695    | 701     |
| Altos 8000-15            | 4,014    | 494     |
| Archives 64K DD          | 4,450    | 512     |
| Compustar Model 30       | 3,595    | 225     |
| Cromemco System 3        | 5,357    | 659     |
| Dynabyte 64K 2 MEG       | 5,929    | 691     |
| Calit. Comp. 64K 1 MEG   | 3,987    | 427     |
| Ithaca System 2A         | 2,520    | 270     |
| Televideo Sys. I         | 2,600    | 349     |
| <b>DISK DRIVES</b>       |          |         |
| Corvus 5 MEG Hard        | 2,588    | 290     |
| Corvus 20 MEG Hard       | 4,450    | 500     |
| Morrow 26 MEG Hard       | 3,596    | 349     |
| <b>CRT'S</b>             |          |         |
| ADDS View Point          | 505      | 36      |
| DEC VT 100               | 1,305    | 130     |
| Hazeltine Esprit         | 565      | 45      |
| IBM 3101 Model 10        | 1,140    | 60      |
| Lear Siegler ADM 3A +    | 710      | 58      |
| Leadex 13" Color Monitor | 350      | 25      |
| NEC 12" Monitor          | 190      | 18      |
| Televideo TVI 910        | 545      | 39      |
| Televideo 950            | 835      | 90      |
| Visual 200               | 765      | 107     |
| <b>PRINTERS</b>          |          |         |
| Anadex 9501              | 1,150    | 125     |
| Centronics 737           | 650      | 86      |
| Diablo 630 R/O           | 1,795    | 200     |
| Epson MX80               | 410      | 58      |
| IDS Paper Tiger 460 G    | 1,020    | 94      |
| IDS 560/g                | 1,220    | 119     |
| NEC 5510 w/Tractor       | 2,360    | 164     |
| C. Itoh 25 cps           | 1,200    | 175     |
| TI 810 Basic             | 1,355    | 135     |
| <b>SOFTWARE</b>          |          |         |
| Word Star                | 249      | 63      |
| Spell Guard              | 200      | —       |

Prices subject to change without notice.

We are buying agents for overseas computer dealers. Export services available.

International Telex 470851

**The Purchasing Agent**  
1635 School Street, Suite 101  
Moraga, CA 94556  
(415) 376-9020

prepared in a second Form. As each image is completed, the two Forms exchange roles, causing the new image to be displayed and making the Form with the old image available for building the next image in sequence.

## Graphical Manipulation—BitBlt

To support a wide range of graphical presentation, we have specified a kernel operation on Forms that we call *BitBlt*. All text and graphic objects in Smalltalk are displayed and modified using this single graphical primitive. The author wrote the original design in October 1975 with the advice and support of Diana Merry. After five years' experience, we have felt the need for only minor changes, and these improvements are largely due to Bob Flegal and Bill Bowman. The remainder of this article describes the current *BitBlt* primitive in detail—its specification, examples of its use, and, finally, the details of its implementation.

One of the first computers on which a Smalltalk system was implemented had an instruction called *BLT* for *block transfer* of 16-bit words. The name *BitBlt* derives from the generalization of data transfer to arbitrary bit locations, or pixels. *BitBlt* is intentionally a very general operation, although most applications of it are graphically simple, such as "move this rectangle of pixels from here to there."

A specific application of *BitBlt* is governed by a list of parameters that includes:

- *destForm*—a Form into which pixels will be stored by *BitBlt*
- *sourceForm*—a Form from which pixels may be copied
- *halftoneForm*—a Form containing a spatial halftone pattern
- *combinationRule*—an Integer specifying the rule for combining corresponding pixels of the *sourceForm* and *destForm*
- *destX*, *destY*, *width*, *height*—Integers specifying the rectangular subregion to be filled in the destination
- *clipX*, *clipY*, *clipWidth*, *clipHeight*—Integers specifying a rectangular

boundary that further restricts the affected region of the destination

- *sourceX*, *sourceY*—Integers specifying the location (top left) of the subregion to be copied from the source

In the remainder of this section, we examine the effect of each of these parameters in greater detail.

## Source and Destination Forms

Figure 2 illustrates the process of copying a character of text into a region on the display. This operation will serve to illustrate most of the characteristics of *BitBlt*. The copy operation involves two Forms, a source and a destination. The source in this example is a *font* containing a set of character glyphs depicted in some uniform style and scale and packed together horizontally. Pixels are copied out of the source (the font) and stored into the destination (the display). The width and height of the transfer correspond to the character size. The source *x* and *y* coordinates give the character's location in the font, and the destination coordinates specify the position on the display where its copy will appear.

## Clipping Rectangle

In its specification, *BitBlt* includes a rectangle that limits the region of the destination that can be affected by its operation, independent of the other destination parameters. We call this rectangle the *clipping rectangle*. Often it is desirable to display a partial *window* onto larger scenes, and the clipping rectangle ensures that all picture elements fall inside the bounds of the window. By its inclusion in the *BitBlt* primitive, the clipping function can be done efficiently and in one place, rather than being replicated in all application programs. Figure 3 illustrates the result of imposing a clipping rectangle on the example of figure 2. Pixels that would have been placed outside the clipping rectangle (the left edge of the "N" and half of the word "the") have not been transferred. If other characters had fallen above or below this rectangle, they would have been clipped similarly.



# 'Universatility,' It's as easy as 1. 2. 3.

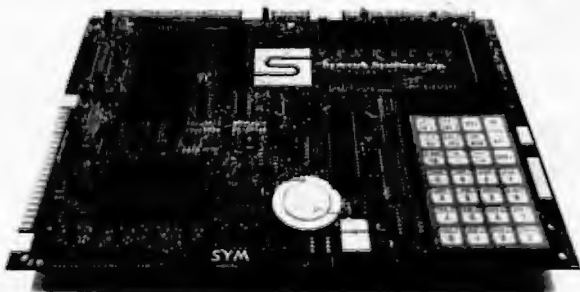

'Universatility' can be found in three versions of Synertek Systems' SYM single board computer — the versatile, universal evaluation board.

Over 20,000 SYM-1 boards have been used for learning about and evaluating 6502 microprocessors for specific applications. OEM SYM boards are used in hundreds of products.

Now Synertek Systems presents the new SYM-1/68 for 6802 microprocessors, and the SYM-1/69 for 6809 microprocessors. These boards are designed to reliably perform the same functions as the SYM-1 board for these popular microprocessors. Each SYM board is complete and ready-to-use with its own version of the 4K byte ROM SUPERMON monitor firmware.

Modification kits are also available to quickly and easily convert existing SYM-1 boards to SYM-1/68 or SYM-1/69 microcomputers.

Build on your microprocessor knowledge with the 'universatility' of SYM microcomputer boards from Synertek Systems.

Every SYM-1, SYM-1/68, and SYM-1/69 single board computer features:

- 28 double-function keypad with audio response
- 4K byte ROM resident SUPERMON with over 30 standard monitor functions and expandable for individual requirements
- Up to 24K bytes of available program memory
- Expansion to 4K bytes of on-board static RAM
- Expansion to 71 Input/Output lines
- Single +5V power supply required
- Standard interfaces for audio cassette with remote control, 185 bytes/second cassette format, TTY and RS-232-C, system expansion bus, four I/O buffers, and oscilloscope single-line display



P.O. Box 552 Santa Clara, CA 95052  
Telephone: (408) 988-5689  
TWX: 910-338-0135

Dealer inquiries invited.

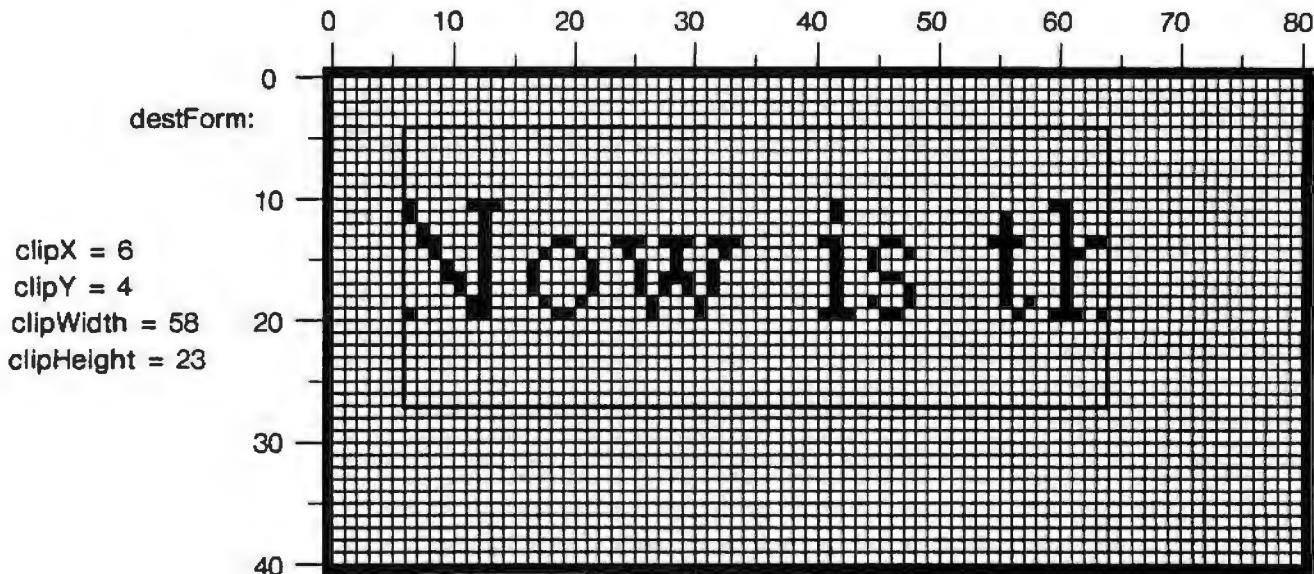

Figure 3: An example of using a clipping window on the illustration in figure 2.

### Halftone Form

It is often desirable to fill areas with a regular pattern that gives the effect of gray shading or texture. To this end, BitBlt provides for reference to a third Form (halftoneForm) containing the desired pattern. This Form is

restricted to a height and width of 16. When halftoning is specified, this pattern is effectively repeated every 16 units horizontally and vertically over the entire destination. There are four "modes" of supplying pixels from the source and halftone controlled by

eliding (supplying nil for) sourceForm or halftoneForm:

- Mode 0—No source, no halftone (supplies solid black)
- Mode 1—Halftone only (supplies halftone pattern)

## Peachtree Software™ Announces

# SALES TRACKER™

**S**olved! The case of ineffective business control. Now Sales Tracker microcomputer software gives business managers unprecedented control over lifestream activities.

You get ANSI COBOL, floppy and hard disk support, and a modular format that lets you install packages as you need them. And look at these outstanding features.

**Accounts Receivable:** Multiple companies on one disk. Nine selectable reports including G/L sales and receivables, customer classes, and sales tax routines.

**Sales Analysis:** Reports by salesman (with commission), product class, inventory item, customer, item by customer, and customer by item.



**Order Processing:** Handles multiple shipping locations, automatic discounting, partial shipments, back orders, demand invoicing, full order status and maintenance.

**Inventory:** Multiple companies on one disk; reports by class, warehouse, price level and quantity break; automatic price updating; maintains items optionally by case, lot or serial number.

**C**lues to why Sales Tracker is so easy to use? Excellent documentation, sample data files, conversant menu-driven programs, and standardized formats. For information call 800-835-2245 ext. 35 (Kansas, 800-362-2421, ext. 35)



The Very Best "Off-The-Shelf" Software Is "Off-The-Tree."



PEACHTREE SOFTWARE, 3 Corporate Square, Suite 700, Atlanta, Georgia 30329 (404) 325-8533  
Telex II: 810-751-0273 PEACHTREE ATL.

Peachtree Software and Sales Tracker are trademarks of Peachtree Software Incorporated.

# Easy on your eyes and your budget.

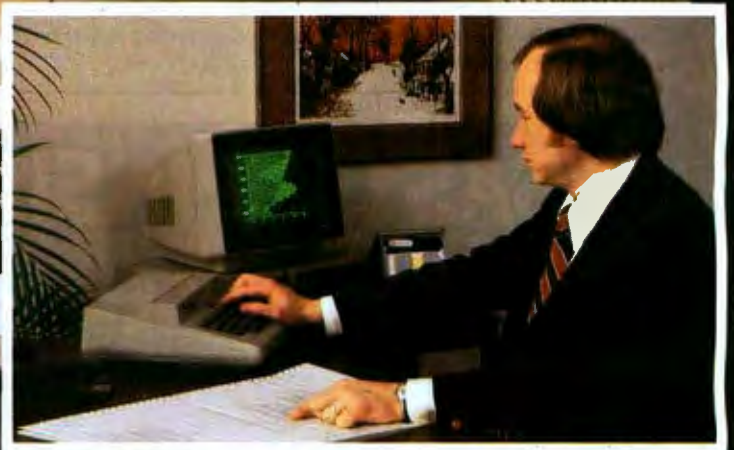

This high quality professional computer monitor provides sharp, clear display of up to 80 characters by 25 lines of text, making it ideal for word processing as well as standard business applications.

Lightweight industrial grade construction gives maximum portability with reliable operation.

Color monitor also available for Apple,<sup>®</sup> Atari<sup>®</sup> and other popular computers. See your authorized NEC America Dealer.

Apple is a registered trademark of Apple Computer, Inc.  
Atari is a registered trademark of Atari, Inc.

80 character display makes it ideal for word processing and scientific applications.

## NEC

**NEC America, Inc.**

1401 Estes Avenue  
Elk Grove Village, IL 60007

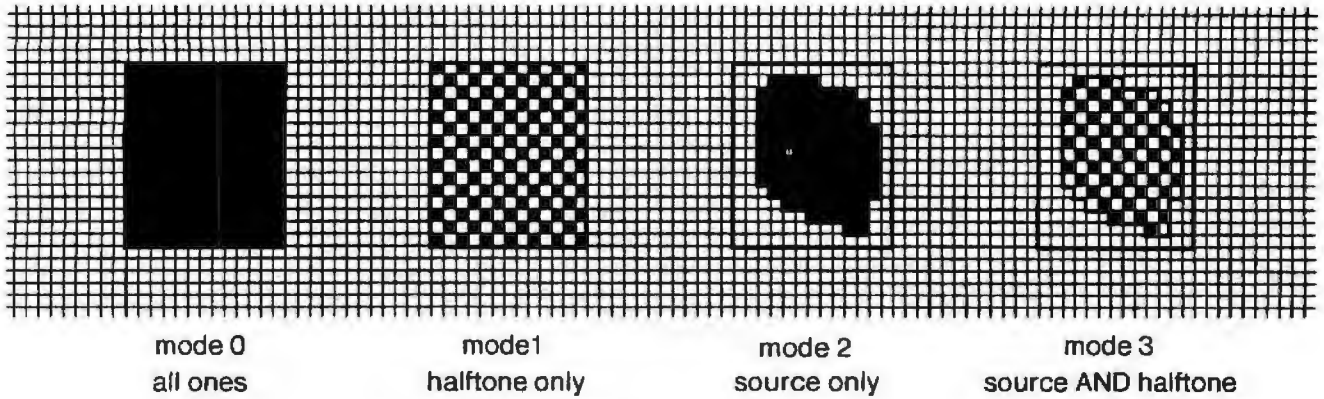

Figure 4: BitBlt's four possible source modes.

- Mode 2—Source only (supplies source pixels)
- Mode 3—Source AND halftone (supplies source bits masked by halftone pattern)

Figure 4 illustrates the effect of these four modes with the same source and

destination and a regular gray halftone.

### Combination Rule

The examples above have all stored their results directly into the destination. There are actually many possible rules for combining each source

element S with the corresponding destination element D to produce the new destination element D'. Such a rule must specify a white or black result for each of the four cases of source being white or black and destination being white or black.

Figure 5 shows a box with four cells corresponding to the four cases encountered when combining source (S) and destination (D). For instance, the cell numbered 2 corresponds to the case where the source was black and the destination was white. By appropriately filling the four cells with white or black, the box can be made to depict any combination rule (there are sixteen possible rules altogether). The numbers in the four cells relate the rule as depicted to the integer value that selects that rule. For instance, to specify that the result

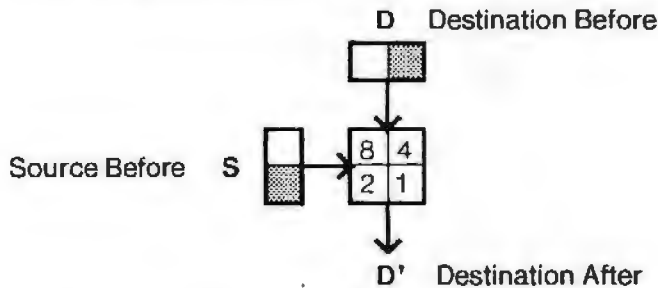

Figure 5: A BitBlt combination diagram. This diagram, when filled in, specifies the effects of a given combination (or "rule") on all combinations of dark and light source and destination cells. Each combination is given a number equal to the sum of the cells that are darkened. See figure 6 for examples.

# DISASTER INSURANCE

## PROTECT YOUR HARDWARE FROM THE UNEXPECTED.

Not to mention the unavoidable pollutants in the air. Performance robbing dust, grime, spills and static electricity.

Cover Craft Dust Covers help extend the useful life of your computer equipment at a fraction of the cost. Perhaps that's why more people throughout the world rely on Cover Craft Dust Covers than any other brand.

Visit your local dealer or contact Cover Craft.

Dust Covers for most terminals, disks, printers, modems, etc.

**\$8.95-\$15.95**  
Shipping extra.

### COVER CRAFT CORP

PO Box 555, Amherst, NH 03031 • (603) 889-6811

# Pure Computing Power



The MicroFrame® is **Pure Power** for computing. It is the industry standard for high quality, reliable S-100 mainframes.

TEI manufactures each MicroFrame® with great care. They deliver pure regulated power at the proper level, improving the reliability of your computer. Typically, the output voltages remain virtually constant, even when the power line voltage varies widely. The MicroFrame® will never notice a brown-out . . . and it provides 100 db noise rejection, protecting your computer from powerline voltage spikes and noise. Complies with I-EEE S-100.

The combination of the lowest noise bus, a regulated power system and a rugged chassis produces a MicroFrame® without equal.

Distributor and OEM Inquiries Invited

For more information, call Rick Barnes at (713) 738-2300



5075 S. LOOP EAST, HOUSTON, TX. 77033  
(713)738-2300 TWX. 910-881-3639

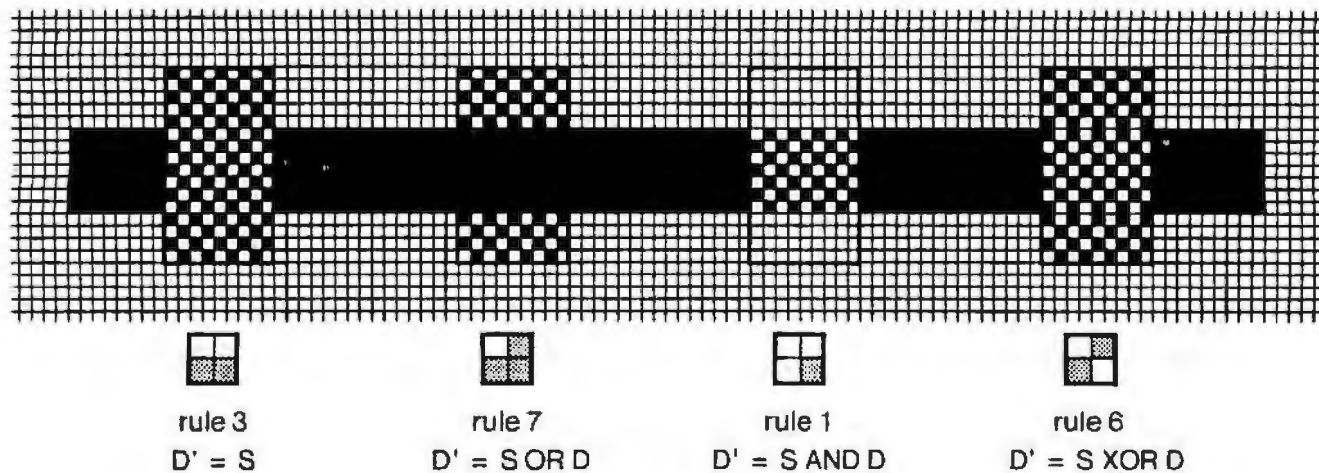

Figure 6: Four common combination rules.

should be black wherever the source or destination (or both) was black, we would blacken the cells numbered 4, 2, and 1. The associated integer for specifying that rule is the sum of the blackened cell numbers, or  $4 + 2 + 1 = 7$ .

Figure 6 illustrates four common combination rules graphically. Each is described by a combination diagram, its integer rule number, and the actual logical function being applied. The earlier case of ORing can be seen in left center of the figure. This case is often described as painting "under" the destination because existing black areas remain black.

### Smalltalk Access to BitBlt

In this section, we present the Smalltalk interface to BitBlt and take a detailed look at the application of BitBlt to text display and line drawing. In preparation, you will need some additional context, which we present here before describing class BitBlt.

Besides class *Form*, two additional classes are used extensively in working with stored images, *Point* and *Rectangle*. *Points* contain *x* and *y* coordinate values and are used for referring to pixel locations relative to the top left corner of a *Form* (or other point of reference). By convention, *x* increases to the right and *y* down, consistent with the layout of text on a page and the direction of TV scanning. A *Rectangle* contains two *Points*: *origin*, which specifies the top left corner, and *corner*, which in-

dicates the bottom right corner of the region described. Class *Point* provides protocol for access to the coordinates and for various useful operations such as translation and scaling. Class *Rectangle* provides protocol for access to all the coordinates involved and other operations such as intersection with other rectangles. It may be useful to note the parallel between classes *Point*, *Rectangle*, *Form* and classes *Number*, *Interval*, *IndexedCollection*. *Numbers* index *Collections* and *Points* index *Forms*. *Intervals* select *subCollections*, and *Rectangles* select *subForms*.

Figure 7 shows the complete representation of the *Form* shown in figure 1. The width and height are stored as *Integers*. The actual pixels are stored in a separate instance of class *Bitmap*. *Bitmaps* have almost no protocol, since their sole purpose is to provide storage for *Forms*. They also have no intrinsic dimensionality, apart from that projected by their own *Form*, although the figure retains this structure for clarity. It can be seen that space has been provided in

the *Bitmap* for a width of 16; this is a manifestation of the hardware organization of storage and processing into 16-bit *words*. *Bitmaps* are allocated with an integral number of words for each row of pixels. The integral constraint on row size facilitates movement from one row to the next during the operation of *BitBlt* and during scanning of the display screen by the hardware. While this division of memory into words is significant at the primitive level, it is encapsulated in such a way that none of the higher-level graphical components in the system need consider word size.

### Class BitBlt

The most basic interface to *BitBlt* is through a class of the same name. Each instance of *BitBlt* contains the parameters necessary to specify a *BitBlt* operation. The *BitBlt* protocol includes messages for initializing the parameters and one message, *copyBits*, that causes the primitive operation to take place. The class template for *BitBlt* is given in table 1.

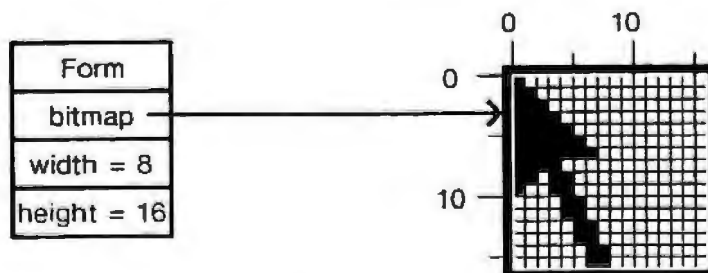

Figure 7: The complete representation of figure 1.





---

## STD-BUS BOARDS

Announcing  
a major price  
reduction.

**MOSTEK.**

---

Mostek, the world's largest manufacturer of STD-Z80 BUS microcomputer boards, is cutting board prices by an average of 30%. How can we do it? High volume. Automated equipment. Advanced manufacturing techniques.

Our price reduction is evidence that STD-Z80 BUS microcomputer boards are following traditional VLSI learning curve trends. And now, more than ever, these system level components are the cost-effective edge. For prototyping. For new designs. For redesigns. For volume applications.

STD-Z80 BUS microcomputer boards give you faster turn-around. More flexibility. More options. More effective use of an engineer's time. And now a price reduction that puts all other systems, and all other design options, in the same category: *over-priced*.

Send for our new price list. Call or write Mostek Micro Systems, 1215 West Crosby Road, Carrollton, Texas 75006. Phone (214) 323-1829. In Europe, contact Mostek Brussels, phone 762.18.80.

**STD-BUS  
BOARD PRICES  
REDUCED BY 30%**

|  |   |
|--|---|
| class name   | BitBlt  |
| superclass   | Object  |
| instance variable names  | destForm sourceForm halftoneForm<br>combinationRule destX destY width height<br>clipX clipY clipWidth clipHeight<br>sourceX sourceY |
| instance messages and methods  |   |
| <p><i>setup</i></p> <p><b>destForm: form1 sourceForm: form2 halftoneForm: form3 rule:<br/>rule destRectangle: destRectangle clipRectangle: clipRectangle<br/>sourceOrigin: sourceOrigin    </b></p> <p>destForm ← form1.<br/>sourceForm ← form2.<br/>halftoneForm ← form3.<br/>combinationRule ← rule.</p> <p>destX ← destRectangle minX.<br/>destY ← destRectangle minY.<br/>width ← destRectangle width.<br/>height ← destRectangle height.</p> <p>clipX ← clipRectangle minX.<br/>clipY ← clipRectangle minY.<br/>clipWidth ← clipRectangle width.<br/>clipHeight ← clipRectangle height.</p> <p>sourceForm == nil iffFalse:<br/>[sourceX ← sourceOrigin x.<br/>sourceY ← sourceOrigin y].</p> <p>self copyBits</p> <p><i>operations</i></p> <p><b>copyBits     &lt; primitive &gt;</b></p> |   |

Table 1: Class template for class BitBlt.

The state held in an instance of BitBlt allows multiple operations in a related context to be performed without the need to repeat all the

setup. For example, when displaying a scene in a display window, the destination Form and clipping rectangle will not change from one

operation to the next. This situation occurs frequently in the graphics kernel, as demonstrated in the following section.

### Image Synthesis of Text

Much of the graphics in the Smalltalk system consists of text and lines. These high-level entities are synthesized by repeated invocation of BitBlt. In this section and the next, we examine these two important applications more closely.

One of the advantages derived from BitBlt is the ability to store fonts compactly and to display them using various combination rules. The compact storage arises from the possibility of packing characters horizontally one next to another (as shown in figure 2), since BitBlt can extract the relevant bits if supplied with a table of left x coordinates of all the characters. This is called a *strike* format, from the typographical term meaning a contiguous display of all the characters in a font.

The scanning and display of text is performed in the Smalltalk-80 system by a subclass of BitBlt. This subclass inherits all the normal state, with destForm indicating the Form in which text is to be displayed and sourceForm indicating a Form containing all the character glyphs side by side (as in figure 2). In addition, this subclass defines further state information, including:

- text—a String of Characters to be displayed
- textPos—an Integer giving the current position in text

## Bower-Stewart & Associates SOFTWARE AND HARDWARE DESIGN

### \$GOLD DISKS\$ CP/M® Compatible Z-80 Software

Available for all 8-5" SS-SD IBM format systems including TRS-80®, Northstar, SD Systems. Also available on 5" double density Superbrain.®

**\$175.**  
ppd

#### Un-can your canned software!

**Z-80 Disassembler** Feel couped up with your canned software? Our Z-80 Disassembler recreates assembly language source files from absolute code enabling users to easily tailor programs to meet their specific needs. The Preconditioner works with the Disassembler to decode ASCII.

Credit cards: Immediate service. Free 24 hr phone - we will credit invoice. Checks, M.O.'s: Ten workday hold. CA res. Add tax



**\$50.**  
ppd

#### Great looking letters & reports!

**E-Z Text** A unique word processor organized around user-created text files, embellished with simple control commands, which supports such 'BIG GUYS' features as Automatic Footnoting, Table Spacing, Heading, Paging, Left & Right Margins, Proportional Spacing and MORE, at a 'LITTLE GUYS' price tag.



State system & controller. Allow time for surface mail. Trademarks: Digital Research, Radio Shack, Intertec

POST OFFICE BOX 1389 HAWTHORNE, CALIFORNIA 90250 213 / 676-5055

# The Text Solution for APPLE II®

## Now APPLE II® Owners Can Solve Text Problems With VIDEOTERM 80 Column by 24 Line Video Display Utilizing 7 X 9 Dot Character Matrix

Perhaps the most annoying shortcoming of the Apple II® is its limitation of displaying only 40 columns by 24 lines of text, all in uppercase. At last, Apple II® owners have a reliable, trouble-free answer to their text display problem. VIDEOTERM generates a full 80 columns by 24 lines of text, in upper and lower case. Twice the number of characters as the standard Apple II® display. And by utilizing a 7 by 9 character matrix, lower case letters have true descenders. But this is only the start.

### VIDEOTERM, MANUAL, SWITCHPLATE

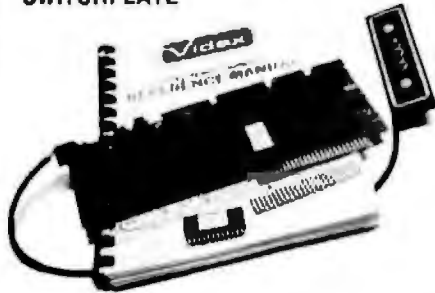

## VIDEOTERM

**BASICs** VIDEOTERM lists BASIC programs, both Integer and Applesoft, using the entire 80 columns. Without splitting keywords. Full editing capabilities are offered using the ESCape key sequences for cursor movement. With provision for stop/start text scrolling utilizing the standard Control-S entry. And simultaneous on-screen display of text being printed.

**Pascal** Installation of VIDEOTERM in slot 3 provides Pascal immediate control of the display since Pascal recognizes the board as a standard video display terminal and treats it as such. No changes are needed to Pascal's MISC INFO or GOTEXY files, although customization directions are provided. All cursor control characters are identical to standard Pascal defaults.

**Other Boards** The new Microsoft Softcard™ is supported. So is the popular D. C. Hayes Micro-modem II™, utilizing customized PROM firmware available from VIDEX. The powerful EasyWriter™ Professional Word Processing System and other word processors are now compatible with VIDEOTERM. Or use the Mountain Hardware ROMWriter™ (or other PROM programmer) to generate your own custom character sets. Naturally, VIDEOTERM conforms to all Apple OEM guidelines, assurance that you will have no conflicts with current or future Apple II™ expansion boards.

**Advanced Hardware Design** VIDEOTERM's on-board asynchronous crystal clock ensures flicker-free character display. Only the size of the Pascal Language card, VIDEOTERM utilizes CMOS and low power consumption ICs, ensuring cool, reliable operation. All ICs are fully socketed for easy maintenance. Add to that 2K of on-board RAM, 50 or 60 Hz operation, and provision of power and input connectors for a light pen. Problems are designed out, not in.

**Available Options** The entire display may be altered to inverse video, displaying black characters on a white field. PROMs containing alternate character sets and graphic symbols are available from Videx. A switchplate option allows you to use the same video monitor for either the VIDEOTERM or the standard Apple II™ display, instantly changing displays by flipping a single toggle switch. The switchplate assembly inserts into one of the rear cut-outs in the Apple II™ case so that the toggle switch is readily accessible. And the Videx KEYBOARD ENHANCER can be installed, allowing upper and lower case character entry directly from your Apple II™ keyboard.

**Firmware** 1K of on-board ROM firmware controls all operation of the VIDEOTERM. No machine language patches are needed for normal VIDEOTERM use.

#### Firmware Version 2.0

|            |   |         |  |
|------------|---|---------|--|
| Characters | 7 x 9 matrix  | Display | 24 x 80 (full descenders)                    |
| Options    | 7 x 12 matrix option;<br>Alternate user definable<br>character set option;<br>inverse video option. |         | 18 x 80 (7 x 12 matrix with full descenders) |

Want to know more? Contact your local Apple dealer today for a demonstration. VIDEOTERM is available through your local dealer or direct from Videx in Corvallis, Oregon. Or send for the VIDEOTERM Owners Reference Manual and deduct the amount if you decide to purchase. Upgrade your Apple II™ to full terminal capabilities for half the cost of a terminal. VIDEOTERM. At last!



7X12 MATRIX  
18X80 OPTIONAL



7X9 MATRIX  
24X80 STANDARD

Apple II™ is a trademark of Apple Computer, Inc.  
ROMWriter™ is a trademark of Mountain Hardware Inc.  
Micromodem II™ is a trademark of D. C. Hayes Associates Inc.  
Softcard™ is a trademark of Microsoft.  
EasyWriter™ is a trademark of Information Unlimited Software Inc.

PRICE: • VIDEOTERM includes manual \$345  
• SWITCHPLATE \$ 19  
• MANUAL refund with purchase \$ 19  
• 7 x 12 CHARACTER SET \$ 39  
• MICROMODEM FIRMWARE \$ 25

## APPLE II® OWNERS!

### Introducing the KEYBOARD & DISPLAY ENHANCER

- PUT THE SHIFT AND SHIFT LOCK BACK WHERE IT BELONGS
- SEE REAL UPPER AND LOWER CASE ON THE SCREEN
- ACCESS ALL YOUR KEYBOARD ASCII CHARACTERS

Videx has the perfect companion for your word processor software: the KEYBOARD AND DISPLAY ENHANCER. Install the enhancer in your APPLE II and be typing in lower case just like a typewriter. If you want an upper case character, use the SHIFT key or the CTRL key for shift lock. Not only that, but you see upper and lower case on the screen as you type. Perfectly compatible with Apple Writer and other word processors like, for example, Super-Text.

If you want to program in BASIC, just put it back into the alpha lock mode; and you have the original keyboard back with a few im-

provements. Now you can enter those elusive 9 characters directly from the keyboard or require the Control key to be pressed with the RESET to prevent accidental resets.

**KEYBOARD AND DISPLAY ENHANCER** is recommended for use with all revisions of the APPLE II. It includes 6 ICs, and EPROM and dip-switches mounted on a PC board, and a jumper cable. Easy installation, meaning no soldering or cutting traces. Alternate default modes are dip-switch selectable. You can even remap the keyboard, selecting an alternate character set, for custom applications.

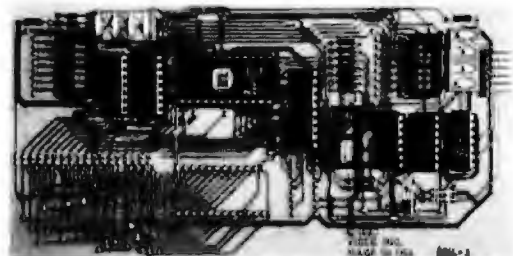

PRICE • KDE-700 (REV. 7 or greater).....\$129.  
• KDE-000 (REV. 6 or less).....\$129.

Apple II™ is a trademark of Apple Computer, Inc.



VIDEX  
897 N.W. Grant Avenue  
Corvallis, Oregon 97330  
Phone (503) 758-0521

Listing 1: The scanWord: method scans or prints text.

**scanWord: endRun**

```

| charIndex |
< primitive > "May be implemented internally for speed"
[charIndex > endRun] whileTrue:
  [charIndex - text at: textPos.
   (exceptions at: charIndex) > 0
   ifTrue: [! exceptions at: charIndex].
   sourceX - xTable at: charIndex.
   width - (xTable at: charIndex + 1) - sourceX.
   printing ifTrue: [self copyBits].
   destX - destX + width.
   destX > stopX ifTrue: [! stopXCode].
   textPos - textPos + 1].
textPos - textPos - 1.
! endRunCode

```

- xTable—an Array of Integers giving the left x location of each character in sourceForm
  - stopX—an Integer that sets a right boundary past which the inner loop should stop scanning
  - exceptions—an Array of Integers that, if non-zero, indicate that the corresponding characters must be specially handled
- Once an instance has been initialized with a given font and text location, the scanWord: loop given in listing 1 will scan or print text until some

horizontal position (stopX) is passed, a special character (determined from exceptions) is found, or the end of this range of text (endRun) is reached. The check on exceptions handles many possibilities in one operation. The space character may have to be handled exceptionally in the case of text that is padded to achieve a flush right margin. Tabs usually require a computation or table check to determine their width. Carriage return is also identified in the check for exceptions. Character codes beyond the

range given in the font are detected similarly and are usually handled by showing an exceptional character, such as a little lightning bolt, so that they can be seen and corrected. The printing flag can be set false to allow the same code to measure a line (break at a word boundary) or to find where the cursor points. While this provision may seem over-general, two benefits (besides compactness) are derived from that generality. First, if one makes a change to the basic scanning algorithm, the parallel functions of measuring, printing, and cursor tracking are sure to be synchronized. Second, if a primitive implementation is provided for the loop, it exerts a threefold leverage on the system performance. The scanWord: loop is designed to be amenable to such primitive implementation; that is, the interpreter may intercept it and execute primitive code instead of the Smalltalk code shown. In this way, much of the setup overhead for copyBits can be avoided at each character, and an entire word or more can be displayed

**HOW TO GET THE SOFTWARE CATALOG WITH APPLE'S STAMP OF APPROVAL.**

We're picky at Apple. So you can imagine how picky we are about which programs we included in our catalog called Special Delivery Software. No, we don't develop these programs here at Apple. But they're so well done, so applicable and so easy to run that we give them our Special Delivery stamp of approval. They're useful and exciting programs - special programs you've never heard about before. But the only way you can get these programs is through our Special Delivery Software catalog. To get this catalog and all the catalog products, just visit your local authorized Apple dealer. Or grab your nearest telephone and dial. The phone call won't cost you a cent. And neither will the catalog: (800) 538-8400. In California (800) 678-1484. **Apple Computer Inc.**



## State-of-the-art hardware demands state-of-the-art software

Operating Systems & Support Software from Technical Systems Consultants

To perform to its fullest capabilities, your hardware demands software designed to meet the specialized requirements of today's microprocessors. State-of-the-art software from Technical Systems Consultants keeps pace with the rapid advancements in computer technology so your hardware can live up to its full potential. Our complete line of state-of-the-art software includes:

### The UniFLEX™ Operating System

UniFLEX, a true multi-user, multi-tasking system for the 6809 and 68000 microprocessors, supports such features as:

- hierarchical file systems
- device independent I/O
- four Gigabyte disk capacities
- full file protection
- inter-task communication via pipes
- I/O redirection
- task swapping
- full random-access files
- comprehensive shell command language

UniFLEX, structured for large-scale microprocessor systems, will not run with minimal systems and thus has avoided design compromise. (Off-the-shelf versions and OEM licenses are available.)

### The FLEX™ Operating System

FLEX, a powerful, easy-to-use operating system designed for the 6800 and 6809 microprocessors, includes:

- dynamic filespace allocation
- random files
- batch job entry
- automatic space compression
- English error messages
- user environment control
- disk resident commands
- flexible device I/O
- printer spooling

Plus, FLEX can accommodate hard disks as well as floppies. The System is available off-the-shelf for a variety of systems and in a field-adaptable version. (OEM licenses available.)

FLEX and UniFLEX are trademarks of Technical Systems Consultants, Inc.

### Support Software

Technical Systems Consultants offers a full line of state-of-the-art support software compatible to FLEX and UniFLEX, some of which are:

- native C and Pascal compilers for advanced programming
- extended BASIC for business and educational applications
- text editing and processing software
- sort/merge package for business applications
- variety of absolute and relocatable assemblers
- debug and diagnostic packages

... and more. Write or call today for our brochures describing our complete product line.

 **technical systems  
consultants, inc.**

Box 2570, 1208 Kent Avenue  
West Lafayette, Indiana 47906  
(317) 463-2502 Telex 27-6143

Sculpture by Joann Chaney

# SPECTACULAR OFFERS

**BASF "FLEXYDISK"...**  
Superior Quality data storage medium. Certified and guaranteed 100% error free.

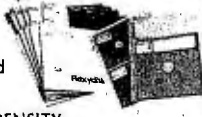

**SINGLE SIDED-SINGLE DENSITY**

5 1/4" or 8" Diskettes ..... 10/\$24  
5 1/4" or 8" Vinyl Storage Pages ..... 10/\$5

**MAXELL-DISKETTES**

The best quality diskette money can buy. Approved by Shugart and IBM.



Sold only in boxes of 10

5", 1 side ..... \$3.30  
8", 1-side ..... \$3.90.  
5", 2-side ..... \$4.25  
8", 2-side ..... \$5.60

**ALL MAXELL DISKETTES ARE DOUBLE DENSITY**

**LIBRARY CASE...**

3-ring binder album. Protects your valuable programs on disks Fully enclosed and protected on all sides. Similar to Kas-sette storage box.

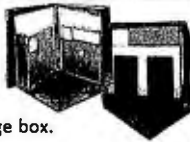

Library 3-Ring Binder ..... \$6.50  
5 1/4" Mini Kas - sette/10 ..... \$2.49  
8" Kas-sette/10 ..... \$2.99

**DISKETTE DRIVE HEAD CLEANING KITS**

Prevent head crashes and insure efficient, error-free operation.



5 1/4" or 8" ..... \$19.50

**SFD CASSETTES**

C-10 Cassettes ..... 10/\$7  
(All cassettes include box & labels)  
Get 8 cassettes, C-10 sonic and Cassette/B library album for only ..... \$8.00  
(As illustrated)



**HARDHOLE**

Reinforcing ring of tough mylar protects disk from damage



5 1/4" Applicator \$3    5 1/4" Hardholes \$6  
8" Applicator \$4    50/8" Hardholes \$8

VISA • MASTERCHARGE • MONEY ORDERS  
CERTIFIED CHECK • FOR PERSONAL CHECKS  
ALLOW TWO WEEKS • C.O.D. REQUIRES A 10%  
DEPOSIT • CAL. RES. ADD 6% SALES TAX  
MIN \$2 SHIPPING & HANDLING • MINIMUM  
ORDER \$10 • SATISFACTION GUARANTEED  
OR FULL REFUND  
Write for our free catalog

# ABM PRODUCTS

8868 Clairemont Mesa Blvd.  
San Diego, CA 92123

Toll Free

1-800-854-1555

For Orders Only

For information or California orders

(714) 268-3537

**Listing 2:** *The drawLoopX:Y: method draws lines.*

**drawLoopX: xDelta Y: yDelta**

```
| dx dy px py p i |
< primitive >
dx - xDelta sign.
dy - yDelta sign.
px - yDelta abs.
py - xDelta abs.
self copyBits.           "first point"

py > px
ifTrue:                   "more horizontal"
  [p - py/ 2.
  1 to: py do:
    [:i | destx - destx + dx.
    (p - p - px) < 0 ifTrue: [desty - desty + dy. p - p + py].
    self copyBits]]
ifFalse:                   "more vertical"
  [p - px/ 2.
  1 to: px do:
    [:i | desty - desty + dy.
    (p - p - py) < 0 ifTrue: [destx - destx + dx. p - p + px].
    self copyBits]]
```

**Listing 3:** *Methods for image magnification. @ is a shorthand message that returns a new Point whose x-value is the receiver (on the left) and whose y-value is the argument (on the right). Points respond to the + and \* messages by distributing them over each of the coordinates.*

**magnify: rect by: scale spacing: spacing**

```
| wideForm bigForm |
wideForm - Form extent: (rect width * scale x) @ rect height.
wideForm spread: rect from: self by: scale x
spacing: spacing x direction: 1 @ 0.
bigForm - Form extent: rect extent * scale.           "Then expand vertically"
bigForm spread: wideForm asRectangle from: wideForm by: scale y
spacing: spacing y direction: 0 @ 1.
↑ bigForm
```

**spread: rect from: sourceForm by: scale spacing: spacing direction: dir**

```
| slice sourcePt |
slice - Rectangle origin: 0 @ 0 extent: dir transpose * self extent + dir.
sourcePt - rect origin.           "transpose returns a Point with swapped coordinates"
1 to: (rect extent dot: dir) do:   "dot product selects direction of stretch"
  [:i | "slice up the original image"
  self copy: slice from: sourcePt in: sourceForm rule: STORing.
  sourcePt - sourcePt + dir. slice moveBy: dir * scale].
1 to: scale - spacing - 1 do:
  [:i | "smear out the slices, leave some space"
  self copyAllTo: 1 @ 0 in: self rule: ORing]
```

directly. Conversely, the Smalltalk text and graphics system requires implementation of only the one primitive operation to provide full functionality.

**Line Drawings, Image Synthesis**

The same design principle applies in the support for drawing lines. By using BitBlt, one algorithm can draw lines of varying widths, different halftone "color," and any combina-

tion rule. To draw a line, an instance of BitBlt is initialized with the appropriate destination Form and clipping window, and with a source that can be any Form to be applied as a pen shape along the line. Starting from the stored destX and destY, the line-drawing loop, drawLoopX:Y: (listing 2), accepts x and y delta values and x and y step values as necessary, calling copyBits at each point along the line. The method used

# THE BACKBONE OF YOUR SYSTEM

The Heath/Zenith 19 Smart Video Terminal gives you all the important professional features, all for under \$700.\* You get the flexibility you need for high-speed data entry, editing, inquiry and transaction processing. It's designed to be the backbone of your system with heavy-duty features that withstand the rigors of daily use.

Standard RS-232C interfacing makes the 19 compatible with DEC VT-52 and most computer systems. And with the 19, you get the friendly advice and expert service that makes Heath/Zenith a strong partner for you.

Pick the store nearest you from the list on page 00. And stop in today for a demonstration of the Heath/Zenith 19 Smart Video Terminal. If you can't get to a store, send \$1.00 for the latest Heathkit® Catalog and the new Zenith Data Systems Catalog of assembled commercial computers. Write Heath Co., Dept. 334-806, Benton Harbor, MI 49022.

## HEATH/ZENITH

Your strong partner

Completely addressable blinking cursor lets you edit anywhere on screen.

Reverse video by character lets you emphasize words, phrases or paragraphs.

High resolution CRT gives you sharp, easy-to-read image, reduces eye-strain.

Z-80 microprocessor-control makes the Heath/Zenith 19 capable of multitude of high-speed functions. It's the only terminal with ROM source code readily available.

Complete ASCII character set including upper case, lower case with descenders, and special graphic symbols.

80 character by 24 line format, plus 25th line for operator messages and prompts.

Professional quality keyboard, standard typewriter layout, 72 keys, including 12 special function keys.

Insert and delete character or line plus erase to end of line and end of screen make the 19 ideal for sophisticated editors like WORDSTAR.

Cursor and special functions are accessible by keyboard or computer, using either DEC VT-52 or ANSI Standard protocols.

Keypad in calculator format permits fast, easy entry of numeric data.

\*In kit form, F.O.B. Benton Harbor, MI. Also available completely assembled at \$995. Prices and specifications are subject to change without notice.

**FREE**  
with software purchase  
One year subscription to **InfoWorld**

# DISCOUNT SOFTWARE

**Ad #16**  
**ULTIMATE SOFTWARE PLAN**

(New items or new prices)

We'll match any advertised price on any item that we carry. And if you find a lower price on what you bought within 30 days of buying it, just show us the ad and we'll refund the difference. It's that simple.

Combine our price protection with the availability of full professional support and our automatic update service and you have the Ultimate Software Plan.

It's a convenient, uncomplicated, logical way to get your software.

**DISK WITH MANUAL ONLY**

CP/M users: specify disk systems and formats. Most formats available

**CP/M**

**ARTIFICIAL INTELLIGENCE**  
Medical(PAS-3) \$849/\$40  
Dental (PAS-3) \$849/\$40

**ASYST DESIGN**  
Prof Time Billing \$549/\$40  
General Subroutine \$269/\$30  
Application Utilities \$439/\$30

**COMPLETE BUS. SYSTEMS**  
Creator \$269/\$25  
Reporter \$189/\$20  
Both \$399/\$45

**COMPUTER CONTROL**  
Fabs (B-tree) \$159/\$20  
UltraSort II \$159/\$25

**COMPUTER PATHWAYS**  
Pearl (level 1) \$ 89/\$25  
Pearl (level 2) \$289/\$40  
Pearl (level 3) \$549/\$50

**DIGITAL RESEARCH**  
CP/M 2.2  
NorthStar \$149/\$25  
TRS-80 Model II (P+T) \$159/\$35  
Micropolis \$169/\$25  
Cromemco \$189/\$25  
PL/I-80 \$459/\$35  
BT-80 \$179/\$25  
Mac \$ 85/\$15  
Sid \$ 65/\$15  
Z-Sid \$ 90/\$15  
Tex \$ 90/\$15  
DeSpool \$ 50/\$10

**D.M.A.**  
Ascsm \$149/\$15  
DMA-DOS \$179/\$35  
CBS \$369/\$45  
Formula \$539/\$45

**GRAHAM-DORIAN**  
General Ledger \$729/\$40  
Acct Receivable \$729/\$40  
Acct Payable \$729/\$40  
Job Costing \$729/\$40  
Payroll II \$729/\$40  
Inventory II \$729/\$40  
Payroll \$493/\$40  
Inventory \$493/\$40  
Cash Register \$493/\$40  
Apartment Mgt \$493/\$40  
Surveying \$729/\$40  
Medical \$729/\$40  
Dental \$729/\$40

**MICRO-AP**  
S-Basic \$269/\$25  
Selector IV \$469/\$35

**MICRO DATA BASE SYSTEMS**  
HDBS \$269/\$35  
MDBS \$795/\$40  
DRS or QRS or RTL \$269/\$35  
MDBS PKG \$1295/\$60

**MICROPRO**  
WordStar \$319/\$60  
Customization Notes \$ 89/\$na  
Mail-Merge \$109/\$25  
WordStar/Mail-Merge \$419/\$85  
DataStar \$249/\$60  
WordMaster \$119/\$40  
SuperSort I \$199/\$40

**MICROSOFT**  
Basic-80 \$289/\$30  
Basic Compiler \$329/\$30  
Fortran-80 \$349/\$30  
Cobol-80 \$574/\$30  
M-Sort \$124/\$30  
Macro-80 \$144/\$20  
Edit-80 \$ 84/\$20  
MuSimp/MuMath \$224/\$25  
MuLisp-80 \$174/\$20

**ORGANIC SOFTWARE**  
Text/Writer III \$111/\$20  
DateBook II \$269/\$25  
Milestone \$289/\$25

**OSBORNE**  
General Ledger \$ 59/\$20  
Acct Rec/Acct Pay \$ 59/\$20  
Payroll w/Cost \$ 59/\$20  
All 3 \$129/\$60  
All 3 + CBASIC-2 \$199/\$75

**PEACHTREE\***  
General Ledger \$399/\$40  
Acct Receivable \$399/\$40  
Acct Payable \$399/\$40  
Payroll \$399/\$40  
Inventory \$399/\$40  
Surveyor \$399/\$40  
Property Mgt \$799/\$40  
CPA Client Write-up \$799/\$40  
Mailing Address \$349/\$40

**SOFTWARE WORKS**  
Adapt (CDOS to CP/M) \$ 69/\$na  
Ratfor \$ 86/\$na

**SOHO GROUP**  
MatchMaker \$ 97/\$20  
WorkSheet \$177/\$20

**STRUCTURED SYSTEMS**  
GL or AR or AP or Pay \$599/\$40  
Inventory Control \$599/\$40  
Magic Worksheet \$219/\$40  
Analysl \$195/\$25  
Letterright \$179/\$25  
QSort \$ 89/\$20

**SUPERSOFT**  
Diagnostic I \$ 49/\$20  
Diagnostic II \$ 84/\$20  
Disk Doctor \$ 84/\$20  
Forth (8080 or Z80) \$149/\$25  
Fortran \$219/\$30  
Fortran w/Ratfor \$289/\$35  
Other less 10%

**TCS**  
GL or AR or AP or Pay \$ 79/\$25  
All 4 \$269/\$99

**UNICORN**  
Mince \$ 99/\$25  
Scribble \$ 99/\$25  
Both \$189/\$50  
Amethyst \$299/\$75

**WHITESMITHS**  
"C" Compiler \$600/\$30  
Pascal (incl "C") \$850/\$45

**"DATA BASE"**  
FMS-80 \$649/\$45  
dBASE II \$629/\$50  
Condor \$599/\$30  
Condor II \$899/\$50  
Access/80 \$749/\$50

**"PASCAL"**  
Pascal/MT+ \$429/\$30  
Pascal/Z \$349/\$30  
Pascal/UCSD \$399/\$50  
Pascal/M \$149/\$20

**"WORD PROCESSING"**  
WordSearch \$179/\$50  
SpellGuard \$229/\$25  
VTS/80 \$259/\$65  
Magic Wand \$289/\$45  
Spell Binder \$349/\$45

**"OTHER GOODIES"**  
The Last One \$549/\$95  
SuperCalc \$269/\$50  
Target \$189/\$30  
BSTAM \$149/\$15  
Tiny "C" \$ 89/\$50  
CBASIC-2 \$229/\$50  
Nevada Cobol \$ 99/\$20  
MicroStat \$129/\$25  
Vedil \$224/\$20  
ESQ-1 \$105/\$15  
MiniModel \$1349/\$50  
StatPak \$449/\$50  
Micro B+ \$429/\$20  
Raid \$224/\$35  
String/80 \$ 84/\$20  
String/80 (source) \$279/\$20

**APPLE II\***

**INFO UNLIMITED**  
EasyWriter \$224  
Datadex \$349  
Other less 15%

**MICROSOFT**  
Softcard (Z-80 CP/M) \$259  
Fortran \$179  
Cobol \$499

**MICROPRO**  
Wordstar \$269  
MailMerge \$ 99  
Wordstar/MailMerge \$349  
SuperSort I \$159

**PERSONAL SOFTWARE**  
Visicalc \$ 99  
Visicalc II \$159  
CCA Data Mgr \$ 84  
Desktop/Plan II \$159  
Visitem \$129  
Visidex \$159  
Visiplot \$149  
Visitrend/Visiplot \$229  
Zork \$ 34

**PEACHTREE\***  
General Ledger \$224/\$40  
Acct Receivable \$224/\$40  
Acct Payable \$224/\$40  
Payroll \$224/\$40  
Inventory \$224/\$40

**"OTHER GOODIES"**  
dBASE II \$329/\$50  
VU #3 (use w/Visicalc) \$ 49  
Super-Text II \$127  
Data Factory \$129  
DB Master \$184  
OEM (complete accting) \$399  
Charles Mann less 15%  
STC less 15%

is the Bresenham plotting algorithm (*IBM Systems Journal*, Volume 4, Number 1, 1965). It chooses a principal direction and maintains a variable, p. When p's sign changes, it is time to move in the minor direction as well. This procedure is another natural unit to be implemented as a primitive, since the computation is trivial and the setup in copyBits is almost all constant from one invocation to the next.

**Image Processing**

We have seen how BitBlt can copy shapes and, in the foregoing examples, how repeated invocation can synthesize more complex images such as text and lines. BitBlt is also useful in the manipulation of existing images. For example, text can be made to look bold by ORing over itself, shifted right by one pixel. Just as complex images can be built from simple ones, complex processing can be achieved by repeated application of simple operations. Here, we present three examples of such structural manipulation: magnification, rotation, and the game of Life. These examples were devised by the author in collaboration with Ted Kaehler.

As we shall see in the next two sections, many applications of BitBlt are very simple, such as filling a Form with white, or copying all of one Form to some location in another. Smalltalk provides for such casual use of BitBlt through a wide range of simple messages to class Form, such as:

```
someForm fillAll: white.
someForm copyAllTo:
destLocation in: destForm.
```

We will not list all such messages here. In the examples that follow, the reader should be able to infer the meaning from the message names and the accompanying explanations.

**Magnification**

It is often useful to magnify an image for closer scrutiny and especially to allow convenient alteration of stored Forms. Photo 1 shows this function providing user control over the font used for display of text.

ORDERS ONLY—CALL TOLL FREE VISA • MASTERCARGE

1-800-854-2003 ext. 823 • Calif. 1-800-522-1500 ext 823

Overseas—add \$10 plus additional postage • Add \$2.50 postage and handling per each item • California residents add 6% sales tax • Allow 2 weeks on checks. C O D ok • Prices subject to change without notice All items subject to availability • ®—Migs Trademark.

**THE DISCOUNT SOFTWARE GROUP**

6520 Selma Ave. Suite 309 • Los Angeles, Ca. 90028 • (213) 666-7877  
Int'l TELEX 499-0032 BVHL Attn DiscSoft • USA TELEX 194-634 BVHL Attn: DiscSoft •  
TWX 910-321-3597 BVHL Attn DiscSoft



# OSBORNE'S LATEST HITS

6 Brand New Books from Osborne/McGraw Hill

## Interfacing to S-100 (IEEE 696) Microcomputers

by Sol Libes and Mark Garetz

This book assists S-100 users in expanding the power and utility of their systems. It describes the S-100 bus with unmatched precision and detail. Various chapters describe its mechanical and functional design, logical and electrical relationships, bus interconnections, and bussing techniques. Both parallel and serial interfacing are described as well as interfacing to RAM, ROM, and the real world. Additional chapters discuss D/A and A/D conversion, interrupts, timers, and direct memory access.

#37-3 \$15 □

## Microprocessors for Measurement and Control

by D.M. Auslander and P. Sagues

Learn to design mechanical and process equipment which use microprocessor based "real time" computer systems. This book shows you how, and, using case studies, builds and explores problems of increasing complexity. The book presents plans for prototype systems, allowing readers (even those unfamiliar with machine or assembly language) to initiate projects and carry them through to completion.

#57-8 \$15.99 □

## Science and Engineering BASIC Programs

edited by John Heilborn

50 programs with a wide range of scientific and engineering applications - Clearly documented and easily adapted for any popular microcomputer - This book is an indispensable tool for any scientist, engineer or student. Included are programs for interpolation, regression, data analysis, roots of polynomials, matrix operations, and linear equations. You'll also find programs for eigenvalues and eigenvectors, differential equations, Fourier analysis, Structural analysis, thermodynamics, and many others.

#63-2 \$15.99 □

## CBASIC™ User's Guide

by Gordon Eubanks, Adam Osborne, and Martin McNiff

The CBASIC language may be the most advanced version of BASIC yet created. Like Pascal, CBASIC requires no line numbers and lends itself to highly organized, structured programs—programs that are readable, modular, and easier to change. CBASIC is as easy to learn as BASIC and contains convenient file handling facilities, making it very useful for many business applications. It may be the only computer language you'll ever need to learn. This guide was co-authored by Gordon Eubanks, the creator of CBASIC. It is not only a self-teaching textbook, it is the definitive reference on the CBASIC language.

#61-6 \$15 □

## ATARI™ Some Common BASIC Programs

### TRS-80™ level II Some Common BASIC Programs

Two new editions of Osborne's celebrated collection of 76 useful and informative programs in Math, Finance, and Statistics. These programs will transform your Atari 400 or 800 or your TRS-80 computer from a plaything into a real workhorse. The programs are clearly documented to serve as a valuable instructional aid in learning BASIC.

ATARI version: #53-5 \$14.99 □

TRS-80 level II version: #54-3 \$14.99 □

Make check payable to:  **OSBORNE/McGraw-Hill**  
630 Bancroft Way, Berkeley, CA 94710 Dept. B19

Phone: (415) 548-2805

TOLL FREE: 800-227-2895 Outside California



Name \_\_\_\_\_

Address \_\_\_\_\_

City/State/Zip \_\_\_\_\_

Plus  .75/item 4th class  \$1.50/item UPS  \$2.50/item Air Mail  \$10.00/Overseas (California Residents add applicable tax.)  
 Please send me your free catalog.

Total amount enclosed \$ \_\_\_\_\_ or charge my  Visa  Mastercharge Card # \_\_\_\_\_ Expiration Date \_\_\_\_\_

Signature \_\_\_\_\_

**Listing 4:** The rotate method. This method rotates an image of size  $2^n$  by  $2^n$  one quarter-turn clockwise.

```
rotate | mask temp quad |
temp — Form extent: self extent.
mask — Form extent: self extent.           "set up the first mask"
mask copy: mask asRectangle halftone: white rule: STORing.
mask copy: mask asRectangle/2 halftone: black rule: STORing.
quad — self width/2. "the size of a quadrant"
[quad > = 1] whileTrueDo:
[ "First exchange left and right halves"
mask copyAllTo: 0 @ 0 in: temp rule: STORing.
mask copyAllTo: 0 @ quad in: temp rule: ORing.
self copyAllTo: 0 @ 0 in: temp rule: ANDing.
temp copyAllTo: 0 @ 0 in: self rule: XORing.
temp copyAllFrom: quad @ 0 in: self rule: XORing.
self copyAllTo: (0 - quad) @ 0 in: self rule: ORing.
temp copyAllTo: quad @ 0 in: self rule: XORing.
"Then flip the diagonals"
self copyAllTo: 0 @ 0 in: temp rule: STORing.
temp copyAllFrom: quad @ quad in: self rule XORing.
mask copyAllTo: 0 @ 0 in: temp rule: ANDing.
temp copyAllTo: 0 @ 0 in: self rule: XORing.
temp copyAllTo: quad @ quad in: self rule: XORing.
"Compute the next fine mask"
mask copyAllFrom: (quad/2) @ (quad/2) in: mask rule: ANDing.
mask copyAllTo: quad @ 0 in: mask rule: ORing.
mask copyAllTo: 0 @ quad in: mask rule: ORing.
quad — quad/2]
```

The character for "7" has been presented magnified nine times. Using a pointing device, the user has blackened some cells to provide a European style "7," and the result can be seen in both the upper-left and lower-right windows on the screen.

A simple way to magnify a stored Form would be to copy it to a larger Form, making a big dot for every little dot in the original. For a height  $h$  and width  $w$ , this would take  $h \times w$

operations. The algorithm presented in listing 3 (as two messages to class Form) uses only a few more than  $h + w$  operations.

The magnification proceeds in two steps. First, it slices up the image into vertical strips in wideForm separated by a space equal to the magnification factor. These are then smeared, using the ORing function, over the intervening area to achieve the horizontal magnification. The process is then

repeated from wideForm into bigForm, with horizontal slices separated and smeared in the vertical direction, achieving the desired magnification. Figure 8 illustrates the progress of the above algorithm in producing the magnified "7" shown in photo 1.

### Rotation

Another useful operation on images is rotation by a multiple of 90 degrees. Rotation is often thought to be a fundamentally different operation from translation, and this point of view would dismiss the possibility of using BitBlt to rotate an image. However, the reader must consent that the first transformation shown in figure 9 is a step toward rotating the image shown: all that remains is to rotate the insides of the four cells that have been permuted. The remainder of the figure shows each of these cells being further subdivided, its cells being similarly permuted, and so on. Eventually each cell being considered contains only a single pixel. At this point, no further subdivision is required, and the image has been faithfully rotated!

Each transformation shown in figure 9 would appear to require successively greater amounts of computation, with the last one requiring several times more than  $h \times w$  operations. The tricky aspect of the algorithm below is to permute the subparts of every subdivided cell at once, thus performing the entire rotation in a constant times  $\log_2(h)$  operations. The parallel permutation of many cells is accomplished with the aid of two auxiliary Forms. The first, mask, carries a mask that selects the upper left quadrant of every cell; the second, temp, is used for temporary storage. A series of BitBlt operations exchanges the right and left halves of every cell, and then another series ex-

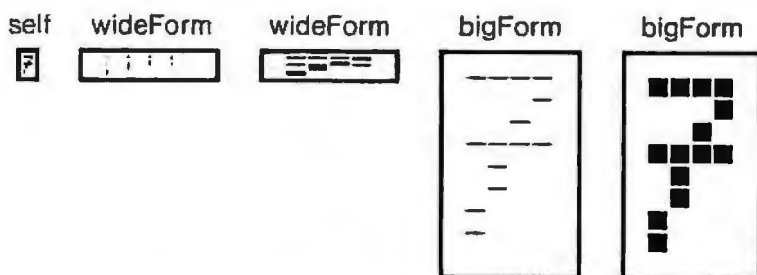

Figure 8: Magnification with BitBlt. See the text for more details.

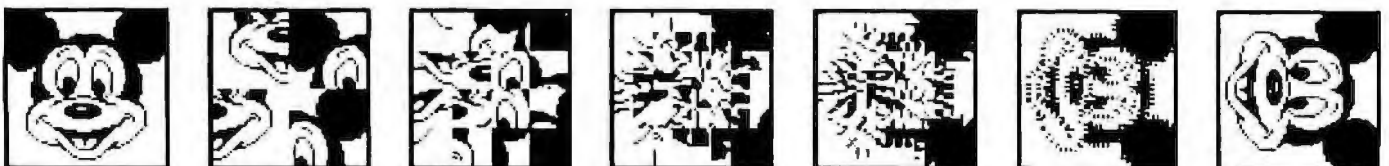

Figure 9: Image rotation with BitBlt. See the text for more details.

# PUT YOUR SYSTEM ON THE FOREFRONT OF TECHNOLOGY

## PROM BLASTER



PROGRAMS MOST FAMILIES OF EPROMS!

- Accepts 1K/2K/4K or 8K EPROMS
- Extended Device Option
- Phantom Slave Option
- All Programming Characteristics Software Controlled
- Accepts Single or 3 Supply Parts
- Device Address Switch Selectable

Kit Price \$199.95

## KLUGE CARD

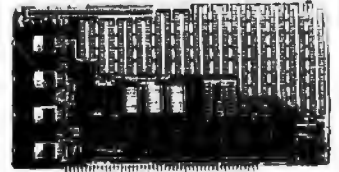

SIMPLIFY YOUR PROJECTS WITH A PROTOTYPE BREADBOARD WITH EXTRAS

- 4 On-Board Pwr. Supplies up to 3 of which can be +5, or  $\pm 5$ ,  $\pm 12$
- Switch Selectable Memory or Device Address
- On-Board Address/Device Decoding
- Bi-Directional Data Bus Buffering
- On-Board Wait States

Bare Board \$39.95

## 6809 SINGLE BOARD COMPUTER

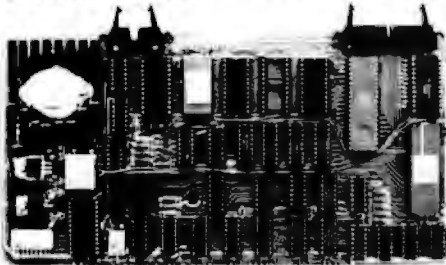

- 2K ROM
- 4K/8K/16K RAM
- 20 Parallel I/O Lines
- RS 232 Interface
- Baud Rates from 110 to 9600
- All Memory/I.O. Relocatable on 4K Boundaries
- 8080 I/O Instructions Memory Mapped (Gives 256 I/O Ports)
- Complete Documentation
- ADSMON Monitor Includes User Callable Functions, Autopatch and more

Kit Price \$299.95 (Includes Software)

## NOISEMAKER



- Two On-Board Audio Amplifiers for Stereo Sound Effects
- Uses the GIAY 3-8910
- Six Tone Generators
- Two Envelope Generators
- Two Noise Sources
- Four 8-Bit I/O Ports
- Up to Two Wait States

ALL SOUND EFFECTS ARE SOFTWARE CONTROLLED FOR AN ENDLESS VARIETY!  
KIT \$84.95

## MOTHER BOARDS

THREE S-100 MOTHER BOARDS AVAILABLE;

- 3 Slots for Stand-Alone Applications
  - 9 Slots for Small Systems
  - 18 Slots for Full Size Systems
  - Active Termination (9 & 18 Slot Boards Only)
  - Extensive Ground Shield
  - Breadboard Area
- (Write for complete information)

The products shown here are just an example of the quality products

and service Ackerman Digital Systems offers. ADS is an engineering company dedicated to providing the micro computer industry with solid quality products to meet a variety of needs.

All ADS products adhere to the I.E.E.E. 696/S-100 Bus standard, a bus noted for its widespread acceptance and versatility.

For catalog containing complete hardware and software information, write Ackerman Digital Systems, Inc., 110 N. York Rd., Elmhurst, IL 60126. TEL 312-530-8992

# ads

ACKERMAN DIGITAL SYSTEMS, INC.

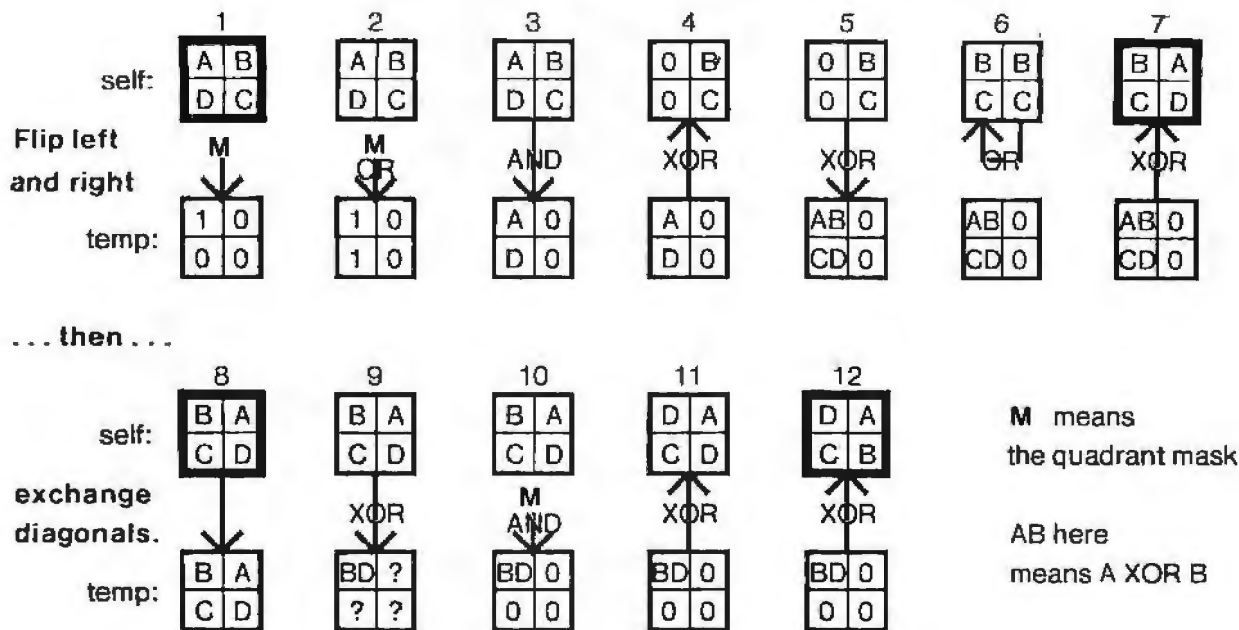

Figure 10: Permuting four quadrants of a cell.

changes the diagonal quadrants, achieving the desired permutation. The complete method for rotation is given in listing 4.

Figure 10 traces the state of temp and self after successive operations. The offsets of each operation are not shown, though they are given in the program listing. After twelve operations, the desired permutation has been achieved. At this point, the mask evolves to a finer grain, and the process is repeated for more, smaller cells. Figure 11 shows the evolution of the mask from the first to the second stage of refinement. The reader will note that the algorithm presented here for rotation is applicable only to square forms whose size is a power of two. The extension of this technique to arbitrary rectangles is more involved and is left as an exercise for the reader. A somewhat simpler exercise is to apply the above technique to horizontal and vertical reflections about the center of a rectangle.

### The Game of Life

John Conway's game of Life is

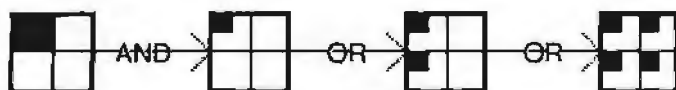

Figure 11: Refinement of the quadrant mask.

probably well known to readers of BYTE. It is a fairly simple rule for successive populations of a bitmap. The rule involves the neighbor count for each cell—how many of the eight adjacent cells are occupied? Each cell will be occupied in the next generation if it has exactly three neighbors, or if it was occupied and has exactly two neighbors. This is explained as follows: three neighboring organisms can give birth in an empty cell, and an existing organism will die of exposure with less than two neighbors or from overpopulation with more than three neighbors. Since BitBlt cannot add, it would seem to be of no use in this application. However, BitBlt's combination rules do include the rules for partial sum (XOR) and carry (AND). With some ingenuity and a fair amount of extra storage, the next generation of any size of bitmap can be computed using a constant number of BitBlt operations.

Listing 5 gives the method for nextLifeGeneration. As shown in figure 12, the number of neighbors is represented using three image planes for

the 1s bit, 2s bit, and 4s bit of the neighbor count in binary. The 8s bit can be ignored, since there are no survivors in that case, which is equivalent to zero (the result of ignoring the 8s bit). This Smalltalk method is somewhat wasteful, as it performs the full carry propagation for each new neighbor, even though nothing will propagate into the 4-plane until at least the fourth neighbor. Some readers may enjoy improving upon this algorithm.

Many other image-processing tasks can be performed with BitBlt. The author has built a complete optical character-recognition system for Sanskrit text using the various combination rules and an operation that counts the number of black bits in any rectangle (how would you do it?).

Bitmap processing is ideally suited to VLSI (very large scale integration) implementation. Readers who are interested in this direction should check the proceedings of the Design Automation Conference, June 1981, for "Parallel Bitmap Processor," by Tom Blank, Mark Stefik, and Willem vanCleemput.

### Efficiency Considerations

Our original specification for BitBlt has been published elsewhere



# **YOUR SOFTWARE STRATEGY FOR THE 80's**

## **New Compiler and Support Team Brings Products to Market Faster and Easier**

If your company's in the big game of small business systems, you'll want to know more about Compiler Systems' support team and its new CB80.

Everyone's talking about the ultimate microcomputer winners and how software will be the driving force in the market. Enter the new CB80 BASIC compiler.

CB80 is derived from the industry's standard CBASIC™ and designed for 8-bit micros supporting CP/M®, MP/M™ and CP/NET™. It retains all of the characteristics that made CBASIC widely used in business applications, while providing substantial improvements in speed and performance.

And advanced CSI design provides CB80 with enhancements for multi-user support further expanding your marketing opportunities.

CSI's support team will assist in your development and marketing efforts — plus special assistance via a technical hotline for users.

CB80 is sold throughout the U.S. and overseas by a network of distributors. Call today (213) 355-4211 for ordering information or write for technical details.

# **CB80**

Compiler Systems, Inc., 37 N. Auburn Ave., P.O. Box 145,  
Sierra Madre, California 91024. (213) 355-1063

CP/M®, MP/M™ and CP/NET™ are trademarks of Digital Research

Circle 248 on Inquiry card.

# SUPERBRAIN

By INTERTEC



64K Double or Quad Density units available. Uses two Z-80 CPU's. Commercial-type terminal with 12" monitor. Dual double density minifloppies. Over 350 kilobytes of storage (twice that with quad density drives). Two serial RS232 ports, I/O ports standard. Expandable with optional S-100 interface. Comes with CP/M™ 2.2 operating system. MiniMicroMart can supply a wide range of CP/M development and application software.

w/64K Double Density, List \$3495... **\$2869**  
 w/64K Quad Density, List \$3995... **\$3395**



**hp HEWLETT PACKARD HP-41CV**  
**\$259.**  
 AVAILABLE NOW!

**ZENITH data systems**  
 Z19 Video Terminal



Limited Time **\$799**  
 List \$995

**hp HEWLETT PACKARD HP-85A**



Desk-Top Computer  
 List \$3250  
**\$2749**

**HP-83**  
 List \$2250 **Special \$1749**

F.O.B. shipping point. All prices subject to change and all offers subject to withdrawal without notice. Advertised prices are for prepaid orders. Credit card and C.O.D. 2% higher. C.O.D. may require deposit.

— WRITE FOR FREE CATALOG —

**MiniMicroMart**  
 1618 James Street

Syracuse, NY 13203 (315) 422-4467  
 192 August 1981 © BYTE Publications Inc

Listing 5: The nextLifeGeneration method. This method calculates the next Life generation given the BitBlit bitmap of the current generation. See figure 12.

```

nextLifeGeneration | nbr1 nbr2 nbr4 carry2 carry4 |
nbr1 — Form new extent: self extent + (2 @ 2).      "temp areas larger by 1"
nbr2 — Form new extent: self extent + (2 @ 2).      "bit all around"
nbr4 — Form new extent: self extent + (2 @ 2).
carry2 — Form new extent: self extent + (2 @ 2).
carry4 — Form new extent: self extent + (2 @ 2).
(1 @ 1) eightNeighbors do:
[:delta | "delta equals a different neighbor-offset each time through this loop"
carry2 copyAllFrom: 0 @ 0 in: nbr1 rule: STORing.
carry2 copyAllFrom: delta in: self rule: ANDing.      "carry into 2"
nbr1 copyAllFrom: delta in: self rule: XORing.      "sum 1"
nbr2 copyAllTo: 0 @ 0 in: carry4 rule: STORing.
carry2 copyAllTo: 0 @ 0 in: carry4 rule: ANDing.      "carry into 4"
carry2 copyAllTo: 0 @ 0 in: nbr2 rule: XORing.      "sum 2"
carry4 copyAllTo: 0 @ 0 in: nbr4 rule: XORing].      "sum 4"
nbr2 copyAllTo: 1 @ 1 in: self rule: ANDing. "perform logic to determine the survivors"
nbr2 copyAllTo: 0 @ 0 in: nbr1 rule: ANDing. "(2s AND self) OR (2s AND 1s)"
nbr1 copyAllTo: 1 @ 1 in: self rule: ORing. "...all AND (NOT 4s)"
nbr4 copyAllTo: 0 @ 0 in: self rule: NOTANDing      "store next generation"
"over self"
    
```

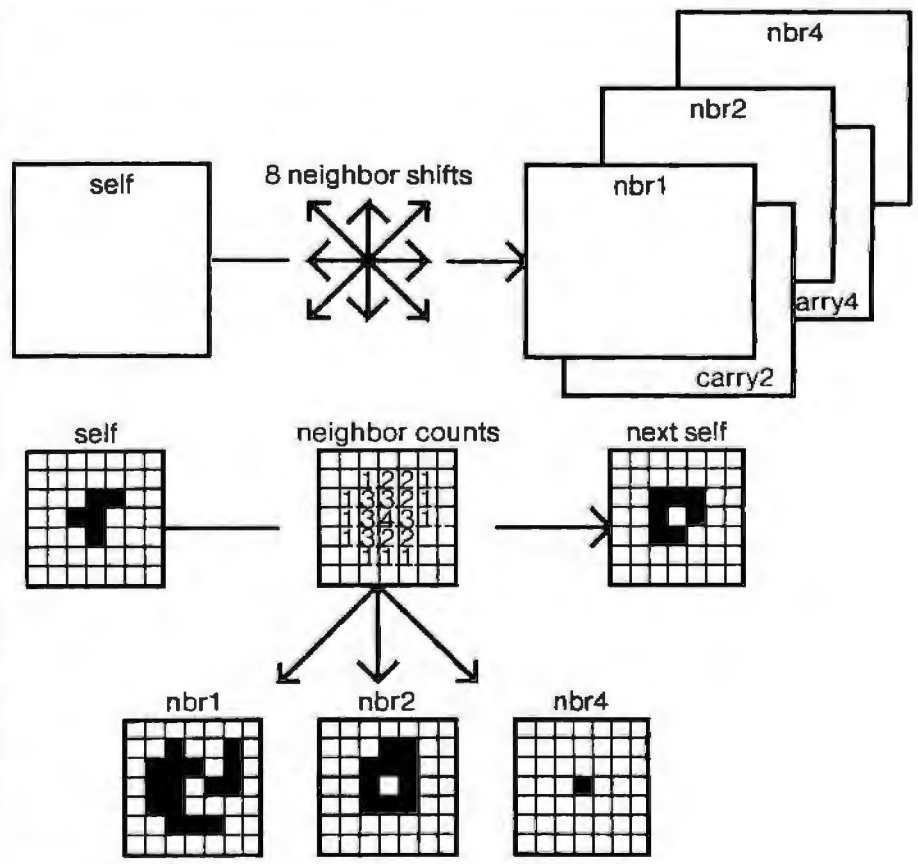

Figure 12: Counting neighbors in the game of Life.

(Newman and Sproull, *Principles of Interactive Computer Graphics*, 2nd edition, McGraw-Hill, 1979) under the name *RasterOp*. The implementation described in that reference can easily be extended to include the full set of combinations, and the addition

of clipping is also straightforward. Here, we add a few notes on efficiency gathered from experience.

BitBlit is so central to the user interface that any improvement in its performance has considerable effect on the interactive quality of the system

# TIRED OF WAITING?



Frustrating isn't it! No matter how much you speed up your program it still seems to take forever to save data onto a cassette. Wouldn't it be great if someone could design a mass storage system with the speed of a disk, but at half the cost? Exatron did, the *Exatron Stringy Floppy (ESF)*.

Totally self-contained, the ESF is an extremely fast, reliable, and economical alternative to cassette or disk storage of programs or data. All of the ESF's operations are under the computer's control, with no buttons, switches, knobs or levers to adjust or forget.

The ESF uses a miniature tape cartridge, about the size of a business card, called a wafer. The transport mechanism uses a direct drive motor with only one moving part. Designed to read and write

digital data only, the ESF suffers from none of the drawbacks of cassettes - without the expense of disks.

Several versions of the ESF are available, for the *TRS-80*, *Apple*, *PET*, *OSI* and an *RS 232* unit. Even the slowest of the units is 15 times faster than a cassette, and all are as reliable as disk drives - in fact a lot of users say they are *more* reliable!



excellence in electronics

## exatron

To get further information about the ESF give Exatron a call on their Hot Line 800-538 8559 (inside California 408-737 7111).

If you can't wait any longer then take advantage of their 30 day money-back guarantee, you've nothing to lose but time!

181 Commercial Street  
Sunnyvale, CA 94086



# STD BUS '6809'

The newest in Datricon's family of low-cost 4th engines.

**MEMORY** capacity to 40k bytes, **RS232/RS422 SERIAL PORT** and the powerful **6809 CPU**, all on one 4.5 x 6.5 inch **STD Bus Card**

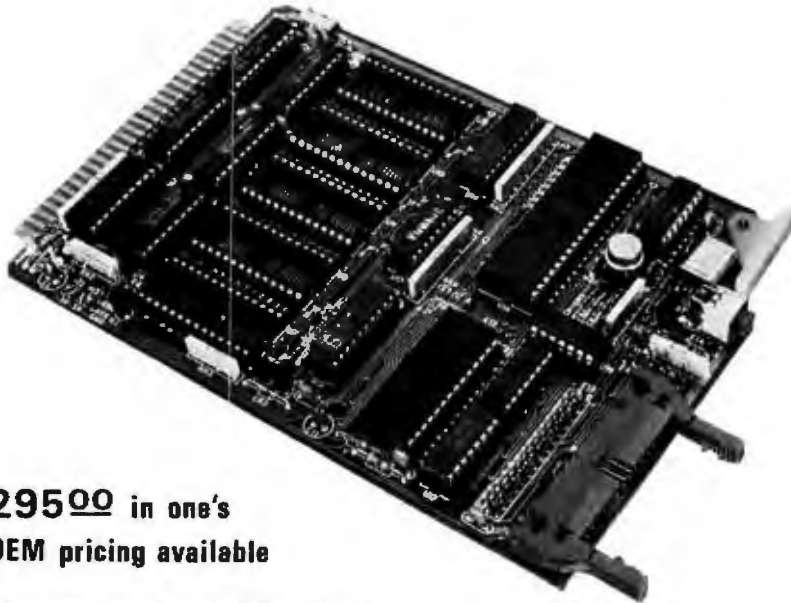

**295<sup>00</sup>** in one's  
**OEM pricing available**

**These Specifications Tell You More!**

Every way you look at it, this powerful STD Bus Processor uses Industry-wide Standards.

**STD Bus** interface (both STD-Z80 and STD-6800 compatible) offers unprecedented user support with Analog, Power Input/Output, Disk and advanced communications protocols.

**SERIAL PORT** supports RS232C or RS422 with full modem controls including software baud rate, from 50 to 19.2Kbaud. User selectable standard since RCVR/DRVR's are factory installed.

**BYTE-WIDE MEMORY** concept permits the use of 20 currently available memory devices from 2k x 8, 4k x 8, and 8k x 8 RAM, ROM and EPROM.

## **QUALITY AND RELIABILITY**

Backed by Datricon's standard one year parts and labor warranty, 200 hour burn-in and extensive factory testing, our customers are assured of receiving high quality product.

## **D-FORTH SOFTWARE**

Datricon's popular D-FORTH software available on the Series 12 and 14 is also available on the Series 09. Optimized for control systems, D-FORTH is high-level and interactive, it is especially useful in interactive control applications such as testing and process monitor/control. Efficient memory utilization and rapid execution provide exceptional Return On Investment.

Contact Datricon's nationwide staff of highly qualified sales representatives or the factory for information.



**QUALITY WITHOUT COMPROMISE**

**503 - 284-8277    7911 NE 33RD Drive    Portland, Or 97211**

as a whole. In normal use of the Smalltalk-80 system, most calls on BitBlt are either in the extreme microscopic or macroscopic range. Let us examine these more closely.

In the macroscopic range, the width of transfer spans many words. The inner loop across a horizontal scan line gets executed many times, and the operations requested tend to be simple moves or constant stores. Examples of these are:

- Clearing a line of text to white
- Clearing an entire window to white
- Scrolling a block of text up or down

It is fortuitous that most processors provide a fast means for block moves and stores, and these can be made to serve the applications above. Suppose we structure the horizontal loop of BitBlt as the following sequence:

1. Move left partial word
2. Move many whole words (or none)
3. Move right partial word (or none)

Special cases can be provided for item 2 if the operation is a simple store or if it is a simple copy with no skew (horizontal bit offset) from source to destination. In this way, most macroscopic applications of BitBlt can be made fast, even on processors of modest power.

The microscopic range of BitBlt is characterized by a zero count for the inner loop in item 2, so that the work on each scanline involves, at most, two words. Both overall setup and vertical loop overhead can be considerably reduced for this case. Because characters tend to be less than a word wide and lines tend to be less than a word thick, nearly all text and line drawing fall into this category. A convenient way to provide such efficiency is to write a special case of BitBlt that assumes the microscopic parameters, but goes to the general BitBlt whenever these are not met. Because of the statistics (many small operations and a few very large ones), it does not hurt to pay the penalty of a false assumption on infrequent calls. ■



# FMS-80

## Organizes Your Organization

**F**MS-80, a data base management system, offers the user a quick and easy way to organize and efficiently manipulate data so sound decisions can be made on facts displayed.

FMS-80\*\*\*

is the most powerful stand alone DBM program available to the micro-computer industry.

Completely menu driven and written in assembly language, it offers these features:

- User definable File Definitions
- Screen Displays
- Reports (with math and field break analysis)
- Selection Criteria (on any or all fields)
- Menus (that applications programs can be selected from)
- Instantaneous data query on indexed records.
- Mathematical manipulation of numeric data fields using the report generator or the programming language EFM (Extended File Maintenance)
- Easy to use video "how to" training tapes are available.
- Manipulation of up to 19 different data files (using EFM) at one time and displaying this information on the screen, gener-

rating reports, generating other data files or on-line updating of input files that already exist

- FMS-80 is able to call other programs like sub-routines in EFM
- FMS-80 is able to read data files that other programs have generated
- No restrictions to record size other than available RAM memory space
- Operates under CP/M\*, MP/M\* or CDOS\*\*

FMS-80 allows the flexibility to quickly create programs that allow data to be entered in a form that a secretary recognizes and generates reports that the manager requires.

If you're continuously asked to do applications programs and don't have time to do it in BASIC, consider FMS-80. For additional information contact

Systems Plus,  
3975 East Bayshore,  
Palo Alto, CA  
94303. Phone  
415/969/7047

**Systems Plus**



\*\*\*TM of DIR Associates

\*\*TM of Cromenco, Sunnyvale, CA

\*TM of Digital Research, Pacific Grove, CA

# ALL THE PROGRAMS YOU'LL EVER NEED. FOR \$600.

Say goodbye to the costs and frustrations associated with writing software: The Last One® will be available very soon.

More comprehensive and advanced than anything else in existence, The Last One® is a computer program that writes computer programs. Programs that work first time, every time.

By asking you questions in *genuinely* plain English about what you want your program to do, The Last One® uses those answers to generate a totally bug-free program in BASIC, ready to put to immediate use.

What's more, with The Last One®, you can change or modify your programs as often as you wish. Without effort, fuss or any additional cost. So as your requirements change, your programs can too.

In fact, it's the end of programming as you know it.

And if, because of the difficulties and costs of buying, writing and customising software, you've put off purchasing a computer system up to now, you need delay no longer.

The Last One® will be available very soon from better computer outlets. To place your order, take this ad into your local dealer and ask him for further details. Or in case of difficulty, please write to us direct.

## **THE LAST ONE®**

YOU'LL NEVER NEED BUY ANOTHER PROGRAM.  
D.J. 'AI' Systems Ltd., Ilminster, Somerset, TA19 9BQ, England  
Telephone: 04605-4117. Telex: 46338 ANYTYR G.

## BYTE's Bits



### Apple Displaces Organ at Wedding

The organ at St Bartholomew Church, Cincinnati, Ohio, stood idle at the wedding of Curt Brookbank and Libby Nieman, but the traditional wedding music of Wagner and Mendelssohn sounded as if an organist were hard at work. The

organist was an Apple II. Ms Nieman, a buyer in the calculator department of the 21st Century Computer store in Cincinnati, decided on computerized wedding music after playing some computerized Christmas carols. The Apple II computer was equipped with ALF and Mountain music boards.

### Old Altairs Never Die . . .

Five years ago, a computer built by students at Venice (California) High School began operation. Today that computer, and a duplicate built one semester later, are still operating. The computers, Altair 8800s, were built from kits for about \$2000 each, which at the time was about a fourth of what an equivalent commercial computer would have cost. The school's principal at the time, Arnold Miller, agreed to buy the computer kits not only for the saving in cost but also for the educational value to the students who would build them and those who would use them.

The computers, running eight hours almost every day, have served hundreds of students in computer programming classes and in math classes. But the most

enthusiastic users are those students who crowd the computer room before and after school and at other times to play computer games.

The student-built computers have been very reliable. They have never had a serious malfunction, requiring only the replacement of two integrated-circuit memory chips. The biggest maintenance problems have been mechanical, primarily the keyboards, which have taken a tremendous amount of pounding over their approximately 8000 hours of operation. It is estimated that total maintenance costs over five years for both Altairs have been less than \$50.

It is estimated that each Altair represents an expenditure of \$3000 including initial cost and additions and improvements over the five-year period. This yields a student-hour cost of less than one-half dollar. ■

# FORTRAN IV

for CP/M

"I needed a FORTRAN with COMPLEX as well as REAL and DOUBLE precision arithmetic, that would produce relocatable code and link in assembly language subroutines. It also had to be a FORTRAN that was easy to use as well as being a complete implementation. SuperSoft/SSS FORTRAN is the only microcomputer FORTRAN that met my requirements."

Supersoft makes full WATFIV FORTRAN IV available to microcomputers. Supersoft/SSS FORTRAN meets and exceeds the ANSI 1966 standard. The compiler supports many advanced features including: variable character strings and recursive subroutines with static variables. Fully compatible RATFOR is also available.

### FEATURES

**Code generation:** ROMable "COM" files or Intermediate code files (saves disk space). External routines may be called. Relocatable format.

**Data types:** Byte, integer, real, double precision, complex, logical, character and varying length strings.

**Operations:** All standard operations plus string comparisons, assignments, and .XOR.

**Constants:** Hexadecimal, decimal, and character literals with features to imbed control characters.

**Statements:** ANSI 1966 standard with multiple statement lines.

**Controls:** Map, List, and Symbol table output options.

**I/O:** Read, Write, Append, Rewind, Close, Delete, Rename, Search, Sequential and Random I/O on disk files. Supports all CP/M devices.

### System Requirements & Prices

SSS FORTRAN requires a 32k CP/M system. Z80 only.

SSS FORTRAN with RATFOR: \$325

SSS FORTRAN alone: \$250

Manual only: \$25

RATFOR alone: \$100

Macro Assembler: \$80

CP/M Formats: 8" soft sectored, 5" Northstar, 5" Micropolis Mod II, Vector MZ, Superbrain DD/QD, Apple II+

All Orders and General Information:  
SUPERSOFT ASSOCIATES  
P.O. BOX 1628  
CHAMPAIGN, IL 61820  
(217) 359-2112

Technical Hot Line: (217) 359-2691  
(answered only when technician is available)

"At last, a FORTRAN that will run my large mainframe programs."



*SuperSoft*

First in Software Technology



# McGraw-Hill helps you do business in the People's Republic of China.

You know how advertising in McGraw-Hill magazines helps your company contact prospects, arouse interest in products, overcome sales resistance, and create preference when you're selling to businesses here in America.

But you may not know that McGraw-Hill's *American Industrial Report* can do the very same things to help you sell to your toughest prospects in the People's Republic of China. And you also may not know that *American Industrial Report*, as the first U.S. technical magazine accepted into modern China, has more than five years of experience and marketing expertise.

During the early 1980's, the People's Republic of China will spend an estimated \$30 billion-plus for foreign technology and capital goods. By 1985, they'll be buying a projected total of \$12-15 billion worth from companies in the United States.

Obviously, the People's Republic of China is an important new market for American manufacturers.

But it's one thing to identify an important new market. And quite another to successfully capture a share of it.

Selling industrial products in the P.R.C. involves the same problems as selling them in the U.S.

Plus the problems of a different language and culture. And a different political, economic and foreign trade system.

**There are almost 1 billion Chinese. McGraw-Hill's *American Industrial Report* reaches the .1% you need to do business with.**

Every month, *American Industrial Report* reaches 35,000 end-users, engineers, managers, Foreign Trade Corporation and

ministry officials. With an estimated pass-along of 50 readers per copy, that gives you exposure to 1 million Chinese — the .1% of the population who, as key decision-makers, are your key prospects.

*American Industrial Report* also helps you reach them in their own language. With free translation of your advertising copy into modern Chinese characters — the kind used in technical journals in the P.R.C., not Hong Kong or Singapore. We also give you free, expert advice on how to avoid the kind of political and cultural errors that could alienate or confuse the very people you're trying to sell to.

**A free guide to selling in the P.R.C. and to the magazine that helps you do it.**

*American Industrial Report* would like to share what it's learned over more than five years of serving end-users in the People's Republic of China — and serving American advertisers who want to sell to them.

We've put it all into a free 84-page guidebook, which you can get by writing *American Industrial Report*, 1221 Avenue of the Americas, New York, New York 10020. Or calling Robert Christie at 212-997-6730.

Write or call for your copy today.

Now that the People's Republic of China has opened the door, see how *American Industrial Report* can help you get a foot in it.

“我不知道你是谁  
I don't know who you are  
我不知道你的公司  
I don't know your company  
我不知道你的公司的产品  
I don't know your company's product  
我不知道你的公司代表什么  
I don't know what your company stands for  
我不知道你的公司有那些顾客  
I don't know your company's customers  
我不知道你的公司办得怎样  
I don't know your company's record  
我不知道你的公司的声誉如何——  
I don't know your company's reputation  
那么，你到底要什么给中国？”  
Now — what was it you wanted to sell us?”



McGraw-Hill Magazines

## The Printer People **ARISTO POLKS**

314 5th Ave. (32 ST) N.Y.C., N.Y. 10001  
Tel: (212) 279-9034 & ask for enquiries

### EPSON

MX70  
\$ 379



MX80T  
\$ 479

## QANTEX

The 150 cps Quality Printer



MODEL 6000 \$ 1299

## OKI Call for \$

### EPSON

FRICION / TRACTOR  
MODEL call for \$

FRICION CONVERSION  
KIT for your EPSON Tractor  
Printer only \$ 69

## VIC 20

\*8 colors - built in \*Sound generation  
- built in \*Programmable function keys  
\*5k memory expandable to 32k \*Standard PETBASIC in ROM \*Full size keyboard \*Graphics character set

\$ 299 4k inc. color

## Atari

MODEL 400 \$ 349  
MODEL 800 \$ 779

**TYMAC APPLE  
TO CENTRONICS  
INTERFACE CARD  
including CABLE \$ 119.99**

At Hayes, we don't believe in second best. Or planned obsolescence. We believe in taking the state of the art to the limit. Our new Smartmodem, for example, is the most sophisticated 300-baud originate/answer modem you can buy. And yet, it is perhaps the easiest-to-use modem ever.

**RS-232C Compatible.** Smartmodem lets any RS-232C compatible computer or terminal communicate by phone with other computers and time-sharing systems located *anywhere in North America*. You get full and half-duplex operation with both Touch-Tone® and pulse dialing.

**Auto-Answer/Dial/Repeat.** Smartmodem can answer the phone, dial a number, receive and transmit data, and then hang up the phone—automatically! If desired, Smartmodem will even repeat the last command. You can depend on Smartmodem for completely unattended operation.

**Completely Programmable.** Smartmodem can be controlled using

# Hayes Stack™

## Microcomputer Component Systems

any programming language. Over 30 different commands can be written into your programs or entered directly from your keyboard.

Smartmodem also includes several switch-selectable features that let you tailor performance to your exact needs. You can "set it and forget it" for the ultimate in convenience.

**Built-in Audio Monitor.** Thanks to an internal speaker, you can actually listen to your connection being made. You'll know immediately if the line is busy or if you reached a wrong number—

and you don't even need a phone!

**Status at a Glance.** Seven LED's indicate Smartmodem's current operating mode: auto-answer, carrier detect, off hook, receive data, send data, terminal ready and modem ready. You're never left in the dark!

**Direct-Connect Design.** Smartmodem is FCC registered for direct connection to any modular phone jack—there's no acoustic coupler to cause signal loss and distortion.

**Smartmodem, Smart Buy.** Professional quality features. Versatile performance. A full two-year limited warranty. A suggested retail price of only \$279.

What more could you want? Perhaps the matching Hayes Stack Chronograph, an RS-232C compatible calendar/clock system.

Check out the Smartmodem wherever fine computer products are sold. And don't settle for anything less than Hayes.



Smartmodem.  
The ultimate concept in modems  
is now a reality.

Hayes Microcomputer Products Inc. 1935 Peachtree Corners East, Norcross, Georgia 30092 (404) 449-8741

Hayes Stack is a trademark of Hayes Microcomputer Products, Inc. Sold only in the U.S.A. TM American Telephone and Telegraph © 1981 Hayes Microcomputer Products, Inc.

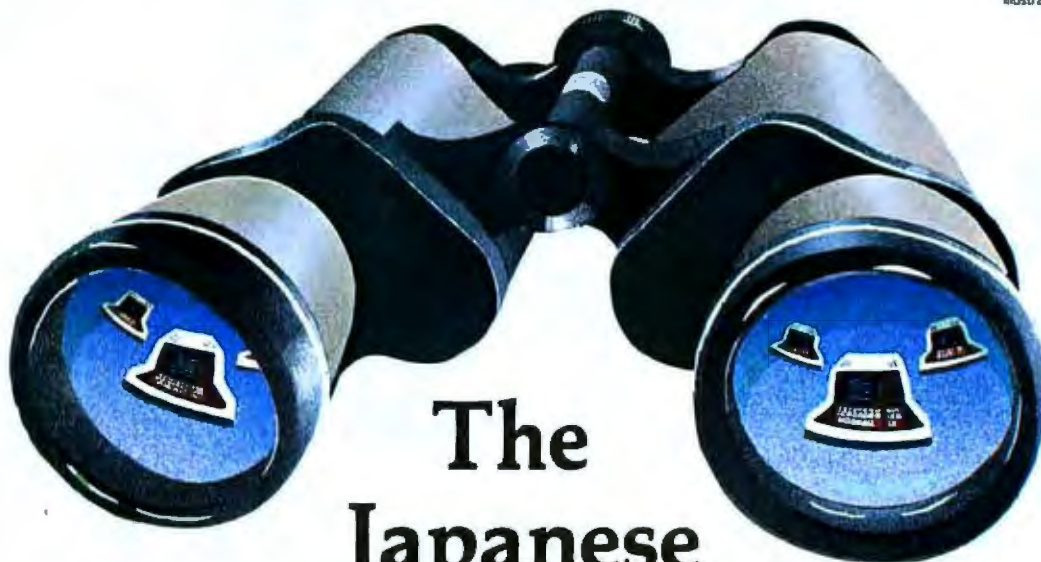

# The Japanese Computer Invasion

Stan Miastkowski, Technical Editor

Whenever computer-industry people get together these days the conversation inevitably turns to the so-called "Japanese Computer Invasion." From conversations I've overheard, it sometimes seems that there is an invasion fleet of Japanese ships off the West Coast, waiting to establish a beachhead in Silicon Valley.

Cutting through the paranoia, rumors, and just plain false information about the Japanese computer industry is a time-consuming and frustrating undertaking. It is further complicated by the intense secrecy of the Japanese, who, unlike their American counterparts, *never* talk off the record.

This article focuses on the Japanese companies who are (or soon will be) marketing personal computers in the United States. Make no mistake: Japanese computers *are* coming—with long-term implications for the American marketplace.

## The Japanese Computer Industry

Contrary to popular belief, there is no such thing as "Japan Incorporated." Although many

Americans view Japanese industry as one huge conglomerate working to take over foreign markets, the truth is that the Japanese computer industry is a group of fiercely competitive companies. It is that competition that fuels a rich variety of high-quality Japanese consumer electronic products.

Another strong reason for the quality of Japanese products is that in Japan a worker generally stays with one company throughout his or her working life. Unlike American industry, where labor and management are often at odds, Japanese workers feel a strong loyalty toward their employers, who pay them back with virtually guaranteed lifetime employment and carefully listen to their suggestions and complaints. This cooperation between management and labor produces a climate where each worker feels personally responsible for product quality.

Finally, one of the strongest points working in favor of the Japanese computer industry is that almost without exception the companies are vertically integrated—they control all aspects of the product, from manufacturing the silicon integrated

circuits to marketing the products. This integration allows the Japanese to closely control costs and ensure product quality.

## Fujitsu—the Company to Watch

Fujitsu Limited is the largest computer company in Japan, taking that coveted position by racking up \$1.55 billion in computer sales during the year ending in April 1980. It edged past the Japanese subsidiary of IBM—which had sales of \$1.54 billion during the same period. Although the margin was small, it gave the Japanese an important psychological boost—it was the first time that a Japanese computer company was number one in Japan. In the year ending this past April, Fujitsu pulled ahead even further.

Unlike the other Japanese conglomerates that have entered the computer market, Fujitsu's main business is computers. Although involved in a number of related fields, Fujitsu's interests do not seem to lie in the broad-ranging diversification of most of the other Japanese giants.

It would be a mistake not to think that Fujitsu is serious about the

# 68K

**WHY SETTLE FOR A 68000 BASED microCOMPUTER  
WHEN YOU CAN HAVE OUR 68K™ MINICOMPUTER ?**

## FEATURES:

- 8 MHz 68000 CPU
- Virtual memory to 4 billion bytes
- 6809 peripheral processor
- Multi-user/multi-tasking memory management
- Each RAM board accomodates 2 megabytes
- High-speed DMA for universal hard disk interface
- 6 RS-232 and 4 8-bit I/O ports standard
- Dual 8" quad-density floppys
- Extensive error checking and recovery

★ **Attend the 68K SEMINAR:**  
our experts will field your 68K questions and discuss:

- ☞ 68000 architecture
- ☞ 68K MiniFrame™ architecture
- ☞ 68K hardware interface
- ☞ MiniFrame programming
- ☞ \$85 registration fee includes all-day seminar, lunch, and take-home documentation
- ☞ in Los Angeles

➤ Please call or write for 68K MiniFrame information and the complete 1981 seminar schedule.

from  **MicroDaSys**

Dept. 5B, P.O.Box 36051  
Los Angeles, CA. 90036  
(213)731-0876

**detach coupon and mail ASAP**

**YES.** Enroll me in your 68K all-day seminar.  
circle day you can attend : July 23 24 25  
Aug 27 28 29  
Sept 24 25 26

name: \_\_\_\_\_  
address: \_\_\_\_\_

tel.# home: \_\_\_\_\_  
work: \_\_\_\_\_

Enclose \$85 registration fee

**MicroDaSys  
seminar  
68K**

worldwide computer market. It owns 27.6% of Amdahl—the California-based manufacturer of IBM-compatible mainframe computers. It is also making strong inroads into the European market with its business ties to the West German electronics company Siemens. In contrast to other Japanese computer makers, who spend 5 to 6% of their sales on research and development, Fujitsu consistently sinks 10 to 12% of its sales into R & D. The company has come a long way since the early 1960s, when it approached IBM about a joint venture to design and build computers for the Japanese market. At that time IBM flatly turned them down.

### The TRW/Fujitsu Connection

It's obvious that the United States will be the next target for Fujitsu. Early on, the company realized that it would have to have strong ties to US companies in order to compete in our market. One of the main reasons for this is that Fujitsu is an intensely

Japanese company. Fujitsu's president rarely meets with foreigners and has broken off discussions in the past because of alleged breaches of Japan's strict business protocols.

The purchase of a partial interest in Amdahl was one of its first steps in the United States designed to create competition in the large-systems business. Fujitsu has also set up a marketing-service organization for its line of Winchester-technology hard-disk drives designed for small and medium systems. In fact, a low-cost 5¼-inch Winchester disk designed expressly for personal computers is expected to be available by the time you read this.

Last year, Fujitsu signed an agreement with another California-based company, TRW. Fujitsu agreed to supply computers, with TRW providing software development and support as well as a nationwide sales and service network.

The power of the TRW/Fujitsu connection cannot be overemphasized. TRW/Fujitsu Vice-President

Garret Fitzgibbons told me the company plans a complete line of computers and peripherals aimed squarely at the personal and small-business markets. Late last year, the company displayed a prototype of a computer that was recently introduced. The Facom 9450, tentatively priced at \$8000-plus, is an extremely powerful system with a custom-designed 16-bit microprocessor. Included in the price are an 80-column video display, two 5¼-inch floppy-disk drives, and a letter-quality printer.

The most revolutionary result of the TRW/Fujitsu connection is in its final development stage. Tentatively named the Bubcom 80, it is a machine that uses *bubble memory*, a technology that American companies have been reluctant to implement. (Bubble memory stores information in nonvolatile magnetic bubbles.)

The Bubcom 80 uses 32 K-byte memory cartridges; 128 K-byte cartridges are scheduled to be introduced in 1982. The computer is based around a Z80 microprocessor and comes with 64 K bytes of standard programmable memory. The Bubcom 80 runs CP/M and comes complete with an updated version of Microsoft BASIC.

Recently introduced in Japan, the Bubcom 80 sells for the equivalent of about \$1200 with one bubble memory cartridge. Extra cartridges are about \$130.

But that's not all from the people at Fujitsu/TRW. Their real personal computer blockbuster, soon to be introduced in the United States, is the Micro-8. This machine uses twin Motorola 6809 microprocessors to greatly increase speed, and the package includes full-color graphics. The Micro-8 has Microsoft's Extended Color BASIC (now available in the TRS-80 Color Computer) and will sell for about \$1000.

In addition, a plug-in Z80 card will convert the Micro-8 into a CP/M machine. Also available are UCSD Pascal and the 32 K-byte bubble memory cartridges that will be standard in the Bubcom 80.

Early in March, a high-end

Text continued on page 206

## ATTENTION GOVERNMENT D P USERS AND PURCHASERS

We represent many fine micro products and manufacturers on the U.S. Government's GSA Schedule, including

***Apple, Cromemco, Micropolis  
and Seequa Computers***

Purchasing from the Schedule will save you the time consumed by the bid process. Products shipped throughout the United States and world-wide. Visit or write any of our stores for more information or to receive our catalogue of products represented.

**Computers,  
Etc.....  
the dependable store**

257 West Street, Annapolis, MD 21401 - (301) 268-6505  
13A Allegheny Avenue, Towson, MD 21204 - (301) 296-0520  
9330 Georgia Avenue, Silver Spring, MD 20910 - (301) 588-3748  
6671 Backlick Road, Springfield, VA 22150 - (703) 644-5500  
Plaza 38, 2442 Route 38, Cherry Hill, NJ 08002 - (609) 779-0023

Callers outside metropolitan areas served by our stores

Please call (301) 268-5801

Career Opportunities Available \* An Equal Opportunity Employer



# T/Maker II:™ it not only does more than VisiCalc,™ it does it on your computer.

VisiCalc is a fine aid for the computation of numerical problems. But it does have two major limitations: it is available only for a small number of systems, and its use is limited strictly to numbers, not words. To overcome these substantial limitations, Lifeboat Associates introduces T/Maker II.

Unlike VisiCalc, T/Maker II is designed to run on most small business computers with CP/M® or similar operating systems and a video terminal with cursor addressing capabilities. And soon there will be T/Maker II versions available for UNIX,™ RT-II™ and other systems.

**Works with words as well as numbers.** Like VisiCalc, T/Maker II reduces the manual tasks involved in computing and calculating financial documents. But since most business problems and reports involve words as well as numbers, T/Maker II also functions as a full-screen text editor for word processing.

T/Maker II is the most advanced aid for the analysis and presentation of numerical data and text material. In a matter of minutes, an entire document—including all edited text, all figures and all calculations—can be created, reviewed on your screen and reported in printed form.

T/Maker II turns your small business computer into a powerful, sophisticated and convenient tool. A tool that will save you money, time and energy, and eliminate the need for costly time-sharing.

With T/Maker II you can easily perform an unlimited number of analytical and reporting tasks which integrate numerical and text processing. You'll find T/Maker II perfect for such things as:

- Financial Statements
- Statistics
- Profitability Reports
- Revenue and Expense Analyses
- Portfolio Evaluations
- Price Lists
- Rate Structures
- Expense Accounts
- Cash Flow Projections
- Checking Account Reconciliations

...and much, much more.

**Easy to learn and use.** You don't have to be a programmer to operate T/Maker II. Just follow T/Maker II's easily understood and ordered instructions, set up your data in

As an example of what T/Maker II can do, see the chart below. The operator entered only the data shown in boldface. T/Maker II calculated and reported all the other values.

|              | — Actual —    |               |                | Growth Rate  | Average        | Total (000's) | — Projected —  |                |                |
|--------------|---------------|---------------|----------------|--------------|----------------|---------------|----------------|----------------|----------------|
|              | 1978          | 1979          | 1980           |              |                |               | 1981           | 1982           | 1985           |
| Item A       | 42,323        | 51,891        | 65,123         | 24.04        | 53,112         | 159.34        | 80,782         | 100,206        | 191,262        |
| Item B       | 45,671        | 46,128        | 49,088         | 3.67         | 46,962         | 140.89        | 50,891         | 52,761         | 58,791         |
| <b>Total</b> | <b>87,994</b> | <b>98,019</b> | <b>114,211</b> | <b>13.93</b> | <b>100,075</b> | <b>300.22</b> | <b>131,673</b> | <b>152,966</b> | <b>250,053</b> |
| % Item       | 48.10         | 52.94         | 57.02          | 8.88         | 52.69          | 158.1         | 61.35          | 65.51          | 76.49          |
| % Item       | 51.90         | 47.06         | 42.98          | -9.00        | 47.31          | 141.9         | 38.65          | 34.49          | 23.51          |
| <b>Total</b> | <b>100.00</b> | <b>100.00</b> | <b>100.00</b>  | <b>—</b>     | <b>100.00</b>  | <b>300.0</b>  | <b>100.00</b>  | <b>100.00</b>  | <b>100.00</b>  |

rows and columns, define the relationships and T/Maker II will do the rest: it will perform the computations and formatting necessary to prepare your document. When you're finished you can analyze your report on your screen or store it on a diskette. Or, you can have the report printed with presentation quality.

And when any changes have to be made, simply enter the new figure or relationship and tell T/Maker II to adjust and recalculate all the new results.

**Editing capabilities.** As a full-screen editor for word processing, T/Maker II handles text up to 255 characters wide. It includes features like text formatting and justification, centered titles, a text buffer for block moves and repeated inserts, global search and replace commands for printing your letters, reports and documents. Wide documents are supported by horizontal scrolling.

**Low cost.** The cost of T/Maker II is only \$275 plus shipping and handling. Dollars well spent once you consider all the time, energy and money it can save. T/Maker II is brought to you exclusively and supported completely by Lifeboat Associates, world's largest computer software publisher. For more information send us the coupon below.

Mail coupon to: Lifeboat Associates, 2005  
1651 Third Ave., NY, NY 10028. Or call (212) 860-0300.

- Please send me more information on T/Maker II.
- Please send me a free Lifeboat Catalog featuring over 200 programs, including integrated accounting and professional practice systems, office tools for bookkeepers and secretaries and sophisticated tools for programmers.

Name \_\_\_\_\_  
Title \_\_\_\_\_  
Company \_\_\_\_\_  
Street \_\_\_\_\_  
City \_\_\_\_\_  
State \_\_\_\_\_ Zip \_\_\_\_\_

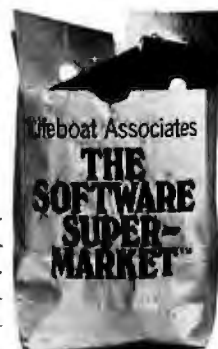

T/Maker II is a trademark of P. Holzen. Personal Software, Inc. UNIX is a trademark of Bell Laboratories. RT-II is a trademark of Digital Equipment Corp. CP/M is a trademark of Digital Research, Inc. VisiCalc is a trademark of Digital Equipment Corp.

LIFEBOAT WORLDWIDE offers you the world's largest library of software. Contact your nearest dealer or Lifeboat:

Lifeboat Associates  
1651 Third Ave  
New York, N.Y. 10028  
Tel: (212) 860-0300  
Telex: 640693 (LBSOFT NYW)  
TWX: 700-581-2524

Lifeboat Inc.  
OK Bldg., 5F  
1-2-8, Shiba-Daimon  
Minato-ku, Tokyo, 105 Japan  
Tel: 03-437-3901  
Telex: 2422723 (ASRTYOJ)

Lifeboat Associates, Ltd.  
PO Box 125  
London WC2H 9LU, England  
Tel: 01-836-9028  
Telex: 893709 (LBSOFTG)

Lifeboat Associates GmbH  
PO Box 168, Aegerstrasse 35  
CH 6340 Baar, Switzerland  
Tel: 042-31-2931  
Telex: 865265 (MICO CH)

Intersoft GmbH  
Schlossgartenweg 5  
D-8045 Ismaning, W. Germany  
Tel: 089-966-444  
Telex: 5213643 (ISOFD)

Lifeboat Associates, SARL  
10, Grande Rue Charles de Gaulle  
92600 Asnieres, France  
Tel: 1-733-08-04  
Telex: 250303 (PUBLIC X PARIS)

## Lifeboat Associates

Software with full support

# DYNACOMP

Quality software for\*:

ATARI                      TRS-80 (Level II)\*\*  
PET                        NORTH STAR  
APPLE II Plus            CP/M Disks/Diskettes

## CARD GAMES

**BRIDGE 2.0 (Available for all computers)**      Price: \$17.95 Cassette/\$21.95 Diskette  
An all-inclusive version of this most popular of card games. This program both BRIDGES and PLAYS either contract or duplicate bridge. Depending on the contract, your computer opponents will either play the offense OR defense. If you bid too high, the computer will double your contract! BRIDGE 2.0 provides challenging entertainment for advanced players and is an excellent learning tool for the bridge novice. See the software review in 80 Software Critique.

**HEARTS 1.5 (Available for all computers)**      Price: \$15.95 Cassette/\$19.95 Diskette  
An exciting and entertaining computer version of this popular card game. Hearts is a trick-oriented game in which the purpose is not to take any hearts or the queen of spades. Play against two computer opponents who are armed with hard-to-beat playing strategies. HEARTS 1.5 is an ideal game for introducing the uninitiated (your spouse) to computers. See the software review in 80 Software Critique.

**STUD POKER (Atari only)**                      Price: \$11.95 Cassette/\$15.95 Diskette  
This is the classic gambler's card game. The computer deals the cards one at a time and you (and the computer) bet on what you see. The computer does not cheat and usually beats the odds. However, it sometimes bluffs! Also included is a five card draw poker betting practice program. This package will run on a 16K ATARI. Color, graphics, sound.

**POKER PARTY (Available for all computers)**      Price: \$17.95 Cassette/\$21.95 Diskette  
POKER PARTY is a draw poker simulation based on the book, POKER, by Oswald Jacoby. This is the most comprehensive version available for microcomputers. The party consists of yourself and six other (computer) players. Each of these players (you will get to know them) has a different personality in the form of a varying propensity to bluff or fold under pressure. Practice with POKER PARTY before going to that expensive game tonight! Apple Cassette and diskette versions require a 32 K (or larger) Apple II.

**CRIBBAGE 2.0 (TRS-80 only)**                      Price: \$14.95 Cassette/\$18.95 Diskette  
This is simply the best cribbage game available. It is an excellent program for the cribbage player in search of a worthy opponent as well as for the novice wishing to improve his game. The graphics are superb and assembly language routines provide rapid execution. See the software review in 80 Software Critique.

## THOUGHT PROVOKERS

**MANAGEMENT SIMULATOR (Atari, North Star and CP/M only)**      Price: \$19.95 Cassette/\$23.95 Diskette  
This program is both an excellent teaching tool as well as a stimulating intellectual game. Based upon similar games played at graduate business schools, each player or team controls a company which manufactures three products. Each player attempts to outperform his competitors by setting selling prices, production volumes, marketing and design expenditures etc. The most successful firm is the one with the highest stock price when the simulation ends.

**FLIGHT SIMULATOR (Available for all computers)**      Price: \$17.95 Cassette/\$21.95 Diskette  
A realistic and extensive mathematical simulation of take-off, flight and landing. The program utilizes aerodynamic equations and the characteristics of a real airfoil. You can practice instrument approaches and navigation using radials and compass headings. The more advanced flyer can also perform loops, half-rolls and similar aerobically maneuvers. Although this program does not employ graphics, it is exciting and very addictive. See the software review in COMPUTRONICS.

**VALDEZ (Available for all computers)**                      Price: \$15.95 Cassette/\$19.95 Diskette  
VALDEZ is a computer simulation of supertanker navigation in the Prince William Sound/Valdez Narrows region of Alaska. Included in this simulation is a realistic and extensive 256 x 256 element map, portions of which may be viewed using the ship's alphanumeric radar display. The motion of the ship itself is accurately modeled mathematically. The simulation also contains a model for the tidal patterns in the region, as well as other traffic (outgoing tankers and drifting icebergs). Chart your course from the Gulf of Alaska to Valdez Harbor! See the software review in 80 Software Critique.

**BACKGAMMON 2.0 (Atari, North Star and CP/M only)**      Price: \$14.95 Cassette/\$18.95 Diskette  
This program tests your backgammon skills and will also improve your game. A human can compete against a computer or against another human. The computer can even play itself. Either the human or the computer can double or generate dice rolls. Board positions can be created or saved for replay. BACKGAMMON 2.0 is played in accordance with the official rules of backgammon and is sure to provide many fascinating sessions of backgammon play.

**CHECKERS 3.0 (PET only)**                      Price: \$16.95 Cassette/\$20.95 Diskette  
This is one of the most challenging checkers programs available. It has 10 levels of play and allows the user to change skill levels at any time. Though providing a very tough game at level 4-8, CHECKERS 3.0 is practically unbeatable at levels 9 and 10.

**CHESSE MASTER (North Star and TRS-80 only)**      Price: \$19.95 Cassette/\$23.95 Diskette  
This complete and very powerful program provides five levels of play. It includes castling, en passant captures and the promotion of pawns. Additionally, the board may be preset before the start of play, permitting the examination of "book" plays. To maximize execution speed, the program is written in assembly language (by SOFTWARE SPECIALISTS of California). Full graphics are employed in the TRS-80 version, and two widths of alphanumeric display are provided to accommodate North Star users.

**NOMINOES JIGSAW (Atari, Apple and TRS-80 only)**      Price: \$16.95 Cassette/\$20.95 Diskette  
A jigsaw puzzle on your computer! Complete the puzzle by selecting your pieces from a table consisting of 60 different shapes. NOMINOES JIGSAW is a virtuous programming effort. The graphics are superlative and the puzzle will challenge you with its three levels of difficulty. Scoring is based upon the number of guesses taken and by the difficulty of the board set-up.

**MONARCH (Atari only)**                      Price: \$11.95 Cassette/\$15.95 Diskette  
MONARCH is a fascinating economic simulation requiring you to survive an 8-year term as your nation's leader. You determine the amount of acreage devoted to industrial and agricultural use, how much food to distribute to the populace and how much should be spent on pollution control. You will find that all decisions involve a compromise and that it is not easy to make everyone happy.

**CHOMP-OTHELLO (Atari only)**                      Price: \$11.95 Cassette/\$15.95 Diskette  
CHOMP-OTHELLO? It's really two challenging games in one. CHOMP is similar in concept to NIM; you must bite off part of a cookie, but avoid taking the poisoned portion. OTHELLO is the popular board game set to fully utilize the Atari's graphics capability. It is also very hard to beat! This package will run on a 16K system.

## DYNACOMP OFFERS THE FOLLOWING

- Widest variety
- Guaranteed quality
- Fastest delivery
- Friendly customer service
- Free catalog
- 24 hour order phone

## AND MORE...

**STARTRAK 3.2 (Available for all computers)**      Price: \$11.95 Cassette/\$15.95 Diskette  
This is the classic Startrak simulation, but with several new features. For example, the Klingons now shoot at the Enterprise without warning while also attacking starbases in other quadrants. The Klingons also attack with both light and heavy cruisers and move when shot at! The situation is hectic when the Enterprise is besieged by three heavy cruisers and a starbase S.O.S. is received! The Klingons get even! See the software reviews in A.N.A.L.O.G., 80 Software Critique and Game Merchandising.

**BLACK HOLE (Apple only)**                      Price: \$14.95 Cassette/\$18.95 Diskette  
This is an exciting graphical simulation of the problems involved in closely observing a black hole with a space probe. The object is to enter and maintain, for a prescribed time, an orbit close to a small black hole. This is to be achieved without coming so near the anomaly that the tidal stress destroys the probe. Control of the craft is realistically simulated using side jets for rotation and main thrusters for acceleration. This program employs Hi-Res graphics and is educational as well as challenging.

**SPACE TILT (Apple and Atari only)**                      Price: \$10.95 Cassette/\$14.95 Diskette  
Use the game paddles to tilt the plane of the TV screen to "roll" a ball into a hole in the screen. Sound simple? Not when the hole gets smaller and smaller! A built-in timer allows you to measure your skill against others in this habit-forming action game.

**MOVING MAZE (Apple only)**                      Price: \$10.95 Cassette/\$14.95 Diskette  
MOVING MAZE employs the game paddles to direct a puck from one side of a maze to the other. However, the maze is dynamically (and randomly) built and is continually being modified. The objective is to cross the maze without touching (or being hit by) a wall. Scoring is by an elapsed time indicator, and three levels of play are provided.

**ALPHA FIGHTER (Atari only)**                      Price: \$14.95 Cassette/\$18.95 Diskette  
Two excellent graphics and action programs in one! ALPHA FIGHTER requires you to destroy the alien starships passing through your sector of the galaxy. ALPHA BASE is in the path of an alien UFO invasion; let five UFO's get by and the game ends. Both games require the joystick and get progressively more difficult the higher you score! ALPHA FIGHTER will run on 16K systems.

**INTRUDER ALERT (Atari only)**                      Price: \$16.95 Cassette/\$20.95 Diskette  
This is a fast paced graphics game which places you in the middle of the "Dreadstar" having just stolen its plans. The dreadstar has been alerted and is directed to destroy you at all costs. You must find and enter your ship to escape with the plans. Five levels of difficulty are provided. INTRUDER ALERT requires a joystick and will run on 16K systems.

**GIANT SLALOM (Atari only)**                      Price: \$14.95 Cassette/\$18.95 Diskette  
This real-time action game is guaranteed addictive! Use the joystick to control your path through slalom courses consisting of both open and closed gates. Choose from different levels of difficulty, race against other players or simply take practice runs against the clock. GIANT SLALOM will run on 16K systems.

**TRIPLE BLOCKADE (Atari only)**                      Price: \$14.95 Cassette/\$18.95 Diskette  
TRIPLE BLOCKADE is a two-to-three player graphics and sound action game. It is based on the classic video arcade game which millions have enjoyed. Using the Atari joystick, the object is to direct your blockading line around the screen without running into your opponent(s). Although the concept is simple, the combined graphics and sound effect lead to "high strategy".

**GAMES PACK I (Available for all computers)**      Price: \$10.95 Cassette/\$14.95 Diskette  
GAMES PACK I contains the classic computer games of BLACKJACK, LUNAR LANDER, CRAPS, HORSESHOE, SWITCH and more. These games have been combined into one large program for ease in loading. They are individually accessed by a convenient menu. This collection is worth the price just for the DYNACOMP version of BLACKJACK.

**GAMES PACK II (Available for all computers)**      Price: \$10.95 Cassette/\$14.95 Diskette  
GAMES PACK II includes the games CRAZY EIGHTS, JOTTO, ACEY-DEUCEY, LIFE, WUMPUS and others. As with GAMES PACK I, all the games are loaded as one program and are called from a menu. You will particularly enjoy DYNACOMP's version of CRAZY EIGHTS.

Why pay \$7.95 or more per program when you can buy a DYNACOMP collection for just \$10.95!

**MOON PROBE (Atari only)**                      Price: \$11.95 Cassette/\$15.95 Diskette  
This is an extremely challenging "lunar lander" program. The user must drop from orbit to land at a predetermined target on the moon's surface. You control the thrust and orientation of your craft plus direct the rate of descent and approach angle.

## ADVENTURE

**CRANSTON MANOR ADVENTURE (North Star and CP/M only)**      Price: \$21.95 Diskette  
At last! A comprehensive Adventure game for North Star and CP/M systems. CRANSTON MANOR ADVENTURE takes you into mysterious CRANSTON MANOR where you attempt to gather fabulous treasures. Lurking in the manor are wild animals and robbers who will not give up the treasures without a fight. The number of rooms is greater and the associated descriptions are much more elaborate than the current popular series of Adventure programs, making this game the top in its class. Play can be stopped at any time and the status stored on diskette.

## ABOUT DYNACOMP

DYNACOMP is a leading distributor of small system software with sales spanning the world (currently in excess of 40 countries). During the past two years we have greatly enlarged the DYNACOMP product line, but have maintained and improved our high level of quality and customer support. The achievement in quality is apparent from our many repeat customers and the software reviews in such publications as COMPUTRONICS, 80 Software Critique and A.N.A.L.O.G. Our customer support is as close as your phone. It is always friendly. The staff is highly trained and always willing to discuss products or give advice.

## BUSINESS and UTILITIES

**SPELLGUARD™ (CP/M only)** Price: \$349.95 Disk  
**SPELLGUARD** is a revolutionary new product which increases the value of your current word processing system (WORDSTAR, MAGIC WAND, ELECTRIC PENCIL, TEXTED EDITOR II and others). Written entirely in assembly language, SPELLGUARD™ rapidly assists the user in eliminating spelling and typographical errors by comparing each word of the text against a dictionary of over 20,000 of the most common English words. Words appearing in the text but not found in the dictionary are "flagged" for easy identification and correction. Most administrative staff familiar with word processing equipment will be able to use SPELLGUARD™ in only a few minutes.

**MAIL LIST 2.2 (Apple, Atari and North Star diskette only)** Price: \$34.95  
 This program is unmatched in its ability to store a maximum number of addresses on one diskette (maximum of 1100 per diskette, more than 2500 for "double density" systems). It many features include alphabetic and zip code sorting, label printing, merging of files and a unique keyword looking routine which retrieves entries by a virtually unlimited selection of user defined codes. Mail List 2.2 will even find and delete duplicate entries. A very valuable program!

**FORM LETTER SYSTEM (FLS) (Apple and North Star diskette only)** Price: \$31.95  
 The FLS is unique and sets from letters and address lists. Forms letters are produced by automatically inserting such address info into a predetermined portion of your letter. FLS is completely compatible with MAIL LIST 2.2, which may be used to manage your address files.  
 FLS and MAIL LIST 2.2 are available as a combined package for \$66.95

**SHORTIT (North Star only)** Price: \$29.95 Diskette  
 SHORTIT is a general purpose text program written in IBM assembly language. This program will sort sequential data files generated by NORTH STAR BASIC. Primary and optional secondary keys may be numeric or use to store character strings. SHORTIT is easily used with files generated by DYNACOMP'S MAIL LIST program and is very versatile in its capabilities for all other BASIC data file sorting.

**PERSONAL FINANCE SYSTEM (Atari and North Star only)** Price: \$34.95 Diskette  
 PFS is a single diskette, menu-oriented system composed of five different programs. Besides recording your expenses and tax deductible items, PFS will sort and summarize expenses by month, and display information on expenditures by any of 25 user defined codes by month or by payee. PFS will even produce monthly bar graphs of your expenses by category! This powerful program requires only one disk drive, minimal memory (24K Atari, 32K North Star) and will store up to 600 records per disk and over 1000 records per disk by making a few simple changes to the program. You can record checks plus cash expenses so that you can finally see where your money goes and eliminate guesswork and tedious hand calculations.

**FAMILY BUDGET (Apple only)** Price: \$34.95 Diskette  
 The FAMILY BUDGET is a very convenient financial record-keeping program. You will be able to keep track of cash and credit expenditures as well as income on a daily basis. You can record tax deductible items and charitable donations. The FAMILY BUDGET also provides a continuous record of all credit transactions. You can make daily cash and charge entries on any of 21 different expense accounts as well as to payroll and tax accounts. Data is easily retrieved giving the user complete control over an otherwise complicated (and unorganized) subject.

**THE COMMUNICATOR (Atari only)** Price: \$49.95 Diskette  
 This software package contains a menu-driven collection of programs for facilitating efficient two-way communication through a full duplex modem (required for use). In one mode of operation you may connect to a data service (e.g., the SOURCE or MICROWORLD) and quickly load data such as stock quotations onto your diskette for later viewing. This greatly reduces "connect time" and thus the service charge. You may also record the complete contents of a communications session. Additionally, programs written in BASIC, FORTRAN, etc., may be built off-line using the support text editors and then "up-loaded" to another computer, making the Atari a very smart terminal. Even Atari BASIC programs may be uploaded. Further, a command file may be built off-line and used later as controlling input for a time-share system. That is, you can tie up your own version of time-share commands and programs, and the Atari will transmit them as needed; batch processing. All this adds up to saving both connect time and your time.

DYNACOMP also supplies THE COMMUNICATOR with an Atari 800 modem for a combined price of \$129.95. The modem is available separately for \$129.95.

**TEXT EDITOR II (CP/M)** Price: \$29.95 Diskette/\$33.45 Disk  
 This is the second release version of DYNACOMP'S popular TEXT EDITOR I and contains many new features. With TEXT EDITOR II you may build text files in disks and assemble them for laser display. Blocks of text may be appended, inserted or deleted. This may be saved on disk/diskette in plain text/normal format or in letter printed by other TEXT EDITOR II or the CP/M ED facility. Further, ASCII CP/M files (including BASIC and assembly language programs) may be read by the editor and processed. In fact, text files can be built using END and later formatted using TEXT EDITOR II. All in all, TEXT EDITOR II is an inexpensive, easy to use, but very flexible editing system.

**DFILE (North Star only)** Price: \$19.95  
 This handy program allows North Star users to maintain a specialized data base of all files and programs in the stack of disks which invariably accumulates. DFILE is easy to set up and use. It will organize your disks to provide efficient backup of the desired file or program.

**FINDIT (North Star only)** Price: \$19.95  
 This is a three-in-one program which automates information accessible by keywords of three types: Personal (e.g. last name), Commercial (e.g. publishers) and Reference (e.g. magazine articles, record albums, etc.). In addition to keyword searches, there are headings, anniversary and appointment searches for the personal records and appointment searches for the commercial records. Reference records are accessed by a single keyword or by cross-referencing two or three keywords.

**GRAPHIX (TRS-M only)** Price: \$14.95 Cassette/\$18.95 Diskette  
 This unique program allows you to easily create graphics directly from the keyboard. You "draw" your figure using the program's extensive cursor controls. Once the figure is made, it is automatically appended to your BASIC program as a string variable. Draw a "happy face", call it HS and then print it from your program using PRINT HS! This is a very easy way to create and save graphics.

## EDUCATION

**HODGE PODGE (Apple only, 48K AppleII or Integer BASIC)** Price: \$19.95 Cassette/\$33.95 Diskette  
 Let HODGE PODGE be your child's baby sitter. Pressing any key on your Apple will result in a different and intriguing "happy message" related to the letter or number of this chosen key. The program's graphics, color and sound are a delight for children from ages 1 1/2 to 6. HODGE PODGE is a non-mathematical teaching device which adds a new dimension to the use of computers in education.

**TEACHER'S PET I (Available for all computers)** Price: \$11.95 Cassette/\$15.95 Diskette  
 This is the first of DYNACOMP'S educational packages. Primarily intended for pre-school to grade 3, TEACHER'S PET provides the young student with counting practice, letter-word recognition and three levels of math skill exercises.

**MORSE CODE TRAINER (TRS-80 only)** Price: \$12.95 Cassette/\$16.95 Diskette  
 MORSE CODE TRAINER is designed to develop and improve your speed and accuracy in deciphering Morse Code. As each letter is typed, the software package for FCC test practice. The code number is obtained through the automatic jack of any standard cassette recorder. You may choose the pitch of the tones as well as the word rate. Also, various modes of operators are available including number, punctuation and alphabet tests, as well as the keying of your own message. A very effective way to learn code!

## MISCELLANEOUS

**CRYSTALS (Atari only)** Price: \$ 9.95 Cassette/\$13.95 Diskette  
 A unique algorithm randomly produces fascinating graphics displays accompanied with tones which vary as the patterns are built. No two patterns are the same, and the combined effect of the sound and graphics are mesmerizing. CRYSTALS has been used in local stores to demonstrate the sound and color features of the Atari.

**NORTH STAR SOFTWARE EXCHANGE (NSSE) LIBRARY**  
 DYNACOMP now distributes the 23 volume NSSE Library. These diskettes each contain many programs and offer an outstanding value for the purchase price. They should be part of every North Star user's collection. Call or write DYNACOMP for details regarding the contents of the NSSE collection.  
 Price: \$K95 (each/\$7.95 each (4 or more))  
 The complete collection may be purchased for \$149.95

## AVAILABILITY

DYNACOMP software is supplied with complete documentation containing clear explanations and examples. Unless otherwise specified, all programs will run within 16K program memory space (ATARI requires 32K). Exceptions where noted, programs are also available on ATARI, PET, TRS-80 (Level I) and Apple (AppleII) cassette and diskette as well as North Star single density double density compact diskette. Additionally, most programs can be obtained on standard IBM format 8" CP/M single density disks for systems running under MBASIC.

## STATISTICS and ENGINEERING

**DIGITAL FILTER (Available for all computers)** Price: \$18.95 Cassette/\$31.95 Diskette  
 DIGITAL FILTER is a comprehensive data processing program which permits the user to design his own filter function or choose from a menu of filter forms. The filter forms are subsequently converted into non-recursive convolution coefficients which permit rapid data processing. In the explicit design mode the shape of the frequency transfer function is specified by directly entering points along the desired filter curve. In the menu mode, ideal low pass, high pass and bandpass filters may be approximated to varying degrees according to the number of points used in the calculation. These filters may optionally also be smoothed with a Hamming function. In addition, multi-stage Butterworth filters may be selected. Features of DIGITAL FILTER include plotting of the data before and after filtering, as well as display of the chosen filter functions. Also included are convenient data storage, retrieval and editing procedures.

**DATA SMOOTHER (Not available for Atari)** Price: \$14.95 Cassette/\$18.95 Diskette  
 This special data smoothing program may be used to rapidly derive useful information from noisy business and engineering data which are equally spaced. The software features choice in degree and range of fit, as well as smoothed first and second derivative calculation. Also included is automatic plotting of the input data and smoothed results.

**FOURIER ANALYZER (Available for all computers)** Price: \$16.95 Cassette/\$26.95 Diskette  
 Use this program to examine the frequency spectra of limited duration signals. The program features automatic scaling and plotting of the input data and results. Practical applications include the analysis of complicated patterns in such fields as electronics, communications and business.

**TFA (Transfer Function Analyzer)** Price: \$19.95 Cassette/\$31.95 Diskette  
 This is a special software package which may be used to evaluate the transfer functions of systems such as hi-fi amplifiers and filters by examining their response to pulsed inputs. TFA is a major modification of FOURIER ANALYZER and contains an engineering-oriented scaled versus log-frequency plot as well as data editing features. Whereas FOURIER ANALYZER is designed for educational and scientific use, TFA is an engineering tool. Available for all computers.

**HARMONIC ANALYZER (Available for all computers)** Price: \$24.95 Cassette/\$38.95 Diskette  
 HARMONIC ANALYZER was designed for the spectrum analysis of repetitive waveforms. Features include data file generation, editing and storage/retrieval as well as scan and spectrum plotting. One particularly unique feature is that the input data need not be equally spaced or in order. The original data is buffered and a cubic spline interpolation is used to create the data file required by the FFT algorithm.  
 FOURIER ANALYZER, TFA and HARMONIC ANALYZER may be purchased together for a combined price of \$49.95 (three cassettes) and \$79.95 (three diskettes).

**REGRESSION I (Available for all computers)** Price: \$19.95 Cassette/\$33.95 Diskette  
 REGRESSION I is a unique and exceptionally versatile one-dimensional least squares "polynomial" curve fitting program. Features include very high accuracy, an automatic degree determination option, an extensive internal library of fitting functions, data editing, automatic data and curve plotting, a statistical analysis set: standard deviation, correlation coefficient, etc.) and much more. In addition, new fits may be tried without reentering the data. REGRESSION I is certainly the cornerstone program to any data analysis software library.

**REGRESSION II (PARAFIT) (Available for all computers)** Price: \$19.95 Cassette/\$33.95 Diskette  
 PARAFIT is designed to handle those cases in which the parameters are imbedded (usually nonlinearly) in the fitting function. The user simply inserts the functional form, including the parameters (A1), (A2), etc.) in one or more BASIC statement lines. Data and results may be manipulated and plotted as with REGRESSION I. Use REGRESSION I for polynomial fitting, and PARAFIT for those complicated functions.

**MULTILINEAR REGRESSION (MLR) (Available for all computers)** Price: \$24.95 Cassette/\$38.95 Diskette  
 MLR is a professional software package for analyzing data sets containing two or more linearly independent variables. Besides performing the basic regression calculation, this program also provides easy to use data entry, storage, retrieval and editing functions. In addition, the user may incorporate the solution by supplying values for the independent variables. The number of variables and data size is limited only by the available memory.  
 REGRESSION I, II and MULTILINEAR REGRESSION may be purchased together for \$31.95 (three cassettes) or \$69.95 (three diskettes).

**ANOVA (Available for all computers)** Price: \$39.95 Cassette/\$49.95 Diskette  
 In the past the ANOVA (analysis of variance) procedure has been limited to the large mainframe computers. Now DYNACOMP has brought the power of this method to small systems. For those conversant with ANOVA, the DYNACOMP software package includes the 1-way, 2-way and N-way procedures. Also provided are the Yates 2<sup>k-p</sup> factorial design for those unfamiliar with ANOVA, do not worry. The accompanying documentation was written by a natural-born fatherly professor in the subject and serves as an excellent introduction to the method. Accompanying ANOVA is a support program for building the data base. Included are several convenient features including data editing, plotting and reporting.

**BASIC SCIENTIFIC SUBROUTINES, Volume II (Not available for Atari)**  
 DYNACOMP is the exclusive distributor for the software listed in the popular TRS-BASIC Scientific Subroutines, Volume I by F. R. DeMott (see the BYTE/Microworld advertisement in BYTE magazine, January 1981). These subroutines have been assembled according to chapter. Included with each collection is a menu program which selects and demonstrates each subroutine.  
 Collection 01: Chapters 2 and 3: Data and function plotting, complex variables  
 Collection 02: Chapter 4: Matrix and vector operations  
 Collection 03: Chapters 5 and 6: Random number generators, series approximations  
 Price per collection: \$14.95 Cassette/\$18.95 Diskette  
 All three collections are available for \$29.95 (three cassettes) and \$46.95 (three diskettes).  
 Because the text is a vital part of the documentation, BASIC Scientific Subroutines, Volume I is available from DYNACOMP for \$19.95 plus 75¢ postage and handling.

**ROOTS (Available for all computers)** Price: \$19.95 Cassette/\$34.95 Diskette  
 In a nutshell, ROOTS simultaneously determines all the zeros of a polynomial (having real coefficients). There is no limit on the degree of the polynomial, and because the procedure is iterative, the accuracy is generally very good. No initial guesses are required as input, and the calculated roots are substituted back into the polynomial and the residuals displayed.

**ACTIVE CIRCUIT ANALYSIS (ACAP) (48K Apple only)** Price: \$88.95/128.95 Diskette  
 ACAP is the analog circuit designer's answer to LOGIC SIMULATOR. With ACAP you may analyze the response of an active or passive component circuit (e.g., a transistor amplifier, band pass filter, etc.). The circuit may be probed at equal steps in frequency, and the resulting complex (i.e., real and imaginary) voltages at each component junction examined. By plotting the magnitude of these voltages, the frequency response of a filter or amplifier may be completely determined with respect to both amplitude and phase. In addition, ACAP prints a statistical analysis of the range of voltage responses which result from tolerance variations in the components.  
 ACAP is easy to learn and use. Simply describe the circuit in terms of the elements and their placements, and specify circuit descriptions may be saved onto cassette or diskette to be recalled at a later time for extension or editing. ACAP should be part of every circuit designer's program library.

**LOGIC SIMULATOR (Apple only, 48K RAM)** Price: \$24.95 Cassette/\$38.95 Diskette  
 With LOGIC SIMULATOR you may easily test your complicated digital logic design with respect to given sets of inputs to determine how well the circuit will operate. The elements which may be simulated include multiple input AND, OR, NOR, EXOR, ENHOR and NAND gates, as well as inverters, J-K and D flip-flops, and one-shots. The response of the system is available every clock cycle. Inputs may be checked in with varying clock cycle lengths/delays and delays may be introduced to probe for glitches and race conditions. At the user's option, a timing diagram for any given set of nodes may be plotted using HIRES graphics. Save your breadboarding until the circuit is checked by LOGIC SIMULATOR.

**LOGIC DESIGNER (North Star and CP/M only)** Price: \$24.95 Cassette/\$34.95 Diskette  
 LOGIC DESIGNER is an exceptional Computer Aided Design (CAD) program. With it you may convert a large and complicated digital truth table (the functional specification) into an optimized Boolean logic equation. This equation is then converted into a circuit design using either NAND or AND/OR gates. Operationally, LOGIC DESIGNER is composed of a BASIC program which runs in a machine language routine to reduce execution time. Example: For a 7 variable by 127 line table, the processing time is only two minutes. LOGIC DESIGNER is clearly a fast and powerful tool for building digital circuitry.

## ORDERING INFORMATION

All orders are processed and shipped within 48 hours. Please enclose payment with order and include the appropriate computer information. If paying by VISA or Master Card, include all numbers on card.

Shipping and Handling Charge: \$3.00 (per shipment)  
 Within North America: Add \$1.50  
 Outside North America: Add 10% (Air Mail)

Quantity Discounts  
 Deduct 10% when ordering 3 or more programs. Dealer discount schedules are available upon request.

8" CP/M Diskette  
 Add \$3.00 to the listed cassette price for each 3 1/2" floppy disk (IBM with formatted CP/M format) Programs run under Microsoft MBASIC or BASIC 80.

5 1/4" CP/M Diskette  
 All software available on 8" CP/M disks is also available on 5 1/4" disks, North Star format.

Ask for DYNACOMP programs at your local software dealer. Write for detailed descriptions of these and other programs from DYNACOMP.

**DYNACOMP, Inc.**  
 1427 Monroe Avenue  
 Rochester, New York 14618  
 24 hour order phone: (716) 586-7579 recording  
 Office phone (9AM-5PM EST): (716) 442-8960



Text continued from page 202:

business microcomputer was announced by TRW/Fujitsu. The TFC-8500 system starts at \$25,000 and goes upward to \$200,000. In addition, the company will market a line of point-of-sale computer cash registers/terminals. This market is very competitive at the present time.

It's obvious that there is a large amount of activity going on behind the scenes at both TRW and Fujitsu—two companies to watch carefully.

### Sharp Electronics

Although not in the multibillion-dollar league of many of the companies we're discussing here, Sharp is one of the most well known in the United States. Its wide-ranging line of calculators and other consumer electronics products is sold by approximately 1400 dealers in the States. Consequently, the company has a great deal of marketing experience here as well as an extremely strong sales and service network.

Over the past few years, Sharp's calculator products have become more and more sophisticated; therefore, it's not surprising that its first personal computer resembled a calculator. It's interesting that instead of marketing the product itself, Sharp sold initial marketing rights to the company with one of the largest sales and service networks in the world—Radio Shack.

The Sharp PC-1211 Pocket Computer became the TRS-80 Pocket Computer, introduced in August 1980 by Radio Shack. By using the immense marketing power of Radio Shack, Sharp was "testing the waters." A source at Sharp told me the company had doubts about how the product would be received.

To say the reception was good is an understatement. Sales of the TRS-80 Pocket Computer during its first six months were estimated at 40,000 units—four times the Radio Shack sales projections. The company initially purchased approximately 10,000 units, creating supply prob-

lems shortly after introduction.

Radio Shack's exclusive marketing rights to the PC-1211 ran out in March 1981. Sharp has started marketing the Pocket Computer with the addition of a printer although Radio Shack will also offer a printer in the near future.

Some observers of the personal computer market feel pocket computers are only a novelty—a fad that will soon pass. However, a number of companies seem committed to their development. Although presently limited in utility, pocket computers will be a major factor in the popularization of personal computers.

In the meantime, Sharp has aimed squarely at the small-business market with the recent introduction of the YX-3200. The system is being sold by 720 Sharp dealers and will retail in the \$6000 range. The powerful Z80-based system includes a 12-inch green-phosphor display (80-characters) and two 5¼-inch quad-density floppy-disk drives. Also included in the price is an Epson MX-80 printer (manufactured by a Japanese subsidiary of Seiko). An interesting sidelight is that the YX-3200 was designed in the United States—by American engineers.

The marketing of the YX-3200 system will also be an experiment. Sharp has projected sales of 5000 systems by April 1982. It will be virtually the first computer system to be sold by persons who are *not* computer dealers. The majority of Sharp salesmen chosen to sell the system are office equipment dealers. As the small-business market continues to grow, we are likely to see more and more personal computer systems sold in this way.

In the realm of the truly personal computer, the MZ-80 is perhaps the most interesting part of the Sharp line. Not currently available in the United States, it is one of the largest-selling personal computers in Europe and Japan. The MZ-80 retails for approximately \$900 with a calculator-style keyboard (not unlike the early PET), \$1200 with a standard keyboard. It's an attractive machine

Text continued on page 212

## HIPAD DIGITIZERS

### Inexpensive Graphic Input To Your Computer

*the Houston way*

The HIPAD Series Digitizers are the ideal graphic input devices for the small system user. Utilizing the principle of X-Y coordinates to obtain positioning, they convert graphic coordinates into digital data that can be processed by the computer.

#### Featuring:

- Digitizing surface of 11" × 11" (28cm × 28cm).
- Translucent digitizing area suitable for backlighting.
- Built-in switch selectable RS-232-C and 8 bit parallel interfaces.
- Resolution of 0.005 inches or .01 inches.
- Standard marking or non-marking stylus.
- Optional one-or four-button cursor models.
- Relocatable origin.
- Optional 5-digit LED display.
- UL Listed — Certified FCC Class B.
- Easily interfaced to Apple™, TRS-80™, Atari™, and most other microcomputers.
- Prices start at \$795.



houston instrument  
GRAPHICS DIVISION OF  
**BAUSCH & LOMB**

One Houston Square, Austin, Texas 78753  
Phone (512) 837-2820  
Outside Texas call 1-800-531-5205

DO IT.....

# YOUR SELF!



**Y**ou've talked about it, you've thought about it. Now, here are four books to help you *do* something about it!

So, for your next microcomputer project . . . do it, and do it right. With the help of BYTE Books.

**BYTE  
BOOKS**

**Mc  
Graw  
Hill**

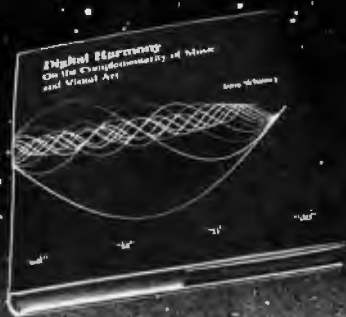

## DIGITAL HARMONY

by John Whitney

**A new synthesis of  
sight and sound**

Digital Harmony lays the foundation for the whole new field of audio-visual art made possible by microcomputers. John Whitney, a pioneer of the special effects technology used in STAR WARS and 2001: A SPACE ODYSSEY explains the special union of computer graphics and music. His computer-generated visual art graphically depicts the laws of harmonic motion common to all music.

Digital Harmony includes a complete description of Whitney's computer, peripherals, and film techniques. Colorful illustrations are included, as well as the program listings that generated them. The descriptions are sufficient for anyone to begin to explore this new territory as a composer and computer experimenter - transforming the small computer into an ideal instrument for creating compositions in aural and visual art.

John Whitney is on the Faculty in the Department of Art at the University of California, Los Angeles.

ISBN 0-07-070015-X  
240 pages  
hardcover  
over 50 color  
photographs

**\$21.95**



## INVERSIONS: A Catalogue of Calligraphic Cartwheels

by Scott Kim  
Foreword by Douglas Hofstadter  
Backword by Jef Raskin

**Surprising symmetries in  
design and letterforms**

Illusion . . . calligraphy . . . visual magic - Scott Kim's new book, *Inversions*, delights the eye and enchants the mind. Filled with intriguing designs, words that read the same right-side up and upside down, words within words, and unexpected symmetries, these compositions create a fresh way to look at the alphabet. The text includes the visual principles of symmetry, lettering, and problem solving that are basic to these images. The author also draws parallels to related exercises in perception in such diverse areas as art, music, word play, and mathematics. Scott Kim's original inversion designs first appeared in *Omni* magazine, inspiring an overwhelming reader response. An irresistible challenge, invertible writing appeals to everyone who loves beauty in mathematics and design.

Scott Kim is a doctoral student in Computer Science at Stanford University and is a concert pianist and composer.

ISBN 0-07-034546-5  
128 pages  
softcover  
over 50 illustrations  
available summer 1981

**\$8.95**

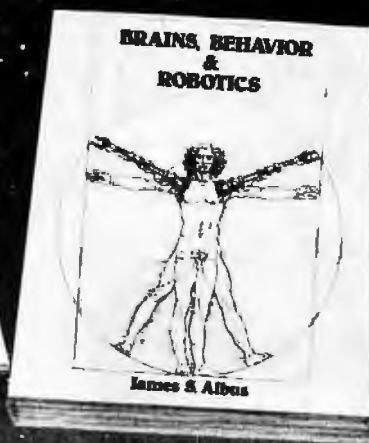

## BRAINS, BEHAVIOR, AND ROBOTICS

by James S. Albus

**Robotics design  
and applications**

This computer-oriented guide explores how the brain functions primarily as a computer device for generating and controlling behavior. The author assesses behavior as a product of three hierarchies of computing modules:

- memory modules
- behavior-generating modules
- sensory-processing modules

A section on artificial intelligence ties this hierarchical model to vital computer science techniques such as planning, problem-solving, machine vision, natural language understanding and knowledge representation. A closing section on robotics discusses the design considerations in constructing a robot control system fashioned after this model of the brain, and explores the current and potential use of robots in our environment.

Dr. James S. Albus is Project Manager with the National Bureau of Standards.

ISBN 0-07-000975-9  
400 pages  
hardcover  
180 illustrations

**\$15.95**

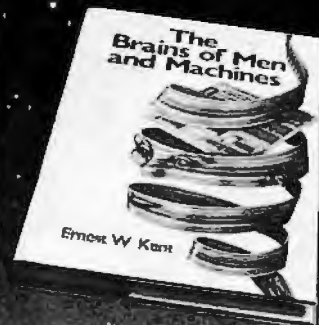

## THE BRAINS OF MEN AND MACHINES

by Ernest W. Kent

**Human models for  
computer design**

When the "Brains of Men and Machines" series of articles first appeared in *BYTE* magazine, the response was immediate and enthusiastic. Now Ernest W. Kent has expanded his ideas about the brain into a full-length book. As researchers begin to unravel the mysteries of the brain's chemical, electrical, and synaptic circuitry, their findings are becoming immediately applicable to advances in robotic behavior and computer design. The Brains of Men and Machines "dissects" the brain to provide new insights into computer design and artificial intelligence.

It is one of the rare books that transcends disciplinary boundaries. In it the ever-increasing relationship between man and machine is freshly examined - a relationship, Professor Kent concludes, that is today being reexamined in the light of man's own neurological self-image.

Dr. Ernest W. Kent is a Professor of Physiological Psychology and Psychopharmacology at the University of Illinois at the Chicago Circle Campus.

ISBN 0-07-034123-0  
304 pages  
hardcover  
illustrated

**\$15.95**

AVAILABLE FALL 1981

# The BYTE BOOK Collection

Circle 40 on inquiry card.

## BASIC SCIENTIFIC SUBROUTINES, VOLUMES 1 AND 2

by Fred Ruckdeschel



### Valuable programs for professional and hobbyist

Designed for the engineer, scientist, experimenter, and student, this series presents a complete scientific subroutine package in BASIC.

- Volume 1 covers plotting, complex variables, vector and matrix operation, random number generation, and series approximations.
- Volume 2 continues with least-squares approximation, special polynomial functions, approximating techniques, optimization, roots of functions, interpolation, differentiation, integration, and digital filtering.

These volumes feature routines written in both standard Microsoft and North Star BASIC, extensive appendices, and subroutine cross-references.

Dr. Fred Ruckdeschel is a Principal Scientist with Dynacomp, Inc.

VOLUME 1  
ISBN 0-07-054201-5  
336 pages  
hardcover  
illustrated

VOLUME 2  
ISBN 0-07-054202-3  
384 pages hardcover  
illustrated  
available Fall 1981

**\$19.95**

**\$23.95**



## THE BYTE BOOK OF PASCAL

Blaise W. Lifflick, Editor

### A powerful, structured language

Based on articles, language forums, and letters from BYTE magazine, this work is a valuable software resource. Pascal continues to be popular as a structured programming language. Written for both potential and established users, this book introduces the Pascal language and examines its merits and possible implementations. Featured are two versions of a Pascal compiler, one written in BASIC and the other in 8080 assembly language; a p-code interpreter written in both Pascal and 8080 assembly language; a chess-playing program; and an APL interpreter.

ISBN 0-07-037823-1  
334 pages  
hardcover

**\$25.00**

## THREADED INTERPRETIVE LANGUAGES

by Ronald Loeliger



### How to implement FORTH on your Z80

Threaded languages (such as FORTH) are compact, giving the speed of assembly language with the programming ease of BASIC. They combine features found in no other programming languages. This book develops an interactive, extensible language with specific routines for the Zilog Z80 microprocessor. With the core interpreter, assembler, and data type defining words covered in the text, it is possible to design and implement programs for almost any application and equivalent routines for different processors.

Ron Loeliger is a Senior Analyst with Intermetrics, Inc.

ISBN 0-07-038360-X  
272 pages  
hardcover  
illustrated

**\$18.95**

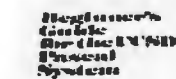

## BEGINNER'S GUIDE FOR THE UCSD PASCAL SYSTEM

by Kenneth L. Bowles

### The most popular Pascal version explained by its creator

Written by the originator of UCSD Pascal System, this informative book is an orientation guide to the UCSD Pascal System. For the novice, this book steps through the System, bringing the user to a sophisticated level of expertise. Once familiar with the System, the reader will find the guide an invaluable reference tool for creating advanced applications. The package offers programs which may be run without alteration on:

- DEC PDP-11 or General Automation minicomputers
- Western Digital Microengines
- 8080, 8085, Z80, 6502, 6800, 9900 or AM-100 based microcomputers (including the popular Apple II and Radio Shack TRS-80 microcomputers)

Dr. Kenneth L. Bowles is Director of the Institute for Information Systems, University of California, San Diego

ISBN 0-07-006745-7  
204 pages  
softcover

**\$11.95**

## YOU JUST BOUGHT A PERSONAL WHAT?

by Thomas Dwyer and Margot Critchfield

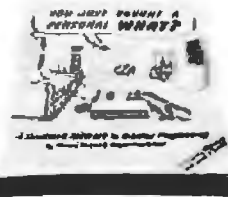

### A Structured Approach to Creative Programming

intended for both the novice programmer and the experienced computer enthusiast, this book presents practical ideas for personal computer use at home or at work.

Its approach is especially suitable for educational purposes. Written by the leading contributors of computer education material, this book is an entertaining and resourceful tool. There are over 60 ready-to-use programs written in Microsoft and Level II BASIC for the TRS-80 in the areas of educational games, financial record keeping, business transactions, disk-based files, and word processing.

Dr. Thomas Dwyer is a Professor of Computer Science at the University of Pittsburgh

Margot Critchfield is a doctoral student in Foundations in Education at the University of Pittsburgh.

ISBN 0-07-018492-5  
343 pages  
softcover  
78 illustrations

**\$11.95**

## BEYOND GAMES: SYSTEM SOFTWARE FOR YOUR 6502 PERSONAL COMPUTER

by Kenneth Skier



### Creating programs for the Apple, Atari, Challenger and PET computers

At last, a complete programming guide-book for owners of personal computers utilizing the 6502 microprocessor. A self-contained course in structures programming and top-down design, this book presents a powerful set of tools for building an extended dump monitor, disassembler, hexadecimal dump routine, and text editor programs. Programs are thoroughly explained, with clear instructions for modifications.

Kenneth Skier is a Systems Programmer for Wang Laboratories, Inc., and a Lecturer at MIT

ISBN 0-07-057860-5  
440 pages  
softcover  
illustrated

**\$14.95**

# stimulating, provocative, problem-solving

## CIARCIA'S CIRCUIT CELLAR

by Steve Ciarcia



### Practical uses for home computers

Imaginative and practical, Ciarcia's Circuit Cellar details a variety of microcomputer projects. A collection of the best articles from the popular series in BYTE magazine, this volume includes

- D/A conversion
- Programming EPROMS
- AC remote-controlled appliances
- digitized speech
- touch input video display

Complete instructions are given on how to construct each project. With amusing anecdotes and an easy-going style, Ciarcia presents his material in such a manner that even a neophyte need not be afraid of it.

ISBN 0-07-010960-5  
125 pages  
softcover  
color photographs and diagrams

**\$8.00**

## CIARCIA'S CIRCUIT CELLAR, VOLUME II

by Steve Ciarcia



### More practical uses for home computers

Composed of popular articles from BYTE magazine, this volume tells how microcomputers can be uniquely interfaced to our environment. Projects include

- building a computer controlled home-security system
- computerizing appliances
- transmitting digital information over a beam of light
- building the Intel 8086 microprocessor system design kit
- input-output expansion for the TRS-80

ISBN 0-07-010963-X  
224 pages  
softcover  
photographs and diagrams

**\$12.95**

## MICRO- COMPUTER STRUCTURES

by Henry D'Angelo



### Digital Electronics, Logic Design, and Computer Architecture

Today, there is an increasing demand for computer users who are not only well-versed in software, but who can also maintain, modify, and design their own hardware systems.

This text introduces computer users with little or no background in digital hardware to the basic computer structures used in microcomputer design and microcomputer interfacing. Helpful examples and end-of-chapter exercises further illustrate the various concepts presented, and a detailed bibliography provides additional reading opportunities. As a resource and textbook, it will assist

- programmers and systems analysts
- engineers and scientists
- managers
- students

Detailed Instructor's Manual also available.

Dr. Henry D'Angelo is the Associate Dean of the College of Engineering and Professor of Manufacturing Engineering at Boston University.

ISBN 0-07-015294-2  
288 pages  
hardcover  
314 illustrations  
available spring 1981

Instructor's Manual  
ISBN 0-07-015298-5  
softcover

**\$18.95**

**\$8.95**

BYTE Books' reputation is based on providing technically accurate, useful, and timely information. Established on the same principle as BYTE magazine, BYTE Books evolved in response to the rapidly expanding audience of home and business computer users. Computer professionals and enthusiastic newcomers need to keep pace with this unabated growth. This selection of BYTE books can expand your library of knowledge and expertise.

**TO ORDER, CALL TOLL  
FREE 800-258-5420, OR  
FILL OUT YOUR CHOICES  
IN THIS COUPON and  
return it with check,  
money order, or charge  
card number to:**

**BYTE  
BOOKS**

70 Main Street  
Peterborough,  
New Hampshire 03458



## BUILD YOUR OWN Z80 COMPUTER

by Steve Ciarcia



### Every step spelled out for do-it-yourself buffs

For the engineer, computer technician, student, and anyone interested in building a computer rather than buying one, this practical guide shows how to build a working computer based on the Zilog Z80 microprocessor. Each computer subsystem is fully explained and supported by proven design and testing information. The description focuses on a basic single-board microcomputer containing

- easy expansion to include a video terminal
- a 1 K-byte operating system
- serial and parallel ports
- hexadecimal display
- audio cassette mass storage

Readers can modify the system to meet personal needs.

Steve Ciarcia is a Computer Consultant, Electrical Engineer, and author of "Ask Byte" and "Ciarcia's Circuit Cellar" columns in BYTE magazine.

ISBN 0-07-010962-1  
330 pages  
softcover  
available summer 1981

**\$15.95**

**BYTE  
BOOKS**

70 Main Street  
Peterborough, New Hampshire 03458

Name \_\_\_\_\_

Address \_\_\_\_\_

City \_\_\_\_\_ State \_\_\_\_\_ Zip \_\_\_\_\_

- Check enclosed in the amount of \_\_\_\_\_
- Bill Visa Card Number \_\_\_\_\_
- Bill MasterCard Card Number \_\_\_\_\_
- Expiration Date \_\_\_\_\_

Include 75c per book to cover postage and handling.

| TITLE | PRICE | QUANTITY | AMOUNT |
|-------|-------|----------|--------|
|       |       |          |        |
|       |       |          |        |
|       |       |          |        |
|       |       |          |        |

SHIPPING  
TOTAL

**order now . . . !**



# LOWEST PRICE - BEST QUALITY

## NORTH STAR



### North Star Horizon 2

2-5 1/4 Disk Drives  
32K Double Den  
Factory assem. & tested  
Factory guaranteed  
List \$3695

only **\$2697**

### POWERFUL NORTH STAR BASIC FREE SUPERB FOR BUSINESS & SCIENCE

| FACTORY ASSEMBLED & TESTED         | LIST   | ONLY        |
|------------------------------------|--------|-------------|
| HORIZON-2-64K-DOUBLE DEN           | \$4195 | \$3062      |
| HORIZON-2-32K-QUAD DENSITY         | \$3995 | \$2916      |
| HORIZON-2-64K-QUAD                 | \$4495 | \$3281      |
| HORIZON RAM ASSM 16K = \$279       |        | 32K = \$479 |
| HORIZON RAM ASSM 48K = \$679       |        | 64K = \$879 |
| HORIZON DISK DRIVE SALE            |        |             |
| DOUB DEN                           | SAVE!  | \$ 445      |
| NORTH STAR HARD DISK 18 Mb         | \$5375 | \$3923      |
| NORTH STAR TIME SHARING MULTI-USER |        | CALL        |

## SUPERBRAIN ZENITH



### SUPERBRAIN QD 64K

List \$3995 only \$2995



### Z-89 48K

List \$2895 only \$2299

## TERMINALS Z-19 \$725

## INTERTUBE III only \$725

DYNABYTE COMPUTER—SAVE—PHONE

EPSON MX-80—PHONE  
ANADEX 9501 \$1349

NEC PRINTER \$2639

TRACTOR,  
THIMBLE,  
RIBBON  
DIP-81 \$395  
TEC LETTER QUAL \$1599



## InterSystems

### ITHACA INTERSYSTEMS 2A



Z-80A CPU 4 MHz  
64K Dynamic RAM  
Front panel  
V I/O—with Interrupts  
FDCII Disk Controller  
20 slot motherboard

### CALL FOR PRICE— TOO LOW TO ADVERTISE!

PASCAL/Z + THE FASTEST PASCAL \$375  
Z-8000 & CACHE BIOS—POWERFUL—PHONE  
8086 16 BIT CPU & SUPPORT CARD SEATTLE \$695  
CALIFORNIA COMPUTER 2210A ONLY \$1795

## MORROW 8" DISK

DISCUS 2D + CP/M® 600K ONLY \$929  
DISCUS 2 + 2 + CP/M® 1.2 MEGA B. \$1240  
ADD DRIVES 2D = \$650 2 + 2 = \$975  
2D-DUAL + CP/M® ONLY \$1540  
FREE MBASIC FROM MORROW!!



MORROW HARD DISK  
26,000,000 BYTES!!  
LIST \$4995 ONLY \$3919  
CP/M® IS INCLUDED!

### SAVE ON MEMORY AND PROGRAMS

|   |                 |                                      |                |
|---|-----------------|--------------------------------------|----------------|
| SYSTEMS MEMORY 64K A & T 4MHz               | \$590           | WORD STAR                            | \$315          |
| SYSTEM MEMORY 64K BANK SELECT               | \$740           | SPECTRUM                             | \$269          |
| ITHACA MEMORY 8/16-bit 64K                  | \$845           | COMPUPRO                             | SAVE           |
| SEATTLE MEMORY 8/16 BIT 16K                 | \$249           | EZ-CODER Translates English to BASIC | \$71           |
| SSM KITS Z-80 CPU                           | \$221           | ECOSOFT FULL ACCOUNTING PKG          | \$355          |
| VIDEO BRO V83 4MHz                          | \$412           | BOX OF DISKETTES                     | \$29           |
| ANADEX PRINTER DP-9500-1                    | \$1349          | SECRETARY WORD PROCESSOR             | The Best! \$99 |
| CAT NOVAION MODEM                           | \$169           | GOFAST NORTH STAR BASIC              |                |
| ECONORAM 2A BK ASSM                         | \$179           | OPTIMIZER—FAST                       | \$71           |
| NSSE 1-22 & P01 TERRIFIC PROGRAMS           | ONLY \$10. EACH | Which Computers are BEST?            |                |
| NORTHWORD \$329 MAILMAN \$245               |                 | BROCHURE                             | FREE           |
| INFOMAN \$411                               |                 | North Star Documentation refundable  | w/HRZ \$35     |
| TARBELL COMPUTER-PHONE                      |                 |                                      |                |
| AMERICAN SQUARE COMPUTERS BEATS ADV. PRICES |                 |                                      |                |

# American Computers

919-889-4577

KIVETT DR. JAMESTOWN N.C. 27282

919-883-1105

® CP/M is a registered trademark of Digital Research, Inc.

Text continued from page 206:

designed with the consumer in mind. The keyboard, 10-inch black-and-white display, and a cassette recorder are all contained in a single compact package. The MZ-80 is based around a Z80 microprocessor and includes 16 K bytes of programmable memory, Microsoft-compatible BASIC, a real-time clock, and sound/music capabilities. Dual 5¼-inch floppy-disk drives as well as a variety of printers are also being sold by Sharp in Europe and Japan, making the MZ-80 a powerful low-end business machine.

Sharp officials deny there are any plans afoot to market the MZ-80 in the United States. My personal feeling is that it will make its appearance here soon. The existing Sharp dealers network is the ideal place to market a machine such as this—designed for the consumer.

#### Hitachi

Hitachi is yet another of the multibillion-dollar Japanese giants.

1980 sales of \$13.4 billion make it the fifth largest company in Japan. Long known for high-quality inexpensive consumer electronics equipment (sold under a variety of names in the United States), Hitachi seemed to be one of the first to plan a marketing strategy to crack the US personal computer market. The problem is that, until recently, it never became serious about the plan.

Hitachi was one of the first Japanese companies to build a personal computer. The HD46800 was announced in June 1978 and was a true home computer designed for environmental control, menu and financial planning, as well as burglar and fire alarm interfacing. But it was too much, too soon. The US personal computer market was then only beginning to develop with the introduction of the first Radio Shack TRS-80 models.

Another major problem with Hitachi is the lack of a marketing organization in the United States. There seems to be little movement in

the direction of developing one. Lately, the company appears to be concentrating on large computers to compete in the IBM mainframe market. Hitachi recently introduced the AS-9000 computer with features far and above IBM's largest computer at a comparable price. But the lack of a US organization has hurt. The AS-9000 is being sold in the United States by National Advanced Systems—a company with a large amount of small computer experience. Although the AS-9000 is receiving a very favorable response, service is already a major problem. Recently, Lockheed Dialog installed an AS-9000 in its well-known database system. It was learned recently that a strange bug caused the entire system to crash at random intervals. Servicing the AS-9000 required that engineers be brought in from Japan, an extremely expensive proposition for Hitachi.

Even with the lack of a US organization, it seems certain that Hitachi will begin a major drive to in-

# Future Shock!

|                     |         |
|---------------------|---------|
| age                 | 65      |
| years worked        | 40      |
| retirement benefits | <hr/> 0 |

Many of the 50 million Americans who are covered by private pension plans think they'll automatically qualify for benefits when they reach retirement age.

They're wrong!

Every plan has requirements that must be met under the Employee Retirement Income Security Act. And the time to find out about those requirements is now—even if retirement is 30 years down the road.

There's a lot more to think about too. Does your plan permit early retirement? How much will your plan pay you? Will you receive a monthly payment or a lump sum?

The U.S. Department of Labor has a free booklet that will help you answer these questions and a lot more. Send for it today.

Write: Pensions, Consumer Information Center  
Pueblo, Colorado 81009

U.S. Department of Labor



Printed by this publication as a public service.



## if He'd used **select**<sup>™</sup> it wouldn't have taken seven days

**Learn SELECT<sup>®</sup> in just 90 minutes.** A whole new word processing software concept that kicks the coded key habit and frees you from complicated instruction manuals. *SELECT* is fast. *SELECT* is logical. With single key mnemonics, you'll use dozens of commands that instantly access the rich capabilities of this system. There's nothing like it.

Simply hit "C" and you'll be ready to Create a document.

Key "I" and you'll be in the Insert mode.

Key "M" and Move entire blocks of text . . . and key dozens more.

That's all there is to it. You'll get all that word processing software promises . . . plus a few surprises.

**SELECT with SUPERSPELL.<sup>®</sup>** The only microcomputer software with an integrated spelling dictionary. To proof your text all you do, of course, is to key "S". *SUPERSPELL* with its 10,000 word dictionary scans your text at computer speed then displays and corrects all your typing errors. You can increase *SUPERSPELL*'s word power and customize the dictionary by adding new words, one at a time. Ask to see it today at your local dealer.

SELECT with SUPERSPELL . . . just a little byte more.<sup>™</sup>



SELECT will run on any machine that uses CP/M or MP/M\*\* or its derivatives. It needs 40K of RAM and two disk drives. Special version now available for Radio Shack Mod II\*\*\* and Apple II\*\*\*\*

\* SELECT and SUPERSPELL are trademarks of Select Information Systems Inc

\*\* CP/M and MP/M are trademarks of Digital Research

\*\*\* A trademark of Tandy Corp.

\*\*\*\* A trademark of Apple Computer Inc

INFORMATION SYSTEMS 919 Sir Francis Drake Boulevard • Kentfield, California 94904 • (415) 459-4003

# MICROMAIL HAS WHAT YOUR SYSTEM NEEDS.

**TELEVIDEO** **910**
**\$599.00**

|            |                 |
|------------|-----------------|
| <b>912</b> | <b>\$699.00</b> |
| <b>920</b> | <b>\$749.00</b> |
| <b>950</b> | <b>\$995.00</b> |

**DIABLO** **630**
**\$1959.00**

|                 |                  |
|-----------------|------------------|
| <b>1640 RO</b>  | <b>\$2269.00</b> |
| <b>1640 KSR</b> | <b>\$2499.00</b> |
| <b>1650 RO</b>  | <b>\$2599.00</b> |
| <b>1650 KSR</b> | <b>\$2599.00</b> |

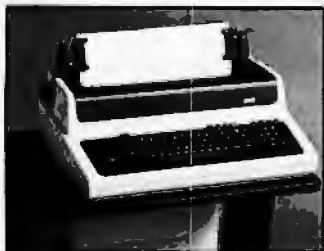
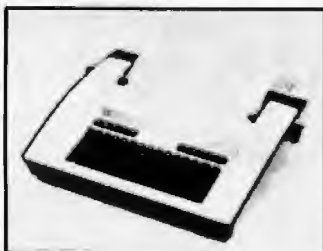
**DEC** **LA34 DA**
**\$899.00**

**TELETYPE** **43 PF(TTL)**
**\$975.00**

**ANADIX**

|                |                  |
|----------------|------------------|
| <b>DP 9500</b> | <b>\$1299.00</b> |
| <b>DP 9501</b> | <b>\$1299.00</b> |
| <b>DP 9000</b> | <b>\$1199.00</b> |
| <b>DP 9001</b> | <b>\$1199.00</b> |

**TEXAS INSTRUMENTS**

|                  |                  |
|------------------|------------------|
| <b>810/2</b>     | <b>\$1549.00</b> |
| <b>810/2 PKG</b> | <b>\$1679.00</b> |

(U/L, VFC, CP)

**SOROC**

|               |                  |
|---------------|------------------|
| <b>IQ 120</b> | <b>\$689.00</b>  |
| <b>IQ 140</b> | <b>\$1099.00</b> |
| <b>IQ 135</b> | <b>\$849.00</b>  |

**DEC**

|                    |                  |
|--------------------|------------------|
| <b>VT 100</b>      | <b>\$1650.00</b> |
| <b>DEC LA 34AA</b> | <b>\$1050.00</b> |

**C. ITOH**

|                |                  |
|----------------|------------------|
| <b>CIT 101</b> | <b>\$1625.00</b> |
|----------------|------------------|

**NEC**

|             |                  |
|-------------|------------------|
| <b>5510</b> | <b>\$2395.00</b> |
| <b>5530</b> | <b>\$2395.00</b> |

produce its personal computers here. The Hitachi BASIC Master Level III is now being sold in Japan and will probably soon be test-marketed in the United States. Based on a Motorola 6809 microprocessor, the unit has Microsoft BASIC, 80-column text display, and high-resolution graphics with six colors available. The US price is expected to be in the \$1500 range. A special color monitor for ultra-high-resolution graphics is \$900.

Hitachi seems to be making a slow but steady penetration into the personal computer market. Although it probably won't be a strong force in the US for a few years, Hitachi's heavy R & D expenditures and quality-at-low-cost reputation make it a strong long-term prospect for major US sales.

**NEC**

Nippon Electric Company is poised for a major move into the US computer market in *both* the personal and small-business markets.

NEC's trump card is the PC-8001, the largest-selling personal computer in Japan (some 3000 to 4000 units are sold monthly). The details of the PC-8001 were covered in an article in the January 1981 BYTE (page 72). It was first shown at the 1980 NCC (National Computer Conference). In January 1981, it was featured at the winter Consumer Electronics Show. NEC's Consumer Electronics Division, based in Elk Grove Village, Illinois, is now marketing it in the US through major personal computer dealers. The base price is \$1295 with 32 K bytes of programmable memory. (A little-known fact about the PC-8001 is that it was jointly developed by NEC and an Arlington Heights, Ohio, company called Just Another Computer Company.)

The major strength of the PC-8001 is that it has something for everyone: dazzling color graphics for the consumer as well as strong computation power and a full line of peripherals for business people.

The key to the unit's success will be its marketing. The NEC name is not well known in the United States and,

To Order: Send check to MICROMAIL, P.O. Box 3297, Santa Ana, CA 92703. Personal or company checks require two weeks to clear. Visa/MasterCard accepted. COD requires a 15% deposit. Handling: Add 3% to orders less than \$750, 2% to orders \$751 - \$2,000, 1% to orders over \$2,000. NOTE: Handling charges are waived on orders pre-paid in advance by check. Shipping: We ship FREIGHT COLLECT via UPS or Motor Freight. Air and Express delivery is available.

# MICROMAIL

P.O. Box 3297  
Santa Ana, CA 92703  
Phone: 714/731-4338  
TWX: 910 595 1146

# THE ORIGINAL MAGAZINE FOR OWNERS OF THE TRS-80™\* MICROCOMPUTER

\* TRS-80™ IS A TRADEMARK OF TANDY CORP

SOFTWARE  
FOR TRS-80™  
OWNERS

# COMPUTRONICS INC.

MONTHLY  
NEWSMAGAZINE  
FOR TRS-80™  
OWNERS

## MONTHLY NEWSMAGAZINE Practical Support For Model I, II & III

- PRACTICAL APPLICATIONS
- BUSINESS
- GAMBLING • GAMES
- EDUCATION
- PERSONAL FINANCE
- BEGINNER'S CORNER
- NEW PRODUCTS
- SOFTWARE EXCHANGE
- MARKET PLACE
- QUESTIONS AND ANSWERS
- PROGRAM PRINTOUTS
- .... AND MORE

### NOW IN OUR 4th YEAR

PROGRAMS AND ARTICLES PUBLISHED IN RECENT ISSUES  
INCLUDE THE FOLLOWING:

- FINCALC - A COMPLETE FINANCIAL APPLICATIONS PACKAGE
- INFORMATION SYSTEM REVIEW
- STATISTICAL COMBINATIONS
- PASCAL'S TRIANGLE
- ASSEMBLY LANGUAGE FOR BEGINNERS
- DISK FILES
- MOD-III REVIEW
- KEYBOARD THUNDER AND LIGHTING EXPLAINED
- DOS COMMANDS IN LEVEL II
- PROBABILITY CURVE GENERATOR
- CALCULATOR SIMULATIONS
- THE MEGABYTE GAP
- STOCKS AND BONDS
- BUDGET ANALYSIS (FOR BUSINESS AND HOME)
- NEWDOS/80 REVIEW
- DUTCHING - THE HORSE SYSTEM THAT CAN'T LOSE
- A SIMULATED GOLF GAME
- CONTINUOUS FORM SOURCES
- TAX/SAVER REVIEW
- .... AND MORE

**FREE\*** WITH  
YOUR  
SUBSCRIPTION  
OR  
RENEWAL

### FINCALC

A Complete Financial Analysis Package Used  
To Calculate Markup, Margin, Annuities, Compound Interest, Nominal  
And Effective Rates, Sinking Funds, Mortgage Calculations, Future Value,  
Savings and Insurance, Percentage Difference Between Two Numbers,  
Amortization Schedule and More . . . . .

SEND FOR OUR NEW 64 PAGE SOFTWARE CATALOG (INCLUDING LISTINGS OF HUNDREDS OF TRS-80™ PROGRAMS AVAILABLE ON CASSETTE AND DISKETTE). \$2.00 OR FREE WITH EACH SUBSCRIPTIONS OR SAMPLE ISSUE

\* All programs are supplied on cassette (add \$3 for Diskette Version - add \$5 for modified Mod-II Version).

## COMPUTRONICS

50 N. PASCACK ROAD  
SPRING VALLEY, NEW YORK 10977

ONE YEAR SUBSCRIPTION \$24 .....  
TWO YEAR SUBSCRIPTION \$48 .....  
SAMPLE OF LATEST ISSUE \$ 4 .....

START MY SUBSCRIPTION WITH ISSUE.....  
(#1 - July 1978 • #12 - June 1979 • #24 - July 1980 • #30 - January 1981)  
NEW SUBSCRIPTION..... RENEWAL.....

**NEW TOLL-FREE  
ORDER LINE**  
(OUTSIDE OF N.Y. STATE)  
**(800) 431-2818**



**24 HOUR  
ORDER  
LINE**  
**(914) 425-1535**



CREDIT CARD NUMBER \_\_\_\_\_ EXP. DATE \_\_\_\_\_

SIGNATURE \_\_\_\_\_ NAME \_\_\_\_\_

ADDRESS \_\_\_\_\_ CITY \_\_\_\_\_ STATE \_\_\_\_\_ ZIP \_\_\_\_\_

\*\*\* ADD \$12/YEAR (CANADA, MEXICO) - ADD \$24/YEAR AIR MAIL - OUTSIDE OF U.S.A., CANADA & MEXICO \*\*\*

# MTI stocks 'em all for faster delivery.

No hidden charges. Prices include delivery.  
Ask about our "QED" discounts.  
VISA and MasterCard orders accepted.

## VIDEO TERMINALS

|  |         |
|--|---------|
| VT100 DECscope.....                    | \$ 1595 |
| VT132 DECscope.....                    | 1995    |
| ADM-3A (dumb terminal) .....           | 795     |
| ADM-3A+ (dumb terminal) .....          | 875     |
| ADM-5 (dumb terminal) .....            | 945     |
| ADM-31 (2 page buffer) .....           | 1185    |
| ADM-42 (8 page buffer avail.) .....    | 2035    |
| 1410 (Hazeltine dumb terminal) .....   | 825     |
| 1420 (dumb terminal) .....             | 895     |
| 1421 (Consol 580 & ADM-3A comp.) ..... | 850     |
| 1500 (dumb terminal) .....             | 1045    |
| 1510 (buffered) .....                  | 1145    |
| 1520 (buffered printer port) .....     | 1395    |
| 1552 (VT52 compatible) .....           | 1250    |

## GRAPHICS TERMINALS

|                                 |      |
|---------------------------------|------|
| VT100 with graphics pkg. ....   | 3160 |
| ADM-3A with graphics pkg. ....  | 1995 |
| ADM-3A+ with graphics pkg. .... | 2075 |

## 300 BAUD TELEPRINTERS

|   |      |
|---|------|
| LA34-DA DECwriter IV .....              | 995  |
| LA34-AA DECwriter IV .....              | 1095 |
| LA36 DECwriter II .....                 | 1295 |
| Teletype 4310 .....                     | 1095 |
| Teletype 4320 .....                     | 1195 |
| Diablo 630 RO .....                     | 2295 |
| Diablo 1640 KSR .....                   | 2775 |
| Diablo 1650 KSR .....                   | 2835 |
| TI 743 (portable) .....                 | 1190 |
| TI 745 (port/built-in coupler) .....    | 1485 |
| TI 763 (port/bubble memory) .....       | 2545 |
| TI 765 (port/bubble/b.i. coupler) ..... | 2595 |

## 600 BAUD TELEPRINTERS

|                         |      |
|-------------------------|------|
| TI 825 RO impact .....  | 1450 |
| TI 825 KSR impact ..... | 1570 |
| TI 825 RO Pkg. ....     | 1825 |
| TI 825 KSR Pkg. ....    | 1795 |

## 1200 BAUD TELEPRINTERS

|  |      |
|--|------|
| LA 120 RO (forms pkg.) .....               | 2295 |
| LA 120-AA DECwriter III (forms pkg.) ..... | 2095 |
| LA 180 DECprinter I .....                  | 2295 |
| TI 783 (portable) .....                    | 1645 |
| TI 785 (port/built-in coupler) .....       | 2270 |
| TI 787 (port/internal modem) .....         | 2595 |
| TI 810 RO impact .....                     | 1760 |
| TI 810 RO Pkg. ....                        | 1950 |
| TI 820 KSR impact .....                    | 2025 |
| TI 820 RO .....                            | 1850 |
| TI 820 KSR Pkg. ....                       | 2195 |
| TI 820 RO Pkg. ....                        | 2025 |

## 2400 BAUD

|                                     |      |
|-------------------------------------|------|
| Dataproducts M200 (2400 baud) ..... | 2595 |
|-------------------------------------|------|

## DATAPRODUCTS LINE PRINTERS

|                           |       |
|---------------------------|-------|
| B300 (300 LPM band) ..... | 5535  |
| B600 (600 LPM band) ..... | 6861  |
| 2230 (300 LPM drum) ..... | 7723  |
| 2260 (600 LPM drum) ..... | 8614  |
| 2290 (900 LPM drum) ..... | 12655 |

## ACOUSTIC COUPLERS

|                                       |     |
|---------------------------------------|-----|
| A/J A242-A (300 baud orig.) .....     | 242 |
| A/J 247 (300 baud orig.) .....        | 315 |
| A/J AD342 (300 baud orig./ans.) ..... | 395 |
| A/J 1234 (Vadic compatible) .....     | 895 |
| A/J 1245 (300/1200 Bell comp.) .....  | 695 |

## MODEMS

|                                       |     |
|---------------------------------------|-----|
| GDC 103A3 (300 baud Bell) .....       | 395 |
| GDC 2028/T (1200 baud Bell) .....     | 565 |
| GDC 212-A (300/1200 baud Bell) .....  | 850 |
| A/J 1256 (Vadic compatible) .....     | 825 |
| A/J 1257 (triple modem w/phone) ..... | 975 |

## CASSETTE STORAGE SYSTEMS

|   |      |
|---|------|
| Techtran 816 (store/forward) .....      | 1050 |
| Techtran 817 (store/for/speed up) ..... | 1295 |
| Techtran 818 (editing) .....            | 1795 |
| Techtran 822 (dual) .....               | 2295 |
| MFE 5000 (editing) .....                | 1495 |

## FLOPPY DISK SYSTEMS

|                                    |      |
|------------------------------------|------|
| Techtran 950 (store/forward) ..... | 1395 |
| Techtran 951 (editing) .....       | 1995 |



Distributors, New York, New Jersey and Ohio.  
New York:  
516/482-3500, 212/895-7177, 516/449-5059  
Outside N.Y.S.: 800/645-8016  
New Jersey: 201/227-5552  
Ohio: 216/464-6688

at present, no large-scale organization exists to support it. However, NEC's marketing manager says the company will have a number of computer distributors and retail outlets in the near future.

NEC is also aiming at the higher end of the small-business market with the Astra system, which is expected to be available soon. NEC Information Systems (Lexington, Massachusetts) is marketing the system, with prices starting at \$11,000.

## Casio

Relatively small (by Japanese standards) Casio is well known for its extensive line of calculators (many sold under different brand names). Casio has had its ups and downs over the past few years and developed a personal computer about three years ago. Although some were sold in Japan, the product was ahead of its time.

Casio is about to make a major bid for the US personal and small-business computer market with the imminent introduction of the FX-9000P.

The FX-9000P has a unique design with a built-in green phosphor 5-inch monitor (similar to the Hewlett-Packard HP-83 and HP-85). One of the most interesting features is the set of plug-in modules for programmable memory expansion, peripheral interface, and software in read-only memory. In addition, the unit will be one of the first to partially use CMOS memory (which doesn't lose data when the power is turned off). As CMOS prices continue to fall, more companies will incorporate this new technology in their computer designs.

The big question mark about the FX-9000P is the price. Although company officials were more than happy to talk about its capabilities, the price is something they refused to even hint at. The unit seems to be aimed at more specialized uses than personal computers made by others. It will probably be marketed for scientific as well as small-business uses—aggressive pricing, however, will make it attractive for lower-end uses. The best guess is that it will sell in the \$1200 to \$1800 range.

## Mitsubishi

Another of the giant Japanese conglomerates, Mitsubishi, builds everything from small consumer appliances to jet planes. The company is one of the few that doesn't (at the moment) seem to be interested in the personal computer market, but its large mainframe systems make it the fifth largest computer company in Japan.

Mitsubishi does have a US subsidiary which is working to market a high-end small-business computer. Melcom systems is expected to market the Melcom Model 18 soon. The system is already being sold in Japan with prices starting at \$18,000.

Rumors about a Mitsubishi personal computer are nonexistent, but the fact that it is developing a computer marketing network portends things to come.

## Seiko

Best known for its line of watches, Seikosha Limited has been rumored for some time to be developing a low-end portable personal computer. Since 1979, the company has been selling a personal computer in Japan (with very limited success). The Seikosha 8500 uses two Intel 8085 microprocessors, has a 12-inch video display, and comes with two 5¼-inch floppy-disk drives. Chances are slim that this product will ever arrive on the American market.

The hottest rumor, circulating for some time now, is that Seiko's low-end personal computer would have a "designer" look created by Pierre Cardin. At the winter Consumer Electronics Show, Seiko displayed a number of products designed by Cardin. Conversations with Seiko personnel brought out the fact that "other products" are under development and will soon be appearing here.

Perhaps the biggest argument for an eventual Seiko push into the US personal computer market is the success of Seiko's Epson subsidiary. Epson printers are rapidly becoming more and more popular in the United States, with a sales and service organization that is building rapidly—an organization that could

# COMPUTRONICS INC.

● EVERYTHING FOR YOUR TRS-80\* ● ATARI\* ● APPLE\* ● PET\* ●

\*TRS-80 is a trademark of the Radio Shack Division of Tandy Corp. - \*ATARI is a trademark of Atari Inc. - \*Apple is a trademark of Apple Corp. - \*Pet is a trademark of Commodore



## BUSINESS PAC 100

### 100 Ready-To-Run

### Business Programs

★ All orders processed within 24-Hours  
★ 30-Day money back guarantee on all Software

(ON CASSETTE OR DISKETTE).....Includes 110 Page Users Manual.....5 Cassettes (Or Diskettes)  
Inventory Control.....Payroll.....Bookkeeping System.....Stock Calculations.....  
Checkbook Maintenance.....Accounts Receivable.....Accounts Payable.....

### BUSINESS 100 PROGRAM LIST

|               |   |
|---------------|---|
| 1 RULE78      | Interest Apportionment by Rule of the 78's            |
| 2 ANNU1       | Annuity computation program                           |
| 3 DATE        | Time between dates                                    |
| 4 DAYYEAR     | Day of year a particular date falls on                |
| 5 LEASEINT    | Interest rate on lease                                |
| 6 BREAKEVN    | Break-even analysis                                   |
| 7 DEPRSL      | Straightline depreciation                             |
| 8 DEPRSY      | Sum of the digits depreciation                        |
| 9 DEPRDB      | Declining balance depreciation                        |
| 10 DEPRDDB    | Double declining balance depreciation                 |
| 11 TAXDEP     | Cash flow vs. depreciation tables                     |
| 12 CHECK2     | Prints NEBS checks along with daily register          |
| 13 CHECKBK1   | Checkbook maintenance program                         |
| 14 MORTGAGE/A | Mortgage amortization table                           |
| 15 MULTMON    | Computes time needed for money to double, triple, etc |
| 16 SALVAGE    | Determines salvage value of an investment             |
| 17 RRVARIN    | Rate of return on investment with variable inflows    |
| 18 RRCONST    | Rate of return on investment with constant inflows    |
| 19 EFFECT     | Effective interest rate of a loan                     |
| 20 FVAL       | Future value of an investment (compound interest)     |
| 21 PVAL       | Present value of a future amount                      |
| 22 LOANPAY    | Amount of payment on a loan                           |
| 23 REGWITH    | Equal withdrawals from investment to leave 0 over     |
| 24 SIMPDISK   | Simple discount analysis                              |
| 25 DATEVAL    | Equivalent & nonequivalent dated values for oblig     |
| 26 ANNUDEF    | Present value of deferred annuities                   |
| 27 MARKUP     | % Markup analysis for items                           |
| 28 SINKFUND   | Sinking fund amortization program                     |
| 29 BONDDVAL   | Value of a bond                                       |
| 30 DEplete    | Depletion analysis                                    |
| 31 BLACKSH    | Black Scholes options analysis                        |
| 32 STOCVAL1   | Expected return on stock via discounts dividends      |
| 33 WARVAL     | Value of a warrant                                    |
| 34 BONDDVAL2  | Value of a bond                                       |
| 35 EPSEST     | Estimate of future earnings per share for company     |
| 36 BETAALPH   | Computes alpha and beta variables for stock           |
| 37 SHARPE1    | Portfolio selection model-i.e. what stocks to hold    |
| 38 OPTWRITE   | Option writing computations                           |
| 39 RTVAL      | Value of a right                                      |
| 40 EXPVAL     | Expected value analysis                               |
| 41 BAYES      | Bayesian decisions                                    |
| 42 VALPRINF   | Value of perfect information                          |
| 43 VALADINF   | Value of additional information                       |
| 44 UTILITY    | Derives utility function                              |
| 45 SIMPLEX    | Linear programming solution by simplex method         |
| 46 TRANS      | Transportation method for linear programming          |
| 47 EOQ        | Economic order quantity inventory model               |
| 48 QUEUE1     | Single server queueing (waiting line) model           |
| 49 CVP        | Cost-volume-profit analysis                           |
| 50 CONDPFROF  | Conditional profit tables                             |
| 51 OPTLOSS    | Opportunity loss tables                               |
| 52 FQOQ       | Fixed quantity economic order quantity model          |

|              |   |
|--------------|---|
| 59 WACC      | Weighted average cost of capital                    |
| 60 COMPBAL   | True rate on loan with compensating bal. required   |
| 61 DISCBAL   | True rate on discounted loan                        |
| 62 MERGANAL  | Merger analysis computations                        |
| 63 FINRAT    | Financial ratios for a firm                         |
| 64 NPV       | Net present value of project                        |
| 65 PRINDLAS  | Laspeyres price index                               |
| 66 PRINDPA   | Paasche price index                                 |
| 67 SEASIND   | Constructs seasonal quantity indices for company    |
| 68 TIMETR    | Time series analysis linear trend                   |
| 69 TIMEMOV   | Time series analysis moving average trend           |
| 70 FUPRINF   | Future price estimation with inflation              |
| 71 MAILPAC   | Mailing list system                                 |
| 72 LETWRT    | Letter writing system-links with MAILPAC            |
| 73 SORT3     | Sorts list of names                                 |
| 74 LABEL1    | Shipping label maker                                |
| 75 LABEL2    | Name label maker                                    |
| 76 BUSBUD    | DOME business bookkeeping system                    |
| 77 TIMECLCK  | Computes weeks total hours from timeclock info.     |
| 78 ACCTPAY   | In memory accounts payable system-storage permitted |
| 79 INVOICE   | Generate invoice on screen and print on printer     |
| 80 INVENT2   | In memory inventory control system                  |
| 81 TELDIR    | Computerized telephone directory                    |
| 82 TIMUSAN   | Time use analysis                                   |
| 83 ASSIGN    | Use of assignment algorithm for optimal job assign. |
| 84 ACCTREC   | In memory accounts receivable system-storage ok     |
| 85 TERMSPAY  | Compares 3 methods of repayment of loans            |
| 86 PAYNET    | Computes gross pay required for given net           |
| 87 SELLPR    | Computes selling price for given after tax amount   |
| 88 ARBCOMP   | Arbitrage computations                              |
| 89 DEPRSF    | Sinking fund depreciation                           |
| 90 UPSZONE   | Finds UPS zones from zip code                       |
| 91 ENVELOPE  | Types envelope including return address             |
| 92 AUTOEXP   | Automobile expense analysis                         |
| 93 INSFILE   | Insurance policy file                               |
| 94 PAYROLL2  | In memory payroll system                            |
| 95 DILANAL   | Dilution analysis                                   |
| 96 LOANAFDD  | Loan amount a borrower can afford                   |
| 97 RENTPRCH  | Purchase price for rental property                  |
| 98 SALELEAS  | Sale-leaseback analysis                             |
| 99 RRCONVBD  | Investor's rate of return on convertible bond       |
| 100 PORTVAL9 | Stock market portfolio storage-valuation program    |

| NAME       | DESCRIPTION                                  |
|------------|--|
| 53 FQEOVSH | As above but with shortages permitted        |
| 54 FQEOQPB | As above but with quantity price breaks      |
| 55 QUEUECB | Cost-benefit waiting line analysis           |
| 56 NCFANAL | Net cash-flow analysis for simple investment |
| 57 PROFIND | Profitability Index of a project             |
| 58 CAP1    | Cap. Asset Pr. Model analysis of project     |

CASSETTE VERSION **\$99.95**  
 DISKETTE VERSION **\$99.95**  
 TRS-80\* MODEL II VERSION **\$149.95**

**NEW TOLL-FREE ORDER LINE**  
 (OUTSIDE OF N.Y. STATE)  
**(800) 431-2818**

ADD \$3.00 FOR SHIPPING IN UPS AREAS  
 ADD \$4.00 FOR C.O.D. OR NON-UPS AREAS  
 ADD \$5.00 OUTSIDE U.S.A, CANADA & MEXICO

## COMPUTRONICS INC.

MATHEMATICAL APPLICATIONS SERVICE

50 N. PASCACK ROAD  
SPRING VALLEY, NEW YORK 10977



**24 HOUR ORDER LINE**  
**(914) 425-1535**

Circle 150 on Inquiry card.



**EPSON**

*... and more*

**Apple II**

- 32K ..... \$1099<sup>00</sup>
- 48K ..... \$1149<sup>00</sup>
- Disk II w/3.3 DOS ... \$ 529<sup>00</sup>
- Disk II ..... \$ 450<sup>00</sup>
- Apple III w/128K .... \$3600<sup>00</sup>

**EPSON**

- MX-70 ..... \$ 399<sup>00</sup>
- MX-80 ..... **CALL**
- Apple card & cable .. \$ 99<sup>00</sup>

**ATARI<sup>®</sup>**

- 400 w/16K ..... \$ 349<sup>00</sup>
- 800 w/16K ..... \$ 775<sup>00</sup>
- 810 Disk Drive ..... \$ 449<sup>00</sup>

**We'll meet or beat  
any advertised price.**



- HP-85A w/16K ..... \$2697<sup>00</sup>

**NEC**

- 5510-2 w/Tractor ... \$2550<sup>00</sup>
- 5520-2 w/Tractor ... \$2850<sup>00</sup>

**SOROC**

- IQ 120 ..... \$ 725<sup>00</sup>
- IQ 135 ..... \$ 799<sup>00</sup>

**C.ITOH**

- Comet ..... \$ 499<sup>95</sup>
- Starwriter ..... \$1450<sup>00</sup>

*Northstar, Altos and Zenith  
All 25% Discount*

**LO-BALL COMPUTERS**

7677 S.W. Cirrus Dr.  
Beaverton, OR. 97005

**TO ORDER**

**CALL (503) 641-0211**

Ordering Information: For fastest service, send money order, cashier's check or bank wire. Visa and MC orders, add 3%. Personal checks accepted (allow minimum 10 days to clear). Hours 9-5, M-F.

**Call for our Free Catalog.**

easily handle personal computers.

**Matsushita**

Matsushita is one of the largest manufacturers and marketers of consumer electronics products in the world, with 1980 sales of \$13.7 billion. In the United States, the company is best known for the Quasar, Panasonic, and Technics brands. Its US marketing organization and expertise are formidable.

Apparently, the company's first thought about entering the US personal computer market was to approach it in a very different way—namely, the Panasonic and Quasar hand-held computer, introduced officially at the winter Consumer Electronics Show. (See BYTE January 1981, page 34.)

Persistent rumors exist in the industry that Matsushita is having second thoughts about the hand-held computer in its present form. Release dates have already been pushed up a few months, lending credence to the rumor that the product will undergo a major redesign. Meanwhile, there are reports that the company is hard at work on a full-sized personal computer in the \$1000 range.

IBM obviously respects the resources of Matsushita in the small computer field; Matsushita officials recently admitted they were approached by IBM to build a personal computer for the US giant. Sources at both companies say nothing came of the meeting, but, in fact, Matsushita and IBM having been working for some time on a joint project to produce a series of personal computers bearing the IBM logo. Code-named "Go," the project now seems to have been suspended. (See the editorial in last month's BYTE.)

**Sord**

Although virtually unknown in the United States, this small company based in Tokyo is planning a major push into the US market. Sord designed and markets the M100 computer in both Europe and Japan. Some 1800 units were reportedly shipped to Europe in 1980. They are evidently being sold under another

name because dealers contacted in the United Kingdom had never heard of them.

Most Japanese companies are secretive, but Sord stands out as one of the most tight-lipped. I was consistently unable to contact company officials and letters went unanswered. Consequently, details of the M100 are not available.

There are, however, persistent rumors that the company will appear suddenly in the US with a strong product, marketed well.

**Other Companies**

A number of other Japanese companies are working on personal and small-business computers designed for the United States market. In most of the following cases, little if any details are available.

Sony recently admitted it is designing a personal computer which will either interface with or be designed around its recently introduced TypeCorder portable typewriter (which fits in a briefcase and stores text on miniature tape cassettes). Sony has what is probably the most formidable marketing/service organization of any Japanese company in the United States. More importantly, the Sony name is synonymous with high quality and innovative technology.

Expect the introduction of a Sony personal computer within a year. It will probably be unlike any other product now on the market and will use Sony's new 3-inch disks. Reported problems with quality control on the disks may, however, delay the process. When the unit does appear, it will certainly give both US and other Japanese computer makers a run for their money.

OKI is expanding its US marketing and service network and quietly showed its OKI IF800 at the winter Consumer Electronics Show. The OKI IF800 is now being sold in Japan (for approximately \$8000) and is a strong seller for small-business applications.

Toshiba is working on small computers but doesn't seem to be interested in either the US or Japanese





# NEECO

## WHY BUY FROM THE BEST? Service... Support... Software...



### MULTI-CLUSTER

For Commodore Systems, allows 3 CPU's (Expandable to 8) to access a single Commodore Disk.  
MULTI-CLUSTER (3 CPU's) . . . . . \$ 795  
Each Additional CPU (up to 8) . . . \$ 199



### commodore

|                                      |        |
|--------------------------------------|--------|
| 16K B (16K RAM-40 Column) - Lim. Qty | \$ 995 |
| 32K B (32K RAM-40 Clm.) - Lim. Qty   | \$1295 |
| 4016 (16K RAM 4.0 Basic-40 Clm.)     | \$ 995 |
| 4032 (32K RAM 4.0 Basic-40 Clm.)     | \$1295 |
| 8032 (32K RAM 4.0 Basic-80 Clm.)     | \$1495 |
| 8050 Dual Disk (1 Meg Storage)       | \$1795 |
| 4040 Dual Disk (343K Storage)        | \$1295 |
| 8010 IEEE Modem                      | \$ 280 |
| C2N Cassette Drive                   | \$ 95  |
| CBM - IEEE Interface Cable           | \$ 40  |
| IEEE - IEEE Interface Cable          | \$ 50  |
| VIC 20 Home/Personal Computer        | \$ 295 |

### ALTOS

|                       |         |
|-----------------------|---------|
| ACS 8000-2 64K 1M     | \$ 4500 |
| ACS 8000-15 64K 1M    | \$ 5990 |
| ACS 8000-6 208K 14.5M | \$10490 |
| ACS 8000-7 208K 29.0M | \$11690 |
| ACS 8000-10 208K 10M  | \$ 8500 |
| ACS 8000-10/MTU       | \$10990 |

### NEC SPINWRITER PRINTERS

|                   |        |
|-------------------|--------|
| 5530 (Parallel)   | \$3055 |
| 5510 (Serial)     | \$3055 |
| 5520 (KSR-Serial) | \$3415 |
| Tractor Option    | \$ 225 |

### EPSON PRINTERS

|                           |        |
|---------------------------|--------|
| MX-80 PRINTER             | \$ 645 |
| MX-80 FT                  | \$ 745 |
| MX-100                    | \$ 945 |
| MX-70                     | \$ 459 |
| INTERFACE CARDS           |        |
| 8141 (RS-232)             | \$ 75  |
| 8150 (2K Buffered RS-232) | \$ 150 |
| 8161 (IEEE 488)           | \$ 55  |
| 8131 (Apple Card)         | \$ 85  |
| 8230 (Apple Card)         | \$ 25  |
| 8220 (TRS-80 Cable)       | \$ 35  |

### DIABLO 630 PRINTER

|                              |        |
|------------------------------|--------|
| DIABLO 630 - Serial - RS-232 | \$2710 |
| Tractor Option               | \$ 250 |

### AMDEK MONITORS

|                       |        |
|-----------------------|--------|
| Video 100 12" B+W     | \$ 179 |
| Video 300 12" Green   | \$ 249 |
| Color I 13" Low Res   | \$ 449 |
| Color II 13" High Res | \$ 999 |

### INTERTEC COMPUTERS

|   |        |
|---|--------|
| 64K Superbrain<br>(380 Disk Storage), CP/M™ . . .     | \$3495 |
| 64K QD Superbrain<br>(700K Disk Storage), CP/M™ . . . | \$3995 |

\*CP/M is a registered trademark of Digital Research.



### ATARI COMPUTERS

|                                      |           |
|--------------------------------------|-----------|
| Atari 400 (16K RAM)                  | \$ 399    |
| Atari 800 (32K RAM) - good thru 8/31 | \$1080    |
| Atari 410 RECORDER                   | \$ 89.95  |
| Atari 810 DISK DRIVE                 | \$ 599.95 |

NEECO carries all available ATARI Software and Peripherals.

### APPLE

|                             |        |
|-----------------------------|--------|
| 16K APPLE II+               | \$1330 |
| 32K APPLE II+               | \$1430 |
| 48K APPLE II+               | \$1530 |
| APPLE DISK w/3.3 DOS        | \$ 650 |
| APPLE DRIVE Only            | \$ 490 |
| APPLE III 128K - In Stock!  |        |
| w/Monitor + Info Analystpak | \$4740 |



### PROFESSIONAL SOFTWARE

|                         |           |
|-------------------------|-----------|
| WordPro 1 8K            | \$ 29.95  |
| WordPro 3 (40 Clm.) 16K | \$ 199.95 |
| WordPro 3+              | \$ 295    |
| WordPro 4 (80 Clm.) 32K | \$ 375    |
| WordPro 4+              | \$ 450    |

JUST A SAMPLE OF THE MANY PRODUCTS WE CARRY. CALL US FOR OUR NEW 60-PAGE CATALOG. WE WILL MATCH ANY ADVERTISED PRICE ON PRODUCTS LISTED UNDER SIMILAR "IN STOCK" CONDITIONS.



# NEECO

679 HIGHLAND AVE.  
NEEDHAM, MA 02194

(617) 449-1760  
Telex: 951021

MON-FRI 9:00 - 5:00



MasterCharge and VISA Accepted

## System Log

3:10 P.M. - System Down!

4:45 P.M. - Problem diagnosed using  
DIAGNOSTICS II.

Board replaced and  
system back on line.



# DIAGNOSTICS II

Diagnostics II is SuperSoft's expanded Diagnostic package.

Diagnostics II builds upon the highly acclaimed Diagnostics I. It will test each of the five areas of your system:

Memory      Terminal      Printer      CPU      Disk

### Every test is expanded.

Every test is "submit"-able. A "submit" file is included in the package which "chains" together the programs in Diagnostics II, achieving an effective acceptance test. All output can be directed to a log file for unattended operation, for example over night testing. Terminal test is now generalized for most crt terminals. A quick-test has been added for quick verification of the working of the system.

The memory test is the best one we have encountered. It has new features, including:

- default to the size of the CP/M Transient Program Area (TPA)
- printout of a graphic memory map
- bank selection option
- burn in test
- memory speed test

Diagnostics-II still includes the only CPU test for 8080/8085/Z80.

A Spinwriter/Diablo/Qume test has been added, which tests for the positioning and control features of the Spinwriter/Diablo/Qume as well as its ASCII printing features. (Serial Interface only)

And, as with all SuperSoft products, a complete online HELP system and user manual is included.

Price: \$100.00 (manual only): \$15.00

Requires: 32K CP/M

CP/M Formats: 8" soft sectored, 5" Northstar, 5" Micropolls  
Mod II, Vector MZ, Superbrain DD/QD



All Orders and General Information:  
SUPERSOFT ASSOCIATES

P.O. BOX 1628  
CHAMPAIGN, IL 61820  
(217) 359-2112

Technical Hot Line: (217) 359-2691  
(answered only when technician is available)

CP/M REGISTERED TRADEMARK DIGITAL RESEARCH

**SuperSoft**

**First in Software Technology**

personal and/or small-business market at this time. The only small computer product it is currently offering is a one-board uncased machine with BASIC and a keyboard that's mainly designed for development work.

AI Electronics Corporation and Logic Systems International are two small companies, based in Tokyo, which seem to be quietly working behind the scenes. Both ship about 2000 personal computers a year to Europe—where they are packaged and sold under different names. In the Japanese tradition of secrecy, details on their products are unavailable; however, watch for the names, possibly in conjunction with US companies. Rumors persist that both companies have had major discussions with US companies regarding the marketing of their personal computers in the United States.

Finally, Sanyo has exhibited some personal computer prototypes at Japanese trade shows, but seems to have put the project on a back burner for the time being.

### Summary

The Japanese personal computers are impressive machines at highly competitive prices. However, the outlook for American computer manufacturers is not entirely grim. There is little if any chance that the influx of Japanese products into our market will have anywhere near the same effect Japanese automobiles and steel have had on those US markets. The American computer industry is far from being the mature and top-heavy group that the auto and steel industries are. The United States developed the computer and that development continues to move forward at a dizzying pace.

In fact, the influx of Japanese personal computers is likely to further spur the domestic computer makers. Their highly experienced marketing and product-development groups are poised to give the Japanese products a run for their money. The bottom line seems to be that the "Japanese Computer Invasion" will result in better products and lower prices for consumers. ■

# If you can't find the right program in our new catalog, it probably hasn't been written.

As the world's largest publisher of professional software for micro-computers, Lifeboat Associates offers the largest selection of state-of-the-art programs. And our new catalog has more to offer than ever. We also add the crucial dimension of after-sales service and full support to everything we sell. Order your free catalog today

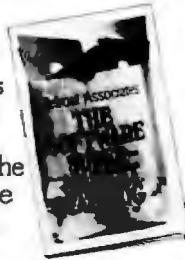

For a free catalog, mail coupon to Lifeboat Associates, 1651 Third Avenue, New York, NY 10028. Or call (212) 860-0300. Telex 640693 (LBSOFT NYK)

Name \_\_\_\_\_ Title \_\_\_\_\_  
Company \_\_\_\_\_  
Street \_\_\_\_\_  
City \_\_\_\_\_ State \_\_\_\_\_ Zip \_\_\_\_\_

Our catalog contains full descriptions and specifications of the following:

|  |  |   |  |
|--|--|---|--|
| <b>DISK OPERATING SYSTEMS</b><br>CP/M CONFIGURED FOR<br>APPLE II<br>DATAPOINT 1550/2150<br>ICOM MICRO DISK<br>ICOM 3712<br>ICOM 3812<br>ICOM 4511/PERTEC D3000<br>INTEL MDS<br>MICROPOLIS FLOPPY DISK<br>MITS/ALTAIR<br>MOSTEK MDX<br>NORTH STAR<br>OSI C3<br>OSI C38<br>OSI C3C Prime<br>TRS-80 MODEL II<br>MP/M FOR INTEL MDS  | <b>TELECOMMUNICATIONS</b><br>BSTAM BSTMS<br><b>LANGUAGES</b><br>ALGOL-80 muSIMP<br>APL/V80 NEVADA COBOL<br>BASIC-80 PASCAL/M<br>(COMPILER) PASCAL/MT<br>BASIC-80 PASCAL/Z<br>(INTERPRETER) PL-1-80<br>BOS C COMPILER S-BASIC<br>BASIC-2 TINY C<br>CIS COBOL TINY C TWO<br>COBOL-80 W'SMITHS C<br>FORTRAN-80 COMPILER<br>JRT PASCAL<br>muLISP XYBASIC   | <b>MAIL LIST APPLICATIONS</b><br>MAILING ADDRESS (PTREE)<br>MAILMERGE FOR WORDSTAR<br>MAD<br>POSTMASTER<br><b>BUSINESS APPLICATIONS</b><br>ACCOUNTS PAYABLE (PTREE)<br>ACCOUNTS PAYABLE (SSG)<br>ACCOUNTS RECEIVABLE (PTREE)<br>ACCOUNTS RECEIVABLE (SSG)<br>GENERAL LEDGER II (CPAIDS)<br>GENERAL LEDGER (PTREE)<br>GENERAL LEDGER (SSG)<br>GLECTOR FOR SELECTOR III-C2<br>INVENTORY (PTREE)<br>INVENTORY (SSG)<br>PAYROLL (PTREE)<br>PAYROLL (SSG)  | THE PASCAL HANDBOOK<br>PASCAL USER MANUAL AND REPORT<br>PAYROLL WITH COST ACCOUNTING-<br>CBASIC<br>STRUCTURED MICROPROCESSOR<br>PROGRAMMING<br>USING CP/M-A SELF-TEACHING GUIDE<br><b>ACCESSORIES</b><br>DC 300 DATA CARTRIDGE<br>HEAD CLEANING DISKETTE<br>FLIPPY DISK KIT<br>FLOPPY SAVER<br>Program names and computer names are generally trademarks or service marks of the author or manufacturing company<br>All software products have specific requirements for hardware and additional associated software (e.g. operating system or language)<br>All products are subject to terms and conditions of sale<br>Prices and specifications are subject to change without notice.<br>All Lifeboat software requires CP/M unless otherwise stated<br>Copyright © 1981 Lifeboat Associates. No portion of this advertisement may be reproduced without prior permission. |
| <b>HARD DISK INTEGRATION MODULES</b><br>CORVUS WITH APPLE II SOFTCARD<br>CORVUS WITH S100 AND TRS-80<br>MODEL II<br>ICOM 4511/PERTEC D3000<br>KONAN PLUS CDC PHOENIX<br>XCOMP 5M/S PLUS CDC PHOENIX<br>XCOMP DFCIO FOR PERTEC D3000  | <b>LANGUAGE AND APPLICATIONS TOOLS</b><br>BASIC UTILITY MDS DRS<br>DISK MDS RTL<br>DATASTAR M-SORT FOR<br>FABS COBOL-80<br>FORMS 1 FOR CIS PEARL<br>COBOL PSORT<br>FORMS 2 FOR CIS QSORT<br>COBOL STRING BIT<br>MAGSAM III STRING-80<br>MAGSAM IV SUPER-80RT<br>ULTRASORT II   | <b>NUMERICAL PROBLEM-SOLVING TOOLS</b><br>ANALYST STAPAK<br>FPL T/MAKER<br>muMATH<br><b>OTHER SPECIALIZED APPLICATIONS</b><br>DATEBOOK<br>ESQ-1<br>PAS-3 DENTAL<br>PAS-3 MEDICAL<br>PROPERTY MANAGEMENT (PTREE)   |  |
| <b>SYSTEMS TOOLS</b><br>BUG AND UBUG SID<br>DESPOOL TRS-80 MODEL II<br>DISILOG CP/M<br>DISTEL CUSTOMIZATION<br>EDIT UNLOCK<br>EDIT-80 WORD-MASTER<br>FILETRAN XASM-18<br>IBM/CPM XASM-48<br>MAC XASM-65<br>MACRO-80 XASM-68<br>PASM XMACRO-86<br>PLINK ZDT<br>PMATE Z80 DEVELOPMENT<br>RAID PACKAGE<br>RECLAIM ZSID  | <b>WORD PROCESSING SYSTEMS AND AIDS</b><br>MAGIC WAND TEX<br>LETTERIGHT TEXTWRITER III<br>MICROSPELL WORDSTAR<br>SPELLGUARD WORDINDEX  | <b>BOOKS AND PERIODICALS</b><br>APL—AN INTERACTIVE APPROACH<br>ACCOUNTS PAYABLE & ACCOUNTS<br>RECEIVABLE-CBASIC<br>8080/280 ASSEMBLY LANGUAGE<br>THE CP/M HANDBOOK<br>THE C PROGRAMMING LANGUAGE<br>CRASH COURSE IN MICROCOMPUTERS<br>FIFTY BASIC EXERCISES<br>GENERAL LEDGER-CBASIC<br>INTRODUCTION TO PASCAL<br>LIFELINES   |  |
| <b>ORDERING INFORMATION. COMPUTERS SUPPORTED INCLUDE:</b><br>ADDS Multivision RT<br>AVL Eagle RB<br>Altair 8800 B1<br>Altos A1<br>Apple CP/M 13 Sector RG<br>Apple CP/M 16 Sector RR<br>BASF System 7100 RD<br>Blackhawk Micropolis Mod II Q2<br>CDS Versatile 3B Q1<br>CDS Versatile 4 Q2<br>Columbia Data Products A1<br>COMPAL-80 Q2<br>CSSN Backup T1<br>Cromenco System 3 RB<br>Cromenco System 2 S06S RB<br>Cromenco System 2 D06S RX<br>Cromenco System 2 D06S RY<br>Datapoint 1550/2150 Single Sided AA<br>Datapoint 1550/2150 Double Sided AB<br>Delta Systems A1<br>Digi-Log Microterm II RD<br>Digital Microsystems A1<br>Durango F-85 RL<br>Dynabyte DB8/2 R1<br>Dynabyte DB8/4 A1 | Exidy Sorcerer + Lifeboat CP/M<br>Exidy Sorcerer + Exidy CP/M<br>Heath HB + H17/H27 disk<br>Heath H89 + Lifeboat CP/M<br>Heath H89 + Magnolia CP/M<br>Heath H89 + Heath CP/M<br>Helios II<br>ICOM 2411 Micro Floppy<br>ICOM 3712<br>ICOM 3812<br>ICOM 4511 5440 Cartridge CP/M 1 4<br>ICOM 4511 5440 Cartridge CP/M 2 2<br>IMS 5000<br>IMS 800<br>IMSAI VDP-40<br>IMSAI VDP-42<br>IMSAI VDP-44<br>IMSAI VDP-80<br>ISC Intecolor 8063/8360/8963<br>Interlec Superbrain Q05 0 1<br>Interlec Superbrain Q05 0 5<br>Interlec Superbrain D05 3 a<br>Interlec Superbrain QD<br>Kontron PSI-80<br>MITS 3200-3202<br>MSD 5 25 in<br>Meca Delta-1 5 25 in | Micromation Q2<br>Micropolis Mod I RW<br>Micropolis Mod II P4<br>Morrow Discus P4<br>Mostek P7<br>NEC PC-8001 P7<br>North Star Single Density B2<br>North Star Double Density R3<br>North Star Quad Density A1<br>Nytec Micropolis Mod II Q2<br>Ohio Scientific C3 D1<br>OKI F-800 Q2<br>Onyx CB001 RA<br>Perlec PCC 2000 A1<br>Processor Technology Helios II R4<br>Quay 500 R4<br>Quay 520 R5<br>Quay 520 R5<br>RAIR Single Density A1<br>RAIR Double Density A1<br>Research Machines 5 25 in. R7<br>Research Machines 8 in. R7<br>SD Systems 5 25 in. RK<br>SD Systems 8 in. RD<br>Sanco 7000 S 25 in. RF<br>Spacebyte B1<br>TEL 5 25 in. RC<br>TEL 8 in. PB | TIP A1<br>TRS-80 Model I STANDARD R2<br>TRS-80 Model I + FEC Freedom R2<br>TRS-80 Model I + Micromation A4<br>TRS-80 Model I + Omikron 5 25 in. RM<br>TRS-80 Model I + Omikron 8 in. A1<br>TRS-80 Model I + Shuttleboard 8 in. A1<br>TRS-80 Model II P2<br>TRS-80 Model III P3<br>Vector MZ Q2<br>Vector System 2800 A3<br>Vector System B R2<br>Vector VIP T2<br>Vista V-80 5 25 in. Single Density A1<br>Vista V200 5 25 in. Double Density P8<br>Zenith Z89 + Zenith CP/M RB<br>Zenith Z89 + Lifeboat CP/M P4<br>Zenith Z89 + Magnolia CP/M P7<br>SS = single sided SD = single density<br>DD = double sided DD = double density<br>The list of available formats is subject to change without notice. In case of uncertainty, call to confirm the format code for any particular equipment.  |

**LIFEBOAT WORLDWIDE**

Lifeboat Inc.  
3-23-8 Nishi-shimbashi  
Minato-ku, Tokyo, 105 Japan  
Tel: 03-437-3901  
Telex: 2422723 (ASRYTDJ)

Lifeboat Associates, Ltd  
PO Box 125  
London WC2H 9LU, England  
Tel: 01-836-9028  
Telex: 893709 (LBSOFTG)

Lifeboat Associates GmbH  
PO Box 166, Aegerstrasse 35  
CH 6340 Basel, Switzerland  
Tel: 042-31-2931  
Telex: 855265 (MICD CH)

Intersoft GmbH  
Schlossgartenweg 5  
D-8045 Ismaning, W Germany  
Tel: 089-956-444  
Telex: 5213643 (ISOFD)

Lifeboat Associates, SARL  
10, Grande Rue Charles de Gaulle  
92800 Asnières, France  
Tel: 1-733-08-04  
Telex: 250303 (PUBLIC X PARIS)

**Lifeboat Associates**  
Software with full support.

**PRINT NEATLY,  
SO WE KNOW  
WHERE TO SEND  
YOUR CHECK.**

(PLEASE PRINT: THIS IS YOUR SHIPPING LABEL)

**FROM:** Name

Address

City/State/ZIP

**TO:**

**Ashton-Tate**

Suite 1510

3600 Wilshire Boulevard

Los Angeles, CA 90010

Buying new software is the pits, isn't it?

You read an ad and it sounds terrific, so you ask around, then buy the manual.

So far, so good—so you spring several hundred dollars for the package.

And it does exactly what they said. But to get exactly what you want, you're going to have to change the way you run your business. Or go through so much hassle that you're not sure it's worth it.

So you grit your teeth and suffer, or put it on a shelf to gather dust.

Sounds familiar, doesn't it?

But there is at least one known exception: an exceptional DBMS called dBASE II.

### For database fans, an offer you shouldn't refuse.

dBASE II is the only high-performance relational Database Management System for micros. And it's the only DBMS that can help you get the DBMS that's right for you, no matter which DBMS you may want. Here's how:

If you have a 48k micro with CP/M, send us its model number and the size of your drives along with \$700 (CP/M 86 version soon—call if you can't wait).

We'll send you a copy of dBASE II that you can run on your system, solving your problems your way, for 30 days. Then just send everything back and we'll return your money, no questions asked.

During that 30 days, you can find out how much a real database management system can do for you. How it will affect your operations. Exactly what you want done. And precisely how you want to do it.

Then even if you go for some other system, you'll be an informed buyer.

And it never hurts to know what you're doing.

### IBM just caught up. So can you.

With dBASE II, you'll get the same kind of system for your micro that IBM introduced a few months ago for their mainframes.

It's a relational DBMS, and that makes it different from any other micro system you've ever seen.

In a relational database, the data is organized as simple tables, with records as the rows and the data fields as the columns, much like your data is organized now. Data relations are logical, so that you can zero in on the specific information you want without knowing a thing about the pre-defined sets, pointers or other cumbersome structures of hierarchal and network DBMS's.

And unlike file management systems, dBASE II gives you program and data independence. You can change your database structure without re-entering your data and without reprogramming, or change some or all of your programs without touching your database. And the same database can be used for any number of different applications.

### dBASE II is a stand-alone applications development system.

You don't need an extra support language, because dBASE II comes with its own Applications Development Language (ADL). With ADL, you can use simple English-like statements to manipulate your data, or use built-in structured constructs to prepare sophisticated applications packages. It's simple and easy to use, yet extremely powerful.

You create a new database and start using it in a minute or less. Just type CREATE, then respond to system prompts to name the file and define the fields. Now enter the data.

Add data to an existing database instantly, whether your file has

10 records or 10,000 records, by typing APPEND, then entering the information.

UPDATE, MODIFY, JOIN and REPLACE whole databases or individual records and characters.

Add or delete fields in your database structure without re-entering all your data.

And with dBASE II, it's easy to get information out once you've put the data in.

Do automatic calculations on fields, records and databases with a few keystrokes.

Organize months' worth of data in minutes with REPORT (printing optional), and get your reports today instead of tomorrow. Use the built-in SORT, with single or multiple keys. Or INDEX your data, then FIND it in seconds, even with floppies.

You can use dBASE II interactively or store a sequence of commands to automate your accounting, billing, mailing lists or whatever data you have to manage.

### You'll wonder how you managed without it.

dBASE II is the most powerful, easiest to use DBMS you can get for a micro.

And instead of poring over the manual, you can run it hands-on, in-house to see exactly what it can do for you. Try it.

What have you got to lose? We even provide the label so you can send it back.

Ashton-Tate, 3600 Wilshire Blvd., Suite 1510, Los Angeles, CA 90010. (213) 666-4409.



# Ashton-Tate

©Ashton-Tate 1981

## News and Speculation About Personal Computing

Conducted by Sol Libes

**S**mall-Computer Confrontation: The battle lines are being drawn between small-computer suppliers and long-established, large-computer companies. Expect the first skirmishes next year. On one side are the microcomputer manufacturers led by Tandy Corporation, Apple Computer Inc, and Commodore Business Machines. On the other, there's IBM, DEC (Digital Equipment Corporation), HP (Hewlett-Packard), Xerox, and Data General. What is at stake is a market estimated at 300,000 units (not including sales to home users) that should exceed \$1 billion in sales in 1982.

Here's what's happening: the small-computer makers are introducing larger systems, while the large-computer makers are bringing out smaller systems. The small-computer makers are expanding and strengthening their marketing and distribution channels, while the large, established companies are crowding into the retail area with their own stores and the same outlets that the small-computer makers have been using. Therefore, both groups will soon be competing in the same price/performance areas.

A third factor that should become a significant presence in the market next year is the Japanese. They are expected to concentrate on the small-business market, at this time.

The key to success will be product marketing and distribution, rather than technology—ask IBM. While other manufacturers always

seem to have a technological edge, IBM supplies a total marketing program—sales, service, and support.

The Radio Shack division of the Tandy Corporation is expected to hold its own because of its firmly entrenched chain of stores. Presently, Radio Shack has 138 computer stores, 200 company-owned stores, and about 7000 franchises. However, the competition is spreading. Both DEC and IBM have more than two dozen stores in operation. Xerox, with fifteen stores, hopes to have twice that number within the coming year, while HP is expected to open several of its own. HP already sells through independent retailers, and DEC and IBM are expected to go this route along with their own retail outlets.

**S**tatus Report: 5-Inch Winchester Disks: Disk manufacturers are rushing into the 5-inch Winchester market with drives providing up to 13 megabytes of storage (unformatted) in the volume of a standard 5-inch floppy-disk drive. The early entrants into the market are Seagate Technology and Tandon Magnetics; both started shipping samples late last year. Other companies with 5-inch hard-disk products in the making are Shugart, International Memories, Irwin International, Olivetti, New World Computer, BASF, Computer Memories, and Rotating Memory Systems. Most companies are forwarding samples to OEMs (original

equipment manufacturers) and expect to be in limited production by year's end.

Capacities range from 2 to 13 megabytes, unformatted. Prices, per megabyte, range from \$90 to \$450 in 100-unit quantities (drive only), which compares favorably with 8-inch Winchesters, which currently cost \$50 to \$400 per megabyte in similar quantities. Although no standard interface has been developed, a number of manufacturers are providing Seagate-compatible interfaces.

**F**loppy- And Winchester-Drive Capacities Increasing: Iomega, Ogden, Utah, is expected to introduce a 10-megabyte 8-inch floppy-disk drive. It's rumored that Iomega plans to push this up to 100 megabytes. Persi is gearing up to produce a 6.4-megabyte dual 8-inch drive that fits in the same space as a Shugart 850 8-inch drive.

Seagate Technology has a new version of its 5-inch Winchester drive with capacities of 12.76 megabytes unformatted and 10 megabytes formatted. The 3M company has decided to enter the Winchester-drive market after making the media for years. It plans to introduce 10-, 20- and 60-megabyte 8-inch Winchesters.

**N**ew 8080/Z80 DOSes: There are three new disk operating systems (DOSes) for Intel's 8080 and Zilog's Z80 microprocessors. MuSys Corporation, Tustin, Califor-

nia, has introduced MuDOS, a CP/M-compatible DOS that provides a management system for handling multi-user access to the disk. MuDOS runs only on Z80-based systems and, MuSys claims, is six times faster than Digital Research's CP/M. The price will be in the \$300 to \$750 range depending on configuration.

Vortex Technology, Culver City, California, will introduce MARC, a UNIX-like DOS for 8080 and Z80 systems. Designed by Leor Zolman (the creator of the BDS C compiler) and Ed Ziemba, it initially boots under CP/M and has the UNIX-like, tree-structured file system replete with users, groups, protections, and the like. It also has a shell-type command interpreter, shell files (pipes), user-customization modes, and utilities. Vortex expects the system to provide for the transparent running of most existing CP/M programs as well as programs written for MARC. Projected price is \$175, and for another \$75, you can have either the BDS C or the MINCE editor.

InfoSoft, Westport, Connecticut, is introducing MULTI/os for 8080 and Z80 systems. MULTI/os will support up to sixteen users, with a shared data base of 975 megabytes and multiple disk controllers. Like the others, it also maintains CP/M compatibility.

**A**da And Little Ada Released: Telesoftware has finally released its Ada com-

# THE MAROT EXECUTIVE MENU

## THE COMPUTER SOLUTION FOR NON-COMPUTER PEOPLE

Now Marot brings you another delicious first: a menu-driven Information system so simple even a CEO can use it.

A single key-stroke takes you directly to the required application:

**DATA BASE MANAGER (CONTROL™):** a combined program generator that works with standard English query. That means it talks your language. So there's no need to learn a computer language or write a program to be a successful user.

**WORD PROCESSOR (MAGIC WAND™):** a powerful word processor that allows full screen creation and editing of files. It also produces true proportional spacing, microjustification and kerning. In addition, documentation can be fully examined at the CRT prior to printing.

**ACCOUNTING:** consists of several complete business packages either in standard ANSI '74 COBOL or OASIST™ BASIC, including accounts receivable and payable, general ledger, payroll, order entry and inventory. Financial modeling and job costing are also available.

**MAILING LIST (POSTMAN™):** delivers up to 65,000 entries in zip and name order and is completely interactive with MAGIC WAND.

**SCHEDULER:** maintains a complete office diary with ability to compare schedules.

Although the Marot Menu appears simplistic, it also incorporates OASIS with user logons, accounting histories and password protection. Languages available include JCL (EXECUTIVE), BASIC, PASCAL, COBOL and FORTRAN.

As a result, the Marot Executive Menu is a tasty pleasure for the higher-ups and the higher-techs.

### A la carte extra

**OPSCAN SERVICE™:** available exclusively from Marot. Send us your well-printed or typed files. We'll read them directly into MAGIC WAND at a speed that would take 20 typists to match. The cost is less than conventional typing and the turn-around is never more than 5 days.

CONTROL and OASIS are trademarks of Phase One Systems Inc.  
POSTMAN is a trademark of Marot Systems Inc.  
OPSCAN SERVICE is a trademark of Marot Systems Inc.  
MAGIC WAND is a trademark of Retail Sciences Inc.



### MAROT SYSTEMS INC.

310 Madison Avenue, Suite 408, New York, N.Y. 10017  
(212) 661-8550 TWX: 710-581-2477

I'd like to order more information on

MAROT MENU  OPSCAN SERVICES.

I am a  computer consultant

computer dealer  computer user  CEO

Name \_\_\_\_\_

Title \_\_\_\_\_

Address \_\_\_\_\_

City/State/Zip \_\_\_\_\_

piler. This is the first implementation of Ada on a microcomputer. The first release is for a 16-bit Motorola 68000 machine and provides most of the features called for in the Department of Defense Ada standard. Telesoftware hopes to add the missing features in the future. A single-user license is \$2000.

For \$50, you can obtain a "Little Ada" compiler and interpreter for 8080/Z80-based systems that executes the primary Ada functions. With it, you can get a feel for what Ada is all about. While the compiler is furnished in object-code form, the L-machine run-time interpreter is furnished in source-code form. For more information, contact Ralph Kenyon, 145-103 S Budding Ave, Virginia Beach VA 23452.

**TEC To Make TRS-80s In Japan:** Tokyo Electric Company (TEC) will manufacture and sell the TRS-80 Model I in Japan through a new agreement with Tandy Corporation. TEC will also market the TRS-80 Models II and III, and the Color units. Tandy stopped the manufacture and sale of the Model I in the US because it did not comply with the FCC (Federal Communications Commission) RF (radio frequency) radiation requirements. TEC is a division of Toshiba, which manufactures its own personal computer.

**AT&T And Publishers Clash Over Electronic Information Test:** Newspaper publishers in Texas have gone to court to prevent AT&T (American Telephone and Telegraph) from testing its "Electronic Information Service" (EIS). The publishers contend that

AT&T is creating a monopoly whereby subscribers would not be properly served. AT&T counters that EIS will be a service from a new company with separate assets. However, the publishers feel that this is a juggling act and a violation of a 1956 Justice Department ruling that stopped AT&T from providing data-processing services of any kind.

The test was to be conducted in Austin, Texas. It was intended to be the prelude to a nationwide information-processing service that would bring yellow-page listings and advertising into the home through television sets.

**Software Broadcast Via Radio:** Radio Netherlands will experimentally broadcast a short computer program this September tenth. The program will be aired in three different formats (TRS-80, Apple II, and PET). Listeners will be able to record the FM broadcast onto a cassette tape and then play it back into their computer systems. The broadcast will be heard in Australia, Europe, Africa, and North America. For information on frequencies and times, write to Computer Experiment, Media Network, Radio Netherlands, POB 222, 1200 JG Hilversum, Holland.

**IEEE-696/S-100 Standard Out Of Committee:** After three years, the IEEE (Institute of Electrical and Electronics Engineers) 696/S-100 Bus Standard Committee has submitted a finished standard to the IEEE's computer-standard adoption committee. The standard is now complete and formal adoption is expected early in 1982.

**Random News Bits:** Sinclair will replace the ZX80 with the ZX81. The ZX81 contains only four integrated circuits in place of the ZX80's twenty-two. The price will drop significantly.

... Apple Computer has signed a lease for a 160,000-square-foot plant in Carrollton, Texas. Apple plans to add 700,000 square feet of manufacturing space during the next twelve months. Tandy will open a fourth TRS-80 plant in San Antonio, Texas, adding 400,000 square feet of manufacturing space.

... Zenith reported that its Heath division had sales of \$104 million last year. Zenith's total sales were \$1.186 billion, with color television sales of \$774 million leading the way.

... Integrated-circuit makers are sharply reducing prices on EEPROMs (electrically erasable, programmable read-only memories). Prices currently average \$115 for 1 K by 8-bit devices and \$67 for the 512 by 8-bit variety, in 100-unit lots. The parts boast a 500 ns access time and 10-year data retention.

... Intel's profits for the first quarter of 1981 were down 91.3%. The decline is attributed to the falling price of memory devices. As a result, Intel plans to cut capital spending by \$30 million. ... Pick & Associates, developer of the Microdata Disk Operating System, is working with Intel on the disk operating system for the 32-bit iAPX-432 microprocessor. It's currently running on Hewlett-Packard, ADDS, Honeywell, ECSC, and Microdata minicomputer systems. Pick is also working on a Motorola 68000 implementation. ... Intel has reduced the price of the 8085 microprocessor to \$4 in large quantities and to under \$5 in 100-unit lots. Intel wants to compete with other

suppliers of the same part (NEC, Toshiba, Mitsubishi, and Siemens) and outrun competition from Zilog's Z80 microprocessor.

**Random Rumors:** IBM is rumored readying two under-\$1000 personal-computer systems at its Raleigh, North Carolina, facility. One system attaches to the telephone line and serves as a home-information system (bank-at-home, teleshoping, etc). The other is a very-small-business system aimed at the professional market (lawyers, doctors, etc). Neither system will be as versatile as a stand-alone product because IBM does not want to hurt its regular systems sales. Also, IBM is said to be developing an under-\$5000 small-business system aimed at competing with the Apple II, TRS-80, and PET. ... DEC reportedly has working prototypes of its Tiny-11, which blends into one integrated circuit the current four-device set of the LSI-11/2. Industry pundits say it works with standard memory and I/O (input/output) devices. ... Zilog is rumored developing a 32-bit microprocessor for introduction by mid or late 1982.

... Later this year, you can expect a removable 1-megabyte bubble-memory cassette from Intel. Fujitsu introduced 8 K- and 32 K-byte bubble cassettes last year. Plan on National Semiconductor to introduce an 8 K-byte bubble cassette and cassette unit with controller in the \$2000 to \$3000 range. ... Rumors from all over: Expect an under-\$2000 small-business computer from Sony to include a Z80, 64 K bytes of programmable memory, video display, 1.2 megabytes of floppy-disk storage, and a printer port. ... Vector Graphic,



# R&D COMPUTER SYSTEMS

## Data Acquisition & Control Systems

16 to 256 ch.; Programmable gain; Voltage or current output;  
12, 14, or 16 bit; 30 to 125 KHz; Stepping motor control

## 8086 16 Bit Micro Systems

31 MByte Winchester Drives  
256 KByte Memory Boards  
8086 Software

## Real Time Video Digitization Systems



### S-100 Boards

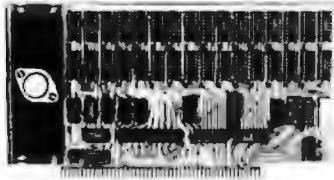

**16 Kilobyte Static RAM**  
8 and 16 bit transfer



**8086 CPU with Vectored Interrupts**

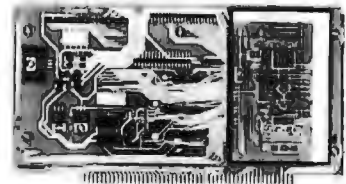

**Analog to Digital Converter and Timer/Counter**  
16 channels expandable to 256  
12, 14, or 16 bit accuracy  
30,40,100,or 125 KHz  
Programmable Gain

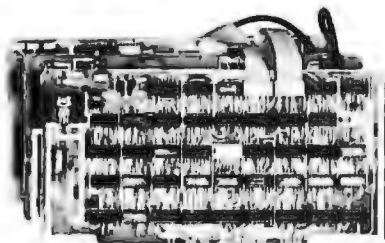

**Real Time Video Digitizer and Display**

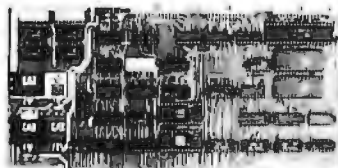

**PROM and I/O**  
2 RS 232 - PIO  
CP/M-86 ROM Boot

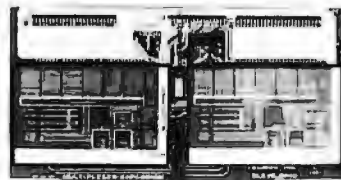

**Expansion Multiplexer**

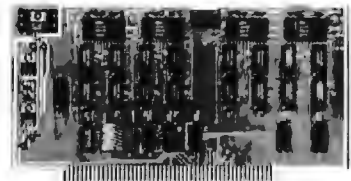

**Digital to Analog Converter**  
4 channels - 12 bit accuracy  
3 microsecond conversion rate

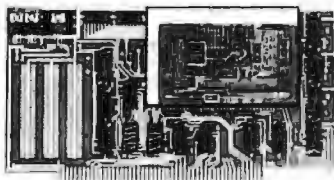

**Analog to Digital Converter**  
16 channels - 12 bit accuracy  
30 KHz Conversion rate

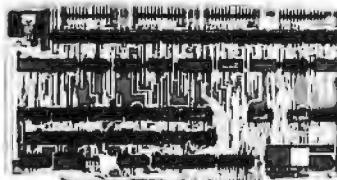

**4 PIO and Timer/Counter**

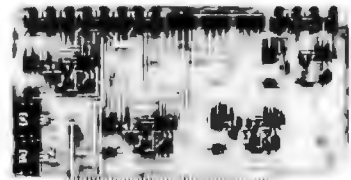

**Digital to Analog Companion**  
4-20 mA output - Filters

### Apple Boards

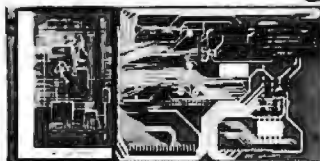

**Analog to Digital Converter**  
16 channels  
12, 14, or 16 bit accuracy  
30, 40, 100, or 125 KHz

**Digital to Analog Companion**  
4-20 mA output - Filters



**Digital to Analog Converter**  
2 channels - 12 bit accuracy  
3 microsecond conversion rate  
1 parallel output port



**TECMAR**  
INC.

23600 Mercantile Rd. • Cleveland, OH 44122

**TECMAR, INC.**  
(216) 464-7410

## BYTELINES

boasting sales in the \$30 million range, will go public with a stock offering this summer. It is also developing a Z8000-based system. . . Cromemco is working on an IBM-compatible tape-drive unit to serve as a backup for hard disks. It's also working on a 68000-based S-100 microprocessor card. . . Godbout Electronics, which recently introduced a 128 K-byte S-100 programmable memory card, is now ready to unveil a 256 K-byte version. . . Sperry Univac may be the first customer for Intel's new 32-bit microprocessor. . .

**Apology:** I must apologize to MicroDaSys, Los Angeles, California. In the March 1981 "BYTELINES" (see page 242), I gave credit to another company for having the first 16-bit system using the new Motorola

68000 microprocessor. MicroDaSys was actually first, advertising its 68000 system in the September 1980 BYTE.

The MicroDaSys "68 K MiniFrame" contains a 68000, 6809 memory manager (for true virtual-memory operation), 512 K bytes or 2 megabytes of programmable memory, disk controller, memory parity, and ten I/O ports. The system operates at 8 MHz and, the company claims, is faster than the DEC PDP-11/45.

**Personal Computer With 768 K Bytes Of Memory:** Southwest Technical Products (SwTPC) will release a new 6809-based personal computer that can address up to 768 K bytes of memory. Also slated to be introduced are hard-disk systems of 32 and 300 megabytes that are chainable—

the maximum number has not been determined. Lastly, SwTPC will market a 32-terminal I/O (input/output) board for the system. The system will run the TSC (Technical Systems Consultants) Uniflex operating system supporting 32 users.

SwTPC has come a long way from its first personal computer, which had 4 K bytes of memory, audio-cassette storage, and a 2 K-byte BASIC interpreter.

**Intel Seeks Injunction:** Intel is seeking an injunction against Seeq Inc, Milipitas, California. The suit seeks to temporarily bar Seeq from making devices similar to Intel's 2864, a 64 K-bit EEPROM (electrically erasable, programmable read-only memory) that may be marketed later this year. Seeq was started by four former Intel staffers who

had worked in Intel's special-products division while the 2864 was being developed. Seeq intends to develop nonvolatile memory devices.

**MAIL:** I receive a large number of letters each month as a result of this column. If you write to me and wish a response, please include a self-addressed, stamped envelope.

**Sol Libes**  
**POB 1192**  
**Mountainside NJ 07081**

SAVE \$\$

DISCOUNT PRICES

SAVE \$\$



**apple computer**

|                    |         |
|--------------------|---------|
| 16K APPLE II       | 1089.00 |
| 32K APPLE II       | 1134.00 |
| 48K APPLE II       | 1179.00 |
| DISK W/CONTROLLER  | 535.00  |
| DISK ONLY          | 455.00  |
| APPLESOFT CARD     | 159.00  |
| INTEGER CARD       | 159.00  |
| PASCAL SYSTEM      | 425.00  |
| SILENTYPE PRINTER  | 525.00  |
| HAYES MICROMODEM   | 295.00  |
| Z-80 SOFTCARD      | 295.00  |
| VIDEX 80 COL. BRD. | 295.00  |
| 16K RAM BOARD      | 169.00  |

### RAM MEMORY

|                         |       |
|-------------------------|-------|
| FOR TRS-80, APPLE II    |       |
| 16K SET 4116's (200 NS) | 34.95 |



**ATARI**

|                      |         |
|----------------------|---------|
| 400 16K              | 349.00  |
| 800 16K              | 759.00  |
| 410 Recorder         | 64.00   |
| 815 Disk             | 1199.00 |
| 810 Disk             | 489.00  |
| 822 Printer          | 359.00  |
| 825 Printer          | 779.00  |
| 830 Modem            | 159.00  |
| 850 Interface Module | 179.00  |
| CX853 RAM            | 85.00   |
| CX70 Light Pen       | 64.00   |
| CX30 Paddle          | 18.00   |
| CX40 Joystick        | 18.00   |

### VERBATIM DISKETTES

|                  |       |
|------------------|-------|
| Box of 10 5 1/4" | 29.50 |
| Box of 10 8"     | 39.50 |



**North Star Computers**

|                  |         |
|------------------|---------|
| HR2-2D-32K       | 2795.00 |
| HR2-2D-48K       | 2956.00 |
| HR2-2D-64K       | 3145.00 |
| HR2-2Q-32K       | 2975.00 |
| HR2-2Q-48K       | 3165.00 |
| HR2-2Q-64K       | 3360.00 |
| HRAM 32K         | 469.00  |
| HRAM 48K         | 662.00  |
| HRAM 64K         | 849.00  |
| HDS-18 HARD DISK | 4025.00 |
| MDS-DRV-D        | 495.00  |
| MDS-DRV-Q        | 665.00  |
| ADC-1-D          | 740.00  |
| ADC-2-D          | 995.00  |
| ADC-1-Q          | 795.00  |
| ADC-2-Q          | 1285.00 |

### PRINTERS

|                        |         |
|------------------------|---------|
| EPSON MX-70            | 399.00  |
| EPSON MX-80            | 499.00  |
| EPSON MX-80 FT         | 599.00  |
| GRAFTRAX               | 90.00   |
| INTERFACE (APPLE)      | 75.00   |
| CABLE                  | 22.50   |
| CENTRONICS 737-1       | 795.00  |
| CENTRONICS 737-3       | 855.00  |
| IDS 445G               | 815.00  |
| IDS 460G               | 1195.00 |
| IDS 560G               | 1450.00 |
| NEC 5510 W/TRACTORS    | 2650.00 |
| NEC 5520 KSR W/TRAC.   | 2995.00 |
| QUME 5/45 SPRINT       | 2675.00 |
| FORMS TRACTOR          | 195.00  |
| STARWRITER W/TRAC.     | 1695.00 |
| STARWRITER W/O TRACTOR | 1500.00 |

### General Information:

We carry a large selection of hardware and software by other companies. Send for our catalog.

We are an authorized repair center for APPLE, ATARI, NORTH STAR, AND EPSON.

PRICES SUBJECT TO CHANGE WITHOUT NOTICE. MARYLAND RESIDENTS ADD 5% SALES TAX

**FREDERICK  
COMPUTER  
PRODUCTS, INC.**

5726 INDUSTRY LANE  
FREDERICK, MD. 21701

**Store Hours:**  
MON. THRU THURS. 9:30 AM—9:00 PM  
FRI. AND SAT. 9:30 AM—5:00 PM

**TO ORDER CALL: (301) 694-8884**

# Teach your little Apple big-time electronic mail.

New York

Los Angeles



For the first time, you can move just about anything in your Apple II™ computer to any other Apple™, anywhere in the world. Micro-Courier™ allows you to electronically mail charts, graphs, correspondence, VisiCalc® reports and entire programs. You

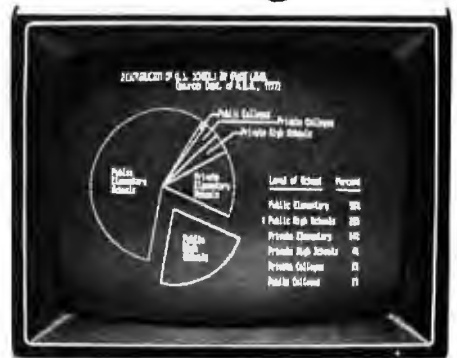

spend far less time on the phone. And, in a matter of moments, you transmit material the Post Office takes days to deliver.

Unlike traditional electronic mail, Micro-Courier doesn't require expensive central computers or special phone lines. Using standard lines, you benefit in two important ways. First, you communicate outside your company, not just within it. And second, you realize tremendous savings on late-night rates. Micro-Courier takes advantage of them automatically, without anyone in attendance.

What's more, Micro-Courier will exchange data with time-sharing systems and larger computers. Even if you don't own an Apple, Micro-Courier is the best reason in years to go out and get one. Call our toll-free number today. And make your little Apple heard 'round the world.

## MICROCOM

We make little computers talk big.

Call 800-547-5995, ext. 188, toll-free, for the Micro-Courier-Apple dealer nearest you.

Microcom, Inc., 89 State Street, Boston, MA 02109. (617) 367-6362

Apple and Apple II are trademarks of Apple Computer, Inc. VisiCalc is a trademark of Personal Software, Inc.

# Building Data Structures in the Smalltalk-80 System

---

James C Althoff Jr  
Learning Research Group  
Xerox Palo Alto Research Center  
3333 Coyote Hill Rd  
Palo Alto CA 94304

---

Most programmers are exposed to the concept of data structures very early in their programming experience. A course in data structures is an integral part of most computer science curricula, and there are many excellent and widely used texts on the subject (see references 1, 2, and 4). The data structures covered in these texts generally include the linear list, stack, queue, tree, and graph.

In this article, we will define and implement some of the simplest structures, including the linear list, stack, and queue. Our approach will be to describe each data structure informally, and then to show a Smalltalk-80 class definition that closely matches this informal description. We will see that it is possible, using the class construct, to create programming structures that clearly mirror the entities being implemented. However, in order to demonstrate how to build these data structures from scratch, we will not make use of any of the advanced data structure classes that already exist in the Smalltalk-80 system.

We will make extensive use of the Smalltalk-80 subclass mechanism in the class definitions we introduce. We will use subclassing to facilitate the construction of different implementations of the same entity. In addition, we will see how the subclass mechanism enables us to define two or more related classes in such a way

that the common parts of their definition can be shared.

## Notation

In order to understand the program examples presented in this article, the reader should have some familiarity with the Smalltalk-80 programming language. For an introduction to the language and a fuller discussion of subclasses, see "The Smalltalk-80 System," on page 36. In addition, a text box on page 240 of this article contains a brief description of some of the messages that we will use in the examples.

---

## **The advantage of the sequential list is that it is easy to access and replace an arbitrary item in the list.**

---

For each data structure that we describe, we will give a corresponding Smalltalk-80 class definition. Each class definition will be presented in the form of a template that shows the instance variables, messages, and other information associated with the class. (A complete description of the template can be found in the article mentioned above.)

The messages defined in the template are partitioned into two main groups. The first comprises the

class messages. These are messages that are sent to the class itself (which is, in actuality, an object). For our purposes, these will be a set of creation messages that can be sent to the class in order to create a new, initialized instance of the class. The second group consists of a set of messages that can be sent to instances of the class. These will be divided into two more groups. The first is a collection of external messages that represent the interface between an instance of the class and clients (ie: other objects in the system) of that instance. The second is a set of internal messages used in methods that are defined in the class or a subclass but are not intended for wider use. Note that the distinction between internal and external messages is made for conceptual clarity. The Smalltalk-80 programming language does not have a mechanism for controlling message usage.

An example of a class definition is given in table 1. This template defines a class whose name is `Card`. An instance of class `Card` can be used to represent a card in a game program. Class `Card` has instance variables named `suit`, `rank`, and `faceUp`. A new instance is created by sending class `Card` the creation message `suit:rank:`. For example:

```
|aCard|  
aCard -- Card suit: 'heart' rank: 7.
```

# Color computer owners, 32K PLUS DISKS\* \$298.00

Yes, that's right - for as little as \$298.00 you can add 32K of dynamic RAM, and a disk interface, to your TRS-80 Color Computer! If you just want the extra memory it's only \$199.00, and you can add the disk interface later for \$99.00.

Just plug the *Color Computer Interface (CCI)*, from Exatron, into your expansion socket and "Hey Presto!" - an extra 32K of memory. No modifications are needed to your computer, so you don't void your Radio Shack warranty, and Exatron give both a 30 day money-back guarantee and full 1 year repair warranty on their interface.

The CCI also contains a 2K machine-language monitor, with which you can examine (and change) memory, set break-points, set memory to a constant and block-move memory.

So what about the *CCI Disk Card*? Well as we said it's only an extra \$99.00, but you'll probably want Exatron's *CCDOS* which is only \$29.95 - unless you want to write your own operating system. The *CCI Disk*

*Card* uses normal TRS-80 Model I type disk drives, and *CCDOS* will even load Model I TRSDOS disks into your color computer - so you can adapt existing TRS-80 BASIC programs.

As a further plus, with the optional *ROM Backup* adaptor, you can dump game cartridges to cassette or disk. Once the ROM cartridge is on cassette, or disk, you can reload, examine and modify the software. The *ROM Backup* adaptor is only \$19.95.

For more information, or to place an order, phone Exatron on their Hot Line 800-538 8559 (inside California 408-737 7111), or clip the coupon.



*excellence in electronics*

**exatron**

## DEALER ENQUIRIES INVITED

Exatron,  
181 Commercial Street,  
Sunnyvale, CA 94086



- Please send a 32K Color Computer Interface for \$199.00
- Please send a CCI Disk Card for \$99.00
- Please include CCDOS and manual for \$29.95
- Also include a ROM Backup adaptor for \$19.95

Please add \$5.00 for shipping to all orders, and 6 percent sales tax in California.

Name .....

Address .....

City .....

State ..... Zip .....

Charge my:

MasterCard Interbank Code .....

Visa Expiration Date .....

Card .....

Check enclosed for .....

Ship COD (\$2.00 extra)

Signature .....



# SOFTWARE FREE OFFER

WITH PURCHASE OF ANY 3 PROGRAMS, YOU WILL RECEIVE FREE THE ORIGINAL ADVENTURE GAME, CONVERTED TO LOAD ENTIRELY INTO 48K RAM ON APPLE. NOTHING LEFT OUT. AMAZING!

## APPLE SOFTWARE

### DISCOUNTS FROM 10% TO 30%

- MAGIC WINDOW .....\$99.95 SALE \$89.50
- SUPER TEXT 11 .....\$150.00 SALE \$135.50
- APPLE PIE (40 OR 80 COL).....\$129.95 SALE \$119.50
- SUPERSCRIBE.....\$99.95 SALE \$94.50
- EASY WRITER 80 COL.....\$250.00 SALE \$225.50
- DB MASTER (STONEWARE).....\$229.00 SALE \$199.00
- PAYROLL (BRODERBUND).....\$395.00 SALE \$359.50
- MODIFIABLE DATABASE.....\$79.50 SALE \$69.50
- MAILING LIST DATABASE.....\$50.00 SALE \$34.50
- GEN. LEDGER (CONT.).....\$175.00 SALE \$140.50
- ACCT RCVBLE (CONT.).....\$175.00 SALE \$140.50
- ACCT PAYABL (CONT.).....\$175.00 SALE \$140.50
- PPTY MANGMT (CONT.).....\$175.00 SALE \$140.50
- VISICALC 3.3 (PERSONAL).....\$199.95 SALE \$169.50
- HOME MONEY MINDER.....\$34.95 SALE \$29.50
- WIN AT RACES (HANDICAP).....\$39.95 SALE \$35.50
- L A LAND MONOPOLY.....\$39.95 SALE \$25.50
- WARP FACTOR.....\$39.95 SALE \$35.50
- ZORK.....\$39.95 SALE \$35.50
- MISSION ASTEROID.....\$19.95 SALE \$17.50
- PRO FOOTBALL POINT PRED.....\$29.95 SALE \$22.50
- ODYSSEY ADVENTURE.....\$30.00 SALE \$26.50
- COMPU-MATH ARITHMETIC.....\$49.95 SALE \$39.50
- COMPU-MATH FRACTIONS.....\$39.95 SALE \$35.50
- COMPU-MATH DECIMALS.....\$39.95 SALE \$35.50
- COMPU-SPELL
- (REG. DATA DISK).....\$29.95 SALE \$25.50
- DATA DISK LEVEL 4.....\$19.95 SALE \$16.50
- DATA DISK LEVEL 6.....\$19.95 SALE \$16.50
- DATA DISK SECRETARIAL.....\$19.95 SALE \$16.50
- STATISTICS 3.0.....\$29.95 SALE \$25.50
- PERCEPTION 3.0.....\$24.95 SALE \$22.50
- ALGEBRA 1.....\$39.95 SALE \$33.50
- SPACE EGGS.....\$29.95 SALE \$25.50
- ALIEN RAIN (GALAXIAN).....\$24.95 SALE \$22.50
- ALIEN TYPHOON.....\$24.95 SALE \$22.50
- SNOGGLE (NEW PUCKMAN).....\$24.95 SALE \$22.50
- WIZARD AND THE PRINCESS.....\$32.95 SALE \$29.50
- MYSTERY HOUSE.....\$24.95 SALE \$22.50
- PULSAR 11.....\$29.95 SALE \$25.50
- ORBITRON.....\$29.95 SALE \$25.50
- GAMMA GOBLINS.....\$29.95 SALE \$25.50
- HI-RES SOCCER.....\$29.95 SALE \$25.50
- SARGON 11.....\$34.95 SALE \$29.50
- ADAMS ADVENTURE #1,2,3.....\$39.95 SALE \$34.50
- ADAMS ADVENTURE #4,5,6.....\$39.95 SALE \$34.50
- ADAMS ADVENTURE #7,8,9.....\$39.95 SALE \$34.50
- ADVENTURE HINT BOOK.....\$7.95 SALE \$6.50
- TEMPLE OF APSHI.....\$29.95 SALE \$24.50
- HELLFIRE WARRIOR.....\$29.95 SALE \$24.50
- FASTGAMMON.....\$24.95 SALE \$22.50
- THREE MILE ISLAND.....\$39.95 SALE \$35.50
- PHANTOMS FIVE.....\$29.95 SALE \$25.50
- E-Z DRAW 3.3.....\$49.95 SALE \$39.50
- THE PRISONER.....\$29.95 SALE \$25.50
- TERRORIST.....\$29.95 SALE \$25.50
- SPACE.....\$29.95 SALE \$25.50
- A.B.M.....\$24.95 SALE \$22.50
- CYBER STRIKE.....\$39.95 SALE \$34.50
- FLIGHT SIMULATOR.....\$35.50 SALE \$31.50
- AUTOBAHN.....\$29.95 SALE \$25.50
- GALACTIC TRADER.....\$24.95 SALE \$22.50
- Z-80 SOFTCARD.....\$349.00 SALE \$299.50
- 16K RAM CARD.....\$195.00 SALE \$175.50
- M/R SUPERTERM 80 COL.....\$375.00 SALE \$325.50

★ SEND FOR FREE PRICE LIST & CATALOG ★

DEDUCT 3% IF PAYMENT ACCOMPANIES ORDER. WE PAY SHIPPING AND IF YOU PHONE YOUR ORDER WE WILL CREDIT \$1.00 FOR CALL. CALIFORNIA RESIDENTS ADD 6% SALES TAX. ALL ORDERS SHIPPED FROM STOCK WITHIN 48 HOURS. WE ACCEPT MASTER CARD AND VISA.

NAME .....

STREET .....

CITY ..... STATE ..... ZIP .....

CARD # ..... PHONE .....

EXP DATE ..... SIGNATURE .....

★ P.O. BOX 796, DEPT B-6, TWIN PEAKS, CA 92391 ★

**PHONE ORDERS (714) 886-0761**

Circle 256 on Inquiry card.

creates a new instance of Card that represents the seven of hearts. In the method for `suit:rank:`, the message `new` creates an uninitialized instance. The internal message `setSuit:setRank:` sets the suit and rank fields and initializes the new instance to be "face down." Given an instance of class Card, we can determine its suit, rank, and orientation, and change the latter using the external messages specified in the class definition. Because we do not want to be able to change the suit and rank of an instance once it has been created, we do not include a message for doing this operation in the set of external messages.

The methods shown here demonstrate a convention we will use in subsequent examples. All of the names that we use for parameters and local variables will be formed by taking the name of a class and preceding it with an indefinite article. For example, the two parameters to the message `setSuit:setRank:` are named `aString` and `anInteger`. Such a name indicates what kind of object is expected as the value of the parameter or local variable to which the name refers. Smalltalk-80 has no

type-checking; this is only a convention to help make the examples more understandable.

We will now examine a number of elementary data structures and their implementation with Smalltalk-80 classes. In the informal description of each data structure, we will include a list of operations that are meaningful for that structure. We will then show a corresponding class definition whose external messages match the listed operations. The details of the implementation of the data structure will be hidden in the class definition. We will see how this process enables us to define different classes that reflect different implementations of the same basic data structure.

### The Linear List

The first data structure we will examine is the *linear list*. A linear list is a sequence of data items that have, essentially, a one-dimensional relationship to one another (see figure 1). That is to say, given an object in the sequence, we can find the object that precedes or follows it. For example, if we have a program that deals with a game of cards, we might represent

|                               |  |
|-------------------------------|--|
| class name                    | Card   |
| superclass                    | Object   |
| instance variable names       | suit rank faceUp   |
| class messages and methods    | <p><b>suit: aString rank: anInteger</b>   aCard  <br/> aCard ← self new. aCard setSuit: aString setRank: anInteger.<br/> ↑ aCard.</p>  |
| instance messages and methods | <p><i>external</i><br/> <b>suit</b>     ↑ suit.<br/> <b>rank</b>     ↑ rank.<br/> <b>turnFaceUp</b>     faceUp ← true.<br/> <b>turnFaceDown</b>     faceUp ← false.<br/> <b>turnOver</b>     faceUp ← faceUp not.<br/> <b>isFaceUp</b>     ↑ faceUp.<br/> <b>isFaceDown</b>     ↑ faceUp not.</p> <p><i>internal</i><br/> <b>setSuit: aString setRank: anInteger</b>    <br/> suit ← aString. rank ← anInteger. self turnFaceDown.</p> |

Table 1: Class template for class Card.

# SUPERBRAIN® & COMPUSTAR™ USERS' GROUP



JOIN SUPER★STAR INTERNATIONAL FOR THE REGULAR YEARLY MEMBERSHIP FEE AND RECEIVE A FREE DISKETTE WITH THE FOLLOWING PROGRAMS:

- ★ "RECOVER", it allows you to recover an erased program.
- ★ "AUTO LOAD", it enables you to load and run a program automatically.
- ★ "RETURN", it gets you back into a crashed program from CP/M'.
- ★ the game "OTHELLO".

Since our first ad in March 1981, we have been contacted from as far away as South America, Europe, Australia, and Indonesia. Super★Star International is becoming a world-wide family whose members will enjoy the benefits of a wide range of hardware and software developments.

Our full color, monthly magazine will print a free program in every issue—programs like an appointment calendar and personal finance record keeping. You'll also find technical information, tips for beginners, special business uses, equipment reviews, and the Intertec Story—the people, ideas, and machines behind your computer.

**WE GIVE YOU VALUE!** Purchase just one commercial program and you will save more than the price of our membership fee. Rent a car or stay in a hotel offered in our discount program and save even more, not to mention insurance discounts, a market place for your personal software, and a shoulder to lean on if something isn't working quite right.

Super★Star International—with savings, service, and efficiency—we're here to win your heart.

## WE NOW OFFER A WIDE RANGE OF PRODUCTS

A few may still be under development at the date of this issue.

### SOFTWARE

- ★ DIAGNOSTICS—for the CPU, Memory, Disk Drives and more
- ★ WORD PROCESSING—WordStar®, MailMerge®, WordMaster®, Magic Wand®
- ★ LANGUAGES—COBOL, FORTRAN, Pascal, FORTH, BASCOM Compiler®
- ★ UTILITIES—Assemblers, Disassemblers, Monitor
- ★ GAMES—Chess, Adventure, Star Trek, Analiza®, and more
- ★ BUSINESS—Real Estate Acquisition Package; Systems Plus®, Peachtree®, and other Accounting Packages; Plus the most powerful, easy to use business package, which automatically updates all information at the point of entry; SuperSort®, DataStar®, dBASE II®, FMS-80®

### HARDWARE

- ★ S-100 Adaptor
- ★ External Controls
- ★ Add-on Disk Storage

### ENHANCEMENTS

- ★ Upgrades for ALL SuperBrains
- ★ SuperDOS (Fantastic!)
- ★ Add-on character sets—including graphics
- ★ MTT Upgrade for the Intertube

# SUPER★STAR™

INTERNATIONAL CORPORATION

P. O. Box 33675, Northglenn, CO 80233 ★ (303) 526-1050

Dealers are invited to contact us concerning a special dealer program.



Charge membership by phone

© 1981 SUPER★STAR INTERNATIONAL. ALL RIGHTS RESERVED. SUPER★STAR INTERNATIONAL IS A REGISTERED TRADEMARK OF SUPER★STAR INTERNATIONAL. SUPER★STAR INTERNATIONAL IS A REGISTERED TRADEMARK OF SUPER★STAR INTERNATIONAL. SUPER★STAR INTERNATIONAL IS A REGISTERED TRADEMARK OF SUPER★STAR INTERNATIONAL.

Yearly membership fee is \$50.00 U.S., \$50 Canada, \$74 Europe & So. America, \$81 Australia, Mid East & Asia.

Your fee may be tax deductible.

Send checks with your name and address, made out to: Super★Star International. (U.S. Currency)

I would like to join Super★Star International. Enclosed in my check for \$\_\_\_\_\_

Name \_\_\_\_\_ Company \_\_\_\_\_

Address \_\_\_\_\_ Phone \_\_\_\_\_

City/State/Zip \_\_\_\_\_

Computer Model \_\_\_\_\_ Version \_\_\_\_\_

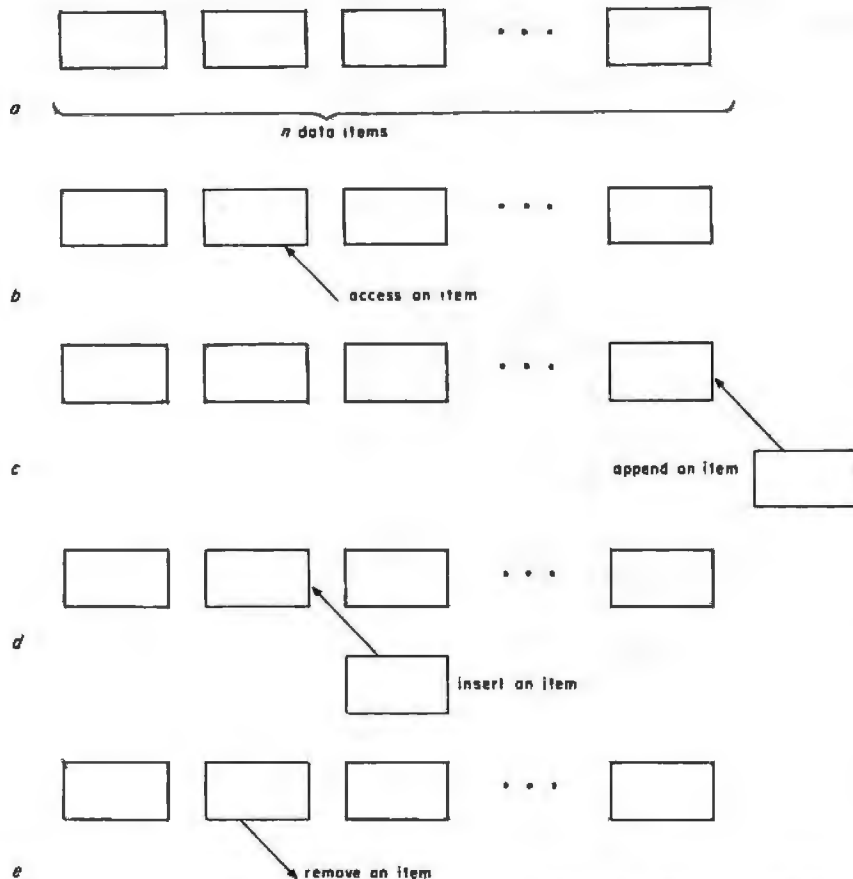

**Figure 1:** A linear list (1a) is a collection of objects arranged in linear sequence. Permissible operations include accessing (1b), appending (1c), inserting (1d), and removing an item (1e).

each card hand as a linear list of cards.

The operations that we might want to perform on a linear list include:

- determine how many items are in the list
- determine whether or not the list is empty
- access the  $i$ th item in the list
- append an item to the end of the list
- insert an item at some position in the list
- replace an item at some position in the list with some other item
- remove an item from the list

In order to implement a linear list of data items, we need to implement both the data items and the linear list. In all of our subsequent examples, we will assume that we have implemented the data items with one or more class definitions (eg: class Card). When we are describing things in general, we will use such terms as "data item" and "linear list." When we are describing a specific implementation, we will refer instead to the "object" (or "instance of a class") that represents the entity under consideration.

Linear lists are partly defined in the template given in table 2. Class `LinearList`, as defined in table 2, is incomplete since there is no mechanism for actually storing objects that represent data items. This is because there are several different strategies for storing these objects in a linear list. For each strategy, we will define a different class, each of which is a subclass of `LinearList`. All of these classes have some characteristics in common; these are captured in the superclass `LinearList`. For example, because all of the subclasses that we

# DOCUMATE/PLUS<sup>T.M.</sup>

## Indexes and Sorts WordStar<sup>T.M.</sup>

### DocuMate/Plus<sup>TM</sup> Features ...

- 8-Level Indexing
- Table of Contents Generation
- New Self-Contained Sort Feature
- "See" and "See Also" References
- New Output Format Control
- New Cross-Documents Index Generation

DocuMate/Plus generates completely collated tables of contents and alphabetical multi-level indexes from WordStar<sup>TM</sup> text files of any length ... as detailed as you desire.

DocuMate/Plus is refreshingly easy to use, and its internal sort feature can save you the cost of an expensive stand-alone sort program. Just type simple DocuMate commands right into your text file. DocuMate/Plus's "Extract" feature automatically finds and places all index references in a separate work file for sorting and collating.

DocuMate/Plus builds master indexes for many documents, such as research notes, books and articles, speeches, hardware and software documentation, and business correspondence

**DocuMate/Plus is today's most flexible indexing program available for professional word processing.**

DocuMate/Plus is available on standard 8" CP/M and 5¼" Northstar diskettes.

- DocuMate/Plus Program with Manual ..... \$125.00
- Manual Only ..... \$ 10.00
- Special Pricing to update existing DocuMate users.

# ORTHO CODE

The Textware Company

THE ORTHOCODE CORPORATION  
P.O. Box 6191 • Albany, CA 94706  
(415) 832-8175

• WordStar is a trademark of MicroPro International • CP/M is a trademark of Digital Research



# CompuServe is a lot more than fun and games and news.

Although we're probably best known for our consumer-oriented services, CompuServe maintains powerful services for the serious computer user. CompuServe has helped some of the nation's largest companies and financial institutions through a wide range of business and scientific-oriented computer programs. With our Information Service, we can extend this expertise to you. Here are some of the programs available to the personal computer user through the CompuServe Information Service:

**PASCAL:** DEC User Group version of this famous language.

**XF4:** Extended CompuServe Fortran compiler.

**MACRO:** Advanced Macro Assembly language for PDP-10. *Talk about fast.*

**FILGE:** Fast, easy file generator and editor. Line oriented, no line numbers required!

**XBASIC:** CompuServe extended BASIC.

**JUMBLE:** File encryption program.

**TECO:** High level text editor.

**LINK:** Linking loader program.

**DDT:** Dynamic debugging tool.

**CREF:** Symbolic cross-reference generator used with language compilers.

**FILCOM:** File comparison program.

**SALARY:** Calculates salary and increases in various time frames including per year, month, period and hour. This program is intended primarily for managers doing reviews.

**SNOBOL:** String manipulation language.

**RUNFLO:** Text formatting program (write resumes etc.).

**RUNF10:** Word processing and text formatting program (write resumes etc.).

**CONCOR:** Concordance generator. This program is very useful for documentation purposes. CONCOR reads an ASCII file and creates an output file which contains a line numbered listing of the original file, and a list of all the words contained in the file along with the numbers of the lines on which each word occurs (similar to an index).

**BLIS10:** High level implementation language for DEC PDP-10.

**BINED:** Binary file editor.

**APL:** A Programming Language.

**FINTOL:** Financial analysis tool. Contains several program modules which can perform financial analysis for business or personal needs.

—Loan Payment and Amortization

—Compound Interest Calculations

—Sum from a Periodic Investment

—Sinking Fund Deposit

—Present Value of Cash Flows

—Present Value and Internal Rate of Return (Capital Projects)

—Depreciation Analysis

—Compound Growth Rates

**RANNO:** Random number generator.

**XEDIT:** XF4 binary file editor.

We also offer high speed professional line printer service, error-free file transfer, CompuServe's Software Exchange, and computer manufacturers' newsletters. Computer Users Groups can exchange information and up-to-the-minute gossip in the computer world.

And . . . if Aunt Matilda comes over, you can still let her play Adventure. Demonstrations and software at all Radio Shack® Computer Centers and many Radio Shack® outlets.



## CompuServe

Information Service Division  
5000 Arlington Centre Boulevard  
Columbus, Ohio 43220  
(614) 457-8600

Radio Shack is a trademark of Tandy Corporation.

|   |            |
|---|------------|
| class name  | LinearList |
| superclass  | Object     |
| instance variable names   | count      |
| class messages and methods  |            |
| "none defined here"   |            |
| instance messages and methods   |            |
| <pre> external count     count. empty     count = 0. "at: anInteger     ... to be defined in subclasses" "append: anObject     ... to be defined in subclasses" "insert: anObject at: anInteger     ... to be defined in subclasses" "replace: anObject at: anInteger     ... to be defined in subclasses" "removeAt: anInteger     ... to be defined in subclasses"  internal initialize     count ← 0. checkIndex: anInteger     (anInteger &lt; 1)   (anInteger &gt; count) ifTrue: [ self error: 'index out of range' ]. </pre> |            |
| <p>Table 2: Class template for class LinearList.</p>  |            |

will define keep count of the number of objects (representing data items) in the list, a corresponding instance variable, *count*, is defined in the superclass *LinearList*. Similarly, all subclasses can make use of an internal message, *initialize*, that initializes *count* to zero, and another message, *checkIndex:*, that insures that any index specified as a parameter to one of the access messages (*at:*, *insert:at:*, and so on) is within range. Since we start the numbering of items in a linear list at 1, the range will always be between 1 and *count* (the number of items in the list). Also, the message *empty* is implemented in the superclass since the answer to whether or not the list is empty can be determined from the value of *count*.

### The Indexed Table

The first strategy we will explore for actually storing data items in a linear list involves the sequential allocation of storage. In order to see how this works, we will interrupt our discussion of the linear list and introduce a very basic data structure that we will call an *indexed table* (see figure 2). An indexed table, which corresponds to what is called a one-dimensional array in many programming languages, is a relatively simple structure that closely matches the physical memory of most computers. As we will see, many useful data structures, including the linear list, can be implemented with an indexed table.

An indexed table comprises a sequence of variables into which we can store and from which we can retrieve data items. Each variable is designated by an integer. The smallest integer used to designate a variable in an indexed table is called the *lower bound* of the table. The largest integer is called the *upper bound*. The operations that we wish to perform on an indexed table are:

- specify the lower and upper bounds of the table (when it is created)
- determine the lower and upper bounds of the table
- determine the number of variables allocated to the table

# NEW FOR APPLE AND ATARI 16K RAM CARD

These exciting new additions to our line will meet the demand for low cost alternatives to the higher priced language and ram cards. The ConComp Apple II 16K Ram Card will work with all existing software compatible with the Apple Language Card<sup>1</sup> and the Microsoft Z-80 Softcard<sup>2</sup>. Allowing up to 64K of user memory, the Ram Card helps make complete use of Pascal, CP/M<sup>4</sup>, and larger programs like Visicalc<sup>3</sup>. The Atari 800<sup>5</sup> version is also compatible with all Atari software that is operational with Atari and other ram cards.

Both cards are constructed using high-speed high-quality dynamic RAM. For more information please contact your local dealer or call us!

**APPLE II**  
**\$130**

**ATARI 800**  
**\$89**

Dealer Inquiries Invited

Available from:  
**ConComp Industries**  
8338 Center Dr.  
La Mesa, CA 92041  
(714) 464-8338

<sup>1</sup>Trademark of Apple Computer, Inc.  
<sup>2</sup>Trademark of Alan, Inc.  
<sup>3</sup>Trademark of Personal Software  
<sup>4</sup>Trademark of Digital Research  
<sup>5</sup>Trademark of Microsoft Consumer Products, Inc.

# MEMOREX

**SUPERB QUALITY AT  
UNBEATABLE PRICES.  
THAT'S MEMOREX  
DISCS FROM PACIFIC  
EXCHANGES**



**For Data Reliability—  
Memorex  
Flexible  
Discs**

**CALL FREE FOR PRICES & INFORMATION**

**(800)235-4137**

**In California, (800)592-5935 or (805)543-1037**

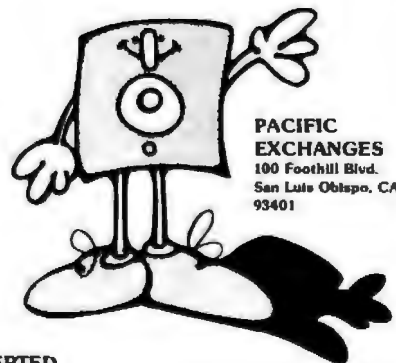

DEALER INQUIRIES INVITED



C.O.D.'s ACCEPTED

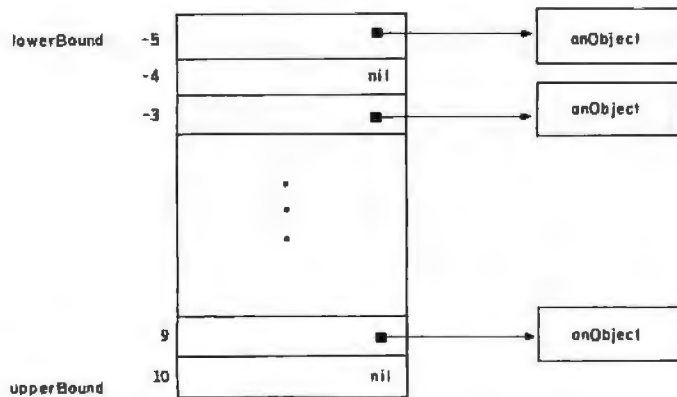

Figure 2: An indexed table.

- access an item at a particular position in the table
- put an item at a particular position in the table

In order to store into an indexed table, we specify an item to be stored and an integer that indicates the particular variable that will contain the item. In order to retrieve from an indexed table, we need only specify which variable of the table has the

data item of interest.

The class definition in table 3 shows how to implement an indexed table. We have seen in the definition of classes *Card* and *LinearList* how to specify a fixed number of named instance variables in a class definition. What we need in order to implement an indexed table, however, is a sequence of unnamed variables that are designated by an integer index. How can we define such a sequence of

variables? We do this by specifying the number of indexed variables needed for an instance at the time that an instance of a class is created. The creation message from:to: in class *IndexedTable* sends the message *new:*, whose parameter is the number of indexed variables required for the instance being created. In order to access these variables, we send low-level (ie: primitive) access messages with a parameter that specifies an appropriate index (starting at 1). The access message *basicAt: i* retrieves the object stored in the *i*th indexed instance variable. The access message *basicAt: i put: anObject* stores a pointer to *anObject* in the *i*th indexed instance variable.

In addition to indexed instance variables, class *IndexedTable* has two named instance variables: *lowerBound* and *upperBound*. *lowerBound* is an integer that indicates the smallest allowable index for a particular instance of *IndexedTable*; *upperBound* indicates the largest allowable index. In order to create a new indexed table, we send the message

NEW  
TITLES

# Computers Are For Everybody!

## How to Get Started with CP/M

Carl Townsend

One of the world's most popular operating systems is explained in simple terms. Includes a handy guide on shopping for an operating system, a glossary, a list of hardware manufacturers supporting CP/M and a list of major CP/M software.

ISBN 0-918398-32-0

\$9.95



## Microsoft Fortran

Paul M. Chirlian

Here is the book for microcomputer users who want to implement FORTRAN on their machines. Even if readers have never used FORTRAN before, they will be writing and running FORTRAN programs almost at once.

ISBN 0-918398-36-0

\$14.95

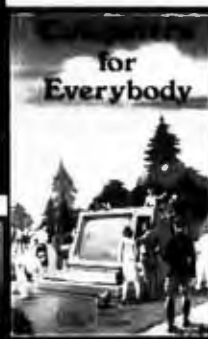

## Computers for Everybody

Jerry Willis and Merl Miller

This fun-to-read book covers all the things a beginner should know about computers. It explains how to use a computer, how to buy and who to buy from, and which are good and which are bad.

ISBN 0-918398-49-5

\$4.95

## 32 BASIC Programs for the Apple Computer

Tom Rugg and Phil Feldman

Chock full of programs with practical applications, educational uses, games and graphics, each of the 32 chapters fully documents a different program.

ISBN 0-918398-34-7

\$17.95

Write or call for free catalog! 1-800-547-1842

Most bookstores and computer stores carry our books. Call us on our toll free number and we'll tell you the one nearest you.

dilithium Press   
P.O. Box 606  
Beaverton, OR 97075

High resolution, dot addressable graphics with vertical resolution of 72 dots per inch and up to 82 dots per inch horizontal resolution.

"Q.T." cover reduces noise to an office comfort level. This is an optional feature to our standard sound deadening case.

Single sheet feeder is very simple to use. The only front load feeder available on the market today.\*

1K standard buffer permits the 88G to print while receiving data. The optional 2K buffer allows a 1920 character dump to the printer freeing the CRT.

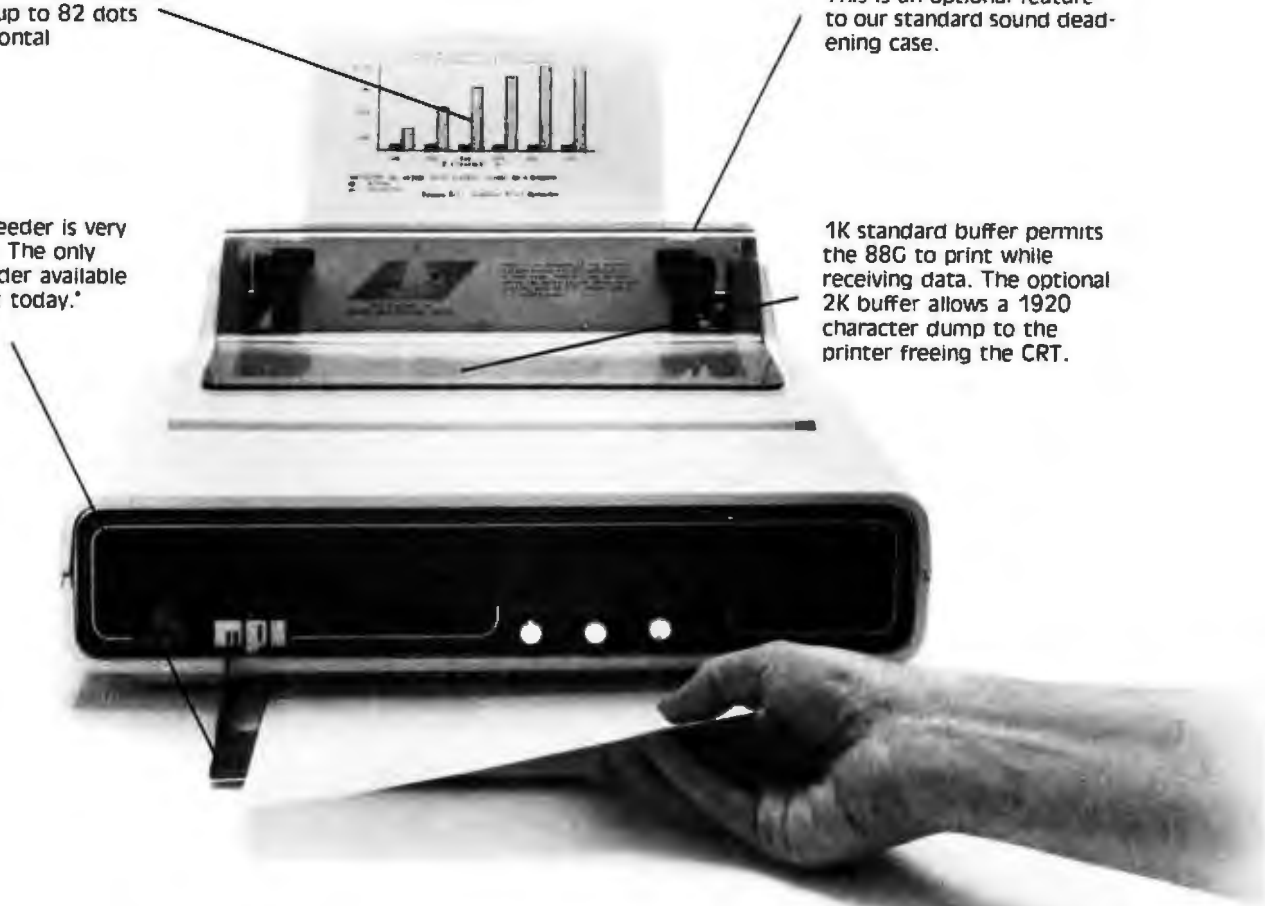

# The Features Leader

## Integrated Paper Handling System

Dual tractor/friction feed allows use of pin feed, roll or single sheet paper.

## Versatile Interface

Data input from most computers can be supported by the 88G. RS232C serial and Centronics® type parallel is standard. Options can be added for current loop, IEEE 488 and high speed serial inputs.

## Letter Quality Capability

The 88G provides a selectable 11 x 7 serif style dot matrix for correspondence printing.

## Cost Effective

The 88G has more features than any other impact printer in its price class. First compare the quality of the 88G, then compare the price —the 88G wins! Single unit price is less than \$800.

\*Optional



Micro Peripherals, Inc. 4426 South Century Drive Salt Lake City, Utah 84107 (801) 263-3081  
**The Printer People**

California VITEK (714) 744-8305 Colorado PLS Associates (303) 773-1218 Minnesota Bohlig & Associates (612) 922-7011 New Jersey Hansen & Hughes (201) 652-7055 Up-state New Jersey QED Electronics (215) 674-9600 Oregon Microware (503) 620-8150 Washington Microware (206) 451-8586 Utah PLS Associates (801) 466-8729 Type-A-Line (801) 521-5310 District of Columbia Wright Marketing (301) 840-1928 International-England Russet Instruments, Ltd. (0734) 868147 Telex: 849721 Phoenix Sigma International (602) 994-3435 Telex: 165-745 Sigma France IER Tel 333.67 81 Telex. 620-289 Canada Spectra Electronics (403) 264-7270.

|                               |   |
|-------------------------------|---|
| class name                    | IndexedTable  |
| superclass                    | Object  |
| instance variable names       | lowerBound upperBound   |
| class messages and methods    | <pre> <b>from: anInteger1 to: anInteger2</b>       (anInteger1 &gt; anInteger2) ifTrue: [   self error: 'invalid bounds' ].     (self new: anInteger2 - anInteger1 + 1)   lowerBound: anInteger1 upperBound: anInteger2. </pre>   |
| instance messages and methods | <pre> <i>external</i> <b>lowerBound</b>       lowerBound. <b>upperBound</b>       upperBound. <b>size</b>       upperBound - lowerBound + 1. <b>at: anInteger</b>       self checkIndex: anInteger.     self basicAt: (anInteger - lowerBound + 1). <b>put: anObject at: anInteger</b>       self checkIndex: anInteger.   self basicAt: (anInteger - lowerBound + 1) put: anObject.  <i>internal</i> <b>lowerBound: anInteger1 upperBound: anInteger2</b>       lowerBound - anInteger1, upperBound - anInteger2. <b>checkIndex: anInteger</b>       (anInteger &lt; lowerBound)   (anInteger &gt; upperBound)   ifTrue: [   self error: 'index out of range' ]. "basicAt: i     ... this is a primitive Smalltalk-80 message that accesses the ith indexed instance variable." "basicAt: i put: anObject     ... this is a primitive Smalltalk-80 message that stores a pointer to anObject in the ith indexed instance variable." </pre> |

Table 3: Class template for class IndexedTable.

from:to: to class IndexedTable. For example:

```

| table |
table -> IndexedTable from: -5 to:
10.

```

creates a new instance of IndexedTable whose indices range from -5 to 10. This message is implemented using an internal message, lowerBound:upperBound:, that sets the instance variables of a newly created instance to their appropriate values.

Once we have created an instance of IndexedTable, we can perform the operations specified in the above description of indexed tables by sending the messages lowerBound, upperBound, size, at:, and put:at:. lowerBound and upperBound return the corresponding values of the instance variables; size computes and returns the number of indexed instance variables in the table. at: and put:at: both use an internal message, checkIndex:, in order to make sure that their index parameter is within range of the lower and upper bounds of the table. at: returns the object stored in the indexed instance variable indicated by the integer parameter; put:at: stores the object, specified as the first parameter, in the indexed instance variable indicated by the second parameter. Notice that both at: and put:at: use the value of lowerBound to map indices from the range of the table to the range of the indexed instance variables that are used to implement the table.

As an example of how we might use class IndexedTable, consider the following sequence of messages:

```

| table |
table -> IndexedTable from: 1 to:
13.
1 to: 13 do: [: i | table put: (Card
suit: 'heart' rank: i) at: i. ]

```

This creates a new instance of class IndexedTable with indices that range from 1 to 13 and fills it with instances of class Card whose ranks match the indices.

## The Sequential List

Now that we have an implementa-

## Some Smalltalk Messages

The following messages are used in this article without having been previously defined. Each is either provided by the Smalltalk-80 system, or easily implemented using other messages provided by the system. For each message, we provide a brief, informal description of its intended effect.

**new**—Creates a new instance.

**new: i**—Creates a new instance with i indexed instance variables.

**error: aString**—Causes some appropriate action to occur, such as interrupting program execution and displaying aString.

**not**—The "logical not" operation.

**|**—The "logical or" operation.

**+, -, \*, /, =, <, >, <=**—Arithmetic operations and relations.

Flow of control is affected by sending messages that correspond to basic control structures. For example:

**a ifTrue: [ b ]** corresponds to: if a then b end

**a ifTrue: [ b ] ifFalse: [ c ]** corresponds to: if a then b else c end

**x to: y do: [ : i | a ]** corresponds to: for i from x to y by 1 repeat a end

**x downTo: y do: [ : i | a ]** corresponds to: for i from x to y by -1 repeat a end

**x timesRepeat: [ a ]** corresponds to: repeat x times a end

# When you can't afford to buy wrong...



"Sorry, Hawkins, we simply can't keep you and replace that non-expandable computer you bought...."

## ... you need Novell's NEXUS™, the starter-priced computer system designed to grow with you.

**B**UYING A COMPUTER is a big decision. How much can you afford to spend? Will the system you're considering do the job? And what happens when your needs outgrow that first computer? Can it expand to handle increasingly larger workloads, or will you have to spend a fortune replacing it? Expandable computer systems are strictly big-league. They've *been* very expensive, and unless you've had *at least* \$40,000 to spend they've been out of reach.

But, now, there's Novell's new NEXUS Series—an incredibly versatile, surprisingly inexpensive computer that expands into a multiple terminal-computer network system just by adding components as your growth requires. You can begin using your NEXUS computer the day it arrives, because it works with the widest assortment of proven software available in the industry today. Exclusive RAM-GUARD™ protection detects and corrects memory errors automatically

as they occur—a feature no other comparably priced computer offers. NEXUS is the one starter-priced computer system you'll never have to replace!

If you're in the market for *any* computer, you can afford the NEXUS I. Since you *can't* afford to buy wrong, you can't afford to miss seeing, trying and learning all about NEXUS.

Call us toll-free and we'll set up a hands-on demonstration. We'll prove how NEXUS will take you all the way to the top. 800-453-1188

 **NOVELL**  
DATA SYSTEMS, INC

1170 No. Industrial Park Drive, Orem, Utah 84057  
Telephone (801) 226-8202



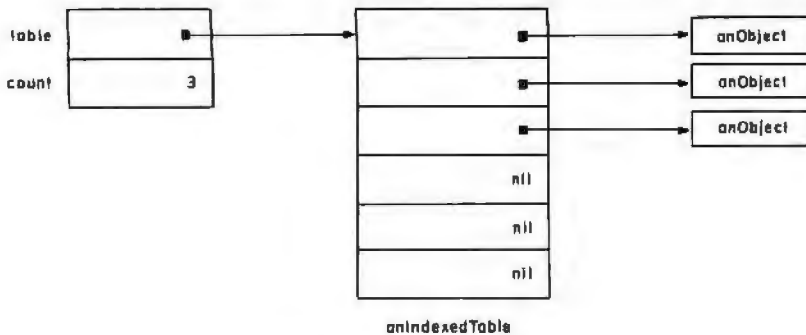

Figure 3: A sequential list.

tion for indexed tables, we can use them to demonstrate our first implementation of linear lists. We will call a linear list that uses an indexed table to store its data items a *sequential list* (see figure 3). The basic idea is to manage an indexed table so that the first *i* consecutive entries in the table are the *i* data items in our linear list. The most difficult operations using this strategy are the insertion and removal of items, since these cause parts of the indexed table to be copied from one area to another. An additional difficulty is that we must

specify, at the time we create the linear list, the expected maximum number of items in the list. This is necessary because indexed tables come in fixed sizes, which means that if the list grows larger than this initial number, we must do something to accommodate the extra items. (Details are shown in the class definition given in table 4.)

The creation message `size:` is used to create an instance of `SequentialList` of some estimated maximum size. For example:

```
| list |
list ← SequentialList size: 5.
```

creates a list with enough space, initially, for five objects. The internal message `initialize:`, which is sent from `size:`, creates an instance of `IndexedTable` of the appropriate size and assigns it as the value of the instance variable named `table`. The other internal message, `expand`, is used to enlarge `table` when it becomes full. This is done by creating a new instance of `IndexedTable` that is twice as large as the original and by copying the objects from the original table into the first half of the new table. The new table is then assigned as the value of `table` for subsequent use.

Retrieval from `SequentialList` is done by retrieving from its associated indexed table. A new object can be appended to the list by storing it in the next available location of the indexed table of that list. This location is determined by the value of `count`. If there is still room in the table, `count` is incremented and the object is stored. Otherwise, the sequential list has to be expanded, which is accomplished using the message `expand`, described previously. Insertion into the list is done by copying from their current location to the next, all objects after, and including, the one at the desired location. A new object can then be stored at that location. Removing an object from a list is done analogously. An object is replaced by storing another object in the corresponding position in the indexed table.

The advantage of the sequential list is that it is easy to access and replace (not remove) an arbitrary item. The disadvantages are that it is necessary both to estimate the maximum size of the list when it is created (although, as we have seen, the list can expand when necessary) and to move items around when inserting or removing them from the list.

Let us now consider an example that shows how to create and send messages to an instance of class `SequentialList`. Suppose we want to represent a deck of cards and two hands, dealt from the deck. To create

SciTronics introduces . . .

## REAL TIME CLOCKS

with full Clock/Calendar Functions

The Worry-free Clocks for People  
Who Don't Have Time to Worry!!

### What makes them worry-free?

- Crystal controlled for high (.002%) accuracy
- Lithium battery backup for continuous clock operation (6000 hrs!!!)
- Complete software in BASIC-including programs to Set and Read clock
- Clock generates interrupts (seconds, minutes, hour) for foreground/background operation

### Applications:

- Logging Computer on time
- Timing of events
- Use it with the SciTronics Remote Controller for Real Time control of A.C. operated lights and appliances

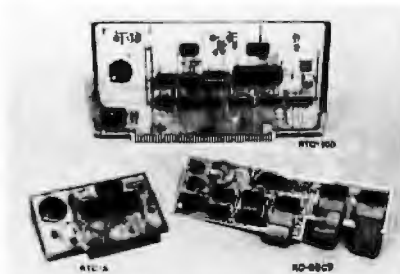

### Versions available for:

- S-100 bus computers **RTC-100 \$159**
- Apple II computer **RTC-A \$129**
- SciTronics RC-80 owners **RC-80CK \$109**

Send  
Check or  
money  
order to:  
**SciTronics Inc.**  
523 S. Clewell St., P.O. Box 5344  
Bethlehem, PA 18015  
(215) 868-7220

Please list system with which you plan to use controller • Master Charge and Visa accepted. COD's accepted. PA residence add sales tax.



# 4MHZ, DOUBLE DENSITY, COLOR & B/W GRAPHICS. .THE LNW80 COMPUTER



When you've compared the features of an LNW80 Computer, you'll quickly understand why the LNW80 is the ultimate TRS80 software compatible system. LNW RESEARCH offers the most complete microcomputer system at an outstanding low price. We back up our product with an unconventional 6 month warranty and a 10 days full refund policy, less shipping charges.

LNW80 Computer . . . . . \$1,450.00  
 LNW80 Computer w/88M Monitor & one 5" Drive . . . . . \$1,915.00  
 All orders must be prepaid, CA residents please include 6% sales tax. Contact us for shipping charges

\* TRS80 Product of Tandy Corporation.  
 \*\* PNC Product of Personal Microcomputer, Inc.

## COMPARE THE FEATURES AND PERFORMANCE

| FEATURES   | LNW80         | PNC-60**   | TRS-80* MODEL III |
|--|---------------|------------|-------------------|
| PROCESSOR  | 4.0 MHZ       | 1.8 MHZ    | 2.0 MHZ           |
| LEVEL II BASIC INTERP.                                     | YES           | YES        | LEVEL III BASIC   |
| TRS80 MODEL I LEVEL II COMPATIBLE                          | YES           | YES        | NO                |
| 48K BYTES RAM  | YES           | YES        | YES               |
| CASSETTE BAUD RATE   | 500/1000      | 500        | 500/1500          |
| FLOPPY DISK CONTROLLER                                     | SINGLE/DOUBLE | SINGLE     | SINGLE/DOUBLE     |
| SERIAL RS232 PORT  | YES           | YES        | YES               |
| PRINTER PORT   | YES           | YES        | YES               |
| REAL TIME CLOCK  | YES           | YES        | YES               |
| 24 X 80 CHARACTERS   | YES           | NO         | NO                |
| VIDEO MONITOR  | YES           | YES        | YES               |
| UPPER AND LOWER CASE                                       | YES           | OPTIONAL   | YES               |
| REVERSE VIDEO  | YES           | NO         | NO                |
| KEYBOARD   | 63 KEY        | 53 KEY     | 53 KEY            |
| NUMERIC KEY PAD  | YES           | NO         | YES               |
| B/W GRAPHICS, 128 X 48                                     | YES           | YES        | YES               |
| HI-RESOLUTION B/W GRAPHICS, 480 X 192                      | YES           | NO         | NO                |
| HI-RESOLUTION COLOR GRAPHICS (NTSC), 128 X 192 IN 8 COLORS | YES           | NO         | NO                |
| HI-RESOLUTION COLOR GRAPHICS (RGB), 384 X 192 IN 8 COLORS  | OPTIONAL      | NO         | NO                |
| WARRANTY   | 6 MONTHS      | 90 DAYS    | 90 DAYS           |
| TOTAL SYSTEM PRICE   | \$1,915.00    | \$1,840.00 | \$2,187.00        |
| LESS MONITOR AND DISK DRIVE                                | \$1,450.00    | \$1,375.00 | ---               |

## LNW80

- BARE PRINTED CIRCUIT BOARD & MANUAL . . . . . \$89.95

The LNW80 - A high-speed color computer totally compatible with the TRS-80\*. The LNW80 gives you the edge in satisfying your computation needs in business, scientific and personal computation. With performance of 4 MHz, Z80A CPU, you'll achieve performance of over twice the processing speed of a TRS-80\*. This means you'll get the performance that is comparable to the most expensive microcomputer with the compatibility to the world's most popular computer (TRS-80\*) resulting in the widest software base.

- FEATURES:
- TRS-80 Model I Level II Software Compatible
  - High Resolution Graphics
    - RGB Output - 384 x 192 in 8 Colors
    - NTSC Video or RF MOD - 128 x 192 in 8 Colors
    - Black and White - 480 x 192
  - 4 MHz CPU
  - 500/1000 Baud Cassette
  - Upper and Lower Case
  - 16K Bytes RAM, 12K Bytes ROM
  - Solder Masked and Silkscreened

## LNW SYSTEM EXPANSION

- BARE PRINTED CIRCUIT BOARD AND MANUAL . . . . . \$89.95  
 WITH GOLD CONNECTORS . . . . . \$84.95

The System Expansion will allow you to expand your LNW80, TRS-80\*, or PNC-60\*\* to a complete computer system that is still totally software compatible with the TRS-80\* Model I Level II.

- FEATURES:
- 32K Bytes Memory
  - 5" Floppy Controller
  - Serial RS232 20ma I/O
  - Parallel Printer
  - Real Time Clock
  - Screen Printer Bus
  - On Board Power Supply
  - Solder Masked and Silkscreened

# LNW RESEARCH CORPORATION

2620 WALNUT ST.  
 TUSTIN CA. 92680

## LN Doubler & DOS PLUS 3.3D

- Assembled and Tested W/DOS PLUS 3.3D . . . . . \$175.00

Double-density disk storage for the LNW Research's "System Expansion" or the Tandy's "Expansion Interface". The LN Doubler™ is totally software compatible with any double density software generated for the Percom's Doubler\*\*\*. The LN Doubler™ provides the following outstanding features.

- Store up to 350K bytes on a single 5" disk
- Single and double density data separation
- Precision write precompensation circuit
- Software switch between single and double density
- Easy plug in installation requiring no etch cuts, jumpers or soldering
- 35, 40, 77, 80 track 5" disk operation
- 120 day parts and labor Warranty

\*\*\* Doubler is a product of Percom Data Company, Inc.

## DOS PLUS 3.3D

Micro Systems software's double density disk operating system. This operating system contains all the outstanding features of a well developed DOS, with ease in useability.

## KEYBOARD

LNW80 KEYBOARD KIT . . . . . \$84.95

The Keyboard Kit contains a 63 key plus a 10 key, P.C. board, and remaining components.

## CASE

LNW80 CASE . . . . . \$84.95

The streamline design of this metal case will house the LNW80, LNW System Expansion, LNW80 Keyboard, power supply and fan, LN Doubler™, or LNW Data Separator. This kit includes all the hardware to mount all of the above. Add \$12.00 for shipping

## PARTS AVAILABLE FROM LNW RESEARCH

- 4116 - 200ns RAM
  - 6 chip set . . . . . \$26.00
  - 8 chip set . . . . . \$33.50
  - 16 chip set . . . . . \$64.00
  - 24 chip set . . . . . \$84.00
  - 32 chip set . . . . . \$124.00
- LNW80 "Start up parts set" LNW80-1 . . . . . \$82.00
- LNW80 "Video parts set" LNW80-2 . . . . . \$31.00
- LNW80 Transformer LNW80-3 . . . . . \$18.00
- LNW80 Keyboard cable LNW80-4 . . . . . \$16.00
- 40 Pin computer to expansion cable . . . . . \$15.00
- System Expansion Transformer . . . . . \$19.00
- Floppy Controller (FD1771) and UART (TR1602) . . . . . \$30.00

ORDERS & INFO. NO. 714-544-5744  
 SERVICE NO. 714-641-8850

Circle 198 on inquiry card.

VISA MASTER CHARGE UNLESS NOTED  
 ACCEPTED ADD \$3 FOR SHIPPING

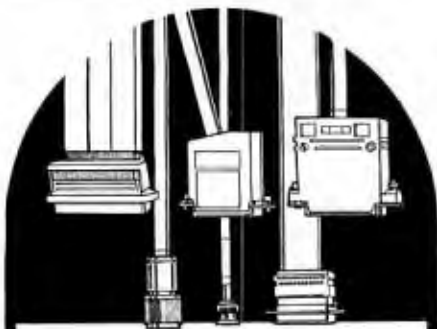

# THINKING ABOUT DATA INTERFACE OR COMMUNICATIONS CABLE ASSEMBLIES? THINK ALLISON!

Allison Data Communications is the most technologically advanced manufacturer of Data Interface cable or Communications Cable Assemblies in the industry, so we can deliver the quality you want, at the prices you need.

Low Cost, High Quality and Fast Delivery is our commitment to you.

Think Cost, Think Quality, Think Allison, The new leader in the field.

### Allison Data Communications Cables include:

- \* EIA RS 232C
- \* EIA RS 499
- \* TEFLON AIR PLENUM
- \* COAXIAL
- \* RIBBON
- \* TELCO
- \* CUSTOM

We can also develop and produce any type of cable needed in special applications. Our Technical Representatives will be happy to provide you with any assistance you might need.

If you are thinking about Cable  
... Think Allison!



**ALLISON DATA COMMUNICATIONS**

1290 MOTOR PARKWAY,  
HARPPAGE, NEW YORK 11788  
(516) 234-2010 • (212) 895-6449  
TWX: 510-227-8892

two initially empty hands we write:

```
| hand1 hand2 deck |
hand1 — SequentialList size: 5.
hand2 — SequentialList size: 5.
```

To create an unshuffled deck of fifty-two cards we write:

```
deck — SequentialList size: 52.
1 to: 13 do: [: i | deck append:
(Card suit: 'heart' rank: i). ].
1 to: 13 do: [: i | deck append:
(Card suit: 'diamond' rank: i). ].
1 to: 13 do: [: i | deck append:
(Card suit: 'club' rank: i). ].
1 to: 13 do: [: i | deck append:
(Card suit: 'spade' rank: i). ].
```

Then, to deal five cards from the deck to the first hand we write:

```
5 timesRepeat: [ hand1 append:
(deck removeAt: 1). ].
```

To deal from the bottom of the deck to the second hand we write:

```
5 timesRepeat: [ hand2 append:
(deck removeAt: deck
count). ].
```

### The Linked List

A second approach for managing the storage of items in a linear list is to use a *linked list*. The strategy for

|                               |  |
|-------------------------------|--|
| class name                    | SequentialList   |
| superclass                    | LinearList   |
| instance variable names       | table  |
| class messages and methods    | <pre>size: anInteger   (anInteger &gt; 0) ifTrue: [ 1 (self new) initialize: anInteger ] ifFalse: [ 1 self error: 'invalid size' ].</pre>  |
| instance messages and methods | <pre>external at: anInteger     self checkIndex: anInteger, 1 table at: anInteger. append: anObject     (count = table size) ifTrue: [ self expand. ]. table put: anObject at: count + 1. count — count + 1. insert: anObject at: anInteger     self checkIndex: anInteger. (count = table size) ifTrue: [ self expand. ]. count downTo: anInteger do: [: i   table put: (table at: i) at: i + 1. ]. table put: anObject at: anInteger. count — count + 1. replace: anObject at: anInteger     self checkIndex: anInteger. table put: anObject at: anInteger. removeAt: anInteger   anObject   anObject — self at: anInteger. anInteger + 1 to: count do: [: i   table put: (table at: i) at: i - 1. ]. count — count - 1. ↑ anObject.  internal initialize: anInteger     super initialize. table ← IndexedTable from: 1 to: anInteger. expand   anIndexedTable   anIndexedTable ← IndexedTable from: 1 to: 2 * count. 1 to: count do: [: i   anIndexedTable put: (table at: i) at: i. ]. table ← anIndexedTable.</pre> |

Table 4: Class template for class SequentialList.

# Put Time and BSR/X-10 Control in Your APPLE II THUNDERCLOCK PLUS™

The THUNDERCLOCK PLUS is two peripheral systems on one card for your APPLE II, II PLUS, or III. An accurate, reliable, real-time clock/calendar and an interface for the popular BSR X-10 Home Control System.

The THUNDERCLOCK clock/calendar makes accurate time and date available to your programs: month, date, day-of-week, hour, minute, and second, in any of four software selectable formats. On-board batteries keep your THUNDERCLOCK running when your APPLE II is turned off - for up to four years before battery replacement. On-card 1K firmware makes reading or setting the time easy from APPLESOFT or INTEGER BASIC, PASCAL, or assembly language programs. And it provides software selectable interrupts at any of three rates: 64, 256, or 2048 interrupts/second. All features are software selectable - no switches or jumpers!

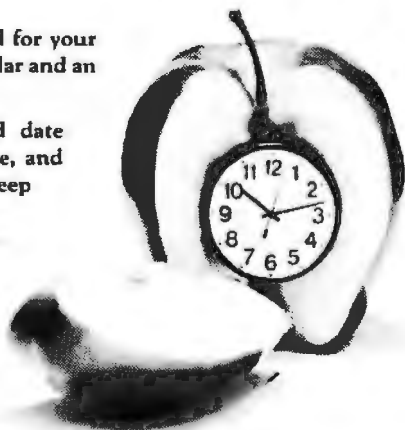

## THE PLUS

Add THUNDERWARE'S X-10 ULTRASONIC INTERFACE

OPTION to your THUNDERCLOCK and your programs can send all 22 BSR X-10 commands so you can remotely control lights and appliances. Plus a powerful disk software package! The THUNDERWARE SCHEDULER software lets you create schedules to control lights, appliances, security systems, or almost any other electrical device. The software includes: SCUTIL - the SCHEDULER utility that lets you make or change a schedule, and SCHED - executes your schedules in real-time using the THUNDERCLOCK. SCHED runs in the 'background' so you can run other programs in the 'foreground'. Our PASCAL software lets you use all the THUNDERCLOCK'S features and sets the file date whenever you boot. The THUNDERCLOCK PLUS is a SYSTEM for your APPLE II. Supported by intelligent, easy to use firmware, a powerful software package, and good documentation!

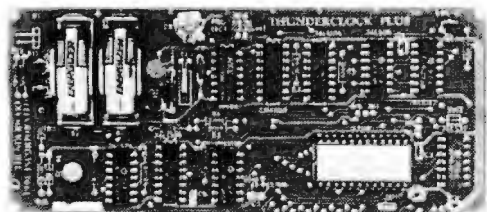

Let the THUNDERCLOCK PLUS time/date stamp your DOS files whenever you create or modify them with our DOS-DATER software.

The THUNDERCLOCK PLUS will work in any APPLE, including the APPLE III.

## See your APPLE dealer.

Suggested retail prices:

- THUNDERCLOCK PLUS.....\$139  
Clock/calendar card with batteries and user's manual
- X-10 INTERFACE OPTION.....\$49  
BSR X-10 Ultrasonic interface, disk with SCHEDULER SOFTWARE & demos, and user's manual
- PASCAL SOFTWARE.....\$29  
Disk with PASCAL interface for clock and X-10 interface, and user's guide
- MANUALS ONLY, each.....\$5

California residents add 6% sales tax

If your dealer doesn't carry the  
THUNDERCLOCK PLUS:

ORDER TOLL FREE (VISA/MC) CALL:  
800-227-6204 Ext 307 (Outside California)  
800-632-2131 Ext 307 (California Only)

OR WRITE TO:

THUNDERWARE INCORPORATED  
P.O. Box 13322, Oakland, CA 94661

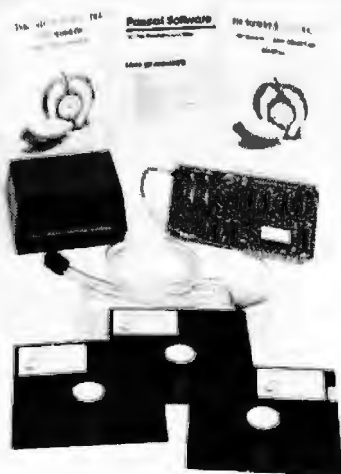

BSR X-10 is a trademark of BSR (USA) LTD.  
APPLE II is a trademark of APPLE COMPUTER, INC.

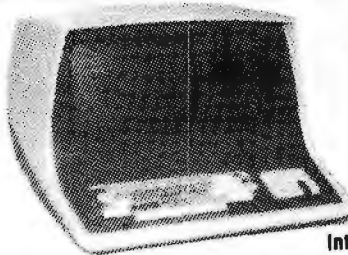

# SUPERBRAIN™

QD - ONLY

## \$2950

Buy Factory Direct and Save! Direct from Intertec to you at the best prices in the country!  
**FREE!** Word processing or single accounting program with purchase of 64k Superbrain at \$2650.

- SUPERBRAIN 5mb** Upgrade kit . . . . . **\$2995**  
Includes ST-506 5 1/4" 5mb Hard disk controller, brackets, cables, CP/M and DOS diskette
- SUPERBRAIN 64k** Double density . . . . . **\$2650**
- HARD DISK 10mb** Winchester-type Intertec. List \$4995 . . . . . **\$3395**

### NORTHSTAR COMPUTERS

- HORIZON II**
- 32k** Double Density. Reg. \$3695 **\$2750**
- HORIZON II**
- 32k** Quad Density. Reg. \$3995 **\$2965**

- HORIZON II**
- 64k** Double Density. Reg. \$4195 **\$3125**
- HORIZON II**
- 64k** Quad Density. Reg. \$4495 **\$3325**

### TERMINALS

- Intertube III** Intertec Reg. \$895 . . . **\$720**
- Emulator** Intertec Reg. \$895 . . . . **\$720**

### PRINTERS - DOT MATRIX

Lowest Prices!

- MPI 88G** . . . . . LIST \$749 **\$550**
- MPI 99G** . . . . . **\$750**
- COMET C** 1104 with RS232 . . . Reg \$ 995 **\$450**
- COMET II** Parallel . . . . . Reg \$1350 **\$825**
- EPSON MX80** Parallel . . . Reg \$ 645 **\$465**
- EPSON MX80** RS232 . . . Reg \$ 720 **\$525**

### PRINTERS-WORD PROCESSING

- STARWRITER** Parallel . . . Reg \$2195 **\$1495**
- STARWRITER** RS232 . . . Reg \$2395 **\$1650**
- STARWRITER II** 45cps. . . Reg \$2795 **\$1795**
- XYMEC** Parallel . . . . . Reg \$2650 **\$1995**
- XYMEC** RS232 . . . . . Reg \$2675 **\$2165**
- NEC 5510** . . . . . **\$2535**

### WORD PROCESSING

- Word Star** . . . . . **\$320**
- Mail Merge** . . . . . **\$110**
- VTS 80** . . . . . **\$449**
- Benchmark** . . . . . **\$400**
- Spellguard** . . . . . **\$225**
- Word Pro** . . . . . **\$170**
- NAD Mail List** Structured Systems . . . **\$100**
- MVF Mailer** . . . . . **\$100**

### DISC DRIVES

- 5 mbyte 5 1/4" Hard Disk ST-506 from Seagate Technology
- LIST \$1500 ONLY...\$1300**
- FLOPPY DISC 5 1/4**
- Tandem TM 100-1 Single Sided Double Density **\$225**
- TM 100-2 Double Sided Double Density **\$395**

### SOFTWARE NORTHSTAR

## 25% OFF!

### ACCOUNTING PLUS

- by Systems Plus
- Accounts Receivable, Payroll, Accounts Payable, Inventory, General Ledger, Sales Order Entry, Purchase Order Entry.
- Each **\$395**

### PEACHTREE

- A/R, A/P, G/L, P/R, INV. . . . . ea. **\$395**
- CPA, Property Mgmt. . . . . ea. **\$795**

### MVF PROGRAMS

- Restaurant Inventory . . . . . **\$250**
- Client Billing . . . . . **\$450**

### DBMS PROGRAMS

- Condor I . . . . . **\$550**
- Data Star . . . . . **\$225**
- FMS-80 . . . . . **\$395**
- C Basic Compiler . . . . . **\$110**
- Microsoft Basic . . . . . **\$325**

using a linked list is the following: instead of allocating sequentially the storage needed to hold data items, we allocate separate storage objects, called *links*, each of which keeps track of a data item and either one or two other links. A set of links are connected together to form a linked list. A *single link* (see figure 4a) is one that keeps track of a data item and one other link, which is its successor. A *double link* (see figure 4b) has a data item and two other links: its successor and its predecessor.

Class SingleLink is defined as shown in table 5. It has instance variables named entry and successor; entry points to an object that represents a data item, successor points either to another instance of class SingleLink, or, if there is no successor, to the object nil. We specify the entry and successor of a single link at the time we create it. For example:

```
| link1 link2 |
link1 — SingleLink entry: (Card
      suit: 'club' rank: 4) successor:
      nil.
link2 — SingleLink entry: (Card
      suit: 'diamond' rank: 6)
      successor: link1.
```

creates two links. The entry of the first link is an instance of class Card that represents the four of clubs. Its successor is nil. The entry of the second link is an instance of class Card that represents the six of diamonds; its successor is the first link.

The class definition for double links is given in table 6. Class DoubleLink inherits from class SingleLink the instance variables and messages that are used to implement the entry and successor of a double link. In addition, there is an instance variable named predecessor that points either to an instance of class DoubleLink or to nil. The messages predecessor: and predecessor set and return, respectively, the value of predecessor.

As stated previously, a linked list is a sequence of links connected in a linear arrangement. We can make different kinds of linked lists depending on the links we use and the precise

\*C/PM is trademark of Digital Research U.S. International Dealer Inquiries Invited

To Order Call (206) 453-8159

Mastercharge VISA add 3% No C.O.D.'s All prices FOB origin



## PACIFIC COMPUTER BROKERS

11056 Palatine North, Seattle, WA 98133

# Introducing CP/M-86 From Digital Research



## The Best Gets Better

CP/M®, the industry standard, continues to expand, because your needs continue to expand.

### CP/M-80™

For cost-effective computing on 8-bit Z-80, 8080 and 8085-based microcomputers, CP/M-80 gives you the widest variety of mature, specialized software products anywhere.

### CP/M-86™

For jobs that require more address space and increased computing resources, CP/M-86 provides the soft-

ware power you need. CP/M-86 is enhanced to operate with Intel's new 16-bit 8086 and 8088 microprocessors, with all the qualities that have given CP/M industry-wide support.

And there's more to come: MP/M™, our multi-programming monitor, and CP/NET™, our network operating system, and PL/I, now available for 8-bit machines, will soon be available for the 8086/8088 family.

CP/M. It's available on over 250 types of computers. For a closer look, ask your dealer, your manufacturer, or Digital Research.

U.S.A.  
DIGITAL RESEARCH  
P.O. Box 579  
801 Lighthouse Avenue  
Pacific Grove, CA 93950  
408-649-3896  
TWX 910 360 5001

EUROPE  
VECTOR INTERNATIONAL  
Research Park  
B-3030 Leuven  
Belgium  
32 (16) 20-24-96  
Telex 26202 VECTOR

FAR EAST  
MICROSOFTWARE ASSOC.  
102 Plasada  
3-16-14 Minami Aoyama  
Minato-ku  
Tokyo 107, Japan  
03-403-2120  
Telex 2426875 MSA

 DIGITAL RESEARCH®



## Send for our FREE Catalog

DATA READER & PRINTOUT RULER FROM LINE-SITE ONLY

# \$2.00

(It's even FREE if you order from our catalog!)

This special price is just to introduce you to our catalog of computer accessories and word processing supplies. We offer you 25-50% off on products like 3M-Scotch\* brand diskettes, computer paper, ribbons, printwheels, binders, and alot more. If you order the Data Reader we'll send you a gift certificate worth \$2.50 when you order from the catalog.

15" flexible plastic, clear & tinted

Highlighted reading window

Vertical spacing scale for 8 lines per inch

6 lines per inch vertical spacing scale

Horizontal spacing scale, 150 print positions

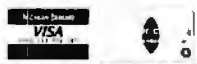
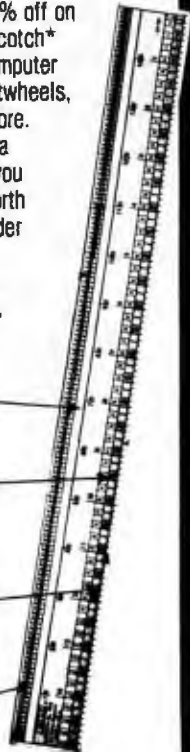

# TRICOR

3601 S. 9th St.  
Kalamazoo, MI 49009  
TOLL FREE: (800) 253-4358  
In Michigan: (616) 375-7519

- Here's my \$2 (plus 50¢ postage and handling) for a Data Reader/Ruler and send me your catalog with 25%-50% savings on name brand disks, paper, labels and other computer accessories.
- I don't need the Data Reader/Ruler but please put me on your catalog mailing list.

Name \_\_\_\_\_  
Company \_\_\_\_\_  
Address \_\_\_\_\_  
City \_\_\_\_\_  
State/Zip \_\_\_\_\_  
\*3M Co.

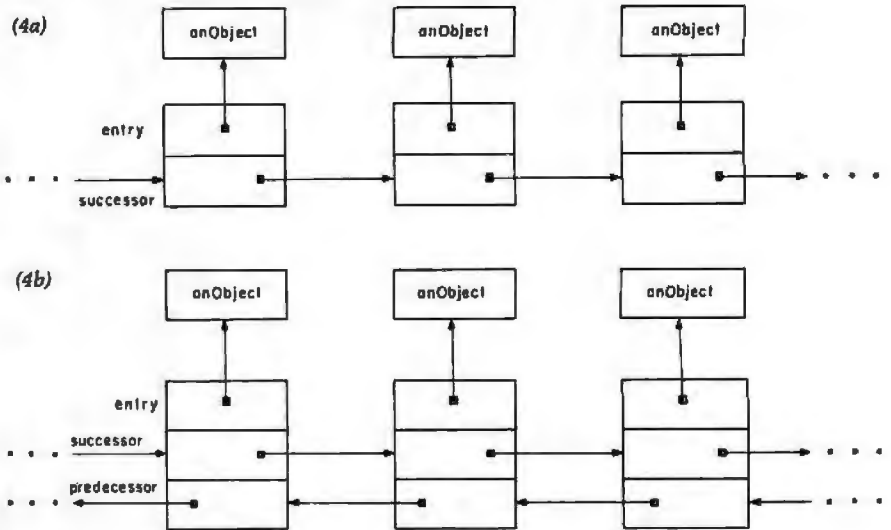

Figure 4: Two kinds of links. Figure 4a shows a list of storage objects joined by single links, while figure 4b shows a similar list joined by double links.

|   |                 |
|---|-----------------|
| class name  | SingleLink      |
| superclass  | Object          |
| instance variable names   | entry successor |
| class messages and methods  |                 |
| <b>entry: anObject successor: aSingleLink    </b><br><b>  ((self new) entry: anObject) successor: aSingleLink.</b>  |                 |
| instance messages and methods   |                 |
| <i>external</i><br><b>entry       entry.</b><br><b>entry: anObject     entry -- anObject.</b><br><b>successor       successor.</b><br><b>successor: aSingleLink     successor -- aSingleLink.</b> |                 |
| <i>internal</i><br>"none defined here"  |                 |

Table 5: Class template for class SingleLink.

way that they are connected together. Table 7 defines class `LinkedList`, which acts as the superclass of the various linked lists we will consider. It collects several messages that are suitable for all of the `LinkedList` subclasses.

The message `linkAt:` is used internally by `LinkedList` methods. Taking an integer as a parameter, it traverses a sequence of connected links looking for the link in the position indicated by that integer. It returns this link as a result. This message is not intended for use outside of the class since we

don't want the rest of the system to have access to the internal structure of the list. The messages `at:` and `replace:at:` can be defined using `linkAt:` since, once the appropriate link is found, it is easy to return or replace its corresponding entry.

### The Singly Linked List

The first type of linked list we will examine is the *singly linked list*. A singly linked list is a sequence of single links connected together so that the successor of the first link is the second link, the successor of the second

SOFTWARE PROFESSIONALS

# Whatever your specialization in software, there's an expanding path at Kearfott.



From high technology to commercial applications, opportunities at Kearfott span the software spectrum. Regardless of the area that intrigues you, you'll be working in one of the most sophisticated DP complexes, using the most advanced IBM Software.

The focus at our Data Center is on breakthrough systems expanding a global network. To this end, we've assembled an elite group of software professionals. Our growth dictates the demand for more. We have a battery of computers that include the 3033, AMDAHL V/6, 43XX series, and more, with complementing front end processors. In support of this hardware, we run a multitude of software including MVS/SE-2 (going MVS/SP), VM/SP, VS1, IMS DB/DC, CICS, TSO/SPF, WYLBUR, ACF/NCP, ACF/VTAM, and more.

In Engineering applications, realtime software designs operate airborne computers in Kearfott avionics systems—from aircraft navigation to missile guidance. You could also be designing for programs comparable in complexity to Kearfott's inertial measurement units on the Space Shuttle and guidance control on Trident submarines. Assignments may include simulation on our 3033.

In business applications, we run the MIS gamut—accounting, finance, inventory, manufacturing, payroll and a whole lot more.

In the Data Center, we support all the hardware, operating systems and language compilers that Kearfott applications professionals need. Prior experience installing System Software qualifies you for our consideration.

Whatever your area of software expertise, you should have an appropriate degree and at least a 3-year record indicating potential to achieve higher professional levels. Send your resume to: **Carol Batte, Singer Company, Kearfott Division, 1150 McBride Avenue, Little Falls, N.J. 07424.**

## Kearfott

a division of The **SINGER** Company

An equal opportunity employer, m/f who creates opportunities.

**NO FRILLS!  
NO GIMMICKS!  
JUST GREAT  
DISCOUNTS  
MAIL ORDER ONLY**

**ATARI 800**  
Personal Computer  
System ..... **\$74900**

**NORTHSTAR**  
Horizon II 32K ..... **234900**  
Horizon II Quad ..... **279900**  
Horizon II 64K ..... **299900**  
Horizon Quad 64K ..... **339900**

**TELEVIDEO**  
Model 912 ..... **74900**  
Model 920 ..... **79900**  
Model 950 ..... **107900**

**HAZELTINE**  
Model 1420 ..... **79500**  
Model 1421 ..... **69500**  
Model 1500 ..... **84900**  
Model 1510 ..... **104900**  
Model 1520 ..... **122900**  
Espirit ..... **64900**  
Executive 80  
Model 20 ..... **119500**  
Model 30 ..... **139500**

**OKIDATA**  
Microline 80 ..... **55900**

**SOROC Technology**  
Model IQ 120 ..... **69900**  
Model IQ 140 ..... **104900**

**CROMEMCO**  
System 3 ..... **569500**  
Model Z2H ..... **799500**

**QANTEX**  
Model 8000 150 CPS  
parallel interface ..... **114900**  
Model 8000 150 CPS  
serial interface ..... **119500**

**DECwriter IV**  
Model LA-34 ..... **93900**

**We'll meet or beat any advertised prices!**

Most items in stock for immediate delivery.  
Factory sealed cartons. Full manufacturer's guarantee.  
All products subject to availability.  
All prices subject to change.

**DATA DISCOUNT CENTER**

135-53 Northern Blvd., Flushing, N.Y. 11354  
Visa • Master Charge • N.Y.S. residents add Sales Tax  
Shipping F.O.B. N.Y.

Phone Orders Call (212) 895-5577

link is the third link, and so on (see figure 5). The successor of the last link is nil.

The definition for class `SinglyLinkedList` is given in table 8. Class `SinglyLinkedList` has an instance variable named `firstLink` that points either to the first object in the list or to nil if the list is empty. The internal message `initialize`, which is sent when

an instance of `SinglyLinkedList` is created, sets `firstLink` to nil. The internal message `firstLink`, which is never sent to an empty list, returns the `SingleLink` instance pointed to by `firstLink`.

In the implementation of the message `append`, we first create a new link whose entry is the object passed as a parameter. We then check

|                               |   |
|-------------------------------|---|
| class name                    | DoubleLink  |
| superclass                    | SingleLink  |
| instance variable names       | predecessor   |
| class messages and methods    | <p><b>entry: anObject successor: aDoubleLink1 predecessor: aDoubleLink2</b>    <br/>                 ↑ (self entry: anObject successor: aDoubleLink1) predecessor: aDoubleLink2.</p>                  |
| instance messages and methods | <p><i>external</i><br/> <b>predecessor</b>     ↑ predecessor.<br/> <b>predecessor: aDoubleLink</b>     predecessor ← aDoubleLink.</p> <p><i>internal</i><br/>                 "none defined here"</p> |

Table 6: Class template for class DoubleLink.

|                               |  |
|-------------------------------|--|
| class name                    | LinkedList   |
| superclass                    | LinearList   |
| instance variable names       | "none defined here"  |
| class messages and methods    | <p><b>new</b>     ↑ (super new) initialize.</p>  |
| instance messages and methods | <p><i>external</i><br/> <b>at: anInteger</b>    <br/>                 self checkIndex: anInteger.<br/>                 ↑ (self linkAt: anInteger) entry.<br/> <b>replace: anObject at: anInteger</b>    <br/>                 self checkIndex: anInteger.<br/>                 (self linkAt: anInteger) entry: anObject.</p> <p><i>internal</i><br/>                 "firstLink     ... to be defined in subclasses"<br/> <b>linkAt: anInteger</b>   aLink  <br/>                 aLink ← self firstLink.<br/>                 (anInteger - 1) timesRepeat: [ aLink ← aLink successor. ]<br/>                 ↑ aLink.</p> |

Table 7: Class template for class LinkedList.



# Account on it.

Inventory

Now

Available

\$295

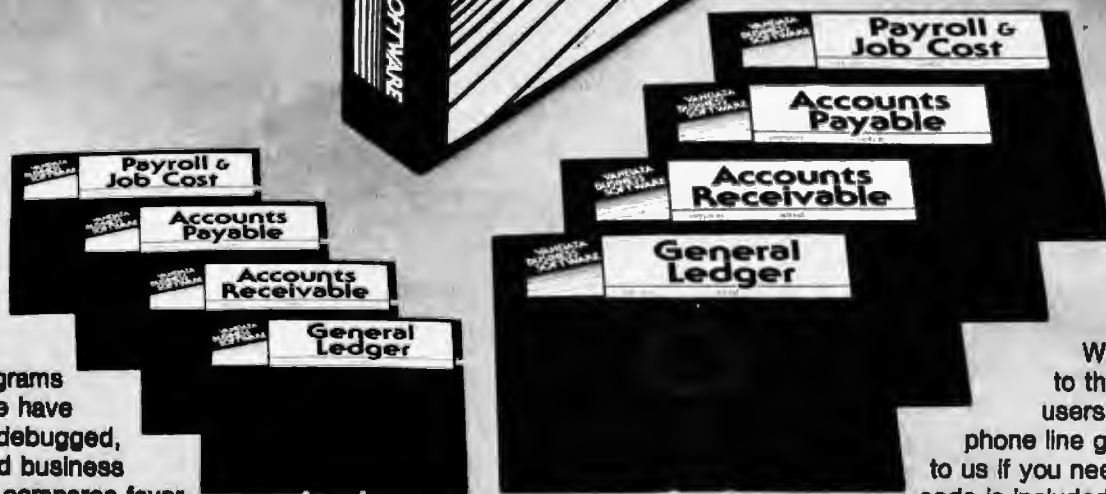

With the Osborne programs as a base, we have developed a debugged, easily installed business package that compares favorably with systems costing much more.

*General Ledger* produces trial, monthly, and quarterly balance sheets and income statements. Journal entries can be entered manually, or automatically from the A/R and A/P systems.

*Accounts Receivable* is an open-item system that handles invoice, payment, credit memo, debit memo, and progress billing transactions. Customer statements are produced when desired.

*Accounts Payable* writes checks to specified vendors from invoice, credit memo, and debit memo transactions. You can distribute each transaction over a series of G/L accounts and job numbers.

Both the A/R and A/P systems produce aged invoice analysis listings based on user-specified time periods.

The *Payroll* system allows hourly, salaried, vacation, holiday, piecework, overtime and miscellaneous pay. Any number of deductions can be entered for each employee. 941-A and W-2 forms are produced when needed. A Job Cost subsystem keeps track of project dates and status, and records hours, cost and overhead information by employee for each job.

The checks and statements fit standard forms readily available from mail-order forms suppliers. You have your choice of a number of different formats.

We are committed to the support of our users. A tech support phone line gives you access to us if you need it. Full source code is included with every system. Our money-back guarantee speaks for itself.

Minimum requirements are 48K RAM, CP/M™ or CDOS, CBASIC2™, a CRT, and a 132-column printer. We can provide standard 8", NorthStar 5" double-density, or Heath/Zenith 5" diskettes — call for availability of other formats. The price is \$295 per system, or \$995 for the complete set of four.

For more information, write VANDATA, Suite 205, 17544 Midvale Ave. N., Seattle, Wa. 98133, or call (206) 542-7611.

Vandata Business Software. You can account on it. Hundreds of other businesses already do.

CBASIC is a trademark of Compiler Systems Inc.  
CP/M is a registered trademark of Digital Research.

# Buy by Mail and SAVE!

## COMPUTERS



### Intertec Superbrain SPECIALS

64K Ram, List \$3495 . . . . . \$2595  
64K Quad, List \$3995 . . . . . \$2995

#### NorthStar

Horizon I 32K DD List \$2695 . . . . . CALL  
Horizon I QD List \$2995 . . . . . CALL  
Horizon 2 32DD List \$3095 . . . . . CALL  
IntersystemDPS-1 List \$1749 . . . . . CALL



Cromemco Z-2H, List \$9995 . . . . . \$7945  
System 2, 64K List \$4695 . . . . . \$3749  
System 3, 64K, List \$7995 . . . . . \$6395

#### Disk Systems

Thinker Toys Discus 2D . . . . . \$939  
Dual Discus 2D . . . . . \$1559  
Discus 2 + 2, List \$1549 . . . . . \$1259  
M26 Hard Disk, List \$4995 . . . . . \$3949  
Discus M-10, List \$3695 . . . . . \$2995

#### Printers & Terminals

Paper Tiger IDS-445 . . . . . \$649  
with graphic option . . . . . \$719  
Centronics 730-1, List \$795 . . . . . \$549  
739-1, List \$995 . . . . . \$769  
704-9 RS232 . . . . . \$1495  
704-11 . . . . . \$1569  
TI 810, List \$1895 . . . . . \$1489  
NEC SPINWRITER 5530 . . . . . \$2395  
NEC SPINWRITER 5515, 5510 . . . . . \$2395  
Diablo 630 List \$2711 . . . . . \$2399  
Intertube III List \$895 . . . . . \$729  
Zenith Z-19 . . . . . \$719  
Televideo 912C . . . . . \$679  
920C . . . . . \$799  
950 . . . . . \$999  
Hazeltime 1420 . . . . . \$789  
1500 . . . . . \$845  
Soroc 120 List \$995 . . . . . \$689  
IQ135 . . . . . \$719  
140 . . . . . \$994

# Computers Wholesale

P.O. Box 144 Camillus, NY 13031

VISA (315) 472-2582 MASTERCARD

Most items in stock for immediate delivery. Factory sealed cartons, w/full factory warranty. NYS residents add appropriate sales tax. Prices do not include shipping. VISA and Master Charge add 3%. C.O.D. orders require 25% deposit. Prices subject to change without notice.

to see if the list is empty, and if so we set firstLink to point to the new link. If the list is not empty, we get the last link in the list and make its successor the new link. In either case, we increment the value of count to keep track of the new number of objects in the list.

In general, to insert a data item into a singly linked list, we create a new

link for the item and then find the link that the new link is to follow. We then make this link point to the new link, and have the new link point to the former successor of this link (see figure 6a). The only exception to this process occurs if we are adding the data item to the beginning of the list. In this case there is no predecessor, so we simply point the new link to the

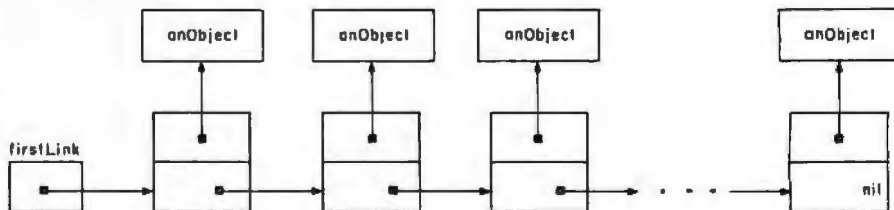

Figure 5: A singly linked list.

|  |                                    |
|--|------------------------------------|
| class name   | SinglyLinkedList                   |
| superclass   | LinkedList                         |
| instance variable names  | firstLink                          |
| class messages and methods   |                                    |
| "none defined here"  |                                    |
| instance messages and methods  |                                    |
| <i>external</i>  |                                    |
| <b>append: anObject</b>   aSingleLink                                    |                                    |
| aSingleLink ← SingleLink entry: anObject successor: nil.                 |                                    |
| self empty   |                                    |
| ifTrue: [ firstLink ← aSingleLink. ]                                     |                                    |
| ifFalse: [ (self linkAt: count) successor: aSingleLink. ]                |                                    |
| count ← count + 1.   |                                    |
| <b>insert: anObject at: anInteger</b>   aSingleLink                      |                                    |
| self checkIndex: anInteger.  |                                    |
| (anInteger = 1)  |                                    |
| ifTrue: [ firstLink ← SingleLink entry: anObject successor: firstLink. ] |                                    |
| ifFalse: [ aSingleLink ← self linkAt: anInteger - 1.                     |                                    |
| aSingleLink successor: (SingleLink entry: anObject successor:            |                                    |
| aSingleLink successor). ]  |                                    |
| count ← count + 1.   |                                    |
| <b>removeAt: anInteger</b>   aSingleLink anObject                        |                                    |
| self checkIndex: anInteger.  |                                    |
| (anInteger = 1)  |                                    |
| ifTrue: [ anObject ← firstLink entry. firstLink ← firstLink successor. ] |                                    |
| ifFalse: [ aSingleLink ← self linkAt: anInteger - 1.                     |                                    |
| anObject ← aSingleLink successor entry.                                  |                                    |
| aSingleLink successor: aSingleLink successor successor. ]                |                                    |
| count ← count - 1.   |                                    |
| ! anObject.  |                                    |
| <i>internal</i>  |                                    |
| <b>initialize</b>  | super initialize. firstLink ← nil. |
| <b>firstLink</b>   | ← firstLink.                       |

Table 8: Class template for class SinglyLinkedList.



# Compare!



APPLE II PLUS:  
16K  
48K  
64K

**SAVE**  
\$1049 22%  
\$1099 29%  
\$1269 27%  
Call

## Apple III

All are 1981 models with Apple RAM. 64K unit is 48K unit with Microsoft 16K RAM board. 48K and 64K units include Applesoft and Integer BASIC's when used with DISK II.

## HARDWARE for Apple II/III+

Disk II & 3.3 Controller  
Disk II  
Micro Sot A70 for Apple II  
286K 5" Drive  
3.3/Pascal/CPM Controller

**SAVE**  
\$ 499 23%  
\$ 439 16%  
\$ 499 18%  
\$ 78 20%

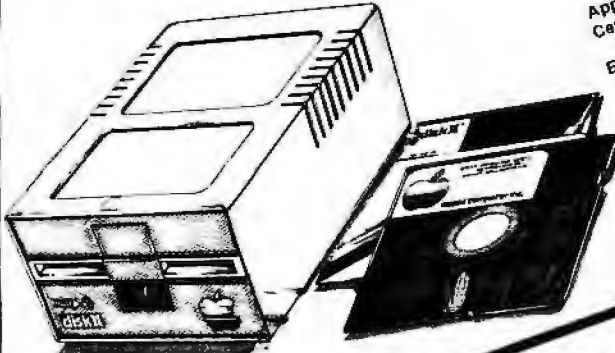

## MONITORS:

Sonyo 9" B&W  
12" B&W  
12" Green  
13" Color  
NEC 12" Green

**SAVE**  
\$ 169 30%  
\$ 249 21%  
\$ 299 21%  
\$ 449 20%  
\$ 225 21%  
\$ 25 38%

RF Modulator, M&R  
Serial/Parallel Interface,  
SSM AIO

\$ 159 20%  
\$ 129 35%  
\$ 89 37%  
\$ 939 25%

Serial Interface Card, CCS  
Parallel Interface Card, CCS  
Apple IEEE Card

\$ 299 17%  
\$ 249 18%  
\$ 239 15%

## PRINTERS:

Apple Silentype w/ Interface  
Centronics 737  
737 Interface & cable  
Epson MX 80  
MX 80 Interface & cable  
Epson MX 100  
MX100 Interface & cable  
Apple Graphics Tablet

\$ 498 22%  
\$ 759 26%  
\$ 168 26%  
\$ 475 27%  
\$ 95 15%  
Call  
Call  
Call  
\$ 685 13%

Microsoft:  
288 Softcard  
16K RAM Card  
Hayes Modem II™  
10 Memorex 5" Diskettes  
10 Maxell 5" Diskettes

\$ 249 28%  
\$ 159 20%  
\$ 299 23%  
\$ 25 45%  
\$ 39 33%

## SOFTWARE for Apple II/III+

Language/Pascal System  
DOS 3.3  
Apple Writer  
The Controller  
Apple Pilot  
DOS Tool Kit  
Apple Fortran  
Apple Plot  
Tax Planner  
Visicalc 3.2  
Visicalc 3.3  
Copy II Plus: Bit copy program.  
COPY II PLUS by Central Point Software.  
Will copy most protected programs for your backup in 45 seconds. \$38.95

**SAVE**  
\$379 24%  
\$ 49 20%  
\$ 59 21%  
\$495 21%  
\$119 27%  
\$ 69 22%  
\$148 26%  
\$ 49 30%  
\$ 99 33%  
\$119 21%  
\$159 20%

MICROSOFT: (all disk)  
Typing Tutor  
Adventure  
Fortran - 80  
A.L.D.S.  
BASIC Compiler  
Olympic Decathlon

\$ 14 30%  
\$ 23 24%  
\$149 26%  
\$ 110 10%  
\$299 25%  
\$ 19 24%

## INSOFT:

ALD System II  
TRANSFORTH II  
Accounting Software  
A full professional quality integrated GL, A/R, A/P, Payroll package. Hot-line support available. Send for free sample printouts.

\$ 110 10%  
\$ 110 10%  
\$365 66%

# NO SALES TAX

# Computer Exchange

P O BOX 1380

Jacksonville, OR 97530

# TOLL FREE (800) 547-1289

Apple Computer  
Sales and Service

**IMPORTANT NOTE:**  
We are an authorized dealer and repair center and will repair all Apple equipment regardless of where you purchased it, in or out of warranty. Normally our turnaround time on repairs is 24 hours. Call before sending equipment.



Above prices for mail orders only. Our store showroom is 126 N.E. "F" St., Grants Pass, OR. Store prices, which include software service, differ from mail order prices. No mail order sales at store. CALL ORDER DESK.

**ORDERING INFORMATION:** Minimum order \$100. Money Orders, Cashier Checks or Bank Wires Welcomed. Visa and MC orders add 3% shipping, handling and insurance. UPS ground is standard. Add 3% for UPS Blue or 10% total for US Parcel Post. Include your telephone number. No COD's. Prices subject to change without notice. Order desk hours are 9 to 6 PDT, 10 to 3 Saturdays.

References:  
We have been an Apple dealer since 1978. Our bank reference is First Interstate Bank (503) 776-5820. We belong to the Chamber of Commerce (503) 772-6293.

# Save.

# The NO Compromise on P<sup>3</sup>\*

## S-100 Plug-Ins

\*(Performance, Power, Price)

### STATIC RAM BOARD



The 32K x 8 bit/16K x 16 bit STATIC RAM BOARD uses low power and its fast device access time of 200 nsec (max.) allows for operation @ 4 MHz without any wait cycles.

**Features:** IEEE-696 compatibility with extended addressing  Memory address may start and stop on any 4K/2K boundary  Special Memory Management and Control Functions (selectable via output port control word(s):

Bank select/deselect 8K/4K  
Bank write protect 8K/4K  
Bank readdress 8K/4K

Software page select/override  Software wait cycle select (if slower devices utilized by user)  External power source back-up capability for Memory Array  Low input power requirements (full memory array - 150 MA max. @ 8 VDC IN - support logic - 500 ma typ @ 8 VDC IN)  Socketed RAMs and support logic IC's for easy maintenance  Comprehensive Manual

Assembled and Tested  
Kit P/N 52748-500 \$395

P/N 52748-500-100 \$485  
Bare Board P/N 52748-5XX \$95

The multiple on-board functions allow for complete software and hardware I/O task(s) control.

**Features:** Two independent SYNC/ASYNCR serial ports (Software programmable with status read interface: RS-232-C or current loop - 20 or 60ma - or TTL with handshaking. Dedicated output connectors for each port)  One strobed 8-bit parallel port with handshaking (Software status read)  Three 8-bit parallel ports undedicated & user configured (Software programmable for input, output, plus input/output/bidirectional with handshaking or combinations thereof. Software status read for handshake logic)  Three independent 16-bit timers (Software programmable for 5 operating modes. Individ. clock source input & gate control - int. or ext. Uninterrupted read. Two buffered outputs)  Eight level priority Interrupt controller (Software programmable highest interrupt level. 8080/280 auto restart command)  Two software programmable baud rate generators with crystal controlled frequencies - .01% tolerance  Large prototyping area with access to regulated +5, +12, -12VDC.

### MULTI-FUNCTION I/O BOARD

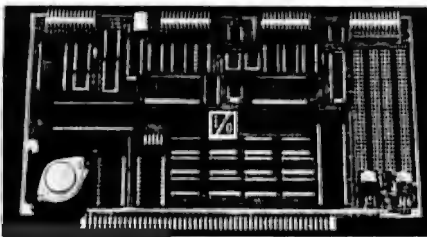

Assembled and Tested  
Kit P/N 52748-100 \$225

P/N 52748-100-101 \$375  
Bare Board P/N 52748-1XX \$85

### PROTOTYPING BOARD

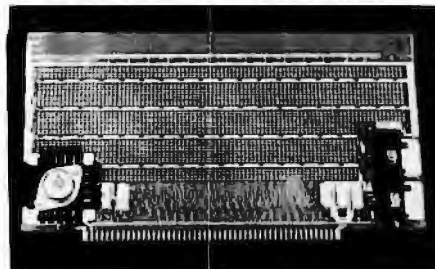

Provides flexibility and saves hours of power busing layout time.

**Features:** Bus-bar power distribution  Allows wire-wrap or soldering of sockets and discrete components  Accepts all std. sockets on .30" & .60" centers  3 regulators (+5V ± 12V) with filter and decoupling capacitors  Accepts edge connectors on .10" centers.

Or complete as shown in photo.

**Kit includes:** 3 regulators w/3 heat-sinks/filter capacitors/2 bus bars and manual P/N 52748-400 \$49.95  
Bare Board P/N 52748-4xx \$34.95

## I/O TECHNOLOGY

P.O. Box 2119  
Canyon Country, CA 91351  
(805) 252-7666



CA residents add 6% tax  
U.S. Domestic Price, FOB Factory



former first link in the list. This procedure is used to implement the message insertAt: in class SinglyLinkedList. We also increment the value of count, just as we do in the message append.

The general procedure for removing a data item from a singly linked list is analogous to that for inserting an item. First we find the link that precedes the one at the position of interest. We then point this link to the link that follows the one of interest. This deletes the link of interest from the list (see figure 6b). We then return the entry of the deleted link. Again, the exceptional case is removing the first item since there is no preceding link. The message removeAt: in class SinglyLinkedList is implemented using this procedure. Since an object has been deleted from the list, we decrement the value of count.

Suppose we wish to use a singly linked list instead of a sequential list in our previous example of a deck of cards. We simply create instances of class SinglyLinkedList for the deck and hands, as shown in the following:

```
| hand1 hand2 deck |
deck - SinglyLinkedList new.
hand1 - SinglyLinkedList new.
hand2 - SinglyLinkedList new.
```

We can then use the rest of the code, unchanged, from that example. We are able to do this because we have hidden the details of each implementation inside the corresponding class definition and, in using the classes, have limited ourselves to a clearly defined set of external messages.

### The Circular List

Another type of linked list is the circular list (see figure 7). A circular list is a singly linked list in which the successor of the last link in the list is the first link in the list. This makes a circular chain of links. If we have access to the last link in a circular list, then we also have easy access to the first link of that list since it is the immediate successor of the last link. By keeping track of the last link of a circular list, we can easily insert and remove items from both the begin-

# 64K Static RAM

available now from stock

#### Ultra Fast - 100 nsec. chips

Fast access allows memory management manipulation without wait states.

#### 8/16 - 8 or 16-bits wide

Dynamically switches data path width per IEEE Standard.

#### Low Power

Typical power consumption less than 2 amps for active board. Less for power down boards.

#### Extended Addressing

24-bit IEEE addressing allows 16-megabyte range. Single shunt changes to 16-bit addressing.

#### Fully Static

No clocks, no refresh required for easy DMA use.

#### Special Features

Any 4K block can be disabled. Or, can disable everything above or below any 4K boundary. Available in 16K increments for OEM quantities.

# \$ 1,295

100 nsec. Chips - Qty. 1-9

OEM & Dealer prices also available.

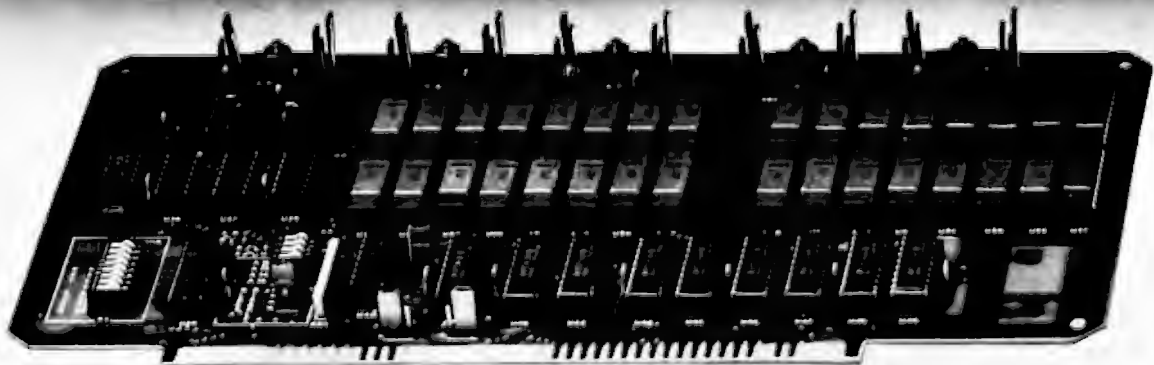

#### TO ORDER:

May be ordered through your local computer store or factory direct. Personal checks, CODs, VISA and MC accepted from within USA. 10-day return privilege on factory orders. Shipping paid by SCP on prepaid USA and Canadian orders. All boards fully assembled, guaranteed one year.

## SEATTLE COMPUTER

1114 Industry Dr. Seattle WA 98188

Information Hotline: 206/575-1830

Send more information: ( ) \_\_\_\_\_

Name \_\_\_\_\_

Company \_\_\_\_\_

Address \_\_\_\_\_

City \_\_\_\_\_ State \_\_\_\_\_ Zip \_\_\_\_\_

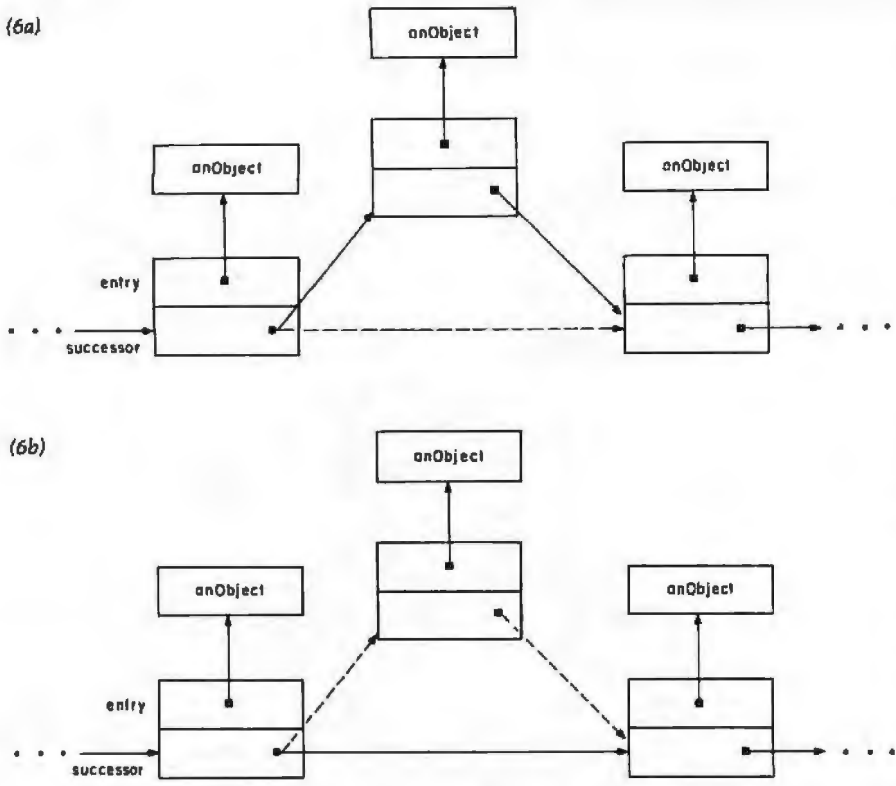

Figure 6: The insertion and deletion of data items from a singly linked list. In both insertion (6a) and deletion (6b) processes, the dotted lines represent the links existing before the process, while the solid lines represent the links existing after the process.

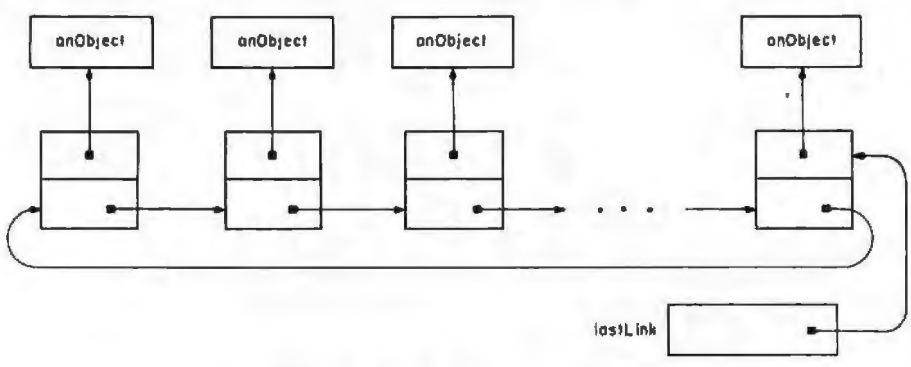

Figure 7: A circular list.

ning and the end of the list. This will be a useful property in some of the data structures that we will build out of circular lists.

The definition of class *CircularList* is given in table 9. Class *CircularList* has an instance variable named *lastLink* that points either to the last link in the list or to *nil* if the list is empty. The internal message *initialize* sets *lastLink* to *nil*. The internal message *firstLink* (again, as in the case of class *SinglyLinkedList*, sent to nonempty lists only) returns the successor of *lastLink*. Since the list is circular, this is the first link in the list.

The *append*, *insert*, and *remove* operations on a circular list are similar to those on a noncircular list. Since we always have a link that precedes any given link in a circular list, we don't have to make exceptions for operations on the beginning of the list. The implementation of these operations is demonstrated in the methods for the messages *append*, *insertAt*, and *removeAt*.

### The Doubly Linked List

Now we will consider the *doubly linked list* (see figure 8). A doubly linked list is a sequence of double links connected together. The successor of a given link is the link that follows it in the sequence, just as in the case of the singly linked list. The predecessor of a given link is the link that precedes it in the sequence. A doubly linked list can be made into a circular list, just as a singly linked list can, by connecting the first and last links. In this case, the successor of the

Text continued on page 260

|  |           |   |           |   |           |
|--|-----------|---|-----------|---|-----------|
| <b>AMS</b>   |           | ADVANCED MICRO SYSTEMS • 26188 ADAMOR ROAD • CALABASAS, CA. 91302 |           | OFFER EXPIRES Oct 31 1981   |           |
| MORROW DESIGNS PRODUCTS AT LOW LOW PRICES!                     |           | Tel.: (213) 880-4670  |           |   |           |
| <b>* HARD DISK SUBSYSTEMS</b>                                  |           | <b>ADDITIONAL HARD DISK</b>                                       |           | <b>* FLOPPY DISK SUBSYSTEMS</b>   |           |
| M-26 DISCUS M26  | \$3697.00 | A-26 DISCUS M26   | \$3337.00 | F-1118 DISCUS 1   | \$ 816.00 |
| M-20 DISCUS M20  | \$3553.00 | A-20 DISCUS M20   | \$3193.00 | F-1218 DISCUS 2D  | \$ 888.00 |
| M-10 DISCUS M10  | \$2760.00 | A-10 DISCUS M10   | \$2400.00 | F-2218 DISCUS 2 4 2   | \$1176.00 |
| <b>DISK CONTROLLERS (A &amp; T)</b>                            |           | <b>STATIC MEMORY (A &amp; T)</b>                                  |           | <b>* DECISION I BASIC UNIT \$1342.00</b>  |           |
| DJ M26 M26 HARD DISK   | \$595.00  | 16K SUPERAM   | \$248.00  | <b>NOTE:</b>  |           |
| DJ M20 M20 HARD DISK   | \$595.00  | 16K MEMORY MASTER   | \$284.00  | 1. The disk subsystems include Digital Research CP/M 2.2 and Microsoft Basic V5.2   |           |
| DJ M10 M10 HARD DISK   | \$595.00  | 24K MEMORY MASTER   | \$378.00  | 2. If you own a MITS controller and disc drive, we have the interface to run them with our new subsystems, and a reformatter for your Peric drives and software to translate your MITS files to your new operating system |           |
| DJ-2208 DOUBLE DENSITY FLOPPY                                  | \$349.00  | 32K SUPERAM   | \$450.00  |   |           |
| DJ-1108 SINGLE DENSITY FLOPPY                                  | \$219.00  | 65K STATIC RAM  | \$870.00  |   |           |
| <b>I/O CONTROLLERS (A &amp; T)</b>                             |           | <b>I.E.E.E. 5-100 BUS (A &amp; T)</b>                             |           |   |           |
| SB-2411 SWITCHBOARD I/O  | \$219.00  | WB-0800 8 SLOT MOTHER BRD.  | \$109.00  |   |           |
| SB-2411-4K 4K RAM OPTION                                       | \$ 60.00  | WB-1200 12 SLOT MOTHER BRD.                                       | \$129.00  |   |           |
| MB 3200 MULT I/O BOARD   | \$309.00  | WB 2000 20 SLOT MOTHER BRD.                                       | \$173.00  |   |           |
| All shipments FOB Calabasas — 90 days warranty on all products |           | Prices, Terms, Specifications subject to change without notice.   |           |   |           |

# ALL THESE FEATURES... IN THIS SMALL SPACE... AT THIS LOW PRICE!

## 4,695

Greater computer power . . . fewer separate components . . . larger capability . . . simpler to operate . . . modular maintenance . . .

These are the unique benefits of the Quasar Data QPD-100 Floppy Disk Computer . . . plus unsurpassed reliability . . . plus 12-month warranty on all PC boards.

Its highly reliable, double density drive is compact. Accepts both single AND double-sided disks.

Upgradeable from the Z-80™ microprocessor-based system to our 16 BIT microprocessor-based system by simply plugging in extra PC cards. Hard disk and multi-user systems available.

As your requirements grow, your QDP-100 can grow to fit them.

The Quasar Data QDP-100H is a larger version with 6-megabyte capacity; includes one double-sided floppy and one 5¼ microwinchester hard disk.

Both the Quasar Data QDP-100 and QDP-100H are fully compatible with all standard terminals.

Phone or write for descriptive bulletin and specifications. And ask for a demonstration. Dealer inquiries invited.

## QUASAR DATA'S QDP-100 COMPUTER SYSTEM.

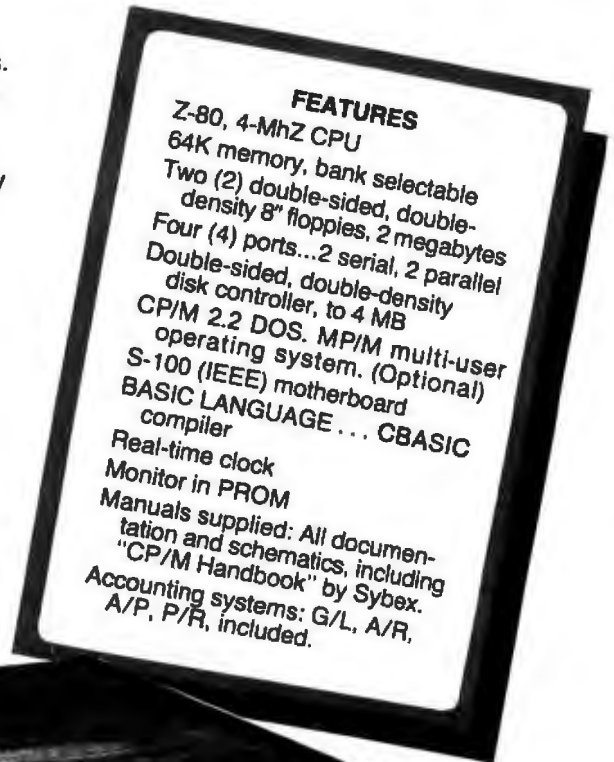

### FEATURES

Z-80, 4-MHz CPU  
64K memory, bank selectable  
Two (2) double-sided, double-density 8" floppies, 2 megabytes  
Four (4) ports...2 serial, 2 parallel  
Double-sided, double-density disk controller, to 4 MB  
CP/M 2.2 DOS. MP/M multi-user operating system. (Optional)  
S-100 (IEEE) motherboard  
BASIC LANGUAGE . . . CBASIC compiler  
Real-time clock  
Monitor in PROM  
Manuals supplied: All documentation and schematics, including "CP/M Handbook" by Sybex.  
Accounting systems: G/L, A/R, A/P, P/R, included.



18" wide  
16 7/8" deep  
11" high

Complete systems available

Z-80 is a trademark of Zilog Corp.

CP/M and MP/M are trademarks of Digital Research Corp.

CBASIC is a trademark of Compiler Systems Inc.

## Quasar Data Products

10330 Brecksville Road, Brecksville (Cleveland), Ohio 44141  
Phone: 216/526-0838 / 526-0839  
Telex: 241596

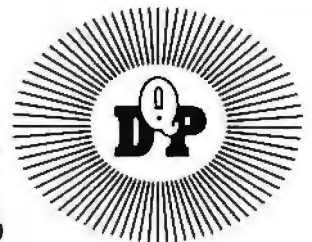

**LOW PRICES.  
QUALITY AND FAST SERVICE**

**LEO CAN FILL YOUR NEEDS**

| MEMORY             | 1-10  | 11-49 |
|--------------------|-------|-------|
| 1702A              | 4.75  | 4.50  |
| 2708               | 3.25  | 3.05  |
| TMS2716            | 6.50  | 6.35  |
| 2716 5V            | 6.50  | 6.35  |
| 2716-1 (350 ns)    | 8.50  | 8.25  |
| TMS2532            | 17.00 | 16.50 |
| 2732               | 17.00 | 16.50 |
| 2732A-3 (300ns)    | 23.00 | 21.50 |
| 2732A-2 (200ns)    | 30.00 | 28.75 |
| 2758               | 8.00  | 7.35  |
| 2114 (450 ns)      | 2.75  | 2.55  |
| 2114 (300 ns)      | 3.00  | 2.90  |
| 2114 (200 ns)      | 3.65  | 3.50  |
| TMS4060-2 (200 ns) | 2.50  | 2.25  |
| 4116 (200 ns)      | 2.50  | 2.35  |
| 4116 (150 ns)      | 3.00  | 2.85  |
| 6810               | 4.25  | 4.00  |
| 6821               | 5.75  | 5.50  |
| 6850               | 5.25  | 5.00  |
| 8080A              | 2.75  | 2.50  |
| 8085A              | 8.75  | 8.50  |
| 8212               | 2.50  | 2.35  |
| 8216               | 2.50  | 2.35  |
| 8748               | 55.00 | 52.00 |
| TMS9900            | 25.00 | 22.00 |
| Z-80 CPU           | 6.50  | 6.25  |
| Z-80A CPU          | 7.50  | 7.25  |

|                |                              |
|----------------|------------------------------|
| <b>SPECIAL</b> | 4116 (200 ns)<br>8 for 19.00 |
|----------------|------------------------------|

**LS PRODUCT**

|      |     |       |      |       |      |       |      |
|------|-----|-------|------|-------|------|-------|------|
| LS00 | 25  | LS74  | 30   | LS158 | 78   | LS244 | 1.20 |
| LS02 | 25  | LS85  | 1.15 | LS161 | 90   | LS245 | 1.20 |
| LS04 | 25  | LS96  | .40  | LS183 | 90   | LS256 | 1.75 |
| LS08 | 25  | LS93  | .80  | LS164 | 85   | LS273 | 1.35 |
| LS10 | 25  | LS95  | .70  | LS185 | 85   | LS283 | .85  |
| LS20 | 25  | LS109 | .45  | LS174 | 1.00 | LS367 | .55  |
| LS30 | 25  | LS123 | .75  | LS175 | 1.00 | LS368 | .85  |
| LS32 | 30  | LS138 | .75  | LS191 | 1.00 | LS373 | 1.40 |
| LS38 | 25  | LS139 | .75  | LS193 | .85  | LS374 | 1.40 |
| LS42 | .75 | LS161 | .75  | LS195 | .70  | LS377 | 1.40 |
| LS51 | 30  | LS153 | .75  | LS221 | 1.15 | LS390 | 1.50 |
| LS54 | 30  | LS155 | 1.00 | LS240 | 1.20 | LS393 | 1.50 |
| LS73 | 40  | LS157 | .75  | LS241 | 1.20 | LS670 | 1.85 |

**S PRODUCT**

|      |      |
|------|------|
| S188 | 3.25 |
| S189 | 3.25 |
| S287 | 3.25 |
| S288 | 3.00 |
| S387 | 3.25 |
| S471 | 7.50 |
| S472 | 9.00 |

**CAN SUPPLY**

|              |
|--------------|
| TTL - CMOS   |
| SOCKETS      |
| CONNECTORS   |
| CAPACITORS   |
| DIP SWITCHES |
| DIODES       |
| TRANSISTORS  |

**CALL FOR VOLUME PRICING**

**LEO ELECTRONICS, INC.**

8921 S. Sepulveda Ste 208  
Los Angeles, CA 90045  
213/641-3101  
800/421-2418



MON THRU FRI  
8:00 am to 5:00 pm

**TERMS:**

CHECK, MONEY ORDER, VISA  
MASTERCARD. CALL FOR COD.  
U.S. FUNDS ONLY  
Calif residents, add 6% tax

**POSTAGE:**

ADD 2.00 Ground  
ADD 5.00 Air  
UPS

ALL MAJOR MANUFACTURERS.

100% GUARANTEED.

|   |              |
|---|--------------|
| class name  | CircularList |
| superclass  | LinkedList   |
| instance variable names   | lastLink     |
| class messages and methods  |              |
| "none defined here"   |              |
| instance messages and methods   |              |
| <p><i>external</i></p> <p><b>append: anObject   aSingleLink  </b><br/>self empty<br/>ifTrue: [ lastLink ← SingleLink entry: anObject successor: nil.<br/>lastLink successor: lastLink. ]<br/>ifFalse: [ aSingleLink ← SingleLink<br/>entry: anObject successor: lastLink successor.<br/>lastLink successor: aSingleLink. lastLink ← aSingleLink. ].<br/>count ← count + 1.</p> <p><b>insert: anObject at: anInteger   aSingleLink  </b><br/>self checkIndex: anInteger.<br/>aSingleLink ← self linkAt: anInteger - 1.<br/>aSingleLink successor:<br/>(SingleLink entry: anObject successor: aSingleLink successor).<br/>count ← count + 1.</p> <p><b>removeAt: anInteger   aSingleLink anObject  </b><br/>self checkIndex: anInteger.<br/>aSingleLink ← self linkAt: anInteger - 1.<br/>anObject ← aSingleLink successor entry.<br/>(count = 1)<br/>ifTrue: [ lastLink ← nil. ]<br/>ifFalse: [ aSingleLink successor: aSingleLink successor successor.<br/>(anInteger = count) ifTrue: [ lastLink ← aSingleLink. ]. ]<br/>count ← count - 1.<br/>↑ anObject.</p> <p><i>internal</i></p> <p><b>initialize</b>     super initialize. lastLink ← nil.<br/><b>firstLink</b>     ↑ lastLink successor.<br/><b>linkAt: anInteger    </b><br/>(anInteger = count)   (anInteger = 0) ifTrue: [ ↑ lastLink ].<br/>↑ super linkAt: anInteger.</p> |              |

Table 9: Class template for class CircularList.

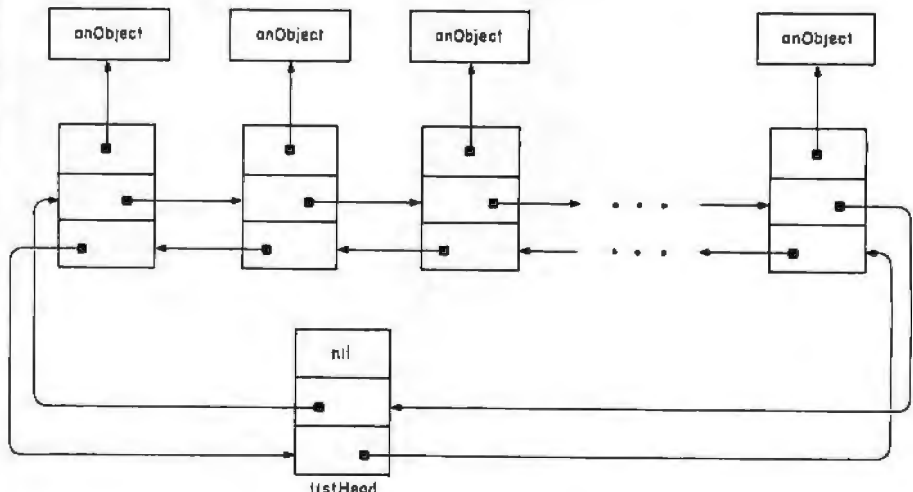

Figure 8: A doubly linked list.



# The A2-3D1 Graphics Family...

## Now for non-programmers!



Running on the Apple II:  
A2-3D/A Saturn Navigator

**A2-3D1 Graphics Package**  
\$59.95 on disk (32K required)  
\$49.95 on cassette (16K  
required)

**A2-3D2 Enhancement**  
\$24.95 on disk (48K and  
A2-3D1 required)  
\$19.95 on cassette (32K and  
A2-3D1 required)

**A2-GE1 Graphics Editor**  
\$34.95 on disk (48K and  
A2-3D1 required)

**A2-3D/A Saturn Navigator**  
\$24.95 on disk (48K and  
A2-3D1 required)

## professional 3D and 2D graphics for the Apple II

The **A2-3D1** is the graphics utility you can depend on whether you're mapping a town, presenting charts at a business meeting, or animating games.

Now this versatility is available for the non-programmer with the **A2-GE1** graphics editor and programmer. Create images as you view them. Scan them, animate them, combine them, or add text or labels. With a minimum of fuss, you can prepare all sorts of scientific, business, or educational presentations.

Add the **A2-3D2** enhancement package for color, and as a bonus you'll also be able to manipulate images independently of each other—as many different objects at once as your memory will accommodate.

When it's time for some challenging and educational entertainment, run the **A2-3D/A** Saturn Navigator. You'll enjoy an adventurous flight to Saturn, enter its orbit, and rendezvous with an orbital space station that awaits your arrival.

We've reached our goal of giving you the most sophisticated graphics utilities in the marketplace . . .

### see them now at your dealer!

# subLOGIC

Communications Corp.  
Box V, Savoy, IL 61874  
(217) 359-8482  
Telex: 206995

For direct order, include \$3 for UPS or \$5 for first class mail delivery.  
Illinois residents add 5% sales tax. Visa and Master Card accepted.

"Apple" is the registered trademark of Apple Computer Inc.

|                               |   |
|-------------------------------|---|
| class name                    | DoublyLinkedList  |
| superclass                    | LinkedList  |
| instance variable names       | listHead  |
| class messages and methods    |   |
|                               | "none defined here"   |
| instance messages and methods |   |
|                               | <p><i>external</i></p> <p><b>append: anObject</b>     self insert: anObject after: listHead predecessor.<br/> <b>insert: anObject at: anInteger</b>    <br/> self checkIndex: anInteger.<br/> self insert: anObject after: (self linkAt: anInteger - 1).<br/> <b>removeAt: anInteger</b>   aDoubleLink  <br/> self checkIndex: anInteger.<br/> aDoubleLink ← self linkAt: anInteger.<br/> aDoubleLink successor predecessor: aDoubleLink predecessor.<br/> aDoubleLink predecessor successor: aDoubleLink successor.<br/> 1 aDoubleLink entry.</p> <p><i>internal</i></p> <p><b>initialize</b>    <br/> super initialize.<br/> listHead ← DoubleLink entry: nil successor: nil predecessor: nil.<br/> listHead successor: listHead. listHead predecessor: listHead.<br/> <b>firstLink</b>     1 listHead successor.<br/> <b>linkAt: anInteger</b>   aDoubleLink  <br/> (anInteger = 0) ifTrue: [ 1 listHead ].<br/> (anInteger ≤ (count / 2)) ifTrue: [ 1 super linkAt: anInteger ].<br/> aDoubleLink ← listhead.<br/> (count - anInteger + 1) timesRepeat:<br/> [ aDoubleLink ← aDoubleLink predecessor. ].<br/> 1 aDoubleLink.<br/> <b>insert: anObject after: aDoubleLink1</b>   aDoubleLink2  <br/> aDoubleLink2 ← DoubleLink entry: anObject<br/> successor: aDoubleLink1 successor predecessor: aDoubleLink1.<br/> aDoubleLink1 successor: aDoubleLink2.<br/> aDoubleLink2 successor predecessor: aDoubleLink2.</p> |

Table 10: Class template for class DoublyLinkedList.

Text continued from page 256:

last link is the first link, and the predecessor of the first link is the last link. The class definition for a circular, doubly linked list is given in table 10.

Class DoublyLinkedList has an instance variable named listHead, which points to a special kind of link known as a list head. A list head is a link whose entry is unused. The idea is to keep the list head in the list so that even when there are no data items in the list, at least one link is present. Having a link present at all times simplifies the implementation of some linked list operations. A list

head can be used in the implementation of a singly linked list, but it is especially convenient in the implementation of a circular doubly linked list. In a circular doubly linked list, the list head successor points to the first link in the list (excluding the list head itself), or to itself if the list is empty (see figure 9). The list head predecessor points to the last link in the list (excluding the list head itself), or to itself if the list is empty. In class DoublyLinkedList, the internal message initialize sets listHead to an instance of DoubleLink whose entry is nil and whose successor and predecessor are both that same in-

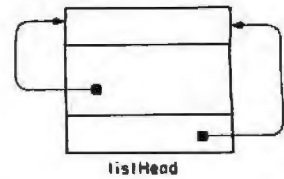

Figure 9: An empty doubly linked list.

stance (ie: the double link is made circular). The message firstLink has been modified to return the list head successor.

Because a doubly linked list is composed of a sequence of double links, it is possible to traverse the list in both directions, forward and backward, with equal facility. The internal message linkAt: in class DoublyLinkedList has been modified to access objects past the middle of the list by starting from the rear and traversing toward the front. This improves the performance of the access message at:.

Inserting an item in a doubly linked list is similar to inserting an item in a singly linked list. We first create a new link for the item. Then we find the link that this new link is to follow, set the successor and predecessor pointers of the new link, and adjust both the successor pointer of the link that precedes the new link and the predecessor pointer of the link that follows the new link (see figure 10a). If we are using a circular list with a list head, we don't have to consider any exceptional cases. Removing an item from a list is an analogous process (see figure 10b). The details of these procedures are demonstrated in the methods for the messages append:, insert:, and removeAt:.

## The Stack

The next data structure that we will look at is the stack (see figure 11). A stack is a linear list of items that is accessed in a very restricted way. In fact, only one side of a stack, the top, can be accessed. The bottom of the stack cannot be accessed. These names are useful because most stack diagrams list their items vertically, with the accessible end higher. The item at the accessible end of the stack

Text continued on page 264

# Printers Plus

...computers, peripherals,  
accessories and supplies!



## APPLE ACCESSORIES

|                                 |      |
|---------------------------------|------|
| LOBO Disk II Add-On .....       | 419. |
| SUPERTERM 80 Col. Card .....    | 329. |
| Z80 Soft Card .....             | 295. |
| H.S. Serial Card .....          | 179. |
| COMM. Card .....                | 179. |
| HAYES Micromodem .....          | 319. |
| PARALLEL Printer Card .....     | 149. |
| 16K Ram Card .....              | 189. |
| GPIB IEEE488 Card .....         | 259. |
| VISTA A40 Disk II Add-On .....  | 349. |
| VISTA A80 Disk II Add-On .....  | 529. |
| VISTA A160 Disk II Add-On ..... | 799. |
| VISTA A800 Dbl. Den. 8" Con. .. | 529. |

## SOFTWARE

|                       |        |
|-----------------------|--------|
| VISICALC .....        | 119.00 |
| DESKTOP Plan II ..... | 169.00 |
| DB MASTER .....       | 209.00 |
| ADDRESS Book .....    | 40.00  |
| SUPER Text II .....   | 125.00 |
| CCA Data Mgmt .....   | 85.00  |

## RIBBONS

|                        |              |
|------------------------|--------------|
| NEC .....              | \$77.00/Doz. |
| QUME .....             | 45.00/Doz.   |
| DIABLO .....           | 66.00/Doz.   |
| ANADEx .....           | 135.00/6 ea. |
| TRITEL .....           | 95.00/Doz.   |
| TI/DEC/TTY .....       | 45.00/Doz.   |
| EPSON .....            | 13.95/ea.    |
| MPI/Axiom/Base 2 ..... | 10.00/ea.    |



## MAGNETIC MEDIA

Premium Quality At Bargain Prices  
5 1/4" Diskettes, all Formats

100% Certified with hub rings, box of 10

|   |       |
|---|-------|
| Single sided, single density .....          | 26.50 |
| Single sided, double density .....          | 29.50 |
| Double sided, double density .....          | 38.50 |
| 8" DISKETTES, ALL FORMATS<br>100% CERTIFIED |       |
| Single sided, single density .....          | 29.50 |
| SSSD Error Free .....                       | 34.50 |
| Single sided, double density .....          | 39.50 |
| Double sided, double density .....          | 49.50 |

|                            |          |
|----------------------------|----------|
| Diablo 630 RO .....        | \$2,395. |
| Diablo 1640 RO .....       | 2,795.   |
| Diablo 1650 RO .....       | 3,095.   |
| C.Itoh Starwriter RO ..... | 1,695.   |
| TI 810 RO .....            | 1,695.   |
| TI 820 RO .....            | 1,795.   |
| Anadex DP9500/9501 .....   | 1,345.   |

# EPSON

Complete Stock of MX-80, MX-80 F/T  
MX-100 Printers, Graphics Chip Sets  
Cards and Cables

## NEW! NOVELL IMAGE 800

150 CPS Heavy Duty Matrix  
15" wide carriage, expanded, compressed and  
double density "correspondence quality"  
printing at 80, 96 and 136 columns, true  
descenders, underlining, superscripts,  
subscripts. Up to 3K Buffer, optional character  
set and graphics option.  
List \$1,395. .... \$1,295.00

## PRINT ELEMENTS

|  |         |
|--|---------|
| NEC Thimbles .....   | \$14.95 |
| Plastic Daisy Wheels<br>for Qume, Diablo, Starwriter ..... | 6.00    |
| Metal Daisy Wheels .....                                   | 59.00   |
| IBM Selectric Elements .....                               | 19.00   |



## MODEMS

|                               |        |
|-------------------------------|--------|
| UDS 103 LP, direct .....      | \$169. |
| 103 JLP Auto Answer .....     | 219.   |
| NOVATION CAT, acoustic .....  | 159.   |
| D-CAT, direct .....           | 169.   |
| Auto Cat .....                | 219.   |
| Apple Cat .....               | 309.   |
| LEXICON LX-11, acoustic ..... | 147.   |
| HAYES Micromodem, S100 .....  | 349.   |

## VIDEO MONITORS

|                              |        |
|------------------------------|--------|
| Sanyo 9" B/W .....           | \$169. |
| NEC 12" Green .....          | 229.   |
| Amdek 12" B/W (Leedex) ..... | 135.   |
| Amdek 13" Color .....        | 399.   |

## VIDEO TERMINALS

|                       |        |
|-----------------------|--------|
| Ampex Dialog 80 ..... | \$995. |
| Ampex Dialog 30 ..... | 795.   |
| Televideo 920C .....  | 845.   |
| Televideo 950 .....   | 995.   |
| Soroc IQ 120 .....    | 795.   |
| Soroc IQ 140 .....    | 1,195. |

## FLOPPY DRIVES

|                                |        |
|--------------------------------|--------|
| 1-SA 400 Case, power .....     | \$399. |
| 1-SA 800/801 Case, power ..... | 995.   |
| 2-SA 800/801 Case, power ..... | 1,495. |
| 2-SA 850/851 Case, power ..... | 1,995. |



## MPI 88 G Matrix

High resolution dot-addressable graphics for  
Apple. Enhanced "correspondence quality"  
printing. Tractor and Friction feed. Serial and  
Parallel Input. 100 cps Bidirectional printing, 80,  
96, and 132 column widths!

List \$799.00 ..... \$599.00

|                           |          |
|---------------------------|----------|
| Apple II I/O Card .....   | \$110.00 |
| PET/IEEE I/O Card .....   | 55.00    |
| Single Sheet Feeder ..... | 25.00    |
| QT Cover .....            | 25.00    |



## NEC SPINWRITERS

|                    |          |
|--------------------|----------|
| 5510/5530 RO ..... | \$2,595. |
| 5520 KSR .....     | 2,895.   |

NEW!

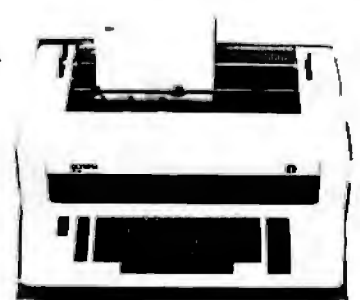

## OLYMPIA ES100 RO

Letter quality, Daisy wheel printer/typewriter  
interfaces to Apple, Atari, NEC, TRS80 and  
RS232 Serial ports. A truly cost effective letter  
quality printer that functions as a typewriter.

List \$1690. .... \$1395.00

## TO PLACE YOUR ORDER CALL:

TELEPHONE (714) 744-7314      TELEX 697120

or write to:

# PALOMAR

Computer Products

910-105 W. San Marcos Blvd., San Marcos, CA 92069

TERMS OF SALE: Cash, check, money order, bank wire transfer,  
credit card or purchase orders from qualified firms and  
institutions. Please include telephone number with order and  
expiration date on credit card orders. California residents add 6%  
sales tax. Advertised prices are for prepaid orders F.O.B. shipping  
point. Add 3% for shipping in U.S. Pricing and availability subject to  
change without notice.

Circle 297 on Inquiry card.



**BEING OVERCHARGED!**

**DON'T**

Pay Credit Card Surcharges  
Pay a U.P.S. C.O.D. "Fee"  
Even Pay for the Call!

**DO CALL OMEGA TOLL FREE!**

**Special  
of the Month!**

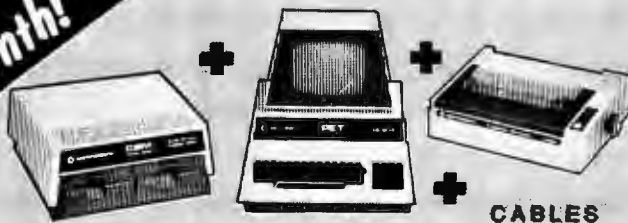

**commodore**

|                  |        |
|------------------|--------|
| 4032 COMPUTER    | \$1061 |
| (8032 Add \$160) |        |
| 4040 DISK        | \$1061 |
| 4022 PRINTER     | \$ 651 |
| CBM-IEEE CABLE   | \$ 33  |
| IEEE-IEEE CABLE  | \$ 41  |

**COMPLETE SYSTEM = \$2841**

**WEST COAST  
1-800-235-3581**

**EAST COAST  
1-800-556-7586**

CALL OMEGA AND FIND OUT WHY WE ARE AMERICA'S FASTEST  
GROWING COMPUTER SALES COMPANY!

**ΩMEGA SALES COMPANY**

WEST COAST / EAST COAST



EPSON MX-80  
\$ 479

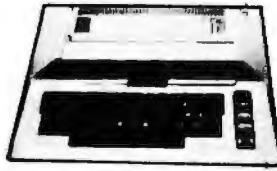

ATARI 800 32K \$ 779

DIABLO 630  
\$2099



Tractor option  
\$ 245

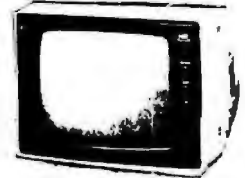

NEC 12" MONITOR  
\$ 229

NEC  
OKIDATA  
APPLE

TELEVIDEO  
COMMODORE

RADIO SHACK  
AMDEK

ATARI

|  |         |
|--|---------|
| DIABLO 630                             | \$2099  |
| INTERTEC SUPERBRAIN 64K RAM            | \$2799  |
| QD SUPERBRAIN                          | \$3195  |
| NEC 5510 SPINWRITER                    | \$2495  |
| NEC 5530 SPINWRITER                    | \$2495  |
| OKIDATA MICROLINE-80                   | \$ 399  |
| OKIDATA MICROLINE-82                   | \$ 529  |
| OKIDATA MICROLINE-83                   | \$ 799  |
| APPLE II PLUS 48K                      | \$1189  |
| APPLE DISK w/3.3 DOS Controller        | \$ 545  |
| APPLE DISK w/o Controller              | \$ 435  |
| BASE II PRINTER                        | \$ 599  |
| HAZELTINE 1420                         | \$ 799  |
| NORTHSTAR HORIZON II 32K QD            | \$2975  |
| ANADEX DP-9500                         | \$1295  |
| TELEVIDEO 912C                         | \$ 669  |
| TELEVIDEO 920C                         | \$ 729  |
| TELEVIDEO 950                          | \$ 959  |
| CBM 8032 COMPUTER                      | \$1225  |
| CBM 8050 DISK DRIVE                    | \$1449  |
| CBM 4032 COMPUTER                      | \$1090  |
| CBM 4040 DISK DRIVE                    | \$1090  |
| CBM 4022                               | \$ 679  |
| CBM VIC-20                             | \$ 289  |
| CBM C2N                                | \$ 85   |
| RADIO SHACK II 64K                     | \$3245  |
| RADIO SHACK III 16K                    | \$ 839  |
| LEEDEX/AMDEK 100                       | \$ 139  |
| LEEDEX/AMDEK 100G                      | \$ 169  |
| LEEDEX/AMDEK COLOR-1 13" Color Monitor | \$ 349  |
| MICROTEK 16K RAMBOARD for Atari        | \$99.95 |
| MICROTEK 32K                           | \$ 165  |
| ATARI 400 16K                          | \$ 349  |
| ATARI 825 PRINTER                      | \$ 619  |
| ATARI 850 INTERFACE                    | \$ 139  |
| or both together                       | \$ 749  |
| ATARI 810 DISK DRIVE                   | \$ 449  |
| ATARI 800 32K                          | \$ 769  |
| Call for price list of ATARI software  |         |
| NEC 12" MONITOR                        | \$ 229  |

PRICES ARE SUBJECT TO CHANGE WITHOUT NOTICE.

No Surcharge for Credit Cards Orders • We Accept C.O.D.'s

All Equipment Factory Fresh With MFT. Warranty • Stock Shipments Same Day or Next

**WEST COAST**  
**1-800-235-3581**

OMEGA SALES CO.  
3533 Old Conejo Rd. #102  
Newbury Park, CA 91320  
1-805-499-3678  
CA. TOLL FREE 1-800-322-1873

Circle 277 on inquiry card.

OMEGA  
SALES  
CO.

**EAST COAST**  
**1-800-556-7586**

OMEGA SALES CO.  
12 Meeting St.  
Cumberland, RI 02864  
1-401-722-1027

**OMEGA SALES COMPANY**

# COMPUTERS OF THE FUTURE

## APPLE II PLUS/III:

16K RAM - 1149; 32K RAM - 1200;  
 48K RAM - 1250; Disk II-Drive w/Controller - 549;  
 Disk II-Drive Only - 479; Silentype Printer - 549;  
 RF Modulator - 29; Applepost - 49;  
 Dan Paymar Lower Case Adapt. - 49; Appleplot - 69;  
 Dow Jones Portfolio Eval. - 49;  
 Personal Finance Mgr. - 75; Apple Taxplanner - 119;  
 Apple III/Info Analyst Package @ 96K RAM - 4199;  
 128K RAM - 4499;  
 A complete line of other Apple Accessories &  
 software - \$CALL FOR PRICE

## ATARI:

400-8K RAM - 399; 800-16K RAM - 799;  
 B10-Disk Drive - 499; 815-Dual Disk Drives - 1199;  
 820-40C Printer - 275; 822-40C Therm Printer - 399;  
 825-80C Printer - 699; 830-Acoustic Modem - 175;  
 850-Interface Mod. - 149; 410-Recorder - 59;  
 32K RAMCARD - \$CALL Atari Light Pen - 75;  
 Paddles - 20; Joysticks - 20;  
 A complete line of other Atari Accessories &  
 software - \$CALL FOR PRICE

## COMMODORE:

VIC-20. \$CALL; #2001 - \$CALL; #4001 - \$CALL;  
 #4016 - \$CALL; #4032 - 1200; #8032 - 1725;  
 #4022 Printer - 749; #4040 Dual Drives - 1149;  
 #8050 Dual Drives - 1849; #8010 Modem - \$CALL  
 C2N Recorder - 75;  
 A complete line of other Commodore Accessories &  
 software - \$CALL FOR PRICE

## OTHERS:

**PRINTERS:** Epson MX70 - 399...MX80 - 599...  
 MPI 88G - 699...MPI 99G - \$CALL  
 Centronics #737 - \$CALL...#778 - \$CALL  
 Anadex DP9500 - 1349...DP9501 - 1349  
 Qume Sprint 5/45 - 2699  
 NEC Spinwriter #5510 - 2499  
 #5520 - 2849...#5530 - 2499  
 IDS Paper Tigers - \$CALL

**DISK DRIVES:** Shugart, Micro Sci,  
 Lobo - \$CALL FOR PRICES

**MONITORS:** Video 100, 100G, 100/80,  
 Color - \$CALL...NEC 12" GRN - 259  
 Sanyo 9" B&W - 199...12" B&W - 299  
 12"GRN - 324

**MODEMS:** DC Hayes Micromodem - 324

**ACCESSORIES:** Microsoft Z80 softcard - 299  
 16K RAM CARD - 184

**HARDWARE:** Mountain Products - \$CALL FOR PRICES

**SOFTWARE:** Insoft Accountant, Controller, Cashier,  
 Visicalc (Apple, Atari, CBM) Superstat II  
 W/P, Apple Wordstar W/P - \$CALL FOR  
 PRICES

## ORDER INFO:

Min. order \$100.00 - Money Orders, Cashiers/certified  
 checks or bank drafts welcomed. VISA & Mastercard  
 orders add 2%...American Exp. & Diners Club add 4%  
 Personal checks accepted w/25 days for clearance. Add  
 3% for shipping in the U.S.A. Prices subject to change  
 without prior notice and Illinois residents must add 8%  
 for sales tax. Please include phone numbers with orders  
 and expiration date on credit card orders. No COD's.

Special discounts for multiple and combination orders  
 placed with the statement "Praise the Lord" preceding  
 the order placement. The above prices apply to mail  
 orders only. Send inquiries to:

**CMS ENTERPRISES**  
 P.O. BOX 1740  
 CHICAGO, IL - 60690  
**(312) 853-1184**



(10a)

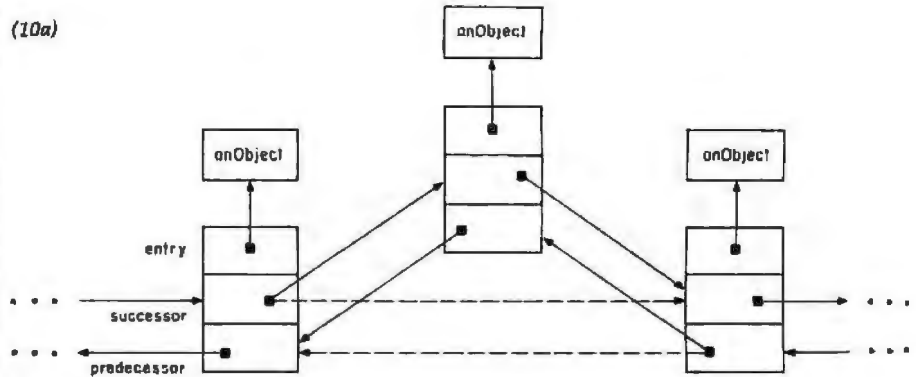

(10b)

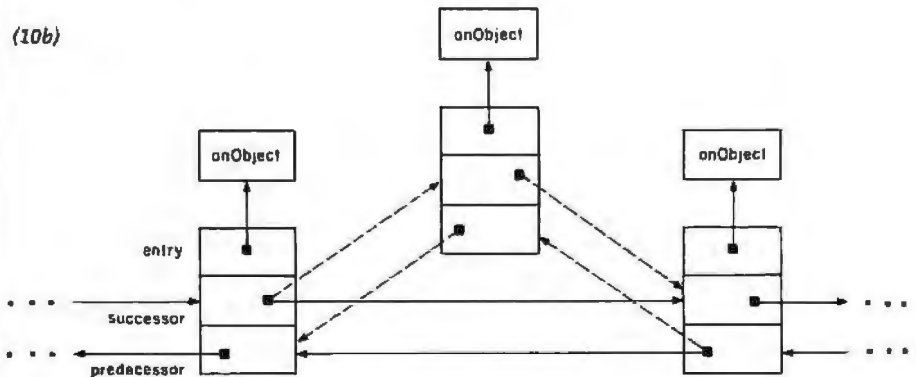

Figure 10: The insertion and deletion of data items from a doubly linked list. In both insertion (10a) and deletion (10b) processes, the dotted lines represent the links existing before the process, while the solid lines represent the links existing after the process.

Text continued from page 260:

is called the *top item*. A new item is added to the accessible end, thereby making it the new top item. This is called *pushing* an item onto a stack. Only the top item can be removed, or *popped*, from a stack. By adding and removing in this fashion (pushing and popping), we are able to access items in a last-in-first-out manner—that is, the last item pushed on a stack is the first item to be popped off the stack. Because of this, a stack is often called a *LIFO* (last-in-first-out).

Many examples of collecting and accessing in stack fashion exist outside the realm of programming. A pile of trays in a cafeteria rack is often used in this way. The same can be true of papers piled on a desk. In programming systems, a number of algorithms call for the use of a stack. For example, arithmetic expressions expressed in prefix or postfix notation can be evaluated using a stack to keep track of partial results.

The operations that we want to perform on a stack include:

- determine the number of items on the stack
- determine whether or not the stack is empty
- push an item onto the stack
- pop an item off the stack
- access the top item on the stack

It is easy to implement a stack using a linear list as the basic storage mechanism. Since we have several kinds of linear lists, it is possible to have several different stack implementations. Table 11 gives the definition of class *Stack*, which serves as a superclass for subsequent stack classes. Each kind of stack has a buffer which is a linear list, either sequential or linked. The messages *count* and *empty* are implemented using the corresponding messages of the linear list. The message *empty-check*, which sends an error message if the stack is empty, will be used in the implementations of the messages *pop* and *top*.

## The Sequential Stack

The first stack implementation we

# MULTI-USER OASIS HAS THE FEATURES PROS DEMAND. READ WHY.

**Computer experts (the pros) usually have big computer experience. That's why when they shop system software for Z80 micros, they look for the big system features they're used to. And that's why they like Multi-User OASIS. You will too.**

## DATA INTEGRITY: FILE & AUTOMATIC RECORD LOCKING

The biggest challenge for any multi-user system is co-ordinating requests from several users to change the same record at the same time.

Without proper co-ordination, the confusion and problems of inaccurate or even destroyed data can be staggering.

Our File and Automatic Record Locking features solve these problems.

For example: normally all users can view a particular record at the same time. But, if that record is being updated by one user, automatic record locking will deny all other users access to the record until the up-date is completed. So records are always accurate, up-to-date and integrity is assured.

Pros demand file & automatic record locking. OASIS has it.

## SYSTEM SECURITY: LOGON, PASSWORD & USER ACCOUNTING

Controlling who gets on your system and what they do once they're on it is the essence of system security.

## (THEN COMPARE.)

Without this control, unauthorized users could access your programs and data and do what they like. A frightening prospect isn't it?

And multi-users can multiply the problem.

But with the Logon, Password and Privilege Level features of Multi-User OASIS, a system manager can specify for each user which programs and files may be accessed—and for what purpose.

Security is further enhanced by User Accounting—a feature that lets you keep a history of which user has been logged on, when and for how long.

Pros insist on these security features. OASIS has them.

## EFFICIENCY: RE-ENTRANT BASIC

A multi-user system is often not even practical on computers limited to 64K memory.

OASIS Re-entrant BASIC makes it practical.

How? Because all users use a single run-time BASIC module, to execute their compiled programs, less

memory is needed. Even if you have more than 64K, your pay-off is cost saving and more efficient use of all the memory you have available—because it services more users.

Sound like a pro feature? It is. And OASIS has it.

## AND LOTS MORE...

Multi-User OASIS supports as many as 16 terminals and can run in as little as 56K memory. Or, with bank switching, as much as 784K.

Multi-Tasking lets each user run more than one job at the same time.

And there's our BASIC—a compiler, interpreter and debugger all in one. An OASIS exclusive.

Still more: Editor; Hard & Floppy Disk Support; Keyed (ISAM), Direct & Sequential Files; Mail-Box; Scheduler; Spooler; all from OASIS.

Our documentation is recognized as some of the best, most extensive, in the industry. And, of course, there's plenty of application software.

Put it all together and it's easy to see why the real pros like OASIS. Join them. Send your order today.

**OASIS IS AVAILABLE FOR SYSTEMS:** Allos, Computecorp, Cromemco, Delta Products, Digital Group, Digital Microsystems, Dynabyte, Godbout, IBC, Index, Intersystems, North Star, Onyx, SD Systems, TRS 80 Mod II, Vector Graphic, Vorimex

**CONTROLLERS:** Bell Controls, Cameo, Corvus, Konan, Micromation, Micropolis, Tarbell, Teletek, Thinkertoys, X Comp

Write for complete, free Application Software Directory

## PLEASE SEND ME:

| Product   | Price with Manual | Manual Only      |
|---|-------------------|------------------|
| <b>OPERATING SYSTEM</b><br>(Includes: EXEC Language, File Management, User Accounting, Device Drivers, Print Spooler, General Text Editor, etc.)<br>SINGLE-USER<br>MULTI-USER | 5150<br>350       | \$17.50<br>17.50 |
| <b>BASIC COMPILER/INTERPRETER/DEBUGGER</b>  | 100               | 15.00            |
| <b>RE-ENTRANT BASIC COMPILER/INTERPRETER/DEBUGGER</b>   | 150               | 15.00            |
| <b>DEVELOPMENT PACKAGE</b><br>(Macro Assembler, Linkage Editor, Debugger)   | 150               | 25.00            |
| <b>TEXT EDITOR &amp; SCRIPT PROCESSOR</b>   | 150               | 15.00            |
| <b>DIAGNOSTIC &amp; CONVERSION UTILITIES</b><br>(Memory Test, Assembly Language, Conversions, File Recovery, Disk Test, File Copy from other OS, etc.)                        | 100               | 15.00            |
| <b>COMMUNICATIONS PACKAGE</b><br>(Terminal Emulator, File Send & Receive)   | 100               | 15.00            |
| <b>PACKAGE PRICE</b><br>(All of Above):<br>SINGLE-USER<br>MULTI-USER  | 500<br>850        | 50.00<br>80.00   |
| <b>FILE SORT</b>  | 100               | 15.00            |
| <b>COBOL-ANSI '74</b>   | 750               | 35.00            |

Order OASIS from:  
**Phase One Systems, Inc.**  
7700 Edgewater Drive, Suite 830  
Oakland, CA 94621

Telephone (415) 562-8085  
TWX 910-386-7139

NAME \_\_\_\_\_  
STREET (NO BOX #) \_\_\_\_\_  
CITY \_\_\_\_\_  
STATE \_\_\_\_\_ ZIP \_\_\_\_\_

AMOUNT \$ \_\_\_\_\_  
(Attach system description, add \$3 for shipping; California residents add sales tax)  
 Check enclosed  VISA  
 UPS C.O.D.  Mastercharge  
Card Number \_\_\_\_\_  
Expiration Date \_\_\_\_\_  
Signature \_\_\_\_\_

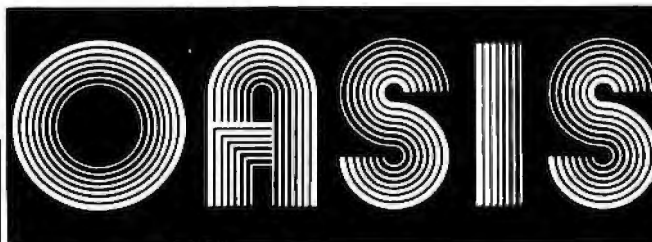

**MAKES MICROS RUN LIKE MINIS**

# Here are the Software Tools you have been looking for!

## 1. Screen Management System Professional Looking Screens as simple as A,B

### A. Create or Update Screens with Mask Builder

- \* Uses Direct Cursor Controls
- \* Define field attributes
- \* Save Screen Masks on Disk
- \* Print out Masks for Program Documentation

### B. Use simple calls to Interface CRT Driver to your programs

- \* Built-in buffer stores mask and field attributes
- \* Display and accept data by field number
- \* Forward and Back Page through Screens
- \* Forward and Back Tab through Fields
- \* Dynamically protect fields
- \* Program definable keys

No Need to use

INPUT or PRINT statements

Available for CP/M, TRS-80 (I&II), Apple II

|             |         |
|-------------|---------|
| Microsoft's | S-BASIC |
| BASIC-80    | CBASIC  |
| COBOL       | and     |
| M80         | more    |

## 2. Which console message do you prefer when your diskette or directory sets full?

A. DISK WRITE ERROR: (Using PIP)

B. Mount Next Diskette—Hit Carriage Return

If you like answer B, you will love BACKUP

- \* Backup your hard disk to any combination of single or double density diskettes
- \* Backup From double sided, double density to single or double density

## 3. Do you need to backup files larger than a single diskette?

You can with our Dump-Restore program

- \* Each diskette is sequentially labeled so your file cannot be restored out of sequence

## 4. Do you need a simple file transfer program?

We think this is it.

- \* Transfer your programs and data files between computers over serial I/O port
- \* Bidirectional transfer with error checking and retries
- \* Easy to interface

### COMING ATTRACTIONS

- CP/M Super Utility
- S-100 Single Board Computer
- \* Priced under 1K \* 64K Memory
- \* Z-80A (4Mhz) or Z-80B (6Mhz)
- \* DD, DS 8" Disk Controller
- \* 2 Serial—4 Parallel Ports
- \* Interrupt Driven CP/M Available

|                          |        |
|--------------------------|--------|
| Screen Management System | 195.00 |
| BACKUP Utility           | 59.95  |
| SAVE-RESTORE Utility     | 49.95  |
| TRANSFER Utility         | 39.95  |

OEM and Dealer inquiries are Welcome

## WESTERN BUSINESS ASSOCIATES

1300 E. Shaw Ave., Suite 164  
Fresno, CA 93710  
Phone (209) 224-0520

\*Requires Softcard

CP/M is a trademark of Digital Research, Inc.  
Z-80 is a trademark of Zilos Inc.  
Apple II is a trademark of Apple Computer Inc.  
TRS-80 is a trademark of Tandy Corp.  
Softcard is a trademark of Microsoft

We accept Visa and Mastercard

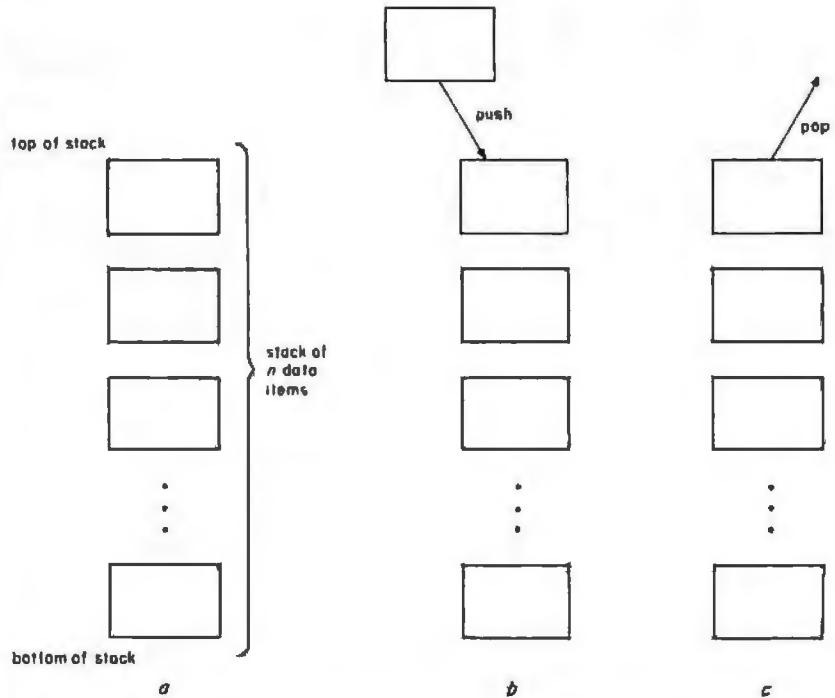

Figure 11: A stack, shown in figure 11a, is a linear collection of objects arranged so that items can be added to or removed from the stack only at the top end of the stack. Figure 11b shows an item being added, or pushed, to the stack. Figure 11c shows an item being taken, or popped, from the stack.

will consider is the *sequential stack*. A sequential stack is simply a stack implemented using a sequential list. The definition of class SequentialStack is given in table 12. An instance of SequentialStack is created by sending class SequentialStack the message size:, whose parameter is an integer indicating the estimated maximum size of the stack. For example:

```
| stack |
stack — SequentialStack size: 20.
```

creates an instance of SequentialStack with space initially for twenty items. This size is expanded when necessary since the sequential list used as a buffer is expanded when required.

The message push: is implemented by appending to the buffer the object passed as a parameter. As we have noted, this is an easy operation for sequential lists to perform, except when the list overflows and requires expansion. The message pop is implemented by first checking to see if the buffer is empty, in which case an error is reported. Otherwise, the last item from the buffer is removed.

Again, we should recall that this is an easy operation for a sequential list to perform. Similarly, in order to access the top of the stack (using the message top), we check to see that the stack is not empty, in which case we return (without removing) the last item in the buffer.

The following is an example using class SequentialStack:

```
| stack a b c |
stack — SequentialStack size: 10.
a — (Card suit: 'heart' rank: 5).
b — (Card suit: 'heart' rank: 6).
c — (Card suit: 'heart' rank: 7).
stack push: a.
stack push: b.
stack push: c.
a — stack pop.
b — stack pop.
c — stack pop.
```

This example creates an instance of class SequentialStack that initially has space for ten objects. The variables a, b, and c are assigned to instances of class Card with ranks 5, 6, and 7, respectively. These instances are pushed on the stack and then popped



# QUALITY DISK SOFTWARE

BACKED BY ON-GOING APPLICATIONS SUPPORT

APPLE II (A)

TRS-80 (T)

## HOME FINANCE PAK I: Entire Series \$49.95 (A) (T)

**CHECK REGISTER AND BUDGET:** This comprehensive CHECKING ACCOUNT MANAGEMENT SYSTEM not only keeps complete records, it also gives you the analysis and control tools you need to actively manage your account. The system provides routines for BUDGETING INCOME AND EXPENSE, AUTOMATIC CHECK SEARCH, and BANK STATEMENT RECONCILING. CRT or printer reports are produced for ACTUAL EXPENSE vs BUDGET, CHECK SEARCH DISPLAY RECONCILIATION REPORT and CHECK REGISTER DISPLAY by month. Check entry is prompted by user-defined menus of standard purposes and recipient codes, speeding data entry and reducing disk storage and retrieval time. Six fields of data are stored for each check: amount, check no., date, purpose, recipient and TAX DEDUCTIBLE REMINDER. CHECK SEARCH routines allow searching on any of these data fields. Up to 100 checks/mo. storage ..... \$39.95

**SAVINGS:** Account management system for up to 20 separate Savings accounts. Organizes, files and displays deposits, withdrawals and interest earned for each account. .... \$14.95

**CREDIT CARD:** Get Control of your credit cards with this program. Organizes, stores and displays purchases, payments and service charges for up to 20 separate cards or bank loans ..... \$14.95

## UNIVERSAL COMPUTING MACHINE: \$49.95 (A)

A user programmable computing system structured around a 50 row x 50 column table. User defines row and column names and equations forming a unique computing machine. Table elements can be multiplied, divided, subtracted or added to any other element. Hundreds of unique computing machines can be defined, used, stored, and recalled, for later use. Excellent for sales forecasts, budgets, inventory lists, income statements, production planning, project cost estimates-in short for any planning, analysis or reporting problem that can be solved with a table.

## COLOR CALENDAR: \$29.95 (A)

Got a busy calendar? Organize it with Color Calendar. Whether it's birthdays, appointments, business meetings or a regular office schedule, this program is the perfect way to schedule your activities. The calendar display is a beautiful HI-RES color graphics calendar of the selected month with each scheduled day highlighted in color. Using the daily schedule, you can review any day of the month and schedule an event or activity in any one of 20 time slots from 8:00 A.M. to 5:30 P.M.

## BUSINESS SOFTWARE: Entire Series \$159.95 (A) (T)

**MICROACCOUNTANT:** The ideal accounting system for small businesses. Based on classic T-accounts and double-entry booking, this efficient program provides a journal for recording posting and reviewing up to 1,000 transactions per month to any one of 300 accounts. The program produces CRT and printer reports covering:

|                     |                              |
|---------------------|------------------------------|
| TRANSACTION JOURNAL | BALANCE SHEET                |
| ACCOUNT LEDGERS     | INCOME AND EXPENSE STATEMENT |

Includes a short primer on Financial Accounting. (48K) ..... \$49.95

**UNIVERSAL BUSINESS MACHINE:** This program is designed to SIMPLIFY and SAVE TIME for the serious businessman who must periodically Analyze, Plan and Estimate. The program was created using our Universal Computing Machine and it is programmed to provide the following planning and forecasting tools.

|                        |                         |
|------------------------|-------------------------|
| CASH FLOW ANALYSIS     | SALES FORECASTER        |
| PROFORMA PROFIT & LOSS | SOURCE AND USE OF FUNDS |
| PROFORMA BALANCE SHEET | JOB COST ESTIMATOR      |
| REAL ESTATE INVESTMENT | INVENTORY ANALYSIS      |

Price, including a copy of the Universal Computing Machine .... \$89.95

**BUSINESS CHECK REGISTER AND BUDGET:** Our Check Register and Budget programs expanded to include up to 50 budgetable items and up to 400 checks per month. Includes bank statement reconciling and automatic check search (48K) ..... \$49.95

## ELECTRONICS SERIES VOL I & II: Entire Series \$259.95

**LOGIC SIMULATOR: SAVE TIME AND MONEY.** Simulate your digital logic circuits before you build them. CMOS, TTL, or whatever, if it's digital logic, this program can handle it. The program is an interactive, menu driven, full-fledged logic simulator capable of simulating the bit-time response of a logic network to user-specified input patterns. It will handle up to 1000 gates, including NANDS, NORs, INVERTERS, FLIP-FLOPS, SHIFT REGISTERS, COUNTERS and user-defined MACROS, up to 40 user-defined random, or binary input patterns. Accepts network descriptions from keyboard or from LOGIC DESIGNER for simulation ..... \$159.95 (A) (T)

**LOGIC DESIGNER:** Interactive HI-RES graphics program for designing digital logic systems. Draw directly on the screen up to 10 different gate types, including NAND, NOR, INVERTER, EX-OR, T-FLOP, JK-FLOP, D-FLOP, RS-FLOP, 4 BIT COUNTER and N-BIT SHIFT REGISTER. User interconnects gates using line graphics commands. Network descriptions for LOGIC SIMULATOR generated simultaneously with the CRT diagram being drawn ..... \$159.95 (A)

**MANUAL AND DEMO DISK:** Instruction Manual and demo disk illustrating capabilities of both program (s) ..... \$29.95 (A) (T)

## ELECTRONIC SERIES VOL III & IV: Entire Series \$259.95

**CIRCUIT SIMULATOR:** Tired of trial & error circuit design? Simulate & debug your designs before you build them! With CIRCUIT SIMULATOR you build a model of your circuit using RESISTORS, CAPACITORS, INDUCTORS, TRANSISTORS, DIODES, VOLTAGE and CURRENT SOURCES and simulate the waveform response to inputs such as PULSES, SINUSOIDS, SAWTOOTHs, etc., all fully programmable. The output is displayed as an OSCILLOSCOPE-STYLE PLOT of the selected waveforms (Apple only) or as a printed table of voltage vs time. Handles up to 200 nodes and up to 20 sources. Requires 48 RAM ..... \$159.95 (A) (T)

**CIRCUIT DESIGNER:** Interactive HI-RES graphics program for designing electronic circuits. Draw directly on the screen up to 10 different component types, including those referenced above. Components interconnect list for CIRCUIT SIMULATOR generated automatically. Requires ..... \$159.95

## MATHEMATICS SERIES: Entire Series \$49.95

**STATISTICAL ANALYSIS I:** This menu driven program performs LINEAR REGRESSION analysis, determines the mean, standard deviation and plots the frequency distribution of user-supplied data sets. Printer, Disk, I/O routines ..... \$19.95

**NUMERICAL ANALYSIS:** HI-RES 2-Dimensional plot of any function. Automatic scaling. At your option, the program will plot the function, plot the INTEGRAL, plot the DERIVATIVE, determine the ROOTS, MAXIMA, MINIMA, INTEGRAL VALUE ..... \$19.95

**MATRIX:** A general purpose, menu driven program for determining the INVERSE and DETERMINANT of any matrix, as well as the SOLUTION to any set of SIMULTANEOUS LINEAR EQUATIONS. .... \$19.95

**3-D SURFACE PLOTTER:** Explore the ELEGANCE and BEAUTY of MATHEMATICS by creating HI-RES PLOTS of 3-dimensional surfaces from any 3-variable equation. Disk save and recall routines for plots. Menu driven to vary surface parameters. Hidden line or transparent plotting ..... \$19.95

## ACTION ADVENTURE GAMES: Entire Series \$29.95 (A)

**RED BARON:** Can you outfly the RED BARON? This fast action game simulates a machine-gun DOGFIGHT between your WORLD WAR I BI-PLANE and the baron's. You can LOOP, DIVE, BANK or CLIMB-and so can the BARON. In HI-RES graphics plus sound. .... \$14.95

**BATTLE OF MIDWAY:** You are in command of the U.S.S. HORNETS' DIVE-BOMBER squadron. Your targets are the Aircraft carriers, Akagi, Soryu and Kaga. You must fly your way through ZEROS and AA FIRE to make your DIVE-BOMB run. In HI-RES graphics plus sound. .... \$14.95

**SUB ATTACK:** It's April 1943. The enemy convoy is headed for the CONTROL SEA. Your sub, the MORAY, has just sighted the CARRIERS and BATTLESHIPS' Easy pickings. But watch out for the DESTROYERS - they're fast and deadly. In HI-RES graphics plus sound ..... \$14.95

**FREE CATALOG:** All programs are supplied on disk and run on Apple II w/Disk & Applesoft ROM Card & TRS-80 Level II and require 32K RAM unless otherwise noted. Detailed instructions included. Orders shipped within 5 days. Card users include card number. Add \$1.50 postage and handling with each order. California residents add 6% sales tax. Foreign orders add \$5.00 postage and handling.



SPECTRUM SOFTWARE

142 Carlow, P.O. Box 2084  
Sunnyvale, CA 94087

FOR PHONE ORDERS: (408) 738-4387  
DEALER INQUIRIES INVITED.



## INTRODUCTORY OFFER!

Turn your Micro-Computer into a Mini-Computer. Try the world's #1 programming language-COBOL! Finally at a price you can afford and with no risk!

Introducing...

## NPS-MICRO-COBOL

This is the Naval Post Graduate School Cobol that you've heard so much about. Designed to pass the stringent government Hypo-COBOL tests used by GSA in their Compiler Certification Program. This is the first public release of version 2.1. This is an elaborate ANSI-COBOL subset. Comes complete with users manual in DeLuxe three-ring binder.

- Perfect for learning COBOL.
- Perfect for teaching COBOL
- FREE sample programs included
- Runs in 24K
- Requires 8080, Z-80®, or 8085 and standard CP/M™ system
- Provided on standard 8" disk or Northstar Double Density CP/M 5"

**Only \$69.95!**

## FREE ALGOL INCLUDED!

**FREE BONUS.** All purchasers receive a FREE copy of NPS-ALGOL at no extra cost. A favorite language in Europe, ALGOL is the original structured language. Comes with FREE sample programs.

**MONEY-BACK GUARANTEE.** If you're not completely satisfied with this software. You may return it within fifteen days for any reason and get a full refund.

**Send Check, Money Order or Credit Card information and order a copy today!** Please add \$2.50 shipping and handling on all orders.

**Credit Card buyers: For Extra Fast service call (415) 527-7730**

Order from: The Software Review  
704 Solano Avenue, Albany, CA 94706

Yes, I want to run COBOL on my system! Enclosed find \$69.95 plus \$2.50 shipping/handling (California residents please add appropriate sales tax). I will receive the NPS-COBOL system plus a FREE copy of NPS-ALGOL. I understand that I may return the software within 15 days if not completely satisfied for a full refund.

NAME \_\_\_\_\_

COMPANY \_\_\_\_\_

STREET \_\_\_\_\_

CITY \_\_\_\_\_

STATE \_\_\_\_\_ ZIP \_\_\_\_\_

AMOUNT ENCLOSED \$ \_\_\_\_\_

Disk size desired: 5" 8"

Check Enclosed  VISA

UPS C.O.D.  Mastercharge

Card number \_\_\_\_\_

Expiration Date \_\_\_\_\_

Signature \_\_\_\_\_

Check here for more information

CP/M is a trademark of Digital Research and Z-80 is a trademark of Zilog.

|  |        |
|--|--------|
| class name   | Stack  |
| superclass   | Object |
| instance variable names  | buffer |
| class messages and methods   |        |
| "none defined here"  |        |
| instance messages and methods  |        |
| <pre>external count       buffer count empty       buffer empty "push: anObject     ... to be defined in subclasses" "pop     ... to be defined in subclasses" "top     .. to be defined in subclasses"  internal emptyCheck     self empty ifTrue: [   self error: 'stack empty' ].</pre> |        |

Table 11: Class template for class Stack.

|   |                     |
|---|---------------------|
| class name  | SequentialStack     |
| superclass  | Stack               |
| instance variable names   | "none defined here" |
| class messages and methods  |                     |
| <pre>size: anInteger     (anInteger &gt; 0) ifTrue: [   (self new) initialize: anInteger ] ifFalse: [   self error: 'invalid size' ].</pre>   |                     |
| instance messages and methods   |                     |
| <pre>external push: anObject     buffer append: anObject. pop     self emptyCheck.   buffer removeAt: buffer count. top     self emptyCheck.   buffer at: buffer count.  internal initialize: anInteger     buffer -- SequentialList size: anInteger.</pre> |                     |

Table 12: Class template for class SequentialStack.

off. The effect is to reverse the assignments to a, b, and c, such that the ranks are 7, 6, and 5, respectively.

### The Linked Stack

Alternatively, we can define a *linked stack*, which is a stack whose buffer is a linked list. The definition of class `LinkedList` is given in table 13. A linked stack is created by send-

ing the message `new` to class `LinkedList`. Since we are using a linked list for the buffer, there is no need to specify a maximum size estimate. For example:

```
| stack |
stack ← LinkedList new.
```

creates a new instance of class

# "WITH THE UCSD p-SYSTEM,<sup>™</sup> WE CAN WRITE ONE APPLICATION THAT GOES FROM APPLE TO ZENITH."

HARRY BLAKESLEE, President, Denver Software

**O**ur business is bigger and better than ever. A lot of the credit for that goes to the UCSD p-System software from SofTech Microsystems. It's given us ten times the market we used to have.

We can write a single, sophisticated applications program with the UCSD p-System—like our financial management package—and it just keeps on running. On Apple, Commodore, Ohio Scientific, Texas Instruments, Zenith, and more. That's the real beauty of the UCSD p-System. Any program you write for one microcomputer runs on others, both today and tomorrow. You protect your software investment, without restricting your hardware options.

And with the UCSD p-System, you can use the language of your choice—UCSD Pascal,<sup>™</sup> FORTRAN-77, BASIC, or assembly language. All are backed by SofTech Microsystems, a leading system software company who's been around for over a decade, who knows how to develop professional quality software, and who's committed to delivering it.

Get a head start on tomorrow. With the microcomputer software that goes from "A" to "Z." Distribution licensing and single copies available. Write or call for details, so you can start going places, too.

**SOFTech**  
**MICROSYSTEMS**  
A SUBSIDIARY OF SOFTech

**For the software that's going places.**  
9494 Black Mountain Road, San Diego,  
CA 92126. (714) 578-6105  
TWX: 910-335-1594

*UCSD p-System and UCSD Pascal are trademarks of the Regents of the University of California.*

|   |                     |
|---|---------------------|
| class name  | LinkedStack         |
| superclass  | Stack               |
| instance variable names                                 | "none defined here" |
| class messages and methods                              |                     |
| <b>new</b>     ↑ (super new) initialize                 |                     |
| instance messages and methods                           |                     |
| <i>external</i>   |                     |
| <b>push:</b> anObject     buffer insert: anObject at: 1 |                     |
| <b>pop</b>     self emptyCheck. ↑ buffer removeAt: 1.   |                     |
| <b>top</b>     self emptyCheck. ↑ buffer at: 1.         |                     |
| <i>internal</i>   |                     |
| <b>initialize</b>     buffer ← LinkedList new.          |                     |

Table 13: Class template for class LinkedStack.

LinkedStack. The message `push:` is implemented by inserting the object passed as a parameter at the beginning of the buffer (ie: at position number 1). This is an easy operation for a singly linked list. The message `pop` is done by removing the first ob-

ject from the buffer—another easy operation. The message `top` is implemented by accessing the object that is the entry of the first link of the buffer. We can use an instance of class `LinkedStack` in the example given for class `SequentialStack` by doing the

following:

```
| stack |
stack ← LinkedStack new.
```

...

The rest of the example is unchanged.

### The Queue

The *queue* is an important data structure that, like the stack, occurs often both in programming systems and outside the realm of programming (see figure 12). A queue is a linear list of items whose access is restricted to the two ends. An item can be appended to only one end of a queue, called the *rear*. An item can be removed only from the other end of the queue, called the *front* of the queue. This causes a sequence of items that are added to a queue and subsequently removed, to be accessed in a strict first-in-first-out fashion (ie: the first item that we put in a queue is the first item that we get out). Because of this, a queue is sometimes called a *FIFO* (first-in-first-out).

Lines of customers at a bank win-

# NEW LOWER 8088 PRICES

## LDP1/2

The LDP1/2 utilizes the advanced 8088 processor to provide up to 8 times the throughput of a 4 MHz Z80A processor. The powerful instruction set of the 8088 is ideally suited to higher level languages such as PASCAL and PL/1. The 10 slot motherboard leaves 7 slots for USER expansion. With the option of a 10 MByte Winchester and MP/M-86, the LDP mainframe becomes a powerful multiuser system with the capability of handling 8 users without the degradation in performance experienced with Z80 CP/M systems. The performance of the LDP1 and LDP2 has never before been available for such an affordable price.

### FEATURES:

- LDP88, 8088 CPU board
- LDP72, advanced floppy disk controller
- LDP64K dynamic RAM
- 1 serial RS232 port
- 10 slot motherboard
- 1 8" Shugart 801R drive (LDP1), 2 Shugart 801R's (LDP2)
- 4K EPROM socket for user population

### OPTIONS:

- HAZITALL
- 8" 10 MByte Winchester (replaces 1 Shugart 801 in LDP2, available Sept. 81)
- MP/M-86 multiuser system (available Sept. 81)
- Woodgrained 7 slot chassis

### PRICES

|                    |           |
|--------------------|-----------|
| LDP88 CPU          | \$ 349.95 |
| LDP72 FDC          | 274.95    |
| LDP64K RAM         | 795.00    |
| LDP128K RAM        | 1295.00   |
| LDP256K RAM        | 2095.00   |
| HAZITALL           | 325.00    |
| LDP1               | 3295.00   |
| 86-DDS             | 195.00    |
| CP/M-86            | 250.00    |
| Microsoft BASIC 86 | 350.00    |

Call for LDP1 option prices and board kit prices.

CP/M-86 and MP/M-86 are trademarks of Digital Research  
86-DOS is a trademark of Seattle Computer Products

## LDP88 8088 CPU BOARD

- 8088 CPU 5 MHz operation upgradeable to 8 MHz • 9 vectored interrupts • Fully complies with IEEE 696 electrical and timing specs
- RS232 serial port with modem controls • 1K bytes of static RAM • 2 EPROM sockets (2716 or 2732) • 8087 upgrade kit available in Sept.
- 8 bit bus eases interface to other S100 bus boards • 1MByte address space • 65K I/O ports

## 64/256K MEMORY

- 8 or 16 bit operation • Meets all IEEE 696 specs • Access time 350 ns from PSYNC low • Intel 8203 dynamic RAM controller • 24 or 16 bit address decoding • No wait states with 5 MHz 8088 or 8086
- Parity with Error interrupt generation • No DMA RESTRICTIONS
- 64K board is upgradeable to 256Kbyte board

## HAZITALL

- 2 Serial RS232 ports • 2 parallel ports with handshake control
- Math processor support (8231/9511 or 8232/9512) • WINCHESTER DISK support • Real time programmable interrupt • Clock/calendar with battery back up • Synchronous data communication supported

## LDP72 FLOPPY DISK CONTROLLER

- IBM compatible single and double density format • Single or double sided drives • Programmable data record length (128 to 8192 bytes/sector) • Multi sector and multi track transfer capability • Parallel seeks on up to 4 drives • On board digital data separator • Software selectable single or double density operation • Separate connectors for 5 1/4" and 8" drives • Software selection of standard or minidrives allowing mixing of both drives on a single controller

**LOMAS  
DATA  
PRODUCTS**

11 Cross Street  
Westborough, MA 01581  
Telephone (617) 366-4335

# COMPUTERS—TERMINALS—MODEMS!

## MODEMS AND COUPLERS

Connect your Apple, TRS-80 or any other computer or terminal to the phone lines!

Penril



**Penril  
300/1200**

Penril 300/1200—Bell 212A style ..... \$799  
Bell 212A style. 1200 baud and 300 baud. Manual originate, auto-answer. Full duplex. RS232. Direct connect to phone lines via RJ11C standard extension phone voice jack. 1 year warranty.



**U.S. Robotics  
USR-330A  
Bell 103/113 style  
USR-330D  
Bell 103/113 style**

USR-330D ..... \$339

Bell 103/113 style. 330 baud. Manual originate, auto-answer. Half/full duplex. RS232. 1 year warranty. Direct connect to phone lines via RJ11C standard extension phone voice jack.

USR-330A ..... \$399  
Same as USR-330D but includes auto-dial capability.



**U.S. Robotics  
The  
Phone Link  
Acoustic  
Modem**

Bell 103/113 style ..... \$179  
300 baud. Sleek, low profile. Originate and answer capability. Half/full duplex. Self-test. RS232. Light displays for On, Carrier, Test, Send Data, Receive Data. 15 oz.

Digital Equipment Corporation



**DEC VT100**

DEC VT100 ... \$1668

Detachable keyboard. Separate numeric keypad with function keys. Business forms character set. Reverse video. Selectable double-size characters. Bidirectional smooth-scrolling. 80 cols or 132 cols. Split screen. Settable tabs. Line drawing graphic characters. Status line. Key-Click.

CRT's

Perkin-Elmer  
Corporation



**Superowl 1251**

Perkin-Elmer Superowl 1251 ..... \$1564  
Intelligent, editing CRT. Detachable keyboard. 32 fully programmable function keys. Intelligent printer part. Business forms character set. Block mode. Protected fields. Blinking fields. Numeric fields. Reverse video. Half intensity. Polling. Down line loading of options. Remote control of all options by host computer. Settable tabs Status line. Separate numeric keypad. Transparent mode.

Perkin-Elmer Corporation



**Bantam 550B .... \$694**  
Compact. Silent. Upper/lower case. 80th col. wrap-around. Bell. Integrated numeric pad. Printer port. Transparent mode. Editing features. Tabbing.

**Bantam 550E .. \$755**  
Same as 550B plus separate numeric keypad and cursor direction keys.

**Bantam 550S ..... \$879**  
Same as 550E plus block mode. 8 function keys, and protected fields, reverse video fields, half intensity fields, blinking fields.

## HARDCOPY TERMINALS

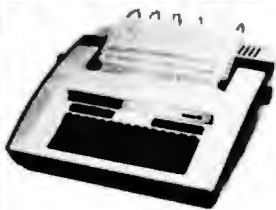

**Teletype  
Model 43**

Teletype  
Corporation

Teletype Model 43 KSR with RS232 and Connector Cable ..... \$999  
30 CPS. Dot matrix. 132 cols. True descenders on lower case. Excellent print quality for dot matrix printer. Pin feed.

## & PRINTERS



**DEC LA120**

Digital Equipment  
Corporation

DEC LA120 ... \$2388

180 CPS. Dot matrix. Upper/lower case. 1K buffer. Designed for 1200 baud communications. 30 character answerback message. Adjustable line spacing. Adjustable character sizes including double sized characters. Settable horizontal and vertical tabs. Top-of-form capability. RS232.

550 Options

20mA Current Loop Interface ..... \$70  
Non-Glare Screen ..... \$25  
2nd page of memory (550S only).. \$100



**DEC LA34DA ... \$939**

30 CPS. Dot matrix. Upper/lower case. 4 character sizes. Up to 217 cols per line. 6 lines per inch settings. Friction feed. Settable tabs. RS232.

**DEC LA34AA ..... \$1095**  
30 CPS. Dot matrix. Upper/lower case. 8 character sizes including double size characters. 6 lines per inch settings. Up to 217 cols per line. Friction feed. Settable horizontal and vertical tabs. Top-of-form capability.

Options for LA34AA and LA34DA

Tractor Feed Mechanism ..... \$114  
Numeric Keypad w/ Function Keys .. \$69  
Pedestal ..... \$100  
Paper Out Sensor ..... \$25  
APL Capability with APL Keycaps .. \$499  
2K Buffer with Text Editor and 1200 Baud Communications Capability ..... \$499

NEC Corporation  
NEC Spinwriter 5510 & 5520

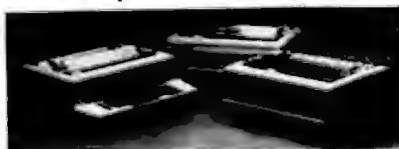

**5520 KSR Spinwriter ..... \$3088**  
55 CPS. Impact printer. Selectric print quality. Changeable print fonts. 110, 300 and 1200 baud data rate. Numeric keypad. Friction and tractor feed.

**5510 Spinwriter ..... \$2754**  
55 CPS. Impact printer. Selectric print quality. Changeable print fonts. 110, 300 and 1200 baud data rate. Friction and tractor feed.

Perkin-Elmer  
Corporation



**Pussycat 650/655  
CRT Screen Printer**

**650/655 Pussycat CRT Screen Printer. \$899**  
100 CPS. Extremely compact and quiet. 110 to 9600 baud rate. 2K buffer. Ideal for producing rapid, reliable hardcopy of your CRT screen display. Can be added to any CRT with our interface option.

Circle 391 on inquiry card.

Leasing rates and lease/purchase plan information is available on request.  
All equipment is shipped with a 10 day money back guarantee.  
We offer full service, on site maintenance plans on all equipment.  
All equipment in stock.



**U.S. ROBOTICS INC.**  
203 N WABASH SUITE 1718 CHICAGO, ILL 60601

SALES  
GENERAL OFFICES  
SERVICE

(312) 346-5650  
(312) 346-5651  
(312) 733-0497

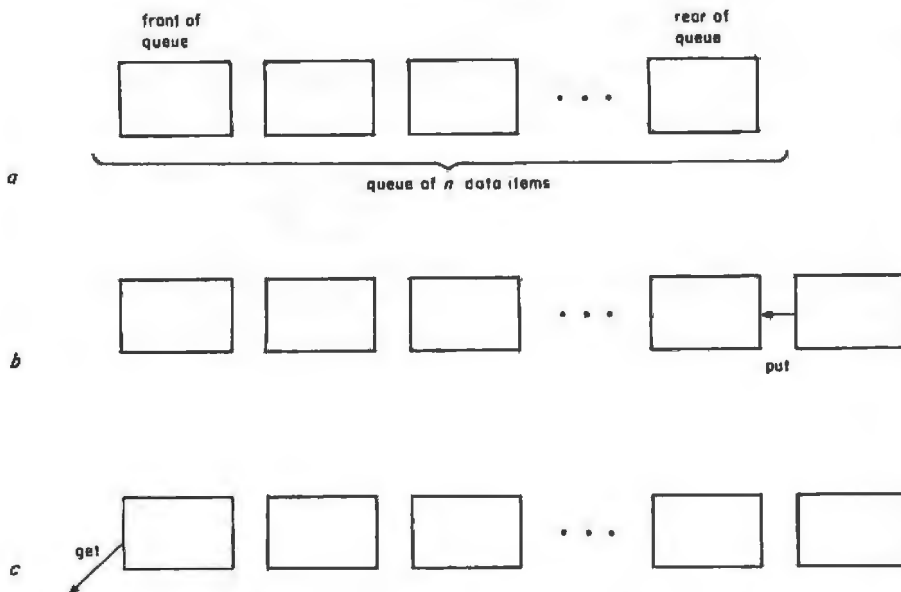

Figure 12: A queue (12a) is a linear collection of objects arranged so that items can be added (or put) only at the rear of the queue (12b) and taken away (or gotten) only at the front of the queue (12c).

dow or checkout counter are everyday examples of this kind of discipline. In programming systems, queues are used for many purposes, for example, to represent a line of

customers in a simulation program or to handle ordered lists of events and processes in operating systems.

The operations we want to perform on a queue include:

- determine the number of items in the queue
- determine whether or not the queue is empty
- put an item in the queue
- get an item from the queue

Just as in the case of the stack, we can have different implementations of the queue depending on the type of buffer we use for storing the data items. Class Queue, which serves as a superclass for the queue classes, is given in table 14. Class Queue contains an instance variable named *buffer* that points to the object that provides the storage for items in the queue. The external messages have been listed to show what must be defined in all subclasses. The message *emptyCheck*, which sends an error message if the queue is empty, will be used in the implementation of *get*.

### The Linked Queue

The first queue we will consider is the *linked queue*. A linked queue is one whose buffer is a linked list. Because we want to remove and add items easily, we will use a circular, singly linked list in our implementation. Class *LinkedListQueue* is shown in table 15. An instance of class *LinkedListQueue* is created by sending the creation message *new* to the class. For example:

```
| queue |
queue ← LinkedListQueue new.
```

creates and initializes a new linked queue. The internal message *initialize* creates a new instance of *CircularList* and stores a pointer to it in *buffer*.

To put an object in a linked queue we use the message *put:*, passing the object as the parameter. This object is then added to the circular list by sending *buffer* the message *append:*. Similarly, the next object can be removed by using the message *get*. The method for *get* first checks to see if *buffer* is empty. If it is, an error message is sent. If not, the first object is removed from *buffer* and returned.

The messages *count* and *empty* are implemented by sending the respective messages to *buffer* and returning

## INFOSOFT Has a Better Way

### I/OS™ Infosoft/operating system

- Full CP/M™, CDOS™, SDOS™, compatibility
- Up to 15 disk units of 65 megabytes each
- Mix 5" and 8" floppies and hard disks
- Autostart and turnkey capabilities
- Adaptable to most 8080/8085/Z80 systems
- Dialog system generation without programming
- Up to 975 megabytes of on-line data storage

**\*New! Developed from the I/OS single-user system\***

### Introducing MULTI/OS™

the complete multi-user operating system

All features of the single-user I/OS plus

- Up to 16 independent users and/or tasks
- Multiple printers with automatic spooling
- Up to 56k bytes in each user partition
- Managable sub-directories allow up to 63,504 files per unit
- Record/file lock capabilities

**Call Us Today  
To Improve Your  
System Performance**

MASTERCARD and VISA accepted

CP/M is a registered trademark of Digital Research, CA.  
CDOS is a registered trademark of Cromemco.  
SDOS is a registered trademark of SD Systems.

**InfoSoft**  
SYSTEMS INCORPORATED  
1850 WILSON AVENUE  
SUNNYVALE, CALIF. 95088  
(415) 255-8887

# AH-HA!

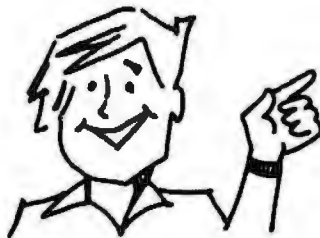

# EUREKA!

# ALL-RIGHT!



Introducing "Popular Computing," the key to understanding.

Now you don't have to be a computer professional to unlock all the mysteries, potential, and pleasures of home and small business computers. *Popular Computing*, the new monthly magazine from McGraw-Hill, is the key.

Created in response to growing demand for our informative quarterly *onComputing*, *Popular Computing* explores every aspect of personal computers and their use. All reported in easy-to-understand nontechnical language.

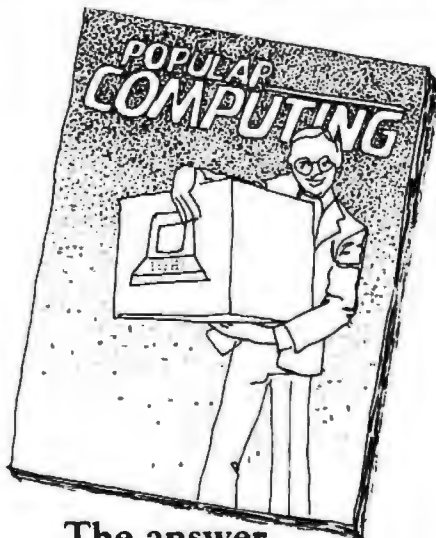

The answer to "Computer-phobia."

Even the most computer-unsophisticated reader will find *Popular Computing* interesting and stimulating. Every issue will contain straight-talking product reviews,

special news briefs, and feature articles by famous guest contributors (like Isaac Asimov). There'll even be a helpful glossary of computer jargon we couldn't avoid using, and much, much more.

### Special Introductory Offer.

Send in this coupon today, and take advantage of *Popular Computing's* Special Introductory Offer.

**SUPER SAVINGS FOR ME...**  
I'm taking advantage of this super introductory offer of 12 issues for only \$11.47 (\$3.03 on the basic rate of \$15.00) — and saving me \$18.03 off the 12 issue newsstand rate of \$30.00

If my 30-day review of your first issue doesn't 100% please me, I may cancel my subscription and you will promptly refund ALL my money or give me a FULL credit on my charge card marked below.

Bill Me  \$11.97 check enclosed  Visa  Mastercard  
Name \_\_\_\_\_  
Address \_\_\_\_\_  
Signature \_\_\_\_\_  
Card # \_\_\_\_\_  
Expires \_\_\_\_\_

# POPULAR COMPUTING

THE KEY TO UNDERSTANDING

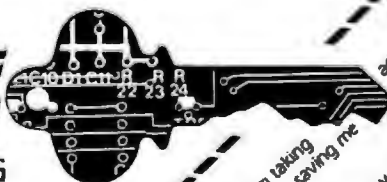

I'm taking saving me

# THE NEW NEVADA COBOL!

**At \$149.95 you can't buy a better COBOL or one residing in less memory.**

Now with the new Nevada COBOL, you can use the programs developed by professional business programmers over the past twenty years to run the big IBM machines. And you can develop and tailor programs on your micro and run them on your micro or recompile and run them on any mainframe computer. What's more you can do it for about one-fifth the cost of comparable COBOL compiler systems.

Almost all the popular microcomputers work with the CP/M operating system we use including Apple, TRS-80, North Star, Superbrain, Cromemco and so on.

**Check the features; you'll go Nevada COBOL.**

A powerful subset of ANSI-74, Nevada COBOL requires a scant 16K of RAM. It's available on 8" CP/M standard single density or 5-1/4" diskettes. Price includes diskette and manual. Price for manual only, \$24.95

**Four COBOL applications packages available too.**

Four COBOL applications packages are currently available. Each is priced at \$24.95 for the diskette. The 73 page manual covering all four applications costs an additional \$24.95. The manual carries complete COBOL source code listings and superior documentation.

Package #1 is the Budget Plan Report Generator. Here's an extraordinary time saver and planning aid for both start-up and well established businesses.

Package #2 is the Personal Financial Planner to give you some eye opening insights into your own personal spending habits.

Package #3 is Labels so you can print name and address labels.

Package #4 is Pre-COBOL for use as a pre-processor of COBOL source programs. A great programming aid.

**Order today or write for complete details.**

Phone (415) 751-1522 or address Ellis Computing, 600 41st Ave, San Francisco, CA 94121. Nevada Cobol is also available at Lifeboat Associates, Discount Software, Westico, Business Micro Products, Computer Information Exchange and other quality computer stores. Mastercard, Visa, C.O.D.s, or checks accepted. California orders please include sales tax.

IBM, TRS-80 and IBM are trademarks of Digital Research, Inc., Corp. and IBM, respectively.



**ELLIS COMPUTING**  
SOFTWARE TECHNOLOGY

|   |                     |
|---|---------------------|
| class name  | Queue               |
| superclass  | Object              |
| instance variable names   | buffer              |
| class messages and methods  |                     |
|   | "none defined here" |
| instance messages and methods   |                     |
| <p><i>external</i><br/>                 "count     ... to be defined in subclasses"<br/>                 "empty     ... to be defined in subclasses"<br/>                 "put: anObject     ... to be defined in subclasses"<br/>                 "get     ... to be defined in subclasses"</p> <p><i>internal</i><br/>                 emptyCheck     self empty ifTrue: [ 1 self error: 'queue empty' ].</p> |                     |

Table 14: Class template for class Queue.

|   |                     |
|---|---------------------|
| class name  | LinkedList          |
| superclass  | Queue               |
| instance variable names   | "none defined here" |
| class messages and methods  |                     |
| <p><b>new</b>     1 (super new) initialize.</p>   |                     |
| instance messages and methods   |                     |
| <p><i>external</i><br/> <b>count</b>     1 buffer count.<br/> <b>empty</b>     1 buffer empty.<br/> <b>put: anObject</b>     buffer append: anObject.<br/> <b>get</b>     self emptyCheck. 1 buffer removeAt: 1.</p> <p><i>internal</i><br/> <b>initialize</b>     buffer — CircularList new.</p> |                     |

Table 15: Class template for class LinkedList.

the result. A simple example of the use of LinkedList is the following:

```

| queue a b c |
queue ← LinkedList new.
a ← (Card suit: 'heart' rank: 5).
b ← (Card suit: 'heart' rank: 6).
c ← (Card suit: 'heart' rank: 7).
queue put: a.
queue put: b.
queue put: c.
a ← queue get.
b ← queue get.
c ← queue get.
    
```

This sequence creates an instance of class LinkedList and assigns to the variables a, b, and c, instances of class Card with ranks 5, 6, and 7, respectively. These instances are put into the queue in the order listed and are then removed and assigned to the variables a, b, and c. The original order is preserved; the ranks of a, b, and c are 5, 6, and 7, respectively.

**The Sequential Queue**

The next implementation of a queue that we might expect to see is



# STATE OF THE ART MEMORY SYSTEMS

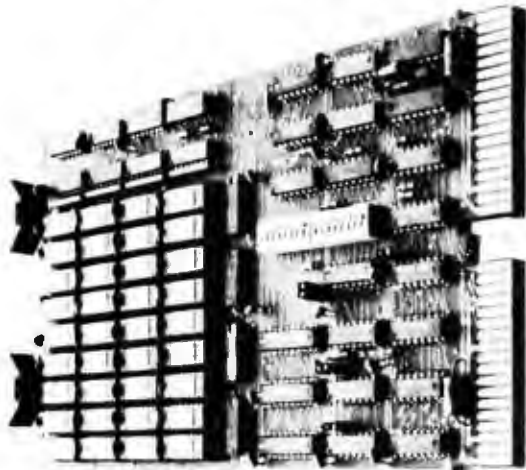

## 256KB LSI 11/23® SINGLE DUAL WIDTH BOARD

The First and Only 256KB Memory on a Single Dual Board.

**4 MEGABYTE ADDRESS FIELD** — Most memories available for the DEC PDP 11/23 are only addressable to 256K bytes (18 address lines). The CI-1123 is addressable to 4 mega bytes (22 address lines) so there is no need to worry about obsolescence.

**FAST ACCESS AND CYCLE TIME** — With an access time of 240 NSEC and cycle time of 400 NSEC one is insured the best throughput on the PDP 11/23 system.

**PARITY** — The CI-1123 generates and checks parity for each byte of memory. Totally DEC compatible.

**BATTERY BACKUP POWER CONSUMPTION** — Power requirement for the module is only 1.2 AMP from the 5 volt supply. The CI-1123 is easily configured for battery back-up mode of operation requiring only 300MA from a single 5 V back-up supply for 256KB memory in the down state.

**SINGLE QTY. PRICE:** 32K x 18 \$575. 128K x 18 \$1925.

## 512KB SINGLE BOARD MULTIBUS® MEMORY

State of the Art Multibus Memory Design.

First to Offer 512KB on One Board.

The CI-8086 module is compatible with both 8 or 16 bit Multibus Systems.

**PARITY** — The CI-8086 generates and checks even parity with selectable interrupt on parity error.

**FAST ACCESS AND CYCLE TIME** — Data access is 270 NSEC and cycle time is 375 NSEC.

**16 MEGA BYTE ADDRESSING** — The memory is addressable in 16K increments up to 16 mega bytes.

**LOW POWER CONSUMPTION** — Total power consumption is under 8 watts.

**SINGLE QTY. PRICE:** 128K x 9 \$1350. 512K x 9 \$2995.

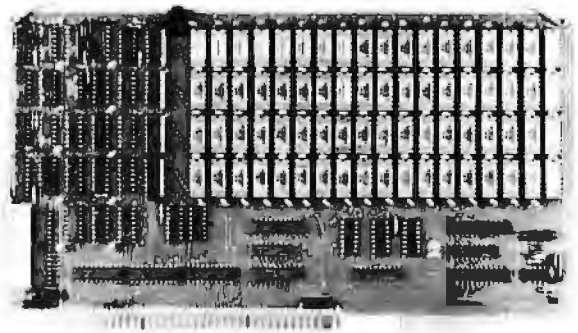

## 64K x 9 EXORCISER® I SINGLE BOARD MEMORY

For Exorciser I, Exorciser II and Rockwell System 65.

**FAST ACCESS AND CYCLE TIME** — Data access time is 225 NSEC and cycle time is 400 NSEC, allowing the unit to work as a static RAM at clock rates in excess of 1.5 mega hertz. For 2 mega hertz operation the board can be easily configured to utilize a cycle stealing refresh operation.

**ADDRESSING** — On-board memory select is available in 4K increments up to 64K words of memory on either the VUA or VXA control inputs.

**PARITY** — On board even parity with output jumper select to the system bus as a parity error or non-maskable interrupt.

Complete board power consumption is under 7 watts.

**SINGLE QTY. PRICE:** 64K x 9 \$575.

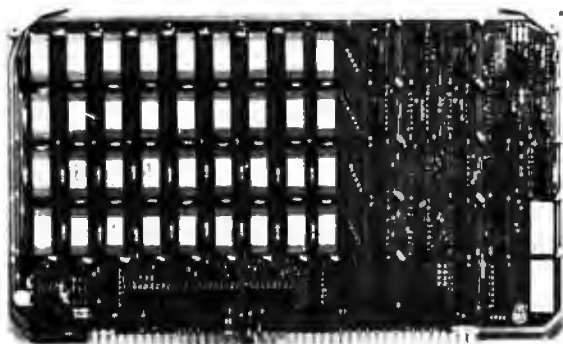

Tested and burned in. Full year warranty.

**DON'T ASK WHY WE CHARGE SO LITTLE, ASK WHY THEY CHARGE SO MUCH.**



# Chrislin Industries, Inc.

31352 Via Colinas • Westlake Village, CA 91362 • 213-991-2254

Multibus is a trademark of the Intel Corp.

LSI II is a trademark of Digital Equipment Corp.

EXORCiser is a trademark of Motorola

one that uses a sequential list to store data items. Unfortunately, a sequential list is not well suited to this purpose, because we need to add items to one end of the list and remove them from the other. You will recall that adding items to the end of a sequential list is an easy operation, but removing them from the beginning is difficult since we have to copy forward all of the succeeding items in the list. Rather than copy forward all items after the first, we would prefer to ignore the item at position 1 of the list and consider the item at position 2 to be the first item in the list. The problem, however, is that as items are added and removed from the list,

the actual positions of the first and last items migrate toward the end of the list. This could cause the list to expand even if it is not full. Fortunately, we can treat the last position in the list as if it preceded the first position: that is, we consider the list to be circular. After we have added an item to the last position, we can start adding items to the beginning of the list, provided some have already been removed. If we use this strategy, then we don't have to expand the list until it is full.

The class definition in table 16 uses the strategy just described to implement a queue using sequential storage. Class `SequentialQueue` uses

an instance of class `IndexedTable` as its buffer. Since class `IndexedTable` does not provide facilities for counting the number of objects stored in an instance (those facilities are provided by class `LinearList`), we need to define an instance variable `count` in class `SequentialQueue`. Additionally, we have instance variables named `front` and `rear`. `front` is the index of the first object stored in buffer (an instance of class `IndexedTable`); `rear` is the index of the last object stored in buffer. Since we are treating buffer as a circular sequence of positions, `front` and `rear` will repeatedly cycle through the values between the lower and upper bounds of buffer.

## KEEP YOUR EYE ON THE BALL

THE FORMULA™ allows the computer professional to focus on the most important part of business: the needs of the client. Customized systems for any business application can be created in a fraction of the time required by conventional methods.

- Interactive data entry, file updating, and maintenance routines are automatically generated from a definition of the fields.
- Reports can be created through a unique full screen editor simply by typing a sample format.
- Menus and job streams are defined through a preprogrammed parameter-driven procedure.
- Fast response time is insured because each routine can be interpreted directly by the computer and data management is controlled by an efficient ISAM algorithm.

THE FORMULA™ is a complete system language which brings the process of developing applications closer to the user's description of his needs. That's THE FORMULA™ for success.

Disk and manual, \$595. Manual only, \$60.

THE FORMULA™ will run on any 8080 or Z80 computer with CP/M,\* 48K RAM, 300K total disk storage, and a CRT.

**DMA • WE SPEAK YOUR LANGUAGE.**

DYNAMIC MICROPROCESSOR ASSOCIATES • 545 Fifth Avenue, New York, New York 10017 • (212) 687-7115

We ship prepaid and COD orders. Shipping & handling charges extra. \$5 UPS areas; \$7 non-UPS areas, Mexico, Canada; \$10+ elsewhere. MasterCard and VISA accepted. New York State residents add appropriate sales tax. \*CP/M is a trademark of Digital Research

# ALPHA BYTE DOES IT AGAIN...



Call us for our never undersold price.

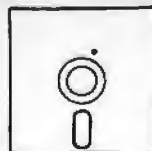

**ALPHA  
BYTE  
STORES**

**(213) 883-8594**

Circle 380 on inquiry card.

**5115 Douglas Fir Road • Suite B • Calabasas, CA 91302**

|   |                  |
|---|------------------|
| class name  | SequentialQueue  |
| superclass  | Queue            |
| instance variable names   | front rear count |
| class messages and methods  |                  |
| <b>size: anInteger    </b><br>(anInteger < 1) ifTrue: [ 1 self error: 'invalid size' ].<br>1 (self new) buffer: (IndexedTable from: 1 to: anInteger) count: 0.  |                  |
| instance messages and methods   |                  |
| <i>external</i><br><b>count</b>     1 count.<br><b>empty</b>     1 count = 0.<br><b>put: anObject    </b><br>(count = buffer size) ifTrue: [ self expand. ].<br>buffer put: anObject at: rear.<br>rear ← self advance: rear.<br>count ← count + 1.<br><b>get</b>   anObject<br>  self emptyCheck.<br>anObject ← buffer at: front.<br>front ← self advance: front.<br>count ← count - 1.<br>1 anObject.<br><br><i>internal</i><br><b>buffer: anIndexedTable count: anInteger    </b><br>buffer ← anIndexedTable. count ← anInteger.<br>front ← buffer lowerBound. rear ← front + count.<br><b>advance: anInteger    </b><br>anInteger = buffer upperBound<br>ifTrue: [ 1 buffer lowerBound ] ifFalse: [ 1 anInteger + 1 ].<br><b>expand</b>   anIndexedTable anInteger  <br>anIndexedTable ← IndexedTable from: 1 to: (2 * buffer size).<br>anInteger ← front.<br>1 to: count do:<br>[ i   anIndexedTable put: (buffer at: anInteger) at: i.<br>anInteger ← self advance: anInteger. ].<br>self buffer: anIndexedTable count: count. |                  |

Table 16: Class template for class SequentialQueue.

Because we are using an instance of class *IndexedTable* for storing objects, we must specify an estimate of the maximum size of an instance of class *SequentialQueue* when we create it. This is done with the creation message `size:`, which creates a new instance of *SequentialQueue* and sends it the internal message `buffer:count:`. The first parameter of `buffer:count:` is an instance of class *IndexedTable*; the second is the number of objects stored in the first parameter (initially zero).

The message `buffer:count:` is also sent from the internal message `ex-`

`pand`, which is used to expand `buffer` when it becomes full. `expand` is implemented by creating a new instance of *IndexedTable* that is twice as large as the current one. All of the objects stored in `buffer` are copied to the first half of the new instance, which then becomes the new `buffer`.

The internal message `advance` is used to advance the values of `front` and `rear`. Normally, this is done by incrementing the current value by 1. However, if the current value is equal to the upper bound of `buffer`, then we must set the value back to the lower bound of `buffer`. The external

messages are those specified in the superclass *Queue*. The message `count` returns the value of the instance variable `count`. The message `empty` tests to see if `count` is zero.

For the message `put:`, we first test to see if `buffer` is full. If `buffer` is full, it is expanded using the message `expand`. The object passed as a parameter to `put:` is then stored in `buffer` at the position indicated by `rear`. `rear` is then advanced one position forward, using the message `advance`. Finally, the value of `count` is incremented.

Similarly, for the message `get`, we first test to see if the queue is empty. If it is, an error message is sent; otherwise, the object stored at the position indicated by `front` is removed from `buffer`. `front` is advanced one position forward, and the value of `count` is decremented. Finally, the removed object is returned.

## Summary

The class construct is an extremely useful tool for implementing data structures. Implementing a data structure with a class makes it possible to confine the details of the implementation to one place and to insure that the resulting object will be accessed by the rest of the system in a secure manner, namely, through the use of a set of messages that correspond to the operations that are well defined for that data structure. Additionally, the ability to create subclasses makes it possible to share variables and methods among similar class definitions, thereby reducing the amount of work needed to implement a set of data structures. ■

## References

1. Horowitz, E and Sarta, S. *Fundamentals of Data Structures*. Potomac MD: Computer Science Press, 1976.
2. Knuth, D E. *The Art of Computer Programming: Volume 1/Fundamental Algorithms*, Second Edition. Reading MA: Addison-Wesley, 1973.
3. Robson, D and Goldberg, A. "The Smalltalk-80 System," August 1981 BYTE, page 36.
4. Wirth, N. *Algorithms + Data Structures = Programs*. Englewood Cliffs NJ: Prentice-Hall, 1976.

# The S-100 Bus is moving!

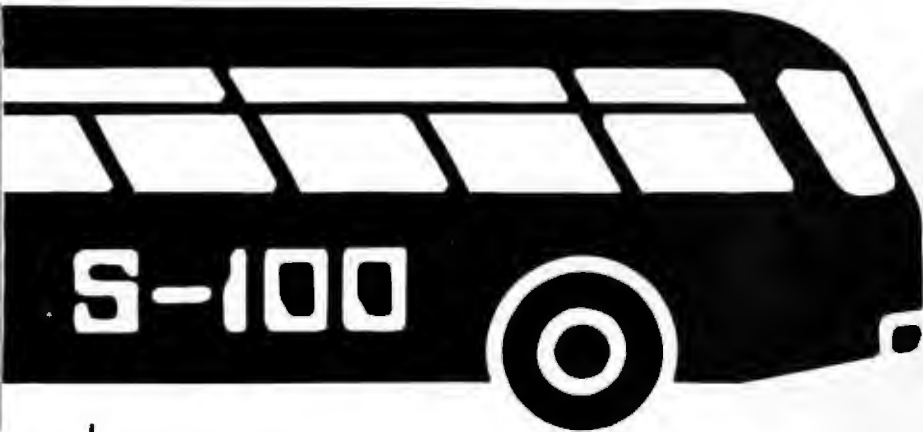

*Our New Address:*  
**14425 North 79th St.  
Suite B  
Scottsdale, Arizona 85260**

*Our New Phone Numbers:*  
**800-582-3138  
602-991-7870**

*From July 25, 1981 to August 10, 1981, we'll be in the process of moving from Clark, NJ to our new larger quarters in order to serve you better with these major lines:*

Anadex  
Apple  
ATV  
California Computer Systems  
Centronics  
Cromemco  
Digital Research  
Electronic Control  
Technology  
Epson  
Executive Data Systems  
Godbout Electronics  
(CompuPro)  
Hayes Microcomputer  
Heuristics  
Integral Data Systems  
Integrand

International Microcomputer  
Corp.  
Ithaca Intersystems  
Maxell  
Micro Pro International  
Morrow Designs  
(Thinker Toys)  
Mountain Computer  
Mullen Computer Products  
North Star  
Para Dynamics  
Persci  
Potomac Micro Magic  
Qume  
Sanyo  
Scion  
SDM Industries

SD Systems  
Shugart  
Soroc  
SSM Microcomputer  
Products  
Tandon Magnetics  
Tarbell Electronics  
TCS  
T.E.I.  
Tecmar  
Teletype  
Televideo  
Texas Instruments  
Three M (Scotch)  
Verbatim  
Vector  
Zenith



## S-100, inc.

14425 North 79th St., Suite B  
Scottsdale, Arizona 85260  
800-582-3138 • 602-991-7870

## MICROBYTE S-100 BOARDS

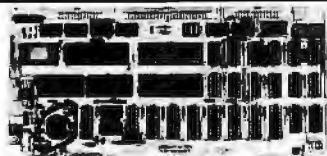

**Z-80A1-I** **\$349.00**  
Assembled & Tested  
Optional Monitor Program \$50.00

- Complete single board Z80A CPU with keyboard interface
- Fully compatible with the proposed IEEE S-100 Bus Standard
- Z80A CPU address range of 2.56M
- 15K instructions—supplies all and would be compatible from the 8080's 15 instructions.
- Up to 4K of on board EPROM with optional 256 monitor program—(K0706, ZM0710) or AK0753
- Full voltage interrupt capability—6 bit with 16K 1 bit
- 2MHz or 4MHz operation is jumper selectable
- Jumperable auto wait state insertion for extending MTBF
- 20Mhz 1024K ROM
- Dual RS-232 serial I/O ports using the Z80A UART with individual handshaking from 50 to 200 baud
- Up to 24 bit parallel I/O ports—fully programmable via 8255A

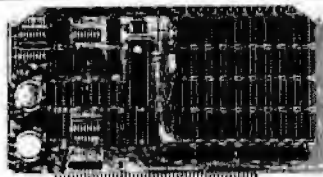

**64K RAM Board**  
Assembled & Tested *Call for Price*

### MICROBYTE

- Fully S-100 bus compatible
- 64K x 8 bit dynamic RAM
- Low power
- 1MVIC at 700 ma
- 8MVIC at 100 ma
- 16MVIC in 25 ma
- Built in parity with LED indicators and voltage monitor
- Memory addressable in four 16K banks
- Hardware refresh
- Gate contacts for high reliability
- 10 Service Environment
- Memory mapped via DIP switch
- Built in programmable write protect
- Programmable control port for parity and bank control
- 8080A/8085
- Miscellaneous

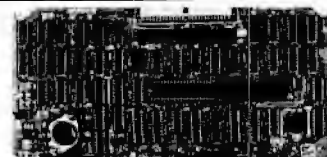

**Disc Controller** **\$389.00**  
Assembled & Tested  
CPM Available (Optional)

### MICROBYTE

- DMA to allow 18K byte of memory
- State-of-the-art MCT805 LSI Controller
- IEEE-488 compatible
- DMA arbitration allows use of multiple boards within a system
- Full data recovery for totally reliable operation
- Write and erase switches as indicators for reliable status to user
- Supports up to 16 low level drives
- Power On, Power Off or Reset de-selects drives to avoid damaging data
- Drive assist time Out, de-select drive not in use
- Single or double ended operation
- Single density/double density operation
- 16" standard drives
- Scattershot floppy for data recovery to simulate possible noise problems



**I/O Board** **\$289.00**  
Assembled & Tested  
Cables Available (Optional)

### MICROBYTE

- Quad RS-232C Serial Port, One 20MA Current Loop Port
- Fully IEEE S-100 Bus Compatible
- 10 Service Environment
- Communications with Z80A Data/Parity Synchronization Communications with Z80A-8000 I/O
- Full Set of Modern Control Signals including RST (Reset Indicator)
- Easily Configurable to Any Type of Terminal Interface
- 10 Service Environment
- (1) Parallel, (2) Bus Vector (3) Z80 Mode 2 Vector
- 20 Board Internal Battery Charge Capability
- Special Protective Conditions
- (1) Framing Error, (2) Parity Error (3) Receiver Overrun Error
- Guard Flares Detected Individually from 50 Baud to 200K Baud
- 12 Hour Burn-in

## CALIFORNIA COMPUTER

|       |                       |
|-------|-----------------------|
| 2032  | 32K STATIC RAM BRD    |
| 2065  | 64K DYNAMIC RAM BOARD |
| 2118  | 18K STATIC RAM BRD    |
| 2200  | MAINFRAME             |
| 2422  | DISK CONTROLLER       |
| 2501  | MOTHERBOARD           |
| 2710  | 4-PORT SERIAL I/O     |
| 2718  | 2 SER PORT & 2 PAR.   |
| 2720  | 4-PORT PARALLEL I/O   |
| 2802  | 6502 CPU BOARD        |
| 2810  | Z-80 CPU BOARD        |
| 7114A | 12K ROM/PROM BRD.     |
| 7424A | CALENDAR CLOCK BD.    |
| 7440A | PROGRAMMABLE TIMER    |
| 7470  | A/D CONVERTER         |
| 7710A | SERIAL SYNCH BRD.     |
| 7712A | SERIAL SYNCH BRD.     |
| 7720A | PARALLEL INTERFACE    |
| 7728A | CENTRONICS INTERFACE  |

CALL FOR PRICE & DELIVERY

## SD SYSTEM / S-100 BOARDS

|                         |     |          |
|-------------------------|-----|----------|
| EXPANDORAM I            | 16K | \$240.00 |
| 2 MHz DYNAMIC RAM BOARD | 32K | \$258.00 |
| KITS                    | 48K | \$276.00 |
|                         | 64K | \$294.00 |

|                         |     |          |
|-------------------------|-----|----------|
| EXPANDORAM II           | 16K | \$250.00 |
| 4 MHz DYNAMIC RAM BOARD | 32K | \$268.00 |
| KITS                    | 48K | \$286.00 |
|                         | 64K | \$304.00 |

|                                    |   |
|------------------------------------|---|
| SBC-100 KIT                        | SBC-200 KIT   |
| 2.5 MHz/Z80 CPU with Serial I/O    | 4 MHz/Z80A CPU with Serial & Parallel I/O Ports & SBC 200 |
| Monitor of your choice at No Chrg. | Monitor of your choice at No Chrg.                        |

\$299<sup>00</sup>

\$325<sup>00</sup>

### VERSAFLOPPY I KIT

Disk Controller for 5 1/4" & 8" Drives, Single or Double Sided/Single Density, S-100 Compatible

\$250<sup>00</sup>

### VERSAFLOPPY II KIT

Disk Controller for 5 1/4" or 8" Drives, Single or Double Sided/Single or Double Density, S-100 Compatible

\$300<sup>00</sup>

### PROM 100 KIT

S-100/EPROM PROGRAMMER for 2708, 2716, 2732 & (TI) 2516

\$210<sup>00</sup>

ALL BOARDS ARE AVAILABLE ASSEMBLED & TESTED CALL FOR PRICES

## ATARI 800

(16K) PERSONAL/BUSINESS COMPUTER

- Computer Console • Operators Manual
- Atari 8K Basic • RF Modulator
- 57 Full Stroke • Power Supply
- Alpha-numeric keys CALL
- & (4) Function Keys FOR PRICE
- Add'l 16K RAM FREE w/Purchase of System

## ATARI OPTIONAL ACCESSORIES

| MODEL # | DESCRIPTION                | PRICE     |
|---------|----------------------------|-----------|
| 810     | Disk Drive System          | \$ 475.00 |
| 815     | Disk Drive System          | \$1199.00 |
| 820     | 40-col. Dot Matrix Printer | \$ 279.00 |
| 822     | 40-col. Thermal Printer    | \$ 349.00 |
| 825     | 80-col. Dot Matrix Printer | \$ 625.00 |
| 830     | Acoustic Modem             | \$ 159.00 |
| 850     | Interface Module           | \$ 139.00 |
| 810     | Cassette Recorder          | \$ 60.00  |

## ATARI SOFTWARE

| Description            | Price   |
|------------------------|---------|
| Basketball             | \$29.00 |
| Super Breakout         | \$28.00 |
| Chess                  | \$28.00 |
| Video Easel            | \$29.00 |
| 3-D Tic Tac Toe        | \$28.00 |
| Star Raiders           | \$34.00 |
| Music Composer         | \$42.00 |
| Educational System ROM | \$19.95 |
| Assembler/Editor       | \$45.00 |
| Telink I               | \$19.95 |
| Space Invaders         | \$15.95 |
| Kingdom                | \$12.95 |
| Blackjack              | \$12.95 |
| Biorhythm              | \$12.95 |
| Graph II               | \$15.95 |
| Energy Czar            | \$12.95 |
| Mailing List           | \$16.95 |
| Statistics I           | \$16.95 |
| Paddle Controls        | \$17.95 |
| Joysticks (pair)       | \$17.95 |
| Touch Typing           | \$19.95 |
| Stock Charting         | \$19.95 |
| Stock Analysis         | \$19.95 |
| Bond Analysis          | \$19.95 |
| Scram                  | \$16.95 |

MANY MORE AVAILABLE

## MAINFRAME & DISK DRIVE CABINETS from INTEGRAD

**MODEL X5** — Desktop Mainframe — 5 Cards — Small Power Supply  
Cabinet size 9 1/2" x 16 1/2" x 7 1/2". Cabinet painted dove grey. Front panel is black. No optional color! 5 position motherboard. 5 connectors installed, card cage with all guides. Master switch on front panel. Power switch, 4 DB25 cables, 1 BMC mounting hole, 70CFM fan, EMI filter, 6" power cord, line fuse, and clamped flat cable exit on rear panel. P194 power supply (+\$8/10A, +16¢/15A, +16¢/20A). Power supply is a removable module.

**MODEL 7000** — Horizontal Desktop Disk/Drive — 2 Eight Inch Drives — Drive Horizontal  
Cabinet size 20" w x 23" d x 7 1/2" h. Cabinet painted dove grey, front panel is black. Mounting for 2 eight-inch Shugart SASDR Floppy Disk Drives (or mechanical equivalent). Drive mounting brackets supplied. Drives not supplied. 70CFM fan, 6" three-wire line cord, power switch, line fuse, EMI filter and clamped flat cable exit on rear panel. P194 power supply (+\$8/1A, +16¢/2A—2A peak, +5¢/7.5A. All voltages regulated. Power supply is a removable module.

**MODEL 9000** — Desktop Main/Frame — 15 Cards — Standard Power Supply  
Cabinet size 17 1/2" w x 20 1/2" d x 7 1/2" h. Cabinet painted dove grey, front panel is black (other color schemes optional). 15 position IEEE compatible motherboard (will accept 1801 terminator kit, optional), card cage with all guides. Reset switch on front panel. Power switch, 4 DB25 cables, 2 BMC mounting holes, 70CFM fan, EMI filter, 6" power cord, line fuse, and clamped flat cable exit on rear panel. P900 power supply (+\$8/15A, +16¢/2A, +16¢/2A). Power supply is a removable module. Miscellaneous connectors optional.

**MODEL 7000S** — Vertical Desktop Disk/Drive — 2 Eight Inch Drives — Drive Vertical  
Cabinet size 13 1/2" w x 23" d x 11 1/2" h. Cabinet painted dove grey, front panel is black. Mounting for 2 eight-inch Shugart SASDR Floppy Disk Drives (or mechanical equivalent). Drive mounting brackets supplied. Drives not supplied. 70CFM fan, 6" three-wire line cord, power switch, line fuse, EMI filter and clamped flat cable exit on rear panel. P194 power supply (+\$8/1A, +16¢/2A—2A peak, +5¢/7.5A. All voltages regulated. Power supply is a removable module.

## PRINTERS

| MFG./MODEL #          | PRICE     |
|-----------------------|-----------|
| ANACOM-150            | \$ 995.00 |
| ANADIX-8501           | \$1300.00 |
| BASE 2-800B           | \$ 650.00 |
| CENTRONICS 739        | \$ 795.00 |
| DIABLO-630R0          | \$2300.00 |
| C. ITOH-Starwriter 45 | \$1925.00 |
| TEXAS INSTR.-810      | \$1650.00 |

## MONITORS

| MFG.    | MODEL #           | PRICE    |
|---------|-------------------|----------|
| Amdek   | 100/12" B&W       | \$139.00 |
| Amdek   | 100-80            | \$169.00 |
| Amdek   | 100G/12" Grn.     | \$169.00 |
| Amdek   | Color I           | \$399.00 |
| APF     | TVM-10/10" B&W    | \$149.00 |
| Hitachi | VM9108" B&W       | \$210.00 |
| Hitachi | VM129/12" B&W     | \$340.00 |
| Sanyo   | DM5012/12" B&W    | \$260.00 |
| Sanyo   | DM5112ex/12" Grn. | \$280.00 |
| Sanyo   | DMC8013/13" Color | \$450.00 |

## MODEMS

| MFG.      | MODEL #      | PRICE    |
|-----------|--------------|----------|
| Novation  | CAT          | \$149.00 |
| Novation  | D-CAT        | \$169.00 |
| Novation  | Auto-GAT     | \$229.00 |
| Lexicon   | Lex-11       | \$139.00 |
| Livermore | LIV-Star 20M | \$149.00 |
| UDS       | UDS 103      | \$189.00 |
| UDS       | UDS 202      | \$295.00 |

## TERMINALS

| MFG.      | MODEL #     | PRICE     |
|-----------|-------------|-----------|
| Ampex     | Diataque 80 | \$ 945.00 |
| Soroc     | IQ120       | \$ 750.00 |
| Soroc     | IQ140       | \$1250.00 |
| Televideo | TVI 910C    | \$ 625.00 |
| Televideo | TVI 912C    | \$ 725.00 |
| Televideo | TVI 920C    | \$ 760.00 |
| Televideo | TVI 950C    | \$ 975.00 |

## QUME DT-8 DISK DRIVE



**Specifications**

- Double-sided
- Single-Density
- IBM-compatible
- 1.2 Mbytes/Disk
- Fast—3 ms.
- Track to Track
- 154 Tracks/Daisy Chain 4 Drives
- ISO Standard
- Write Protect
- Programmable Door Lock

CALL FOR PRICE & DELIVERY

O.E.M. Pricing Available on Request  
120 Day Factory Warranty

## WAMECO INC. Bare Boards & Kits

| KITS   |                     |          | BARE BOARDS |                  |         | BARE BOARDS |                      |         |
|--------|---------------------|----------|-------------|------------------|---------|-------------|----------------------|---------|
| PART # | DESCRIPTION         | PRICE    | PART #      | DESCRIPTION      | PRICE   | PART #      | DESCRIPTION          | PRICE   |
| EPM-1  | 4K EPROM            | \$ 59.95 | EPM-1       | 4K EPROM         | \$29.95 | CPU-2       | Z80 CPU              | \$39.95 |
| EPM-2  | 16K or 32K EPROM    | \$ 74.95 | EPM-2       | 16K or 32K EPROM | \$29.95 | RTC-1       | Real Time Clock      | \$27.95 |
| MEM-1  | 8K Static           | \$ 71.95 | MEM-1       | 8K Static        | \$29.95 | QMB-9       | 9 Slot Motherboard   | \$34.95 |
| MEM-2  | 16K Static          | \$ 80.95 | MEM-2       | 16K Static       | \$31.95 | QMB-12      | 12 Slot Motherboard  | \$39.95 |
| FPB-1  | Front Panel         | \$159.95 | MEM-3       | 32K Static       | \$35.95 | CRT-1       | 80 x 24 Video        | CALL    |
| CPU-1  | 8080A CPU           | \$119.95 | FPB-1       | Front Panel      | \$49.95 | IOB-1       | 2 Par. & 1 Ser I/O   | CALL    |
| RTC-1  | Real Time Clock     | \$ 75.95 | FDC-1       | Disk Controller  | \$44.95 | IOB-2       | 8-Parallel I/O Ports | \$35.95 |
| QMB-9  | 9 Slot Motherboard  | \$ 99.95 | CPU-1       | 8080A CPU        | \$31.95 | IOB-5       | 4-Serial I/O Ports   | \$35.95 |
| QMB-12 | 12 Slot Motherboard | \$109.95 |             |                  |         |             |                      |         |

KITS LESS EPROM OR RAM CHIPS

**COMPONENTS**

**4116's (200 ns.)**  
 Apple, TRS-80, Heath  
**8 for \$18<sup>00</sup>**  
 16-49 .....\$2.25 ea.  
 50-99 .....\$2.15 ea.  
 100 Up .....\$2.05 ea.

**2114 L-2/200 NS**  
 Lo-Power 1Kx4 Static RAM  
 1-16 .....\$3.05 ea.  
 17-49 .....\$2.95 ea.  
 50-99 .....\$2.85 ea.  
 100 Up .....\$2.70 ea.

74LS240 .....\$1.25 ea.  
 74LS241 .....\$1.10 ea.  
 74LS244 .....\$1.25 ea.  
 74LS373 .....\$1.25 ea.  
 74LS374 .....\$1.25 ea.  
 8T245 .....\$1.50 ea.

**2708/450 NS**  
 1K x 8 EPROM  
**\$4.25 ea.**  
 OR  
**8/\$32.<sup>00</sup>**

**2716/5 VOLT**  
 2K x 8 EPROM  
**\$6.95 ea.**  
 1 YR. WARRANTY

8080A-CPU ....\$ 2.50  
 Z80A-CPU ....\$ 8.95  
 Z80A-CTC ....\$ 8.95  
 Z80A-DART ....\$13.95  
 Z80A-SIO ....\$22.00  
 8255AC5 .....\$ 6.95  
 8257AC5 .....\$15.00

320T5 .80 320T12 .80  
 340T5 .70 340T12 .75

1-9 10-24 25 Up  
 DB25P 2.65 2.60 2.40  
 DB25S 3.60 3.40 3.25  
 DB25C 1.00 .90 .80

**100 PIN IMSAI**  
 Gold / S-100  
 Soldertail  
 Connectors  
**\$2.40 each**  
 OR  
**10/\$2.25 each**

**CAPACITORS**  
**.1 @ 12 Volt**  
 Ceramic  
**8¢ ea.**  
 or  
**100/\$7.00**

**DISKETTES FROM asap**

| VERBATIM 5 1/4" DISKETTES |                           |          |  |
|---------------------------|---------------------------|----------|--|
| PART #                    | DESCRIPTION               | PRICE    |  |
| HD25-01                   | SOFT SECTOR               | 10-27 50 |  |
| HD25-10                   | HARD 10 SECTOR            | 10-29 50 |  |
| HD25-18                   | HARD 18 SECTOR            | 10-29 50 |  |
| 5 1/4" DISKETTES          |                           |          |  |
| FD35-1000                 | HARD SECTOR               | 10-28 00 |  |
| FD34-1000                 | SOFT SECTOR               | 10-29 00 |  |
| MEMOREX 5 1/4" DISKETTES  |                           |          |  |
| MEM 3401                  | 1/4 SINGLE SOFT SECTOR    | 10-22 00 |  |
| MEM 3403                  | 1/4 SINGLE HARD 10 SECTOR | 10-25 00 |  |
| MEM 3405                  | 1/4 SINGLE HARD 18 SECTOR | 10-25 00 |  |
| 5 1/4" DISKETTES          |                           |          |  |
| MEM 3101                  | 1/4 SINGLE SOFT SECTOR    | 10-23 00 |  |
| MEM 3102                  | 1/4 SINGLE SOFT SECTOR    | 10-24 00 |  |
| MEM 3103                  | 1/4 SINGLE SOFT SECTOR    | 10-24 00 |  |
| MEM 3104                  | 3/4 DOUBLE SOFT SECTOR    | 10-24 00 |  |
| DYBAN 5 1/4" DISKETTES    |                           |          |  |
| D022B                     | 1/4 SINGLE SOFT SECTOR    | 10-24 00 |  |
| D022B                     | 1/4 DOUBLE SOFT SECTOR    | 10-24 00 |  |
| D022B                     | 3/4 DOUBLE SOFT SECTOR    | 10-24 00 |  |
| 5 1/4" DISKETTES          |                           |          |  |
| D022B                     | 1/4 SINGLE SOFT SECTOR    | 10-24 00 |  |
| D022B                     | 1/4 DOUBLE SOFT SECTOR    | 10-24 00 |  |
| D022B                     | 3/4 DOUBLE SOFT SECTOR    | 10-24 00 |  |

| SCOTCH 3M 5 1/4" DISKETTES |                           |            |  |
|----------------------------|---------------------------|------------|--|
| PART #                     | DESCRIPTION               | PRICE      |  |
| F44-0                      | 1/4 SINGLE SOFT SECTOR    | 10-23 00   |  |
| F44-10                     | 1/4 SINGLE HARD 10 SECTOR | 10-23 00   |  |
| F44-18                     | 1/4 SINGLE HARD 18 SECTOR | 10-23 00   |  |
| F45-0                      | 1/4 DOUBLE SOFT SECTOR    | 10-24 00   |  |
| F45-10                     | 1/4 DOUBLE HARD 10 SECTOR | 10-24 00   |  |
| F45-18                     | 1/4 DOUBLE HARD 18 SECTOR | 10-24 00   |  |
| MAXELL 5 1/4" DISKETTES    |                           |            |  |
| MD1                        | 1/4 SINGLE SOFT SECTOR    | 10-24 00   |  |
| MD2                        | 1/4 DOUBLE SOFT SECTOR    | 10-24 00   |  |
| MH1                        | 1/4 SINGLE HARD 10 SECTOR | 10-24 00   |  |
| MH2                        | 1/4 DOUBLE HARD 10 SECTOR | 10-24 00   |  |
| 5 1/4" DISKETTES           |                           |            |  |
| PD1-120                    | 1/4 SINGLE SOFT SECTOR    | 10-24 00   |  |
| PD1-32                     | 1/4 SINGLE SOFT SECTOR    | 10-24 00   |  |
| PD3-10                     | 1/4 DOUBLE SOFT SECTOR    | 10-24 00   |  |
| SRW MEDIA STORAGE CASSES   |                           |            |  |
| SRW-5                      | 5 1/4"                    | \$2.50 ea. |  |
| SRW-8                      | 8"                        | \$3.75 ea. |  |

**DIP SOCKETS/LOW PROFILE TIN SOLDER TAIL**

| DESCRIPTION   | 1-9 | 10-49 | 50-99 | 100 Up |
|---------------|-----|-------|-------|--------|
| 14 PIN TIN ST | .15 | .13   | .12   | .11    |
| 16 PIN TIN ST | .16 | .14   | .13   | .12    |
| 18 PIN TIN ST | .19 | .18   | .16   | .14    |
| 20 PIN TIN ST | .25 | .23   | .21   | .20    |
| 24 PIN TIN ST | .26 | .24   | .22   | .20    |
| 28 PIN TIN ST | .32 | .30   | .29   | .27    |
| 40 PIN TIN ST | .42 | .40   | .38   | .34    |

**INTRODUCING**  
**asap's Atari 800**  
 Computer System • 16K RAM Module  
**\$75<sup>00</sup>**  
 1 YEAR WARRANTY PARTS AND LABOR

**PERSONAL SOFTWARE FOR APPLE, TRS80, PET, & ATARI**

| DESCRIPTION                   | PRICE  |
|-------------------------------|--------|
| VISICALC APPLE DISK           | 125.00 |
| DESKTOP PLAN APPLE DISK       | 75.95  |
| MICROCHESS 2.0 APPLE DISK     | 21.95  |
| MICROCHESS 2.0 APPLE          | 17.95  |
| CHECKER KING APPLE DISK       | 21.95  |
| CHECK KING APPLE              | 17.95  |
| GAMMON GAMBLER APPLESOFT DISK | 21.95  |
| GAMMON GAMBLER APPLE          | 17.95  |
| BRIDGE PARTNER APPLESOFT DISK | 21.95  |
| BRIDGE PARTNER APPLE          | 17.95  |
| CCA DATA MGMT SYS APPLE DISK  | 79.95  |
| MICROCHESS 2.0 B-32K PET      | 17.95  |
| CHECKER KING PET              | 17.95  |
| GAMMON GAMBLER PET            | 17.95  |
| BRIDGE PARTNER PET            | 13.95  |
| VISICALC - PET                | 175.00 |
| CCA DATA MGMT SYS TRS80 DISK  | 65.00  |
| MICROCHESS 1.5 TRS80          | 17.95  |
| CHECKER KING TRS80            | 17.95  |
| BRIDGE PARTNER TRS80          | 13.95  |
| TIME TREK TRS80               | 13.95  |
| VITAFACTS PKG/6 PET APPLE TRS | 100.00 |
| VISICALC - ATARI              | 175.00 |

**APPLE SOFTWARE**  
 by EDU-WARE

| DESCRIPTION            | PRICE |
|------------------------|-------|
| COMPU-MATH (FRACTIONS) | 29.95 |
| COMPU-MATH (DECIMALS)  | 29.95 |
| COMPU-READ             | 19.95 |
| EDU-PAK I              | 35.00 |
| TERRORIST              | 24.95 |
| WINDFALL               | 16.95 |
| NETWORK                | 18.95 |
| SPACE                  | 24.95 |
| PRISONER               | 24.95 |

(ALL SOFTWARE ON DISK)

**PANAVISE** BASES, HEADS, MTS. & COMBINATIONS

| PART # | DESCRIPTION          | PRICES |
|--------|----------------------|--------|
| 300    | STANDARD BASE        | 11.95  |
| 301    | STANDARD PANAVISE    | 24.05  |
| 303    | STANDARD HEAD        | 14.49  |
| 304    | LOW PROFILE HEAD     | 15.25  |
| 308    | LOW PROFILE BASE     | 11.95  |
| 308    | WEIGHTED BASE        | 14.25  |
| 310    | SURFACE PLATE        | 33.95  |
| 311    | BENCH CLAMP          | 14.49  |
| 315    | CIRCUIT BOARD HOLDER | 18.95  |
| 333    | RAPID ASSEMBLY       | 30.95  |
| 350    | WORK CENTER STATION  | 38.95  |
| 366    | WIDE OPEN HEAD       | 13.95  |
| 376    | SELF-CENTERING HEAD  | 16.95  |
| 380    | VACUUM BASE          | 16.95  |

| PART # | ACCESSORIES DESCRIPTION | PRICE |
|--------|-------------------------|-------|
| 316    | EXTRA ARMS              | 9.50  |
| 318    | 12" BAR                 | 3.49  |
| 343    | NYLON JAWS (PAIR)       | 2.00  |
| 344    | GROOVED NYLON JAWS      | 2.00  |
| 346    | NEOPRENE JAWS           | 2.50  |
| 353    | STEEL JAWS              | 16.95 |
| 359    | UNIVERSAL HOLDER        | 6.95  |

**SHUGART 801R DISK DRIVE**

| Capacity       | Single Density   | Double Density   |
|----------------|------------------|------------------|
| Unformatted    |                  |                  |
| Per Disk       | 400K             | 800K             |
| Per Track      | 5.2K             | 10.4K            |
| IBM Format     |                  |                  |
| Per Disk       | 256K             | 512K             |
| Per Track      | 3328             | 6656             |
| Transfer Rate  | 250 kilobits/sec | 500 kilobits/sec |
| Latency (avg.) | 83 ms            | 83 ms            |
| Access Time    |                  |                  |
| Track to Track | 8 ms             | 8 ms             |
| Average        | 260 ms           | 260 ms           |
| Settling Time  | 8 ms             | 8 ms             |
| Head Load Time | 35 ms            | 35 ms            |

Model 801 .....\$400.00  
 Case & Power Supply .....\$265.00

**ZIP DIP II**

Zero Insertion Pressure Test Socket

| PART # | PINS | 1-9  | 10-24 | 25 UP |
|--------|------|------|-------|-------|
| ZD1116 | 16   | 5.35 | 5.15  | 4.95  |
| ZD1124 | 24   | 7.35 | 7.10  | 6.85  |
| ZD1140 | 40   | 9.75 | 9.50  | 9.25  |

**DIP SWITCHES**

| PART # POSITIONS | 1-9 | 10-24 | 25 UP |      |
|------------------|-----|-------|-------|------|
| DS4P             | 4   | 1.25  | 1.20  | 1.15 |
| DS5P             | 5   | 1.30  | 1.20  | 1.10 |
| DS6P             | 6   | 1.35  | 1.25  | 1.10 |
| DS7P             | 7   | 1.40  | 1.25  | 1.10 |
| DS8P             | 8   | 1.40  | 1.20  | 1.05 |

**IDS SOCKET CONNECTORS**  
 Crimp-On Type

| Contacts | 1-9  | 10-24 | 25 Up |
|----------|------|-------|-------|
| 20 PINS  | 2.85 | 2.75  | 2.50  |
| 26 PINS  | 3.25 | 2.95  | 2.75  |
| 34 PINS  | 4.45 | 4.25  | 3.95  |
| 40 PINS  | 5.65 | 5.35  | 4.95  |
| 50 PINS  | 5.95 | 5.65  | 5.25  |

**IDS CARD-EDGE CONNECTORS**  
 Crimp-On Type

| Contacts | 1-9  | 10-24 | 25 Up |
|----------|------|-------|-------|
| 20 PINS  | 3.95 | 3.75  | 3.50  |
| 26 PINS  | 4.95 | 4.55  | 4.25  |
| 34 PINS  | 5.25 | 4.95  | 4.75  |
| 40 PINS  | 6.25 | 5.85  | 5.50  |
| 50 PINS  | 6.95 | 6.35  | 5.95  |

**The Epson MX-80**  
 80 COLUMN DOT MATRIX PRINTER

**SPECIFICATIONS**  
 Print method - serial impact dot matrix  
 Print rate - 80 CPS  
 Print direction - bidirectional  
 Number of pins in head - 9  
 Matrix - 9 x 9  
 Line spacings - 1/8", 1/6", 7/72" + programmable  
 Throughput at 10 CPI - logical seeking function - 105 LPM, 20 character line; 73 LPM, 43 char. line; 48 LPM, 80 char. line

**PRINTING CHARACTERISTICS**  
 Character set - full 96-character ASCII with descenders  
 Graphics characters - 64 block characters

**INTERFACES**  
 Standard - Centronics-style 8-bit parallel  
 Optional - RS232, IEEE488.  
 Buffer size - 1 line

New MX80FT Available  
 CALL FOR PRICE & DELIVERY

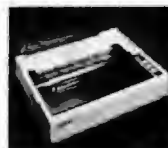

**MICROBYTE 32K STATIC RAM BOARD**

**\$450<sup>00</sup>**

- \*2 MHz or 4 MHz operation
- \*All hardware or software selectable
- \*Will operate with or without front panel
- \*Low power consumption 800mA
- \*Fully warranted for 120 days from date of shipment
- \*Uses ultra low-power 21411 & 41x1 Static RAM
- \*Each 4k bank addressable to any 4k slot within a 16k boundary

Fully 5100 bus compatible  
 IMSAI, SOL  
 ALTIR  
 ALPHA MICRO

**asap** DISK DRIVE CABLE ASSEMBLY

DESCRIPTION  
 PART # CONNECTS (2) 8"  
 CAB32PT DISK DRIVES (Shugart Qume, etc.) TO STANDARD DISK CONTROLLER BOARD

**\$24<sup>50</sup> ea.**

**GODBOUNT 32K ECONORAM XX**  
 Static S-100 Memory

32K Bank Select. IEEE S-100 compatible One 32K block can be addressed on 4K boundaries. Compatible with IEEE proposed standard of 24 address lines and all currently used bank select configurations. Disable any or all of the eight 4K blocks to create as many windows in memory to avoid system memory conflicts.

| PART #       | DESCRIPTION | PRICE    |
|--------------|-------------|----------|
| GB ER XX 16K | 16K A & T   | \$339.00 |
| GB ER XX 24K | 24K A & T   | \$449.00 |
| GB ER XX 32K | 32K A & T   | \$579.00 |

**CATALOG REQUEST**  
 Please send me your 1981 asap Full Line Catalog

Name \_\_\_\_\_  
 Address \_\_\_\_\_  
 City \_\_\_\_\_  
 State \_\_\_\_\_ Zip \_\_\_\_\_

**asap** computer products, inc.

**NEW LOCATION**  
 1198 E. Willow Street  
 Signal Hill, CA 90806  
 Toll Free (800) 421-7701 Outside Calif.  
 (213) 595-6431 Inside Calif.

**ORDERING INFO**  
 Name, address, phone  
 Ship by UPS or Mail  
 Shipping Chrg. Add \$2.50 up to 1 lb. Call for larger shipments  
 Freight, U.S. Mail Add \$1.50  
 U.S. Only up to 2 lbs.

**TERMS**  
 We Accept Cash, Check, Money Orders, Visa & Master Charge (U.S. Funds Only)  
 Tax: 8% Calif. Res.  
 COD's & Terms Available on Approval (School PO's Accepted) (\$25.00 Minimum Order)

## Letters

Continued from page 34:

Venice, only to find the wares Much Ado About Nothing, or even The Comedy of Errors? Or, after conceiving a program during A Midsummer Night's Dream, who has not labored until the Twelfth Night just to get the output As You Like It? . . . CPF

### Modification Caveat

While I especially enjoyed the article "What's Inside Radio Shack's Color Computer" (March BYTE 1981, page 90), there is a problem I would like to pass on to other BYTE readers.

The authors indicated that the processor speed can be doubled by issuing a POKE 65495,0 command. Before I had my computer upgraded for Extended Color BASIC, I used this method to make programs run faster. But after getting the Extended BASIC upgrade, I had problems with double speed. During program execution, everything worked. But if the machine was still operating at double speed when the program ended, the computer would hang up, requiring me to reset it. (I solved this by restoring the nor-

mal speed with POKE 65494,0 before the program ended.) But if the program ended unexpectedly, before I could restore normal speed, the computer would hang up.

Richard A Schafer  
POB 1171  
Fond du Lac WI 54935

*The people at Radio Shack advise us that the processor and other parts are designed for 1 MHz operation, and that any time you try to double this speed, you're inviting problems. The reason you had problems with Extended BASIC at the higher speed is that it keeps certain parts (eg: processor and the peripheral interface adapter) busier than non-Extended BASIC does. At 2MHz, these parts are overloaded. . . . GS*

### Define the Problem

I read Gregg Williams's "Is This Really Necessary? A First Look at Design Techniques" (March 1981 BYTE, page 6) with interest. Concerning the lifespan of a medium-sized system (described on page

8), the first phase will also be called *system and problem analysis* instead of (system) design.

In the *system analysis*, the system environment is studied and all the parameters that have an influence on the system are resumed and their interrelation is defined (perhaps using decision tables). In the *problem analysis*, the designer must devise alternative schemes to solve the problem and choose the best approach. By the end of the analysis, the system has been completely specified (hardware and software). But, more important than the designation of the different phases is the fact that, as Mr Williams mentioned, the designer must at first respond to the "what" of the question. In practice, most people try to solve a problem before it has been specified.

The importance of the analysis/specification and design phases in a well-managed project is shown by T H Bruggere in his article "On-Schedule, Reliable Software Depends on Sound Methodology" (EDN January 7, 1981).

Finally, in the references, Mr Williams failed to mention M A Jackson's *Principles of Program Design* (New York: Academic

## DISCOUNT PRINTER RIBBONS

Brand New, Top Quality, Exact Replacement Ribbons & Cartridges. These Ribbons Produce Super Jet Black Impressions and Ultra Reliable Print Life. They Are Delivered to Your Door Promptly for Much Less Than Most Retail Stores

★SPECIAL! BUY 10 and GET ONE FREE!

| YOUR PRINTER   | PACK SIZE | RETAIL LIST** | YOUR WHOLESALE PRICE            | SIZE                 | COMMENTS           | CAT. ORDER# |
|--|-----------|---------------|---------------------------------|----------------------|--------------------|-------------|
| RADIO SHACK LPIII, LPIV  | one/pk    | 13.95/cart    | 8.95/Reload rib. only (8.95 ea) | 500" x 45'           | Nylon Incl Instr   | R-73        |
| RADIO SHACK LPIII, LPIV  | 3/pk      | 18.95/3 pk    | 11.95/3 pk (3.98 ea)            | 563" x 45'           | Nylon Jet Blk      | C-700       |
| CENTRONICS MODS 700 to 703   | 3/pk      | 18.95/3 pk    | 11.95/3 pk (3.98 ea)            | 563" x 45'           | Nylon Jet Blk      | C-700       |
| CENTRONICS 100, 101A, 102, 103, 300, 301, 308, 308, 330, 358, 398, 500, 501, 503, 508, 588, 820, 820                                 | 3/pk      | 28.33/3 pk    | 17.55/3 pk (5.85 ea)            | 1" x 108'            | Nylon Jet Blk      | C-100       |
| CENTRONICS 704-706   | 1/pk      | 16.95 ea      | 13.95/Giant Cart (13.95 ea)     | 5/16" x 210'         | Giant Cart         | C-7045      |
| IBM "SILVER ODLAR" Sys. 34, Sys. 32 MDLA, Series IMDLA974, 5256, 3287, 3770, 3771-3774, 4974, 5100, 5103, 5110, 5228, 5258, 5320MDLA | 5/pk      | 5.80 ea       | 14.90/5 pk (2.98 ea)            | 8/16" x 30'          | Nylon Jet Blk      | R-300       |
| IBM - HARMONICA 1/2" SERIES I, MOD 4973/II, 3200, 3288, MOD 2.   | 3/pk      | 9.42 ea       | 20.85/3 pk (6.95 ea)            | 1/2" x 108'          | Nylon Jet Blk      | C-350       |
| TELETYPE MOD 33, 28, 35, 37, 38, 88.   | 10/pk     | 2.40 ea       | 13.90/10 pk (1.39 ea)           | 1/2" x 38'           | Nylon Jet Blk      | R-450       |
| DIABLO HYTYPE II (M/S BLK) HI YIELD. FITS 70 PRINTERS!   | 1/pk      | 9.31 ea       | 6.87 ea (6.87 ea)               | 5/16" x "High Yield" | 300,000 plus imp.  | C-511       |
| QUIME (FITS 80 PRINTER MODS)   | 3/pk      | 18.00/3 pk    | 13.95/3 pk (4.65 ea)            | 1/4" x 310'          | Multistrike Film   | C-525       |
| WANG M/S. 5541W, WC, 5581, WD, 8581W, 2281W  | 1/pk      | 6.85 ea       | 5.95 ea (5.95 ea)               | 5/16" x 383'         | Multistrike Film   | C-550       |
| DEC 1/2 x 40YD.  | 3/pk      | 17.77/3 pk    | 12.95/3 pk (4.32 ea)            | 1/2" x 120'          | Double Spools      | R-800       |
| DEC 1/2 x 60YD.  | 3/pk      | 20.12/3 pk    | 14.25/3 pk (4.75 ea)            | 1/2" x 180'          | Double Spools      | R-844       |
| NEC SPINWRITER   | 4/pk      | 23.40/3 cart  | 23.80/4 pk rib reload (5.90 ea) | 1/2" x 51'           | Nylon/Ex. Lng Life | R-400       |

40% OFF!! OR MORE!

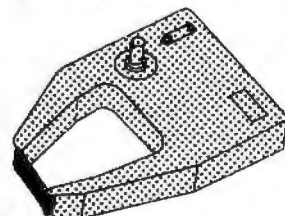

### TERMS:

MINIMUM PURCHASE - \$20  
PAYMENT BY: C.O.D. (UPS), CHECK, MASTER CARD, OR VISA CHARGE CARD.

### VOLUME DISCOUNTS:

20 - 50 PACKS 10%  
51 - 100 PACKS 15%

\*UNDER \$20, ADD \$5 HANDLING.  
\*\*APPROX. RETAIL. PRICE VARIES.

### ANCIE LABORATORIES

9204 Baltimore Blvd  
College Park, MD 20740

301-345-6000 (Wash. D.C. Local)  
301-792-2060 (Balt. MD Local)  
800-836-0987 (National)

NAME \_\_\_\_\_  
ADDRESS \_\_\_\_\_  
CITY \_\_\_\_\_ STATE \_\_\_\_\_ ZIP \_\_\_\_\_

QTY \_\_\_\_\_ CAT.# \_\_\_\_\_ AMT \_\_\_\_\_

Check Enclosed  
 C.O.D.  
 VISA  
 MASTER CHARGE  
ACCT. # \_\_\_\_\_  
EXP. DATE \_\_\_\_\_  
MIN. ORDER \$20  
PRICES SUBJECT TO CHANGE

TOTAL \_\_\_\_\_

ANCIE Laboratories 301-345-6000 (Wash. D.C. Local)  
9204 Baltimore Blvd 301-792-2060 (Balt. MD Local)  
College Park, MD 20740 800-836-0987 (National)



# we carry it all...

## Atari® Software

|                                       |     |
|---------------------------------------|-----|
| VisiCalc.....                         | 149 |
| CX4101 Invitation to Programming 1 .. | 17  |
| CX4104 Mailing List.....              | 17  |
| CX4102 Kingdom.....                   | 13  |
| CX4103 Statistics.....                | 17  |
| CX4105 Blackjack.....                 | 13  |
| CX4106 Invitation to Programming 2 .. | 20  |
| CX4107 Biorhythm.....                 | 13  |
| CX4108 Hangman.....                   | 13  |
| CX4109 Graph It.....                  | 17  |
| CX4111 Space Invader.....             | 17  |
| CX4110 Touch Typing.....              | 20  |
| CX4115 Mortgage & Loan Analysis.....  | 13  |
| CX4116 Personal Fitness Program.....  | 13  |
| CX4117 Invitation to Programming 3 .. | 20  |
| CX4118 Conversational French.....     | 45  |
| CX4119 Conversational German.....     | 45  |
| CX4120 Conversational Spanish.....    | 45  |
| CX4121 Energy Czar.....               | 13  |
| CX4125 Conversational Italian.....    | 45  |
| CX8108 Stock Charting.....            | 20  |
| CXL4001 Educational System Master ..  | 21  |
| CXL4002 Basic Computing Language ..   | 46  |
| CXL4003 Assembler Editor.....         | 46  |
| CXL4004 Basketball.....               | 30  |
| CXL4005 Video Easel.....              | 30  |
| CXL4006 Super Breakout.....           | 30  |
| CXL4007 Music Composer.....           | 45  |
| CXL4009 Chess.....                    | 30  |
| CXL4010 3-D Tic-Tac-Toe.....          | 30  |
| CXL4011 Star Raiders.....             | 33  |
| CXL4015 TeleLink.....                 | 20  |

Talk & Teach Courseware:  
CX6001 to CX6017..... 23



## ATARI 800™

### with 32K RAM

### only \$759



everything for Commodore  
and Atari

## Atari® Peripherals:

|                           |       |
|---------------------------|-------|
| 400 16K.....              | \$349 |
| 410 Recorder.....         | 59    |
| 810 Disk.....             | 469   |
| 815 Disk.....             | 1199  |
| 822 Printer.....          | 359   |
| 825 Printer.....          | 629   |
| 830 Modem.....            | 159   |
| 850 Interface Module..... | 139   |

## Atari® Accessories

|  |     |
|--|-----|
| CX853 16K RAM.....                                     | 89  |
| CX70 Light Pen.....                                    | 64  |
| CX30 Paddle.....                                       | 18  |
| CX40 Joystick.....                                     | 18  |
| CX86 Printer Cable.....                                | 42  |
| CO16345 822 Thermal<br>Printer Paper.....              | 5   |
| CAO16087 825 80-col.<br>Printer Ribbon<br>(3/box)..... | 17  |
| Microtek 16K RAM.....                                  | 79  |
| Microtek 32K RAM.....                                  | 179 |



## commodore

|                       |        |
|-----------------------|--------|
| VIC-20.....           | \$ 279 |
| 4032 N.....           | 1020   |
| 8032.....             | 1175   |
| CBM 4022 Printer..... | 630    |
| CBM 4040 Drive.....   | 1020   |
| CBM 8050 Drive.....   | 1420   |
| CBM C2N Drive.....    | 87     |
| PET-IEEE Cable.....   | 37     |
| IEEE-IEEE Cable.....  | 46     |

## Disks

|                   |             |
|-------------------|-------------|
| Maxell Disks..... | 10 for \$36 |
| Syncom Disks..... | 10 for 29   |
| Atari Disks.....  | 5 for 22    |

## Software

|  |       |
|--|-------|
| EBS Accounts Receivable<br>Inventory System..... | \$595 |
| OZZ Information System.....                      | 329   |
| BPI General Ledger.....                          | 329   |
| Tax Package.....                                 | 399   |
| Dow Jones Portfolio Management ..                | 129   |
| Pascal.....                                      | 239   |
| WordPro 3 (40 col.).....                         | 186   |
| WordPro 4 (80 col.).....                         | 279   |
| WordPro 4 Plus (80 col.).....                    | 339   |
| Wordcraft 80.....                                | 319   |

## Printers

|                   |        |   |      |
|-------------------|--------|---|------|
| NEC 5530.....     | \$2495 | Paper Tiger 445G.....                         | 769  |
| Diablo 630.....   | 2195   | Paper Tiger 460G.....                         | 1219 |
| Trendcom 100..... | 299    | Epson MX-80<br>MX-80FT } Call for new prices! |      |
| Starwriter.....   | 1495   | MX-70 }                                       |      |
| Trendcom 200..... | 489    | Tally 8024.....                               | 1699 |

No Risk -

No Deposit On  
Phone Orders -

COD or

Credit Card - Shipped Same Day You Call\*

Prepaid Orders Receive Free Shipping

\* on all in stock units

Circle 73 on Inquiry card.

Please Call Between 11 AM & 6 PM  
(Eastern Standard Time)

# (800) 233-8950



Computer Mail Order

501 E. Third St., Williamsport, PA 17701 (717) 323-7921

# IF YOU'RE IN COMPUTERS, YOU SHOULD BE IN AKRON

## FIND OUT WHY!

For more information about Akron write to:  
Mr. David B. Petersilge  
Private Industry Council Coordinator  
c/o Akron Regional Development Board  
One Cascade Plaza  
Suite 800  
Akron, Ohio 44308  
(216) 376-5550

NAME \_\_\_\_\_  
TITLE \_\_\_\_\_  
COMPANY \_\_\_\_\_  
ADDRESS \_\_\_\_\_  
CITY \_\_\_\_\_  
STATE \_\_\_\_\_ ZIP \_\_\_\_\_



This advertisement prepared and placed by the Private Industry Council (PIC) for the City of Akron and Summit and Medina Counties.

### Letters

Press, 1975), which shows how to correctly dissect a problem. In his method, the program structure is based on the data structure that is first defined.

Roland Vannay  
Kirchweg 43a  
5415 Nussbaumen  
Switzerland

### Correction

I want to correct an inaccuracy in Chris Morgan's editorial in the May 1981 BYTE. (See "How Can We Stop Software Piracy?", page 6.) RCS/MicroModeller was developed in the United States by Ferox Microsystems Inc (Falls Church, Virginia) and is marketed in England by Intelligence (UK) Limited. RCS has been marketed in the United States and Canada under the name Micro DSS/F by Addison-Wesley Publishing Company since June, 1981.

Any BYTE readers interested in further information about RCS should contact Phil Evans, our vice-president of marketing, at the address below or call him at (800) 336-4766; in Virginia (703) 998-0330.

Rusty Luhring  
President  
Ferox Microsystems Inc  
5881 Leesburg Pike  
Suite B-1  
Falls Church VA 22041

### Manual Printers

"The Epson MX-80 and MX-70 Printers" was a very informative article. (See the May 1981 BYTE, page 22.) However, I called Epson in Great Neck, New York, to see if I could get David Lien's *MX-70 User's Manual*, as mentioned on page 30, and I was told it does not exist! Does BYTE know something Epson doesn't? If so, how can I get this manual?

Richard FitzHugh  
3806 Everett St  
Kensington MD 20795

*Early shipments of Epson printers were not accompanied by a user's manual. Owners of Epson printers can obtain a user's manual, free of charge, by contacting Kari Westlake, Epson America Inc, 23844 Hawthorne Blvd, Torrance CA 90505, (213) 378-2220. . . . MH*

**Begin  
at  
square  
one.**

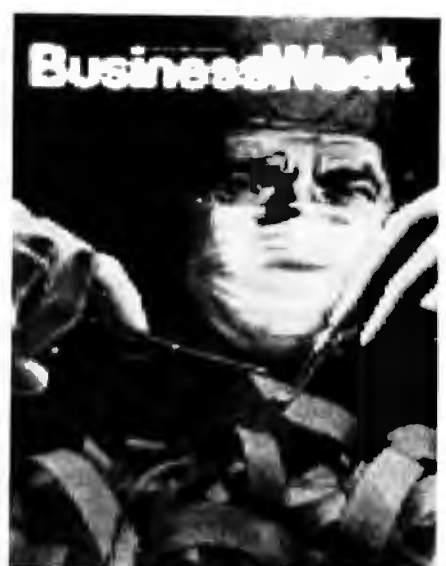

**No one covers the computer world like Business Week.** Business Week is the only business publication with an entire editorial section, Information Processing, covering the computer industry. Week after week, Business Week keeps more than 5 1/2 million

business leaders up to date on important changes and developments in the world of computers, computer software and services. When it comes to computers, Business Week has much more coverage than Fortune, Forbes or the Wall Street Journal.

**Business Week readers have purchasing power.** 9 out of 10 Business Week subscribers hold management positions. And over 30% are involved in the purchasing or leasing decisions for computer equipment, services and software. **Business Week has the lowest cost per thousand.** Business Week has the lowest CPM of any

newsweekly or business publication in reaching managers who make purchasing decisions in the electronic data processing category, both for equipment and services. You get the best audience there is, for the smallest byte out of your advertising budget. So get the complete picture

from Frank Long at Business Week, McGraw-Hill Building, 607 Boylston Street, Boston, Massachusetts 02116, 617-262-1160, or Donald Thompson, Business Week, 425 Battery Street, San Francisco, California 94111, 415-362-4600, or your nearest Business Week representative. Sources: BW Profile '81, MRI (Spring 1981)

**BusinessWeek** 

# Design Principles Behind Smalltalk

The purpose of the Smalltalk project is to provide computer support for the creative spirit in everyone. Our work flows from a vision that includes a creative individual and the best computing hardware available. We have chosen to concentrate on two principal areas of research: a language of description (programming language) that serves as an interface between the models in the human mind and those in computing hardware, and a language of interaction (user interface) that matches the human communication system to that of the computer. Our work has followed a two- to four-year cycle that can be seen to parallel the scientific method:

---

Daniel H H Ingalls  
Learning Research Group  
Xerox Palo Alto Research Center  
3333 Coyote Hill Rd  
Palo Alto CA 94304

---

- Build an application program within the current system (make an observation)
- Based on that experience, redesign the language (formulate a theory)
- Build a new system based on the new design (make a prediction that can be tested)

The Smalltalk-80 system marks our fifth time through this cycle. In this article, I present some of the general principles we have observed in the

course of our work. While the presentation frequently touches on Smalltalk "motherhood," the principles themselves are more general and should prove useful in evaluating other systems and in guiding future work.

Just to get warmed up, I'll start with a principle that is more social than technical and that is largely responsible for the particular bias of the Smalltalk project:

**Personal Mastery:** *If a system is to serve the creative spirit, it must be entirely comprehensible to a single individual.*

The point here is that the human potential manifests itself in individuals. To realize this potential, we must provide a medium that can be mastered by a single individual. Any barrier that exists between the user and some part of the system will eventually be a barrier to creative expression. Any part of the system that cannot be changed or that is not sufficiently general is a likely source of impediment. If one part of the system works differently from all the rest, that part will require additional effort to control. Such an added burden may detract from the final result and will inhibit future endeavors in that area. We can thus infer a general principle of design:

**Good Design:** *A system should be built with a minimum set of unchangeable parts; those parts should be as general as possible; and all parts of the system should be held in a uniform framework.*

## Language

In designing a language for use with computers, we do not have to look far to find helpful hints.

## ATTENTION GOVERNMENT D P USERS AND PURCHASERS

We represent many fine micro products and manufacturers on the U.S. Government's GSA Schedule, including

*Apple, Cromemco, Micropolis  
and Seequa Computers*

Purchasing from the Schedule will save you the time consumed by the bid process. Products shipped throughout the United States and world-wide. Visit or write any of our stores for more information or to receive our catalogue of products represented.

**Computers,  
Etc.....  
the dependable store**

257 West Street, Annapolis, MD 21401 - (301) 268-6505  
13A Allegheny Avenue, Towson, MD 21204 - (301) 296-0520  
9330 Georgia Avenue, Silver Spring, MD 20910 - (301) 588-3748  
6671 Backlick Road, Springfield, VA 22150 - (703) 644-5500  
Plaza 38, 2442 Route 38, Cherry Hill, NJ 08002 - (609) 779-0023

Callers outside metropolitan areas served by our stores

Please call (301) 268-5801

Career Opportunities Available \* An Equal Opportunity Employer

# BETA COMPUTER DEVICES

## FEATURE PRODUCT



\$629.00

### ADDS VIEWPOINT TERMINAL

- Detachable keyboard weighs only 2 lbs.
- 110-19,200 Baud - RS-232C
- Cursor control keys - audible tone
- 24 x 80 characters - 12" screen
- 14 key numeric keypad
- 7 switch selectable character sets
- Addressable cursor
- 2 position screen tilt
- Normal or reverse video
- Half or zero intensity
- 3 function keys (six functions)
- Lightweight (22 lbs. with keyboard)
- Switch select block or underline cursor
- Switch select blinking or steady cursor

## S-100 PRODUCTS

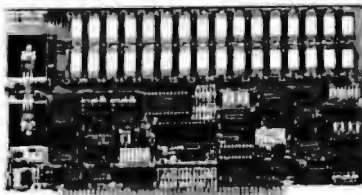

### QUALITY RAM FROM SYSTEMS GROUP

- Z-80 4MHZ operation with no wait states
  - IEEE compatible timing - 200 NS 4116's
  - Factory assembled, tested & burned in
- |                                       |          |
|---------------------------------------|----------|
| DMB8400 64K (Bank Select, shown)..... | \$749.00 |
| DM6400 64K .....                      | 545.00   |
| DM4800 48K.....                       | 520.00   |
| DM3200 32K.....                       | 495.00   |

### 16K MEMORY EXPANSION KIT \$29.00

For Apple, TRS-80 keyboard, Exidy, and all other systems using 4116 dynamic rams or equivalent. All IC's are prime Mitsubishi MK 4116-3.

- 200 NSEC access, 375 NSEC cycle
- Burned-in and fully tested
- 1 full year parts replacement guarantee

wabash

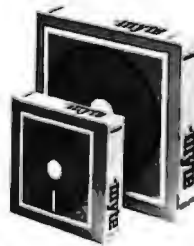

8" or 5 1/4" flexible diskettes certified 100% error free with manufacturers 5 year limited warranty on all 8" media. Soft sectored in tilt-back\* boxes of 10. 5 1/4" available in 10 Sector. (Add \$3.00 for plastic library cases)

|  |         |
|--|---------|
| 8" single sided, single density.....     | \$29.95 |
| 8" single sided, double density.....     | 37.95   |
| 8" double sided, double density.....     | 48.95   |
| 5 1/4" single sided, single density..... | 27.95   |
| 5 1/4" single sided, double density..... | 29.95   |

### 8" DISK DRIVES

|   |            |
|---|------------|
| Shugart 801R.....   | \$390.00   |
| NEC FD1180 (double sided).....  | 595.00     |
| Memorex MRX-101 8" Winchester style, hard disk drive, 10 megabytes..... | \$2,000.00 |

TERMS: Minimum order \$15.00. Minimum shipping and handling \$3.00. Calif. residents add 6% sales tax. Cash, checks, Mastercard. Visa and purchase orders from qualified firms and institutions are accepted. Product availability and pricing are subject to change without notice.

INTERNATIONAL ORDERS: Add 15% to purchase price for all orders. Minimum shipping charge is \$20.00. Orders with insufficient funds will be delayed. Excess funds will be returned with your order. All prices are U.S. only.

## 6502 PRODUCTS

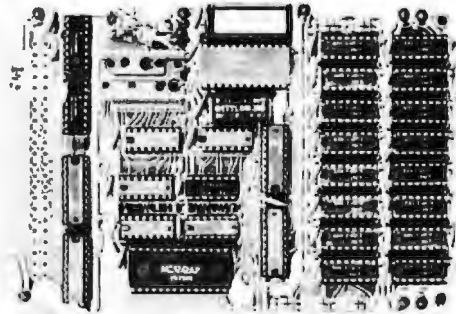

### BETA 32K BYTE EXPANDABLE RAM FOR 6502 AND 6800 SYSTEMS

#### AIM 65 KIM SYM PET S44-BUS

- Plug compatible with the AIM-65/SYM expansion connector by using a right angle connector (supplied).
- Memory board edge connector plugs into the 6800 S44 bus.
- Connects to PET using an adaptor cable.
- Uses +5V only, supplied from the host computer.
- Full documentation. Assembled and tested boards are guaranteed for one full year. Purchase price is fully refundable if board is returned undamaged within 14 days.

Assembled with 32K RAM.....\$349.00  
 & Tested with 16K RAM..... 329.00  
 Bare board, manual & 6 hard-to-get parts. 99.00  
 PET interface kit. Connects the 32K RAM board to a 4K or 8K PET.....\$ 69.00

### ROCKWELL AIM 65

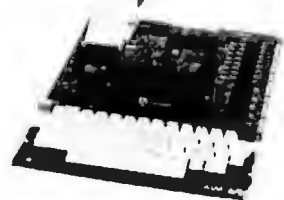

|                                 |          |
|---------------------------------|----------|
| AIM 65 with 1K ram.....         | \$425.00 |
| AIM 65 with 4K ram.....         | 485.00   |
| AIM power supply.....           | 125.00   |
| Professional AIM enclosure..... | 169.00   |
| Budget AIM enclosure.....       | 50.00    |
| KIM enclosure.....              | 40.00    |
| SYM enclosure.....              | 30.00    |

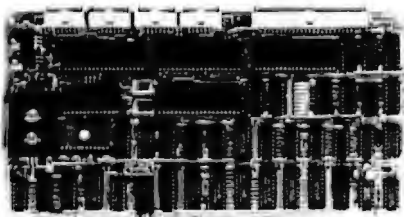

### CONFIGURE A COMPLETE S-100 SYSTEM WITH 2nd GENERATION\* PRODUCTS FROM SYSTEMS GROUP.

- CPC 2810 (shown) Z-80A processor board (4MHZ) with 4 serial & 2 parallel ports.....\$380.00
- CPC2813 - same as CPC2810 but 2 serial ports only.....\$345.00
- FDC2801/8 - 8" floppy disk controller board, up to 4 single/double sided drives, single or double density.....\$349.00
- INO-2804 - 4 channel serial I/O..... 329.00
- CRA-100 - Cromix\* adaptor board.. 45.00

CALL US FOR OUR MOST CURRENT PRICES!

\*2nd Generation is a trademark of Measurement Systems and Controls. Cromix is a trademark of Cromemco, Inc. Tilt-Back is a trademark of Wabash, Inc.

BETA  
COMPUTER DEVICES

1230 W. COLLINS AVE.  
ORANGE, CA 92668  
(714) 633-7280



Everything we know about how people think and communicate is applicable. The mechanisms of human thought and communication have been engineered for millions of years, and we should respect them as being of sound design. Moreover, since we must work with this design for the next million years, it will save time if we make our computer models compatible with the mind, rather than the other way around.

Figure 1 illustrates the principal components in our discussion. A per-

son is presented as having a body and a mind. The body is the site of primary experience, and, in the context of this discussion, it is the physical channel through which the universe is perceived and through which intentions are carried out. Experience is recorded and processed in the mind. Creative thought (without going into its mechanism) can be viewed as the spontaneous appearance of information in the mind. Language is the key to that informa-

**Purpose of Language:** *To provide a framework for communication.*

The interaction between two individuals is represented in figure 1 as two arcs. The solid arc represents explicit communication: the actual words and movements uttered and perceived. The dashed arc represents implicit communication: the shared culture and experience that form the context of the explicit communication. In human interaction, much of the actual communication is achieved through reference to the shared context, and human language is built around such allusion. This is the case with computers as well.

It is no coincidence that a computer can be viewed as one of the participants in figure 1. In this case, the "body" provides for visual display of information and for sensing input from a human user. The "mind" of a computer includes the internal memory and processing elements and their contents. Figure 1 shows that several different issues are involved in the design of a computer language:

**Scope:** *The design of a language for using computers must deal with internal models, external media, and the interaction between these in both the human and the computer.*

This fact is responsible for the difficulty of explaining Smalltalk to people who view computer languages in a more restricted sense. Smalltalk is

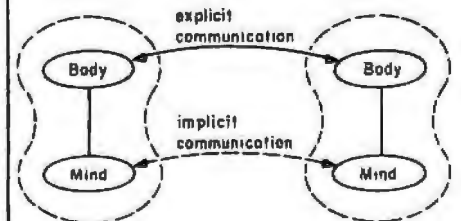

**Figure 1:** *The scope of language design. Communication between two people (or between one person and a computer) includes communication on two levels. Explicit communication includes the information that is transmitted in a given message. Implicit communication includes the relevant assumptions common to the two beings.*

★ ★ ★ WRITE OR CALL FOR FREE CATALOG ★ ★ ★

**The MAX BOX:** Manufactured by John D. Owens Associates. 8" dual drive cabinet complete with power supply & fan. Will hold Qumes, Shugarts or Siemens. Excellent design and engineering . . . . . \$ 325.  
With 2 Shugart 801R Drives . . \$1,275. With 2 QUME Double sided drives . \$1,680.

**CALIFORNIA COMPUTER SYSTEMS HIGH IN QUALITY. LOW IN PRICE**  
Z80 CPU, 4 Mhz, with one serial port; 12 slot S-100 mainframe, disk controller, 64K Dynamic Ram, CP/M 2.2<sup>®</sup> SYSTEM 2210A . . . . . \$1,750.  
*We configure complete systems with drives and additional I/O.*

**IMS 5000 and 8000 Systems and IMS Memory**  
Outstanding long term reliability and performance. These systems feature a Z80A CPU, S-100 bus; double density drives (either single or double sided), DMA disk controller, 64K RAM, 2 serial & 1 parallel port. Prices include the very finest implementation of CP/M<sup>®</sup> available in the entire industry. Hard disk and multi user software options.

**Multi-User, Networking Operating System: TURBODOS**  
Turbodos: Spectacular new CP/M<sup>®</sup> compatible operating system. Z80 code, interrupt driven. Up to 6X faster than CP/M<sup>®</sup> up to 35% increased disc capacity. IMS compatible.  
Multi-user (up to 16 users) . . . . . \$750. Single user . . . . . \$250.

**PER SCI—THE KING AND QUEEN OF DRIVES!**  
Model 299B: Dual headed drives, total 3.2 MB unformatted . . . . . \$2,300.  
Model 277: Dual 8 inch drives, voice coil positioned, IBM compatible, 1600 K BYTES per drive, unformatted . . . . . \$1,245.  
Slimline cabinet and power for either 277 or 299 . . . . . \$ 300.

**GRAPHICS EQUIPMENT**  
**MICROANGELO** . . . . . \$2,295.  
High resolution graphics system, 15" 22MHZ, green phosphor screen, 72 key keyboard; includes complete cabling and software. From SCION. Screenware PAK II . . . . . \$ 350.  
S-100 Graphics card . . . . . \$ 985.

**HIPAD DIGITIZER from Houston Instruments.** Create graphics using stylus. Easier than joystick or keyboard input. For S-100, Apple, TRS-80, PET . . . . . \$755.

**GRAPHICS SOFTWARE.** On line, real time, for the M9900 to drive the Microangelo. For use in design of PC board masks, IC masks and other applications . . . . . \$1,000.

**CAT 100 Full Color Graphics: Digital Graphics Complete S-100 color imaging system w/high performance video FRAME/GRABBER.** . . . . . \$1,875.

**MAURO MP-250B Proac Plotter:** Uses standard paper, choice of pen colors and line widths, resolution is 200 steps per inch; .005" tracking error; R5232 . . . . . \$895.

**WE EXPORT:** Overseas Callers: TWX 710 588 2844  
Phone 212 448-6298 or Cable: OWENSASSOC

WE OFFER A FULL RANGE OF EXPERT CONSULTING SERVICES

**JOHN D. OWENS**  
**Associates, Inc.**  
12 Schubert Street  
Staten Island, New York 10305

212 448-6283 212 448-2913 212 448-6298

not simply a better way of organizing procedures or a different technique for storage management. It is not just an extensible hierarchy of data types, or a graphical user interface. It is all of these things and anything else that is needed to support the interactions shown in figure 1.

### Communicating Objects

The mind observes a vast universe of experience, both immediate and recorded. One can derive a sense of oneness with the universe simply by letting this experience be, just as it is. However, if one wishes to participate, literally to *take a part*, in the universe, one must draw distinctions. In so doing one identifies an object in the universe, and simultaneously all the rest becomes not-that-object. Distinction by itself is a start, but the process of distinguishing does not get any easier. Every time you want to talk about "that chair over there," you have to repeat the entire process of distinguishing that chair. This is where the act of reference comes in: we can associate a unique identifier with an object, and, from that time on, only the mention of that identifier is necessary to refer to the original object.

We have said that a computer system should provide models that are compatible with those in the mind. Therefore:

**Objects:** *A computer language should support the concept of "object" and provide a uniform means for referring to the objects in its universe.*

The Smalltalk storage manager provides an object-oriented model of memory for the entire system. Uniform reference is achieved simply by associating a unique integer with every object in the system. This uniformity is important because it means that variables in the system can take on widely differing values and yet can be implemented as simple memory cells. Objects are created when expressions are evaluated, and they can then be passed around by uniform reference, so that no provision for their storage is necessary in the procedures that manipulate them.

When all references to an object have disappeared from the system, the object itself vanishes, and its storage is reclaimed. Such behavior is essential to full support of the object metaphor:

**Storage Management:** *To be truly "object-oriented," a computer system must provide automatic storage management.*

A way to find out if a language is

working well is to see if the programs look like they are doing what they are doing. If they are sprinkled with statements that relate to the management of storage, then their internal model is not well matched to that of humans. Can you imagine having to prepare someone for each thing you tell them or having to inform them when you are through with a given topic and that it can be forgotten?

Each object in our universe has a life of its own. Similarly, the brain

**★ ★ ★ GREETINGS TO OUR FRIENDS IN CHILE ★ ★ ★**

|  |  |
|--|--|
| <p><b>SD SYSTEMS</b><br/> <b>Z80 STARTER KIT:</b> single board computer with RAM / ROM, I/O, display, keyboard, kluge area . . . . . \$360<br/> <b>VFI:</b> double density floppy controller kit, with software . . . . . \$390<br/> <b>CPU Z80A,</b> 4 Mhz, serial &amp; parallel I/O IK on-board RAM, Z80 CTC . . . . . \$345<br/> <b>EXPANDORAM II</b> including high quality 4116s . . . . . \$540<br/>         Complete SD line available including kits and <b>FACTORY</b> Assembled and tested boards &amp; systems at discount prices.</p> <p><b>TELETYPE</b><br/> <b>Model 4320 AAA or AAK</b><br/> <b>Model 43ASR,</b> 8 level, 1" tape . . \$2,595.</p> <p><b>dBASE II Ashton-Tate</b> . . . . . \$615.<br/>         Brings power of mainframe database software to a microcomputer. Runs under CP/M®. Extremely easy to use. Manual and demo software . . . . . \$50.<br/>         Money Back Guarantee</p> <p><b>MUSYS Single BD Computer</b><br/>         Z80 processor, 64K Dyn RAM. Console serial port, S-100 parallel interface, Bootstrap PROM . . . . . \$1300.</p> <p><b>HAZELTINE 1500</b> . . . . . \$ 925.<br/>         1510 . . . . . \$1,030.<br/>         1520 . . . . . \$1,265.<br/>         220 volt models, add \$100<br/> <b>EXEC 80</b> . . . . . \$1,115.<br/>         90 day on-site warrantee.</p> <p><b>IBM 3101 CRT Model 10</b> . . . . . \$1,250.<br/>         Model 20 . . . . . \$1,450.<br/>         Selectric-like, detached keyboard. 9x16 dot matrix. Maintenance contract from IBM only \$70 per year.</p> <p><b>ITHACA INTERSYSTEMS</b><br/>         Inventory sale on board sets &amp; systems</p> <p><b>MARINCHIP SYSTEMS M9900</b><br/>         Uses T19900 16 bit CPU. Full S-100, IEEE. Extensive software. Boards from \$550, systems \$4,995.</p> | <p><b>TEXAS INSTRUMENTS Printers</b><br/>         10% off list price on entire T1 printer line.</p> <p><b>CENTRONICS 737</b> . . . . . \$780.</p> <p><b>EPSON MX80</b> . . . . . 550.<br/>         RS 232 Interface . . . . . \$ 50.</p> <p><b>CORVUS Hard Drives</b><br/> <b>Model 11,</b> Hard Disk System . . . \$4,820.<br/>         Mirror Backup System . . . . . \$ 715.</p> <p><b>DMA-DOS NORTH STAR 8" Floppy Subsystem</b><br/>         A new operating system, completely CP/M® compatible that allows use of both 8" (Shugart single sided, double density via Tarbell controller) and 5¼" drives. Allows transfer of file from 8" to 5¼" and vice versa. Complete hardware, with software package . . . . . \$1,955.</p> <p><b>TARBELL</b><br/>         Double density controller . . . . . \$435.<br/>         Z80 CPU . . . . . \$395.</p> <p><b>TEI MAINFRAMES, S-100</b><br/>         We are proud to announce that we are now a TEI stocking distributor. For the best in mainframes . . . TEI!!</p> <p><b>TELEVIDEO CRTs</b><br/>         912 . . \$780. 920 . \$850. 950 . \$1,050.</p> <p><b>COMMUNICATIONS SOFTWARE from Hawkeye Grafik</b><br/>         Enables communications from a micro to a terminal or to another micro, mini or maxi computer.<br/>         Object Code \$75. Source Code \$250.</p> <p><b>3M SCOTCH® Diskettes</b><br/>         5 box minimum, price per box<br/> <b>Model 740,</b> 8" single sided, single density . . . . . \$27.00<br/> <b>Model 741,</b> 8" single sided, double density . . . . . 35.50<br/> <b>Model 743,</b> 8" double sided, double density . . . . . 43.00<br/> <b>Model 744-0,</b> 5¼" soft sector, single sided 744-10, 5¼", hard sector, single sided . . . . . 27.00</p> |
|--|--|

Prices subject to change without notice

JOHN D. OWENS Associates, Inc.

SEE OUR AD ON FACING PAGE

provides for independent processing along with the storage of each mental object. This suggests a third principle for object-oriented design:

**Messages:** *Computing should be viewed as an intrinsic capability of objects that can be uniformly invoked by sending messages.*

Just as programs get messy if object storage is dealt with explicitly, control in the system becomes complicated if processing is performed extrinsically. Let us consider the process of adding 5 to a number. In most computer systems, the compiler figures out what kind of number it is and generates code to add 5 to it. This is not good enough for an object-oriented system because the exact kind of number cannot be determined by the compiler (more on this later). A possible solution is to call a general addition routine that examines the type of the arguments to determine the appropriate action. This is not a good approach because it means that

this *critical* routine must be edited by novices who just want to experiment with their own class of numbers. It is also a poor design because intimate knowledge about the internals of objects is sprinkled throughout the system.

Smalltalk provides a much cleaner solution: it sends the *name* of the desired operation, along with any arguments, as a *message* to the number, with the understanding that the receiver knows best how to carry out the desired operation. Instead of a bit-grinding processor rapping and plundering data structures, we have a universe of well-behaved objects that courteously ask each other to carry out their various desires. The transmission of messages is the only process that is carried on outside of objects and this is as it should be, since messages travel between objects. The principle of good design can be restated for languages:

**Uniform Metaphor:** *A language should be designed around a power-*

*ful metaphor that can be uniformly applied in all areas.*

Examples of success in this area include LISP, which is built on the model of linked structures; APL, which is built on the model of arrays; and Smalltalk, which is built on the model of communicating objects. In each case, large applications are viewed in the same way as the fundamental units from which the system is built. In Smalltalk especially, the interaction between the most primitive objects is viewed in the same way as the highest-level interaction between the computer and its user. Every object in Smalltalk, even a lowly integer, has a set of messages, a *protocol*, that defines the explicit communication to which that object can respond. Internally, objects may have local storage and access to other shared information which comprise the implicit context of all communication. For instance, the message + 5 (add five) carries an implicit assumption that the augend is the present

# MAIL ORDER DISCOUNTS



**APPLE II PLUS 48K**  
**\$1,099**

WE DISCOUNT PRICES — NOT SERVICE

## HARDWARE

|   |      |
|---|------|
| DISK II DRIVE & INTERFACE .....         | 499  |
| DISK II SECOND DRIVE .....              | 445  |
| BASF 5 1/4" DISKETTES (10) .....        | 25   |
| LANGUAGE SYSTEM W/PASCAL .....          | 395  |
| INTEGER BASIC FIRMWARE CARD .....       | 149  |
| APPLESOFT II FIRMWARE CARD .....        | 149  |
| CENTRONICS PRINTER INTERFACE CARD ..... | 179  |
| HIGH-SPEED SERIAL INTERFACE CARD .....  | 145  |
| GRAPHICS TABLET .....                   | 649  |
| APPLE IEEE-488 INTERFACE CARD .....     | 369  |
| M&R SUP-R-MOD RF MODULATOR .....        | 30   |
| MICROSOFT Z-80 SOFTCARD SYSTEM .....    | 290  |
| MICROSOFT 16K RAM CARD .....            | 169  |
| VIDEX 80 COLUMN BOARD .....             | 295  |
| HAYES MICROMODEM II .....               | 299  |
| AMDEX 13" COLOR MONITOR .....           | 429  |
| NEC 12" GREEN MONITOR .....             | 239  |
| SILENTYPE PRINTER W/INTERFACE .....     | 350  |
| EPSON MX-80 FT .....                    | 649  |
| QUME SPRINT 5/45 PRINTER .....          | 2499 |



## SOFTWARE

|  |     |
|--|-----|
| APPLE DOS TOOLKIT .....                | 65  |
| APPLE PLOT .....                       | 60  |
| TAX PLANNER .....                      | 99  |
| APPLE FORTRAN .....                    | 150 |
| APPLE PILOT .....                      | 125 |
| APPLE MUSIC THEORY .....               | 39  |
| APPLEWRITER .....                      | 65  |
| DOW JONES PORTFOLIO EVALUATOR .....    | 45  |
| DOW JONES NEWS & QUOTES REPORTER ..... | 85  |
| THE CONTROLLER .....                   | 515 |
| VISICALC (16 SECTOR) .....             | 165 |
| VISILOT .....                          | 149 |
| VISITREND/VISILOT .....                | 215 |
| DESKTOP PLAN II .....                  | 159 |
| BPI BUSINESS SOFTWARE (EACH) .....     | 335 |
| SUPER TEXT II .....                    | 125 |
| PROGRAMMA APPLE PIE .....              | 110 |
| EASYWRITER (80 COLUMNS) .....          | 219 |
| D.B. MASTER .....                      | 180 |
| MICROSOFT FORTRAN .....                | 165 |



**ATARI 800 32K\***  
**\$759**

|                                    |      |
|------------------------------------|------|
| ATARI 400 (16K) .....              | 350  |
| 410 PROGRAM RECORDER .....         | 69   |
| 810 DISK DRIVE .....               | 499  |
| 815 DUAL DISK DRIVE .....          | 1199 |
| 16K RAM MEMORY MODULE .....        | 89   |
| 850 INTERFACE MODULE .....         | 175  |
| 830 ACOUSTIC MODEM .....           | 159  |
| 825 PRINTER (CENTRONIC 737)* ..... | 650  |
| JOYSTICK PAIR .....                | 18   |
| LIGHT PEN .....                    | 65   |
| ATARI VISICALC .....               | 169  |
| BASIC LANGUAGE .....               | 45   |
| ASSEMBLER EDITOR .....             | 45   |
| MUSIC COMPOSER .....               | 45   |
| STAR RAIDER .....                  | 39   |
| COMPUTER CHESS .....               | 30   |
| BASKETBALL .....                   | 30   |
| TELELINK .....                     | 20   |

\*SPECIAL: Effective until 8/31/81

**computer age, inc.**

Authorized Apple Dealer & Service Center

4688 CONVOY STREET, SAN DIEGO, CA 92111

(714) 565-4062

TO ORDER: Please send cashier's check, money order or personal check (allow 10 business days to clear). VISA and Master Card credit card service add 3%. American Express credit card service add 5%. Shipping, handling and insurance in U.S. add 3% (minimum \$4). California residents add 6% sales tax. Foreign orders add 10% for shipping. Equipment is subject to price change and availability. All equipment carries factory warranty. Store prices differ from mail order prices. TELE: 607120 DATAMAX-SDG

CALL OR WRITE FOR A COMPLETE PRICE LIST



# Ten reasons why your floppy disk should be a BASF FlexyDisk.<sup>®</sup>



**BASF BASF FlexyDisk<sup>®</sup>**

More than four decades of experience in magnetic media—BASF invented magnetic recording tape, the forerunner of today's wide range of magnetic media, back in 1934, and was the first independent manufacturer of IBM-compatible floppy disks.

Tough Tyvek sleeve—no paper dust, no static electricity.

Special self-cleaning jacket and liner help eliminate data errors and media wear and tear.

Packaging to suit your requirements—standard flip-top box, Kassetette 10<sup>®</sup> storage case, or bulk pack.

Center hole diameter punched to more accurate standards than industry specifications, for top performance.

100% certification—every single disk is tested at thresholds 2-3 times higher than system requirements, to be 100% error-free.

Bi-axially oriented polyester substrate—for uniform and reliable performance year after year.

For the name of your nearest supplier, write BASF Systems, Crosby Drive, Bedford, MA 01730, or call 617-271-4030.

Cross-linked oxide coating—for low head wear and long trouble-free media life.

Total capability—one of two manufacturers in the world that makes both 8" and 5.25" models, has tape and disk experience, and manufactures floppy disk drives.

Double lubrication—lubricants both in the formula and on the disk surface, to minimize media wear due to head friction.



**BASF**

Floppy Disks Mag Cards Cassettes Computer Tapes Disk Packs Computer Peripherals

value of the number receiving the message.

### Organization

A uniform metaphor provides a framework in which complex systems can be built. Several related organizational principles contribute to the successful management of complexity. To begin with:

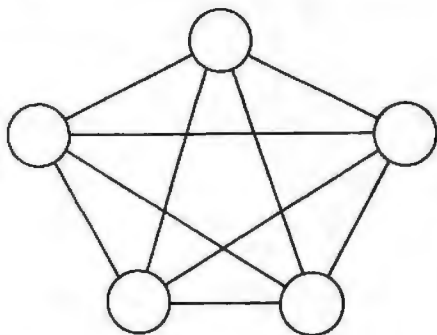

Figure 2: System complexity. As the number of components in a system increases, the chances for unwanted interaction increase rapidly. Because of this, a computer language should be designed to minimize the possibilities of such interdependence.

**Modularity:** *No component in a complex system should depend on the internal details of any other component.*

This principle is depicted in figure 2. If there are  $N$  components in a system, then there are roughly  $N$ -squared potential dependencies between them. If computer systems are ever to be of assistance in complex human tasks, they must be designed to minimize such interdependence. The message-sending metaphor provides modularity by decoupling the intent of a message (embodied in its name) from the method used by the recipient to carry out the intent. Structural information is similarly protected because all access to the internal state of an object is through this same message interface.

The complexity of a system can often be reduced by grouping similar components. Such grouping is achieved through data typing in conventional programming languages, and through classes in Smalltalk. A

class describes other objects—their internal state, the message protocol they recognize, and the internal methods for responding to those messages. The objects so described are called *instances* of that class. Even classes themselves fit into this framework; they are just instances of class Class, which describes the appropriate protocol and implementation for object description:

**Classification:** *A language must provide a means for classifying similar objects, and for adding new classes of objects on equal footing with the kernel classes of the system.*

Classification is the objectification of *nessness*. In other words, when a human sees a chair, the experience is taken both literally as “that very thing” and abstractly as “that chair-like thing.” Such abstraction results from the marvelous ability of the mind to merge “similar” experience, and this abstraction manifests itself as another object in the mind, the Platonic chair or chairness.

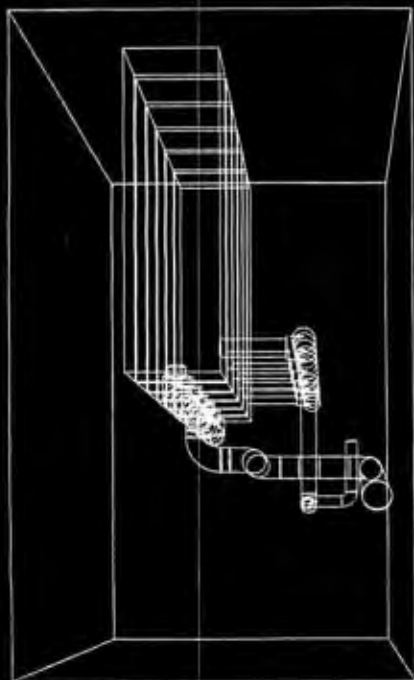

# GRAPHIC SOFTWARE FOR MICROCOMPUTERS

by B.J. Korites, PhD - a self-teaching guide that will show you how to write graphics software on your microcomputer. Theory and program listings presented side by side. Contains 61 programs for 2 and 3 dimensional graphics, isometric and perspective transformations, scaling, stretching, clipping, intersections, shading, tablet software, hidden line removal, dynamic simulation, applications to engineering, science and business. Practice problems for classroom use. Covers elementary to advanced concepts. Perfect for professionals, students and software developers. All programs in BASIC, written on the Apple II Plus 48K but convertible to other systems.

Book with program listings - \$19.95 Disk of programs - \$18.95 Add \$2 per item shipping in US and Canada, \$12 elsewhere. Add \$5 for UPS. visa/mastercharge accepted. Call (517)934-0445 for faster delivery

KERN PUBLICATIONS • PO Box 1029A • Duxbury, MA 02332 (617)934-0445



**\$339**  
**10MB**

# THE HARD DISK YOU'VE BEEN WAITING FOR

**XCOMP** introduces a complete micro-size disk subsystem with more...

- MORE STORAGE
- MORE SPEED
- MORE VALUE
- MORE SUPPORT

S100 users . . . The XCOMP subsystem is now available with 10 megabytes of storage; 5 megabytes also available at \$2,898.00. Compare the price and features of any other 5¼-inch — or even 8-inch system, and you'll agree that XCOMP's value is unbeatable.

#### OUTPERFORMS OTHER HARD DISKS

Floppy disk and larger, more expensive hard disks are no match for this powerful little system. More data is available on every seek: 64K on 10MB and 32K on 5MB. Faster seek time too — an average of 70MS. It provides solid performance anywhere with only 20 watts of power. Data is protected in the sealed enclosure, and the landing zone for heads provides another margin of safety. The optional power board plugs directly into the S100 bus and provides power for the drive.

#### FAST CONTROLLER

The XCOMP controller is the key to this system's high efficiency operation. Speed-up features include interleave without table lookup, block-deblock with controller buffer, and read lookahead. OEMs worldwide have already proven the outstanding performance of the XCOMP controller.

#### MORE SOFTWARE

Included with the system is software for testing, formatting, I/O drivers for CP/M®, plus an automatic CP/M driver attach program. Support software and drivers for MP/M® and Oasis® are also available. The sophisticated formatting program assigns alternate sectors for any weak sectors detected during formatting, assuring the lowest possible error rate — at least ten times better than floppies.

#### WARRANTY

The system has a full one-year warranty on parts and workmanship.

#### ALSO AVAILABLE FROM XCOMP

- General Purpose controllers (8 bit interface), with easy interface to microprocessor-based systems.
- GP controller adapter that plugs directly into most Z80 computers.
- ST/R GP controller for the 5MB and 10MB drive above, with ST506 type interface.
- SG/R GP controller for SA1000 interface.
- SM/R GP controller for storage module drives.
- ST/S, SG/S, and SM/S, same as above, for the S100 bus.

Quantity discounts available. Distributor, Dealer, and OEM inquiries invited.

See your local Dealer, or call:

XCOMP, Inc.  
7566 Trade Street  
San Diego, CA 92121  
Tel: (714) 271-8730  
Telex: 182786



Classes are the chief mechanism for extension in Smalltalk. For instance, a music system would be created by adding new classes that describe the representation and interaction protocol of Note, Melody, Score, Timbre, Player, and so on. The "equal footing" clause of the above principle is important because it insures that the system will be used as it was designed. In other words, a melody could be represented as an ad hoc collection of Integers representing pitch, duration, and other parameters, but if the language can handle Notes as easily as Integers, then the user will naturally describe a melody as a collection of Notes. At each stage of design, a human will naturally choose the most effective representation if the system provides for it. The principle of modularity has an interesting implication for the procedural components in a system:

**Polymorphism:** *A program should specify only the behavior of objects, not their representation.*

A conventional statement of this principle is that a program should never declare that a given object is a SmallInteger or a LargeInteger, but only that it responds to integer protocol. Such generic description is crucial to models of the real world.

Consider an automobile traffic simulation. Many procedures in such a system will refer to the various vehicles involved. Suppose one wished to add, say, a street sweeper. Substantial amounts of computation (in the form of recompiling) and possible errors would be involved in making this simple extension if the code depended on the objects it manipulates. The message interface establishes an ideal framework for such extension. Provided that street sweepers support the same protocol as all other vehicles, no changes are needed to include them in the simulation:

**Factoring:** *Each independent component in a system should appear in only one place.*

There are many reasons for this principle. First of all, it saves time, effort, and space if additions to the system need only be made in one place. Second, users can more easily locate a component that satisfies a given need. Third, in the absence of proper factoring, problems arise in synchronizing changes and ensuring that all interdependent components are consistent. You can see that a failure in factoring amounts to a violation of modularity.

Smalltalk encourages well-factored designs through *inheritance*. Every class inherits behavior from its superclass. This inheritance extends through increasingly general classes, ultimately ending with class Object which describes the default behavior of all objects in the system. In our traffic simulation above, StreetSweeper (and all other vehicle classes) would be described as a subclass of a general Vehicle class, thus inheriting appropriate default behavior and avoiding repetition of the same concepts in many different places. Inheritance illustrates a fur-

# 6809 COLOR COMPUTER

## EDITOR, ASSEMBLER AND MORE!

**NEW!**

### SOFTWARE DEVELOPMENT SYSTEM

The Micro Works Software Development System (SDS80C) is a complete 6809 editor, assembler and monitor package contained in one Color Computer program pack! Vastly superior to RAM-based assemblers/editors, the SDS80C is non-volatile, meaning that if your application program bombs, it can't destroy your editor/assembler. Plus it leaves almost all of 16K or 32K RAM free for your program. Since all three programs, editor, assembler and monitor are co-resident, we eliminate tedious program loading when going back and forth from editing to assembly and debugging!

The powerful screen-oriented Editor features finds, changes, moves, copies and much more. All keys have convenient auto repeat (typamatic), and since no line numbers are required, the full width of the screen may be used to generate well-commented code.

The Assembler features all of the following: complete 6809 instruction set; complete 6800 set supported for cross-assembly; conditional assembly; local labels; assembly to cassette tape or to memory; listing to screen or printer; and mnemonic error codes instead of numbers.

The versatile ABUG monitor is a compact version of CBUG, tailored for debugging programs generated by the Assembler and Editor. It features examine/change of memory or registers, cassette load and save, breakpoints and more. SDS80C Price: \$89.95



### CRACK THOSE ROMS!



**SOURCE GENERATOR:** This package is a disassembler which runs on the color computer and generates your own source listing of the BASIC interpreter ROM. Also included is a documentation package which gives useful ROM entry points, complete memory map, I/O hardware details and more. A 16K system is required for the use of this cassette. 80C Disassembler Price: \$49.95

### CBUG IS HERE!

**MONITOR TAPE:** A cassette tape which allows you to directly access memory, I/O and registers with a formatted hex display. Great for machine language programming, debugging and learning. It can also send/receive RS232 at up to 9600 baud, including host system download/upload. 19 commands in all. Relocatable and reentrant. CBUG Tape Price: \$29.95

**MONITOR ROM:** The same program as above, supplied in 2716 EPROM. This allows you to use the entire RAM space. And you don't need to re-load the monitor each time you use it. The EPROM plugs into the Extended Basic ROM Socket or a modified ROMPACK. CBUG ROM Price: \$39.95

### LEARN 6809!

**6809 ASSEMBLY LANGUAGE PROGRAMMING,** by Lance Leventhal, contains the most comprehensive reference material available for programming your Color Computer. Price: \$16.95

### PARALLEL O!

**USE A PARALLEL PRINTER** with your Color Computer! Adaptor box plugs into the serial port and allows use of Centronics/Radio Shack compatible printers with parallel interface. Assembled and tested. PI80C Price: \$69.96

### 32K RAM!

**MEMORY UPGRADE KITS:** Consisting of 4116 200ns. integrated circuits, with instructions for installation. 4K-16K Kit Price: \$39.95. 16K-32K Kit (requires soldering experience) Price: \$39.95

THE **MICRO WORKS**



**GOOD STUFF!**

**WE SHIP FROM STOCK!**

Master Charge/Visa and COD Accepted

P.O. BOX 1110 DEL MAR, CA 92014 714-942-2400

# MAKE YOUR SYSTEM "CHRISLIN"



***If your looking for  
reliability instead of promises and  
you need high performance at low  
prices, Chrislin Industries, Inc.  
can bring it to you!***



## ***Chrislin Industries, Inc.***

31352 Via Colinas • Westlake Village, CA 91362 • 213-991-2254 • TWX 910-494-1253 CHRISLIN WKVG

DEC, LSI, PDP are Trademarks of Digital Equipment Corp.

ther pragmatic benefit of factoring:

**Leverage:** *When a system is well factored, great leverage is available to users and implementers alike.*

Take the case of sorting an ordered collection of objects. In Smalltalk, the user would define a message called sort in the class OrderedCollection. When this has been done, all forms of ordered collections in the system will instantly acquire this new capability through inheritance. As an aside, it is worth noting that the same method can alphabetize text as well as sort numbers, since comparison protocol is recognized by the classes which support both text and numbers.

The benefits of structure for implementers are obvious. To begin with, there will be fewer primitives to implement. For instance, all graphics in Smalltalk are performed with a single primitive operation. With only one task to do, an implementer can bestow loving attention on every instruction, knowing that each small improvement in efficiency will be

amplified throughout the system. It is natural to ask what set of primitive operations would be sufficient to support an entire computing system. The answer to this question is called a *virtual machine specification*:

**Virtual Machine:** *A virtual machine specification establishes a framework for the application of technology.*

The Smalltalk virtual machine establishes an object-oriented model for storage, a message-oriented model for processing, and a bitmap model for visual display of information. Through the use of microcode, and ultimately hardware, system performance can be improved dramatically without any compromise to the other virtues of the system.

#### User Interface

A user interface is simply a language in which most of the communication is visual. Because visual presentation overlaps heavily with established human culture, esthetics plays a very important role in this

area. Since all capability of a computer system is ultimately delivered through the user interface, flexibility is also essential here. An enabling condition for adequate flexibility of a user interface can be stated as an object-oriented principle:

**Reactive Principle:** *Every component accessible to the user should be able to present itself in a meaningful way for observation and manipulation.*

This criterion is well supported by the model of communicating objects. By definition, each object provides an appropriate message protocol for interaction. This protocol is essentially a microlanguage particular to just that kind of object. At the level of the user interface, the appropriate language for each object on the screen is presented visually (as text, menus, pictures) and sensed through keyboard activity and the use of a pointing device.

It should be noted that operating systems seem to violate this principle. Here the programmer has to depart

## ELECTRONICS CENTER

CALL TOLL FREE

**1-800-228-4097**

Call Toll Free For  
"Unbelievable"  
Low Low  
Prices On These  
Lines:

APPLE — ATARI — BASE 2  
CENTRONICS  
COMMODORE — DC HAYES  
HAZELTINE — LEEDEX  
MACROTRONICS — MAXELL  
MOUNTAIN HARDWARE  
NORTH STAR — PANASONIC  
SANYO — SYNCOM

YOUR

## ELECTRONICS PLAYGROUND

1840 "O" Street Lincoln, Nebraska 68508  
In Nebraska Call (402) 476-7331

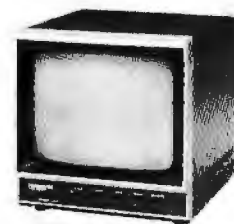

# SPEND \$62.40 TO READ THIS ADVERTISEMENT.\*

A salesman generating 1.5 million dollars in sales annually for his company does so at the rate of \$12.48 per minute. That's expensive time—should it really be used in rummaging through filing cabinets, writing long reports or talking to dozens of people looking for one small, crucial piece of information?

Of course not, so you hire an accounting staff, customer support personnel, and marketing people to support the business and let your salespeople sell. But the overhead takes a large slice of that \$12.48.

A Delta system can do the work of a swarm of secretaries, a fleet of filers, a ton of telephones—simultaneously. It's a highly developed work processing system that can maintain files, generate reports, process orders and do all routine office work with speed and accuracy. It lets your people get on with the business of making money.

We at Delta Products have spent five years designing the most reliable, efficient Z80 based microcomputer available on the marketplace. It's fast—some models use multi processors to eliminate the delays associated with other multi user systems. It's expand-

able, allowing your Delta system to grow with your company's growth and change with your company's needs. And it's rugged; requiring a minimum of service or maintenance.

But the soul of any computer system is the software; therefore, having perfected the hardware technology, Delta is now dedicated to the development of application packages designed to warm the cockles of a corporate executive's heart. Our "Uni-form", for example, will keep purchase orders, account statements, sales and shipping orders indexed, cross-indexed and filed in any manner required.

And when your Delta system has helped your business grow, it's ready to grow right along with you—every Delta System is completely expandable and configurable.

You have spent five minutes reading this advertisement, at a cost of \$62.40 in potential sales. Have you calculated what a Delta system can save your company? (Hint: a Delta system can pay for itself in less than 24 hours of time saved.)

Call us today for the name of your nearest Delta distributor.

\*(and save thousands later)



Delta Products  
15392 Assembly Lane  
Huntington Beach, CA 92649  
Telephone (714) 898-1492  
TELEX: 681-367 DELTAR HTHH

from an otherwise consistent framework of description, leave whatever context has been built up, and deal with an entirely different and usually very primitive environment. This need not be so:

**Operating System:** *An operating system is a collection of things that don't fit into a language. There shouldn't be one.*

Here are some examples of conventional operating system components that have been naturally incorporated into the Smalltalk language:

- **Storage management**—Entirely automatic. Objects are created by a message to their class and reclaimed when no further references to them exist. Expansion of the address space through virtual memory is similarly transparent.
- **File system**—Included in the normal framework through objects such as Files and Directories with message protocols that support file access.
- **Display handling**—The display is

simply an instance of class Form, which is continually visible, and the graphical manipulation messages defined in that class are used to change the visible image.

- **Keyboard input**—The user input devices are similarly modeled as objects with appropriate messages for determining their state or reading their history as a sequence of events.
- **Access to subsystems**—Subsystems are naturally incorporated as independent objects within Smalltalk: there they can draw on the large existing universe of description, and those that involve interaction with the user can participate as components in the user interface.
- **Debugger**—The state of the Smalltalk processor is accessible as an instance of class Process that owns a chain of stack frames. The debugger is just a Smalltalk subsystem that has access to manipulate the state of a suspended process. It should be noted that nearly the only run-time error that can occur in Smalltalk is for a message not to be recognized by its receiver.

Smalltalk has no "operating system" as such. The necessary primitive operations, such as reading a page from the disk, are incorporated as primitive methods in response to otherwise normal Smalltalk messages.

### Future Work

As might be expected, work remains to be done on Smalltalk. The easiest part to describe is the continued application of the principles in this paper. For example, the Smalltalk-80 system falls short in its factoring because it supports only hierarchical inheritance. Future Smalltalk systems will generalize this model to arbitrary (multiple) inheritance. Also, message protocols have not been formalized. The organization provides for protocols, but it is currently only a matter of style for protocols to be consistent from one class to another. This can be remedied easily by providing proper protocol objects that can be consistently shared. This will then allow formal typing of variables by protocol without losing the advantages of polymorphism.

The other remaining work is less easy to articulate. There are clearly other aspects to human thought that have not been addressed in this paper. These must be identified as metaphors that can complement the existing models of the language.

Sometimes the advance of computer systems seems depressingly slow. We forget that steam engines were high-tech to our grandparents. I am optimistic about the situation. Computer systems are, in fact, getting simpler and, as a result, more usable. I would like to close with a general principle which governs this process:

*Natural Selection: Languages and systems that are of sound design will persist, to be supplanted only by better ones.*

Even as the clock ticks, better and better computer support for the creative spirit is evolving. Help is on the way. ■

# THE WORD™

\$75<sup>00</sup>  
COMPLETE

## SPELLING PROOFREADER and COMPUTER DICTIONARY

### The WORD is out!

Works with the editor of your choice to find those lurking spelling errors and sneaky typos.

### SPELLING CHECKER

- 45,000 word dictionary
- Checks over 10 pages/minute
- Handles apostrophes, hyphens
- Marks mistakes in file
- CDOS™, CP/M™ compatible
- Needs only 32K system

### EXTRA FEATURES

- Automatic rhyme finder
- Crossword puzzle solver
- Correct spelling finder
- Word counter
- Word frequency analyzer
- Dictionary builder

### AVAILABLE FOR:

- 8" Single Density CP/M™  
— soon —
- 5¼" North Star™
- 5¼" Superbrain™
- Apple™ / Softcard™ CP/M

**OASIS SYSTEMS** (714) 291-9489  
2765 Reynard Way, San Diego, CA 92103



# TWO SIZZLING SPECIALS

## FOR THE IEEE 696/S-100 BUS: CPU Z for \$199!

**CPU Z** hardly needs any introduction—since the day we introduced this Z80\* workhorse, professional systems integrators have made it the CPU board of choice for high performance 8 bit systems.

What is new is the price: Until September 30th, **CPU Z** (assembled) is yours for an amazingly low \$199!

For new systems, **CPU Z's** superior flexibility (24 bit addressing, sockets for adding up to 8 Kbytes of on-board RAM or ROM, 4 MHz operation, on-board fully maskable interrupts, and much more) puts it miles ahead of the competition. For upgrading

older systems, **CPU Z** is backward compatible with most S-100 mainframes, down to a switch selectable choice of 2 or 4 MHz operation—there's even a plug that accepts the connector from an IMSAI front panel.

Here's one deal you can't afford to pass up. . . visit your local **CompuPro** representative, or order direct from the factory, but hurry—quantities are limited.

## FOR MEMORY EXPANSION: EIGHT 16K DYNAMIC RAMS for \$19.95!

You can't beat the quality or the price: eight low power, high speed dynamic RAMs, suitable for expanding memory in TRS-80\* -I, -II, and -III (color computer too); H89; Apple; newer PETs; etc. Backed by 1 year limited warranty. Add \$3 for two DIP shunts plus TRS-80 conversion instructions.

## IEEE 696/S-100 COMPONENT LEVEL PRODUCTS

### DISK EQUIPMENT/SYSTEMS

**Disk 1 Controller Board** Ultra-fast operation, thanks to properly implemented DMA (with arbitration) and data transfer that's independent of CPU speed. Handles up to four 8" or 5.25" floppy disk drives, single or double-sided, single or double density (soft sectored). Includes BIOS for CP/M-80 (provided on 8" soft sectored diskette). Manual only: \$25. A/T \$495, CSC \$595.

Available only with Disk 1 purchase: CP/M-80 diskette with documentation, \$175; CP/M-86 diskette with documentation, \$300.

**Complete Dual Disk Drive System** With Disk 1 board, desktop dual drive enclosure with Shugart SA-800 series drives, disk cables, and power supply cable. Also includes CP/M-80. Introductory special: \$2195.

### COMPUTER ENCLOSURES

**Computer Enclosure 2.** With fused, constant voltage power supply (+8V at 25A, +16V at 3A, and -16V at 3A); line filter; 20 slot shielded/active terminated motherboard; and rugged, all-metal enclosure that minimizes interference problems. \$825 desk top version, \$895 rack mount version.

**Computer Enclosure 1.** Same as CE2, but enclosure only. \$289 desktop, \$329 rack mount (slides included).

### INTERFACERS

**Interfacer 1.** Two RS-232 serial ports, with full handshaking and independently selectable Baud rates. \$199 Unkit, \$249 A/T, \$324 CSC.

**Interfacer 2.** Three full duplex parallel ports, plus one serial port. \$199 Unkit, \$249 A/T, \$324 CSC.

**Interfacer 3-5.** Five RS-232 serial ports (2 synchronous/asynchronous, 3 asynchronous) with full handshaking. \$599 A/T, \$699 CSC.

**Interfacer 3-8.** Eight full RS-232 serial ports (2 synchronous/asynchronous, 6 asynchronous). Ideal for multi-user/multi-terminal systems. \$699 A/T, \$849 CSC.

### MEMORY BOARDS

**48K/64K RAM 17 Static Memory Board.** Exceptionally low power (4W max, 2W typ for 64K), high speed static memory; runs faster, cooler, and handles DMA better in ultra-high speed systems than competing dynamic memory boards. **RAM 17-48K:** \$1048 A/T, \$1198.50 CSC. **RAM 17-64K:** \$1095 Unkit, \$1395 A/T, \$1595 CSC.

**96K/128K RAM 21 Static Memory Board.** Exceptionally low power, high speed static memory. **RAM 21-96K and RAM 21-128 K:** Price upon request.

**2708 EPROM Board.** This board is the way to store often used routines or pieces of software. \$85 Unkit, \$135 A/T, \$195 CSC (2708s not included).

### DOCUMENTATION

User manuals are available for all products for \$5, with the following exceptions: Interfacer 3, \$10; Disk Controller, \$25; System Support 1, \$20. Also available: "CompuPro Product User Manuals: 1975-1980". 250+ pages on all Godbout/CompuPro products up through 1980. Excellent for evaluating the innovative engineering behind CompuPro products, or studying the nuts and bolts of high speed computer operation. \$20 plus shipping.

**FLASHI** Phase 1's single- and multi-user Oasis operating system is now available configured for Disk 1. See next month for full details and prices.

Most CompuPro products are available in Unkit form, Assembled/Tested, or qualified under the high-reliability Certified System Component (CSC) program (200 hour burn-in more). Note: Unkits are not intended for novices, as de-bugging may be required due to problems such as IC infant mortality. Factory service is available for Unkits at a flat service charge.

**TERMS:** Prices shown do not include dealer installation and support services. Call res add tax. Allow at least 5% shipping; access refunded. Orders under \$15 add \$2 handling. VISA® and Mastercard® orders (\$25 min) call our 24 hour order desk at (415) 562-0636. Include street address for UPS delivery. Prices and specifications subject to change without notice.

\*LEGAL COLLINS: Z-80 is a registered trademark of Zilog. CP/M is a registered trademark of Digital Research. TRS-80 is a trademark of the Tandy Corporation.

**If your computer store doesn't stock CompuPro products yet,  
call (415) 562-0636 and we'll tell you who does.**

**CompuPro™**

BOX 2355, OAKLAND AIRPORT, CA 94614

division of

**GODBOUT**  
ELECTRONICS

(415) 562-0636

# The Smalltalk-80 Virtual Machine

Glenn Krasner  
Learning Research Group  
Xerox Palo Alto Research Center  
3333 Coyote Hill Rd  
Palo Alto CA 94304

The Smalltalk-80 system is a powerful system that encourages the development of large applications programs. The system contains a compiler, a debugger, a storage management system, text and picture editors, and a file system. It also contains a highly interactive user interface based on graphics that include overlapping windows.

Typically the task of bringing up such a powerful system on a new computer includes writing code to implement these pieces. The Smalltalk-80 system is different in that most of these pieces are written in Smalltalk-80 itself. The part that can be written in Smalltalk-80 is called the *Smalltalk-80 Virtual Image*, and it includes the compiler, debugger, editors, decompiler, and the file system.

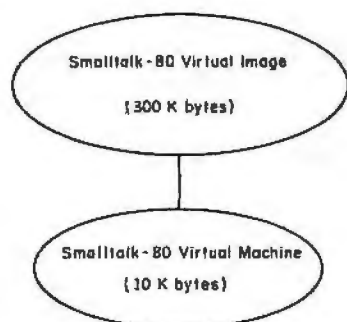

Figure 1: The Smalltalk-80 Virtual Machine. Most of Smalltalk-80 is written in Smalltalk-80 (the Virtual Image), leaving only a small amount of code that has to be rewritten for each processor on which the language is implemented (the Virtual Machine).

The remaining part of the Smalltalk-80 system is defined in terms of an abstract machine called the *Smalltalk-80 Virtual Machine* (see figure 1). The Smalltalk-80 compiler translates source code into machine instructions for this virtual machine, rather than translating directly into machine instructions for a particular hardware machine. The task of bringing up a Smalltalk-80 system on a new "target" computer consists only of implementing (writing a program to simulate) the Smalltalk Virtual Machine on the target computer.

In this article, we will present an overview of the elements needed to implement the Smalltalk Virtual Machine. These elements are:

- the *Storage Manager*
- the *Interpreter*
- the *Primitive Subroutines*

## Background

A Smalltalk-80 system is made up of *objects* that have state and exhibit behavior. Their state consists of the values of both named and indexed instance variables (which we will call *fields*), and their behavior is exhibited through sending and receiving *messages*. Objects are members of *classes*.

Classes may be *subclasses* of other classes—that is, they may inherit attributes from other classes. Programming in Smalltalk-80 is done by defining the procedures, or *methods*, that are executed when objects receive messages. Typically, messages are

sent to other objects to invoke their methods. Sometimes messages invoke *primitive* (machine-code) *subroutines* rather than Smalltalk-80 methods.

From this brief description of Smalltalk-80, we can consider the information needed to implement each of the three elements of the Smalltalk Virtual Machine:

1. To implement the storage manager, we need the information necessary to represent objects in the computer's memory. This information consists of the amount of memory that each object will occupy, which can be computed from the number of fields the object has, and the representation of fields in memory. Objects that describe classes define the number of fields their instances will have, so we also need to know how this number is represented. With this information, we can design a storage manager for objects in a Smalltalk-80 system that will:

- fetch the class of objects
- fetch and store fields of objects
- create new objects
- collect and manage free space

2. The interpreter executes the machine instructions of the Smalltalk-80 Virtual Machine. The information needed to design the interpreter is a description of these machine instructions, called *bytecodes* (the idea is similar to Pascal p-codes). The bytecodes are contained in *methods*, so we also need to know the representa-

We're  
known  
for our  
fine print.

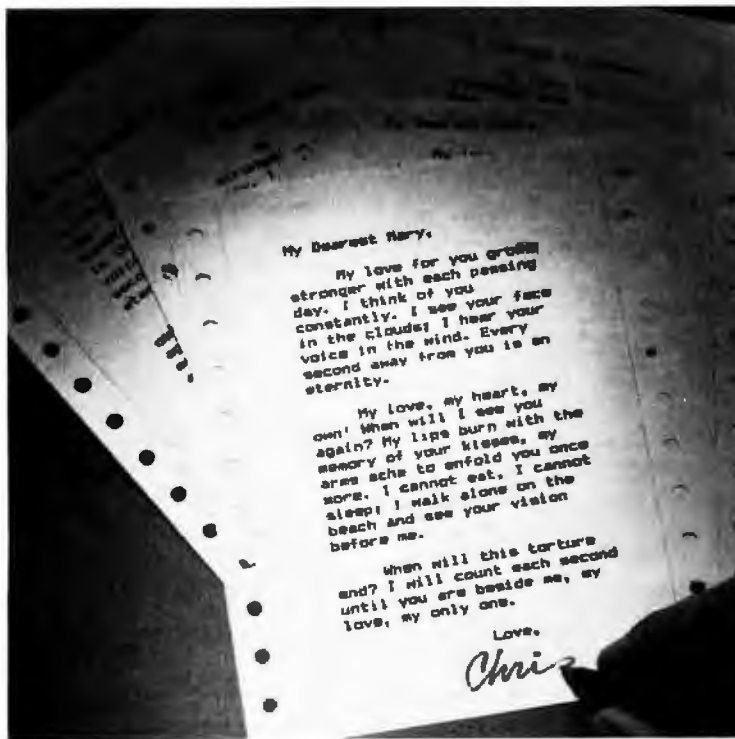

# Epson.

The type you get out of most printers you wouldn't send to your maiden aunt, much less use for your *important* correspondence. And up to now, in order to get a dot matrix hardcopy you could really call correspondence quality, you had to spend on the high side of a thousand bucks.

Not any more.

The Epson MX-80 challenges any dot matrix printer anywhere to match our type at our price. Or even come close.

Our emphasized print mode gives you a tack-sharp, clean, easy-to-read face with true descenders—at a fraction of the price of daisy wheel printers. We give you a user-defined choice of twelve different weights and sizes of letters in 40, 80, 66 or 132 columns. We give you adjustable tractors so you can do anything from labels to memos to manuscripts. Fast and clean.

But if you think print quality is the only thing we have

to sell, you're wrong. The MX-80 may be the most revolutionary printer to come out in the past ten years.

For starters, it features the world's first *disposable* print head—after it's printed between 50 and 100-million characters, just throw it away. A new one costs less than \$30 and you can change it yourself with one hand. Plus, the MX-80 prints bidirectionally and 80 CPS with a logical seeking function to minimize print head travel time and maximize throughput. Finally—and this is the best part—you can buy an MX-80 right now for less than \$650.

And that's what we call a lot of fine print for the money.



**EPSON**  
EPSON AMERICA, INC.

23844 Hawthorne Boulevard • Torrance, CA 90505 • (213) 378-2220



## SIMPLY BEAUTIFUL.

CF&A furniture looks terrific. But beauty is more than skin deep. That's why our line of desks, stands, and enclosures also features rugged construction, low cost, and quick delivery. In a wide range of sizes and configurations. With accessories to meet your individual requirements. With a smile and a thank you.

Call CF&A. We make it simple. We make it beautiful.

# CF&A

**Computer Furniture and  
Accessories, Inc.**  
1441 West 132nd Street  
Gardena, CA 90249  
(213) 327-7710

### Who's Who

The design of the Smalltalk-80 Virtual Machine is based on previous Smalltalk systems implemented by the Learning Research Group at Xerox PARC. The original bytecode interpreter design was made for Smalltalk-76 by Dan Ingalls (Ingalls, Dan. "The Smalltalk-76 Programming System: Design and Implementation." In Fifth Annual ACM Symposium on Principles of Programming Languages, 1978, pages 9 through 16). Smalltalk-76 was implemented on the Xerox Alto by Dan Ingalls, Ted Kaehler, Dave Robson, Steve Weyer and Diana Merry, on the Xerox Dolphin by Peter Deutsch, and on the Xerox Dorado by Bruce Horn. TinyTalk was implemented on a Xerox microcomputer by Larry Tesler and Kim McCall (McCall, Kim and Larry Tesler. "Tiny Talk, a Subset of Smalltalk-76 for 64KB Microcomputers." In Proceedings of the Third Symposium on Small Systems, ACM Sigsmall Newsletter, Volume 6, Number 2, 1980, pages 197 through 198). Smalltalk-78 (a revised version of Smalltalk-76 similar to Smalltalk-80) was implemented on the Xerox microcomputer by Dan Ingalls, Ted Kaehler, and Bruce Horn, on the Xerox Dorado by Jim Stamos, and on a Norwegian microcomputer (under a research license from Xerox) by Bruce Horn. Smalltalk-80 has been implemented on the Xerox Dorado by Peter Deutsch, on the Xerox Dolphin by Kim McCall, and on the Xerox Alto by Glenn Krasner. The designs of these systems were made by the implementors and other members of the Learning Research Group.

tion of methods. From this information we can decide how the interpreter will fetch and execute bytecodes and how it will find methods to run when messages are sent.

3. The last piece of information we need to know is which messages will invoke primitive subroutines; that is, which methods we must implement in machine code to terminate the recursion of message sending and to optimize performance.

Before we go into more detail about these elements of a Smalltalk-80 Virtual Machine implementation, here are a few typical figures that will provide a little "reality" to implementors. For the systems that we have implemented at Xerox, the Smalltalk-80 Virtual Image consists of about 300 K bytes of objects. Our typical implementation of the Smalltalk-80 Virtual Machine is 6 to 12 K bytes of assembly code, or 2 K microcode instructions plus 10 K bytes of assembly code. Of this, about 40% is in the storage manager, 20% in the interpreter, and 40% in the primitive subroutines. Our average is about one person-year to implement a fully debugged version of this code.

### The Storage Manager

Although the storage manager tends to be the largest and most complex of the three parts of a Small-

talk-80 implementation, the functions it provides are few and relatively simple to understand.

## Everything In a Smalltalk-80 system Is an object.

Everything in a Smalltalk system is an object, so from a storage point of view memory needs to be divided into blocks, one for each object, plus a pool of memory that is not yet used. Every time a new object is created, a new block of the appropriate size must be found for that object: when objects are no longer used, their memory block may be returned to the pool (see figure 2).

A special entity called an *object pointer* is assigned to each object. If an object pointer were the actual core address of the memory occupied by that object, then there would be fast access to an object given its pointer. However, in the Smalltalk-80 system the object pointer is an *indirect* pointer to the object through a table kept by the storage manager. This allows the storage manager to move an object around in memory without affecting any object that refers to it. It also insures that the storage manager is the only entity in the system concerned with (and allowed to change)



Atari graphics and sound stand in a class by themselves."

David D. Thornburg  
Compute Magazine, November/December 1980

"Its superiority lies in three areas: drawing fancy pictures (in color), playing music, and printing English characters onto the screen. Though the Apple can do all these things, Atari does them better."

Russell Walter  
"Underground  
Guide to Buying a  
Computer"  
Published 1980,  
SCELBI Publications

"The Atari machine is the most extraordinary computer graphics box ever made..."

Ted Nelson  
Creative Computing Magazine, June 1980

"...so well packaged that it is the first personal computer I've used that I'm willing to set up in the living room."

Ken Skier, OnComputing, Inc. Summer 1980

**What computer people  
are saying about  
Computers for people.™**

"...well constructed, sleekly designed and user-friendly—expect reliable equipment, and strong maintenance and software support."

Videoplay  
December, 1980



To find out about the ATARI<sup>®</sup> 800™ Computer first hand, ask your local computer dealer for a hands-on demonstration. Or call, 800-538-8547 (In California 800-672-1404)



**ATARI**  
Computers for people:

For further information write: Atari Inc., Computer Division, 1196 Borregas Avenue, Sunnyvale, CA 94086

Dept. C-11

Circle 27 on Inquiry card.

©1981, Atari, Inc.  
A Warner Communications Company

# Lowest Prices on Personal Computers



800™...\$789

ATARI™ List \$1080

**NEW LOW PRICE!**

ATARI® 400...\$359

**hp HEWLETT PACKARD HP-85**



**\$2795**

## HP-85 Accessories

- 6 1/4" Dual Master Disc Drive List \$2500... \$2125
- 5 1/4" Single Master Disc Drive List \$1500... \$1275
- HP 7225A Graphics Plotter List \$2050... \$1845
- HP-85 16K Memory Module List \$395... \$355
- HP-85 Application Pacs Standard List \$85... \$85
- Serial (RS-232C) Interface Module List \$395... \$355
- GPIO Interface Module List \$485... \$445

**new HP-83** List \$2250 **\$1895**

**NEW HP-41CV** with five times more memory **built in.**



List \$325

**\$249**

**HP-41C** List \$250

**\$199**

- HP-32E Scientific w/Statistics — \$39.95
- HP-33C Scientific Programmable \$79.95
- HP-34C Advanced Scientific Programmable — 123.95
- HP-37E Business Calculator — \$49.95

# Personal PC Computer Systems

609 Butternut Street  
Syracuse, N.Y. 13208

(315) 475-6800

Prices do not include shipping by UPS. All prices and offers subject to change without notice.

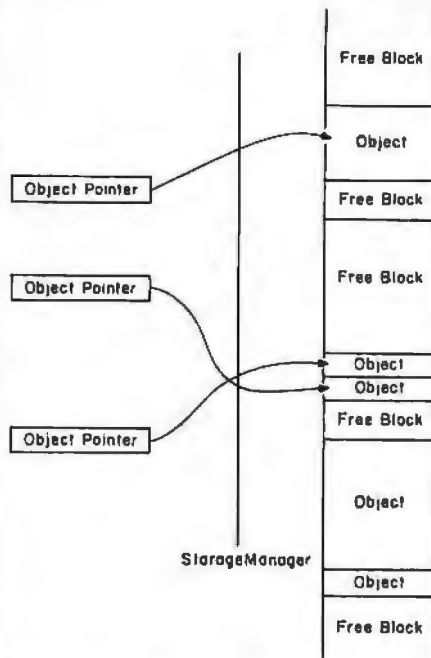

Figure 2: Objects and memory usage in Smalltalk-80. Each Smalltalk-80 object has an object pointer that points to a block of memory that describes the object. When an object is no longer used, its memory is made available for use.

|                              |
|------------------------------|
| (Length) 4                   |
| (Class description)<br>Point |
| (x-coordinate)               |
| (y-coordinate)               |

|                                 |
|---------------------------------|
| (Length) 5                      |
| (Class description)<br>Triangle |
| (First vertex)                  |
| (Second vertex)                 |
| (Third vertex)                  |

|                                  |   |
|----------------------------------|---|
| (Length) 4                       |   |
| (Class description)<br>ByteArray |   |
| 1                                | 2 |
| 3                                | 4 |

Figure 3: Typical object representations in Smalltalk-80.

the actual memory. In the Smalltalk-80 Virtual Image, object pointers are single 16-bit words. This allows for 64 K objects in the system; these objects may take up much more than 64 K words of memory.

Since an object's class and fields are themselves objects, we can see that the block of memory corresponding to an object contains the object pointer of the object's class plus the object pointer for each of the object's fields. The storage manager also keeps the length of the block as one word of the block. This means, for example, that the block corresponding to an object that is an instance of class Point (see figure 3) will have:

- one word that says this block is four words long
- one word that is the object pointer of the object that describes class Point
- one word that is the object pointer of an object that is the x-coordinate field of the point
- one word that is the object pointer of an object that is the y-coordinate field of the point

Similarly, the block corresponding to an object that is an instance of class Triangle will have:

- one word saying this block is five words long
- one word that is the object pointer of the object that describes class Triangle
- one word that is the object pointer of an instance of class Point, representing one vertex field
- one word that is the object pointer of an instance of class Point, for the second vertex field
- one word that is the object pointer of an instance of class Point, for the third vertex field

For performance optimization, the values in the fields of some objects, such as instances of class ByteArray, will be interpreted as the numerical values themselves, rather than as object pointers. The block corresponding to the byte array containing the elements 1, 2, 3, and 4, in order, will have:

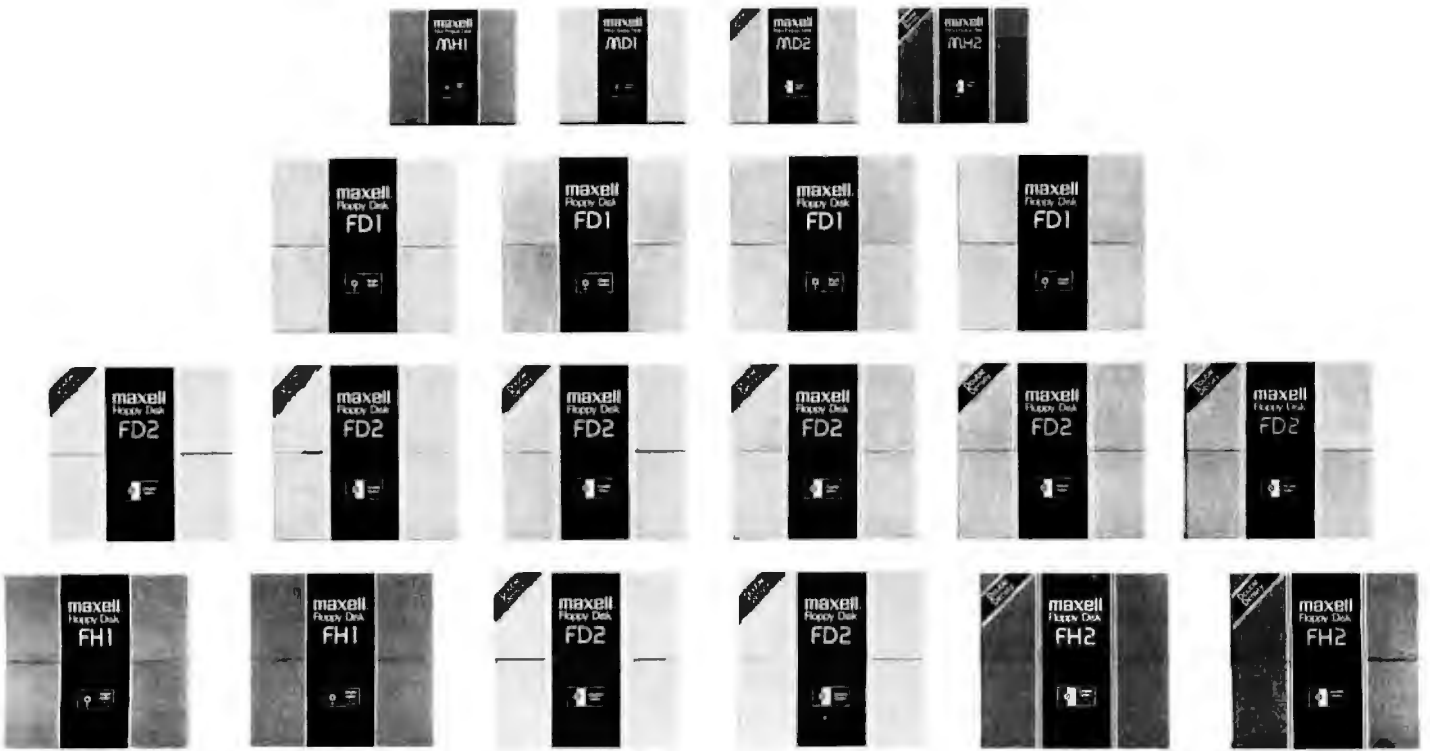

# Maxell Floppy Disks. Class of '81.

## Not a single dropout among them.

These are the disks that achieve all you expect from them. They are certified free of dropouts. And each one meets or exceeds the most demanding specifications every computer authority can set. That includes ISO, IBM, ECMA, ANSI, JIS and Shugart.

The quality begins with the finest raw materials available, and we make sure the quality stays high. Every Maxell floppy disk must pass an exhaustive series of eight quality control inspections. Under test conditions, after 10,000,000 passes, there is no loss of quality.

Maxell Floppy Disks actually help protect your computer drive heads. The self-cleaning jacket liner

inside every Maxell disk removes dust before it can affect your system. The surface lubricant reduces any chance of disk-caused head-wear.

There are Maxell disks for every disk drive system in operation today. Maxell is leading the way with new disk technology for tomorrow's computers. Your Maxell Business or Maxell Personal Computer Products supplier can put our "honor-grad" to work for you, and for your computer, now and in the future.

Call or write for more information. You'll learn that the care we take manufacturing Maxell Floppy Disks makes them live up to your highest expectations.



**maxell** 

Circle 212 on Inquiry card.

Maxell Corporation of America, Business Products Division, 60 Oxford Drive, Moonachie, N.J. 07074. (201) 440-8020

- one word saying this block is four words long
- one word pointing to the object that describes class `ByteArray`
- one byte encoding the number 1
- one byte encoding the number 2
- one byte encoding the number 3
- one byte encoding the number 4

We will represent all objects as having fields interpreted as object pointers or numerical values, not both. Objects may store numerical values as bytes or words, but not both.

As we have mentioned, the objects that describe classes also need to represent the form of instances of those classes. The essential information is the number of fields the instances will have, and whether these will be pointer or nonpointer fields. For example, the describer of class `Point` says that its instances will have two fields (*x*- and *y*-coordinates) and that these will be pointers (see figure 4). The describer of class `ByteArray` says that its instances may

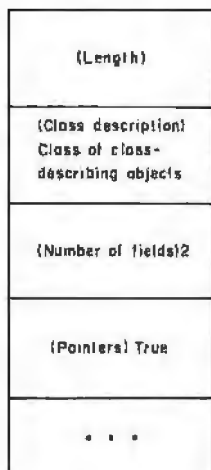

Figure 4: Class-describing object for class `Point`.

have a variable number of fields and that these fields will not be pointers but will be numerical values stored in bytes.

The purpose of the storage manager is to fetch and store fields of objects, to create objects, and to manage free space. A clean implementation of the storage manager

would be one in which the other parts of the system had access only to the object pointers and made requests of the storage manager only through the following subroutine calls:

- `getClass(objectPointer)` returns the object pointer of the class of the given object
- `getField(objectPointer,fieldOffset)` returns the field
- `storeField(objectPointer,fieldOffset,newValue)` replaces that field with the new value `newValue`
- `newInstance(classObjectPointer,numberOfFields)` returns the object pointer of a new instance of that class, and, if that class can have indexed instance variables, this instance has the given number of fields (`numberOfFields`)

Requests can be made for new storage (with the `newInstance` subroutine), but not to return used storage. In some other systems, storage that is no longer used must be explicitly returned to the free storage pool. The `Smalltalk-80` philosophy is that neither the user nor any part of the system other than the storage manager need have such concerns. Therefore the storage manager must know which objects are no longer being used, so that their storage may re-enter the free pool. Typically, `Smalltalk-80` Virtual Machine implementations use *reference-counting* to accomplish this. For every object in the system, the storage manager keeps a count of the number of other objects that point to it. This number will change only during execution of the four storage-manager subroutines. When this count reaches zero, the object's memory block may be reused because there are no references to that object anywhere else in the system.

### The Interpreter

The interpreter is that portion of the `Smalltalk-80` Virtual Machine that performs the actions described in the bytecodes of methods (ie: the machine code of the Virtual Machine). The information needed to implement the interpreter is the

## FINDING SOLUTIONS AND BEING COMPETITIVE IS OUR BUSINESS.

Having problems and looking for a computer to help solve them? Are you finding computer dealers come in one of two ways? Either Full system support with Full price or Take it or Leave it with Low price. At Omega we don't believe that you should have to make a choice. Yes, we're in business to sell products but also, to solve your problems. Our prices will be the lowest possible. Our support and product quality will be second to none. Check out our Mail Order prices in this ad (our retail prices will be higher). See if you don't agree with our first claim. For our second claim, call us with your data processing needs and problems. Better yet, come in and see us. Finding solutions and being competitive is our business. We never forget either of them.



|                              |           |
|------------------------------|-----------|
| APPLE III                    | CALL      |
| APPLE II "PLUS" 48K          | \$ 129.00 |
| HEWLETT PACKARD 85 or 93     | CALL      |
| <b>APPLE II ACCESSORIES:</b> |           |
| Disk II with controller      | \$ 515.00 |
| Disk II 2nd drive            | 452.00    |
| Graphics Tablet              | 665.00    |
| Language System with PASCAL  | 385.00    |
| Silentype Printer W/Int      | 526.00    |
| Integer Firmware Card        | 152.00    |
| Microsoft Z-80 Softcard      | 259.00    |
| Videx videoterm 80 col Card  | 256.00    |
| Sanyo 12" Green Monitor      | 269.00    |

|                                     |          |
|-------------------------------------|----------|
| <b>Supplies:</b>                    |          |
| Scotch Diskettes - Best of Quality! |          |
| price per box of (10)               |          |
| 744-0, 10, 32                       | \$ 27.00 |
| 740-0 SS/SD 0 Sector                | 31.00    |
| 741-0 SS/DD 0 Sector                | 37.00    |
| 743-0 DS/DD No Format               | 44.00    |
| <b>New Products:</b>                |          |
| Videx L/C Adapter                   | 110.00   |
| Microsoft 16K RAM Card              | 169.00   |
| D.C. Hayes Micromodem II            | 307.00   |
| Novation DCAT Modem                 | 195.00   |
| EPSON MX-80                         | CALL     |

Mail Order Terms of Sales: Price based on prepaid orders. NO COD's. Allow 14 working days for personal and company checks to clear. Order under \$100.00 add \$3.00 for shipping and handling. All orders (unless specified in ad) within Continental U.S. shipped U.P.S. no charge. APO or out of Continental U.S. write or call for shipping charges. All prices subject to change and all offers subject to withdrawal without notice. CA residents add 6% sales tax.

## OMEGA MICRO COMPUTERS

The Problem Solving Company

3447 Torrance Boulevard • Torrance, California 90503 • (213) 328-1760



# Now a microcomputer financial planning program so advanced it's like having a main frame on every desk.

## Introducing FPL™

FPL is the remarkable new Financial Planning Language software that, for the first time, turns the microcomputer into the most sophisticated financial planning tool.

### FPL is comprehensive.

Incredibly, FPL is comparable in capabilities to Autotab™ and other successful packages previously available only on main frame computers.

With FPL, you can plan, analyze, project, track and control an enormous number of business variables with a single microcomputer program.

FPL can perform such functions as Profit and Loss Forecasts, Budget Planning and Consolidation, Acquisition or Merger Analysis, Capital Investment Analysis, Product Line Planning and many more.

Unique features include the handling of complex rules that are necessary with varying tax rates and the conditional handling of investment tax credits.

With FPL, you can preview the results on the screen and then use the powerful report generator to produce

presentation-quality financial reports directly.

**FPL: an alternative to time-sharing.**

FPL gives you the same

conversational ease of time-sharing, enhanced with a screen-oriented Decision Support System, with none of the runaway costs. You are able to try many more alternatives, examine many more options, and better understand models.

Priced at only \$695, FPL gives you improved service and reduces costs.

FPL runs on most small business computers with CP/M® or similar operating systems.

### Get full support from Lifeboat.

FPL is brought to you exclusively and supported completely by Lifeboat Associates, world's largest computer software marketer. For more information about this revolutionary financial planning package and how you can profit from it, send us the coupon below.



Mail coupon to: Lifeboat Associates, 1651 Third Ave., NY, NY 10028 Or call (212) 860-0300.

- Please send me more information on FPL  
 Please send me a free Lifeboat catalog

Name \_\_\_\_\_ Title \_\_\_\_\_

Company \_\_\_\_\_

Street \_\_\_\_\_

City \_\_\_\_\_ State \_\_\_\_\_ Zip \_\_\_\_\_

FPL is a trademark of Information Access  
 CP/M is a trademark of Digital Research, Inc

Autotab is a trademark of Capex Corporation

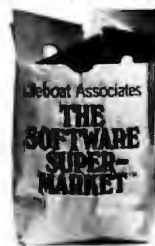

2006

LIFEBOAT WORLDWIDE offers you the world's largest library of software. Contact your nearest dealer or Lifeboat:

Lifeboat Associates  
 1651 Third Ave.  
 New York, N.Y. 10028  
 Tel: (212) 860-0300  
 Telex: 640693 (LBSOF) NYK  
 TWX: 710-581-2524

Lifeboat Inc.  
 OK Bldg., 5F  
 1-2-8 Shiba-Daimon  
 Minato-ku, Tokyo, 105 Japan  
 Tel: 03-437-3901  
 Telex: 2422723 (ASRYOJ)

Lifeboat Associates, Ltd  
 PO Box 125  
 London WC2H 9LJ, England  
 Tel: 01-836-9028  
 Telex: 893709 (LBSOFTG)

Lifeboat Associates GmbH  
 PO Box 168, Aegerstrasse 35  
 CH 6340 Baar, Switzerland  
 Tel: 042-31-2931  
 Telex: 865265 (MICO CH)

Intersoft GmbH  
 Schlossgartenweg 5  
 D-8045 Ismaning, W. Germany  
 Tel: 089-966-444  
 Telex: 5213643 (ISOFT)

Lifeboat Associates, SARL  
 10, Grande Rue Charles de Gaulle  
 92600 Asnieres, France  
 Tel: 1-733-08-04  
 Telex: 250303 (PUBLIC X PARIS)

## Lifeboat Associates

Software with full support

description of the bytecodes, the representation of methods, and the technique to find the method to run when sending a message.

The bytecodes define the Smalltalk-80 Virtual Machine as a stack-oriented machine. Each bytecode represents one of the following actions:

- push an object onto the stack
- store the top of the stack as the value for a variable
- pop the top of the stack
- branch to another bytecode
- send a message using the top few elements of the stack
- return the top of the stack as the value for this method

In the Smalltalk-80 Virtual Machine, each of these actions is realized by one or more bytecodes. Note that pushing, storing, popping, and branching are standard instruction types for any stack machine, that sending a message corresponds to calling a procedure using the top few

| Bytecode   | Stack Contents After Execution (Top of Stack to Right) |
|------------|--|
| -1- Push 3 | (3)  |
| -2- Push 4 | (3 4)  |
| -3- Push 5 | (3 4 5)  |
| -4- Send + | (3 9)  |
| -5- Send * | (27)   |

**Table 1: Bytecodes for the Smalltalk expression  $3 * (4 + 5)$ .**

elements of the stack as arguments, and that returning an object from a method corresponds to returning a value from a procedure. The difference between the Smalltalk-80 Virtual Machine and procedure-based stack machines is in the way the procedure is found. In most procedure-based stack machines the address of a procedure is provided in the *execute procedure* instruction; in the Smalltalk-80 system only the "name," called the *selector*, of the message is provided; the method (or procedure) to be executed is found through a strategy involving the receiver of the message and its class. We will first describe the bytecodes, then how

methods are represented, and finally give a strategy for finding methods.

### Stack Operations

The Smalltalk-80 Virtual Machine and corresponding bytecode set are stack oriented. Object pointers are pushed and popped from a stack, and when a message is sent, the top few elements of the stack are used as receiver and arguments of the method. These are replaced by the object returned as the value of that method. For example, the Smalltalk-80 expression:

$$3 * (4 + 5)$$

is encoded by the bytecodes shown in table 1.

As bytecodes labeled -1-, -2-, and -3- are executed by the interpreter, the objects 3, 4, and 5 are pushed onto the stack. When bytecode -4- is executed, the message + is sent to the second object on the stack (4) with the top object of the stack as the argument (5). The 4 and 5 are popped off this stack when the message is sent, and the interpreter begins executing the bytecodes for the method corresponding to the message + in the Smalltalk class of small integers. This method will eventually return an object, in this case 9, as its value, and the interpreter will push the 9 onto the original stack above the 3 and resume execution with bytecode -5-. Bytecode -5- will produce an effect similar to that produced by -4-, leaving the object 27 on the stack. In the same way that other stack machines push *data* onto a *stack* and use the top few data items as *arguments* for a *procedure*, replacing them with the *value* returned from that procedure, the Smalltalk-80 Virtual Machine pushes *object pointers* onto a *stack*

# Happy Hands

Offers Discounts on All

# TRS-80<sup>TM</sup>

# COMPUTERS

We Have What You Are Looking for

PROMPT SHIPPING

AVAILABLE SERVICE CONTRACTS

DISCOUNTED PRICES COMPARED TO ANY OTHERS

NO TAX ON OUT OF STATE SHIPMENTS

Call Collect For Prices  
And Shipping Schedules

505-257-7865

HAPPY HANDS

or write

P.O. DRAWER I

RUIDOSO, NEW MEXICO

88345



and uses the top few as *receiver* and *arguments* of a *message*, replacing them with the *object* returned from that method.

In both machines, values from the top of the stack may be stored as the values of variables. As an example, the Smalltalk expression:

$a - 3 + 4$

will be represented by the bytecodes in table 2. Here, -1-, -2- and -3- act as before and the interpreter executes bytecode -4- by storing the top of the stack 7 into the variable *a*.

Stack machines in general, and the Smalltalk-80 Virtual Machine in particular, also have the ability to pop the top element off the stack. In the statements:

$a - 3.$   
 $b - 4$

once the 3 is stored into variable *a*, it is no longer needed, so it is popped from the stack. These statements are represented by the bytecodes shown in table 3.

The top of the stack may be returned as the value for the method. The statements:

$a - 3.$   
 $! a$

are represented by the bytecodes shown in table 4.

### Branching Operations

Conditional and looping messages are used so often that they are represented not by actual messages but by bytecodes for conditional and unconditional jumps. (This is *only* for performance reasons; these branching and looping messages would work if they were actually sent like other messages.) For example:

$a > 4$  ifTrue: [ $a - a - 1$ ]

(which in the Smalltalk-80 system means execute the code within the brackets only if the object returned from the  $>$  message is not *false*) is represented in table 5 (ignoring the stack from now on).

| Bytecode         | Stack Contents After Execution (Top of Stack to Right) |
|------------------|--|
| -1- Push 3       | (3)  |
| -2- Push 4       | (3 4)  |
| -3- Send +       | (7)  |
| -4- Store into a | (7)  |

**Table 2:** Bytecodes for the Smalltalk expression  $a - 3 + 4$ .

| Bytecode         | Stack Contents After Execution (Top of Stack to Right) |
|------------------|--|
| -1- Push 3       | (3)  |
| -2- Store into a | (3)  |
| -3- Pop          | ( )  |
| -4- Push 4       | (4)  |
| -5- Store into b | (4)  |

**Table 3:** Bytecodes for the Smalltalk expression  $a - 3. b - 4$ .

| Bytecode                | Stack Contents After Execution (Top of Stack to Right) |
|-------------------------|--|
| -1- Push 3              | (3)  |
| -2- Store into a        | (3)  |
| -3- Pop                 | ( )  |
| -4- Push a              | (3)  |
| -5- Return top of stack | ( )  |

**Table 4:** Bytecodes for the Smalltalk expression  $a - 3. ! a$ .

# DISCOUNT PRICES

Microcomputers & Peripherals



North Star • SWTPC • Lear-siegler  
Hazeltime • Centronics • Cromemco  
Wabash • Perkin Elmer and others

Fast, off the shelf delivery.  
Call TOLL FREE 800/523-5355

**MARKETLINE SYSTEMS, Inc.**  
2337 Philmont Ave., Huntingdon Valley, Pa. 19006  
215/947-6670 • 800/523-5355

Dealer Inquiries Invited

# Q. What do these four boards have in common?

## A. Tarbell quality.

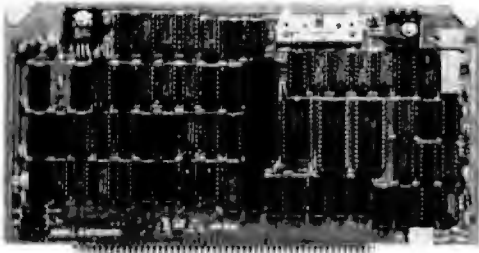

### CPU/IO BOARD

Allows dynamic mapping of logical to 1 Megabyte of physical memory in 4K blocks. □ Designed to implement multi-user operating systems, such as MP/M<sup>®</sup> from Digital Research. □ Includes crystal-controlled programmable timer (8253), which can be used for time-slicing multi-tasking operations. □ Programmable priority vectored interrupt hardware allows the programmer to selectively disable any combination of six interrupt lines.

**A & T \$450**

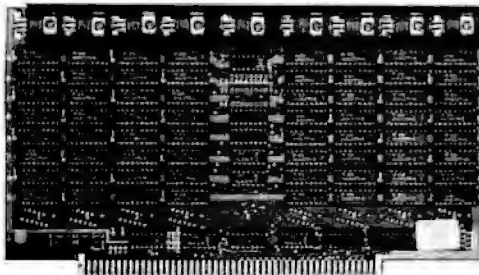

### 32K RAM

S-100 Bus □ Works at 4 MHz □ Static Memory for Ease of Maintenance □ 9 Regulators Provide Excellent Heat Distribution □ Extended Addressing (Bank Switching) □ Low Power Requirement □ Phantom Line □ Each 4K Block is Individually Addressable Within 32K □ Full 1-Year Warranty

**A & T \$725**

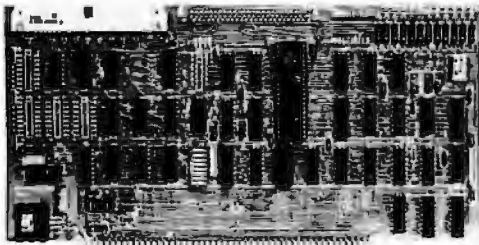

### SINGLE DENSITY FLOPPY DISK INTERFACE

Adaptable to wide variety of drives, including older models, 5-inch, 8-inch, Shugart, PerSci. □ Fully software-supported by Tarbell with a CP/M<sup>®</sup> disk operating system. □ Capable of running with several formats, including standard IBM (128 bytes per sector, 26 sectors, 76 tracks), 256, 512, or 1024 bytes per sector. □ Available in kit or fully assembled and tested form. □ Supports up to 4 8-inch drives, single or double sided. 5-inch drives can be used with modifications to the interface (included in manual).

**KIT \$225 A & T \$325**

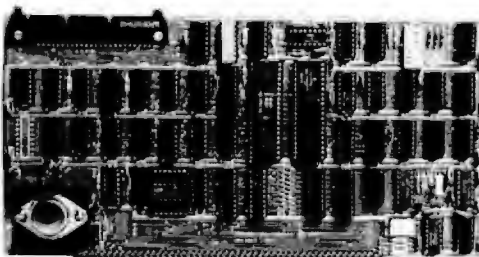

### DOUBLE DENSITY FLOPPY DISK INTERFACE

Fully software-supported by Tarbell with the CP/M disk operating system and the MP/M multi-user multi-tasking operating system. □ Under the Tarbell double-density CP/M, single and double density disks can be mixed automatically. □ True Direct Memory Access (DMA) in single or double density mode makes possible efficient multi-user and multi-tasking systems. □ Also capable of programmed-data-transfer method, which works in single density at 2 or 4 Mhz, and double density at 4 Mhz. □ Extended addressing capability provides 8 extra address bits on the lines defined by the IEEE S-100 standard. This allows direct transfers to and from anyplace in 16 Mbyte address range.

**A & T \$495**

You'll find these quality S-100 boards at your local Tarbell Dealer.

*Tarbell*  
Electronics

**MANUFACTURER OF COMPUTERS,  
COMPONENTS AND SOFTWARE.**

950 Dovlen Place • Suite B • Carson, CA 90746 • (213) 538-4251

CP/M and MP/M are trademarks of Digital Research

Circle 375 on Inquiry card.

BYTE August 1981 311

# Factory Direct

ELIMINATE THE MIDDLE MAN!

## 16K STATIC RAM



### RAM 16

#### COMPARE OUR FEATURES!

S-100 • 16K X 8 Bit Static RAM • 2114 1K X 4 Static RAM Chip • 2 or 4 MHZ • 4K Step Addressable • 1K Increment Memory • Protection from Top Board Address Down or from Bottom Up • Deactivates up to 6 1K Board Segments to Create Holes for Other Devices • Phantom Line DIP Switch • DIP Switch Selectable Wait States • 8 Bank Select Line Expands to 1/4 Million Bytes • All Data Address and Control Lines Are Input Buffered • Ignores I/O Commands at Board Address • Our Most Popular Board — Over 5000 Now in Use Worldwide!

A & T Factory Direct Price:

# \$175.00

One Year Warranty  
DON'T PAY MORE!



### NEW! — RAM 65

All of the Above Advanced Features PLUS: Bank Selection by I/O Instruction Using Any One of 256 DIP Switch-Selectable Codes • This Allows Up to 256 Software Controlled Memory Banks! • Our Most Advanced 16K Add-On Board.

A & T Factory Direct Price:

# \$185.00

One Year Warranty  
DON'T PAY MORE!

All of our Boards Are the Highest Quality MIL SPEC G-14 Fibreglass. All utilize Solder Mask over Copper Technique for Higher Reliability!  
MIX AND MATCH FOR BEST PRICING. Include \$3.00 shipping & handling per order. California residents include 6% sales tax.  
TERMS. Cash, checks, money orders or purchase orders from qualified firms or institutions. Pricing and availability subject to change without notice. International sales in U.S. funds only. COD's include 25% with order.

Quality Computer Parts  
P.O. BOX 743, DEPT. B1  
CHATSWORTH, CA 91311  
Telephone (213) 882-3142

### Bytecode

- 1- Push 4
- 2- Push a
- 3- Send >
- 4- Jump to -10- if the top of the stack is false
- 5- Push a
- 6- Push 1
- 7- Send -
- 8- Store into a
- 9- Pop
- 10- < the next bytecode >

Table 5: Bytecodes for the Smalltalk expression  $a > 4$  ifTrue: [a - a - 1].

### Bytecode

- 1- Push a
- 2- Push 4
- 3- Send >
- 4- Jump to -11- if top of stack is false
- 5- Push a
- 6- Push 1
- 7- Send -
- 8- Store into a
- 9- Pop
- 10- jump to -1-
- 11- < the next bytecode >

Table 6: Bytecodes for the Smalltalk expression  $[a > 4]$  whileTrue: [a - a - 1].

Table 6 shows the bytecodes for the looping expression:

$[a > 4]$  whileTrue: [a - a - 1]

(which means execute the code in the second brackets as long as the code in the first set of brackets evaluates to something other than false).

### Addressing Variables

Methods are implemented as objects whose fields contain the bytecodes plus a group of pointers to other objects called the *literal frame*. The interpreter can use the getField subroutine of the storage manager to fetch the next required bytecode to execute. This takes care of returns, jumps, and pops, but for the other bytecodes we need to represent more information. In particular, for the push and store bytecodes, we need to represent where to find the object pointers to push; for the send bytecodes, we need to represent where to find the selector of the message and which stack elements are

the receiver and arguments.

The source code for a method contains variable names and literals, but the bytecodes of the Virtual Machine are defined only in terms of field offsets. From the Virtual Machine's point of view, there are three types of variables: variables local to the method (called *temporaries*), variables local to the receiver of the message (*instance variables*), or variables found in some dictionary that the receiver's class shares (*global variables*). Note that *class variables* are treated in the same way as other global variables. The Smalltalk-80 compiler (itself written in Smalltalk-80) translates references to these variables into bytecodes that are references to field offsets of the receiver, the temporary area, or globals. The instance variables are translated using a field of class-describing objects that associates instance variable names with field offsets. The assignment of offsets to temporaries is done when the compiler translates a method by associating

# Engineers and other Aerospace Professionals

## Are You Tomorrow-minded...



...about America's defense capability, today and tomorrow?



...about space achievements and their importance to tomorrow's science and industry?



...about the environment and lifestyle you choose for all your family's tomorrows?



...about your career progress in tomorrow's technologies?



If you're tomorrow-minded, you've given a lot of thought to these critical elements of your future. Martin Marietta Aerospace is where you can apply your own unique vision to enhance our capabilities and satisfy your ambitions.

At Martin Marietta Aerospace, keen, innovative minds deal with the forerunners of 21st century technology. Projects in such areas as Command and Information Systems, Copperhead, TADS/PNVS, Solar Energy, Space Satellites and Space Launch Systems place Martin Marietta at the leading edge.

Denver, Colorado-Orlando, Florida-Vandenberg AFB, California-New Orleans, Louisiana are a few of our key locations. Each has its own attractive qualities. Each offers its own professional opportunities with those special challenges and benefits unique to Martin Marietta. If you're tomorrow-minded, talk to Martin Marietta

Aerospace today! Send us your resume or contact:

In Denver: P.O. Box 179, Mail#D-1311, Denver, CO 80201

At Vandenberg AFB, Box 1681, Vandenberg AFB, CA 93437

In New Orleans: Michoud Assembly Facility, Box 29304, New Orleans, LA 70189

In Orlando: P.O. Box 5837-MP#9, Orlando, FL 32855

We are an equal opportunity employer, m/f/h.

**MARTIN MARIETTA**

# WHAT'S BETTER THAN AN ISAM

And Will Turn

MICROSOFT'S  
BASIC  
COBOL  
FORTRAN

DIGITAL'S  
PL/I-80

CBASIC  
PASCAL/MT+  
S-BASIC

CROMEMCO 16K BASIC

Into first class application languages?

## MICRO B+™

The first and most complete implementation of B-TREE index structures for micro-computers. B-TREES eliminate index file reorganization.

### Search

An index of over

**10,000 Key Values In Less Than One Second**

On A Floppy Disk System for only

**\$260.00!**

System Houses:

MICRO B+™

Available in Language C

**FAIR COM**

2606 Johnson Drive  
Columbia, MO 65201  
(314) 445-3304

©1980 Fair Com

Shipping \$4 USA / \$8 Foreign  
We accept VISA and MASTERCARD

PL/I-80 is a trademark of Digital Research  
CBASIC is a trademark of Compiler Systems, Inc.  
S-BASIC is a trademark of Tapaz Programming  
PASCAL/MT+ is a trademark of MT MicroSystems

names of temporaries to offsets in the temporary area. The compiler creates instances for the literals, puts their object pointers into the literal frame of the method, and produces bytecodes in terms of offsets into the literal frame. For global variables, the compiler uses system dictionaries that

associate global names to indirect references to objects. Object pointers of the indirect references to the global objects are also placed in the literal frame of the method. The bytecodes for accessing globals are encoded as indirect references through field offsets of the literal frame.

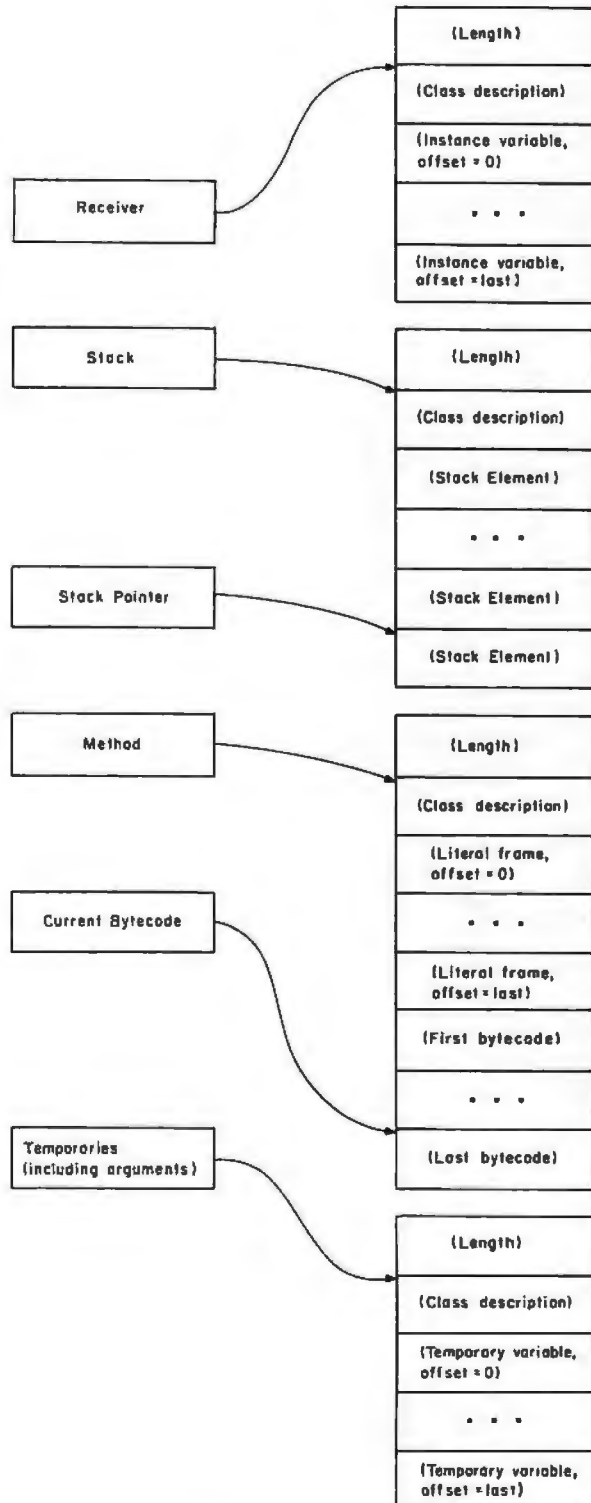

Figure 5: Object pointers held by the interpreter.





# Hayden APPLESOFT COMPILER means Speed for your Apple II™

New! **HAYDEN APPLESOFT™ COMPILER** (Eiten) At last — a program that translates your standard Applesoft™ BASIC program into true machine code! The resulting binary program runs 3 to 10 times faster than normally interpreted code ... the longer and more complex the source program, the greater the increase in execution speed. The file is B RUN to execute the final compiled product. \*08809, *Apple II Disk*, \$200.

**DISK CERTIFIER AND COPIER** (Jacc Inc.) A handy utility program that certifies the acceptability of blank diskettes and rejects those with flaws. It also includes a fast machine language disk copying program that will work on single and dual drive systems. 07809, *APPLE II Disk*, \$19.95

**LINE & VARIABLE CROSS REFERENCE GENERATOR** (Johnson) Provides a cross-reference of line numbers and variable names. 07301, *PET tape*, \$16.95

**RENUMBER & APPEND: Utility Programs for the Apple** (Gilder) Renumber your Applesoft program and append a second program to the one in memory. 03804, *Apple II tape*, \$14.95

**REVIVE** (Gilder) When a program is accidentally erased, REVIVE searches through memory and finds the information that enables it to restore the pointers that have been changed. 03604, *Apple II tape*, \$19.95

## ORDER NOW!

Hayden Book Co., Inc.  
50 Essex St. Rochelle Park, NJ 07662

Please send me the software checked on a 10-day FREE examination. At the end of that time, I will send payment, plus postage and handling, or return the software and owe nothing. On all pre-paid orders, Visa, and Master Card charges, publisher pays postage and handling — same return guarantee. Residents of NJ and CA must add sales tax. Offer good in USA only. Prices subject to change without notice. Payment must accompany orders from PO Box numbers. Allow 4 to 6 weeks for delivery. Name of individual ordering must be filled in.

|       |       |       |       |
|-------|-------|-------|-------|
| 03504 | 04909 | 05208 | 08809 |
| 03604 | 05004 | 05409 | 09109 |
| 03804 | 05009 | 05509 | 09409 |
| 03904 | 05103 | 07301 | 09704 |
| 04609 | 05108 | 07809 |       |
| 04804 | 05203 | 08609 |       |

Name \_\_\_\_\_

Street \_\_\_\_\_

City / State / Zip \_\_\_\_\_

B 8/81-009

**APPLESOFT UTILITY PROGRAMS** (Gilder) Increase your BASIC programming speed and flexibility. Contains 9 useful subroutines: 1 REM Writer 2 PRINT Writer 3 POKE Writer 4 Hexadecimal/Decimal Converter 5 Line Counter 6 Renumber 7 Append 8 Byte Counter 9 Slow List/Stop List. 03504, *Apple II tape*, \$29.95

**SLOW LIST/STOP LIST: Utility Programs for the Apple** (Gilder) Start, stop, and control the speed of your program with Apple II's game paddles. 03904, *Apple II tape*, \$10.95

**PSEUDODISK** (Neuschatz) This money-saving program simulates a disk memory system for Integer BASIC programs. It allows multiple programs in memory at the same time which can be run from a catalog. 04804, *APPLE II tape*, \$24.95

**6502 DISASSEMBLER** (Stamm) Produce assembly language source files with labeled subroutines and references from programs already in memory. It is compatible with Hayden's ASSEMBLY LANGUAGE DEVELOPMENT SYSTEM. 08609, *APPLE II Disk*, \$39.95

**DISK CATALOGER** (LeBar) Automatically maintains a cross-reference listing of all your programs, their location by disk number, their function and use. Catalogs, lists and sorts programs. 05203, *TRS-80 Level II tape*, \$16.95; 05208, *TRS-80 Level II Disk*, \$21.95

**FINPLAN: A Financial Planning Program for Small Businesses** (Montgomery) Allows you to enter data from a balance sheet into the program, to make assumptions about the future growth of business, and to have the computer project results for up to a five year period based on those assumptions. And if you change any data, the program revises all resulting data automatically. The disk version can be used only with TRSDOS version 2.3. 05103, *TRS-80 Level II tape*, \$69.95; 05108, *TRS-80 Level II Disk Version*, \$74.95

**DATA MANAGER: A Data Base Management System and Mailing List** (Lutus) Store information on a floppy disk, and retrieve it quickly and easily by specific names, or by category. 04909, *Apple II Disk Version*, \$49.95.

**PROGRAMMING IN APPLE™ INTEGER BASIC: Self-Teaching Software** (Banks & Coan) Teach yourself Apple Integer BASIC and control your own progress at all times with this interactive programmed instruction format. 05004, *Apple II tape*, \$29.95; 05009, *Apple II Disk Version*, \$39.95

**APPLE™ ASSEMBLY LANGUAGE DEVELOPMENT SYSTEM: An Assembler/Editor/Formatter** (Lutus) Write and modify your machine language programs quickly and easily. 04609, *Apple II Disk Version*, \$39.95.

**SUPER APPLE™ BASIC** (Lutus) A structured BASIC that compiles into an optimized Applesoft or Integer BASIC program. 05409, *Apple II Disk*, \$39.95

**Super FORTH** (Bugbee) This is a fast, high-level, expandable language that features integer and floating-point math, high-resolution graphics and string handling capability. 05509, *APPLE II Disk*, \$49.95

## NEW!

**OP-AMP DESIGN** (Gabrielson) Provides the necessary values for your design and will suggest appropriate op-amp types. Includes a choice of six op-amps, and the program will then determine if your selection of an op-amp will be acceptable within your chosen parameters. Can be updated to accommodate future op-amps. 09704, *Apple II tape*, \$16.95

**DOUBLE PRECISION FLOATING POINT FOR APPLESOFT** (S-C Software) Extends the accuracy of the arithmetic available on the Apple from nine digits to a full 21-digit precision on all functions in Applesoft compatible format. 09409, *Apple II Disk*, \$49.95

**DATA-GRAPH** (Boyd) Aids in the preparation of graphs and charts. Numeric data can be entered into Data-Graph and used to create colorful one-, two-, or four-quadrant graphs. 09109, *Apple II Disk*, \$49.95

Apple is a trademark of Apple Computer Company, Inc. and is not affiliated with Hayden Book Company, Inc.

Available at your local computer store!

For Orders and Inquiries Call Toll Free

**HAYDEN HOTLINE 800-631-0856**

# Hayden

50 Essex Street, Rochelle Park, NJ 07662 **Book Company, Inc.**

# APPLESOFT® Basic Compiler

**\$167.50**

Compiles APPLESOFT® BASIC programs into native 8502 code, allowing programs to run up to 10 times faster. Handles graphics and shape tables. Requires 48K, autostart ROM, language system and at least one drive. List Price: \$200.00

This means that when the interpreter is executing a method, it has to keep a stack, a temporary area, a pointer to the receiver and arguments of the method, and a pointer to the method itself (see figure 5). It uses the storage manager's `getField` and `storeField` subroutines to push and pop pointers from the stack object, to retrieve and set values of variables in the temporary area, to retrieve and set values of variables of the receiver, and to get bytecodes and values of global variables from the method.

## Finding Methods

When a message is sent, the receiver and arguments must be identified, and the appropriate method must be found by the interpreter. The technique used in Smalltalk-80 is to include in each class-describing object a dictionary, called the *method dictionary*, that associates selectors with methods. Pointers to the selectors that will be sent by any method are kept in the method (along with global variable pointers and bytecodes). The bytecodes that tell the interpreter to send a message encode a field offset in the literal frame where the selector is found, plus the number of arguments that that method needs. By convention, the top elements of the stack are the arguments and the next one down is the receiver. For example, the send bytecode for the expression:

3 + 4

will stand for "send the selector in field X of the method (which will be +), and it takes one argument." The interpreter will ask the storage manager for the X field of the method, will get the top of the stack (4) as the argument, and the next element down (3) as the receiver. It will locate the receiver's class, its method dictionary, search it for an association of the + selector with some method, and, when found, execute that method.

If no such association is found, the searching does not end. The receiver's class may be a subclass of another class, called its *superclass*. If this is the case, the method for + may be

# Microhouse™

## SPELLSTAR

New! Option for Wordstar. Compares words in your text to its 20,000-word compressed dictionary. Jumps back to WordStar for correction of errors or addition of new words to the dictionary. Price includes update of registered 2.x and earlier WordStar (must send master disk).  
List Price: \$250.00  
Microhouse Price: \$165.00/NA

## WORDSTAR

Version 3.0! Now featuring horizontal scrolling and column moves.  
List Price: \$495.00  
Microhouse Price: \$322.00/\$40.00

## WORDSTAR for APPLE

List Price: \$375.00  
Microhouse Price: \$245.00/\$40.00

## WORDSTAR CUSTOMIZATION NOTES

Package includes manual and diskette  
List Price: \$150.00  
Microhouse Price: \$95.00/NA

## MAILMERGE

Option for Wordstar.  
List Price: \$150.00  
Microhouse Price: \$110.00/\$40.00

## MAILMERGE for APPLE

List Price: \$125.00  
Microhouse Price: \$85.00/\$25.00

## VISICALC for APPLE

List Price: \$150.00  
Microhouse Price: \$107.00/NA

## SUPERSORT I

List Price: \$250.00  
Microhouse Price: \$170.00/\$40.00

## SUPERSORT II

List Price: \$200.00  
Microhouse Price: \$145.00/\$40.00

## SUPERSORT for APPLE

List Price: \$200.00  
Microhouse Price: \$130.00/\$40.00

## DATASAR

List Price: \$350.00  
Microhouse Price: \$245.00/\$40.00

## WORDMASTER

List Price: \$150.00  
Microhouse Price: \$119.00/\$40.00

CALL OR WRITE FOR FREE CATALOG

## MICROSOFT BASIC 80

List Price: \$350.00  
Microhouse Price: \$273.00/\$30.00

## MICROSOFT BASIC 80 COMPILER

Language compatible with MBASIC but code runs 3-10x faster.  
List Price: \$395.00  
Microhouse Price: \$308.00/\$30.00

## MICROSOFT FORTRAN 80

Compiler is ANSI '66 compatible (except for COMPLEX)  
List Price: \$500.00  
Microhouse Price: \$345.00/\$30.00

## muSIMP/muMATH by Microsoft

List Price: \$250.00  
Microhouse Price: \$195.00/\$25.00

## COBOL 80 by Microsoft

List Price: \$750.00  
Microhouse Price: \$562.50/\$30.00

## MACRO 80 by Microsoft

List Price: \$200.00  
Microhouse Price: \$140.00/\$20.00

## EDIT 80 by Microsoft

List Price: \$120.00  
Microhouse Price: \$84.00/\$20.00

## WHITESMITHS C

List Price: \$630.00  
Microhouse Price: CALL/\$30.00

## TINY C Interpreter

List Price: \$100.00  
Microhouse Price: \$79.00/\$50.00

## TINY C Compiler

List Price: \$250.00  
Microhouse Price: \$195.00/\$50.00

## SPELLGUARD

Fast stand-alone program works with nearly any CP/M® word processor  
List Price: \$295.00  
Microhouse Price: \$230.00/\$25.00

## STACKWORKS FORTH

For Z80 or 8080 (specify).  
List Price: \$175.00  
Microhouse Price: \$160.00/\$30.00

## WHITESMITHS PASCAL

Includes Whitesmiths C Compiler  
List Price: \$850.00  
Microhouse Price: CALL/\$45.00

# Microhouse

P.O. BOX 498  
BETHLEHEM PA 18016  
(215) 868-8219

|  |
|--|
| (Length) 17  |
| (Class description)<br>Class of class-<br>describing objects |
| (Number of fields) 2   |
| (Pointers) True  |
| (Instance Variable<br>Names) "xCoordinate<br>yCoordinate"    |
| (Global Variable<br>Dictionaries)                            |
| (Method Dictionary)  |
| (SuperClass)   |

Figure 6: Class-describing object for class Point, revisited.

defined in the superclass, so the interpreter must check there. This means that each class must have a field that refers to its superclass (see figure 6). The interpreter searches the method dictionary of the superclass, its superclass, and so on, until either an appropriate method is found or it runs out of superclasses, in which case an error occurs.

To execute a method, the interpreter needs a place for temporaries and a stack for that method. In the Smalltalk-80 Virtual Machine, this is done by allocating an object that is an instance of class MethodContext. Objects in MethodContext keep track of the method, the stack for that method, a pointer to the next bytecode to be executed in that method, the temporary variables for that method, and the context from which that method was invoked, called the caller of that method (see figure 7). When a method returns, the value returned is pushed on the stack of the caller context, and execution continues at the next bytecode of the caller's method.

## The New ADDS Viewpoint Video Terminal.

Features a detachable Tektronics-made keyboard with keypad. Function keys. Reverse video, half-intensity, underlining by fields. Printer port. ADDS quality construction.

# \$649

# Microhouse™

CALL FOR LOW PRICES ON IMS Series 5000 and 8000 Computers

### C ITOH STARWRITER I

Letter-quality printer uses Diablo plastic printwheels and ribbons. 25 cps bidirectional, logic-seeking. Parallel interface.

List Price: \$1895.00  
Microhouse Price: \$1431.00

### C ITOH STARWRITER I (Serial)

List Price: \$1980.00  
Microhouse Price: \$1502.00

### DIABLO 630

Letter-quality printer uses plastic and metal printwheels. 40 cps, bidirectional, logic-seeking. Optional tractor. \$225.

List Price: \$2710.00  
Microhouse Price: \$1999.00

### EPSON MX70

Includes GRAFTRAX II dot-addressable graphics. Monodirectional. 80 cps. Adjustable tractor. Parallel only.

List Price: \$450.00  
Microhouse Price:

### EPSON MX80

Removable print head, bidirectional, logic-seeking, adjustable tractor, parallel interface. Easily converted to RS232, IEEE 488, Apple or ATARI. CALL FOR INFORMATION ON THE NEW GRAPHICS ROM PACK!

List Price: \$845.00  
Microhouse Price:

### EPSON MX-80 FT

Friction AND tractor feed version of the MX-80. Parallel interface included.

List Price: \$745.00  
Microhouse Price:

### TELEVIDEO 910 Terminal

List Price: \$699.00  
Microhouse Price: \$595.00

### TELEVIDEO 950

List Price: \$1195.00  
Microhouse Price: \$995.00

CALL OR WRITE FOR FREE CATALOG

PRICES AND SPECIFICATIONS SUBJECT TO CHANGE WITHOUT NOTICE



Software Manual & Manual Only

ASK ABOUT THE NEW Televideo COMPUTER SYSTEMS

### IDS PAPER TIGER 560G

List Price: \$1695.00  
Microhouse Price: \$1464.00

### VIDEX VIDEOTERM SPECIAL!

Carried over by popular demand. Converts your Apple screen to 80x24 upper and lower case. Purchase VIDEOTERM with WordStar and save! If purchased separately: \$290.

List Price: \$345.00  
Microhouse Price: \$270.00

### MORROW DISCUS 2D

8 inch single-sided double-density floppy disk drive subsystem. Includes CP/M\* and MBASIC.

List Price: \$1199.00  
Microhouse Price: \$995.00

### MORROW HARD DISK SUBSYSTEM

10 Megabyte. Includes S-100 controller card, CP/M\*, and enclosure.

List Price: \$3695.00  
Microhouse Price: \$3062.00

### MICROSOFT APPLE SOFTCARD

Purchase the softcard with MicroPro's WordStar and save \$70! Converts your Apple II or II plus to a CP/M\* system. Includes MBASIC! Price if purchased separately, \$295.

List Price: \$349.00  
Microhouse Price: \$279.00

### TCS/Atlanta INTERACTIVE

#### ACCOUNTING SYSTEM

for small businesses. Ver. 5.0. Each package can be used alone or post automatically to the General Ledger. Compiled version (no support language needed). Price listed is per package. General Ledger, Accounts Receivable, Accounts Payable, and Payroll packages available. Call for details on new Order Entry & Inventory packages. ALSO AVAILABLE FOR APPLE II. Also available in source.

List Price: Compare at \$530  
Microhouse Price: \$79.00/\$25.00

#### ALL FOUR TCS PACKAGES (compiled)

List Price: Compare at \$530/pkg  
Microhouse Price: \$269.00/\$90.00

CP/M is a registered trademark of Digital Research. UNIX is a registered trademark of Bell Labs. APPLE is a registered trademark of Apple Computers. TRS80 is a registered trademark of Tandy Corp.

SHIPPING: Add \$5 per manual or software package. Add \$2.50 for COD orders. Call for shipping charges on other items. Pennsylvania residents add 6 per cent sales tax.

# Microhouse

P.O. BOX 498  
BETHLEHEM, PA 18016  
(215) 868-8219

If you're looking for  
the best prices  
in the U.S.A. on



## TRS-80 MICROCOMPUTERS

We have consistently offered the TRS-80 line at savings up to 20%. You can save up to \$1500 by buying from Computer Discount of America.

## ATARI<sup>®</sup> MICROCOMPUTERS



We have the full line of ATARI personal computers and systems.

|                       |                              |           |
|-----------------------|------------------------------|-----------|
| <b>Model II</b>       |                              |           |
| 26-4002               | 64K, 1 disc                  | \$3385.00 |
| <b>Model III</b>      |                              |           |
| 26-1061               | 4K, Level I                  | \$ 610.00 |
| 26-1062               | 16K, Level III               | \$ 845.00 |
| 26-1066               | 48K, Level II 2-drive/RS-232 | \$2115.00 |
| <b>Color Computer</b> |                              |           |
| 26-3001               | 4K                           | \$ 329.00 |
| 26-3002               | 16K w/Ext Basic              | \$ 499.00 |
| <b>EPSON</b>          |                              |           |
| MX70                  | Printer                      | \$ 375.00 |
| MX80                  | Printer                      | \$ 485.00 |
| MX80FT                | Printer                      | \$ 639.00 |

Our savings are as big on expansion interfaces, printers, diskettes, Apple Computers, OKIDATA Microline, C-ITOH Starwriter, Lexicon Modems — everything for your computer.

We have the largest inventory in the Northeast, and most models are in stock, for immediate delivery. Our full price catalog or a price quote is as near as your phone.

**CALL TOLL FREE:  
800-526-5313**

**Computer  
Discount  
of America**

COMPUTER DISCOUNT OF AMERICA, INC.  
15 Marshall Hill Road, West Milford Mall  
West Milford, New Jersey 07480  
In New Jersey Call 201-728-8080

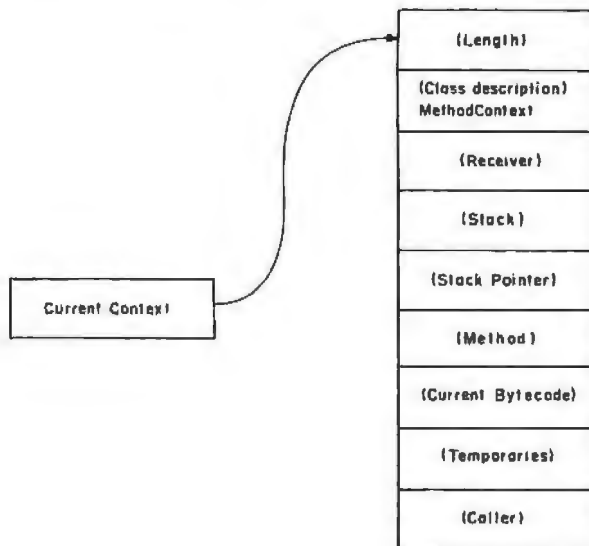

Figure 7: The only object pointer used by the Smalltalk-80 interpreter is a reference to a MethodContext.

## The Smalltalk-80 Virtual Machine Implementation Is a program running in the machine language of the target computer.

### Primitive Subroutines

The Smalltalk-80 Virtual Machine implementation is a program running in the machine language of the target computer. The storage manager is the collection of subroutines in this program that deals with memory allocation and deallocation. The interpreter is the collection of subroutines in this program, one of which fetches the next bytecode from the currently running method and calls one of the others to perform the appropriate action for that bytecode. In addition to these functions, we have found that there are several other places in the Smalltalk-80 system where performance considerations make it necessary, or at least desirable, to implement certain functions as machine-code subroutines in the Smalltalk-80 Virtual Machine. These places are:

- input/output: connecting the

Smalltalk-80 system to the actual hardware

- arithmetic: basic arithmetic for integers
- subscripting indexable objects: fetching and storing indexable instance variables
- screen graphics: drawing and moving areas of the screen bitmap quickly
- object allocation: connecting the Smalltalk-80 code for creating a new instance with the storage manager subroutines

We call this set of subroutines the *primitive subroutines*.

The primitive subroutines are represented in the Smalltalk Virtual Image as methods with a special flag that says to run the corresponding subroutine rather than the Smalltalk-80 bytecodes. When the interpreter is executing the code to send a message and finds one of these flags set, it calls the subroutine and uses the value returned from it as the value of the method. The number of these methods in Smalltalk-80 is small (around one hundred) in order to keep the rest of the system as flexible and extensible as possible. We will not list those methods that are primitives, but will refer the reader to *Smalltalk: the Language and Its Implementation* (Goldberg, Robson, and Ingalls, 1981) for details.

# ASMB.

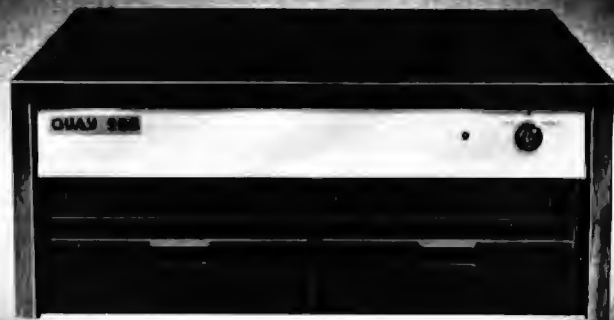

## standard on our 900 SERIES microcomputer system . . . under \$4,000.00\*

Having so much disk capacity as standard in a low cost microcomputer system is reason enough to make the 900 Series your logical choice — but the fact is, it's only one of the reasons why this system offers the best price/performance value of any now on the market. There's also a simple modular design, a reliable single board computer, dual flexible disk drives, a versatile disk operating system, plenty of room for expansion, and attractive quantity discounts — plus a lot more.

Just check out these standard features and expansion capabilities.

### STANDARD ON THE 900 SERIES:

- Single board microcomputer: Z80 based; 4 MHz. operation; DMA controlled disk access.
- Dual eight inch flexible disk drives: on-line formatted capacity of 2.5 megabytes expandable to 5 Mb; access time of 3 milliseconds track-to-track; 8000 hour MTBF reliability rating.
- IBM 3740 format compatible
- 48 kilobytes of dynamic RAM, expandable to 65 Kb.
- CP/M® Disk Operating System with assembler, editor and debug subsystems.
- RS232 or TTY serial port for system console.
- Parallel line printer port (Centronics-compatible).

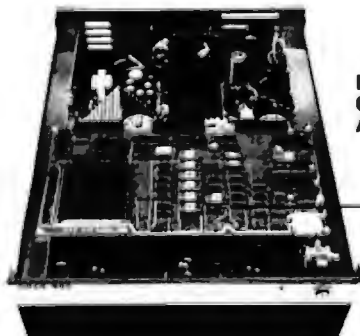

### DESIGNED FOR OPTIMUM RELIABILITY AND EASY SERVICING

Single board design  
Quad-density flexible disk drives  
Turn-key operation and security  
Expansion capabilities  
Industrial quality construction

### OPTIONS FOR THE 900 SERIES:

- Disk expansion: up to 5 Mb formatted capacity.
- Serial I/O expansion: two additional RS232 ports (serial printer, modem, etc.)
- S100 bus adaptor for system expansion.
- Multi-user operation
- Hard disk subsystem     OASIS operating system

### AVAILABLE SOFTWARE FOR THE 900 SERIES:

- High level languages include: BASIC, FORTRAN, COBOL and PASCAL.
- Application packages include: Inventory, Word Processing, GL, AR, AP and Payroll.

***the Quay 900 Microcomputer System offers the most complete package for the money***



# QUAY CORPORATION

P.O. Box 783, 527 Industrial Way West,  
Eatontown, N.J. 07724 ■ (201) 542-7340

**DISTRIBUTOR AND REPRESENTATIVE INQUIRIES WELCOME**

\*In OEM/Dealer quantities, please contact factory for pricing detail

CP/M® is a registered trademark of Digital Research

# Need a Real-Time Multi-Tasking Executive for 8080 and Z80?

CP/M®  
Interface  
Also Available

## AMIX

- Faultless operation proven in world wide use
- Truly hardware independent
- Optimized for fast interrupt response
- Minimal memory requirements
- ROMable for control applications
- Terminal Handler is CP/M BDOS compatible
- Console Driver supports Intel iSBC boards
- SYSGEN speeds user system configuring
- Program in PL/M, Fortran, Pascal or Assembler
- Source code included (Intel or Zilog mnemonics)
- Unlimited use licence agreement
- Complete documentation (available separately)
- Low cost

Circle 418 on Inquiry card.

Dealer enquiries invited

CP/M is a trademark of Digital Research Corp., RMX/80, iSBC are trademarks of Intel Corp



### KADAK Products Ltd.

206-1847 West Broadway Avenue  
Vancouver, B.C., Canada V6J 1Y5  
Telephone (604) 734-2796

## ADA A NEW BEGINNING

**ADA/M** - Compiles **ADA** program into the Host assembly language. Excellent for learning **ADA** and converting existing programs. Includes **ADA** Compiler and Compiler **ADA** Programming Support Environment (CAPSE) ..... \$495.

**ADA/P** - Compiler and Kernal APSE (KAPSE) for Apple / ATR1 ..... \$995.

**ADA/R** - Compiler and KAPSE for TRS-80 ..... \$995.

**ADA/H8** - **ADA** Language System (ALS). Includes Compiler, KAPSE, Minimal APSE (MAPSE) and Library APSE (LAPSE). Z80,8080 ..... \$2,995.

**ADA/H16** - ALS. Includes Compiler, KAPSE, MAPSE, and LAPSE. PDP-11, Z8000, 8086, 9900 ..... \$3,995.

**ADA** Programmers Manual ..... \$25.

**ADA** Syntax Reference Card ..... \$6.

Credit for purchase of **ADA/M** will be given toward purchase of larger ALS. Royalty will be paid to customers who convert existing programs into **ADA** for inclusion in the ALS library.

**DIGITAL ELECTRONIC SYSTEMS, INC.**  
Box 5252, Torrance, California 90510

A few of these primitive methods are executed so often that even the cost of looking them up in their classes' method dictionaries would be excessive. These methods are instead represented as special versions of the Send Message type of bytecodes. The message +, for example, is represented this way. When this bytecode is executed and the top two elements of the stack are small integers, then the primitive method is called as a subroutine. When this bytecode is executed and the top two elements of the stack are not small integers, then the + message is sent normally.

### Conclusion

The Smalltalk-80 Virtual Machine is a fairly small computer program that consists of a storage manager, an interpreter, and a set of primitive subroutines. The task of implementing a Smalltalk-80 Virtual Machine for a new target computer is not large (especially when compared with the task of implementing other large programming systems) because most of the functions that must usually be implemented in machine code are already part of the Smalltalk-80 Virtual Image that runs on top of the Virtual Machine.

The Smalltalk-80 Virtual Machine could also be implemented in hardware, although this has not yet been done. Such an implementation would sacrifice some of the flexibility of software, but it would result in the performance benefits that hardware provides. Given the evolving nature of Smalltalk, it may not yet be time to implement the Virtual Machine in hardware: new Smalltalks that are more powerful would likely need at least small changes in Virtual Machine definition and implementation. However, hardware assists to Smalltalk-80 Virtual Machine software can greatly improve performance. Writable microcode stores for the pieces of code that are frequently run, hardware assists for graphics, or hardware assists for the fetching of bytecodes could all potentially improve the performance of a Smalltalk-80 Virtual Machine implementation. ■

# INTRODUCING... -

COMES WITH: (ADDITIONAL)

- ▲ WORD STAR® WORD PROCESSOR
- ▲ ACCOUNTS PAYABLE
- ▲ ACCOUNTS RECEIVABLE
- ▲ GENERAL LEDGER
- ▲ SALES ORDER ENTRY
- ▲ INVENTORY CONTROL

ONLY

## \$3450.00

QUANTITY DISCOUNTS  
AVAILABLE!

INCLUDING CP/M2.2®  
(\$4950.00 INCLUDING  
ACCOUNTING SOFTWARE  
AND WORD STAR® )



320K  
MINI DRIVES  
SHOWN, 8"  
and 5 1/4" 10MB  
HARD DISK  
OPTIONAL

IMMEDIATE DELIVERY!

**1 YEAR PARTS WARRANTY!**  
(90 DAYS ON DRIVE PACKAGE, KEYBOARD AND LABOR)

**U.S. MICRO SALES S-100-8**

## CHECK THESE FEATURES!

### TERMINAL

- Feather Touch Capacitance Keyboard
- 60 Key Standard ASCII  
PLUS + Hex Keypad  
PLUS + 8 Special Function Keys  
PLUS + 20 Screen Editing Keys
- SOROC Type Screen Attribute Set
- Half Intensity

### COMPUTER

- 8 Slot S-100
- 64K Dynamic Ram
- 4MHZ Z-80
- Serial Printer Port (150 - 19.2K)
- Double Density Disk Controller
- Programmable Baud Rate
- Programmable Keyboard Set

### DISK STORAGE

- Dual Double Density  
5 1/4 Single Sided Drives
- DOUBLE SIDED Option
- Double Sided, 77  
Track, Option
- Color Matched Enclosure
- Self Contained Power Supply

#### OPTIONS:

- ◆ Dual 5 1/4" Double Sided MPI B51 (640K) add \$225.00
- ◆ Dual 5 1/4" Double Sided MPI B91 (1.2MB) add \$360.00
- ◆ Dual 8" SIEMANS FDD120-8 Drives (1MB) add \$250.00
- ◆ Dual 8" QUME Double Sided Drives (2MB) add \$625.00

**U.S. MICRO SALES**  
11 EDISON DRIVE ★ NEW LENOX, ILLINOIS 60451 ★ (815) 485-4002

WORD STAR is a TM of Micropro Inc. - CP/M2.2 is a TM of Digital Research Inc.

Circle 389 on Inquiry card.

# Building Control Structures in the Smalltalk-80 System

---

L Peter Deutsch  
Learning Research Group  
Xerox Palo Alto Research Center  
3333 Coyote Hill Rd  
Palo Alto CA 94304

---

Just as *data structures* refer to the ways that we group data together by using simple *objects* to represent more complex objects, *control structures* refer to the ways a programmer can build up complex sequences of *operations* from simpler ones. The easiest example of a control structure is sequencing: do something and then do something else. Two other familiar examples are the *conditional* structure (if some condition is true, do something, otherwise do something else) and the *loop* (do something as long as some condition remains true).

Most languages provide a few common control structures, typically sequencing, conditional, looping, and procedures, but no way for a programmer to define new structures. One useful control structure that many languages omit is the simple *case* statement (given *N* alternative things to do, numbered from 1 to *N*, and a variable *K*, do the *K*th thing). If the language doesn't provide a case statement, you can always simulate it with a long string of conditionals, but it makes your program harder to read. Other useful control structures are much more difficult to simulate if the language fails to provide them.

The Smalltalk-80 language and system (which will be called simply "Smalltalk") is one of the few languages in which a programmer can invent and implement, with relative ease, new control structures that aren't provided by the system implementors. The rest of the article illustrates this point with examples that have actually been run on a Smalltalk-80 implementation.

## What's Built In

Smalltalk provides very few built-in control structures. There is the conditional structure, implemented as follows:

```
someCondition ifTrue: [somethingToDo]
someCondition ifFalse: [somethingToDo]
someCondition
  ifTrue: [somethingToDo]
  ifFalse: [somethingElseToDo]
```

and the simple loop:

```
[someCondition] whileTrue: [somethingToDo]
[someCondition] whileFalse: [somethingToDo]
```

The most powerful tool for building new structures is the *block*. Two examples are:

```
[somethingToDoLater]
```

and:

```
[:anArgumentName| somethingToDoLater]
```

The block allows a caller to pass to the implementor of a control structure a piece of code to be executed (possibly with arguments, as in the second example) at an appropriate time.

## Case Statement

Our first example is the case statement described before. We would like a construct that includes an indexed collection of blocks for the expected cases and another block for the situation where the index is out of range. Without any particular trouble we can have a construct like this:

```
someExpression
case: (Array with: [case1] with: [case2] with:
  [case3])
otherwise: [somethingElse]
```

where [somethingElse] gets evaluated if someExpression isn't 1, 2, or 3. Then the definition is simple. We add a message to the existing class Number. In order to distinguish adding methods to existing classes from creating new classes, we will label templates "existing" if they are to be seen as partial templates adding new methods to existing classes.

Table 1 shows the code necessary to add the case method to the class Number. As far as the control struc-



# AUTOMATED EQUIPMENT INCORPORATED



18430 Ward, Fountain Valley, CA 92708

Call Toll-Free for latest low prices!  
1-800-854-7635 Outside CA  
714-963-1414 Inside CA  
1-800-854-7635 Outside Cont. USA  
Prices change daily to meet competition.



### TERMINALS

|                       |      |
|-----------------------|------|
| TELEVIDEO 912 B ..... | CALL |
| TELEVIDEO 912 C ..... | CALL |
| TELEVIDEO 920 B ..... | CALL |
| TELEVIDEO 920 C ..... | CALL |
| SOROC IQ-120 .....    | 675  |
| ZENITH A-19 .....     | 750  |
| HAZELTINE 1500 .....  | 995  |
| TELEVIDEO 950 .....   | CALL |



### NORTHSTAR

|   |      |
|---|------|
| HRZ-1D-32K .....  | CALL |
| HRZ-2D-32K .....  | CALL |
| HRZ-10-32K .....  | CALL |
| HRZ-20-32K .....  | CALL |
| ADDITIONAL 16K RAM .....  | CALL |
| ADDITIONAL 32K RAM .....  | CALL |
| HARD DISK SYSTEM .....  | CALL |
| SPECIAL MEMORY CONFIGURATIONS<br>AVAILABLE, INCLUDING SYSTEMS GROUP |      |



### PRINTERS

|                                     |        |
|-------------------------------------|--------|
| NEC 5510 (TRACT., RIB., THIM) ..... | \$2600 |
| NEC 5515 (TRACT., RIB., THIM) ..... | 2600   |
| NEC 5520 (TRACT., RIB., THIM) ..... | 2900   |
| NEC 5530 (TRACT., RIB., THIM) ..... | 2540   |
| TI-810 .....                        | 1495   |
| TI-820 .....                        | 1625   |
| EPSON MX 100 .....                  | CALL   |
| EPSON MX 80 .....                   | CALL   |
| EPSON MX 70 .....                   | CALL   |
| ANADEX DP-9500/9501 .....           | CALL   |

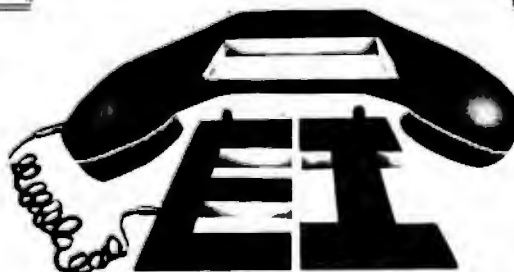

VIP's customarily need top quality and service within stringent budgetary limits. naturally, they call A.E.I.

Item: A.E.I. tests virtually every\* item sold, before shipping.

Item: A.E.I. initializes every piece of software, and makes a copy. If you have a problem, A.E.I. can check to locate the problem by using the in-house duplicate, saving you time.

Item: A.E.I. has in-house expertise on every item offered

Item: A.E.I. prices are competitive with the lowest, no-service, no in-house expertise dealer.

40% OF ALL A.E.I. SALES ARE TO PUBLIC AND SEMI-PUBLIC INSTITUTIONS.

A partial list\*\* of A.E.I. customers who purchased during the last quarter of 1980 includes: University of Nebraska, Univer-

sity of Virginia, U.S. Dept of Interior, University of Kentucky, University of California, Massachusetts Institute of Technology, U.S. Air Force, Naval Air Development Center, Brown University, University of Oregon, University of Utah, Ohio State University, University of Southern California, California State Dept. of Water Resources, University of Michigan, and Princeton University.

In the private sector, an equal number of major national organizations purchased during the same period.

You can call A.E.I. too!

## VIP's Call A.E.I.

\*With our normal fast shipping, we have time to test; expedited shipment may preclude testing.  
\*\*A.E.I. does not wish to imply that any of these fine organizations endorse A.E.I., merely that A.E.I. is proud to have them as customers.

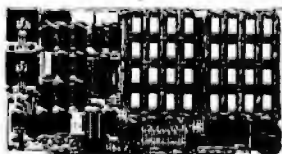

| S.S.M.                             | KIT   | ASM   |
|------------------------------------|-------|-------|
| CB2 Z80 CPU .....                  | \$200 | \$265 |
| VB1C VIDEO .....                   | 140   | 190   |
| VB2 VIDEO .....                    | 155   | 210   |
| VB3 VIDEO .....                    | 375   | 440   |
| IO4 INTERFACE .....                | 165   | 225   |
| SB1 SYNTHESIZER .....              | 195   | 270   |
| <b>MEASUREMENT SYSTEMS MEMORY</b>  |       |       |
| DM3200 32K 4MHZ .....              |       | 480   |
| DM6400 64K 4MHZ .....              |       | 595   |
| DMB3200 32K 4MHZ BANK SELECT ..... |       | 630   |
| DMB6400 64K 4MHZ BANK SELECT ..... |       | 745   |

### DYNABYTE SYSTEMS ALSO AVAILABLE—CALL FOR THE EXCITING NEWS ABOUT NEW COMPETITIVE PRICING!

WE WILL TRY TO BEAT ANY  
ADVERTISED PRICE.

**TERMS:** All prices listed are cash discounted and subject to change. COD's are 2% additional. Universities and well-rated firms Net-10

**SHIPPING:** ADDITIONAL IN ALL CASES.

**TECHNICAL ASSISTANCE:**

WE TRY TO HELP INTERFACE AND TROUBLESHOOT—CALL (714) 963-1414.

Open Monday-Friday, 8:00 a.m.-5:00 p.m.

Dealer Inquiries Invited.



### MORROW

|                            |        |
|----------------------------|--------|
| DECISION 1 BASIC .....     | \$1550 |
| DISCUS-1 2 DRIVE .....     | 1550   |
| DISCUS 2D 1 DRIVE .....    | 935    |
| DISCUS 2D 2 DRIVE .....    | 1550   |
| DISCUS 2+2 1 DRIVE .....   | 1250   |
| DISCUS 2+2 2 DRIVE .....   | 2190   |
| DISC JOCKEY 2D .....       | 350    |
| DISCUS M26 HARD DISC ..... | 3925   |
| ADDITIONAL HARD DISC ..... | 3685   |
| DISCUS M10 .....           | 2990   |

### MISCELLANEOUS

|                        |      |
|------------------------|------|
| NEC THIMBLES .....     | \$16 |
| NEC RIBBONS .....      | 7    |
| RS232C CABLE 5' .....  | 20   |
| RS 232 CABLE 10' ..... | 25   |
| LEDEX MONITOR .....    | 145  |
| NOVATION CAT .....     | 145  |

### SOFTWARE

|                   |       |
|-------------------|-------|
| WORDSTAR .....    | \$330 |
| MAILMERGE .....   | 100   |
| DATASAR .....     | 250   |
| N.S. PASCAL ..... | 160   |
| MAGIC WAND .....  | 290   |
| C BASIC .....     | 100   |

### GRAHAM-DORIAN

|                   |       |
|-------------------|-------|
| JOB COSTING ..... | \$700 |
| INVENTORY .....   | 475   |
| CASH REG. .....   | 475   |
| APARTMENT .....   | 475   |
| MEDICAL .....     | 700   |

ADDITIONAL SOFTWARE DISCOUNTS WITH SYSTEM PURCHASE

### DISCS—BOX OF 10

|                                |      |
|--------------------------------|------|
| VERBATUM 5 1/4 1 SIDE .....    | \$27 |
| VERBATUM 5 1/4 2 SIDE .....    | 45   |
| VERBATUM 8 1 SIDE .....        | 35   |
| VERBATUM 8 2 SIDE .....        | 55   |
| OTHERS .....                   | CALL |
| PLASTIC STORAGE<br>BOXES ..... | 3    |

### OUR SYSTEMS WORK!

All systems normally tested and configured in our repair facility before delivery. Service contracts available. Prompt repairs and warranties.

Circle 31 on Inquiry card.

# FOR ONLY \$129.95 Learn Computing From The Ground Up

Build a Computer kit that grows with you, and can expand to 64k RAM, Microsoft BASIC, Text Editor/Assembler, Word Processor, Floppy Disks and more.

## EXPLORER/85

Here's the low cost way to learn the fundamentals of computing, the all-important basics you'll need more and more as you advance in computer skills. For just \$129.95 you get the advanced-design Explorer/85 motherboard, with all the features you need to learn how to write and use programs. And it can grow into a system that is a match for any personal computer on the market. Look at these features: 8085 Central Processing Unit, the microprocessor "heart" of the Explorer/85. (Join the millions who will buy and use the 8085/85 this year alone!)... Four 8-bit plus one 6-bit input/output ports from which you can input and output your programs, as well as control exterior switches, relays, lights, etc. a cassette interface that lets you store and reload programs you've learned to write... a 2,000 byte operating system/monitor makes it easy to learn computing in several important ways: • It allows simpler, faster writing and entering of programs • It permits access by you to all parts of the system so you can check on the status of any point in the program • It allows tracing each program step by step, with provision for displaying all the contents of the CPU (registers, flags, etc.) • . . . and it does much more!

You get all this in the starting level (Level A) of the Explorer/85 for only \$129.95. Incredible! To see, just plug in your 8VDC power supply and terminal or keyboard/display — if you don't have them, see our special offers below.

- Level A computer kit (Terminal Version) . . . \$129.95 plus \$3 P&I \*
- Level A kit (Hex Keypad/Display Version) . . . \$129.95 plus \$3 P&I \*

**LEVEL B** — This "building block" converts the motherboard into a two-slot 5100 bus (industry standard) computer. Now you can plug in any of the hundreds of 5100 cards available.

- Level B kit . . . \$49.95 plus \$2 P&I \*
- 5100 bus connectors (two required) . . . \$4.95 each, postpaid

**LEVEL C** — Add still more computing power: six "building blocks" mounts directly on the motherboard and expands the 5100 bus to six slots.

- Level C kit . . . \$39.95 plus \$2 P&I \*
- 5100 bus connectors (five required) . . . \$4.95 each, postpaid

**LEVEL D** — When you reach the point in learning that requires more memory, after being satisfied with either 4k of memory directly on the motherboard, or add 16k to 64k of memory by means of a single 5100 card, our famous "JAWS"

- Level D kit (CHECK ONE) . . .  4k on-board . . . \$49.95 plus \$2 P&I \*  16k 5100 "JAWS" . . . \$79.95 plus \$2 P&I \*  32k 5100 "JAWS" . . . \$109.95 plus \$2 P&I \*  48k 5100 "JAWS" . . . \$249.95 plus \$2 P&I \*  64k 5100 "JAWS" . . . \$299.95 plus \$2 P&I \*

**LEVEL E** — An important "building block" it activates the 8k ROM/EPROM space on the motherboard. Now just plug in one of the Microsoft BASIC or your own custom programs.

- Level E kit . . . \$8.95 plus 50¢ P&I \*

**MICROSOFT BASIC** — It's the language that allows you to talk English to your computer. It's available three ways:  8k cassette version of Microsoft BASIC (requires Level B and 12k of RAM minimum; we suggest a 16k 5100 "JAWS" — see above) . . . \$64.95 postpaid

- 8k ROM version of Microsoft BASIC (requires Level B and Level E and 4k RAM; just plug into your Level E socket. We suggest either the 4k Level D RAM expansion or a 16k 5100 "JAWS") . . . \$69.95 plus \$2 P&I \*

- Disk version of Microsoft BASIC (requires Level B, 32k of RAM, floppy disk controller, 8" floppy disk drive) . . . \$225.95 postpaid

**TEXT EDITOR/ASSEMBLER** — The editor/assembler is a software tool (program) designed to simplify the task of writing programs. As your programs become longer and more complex, the assembler can save you many hours of programming time. This software includes an editor program that enters the programs you write, makes changes, and saves the programs on cassette. The assembler performs the clerical task of translating symbolic code into the computer-readable object code. The editor/assembler program is available either in cassette or a ROM version.

- Editor/Assembler (Cassette version; requires Level "B" and 8k (min.) of RAM — we suggest 16k "JAWS" — see above) . . . \$99.95 plus \$2 P&I \*
- Editor/Assembler (ROM version, supplied on a 5100 card; requires Level B and 4k RAM (min.) — we suggest either Level D or 16k "JAWS") . . . \$89.95 plus \$2 P&I \*

**8" FLOPPY DISK** — A remarkable "building block." Add our 8" floppy disk when you need faster operation, more convenient program storage, perhaps a business application, and access to the literally thousands of programs and program languages available today. You simply plug them into your Explorer/85 disk system — it accepts all IBM-formatted CPM programs.

- 8" Floppy Disk Drive . . . \$499.95 plus \$12 P&I \*
- Floppy Controller Card . . . \$199.95 plus \$2 P&I \*
- Disk Drive Cabinet & Power Supply . . . \$99.95 plus \$3 P&I \*
- Drive Cables (set up for two drives) . . . \$29.00 plus \$1.50 P&I \*

**CP/M 2.2 Disk Operating System** includes Text Editor/Assembler, dynamic debugger, and other features that give your Explorer/85 access to thousands of existing CPM-based programs \$150.00 postpaid.

**NEED A POWER SUPPLY?** Consider our AP-1. It can supply all the power you need for a fully expanded Explorer/85 (note: disk drives have their own power supply). Plus the AP-1 fits neatly into the attractive Explorer steel cabinet (see below).

- AP-1 Power Supply kit (8V @ 3 amps) in deluxe steel cabinet . . . \$29.95 plus \$2 P&I \*

**NEED A TERMINAL?** We offer you choices: the least expensive one is our Hex Keypad/Display kit that displays the information on a calculator-type screen. The other choice is our ASCII Keyboard/Computer Terminal kit that can be used with either

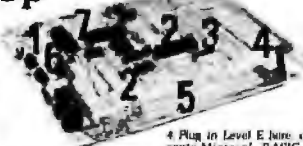

1. Plug in Motorola's Hex Keypad/Display
2. Add Level B in order to use Microsoft BASIC
3. Add 4k RAM
4. Plug in Level E kit to accept Microsoft BASIC or Editor/Assembler in ROM
5. Add two 5100 boards

2. Add Level B in order to use Microsoft BASIC (requires 12k of RAM minimum)

- CRT monitor or a TV set (if you have an RF modulator)
- Hex Keypad/Display kit . . . \$99.95 plus \$2 P&I \*
- ASCII Keyboard/Computer Terminal kit (featuring a full 120 character set and case, full cursor control, 75 ohm video output, convertible to baudot output, selectable baud rate: RS 232-C or 20 ma I/O, 32 or 64 character by 16 line for mate) . . . \$149.95 plus \$3 P&I \*
- Steel Cabinet for ASCII Keyboard/Terminal . . . \$19.95 plus \$2 P&I \*
- RF Modulator kit (allows you to use your TV set as a monitor) . . . \$4.95 postpaid
- 12" Video Monitor (10MHz bandwidth) . . . \$139.95 plus \$3 P&I \*
- Deluxe Steel Cabinet for the Explorer/85 . . . \$49.95 plus \$3 P&I \*
- Fan for cabinet . . . \$19.00 plus \$1.50 P&I \*

**ORDER A SPECIAL-PRICE EXPLORER/85 PAK — THERE'S ONE FOR EVERY NEED.**

- Beginner Pak (Save \$20.00) — You get Level A (Terminal Version) with Monitor Source Listing (\$25 value), AP-1, 5-amp power supply, Intel 8085 User Manual. . . (Reg. \$199.95) SPECIAL \$179.95 plus \$4 P&I \*
- Experimenter Pak (Save \$37.00) — You get Level A (Hex Keypad/Display Version) with Hex Keypad/Display, Intel 8085 User Manual, Level A Hex Monitor Source Listing, and AP-1, 5-amp power supply. . . (Reg. \$279.95) SPECIAL \$242.95 plus \$6 P&I \*
- Special Microsoft BASIC Pak (Save \$103.00) — You get Levels A (Terminal Version), B, D (4k RAM), E, 8k Microsoft in ROM, Intel 8085 User Manual, Level A Monitor Source Listing, and AP-1, 5-amp power supply. . . (Reg. \$439.70) SPECIAL \$336.70 plus \$7 P&I \*

- ADD A ROM-VERSION TEXT EDITOR/ASSEMBLER (Requires Levels B and D or 5100 Memory) . . . \$99.95 plus \$2 P&I \*

**Starter 8" Disk System** — Includes Level A, B floppy disk controller, one CDC 8" disk-drive, two-drive cable, two 5100 connectors; just add your own power supplies, cabinets and hardware . . . (Reg. \$100.00) SPECIAL \$99.95 plus \$13 P&I \*  32k Starter System, \$194.95 plus \$13 P&I \*  48k Starter System, \$149.95 plus \$13 P&I \*  64k Starter System, \$149.95 plus \$13 P&I \*  Add to any of above Explorer steel cabinet, AP-1 five amp power supply, Level C with two 5100 connectors, disk drive cabinet and power supply, two sub-D connectors for connecting your printer and terminal . . . (Reg. \$225.95) SPECIAL \$199.95 plus \$13 P&I \*  Complete 8k System, Wired & Tested . . . \$189.00 plus \$25 P&I \*  Special Complete Business Software Pak (Save \$625.00) — Includes CP/M 2.2 Microsoft BASIC, General Ledger, Accounts Receivable, Accounts Payable, Payroll Package . . . (Reg. \$1325) SPECIAL \$699.95 postpaid.

\*P&I stands for "postage & insurance." For Canadian orders, double this amount.

Continental Credit Card Buyers Outside Continental:  
**TO ORDER**  
**Call Toll Free: 800-243-7428**  
To Order From Continental, or For Technical Assistance, call (203) 354-9375

★ (Clip and mail until mid ad) ★

**SEND ME THE ITEMS CHECKED ABOVE**

Total Enclosed (Contn. Residents add sales tax): \$ \_\_\_\_\_

Paid by:

Personal Check  Cashier's Check/Money Order

VISA  MASTER CARD (Bank No. \_\_\_\_\_)

Acct. No. \_\_\_\_\_ Exp. Date \_\_\_\_\_

Signature \_\_\_\_\_

Print Name \_\_\_\_\_

Address \_\_\_\_\_

City \_\_\_\_\_

State \_\_\_\_\_ Zip \_\_\_\_\_

**NETRONICS Research & Development Ltd.**  
333 Litchfield Road, New Milford, CT 06776

ture goes, this is all there is to it: alternativeBlocks is an array of blocks, and the method in Number simply picks the appropriate one to evaluate. However, the syntax looks clumsy. We might like to have something that looks more like the following:

```
someExpression
case: [case1], [case2], [case3]
otherwise: [somethingElse]
```

One way to do this is to arrange for appropriate interpretation of the message , (comma) by BlockContext (table 2a) and to invent a new subclass of IndexedCollection (table 2b) that will also interpret , appropriately. We also have to add some protocol to BlockContext to handle the situation of a single block. Note that double quote marks delineate comments in Smalltalk.

As a matter of style, we generally discourage syntactic embellishments of this kind; their implementation tends to be obscure and they don't add that much to the ease of writing programs.

### Generator Loops

Many languages provide a kind of loop called a generator, which sets a variable to successive values generated by some algorithm each time through the interior of the loop. The familiar kind of loop that runs through successive integers from 1 to N is one such example. Another example is looking at successive elements of a linked list, or any ordered collection.

Smalltalk actually provides simple generators of the form:

```
someCollection do:
[:anElement] doSomethingWithTheElement]
```

but it is instructive to see how we could have constructed them ourselves. This could be accomplished by having each kind of collection object implement the message do:

| class name (existing)                             | Number            |
|---|-------------------|
| superclass  | "none added here" |
| instance variable names                           | "none added here" |
| class messages and methods                        |                   |
| "none added here"                                 |                   |
| instance messages and methods                     |                   |
| control   |                   |
| case: alternativeBlocks otherwise: aBlock         |                   |
| (self >= 1 and: [self <= alternativeBlocks size]) |                   |
| ifTrue: [1 (alternativeBlocks at: self) value]    |                   |
| ifFalse: [1 aBlock value]                         |                   |

Table 1: Template showing additions to existing class Number.

**C**ameo's DC-500 Subsystem increases data capacity to 10 megabytes for your Apple II, TRS-80 Model I or Model II, Heath H89 or Zenith Z89 computer and most S-100 based systems.

Cartridge Drives have removable disk packs, allowing interchangeability of on-line data, simply by swapping packs. Back-up is not a problem . . . It's simple and efficient. Now you can have "Big Computer" capability without the expense of buying one.

The Cameo DC-500 Subsystem . . . the cost effective solution to give your micro megabytes.

## OPERATING SYSTEMS AVAILABLE FOR THE CAMEO CARTRIDGE DISK

### APPLE II and APPLE II Plus

- Apple DOS 3.2
- Apple DOS 3.3
- CP/M
- Pascal

### Standard S-100 Bus or Z-80 processor

- CP/M
- MP/M
- La Salle Screen Edit Processor
- Oasis

### TRS-80 Model II

- CP/M
- Oasis
- TRS DOS

### TRS-80 Model I

- La Salle Screen Edit Processor-C Basic

### HEATH H89 and ZENITH Z89

- CP/M

# MEGABYTES FOR YOUR MICRO



1626 Clementine, Anaheim, CA 92802 (714) 535-1682

# Small Business Systems User!

**WHEN BUYING CHECKS, STATEMENTS AND INVOICES — LOOK FOR THIS MARK:**

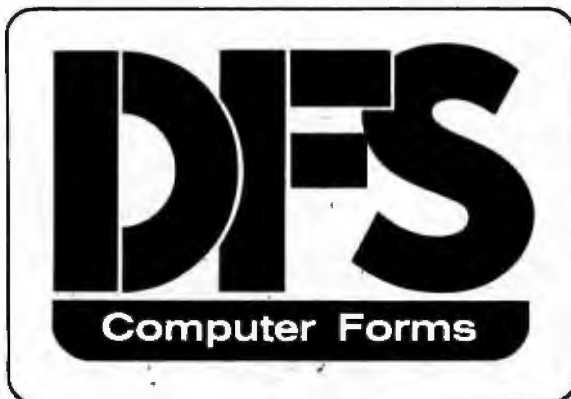

**ON THE DOOR OF YOUR COMPUTER STORE**

DFS Computer Forms are

- Sold by a Local Business
- Satisfaction Guaranteed
- Available in Small Quantities
- Compatible with Existing Software
- Very Economical

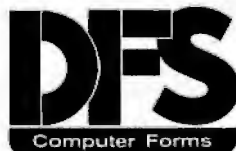

P.O. Box 643 • Townsend, MA. 01469

directly; we would get simple arithmetic loops by using `do:` with an `Interval`, a kind of collection that represents a bounded arithmetic progression. Using `do:` is convenient when we know that we want to look at all the elements of the collection, and do the same thing to each one. For example `IndexedCollection` might implement `do:` as shown in table 3.

However, if we want to retain more flexibility in controlling the generation process, there is a better way. We define the notion of a *supplier*, which will deliver the elements of a collection one at a time in response to messages. The protocol (set of messages and their intended meanings) for suppliers consists of the messages:

`s atEnd`

|                               |  |
|-------------------------------|--|
| class name (existing)         | BlockContext   |
| superclass                    | "none added here"  |
| instance variable names       | "none added here"  |
| class messages and methods    |  |
|                               | "none added here"  |
| instance messages and methods |  |
|                               | <pre> <i>constructing</i> , aBlock         ↑BlockCollection with: self with: aBlock  <i>accessing</i> size         "Behave like a BlockCollection with self as the only element"     ↑↑  at: Index         "Behave like a BlockCollection with self as the only element"     index = 1 ifTrue: [↑self].     self error: 'Subscript out of bounds'         </pre> |
| class name (existing)         | BlockCollection  |
| superclass                    | IndexedCollection  |
| instance variable names       | "none defined here"  |
| class messages and methods    |  |
|                               | "none defined here"  |
| instance messages and methods |  |
|                               | <pre> <i>constructing</i> , aBlock         ↑self add: aBlock         </pre>  |

Table 2: Templates showing additions to existing class `BlockContext` (2a) and the creation of a class template for class `BlockCollection` (2b).

## CSC Logic Probe Kit.

**\$1795** Complete, easy-to-follow instructions help make this a one-night project.

**BUY 5 FOR \$16.15 each**

## APPLE CARDS

- SERIAL CARD → \$159.00
- PARALLEL CARD → \$39.00
- INTEGER OF APPLESOFT CARD → \$189.00
- PARCAL SYSTEM → \$425.00
- PROTO BOARD → \$25.00

## "APPLE II Plus"

**48k-\$1199.00**  
**64k-\$1399.00**

**W/PURCHASE OF APPLE RECEIVE SPECIAL PRICING:**

- BASE II PRINTER → \$619.00
- DISK II w/cont. → \$595.00
- DISK II w/o cont. → \$495.00
- SUP'N MOD II → \$23.00
- MONITOR: 8" W → \$125.00
- INTEGER BASIC CARD → \$169.00

## TTL SALE

|         |    |          |      |
|---------|----|----------|------|
| SN7400N | 20 | SN7482N  | 1.05 |
| SN7402N | 22 | SN7492N  | 50   |
| SN7404N | 22 | SN7493N  | 48   |
| SN7408N | 24 | SN7495N  | 60   |
| SN7410N | 22 | SN7498N  | 70   |
| SN7412N | 28 | SN74122N | 39   |
| SN7413N | 35 | SN74136N | 95   |
| SN7414N | 49 | SN74141N | 89   |
| SN7416N | 29 | SN74151N | 65   |
| SN7417N | 29 | SN74153N | 65   |
| SN7423N | 28 | SN74154N | 125  |
| SN7425N | 22 | SN74155N | 80   |
| SN7430N | 23 | SN74157N | 89   |
| SN7437N | 29 | SN74160N | 95   |
| SN7438N | 24 | SN74161N | 65   |
| SN7440N | 22 | SN74163N | 85   |
| SN7442N | 57 | SN74164N | 87   |
| SN7443N | 78 | SN74165N | 87   |
| SN7445N | 78 | SN74174N | 95   |
| SN7451N | 20 | SN74175N | 69   |
| SN7454N | 20 | SN74180N | 75   |
| SN7474N | 32 | SN74181N | 115  |
| SN7475N | 32 | SN74193N | 169  |

## Digital Pulsar

The simplest professional pulse generator. No in the palm of your hand.

**\$62.49**

## MULTI-OUTLET STRIP UL2078C-SWITCH, PILOT and BREAKER.

**\$19.99**

## MSM5832 MICROPROCESSOR REAL-TIME CLOCK/CALENDAR

**GENERAL DESCRIPTION**

The MSM5832 is a monolithic microprocessor which integrates the functions of a real-time clock, calendar, and timer. It is designed to be used in a wide variety of applications. It is available in both 8-pin and 16-pin packages.

**FEATURES**

- Real-time clock
- Calendar
- Timer
- Alarm
- Interrupt
- Watchdog timer
- Power-on reset
- Low power consumption
- High accuracy
- Easy to use
- High reliability
- High performance
- High speed
- High precision
- High resolution
- High accuracy
- High reliability
- High performance
- High speed
- High precision
- High resolution

**\$7.45**

## video 100

**\$299.00**

**Green Phos 12 inch.**

**\$155.00**

## SOROC IQ120

**\$689.00**

## Global Specialties Logic Probes

LP1 **\$40.00**

LP3 **\$60.00**

|          |              |               |
|----------|--------------|---------------|
| 2716     | 7.25ea       | 8 for 6.50ea  |
| 5V 450NS |              |               |
| 2708     | 4.25ea       | 8 for 4.00ea  |
| 450NS    |              |               |
| 2732     | 24.50ea      | 4 for 19.50ea |
| 4116     | 300NS 3.00ea | 8 for 17.50   |
|          | 200NS 3.75ea | 8 for 19.50   |
| 2114L    | 300NS 3.50ea | 4 for 13.75   |
|          | 200NS 3.75ea | 4 for 14.25   |

## base 2 inc.

**\$649.00**

**IMPACT PRINTER**

- Dot resolution graphics in six densities
- 1820 character buffer
- Fully adjustable tractor to 9-1/2"

## Summer SALE!!

2102A .65¢  
1kx1 RAM

UPD411-2  
4kx1 RAM **\$3.25**

## IC SOCKETS

|       |         |
|-------|---------|
| 8 PIN | 10/1.20 |
| 14    | 10/1.40 |
| 16    | 10/1.60 |
| 18    | 10/1.80 |
| 20    | 10/2.00 |
| 22    | 10/2.20 |
| 24    | 10/2.40 |
| 28    | 10/3.00 |
| 40    | 10/4.75 |

**AY5-1013A \$2.95**  
30K Band UART

**4116-300NS \$2.25ea**  
16k x1 RAM

**8/\$16.00**

## CPU's

|                 |        |
|-----------------|--------|
| Z-80            | 8.95   |
| Z-80A CTC       | 12.50  |
| Z-80A CPU       | 12.50  |
| Z-80 002 16-64K | 129.00 |
| 8085A           | 11.50  |
| 2901A           | 12.50  |
| MC6800          | 9.50   |

## New for the APPLE

**16K RAM CARD \$159.95**

## 16K STATIC RAM \$269.

ASSEMBLED & TESTED

California Computer Systems

## Apple Expansion Kit 16K Memory Add-On Includes Instructions \$25.95

## TRS80 16K Add-On Instructions & Dip Switches \$25.95

## ATARI 800™ COMPUTER SYSTEM

400 Computer 8K → \$419.00  
800 Computer 16K → \$719.00

**\*800 COMPUTER w/48K → \$989.00**

**Best Buy**

## VISICALC "1981" I.C. Master \$59.95

ATARI → 129.  
ATARI → 154.

MB8264-20 64K RAM → \$29.50  
ER 2051 16K RAM → \$19.50  
EARM → 4.50

**"ALLOW 2 WKS. DEL'Y IF PERSONAL CHECK IS SENT"**

## EPSON MX-80 \$560.00

|         |     |         |      |
|---------|-----|---------|------|
| 74LS00  | .28 | 74LS155 | 115  |
| 74LS02  | .26 | 74LS158 | 75   |
| 74LS03  | .26 | 74LS160 | 95   |
| 74LS04  | .26 | 74LS161 | 85   |
| 74LS08  | .28 | 74LS162 | 95   |
| 74LS09  | .26 | 74LS163 | 160  |
| 74LS10  | .26 | 74LS164 | 65   |
| 74LS20  | .28 | 74LS165 | 65   |
| 74LS21  | .26 | 74LS170 | 175  |
| 74LS22  | .26 | 74LS174 | 75   |
| 74LS26  | .49 | 74LS175 | 75   |
| 74LS27  | .26 | 74LS190 | 75   |
| 74LS30  | .28 | 74LS193 | 95   |
| 74LS32  | .32 | 74LS195 | 95   |
| 74LS38  | .32 | 74LS196 | 85   |
| 74LS42  | .65 | 74LS221 | 140  |
| 74LS48  | .78 | 74LS240 | 165  |
| 74LS51  | .25 | 74LS241 | 165  |
| 74LS54  | .35 | 74LS243 | 145  |
| 74LS74  | .38 | 74LS244 | 145  |
| 74LS75  | .60 | 74LS245 | 225  |
| 74LS83  | .44 | 74LS253 | 95   |
| 74LS85  | .95 | 74LS257 | 95   |
| 74LS86  | .95 | 74LS258 | 95   |
| 74LS90  | .69 | 74LS259 | 2.85 |
| 74LS93  | .69 | 74LS279 | 44   |
| 74LS107 | .45 | 74LS283 | 100  |
| 74LS112 | .38 | 74LS293 | 185  |
| 74LS113 | .48 | 74LS298 | 120  |
| 74LS122 | .48 | 74LS366 | 95   |
| 74LS123 | .95 | 74LS367 | 55   |
| 74LS126 | .69 | 74LS368 | 55   |
| 74LS138 | .69 | 74LS373 | 139  |
| 74LS151 | .44 | 74LS374 | 139  |
| 74LS153 | .44 | 74LS386 | 65   |

## ATARI PERIPHERALS:

|                          |                          |
|--------------------------|--------------------------|
| Printer (825) \$775.00   | Printer (822) \$379.00   |
| Recorder \$65.00         | Disk Drive \$665.00      |
| Interface (850) \$175.00 | Modem \$169.00           |
| Palettes \$17.00         | Joysticks \$17.00        |
| Star Raiders \$49.00     | Assembler Editor \$49.00 |
| Specs Invaders \$17.00   | Music Composer \$49.00   |
| Chess \$32.00            | Mailing List \$17.00     |
| Kingdom \$12.00          | TV Switch Box \$8.95     |
| Hongmas \$12.00          | 16K RAM \$155.00         |
| Blackjack \$12.00        | 8K RAM \$119.00          |

Circle 88 on Inquiry card.

## CONCORD COMPUTER PRODUCTS

1971 SO STATE COLLEGE ANAHEIM, CALIF. 92806  
(714) 937-0637

**\$10. MIN. ORDER/ NO. RES. ADD 6% FRT.**

5 10-495 2.005 310-3995 8.00  
50-99 4.00 500-999 10.00  
100-24 7.00 1000-14 14.00

**send \$1.00 for 1st catalog**

## 5712 5722

**\$145.00 \$155.00**

Description: The RE-232C Compatible Digital Transfer Switch is designed to interface modems between front end processors. All 24 pins of the connector are terminated with Pin 1 to ground.

## Tbar INCORPORATED

# SORCERER SOFTWARE

## from QUALITY SOFTWARE

All Programs Are On Cassette

### VISI-WORD by Lee Anders

From preparing short letters to writing a book, word processing becomes easy and inexpensive using VISI-WORD, a cassette based word processor. VISI-WORD is designed to interface with just about any printer you can attach your Sorcerer to. VISI-WORD can accept control characters, which allows you to issue special commands to those printers with graphics controls, font control, and the like. A special feature of VISI-WORD, from which it gets its name, is the "command display off" feature. This command eliminates all special end of line markers and other non-printing characters and automatically performs right-justification, centering, and indenting right on the video, so that you can see what your text will look like before it is printed. Other features of VISI-WORD include four separate buffers (to assist with form letters, boiler plating, and shifting text around), automatic page numbering and titling, partial print, and locating strings. **\$59.95**

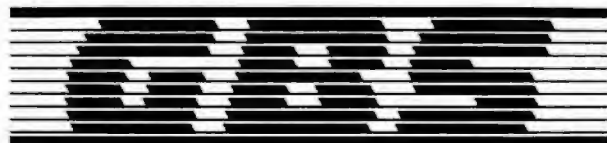

## General Business System

by Lee Anders

GBS is a general purpose programming system that can be used for many business applications. Use this system to create, edit, format, and print mailing lists. Or set up an inventory system, an accounts receivable file, or a payroll system. Or use it to enter orders. Delete, modify or append records, and then summarize and tabulate the results. You design (with the help of an extensively documented user manual) a system of records. Then use the power of GBS to compute, sort, select, merge, add, and modify your data. GBS will provide you with the kind of fast, accurate, flexible tools you always knew a home computer could provide. Four example application programs are included. Of course, you don't need to use GBS for business. You can use it for personal finance, club or personal record keeping, or almost any type of problem that involves the management of records. Written in machine language with flexible cassette interfacing, this program requires a Sorcerer with at least 32K of memory. **\$99.95**

**FORTH for the Sorcerer.** Now Sorcerer owners can enjoy the convenience and speed of the fascinating FORTH programming language. Based on fig-FORTH and adapted for the Sorcerer by James Albanese, this version uses simulated disk memory in RAM and does not require a disk drive. Added to standard fig-FORTH are an on-screen editor, a serial RS-232 driver, and a tape save and load capability. Numerous examples are included in the 130 pages of documentation. Requires 32K or more of RAM. **\$59.95**

### ARROWS AND ALLEYS™ by Vic Tolomei

The latest of Quality Software's great arcade games for the Sorcerer is ARROWS AND ALLEYS, by Vic Tolomei. You drive your car in a maze of alleys. Your task is to eliminate a gang of arrows that constantly pursues you. You have a gun and the arrows don't, but the arrows are smart and they try to stay out of your sights and will often attack from the side or from behind. Eliminate the arrows and another, faster gang comes after you. Four levels of play. Requires 16K or more of RAM. **\$17.95**

We have more than 20 programs for the Sorcerer  
PLEASE WRITE FOR OUR CATALOG



## QUALITY SOFTWARE

6660 Reseda Blvd., Suite 105, Reseda, CA 91335  
Telephone 24 hours, seven days a week (213) 344-0599

**HOW TO ORDER:** If there is no SORCERER dealer near you, you may order directly from us. MasterCard and Visa cardholders may place orders by telephone. Or mail your order to the address above. California residents add 6% sales tax. **Shipping Charges:** Within North America orders must include \$1.50 for shipping and handling. Outside North America the charge for airmail shipping and handling is \$5.00. Pay in U.S. currency.

\*The name "SORCERER" has been trademarked by Exidy, Inc.

which returns true if there are no more elements to be supplied, and:

s next

which returns the next element. Now we can build our do: operation as shown in table 4. Then each kind of collection needs to implement the message asSupplier, which returns an appropriate supplier. Table 5 shows what a supplier might look like for IndexedCollection (including its creation). If an attempt is made to read past the end, position will be incremented beyond the size of the collection, and next will provoke an error when the at: tries to

|                                 |                   |
|---------------------------------|-------------------|
| class name (existing)           | IndexedCollection |
| superclass                      | Collection        |
| instance variable names         | "none added here" |
| class messages and methods      |                   |
|                                 | "none added here" |
| instance messages and methods   |                   |
| enumeration                     |                   |
| do: aBlock                      |                   |
| index limit                     |                   |
| index -- 1.                     |                   |
| limit -- self size.             |                   |
| [index <= limit] whileTrue:     |                   |
| [aBlock value: (self at: index) |                   |
| index -- index + 1]             |                   |

Table 3: Template showing additions to existing class IndexedCollection.

|                               |                   |
|-------------------------------|-------------------|
| class name (existing)         | Collection        |
| superclass                    | "none added here" |
| instance variable names       | "none added here" |
| class messages and methods    |                   |
|                               | "none added here" |
| instance messages and methods |                   |
| enumeration                   |                   |
| do: aBlock                    |                   |
| supplier                      |                   |
| supplier -- self asSupplier.  |                   |
| [supplier atEnd] whileFalse:  |                   |
| [aBlock value: supplier next] |                   |

Table 4: Template showing additions to existing class Collection.

# STEAL US BLIND



Are you tired of being nickel-dimed to death by add-on's? When you look at the total price you have to pay for a good professional system do you begin to think of murder? Well here's your chance to get even. Until August 31st we'll let you steal us blind.

**STEAL #1! THE EXO:** Start with our basic dual drive 8" CP/M system. A 280 running at 4MHz with 64K of 200ns dynamic ram. Fast, reliable and quiet 2 serial and 2 parallel I/O ports with an expansion buss for optional hard disk, more I/O, networking, and up to 4 more users, each with 64K of memory PRICE \$3,995 (A Steal).

**STEAL #2! FREE:** With Steal #1 a box of 10 Maxell or 3M double density disks.

**STEAL #3! PERIPHERALS:** Choose from a range of fine peripherals at prices so low that the cops keep asking us where we got them. Examples Televideo 950C- \$970; Televideo 920C- \$770; Hazeltine Esprit- \$625; NEC \$530-\$2,430; Diablo 630- \$2,150; Centronics 739-\$760; Epson MX-800- \$460; Qume Sprint S-45 RO- \$2,495.

**STEAL #4! SOFTWARE:** Need some good software to go with your new system? When you purchase Steal #1 we'll throw in your choice of a quality software package for a criminally low price of \$250. Choose from Magic Wand, Spellguard, dBaseII, PASCAL MT+, Pearl Level II, or 55 Fortran, just to name a few.

**JOIN THE EXPLOSION IN COMPUTER CRIME  
ORDER NOW AND STEAL US BLIND!**



**MICRO BUSINESS ASSOCIATES, INC.**  
500 SECOND STREET  
SAN FRANCISCO, CA 94107 415-957-9195



## Terrapin Turtle - The Teachers Pet™

### It Makes Kids Think.

The Turtle is the perfect teaching and learning tool for mathematics or programming because abstract ideas are made visible and concrete. This small robot is easy to connect and simple commands can be mastered in minutes. Students absorb powerful ideas while having fun programming the Turtle to move, blink, beep, draw, or use its touch sensors. Interfaces for APPLE, Atan and S-100 bus computers are available. The following books are also available from Terrapin. Mindstorms \$12.95 Artificial Intelligence \$18.95, Katie and the Computer \$6.95, Small Computers \$9.95, Turtle Geometry \$20. Add \$2.00 shipping for 1 book and \$1 for each additional book. MA residents add 5% sales tax. For more information, write or call **Terrapin Inc.** / 678 Massachusetts Avenue / Cambridge, MA 02139 / (617) 492-8816

## StackWork's

# FORTH

A full, extended FORTH interpreter/compiler produces COMPACT, ROMABLE code. As fast as compiled FORTRAN, as easy to use as interactive BASIC.

### SELF COMPILING

Includes every line of source necessary to recompile itself.

### EXTENSIBLE

Add functions at will.

### CP/M\* COMPATIBLE

**Z80 or 8080 ASSEMBLER included**

Single license

Supplied with extensive user manual and tutorial:  
**\$175.00**

Documentation alone: **\$25.00**

OEM's, we have a deal for you!

CP/M Formats: 8" soft sectored,  
5" Northstar, 5" Micropolis Mod II,  
Vector MZ, TRS-80 Mod II

Please specify CPU type.  
Z80 or 8080

**All Orders and General Information:  
SUPERSOFT ASSOCIATES**

**P.O. BOX 1628  
CHAMPAIGN, IL 61820  
(217) 359-2112**

**Technical Hot Line: (217) 359-2691  
(answered only when technician is available)**



## SuperSoft

### First in Software Technology

\*CP/M registered trademark Digital Research

access an element beyond the size. An alternative approach, which gives a more useful error message at the expense of duplicating a check that `at:` must perform anyway, is to define `next` as follows:

```
next ||
  position > = collection size
  ifTrue:
    [self error: 'Attempt to read beyond last
      element'].
  position -- position + 1.
  | collection at: position
```

Similar supplier classes would be needed to provide generation capability for all of the different kinds of Collections.

With the supplier approach to generators, we can easily build a loop that sequences through two collections in parallel (see table 6). This would be very difficult if we did not have suppliers, but made collections implement `do:` directly. The problem is that while we could use `do:` to get one of the two collections to deliver its elements to a block of our choosing, there would be no way to get the other collection to deliver exactly one element each time the block is invoked.

Suppliers are so useful as a concept and as a protocol that Smalltalk actually includes them, under the name of

`ReadStream`. The important point is that we could have built them ourselves if the system implementors hadn't gotten there first.

Although the only kind of supplier we have constructed is one that sequences through a collection, other kinds of suppliers are possible: they just have to respond appropriately to `atEnd` and `next`. For example, one could imagine a supplier that selected elements at random from a collection in response to `next`.

### Exceptional Conditions

One of the difficulties in designing programs that (at least appear to) work reliably is designing the control structures for handling "infrequent" events. An infre-

|   |  |
|---|--|
| class name (existing)   | <code>IndexedCollection</code>         |
| superclass  | "none added here"                      |
| instance variable names   | "none added here"                      |
| class messages and methods  |  |
|   | "none added here"                      |
| instance messages and methods   |  |
| <i>enumeration</i><br><b>asSupplier</b>    <br>  <code>IndexedCollectionSupplier</code> of: self  |  |
| class name  | <code>IndexedCollectionSupplier</code> |
| superclass  | <code>Object</code>                    |
| instance variable names   | <code>collection position</code>       |
| class messages and methods  |  |
| <i>creation</i><br><b>of: aCollection</b>    <br> self new of: aCollection  |  |
| instance messages and methods   |  |
| <i>creation</i><br><b>of: aCollection</b>    <br>collection -- aCollection.<br>position -- 0  |  |
| <i>accessing</i><br><b>atEnd</b>    <br> position > = collection size<br><b>next</b>    <br>position -- position + 1.<br> collection at: position   |  |
| <b>Table 5: Templates showing additions to existing class <code>IndexedCollection</code> (5a) and the creation of a class template for class <code>IndexedCollectionSupplier</code> (5b).</b> |  |

## JOIN A WINNING TEAM!

Datasoft is looking for new authors who are writing professional, innovative and high quality programs for the Atari, Apple and Radio Shack computers. Your program can join our lineup of successful selling programs such as:

**Micro-Painter \* SIGMON \* Mychess  
App-L-ISP \* Text Wizard \* Le Stick**

Datasoft is a professional software publishing organization with a full-time marketing and program support staff. You as an author receive royalties for your work. And you will be supported by an established dealer distributor network around the world.

So if you have Business, Educational, Utility or Entertainment software, call or write us for more information.

**Datasoft Inc.**<sup>TM</sup>  
COMPUTER SOFTWARE

19519 Business Center Drive  
Northridge, CA 91324  
(213) 701-5161



# APPLESCOPE

DIGITAL STORAGE OSCILLOSCOPE  
Interface for the Apple II Computer

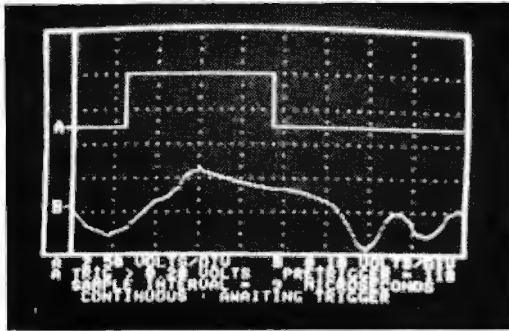

The APPLESCOPE system combines two high speed analog to digital converters and a digital control board with the high resolution graphics capabilities of the Apple II computer to create a digital storage oscilloscope. Signal trace parameters are entered through the keyboard to operational software provided in PROM on the DI control board

- DC to 3.5 Mhz sample rate with 1024 byte buffer memory
- Pretrigger Viewing up to 1020 Samples
- Programmable Scale Select
- Continuous and Single Sweep Modes
- Single or Dual Channel Trace
- Greater than or less than trigger threshold detection

Price for the two board Applescope system is \$595

For further information contact.

**RC ELECTRONICS INC.**  
7265 Tuolumne Street  
Goleta, CA 93117  
(805) 968-6614

Dealer Inquiries Invited

# ASSESS YOUR ASSETS.

Get a better insight into your expenditure decisions with an Apple personal computer.

Evaluate your financial position with Tax Planner. Chart your progress with Apple Plot. And take stock of your portfolio with The Dow Jones News & Quotes Reporter.

To discover how an Apple can be your greatest asset, drop by our store today.

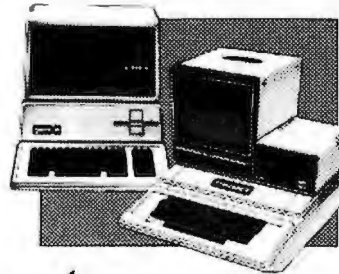

**apple computer**  
A World of Freedom

**August Special**  
**10% off all Apple Products**

Sale ends Aug 31

Visit us at the Midwest Computer Show,  
Chicago, Ill., Sept 10 thru 13 See an  
original Apple I on display



## FARNSWORTH COMPUTER CENTER

1891 N. Farnsworth Ave. (at the E-W Tollway)  
Aurora, Ill. 60505 Ph. (312) 851-3888  
Weekdays 10-8: Sat. 10-5

THE UNBEATABLE COMBINATION :



1 (800) 547-2492

**APPLE 16k+ \$1039**

**APPLE 48k+ \$1089**

**ATARI 400 (16k)\* \$329**

**ATARI 800 (16k) \$749**

\*w/o BASIC

TOLL FREE NUMBER FOR ORDER DESK ONLY. IN OREGON CALL 479-8723. REPAIRS, PARTS, AND WARRANTIES CALL (503) 479-4150. SORRY NO C.O.D.'S. MASTERCHARGE AND VISA ADD 3%. WE WILL SHIP U.P.S. FREIGHT COLLECT OR ADD 3% FOR FREIGHT AND INSURANCE TO AVOID C.O.D. CHARGES. ALLOW 10 DAYS FOR PERSONAL CHECKS TO CLEAR. PRICES SUBJECT TO CHANGE WITHOUT NOTICE. PRICES GOOD AT MAIL ORDER DEPARTMENT OF STORE #182 ONLY.

| APPLE                             |     |
|-----------------------------------|-----|
| DISK DRIVE W/3.5 CONTROLLER       | 499 |
| DISK DRIVE ONLY                   | 429 |
| SILENTTYPE PRINTER W/INTERFACE    | 349 |
| GRAPHICS TABLET                   | 879 |
| APPLESPEAK OR INTEGER FIRMWARE    | 139 |
| LANGUAGE CARD (PASCAL)            | 369 |
| PARALLEL PRINTER CARD             | 129 |
| SERIAL PRINTER CARD               | 159 |
| CENTRONICS PRINTER INTERFACE CARD | 149 |
| C.C.S. 7720A                      | 139 |
| C.C.S. 7720A                      | 109 |
| DATA SHEET ADAPTOR                | 59  |
| 16K RAM CARD (MICROSOFT)          | 169 |
| 2 88 CARD (MICROSOFT)             | 289 |
| HAYES MICROMODEM                  | 279 |
| A 4 I/O KEY PAD                   | 99  |
| M&R SUP'R TERM                    | 299 |
| M&R SUP'R MOD (MODULATOR)         | 77  |
| 16K MEMORY EXPANSION              | 49  |
| PROGRAMMA JOYSTICK                | 49  |

| ATARI                            |     |
|----------------------------------|-----|
| 410 PROGRAM J1 GORDE II          | 59  |
| 610 DISK DRIVE                   | 429 |
| 820 PRINTER II                   | 499 |
| 825 THE REAL PRINTER             | 369 |
| 825 NO COLOR MAN PRINTER II      | 609 |
| 830 MODEL M                      | 199 |
| 860 INT'L CONTACT MODULE         | 139 |
| 857K MEMORY EXPANSION            | 45  |
| 853 128K MEMORY EXPANSION        | 89  |
| BASIC LANGUAGE CARTRIDGE         | 49  |
| VISICALC (ATARI)                 | 199 |
| WE HAVE ATARI GAMES CONTINUOUSLY |     |

| HARDWARE                  |      |
|---------------------------|------|
| 9" BW MONITOR (SANYO)     | 159  |
| 9" BW MONITOR (N.E.C.)    | 169  |
| 12" BW MONITOR (SANYO)    | 199  |
| 12" COLOR MONITOR (SANYO) | 259  |
| 13" COLOR MONITOR (E.I.)  | 349  |
| I.D.S. 445G PRINTER       | 599  |
| I.D.S. 460G PRINTER       | 1099 |
| I.D.S. 560G PRINTER       | 1329 |
| EPSON MX 80 PRINTER       | 499  |
| EPSON CABLE AND INTERFACE | 99   |
| CENTRONICS 737-1 PRINTER  | 749  |
| CENTRONICS 779-2 PRINTER  | 889  |
| N.E.C. SPINWRITER PRINTER | 2639 |
| QUME SPRINT PRINTER       | 2499 |
| TEXAS INST 9914           | 499  |

### APPLE SOFTWARE

|   |     |
|---|-----|
| VISICALC  | 199 |
| VISIDEX   | 139 |
| VISIPLOT  | 129 |
| VISITRAN  | 109 |
| VISITREND   | 179 |
| D.D.S. TOOL KIT   | 59  |
| D.D.S. 3.5 UPDATE   | 52  |
| APPLE WRITER  | 59  |
| SUP'R TECT II   | 109 |
| GENERAL BUSINESS CONTROLLER                               | 459 |
| SKY F TECH PAYROLL  | 179 |
| STOCK I/F INVENTORY PROGRAM                               | 359 |
| APPLE ADVENTURE   | 29  |
| ZORK  | 29  |
| NAHSON CHESS  | 29  |
| GALAXIAN  | 22  |
| HIBIS FOOTBALL  | 35  |
| COMPUTER QUARTERBACK                                      | 35  |
| MANY OTHER BUSINESS, PERSONAL AND GAME SOFTWARE AVAILABLE |     |



530 N.E. "E" STREET  
GRANTS PASS, ORE  
97526



quent event is any event which is (a) qualitatively different from what happens most of the time and (b) not so common that one wants to test for it in the normal flow of control. One example of an infrequent event is an ad-

|   |   |
|---|---|
| class name (existing)   | Collection  |
| superclass  | "none added here"   |
| instance variable names   | "none added here"   |
| class messages and methods  |   |
|   | "none added here"   |
| instance messages and methods   |   |
|   | <pre> enumerating with: anotherCollection do: aBlock   mySupplier itsSupplier   mySupplier ← self asSupplier. itsSupplier ← anotherCollection asSupplier. [mySupplier atEnd or: [itsSupplier atEnd]] whileFalse:     [aBlock      value: mySupplier next      value: itsSupplier next] </pre> |
| <p><b>Table 6:</b> Template showing additions to existing class Collection.</p> |   |

|  |   |
|--|---|
| class name (existing)  | OrderedCollection   |
| superclass   | "none added here"   |
| instance variable names  | "none added here"   |
| class messages and methods   |   |
|  | "none added here"   |
| instance messages and methods  |   |
|  | <pre> searching maxBefore1000   supplier max value theLoop   max ← 0. supplier ← self asSupplier. theLoop ←     [[supplier atEnd]      whileFalse:          [value ← supplier next.           value &gt; 1000 ifTrue: [theLoop exit].           max ← max max: value]] withExit. theLoop value. "Actually do the loop block" ↑ max </pre> |
| <p><b>Table 7:</b> Template showing additions to existing class OrderedCollection.</p> |   |

ditional exit from a loop. Suppose we would like to write a searching loop that finds the maximum element of a collection of non-negative numbers but stops searching if it finds an element greater than 1000. Such a loop might be implemented as shown in table 7.

We want the block [[supplier atEnd] ...] to respond to the withExit message by giving back a blocklike object which we can assign to the variable theLoop. The ability to name this object allows us to exit from it midcourse. These BlockWithExit objects (see table 8) need to remember only two pieces of information: the original block, to execute in response to the value message, and where to send control if an exit message is sent.

The original statement theLoop ← ... doesn't actually

|   |   |
|---|---|
| class name  | BlockWithExit   |
| superclass  | Object  |
| instance variable names   | block exitBlock   |
| class messages and methods  |   |
|   | <pre> creation with: aBlock     ↑ self new with: aBlock </pre>  |
| instance messages and methods   |   |
|   | <pre> creation with: aBlock     block ← aBlock  control value     exitBlock ← [↑ nil]. "Exit to my caller if the block ever sends me the exit message" ↑ block value "Actually do the computation"  exit     exitBlock value "Exit from the computation to the caller who sent the value message to me in the method just above" </pre> |
| class name (existing)   | BlockContext  |
| superclass  | "none added here"   |
| instance variable names   | "none added here"   |
| class messages and methods  |   |
|   | "none added here"   |
| instance messages and methods   |   |
|   | <pre> control withExit     ↑ BlockWithExit with: self </pre>  |
| <p><b>Table 8:</b> Templates showing the creation of a class template for class BlockWithExit (8a) and additions to existing class BlockContext (8b).</p> |   |

**DISK DRIVE WOES?  
PRINTER INTERACTION?  
MEMORY LOSS?  
ERRATIC OPERATION?**

# Don't Blame The Software!



Power Line Spikes, Surges & Hash could be the culprit! Floppies, printers, memory & processor often interact! Our patented ISOLATORS eliminate equipment interaction AND curb damaging Power Line Spikes, Surges and Hash.

- ISOLATOR (ISO-1) 3 filter isolated 3-prong sockets; integral Surge/Spike Suppression; 1875 W Maximum load, 1 KW load any socket ..... \$62.95
- ISOLATOR (ISO-2) 2 filter isolated 3-prong socket banks; (6 sockets total); Integral Spike/Surge Suppression; 1875 W Max load, 1 KW either bank ..... \$62.95
- SUPER ISOLATOR (ISO-3), similar to ISO-1 except double filtering & Suppression ..... \$94.95
- ISOLATOR (ISO-4), similar to ISO-1 except unit has 6 individually filtered sockets ..... \$106.95
- SUPER ISOLATOR (ISO-11) similar to ISO-2 except double filtering & Suppression ..... \$94.95
- CIRCUIT BREAKER, any model (add-CB) ..... Add \$ 8.00
- CKT BRKR/SWITCH/PILOT (-CBS) ..... Add \$16.00

AT YOUR DEALERS

Master-Card, Visa, American Express  
Order Toll Free 1-800-225-4876  
(except AK, HI, PR & Canada)

**Electronic Specialists, Inc.**  
171 South Main Street, Natick, Mass. 01760  
Technical & Non-800: 1-617-655-1532

# KILL SURGES LIKE LIGHTNING!

AC power line surges are destructive, can cost you money, and can't be prevented. But you can stop them from reaching your sensitive electronic equipment with a Surge Sentry.

Surge Sentry acts in picoseconds to dissipate up to a 1,000,000 W, 100µ second surge. Triggers at 10% above nominal peak voltage. Works in parallel with the power line. Is easy to install for immediate protection. No complicated wiring or special tools required.

Several different models to choose from, including an OEM version. Call or write today for a free brochure



## ComputerWatch Clock/Calendar

Now available on Three Buses

### Features

- 12/24 Hr. Format
- Month-Day-Year
- Day of Week
- Leap Year Bit
- 4 Interrupts
- +/- 30 Sec. Adjust
- Battery Backup
- Simple to Program

\*APPLE II

\*TRS-80

**\$100**

**\$150 FOB**  
**CompuTime**

\* Apple is a Trademark of Apple Computer Co.  
\* TRS80 is a Trademark of Tandy Corp.



Dealer Inquire (714) 536-5000  
P.O. Box 5343 Huntington Beach, CA 92646



## RKS ENTERPRISES, INC.

643 South 6th Street, San Jose, CA 95112  
(408) 288-5565

DEALER INQUIRIES INVITED

execute the loop: it creates a block whose code is [supplier atEnd] ... . This block becomes the block variable of a new BlockWithExit as a result of the withExit message being sent. theLoop is set to the BlockWithExit just created. When theLoop is sent the message value, the value method in BlockWithExit first creates another block, the exitBlock, which, if evaluated, will return to the sender of value regardless of how many other activations have intervened. The value method in BlockWithExit then sends value to the original block, causing it to execute. If no exit is sent, the loop completes normally. If an exit is sent, the exitBlock is evaluated and control returns to the last statement of maxBefore 1000, just as if the loop had completed.

### Dynamic Binding

Another common kind of infrequent event is a request for information. For example, suppose we want to specify a default directory for disk files throughout some part of a program. We could pass this information as an argument through all intervening calls, but this would place an added burden (in time, space, and complexity) on many parts of the program that have no interest in this information. An alternative would be to set a global variable before starting the computation, and reset it afterwards; unfortunately, if the computation is interrupted (say by something like the loop exit construct we described earlier), this leaves the variable with the wrong value. Ideally, we would like to set up a structure that

will get control if the default information is ever needed, without getting in the way of the rest of the program. Such an arrangement is called *dynamic binding*. We will illustrate how it can be used both for data and control.

Suppose we want to write something such as the following:

```
#defaultDirectory bindTo: 'Smith' in:
[someComputation]
```

and then have the file system be able to ask for the current default directory by:

```
#defaultDirectory binding
```

Since we want the binding of defaultDirectory to 'Smith' to last only for the duration of someComputation, it follows that in order to find the binding of a dynamic variable, we must examine the data structures that Smalltalk uses to represent the state of a computation. In

|                               |  |
|-------------------------------|--|
| class name                    | Binding  |
| superclass                    | Association "Provides key and value variables, and messages for accessing them"  |
| instance variable names       | "none defined here"  |
| class messages and methods    |  |
| creation                      | of: aSymbol to: aValue in: aBlock    <br>  self new of: aSymbol to: aValue in: aBlock  |
| instance messages and methods |  |
| initialization                | of: aSymbol to: aValue in: aBlock    <br>key -- aSymbol.<br>value -- aValue.<br>  aBlock value "Actually does the computation" |
| class name (existing)         | Symbol   |
| superclass                    | "none added here"  |
| instance variable names       | "none added here"  |
| class messages and methods    |  |
|                               | "none added here"  |
| instance messages and methods |  |
| binding                       | bindTo: value in: aBlock    <br>  Binding of: self to: value in: aBlock  |

Table 9: Templates showing creation of a class template for class Binding (9a) and additions to existing class Symbol (9b).

## A LOGIC ANALYZER FOR \$395?



**YES!**  
**OWL**  
LA 1600-A  
High Speed  
16 Channels

Interfaces to dual channel scope or Apple computer.

- 10 MHZ capture rate
- Gold plated connectors and clips
- Stores 16 words of 16 bits
- Crystal controlled internal clock
- 1, 0, X compare word bit selection
- Time domain display
- Data domain display\*
- Hex display\*
- Internal and external trigger modes

\*Options with use of Apple computer

Comes complete with interconnecting cables; logic probe clips, diskette for Apple computer, and operating instructions.



— Send for FREE brochure —  
**Osborne Wilson Labs.**  
508 Waterberry Drive  
Pleasant Hill, California 94523  
(415) 932-5489

# "THIS IS DIGITALKER" OUT 127,0



This is all it takes to say this or 143 other expressions with MICRO-MOUTH\* No software drivers or subroutines to load MICRO-MOUTH\* the latest Circuit Celler product can be used as an emergency annunciator, as an aid for the handicapped, for process control and to add dimensions to computer games.

Sample phrases that can be programmed are:

"THE TIME IS 4 HOURS 23 MINUTES . . . (BEEP)"

"THE SPEED IS 100 METERS A SECOND . . . SLOW DOWN"

Thousands of expressions can be added by changing the ROM chips. MICRO-MOUTH\* is plug compatible with APPLE II and TRS-80\*.

Directions included for S100, H8 and parallel port operation.

As featured in BYTE, June, 1981

Complete Kit: APPLE II . . . . \$120.00  
TRS-80 Model I . \$150.00

Assembled and tested:

APPLE II . . . . . \$150.00  
TRS-80 Model I w/power  
supply and cable . . . . . \$170.00  
TRS-80 Model III . . . . . \$200.00

\*MICROMOUTH is a trademark of Micromint Inc  
\*DIGITALKER is a trademark of  
National Semiconductor Corp

**MICROMINT INC.**  
917 Midway  
Woodmere, N.Y. 11598  
Dealer Inquiries Invited

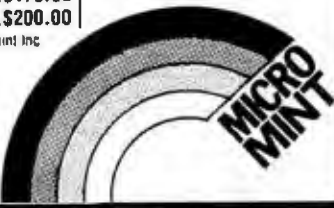

Call 1-800-645-3479,  
in N.Y. 1-516-374-6793

SAVE SALE SAVE SALE SAVE SALE SAVE

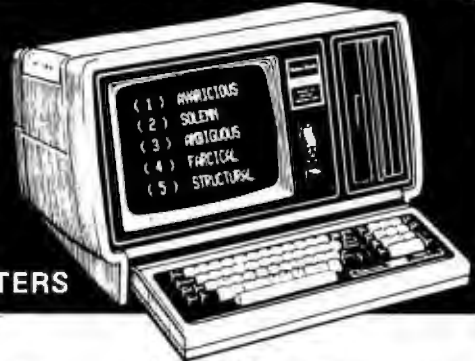

**TRS-80  
COMPUTERS**

Model II 64K 3360.00 freight included  
Model III 32K 2150.00 freight included  
Daisy Wheel Printer 1710.00 freight included

We can save you more on all the TRS-80 Computers, and we will! All items are brand new. We have the full line of TRS-80 computer products. Call collect (303) 945-2864 for price quotes.

**WE PAY ALL SHIPPING  
NO TAXES ON OUT OF STATE SHIPMENTS**

**W-B SPORTING GOODS**  
727 Grand Avenue  
Glenwood Springs, Colorado 81601  
**CALL COLLECT (303) 945-2864**

SAVE SALE SAVE SALE SAVE SALE SAVE

# Does Your Printer Have a One Track Mind? Then You Need The Paper Tractor™

The Paper Tractor™ turns your tractor feed printer into a friction feed printing system. Inexpensively.

With The Paper Tractor you can abandon dull continuous form stock and move into new realms of high quality personalized writing paper. Without costly hardware modifications.

This revolutionary product acts as a carrier, protecting and guiding any standard letter or

Circle 300 on inquiry card.

legal size paper through the printing area. Any paper. Bond, parchment, onionskin, vellum, NCR, manuscript paper (sheet music). Even your company or personal letterhead.

**The Paper Tractor is a unique solution to the restrictive nature of the tractor feed printer.**

- \*Fits 9½" or 15" print frame.
- \*Compatible with Matrix, Impact, Daisywheel and Ink Ejection printheads.
- \*Fits front, back and dual tractor paper feeds.
- \*Designed with self-aligning feed system.
- \*Positions letter or legal size paper automatically with an edge-protecting guide.
- \*Designed for use with forward/reverse plotting printers.
- \*Proven with all major manufacturer's printers, including Epson, Tiger, TI, GP-80M, DEC-Writer, Commodore, Centronics, Radio Shack V VI VII, Beehive, Vista, Grafix-Plus, Axiom, Coment, HI-Q, DIP, C-ITOH, Cromemco, Okidata and many more.

Retails for only \$19.50

**Contact your local computer dealer. If he doesn't carry the Paper Tractor, call or write us.**

**Paper Tractor, Ltd.™**

P. O. Box 4218  
Santa Barbara, CA 93103

**Information line:**

800-235-6967  
In Calif (805) 966-5448

9½"  15" wide printer. Model \_\_\_\_\_

Name \_\_\_\_\_

Street \_\_\_\_\_

City \_\_\_\_\_ State \_\_\_\_\_ Zip \_\_\_\_\_

\* DISTRIBUTORS WELCOME \*

|  |                   |
|--|-------------------|
| class name (existing)  | Symbol            |
| superclass   | "none added here" |
| instance variable names  | "none added here" |
| class messages and methods   |                   |
| "none added here"  |                   |
| instance messages and methods  |                   |
| <i>binding</i>   |                   |
| <b>binding</b>   context   |                   |
| context ← thisContext. "Start here. thisContext is a machine register" |                   |
| [context = nil] whileFalse:  |                   |
| [((context receiver isMemberOf: Binding)                               |                   |
| and: [context selector = #of:to:in: "Is it a binding..."]              |                   |
| and: [context receiver key = self]) "...of this variable?"             |                   |
| ifTrue: "Yes, return its value"  |                   |
| [  context receiver value]   |                   |
| ifFalse: "No, go on to the next context in the chain"                  |                   |
| [context ← context sender]].   |                   |
| self error: ('No binding for' concatenate: self)                       |                   |
| Table 10: Template showing additions to existing class Symbol.         |                   |

particular, even though many messages may be sent in someComputation before the file system needs to find the binding of defaultDirectory, there must be some way to search the stack of methods that have been started but not completed, looking for whatever represents the binding of defaultDirectory. In Smalltalk, each element of this stack is a MethodContext object, and the variable in a MethodContext that refers to its caller is called its sender. So searching this stack just means checking the current context's sender, its sender, and so on, until we find a binding of the variable. We know we have found a binding when we recognize a MethodContext in which the receiver of the message is a Binding (see tables 9a and 9b), and which was created in response to a particular message. During this computation (I aBlock value in table 9a), a MethodContext will exist in which the receiver is the Binding and the message is of:to:in:. This is how we recognize a binding in the stack of MethodContexts. The searching process is shown in table 10.

Note that by combining dynamic binding with the ability to name exit points (eg: by doing #theExit bindTo: to create a BlockWithExit), we can arrange for dynamically bound exceptional events to stop a computation in midstream. More complicated arrangements that allow the parts of the computation being stopped to clean up after themselves are also easy to construct.

#### Coroutines

Generator loops are an example of producer/consumer

TALK'S ~~XXXXXXXXXX~~ INEXPENSIVE

## ECHO<sup>T.M.</sup> SPEECH SYNTHESIZERS

Don't limit your computer! Let it speak its mind with an ECHO SPEECH SYNTHESIZER. There are now three new additions to the ECHO family: the ECHO-80 (TRS-80 MODEL I), the ECHO-GP (general purpose serial/parallel), and the ECHO-100 (S-100). These join the already popular ECHO I (Apple).

All ECHO SYNTHESIZERS use a combination of Texas Instrument's LPC synthesis and phoneme coding to produce an unlimited vocabulary while using a minimal amount of memory. New male and female phonemes and TEXTALKER™ software (converts English text to speech) make them easier to use than ever before.

Speech applications are virtually unlimited, including education, games, and aiding the handicapped. The flexibility and low price of the ECHO SYNTHESIZERS make them the logical choice for adding speech to your system. For further information see your dealer or contact Street Electronics Corporation.



**STREET ELECTRONICS CORPORATION**

3152 E. La Palma Ave., Suite C  
Anaheim, CA 92806 (714) 632-9950

Circle 99 on Inquiry card.

## Find Your Way Around The New Apple® DOS With The Dakin5® Programming Aids 3.3\*



Dakin5 Corporation, a Colorado software house, is making available to the public 12 utility programs on one 16 sector diskette, utilizing the new Apple DOS 3.3, which provides 23% more storage.

All of the Dakin5 Programming Aids 3.3 programs are also compatible with the Corvus Disk Drive system.

### Features

- Remove REM statements, unreferences (dead) code, and compress code to increase program speed and save memory and disk space.
- Copy any file or program from one diskette to another. Only the name is needed.
- Print or display a line cross reference and variable name cross reference.
- Print or display all or selected records from a text file.
- Display any sector of a given file or program, and then update any data within that sector, or specify the sector you wish to update, such as directory sectors and sectors occupied by DOS.

- Create, print and modify your own text and Exec files.
- Perform 20-digit arithmetic.
- Copy a diskette without DOS; initialize without DOS; verify source diskette; verify copied data is the same as the original.
- Use a powerful data entry routine that handles both string and numeric data.

### Plus Many More Utility Programs for Sophisticated Programmers

Many of these utility programs have been developed and tested for in-house use while producing The Controller™ business package for Apple Computer Inc.

Each programming aids package includes a program diskette and very complete documentation, all attractively packaged in a padded, blue print vinyl 3-hole notebook with silver lettering. An identifying tab separates each program for convenient reference.

See your Apple dealer or contact Dakin5 Corporation, P.O. Box 21187, Denver, Colo. 80221. Telephone: 800-525-0463. VISA or MC welcome.

**DAKINS CORPORATION**

Apple is a registered trademark of Apple Computer Inc. The Controller is a registered trademark of Dakin5 Corporation.

# ZVX4 FOUR TIMES THE BYTE

The ZVX4 MEGABYTER is for the APPLE II user who wants to DOUBLE file size, expand the capability of existing business software, and make other SERIOUS applications more viable.

Now you can have compatibility with IBM, INTEL, CP/M\*, Z80 Softcard\*, UCSD Pascal, and others.

Look what the MEGABYTER dual density 8" floppy disk controller, with its LSI circuitry and reliable industry standard IBM 3740 format, means to you:

### INCREASED STORAGE

- Increase online storage to 2 Mega bytes
- Double your maximum accounts and file size
- Add high capacity efficient hard disk backup
- Control up to 4 Shugart SA800/SA850 drives

### IMPROVED COMPATIBILITY

- Operate APPLE DOS 3.1/3.2/3.3, mini disks
- Preserve existing software investment
- Interchange data with other computers

### SIMPLIFIED OPERATION

- Reduce disk handling and I/O slot usage
- Gain automatic single/double density operation
- Change to double sided drives with one switch

Available at your Apple dealer. Call or write today!!



**SORRENTO VALLEY ASSOCIATES**  
11722 SORRENTO VALLEY ROAD  
SAN DIEGO, CA 92121  
(714) 452-0101

\* CP/M trademark of Digital Research, Inc.  
Z80 Softcard trademark of Microsoft, Inc.

## Components Express, Inc.

"Have you kissed your computer lately?"

1380 E. Edinger, Unit CC Santa Ana, CA 92705 (714) 558-3972

### BROAD BAND MICROWAVE RECEIVER SYSTEM 1.8GHZ to 2.4 GHZ

only  
**\$295.00**



With built-in-converter to channel  
2, 3, or 4 of any standard TV set.

RANGE Line of sight to 250 miles

SCOPE Will receive within the frequency band from satellites, primary microwave stations, and repeater microwave booster stations

CONTENTS: Packaged in 19"x19"x4 1/2" corrugated carton complete with:

- 24" Dish
- Feed-Horn Receiver
- Mounting Bracket
- Mounting Clamp
- Instructions
- 300 Ohm to 75 Ohm Adapter
- 750 Ohm to 300 Ohm Adapter
- 60 Feet Coax Cable with Connectors
- 3 Feet Coax Cable with Connectors

### WARRANTY

180 days for all factory defects and electronic failures for normal usage and handling. Defective sub assemblies will be replaced with new or re-manufactured sub assembly on a 48 hour exchange guarantee.

This system is not a kit and requires no additional devices or equipment other than a TV set to place in operation. **DEALER INQUIRIES INVITED.**

Circle 60 on inquiry card.

structures: the supplier produces elements, and the program that invoked the loop construct consumes them. As we saw earlier, one way to do this is to assign responsibility as follows:

#### Producer

implements: do: aBlock  
 delivers values by: aBlock value: theNextElement

#### Consumer

receives values using: [:elementName]  
 dosomethingToTheElement]

Under this arrangement, the producer can use any desired control structure internally, just by sending the message:

aBlock value: theNextElement

to the block whenever a new element has been generated; the consumer, however, is confined to executing the same block for each element. The other arrangement reverses the situation:

#### Producer

implements: atEnd. next  
 delivers values by: returning a value from next

#### Consumer

receives values using: producer next

Under this arrangement, the producer has to use instance variables, rather than control variables, to remember what state it is in, but the consumer can call for new elements using any control pattern it wants.

The control structure *coroutines* allows both the producer and consumer to use any control pattern. Notice that in the first arrangement, the producer has to retain its argument aBlock to be able to send it value: for each element; in the second arrangement, the consumer has to retain the producer to be able to send it next for each element. In the coroutine arrangement, both sides retain a common object called a *port*. The purpose of the port is to remember the control state of one partner while the other partner is running. Let us now build a port in which the consumer invokes the producer with the messages next and atEnd, and the producer invokes the consumer with the messages nextPut: anElement and markEnd. A loop in this implementation might look similar to the following:

#### Consumer

```
| first second |
portForProducer — someCollection asProducer.
"Here is a sample loop that takes elements two at a time"
[portForProducer atEnd]
whileFalse:
  [first — portForProducer next.
  second — portForProducer next.
  "Do something with first and second"]
```

#### Producer Collection

```
asProducer | port |
  port — Port new.
  port producer: [CollectionProducer of:
  self with: port].
  "Create a new process for the producer"
  ↑ port
```

#### CollectionProducer

```
of: aCollection with: portForConsumer | |
  "Here is a sample loop that generates elements three at a
  time"
  [someCondition]
  whileTrue:
    [portForConsumer nextPut:
    someComputation1.
    portForConsumer nextPut:
    someComputation2.
    portForConsumer nextPut:
    someComputation3].
  portForConsumer markEnd
```

The code in both consumer and producer can involve any combination of loops, messages, or other control structures: the consumer can request a new element at any time with portForProducer next, and the producer can deliver an element any time it has control with port-



# Comp Case

● RS205

|         |   |       |
|---------|---|-------|
| ● AP101 | Apple II with Single Disk Drive .....         | \$109 |
| ● AP102 | Apple II with Double Disk Drives .....        | 119   |
| ● AP103 | Apple II, 9 inch Monitor & Double Drives ...  | 129   |
| ● AP104 | Apple ///, two additional Drives & Silentype  | 139   |
| ● AP105 | 12 inch monitor plus accessories .....        | 99    |
| ● RS201 | TRS-80 Model I, Expansion Unit & Drives.....  | 109   |
| ● RS202 | TRS-80 Monitor or TV set .....                | 84    |
| ● RS204 | TRS-80 Model III .....                        | 129   |
| ● RS205 | Radio Shack Color Computer .....              | 89    |
| ● P401  | Paper Tiger 440/445/460 .....                 | 99    |
| ● P402  | Centronics 730/737 - Line Printer II/IV ..... | 89    |
| ● P403  | Epson MX70 or MX80 .....                      | 89    |
| ● CC90  | Matching Attaché Case .....                   | 75    |

**computer case company**

5650 INDIAN MOUND CT. COLUMBUS, OHIO 43213 (614) 868-9464





## Expand Your HEATH/ZENITH-89

- MP/M, multi-user, multi-terminal ..... \$ 375
- The MDS Networking Data Base System with Query, Recovery, Logging, Restructure, more .... \$1400
- Mass Storage
  - 8" REMEX drives, single ..... \$1650
  - dual ..... \$2350
  - ST506 5MB  $\mu$ Winchester ..... \$1400
  - with two drive ACT controller ..... \$2500
- GRAPHICS for the Z-89
  - Maxtek 512x240 graphics board ..... \$ 850
- New IDS Tiger 560 Printer, 14.5", Hi-Res Matrix with Plot and Word Processing firmware ..... \$1595
- PLUS, the whole Magnolia Microsystem line (discounted up to 10%)



1445 Koll Circle, Suite 111, San Jose, CA 95112 • (408) 947-1101  
(call 800/555-1212 for our toll free number)

# K-25 BISYNC SDIC/MSMA

Software for Your Microcomputer

8080 Z80 8086 Z8000

WINTERHALTER & ASSOCIATES, INC.  
SPECIALISTS IN DATA COMMUNICATIONS  
3825 ZEEB ROAD  
DEXTER, MICHIGAN 48130  
313-426-3029 or  
313-665-5582

IBM 2770  
IBM 2780  
IBM 3270  
IBM 3741  
IBM 3780  
IBM 3775

# Radio Shack TRS-80™ COMPUTERS SAVE \$\$\$

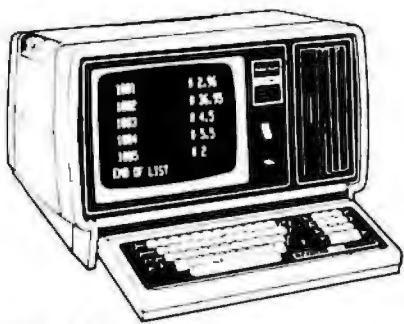

TRS-80  
MODEL II     Reg. \$3,899<sup>00</sup>  
64 K             **\$3,439<sup>00</sup>**  
26-4002

**CALL US**  
For Low, Low  
Prices on All  
RADIO SHACK  
Hardware and  
Software

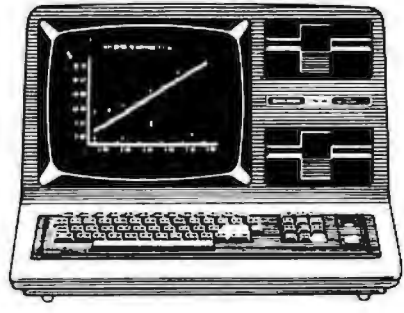

TRS-80 MODEL III     Reg. \$2,495<sup>00</sup>  
48 K; 2 Disks             **\$2,220<sup>00</sup>**  
26-1066

**(209) 526-1475**  
**Radio Shack**  
221 McHenry Ave.  
Modesto, Calif. 95354

*We Pay Shipping*  
*No Tax on Out of State Shipments*  
*Warranties Honored by Radio Shack Stores*

Certified Checks  
Cashiers Checks  
Credit Cards

Franchise Store 7079

ForConsumer nextPut: anElement. Interleaving a consumer that wants pairs of elements with a producer that generates triplets is a very simple example of the freedom that both partners enjoy in this arrangement.

To implement Port we need to consider how Smalltalk

|   |  |
|---|--|
| class name  | Port   |
| superclass  | "none added here"  |
| instance variable names   | consumerSemaphore<br>producerSemaphore<br>nextElement<br>endMark |
| class messages and methods  |  |
|   | "none defined here"  |
| instance messages and methods   |  |
| <pre> initialize producer: aBlock         "Assume we are running in the consumer process, so create a     new process for the producer"     endMark ← false.     consumerSemaphore ← Semaphore new.     producerSemaphore ← Semaphore new.     producerSemaphore signal. "So producer will proceed     the first time"     aBlock fork consumer next   anElement       consumerSemaphore wait. "Wait for producer to deliver     an element"     endMark ifTrue: "No more elements"         [self error: 'Attempt to read past last element'].     anElement ← nextElement.     producerSemaphore signal. "Restart producer"     ↑ anElement atEnd         consumerSemaphore wait. "Wait for an element or end     mark"     consumerSemaphore signal. "Doesn't consume the ele-     ment"     ↓ endMark  producer nextPut: anElement         producerSemaphore wait. "Wait for consumer to have     taken last element"     nextElement ← anElement.     consumerSemaphore signal "Restart consumer" markEnd         producerSemaphore wait.     endMark ← true.     consumerSemaphore signal </pre> |  |
| <p>Table 11: Class template for class Port.</p>   |  |

allows us to get hold of our current control state, since whenever control goes from consumer to producer or vice versa, we have to save the state of the partner that is giving up control. For just such purposes, Smalltalk provides a primitive notion of a *process*, an entity which has its own control state and can be suspended and resumed. The usual way to create a new process is with:

```
aProcess ← [someComputation] newProcess.
```

The process can then be started up by:

```
aProcess resume
```

and it will compute "in parallel" with the current computation until it finishes *someComputation* or it (or some other process) executes:

```
aProcess terminate
```

which stops it midflight. Alternatively:

```
[someComputation] fork
```

creates and starts an unnamed process that will proceed until the computation finishes.

To allow processes to synchronize their control or their use of data in an orderly way, Smalltalk provides *semaphores*. A semaphore logically represents the current availability of a finite resource: aSemaphore signal indicates that one unit of the resource has just become available, and aSemaphore wait indicates that the currently running process needs to take one unit of the resource and must wait if none is available (presumably until some other process does aSemaphore signal). A useful special case of this is a semaphore that always holds either 1 (meaning a resource is available) or 0 (meaning it is unavailable).

As an aside, we note that semaphores could have been implemented in Smalltalk (ie: not as primitive entities) at a considerable cost in performance: we only need the ability to temporarily guarantee that no other process could run aside from the one currently running (on this processor in a multiprocessor system). Smalltalk provides semaphores at a primitive level because they are such a help in building multiprocess systems that we wanted people to feel free to use them without worrying about their cost.

Given processes and semaphores, we are ready to implement Port (see table 11). The producer and consumer will each run in a process of their own, and we will use semaphores to make sure only one of them is running at a time. (The reader can easily imagine and might enjoy thinking about a version of coroutines which allows the producer to "get ahead" of the consumer. This requires a queue between the two, like the SharedQueue we will develop later.) The "resource" controlled by the semaphores will be free access to the variables in the port, nextElement and endMark, under the following arrange-

**GENERAL LEDGER • PAYABLES  
RECEIVABLES • ORDER ENTRY  
INVENTORY CONTROL • PAYROLL  
JOB COSTING • WORD PROCESSING  
DATA BASE MANAGEMENT**

Quick up and running  
Step by step instruction manual  
Complete instructions—over 900 pages  
Free telephone assistance

All Bookkeeping packages are Interactive or Stand Alone  
Originally developed by Osborne and Associates  
Return within 15 days if not satisfied for refund  
CRT Independent—runs on any terminal  
Requires 2.2 CP/M and 2.07 C-Basic  
Up and running on: Altos, any 8" Single density CP/M  
system format, Altos, Cromemco, Dynabyte,  
TRS-80 Mod II, Northstar DD, Vector Graphics.  
Many others. Sample data with each program

|                            |       |                         |       |
|----------------------------|-------|-------------------------|-------|
| General Ledger .....       | \$195 | Inventory .....         | \$395 |
| Payables .....             | \$195 | (Manufacturing)         |       |
| Receivables .....          | \$195 | Inventory .....         | \$395 |
| Payroll and Job Costing .. | \$195 | (Wholesale)             |       |
| Order Entry .....          | \$395 | Inventory .....         | \$395 |
| Manuals for above .....    | \$20  | (Retail)                |       |
|                            |       | Manuals for above ..... | \$20  |

**MARATHON COMPUTER SYSTEMS**  
575 Middlefield Road Suite #J  
Palo Alto, CA 94301, 415-328-5391  
VISA • Master Charge • C.O.D. • Company Check  
TRS-80 is a Trademark of Radio Shack, Inc.  
CP/M is a Trademark of Digital Research, Inc.

Spelling Errors?  
Does your TRS-80\* wordprocessor need help?

**PROOFREADER™**

**CAN SPELL rendezvous AND mnemonic  
AND OVER 38,000 OTHER WORDS**

Now let your TRS-80 and Proofreader by Soft-Tools check your Script\*, Electric Pencil, or other documents for spelling and typographical errors. It has all of the features needed to meet your proofreading requirements.

- Checks every single word of even your biggest document in under 5 minutes.
- The 38,000 word dictionary is one of the largest available.
- Dictionary can be easily extended to add more words such as technical terms or names.
- All unknown words are listed on the screen and can be saved on a file for printing.
- Works with almost any TRS-80 wordprocessor including Script and Electric Pencil.
- Comes with complete and easy to understand User's Manual.
- Developed for the TRS-80 by a Ph.D. in Computer Science.

|           |   |          |
|-----------|---|----------|
| MODEL-I   | Requires 32 K RAM, 1 disk drive, TRSDOS* or NEWDOS..... | \$54.00  |
| MODEL-II  | Requires 64K RAM, 1 disk drive, TRSDOS Version 2.0..... | \$109.00 |
| MODEL-III | Requires 32 K RAM, 1 disk drive, TRSDOS.....            | \$64.00  |

User's Manual only, specify model..... \$3.00  
When ordering, specify model, memory size, number of drives.

Other professional quality software tools available from Soft-Tools include: SOFT-SCREEN™ - a full screen text editor for the Model-II and III, Ratfor - a structured programming language pre-processor for FORTRAN, PP-Ratfor - an automatic program pretty printer for Ratfor plus more in the coming months. Please call or write for more details.

**SOFT-TOOLS™**

Orders sent postpaid by first class mail.  
Terms: Cash, check, money order, VISA,  
or MASTERCARD. NH residents add 4% tax.  
Dealer inquiries invited.  
Proofreader, Soft-Tools, and Soft-Screen are trademarks of Soft-Tools.  
\* Trademark of Tandy Corporation.



**SOFT-TOOLS**  
P.O. Box 338  
Dept. B  
Tijeras, NJ 07056  
(609) 261-1634

TOLL FREE OUTSIDE CALIFORNIA 1(800) 423-5886

**QSTAR PRESENTS  
the QRAM  
16K Ram Expansion Board  
for the Apple II\***



- Expands your 48K Apple to 64K of programmable memory
- Works with Microsoft Z-80 card, Visicalc, LISA ver 2.0 and other software
- Eliminates the need for an Applesoft\* or Integer Basic ROM Card
- Includes Installation and manual
- Fully assembled and tested
- FULL ONE YEAR warranty including parts and labor

**Introductory Price: \$149.00**

\* Apple is a registered trademark of Apple Computer, Inc.

**Apple II & II Plus**

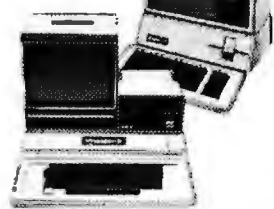

16K-Call 32K-Call 48K-Call

**APPLE III is Here**  
CALL TODAY and be the first to have the most powerful professional computer in its class!



**MONITORS**  
9" Black and White Only \$185.  
Also available in Sanyo  
12" Black and White  
12" Green and Black \$225

**PRINT WHEELS AND THIMBLES**  
Huge selection for Qume, Diablo, NEC. Plastic or metal. Call

**THE HP-85**  
The HP-85 is a powerful BASIC language computer complete with keyboard, CRT display, printer, and tape drive — all in one compact unit.

OUTSIDE CA CALL TOLL FREE 1(800) 423-5886. IN CA (213) 996-2252

**SEND ALL MAIL ORDERS TO:**  
Telex: 1820852  
Answer: MICKO TZNA



Prices subject to change without notice. Please allow time for checks to clear. Add 2% for shipping and handling — \$5.00 minimum. California residents please add 6% sales tax. Sorry, no C.O.D.

**WHEN IN CALIFORNIA VISIT OUR RETAIL LOCATIONS**  
In Torrance/Lawndale Computer World 16206 Hawthorne Blvd. (213) 370-1577  
In Woodland Hills 20929 Ventura Blvd. (213) 704-6895

## Consumer

"In portForProducer next:"

consumerSemaphore wait.

"Semaphore started with 0, consumer waits."

anElement -- nextElement.

producerSemaphore signal.

"Semaphore had 0, now has 1"

| anElement

## Producer

"In port nextPut:"

producerSemaphore wait.

"Semaphore started with 1, now has 0"

nextElement -- anElement.

consumerSemaphore signal.

"Semaphore started with 0, now has 1"

"nextPut: returns, producer proceeds."

"Later, producer does another port nextPut:"

producerSemaphore wait.

"Semaphore goes from 1 to 0 again"

Table 12: Dialog between consumer and producer objects using the Port defined in table 11.

ment: when consumerSemaphore has a 1, it means nextElement has something in it (or endMark has been set) and the consumer needs to run; when producerSemaphore has a 1, it means nextElement is vacant and the producer needs to run. Notice that the next and nextPut: methods are very similar.

A partial trace through an exchange of control would look like the dialog shown in table 12. Note that if the producer reached the second wait before the consumer took the first element, the producer would wait until the consumer did the producerSemaphore signal. A full discussion of how semaphores should be used to produce minimum waiting, minimum process switching, and correct synchronization is beyond the scope of this article; one important and useful special case will be presented in

the following section.

### Monitors—Asynchronous Structures

Even in personal computer systems there are often reasons to allow for the possibility of several things happening "at once" (ie: not synchronized with each other beforehand). The best examples involve communication with other users. For example, your machine could be listening for incoming messages through a network connection. But even on an isolated personal machine, you would like to be able to start the system on a time-consuming project (like printing on a hardcopy device) and continue to do interactive work. As we saw before, Smalltalk provides the ability to create independent processes and set them going "in parallel," and provides

## WE'VE DONE IT AGAIN: 64K OF S-100 STATIC RAM — PLUS Z80A CPU BOARD — FOR AN AMAZINGLY LOW \$899!

That's right, \$899...and Mullen Computer Products makes it possible! We bought a batch of production overrun Z80A CPU boards, along with static RAM boards with some minor cosmetic defects, from a leading IEEE-696/S-100 board manufacturer. For expanding present systems or upgrading older systems to the current state-of-the-art, these boards are the lowest priced around. But you don't sacrifice one bit of quality—here's what we mean:

**64K Static RAM**—Includes bank select and extended addressing for maximum flexibility. Fast low power operation, many convenience features.

### 32K STATIC RAM BOARDS ALSO AVAILABLE SEPARATELY FOR \$399.

Some boards as described above; all that's needed to complete these fast, low power memories is to insert some ICs into the board's sockets and solder in a few other parts. With instructions and all components. Don't miss out on this exceptional memory offer! (Limited quantity, first-come-first-served.)

**CPU Board**—Runs at 4 MHz and takes full advantage of all Z-80A features. Features include maskable interrupts, extended addressing, RAM/ROM sockets for optional RAM/ROM, and much more.

Boards may be assembled or partially assembled; instructions included on how to complete partially assembled boards (takes less than an evening's work), along with all other documentation. Best of all, you'll end up with the same reliable, low power performance you've come to expect from the boards made by this prominent company.

Don't miss out on the CPU/memory deal of the year—these are limited quantity, first-come-first-served.

**MULLEN Computer Products**  
BOX 6214, HAYWARD, CA 94544

CONDITIONS OF SALE: VISA® /Mastercard® accepted, call (415) 753-2886, include \$1.50 for shipping and handling, California residents add tax. Z80 is a trademark of Intel.

# BUY COMPUTERS BY MAIL ORDER AND SAVE 16%

## APPLE HARDWARE

|                              |            |
|------------------------------|------------|
| 48K                          | \$1,189.00 |
| Disk with Controller         | \$ 540.00  |
| Disk                         | \$ 440.00  |
| Pascal                       | \$ 445.00  |
| Graphics Tablet              | \$ 655.00  |
| Versawriter Digitizer System | \$ 215.00  |

## TERMINALS

|                |           |
|----------------|-----------|
| Zenith Z-19    | \$ 789.00 |
| Soroc IQ120    | \$ 729.00 |
| Televideo 850  | \$ 889.00 |
| Televideo 920C | \$ 759.00 |
| Televideo 912C | \$ 729.00 |
| ADDS Viewpoint | \$ 589.00 |

## SOFTWARE

|                               |            |
|-------------------------------|------------|
| Superbrain Double Density 64K | \$2,650.00 |
| Quad Density 64K              | \$2,977.00 |

## NORTHSTAR

|                 |            |
|-----------------|------------|
| Horizon-2-64 QD | \$3,350.00 |
|-----------------|------------|

## VERBATIM & MEMOREX

|        |          |
|--------|----------|
| 5 1/4" | \$ 27.50 |
|--------|----------|

## MONITORS

|                |           |
|----------------|-----------|
| Leadex 12" B&W | \$ 138.00 |
| 12" GP         | \$ 152.00 |

ATARI 800 16K \$ 775.00

## PRINTERS

|                         |            |
|-------------------------|------------|
| T1 Basic Serial         | \$1,495.00 |
| Epson MX-80             | CALL       |
| Centronics 737 Parallel | \$ 718.00  |
| IOS 560                 | \$1,395.00 |

Send certified check (regular checks require 2 weeks to clear) or charge to VISA or Master Charge. Customer pays shipping.

## MIRO COMPUTERS, INC.

27 Long Meadow Place South Setauket, L.I., N.Y. 11720  
(516) 423-7955 CALL MON.-SAT., 10AM-6PM

Circle 220 on Inquiry card.

Take Along Your  
Apple  
in



# MICROCASE

Convenient for Business, School, Home or Travel Pack your Apple in lightweight MICROCASE. MICROCASE holds Apple II or Apple II Plus, two disk drives and Silentype protected by five inches of dye cut foam inside a plastic shell with a foam divider pad. Outside case is made of heavy-duty cordura in Cobalt Blue or Desert Tan. MICROCASE is waterproof, weighs under 4 lbs., and withstands 150 lbs. of pressure. Your Apple never had it so good! Available at your dealer or through manufacturer with money back guarantee.

**One Time Only Offer!** Aug. 1 - Sept. 15 \$99.00  
(after Sept. 15, \$120.00)

Send check or money order to:

## Casemaker

13715 Quito Road • Saratoga, CA 95070  
(toll free) 800/543-3000 ext. 3622

\*MICROCASE also available for Epson printers

# MARYMAC INDUSTRIES, INC.

In Texas Orders  
Questions & Answers  
1-713-392-0747

21969 Katy Freeway  
Katy (Houston) Texas 77450

To Order  
1-800-231-3680  
800-231-3681

## SAVE BIG DOLLARS ON ALL TRS-80<sup>1</sup> HARDWARE & SOFTWARE

TRS-80<sup>1</sup> BY RADIO SHACK. Brand new in cartons delivered. Save state sales tax. Texas residents add only 5% sales tax. Open Mon.-Sat. 9-6. We pay freight and insurance. Come by and see us. Call us for a reference in or near your city. Ref: Farmers State Bank, Brookshire, Texas.

## WE OFFER ON REQUEST

- Federal Express (Overnight Delivery)
- Houston Intercontinental Airport Delivery (Same Day)
- U.P.S. BLUE (Every Day)
- References from people who have bought computers from us probably in your city
- Telex 77-4132 (Flaks Hou)

<sup>1</sup> TRS 80 is a Registered Trademark of Tandy Corp

ED McMANUS

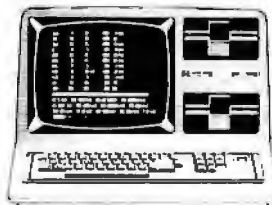

In stock TRS-80 Model II and III

No Tax on Out of Texas Shipments!

Save  
**10% 15%**  
OR MORE

We Specialize In Overseas Shipments

Telex 77-4132 (Flaks Hou)

## WE ALWAYS OFFER

- NO extra charge for Master Card or Visa
- We use Direct Freight Lines. No long waits.
- We always pay the freight and insurance
- Toll free order number
- Our capability to go to the giant TRS-80<sup>1</sup> Computer warehouse 5 hours away, in Ft. Worth, Texas, to keep you in stock.

JOE McMANUS



|   |  |
|---|--|
| class name  | Queue  |
| superclass  | Object   |
| instance variable names   | array writer reader  |
| class messages and methods  |  |
| creation  | <b>new: size</b>    <br>↑ self allocate init: size                                       |
| instance messages and methods   |  |
| initialization  | <b>init: size</b>    <br>array ← Array new: size.<br>reader ← 0.<br>writer ← 0           |
| access  | <b>removeFirst</b>    <br>reader ← reader + 1.<br>↑ array at: reader                     |
|   | <b>addLast: anElement</b>    <br>writer ← writer + 1.<br>array at: writer put: anElement |
| <b>Table 13:</b> Class template for an initial implementation of class Queue. |  |

|  |                      |
|--|----------------------|
| <b>Process A</b>   | <b>Process B</b>     |
| reader ← reader + 1.   | reader ← reader + 1. |
| ↑ array at: reader   | ↑ array at: reader   |
| <b>Table 14:</b> Execution of the removeFirst method using the implementation of table 13. |                      |

|  |   |
|--|---|
| class name   | SharedQueue   |
| superclass   | Object  |
| instance variable names                                | array writer reader<br>accessSemaphore  |
| class messages and methods                             |   |
| creation   | <b>new: size</b>    <br>↑ self allocate init: size  |
| instance messages and methods                          |   |
| initialization   | <b>init: size</b>    <br>array ← Array new: size.<br>reader ← 0.<br>writer ← 0.<br>accessSemaphore ← Semaphore new.<br>accessSemaphore signal "Give it the baton" |
| <b>Table 15:</b> Class template for class SharedQueue. |   |

semaphores for synchronizing their behavior.

From semaphores we can easily build a more useful construct, called a *monitor*. The purpose of a monitor is to allow several processes to communicate with a data structure without getting in each other's way; failing to provide for this is another common source of bugs—consider the simple-minded implementation of a queue given in table 13. (The reader should ignore the obvious bugs: there is no check for an empty queue or for exceeding the size of the array.)

Suppose two processes both try to remove an element at about the same time, and the removeFirst method gets executed as shown in table 14 (the flow of time is vertical down the page, interleaving the statements executed by process A in the left column and process B in the right). One element is skipped—and one is returned twice! The solution to this problem is to consider "permission to update the state of the queue" as a resource that only one process can hold at any given time, like the baton in a relay race. So we can construct a safe Queue by giving it a semaphore that starts out with one unit of the resource (see table 15).

A pattern we will encounter in the implementation of SharedQueue will be to reserve a resource during the execution of a piece of code:

```
someSemaphore wait.    "Acquire the resource"
someComputation.
someSemaphore signal. "Release the resource"
```

The code someComputation is called a *critical section*. We would like to be able to write the previous code fragment as:

```
someSemaphore critical: [someComputation].
```

|  |   |
|--|---|
| class name (existing)  | Semaphore   |
| superclass   | "none added here"   |
| instance variable names  | "none added here"   |
| class messages and methods   |   |
|  | "none added here"   |
| instance messages and methods  |   |
| critical sections  | <b>critical: aBlock</b>   result  <br>self wait. "Acquire the resource"<br>result ← aBlock value. "Do the computation, save the result"<br>self signal. "Release the resource"<br>↑ result "Return the result of the computation" |
| <b>Table 16:</b> Template showing additions to existing class Semaphore. |   |

# Disc/3 MART, INC.

## GO FOR IT!

FOR PRICE, QUALITY & RELIABILITY

|  |           |
|--|-----------|
| ACOUSTIC COUPLERS .....                | CALL      |
| ADDS VIEWPOINT Terminal                | \$ 585.00 |
| ANACOM Printer (Ser/Par) 150 CPS ..... | 1095.00   |
| ANADIX Printer DP-9000 .....           | 1199.00   |
| BASE 2 850 Impact Printer .....        | 700.00    |
| EATON Dot Matrix Parallel .....        | 399.00    |
| EPSON Printers (All) .....             | CALL      |
| MICRO TERM Terminals .....             | CALL      |
| OKIDATA Microline Series .....         | CALL      |
| PAPER TIGER 460G .....                 | 1145.00   |

**COMBINATION SPECIAL:** .....

Apple II Plus 48K, w/Drive & Controller;  
Epson MX80 Printer,  
Interface & Cable .....

2225.00

CALL FOR QUOTES ON ANY OTHER MICRO PRODUCTS

We are dealers for BASF, DYSAN, 3M(SCOTCH) Dis-  
kettes, Cartridges, Mag Tape, etc. In addition we carry a  
complete line of Printer Ribbons and other data process-  
ing accessories.



1840 LINCOLN BLVD.,  
SANTA MONICA, CA 90404  
(213) 450-5911 (CALL COLLECT)

PRICES SUBJECT TO CHANGE

## Complete AIM 65 Expansion

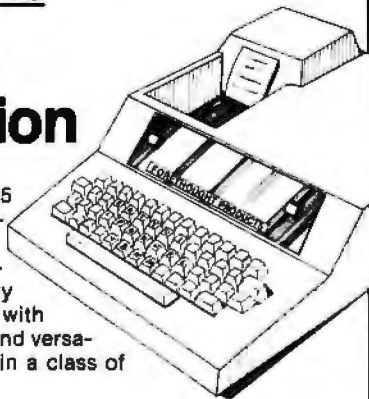

For complete AIM 65 expansion, Forethought Products brings you the AIM-Mate Series, quality expansion products with price, performance and versatility that puts them in a class of their own.

AIM-Mate Series expansion, including RAM (to 48K), PROM, I/O, video and floppy disk interface, STD BUS interface, parity protection and more, lets you configure the kind of system you need.

The compact AIM-Mate case puts it all together in a sturdy, portable, desk top unit.

Write today for complete details on the AIM-Mate System- AIM 65 expansion products for the professional.



87070 Dukhobar Road, Eugene, Oregon 97402 (503) 485-8575

## Introducing a totally new world in professional software for the Apple II and Commodore Pet.

Until recently, the tremendous explosion in micro-computer technology left an unfilled void in real quality software. MicroCraft Systems is totally dedicated to filling that void for the Apple II and the Commodore Pet. With powerful, elegant and versatile software.

### Beyond the software house. To a complete 6502 development system.

More than a software distributor or discount house, MicroCraft Systems now provides you with access to a whole new spectrum in software systems. MicroCraft software includes: MacroLink, a complete macroassembler for the 6502, SuperEdit, a full-screen editor with a superb range of powerful capabilities plus, DiskScreen, a screen-oriented disk utility. Complete System \$200/\$40

### MacroLink \$125/\$20

Uses text files for source code • Links source code or object code programs • Fully nestable file include capability • Recursive macros • Nestable conditional assembly • Over 50 error messages • File I/O macros • Sample programs • Disk assembler: source code need NOT fit in memory.

### SuperEdit \$75/\$20

Full Screen Editor • Single keystroke commands • Uses standard text files • Move cursor by character, line or page • Block move and copy • Search and replace • Macro capability • Plus extra software: SuperEdit '56 x 27' provides 56 x 27 character screen for Apple II • And more!

### DiskScreen \$40/\$10

Displays a complete sector in hex and ASCII • Completely visual and interactive • Sector move and copy • To change byte value, move cursor and type.

NOTE: All programs require single disk drive. MacroLink also requires 48K. First price: software and manual. Second price: manual only (applied toward purchase of software).

Call or write for our complete MicroCraft Systems catalog at no extra charge. Other programs include: S.T.A.R. Reading Program • "C" Compiler • Graphics Development Systems • Programs in ROM • SuperEdit for 80 x 24 video cards



## MicroCraft Systems, Inc. In software systems, a name to remember.

188 Kerby Road  
Grosse Pointe Farms, MI 48236  
(313) 881-3089

Source I.D. CL0472

MicroNet I.D. 70270, 222

VISA or MasterCard accepted. Inquire at your local computer store or order direct.

The system actually provides this message to Semaphore, with a straightforward implementation which is shown in table 16. It is then easy to appropriately modify the two messages in SharedQueue (see table 17).

If two processes try to access the queue, the interchange shown in table 18 occurs (with a few steps left out). Note that the variable `anElement` is a local variable, and since the two processes have different contexts (despite the fact that they share the same instance of SharedQueue in this example), the variable `anElement` in Process A is different from `anElement` in Process B.

|   |                     |
|---|---------------------|
| class name  | SharedQueue         |
| superclass  | "none defined here" |
| instance variable names   | "none defined here" |
| class messages and methods  |                     |
|   | "none defined here" |
| instance messages and methods   |                     |
| <i>access</i>   |                     |
| <b>removeFirst</b>   <code>anElement</code>   |                     |
| <code>accessSemaphore</code> critical: "Reserve access for the duration of the block" |                     |
| [ <code>reader</code> ← <code>reader</code> + 1.                                      |                     |
| <code>array</code> at: <code>reader</code> ]  |                     |
| <b>addLast: anElement</b>   |                     |
| <code>accessSemaphore</code> critical: "Reserve access for the duration of the block" |                     |
| [ <code>writer</code> ← <code>writer</code> + 1.                                      |                     |
| <code>array</code> at: <code>writer</code> put: <code>anElement</code> ]              |                     |
| Table 17: Class template for class SharedQueue.                                       |                     |

## Final Comments

Many languages don't have the flexibility we've just described; others, such as assembly language, have great flexibility at the expense of readability. What is it about the Smalltalk-80 language and system that makes all of the foregoing both possible and fairly readable? Three things come to mind:

- The existence of blocks, with and without arguments, and the simple square-bracket notation for writing them. This makes it possible to pass a piece of code to the implementor of a control structure, which can then execute the code whenever and however it is appropriate. ALGOL and LISP have constructs which capture some, but not all, of the power of blocks.
- The ability to manipulate the control state directly, as in the dynamic binding example. Of course disaster can result if you aren't careful, but a challenge like this is necessary to exploit the full power of your imagination. InterLISP (a widely used LISP dialect) has facilities which capture some of the power of Smalltalk in this area.
- The accessibility of the entire system to modification. Several of the examples we've described involve adding messages to fundamental classes like Object and BlockContext. Restraint is important here too. Several LISP systems derive tremendous power from this kind of openness.

Of course, we pay a price for all this flexibility and simplicity. A discussion of the time and space cost of blocks, visible control state, and a completely accessible system is beyond the scope of this article; we will just observe that the elementary instructions which implement control structures (branch, call, and return) take about the same proportion of the total execution time in a typical Smalltalk-80 implementation as they do in more conventional languages that don't use globally optimizing compilers. ■

| Process A  | Process B   |
|--|---|
| <code>accessSemaphore</code> wait  |   |
| "Semaphore now has 0 units of resource"  |   |
| <code>reader</code> ← <code>reader</code> + 1.   |   |
| <code>anElement</code> ← <code>array</code> at: <code>reader</code> .                            |   |
| <code>accessSemaphore</code> signal.   |   |
| "Process B can proceed now, but immediately reacquires the semaphore"                            |   |
|  | <code>accessSemaphore</code> wait.                                    |
|  | "Waits here"  |
|  |   |
|  | <code>reader</code> ← <code>reader</code> + 1.                        |
|  | <code>anElement</code> ← <code>array</code> at: <code>reader</code> . |
|  | <code>accessSemaphore</code> signal.                                  |
|  | 1 <code>anElement</code>  |
| 1 <code>anElement</code>   |   |
| Table 18: Execution of the <code>removeFirst</code> method using the implementation of table 17. |   |



# Main/Frames from \$200

# Main/Frames from \$200

- 14 Basic Models Available
- Assembled & Tested
- Power Supply:  
8v@15A, ± 16v@3A
- 15 Slot Motherboard  
(connectors optional)
- Card cage & guides
- Fan, line cord, fuse, power  
& reset switches, EMI filter
- 8v@30A, ± 16v@10A  
option on some models



Rack mounted Main/Frame



8" Floppy Main/Frame (includes power for drives and mainframes)

Write or call for our brochure which includes our application note: 'Building Cheap Computers'

## INTEGRAND

8474 Ave. 296 • Visalia, CA 93277 • (209) 733-9288  
We accept BankAmericard/Visa and MasterCharge

# STRETCH THE POWER

Of Your HP-85 or Commodore Pet/CBM With TNW's IEEE-488 Bus System Building Blocks.



TNW-2000

### TNW's RS-232 SERIAL INTERFACES

Connect your PET/CBM to any RS-232 Serial Printer Plotter CRT Terminal, Modem, or other device

|                 |   |              |
|-----------------|---|--------------|
| <b>TNW-1000</b> | ONE CHANNEL OUTPUT ONLY                                 | <b>\$129</b> |
| <b>TNW-2000</b> | ONE CHANNEL INPUT AND OUTPUT                            | <b>\$229</b> |
| <b>TNW-232D</b> | TWO CHANNELS, INPUT & OUTPUT, 12 RS-232 CONTROL SIGNALS | <b>\$369</b> |

### TURN YOUR PET INTO A TERMINAL

Access Timesharing Systems and Bulletin Boards with TNW's Pterm Software and full service telephone modem

|                |                                    |              |
|----------------|------------------------------------|--------------|
| <b>TNW-103</b> | AUTO ANSWER/AUTO DIAL USE WITH DAA | <b>\$389</b> |
|----------------|------------------------------------|--------------|

Pterm also works with acoustical couplers and other modems interfaced to the PET with the TNW-2000 or TNW-232D. Electronic mail and TWX Terminal programs also available. All units are addressable IEEE-488 devices, complete with power supply cabinet, full documentation and one year warranty.

## TNW CORPORATION

3351 Hancock St • San Diego, CA., 92110 (714) 225-1040  
TWX910-335-1194  
Visa/Mastercharge Welcome • Dealer inquiries invited

# THE SYSTEM INTEGRATORS

- Are you tired of installing systems that cannot expand to meet your needs?
- Are you tired of the problems of interfacing multi-vendor systems?
- Are you tired of receiving new systems that don't work and waiting days or weeks for replacements?
- Are you tired of making a computer investment and not receiving the professional help and support you deserve?

If you have answered yes to any one of the above questions, you need a change!

We have combined the most flexible microcomputer on the market (Ithaca InterSystems<sup>®</sup>) with reliable, large capacity floppy and hard disk storage systems from Qume, Memorex, Shugart and Priam, along with the most dependable CRTs and printers available today. Using the industry standard CP/M\* Operating System, our turnkey systems are delivered to you fully assembled, tested and burned in.

**PROVEN RELIABILITY** — Our turnkey systems have been performing daily for over a year in high volume point-of-sale operations throughout the country.

**SOFTWARE AVAILABILITY** — A wide variety of application software packages are ready for CP/M systems. Our library contains many of these systems, and it is expanding daily.

**CUSTOM DESIGN** — P.O.S. Terminals, hardware and software interfaces between Ithaca InterSystems and other specialized I/O devices.

**COMPETITIVE PRICES** — Floppy-based systems start at \$7,950, 10MB hard-disk systems with floppy back-up start at \$10,650. These are true turnkey system prices that include CRT, printer, and double-sided/density floppies, tested and burned in.

TALK TO THE PEOPLE WHO SELL CUSTOMER SATISFACTION



## Specialized Business Systems

5306 S. Bannock, Littleton, CO 80120  
(303) 797-8709

<sup>®</sup>Trademark of Ithaca InterSystems, Inc.

\*CP/M is a Registered Trademark of Digital Research

# Is the Smalltalk-80 System for Children?

---

Adele Goldberg and Joan Ross  
Learning Research Group  
Xerox Palo Alto Research Center  
3333 Coyote Hill Rd  
Palo Alto CA 94304

---

For many years our work on the Smalltalk project has carried with it the purpose of creating new technologies that can be used effectively for instruction, both to teach programming and to support the implementation of educational activities. While the Smalltalk-80 system is not specifically designed for school-age children, most of the applications that we developed as tests of the earlier Smalltalk systems were.

This article will present a brief history of the development of the Smalltalk-80 system that focuses on the instructional uses of its various predecessors. A significant part of this history is the redesign of the language syntax. Programming in Smalltalk involves creating a language for communicating among objects; this language is created within the syntactic restrictions of the Smalltalk-80 system. Often the programmer adds an additional level of syntax in which the language for communicating among objects is presented in terms of graphic images. An example of an instructional activity, the *Dance Kit*, illustrates the idea of such a language. Its design was motivated by the rich support for generalization and interactive graphics available in the Smalltalk-80 system.

Our original intention in writing this article was to *disabuse* readers of the idea that the Smalltalk-80 system, like LOGO, is a language for children. We concluded, however, that the other articles in this issue and the two books on the system (see references) will easily accomplish that task. It remains, then, for us to comment on the style of use of the system that our instructional work has taught us. Although there are a few places where knowledge of the Smalltalk-80 system is helpful, this article does not, in general, require such knowledge.

## Learning to Program in Smalltalk

Initially when we ventured out into the schools to teach programming classes, we used a version of Smalltalk known as Smalltalk-72 (see reference 3). Our purpose in teaching these classes was threefold. First, we wanted to know if the language was teachable. In particular, we wanted to devise an appropriate pedagogical

approach that could provide feedback on the design of the user interface as well as a basis for language redesign. And we wanted to begin to find out if software based on the concepts of objects and message-passing offered something special in the way of problem-solving tools for children and adults alike. The outcome of these investigations reinforced the value of the semantics of Smalltalk: that is, from the point of view of supporting computer-based problem solving, we found that the ability to organize information into objects that can be independently explored and linked together to create new kinds of behavior is a powerful computational tool.

Smalltalk-72 took the approach that the syntax was defined by the receiver of the message: the receiver read as much of the message as the receiver's method determined and then passed control to the next remaining token, which was seen as the receiver of the remainder of the message. This design came out of our assumption that the system user should have total flexibility in making the system be, or appear to be, *anything* that the user might choose. However, this meant that the only way that a reader could understand an expression was to execute the methods in his head. Furthermore, if a human could not parse an expression without executing the methods, the system itself would not be able to parse it. Thus Smalltalk-72 was a purely interpretive system, and its performance suffered accordingly.

The syntax design (or lack of it) was an example of taking the "flexibility" position to an extreme. Our experience in teaching Smalltalk-72 convinced us that overly flexible syntax was not only unnecessary, but a problem. In general, communication in classroom interaction breaks down when the students type expressions not easily readable by other students or teachers. By this we mean that if the participants in a classroom cannot read each other's code, then they cannot easily talk about it. Our intention was that the Smalltalk system serve as a communication mediator, but the lack of communication due to the runtime parsing of expressions was hindering this goal.

The Smalltalk-76 system took a stricter approach to

# DON'T BE HELD UP!

## QUALITY SOFTWARE

## DISCOUNT PRICES

Creative Discount Software  
256 S. Robertson, Ste. 2156  
Beverly Hills, CA. 90211

CALL for our catalog  
TOLL FREE

Operator 831

800-824-7888

Alaska/Hawaii 800-824-7919 California 800-852-7777



## What's New With The SoHo Group?

**WORKSHEET** — *The CP/M "What-if" Language.* For any problem that can be attacked by a row-column spreadsheet, this is the professional choice of CP/M users. Define the cells in your report as numbers or by formulas, try the result, substitute new values, and reiterate it interactively. Available for use with *MicroSoft Basic, CBasic, or the North Star Basic-Matchmaker combination.* Requires 48K RAM.

**SuperBatch** — Much faster and more convenient than SUBMIT, this excellent tool allows you to build batches, "stack" many commands on a single line of keyboard input, and return control to the keyboard during a program started in batch mode.

**COMPARE** — Compares two ASCII files (text, programs, etc.) and identifies differences including inserted lines. Perfect for use with editors that make BAK files (ED, WordStar, etc.).

**MATCHMAKER II** — This is a very professional piece of systems software that allows CP/M users to run the powerful North Star Basic interpreter. North Star Basic has multi-line functions, files that can be addressed both sequentially and randomly, and many other features. Includes release 5.2.

**CP/M for North Star** — *The North Star factory version.* It runs with the North Star hard disk system as well as with Horizon and Micro-Disk systems.

**North Star Basic and DOS release 5.2** — A really major upgrade. All the software (DOS, Monitor, Basic, etc.) is relocatable.

|  | Complete | Manual Only |
|--|----------|-------------|
| WORKSHEET Language (MicroSoft Basic, CBasic, or North Star/Matchmaker . . . specify) | 199.95   | 19.95       |
| SuperBatch + COMPARE   | 44.95    | 14.95       |
| MATCHMAKER II (includes 5.2)   | 109.95   | 9.95        |
| CP/M for North Star  | 209.95   |             |
| North Star Release 5.2   | 24.95    |             |
| CP/M plus MATCHMAKER   | 299.95   |             |
| CP/M, MATCHMAKER, WORKSHEET  | 459.95   |             |

ALL SOFTWARE RUNS ON ANY STANDARD CP, M SYSTEM

The SoHo Group  
140 Thompson St., Suite 4-B  
New York, NY 10012

Note: Horizon, CBasic, CP/M are trademarks of Compiler Systems, North Star Computers, and Digital Research respectively.

### MICROSTAT

Microstat is an advanced statistics package designed for use in research, education and industry. Microstat is a file-oriented statistics package with a Data Management Subsystem (DMS) that creates the data files plus the ability to: edit, list, destroy, delete cases, augment, sort, rank-order, lag, move, merge and transform the data. The data transforms include: add, subtract, multiply, divide, reciprocal, log, natural log and antilog, exponential, linear transformations plus adding any number of variables to create new variables.

Once the file is created, it can be used to produce: Descriptive statistics, Hypothesis tests (mean and proportion), ANOVA (one-way, two-way and random blocks), Scatterplots, Frequency distributions, Correlation analysis, Simple and Multiple regression, Time Series, Nonparametric tests (11 of them), Crosstabs and Chi-square, Factorials, Permutations, Combinations, and 8 Probability distributions.

The price of Microstat is \$250.00 and the user's manual is available for \$20.00 and includes sample printouts. Since the printouts reference standard statistics textbooks and journal articles, you can compare the accuracy of Microstat to results produced on much larger systems. No other statistics package seems to have the confidence to do that . . . at any price.

Microstat is available for the North Star DOS and Basic, Microsoft's Basic-80™ (5.03 or later) and Compiler Systems' CBasic2™. Please specify 8" SD (soft-sectored) or North Star 5¼" disk when ordering.

ECOSOFT  
P.O. Box 68602  
Indianapolis, IN 46268  
(317) 283-8883



### INTERCHANGE

If you use the CP/M™ operating system, life just got a whole lot easier for you. Interchange is a Z-80™ assembly language program that gives you all of the features that PIP doesn't, plus several unique features. Some of the features of Interchange include:

**DIR**, in the usual fashion, plus listing all files excluding those with a specified character. Read/write status is also given.

**ERA**, as usual plus exclusive erases. In addition, a "Q" switch can be used to query on each erase, a "W" allows erases of R/O files without query (normally you are queried), and an "R" switch if system files are to be included.

**LIST** permits printer listings with formatting controlled by TAB, WIDTH, LINES and WRAP. If you are using the QT Systems Clock Board, listings include the date and time.

**COPY** including exclusive copies and the optional "Q", "W" and "R" switches plus an "E" switch that queries if the file already exists. It also allows for changing disks in the middle of a copy if either the disk or directory become full. It automatically verifies copies.

**STAT**, with ambiguous, unambiguous and exclusive listings. It produces an alphabetized listing and includes each file length, total directory entries and space used and unused.

Other commands include RENAME (including ambiguous), HELP, START, END, CLEAR, RESET, DATE, TIME, TAB, WIDTH, LINES, WRAP, QT, SETIT and TYPE. Once you've used Interchange, we doubt that you'll ever use PIP again. The price of Interchange is \$59.95 and the manual is available for \$10.00. Orders must be accompanied with your CP/M serial number. Interchange is recommended for a 32K or larger system and will not run with an 8080 CPU. At the present time, only User 0 is supported.

CBasic2 is a registered trademark of Compiler Systems.  
CP/M is a registered trademark of Digital Research.

syntax, making an incremental compiler a vital part of the system design. Expressions could be parsed by the human reader, although full understanding of the expressions required that the programmers choose identifiers and message names wisely. In this way, the programs could be read by other students or teachers. This approach to syntax remains in the Smalltalk-80 system.

In Smalltalk, languages are designed whenever the programmer specifies the message protocol of a class description. These are the languages with which objects in the system share information among themselves as well as with the human user. Users can profit enormously from defining their own language, learning about their native language in the process of constructing another. In addition, the concept of classes and instances provides a uniform way to organize information in Smalltalk. Communication and organization of information are fundamental aspects of problem-solving activities. In this regard, the needs of school children match those of system designers.

In order to teach Smalltalk programming, the pedagogical approach we developed is to present a fully implemented model of something that the student can use and then modify. The idea is to help early learners grow accustomed to computer interaction and to the notion of sending messages in order to invoke behavior from existing objects. The students can then create two or more instances of an existing class and, through experimentation with the messages to which the class of ob-

jects responds, discover the similarities and differences among the instances. In this way, the students apply observation and hypothesis-generating skills while enjoying a highly interactive, graphical discourse with the system. This latter characteristic depends, of course, on the user's ability to provide enticing visual displays of the instances.

We can use this pedagogical approach for learners with varying levels of skills by adjusting the complexity of the initial model. Instruction proceeds by having the students learn to "read" the description of the model (that is, the code). They then modify it so that each existing instance demonstrates a new, shared behavior (ie: the student adds a message/method to the class description). At this level, we are teaching students fairly standard programming skills that involve sequencing of messages to objects. The concept of naming variables was previously explored as part of the process of creating instances of classes. It is further explored in declaring and using temporary variables in support of a method. Self-reference in the form of messages to the object denoted by *self* comes naturally and is not dealt with as extraordinary. The curriculum framework we follow involves:

- use of an already existing model
- reproduction of the model with some addition
- substitution into the model to produce a new result
- introduction of the model into new contexts (ie: using it as a component of some other example)

## DEC LSI-11 Components

Dependable service  
at discount prices

Domestic  
and Export

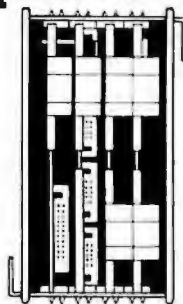

Mini  
Computer Suppliers, Inc.

25 Chatham Rd., Summit, N.J. 07901  
Since 1973

(201) 277-6150 Telex 13-6476

©Mini Computer Suppliers, Inc.  
1979

Fully TRS-80®  
Compatible

MPI B/51  
DISK DRIVE

Includes: Case and Power Supply

In Stock!  
Limited Quantities.

\$ **321**<sup>00</sup>

We pay UPS charges  
in Continental U.S.

Guaranteed for 90 days!

030181

- 40 tracks
- 102K per disk
- 5 ms track-to-track

Save time . . . Order by phone

Toll free: 1-800-621-3229

IN ILLINOIS CALL: 312-887-1024

**FREE CATALOG**

Hundreds of other computer  
products at major savings.

Complete systems  
and a wide selection  
of accessories at  
a discount.

**Midwest  
Computer  
Peripherals**

1467 S. Michigan Ave. Chicago, IL 60605





**COMPUTER SYSTEM DESK**

Overall Dimensions . . . . . 60"L x 24"D x 30"H  
 Terminal Surface . . . . . 34"L x 24"D x 27"H  
 Shelf Will Accept . . . . . 21"W x 24"D x 12 1/4"H

- Designed for commercial use
- Easy to assemble and disassemble
- Radius on outside corners of tops for operator safety
- Separate shelf for computer and disk drives below work surface
- Lower terminal height for operator comfort
- Standard table height section for printers or work area
- Durable formica covered tops, shelf & legs
- Open back on shelf for cables and ventilation
- Modular construction—can add on as system expands
- Enhances user production by providing effective equipment layout

PRICE \$230.00 + SHIPPING (125 LBS)

**COMPUTER CROSSROADS**

3800 SOUTH TAMiami TRAIL  
 SARASOTA, FLORIDA 33579  
 813-349-0200



• TRS-80 • APPLE 2 • ATARI • SCORCERER • PET  
 SCORCERER • TRS-80 • APPLE 2 • ATARI • SCORCERER • PET  
**FREE!**  
 The New Adventure International Catalog is available now! Write to:  
 Adventure International  
 Box 3435  
 Longwood, FL. 32750  
 TRS-80 • APPLE 2 • ATARI • SCORCERER

(305) 862-6917  
  
**Adventure INTERNATIONAL**  
 A DIVISION OF SCOTT ADAMS, INC.  
 BOX 3435 • LONGWOOD, FLA. 32750

**Select a modem for your computer ... easy as ABC.**

**CHOOSE A.** The Smart One™, Model AM232, with its own built in microcontroller. Auto Dials, Auto Answers, Auto Modes (originate/answer), "Direct Connect" for any computer with an RS232 interface . . . \$299.00.

**CHOOSE B.** The Acoustic Modem, Model AM11/A, for the Apple\*. Comes complete with a powerful operating system. Supports 25 easy to use keyboard commands and operates interactively with your programs. No interface card required! . . . \$179.00.

**CHOOSE C.** The "Direct Connect" Modem, Model AM11, for the Apple\*. Comes complete with a powerful operating system. Supports Auto Dial, Auto Answer, 27 easy to use keyboard commands and operates interactively with your programs. No interface card required! . . . \$289.00.

*Be a part of the information revolution. It's fun, exciting, informative, educational. Call or write your order today. COD's accepted.*



**MICROMATE ELECTRONICS, INC.**

2094 Front Street • East Meadow, New York 11554 • Telephone 516.794.1072  
 All "Direct Connect" modems are FCC certified. \*Registered trademark of Apple Computer, Inc.

# POCKET ASCII TERMINAL

**MIDGET  
DUPLEX UNIT  
WITH MAN-SIZED  
CAPABILITIES**

Here's \$395 worth of convenience for anyone working with digital systems. Carry it anywhere in a pocket, valise or toolkit to enter and retrieve data, run diagnostics, change constants, test data links, etc.



- Look at its facilities:
- Transmits 128 ASCII codes
  - Can display last 30 characters received
  - Displays full 64-character ASCII set on clear 16-segment LEDs
  - 25-line RS232/c compatible interface
  - Single 5V supply required at 400mA typical
  - 110 or 300 baud transmission selectable
  - Parity codes, stop bits settable to your standard
  - Obeys bell, cursor and data format control codes

Phone or write us for more details now:

**GR ELECTRONICS**  
1640 Fifth Street,  
Santa Monica, CA 90401.  
Telephone: (213) 395-4774.  
Telex: 65-2337 (BT Smedley SNM).

One introductory example we employed with elementary and junior high school students was a series of projects to use, modify, and extend the definition of a Box description. A box is an object that looks like a square: it can be drawn on the display screen or erased. It can grow bigger or smaller, and turn right or left, and it can be moved to different screen locations.

Suppose we create *jill* as an instance of a Box:

*jill* ← Box new.

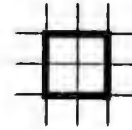

Then *jill* can grow and turn:

*jill* grow: 50.

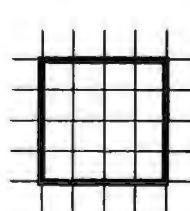

*jill* turn: 45.

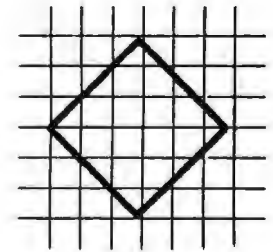

Many boxes can be created:

*jan* ← Box new.

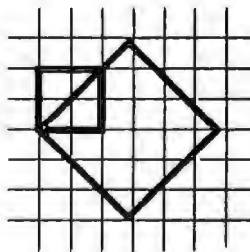

*jan* grow: 25.

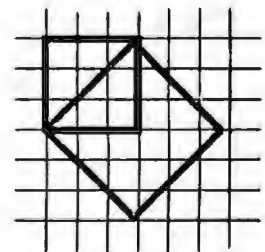

*jan* turn: 90.

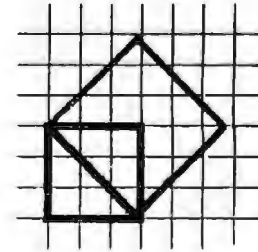

Animations and pretty designs come from sending a sequence of *grow:*, *turn:*, and *move:* messages to the various boxes.

Once the students used several instances of Box, they modified the definition of Box in order to have all its instances follow the display screen cursor as the cursor was moved about by a pointing device. Generalizations of Box led to descriptions of triangles, hexagons, and other polygons. Simple games of "leap frog" or space war

# GET THE BUG OUT OF YOUR PROGRAM!



Locate the bug in your program quickly with the all-new BUG CATCHER. Reliable and easy to use, this timesaver fits easily in pocket or case. Functional for any computer where EPROMs



are used. Capable of halting the cpu at any specific address. Stop losing time and patience. BUG CATCHER is the efficient answer \$195 complete (plus applicable sales tax)



## BUG CATCHER

MARTEC SYSTEMS, INC.  
P.O. BOX 2069, NEWBURGH, NY 12550 (914) 265-4044

# COMPUTERWARE™

## COLOR COMPUTER

PROGRAMMERS TOOLS Monitor Assembler  
• Editor • PASCAL • Diagnostics

GAMES  Color Invaders • Action Games  
• Asteroid Action • Adventures and More

HOME PROGRAMS Data Organizer  
• Home Finance • Educational Programs

MEMORY • BOOKS • ACCESSORIES  
Shipping from Stock

Call or Write:  
 **COMPUTERWARE™**  
 Dept. C • Box 668  
 6809 Specialists Encinitas, CA 92024 • (714) 436-3512  
 Computerware is a trademark of Computerware

### Computers, Peripherals, Unlimited! DON'T MISS THIS MONTH'S SPECIALS!!!

**19" COLOR MONITORS** Manufactured by CONRAC studio quality, full color monitors with built-in de-Gauss, independent R G B & Sync inputs & much much more. Originally over \$1K

- 19" Diagonal Screen
  - by CONRAC: Pro-Quality
  - 120VAC, 50/60 Hz
  - R, G, B & Sync inputs
  - Perfect for Graphics, Etc.
  - Locked Access Door
  - Ideal Color Monitor for All Purposes
  - Like New, Unused (as-is)
- Model #5111/10  
**Only \$479.00**  
each w DATA



**\*Electric-II I/O PRINTER** DC stepper motors position the carrier and platen, and the standard "Electric" selection and function solenoids offer parallel control capabilities. Driver circuitry not included. Fantastic bidirectional capabilities for plotting, proportional spacing and more! Used removed from sophisticated word processors, whole AS-IS. Includes data and info. No type element included. Only.

**\$349.00**  
each

Electric II is a trademark of IBM Corp.  
 Packaging & Handling \$29. Ship. & On Delivery



**12" P-31 VIDEO MONITORS** OEM-QUALITY!!!  
 Motorola #XM 351 featuring adjustable horizontal osc for all display configurations. 117/230 VAC operation. Xfr input for isolation. BNC composite video input, contrast & brightness controls. Used, tested and operational, good cond. 16K64 or 80x24 formats. Originally cost over \$200.00!  
**TOP QUALITY DISPLAY!! DATA INCLUDED.**

**DAISY WHEEL TERMINAL** Tested & Functional. **NOW ONLY \$999.00**

Only **\$79.00**  
each Plus Shipping

Packaging & Handling \$5.00



**COMPUTERS, PERIPHERALS, UNLIMITED!**

Formerly CFR Associates, Inc. - NEW NUMBER -  
**617/372-8637**  
 18 GRANITE STREET  
 HAVERHILL, MASS. 01830

MasterCharge & VISA Accepted



# NEMESIS

FOR CP/M

■ Theus, a level twenty-Raver, finds himself cornered by two fierce Chimera during his exploration of level ten. With lightning quick dexterity he makes five mighty swings with his Vorpal Blade, slaying both attackers. He considers himself lucky - not only has he survived, but he is able to remove the Chimera's Mithril Cloak.

■ NEMESIS... a journey into the unknowns of a multi-level dungeon. There are many factors contributing to the success or demise of your character, not only your character's innate and acquired abilities, but also your ability to react in abundant information to aid you in your quest, including a map of your character's REAL TIME to the changing situations your character encounters. You are given as he desires, and there is no limit to the power your character can acquire as it delves into the mysteries of the dungeon.

■ DUNGEON MASTER allows you to create entire dungeons for Nemesis. You have complete control over the monster population, the items which may be found, and the architectural layout of the dungeon. Up to one thousand levels are allowed in each of the dungeons created.

■ NEMESIS and DUNGEON MASTER are available on the following CP/M media: 8" soft sector, 5" Northstar, 5" Micropolis, 5" Apple II Plus, Vector MZ, and Superbrain DD/QD.

NEMESIS: \$40 for discette and manual.  
 DUNGEON MASTER: \$35 for discette and manual (requires NEMESIS).

First In Software Technology  
**SUPERSOFT ASSOCIATES**  
 P.O. BOX 1628  
 CHAMPAIGN, IL 61820  
 Technical Hot Line: (217) 359-2691  
 (answered only when technician is available)

All Orders:  
 (217) 359-2112



## Ultimate STATIC RAM is here!

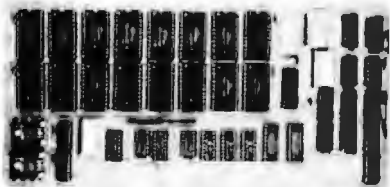

- Bank Select
- Extended Address
- 8/16 bit Data

\$ 295 16KB  
\$ 465 32KB

Assembled and Tested.

Features: Model 32KUS "Uniselect: 3"

- S-100 Bus - confirms with IEEE-696(S100) specifications.
- Data-8 or 16 bit wide, compatible with 8 bit or new 16 bit machines.
- Extended Address - 24 bit addressing.
- Bank Select - by ports and bits, compatible with Cromemco, Alph Micro, North Star, and many others.
- Fully Static and low power - current is 0.6A typical with 32K byte.
- Two separate 16K addressing, 32K bank select with window capability in any 2K increments, any place within the addressed.
- EPROM, 2716, can be mixed with RAM in any place.
- Has provision to take new CMOS mem chips with battery back-up.
- Will support Z80-Z8000 up to 4Mhz clock, 8086/8088 up to 8Mhz.

Other S-100 Boards Available: Z80 based CPU, I/O Memory Interface, 16K Static Ram.

Fully socketed, solder masks, gold contacts and guaranteed for one full year. Delivery: from stock to 72 hours. Ordering: you may call for MC, Visa or COD orders. (Add \$5.00 for C.O.D.) Personal checks OK but M.O. speeds shipping. Allow 7 to 15 days to clear personal checks before shipping. Undamaged boards can be returned within 10 days for full refunds.

Illinois residents add 5 1/4% sales tax.

DEM, Dealer pricing available

### S.C. Digital

P.O. Box 906 Phone:  
Aurora, IL 60507 (312) 897-7749

# S-100 Modem

An Atlanta bulletin board system uses a Hayes S-100 modem around the clock. Since March 1979, it has logged over 21,500 calls and been down a mere 10 minutes. For performance like this, depend on the Hayes Micromodem 100.™ Features include automatic dialing/answering, 45 to 300 baud operation, a built-in serial interface and direct connection to any modular phone jack.

The Micromodem 100—and Micromodem II™ for Apple II® computers—are now available nationwide. Call or write for the name of your nearest dealer.



Hayes Microcomputer Products Inc.

5835 Peachtree Corners East, Norcross, GA 30092 (404) 449-8791

Micromodem 100 & Micromodem II are trademarks of Hayes Microcomputer Products Inc. TM Apple Computer Inc.

were new contexts in which to place the geometric objects. Students discovered that judicious placement of geometric shapes formed pictures, and so "painting editors" were popular project areas for the students.

The resource-center approach we took in locating our computer system in a school emphasized shared projects, so that each student might bring a different skill to a project. Because we feel *design* is at least as important as implementation (programming), we encouraged students with good ideas for projects to act as resources for those students who preferred to write programs. Miniature research teams seemed to form in a natural way. The nonprogrammers on the team did their designs both visually (by sketching drawings of desired outcomes) and verbally. In the latter case, they designed by determining the needed objects and then specifying the language with which these objects would interact. The students benefited from the Smalltalk approach to description even before completing, or perhaps without completing, a running program.

After our experiences in the schools, we felt that further studies of graphical user interfaces were needed in order to improve the visual feedback Smalltalk provides as its programming interface. The Smalltalk-76 system was created primarily as a basis for implementing and studying various user-interface concepts. It gave the users, mostly adult researchers, further ability in refining existing classes through the use of subclassing. This meant that the programmer could now modify a running model without creating a change to already existing examples of that model. *Programming-by-refinement*, then, became a key idea in our ability to motivate our users.

Contrary to the idea that a computer is exciting because the programmer can create something from seemingly nothing, our users were shown that a computer is exciting because it can be a vast storehouse of already existing ideas (models) that can be retrieved and modified for the user's personal needs. Programming could be viewed and enjoyed as an evolutionary rather than a revolutionary act. The frustration of long hours of writing linear streams of code and then hoping to see some aspect of that code execute was replaced by incremental development. Emphasis was placed on learning how to make effective use of existing system components (objects in the Smalltalk sense). Much of the teaching we did was to show users how to search for and read the descriptions of the many useful components we and others (and even new users) continued to add to the system.

Fundamentally, the Smalltalk approach to software has exciting potential for educational use. But why only "potential"? As the system development work has proceeded from our initial work in the schools using Smalltalk-72, greater emphasis has been placed on providing a powerful system that is of interest to computer professionals as well as children. The Smalltalk-80 system, in its approach to providing a programming





interface, focuses more on software development for the professional. But the basic design of the system remains that of collections of objects. There is a clear layering of these objects in terms of system versus user-interface support. Our success in bringing this system back into the classroom depends upon our ability to create a set of useful components (class descriptions) that the user can manipulate, as well as modify and combine, in order to create new components. Among the components already developed toward this goal are text and text editors, graphical images and "sketching" and animation editors, as well as "browsers" for seeking out other, already existing components from libraries of such information. We have begun, but we still have a great deal of work ahead of us to design and store in libraries the viewing and controlling components of graphical user interfaces.

### Kits for Instructional Activities

So far we have commented on the use of the Smalltalk-80 system for programming. In doing so, we have placed a great deal of importance on the existence of a library of components. Such a library is needed for both professionals and nonprofessionals. In order to improve the system for educational use, better support is needed to assist computer-based curriculum designers in developing flexible instructional activities (perhaps in the form of a special library). Several examples of instructional activities that have been implemented in

Smalltalk-72 or Smalltalk-76 are described in Laura Gould and William Finzer's "A Study of TRIP: A Computer System for Animating Time-Rate-Distance Problems", (see reference 5) and Adele Goldberg's "Educational Uses of a Dynabook" (see reference 2).

More recently, we have been trying to work out the idea of a kit for constructing such activities. By a "kit" we mean a set of components and a set of tools (by means of which these components can be viewed and manipulated) that can be used to create many different but related things. Thus, the VisiCalc program (see reference 1) can be viewed as a kit for making business forms; any text editor is a kit for creating textual documents, and any "painting" system such as the Smalltalk ToolBox is a kit for making sketches (see "ToolBox: A Smalltalk Illustration System," by William Bowman and Bob Flegal, on page 369 of this issue).

For developing instructional activities, we believe that a kit can be used as an interface to hide the unnecessary details of the Smalltalk-80 system. A kit could provide a (possibly graphical) interface to the system for the user (student, teacher or curriculum developer) who prefers to focus attention on only one or two aspects of the system. In such a kit, we maintain the Smalltalk approach of selecting objects that respond by receiving a message. The experience gained using one level of the system can be applied to learning successively lower levels. Of utmost importance, the code that implements the kit should be accessible at the next level of interface so that the kit can act as a starting point for further refinement and instructional design.

For the most part, the kits we have designed create new programming interfaces. Most came about by looking at instructional activities from other systems and seeing which ones we liked. We then used the concepts of Smalltalk classes and instances in order to help us generalize the idea of the activity into kit form so that a teacher or student would be able to create personal variations of the activity. The remainder of this article presents an example of a kit that could be implemented in the Smalltalk-80 system.

### Invitation to the Dance: Prelude

Imagine that you are a choreographer, able to direct the movements of a dancer on the stage. As the dancer follows your instructions and you see their effect, you may modify them, partly to more closely fulfill your initial images, and partly because observing the actual execution may give rise to new creative ideas.

Since you probably don't have access to a real stage and a real dancer, imagine that your computer's video screen is the stage on which you can direct the movement of a graphical dancer by means of a simple programming language. You can experiment with different sequences of instructions that direct your graphical dancer to replace parts of itself with other parts (thus raising and lowering its arms and legs) and to move in various directions across the screen. The system that allows you to create such dances is called the "Dance Kit."

## Now Available COMPUSTAR SUPERBRAIN ◉ SUPERBRAIN 5MB

East Coast **DEALERS & OEM's** wanted

Kramer Systems International, Inc. is an authorized and established distributor for the complete Interloc Data Systems Product line. We have a proven record of providing full support and services to all of our customers.

#### COMPUSTAR

Model 10  
Model 20  
Model 30  
Model 40

#### DISC STORAGE SYSTEMS

10 MB  
20 MB  
80 MB

#### SUPERBRAIN

SUPERBRAIN 00  
SUPERBRAIN 5MB

#### SOFTWARE

BASIC-80  
BASIC Compiler  
COBOL 80  
FORTRAN-80  
Accounts Payable  
Accounts Receivable  
General Ledger  
Payroll  
Word Star  
Mail Merge  
Data Star  
Survey Sort  
Word Master  
Spell Star



**FANTASTIC DISCOUNTS AVAILABLE**

#### MAINTENANCE & SUPPORT

On-site maintenance in the Greater Washington area and selected areas throughout the east coast.  
Modular replacement available to all customers with 48 hour response in most cases.  
Our maintenance personnel are experienced knowledgeable professionals who have finished government and commercial technicians in the repair and maintenance of the Superbrain.

Kramer Systems International, Inc. has successfully installed hundreds of COMPUSTARS, SUPERBRAINS and INTERTUBES throughout the world.

Join the **WINNING TEAM** —  
Fantastic opportunities exist NOW!!!

Call or Write  
**KRAMER SYSTEMS INTERNATIONAL, INC.**

8403 Dixon Avenue  
Silver Spring, MD 20910  
301-585-7480

# TERMINALS FROM TRANSNET

PURCHASE PLAN • 12-24 MONTH FULL OWNERSHIP PLAN • 36 MONTH LEASE PLAN

| DESCRIPTION                   | PURCHASE PRICE | PER MONTH |        |        |
|-------------------------------|----------------|-----------|--------|--------|
|                               |                | 12 MOS    | 24 MOS | 36 MOS |
| <b>DEC</b>                    |                |           |        |        |
| LA36 DECwriter II             | \$1,095        | \$105     | \$ 58  | \$ 40  |
| LA34 DECwriter IV             | 995            | 95        | 63     | 36     |
| LA34 DECwriter IV Forms Ctrl. | 1,095          | 105       | 58     | 40     |
| LA120 DECwriter III KSR       | 2,295          | 220       | 122    | 83     |
| LA120 DECwriter III RO        | 2,095          | 200       | 112    | 75     |
| VT100 CRT DECscope            | 1,595          | 153       | 85     | 58     |
| VT132 CRT DECscope            | 1,995          | 190       | 106    | 72     |
| <b>TEXAS INSTRUMENTS</b>      |                |           |        |        |
| T1745 Portable Terminal       | 1,595          | 153       | 85     | 58     |
| T1765 Bubble Memory Terminal  | 2,595          | 249       | 138    | 93     |
| T1 Insight 10 Terminal        | 945            | 90        | 53     | 34     |
| T1785 Portable KSR, 120 CPS   | 2,395          | 230       | 128    | 86     |
| T1787 Portable KSR, 120 CPS   | 2,845          | 273       | 152    | 102    |
| T1610 RO Printer              | 1,895          | 182       | 102    | 69     |
| T1820 KSR Printer             | 2,195          | 211       | 117    | 80     |
| <b>DATAMEDIA</b>              |                |           |        |        |
| DT80 1 CRT Terminal           | 1,695          | 162       | 90     | 61     |
| DT80 3 CRT Terminal           | 1,295          | 125       | 70     | 48     |
| DT80 5L APL 15 CRT            | 2,295          | 220       | 122    | 83     |
| <b>LEAR SIEGLER</b>           |                |           |        |        |
| ADM3A CRT Terminal            | 875            | 84        | 47     | 32     |
| ADM31CRT Terminal             | 1,450          | 139       | 78     | 53     |
| ADM42 CRT Terminal            | 2,195          | 211       | 117    | 79     |
| <b>HAZELTINE</b>              |                |           |        |        |
| 1420 CRT Terminal             | 945            | 91        | 51     | 34     |
| 1500 CRT Terminal             | 1,095          | 105       | 58     | 40     |
| 1552 CRT Terminal             | 1,295          | 125       | 70     | 48     |
| <b>TELEVIDEO</b>              |                |           |        |        |
| 920 CRT Terminal              | 895            | 86        | 48     | 32     |
| 950 CRT Terminal              | 1,075          | 103       | 57     | 39     |
| <b>NEC SPINWRITER</b>         |                |           |        |        |
| Letter Quality, 55 15 RO      | 2,895          | 278       | 154    | 104    |
| Letter Quality, 55 25 KSR     | 3,295          | 316       | 175    | 119    |
| <b>QUME</b>                   |                |           |        |        |
| Letter Quality KSR, 55 CPS    | 3,395          | 326       | 181    | 123    |
| Letter Quality RO, 55 CPS     | 2,895          | 278       | 154    | 104    |
| <b>CENTRONICS</b>             |                |           |        |        |
| 730 Desk Top Printer          | 715            | 69        | 39     | 26     |
| 737 W P Desk Top Printer      | 895            | 86        | 48     | 32     |

FULL OWNERSHIP AFTER 12 OR 24 MONTHS • 10% PURCHASE OPTION AFTER 36 MONTHS

## MICROCOMPUTERS

APPLE • COMMODORE • HP85 • DEC LSI 11

## ACCESSORIES AND PERIPHERAL EQUIPMENT

ADAPTIC CABLES • MODEMS • THERMAL PAPER • RIBBONS • INTERFACE MODULES • FLOPPY DISK UNITS



**TRANSNET CORPORATION**

1945 ROUTE 22 • UNION, N.J. 07083 • (201) 688-7800  
TWX 710-985-5485

# S-100 GRAPHICS



Unretouched photograph

- 512 x 640 matrix available in black and white, gray tones, or color
- Bit mapped design for high speed performance
- Easily expandable from basic black and white by adding memory planes.
- Variety of software: graphical BASIC, Tektronix emulator, printer drivers, character editor
- Compatible monitors and printers available.



**CAMBRIDGE DEVELOPMENT LABORATORY**

36 Pleasant Street, Watertown, MA 02172  
(617) 926-0869

**NOW!**  
FOR ATARI®

# BASIC A+

## FROM THE AUTHORS OF ATARI® BASIC

**NEW!**  
FOR APPLE®

### BASIC A+ for the ATARI 800™

BASIC A+ will rate an A+ from any Atari user! Upward compatible with Atari Basic, it adds statements and features that enhance the Atari 800's real power, flexibility, and ease of use: Superior I/O features for business and other applications. Additional file manipulation commands. Significant help in program development and debug. Structured programming aids. And MORE! A partial list of the enhancements of BASIC A+ includes:

**PRINT USING** (for business, sophisticated)  
**RPUT/RGET** (record I/O) **SET TAB**  
**BPUT/BGET** (binary I/O) **INPUT"..."** **DIR**  
**ERASE** **PROTECT** **RENAME** **TRACE**  
**WHILE...ENDWHILE** **IF...ELSE...ENDIF**  
**PLAYER/MISSILE GRAPHICS**

BASIC A+ requires a disk and 32K bytes of RAM. Since no cartridge is used, BASIC A+ will take advantage of all the RAM (48K bytes) in a maximum Atari 800 system (recommended).

### OS/A+ for the ATARI 800

Simple. Flexible. Powerful. Compatible. A command driven DOS Control Program that allows user-written commands, ease of interface, and total compatibility with all devices and features of the Atari DOS and file system. Using less room than a menu-driven DOS, OS/A+ allows utilities to be dynamically accessed from disk as needed.

### Powerful Utilities INCLUDED with OS/A+

All the following utilities are included in the price of OS/A+ but you can easily add your own for even more flexibility and power.

### EDITOR/ASSEMBLER/DEBUG

**EASMD** is a simple but complete all-in-one assembly language development package for the 6502 microprocessor. The editor provides global functions such as **FIND** and **REPLACE** (with optional query!) and can be used to edit BASIC A+ programs. The assembler supports standard 6502 mnemonics; can include multiple files in a single assembly; outputs the listing to printer, screen, or disk; produces readable error messages and a flagged symbol table; places the object code in memory or to a disk file. The object code produced is compatible with Atari DOS or Apple DOS (BLOAD) as appropriate. The debug capabilities include **STEP**, **TRACE**, mini-assembler, disassembler, and more.

### DUPDSK and FORMAT

Allows creation of master disks, slave disks, and sector-by-sector copies of any OS/A+ disk.

### COPY

Single file copy utility. Destination can be disk, screen, printer, or any device.

### PARTIAL SOURCE CODE

For system equates and some system drivers. Customize your system.

### BASIC A+ for the APPLE II®

All the features\* of our Atari BASIC A+! Includes the advanced commands and programming aids that make Atari Basic flexible, easy-to-use, and powerful:

**DECIMAL ARITHMETIC** (10 digits to the penny)  
**SYNTAX CHECK ON PROGRAM ENTRY**  
**LONG VARIABLE NAMES** (all chars. used)  
**STRINGS UP TO 32K BYTES IN LENGTH**  
**SEMI-COMPILED CODE** (no penalty for those long names)

BASIC A+ requires and takes advantage of all the features and power of OS/A+.

\*Some Atari hardware related features cannot be supported on the Apple II

### OS/A+ for the APPLE II®

A DOS with a **DOCUMENTED** assembly language interface! Simple. Elegant. Upward compatible with the file systems of Apple's DOS 3.2 and 3.3 but with flexibility not available until now. Add your own commands. Add your own device drivers. Easy **FAST** random access from assembly language or BASIC A+. Requires 48K RAM and one disk drive. Hundreds of Apple owners enjoy OS/A+ under its former name, CPA.

### ORDER TODAY!

All software is licensed for single system use only. **PLEASE SEE YOUR DEALER FIRST.** If he cannot supply you, ordering info is below. **DEALER AND DISTRIBUTOR INQUIRIES INVITED**

OS/A+ and BASIC A+ are trademarks of Optimized Systems Software. APPLE and APPLE II are registered trademarks of Apple Computer, Inc. ATARI and ATARI 800 are registered trademarks of Atari, Inc.

Optimized Systems Software  
10379-B Lansdale Avenue  
Cupertino, CA 95014  
(408) 446-3099



Checks, M.O.

|                        |       |       |
|------------------------|-------|-------|
|                        | Atari | Apple |
| OS/A+ .....            | \$ 80 | \$ 80 |
| BASIC A+ .....         | \$ 80 | N/A   |
| OS/A+ & BASIC A+ ..... | \$150 | \$150 |

Add \$5 per package shipping in U.S. 6% tax in CA.

## Setting

The original idea for the Dance Kit came from Bill Finzer, a mathematics teacher at San Francisco State University. Bill was introducing a friend to a Commodore PET computer. Because both he and his friend are fans of an Indonesian dancer called Pak Jana, Bill conceived the idea of teaching his friend about programming in the context of choreography. He wrote a BASIC program called PAKJANA that allowed her to control the movements of a highly stylized dancer on the screen. (It has subsequently been used as a very successful introduction to programming for students in a course called "Computers without Fear.")

The PAKJANA figure is shown in figure 1. It is controlled by a sequence of commands, including a repetition construct. The commands either:

- replace a face, an arm, or a leg

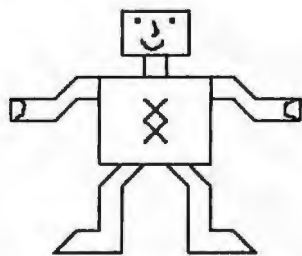

Figure 1: The PAKJANA figure. Children were taught the basic ideas of programming by teaching this figure how to "dance."

- move the whole body up, down, to the right, or to the left
- create a pause (wait command)
- create a repetition of the commands

A large set of "replacement parts" is provided: there are nine different expressions and nine different positions in which any arm or leg may appear. The user specifies these replacement parts and the movements that the dancer can make by choosing from a list of commands in a very simple language. Thus, users can create programs that move the dancer in a predictable sequence of dance routines. (That users may initially find the effects of their programs not entirely predictable only adds to the fun.) The replacement parts for PAKJANA are shown in figure 2. (The program is available from Bill Finzer at the Center for Mathematical Literacy, Mathematics Department, San Francisco State University, 1600 Holloway, San Francisco CA 94132. The project was supported by an Academic Development Grant for the California State College System.)

## Theme

Our Dance Kit evolved from Bill's BASIC program by considering possible extensions given the interactive graphics support of the Smalltalk-80 system. The goal of the Dance Kit is to provide a very flexible programming language by giving the user (the "programmer") the ability to draw the figure for which a dance can be choreographed. This figure not only moves about the screen, but also may change the position, size, shape, or color of its parts. One of the editing capabilities provided to the user of the kit is the ability to draw and subdivide the figure into parts. The user can then draw a set of images that replace each of the subdivisions. We call these replacement parts. They appear on the display screen as a part of the programming language the user can employ to create dance routines. An example figure is shown next to the label POSITIONS in figure 3. The user can view replacement parts of a particular subdivision by pointing on the screen to the part of the figure to be replaced. As an example, see the sequence of display screen views shown in figure 5 on pages 362 and 364.

The programming language also contains "steps" for placing the figure and "bridges" that allow repetition of some sequences of instructions. The steps, GO, TURN,

# Apple Dealers....

We Need  
You



 **apple computer**

We've written TRAV<sup>®</sup>, a complete surveying package that is second to none. It has all the routines needed for surveying. It's menu driven and heavily prompted. The manual was written in straightforward every day surveying language by a third generation surveyor who has been working with computers since 1965. Surveyors are generally accustomed to dedicated calculators or computers. Most of them are just doing their surveying and engineering computations and are not utilizing the capability of a general purpose computer like the Apple to do payroll, G/L, A/P, A/R, word processing or job costing.

That's where you come in. You sell 'em the hardware and the other software and we'll help you sell 'em our program. If you or your customer have questions, we'll be happy to answer them for you.

TRAV is no stranger to surveyors. We're advertising in all national surveying publications. We have satisfied users all over the U.S.

Our discounts are great.  
Call or write for a user manual.

## Surveyors Supply Co.



P.O. Drawer 808 Hwy 64 at Old Hwy 1  
Apex, N.C. (919) 362-7000

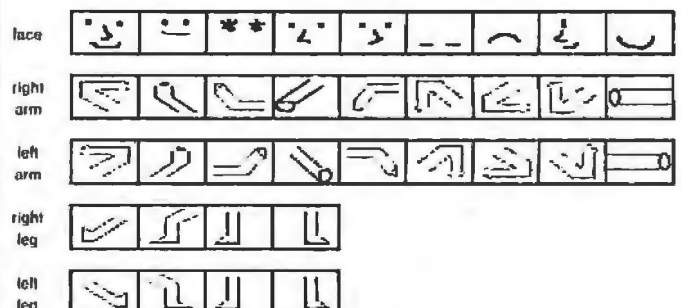
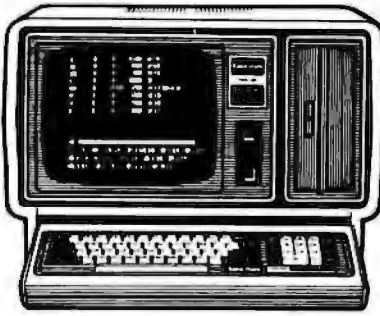

Figure 2: Replacement parts for the PAKJANA figure. Combinations of these options allow the figure to be animated.

THE BIGGEST NAME IN LITTLE COMPUTERS™

TRS-80™ Model II—Your Best Buy  
In a Business Microcomputer



**UP  
TO  
15%  
OFF!**  
on

**TRS-80™ computers,  
software and peripherals**

Similar values on all merchandise

CALL COLLECT:

**915-283-2920**

**Van Horn Office Supply**

701 W. Broadway -- P.O. Box 1060

Van Horn, Texas 79855

DEALER G055

Form F48 Provided

Standard Warranty on Merchandise

THE NATIONWIDE SUPERMARKET OF SOUND™



**MAPS**

**Multi-Application Processing System**



**THREE COMPUTERS IN ONE!**

THE DIGIAC MAPS® CT-80 SYSTEM

**Multi-User, Multi-Tasking, Cost Effective.**

• 3 business systems can run concurrently - that's 3 times the overall system productivity! • Time share word processing, accounting, order processing, inventory, forms processing, billing & more! • 3 workstations can share data base - preparations can be done by several operators concurrently! • All workstations can share common peripherals. • Uses DIGIAC MAPS-80 operating system. (Digital Research MP/M) • High level language processors including Fortran - Basic - Pascal - Cobol. • Complete Turn-key system for ease of operation & learning!



For Additional Information Contact:

MAPS, Commercial Products Division of:

DIGIAC CORPORATION

175 Engineers Road, Smithtown, N.Y. 11787

Phone: (516) 873-8600

MP/M is a trademark of Digital Research Corp.

**PMC PERSONAL COMPUTER**

Ideal for small businesses, schools, colleges homes, etc. Suitable for the experienced, inexperienced, hobbyist, teacher, etc.

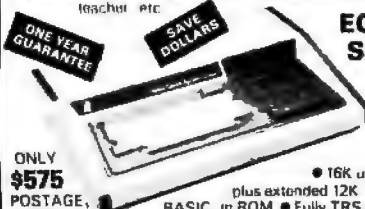

**EG3000 Series**

WITH NEW EXTRA KEYS!

ONLY \$575 POSTAGE \$20

• 16K user RAM plus extended 12K Microsoft BASIC in ROM • Fully TRS 80 Level II software compatible • Huge range of software already available • Self contained, PSU, UHF modulator, and cassette • Simply plugs into video monitor or UHF TV • Full expansion to disks and printer • Absolutely complete - just fit into mains plug



**SHARP PC1211 \$190**

COMPUTER POWER THAT ONCE FILLED A ROOM CAN NOW BE CARRIED IN YOUR POCKET!

• Programs in BASIC • "QWERTY" Alphabetic Keyboard • 1.9K Random Access Memory • Long Battery Life.

**TV GAME BREAK OUT KIT**

Has got to be one of the world's greatest TV games. You really get hooked. Has also 4 other pinball games and lots of options. Great kit for upgrading old amusement games.



MINI KIT PCB sound & vision modulator, memory chip and de code chip. Very simple to construct. \$30.00 OR PCB \$6.00 MAIN LSI \$17.00

**TTL SALE**

|               |                |                 |
|---------------|----------------|-----------------|
| 74LS00 \$0.16 | 74LS74 \$0.45  | 74LS365 \$0.75  |
| 75LS04 \$0.15 | 74LS86 \$0.55  | 74LS373 \$2.20  |
| 74LS05 \$0.20 | 74LS93 \$0.90  | Z80A \$6.50     |
| 74LS10 \$0.29 | 74LS157 \$1.20 | Z80 \$4.20      |
| 74LS32 \$0.35 | 74LS165 \$1.75 | REG 7805 \$0.90 |

**SOCKETS LOW PROFILE**

|   |               |               |
|---|---------------|---------------|
| 14 PIN \$0.10   | 18 PIN \$0.15 | 24 PIN \$0.25 |
| 16 PIN \$0.10   | 20 PIN \$0.15 | 40 PIN \$0.30 |
| 10V Power Adapter 600ml. \$6.90 UHF Modulators \$9.90 |               |               |

**GET YOURSELF A NEW EPSON MX80 & MX70 PRINTER AND SAVE A FORTUNE**

Price on application Interface Cards for Apple, Pat. TRS80 and IBM RS232 Interface Cards not necessary for parallel Full TRS80



POSTAGE \$20

**COMP PRO MIXER**

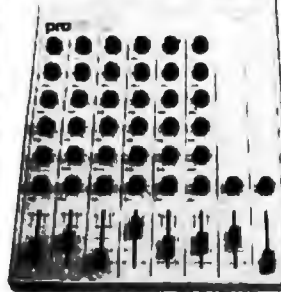

Professional audio mixer that you can build yourself and save over \$200.

Only \$199 for complete kit power supply \$50.00 POSTAGE \$20

**ACCESSIT AUDIO ADD-ONS**

**LOOK! MICROACE/SINCLAIR USERS**

**8K FLOATING POINT SUPER ROM PACK**

WITH NEW MANUAL ONLY \$35

**MICROACE/SINCLAIR VIDEO UPGRADE KIT**

Only runs with NEW ROM (Smooth screen display) ONLY \$29

**MICROACE/SINCLAIR 16K RAM PLUS EXPANSION BOARD**

3 SLOTS WITH EXTRA POWER SUPPLY  
16K ONLY \$149 4K ONLY \$110

**MicroAce**

**A COMPLETE COMPUTER**



A new generation of miniature computers

2K Kit ONLY \$149 Post and Packing FREE

Sinclair is a Registered Trademark of Sinclair Research Ltd.

**MicroAce**



Please make checks and money orders payable to **MicroAce** or phone your order quoting **Master Charge, Visa, Diners Club or American Express** number for immediate despatch. Add 6% Tax for Shipments inside California. **MicroAce, 1348 East Edinger, Santa Ana, California, Zip Code 92705. Telephone: (714) 547-2526**

and PAUSE, are given numerical parameters that indicate how large a step the figure should take. The user selects steps GO and TURN in cases where relative directional placement is desired. Alternatively, the user programs with a step that combines a direction and movement. For example, to take three steps in an upward (1) direction, the step instruction is:



The user sets the arrow icon to specify the direction. Bridge REPEAT is given a numerical parameter specifying the number of times a sequence of positions and steps should be repeated. Bridge REPEAT UNTIL is associated with a condition for terminating the repetition. We envision a fixed set of conditions such as:



A GHOST bridge indicates that an image of the dancer should remain on the screen in the dancer's last position whenever the figure steps using the GO instruction. If replacement parts include:



for the right arm, and:



for the left arm, then a simple sequence to have the dancer wave each arm three times looks like:

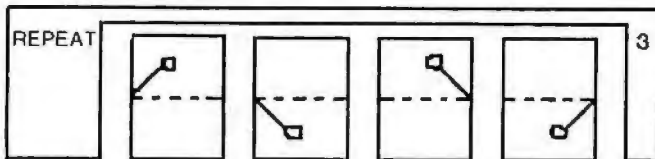

Notice that the replacement parts can overlap. For example, the arm parts are large and overlap the head part so that it is possible to lift the arms above the head. Similarly, the leg parts allow overlap with arm parts. The bridge "covers" the steps to be requested, with a condition specified at the right girder. The figure can slowly dance stage right using:



The user is also able to define "dance routines" that enable certain fixed sequences to be named, stored, retrieved for further editing, and used as a "sub-routine." Suppose the first sequence of commands is stored as the Dance Routine known as WAVE. We can then use this routine in another one to get:

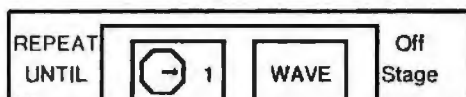

On the screen, one routine (the one being edited by the user) is active at a time. Controls for managing routines are:

- DELETE (delete the routine from the language)
- STORE (store the current dance act as this routine)
- NEW (start a new dance act)
- COPY (make a dance act exactly like the current one)
- EDIT (make the selected routine be the current one you are editing)

A new dance act has the initial name CURRENT DANCE, as shown in the figure 4.

The user creates a Dance Act by using these elements (steps, bridges, and routines) of the programming language "DanceTalk" as shown in figure 4. This is done by simply pointing at the desired element and moving it

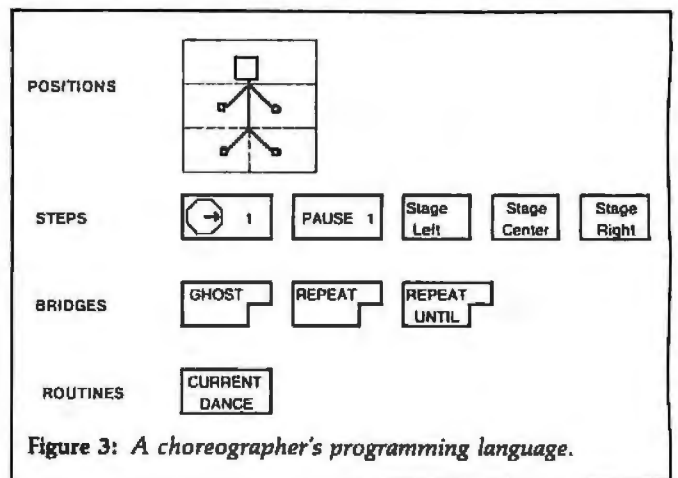

Figure 3: A choreographer's programming language.

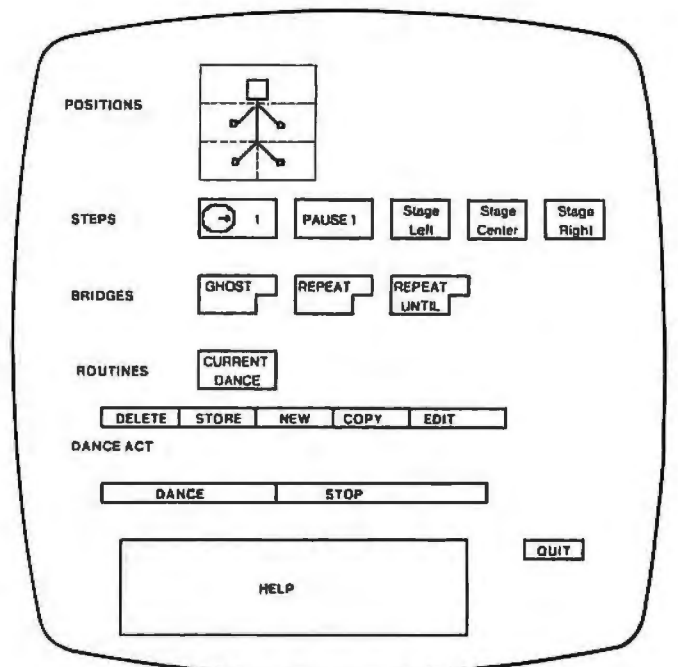

Figure 4: A screen view of DanceTalk. This image, which appears on the video display of a Smalltalk system running the Dance Kit program, gives the user a menu of options with which to animate the "dancer."

*Introducing the language that is based on the past but looks to the uses of the future:*



JANUS is a compiler for a subset of ADA. ADA is the much awaited U.S. Department of Defense language. With JANUS, it is available now on your CP/M system.

**JANUS has such features as:**

- Separate Compilation Records with variants
- Subranges, Enumerations, and Arrays
- Case statement with others clause
- Integers and Arbitrary Precision Reals and much more . . .

JANUS is the face of the future. The structured language that you need for efficient programming. This is your chance to get to the head of the crowd and learn the language that will be the language of the 80's.

JANUS requires an 8080/8085 or Z80 CPU, 56K of memory, and at least one 8" floppy disk. JANUS is supplied on a single density 8" floppy. For \$250, you get the JANUS compiler, linker, assembler, and owners manual.

CP/M is a trademark of Digital Research, Inc.  
ADA is a trademark of the U.S. Department of Defense

**RR SOFTWARE**

*specialists in state of the art programming*

P.O. BOX 1512

MADISON, WISCONSIN 53701

# HOBBY ROBOTICS' Shoppers Mart

— For the SERIOUS Hobbyist —

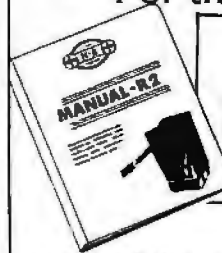

ARD Newsletter. Quarterly. Keeps you abreast of latest news, perks up interest! \$6.00

**Complete RU-2 Manual!** Everything you need to build your own robot shown, detailed! Build from base up with Hobby Robotics' highly maneuverable 2-ft. per sec. super-traction base, extendable arms (littered at 15 lbs., grip-like hands. Manual only \$25.00, refundable with first purchase.

**Hobby Robotics' Parts Supplier Directory.** Chock-full of names, addresses, phone numbers you want for hard-to-find parts, systems, build-your-own-robot info. Only \$3.50. Get yours now!



**HOBBY ROBOTICS' ROBOT BASE**  
Ready to roll!

**ONLY \$495 (includes shipping)**

**HOBBY ROBOTICS**

5070 Buford Highway  
Norcross, Ga. 30071 404/448-0190

Please send items checked below:

- Qrt. Newsletter  RU-2 Manual
- Parts Directory  Robot Base

FREE  Hobby Robotics' Catalog  FREE  
Total Enclosed \$\_\_\_\_\_ (includes shipping)

- Personal Check  Cashiers Check/M.O.
- Mastercharge  Bank Americard

Acct. # \_\_\_\_\_  
Signature \_\_\_\_\_ Exp. \_\_\_\_  
Name \_\_\_\_\_  
Address \_\_\_\_\_  
City \_\_\_\_\_  
State \_\_\_\_\_ Zip \_\_\_\_\_

# Why Do Professionals Prefer

**BECAUSE**

- Unique software • Technical support • Quick delivery • Established company • Release 2 CP/M (some packages under UNIX and TRSDOS)
- Quality software • In-house expertise • Fast response • User orientation • Competitive prices • Customer service • Verbatim® media • Onyx hardware (CP/M and UNIX versions)

**BECAUSE**

Unique swift routing cybernetics response system gives you no-nonsense technical answers that save you time. Call: (714) 848-1922.

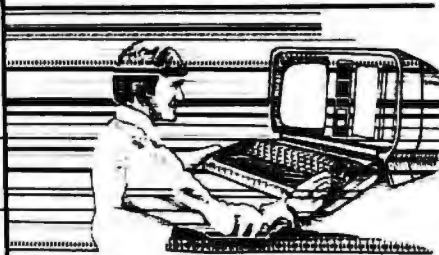
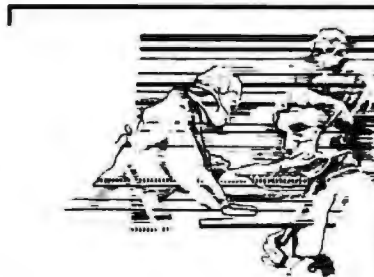

- NEW RM/COBOL applications:  
• Order Entry/Inventory • Receivables • Payables • General Ledger • Financial Modeling • Client Accounting—and more on the way!
- NEW CBASIC2 applications:  
• REAP (Real Estate Acquisition Package).

Business  
Medical  
Real Estate  
Computer Systems

## Software from Cybernetics?

**RM/COBOL**—The new standard for microcomputer COBOL! The only COBOL for CP/M (also on TRSDOS & UNIX) with alternate keys (multi-key ISAM), CRT screen handling, interactive debug, and the most useful Level 2 features. Compatible with RSCOBOL—but runs faster.

Plus existing CBASIC2 packages:  
APH (Automated Patient History)  
Osborne & Assoc—Payroll • Payables/Receivables • General Ledger  
NAD\* (Name and Address)  
PMS (Property Management System)

And system software packages:  
MAGIC WAND® Editing/Word Processing  
CBASIC2 Compiler BASIC  
QSORT® Sort Merge Package



Distributed in UK by  
Microcomputer Applications Ltd  
11, Riverside Court, Caversham, Reading, England  
TEL: (0734) 470425

Inquire for details  
Trademarks of Ryan-McFarland Corp., Compiler Systems, Inc., Digital Research, Bell Telephone Laboratories, Inc., Tandy Corp., Verbatim Inc., Cybernetics Inc., Structured Systems Group, Inc., Small Business Applications, Inc.



8041 Newman Ave., Suite 208  
Huntington Beach, CA 92647  
(714) 848-1922

into the initially empty area in the lower part of the screen. Selected elements are highlighted by complementing their screen area. Notice the rectangular area labeled HELP at the bottom of the screen. When the user points into this area, a description of what to do next is shown, or a comment about a selected element is given.

### First Variation: The Stick Person

A user of our Dance Kit might see the sequence of screen views shown in figures 5a through 5f. After a user has completed a longer Dance Act with two choreographed (sub-)routines KICK and JUMP, the screen might look like figure 5f. Now when the user indicates DANCE in the bottom menu of commands, the top part of the screen clears as if a curtain were rising, and the user sees the given sequence of views—an animation (see figure 6).

Note that a grid with a scale underlies both the space and time dimensions. These could be specified and experimented with by the user.

### Second Variation: The Big Turtle

Our dancer may assume any size and shape we desire, and we can subdivide the dancer into any number of rectangular areas in order to create replaceable parts. The basic figure shown in figure 7 might be used. The dotted lines show the user's subdivision of the figure. Replacement parts for the section labeled D overlap section A,

and might appear as shown in figure 8. Other replacement parts are left to the imagination of the reader.

Dance Acts can be shared by different figures, except that both replacement parts and routines will have to be

Text continued on page 365

(5a)

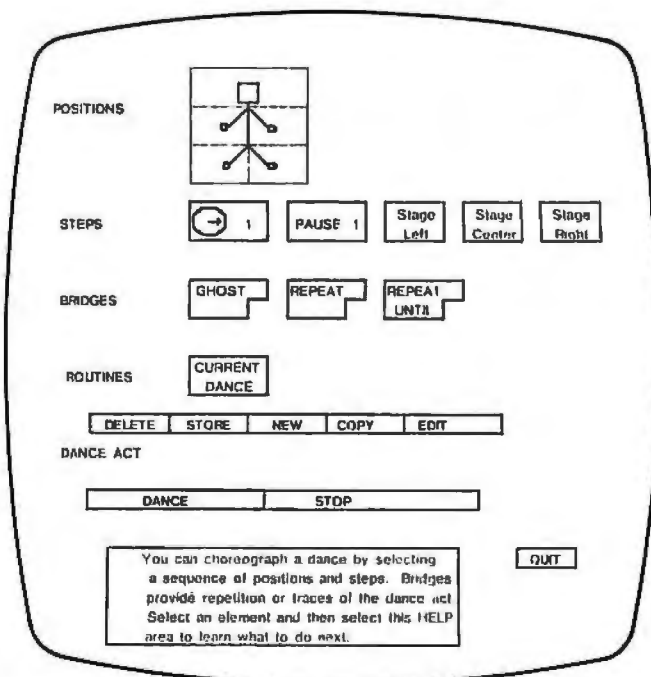

(5b)

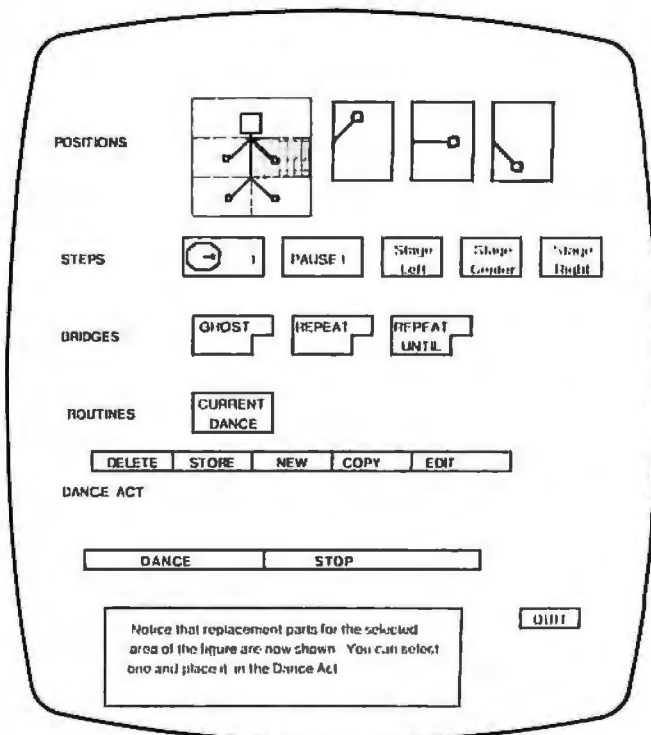

Figure 5: Here and on page 364 are six views of the Dance Kit program during the creation of a dance. The "help" box, shown at the bottom of each figure, is always active. The shaded area indicates the item currently being worked on.

## McGraw-Hill's Electronic Bookshelf Is On The Air

Ask your computer to call 212-997-2488 for the latest info on our computer and electronics books. The system is up daily from 6 p.m. to 8 a.m. and 24 hours on weekends.







Figure 5 continued:

(5c)

POSITIONS

STEPS 1 PAUSE 1 Stage Left Stage Center Stage Right

BRIDGES GHOST REPEAT REPEAT UNTIL

ROUTINES CURRENT DANCE

DELETE STORE NEW COPY EDIT

DANCE ACT

DANCE STOP

You can see your Dance Act as it is now constructed by selecting the command DANCE. If the Dance goes on too long, select STOP.

QUIT

(5d)

POSITIONS

STEPS 1 PAUSE 1 Stage Left Stage Center Stage Right

BRIDGES GHOST REPEAT REPEAT UNTIL

ROUTINES CURRENT DANCE

DELETE STORE NEW COPY EDIT

DANCE ACT

DANCE STOP

The selected element is a Bridge. It can cover a number of dance elements in order to repeat them a fixed number of times. After you select the bridge, point to the first element to be under the bridge. Then move the pointer over each successive element until the bridge is constructed.

QUIT

(5e)

POSITIONS

STEPS 1 PAUSE 1 Stage Left Stage Center Stage Right

BRIDGES GHOST REPEAT REPEAT UNTIL

ROUTINES CURRENT DANCE

DELETE STORE NEW COPY EDIT

DANCE ACT

REPEAT 2

DANCE STOP

Repeat 2 is the default. Select the 2 in order to change the number.

QUIT

(5f)

POSITIONS

STEPS 1 PAUSE 1 Stage Left Stage Center Stage Right

BRIDGES GHOST REPEAT REPEAT UNTIL

ROUTINES KICK JUMP Current Dance

DELETE STORE NEW COPY EDIT

DANCE ACT

Stage Left 3 REPEAT 2 KICK PAUSE 1 2

2 REPEAT UNTIL 4 OH Stage

DANCE STOP

HELP

QUIT

Text continued from page 362:

changed appropriately. A Turtle Dance Act that is akin to the Stick Person Dance Act shown in the first variation appears in figure 9. The animation for this Dance Act consists of the sequence of views shown in figure 10.

### Third Variation: Boxes

The dancer might be a simple geometrical shape. The dancing needn't be subdivided, but replacement parts for the whole figure might be available.

For example, the user might create the following replacement parts:

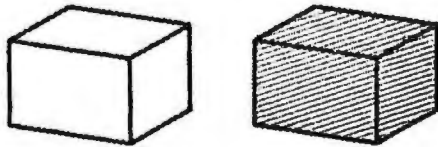

Suppose the initial dance is set with the dancer moving toward the right. A possible Dance Act is shown in figure 11, where next HEX is defined as:



The ghost is used to leave a trace of the box after each step. Each step unit was presumably scaled by the user to be the size of the box so that no overlapping occurs. At the end of this act the screen would look like figure 12.

Another possible geometric design comes from the building blocks shown in figure 13. If the dance act is defined as shown in figure 14, then at the end of the dance the screen will look like figure 15. When a figure of one color is superimposed on a figure of another color, the underlying figure disappears.

### Fourth Variation: The Degenerate Turtle

The Dance Kit can be used to do conventional Turtle geometry (see reference 6) by allowing the figure to degenerate to a point (no replacement parts need apply) and defining a scale such that GO 1 means to go to the next point on the screen.

### Dancing School

The Dance Kit is one example from a variety of kits and ideas for kits that we have entertained and that have entertained us. One of our major concerns is to create an environment in which the design of interesting and imaginative educational materials will be fostered, and we believe that the Smalltalk-80 system will make it easier to create such kits.

We have given much thought to some necessary characteristics of a framework for a Dance (or any other) Kit. We suggest that certain services always be present on the screen. For example, a help system is of supreme importance. We have provided an indication of the help system we would incorporate into the Dance Kit. The TRIP system for animating algebra word problems (see reference 5) provides such a complete HELP facility that

even fearful users need be told only how to use the pointing device in order to control all the functionality of the system. Other possibilities for services include a LIBRARY, a GUIDE to other activities that might be appropriate, and a facility that allows users to enter sug-

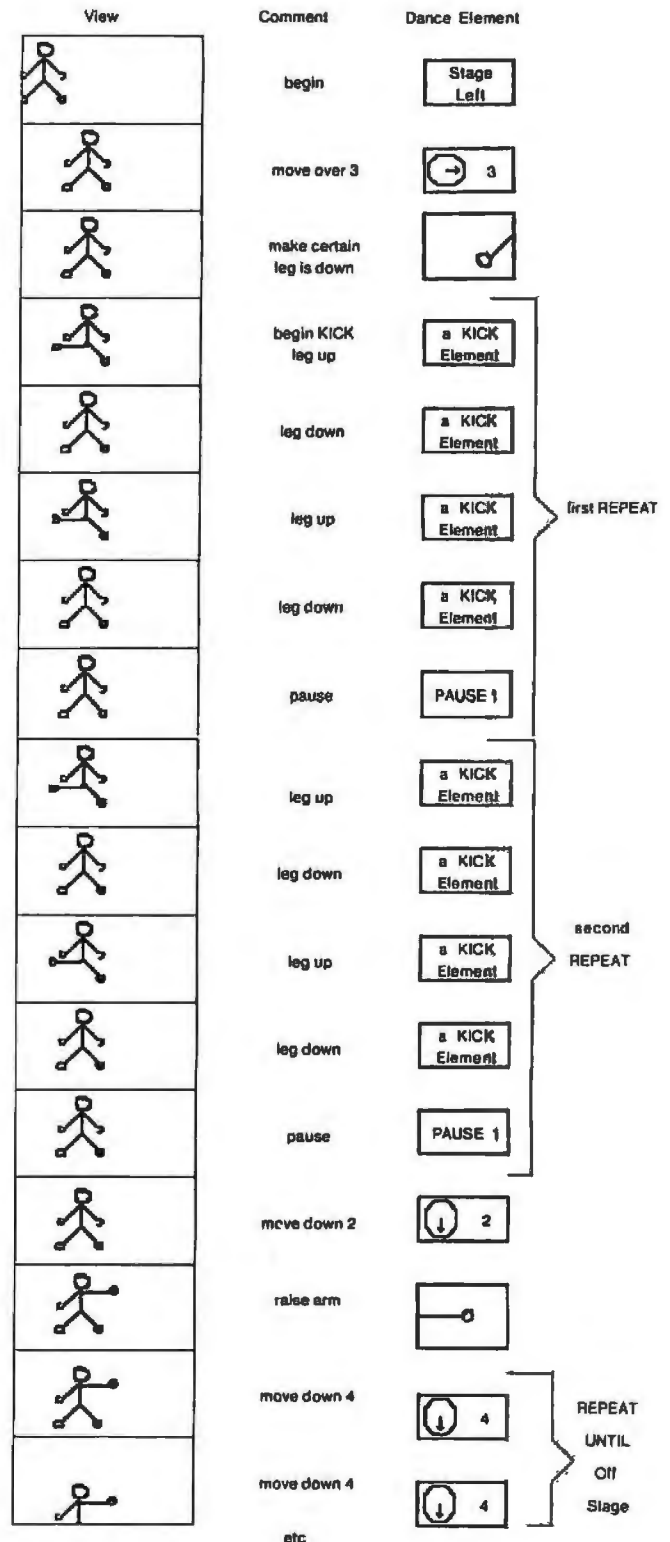

Figure 6: Execution of the dance given in figure 5f.

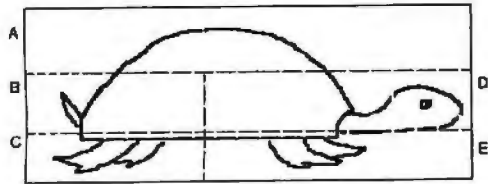

Figure 7: A basic drawing of a big turtle that can be animated.

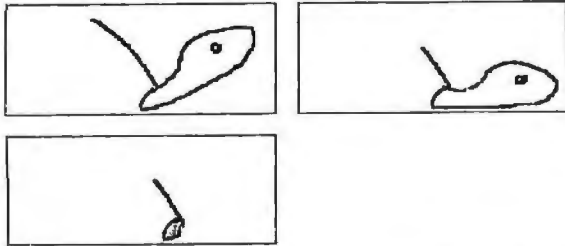

Figure 8: Example alternate replacement parts for the big turtle.

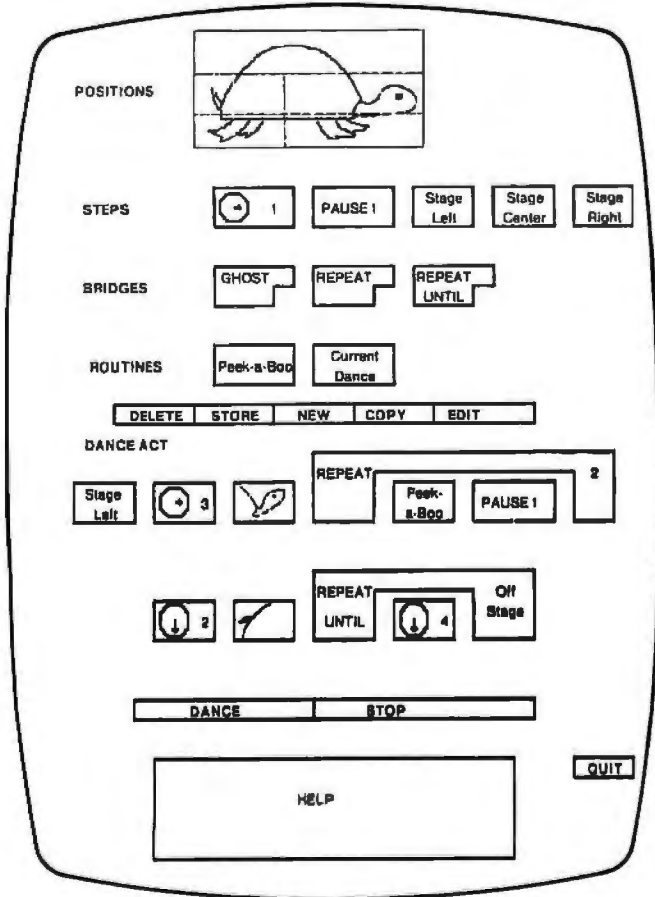

Figure 9: Screen view of the Dance Kit being used to animate the big turtle.

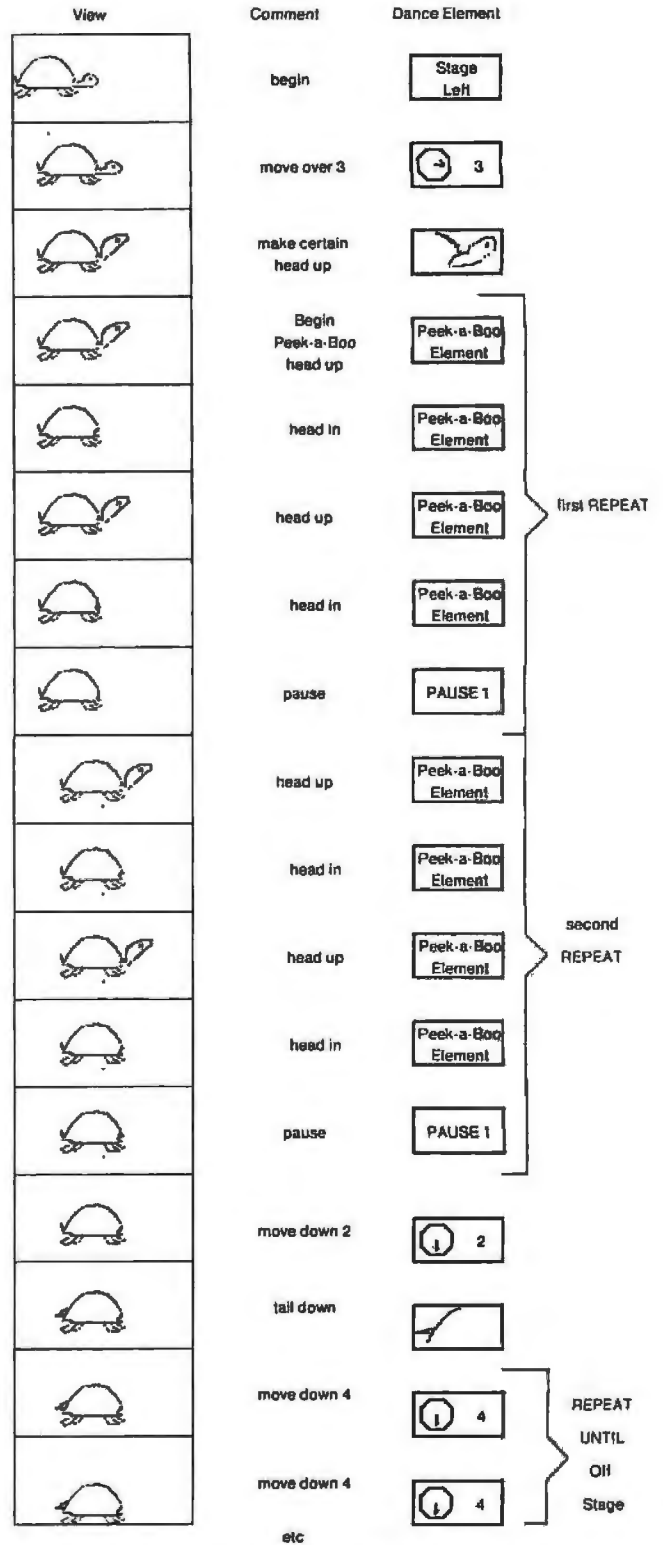
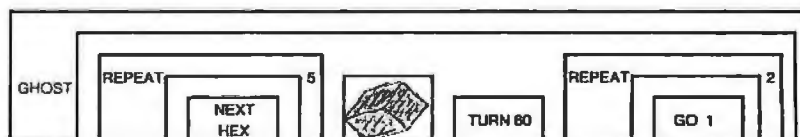

Figure 10: Execution of the dance given in figure 9.



Figure 11: Possible Dance Act for a set of box shapes.



gestions and other feedback for the instructor (ie: a GRIPE).

We have also imagined a Dance Kit in a computerless classroom. The idea that computer-based activities should have concrete analogues, especially for young children, has been well received in the experience of the MIT LOGO group. We would use the children as the figures in the dances and create the Dance Act instructions and routines on paper or a blackboard or.... Of course if we want to leave ghosts, we will need to enlist the services of more than one child.

In this mode of use of the Dance Kit we are fond of imagining children as the design elements of the seven possible friezes shown in figure 16; each frieze is characterized by the group of transformations or symmetries that

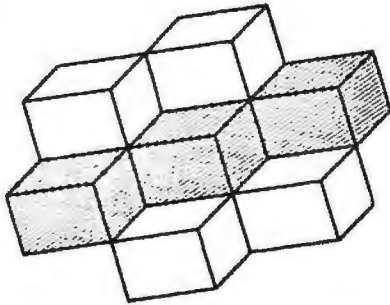

Figure 12: Drawing made by the Dance Act of figure 11.

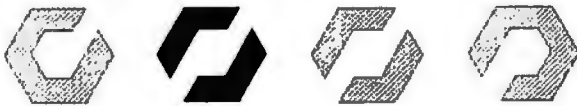

Figure 13: A basic drawing of some geometric designs that can be used by the Dance Kit.

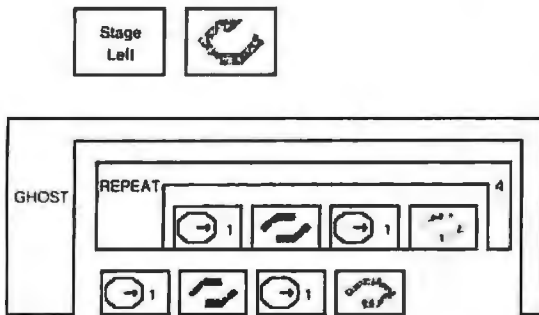

Figure 14: Possible Dance Act for the set of geometric designs.

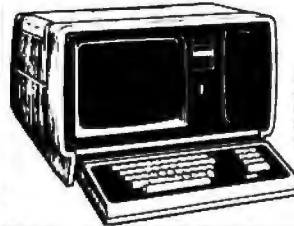

Figure 15: A drawing made by the Dance Act of figure 14.

# TEXAS COMPUTER SYSTEMS

Offers Lowest Prices on

# TRS-80 COMPUTERS



**Model II 64K  
\$3349**

An excellent computer for your business needs. Easy expandability & compatibility. No formal operator training needed. All accessories available - disk expansions, printers, software at our low discount prices. Our fast Dallas air freight service can assure most deliveries within seven days after payment is received.

Free with purchase:

1 box of 10 double density diskettes. A \$69 value

|                            |                         |
|----------------------------|-------------------------|
| <b>Model III 16K \$849</b> | <b>With TCS Memory:</b> |
| Model III 32K \$979        | Model III 32K \$909     |
| Model III 48K \$1089       | Model III 48K \$969     |

|                            |        |
|----------------------------|--------|
| Model III 32K 2 Disk RS232 | \$2100 |
| Model III 48K 2 Disk RS232 | \$2230 |
| Model III 32K 1 Disk       | \$1729 |
| Model III 48K 1 Disk       | \$1849 |



**Special—With TCS Memory  
★ Model III 48K 2 Disks \$1895**

Uses proven MPI drives modified for floppy operation and Percam controller. Limited 90 day warranty. Call for details.

|                          |                          |
|--------------------------|--------------------------|
| <b>Color Computer</b>    | <b>With TCS Memory:</b>  |
| 4K Level I \$329         | 16K Level I \$369        |
| 16K Level I \$439        | 16K Extended Basic \$449 |
| 16K Extended Basic \$489 |                          |

|                             |                         |
|-----------------------------|-------------------------|
| <b>Expansion Interfaces</b> | <b>With TCS Memory:</b> |
| Zero K Interface \$254      | 16K Interface \$318     |
| 16K Interface \$359         | 32K Interface \$388     |
| 32K Interface \$469         |                         |

**Pocket Computer & Interface** \$ Call toll free for the low, low sale price.

**Epson MX-80 \$ Call**  
Letter quality matrix similar to Line Printer IV & Centronics printer but has full software control of 40, 80, 66 or 132 columns. 80 cps bidirectional tractor feed, disposable printhead \$300 less than nearest competitive printer. Lists \$645. Our price includes cable.

- Payment: Money Order, Cashier's Check, Certified Check, Personal checks take 3 wks. VISA, MC, add 3%.
- Prices subject to change any time.
- No tax out-of-state. Texans add 5%.
- Delivery subject to availability.
- Shipping extra, quoted by phone.

## TEXAS COMPUTER SYSTEMS

Box 951, Brady Texas 76825

For fast, efficient service, we can air freight from Dallas to major a/p near you. Call for information.

**Toll Free Number 800-351-1473**

**Texas Residents 915-597-0673**

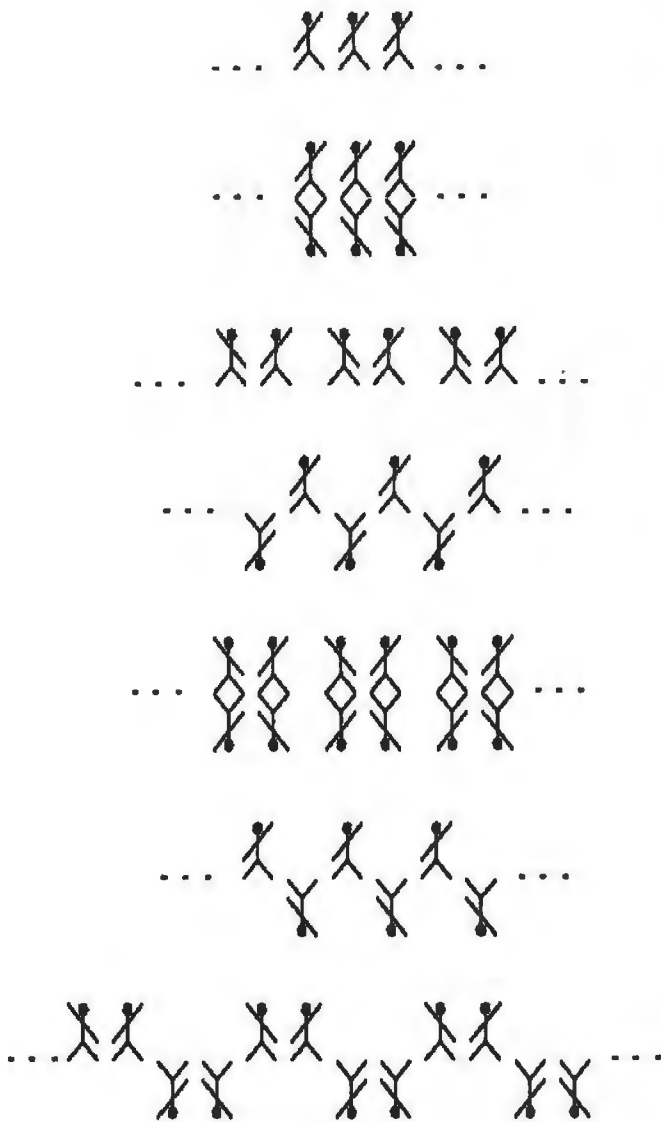

Figure 16: Frieze patterns of stick men. By combining a basic pattern and its variations, many frieze patterns can be made.

preserve them. (A symmetry is a one-to-one transformation that preserves distance.) The basic symmetries are translations, rotations, and reflections. We envision the children casting their shadows to form the patterns—or perhaps even lying on the floor. (Of course, mathematical friezes are like lines—infinitely long—but we can enjoy thinking about finite pieces.)

Frieze patterns might look like those in figure 16. However, we will leave the Dance Acts for the frieze patterns as an exercise for the reader.

The Dance Kit can be thought of as a forum for learning introductory programming concepts. A curriculum developer would create a dancer and replacement parts that are of interest to the student; the developer would also select steps, bridges, and initial (sub-)routines that support recommended or assigned exercises. The combination of dancer replacement parts, steps, bridges, and subroutines makes up a "programming language." Alternatively, the student could do more of the creation of the language. The Dance Kit has our approval because of this possibility of dual and flexible use. ■

#### References

1. Bricklin, Dan and Bob Frankston. VisiCalc™ Computer Software Program, 1979.
2. Goldberg, Adele. "Educational Uses of a Dynabook." *Computers in Education*, Volume 3. Great Britain: Pergamon Press Ltd, 1979, pages 247 through 266.
3. Goldberg, Adele and Alan Kay. *Teaching Smalltalk*. Technical Report SSL 77-2, Xerox Palo Alto Research Center, 1977.
4. Goldberg, Adele, Dave Robson, and Dan Ingalls. *Smalltalk-80: The Language and Its Implementation and Smalltalk-80: The Interactive Programming Environment* (forthcoming).
5. Gould, Laura and William Finzer. "A Study of TRIP: A Computer System for Animating Time-Rate-Distance Problems." *Proceedings of the IFIP Third World Conference on Computers in Education (WCCE-81)*. July 1981, Lausanne, Switzerland.
6. Papert, Seymour. *Mindstorms: Children, Computers, and Powerful Ideas*. New York: Basic Books, 1980.

**SYNCHRO-SOUND**  
THE COMPUTER PEOPLE

**CROMEMCO**  
System 3



**HAZELTINE**  
1421 Video Terminal



**MORE SPECIALS**

|   |          |                            |          |
|---|----------|----------------------------|----------|
| Integral Data Systems Model 445 Printer | \$695.00 | Livermore Acoustic Coupler | \$159.95 |
| Televideo Model 950                     | 1295.00  | Centronics Micro Printer   | 349.00   |
| Industrial Micro Systems                | 349.00   | 5" Scotch Diskette Box     | 34.95    |
|   |          | 8" Scotch Diskette Box     | 39.95    |

**ATARI**  
800  
400



**ALPHA-MICRO**  
Computer System



We have a full staff of Programmers and Computer Consultants to design, configure and deliver a Turnkey Computer System to meet your specific requirements



**SYNCHRO-SOUND ENTERPRISES, INC.**  
THE COMPUTER PEOPLE 125 Mineola Ave., Roslyn Hts., N.Y. 11577  
Phone Orders call: 516/484/1852 • Toll Free: 800/645-3820 • TWX 510-220-0021

CALL, WRITE OR VISIT OUR NEW COMPUTER SYSTEMS CENTER 10-4 Daily & Saturday

# ToolBox: A Smalltalk Illustration System

---

William Bowman and Bob Flegal  
Learning Research Group  
Xerox Palo Alto Research Center  
3333 Coyote Hill Road  
Palo Alto CA 94304

---

Computer art is usually thought of as linear, geometric, and repetitious. The Smalltalk group at the Xerox Palo Alto Research Center has been exploring the potential image-making capabilities of the computer-powered display medium for almost ten years. We have investigated the idea of using the computer and its associated display as an art medium for a user/artist to create visual material. We allow the mixture of an artist's free-hand sketches with structured commands for manipulating graphic forms. This approach can be contrasted with the more traditional approach where the machine is programmed to "draw," usually with lines, some visual image on the display screen. Figure 1 is a typical computer-generated pattern in which symmetrically ordered lines form an illusion of spherical volume.

This article reports on one of our developments in the area of computer-assisted image creation. ToolBox is a drawing system designed for general-purpose, interactive image creation and editing. ToolBox was designed jointly by artist William Bowman and computer

---

## ToolBox Is a graphics system designed for general-purpose, interactive image creation and editing.

---

scientist Bob Flegal to explore graphic specialization within the computer-powered display medium. We were interested in determining the areas within the visual and graphic arts for which the computer-powered display medium is a particularly suitable and

efficient graphic tool. To do so we investigated possible tools, techniques, and image-making capabilities of this new medium. The underlying implication (and intention) of this approach is a new role in professional graphics: that of the illustrator/artist who creates images with computer machine tools rather than with conventional hand tools.

The ToolBox system receives input from the user/artist from a graphics tablet and keyboard and modifies the screen image based on his/her actions. The computer program does not generate the image from a set of programmed drawing instructions. For example, to specify a straight-edge line, the artist need only specify the two end points of the line with the graphics tablet and the program completes the line. This is in contrast to methods where a "pen" is programmed with up, down, and draw commands with coordinates as arguments. This idea is illustrated in figure 2.

### System Description

ToolBox consists of a coordinated set of graphic tools that provide a wide range of form construction options for use in testing machine illustration concepts. Five fundamental tool functions comprise the basic graphical form vocabulary. Each of these tools can be modified in its use by one or more of four sets of variables that can affect its form source, color tone, grid spacing, and functional mode. Brief descriptions of the

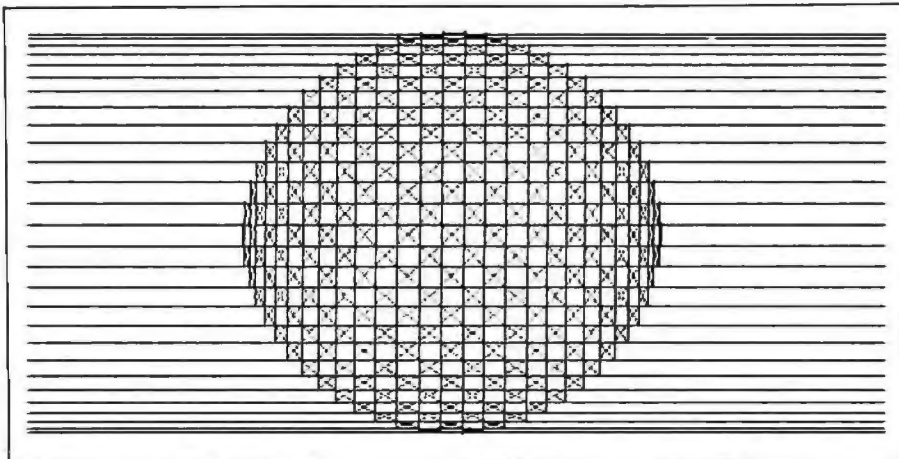

Figure 1: A typical computer-generated geometric design in which symmetrically ordered lines form an illusion of spherical volume.

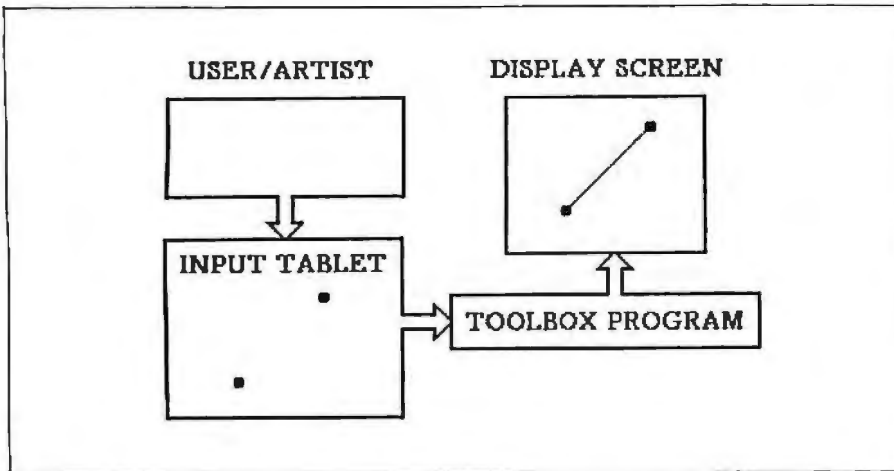

Figure 2: Modification of the ToolBox screen image based on user/artist input. The computer assists in drawing a line after the artist has entered end points on a graphics tablet.

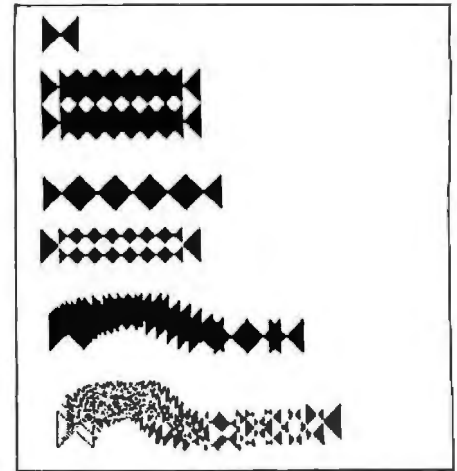

Figure 3: ToolBox variations on a single form source—two triangles.

tools and the variables affecting them follow.

Select Form allows the user/artist to select a rectilinear-shaped picture from the display screen as the form source. The form selected can be thought of as a brush which the other five tools use as their source picture. The artist can create a form source using any of the tools available in the ToolBox system, from Smalltalk graphic commands, from the Smalltalk text editor, or from a library of form sources.

The following are ToolBox tool functions:

- COPY enables continuous individual copies of the form source onto the display screen. This can be thought of as painting on the display screen using a brush (the form source)
- DRAW enables freehand line drawing or sketching by connecting form source copies with line segments
- ARC enables curve construction (using spline functions)
- BLOCK enables solid rectangles to be formed
- LINE enables straight-line construction between two points

Grid spaces modulate the tools to function on specifiable horizontal and vertical grid lines.

Color tones allow creation of form in black, white, or one of the four intermediate grays (spatial-halftones).

There are three modes affecting the

copying of source forms onto the display: store, or, and xor. We called these modes "over," "under," and "reverse."

### Art Examples

Figure 3 shows some of the visual effects that are possible with a single form source—two triangles. Since each form source can have five tools, five griddings, six colors, and three modes, the number of possible pictorial effects is staggering.

The display screen upon which the pictures in this article were made is

606 by 808 dots, and each dot is either black or white (no gray scale). The display is refreshed out of the computer's main memory. Thus, to turn a display dot black or white, 1 or 0 is written into memory.

During the programming and development of the ToolBox system, a series of image-making experiments were conducted, both as active input to the evolving design of the system and as a preliminary test of its capabilities. The main purpose of these experiments was to explore the potential of the machine tools for enabling

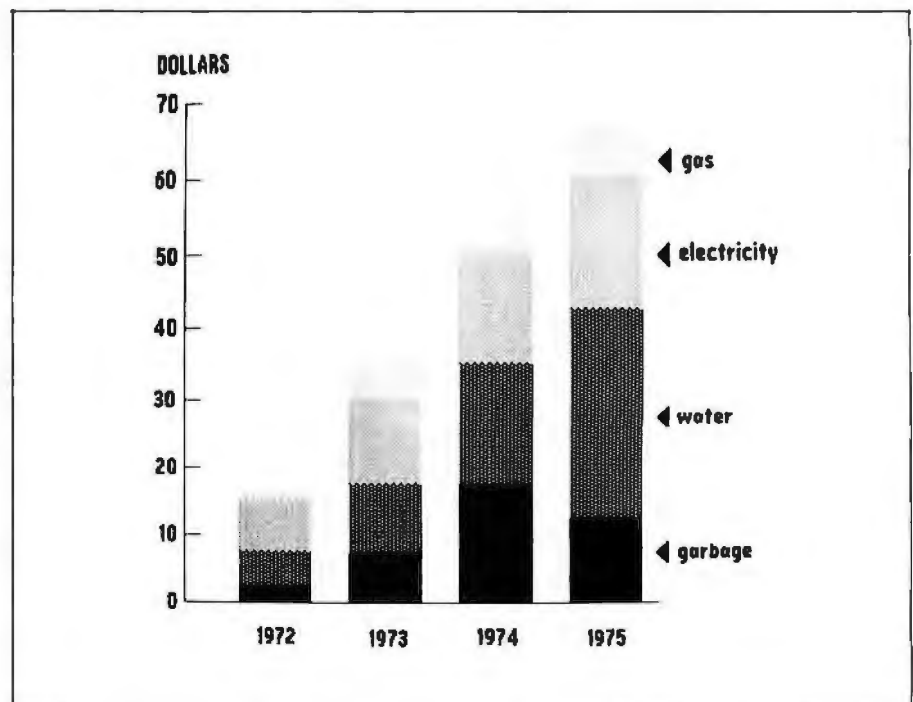

Figure 4: A bar chart designed by William Bowman.



# Qume® Data Trak™ Floppy Disk Drives

Distributed by: **asap**  
computer  
products, inc.

**The Data Trak™ 5** double-sided double-density drive uses state-of-the-art technology to give you superior data integrity through improved disk life, data reliability, and drive serviceability using 5¼" media.

Qume's independent head load yields wear characteristics far superior to competitive drives. This superior wear performance produces savings on both diskette usage and drive maintenance.

Improved data reliability, resulting from superior amplitude and bit shaft characteristics, optimizes operator efficiency and reduces processing time for end-users.

And Data Trak's unique modular design means simplified field servicing for you and your customers.

## Design Features

**Expanded storage capacity** • Two-sided, double-density

**Proven head carriage assembly** • Ceramic head with tunnel erase • Dual-head flex mounting arrangement • Superior head load dynamics

**Precise lead screw actuator** • Fast access time — 12 ms track-to-track • Low friction and minimum wear • Low power dissipation

**Additional features** • Industry standard 5¼" media format • ISO standard write protect • Door lock out for media protection • Requires DC voltage only • Daisy Chain up to 4 drives • Heads load on command independent of loading media

## Product Specifications

**Performance Specifications** • Capacity: Unformatted: 437.5K or 500K bytes; Qume Formatted: 286.7K or 327.7K bytes • Recording Density: 5456 BPI • Track Den-

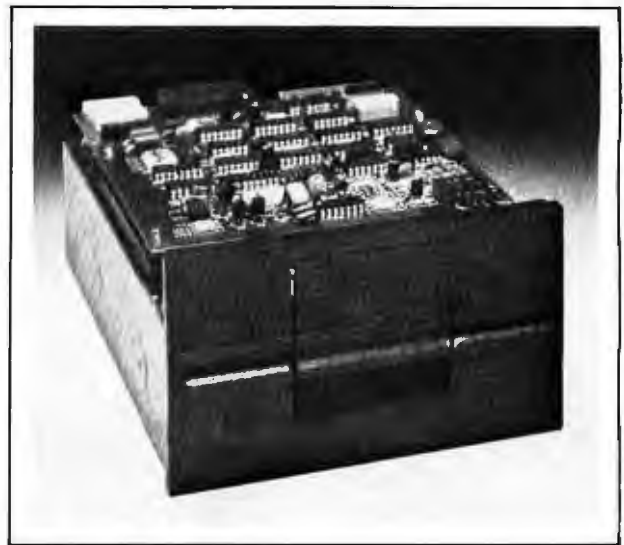

sity: 48 TPI • Cylinders: 35 or 40 • Tracks: 70 or 80 • Recording Method: FM or MFM • Rotational Speed: 300 RPM • Transfer Rate: 250K bits/second • Latency (avg.): 100 ms • Access Time: Track-to-track 12 ms; Settling 15 ms • Head Load Time: 50 ms

**The Data Trak™ 8** double-sided double-density drive uses state-of-the-art technology to give you superior data integrity through improved disk life, data reliability, and drive serviceability.

Qume's innovative approach to controlling head load dynamics yields wear characteristics far superior to competitive drives. In independent evaluation, Data Trak 8 is setting industry standards for tap test performance. This superior wear performance produces savings on both diskette usage and drive maintenance.

Improved data reliability, resulting from superior amplitude and bit shift characteristics, optimizes operator efficiency and reduces processing time for end-users.

And Data Trak's unique modular design means simplified field servicing for you and your customers.

## Design Features

**Expanded storage capacity** • Two-sided, double-density

**Fully IBM compatible** • IBM 3740 and System 32 drives • IBM 3600 and 4964 drives • IBM System 34 drives

**Proven head carriage assembly** • Ceramic head with tunnel erase • Dual-head flex mounting arrangement • Superior head load dynamics

**Fast, precise steel belt drive** • Fast access time — 3 ms track-to-track • Low friction and minimum wear • Low power dissipation

**Additional features** • ISO standard write protect • Programmable door lock • Negative DC voltage not required • Daisy Chain up to 4 drives • Side-by-side mounting in standard 19" RETMA rack • Compatible with Shugart SA850/SA851



## Product Specifications

**Performance Specifications** • Capacity: Unformatted: 1.6 Mbytes/disk; IBM Format: 1.2 Mbytes/disk • Recording Density: 6816 BPI • Track Density: 48 TPI • Cylinders: 77 • Tracks: 154 • Recording Method: MFM • Rotational Speed: 360 RPM • Transfer Rate: 500Kbits/second • Latency (avg.): 83 ms • Access Time: Track-to-track 3 ms; Settling 15 ms; Average 91 ms • Head Load Time: 35 ms • Disk: Diskette 2D or equivalent

**asap**  
computer  
products, inc.

1198 E. Willow, Signal Hill, CA 90806

Call Toll Free (800) 421-7701

AUTHORIZED DISTRIBUTOR FOR QUME  
CALL FOR PRICE AND DELIVERY

(213) 595-6431 or (714) 891-2663 In California

# THE MOST

# POWERFUL SMALL BUSINESS COMPUTER

# IN THE WORLD

The IBC ENSIGN business computer was designed from the ground up to run MP/M, multi-user OASIS, MVT-FAMOS, and other multi-user Z-80 operating systems faster than any other computer in the world.

Consider these features:

- Up to 16 users
- Up to 768K byte memory
- Up to 150M bytes/disk drive
- 17M byte tape cartridge
- 46M byte 9 track tape
- 6 MHz Z-80B CPU

But it takes more than a lot of I/O ports, memory, and disk storage to make a super multi-user computer. The ENSIGN has what it takes.

**MULTIPLE MICROPROCESSORS:** The ENSIGN has two separate Z-80's and 32K byte memory buffer to handle all I/O between CRT's and printers at baud rates up to 19,200 baud

A third Z-80 handles all disk and tape I/O. Commands from the main CPU are totally supervised by the disk slave Z-80.

And the main CPU is the new 6 MHz Z-80B running at full speed with 120 nsec memory.

**PERIPHERALS:** The ENSIGN supports the tape and winchester disk family from Kennedy Co. These drives, tape cartridges, and 9 track tape drives are the premier of the industry. Yet prices are low on the ENSIGN.

**SOFTWARE:** If you are running MP/M, OASIS, or MVT-FAMOS you will run better on an ENSIGN. And if you're not already tied to one of these systems you may want to try IBC-SUPERDOS. SUPERDOS is very powerful and very very fast.



For dealership information contact:

# IBC / Integrated Business Computers

22010 S. Wilmington Avenue, Suite 306  
Carson, CA 90745 • Call (213) 518-4245

The following are registered trademarks: IBM, MP/M, DIGITAL RESEARCH, OASIS, BASE 010 SYSTEMS, MVT-FAMOS, MVT MICROCOMPUTER SYSTEMS

Figure 5

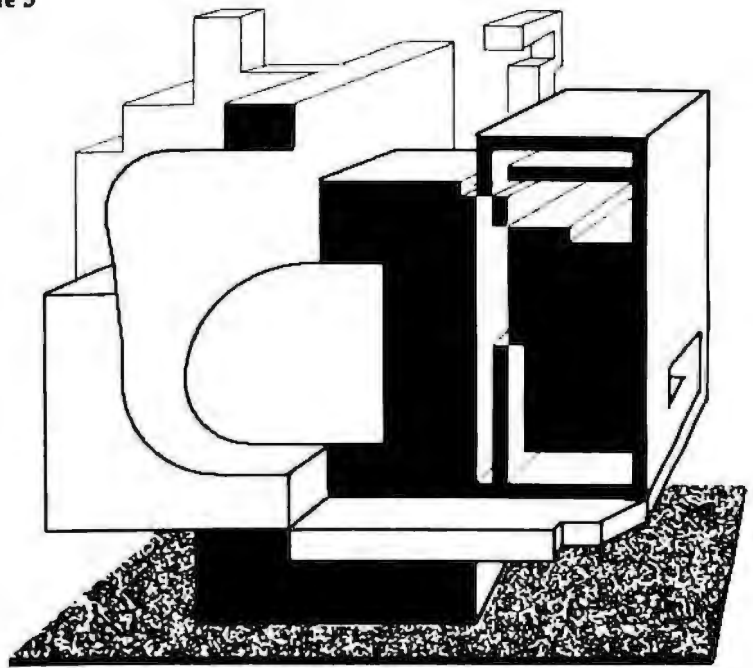
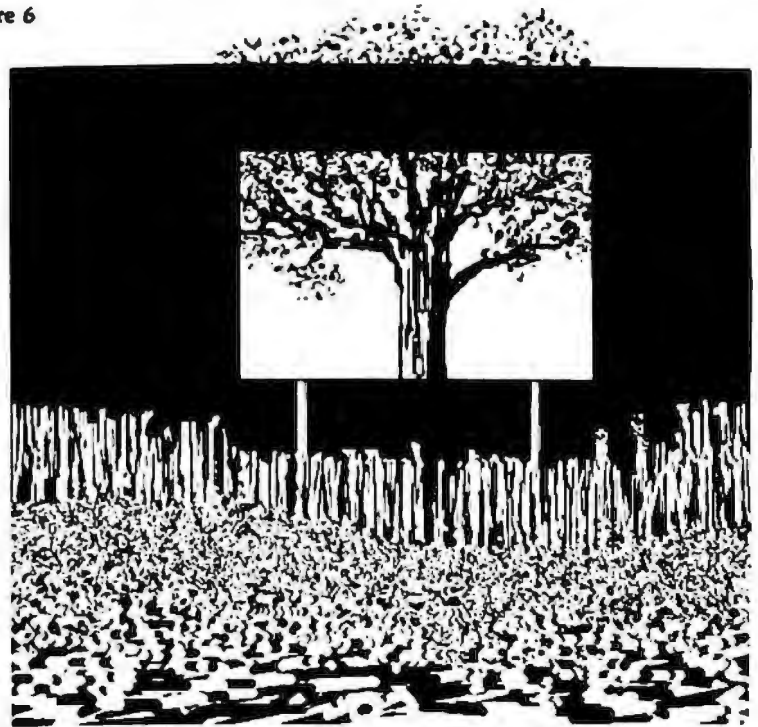

Figure 6



Figures 5, 6, 7, 8: These four illustrations by Bowman were created using the ToolBox graphics system.

a variety of graphic strategies for image design and execution. Some of these strategies resembled conventional graphic techniques; however, most of them turned out to be unique to the machine medium.

The remainder of this article consists of pictures that grew out of these

early experiments. They are intended as a demonstration of the range and depth of graphic language effects that can be achieved with the ToolBox system.

Figure 4 is a simple bar chart. This figure made heavy use of the BLOCK tool and several grid settings. The

Figure 7

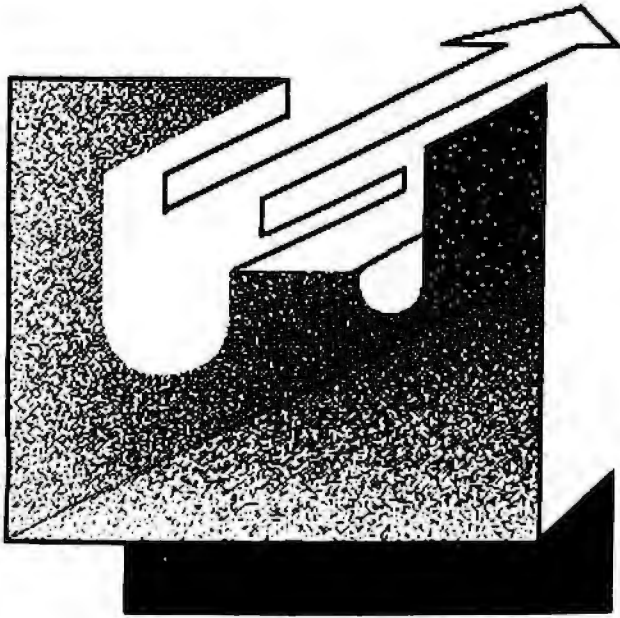

Figure 8



illustration was done in a very short amount of time compared to the amount of time it would take to draw a simple bar chart using conventional media. The ToolBox system is particularly effective for images involving horizontal and vertical elements. (Figures 4, 5, 6, 7, and 8 were ex-

ecuted by William Bowman.)

The BLOCK, LINE, and CURVE tools were heavily used in figure 5. Note the texturing at the bottom of the illustration; it was created using the COPY tool in reverse mode with the color variable set to black.

In figure 6, the COPY tool in

Circle 131 on inquiry card.

# CHOOSE...

## Choose an Apple Desk



A compact bi-level desk ideal for an Apple computer system. This 42" x 31 1/2" desk comes with a shelf to hold two Apple disk drives. The top shelf for your TV or monitor and manuals can also have an optional paper slot to accommodate a printer.

## Choose a Micro Desk



Get your micro computer off the desk top and into the micro shelf under our Designer Series desks. Suitable for the North Star, Dynabyte, Vector Graphics, and Altos computers. The desks come in a variety of sizes and colors.

## Choose a Mini Rack



Mini racks and mini micro racks have standard venting, cable cut outs and adjustable RETMA rails. Choose a stand alone bay or a 48", 60", or 72" desk model in a variety of colors and wood tones. A custom rack is available for the Cromemco.

## Choose a Printer Stand



The Universal printer stand fits the:

|                    |                        |
|--------------------|------------------------|
| Centronics 700's   | Diablo 1600's & 2300's |
| Dec LA 34          | T.I. 810 & 820         |
| NEC Spinwriter     | Okidata Slimline       |
| Lear Siegler 300's | Anadex 9500's          |

Delivery in days on over 200 styles and colors in stock. Dealer inquiries invited.

**ELECTRONIC SYSTEMS  
FURNITURE  
COMPANY**

17129 S. Kingsview Avenue  
Carson, California 90746  
Telephone: (213)538-9601

reverse mode was used to create the effects in the bottom half of the image and for the leaves and the bark on the tree.

The perspective effect in figure 7 was easily obtained using the grid settings in the system. The shading was created using a "brush" containing just a few black dots with the COPY tool used in erase mode on a black background.

Note the use of the COPY tool and grid settings to construct the chain on the socket in figure 8. The ToolBox system proved particularly effective for rapid construction of repeated patterns.

The next four pictures were done by Howard Foote, an artist and college art teacher who had never worked on a computer system or terminal. He was contracted to use the system and push it to its graphical limits. In the picture in figure 9, Foote made considerable use of the COPY tool and DRAW tool.

In the picture in figure 10, Foote was able to represent his subject with remarkable loyalty to physical realities when he wanted to and at the same time seemed able to maintain a flexible control over compositional features. His form vocabulary was wide and included a rich use of line, shape, texture, and tonal value.

In the picture in figure 11, Foote made considerable use of the DRAW tool to achieve a free and open effect. Geometrical forms and exact technical mastery of fine detail were the only major areas of pictorial interest with which he did not choose to deal when using the ToolBox system.

The illustration in figure 12 shows a technique often used by Foote: a spatial-saturation strategy using personally constructed form units with the COPY tool in different tones and modes.

The final illustration, figure 13, was done by Bob Flegal. The motifs in the border were taken from North

Figure 9



Figure 10



**Figures 9, 10, 11, 12:** The drawings in these four figures were done by Howard Foote, an artist and college art teacher who was contracted to use the ToolBox system and to push it to its graphical limits.



Figure 11



Figure 12

**MAIL ORDER ONLY**

**Micro Computer**  
**DISCOUNT** Co  
 QUALITY • DELIVERY • SERVICE  
 Your One Stop For... Quality and Huge Savings

★ **MONTHLY** ★  
 ☆ **SPECIAL** ☆  
 ★ Commodore 8032 Only \$1195 ★

**PAPER TIGER**  
 445 & 460 & 560 CALL FOR PRICE

|  |   |
|--|---|
| <p><b>EPSON</b><br/>                 Call for Best Price &amp; Delivery</p>  |  <p><b>COMMODORE</b><br/>                 16K - \$859<br/>                 32K - \$1079<br/>                 2022 - \$695<br/>                 4040 - \$1079<br/>                 8050 - \$1495<br/>                 8032 - \$1195</p> |
|--|---|

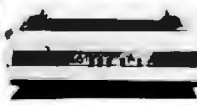
|   |   |
|---|---|
|  <p><b>SUPERBRAIN*</b><br/>                 64K - \$2595<br/>                 64KQD - \$3295</p> | <p><b>QUME SPRINT 9</b><br/>                 Call For Price</p>  |
|---|---|

|  |   |
|--|---|
| <p><b>ATARI</b><br/>                 800 - \$759<br/>                 400 - 339</p>  |  <p><b>CENTRONICS</b><br/>                 CALL FOR PRICES</p> |
|--|---|

**MONITORS**

|            |       |       |
|------------|-------|-------|
| Sanyo 9"   | B & W | \$180 |
| Sanyo 12"  | B & W | 239   |
| Sanyo 12"  | Green | 279   |
| NEC 12"    | Green | 249   |
| BMC 12"    | Green | 249   |
| Zenith 13" | Color | 359   |
| Amdex 13"  | Color | 389   |

\*(DENOTES ITEMS SHIPPED F.O.B. NYC)  
**MAIL ORDER ONLY**  
 Send Certified Check (Personal or Company Checks require 2 weeks to clear.) We pay all shipping and insurance charges except items marked with asterisk. VISA, MasterCard add 5% N.Y.S. Residents add appropriate sales tax.  
**PHONE (212) 986-7690**  
 Micro Computer Discount Company  
 60 E. 42nd St. Suite 411 New York, NY 10017

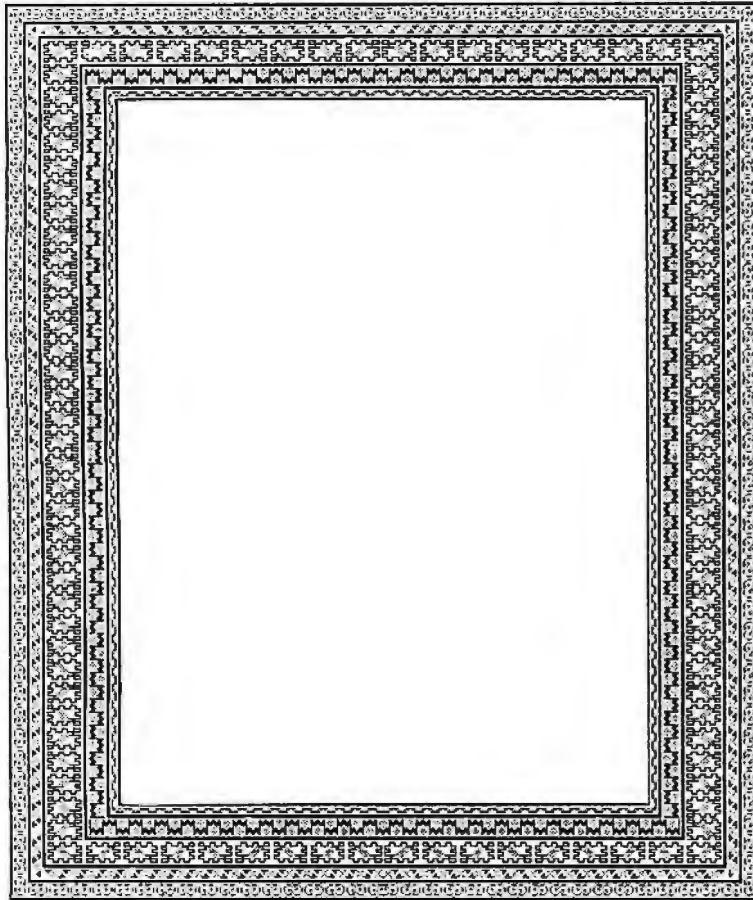

**Figure 13:** A border design created by Bob Flegal. The motifs are from North African carpet patterns.

African carpet designs. They were pieced together using the COPY tool with various grid settings. The Tool-Box system allows rapid construction of material involving repeated design modules.

### Summary

Based on the speed of execution and the range and depth of graphic language effects that can be created with the ToolBox system we feel that similar systems will become another common graphic tool for professional-level designers and illustrators. Extensions of the basic ideas presented in this article are numerous and provide a fertile ground for research in computer-mediated illustration and design. ■

# BYTE

TOLL-FREE  
SUBSCRIPTION LINE  
**1-800-258-5485**

The Quickest Way To

- Order a Subscription
- Renew a Subscription
- Change or Correct an Address
- Give a Friend a Gift Subscription
- Inquire about a Subscription

We are waiting to help you. Call us between:

**8:30-4:00 Mon.-Thurs.**

**8:30-12:30 Fridays**

(Eastern Time)

**BYTE** the small systems journal

## BYTE Back Issues for sale

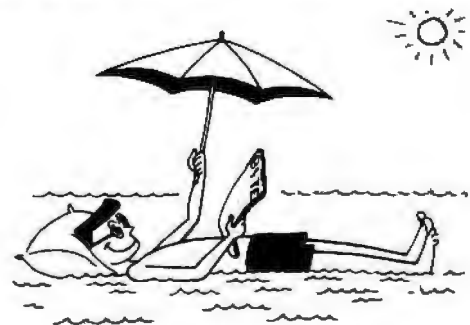

The following issues are available:

1976: July

1977: April thru December except October

1978: February thru December except November

1979: January thru December except March

1980: January, March thru August, and December

1981: February to current issue

Cover price for each issue through August 1977 is \$1.75

Domestic, \$2.75 Canada and Mexico; \$3.75 Foreign.

September 1977 through October 1979 issues are \$2.50

Domestic, \$3.50 Canada and Mexico; \$4.50 Foreign

November 1979 to current is \$3.00 Domestic, \$4.00 Canada and Mexico; \$5.00 Foreign.

Send requests with payment to:

**BYTE Magazine**

70 Main St, Peterborough NH 03458

Attn: Back Issues

Ready Ship 4 weeks for domestic delivery and 8 weeks for foreign delivery

\* Payments from foreign countries must be made in US funds payable at a US bank

# Do more with your Commodore. Plug in the printer that business professionals prefer.

Discover the quality difference and move up to Mannesmann Tally printing. The high speed 8024 serial printer comes ready to plug into and work with your Commodore system. No fussing with convertors or adapter boxes.

Here's what you get. Print speeds up to 200 lines per minute. Full 132 column printing. Conforms with Commodore specified program functions for full software compatibility. Whisper quiet operation. Clean, crisp and pleasing print quality that's always consistent copy to copy. Rugged, industrial strength construction. A print head that promises years of usage before replacement. A machine you can drive as hard as you want, yet it never requires preventive maintenance. Never needs periodic adjustments.

There's more. An easy to change, snap-in ribbon cartridge. Dual tractor paper engagement for positive alignment. A built-in self-test routine. Double wide printing on demand. A nine-needle print head model for true descenders on lower case characters. An optional Quick-Tear kit for forms removal immediately after printing. See this machine for yourself.

Ask for the Model 8024 at your nearest Commodore dealer or contact us.

**Mannesmann Tally, 8301 S. 180th St. Kent, WA 98031. Phone:  
(206) 251-5524.**

## MANNESMANN TALLY



# Virtual Memory for an Object-Oriented Language

---

Ted Kaehler  
Learning Research Group  
Xerox Palo Alto Research Center  
3333 Coyote Hill Rd  
Palo Alto CA 94304

---

The amount of information in a person's brain is truly vast; even the amount accessed in the course of a few hours of thought is vast. This is in contrast to the amount of information in the main memory of a computer, which is minuscule by comparison. The exciting thing about computers, though, is that we can use them to extend and enhance our thought. If a computer is to serve effectively as an aid to thought, it must be able to hold enough information to be useful. However, the memory of the largest computer today is so small that it severely limits what that computer can do. There are so many orders of magnitude between the capacity of the brain and the capacity of a computer that given the question "How much memory will the computer need?" the answer should always be "As much as possible."

Software for personal computers is just crossing a threshold of usefulness and flexibility. There are tasks, such as revising a draft of a paper, which are tremendously easier to do with a computer than without. Once you have edited with a computer, it seems absurd to edit by hand. The *number* of tasks for which the computer is

essential is growing rapidly, causing a very sharp rise in the demand for storage in each personal computing system. As we design more useful aids to human thought, we will immediately want to access an amount of information closer to the amount in someone's head. Many extraordinary ideas will become software realities in the next few years. And large quantities of memory will be needed to run and store all of that wonderful software.

---

**Given the question  
"How much memory  
will the computer  
need?" the answer  
should always be "As  
much as possible."**

---

The practical limit on the size of a computer's memory is cost. Every project, especially a personal computer, has cost limits. The question becomes how to get the most memory for the least cost. Roughly speaking, memory falls into two categories: fast, expensive memory and slow, in-

expensive memory. *Main memory* and *core* are common names for the fast, semiconductor memory. The slow memory, *secondary memory*, is almost always a disk. If we bought all slow memory, the processor would continually wait for the disk and would give very poor performance. If we spent all our money on fast memory, we would not get very much of it, and many of the bigger and better programs would not fit in. The game is to buy some fast memory and some slow memory and arrange things so that the processor rarely has to wait for the slow memory. This game, and specifically the mechanism which hides the slow memory from the processor, is called *virtual memory*.

If there were no way at all to predict which byte of memory the processor might want next, it would be impossible to win the game of virtual memory. However, pieces of data that are used together are often stored together, and program instructions tend to be executed and stored in a sequence. The principle of *locality of reference* states that the processor is most likely to access a memory location very near the last



one it accessed (see reference 2 at the end of this article). The game of virtual memory is based on a trick: when the processor starts to ask for bytes from a block of code or data, it should move that code or data into the fast memory. If the processor continues to access that information, all of the accesses will be to fast memory. When the program moves on to a new activity, it may again be forced to get its information from the slow memory. To win the game, a virtual memory must maintain a situation where most of the processor's accesses are to the fast memory. If the strategy fails and the processor often wants data from the slow memory, the entire system will run very slowly.

The act of moving programs or data between the two kinds of memory is called *swapping* (see figure 1). The program that the user is running may or may not control the swapping explicitly. Overlays are large groups of subroutines that are

moved to and from the disk under control of the user program. In an *automatic virtual memory*, however, the user program is unaware that swapping is occurring. The programmer does not specify how the program should be divided up into pieces or when swapping should occur.

In certain cases, letting the programmer control swapping directly can result in good performance. However, the virtual memory game is very complex and is played very quickly inside the computer. We believe that the programmer should not be burdened with deciding what part of the data to swap and when to do it. Asking the programmer to instruct the virtual memory is like asking a race car designer to write down, for the driver, exactly how to move the steering wheel in some future race.

In this article, we first look at a common type of automatic virtual memory called *paging*. We then introduce a new type of virtual

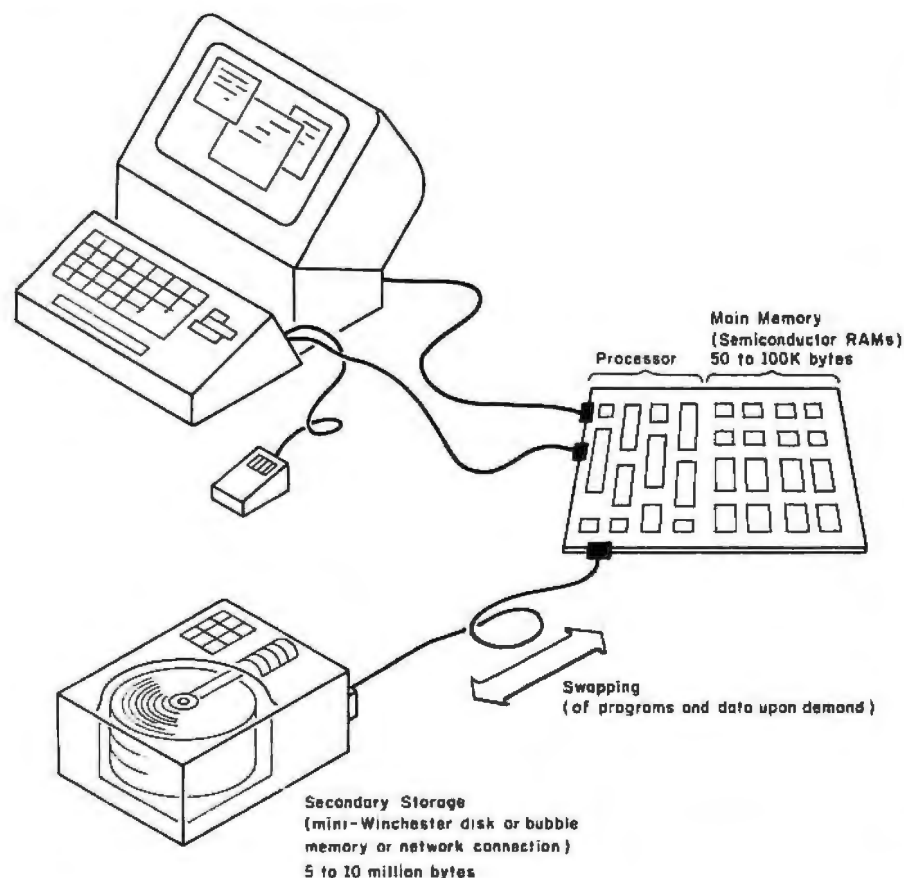

Figure 1: Main memory, secondary memory, and swapping combine to form a virtual machine that seems to have more memory.

## UNBELIEVABLE!

S-100 State-Of-The-Art Single Card CP/M Computer NOW AVAILABLE!

- Z80A or Z80B
- 64K RAM
- 2 Serial Ports (SIO)
- 4 Parallel Ports (PIO)
- 4 Timers (CTC)
- Floppy Disk Controller
- Intelligent Winchester Interface
- Prom Programmer

Single-unit pricing, Assembled, Tested, Burned-In

4 Mz Version .....\$895

6 Mz Version .....\$1,195

All you need to configure a single-user CP/M system or act as either a Master, Slave or a Peripheral Controller in multiple-processor configurations. It incorporates the NEC Floppy Disk Controller, which supports up to 4 double-sided double-density 8" disk drives, and the powerful Zilog family.

Our CPM version 2.2 BIOS is interrupt driven, resulting in extremely high throughput (TURBO-DOS version also available). Features are:

- High speed Bus transfer utilizing the Z80 OTIR and INIR instructions
- All devices interrupt-driven
- Type-Ahead I/O buffers
- Real-Time clock
- Time-of-Day clock
- Multi-level password support
- Menu-driven utilities for Format and Disk-Copy
- Configuration utility

Trademarks: CP/M by Digital Research, TURBO-DOS by Software 2000

VISA and Master Charge accepted

Dealer inquiries invited

Sierra Data Sciences  
1300 East Shaw, Suite 164  
Fresno, California 93710  
(209) 224-0520

memory that takes advantage of its knowledge of objects. We describe in detail a specific object-oriented virtual memory for the Smalltalk-76 system and explain how it plays the virtual memory game better than a paging system.

### Paging

The most common kind of automatic virtual memory is called paging. In paging, the program is cut up arbitrarily into pieces. Each piece is called a *page* and contains the same number of bytes as every other page—say, 512. There are many more pages than will fit into main memory at once, so most of them stay on the disk. The processor knows only about byte addresses in one large address space called the *virtual address space*. Every time the processor accesses a byte, the address of the byte is checked. The high-order bits of the address tell which page contains that byte. (The low-order bits tell which byte within the page.) If that page is not in main memory, the user pro-

gram stops. The virtual memory program starts up, finds an old page, moves it to the disk, and brings the desired page into memory in its place. (We will use the term “memory” to refer to the fast, main memory only.) The act of discovering that a page is needed from the disk and bringing it into memory is called a *page fault*.

An advantage of paging is that it works regardless of the contents of the pages. The mechanism needed to determine whether a given page is in memory is simple. Many computers have special hardware to speed up the translation between an address in the virtual space and a page in memory.

There are problems with paging, however. If the program needs a particular byte, the entire page surrounding that byte must be brought into memory. If no other bytes on that page are useful at the moment, a large amount of main memory is wasted. Since programs are cut up arbitrarily into pages in the first place, it is common that the rest of the page has nothing to do with the part currently

wanted. Sometimes a significant fraction of memory is taken up by pages from which the processor wants only a few bytes (see figure 2). These pages crowd out pages containing other parts of the program, causing many pages to be swapped to run the rest of the program. The many accesses to slow, secondary memory cause the whole system to be slow.

Another problem with paging is that every address of a byte or a word must be a long address. When an object-oriented language is built on a paging system, a pointer to an object is typically the address of the first word of the object. Every pointer must be capable of reaching any word in the entire virtual space, and each one must have enough bits to span the space. Pointers comprise a large fraction of many programs and data structures. If they could be shorter, more of the program could be packed into one page in memory and the entire program would take fewer pages of memory.

### Object-Oriented Virtual Memory

Smalltalk is a system composed of *objects*. An object is a little package of functionality. It contains the values of a few variables or a small piece of program. The important thing about an object is that its parts belong together. If a program wants a part of an object, it probably wants other parts, too. Different pieces of information were packaged together in that object exactly because they will be used together. Locality of reference is strong inside an object and, in general, weak between objects.

An object-oriented virtual memory swaps individual objects instead of entire pages between disk and main memory. Objects that are brought into memory are packed end to end with the objects already there. Memory is thus entirely filled with useful or likely-to-be-useful data. A larger percentage of memory is actually holding useful information than it would under a paging system. The result is that a larger part of the program can fit into memory at once.

There is a penalty for swapping ob-

Wondering where to find programs for your new

# VIC'?



## CREATIVE SOFTWARE

is your source for VIC programs.

**Our Introductory Offer . . .**

### THREE CHALLENGING GAMES on cassette

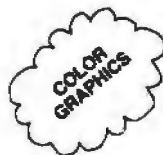

- Seawolf
- Bounce Out
- VIC Trap



**READY TO LOAD...FUN TO PLAY**

**\$24.95**

Add \$1.50 for shipping/handling

Calif residents add Sales Tax

MasterCard and VISA orders accepted

Write or phone for information on our other games, household utility and educational programs for your VIC.



## CREATIVE SOFTWARE

201 San Antonio Circle, # 270  
Mountain View, CA 94040  
(415) 948-9595

jects, however. Objects are generally smaller than pages, and there are a lot of them in memory at once. The virtual memory program must keep track of which object is in which place in the memory, and it must be able to find out where each object came from on the disk. Managing individual objects is more complicated than managing pages, but the advantage of packing main memory with useful objects makes up for the time spent managing the objects.

By object-oriented virtual memory, we mean a system that swaps objects which have meaning in the high-level language and which are typically small. Segments in the B5500 (reference 4) and objects in HYDRA (reference 5), while being the units of swapping in their systems, are large. These "objects" require tens or hundreds of bytes of overhead information each. An object-oriented virtual memory, in our sense, gives an object the same swapping freedom as a segment and shrinks the overhead to a few bytes per object.

### Pointers to Objects

An object consists of *fields*, which hold the values of their named and indexed instance variables. Each field contains a numeric value, which can be interpreted as itself or (usually) as a pointer to another object. This number, called the *object pointer*, is

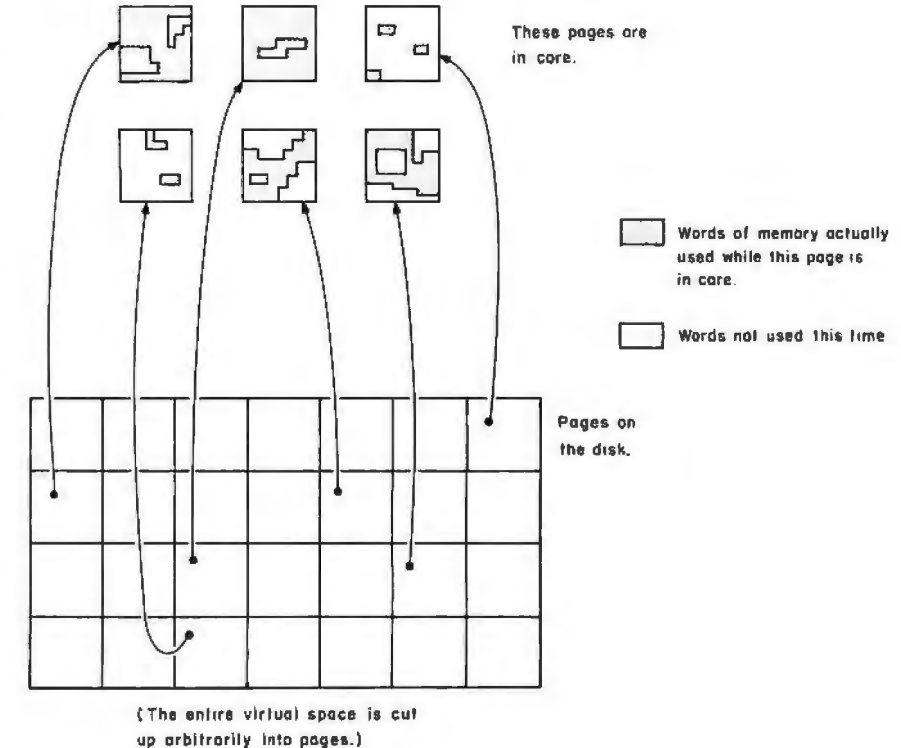

Figure 2: Virtual memory by paging.

the unique identifier of the other object. Every object has an object pointer. Given an object pointer, the virtual memory must be able to locate that object, whether it is in memory or on the disk (see figure 3).

Creating, destroying, and moving objects in memory is the job of a storage manager. The virtual memory program takes the place of

the storage manager (as described in Glenn Krasner's article, "The Smalltalk-80 Virtual Machine," on page 300 of this issue). It fetches and stores the fields of objects, creates new objects, and collects and manages free space. It also keeps track of the length of each object and the Smalltalk class of each object.

When the interpreter is working on

# Plug in Pascal Power...

## Microengine Power

Plug in PASCAL-100's new CPU Boardset for S-100 computers. Go with the power of the Pascal Micro-engine! Run UCSD Pascal<sup>2</sup> up to 10 times faster than typical implementations—with twice the memory capacity. You've got the best hardware for the best software around.

## On-board Z80

PASCAL-100 includes a Z80<sup>3</sup> processor, so you can run your current software—including CP/M<sup>4</sup>—without modification. Ready to convert an application to Pascal? Do it anytime, with no disruptive hardware changes.

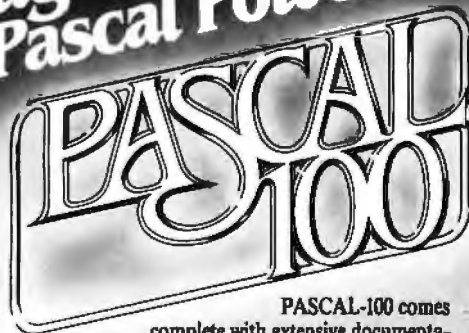

PASCAL-100 comes complete with extensive documentation—our users say it's the best around!

## New Generation S-100

PASCAL-100 is designed for the versatile, flexible S-100 bus. Fully compatible with the new IBEE-696 standard, yet works with

- most pre-standard
- 16 bit
- 128K memory capacity
- byte with Extended Memory Map
- Works with 8 or 16 bit memory

Want to know more? Call our toll-free number on the reader service card for fast action, call or write us directly.

### OEM'S/DEALERS

Be sure to specify our PASCAL-100 OEM/Dealer Information Package

Digicomp Research  
Terrace Hill Ithaca, NY 14850  
(607) 273-5900



<sup>1</sup>Trademark of Western Digital <sup>2</sup>Trademark of University of California  
<sup>3</sup>Registered Trademark of Zilog, Inc. <sup>4</sup>Registered Trademark of Digital Research



## Spelling Checker for Professionals.

SPELLGUARD eliminates spelling and typographical errors in documents prepared with CP/M<sup>1</sup> or CDOS<sup>2</sup> word processors.

SPELLGUARD is a unique program that leads the microcomputing industry in its efficiency, ease of use, and reliability.

### FAST

- Proofreads 20 pages in under one minute.\*

### POWERFUL

- 20,000 word dictionary, expandable with single keystroke.
- Properly handles hyphens and apostrophes.
- Allows multiple, technical dictionaries.

### RELIABLE

- Over 500 shipped by March 1981.
- 30-day money-back limited warranty.
- Industry leading Softguard<sup>SM</sup> feature ensures diskette copy of program is undamaged.

### EASY TO USE

- On-line help feature.
- Misspelled words marked in text for easy, in-context correction.
- Examples of all functions in 120 page manual.

### COST EFFECTIVE

- SPELLGUARD'S unique speed and accuracy easily recovers the suggested \$295 price.

\*Time estimates based on double density 8" diskettes and 4Mhz system.

Trademarks: Digital Research, Cromemco

Contact your local dealer or write ISA for a SPELLGUARD brochure.

## The fast, accurate proofreader.

INNOVATIVE SOFTWARE APPLICATIONS  
P.O. Box 2797, Menlo Park, CA 94025  
(415) 326-0805

an object that is in memory, the operations of fetching a field and storing a field must run fast. Both the fetch and store operations specify an object by giving its unique object pointer. The translation from the object pointer to the object's location in memory must be fast. The virtual memory spends most of its time doing this translation. A fixed correspondence between object pointers and locations in memory does not work, since almost any combination of objects may be in memory at the same time. The translation from object pointer to memory location must be highly variable.

Once in a while, the interpreter attempts access to an object that is not in memory. The virtual memory must detect the attempt, find the object on the disk, and bring it into memory. This process is called an *object fault*. Sometimes other objects must first be removed from memory to make room for the incoming object. In order to find an object on the disk, there must

be a correspondence between an object pointer and that object's location on the disk. The data needed to hold this correspondence must be compactly represented, as there may be many objects in the system.

### OOZE

In 1975 and 1976, Dan Ingalls and I designed and built a virtual memory to support the Smalltalk-74 system, called OOZE (Object-Oriented Zoned Environment). It then became the foundation for the Smalltalk-76 system (reference 3). The combination was very successful, and many interesting projects have been built in it. OOZE serves as an excellent illustration of a usable object-oriented virtual memory implemented entirely in software. At the end of this article, we discuss possible modifications of OOZE for the Smalltalk-80 system.

For OOZE to play the game of virtual memory well, we had to design it to fit the rules. Economics (of our existing hardware) dictated the size of

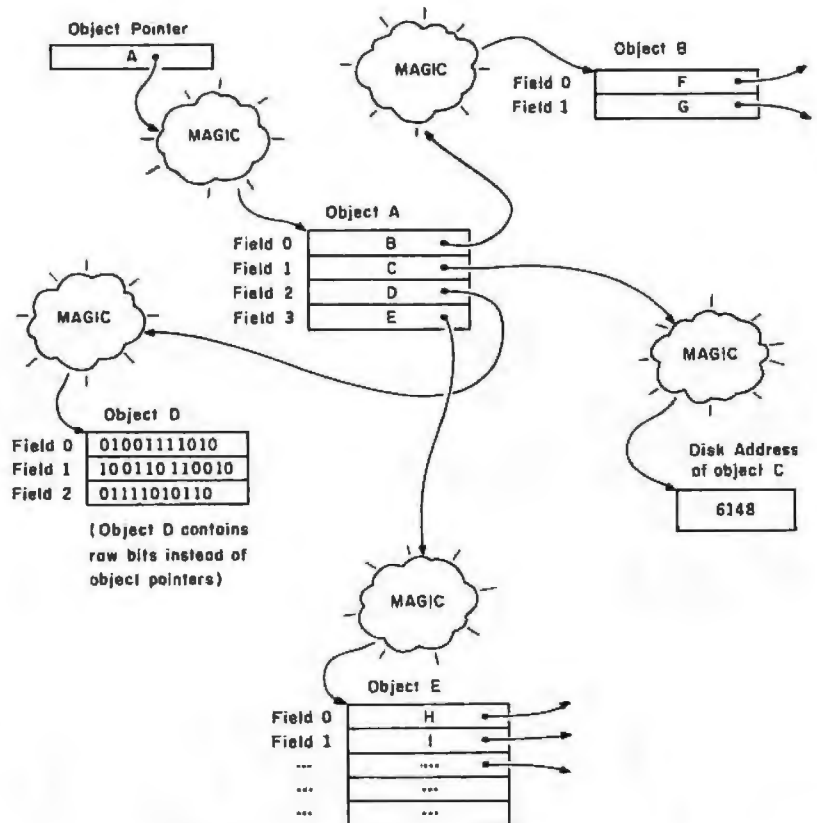

Figure 3: Objects and object pointers (as seen by casual observers). The "magic" is the unspecified process of translating the value of the object pointer to the actual address at which the object is stored.

main memory, the size of the disk, and the ratio of their speeds. The rules also included the things that the Smalltalk interpreter expected objects to do. We considered these and decided that in OOZE an object pointer would be 16 bits long, to fit into a machine word. We wanted every combination of 16 bits to be a legal object pointer, giving a total of 64 K objects. With a mean object size of 10 to 20 words, this was a good match to the size of our disk. To guarantee good performance during a fault on an object, we specified that any object can be brought into memory by reading, at most, one place on the disk. We did not allow one disk read to look up the disk address and another disk read to get the actual object.

The design of OOZE centers around the handling of the two important object pointer translations. Finding an object's location in memory from its object pointer must be fast. This mapping must also be flexible, since the exact combination of objects in memory changes from moment to moment. The correspondence between object pointer and memory location is a large hash table, called the *Resident Object Table* (ROT). Of the 64 K objects on the disk, perhaps 4000 are in memory at once. Each of these has an entry in the ROT. To find the location of an object, the hash routine uses the object pointer to compute where to look in the ROT. If it finds an entry whose object pointer matches, that entry also contains the memory address of the object (see figure 4). If the hash routine finds no match in the few entries it searches, the object is not in memory. The magic puffs of smoke in figure 3 depict the act of hashing an object pointer into the ROT to find its memory address.

OOZE must maintain the ROT. When an object is brought in from the disk, OOZE hashes its object pointer and looks in the ROT. When it finds an empty entry among the few possibilities, it claims that entry for the new object. Conversely, when an object is removed from memory and put back on the disk, its entry in the

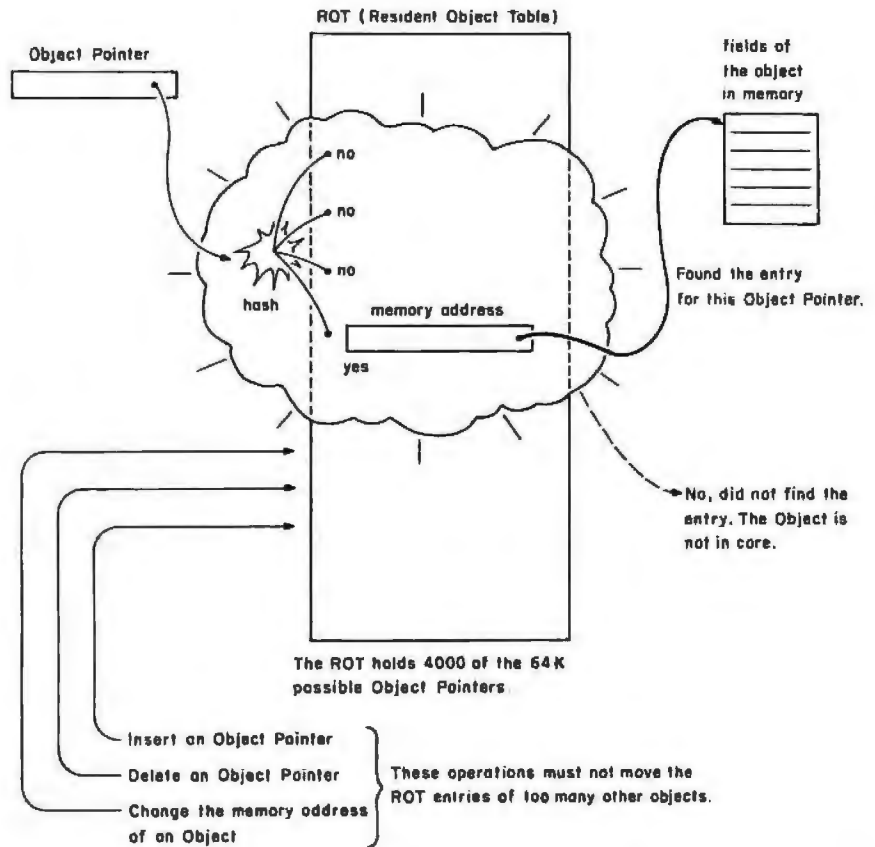

Figure 4: Hashing an object pointer in the Resident Object Table (ROT).

## ATTENTION GOVERNMENT D P USERS AND PURCHASERS

We represent many fine micro products and manufacturers on the U.S. Government's GSA Schedule, including

***Apple, Cromemco, Micropolis  
and Seequa Computers***

Purchasing from the Schedule will save you the time consumed by the bid process. Products shipped throughout the United States and world-wide. Visit or write any of our stores for more information or to receive our catalogue of products represented.

**Computers,  
Etc.....  
the dependable store**

257 West Street, Annapolis, MD 21401 - (301) 268-6505  
13A Allegheny Avenue, Towson, MD 21204 - (301) 296-0520  
9330 Georgia Avenue, Silver Spring, MD 20910 - (301) 588-3748  
6671 Backlick Road, Springfield, VA 22150 - (703) 644-5500  
Plaza 38, 2442 Route 38, Cherry Hill, NJ 08002 - (609) 779-0023  
Callers outside metropolitan areas served by our stores  
Please call (301) 268-5801

*Career Opportunities Available \* An Equal Opportunity Employer*

ROT is marked empty. Sometimes an object moves in memory, and its memory address in its ROT entry must be updated (as referred to in figure 4).

Hashing object pointers into the ROT to find memory addresses is the highest bandwidth operation in OOZE. If hashing were supported by special-purpose hardware, the hashing operation would not consume much time. (Many machines provide similar hardware support for paging.) In our implementations of the Smalltalk-76 system, the best we were able to do was to write the ROT hashing algorithm in microcode. In spite of this, OOZE spends a large fraction of its time hashing into the ROT. Any hash that can be avoided saves time. We modified the Smalltalk interpreter to remember the memory addresses of certain frequently used objects. During the straight-line execution of a Smalltalk method, the interpreter holds the memory address of the currently executing method, the receiver, and the

object on the top of the stack. Smalltalk spends significantly less time in OOZE when hashes of these frequently used objects are circumvented.

Hashing into the ROT is optimized in yet another way. As mentioned before, the hash routine uses the object pointer to compute a series of places to search in the ROT. The entries examined form a chain, with different object pointers having different chains. These chains crisscross throughout the ROT. An entry on one chain is many times filled by an object pointer from a different chain that also uses this entry. The hash routine is searching for an entry that matches a certain object pointer. The search will succeed faster if the chain has all its own entries at the beginning and all other chains' entries at the end. The algorithm for deleting an entry from the ROT provides this optimization. After deleting the proper entry, it shuffles the remaining entries and moves them forward in their chains. Because of this strategy, the

average number of entries examined to find an object in memory is only 1.8. Typically, the resident object table is 80 percent full.

### Finding an Object on the Disk

The translation from an object pointer to the disk address of the object is also important. Since a list of the disk addresses of all 64 K objects would easily fill up main memory, OOZE must use a trick. Instead of object pointers being assigned randomly to objects, information is encoded in each object pointer. This is done by dividing the set of object pointers into *pseudoclasses*. The bits in the upper part of the pointer indicate to which pseudoclass that object belongs. All objects in a pseudoclass have the same Smalltalk class and have the same length. The *Pseudoclass Map* is a table that is indexed with the pseudoclass number. There OOZE finds the length of the object and its class (see figure 5). A single Smalltalk class may own as many pseudoclasses as it needs to cover all of its instances. Classes whose instances may have indexable variables, such as class String, own a different pseudoclass for each length or range of lengths. The pseudoclass encoding saves space because each object does not use a word to hold its class or a word to hold its length. Objects in memory in OOZE are actually two words shorter than objects in the Smalltalk-80 system.

The disk address of an object is also found by using its pseudoclass. All objects in a pseudoclass are the same length, and they are stored consecutively on the disk. By knowing which object we want within the pseudoclass, we can compute its offset from the beginning of the pseudoclass. If we know the starting disk address of the pseudoclass, we can add the offset and find the object. The Pseudoclass Map contains the starting disk address of the object's pseudoclass (see figure 5). The low bits of the object's pointer tell which object it is within the pseudoclass. This encoding allows the disk addresses of all 64 K objects to be stored in 512 words of memory.

# MARK GORDON COMPUTERS

DIVISION OF MARK GORDON ASSOCIATES, INC.  
P.O. Box 77, Charlestown, MA 02129 (617) 491-7505

## COMPUTERS

|                     |         |
|---------------------|---------|
| Alari 800 W 16K     | 799.00  |
| 4K Model II         | 599.00  |
| Model II 64K System | 3499.00 |
| 16K Model III       | 879.00  |

## DISK DRIVES

|                           |                |
|---------------------------|----------------|
| 40 Track 5 1/4 inch drive | 314.00         |
| 80 Track 5 1/4            | 544.00         |
| 4 Disk Drive Cable        | 39.00          |
| Lobo w/controller         | Call for price |
| Lobo w/a controller       | Call for price |

## PRINTERS

|                      |                |
|----------------------|----------------|
| Epson MX80           | Call for price |
| Epson MX70           | Call for price |
| Okidata Microline 80 | 479.00         |
| Okidata Microline 82 | 599.00         |
| Okidata Microline 83 | 989.00         |
| NEC 5510 w/fractor   | 2679.00        |
| Diablo 630           | 2495.00        |

## MISC HARDWARE

|                             |                 |
|-----------------------------|-----------------|
| Expansion int TRS-80(OK)    | 289.00          |
| Novation D-Cat Modem        | 166.00          |
| 16K Memory Kit              | 35.00 (2/65.00) |
| Leadex Monitor              | 149.00          |
| Leadex 100G                 | 169.00          |
| Leadex Color Monitor        | 399.00          |
| Printer Cable for above     | 49.00           |
| ISO-2 Isolator              | 54.00           |
| AC LINE FILTER              | 24.00           |
| 280 Softcard                | 289.00          |
| Ramcard                     | 169.00          |
| Videx 80 COL BOARD          | 289.00          |
| Videx KBD Enhancer          | 109.00          |
| DC Hayes Micro Modem II     | 319.00          |
| CCS and SSM Interface Cards | Call for price  |

## STORAGE MEDIA

|                      |       |
|----------------------|-------|
| Scotch-box 10-5 1/4  | 27.00 |
| Memorex-box 10-5 1/4 | 22.00 |
| Plastic Storage Box  | 5.00  |
| Verbatim 5 1/4       | 25.00 |

## OPERATING SYSTEMS

|                           |        |
|---------------------------|--------|
| NEWDOS by APPARAT INC     | 49.00  |
| NEWDOS+ by APPARAT INC    | 99.00  |
| MMS FORTH DISKETTE PRIMER | 79.95  |
| NEWDOS 80                 | 135.00 |
| VTOS                      | 99.00  |

## BUSINESS SOFTWARE FOR TRS-80, APPLE AND ATARI

|  |                |
|--|----------------|
| Free enhancements and upgrades to registered owners for the cost of media and mailing. 30 day free telephone support. User reference on request. |                |
| Fully Interactive Accounting Package. General Ledger, Accounts Payable, Accounts Receivable and Payroll Report Generating                        |                |
| Complete Package (requires 3 or 4 drives)  | 475.00         |
| Individual Modules (requires 2 or 3 drives)  | 125.00         |
| Inventory II (requires 2 or 3 drives)  | 99.00          |
| Mailing List Name & Address II (requires 2 drives)   | 129.00         |
| Intelligent Terminal System ST-80 III  | 150.00         |
| The Electric Pencil from Michael Shrayar   | 150.00         |
| File Management System   | 49.00          |
| Sort 80  | 59.00          |
| LJK Letter Perfect (Alari, Apple)  | 139.00         |
| DB Master (Apple)  | 169.00         |
| Disk Business Software available for Model III   | Call for price |

## FINE PRINT

TRS-80 is a Tandy Corporation trademark. Use of above operating systems may require the use of Radio Shack TRS-DOS. Radio Shack equipment subject to the will and whim of Radio Shack.

## ORDERING INFORMATION

We accept Visa and Mastercard. We will ship C.O.D., certified check, or money order only. There will be a 40 percent deposit required on all C.O.D. orders over \$300.00. Massachusetts residents add 5 percent sales tax. Stock to three weeks for delivery.

TWX #710-320-7693  
For information call 617-491-7505  
To order, call toll-free 1-800-343-5206



The company cannot be liable for pictorial or typographic inaccuracies.  
The above prices do not include shipping.

(There are actually two additional levels of translation for the disk address. Tables for these take another 740 words).

By using the Pseudoclass Map, OOZE can find the disk address of any object from its object pointer. If it is in memory, OOZE also finds the object from its object pointer. Thus the same object pointer serves to identify and find an object, no matter where the object is. Because moving an object between disk and memory does not change its pointer, fields that point to the object need not change when the object moves. A field always contains the object pointer of the object to which it refers, regardless of the field's location and regardless of the object's location.

### Storage Management

The management of the swapping space has several aspects. Objects are created and destroyed by Smalltalk upon request, and they are also moved in and out of memory. Each of these actions causes insertion or deletion in the ROT and allocation or deallocation in memory. Consider a

class that wants to create a new instance: the new instance must receive an object pointer whose pseudoclass is already owned by that class. For this reason, we treat free instances of a class as legitimate objects. They "belong to the class" and can be swapped to and from the disk just like normal instances. Each class keeps a linked list of free instances. The class thinks that there are an infinite number of free instances on the disk, waiting to be swapped in. To create a new instance, the class merely pulls the first object off its "free list." If that object is not in memory, a fault brings it in from the disk. When a free list on the disk runs out, OOZE constructs new free instances on the disk as they are requested.

We have reduced the problem of managing memory and the ROT to the problem of swapping. Main memory has some free blocks between the areas being used for objects. These free blocks are linked together on free lists according to their size. The ROT also contains unused entries, which are marked as such. During an object fault, OOZE

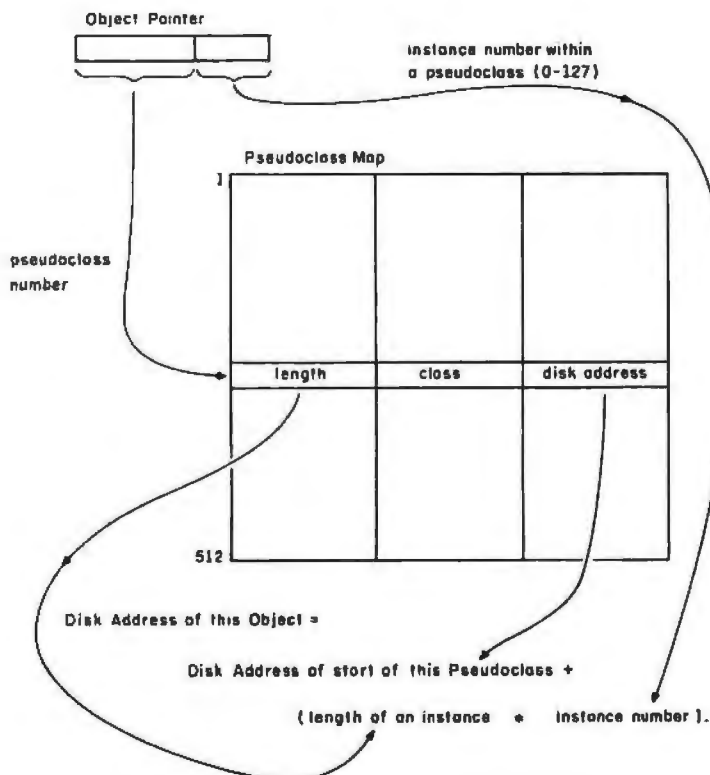

Figure 5: Information encoded in an object pointer.

## DATA COMMUNICATIONS

Apple • TRS-80 • S-100  
Alpha-Micro • CP/M and  
many others

Finally, you can talk with the big boys (or another mini/micro) by using our data communications products:

### SACP Stand-Alone Communications Processor

This unit is a self-contained front-end data communications processor. The size of a MODEM, it interfaces to your mini/micro system through any available RS-232 port and manages the communications line **independently**.

### SACP-100 S-100 Stand-Alone Communications Processor

Similar to the SACP described above, this unit can be inserted into an open S-100 slot on your system. It performs all of the functions of the SACP and, additionally, supports CPU to CPU data transfer through the use of a special I/O ports.

### ZSIO-100 S-100 Data Communications Board

A four port RS-232 Serial I/O and Real Time Clock board that establishes an interface to the powerful Zilog SIO chips. Maximum system throughput is achieved by utilizing the interrupt facilities of the Zilog ZSIO/2 and CTC LSI chips.

### Available Protocols

2780 • 3780 • HASP • JES1  
JES2 • VMRSCS • 3275 Emulation  
3271/3277 Emulation

Trademarks: CP/M by Digital Research  
VISA and Master Charge accepted  
Dealer inquiries invited

Sierra Data Sciences  
1300 East Shaw, Suite 164  
Fresno, California 93710  
(209) 224-0520

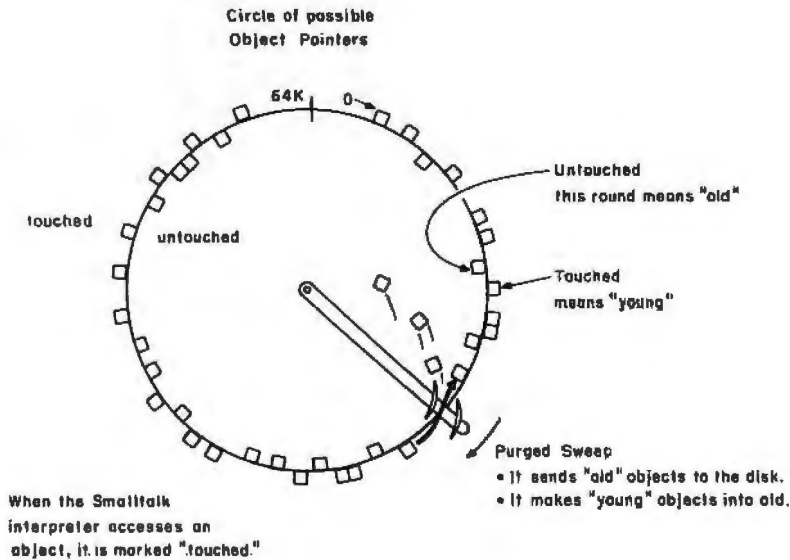

Figure 6: The order in which objects are purged from main memory.

claims a free ROT entry and a properly-sized block of memory for the incoming object. Occasionally, OOZE cannot find a legal ROT entry or a free block of memory that is large enough. The fault routine stops, and OOZE starts purging objects from memory by copying them to their proper places on the disk. It then frees the memory space and ROT entries of the objects it throws out. When the purge routine finishes, the fault routine resumes its work.

The purge routine must decide which objects to throw out of memory. To play the game of virtual memory perfectly, OOZE should keep the objects which will be used soon and throw out those which will not. Since OOZE cannot see into the future, it throws out the least recently used objects. Objects that have been active recently are kept, and inactive ones are tossed out. The purge routine examines objects in memory in an order determined by their object pointers. Consider the space of all object pointers to be a circle. The purge routine tours the circle, keeping objects that have been accessed since the last time around. Objects that have remained unaccessed since the routine last visited them are purged to the disk (see figure 6). Typically, it takes several calls on the purge routine to complete a tour of the circle of object pointers.

Purging objects in order of their object pointers has a very important side effect. Since all objects in a pseudoclass are consecutive on the disk, purge sends out the objects it is purging in the same order that they appear on the disk. This minimizes the movement of the disk head and saves time.

Objects that have not been changed since they came in from the disk do not have to be rewritten. They are correct as they stand on the disk. A single bit in each object in memory tells if it is "dirty" (ie: if it has been changed since it was copied to memory). If an object about to be purged is not dirty, we do not rewrite it on the disk and thus save time. This savings can be enhanced by purging in the background. Normally the purge routine runs in response to an immediate demand for space in memory. A special version of the routine runs when Smalltalk is idle and looks ahead in the circle of object pointers. It writes dirty objects to the disk and marks them as being "clean." A subsequent demand call on the purge routine will run quickly because many of the objects it wants to throw out are already written on the disk.

After each round of purging, the degree of fragmentation of memory is tested. If there are too many small blocks and no big ones, we perform a

compaction. All objects are moved to one end of memory and all free blocks are merged into a single block at the other end. Memory addresses are updated in the ROT entries of the objects that have moved. OOZE performs this operation without using additional storage in order to keep a list of which objects have moved to which place in memory.

As a storage manager, OOZE must detect when an object is no longer being used. Like the storage manager mentioned in Krasner's article, OOZE uses *reference counting*. When the reference count of an object goes to zero, its object pointer is not in any field of any other object. At this point, it is impossible for that object ever to be accessed by the interpreter. OOZE, therefore, puts the object on its class's free list. Before doing so, however, it decreases the reference count of the object pointed to by each field of this object. In the process, more counts may go to zero, and more objects may get freed. To save space, reference counts are only four bits wide. The few objects with fifteen or more fields pointing at them are noted in a separate overflow reference count table.

## Performance

An average Smalltalk-76 system with OOZE contains 40,000 objects and occupies one megabyte of disk space. In main memory, the system uses 96 K words, including 8 K words for the ROT and 40 K words for the objects that are currently swapped in. (We sometimes run with only 64 K words of memory.) On the Alto computer (see reference 1), we implement hashing into the ROT and the allocation of common objects in microcode. Performance is equivalent to a paging system with several times the swapping space. The OOZE virtual memory has allowed the Smalltalk-76 system to grow from an experiment into a system for building large and serious applications.

OOZE was designed in 1975. Several rules of the virtual memory game have changed since then. Here are some ways in which OOZE shows its age at Xerox PARC:



●Users can afford more disk and more memory. They want to build systems that contain more than 64 K objects. OOZE cannot be easily expanded beyond this limit.

●Several extensions to the Smalltalk language encourage the user to create lots of classes. OOZE has a limit of 245 classes, and many serious users have encountered this limit.

Naturally, our minds have turned to building a virtual memory for the Smalltalk-80 system with even better performance than OOZE. In 1980, a group of us at Xerox PARC designed just such a system, the *Large Object-Oriented Memory* (LOOM). Individual objects in LOOM carry slightly more overhead than objects in OOZE. (Since users can afford more memory, this is not a problem.) Besides allowing a much larger virtual space and unlimited classes, LOOM provides some new properties:

●LOOM accesses objects that are in memory simply by indexing a table, as does the resident Smalltalk-80 system. LOOM thus saves the time that OOZE spends hashing into the ROT whenever it wants a memory address. During the table lookup which finds an object's memory address, LOOM tests for the case when the object is not actually in memory. To run faster than a hash in OOZE, the test must be very simple and fast.

●LOOM is designed with the idea in mind of grouping objects on the disk. If objects that are faulted on together can be arranged into groups on the disk, the system will run faster. LOOM will be a test bed for schemes that optimize the organization of objects on the disk.

## Conclusion

The goal of the virtual memory game is to make a mixture of fast and slow memory perform almost as well as if it were all fast memory. The strategy is to guess what information the processor will need soon and move it to fast memory. In an object-oriented language such as Smalltalk, the object is an excellent unit for

locality of reference. Once an object is accessed, it will most likely be accessed again soon. Recently used objects have a similar degree of locality to recently used pages, and many more objects than pages fit into a given amount of fast memory.

OOZE is the first representative of the new category of object-oriented virtual memories. These systems use a construct in the high-level language, the object, as the unit of swapping. Objects as small as one field in length are swapped individually by the same mechanism used for large strings and arrays. To be a member of this category, a virtual memory must also have automatic control of swapping and automatic creation and freeing of objects. While OOZE is implemented in software, we believe that future systems will be implemented like languages: hardware assist for a few high-bandwidth operations, some microcode, and support code in machine- or high-level language. We expect that mature object-oriented virtual memories will identify groups of objects that are used together and swap them as a unit.

As the virtual memory which supports the Smalltalk-76 system, OOZE is interesting in itself. It provides the ability to address  $2^N$  objects with  $N$ -bit pointers. Only currently active objects occupy memory, and they are packed end to end. This provides exceedingly good use of memory. Because the class and length of an object are encoded in the object pointer, that information does not occupy space with each object in memory. Movement of the disk head is reduced because objects are purged to the disk in the order of their disk addresses. OOZE is implemented in software without any special hardware support. It runs in an amazingly sprightly fashion and performs as well as paging systems with several times the swapping space.

The fact that Smalltalk uses objects consistently and completely allows its virtual memory to be radical in design. Object-oriented virtual memories get their power from a close coupling with the high-level languages they serve. The success of

OOZE and the changing rules of the virtual memory game have inspired the design of LOOM, a larger and more efficient object-oriented virtual memory. ■

## References

1. Bell, C G and Alan Newell. *Computer Structures: Readings and Examples*, New York: McGraw-Hill, 2nd edition, 1980.
2. Denning, P J. "Virtual Memory," *Computing Surveys*, Volume 2, Number 3, September 1970, page 153.
3. Ingalls, Daniel H H. "The Smalltalk-76 Programming System: Design and Implementation," *Conference Record, Fifth Annual ACM Symposium on Principles of Programming Languages*, 1978.
4. Shaw, Alan C. *The Logical Design of Operating Systems*, Englewood Cliffs NJ: Prentice-Hall, 1974.
5. Wulf, W A, et al. *HYDRA/C.mmp*, New York: McGraw-Hill, 1981, Chapter 11.

# Is two years too much to ask for an experience that lasts a lifetime?

Americans from every background working together with people around the world to meet their basic human needs—that's what the Peace Corps is all about.

It isn't easy, and it's not for everyone. For an experience you'll never forget, call toll free 800-424-8580. Or write Peace Corps, Washington, D.C. 20525.

**Peace Corps**  
The toughest job  
you'll ever love.



A Public Service of This Magazine  
& The Advertising Council

# Ask BYTE

Conducted by Steve Ciarcia

## Language Requirements

Dear Steve,

How much ROM (read-only memory) and programmable memory is necessary to program in languages like BASIC, FORTRAN, Pascal, and COBOL? I have read your articles in BYTE, but I haven't seen anything about this subject.

Stephen Walaski  
Russellville AR

The actual amount of memory in a system is often more dependent upon economics than on need. There are systems sold with anywhere from 2 K- to 12 K-byte BASIC interpreters. Generally speaking, a "tiny" BASIC would require 2 K to 4 K bytes of ROM (read-only memory) and from 1 K to 4 K bytes of programmable memory for operator entries. A full BASIC, or extended BASIC as it's often called, usually occupies between 8 K and 12 K bytes of ROM space. Systems that have a ROM BASIC usually have 4 K to 16 K bytes of programmable memory. This is what's typically found on the Radio Shack TRS-80 and Apple II computers. In both of these systems, the programmable memory can be expanded to 48 K bytes.

For high-level languages such as FORTRAN, Pascal, or COBOL, which are compilers rather than interpreters, a disk is a necessary part of the computer system. The disk operating system can often occupy 4 K to 8 K bytes and is generally stored in the programmable memory when in use. When you load the compiler software, it can use an additional 12 K to 20 K bytes. So, for FOR-

TRAN, Pascal, or COBOL, you may have 20 K to 28 K bytes of programmable memory occupied before you've written a single line of code.

Generally speaking, anyone wishing to use such high-level languages would be well advised to have, at a minimum, 48 K bytes of programmable memory. When operating with a disk, the ROM often becomes immaterial other than as a "bootstrap" loader, so I don't see that any particular amount is necessary. . . . Steve

## A Tank List Job

Dear Steve,

I would like to know two things about your article "A Computer-Controlled Tank." (See the February 1981 BYTE, page 44.)

- What computer was the control program written for?
- Can the circuitry be modified for an Ohio Scientific CIP to control a small Radio Shack tank?

Ken Pataska  
Kenosha WI

The control program for my computerized tank was written in standard extended BASIC. I used a Digital Group Z80-based computer to write the original program, but the same program has been run on both a Radio Shack Model I and Model III.

As far as using a similar circuit for the Radio Shack tank, I would guess that the circuit could provide on/off control, but the operation of Radio Shack's tank is very different from Milton Bradley's Big Trak. If you can live with sending out single commands and no local program

storage in the tank, there should be no reason why the Radio Shack tank could not be controlled by any computer. . . . Steve

## Modem Inquiries

Dear Steve,

I have a few questions about your August 1980 BYTE article "A Build It Yourself Modem for Under \$50."

- How does one calibrate the frequencies accurately?
- Is this modem a two-line, full-duplex coupler?
- Are the kits you mentioned at the end of the article still available?
- Where can I purchase cables and connectors?

I own a Heathkit H-89 (alias Zenith Z89) with a three-port RS-232C board installed.

Brian J Mork  
Holland MI

The modem presented in that article has been very popular, and many hundreds have been purchased by experimenters. It is still available from The Micromint (917 Midway, Woodmere NY 11598). It costs \$39.95, plus \$2 for shipping.

Regarding the electronics of the modem, it could be considered a two-line, full-duplex modem except that there are really three wires between the computer. One carries data from the modem to the computer, one carries data from the computer to the modem, and the third is the ground. You should have no problems attaching the modem to a Heath H-89; and, to my knowledge, the connectors and cables are

available from Radio Shack.

As far as calibrating the frequencies: the manual provided with the Modem Kit describes calibration using standard test instruments. It also describes a fairly quick and easy way to accomplish this. The method uses an answer modem to serve as a frequency source. The Micromint also has recorded answer-modem frequencies on cassette tape available. . . . Steve

## Multi-Dimensional Problem

Dear Steve,

We bought an Olivetti electronic typewriter that features a daisy-wheel head, proportional spacing, memory, etc. We were told it would "interface" with a computer. At that time we didn't even know what interface meant, but found out later. We then looked at word processors, such as Vydec and Dictaphone, that are able to show a whole page of 69 lines with 160 columns. In our ignorance, we thought that was standard, even though we saw some machines with only 80 columns by 24 lines. Not being able to afford the \$8500 to \$15,000 cost of a word processor, we thought that we had a line printer in the Olivetti. We decided to get a cheap computer, hook them together, and then we would have what we needed, and cheap.

That's when we ran up against the 24-line, 80-column problem. Now giving us 24 lines and 80 columns when we have hundreds of pages to lay out, with printing to go around pictures, etc, is like trying to do layouts on a sheet of 8½-by 11-inch

paper with about two-thirds of it covered at all times. Sure, you can scroll up and down and sideways, but how can you judge a layout if you can't see the whole page? When you are writing, how can you remember what you said in the first paragraph when you are at the bottom of the page?

Everywhere we went, we asked why microcomputers were limited to 80 columns and 24 lines, and we got a different answer from each store. One said it was the video display that limited it, one said it was some circuit in the computer, one said it was the cheap way that computers are built, but mostly they looked at us blankly and said they didn't know. We wrote to manufacturers, to companies all over, and no one has even answered our letters, so now it's your turn: What limits the format size of the video display, and can we get a full 160-character by 69-line page on a video display using one of the less expensive computers such as the Radio Shack TRS-80?

Sam Millar  
Olympia WA

Let me assure you that video displays with 69 lines by 160 characters are very unusual. Most personal computers have 16 or 24 lines of 64 characters, and most commercial units have 24 lines of 80 characters. The difference between them is not that one is a cheap computer and the other is not, but that the electronics of a 69 by 160 format is considerably more expensive than a 24 by 80 format.

When you buy a word-processing system, be aware that there are many more features than the number of lines that are displayed on the screen. The software is far more important. Frequently, word-processing systems have 16 by 64 characters on a screen, but good word-pro-

cessing software will allow you to print the final copy at any line length. In fact, the system that I use has a 16-line by 64-character display, but it allows me to print out up to 132 characters per line.

One possible approach for you is to attach your Olivetti to an inexpensive personal computer and get some high-powered software. If you don't mind the time limitations involved with occasionally dumping the full document to the printer to see how it looks, it should not be too cumbersome.

Keep in mind that you get what you pay for. If you buy a \$20,000 word-processing system, one of the features you can get is full-page display. However, you should be able to configure a microcomputer-based word-processing system that produces almost identical final copy for under \$4000.

I hope I've helped you in some way. I do all of my writing on a word processor and I find it invaluable.  
... Steve

---

### Coming Across Assemblers

Dear Steve,

I can't seem to be able to find a cross-assembler for the Texas Instruments TMS-1000 microcomputer, written in FORTRAN or in BASIC, that could run on a home computer such as the Apple II. Does something like this exist? If not, do you know of a development system?

Guy Chemla  
Le Kremlin Bicetre, France

Texas Instruments has cross-assemblers that run on Digital Equipment Corporation's PDP-11/70 and VAX systems and on the IBM 370. These are hardly inexpensive cross-assemblers. Texas Instruments does, however, sell a 9900-based computer that

emulates and supports the TMS-1000. The hardware includes a video display, two floppy-disk drives, the chassis with 9900 processor, 64 K bytes of memory, and the software. It's called the TAM 9000 system. It costs approximately \$20,000.  
... Steve

---

### Article Information

Dear Steve,

I would like to interface my IBM Selectric typewriter to my 16 K-byte TRS-80 Level II. I do not have the Expansion Interface, but I would like to have Selectric-quality hard copy.

Where can I get information on buying or building the necessary interfacing circuitry and other items essential for the conversion?

J W Rankin, Jr  
Memphis TN

There are many different ways of attaching an IBM Selectric to a computer. You don't necessarily need the Expansion Interface to do it with a TRS-80.

Many articles have been published in the past few years concerning the Selectric. You may do better to look up a few and choose among the different ways presented.

The following is a partial list:

Interface Age, January 1978, page 148.  
Kilobaud, May 1978, page 64  
Kilobaud, June 1978, page 22  
Kilobaud, July 1978, page 40  
Kilobaud, November 1979, page 134  
Kilobaud, December 1979, page 144  
BYTE, June 1977, page 46  
BYTE, October 1977, page 174  
BYTE, October 1977, page 36  
Kilobaud, July 1977, page 5

These magazine article listings came from the Periodical Guide for Computerists by E Berg Publications, 622 E Third, Kimball NE 69145.  
... Steve

---

### One Eye Toward the Past

Dear Steve,

I read your columns in BYTE and enjoy them very much. A few years back there was an article about a solid-state television-camera project called Cyclops. The heart of the system was a 32 by 32 photosensitive array. Have you heard of this device or the article?

Dennis Sprague  
Great Falls MT

The article that you are interested in is indeed called "Cyclops." It was in the February, 1965, Popular Electronics. The 32 by 32 photosensitive array is in fact a dynamic memory chip.  
... Steve

---

### Off to a Slow Start

Dear Steve,

In college, the only computer I had a chance to use was a PDP-8. Since that time, I haven't had an opportunity to use a computer, with the exception of my Texas Instruments SR-56 and a TRS-80 down at the Radio Shack. I try to keep up-to-date on the microcomputer field as much as possible. I have basic knowledge of electronics and microcomputers, but the language used in BYTE is sometimes too technical for me. Could you recommend some books, articles, etc?

I have concentrated my study on Intel's 8080 microprocessor, and am interested in building a system around it, using the S-100 bus. I envision using a video display for

## Ask BYTE

writing programs and a cassette for storage.

My budget is limited, so I was wondering if this system is my best approach? I plan to buy bare boards and do most of the construction myself. How do I know which boards will be best for my system? Where can I get more information on system components, such as floppy disks, video-display and processor boards, etc?

Any advice would be greatly appreciated.

Douglas B Powers  
North Platte NE

Many people write and ask me where to start. Generally, I have the same answer: It really depends upon what you mean by "starting." Are you just concerned with learning about microcomputers or are you trying to build a system, one board at a time, that

will compete with an IBM 370? You either have to have an idea of what you want as an end result when you start, or be satisfied with learning the basics and possibly replacing that system. Your second system would attempt to be closer to the final system that you want.

As far as books, the best suggestion, obviously, is to go to a bookstore that has many technical books and look through them. Or join the McGraw-Hill Electronic Engineers Book Club—I've belonged to it for years.

I have just written a book on building your own Zilog Z80-based computer from scratch that I would like to recommend, but it is intended to teach you about the Z80. I doubt that it could ever compete with a quad-disk Cromemco System simply by the fact that much more support is needed to

add disk drives, etc.

If you are intent upon starting with a system that is not of your own design, then I recommend buying blank S-100 boards and "populating" them. It is a very inexpensive path to follow and can result in a valuable system later on. Unfortunately, populating boards does not necessarily teach you much about designing a custom computer system nor does it allow you to deviate from the functions available on those cards.

One final note, this

month's and last month's "Circuit Cellar" articles are about a 4- by 4½-inch tiny BASIC computer, which is offered as an inexpensive kit. All you have to do is add a video terminal (you envisioned starting with video display anyway) and immediately you would be able to start off with a tiny BASIC preprogrammed in ROM. It also has 4 K bytes of programmable memory on board. You might want to consider it as an inexpensive way of starting. . . . Steve ■

In "Ask BYTE," Steve Ciarcia answers questions on any area of microcomputing. The most representative questions received each month will be answered and published. Do you have a nagging problem? Send your inquiry to:

Ask BYTE  
c/o Steve Ciarcia  
POB 582  
Glastonbury CT 06033

If you are a subscriber to The Source, send your questions by electronic mail or chat with Steve (TCE317) directly. Due to the high volume of inquiries, personal replies cannot be given. Be sure to include "Ask BYTE" in the address.



# This is it . . .

the answer to your problem of how to run single sheets of your letterhead or a snap-a-part form thru a tractor feed printer.

. . . just insert your form or stationery into the **PAPER PORTER™**, place in your printer, align the print head and start printing . . . .

**ONLY \$2.75** EACH  
FORM MF-006 In quantities of 5 or more

**\$4.50 EACH SINGLY**

PRICE INCLUDES SHIPPING IN CONT. U.S.A.

You may mix items to obtain quantity discount.

**MINIT-MAN PRINTING Dept. B881**

211 E. Allegan St., Otsego, MI 49078 (616) 694-9141

Please Rush the following

| QUANTITY | ITEM | PRICE | TOTAL PRICE |
|----------|------|-------|-------------|
|          |      |       |             |
|          |      |       |             |

**PAYMENT  
MUST  
ACCOMPANY  
ORDER.**

Charge it to  Visa  Mastercharge TOTAL \_\_\_\_\_

Acct. No. \_\_\_\_\_ Exp. Date \_\_\_\_\_

Name \_\_\_\_\_

Address \_\_\_\_\_

City/State/Zip \_\_\_\_\_

Michigan Residents add 4% Sales Tax

THANK YOU

### OTHER PRODUCTS

- MF-001 Video Layout Pads for Heath, Zenith H19, Z19, H89 & Z89
- MF-002 Gen. Purpose Programming Pads for Basic & Assembly Lang.
- MF-003 Flow Charting Pads no need for templates, carries most sym.
- MF-004 Printer Layout Pads 10 char. hoz. by 6 lines vert., 132 column.
- MF-005 Printer Overlay Same as #4 but clear mylar, available singly
- MF-007 Cobol Programming Pads uses standard Cobol layout & col

All Items except MF-005 & MF-006 are printed in fadeout blue on offset stock and are padded in 50's. Available **5 pad minimum, \$2.75 each.** Prices include shipping within Cont. U.S.A.

DEALER INQUIRES INVITED

# Books Received

This is a list of books received at BYTE Publications during this past month. Although the list is not meant to be exhaustive, its purpose is to acquaint BYTE readers with recently published titles in computer science and related fields. We regret that we cannot review or comment on all the books we receive; instead, this list is meant to be a monthly acknowledgment of these books and the publishers who sent them.

*Basic Business Software*, E G Brooner. Indianapolis IN: Howard Sams & Company, 1980; 13.5 by 22 cm, 141 pages, softcover, ISBN 0-672-21751-1, \$9.95.

*Basic Electrical Engineering, Fifth Edition*, A E Fitzgerald, D Higginbotham, and A Grabel. New York: McGraw-Hill, 1981; 17.5 by 24.5 cm, 937 pages, hardcover, ISBN 0-07-021154-X, \$28.95.

*Computer Language Reference Guide*, Harry L Helms Jr. Indianapolis IN: Howard Sams & Company, 1980; 13.5 by 22 cm, 109 pages, softcover, ISBN 0-672-21786-4, \$6.95.

*Computer Networks and Distributed Processing: Software, Techniques, and Architecture*, James Martin. Englewood Cliffs NJ: Prentice-Hall, 1981; 19 by 24.5 cm, 562 pages, hardcover, ISBN 0-13-165258-3, \$34.

*Computer Networks in the Chemical Laboratory*, G Levy and D Terpstra, editors. New York: John Wiley & Sons, 1981; 16 by 23.5 cm, 221 pages, hardcover, ISBN 0-471-08471-9, \$27.50.

*Computer Programs in BASIC*, Paul Friedman. Englewood Cliffs NJ: Prentice-Hall, 1981; 23 by 29.5 cm, 271 pages, hardcover, ISBN 0-13-165225-7, \$19.95. Available in softcover for \$10.95.

*Database Security and Integrity*, E Fernandez, R Summers, and C Wood.

Reading MA: Addison-Wesley, 1981; 16.5 by 24.5 cm, 320 pages, hardcover, ISBN 0-201-14467-0, \$17.95.

*Data Dictionaries and Data Administration—Concepts and Practices for Data Resources Management*, Ronald G Ross, New York: AMACOM, 1981; 16.5 by 23.5 cm, 454 pages, hardcover, ISBN 0-8144-5596-4, \$29.95.

*History of Programming Languages*, R Wexelblat, editor. New York: Academic Press, 1981; 18.5 by 26 cm, 758 pages, hardcover, ISBN 0-12-745040-8, \$45.

*Introduction to 8080/8085 Assembly-Language Programming: A Self-Teaching Guide*, J Fernandez and R Ashley. New York: John Wiley & Sons, 1981; 17.5 by 25.5 cm, 303 pages, softcover, ISBN 0-471-08009-8, \$8.95.

*Introduction to Pascal for Scientists*, James W Cooper. New York: John Wiley & Sons, 1981; 16 by 23.5 cm, 260 pages, hardcover, ISBN 0-471-08785-8, \$19.95.

*Lecture Notes in Computer Science, Directions in Human Factors for Interactive Science*, H Ledgard, A Singer, and J Whiteside, edited by G Goos and J Hartmanis. New York: Springer-Verlag, 1981; 16.5 by 24.5 cm, 190 pages, softcover, ISBN 3-540-10574-3, \$11.80.

*Managing a Programming Project, Second Edition*. Philip W Metzger. Englewood Cliffs NJ: Prentice-Hall, 1981; 16 by 23.5 cm, 244 pages, hardcover, ISBN 0-13-550772-3, \$22.95.

*Microcomputer Architecture and Programming*, John F Wakerly. New York: John Wiley & Sons, 1981; 17.5 by 23.5 cm, 692 pages, hardcover, ISBN 0-471-05232-9, \$27.95.

More TRS-80 BASIC, A

*Self-Teaching Guide*, D Inman, R Zamora, and B Albrecht. New York: John Wiley & Sons, 1981; 18.5 by 23.5 cm, 280 pages, softcover, ISBN 0-471-08010-1, \$9.95.

*Nailing Jelly to a Tree*, J Willis and W Danley Jr. Beaverton OR: Dilithium Press, 1981; 14 by 22 cm, 244 pages, softcover, ISBN 0-918398-42-8, \$12.95.

*Structured COBOL, Fundamentals and Style*, Tyler Welburn. Palo Alto CA: Mayfield Publishing, 1981; 22 by 27.5 cm, 535 pages, softcover, ISBN 0-87484-543-2, \$18.95.

Systems Programmer's

*Problem Solver*, William S Mosteller. Englewood Cliffs NJ: Prentice-Hall, 1981; 16 by 23.5 cm, 223 pages, hardcover, ISBN 0-87626-830-0, \$18.95.

*Telecommunications—Management for Business and Government*, Larry A Arrendondo. New York: Telecom Library, 1981; 22 by 28 cm, 270 pages, softcover, ISBN 0-936648-07-4, \$30.

*User's Guidebook to Digital CMOS Integrated Circuits*, Eugene R Hnatek. New York: McGraw-Hill, 1981; 16 by 23.5 cm, 339 pages, hardcover, ISBN 0-07-029067-9, \$24.50. ■

# Software Received

*Automatic Graphing of Functions*, multifaceted function plotter for the TRS-80 Model I Level II and Model III. Cassette, \$19.95. David L Modney, 4144 N Via Villas, Tucson AZ 85719.

*B.I.T.S. BASIC Interactive Terminal Software, Version 3.0*, intelligent terminal software for the Apple II. Floppy disk, \$44.95. Software Sorcery Inc, 7927 Jones Branch Dr, McLean VA 22102.

*Hyper-B.I.T.S.*, 1200 baud version of B.I.T.S. for the Apple II. Floppy disk, \$64.95. Software Sorcery Inc (see above).

*Mailing List Package Version 3.1*, name and address data base for the Apple II. Floppy disk, \$49.95. Software Sorcery Inc (see above).

*Pool 1.5*, pool table simulation for the Apple II. Floppy disk, \$34.95. IDSI, 3210 Mercury, Las Cruces NM 88004.

*Raster Blaster*, electronic pinball simulation for the Apple II. Floppy disk, \$19.95. BudgeCo, 428 Pala Ave, Piedmont CA 94611.

*Super Invasion*, Space-Invader-type game for the Sinclair ZX80. Cassette, \$14.95. Softsync Inc, POB 480, Murray Hill Sta, New York NY 10156. ■

This is a list of software packages that have been received by BYTE Publications during the past month. The list is correct to the best of our knowledge, but it is not meant to be a full description of the product or the forms in which the product is available. In particular, some packages may be sold for several machines or in both cassette and floppy-disk format; the product listed here is the version received by BYTE Publications.

This is an all-inclusive list that makes no comment on the quality or usefulness of the software listed. We regret that we cannot review every software package we receive. Instead, this list is meant to be a monthly acknowledgment of these packages and the companies that sent them. All software received is considered to be on loan to BYTE and is returned to the manufacturer after a set period of time. Companies sending software packages should be sure to include the list price of the packages and (where appropriate) the alternate forms in which they are available.

# Clubs and Newsletters

## UNIX Users Club

Uni-ops is a new group for UNIX supporters. Uni-ops publishes a monthly journal and a directory. Contact Uni-ops at POB 5182, Walnut Creek CA 94596, (415) 933-8564.

## TI-99/4 Users Groups In Your Area

San Diego 99/4 Users Group, 4037 Johnson Dr, Oceanside CA 92054, (714) 758-4292, Contact Paul Yates.

Denver 99/4 Users Group, CRS Inc, 4860 Ironton, Suite E, Denver CO 80239, (303) 371-8272. Contact Rick Savage.

99/4 Home Computer Users-Group Inc, POB 95148, Oklahoma City OK 73143, (405) 787-8521. Contact Charles LaFara.

Pacific Northwest TI-99/4 Users Group, POB 5537, Eugene OR 97405, (503) 485-8796. Contact Gary Kaplan.

Pittsburgh 99/4 Users Group, 111 Teeple Ave, Donora PA 15033, (412) 379-5976. Contact R Riley.

Houston Users Group, 8922 Roos Rd, Houston TX 77036, (713) 771-3483. Contact Raymond Wells.

Washington DC 99/4 Users Group, POB 267, Leesburg VA 22075, (703) 777-2017. Contact Bill Whitmore.

## Atlanta TRS-80 Users

The TRS-80 Users Group of Atlanta, Georgia, meets on the second Tuesday of each month at 7:30 PM at radio station WABE on 740 Bismarck Rd NE in Atlanta. Contact Bob Green, 1315 Rustic Ridge Dr NE, Atlanta GA 30319, (404) 451-9813.

## Users Group of Florida

The Tallahassee Amateur Computer Society meets on the second Thursday of the month. Members' computers range from HP-41Cs to Apples, Ataris, TRS-80s, and S-100 systems. Club interests are in the uses of microcomputers in education, business, and personal applications. A monthly newsletter, *Text File*, is published. Contact the

group at POB 6716, Tallahassee FL 32301.

## CAPE

CAPE (Capital Area PET Enthusiasts) meets monthly and discusses problems, swaps ideas and programs, and works on hardware projects. For information, contact CAPE, c/o Bob Karpen, 2054 Eakins Ct, Reston VA 22091, (703) 860-9116.

## Robot Builders and Users

David Smith is starting a club in the northern New Jersey/New York Metropolitan area for those interested in building or working with robots. Even if you are too far away to attend meetings, he wishes to hear from you. David offers help to anyone with questions or problems concerning robots. Contact him at 4505 Kennedy Blvd, North Bergen NJ 07047, (201) 856-4890.

## Atari Users Group

The Cincinnati area has a new group for Atari 400 and 800 users. Anyone who uses

or owns Atari microcomputers is welcome. Contact Ron Shaefer, (513) 671-1671; or Tom Candelaresi, c/o Computer-Tutor, 4012 Benjamin Dr, Cincinnati OH 45245, (513) 752-7522.

## DENSPET

DENSPET is an international association for the exchange of programs for the MTU 200 by 320 dot high-resolution PET accessory. Send a sample of your work or \$5 and receive a sample in return plus a subscription to a newsletter and lists of available programs. Contact DENSPET, Rock House, Ballyoroy, Westport, County Mayo, Ireland.

## Vancouver Users

The Vancouver TRS-80 Users Group wishes to exchange newsletters and information on homebrew software and hardware with other TRS-80 clubs. Contact them at POB 46608, Station G, Vancouver, British Columbia, V6R 4G8, Canada. Their newsletter is entitled *USR(80)*. ■

# BYTE's Bugs

## Incorrect BASIC Sorcery

We regret that some errors popped up in "Whose BASIC Does What?" by Teri Li (January 1981 *BYTE*, page 318) in the entries for the Exidy Sorcerer computer.

Checkmarks should have appeared in the Exidy column for these BASIC statements: CLEAR *n*, DEF FNY (*name*), DIM *var(k)*, and OUT *portnum, val*. The column for the HOME command should have contained the equivalent PRINT CHR\$(17), and

the column for the CLS keyword should have included PRINT CHR\$(12).

The Sorcerer's BASIC interpreter also contains some features not found in other versions of BASIC, but due to the nature of the article, we were not able to include many of these. In any event, when choosing a computer or translating a program, you may still need to consult the reference manuals for the computers involved.

Thanks to Robert W Harrison of Cortland, New York, and others for pointing out the errors.

## Forgotten Line

One line of BASIC code was inadvertently omitted from listing 1 of "Generating Bar Code in the Hewlett-Packard Format," by Thomas McNeal. (See the January 1981 *BYTE*, page 148.) The line, which should be placed at the beginning of page 162, is shown in listing 1.

We regret the error.

### Listing 1

```
1855 M1 = 1 !START MACHINE-  
CODE ARRAY INDEX AT 1
```

## March Editorial Error

An error occurs in listing 1 (page 212) of Gregg Williams' March 1981 editorial, "Is This Really Necessary?" The second *else* in the listing, the one that precedes the statement "check-amount=0" should follow that statement. In other words, the check amount should be set to 0 only when no table match has been found. Our thanks go to Mr M F Fay of Cincinnati, Ohio, for pointing this out. ■

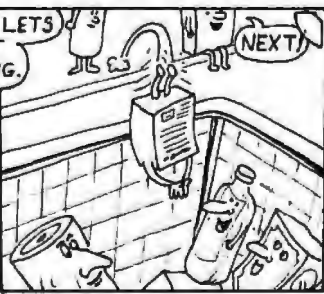
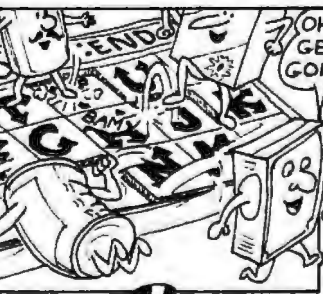
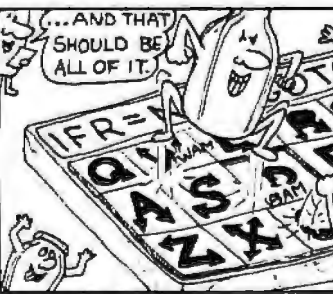
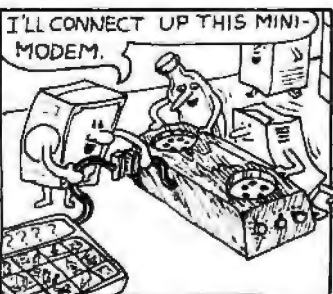
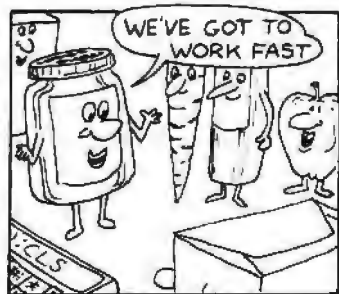
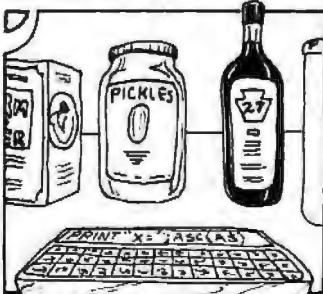
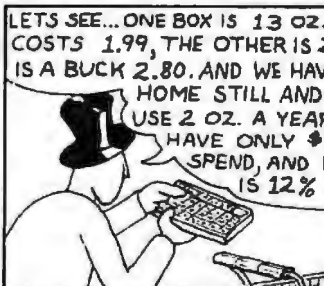
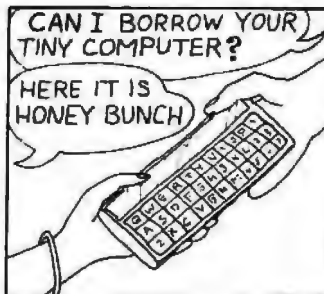
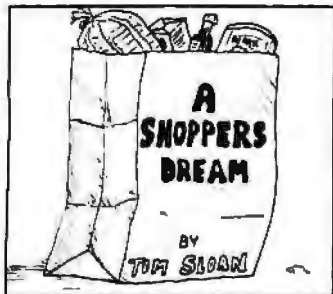

# Event Queue

## August 1981

August-October

**Writing for Results: A Course for Computer Professionals**, various sites throughout the US. These courses are intended to help those in the computer field write clear and simple prose. Fees range from \$490 to \$660 for the weekend courses. For schedules of cities and dates, contact American Management Associations, 135 W 50th St, New York NY 10020, (212) 586-8100.

August 3-7

**Workshops in Digital Sound Synthesis and Processing**, Digital Music Systems Inc, Boston MA. These courses will provide a hands-on introduction for electronic-music composers and performers, recording engineers, psychoacoustic researchers, and others working in the digital-audio field. Fundamentals of digital audio, unit generators, automated synthesis and processing, non-linear techniques, digital delay, filtering and reverb, digital-audio hardware, and future trends in digital audio will be covered. The fee is \$300. Contact Digital Music Systems Inc, POB 1632, Boston MA 02110, (617) 542-3042.

August 10-12

**Financial Fundamentals Using Computers**, Boston MA. This seminar will focus on the nonfinancial manager's needs to understand the fundamentals of accounting and finance in a computerized environment. Attendees will learn to use Apple II microcomputers for financial procedures and transactions. Registration fees are \$795. Contact the American Institute for Professional Education, Carnegie Bldg, 100 Kings Rd, Madison NJ 07940, (201) 377-7400.

August 10-14

**Reliability and Life Testing**, UCLA, Los Angeles CA. Engineers and scientists in-

cluded with the reliability, design, product assurance, quality, and safety aspects of components, equipment, and systems are invited to attend this course. The fee is \$775. Contact the Short Course Program Office, 6266 Boelter Hall, UCLA Extension, Los Angeles CA 90024, (213) 825-1047.

August 10-14

**Workshops in Digital Sound Synthesis and Processing**, Digital Music Systems Inc, Boston MA. For details, see August 3-7.

August 17-21

**Workshops in Digital Sound Synthesis and Processing**, Digital Music Systems Inc, Boston MA. For details, see August 3-7.

August 24-27

**Software Design, Reliability, and Testing**, Sheraton Motor Inn, Lexington MA. This four-day seminar for engineers, programmers, and technical managers examines concepts and techniques for developing and testing reliable, cost-effective software. Management concerns and recommended policies are also addressed. Tuition is \$600, which includes course notes, luncheon, refreshments, and an evening reception. Contact Professor Donald D French, Institute for Advanced Professional Studies, One Gateway Ctr, Newton MA 02158, (617) 964-1412.

August 24-28

**The Seventh International Joint Conference on Artificial Intelligence**, University of British Columbia, Vancouver BC, Canada. This conference will examine computer applications of medical diagnosis, computer-aided design, robotics, programmable automation, speech understanding, vision, and other related topics. A tutorial program and artificial-intelligence exhibits will also be presented. For more information, contact Louis G Robinson,

American Association for Artificial Intelligence, Stanford University, POB 3036, Stanford CA 94305, (415) 495-8825.

August 25-27

**BASIC: A Computer Language for Managers**, Sheraton Centre and the New York Hilton, New York NY. This course is for managers needing to learn the fundamentals of computers and programming. Programming basics, simple examples of BASIC programs, problem solving, and simulation modeling will be covered. Contact American Management Associations, 135 W 50th St, New York NY 10020, (212) 586-8100, ext 514.

August 25-28

**Vector and Parallel Processors in Computational Science**, Chester, England. The conference will concentrate on hardware, software, algorithms, applications, and case studies concerning vector and parallel processors. For details, contact Mrs S A Lowndes, Science Research Council, Daresbury Laboratory, Daresbury, Warrington, WA4 4AD, England.

August 26-29

**The Fifth Annual National Small Computer Show**, New York Coliseum, New York NY. Daily lectures and a five-hour executive-only seminar will be featured. The executive seminar is designed for upper-level managers who need an introduction to the understanding, acquisition, and use of computers in business. The registration fee for the show is \$10 per day. The seminar for executives is \$200, which includes all materials and show registration. For information, contact the National Small Computer Show, 110 Charlotte Pl, Englewood Cliffs NJ 07632, (201) 569-8542.

August 28-30

**Personal Computer Arts Festival (PCAF '81)**, Philadelphia Civic Center, Philadelphia PA. PCAF '81 will in-

clude technical sessions, demonstrations, and exhibits. Also featured is the annual computer-music concert and computer-graphics film and video show. PCAF '81 is being held in conjunction with the Personal Computing Show '81. For complete details, contact PCAF '81, POB 1954, Philadelphia PA 19105.

## September 1981

September-December

**Four Seminars from Management Information Corporation (MIC)**, various sites throughout the US. These seminars are designed for businesspeople who need an introduction to system selection and use. For a complete schedule of seminars, fees, and locations, contact Carol Bell, c/o MIC, 140 Barclay Ctr, Cherry Hill NJ 08034, (609) 428-1020.

September 1-3

**Computerized Office Equipment Expo (COEE)**, Civic Center, Atlanta GA. COEE provides a forum where the owners and executives of small and large businesses can learn about office automation. Office equipment for word processing, record storage and retrieval, and micrographics will be exhibited. Contact Cahners Exposition Group, 222 W Adams St, Chicago IL 60606, (312) 263-4866.

September 9-11

**Eurographics '81**, Technical University, Darmstadt, West Germany. Almost seventy exhibitors are expected to attend this computer-graphics show. Detailed information can be obtained from Diebold Deutschland GmbH, Attn: Dr H J Grobe, Feuerbachstrasse 8, D-6000 Frankfurt/Main, West Germany.

September 10-13

**Mid-West Computer Show**, McCormick Place, Chicago IL. This show features office systems, data- and word-pro-



cessing equipment, telecommunications equipment, microcomputers, computer graphics, peripherals, and other related supplies. For information, contact the National Computer Shows, 824 Boylston St, Chestnut Hill, MA 02167, (617) 739-2000.

*September 14-17*

**Software Info '81**, Merchandise Mart ExpoCenter, Chicago IL. The conference theme is "Productivity Through Packaged Software." Fran Tarkenton will be the keynote speaker. For more information, contact Software Info, 1730 N Lynn St, Suite 400, Arlington VA 22209, (703) 521-6209.

*September 14-17*

**Productivity—An Urgent Priority**, Capital Hilton Hotel, Washington DC. This conference is intended to provide a focus on productivity throughout the computer industry. General inquiries for program information should be addressed to Compcon Fall '81, POB 639, Silver Spring MD 20901, (301) 589-3386.

*September 15-17*

**WESCON/81**, Brooks Hall, Municipal Auditorium, and Hilton Hotel, San Francisco CA. Sessions on communications, components and devices, computer and microprocessor hardware and software, office automation, and memory systems will be presented. Exhibits of computer equipment and related products will be featured. Contact Electronic Conventions Inc, Suite 410, 999 N Sepulveda Blvd, El Segundo CA 90245, (213) 772-2965.

*September 16-18*

**Diagnostic Software: Planning and Design**, Boston MA. This seminar is directed toward the design, test, and diagnostic engineer and manager. Design examples, lectures, informal sessions, and individual and group diagnostic-programming sessions are part of the course. Tuition is \$495. Contact Professor Donald D French, Institute for Advanced Profes-

sional Studies, One Gateway Ctr, Newton MA 02158, (617) 964-1412.

*September 16-18*

**The Engineer as a Communicator**, Crystal City Marriott, Arlington VA. This conference will feature discussions on communications technology, information gathering, storage, and retrieval, using computers in technical communications, and other related topics. Contact Dr Daniel Rosich, School of Business Administration, University of Connecticut, Stamford CT 06903, (203) 322-1673.

*September 24-25*

**Microprocessors: Hardware, Software, and Applications**, Worcester Polytechnic Institute, Worcester MA. Among the courses to be offered are hardware and software basics, selection and evaluation of microprocessors, memory and input/output systems, multiprocessor systems, real-time-system design, and debugging and circuit testing. For more information, contact Ginny Bazarian, c/o Worcester Polytechnic Institute, Worcester MA 01609, (617) 753-1411.

*September 24-27*

**Mid-Atlantic Computer Show**, Washington Armory, Washington DC. For details, see September 10-13.

*September 30-October 2*

**Data and Telecommunications Expo '81**, Rhein-Main-Halle, Wiesbaden, West Germany. This exhibition and conference will cover all areas of technology in data handling and distribution and telecommunications networks in office environments will also be discussed. Contact Cahners Exposition Group, 222 West Adams St, Chicago IL 60606, (312) 263-4866. In Europe, contact Kiver Communications S A, U K Branch Office, Millbank House, 171/185 Ewell Rd, Surbiton, Surrey, KT6 6AX, England.

## October 1981

*October 7-21*

**The 1981 Far East Computer Tour**, Hong Kong, Japan, Korea, and Taiwan. This tour group visits various computer-related conferences and exhibitions throughout the Far East. Transportation for this three-week tour, plus shows, meals, and other items are included in trip packages, ranging in price from \$2290 to \$3095. For more information, contact Terry Butler, Commerce Tours International Inc, 870 Market St, Suite 742-744, San Francisco CA 94102, (415) 433-3072.

*October 12-15*

**Information Management Exposition and Conference/INFO 81**, Coliseum, New York NY. Discussions on pre-packaged, customized pre-packaged, and custom-designed software will complement hardware and software exhibits. For more information, contact Clapp & Poliak Inc, 245 Park Ave, New York NY 10167, (212) 661-8410.

*October 19-23*

**Systems 81**, Munich, West Germany. Computer systems and their applications will be featured. Additional information is available from Kallman Associates, 30 Journal Sq, Jersey City NJ 07306, (201) 653-3304.

*October 20-22*

**Computertized Office Equipment Expo/Southwest**, Astrohall, Houston TX. Approximately 100 exhibitors will present office equipment and supplies, including word-processing systems, at this

show. Contact Industrial Scientific and Conference Management Inc, 222 W Adams St, Chicago IL 60606, (312) 263-4866.

*October 21-24*

**Computa 81**, World Trade Center, Singapore. This international show attracts professionals and buyers from Hong Kong, India, and Sri Lanka. Additional information can be obtained from Kallman Associates, 30 Journal Sq, Jersey City NJ 07306, (201) 653-3304.

*October 25-30*

**The Information Community: An Alliance for Progress**, Washington DC. This conference provides a forum for professionals in information technology, research operations, management, and education. The technical program includes presentations, contributed papers, special-interest group sessions, exhibits, and more. Contact the American Society for Information Science, 1010 16th St, NW, Washington DC 20036, (202) 659-3644.

*October 27-29*

**Computer Graphics 81**, Regent Centre Hotel, London, England. Conference topics include graphics systems hardware and software, animation, image processing, simulation, business graphics, and home graphics. An equipment exhibition will also be presented. Contact Online Conferences Ltd, Argyle House, Northwood Hills, Middlesex, HA6 1TS, England. ■

In order to gain optimal coverage of your organization's computer conferences, seminars, workshops, courses, etc, notice should reach our office at least three months in advance of the date of the event. Entries should be sent to: Event Queue, BYTE Publications, 70 Main St, Peterborough NH 03458. Each month we publish the current contents of the queue for the month of the cover date and the two following calendar months. Thus a given event may appear as many as three times in this section if it is sent to us far enough in advance.

**ADVANCED APPLICATIONS**

Advanced Applications  
Business Analysis  
Calculator (BASIC Program)  
Data Base Management  
Electronic Engineering Computations  
Files  
Mathematical Computations  
Mechanical Engineering Computations  
Program Debugger  
Programming—Basic Language  
—Cobol Language  
—Cross Assemblers  
—Fortran Language  
—RPGII Compiler

Programming Guides  
Reference Manuals  
Simulation of Pollutants  
Statistical Computations/Analyses  
System Commands

**BUSINESS & MONEY MATTERS**

Aid, Financial for College  
Bartering Goods, Services  
Business

Business Analysis, Planning:  
Analysis Programming  
Annuities Analysis  
Aware Financial Service  
Charting  
Planning, Forecasting

**Business Programs:**

Amortization of Loans  
Amortization of Loan UNK Term  
Annuity Debt Payment  
Balancing Checkbook  
Capital, Cost of Equity  
Cashflow, Present Value  
Commission, Sales Report  
Depreciation Schedule  
Equipment, Lease vs Purchase  
Equity Capital, Cost of  
Interest, Bonds  
Interest, Loans  
Sales Commission Report

**Business News**

Business Outlook, Current  
Business Outlooks, Previous  
Company Profiles, Reports  
Consumer Behavior  
Credit Cards  
Daily Investor  
Economy  
Economic Planning  
Economist

**Electronic Funds Transfer Systems**

Employee Owned Companies  
Executives

**Fast Food Industry**

Financial Advice (Raylux)  
Financial Commentary, Current  
Financial Commentary, Previous  
Financial Model for Forecasting  
Financial Interpretation  
Industrial & Occupational Hazards  
Industrial Production Index  
Information on Demand (research)  
Interest, Money  
Int'l Monetary Systems  
Jewels & Jewelry  
Labor & Management  
Labor & Politics

Management  
Money Savers  
Office Equipment  
Pensions  
Raylux (financial advice)  
Stock, Bond, Commodity listings  
Trading Business Goods, Services  
**COMMUNICATIONS INDUSTRY**

Cable Television  
CBS News  
Citizens Band Radio  
Newspapers  
Personal Computers  
RKD Forum  
Television  
Writing & Writers  
**CONSUMER/SHOPPING**

Automobiles  
Safety & Defects  
New Models

Sales  
Electric Vehicles  
Gas Rationing  
Synthetic Fuels

Beauty & Fashion  
Collectables  
Collectors/Collections  
Consumer Issues

Behavior  
"Consumer Question Box"  
Consumer Reports

Credit  
Credit Cards  
Protection

Decorating & Design  
Antiques  
"Decorating"  
"Interior Decorating"

Painting & Decorating  
Food & Cooking  
"Food"

Food Additives  
"Slim Gourmet"  
Trading of goods & services

WINE (31 separate listings)  
"Growing Older" (advice)  
Health Care Advice

Home Repairs  
Energy Savings  
"First Aid for Ailing House"

Hardware  
Solar Energy  
Inventions & Inventors

Shopping & Trading  
Bartering  
Catalog (of goods)

Discounts  
Equipment, Lease vs Purchase  
"Family Shopper"

Generic vs Brand Names  
Joining a Merchandise Service  
Merchandise

Money Savers  
Premiums, Coupons  
Price Quotes

Shopping at Home  
Trading of Goods & Services

Office Equipment  
Purchase vs Production Comparison  
Software

Toll-free Numbers (over 90 listed)

**CURRENT NEWS**

Anderson, Jack  
Domestic News  
Foreign News  
International News  
National News  
News (50 states)  
New Focus  
News Summary  
Tomorrow's News Today  
United Press International  
United States Nat'l News

**EDUCATION**

Addition  
Aid, Financial for College  
Aphorisms  
Art Objects  
Arts  
Book Reviews  
College Admissions

Counting Lesson  
Days (spelling lesson)  
Education  
English Lesson

Esperanto Lesson  
French Vocabulary Drill  
Geometry Lesson  
German Adjectives

German Vocabulary Drill  
Gifted Students  
Grammar (story fun)

Greek Root Exercises  
Information on Demand (Research)  
Italian Vocabulary Drill

Library  
Mathematics  
Metric System

Numbers  
Poetry (random)  
Quotations

Random Sonnets  
Remedial Education  
Sayings

Spanish Vocabulary Drill  
Spelling Lessons  
Translation Services

Writing & Writers  
Wisdom of the Ages  
**ENERGY**

Gasoline Rationing  
Energy (22 savings subjects)  
Nuclear Wastes

Regulatory Agencies  
Solar Energy  
Synthetic Fuels

**ENTERTAINMENT/HOBBIES**  
Absurdity  
Aces on Bridge

Adventure  
Amusement  
Arts  
Astrology

Cinema (reviews)  
Collectables  
Collectors/Collections

Computer Conferencing  
Dating  
Drawings

Hobbies  
Horse Racing  
Humor

**Marriage Analysis**

Mockridge, Norton  
Movie Reviews  
Music  
Photography  
"Pop Scene"  
Previews (TV)  
Q & A (TV)  
Satellite TV  
Science Fiction

Sewing  
Sounds (rock)  
Single Persons  
Soap Operas

**SOURCEWORLD Magazine**  
Stared/TV  
"Stitch-N-Time" (sewing)

Television—Features, Previews, Quiz  
Time of Your Life (Aging)  
Unidentified Flying Objects

Video  
Wines  
Words, Wit & Wisdom  
"Wry Comment"

**GAMES & TRICKS**  
Ace—(trick)  
Backgammon

BlackJack  
Bridge  
Card Tricks

Casino 21  
Checkers  
Chess

Children's Programs  
Civil War (game)  
Coin Flipping

Crope  
Danger  
Decks (cards)

Draw (trick)  
Farmer (game)  
Fill in Letters (game)

Flipping Coins  
Football (game)  
Golf (game)

Guess Computer's Number (game)  
Hangman (word game)  
Horse race (game)

1-Ching  
Intelligence Test (game)  
IQ Test (game)

Joker (trick)  
Life (game)  
Lunar Landing (game)

Magic  
Market A Product (game)  
Mastermind (game)

Maze Generation (game)  
Mind Reading (tricks)  
Nim (game)

Patrol Streets (game)  
Pica-Centra (game)  
Pits (game)

Poker (game)  
Posters (game)  
Puzzles

Rocket Game  
Rule Sumera (game)  
Score Four (game)

Selling Product (game)  
Sinners (game)

**Slot Machine (game)**

Sonnets (game)  
Statistics (date game)  
Star-Trek (game)  
Target Practice  
Tie Tac Toe (game)  
Tic Tac Toe in Spanish  
Tomb (bullfight game)

Tricks  
Vegas (game)  
Wumpus Hunt (game)

**GOVERNMENT**  
Anderson, Jack  
Armed Services  
Arms Control

Business Role in Politics  
Census  
Democratic Nat'l Convention

Equal Rights Amendment  
Federal Revenue Sharing  
Intelligence Services

Issue and Debate  
Labor & Management  
Labor & Politics

Lobbying & Lobbyists  
Loftan, John  
Medicare

Metric System  
National Health Insurance  
Political Action Report

Population—Vital Statistics  
Postal Service  
Presidential Elections (1980)

Privacy  
Regulatory Agencies  
Republican Nat'l Committee

Social Security  
Taylor, Henry  
U.S. Population State

Veterans  
Volunteer Military  
Washington, D.C.:

Capitol News Service  
Editorial Summary  
Emergency Numbers

"Everything Else"  
Hotline  
House Committee Hearings

Meetings, Conferences  
People, Places, Things  
President's Schedule

Senate Committee Hearings  
Whistle Blowers  
**HEALTH**

Abortian  
Acupuncture  
Alcoholism

Aylward, Jim (Journal)  
Birth Control  
Care

Arthritis  
Chest Pain  
Childhood Rashes with Fever

Common Skin Problems  
Digestive Tract  
Ear, Nose & Throat

Eye Problems  
For Women Only  
Nervousness & Nerve Problems

Poisons  
Urinary Tract

# All these programs

Now you can get up-to-the-minute news and business information, current market quotes and financial advice, and over 1,000 other valuable programs on your microcomputer, data terminal, or communicating word processor. You can even make hotel and airline reservations, send electronic mail across the country instantly, carry out research and shop at home.

All these programs and more are available with **THE SOURCE<sup>SM</sup>**, America's first information and communication utility. The Source is a product of Source Telecomputing Corporation, a subsidiary of The Reader's Digest Association, Inc.

With The Source you can have a UPI news service right in your office or home with international, national, local and business news available minutes after release. The Source also gives you regularly updated market reports, portfolio management systems, business accounting programs, plus educational and entertainment programs for all members of the family. Many Source programs have keyword search capability.

## The Source is economical to use.

All the programs currently offered through The Source are available for an initial, one-time subscription fee of \$100. The connect time is an unbelievable 7 cents per minute during evenings and weekends, 25 cents per minute on weekdays, and 4½ cents per minute from after midnight to 7 A.M.\* You can be on-line with The Source quickly, for the cost of a local phone call in over 300 cities.

## The Source can increase the storage and programming capacity of your microcomputer to infinity.

You can now store your own data and program your own systems directly on The Source's mainframes. Basic, Cobol, Fortran, RPG II and assembly language are all available. The cost is 50 cents per month for 1K block of storage. That's it! All other costs are covered in the subscriber fee plus the normal connect time costs. As for

**Drug Addiction**  
 Drugs & Drugstore  
 Food Additives  
 Health & Smoking  
 Health Care Advice  
 Industrial & Occupational Hazards  
 Marijuana  
 Medical  
 Medicare  
 Mental Health & Disorders  
 National Health Insurance  
 Obstetrics  
 Pregnancy/Maternal  
 Sarcasm  
 Sleep  
 Therapy for Addicts  
 Transplants  
 Vitamins  
**LAW**  
 Cases Accepted  
 Cases Refused  
 Fair Trial vs Free Press  
 International Law  
 Legal Profession  
 "What's the Law?"  
 White Collar Crime  
**REAL ESTATE/HOME:**  
 About Real Estate  
 "Aid for Ailing House"  
 Amortization of Loans  
 Amortization of Loan, UNK Term  
 Apartments (rent)  
 Home:  
 Ailing  
 Buying  
 Decorating  
 Loans  
 "Household Hints"  
 Selling  
 Interest, Loan  
 "Interior Decorating"  
 Loan:  
 Installment Interest  
 Amortization, UNK Term  
 Amortization Schedule  
 Malino, Emily (home decorating)  
 Mortgage Analysis  
 Moving Plans  
 Painting & Decorating  
 Property for Rent  
 Property for Sale  
 Property for Swap  
 Property Wanted  
 Real Estate  
**SCIENCE & TECHNOLOGY:**  
 Advanced Applications/Programs  
 Aircraft  
 Amperage  
 Angle, Quadrant Ref  
 Base Conversion  
 Bessel Function (statistics)  
 Binomial Coefficients (statistics)  
 Binomial Probabilities (statistics)  
 Chi-Square (statistics)  
 Circular Path Speed  
 Cloning  
 Coefficients, Binomial (statistics)  
 Commands  
 Coordinates (polyhedra; statistics)  
 Correlation Coefficient (statistics)  
 Cross Assemblers  
**Data Computation (statistics)**  
 Denominator  
 Dispersion Measures (statistics)  
 Electric Vehicles  
 Electrical Engineering  
 Engineering  
 Esobiology  
 Factorial (statistics)  
 Fall Distances (statistics)  
 Filter Capacitor Values (statistics)  
 Filter Design (statistics)  
 Fortran  
 Geography  
 Genetic Engineering  
 Greatest Common Denominator  
 Greek Root Exercise  
 Ham Radio  
 Hardware  
 Inertia Moment  
 Inventions & Inventors  
 Least Squares (statistics)  
 Manuals  
 Markov Chain (statistics)  
 Mathematics  
 Mean Computation (statistics)  
 Mechanical Engineering  
 Medical  
 Metric System  
 Molecule Thickness  
 Motion Graphs  
 Nuclear Wastes  
 Ohm's Law (statistics)  
 Parabola Graphing (statistics)  
 Perfect Number?  
 Personal Computers  
 Pet Computers  
 Poison (statistics)  
 Pollutants  
 Primes (statistics)  
 Probabilities (statistics)  
 Programming Manuals  
 Research  
 Science & Engineering  
 Science & Technology  
 Smithsonian Exhibits  
 Software  
 Space Shuttle  
 Statistics  
 Transplants  
 Unidentified Flying Objects  
 Weather  
**SOCIAL AFFAIRS**  
 Adolescence  
 Adoption  
 Age (elderly)  
 Alcoholism  
 Battered Wives  
 Behavior  
 Birth Control  
 Black Studies  
 Capital Punishment  
 Child Abuse  
 Child Custody  
 Child Support  
 Divorce  
 Drug Addiction  
 Equal Rights Amendment  
 Etiquette  
 Family Life  
 Gasoline Rationing  
 Homosexuality  
**Labor & Management**  
 Labor & Politics  
 Life Styles  
 Marijuana  
 Prostitution  
 Religion & Churches  
 Retirement  
 Sex Crimes  
 Single Persons  
 Social Commentary  
 Social Contacts  
 Teenagers  
 Teen Forum  
 Therapy for Addicts  
 "Time of Your Life" (elderly)  
 White Collar Crime  
 Women's Liberation  
**SPORTS**  
 Baseball  
 Basketball  
 Box Score (sports)  
 Football  
 Olderman (sports)  
 Olympic Games (1980)  
 Sports (50 states)  
**STOCKS & BONDS/INVESTMENTS**  
 Advice  
 American Stock Exchange:  
 Daily Listing  
 Daily Prices  
 Motion Graphs  
 Ten Most Active  
 Weekly Comp. Prices  
 Wind Bond Prices  
**Bonds:**  
 AMEX Daily Listing  
 Fed Land Bank, Dly.  
 NYSE Daily Listing  
 Treasury OTC, Dly  
 World Bank, OTC, Dly  
 Treasury, OTC, Wkend.  
**Bond Yield**  
 Bond Price, Accrued Interest  
 Boston & Northeast OTC Exchange  
 California North & South OTC Exchange  
 Chicago Mercantile OTC Exchange  
 Citrus  
 Closings  
 Commodities  
 Dividends, Earnings  
 Dow Jones  
 Annual Stock Avg.  
 Market Indexes  
 Earnings Dividends  
 Earnings Reports  
 Exchange Rates, Foreign  
 Federal Land Bank Bonds  
 Foreign Exchange Rates  
 Funds, Mutual  
 Futures, Treasury Bills  
 Futures & Options  
 Cotton Futures  
 Lumber and Plywood Futures  
 Orange Juice Futures  
 Potatoes Futures  
 Sugar Futures  
 Glossary of Stock Investment Terms  
**Gold:**  
 Stones  
 Spot Prices  
 Indexes, Stock Market Dly. Avgs.  
 Interest, Bonds  
**Jewels & Jewelry**  
 Metals:  
 NY/London Mkt Prices  
 NY/Chicago Mkt Prices  
 Midwest OTC Exchange Market  
 Moody's Index  
 Money Market News and Comments:  
 Futures  
 Opening Lead  
 Noon Lead  
 Afternoon Lead  
 Night Lead  
 Markets at a Glance  
 Stock Pulse  
 NYSE Trends  
 What the Market Did  
**Mutual Funds**  
 Mutual Funds: Prices  
 Summaries  
 New York Stock Exchange:  
 Bonds  
 Dly Prices  
 Wkend: Comp. Prices  
**Notes, Treasury**  
 Options & Futures (AMEX, CBOE)  
 Over-the-Counter Exchange Markets  
 Daily:  
 Banks & Insurance  
 Closings (Complete)  
 Gainers & Losers  
 Index, NASDAQ  
 Industrials  
**Weekend:**  
 Gainers & Losers  
 NASDAQ, Weekly  
**Boston & Northeast:**  
 Selected Stocks  
 Closing Prices  
**California North & South**  
 No.—Selected OTC  
 So.—Selected OTC  
**Chicago Mercantile: Quotations**  
 Midwest:  
 Price  
 Weekend  
**Pacific:**  
 Adv. & Dealings  
 Closing  
 Most Active  
 Options  
**Pacific OTC Exchange**  
 Platinum, Prices  
**Silver:**  
 Coins  
 Spot Prices  
 Stories  
**Stocks:**  
 Daily Avgs, 11:00 A.M.  
 Daily Avgs, 12:00 A.M.  
 Daily Avgs, 1:00 P.M.  
 Daily Avgs, 2:00 P.M.  
 Daily Avgs, 3:00 P.M.  
 Daily Avgs, Closings  
 Daily Avgs, Hi's & Lows (NYSE)  
 Daily Avg, Market Indexes  
 Weekend Summaries (NYSE)  
 Weekly Comp. Prices (NYSE)  
 Annual Avgs, Dow Jones  
 Standard & Poor's: Hourly Index  
**Toronto OTC Exchange**  
 Selected Stocks, Weekend  
**Treasury:**  
 Notes, Daily Latg  
 Bonds, OTC, Daily Latg  
 Bonds, OTC, Weekend  
 Unistax Report Index  
 World Bank Bonds, OTC  
**SUBSCRIBER COMMUNICATION**  
 Advertising (personal classified)  
 Announcements (from The Source)  
 Apple Computer Information  
 Bulletin Board  
 CHAT (direct communication)  
 Clubs  
 Computer Conferencing  
 Contents of The Source  
 Correspondence  
 Dating  
 Express (sends letters with express alert)  
 Grips (about The Source)  
 Help Wanted  
 Mail  
 Personal Calendar & Notebook  
 Services  
 Suggestions (for The Source)  
 User Directory (for The Source)  
 Users On-Line  
**TAXES**  
 Assets  
 Calculation of Income Stmt  
 Capital Gains Tax  
 Computing Taxes  
 Contributions  
 Credits  
 Debits  
 Deductions  
 Dependents  
 Depreciation Schedule  
 Donations  
 Expenses  
 Income Statement, Pro Forma  
 Income Tax  
 Joint Tax Filing  
 Taxes  
**TRAVEL & LEISURE**  
 Airline Schedules  
 Airline Toll-Free Numbers  
 Alert (natl/travel)  
 Bargains (travel)  
 Car Rentals (toll free no. 1)  
 Climate (geography)  
 Customs (tariff)  
 Dining Out  
 Fairs & Festivals  
 Flight Reservations  
 Flight Schedules  
 National Parks  
 Restaurants & Wine  
 Restaurants  
 Ski Resorts (toll free non.)  
 Smithsonian Exhibits  
 Tour Packages  
 Travel Plans  
 Vacation Specials  
 Weather  
 Weekend-Getaway  
**etc.**

# and more for \$100.

response time, it's faster than ever, thanks to The Source's new bank of larger, mainframe computers.

## Today, The Source is faster and better than ever.

If you're not a subscriber to The Source already, send in the coupon and we'll send you our free information kit. Or call (800) 336-3330 from 8:30 a.m. to 6:30 p.m., EST, for further information.

Join The Source now and you'll have an incredible information utility system at your fingertips for just pennies a day.

\*Usage Fees: \$4.25/hour or 7.1¢/minute on weekends and evenings from 6 p.m. to midnight. \$15/hour or 25¢/minute on weekdays from 7 a.m. to 6 p.m. \$2.75/hour or 4.6¢/minute after midnight to 7 a.m. \$10 minimum monthly charge. Rates applicable to 300 baud only in the 48 contiguous United States.

Please send me your free information kit. I'm ready to see what \$100 can do for my system.

Name \_\_\_\_\_  
 Address \_\_\_\_\_  
 City \_\_\_\_\_ State \_\_\_\_\_ Zip \_\_\_\_\_  
 Phone ( ) \_\_\_\_\_  
 My current equipment is \_\_\_\_\_  
 (manufacturer)

(model # & description)

(specific configuration)

Send to: Source Telecomputing Corp., 1616 Anderson Road, McLean, Virginia 22102. (703) 821-6660.

**THE SOURCE**  
 AMERICA'S INFORMATION UTILITY

The Source is a servicemark of Source Telecomputing Corporation, a subsidiary of The Reader's Digest Association, Inc.

Circle 413 on inquiry card.

## Microsoft Editor/Assembler Plus

Keith Carlson, 43 McDill Rd, Bedford MA 01730

When I opened the manual for Microsoft's Editor/Assembler Plus, I felt like crying. I had just spent a hard-earned \$29.95 for Radio Shack's original Editor/Assembler, and now I felt cheated. It has been my experience with electronics that no matter what I buy, the price goes down soon after I buy it. Perhaps the old cliché is true: all things come to he who waits.

The price for Editor/Assembler Plus is actually the same as the earlier version, but its value has increased enormously. This is what prompted me to consider wreaking havoc on nearby inanimate objects. As I read the manual and discovered its extensively upgraded features, however, my resentment and frustration turned to delight. Microsoft had turned my Level II 16 K TRS-80 into a full-blown assembly-language development system, something that Radio Shack had failed to do.

The features of Editor/Assembler Plus are those of a much larger machine. There are some limitations, but the result satisfies my need to economize by squeezing every last drop of value out of my TRS-80.

It helped that one of the authors of Editor/Assembler Plus, Mark L Chamberlin, wrote Radio Shack's Editor/Assembler. Both authors have previous experience with the TRS-80 and probably were involved with the design of Level II BASIC.

After all the plaudits, however, some problems remain. One of the major problems is documentation.

### Documentation

The documentation, fine as far as it goes, is definitely not enough. The manual was written by William Barden Jr, who has written several other books on both the TRS-80 and the Zilog Z80 microprocessor. Helpful hints and warnings are printed throughout the manual. They deal with the problem of printing a screen full of information in a book that measures only 4 3/4 by 6 1/2 inches. There are also copious notes explaining that Shift-Up Arrow was printed as \$ on the screen in the Z-BUG debugging mode. The text is simple and easy to read with plenty of illustrations and examples included. The only problem is the assumption that the reader has had previous experience with Radio Shack's Editor/Assembler and assembly-language coding.

In fact, that assumption pervades Microsoft's attitude about Editor/Assembler Plus. When I bought Radio Shack's Editor/Assembler, I received all the goodies, such as the instruction-set data, *Z80 Micro-Reference*

*Manual*, and some handy ROM (read-only memory) entry points. All these are conspicuously absent from Editor/Assembler Plus. People having an interest in assembly-language programming would buy Editor/Assembler Plus instead of Editor/Assembler. Doing so, though, would leave them wondering where the rest of the documentation was. Luckily, auxiliary documentation is available at low cost elsewhere (Radio Shack's new T-BUG manual, for example). However, this kind of information should have been included by Microsoft.

Other documentation is also needed. There is no documentation concerning Editor/Assembler Plus itself. The manual doesn't even give the load address, ending address, or entry address! If it weren't for the errata sheet included, it would be irritating and time-consuming to find the proper addresses needed to make a backup copy. A backup copy is a necessity, especially when you are using ordinary cassette tapes. It would be even more convenient to have certain entry points available to make modifications, such as adding a hard-copy print routine, which is sadly lacking in Z-BUG.

In these times of software piracy, it is easy to understand why Microsoft is highly protective of its software. But it doesn't explain why it won't even sell documentation! In short, the existing documentation is adequate for anyone who is merely an end user of Editor/Assembler Plus, as long as the additional Z80 instruction-set documentation is available.

### At a Glance

|  |  |
|--|--|
| <b>Name</b><br>Editor/Assembler Plus   | <b>Format</b><br>Cassette tape   |
| <b>Type</b><br>Assembly-language development package, including a Z80 macro assembler, line-oriented text editor, and interactive debugger | <b>Language</b><br>Z80 machine language  |
| <b>Manufacturer</b><br>Microsoft Consumer Products<br>10800 NE Eighth, Suite 507<br>Bellevue WA 98004<br>(206) 454-1315                    | <b>Computer</b><br>Radio Shack TRS-80 Level II with at least 16 K memory                 |
| <b>Price</b><br>\$29.95  | <b>Documentation</b><br>112 pages softcover, 4 3/4 by 6 1/2 inches; Quick Reference Card |
|  | <b>Audience</b><br>TRS-80 assembly-language programmers                                  |

## Editor

The editor, which was adequate before, is better now. The functions remain much the same as in Editor/Assembler, but new power and versatility have been added through the extension of the range and line-number specifications. They are a necessity in a line-oriented editor.

Where there was only one way to specify a range of line numbers, there are now four. You can specify a range by two line numbers separated by a colon, a line number followed by the number of lines separated by an exclamation mark, an offset (either plus or minus), or no line number at all. Also, these specifiers can be used in any editing-command parameter requiring a line number, allowing various combinations. They can even be used in the E(dit) command to edit a set of contiguous lines without constantly entering the Edit command. The F(ind) command accepts a range, searches for a string over that range (the whole buffer, if necessary), and finds every occurrence, not just the first. While range specification greatly extends the versatility of both the editor commands and subcommands, more was needed to produce a top-notch editor, and Microsoft responded.

Editor/Assembler Plus adds five new commands that further increase the editor's efficiency. The first two are related: M(ove) and C(opy). Copy merely duplicates a specified range of lines to another range. Move duplicates the lines and also deletes the source lines. To add to the power of these commands, you can specify a new line increment for the destination code. The S(ubstitute) command has the capability to substitute all occurrences in a range. This feature is useful when you have to change some labels or have finally realized that RET, not RTN, is the mnemonic for return. The X(eXtend) command is useful for adding comments to finished programs.

The frosting on the cake is the Q(uash) command. It allows you to delete either Z-BUG or both the assembler and Z-BUG from memory, increasing the editor-buffer space. Quashing Z-BUG presents certain problems since debugging is difficult without it, to say the least. Microsoft has an answer in the form of a stand-alone Z-BUG on the other side of the cassette. Quashing the assembler usually results in a source file that is too large to assemble in 16 K bytes, but it leaves plenty of room for general text editing.

## Assembler

The assembler portion of this package unlocks the machine-language power of the TRS-80. In addition to interesting new ways to set the origin of the assembly code, the assembler now supports assembly into memory. Also, the assembler supports macroinstructions and conditional assembly. This lets my "plain old" Level II 16 K-byte machine become a powerful assembly-language development system; before and after is like Clark Kent and Superman.

The inconvenience of writing object code to tape and then reloading it (usually with a monitor program like T-BUG or RSM-2) is gone. An assembler switch (option)

signifies that the object code is to be loaded into memory where it can be run under Z-BUG. The origin of the code is automatically set by the assembler at the end of the text buffer, which is variable in size (it must be, but the documentation is unclear on this point). That's where the difficulty comes. Suppose the buffer is filled with a 3 K-byte source file. That represents around 60 lines of 50 bytes, including comments—not unreasonable. If there are fifteen labels, the symbol table is a maximum of 135 bytes. Since the text buffer starts at location hexadecimal 7263 and the text buffer is 3 K bytes long, that leaves 412 bytes for the symbol table and object code in a 16 K-byte machine. This may be enough for most programs, but the only alternative is to quash Z-BUG, write the object code to tape, reload the stand-alone Z-BUG, and load the object code again. This defeats the in-memory assembly. If you have more than 16 K bytes of memory, the problem becomes trivial. The ORG statement should not be used for automatic origin as it will add the address given in the origin statement to the automatic origin.

If you want to choose that automatic origin, another assembler switch allows you to set it. This may be helpful when you want to debug the code at its actual location. The last new assembler switch allows for an absolute origin. In this case, an ORG statement must be used. This is the default for all assemblies to tape. It is possible to have an in-memory assembly with an absolute origin, but it is not recommended. To overcome this, set the automatic origin as in the manual and use the manual-origin assembler switch.

These additions are efficient and pleasing, but the most interesting features are macros (macroinstructions) and conditional assembly. These two features contribute most of the power to Editor/Assembler Plus.

This is probably why Barden spends an entire chapter on macros. Macros in the Editor/Assembler Plus resemble those of much larger machines. Several rules apply, but they are very reasonable. The manual states that there can be "...any reasonable number of macro definitions..." and "...each macro definition may have many arguments..." Since this is rather vague, I assume that they are limited by available space. Macros must be defined before they are referenced, so it is wise to define all macros at the beginning of the source text. Parameters can be passed to the macro, but the manual doesn't state whether a macro reference can be passed. I tried it, and found they can't. This is logical since nested macros are not allowed. Editor/Assembler Plus does allow synthetic labels in order to avoid doubly defined labels upon expansion. Barden gives several examples to demonstrate possible uses of the macro facility. He uses the long-standing practice of using macros for subroutine calls. He also demonstrates the use of macros to build a cross-assembler for the Motorola 6800 microprocessor (I used them to work on an Intel 8080 assembly-language translator). These examples are only a small portion of the numerous uses.

The conditional-assembly facility is explained as a tool for production of software for different configurations.

Even though this is the only example, it is still impressive. It is nice to have if you need it, but most users don't. Its use is extended greatly by the updated expression evaluation, which adds operators for logical, arithmetic, and parenthesized operations. The flexibility is enhanced by the ability to nest conditions.

The symbol table adds codes to indicate how labels are defined (or undefined). One thing that is lacking is a cross-reference facility for the symbol table. While not necessary, a cross-reference is extremely helpful. Unfortunately, it is expensive in overhead code.

## Z-BUG

Z-BUG is a new item, rather than an update of part of a previous system. It only remotely resembles Radio Shack's T-BUG. In fact, this debugger is one of the best I've seen, presenting an exceptional value. The editor, assembler, and debugger come in one package for the price of Radio Shack's Editor/Assembler. If you add T-BUG, which is inferior to Z-BUG, you have a bigger bill. Z-BUG can't do everything, but it can do many interesting and helpful things. It can display and modify memory in several modes, set up to eight breakpoints, single-step through machine-language programs, act like a calculator, and reference the symbol table so you can use symbolic references when you are debugging.

First, let's see what Z-BUG can't do. My main complaint is that it cannot provide hard copy. It seems like such a simple task to have the displays shuttled off to the printer. Combine this with the fact that there are no entry points given for the program itself and you have a frustrating and time-consuming task if you want to correct the omission. My only suggestion is to place a print driver somewhere in memory so you can use the \$G command to jump to it and then have it return to the beginning of Editor/Assembler Plus. The "Quick Reference Card" indicates that an entry point is provided that does not destroy the contents of the buffer.

My second complaint is the lack of a routine to disassemble to tape. That would be handy if you had an object module without the source code. It also might be useful for modifying a routine provided in ROM. You couldn't replace it in ROM, of course, but there are many routines already worked out if you can get to them.

Now, what can Z-BUG do? It's truly amazing what they can do at Microsoft. There are four modes in which you can examine memory: mnemonic, byte, word, and ASCII. Each one is descriptive of what is displayed. To open any memory location for display, just type its location followed by a slash. You can then examine the location and type in a new value, as you like. If you use the Down Arrow key, it automatically opens the next location, dependent on the mode you are in. If in byte mode, the next byte; if in word mode, the next word; if in mnemonic mode, the next instruction, and so on. To close the location and end the parade of locations, type Enter and Z-BUG responds with its prompt. The process is simple and convenient. Z-BUG doesn't stop there, however. You can easily set the input and output radices.

This allows, say, decimal input and hexadecimal output or almost any other combination between base 2 and base 16. You can also modify any of the registers (except the refresh register) after they are displayed. There are several commands to get a one-time display in a different mode.

If you liked that, you'll love the fact that you can set up to eight breakpoints. Each one is numbered automatically. You can examine locations and registers and even modify them before continuing the program. You can also specify the number of times the breakpoint is passed before it stops the program. Single stepping can be ordered after a breakpoint or all by itself. You can also reference your breakpoints and single-stepping entry points by symbolic reference.

Symbolic reference can be used throughout the program with any command. You can set the mode to \$\$, denoting symbolic reference, or just use them. If you are not in symbolic mode, any nonnumeric input sends Z-BUG to the symbol table to resolve the address associated with that reference. In fact, you can use any standard suffix (such as T for decimal, H for hexadecimal, etc) no matter what the radix is set to and the program resolves it. And if it isn't flexible enough, it also works as a calculator, doing all your arithmetic in any base between 2 and 16.

I am quite impressed with Z-BUG. It is an extremely flexible debugging tool. However, there are two minor problems that need pointing out. First, if you have to use the stand-alone version of Z-BUG, you won't be able to use symbolic references. This is because Z-BUG resolves symbolic references by a look at the symbol table. When you reload the object module, you don't have the symbol table to look at. Second, the manual suggests that you use a dummy address for the entry or execution address when you punch out a system tape if you don't have one. *Don't do it!* When you read it back in under SYSTEM and type the slash to start it, it tries to start it at the dummy address. Instead, use the starting address for the entry address. It will avoid problems when you try to run the program you spent two days on.

## Conclusions

Microsoft's Editor/Assembler Plus is an excellent editor/assembler/debugger. It has a few problems that prevent it from being outstanding. It can turn any Radio Shack TRS-80 Level II with at least 16 K bytes of memory into an assembly-language development system with little effort. Microsoft has learned from the problems and complaints that came from the users of Radio Shack's Editor/Assembler.

Documentation has usually been a problem with Microsoft products, and that has not changed with Editor/Assembler Plus. There is a definite lack of support documentation with the package. The documentation that is included is well done.

Editor/Assembler Plus is an outstanding value for its price. Not only is an editor and macro assembler included in the package, but a powerful debugger as well. ■

## BOSS: A Debugging Utility for the TRS-80 Model I

Scott Mitchell, 346 S Taylor St, Manchester NH 03103

BOSS is a utility program to help debug programs written in TRS-80 Microsoft BASIC by dynamically tracing steps in execution. Essentially, this program intercepts the TRACE function included with TRS-80 BASIC and modifies its operation. The result is a more versatile debugging utility with a more meaningful and readable screen display.

The first thing you notice after BOSS is loaded is that the line numbers normally output by the TRACE function no longer print all over the screen, making the display scroll uncontrollably. The trace-line numbers now print in a vertical column in the upper right-hand part of the screen. Four line numbers are displayed, with an arrow pointing to the one currently executing. This is a big advantage when trying to debug a graphics program or any program that specially formats information output to the screen. With BOSS, all the graphics and formatted information stay where they should; BOSS

doesn't destroy or interfere with the video output of the program being debugged.

The numbers of the program lines being traced may be output to a printer, if necessary. The functions of tracing and sending the trace-line numbers to the video display or printer can be controlled either manually during the program execution and debugging, or by POKE commands within the program being tested. Using the POKE commands, you can start and stop BOSS functions at points specified by the program being traced.

BOSS stands for BASIC Operated Single Stepper, meaning that instead of watching your regular trace whiz by, you can slow down or single-step the trace. You can step through the program line by line, or in the case of multi-instruction lines, instruction by instruction. Tracing a program is made much easier.

Variables can be examined any time, and BOSS lets you tell it which ones you're trying to keep track of. Once you've told BOSS what you want, pressing two control keys lists out the variables and their contents.

You can also stack programs in memory to the extent of memory available. With this function, you can append one program with others quite easily. You load a program and give the command to push it to locations high in memory. BOSS does this and resets the pointers for the new limits of your BASIC source-code buffer. Now, load a second program and give the command to append it with the first program. BOSS is happy doing its own memory management. It checks the amount of memory you have and keeps track of how much you have used or will need. BOSS asks how much memory to protect and locates itself just under your stated protected-memory limit. It also tells what memory size to give when you enter BASIC. The BOSS program has no problem working with either a TRS-80 Level II cassette system or the TRSDOS disk operating system.

BOSS did lock up on me sometimes, but this was mostly because I did not follow directions. For instance, I did not set a memory size, or I pressed the control keys to send output to the printer when no printer was on line.

Overall, BOSS has many good features, with only a few bad ones. Since it works so well, BOSS has become one of my most used BASIC utilities. ■

### At a Glance

**Name**  
BOSS (BASIC Operated  
Single Stepper)

**Type**  
Debugging utility (replaces  
the TRACE function)

**Distributor**  
Level IV Products Inc  
32238 Schoolcraft  
Livonia MI 48150  
(800) 521-3305

**Price**  
\$29.95

**Format**  
5-inch floppy disk or  
cassette tape

**Language used**  
Z80 machine language

**Computer needed**  
TRS-80 Model I, minimum  
of 16 K bytes of memory,  
cassette or disk based

**Documentation**  
13-page pamphlet

**Audience**  
TRS-80 BASIC programmers  
dissatisfied with the opera-  
tion of the present TRACE  
function

## Indirect I/O Addressing on the 8080

Paul Zarucki, 30 Long Leasow, Selly Oak,  
Birmingham, B29 4LT United Kingdom

It is frequently useful to be able to specify the address of an I/O (input/output) port by the contents of a register or memory location, to allow a common I/O routine to service a number of similar devices connected to separate ports. If you have a system based on Intel's 8080 microprocessor that does not have memory-mapped I/O, you cannot do this using the 8080 I/O instructions in the normal manner, because only direct addressing is allowed for I/O instructions.

One solution is to modify the I/O instruction each time, prior to executing it, so it addresses the required port. Two possible problems with this method are:

- the program will not work if stored in ROM (read-only memory) since the instructions cannot be modified
- the program is not reentrant, which makes simultaneous I/O to several ports impossible (as in multiprogramming or multitasking)

For the program to be reentrant, it must store variable data either in the processor's registers or in memory locations assigned at execution time. If the I/O instruction could be regarded as a variable and stored in this manner (but also executed as though it were part of the program), we could solve the two problems mentioned above.

### Enter the Stack

The stack is an area of programmable memory that is dynamically assigned at execution time and is present in most 8080 systems; thus, it is ideal for this application.

In the method presented here, we assemble the I/O instruction code in the processor's registers and store it on the stack together with a RET (subroutine return) instruction. Then it is called as though it were a subroutine, and, finally, the instructions are cleared from the stack (see figure 1).

One problem with calling a subroutine on the stack is that its *absolute start address* cannot be predicted when

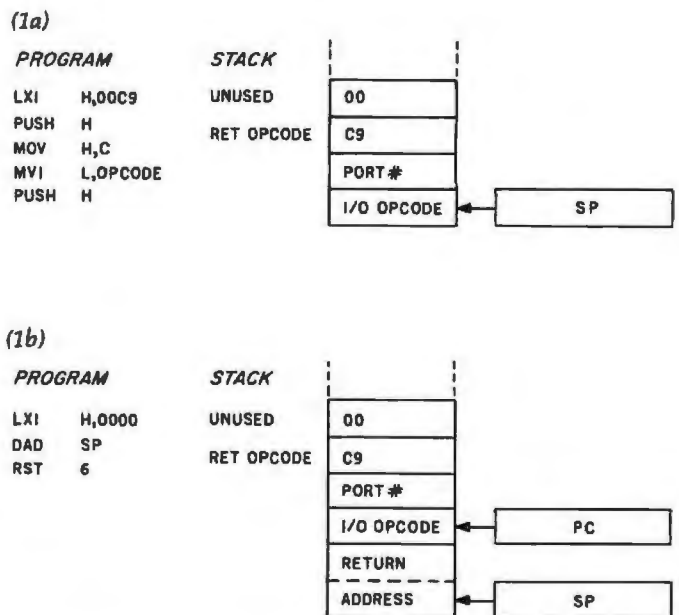

Figure 1: Stages in the assembly and execution of an indirect I/O subroutine. The C register is assumed to contain the I/O port address. Figure 1a shows how the code is assembled in the registers and pushed onto the stack. In figure 1b, the start address for the code on the stack is loaded into the HL register pair and an indirect subroutine call is performed.



**Listing 1:** Subroutines for performing indirect input and output operations. With the I/O port address stored in the C register, data is transferred to (or from) register A, as with normal 8080 I/O instructions.

```
(1a)
00001                ;P6S1
00002                ;=====
00003                ;DATE: 21/7/1980                                INDIRECT INPUT SUBROUTINE.

00010      0000      21C900      INPUT      LXI      H,0C9H
00011      0003      E5          PUSH     H          ;STORE "RET" OPCODE ON STACK.
00012      0004      61          MOV      H,C
00013      0005      2EDB       MVI      L,0DBH
00014      0007      E5          PUSH     H          ;STORE "IN" OPCODE ON STACK.
00015      0008      210000     LXI      H,0
00016      000B      39          DAD      SP         ;MOVE SP TO HL.
00017      000C      F7          RST     6          ;CALL TO ADDRESS IN HL.
00018      000D      E1          POP      H          ;CLEAR STACK.
00019      000E      E1          POP      H
00020      000F      C9          RET

00022                END

(1b)
00001                ;P6S2
00002                ;=====
00003                ;DATE: 21/7/1980                                INDIRECT OUTPUT SUBROUTINE.

00010      0000      21C900      OUTPUT     LXI      H,0C9H
00011      0003      E5          PUSH     H          ;STORE "RET" OPCODE ON STACK.
00012      0004      61          MOV      H,C
00013      0005      2ED3       MVI      L,0D3H
00014      0007      E5          PUSH     H          ;STORE "OUT" OPCODE ON STACK.
00015      0008      210000     LXI      H,0
00016      000B      39          DAD      SP         ;MOVE SP TO HL.
00017      000C      F7          RST     6          ;CALL TO ADDRESS IN HL.
00018      000D      E1          POP      H          ;CLEAR STACK.
00019      000E      E1          POP      H
00020      000F      C9          RET

00022                END
```

**Listing 2:** A simulated indirect subroutine call. A call to this subroutine causes a jump to the address contained in the HL register pair.

This code is necessary for the indirect subroutine call. It consists of a single indirect jump instruction, located at address 0030H, which is executed when the RST 6 instruction is performed.

```
00001                ;P6S3
00002                ;=====
00003                ;DATE: 21/7/1980                                INDIRECT SUBROUTINE CALL.

00010      0030      E9          PCHL     ;JUMP TO ADDRESS IN HL.

00012                END
```

the program is written. Thus, we need an indirect subroutine call—something the 8080 microprocessor does not have. This can be simulated by a call to a subroutine that causes a jump to an address contained in the HL register pair (shown as an RST 6, but it could be an ordinary subroutine).

After the assembled code is pushed onto the stack, SP points to the first byte of the I/O subroutine. SP is loaded into HL and an indirect call is performed. The stack now appears as figure 1b, with the return address at the top and the PC (program counter) pointing to the first byte of the I/O subroutine. The 3 bytes of code on the stack are then executed. The RET instruction causes the return

address to be popped off the stack and execution continues within the main body of the program.

Listings 1a and 1b show subroutines for performing indirect input and output operations, respectively. They are both relocatable and reentrant and can reside in either programmable or read-only memory.

Both subroutines shown assume that register C contains the I/O port address. Data is loaded into register A or stored from register A, as with the normal 8080 I/O instructions. The only other registers modified are H and L.

Indirect subroutine calls are also useful in other applications where it is desired to specify the start address of a subroutine at execution time. ■

## A Disk Catalog for the Eighties

Bob Liddil, POB 66, Peterborough NH 03458

DISK/CAT, a NEWDOS-based, commercial-quality cataloging program for a Radio Shack TRS-80 with two or more drives, performs several useful services (see listing 1). In addition to recording and filing the contents of every disk run through it, the program assigns to each a permanent number (which is placed in the directory). Updating is performed by simply reinserting the disk and running DISK/CAT again. The contents of the disk are then recataloged, and file names are deleted or added while retaining the number.

*Listing 1: DISK/CAT for the Radio Shack TRS-80. The program numbers each disk, and catalogs its contents. The stored files can be printed or displayed on the video monitor in alphabetical order or on a disk-by-disk basis.*

```
5 GOSUB5000:
  CLS:
  CLEAR50000:
  PRINT@276,"          DO YOU WANT TO
1  CATALOG A NEW DISK OR UP DATE
  OLD DISK    2  LOOK AT PROGRAM
  FILE OR SEARCH FOR PROGRAM";
10 A$=INKEY$:
  IF A$="" THEN GOTO 10
15 A=VAL(A$):
  IF A<1 OR A>2 THEN GOTO 10
20 ON A GOTO 25,200
25 TROFF:
  CLS:
  GOSUB 395:
  CLS:
  PRINT@512,"PLEASE INSERT THE DISK
  TO BE CATALOGUED IN DRIVE #";DK;
  " AND PRESS <ENTER> ";
30 QQ$=INKEY$:
  IF QQ$="" THEN GOTO 30
```

DISK/CAT can remember a particular program and report its whereabouts, on a disk-by-disk basis, repeating all occurrences of the program. The search routine can be initialized from the beginning or from the end.

The display mode will print all disk directories to the screen (or to a printer, see listing 2a), give the directory of any specified disk, or alphabetize all file names and print them to screen or printer with their disk number (see listing 2b).■

```
35 DIMA$(50):
  CLS:
  GOSUB420:
  N=15360+(63*2)+2
40 X=PEEK(N):
  IFX<>32ANDPEEK(N-1)=191 THEN I=I+1:
  C=0
45 IFC>30 THEN70
50 IFN>16382 THEN70
55 IFX=32 THENPOKEN,191:
  N=N+1:
  C=C+1:
  GOTO40
60 POKEN,191:
  POKEN,X:
  A$(I)=A$(I)+CHR$(X):
  N=N+1:
  IFC>30 THEN70
65 IFN<16382 THEN40
70 CLS:
  FORX=0 TO I:
  IFA$(X)="P" OR A$(X)="NUMBER" THEN
  A$(X)=CHR$(191):
  GOTO80
75 PRINTA$(X),:
  IFPOS(0)+LEN(A$(I+1))+9>64 THEN
  PRINT
```

```

80 NEXT:
  ONERRORGOTO85:
  OPEN" I",1,"DN:0":
  INPUT#1,DH:
  CLOSE:
  GOTO90
85 CLOSE:
  OPEN"O",1,"DN:0":
  PRINT#1,0:
  CLOSE:
  RESUME
90 ONERRORGOTO100:
  OPEN" I",1,DK$:
  INPUT#1,DN:
  CLOSE:
  SK=DN:
  IFDH>DNTHEN115
95 OPEN"O",1,"DN:0":
  PRINT#1,DN:
  CLOSE:
  GOTO115
100 CLOSE:
  OPEN" I",1,"DN:0":
  INPUT#1,DN:
  CLOSE:
  OPEN"O",1,DK$:
  PRINT#1,DN+1:
  CLOSE:IFDN+1<=DHTHEN110
105 OPEN"O",1,"DN:0":
  PRINT#1,DN+1:
  CLOSE
110 RESUME
115 ONERRORGOTO140:
  CLOSE:
  CLS:
  PRINT"THIS IS DISK #";DN:
  OPEN" I",1,"FILE:0":
  INPUT#1,NP:
  DIMN$(NP+I+1),D(NP+I+1),O(NP+I+1):
  IFNP=0THEN130
120 FORX=1TONP:
  INPUT#1,N$(X):
  NEXT:
  CLOSE:
  ONERRORGOTO0:
  OPEN" I",1,
  "FILE:0":
  FORX=1TONP:
  INPUT#1,D(X):
  IFD(X)=SKTHENN$(X)=CHR$(191)
125 NEXT
130 CLOSE:
  ONERRORGOTO0:
  X=NP:
  N=0:
  CLS:
  FORL=X+1TOX+I+1:
  N$(L)=A$(N):
  N=N+1:
  D(L)=DN:
  NEXT:
  NP=NP+I+1:
  FORI=1TONP:
    O(I)=I:
    NEXT:
    GOSUB145:
    FORX=1TONP:
      IFN$(O(X))<>CHR$(191)THENNP=X
135 NEXT:
  OPEN"O",1,"FILE:0":
  PRINT#1,NP:
  FORI=1TONP:
  PRINT#1,N$(O(I)):
  NEXT:
  CLOSE:
  OPEN"O",1,"FILE:0":
  FORI=1TONP:
  PRINT#1,D(O(I)):
  NEXT:
  CLOSE:
  GOTO5
140 CLOSE:
  OPEN"O",1,"FILE:0":
  PRINT#1,0:
  CLOSE:
  RESUME
145 L=1:
  C=0:
  FORN=1TONP:
  IFN$(O(N))=CHR$(191)THENC=C+1
150 NEXT:
  FORX=1TONP-C-1:
  IFN$(O(X))=CHR$(191)THENGOSUB160
155 NEXT:
  GOTO165
160 CLS:
  PRINT"PRE SORT":
  A=O(X):
  FORN=XTONP-1:
  O(N)=O(N+1):
  NEXT:
  O(NP)=A:
  X=X-1:
  RETURN
165 C=0:
  FORX=LTONP-1:
  IFN$(O(X))>N$(O(X+1))THENGOSUB175:
  X=NP-1:
  NEXT:
  GOTO165
170 L=X:
  NEXT:
  TROFF:
  RETURN
175 CLS:
  PRINT"SORTING DATA":
  FORI=X+1TO1 STEP-1:
  IFN$(O(I))<N$(O(I-1))THENA=O(I):
  O(I)=O(I-1):
  O(I-1)=A:
  C=I
180 IFC=0THENI=1:
  NEXT:
  GOTO190
185 C=0:
  NEXT

```

Listing 1 continued on page 406

## Programming Quickies

Listing 1 continued:

```
190 L=L-1:
    IFL<1 THEN L=1
195 RETURN
200 ON ERROR GOTO 5:
    OPEN "I",1,"FILE:0":
    INPUT#1,NP:
    DIM N$(NP),D(NP):
    FOR X=1 TO NP:
    INPUT#1,N$(X):
    NEXT:
    CLOSE:
    OPEN "I",1,"FILE:0":
    FOR X=1 TO NP:
    INPUT#1,D(X):
    NEXT:
    CLOSE:
    OPEN "I",1,"DN:0":
    INPUT#1,DN:
    CLOSE
205 CLS:
    PRINT "DO YOU WANT TO SEARCH
    FOR PROGRAM (N) CHAR. FROM
    BEG IN 2 SEARCH (N) CHAR. FROM
    END 3 PRINT ALL DISKS TO
    PRINTER 4 PRINT ALL DISKS TO
    SCREEN
210 PRINT 5 ALL PROGRAMS TO PRI
    NTER IN ALPH. ORDER WITH DISK#:
    PRINT 6 DIR OF ANY DISK":
    PRINT 7 RESTART 8 END
215 QQ$=INKEY$:
    IF QQ$="" THEN GOTO 215
220 FL=VAL(QQ$):
    IF FL<1 OR FL>8 THEN GOTO 215
225 ON FL GOTO 230,300,335,345,360,365,
    5,390
230 CLS:
    PRINT "YOU GIVE ME ANY NUMBER OF
    CHAR. I WILL LIST ALL DISKS THAT
    CONTAIN A PROGRAM THAT START WITH
    THOSE CHAR.": INPUT "CHAR. TO SEARCH
    FOR";A$:L=LEN(A$):PRINT "OUTPUT TO
    PRINTER Y/N"
235 P$=INKEY$:
    IF P$="" THEN GOTO 235
240 IF P$="Y" THEN P=1:
    GOTO 255
245 IF P$="N" THEN P=0:
    GOTO 255
250 GOTO 235
255 CLS:
    P$="":
    FOR X=1 TO NP:
    IF LEFT$(N$(X),L)=A$ THEN 265
260 GOTO 280
265 IF P=1 THEN 275
270 PRINT N$(X),"DISK #";D(X):
    GOTO 280
275 LPRINT N$(X),"DISK #";D(X)
280 NEXT
285 PRINT @980,"PRESS <ENTER> TO CONT
    INUE";
290 QQ$=INKEY$:
    IF QQ$="" THEN GOTO 290
295 GOTO 205
300 CLS:
    PRINT "YOU GIVE ME ANY NUMBER OF
    CHAR. I WILL LIST ALL THE PROGRAMS
    THAT END IN THOSE CHAR.": INPUT "TO
    SEARCH FOR----";A$:
    L=LEN(A$):PRINT "OUTPUT TO PRINTER
    Y/N "
301 P$=INKEY$:
    IF P$="" THEN 301
302 IF P$="Y" THEN P=1:
    GOTO 305
303 IF P$="N" THEN P=0:
    GOTO 305
304 GOTO 301
305 CLS:
    FOR X=1 TO NP:
    IF RIGHT$(N$(X),L)=A$ THEN 315
310 GOTO 330
315 IF P=0 THEN 325
320 LPRINT N$(X),"DISK #";D(X)
325 PRINT N$(X),"DISK #";D(X)
330 NEXT:
    GOTO 285
335 OPEN "I",1,"DN":
    INPUT#1,DN:
    CLOSE:
    FOR X=1 TO DN:
    LPRINT " ":
    LPRINT " ":
    LPRINT "-----DISK #";X;
    "-----":
    LPRINT " ":
    FOR N=1 TO NP:
    IF D(N)=X THEN LPRINT " ";
    N$(N)
340 NEXT:
    NEXT:
    GOTO 285
345 FOR X=1 TO DN:
    CLS:
    PRINT "DISK #";X;
    PRINT:
    PRINT:
    PRINT:
    FOR N=1 TO NP:
    IF D(N)<>X THEN 355
350 PRINT N$(N),:
    IF POS(0)>50 THEN PRINT
355 NEXT:
    PRINT:
    PRINT:
    FOR I=1 TO 2000:
    NEXT:
    NEXT:
    GOTO 205
360 CLS:
    FOR X=1 TO NP:
    LPRINT N$(X),"DISK #";D(X):
```

```

PRINTN$(X),"DISK  #";D(X):
NEXT:
GOTO205
365 CLS
370 INPUT"DIR OF WHAT DISK";D:
  IFD>DNTHENPRINT"DISKS ONLY CATALOG
  ED UP TO ";DN:
  GOTO370
375 CLS:
  PRINT"DISK  #";D:
  PRINT:
  FORX=1TONP:
    IFD(X)=DTHENPRINTN$(X),
380 IFPOS(0)>50THENPRINT
385 NEXT:
  GOTO285
390 END
395 CLS:
  PRINT"ON WHICH DRIVE (1 THRU 3)
  WILL YOU PLACE YOUR DISK TO BE
  CATALOGED?":
  LINEINPUT DK$
400 DK=VAL(DK$):
  IF DK<1 OR DK>3 THEN CLS:
  GOTO395
405 IF DK=1 THEN DK$="NUMBER:1":
  RETURN
410 IF DK=2 THEN DK$="NUMBER:2":
  RETURN
415 IF DK=3 THEN DK$="NUMBER:3":
  RETURN
420 IF DK=1 THEN CMD"DIR :1":
  RETURN
425 IF DK=2 THEN CMD"DIR :2":
  RETURN
430 IF DK=3 THEN CMD"DIR :3":
  RETURN
500 CLS:
  PRINTCHR$(23):
  PRINT@24,"NOTICE":
  PRINT:
  PRINT"THIS PROGRAM WILL NOT WORK
  WITH A SINGLE DRIVE DISK SYSTEM"
510 FOR ZZ=1TO 1500:
  NEXT:
  RETURN

```

Listing 2: Sample printer output from DISK/CAT. The directories of all disks, in disk-number order, are shown in listing 2a; listing 2b shows the directories in alphabetical order.

(2a)-----DISK # 1 -----

```

BARTEND
DISKED35/CMD
FCC1
FCC2
FCC3
FCC4
FCC5
TEMP1

```

-----DISK # 2 -----

```

DSHIP/CMD
DUTCHMAN
INTRO
SPIDER

```

-----DISK # 3 -----

```

DSHIP/CMD
STARTREK

```

-----DISK # 4 -----

```

CATALOG
DECODE
ETCH/PCL
LCPRINT/CMD
LETTER
PENCIL/CMD
REPORT/PCL
TEST
VOICE

```

(2b)

```

BARTEND          DISK # 1
CATALOG          DISK # 4
DECODE          DISK # 4
DISKED35/CMD    DISK # 1
DSHIP/CMD       DISK # 2
DSHIP/CMD       DISK # 3
DUTCHMAN        DISK # 2
ETCH/PCL        DISK # 4
FCC1            DISK # 1
FCC2            DISK # 1
FCC3            DISK # 1
FCC4            DISK # 1
FCC5            DISK # 1
INTRO           DISK # 2
LCPRINT/CMD     DISK # 4
LETTER          DISK # 4
PENCIL/CMD     DISK # 4
REPORT/PCL     DISK # 4
SPIDER         DISK # 2
STARTREK       DISK # 3
TEMP1          DISK # 1
TEST           DISK # 4
VOICE          DISK # 4

```

DISK/CAT was written by David Huntress of Boston MA. Enhancements were added by Reese Fowler of Peterborough NH. Copies are available on tape for disk BASIC from The Programmer's Guild, POB 66, Peterborough NH 03458, for \$19.95.

## Alpha-Beta Tree Search Converted to Assembler

Stephen F Gale, 22 Lloyd Pl,  
St Albert, Alberta T8N 2H4, Canada

In part three of his article "Machine Problem Solving" (November 1980 BYTE, page 224), Peter Frey discussed the alpha-beta pruning algorithm as applied to searching a look-ahead tree for the best strategy in a two-player game. He included a BASIC demonstration game of the alpha-beta procedure called Treasure Search. In this game, the user plays against the computer on an 8 by 8 grid that has a digit between 1 and 9 randomly assigned to each of the 64 grid locations. Players take turns moving from one spot to another, adding the value of each location they land on to their scores. Once a location has been occupied, its value is reduced to 0. Each player attempts to follow a path that leads to the highest numbers; the first player to reach 100 points wins.

Listings 1 and 2 are an improved version of this game for a Radio Shack TRS-80 Model I. The highly efficient alpha-beta tree search has been rewritten in Z80 assembly language, and it now runs about 300 times faster than the original BASIC program. My version has also been enhanced through the use of the *killer heuristic* that was described in Mr Frey's article. Effective moves stored by the regular tree-search routine are recalled by the killer heuristic when the current situation is recognized as

being similar to one previously encountered in the course of a game.

This improved program plays a good game at levels five, six, and seven; at levels eight, nine, and ten it should be excellent. Note that even with the reduced computing time of the new version, level ten requires about forty minutes per move. By contrast, a move by the computer at level five in the original version required fifteen minutes; the same level on the improved version takes less than ten seconds.

As given, the program in listing 2 must be loaded beginning at hexadecimal memory location 6000. Altering the ORG statement prior to assembly will allow you to place the code elsewhere in memory. Line 400 of the BASIC program must also be modified so that it will know the new entry point for the machine code.

In a cassette-based system, after you have put these programs on tape, load the BASIC program of listing 1 with the CLOAD command. Then use the SYSTEM command to load the machine-language program assembled from listing 2. Press BREAK after the second program has been loaded to return to the BASIC editor, then type RUN. ■

**Listing 1:** BASIC portion of an improved version of the game Treasure Search, described in the November 1980 BYTE. This program runs in conjunction with listing 2. Line 400 contains the code that gives the entry point for the machine-language routines in listing 2.

```
0 CLS:PRINT@5," * TREASURE SEARCH * BYTE MAGAZINE - NOVEMBER, 1980"
5 PRINT:PRINT" TREE SEARCH CONVERTED TO ASSEMBLER BY S.F.GALE B.S.C ASPH(CPSC) IN DECEMBER, 19
80"
10 PRINT:PRINT
15 PRINT" THE OBJECT OF THE GAME IS TO SCORE 100 POINTS BEFORE"
20 PRINT"THE COMPUTER DOES. THE COMPUTER MOVES THE '*' AND YOU"
25 PRINT"MOVE THE 'X' ABOUT AN 8X8 BOARD THAT CONTAINS RANDOM"
30 PRINT"NUMBERS BETWEEN 1 AND 9. WHEN A SQUARE HAS BEEN"
35 PRINT"VISITED, THE VALUE ON THE SQUARE IS THEN ZERO. MOVES"
40 PRINT"ARE MADE BY PRESSING ONE OF THE FOUR ARROW KEYS."
45 PRINT:PRINT:INPUT"PRESS <ENTER> TO CONTINUE";A$
50 CLS:PRINT" THE PROGRAM USES THE ALPHA-BETA TREE SEARCH"
55 PRINT"ENHANCED BY THE KILLER HEURISTIC."
60 PRINT:PRINT" MOVE TIMES ARE ROUGHLY AS FOLLOWS:"
65 PRINT"  LEVELS 1 TO 6 - UNDER 10 SECONDS,
70 PRINT"  LEVEL 7   - UNDER 60 SECONDS,
73 PRINT"  LEVEL 8   - UNDER 2 MINUTES,
```

```

75 PRINT" LEVEL 9 - UNDER 10 MINUTES,
80 PRINT" LEVEL 10 - ABOUT 40 MINUTES.
85 PRINT:PRINT" THESE TIMES COMPARE FAVORABLY TO BASIC WHERE":PRINT"LEVEL 5 TAKES ABOUT 15 M
INUTES."
95 PRINT:PRINT:INPUT"PRESS <ENTER> TO CONTINUE";A$
100 CLEAR100:CLS:DEFINTA-Z:RANDOM:SH=0:ST=0:Z%=STRING$(32," ")
110 PRINT@463,"PLEASE ENTER YOUR NAME";:INPUTN$
120 DIMA(8),B(99),D(4),E(12),M(12)
130 DIMPV(12,12),Q(12),V(12),Z(12)
140 D(1)=-10:D(2)=-1:D(3)=1:D(4)=10
150 A(1)=10:A(2)=-10:A(4)=-1:A(8)=1:CLS
160 PRINT@461,"COMPUTER PLAYING STRENGTH (1 TO 10) !";:INPUTY
170 DM=2*Y:FORI=11TO88:B(I)=RND(9):NEXTI
180 FORI=0TO10:B(I)=99:NEXTI:FORI=89TO99:B(I)=99:NEXTI
190 FORI=19TO79:STEP10:B(I)=99:B(I+1)=99:NEXTI
195 CLS:PRINT@463,"DO YOU WANT TO GO FIRST";:INPUTA$
220 CLS:FORI=11TO88:IFB(I)=99THENZ40
230 X%=RIGHT$(STR$(B(I)),I):GOSUB1000
240 NEXTI:PRINT@22,"TREASURE SEARCH";Y
250 PRINT@256,N$;:PRINT@448,"TRS-80";Y%=STRING$(12," ")
260 T=54:T$=" ";H=45:H$=" X"
270 I=T:X%=T$:GOSUB1000:B(T)=99:B(H)=99
280 I=H:X%=H$:GOSUB1000
285 IFA$="YES"THEN300ELSE400
290 PRINT@788,"ILLEGAL MOVE, TRY AGAIN";:FORI=1TO999:NEXTI
300 PRINT@788,Z$;:PRINT@788,"WHICH DIRECTION FOR X";
310 IFINKEY$=""THEN310ELSER=PEEK(16444)
320 R=INT(R/8):J=H+A(R)
330 IFB(J)=99THEN290ELSEPRINT@788,Z$
360 I=H:B(I)=0:X$=" 0":GOSUB1000:SH=SH+B(J)
370 H=J:B(H)=99:I=H:X%=H$:GOSUB1000
380 PRINT@321,SH;:IFSH>99THEN930
400 POKE16526,0:POKE16527,96
410 FCRI=0TO99:POKE32261+I,B(I):NEXTI
420 POKE32258,DM:POKE32259,T:POKE32260,H
430 BM=USR(N)
800 I=T:B(I)=0:X$=" 0":GOSUB1000:PRINT@179,Y$;
810 T=BM:ST=ST+B(T):B(T)=99:I=T:X%=T$
820 GOSUB1000:PRINT@513,ST;:IFST<100THEN300
910 PRINT@915,"THANK YOU FOR A PLEASANT GAME";
920 GOTO920
930 PRINT@917,"CONGRATULATIONS, YOU WIN";:GOTO920
1000 R=INT(I/10):C=I-10*R:K=141+(8-R)*64+C*4
1010 PRINT@K,X$;:RETURN

```

**Listing 2:** *The more time-consuming portions of the game have been coded in Z80 assembly language, improving the program speed 300 times. This section of the game must be loaded into otherwise unused memory before you attempt to run the program in listing 1.*

```

00100      ORG      6000H
00110 BRD      EQU      7E05H
00120 MXDPH    EQU      7E02H
00130 TRS80    EQU      7E03H
00140 HUMAN    EQU      7E04H
00150 FROM     EQU      -12
00160 TO       EQU      +00
00170 DCOUNT   EQU      +01
00180 ALPHA    EQU      -04
00190 BETA     EQU      +02
00200 MAX      EQU      +08
00210 SAVSQR   EQU      +03
00220 SAVSCR   EQU      +04
00230 KILLER   EQU      +05

```

*Listing 2 continued on page 410*

## Programming Quickies

Listing 2 continued:

```
00240 ;
00250 ;* * * SET UP TREE SEARCH PARAMETERS.
00260     LD     A,(MXDPH)      ;SET SEARCH
00270     LD     (MAXLVL),A    ; MAXIMUM DEPTH.
00280     LD     A,1          ;SET THE PLY
00290     LD     (PLYLVL),A   ; LEVEL COUNTER.
00300     LD     A,-1
00310     LD     (SIDE),A     ;SET SIDE-TO-MOVE.
00320     LD     A,0         ;ZERO CUMULATIVE
00330     LD     (SCORE),A    ; SCORE COUNTER.
00340     LD     IX,TREE+6   ;START OF TREE DATA.
00350     LD     (IX+ALPHA),-99
00360     LD     (IX+BETA),-99
00370     LD     A,(TRS80)    ;SET LOCATION OF
00380     LD     (IX-06),A    ; COMPUTER'S PIECE.
00390     LD     A,(HUMAN)   ;SET LOCATION OF
00400     LD     (IX+00),A   ; HUMAN'S PIECE.
00410 ;
00420 ;* * * MOVE DOWN ONE PLY LEVEL IN TREE.
00430 NXTLVL LD     HL,PLYLVL ;INCREMENT THE
00440     INC    (HL)         ; PLY LEVEL COUNTER.
00450     LD     DE,6        ;MOVE TREE POINTER
00460     ADD   IX,DE        ; FORWARD TO NEXT PLY.
00470     LD     (IX+DCOUNT),5 ;SET THE MOVE COUNTER.
00480     LD     A,(SIDE)   ;CHANGE THE
00490     NEG   (SIDE),A     ; SIDE-TO-MOVE
00500     LD     A,(IX-10)  ; INDICATOR.
00510     LD     (IX+ALPHA),A ;SET NEXT ALPHA,
00520     LD     (IX+BETA),A ; BETA VALUE.
00530 ;
00540 ;* * * CHECK IF THE KILLER MOVE IS LEGAL.
00550     LD     HL,DIR      ;DIRECTION TABLE.
00560     LD     B,4
00570 NXTDIR LD     A,(HL)  ;GET NEXT MOVE DIRECTION.
00580     ADD   A,(IX+FROM)  ;CALCULATE NEW SQUARE.
00590     CP   (IX+KILLER)  ;CHECK IF THIS SQUARE IS
00600     JF   Z,TRYKIL     ; THE KILLER MOVE.
00610     INC   HL
00620     DJNZ NXTDIR
00630 ;
00640 ;* * * CHECK A MOVE AT THIS PLY LEVEL.
00650 NXTMOV DEC    (IX+DCOUNT) ;UPDATE MOVE COUNTER.
00660     JF   Z,PRELVL     ;IF DONE GOTO PLY-1.
00670     LD   HL,DIR-1    ;DIRECTION TABLE.
00680     LD   C,(IX+DCOUNT)
00690     LD   B,0
00700     ADD  HL,BC
00710     LD   A,(HL)      ;RETRIEVE DIRECTION.
00720     ADD  A,(IX+FROM) ;CALCULATE NEW SQUARE.
00730 ;
00740 ;* * * CHECK IF MOVE IS KILLER (WHICH HAS BEEN DONE).
00750     CP   (IX+KILLER)
00760     JF   Z,NXTMOV
00770 ;
00780 ;* * * CHECK IF THE MOVE IS LEGAL.
00790 TRYKIL LD     (IX+TO),A ;SAVE NEW SQUARE.
00800     LD   HL,BRD      ;BOARD TABLE.
00810     LD   C,A
00820     LD   B,0
00830     ADD  HL,BC
00840     LD   A,(HL)      ;RETRIEVE PIECE.
00850     CP   99         ;CHECK IF LEGAL MOVE.
00860     JF   Z,NXTMOV   ;IGNOR IF ILLEGAL.
```



```

00870          LD      (IX+SAVSQR),A      ;SAVE VALUE OF SQUARE.
00880          ;
00890          ;* * * 'MAKE' MOVE ON BOARD.
00900          LD      (HL),99            ;MARK NEW SQR ILLEGAL.
00910          LD      HL,BRD             ;HL=BOARD ADDRESS.
00920          LD      C,(IX+FROM)        ;RETRIEVE FROM SQR.
00930          ADD     HL,BC              ;CALCULATE SQR.
00940          LD      (HL),0            ;MARK SQR LEGAL.
00950          ;
00960          ;* * * UPDATE THE CUMULATIVE SCORE.
00970          LD      A,(SIDE)           ;RETRIEVE SIDE-TO-MOVE
00980          OR      A                 ; AND SET FLAGS
00990          LD      A,(IX+SAVSQR)      ;GET VALUE OF SQR.
01000          JP      P,SKIP02          ;BRANCH IF SIDE POSITIVE.
01010          NEG
01020  SKIP02  LD      (IX+SAVSCR),A      ;SAVE SIDE*SAVSQR.
01030          LD      HL,SCORE           ;ADDR OF CUMULATIVE SCORE
01040          ADD     A,(HL)             ;UPDATE SCORE
01050          LD      (HL),A            ; AND RESTORE.
01060          ;
01070          ;* * * CHECK IF SEARCHED TO MAXIMUM DEPTH.
01080          LD      HL,MAXLVL
01090          LD      A,(PLYLVL)
01100          CP      (HL)
01110          JP      C,NXTLVL          ;BRANCH IF NOT AT MAX.
01120          ;
01130          ;* * * SET SCORE ON THIS TERMINAL NODE.
01140          LD      A,(SIDE)           ;RETRIEVE SIDE-TO-MOVE,
01150          OR      A                 ; SET THE FLAGS,
01160          LD      A,(SCORE)          ;GET CUMULATIVE SCORE.
01170          JP      M,SKIP04          ;BRANCH IF SIDE NEGATIVE.
01180          NEG
01190  SKIP04  LD      (IX+MAX),A        ;SET SCORE ON THIS NODE.
01200          ;
01210          ;* * * TAKE BACK THE MOVE.
01220  TAKBAK  LD      A,(SCORE)          ;GET CUMULATIVE SCORE.
01230          SUB     (IX+SAVSCR)        ;UPDATE THE SCORE
01240          LD      (SCORE),A         ; AND RESTORE IT.
01250          LD      HL,BRD
01260          LD      C,(IX+TO)
01270          LD      B,0
01280          ADD     HL,BC              ;HL=TO SQR.
01290          LD      A,(IX+SAVSQR)
01300          LD      (HL),A            ;RESTORE BRD.
01310          LD      HL,BRD             ;HL=BRD ADDRESS.
01320          LD      C,(IX+FROM)
01330          ADD     HL,BC
01340          LD      (HL),99            ;RESTORE BRD AT FROM.
01350          ;
01360          ;* * * CHECK IF BEST SCORE AT THIS NODE.
01370          LD      A,(IX+MAX)
01380          NEG
01390          LD      B,(IX+BETA)
01400          CALL    CMPARE
01410          CP      1
01420          JP      NZ,NXTMOV
01430          LD      A,(IX+MAX)
01440          NEG
01450          LD      (IX+BETA),A
01460          ;
01470          ;* * * STORE BEST MOVE AT LOWEST PLY.
01480          LD      A,(PLYLVL)         ;CHECK IF AT
01490          CP      2                  ; LOWEST PLY LEVEL.

```

Listing 2 continued on page 412

## Programming Quickies

Listing 2 continued:

```
01500      JP      NZ,SAVKIL      ;BRANCH IF NOT.
01510      LD      A,(IX+TD)      ; OTHERWISE UPDATE
01520      LD      (BESTMV),A      ; THE BEST MOVE.
01530      JP      PRUNE
01540      ;
01550      ;* * * STORE THE NEW KILLER MOVE.
01560 SAVKIL LD      A,(IX+TD)
01570      LD      (IX+KILLER),A
01580      ;
01590      ;* * * PERFORM ALPHA-BETA PRUNING.
01600 PRUNE LD      A,(IX+ALPHA)
01610      NEG
01620      LD      B,(IX+BETA)
01630      CALL   CMPARE
01640      CP      1
01650      JP      Z,NXTMOV
01660      ;
01670      ;* * * MOVE BACK IN TREE TO PREVIOUS LEVEL,
01680 PRELVL LD      A,(SIDE)      ;CHANGE THE
01690      NEG      ; SIDE-TO-MOVE
01700      LD      (SIDE),A      ; INDICATOR.
01710      LD      DE,-6      ;MOVE TREE POINTER
01720      ADD     IX,DE      ; BACK ONE PLY LEVEL.
01730      LD      HL,PLYLVL      ;DECREMENT THE
01740      DEC     (HL)      ; PLY LEVEL COUNTER.
01750      LD      A,1      ;CHECK IF DONE
01760      CP      (HL)      ; LAST PLY.
01770      JP      C,TAKBAK      ;BRANCH IF NOT.
01780      ;
01790      ;* * * SET HL FOR THE RETURN TO BASIC.
01800      LD      A,(BESTMV)
01810      LD      L,A
01820      LD      H,0
01830      JP      0A9AH
01840      ;
01850      ;* * * THIS SUBROUTINE COMPARES TWO 8-BIT SIGNED
01860      ; OPERANDS IN A AND B.
01870 CMPARE CP      B
01880      JP      NZ,NOTEQL
01890      LD      A,0
01900      RET
01910 NOTEQL PUSH   AF
01920      XOR     B
01930      RLA
01940      JP      C,DIFFER
01950      POP    AF
01960      JP      C,LESST
01970 GREATR LD      A,1
01980      RET
01990 DIFFER POP    AF
02000      JP      C,GREATR
02010 LESST LD      A,-1
02020      RET
02030 MAXLVL DEFS   1
02040 FLYLVL DEFS   1
02050 SCORE DEFS    1
02060 BESTMV DEFS   1
02070 SIDE DEFS     1
02080 DIR DEFB     -10
02090 DEFB     -1
02100 DEFB     +1
02110 DEFB     +10
02120 TREE DEFS    250
02130      END
```

## AIM-65 16-Bit Hexadecimal to Decimal Conversion

R A Young, Bio-Medical Engineering Unit, Room 280, Earl Hall, Queen's University, Kingston, Ontario, K7L 3N6 Canada

In the early stages of programming our AIM-65 microcomputer, we could not find a 16-bit binary to decimal number conversion subroutine so we developed the subroutine shown in listing 1. The subroutine is entered with the 16-bit number to be converted stored at hexadecimal memory locations 5E (MSB) and 5F (LSB). The

results are stored in locations 75 (MSB) to 79 (LSB). The decimal digits are stored with one digit per location. Therefore, if conversion to ASCII is also required, it becomes a simple matter of adding 30 to each digit at the end of the subroutine. Note that the values 10 E8 etc, shown at the end of the listing, must be stored starting at location 780 etc; they are the conversion constants.

Care must be taken if it is necessary to relocate this subroutine since there are several position-dependent instructions. ■

Listing 1: A subroutine for the AIM-65 microcomputer which converts 16-bit binary numbers to decimal values.

```
K>*=700
/50
0700 A9 LDA #00
0702 85 STA 75
0704 85 STA 76
0706 85 STA 77
0708 85 STA 78
070A 85 STA 79
070C A9 LDA #75
070E 8D STA 0731
0711 A9 LDA #80
0713 8D STA 071F
0716 A9 LDA #84
0718 8D STA 0726
071B 38 SEC
071C A5 LDA 5E
071E ED SBC 0785
0721 85 STA 79
0723 A5 LDA 5F
0725 ED SBC 0789
0728 90 BCC 0735
072A 85 STA 5F
072C A5 LDA 79
072E 85 STA 5E
0730 E6 INC 7A
0732 4C JMP 071B
0735 EE INC 071F
0738 EE INC 0726
073B EE INC 0731
073E AD LDA 0731
0741 C9 CMP #7A
0743 F0 BEQ 0748
0745 4C JMP 071E
074E A5 LDA 5E
```

```
074A 8C STA 79
074C EA NOP
074D EA NOP
074E EA NOP
074F EA NOP
0750 A0 LDY #00
0752 A9 LDA #5C
0754 8D STA 075A
0757 B1 LDA (88),Y
0759 4C JMP 076C
075C D0 BNE 0765
075E A9 LDA #20
0760 91 STA (88),Y
0762 4C JMP 0771
0765 A9 LDA #6C
0767 8D STA 075A
076A B1 LDA (88),Y
076C 18 CLC
```

```
<
K>*=76D
/09
076D 69 ADC #30
076F 91 STA (88),Y
0771 C8 INY
0772 98 TYA
0773 C9 CMP #06
0775 D0 BNE 0757
0777 EA NOP
0778 EA NOP
0779 60 RTS
```

```
<
M>=0780 10 E8 64 0A
< > 0784 27 03 00 00
<
```

## Fast Line-Drawing Technique

Mike Higgins, POB 197, Duncans Mills CA 95430

Almost everyone who has a home computer would like to take full advantage of its graphics capabilities, whether this is high-resolution graphics, an addressable cursor capability, or a printer or plotter capable of drawing lines.

Line drawing is the most basic of graphics functions, and in recent years, countless schemes have been put forth in an attempt to devise the best method of performing it. You've been advised to use the point-slope formula to draw lines, but this technique demands lots of floating-point arithmetic and does not draw solid lines when the slope of a line is greater than 1.0 or less than -1.0. One article I read suggested a problem reduction method, where the line segment to be drawn is repeatedly chopped in half until you have two adjacent points. This technique used only integer arithmetic, but it did a lot of redundant calculation. Home-computer owners have devoted an incredible amount of time and effort to coming up with new and creative ways to draw lines, when a simple, efficient algorithm has been available for at least a decade.

The technique I use is called the DDA, for Digital Differential Analyzer. I first learned about it from Newman and Sproull's book *Principles of Interactive Computer Graphics* (New York: McGraw-Hill, first edition, 1973; second edition 1979). The book was first printed in 1973,

so DDA has been around for quite some time. DDA is a technique for producing discrete approximations to the solution of any differential equation, and calculating the values of the coordinates on a line is just one of its uses. DDA produces simple equations that make a lot of intuitive sense. Here's how DDA works: imagine that all the lines you wish to draw are always at angles between 0 and 45° (slope between 0 and 1) and are always drawn left to right, bottom to top.

In figure 1, the number of dots in each line is always equal to the length of the line along the x axis. This is the number of times you will have to perform a loop to generate all the dots in your line. According to the DDA, you should perform the equations inside this loop as shown in listing 1. X0 and Y0 are the coordinates of the starting point, and DX and DY are the lengths of the line along the x and y axes respectively. Incidentally,  $DY/DX$  is the slope of the line. Each time through the loop, X0 and Y0 are incremented until they are equal to the end-point of the line, when the loop is finished. Notice that X0 is always incremented by 1, but Y0 is incremented by a floating-point value between 0 and 1. Presumably, the plotting device or graphics hardware on a computer can only plot to integer positions, so Y0 must be truncated or rounded off before it is used.

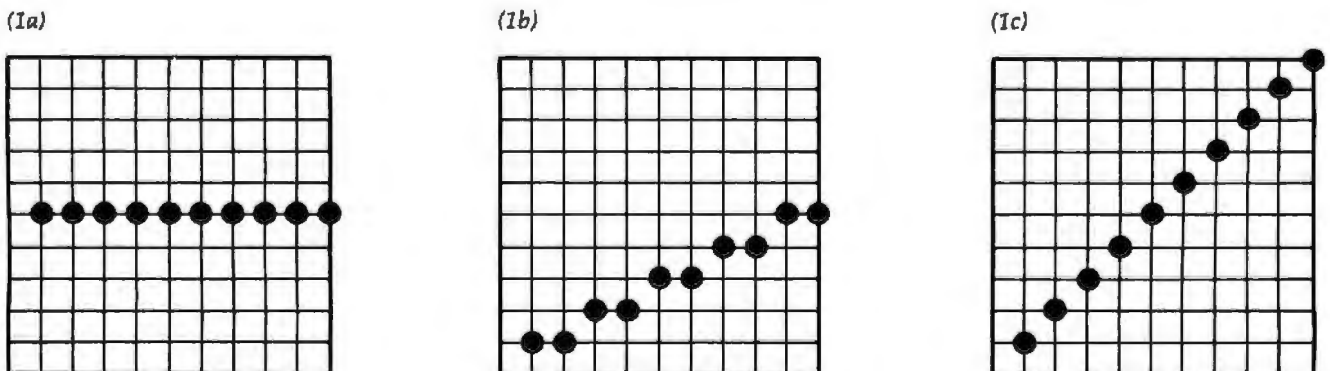

Figure 1: Examples of simple lines represented by individual coordinate points.

Newman and Sproull's most sophisticated algorithm separated all the integer operations from the floating-point ones. (See listing 2a.) In the first line of this routine, the remainder value, R, is initialized to  $\frac{1}{2}$ , so that all results that follow will be rounded off automatically. The slope is calculated outside the loop, so the only floating arithmetic that must be done is addition and subtraction. The integer variable Y0 is incremented by 1 every time R climbs back to a value of 1 or more. After all this work, however, the algorithm still uses floating-point arithmetic, so one further step is required.

I took this algorithm and multiplied all the floating-point equations by DX to come up with a different procedure. (See listing 2b.) Note that the slope calculation can now be eliminated, because the slope, DY/DX, multiplied by DX is equal to DY. Now all the equations in the procedure can be done quickly with integers. The division where R is initialized to DX/2 is the only operation that might take more time; being outside the loop, it is done only once.

This procedure can be adapted to assembly language, where a divide by 2 is a right-shift instruction. In fact, I have written this procedure in Z80 assembly language in which all the variables were stored in the processor registers. That routine can flash a line onto the screen in between video refreshes, and allows some highly interactive programs to be written when called from BASIC.

Even this algorithm, however, has the restrictions mentioned earlier; ie: it only works on lines that have slopes between 0 and 1, and can only draw from left to right, bottom to top. To solve several of these problems, I changed the procedure so that variables are added to X0 and Y0 rather than a constant +1. (See listing 3.) These variables are initialized to 1, but are changed to -1 if the line goes right to left or top to bottom.

The algorithm still needs a way to cope with slopes that have absolute values greater than 1. My solution in those cases is to transpose the axes. That's not as complicated as it sounds, because it means I pretend that the x axis is the y axis and vice versa. When you do that, the slope of the resulting line is always the reciprocal of what it was before, and values greater than 1 become less than 1. To see how this is done, refer to the sample program in listing 4 on page 416.

The subroutine in listing 4 is very flexible. Instead of performing the loop with FOR . . . NEXT statements, it returns each point one at a time to the calling program. I use this routine to plot on a Qume printer/plotter, to move a spaceship or a torpedo on a graphics display grid, and even to draw lines. Each of these applications does something different with the x-y coordinate pairs that the routine returns, but the same routine is used in all of them. The routine returns coordinates and lets the individual main program decide what to do with each pair. Your programs would, perhaps, run faster if you optimized the subroutine for the individual program you use it in. I prefer using modular programming methods,

where a routine like this one can be used in several different programs without change.

When I originally wrote the subroutine in listing 4, I used multiple-statement lines, making it much smaller. I also used more descriptive variable names like DX, AX, SX, etc. The routine has been rewritten in elementary BASIC to make it more transportable. Have fun, and good luck! ■

**Listing 1:** In the simplest form of the DDA algorithm, DX is the difference of the x coordinates of the starting and end points of a simple line; DY is the difference of the y coordinates. The coordinates of the starting point, X0 and Y0, are incremented until they are equal to the coordinates of the end point.

```
FOR I = 1 TO DX
  X0=X0+1
  Y0=Y0+(DY/DX)
NEXT I
```

**Listing 2:** Improved line-drawing algorithms. Listing 2a, which is more easily adapted for graphics hardware, produces only integer values for Y0. Listing 2b is the same procedure with the floating-point calculations completely eliminated.

(2a)

```
R=0.5
SLOPE=DY/DX
FOR I = 1 TO DX
  X0=X0+1
  R=R+SLOPE
  IF R >= 1.0 THEN Y0=Y0+1 : R=R-1.0
  PLOT X0, Y0
NEXT I
```

(2b)

```
R=DX/2
SLOPE=DY
FOR I = 1 TO DX
  X0=X0+1
  R=R+SLOPE
  IF R >= DX THEN Y0=Y0+1 : R=R-DX
  PLOT X0, Y0
NEXT I
```

**Listing 3:** Revision of listing 2 which will draw lines from right to left and top to bottom as well as vice versa.

```
R=DX/2
AX=1
SY=1
IF DX < 0 THEN DX=ABS(DX) : AX=-1
IF DY < 0 THEN DY=ABS(DY) : SY=-1
FOR I = 1 TO DX
  X0=X0+AX
  R=R+DY
  IF R >= DX THEN Y0=Y0+SY : R=R-DX
  PLOT X0, Y0
NEXT I
```

## Programming Quickies

Listing 4: Sample BASIC program that returns the  $x$  and  $y$  coordinate points between given starting and end points. Lines of any slope between  $-1$  and  $1$  can be calculated with this version of the DDA algorithm.

```
10 REM *****
20 REM PROGRAM TO DEMONSTRATE THE LINE SUBROUTINE
30 REM *****
40 PRINT "WHAT IS THE FIRST POINT";
50 INPUT X0,Y0
60 PRINT "WHAT IS THE SECOND POINT";
70 INPUT X1,Y1
80 GOSUB 6000
90 PRINT X0,Y0
100 IF N1>D1 THEN STOP
110 GOSUB 6300
115 PRINT X0,Y0
120 GO TO 100
5974 REM*****
5975 REM LINE DRAWING ROUTINE. THIS ROUTINE RETURNS
5976 REM ALL THE X,Y CO-ORDINATE POINTS BETWEEN
5977 REM TWO POINTS. THE STARTING AND ENDING CO-ORDINATES MUST
5978 REM BE SENT IN THE VARIABLES X0,Y0 AND X1,Y1. TO INITIATE
5979 REM A LINE, YOU MUST GOSUB 6000. TO GET EACH SUCCESSIVE POINT,
5980 REM YOU GOSUB 6300, AND THE NEXT POINT IS RETURNED IN X0,Y0.
5981 REM TO TELL WHEN THE LINE IS FINISHED, YOU
5982 REM MUST CHECK THE VARIABLE N1, IF N1<=D1 THEN THERE ARE
5983 REM STILL MORE POINTS TO GO.
5984 REM
5985 REM VARIABLES USED:
5986 REM X0,Y0,X1,Y1 - PARAMETERS SENT TO THE LINE ROUTINE
5987 REM X0,Y0,N1,D1 - RETURN VALUES AND STATUS
5988 REM D2,D3,S1,S2,A1,A2 - INTERNAL SCRATCH VARIABLES.
5989 REM NONE OF THESE VARIABLES SHOULD BE USED IN YOUR MAIN PROGRAM
5990 REM *****
6000 D1=X1-X0
6010 D2=Y1-Y0
6020 S1=0
6030 S2=1
6040 A1=1
6050 A2=0
6060 IF D1>=0 GO TO 6090
6070 A1=-1
6080 D1=-D1
6090 IF D2>=0 GO TO 6120
6100 D2=-D2
6110 S2=-1
6120 IF D1>=D2 GO TO 6200
6130 N1=D1
6140 D1=D2
6150 D2=N1
6160 S1=A1
6170 A1=0
6180 A2=S2
6190 S2=0
6200 D3=D1/2
6210 N1=1
6220 RETURN
6230 REM *****
6240 REM HERE IS WHERE THE DDA (DIGITAL DIFFERENTIAL ANALYZER)
6250 REM ALGORITHM IS ACTUALLY PERFORMED. EACH GOSUB TO THE ROUTINE
6260 REM INCREMENTS X0,Y0 BY THE CORRECT AMOUNT. WHEN N1>D1 THE LAST
6270 REM POINT HAS ALREADY BEEN RETURNED, AND SUCCESSIVE CALLS WILL
6280 REM EXTRAPOLATE X0,Y0 PAST THE END POINT OF THE LINE.
6290 REM *****
6300 X0=X0+A1
6310 Y0=Y0+A2
6320 D3=D3+D2
6330 N1=N1+1
6340 IF D3<=D1 THEN RETURN
6350 D3=D3-D1
6360 X0=X0+S1
6370 Y0=Y0+S2
6380 RETURN
```

## Word Ujbnmurle

Leonard Gorney, Box 91 RD 5, Clarks Summit PA 18411

Here is a short routine I use on my Radio Shack TRS-80 Model I Level II when I try to solve scrambled word puzzles in a "friendly" game of Scrabble, or the like.

The program accepts the letters you wish to form into an acceptable English word, rearranges the letters in a random fashion, and prints each rearrangement for viewing. This method parallels the situation in which a monkey is given a typewriter. How long will it take the monkey, typing at random, to type an English word? The program plays the part of the monkey.

The user of this short routine must look at each of these

**Listing 1:** This routine in Radio Shack TRS-80 Level II BASIC accepts a string of up to 30 letters and displays them in a randomly rearranged form. Ideally, the user will be able to discern the English word in the jumbled letters.

```
1000 REM WORD UNJUMBLER
      LEN GORNEY
1010 DIM A$(30), B(30)
1020 REM FORCE 32 CHARACTERS/LINE MODE
1030 CLS: PRINT CHR$(23)
1040 PRINT TAB(7); "ENTER YOUR LETTERS": INPUT W$
1050 REM FILL EACH A$ LOCATION WITH ONE LETTER
      FROM W$
1060 FOR J = 1 TO LEN(W$): A$(J) = MID$(W$, J, 1):
      NEXT J
1070 REM A LOCATION IN B WILL BE ZERO IF LETTER NOT
      USED YET OR A -1 IF LETTER USED BEFORE
1080 FOR J = 1 TO LEN(W$): B(J) = 0: NEXT J
1090 CLS: PRINT CHR$(23)
1100 REM GENERATE A RANDOM NUMBER IN THE RANGE 1
      TO LEN(W$) USE THIS NUMBER TO PICK A LETTER
      FROM A$
1110 N = RND(LEN(W$))
1120 IF B(N) = 0 THEN PRINT A$(N): B(N) = 1
1130 REM HAVE ALL THE INPUT LETTERS BEEN
      REARRANGED ?
1140 FOR J = 1 TO LEN(W$): IF B(J) = 0 THEN 1110
1150 NEXT J
1160 REM STALL THE REARRANGED WORD FOR VIEWING
1170 FOR J = 1 TO 1000
1180 NEXT J
1190 GOTO 1080
1200 END
```

rearrangements to see if a valid English word is printed. At times, a valid English word will magically appear on the screen; however, the human eye and brain can, in more cases than not, discern a particularly scrambled string of letters as an English word. This will often be the case, even though many of the letters are not in their proper positions within the word.

As an example of this, look again at the second word of the title of this article. Can you discern what English word is represented by that string of letters? How about this string of letters: ENLIGSH ?

### Permutations

Mathematically, rearranging a given set of letters involves the application of permutations. For example, given the letters GELNSIH, the number of different ways in which those 7 letters can be rearranged to give different rearranged strings is equal to 7! (read 7 factorial) or  $7 \times 6 \times 5 \times 4 \times 3 \times 2 \times 1$  which is equal to 5040 different rearrangements. This program does not use this idea; rather, the input set of letters is rearranged randomly. Usually, a certain rearrangement of the input string will be sufficient for the user to "see" the English word in that set of letters. This assumes that an acceptable English word can be spelled by using those input letters. Otherwise, you will continue to see gibberish on your screen.

### Program Operation

Running the program is rather easy; the only external entry you need to make is to enter the letters you wish to unscramble. Just press each letter key, and when you are finished with the string, press the enter key.

Each rearrangement of those input letters will be displayed on the screen in 32-character-per-line mode. The choice of a maximum of 30 characters for the input set of letters was done so that the entire word would fit on a single line of the screen. Each rearrangement will be frozen on the screen for approximately 2 seconds. When you see a particularly suitable rearrangement, press the *break* key to stop the program. Not being a particularly intelligent monkey, the computer will continue printing rearrangements until it powers down, unless stopped in this way. ■

## Binary-to-BCD Converter Program for the 8080

D M Brockman, 11648 Military Rd S, Seattle WA 98168

Conversion of multiple-precision binary numbers to BCD (binary-coded decimal) for printing or display output is often encountered in assembly-language programming. The algorithm described here makes use of the 8080's DAA (decimal-adjust accumulator) instruction to implement the BCD analogy of a binary shift-left register. With this algorithm, a binary number is converted to packed BCD (2 digits per byte) by shifting the binary number, MSB (most significant bit) first, bit by bit, into the least significant end of the BCD register. (See figure 1.) When the last binary bit has been shifted in, the result is in the BCD register.

To understand how the BCD register operates, consider a conventional binary-shift register. When shifted

left, the numeric content doubles and the carry input (if any) comes in at the least significant end. The same thing happens when the BCD register is "shifted." The numeric doubling is accomplished by adding the BCD register to itself using BCD arithmetic. The carry is brought in by using the ADC (add with carry) instruction for the first "add."

A typical implementation of the algorithm is shown in listing 1 in the form of an 8080 assembly-language listing. Looping constructs have been employed to minimize size. For maximum speed, the loops should be "unrolled." The implementation converts a 32-bit (4-byte) binary number into a 10-digit (5-byte) packed BCD result. The number of bytes converted can be easily changed by altering the looping counters. Note that the number of BCD result bytes required is given by:

Number of BCD bytes = INT(0.5 + 1.204 × (Number of binary bytes))

An advantage of this algorithm is that the conversion time is independent of the size of the number being converted. The sample routine in listing 1 requires 13,944 machine cycles to execute. The results of a typical run of the sample routine are shown in table 1. ■

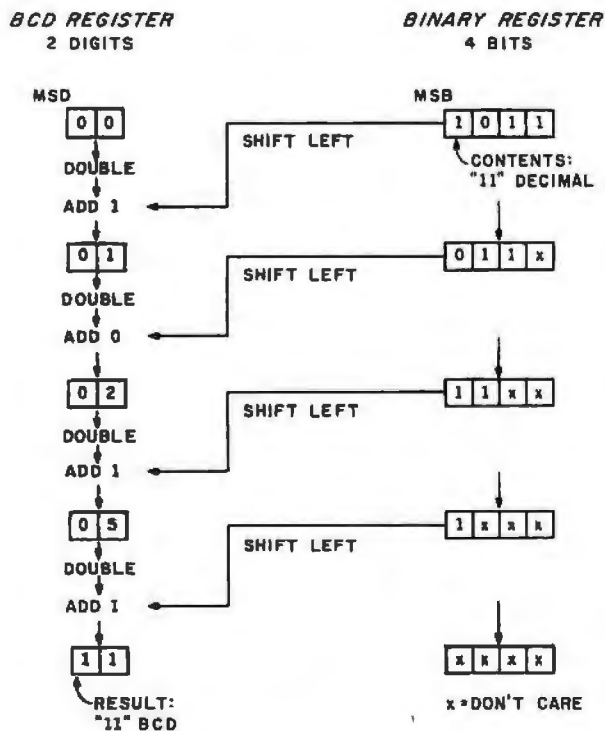

Figure 1: Contents of the BCD and binary registers during the conversion process using the program shown in listing 1.

| Memory Address | Before Run | After Run |
|----------------|------------|-----------|
| BIN:           |            |           |
| 0200           | 3A         | 00        |
| 0201           | F6         | 00        |
| 0202           | 23         | 00        |
| 0203           | 81         | 00        |
| BCD:           |            |           |
| 0204           | XX         | 58        |
| 0205           | XX         | 76        |
| 0206           | XX         | 61        |
| 0207           | XX         | 66        |
| 0208           | XX         | 21        |

Table 1: A sample run of the binary-to-BCD converter program shown in listing 1. All numbers shown are hexadecimal. XX indicates a don't care.



Listing 1: A binary-to-BCD converter program for the Intel 8080 microprocessor.

```

;TITLE "BINARY TO BCD CONVERTER"
;BY D. M. BROCKMAN, 11648 MILITARY RD. SO., SEATTLE, WA 98164
;
;THIS SUBROUTINE CONVERTS THE 32-BIT BINARY NUMBER STORED
; AT 'BIN' TO A 10-DIGIT PACKED BCD NUMBER STORED AT 'BCD.'
; REGISTERS B, C, H, L, AND A ARE USED.
;
;
;DEFINE STORAGE FOR NUMBERS:
;
0200          JKG 200H
0200      BIN:  DS 1          ;LSB BYTE
0201          DS 2
0203          DS 1          ;MSB BYTE
;
0204      BCD:  DS 1          ;LS DIGITS
0205          DS 3
0208          DS 1          ;MS DIGITS
;
;
;INITIALIZE THE BCD RESULT BYTES TO ZERO:
;
0100          ORG 100H
0100      BINBCD: LXI H,BCD      ;POINT AT RESULT
0103      MVI B,5          ;SET LOOP COUNTER
0105      MVI M,0          ;STORE A ZERO
0107      INX H            ;POINT TO NEXT BYTE
0108      DCR B            ;DECREMENT LOOP COUNTER
0109      JNZ ILOOP       ;LOOP IF NOT DONE
;
;INITIALIZE THE BIT COUNTER TO EQUAL THE NUMBER OF
; BINARY BITS TO BE SHIFTED:
;
010C      MVI B,32         ;NUMBER OF BITS TO SHIFT
;
;INITIALIZE FOR A MULTIPLE PRECISION LEFT SHIFT
; OF THE BINARY NUMBER:
;
010E      LXI H,BIN        ;POINT AT NUMBER
0111      MVI C,4          ;NUMBER OF BYTES
0113      XRA A            ;CLEAR THE CARRY
;
;SHIFT THE BINARY NUMBER ONE PLACE LEFT AND LEAVE THE MSB
; IN THE CARRY:
;
0114      MOV A,M          ;GET BYTE
0115      RAL              ;SHIFT LEFT
0116      MOV M,A          ;STORE BYTE
0117      INX H            ;POINT AT NEXT BYTE
0118      DCR C            ;DECREMENT BYTE COUNT
0119      JNZ RLOOP       ;LOOP IF NOT DONE
;
;INITIALIZE TO DOUBLE THE BCD RESULT REGISTER CONTENTS
; BY PERFORMING A MULTIPLE PRECISION BCD ADD:
;
011C      LXI H,BCD        ;POINT AT RESULT
011F      MVI C,5          ;SETUP BYTE COUNTER
;
;DOUBLE THE RESULT BCD FASHION, ADDING IN THE CARRY BIT:
;
0121      MOV A,M          ;GET BYTE
0122      ADC M            ;ADD IT TO ITSELF
0123      DAA              ;BCD CONVERT
0124      MOV M,A          ;RESTORE
0125      INX H            ;POINT AT NEXT BYTE
0126      DCR C            ;DECREMENT BYTE COUNTER
0127      JNZ BLOOP       ;LOOP IF NOT DONE
;
;TEST TO SEE IF ALL BITS HAVE BEEN SHIFTED FROM BINARY
; NUMBER TO THE BCD RESULT. IF NOT, RETURN TO MAIN LOOP.
;
012A      DCR B            ;DECREMENT BIT COUNTER
012B      JNZ CLOOP       ;LOOP IF NOT DONE
012E      RET
;
012F      END

```

A>

# AMAZING VALUES...

HEAD  
CLEANING KIT

**\$24<sup>95</sup>**

FOR 5 1/4" DRIVES

"OTHER  
MYSTERIES"  
VOLUME I

**\$19<sup>95</sup>**

"OTHER  
MYSTERIES"  
VOL. II or VOL. III

**\$29<sup>95</sup>**

VERBATIM  
FD34-8000  
DISKETTES

**\$43<sup>95</sup>**

BOX OF 10  
SS, SS, DD

DISKETTE  
FILE BOX

**\$29<sup>95</sup>**

HOLDS 50-60  
8" DISKS

TRI-STAR  
FLOPPY  
SAVER™  
HUB RING KIT

**\$10<sup>95</sup>**

FOR 5 1/4"  
DISKS

EPSON  
MX-80  
MX-80FT

—PRINTERS—  
CALL FOR  
PRICE

**CABLE**  
**\$24<sup>95</sup>**

CONNECTS EPSON  
PRINTER & TRS-80  
MICRO

DISK DRIVE  
EXTENDER  
CABLE

**\$9<sup>95</sup>**

FOR VISTA, MTI,  
PERTEC, PERCOM  
& OTHERS

VERBATIM  
DATALIFE  
DISKETTES

**\$26<sup>95</sup>**

BOX OF 10  
SS, SS, 5 1/4"

PLAIN JANET™  
*Gold 5 1/4"*  
DISKETTES

**\$25<sup>95</sup>**

SS, SS, DD  
HUB RING

PLAIN JANET™  
DISKETTES

**\$21<sup>95</sup>**

BOX OF 10  
SS, SS, 5 1/4"

DISKETTE  
FILE BOX

**\$24<sup>95</sup>**

HOLDS 50-60  
5 1/4" DISKS

FROM

**M** **ETATRONICS**  
CORPORATION

RETAIL STORE  
22297 EUCLID AVENUE  
EUCLID, OHIO 44117  
(EAST 222nd & EUCLID AVE.)

MOST ORDERS  
SHIPPED WITHIN  
ONE BUSINESS DAY

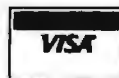

TO ORDER  
CALL TOLL FREE  
1-800-321-9390  
IN OHIO, call  
(216) 289-1210 (COLLECT)

OFFICES  
26111 BRUSH AVENUE  
EUCLID, OHIO 44132  
(SEND MAIL ORDERS HERE)

TRS-80 is a trademark of the  
Radio Shack Division of Tandy  
Corporation. PLAIN JANE is a  
Trademark of Meta Technologies  
Corporation.

PRICES IN EFFECT  
August 1, 1981 THRU  
August 31, 1981.

Prices, Specifications,  
and Offerings subject to change  
without notice.

•Add \$3.00 for shipping & handling.  
•\$3.00 EXTRA for C.O.D.  
•Ohio residents add 6 1/2 % sales  
tax.

© 1981 by Metatronics Corp.

# What's New?

## PERIPHERALS



### Graphics for Okidata Printers

The PF/2A print formatter uses the plotting capability of the Okidata SL125 and SL250 printers to create bar codes, variable-size and aspect-ratio characters, product and corporate logos, variable-forms layouts, banners, and signs. The formatter permits normal matrix-character printing as well. The PF/2A has a suggested retail price of \$2295. Contact Technical Analysis Corporation, 120 W Wieuca Rd NE, Atlanta GA 30042, (404) 252-1045.

Circle 500 on inquiry card.

### Phonetic Speech Kit from Votrax

A sample voice-synthesizer evaluation kit is available from Votrax. The Speech PAC (Phoneme Access Controller) is a circuit board made up of a speech integrated circuit, external controller, memory, and an on-board audio amplifier. The unit comes with 250 words and phrases stored in memory that can be intermixed with phoneme sequences to provide an unlimited vocabulary. Priced at \$275, the Speech PAC can be expanded and configured into microcomputer systems.

For complete details, contact Votrax, 500 Stephenson Hwy, Troy MI 48084, (800) 521-1350; in Michigan (313) 588-0341.

Circle 501 on inquiry card.

### Hard Copy for \$299

Microtek Inc has announced a \$299 dot-matrix printer. The Bytewriter-1 features 80 columns and accepts single-sheet or roll paper up to 8½ inches wide. It prints at 60 lpm (lines per minute) using a 7 by 7 matrix. The interface is similar to Centronics's and has been designed to operate with the Apple II, Atari 400 and 800, and all TRS-80 microcomputers. Contact Microtek Inc, 9514 Chesapeake Dr, San Diego CA 92123, (714) 278-0633.

Circle 502 on inquiry card.

### Amtek's Universal Terminal

The ABM 80 video terminal can replace most commercial terminals. It features a 12-inch high-resolution green screen; numeric and special-function keypad; editing, block, and monitor modes; protective and unprotective fields; foreground and background; programmable key click; and margin bell. It includes 7 by 9 dot matrix uppercase and 7 by 11 lowercase. Switch-selectable emulation of Hazeltine 1500, ADDS 25, ADM-3A, and VT-52, with block mode and advanced editing features, is included in this \$800 terminal. Contact Amtek Business Machines Inc, 2255H Martin Ave, Santa Clara CA 95050, (408) 727-1510.

Circle 503 on inquiry card.

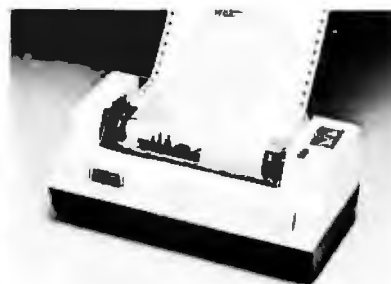

### Single-Hammer Printer

The GP-80M printer uses a single print hammer in a 5 by 7 dot matrix. It can print graphics and alphanumerics. The GP-80M uses a rotating platen with protruding splines positioned behind the paper. The image is created by multiple hammer strikes as the printhead moves across the paper in front of the platen. Features include upper- and lowercase character sets, up to 80 columns with 12 characters per inch, tractor feed, three-copy reproduction, 12 W power consumption, and a Centronics parallel interface. RS-232C and other common interfaces are optional.

The graphics capability provides more than 60 dots per inch. Dot graphics and alphanumerics can be mixed under software control. Print speed is 30 cps (characters per second). The price is \$399 from Axiom, 1014 Griswold Ave, San Fernando CA 91340, (213) 365-9521.

Circle 504 on inquiry card.

### Where Do New Products Items Come From?

The information printed in the new products pages of BYTE is obtained from "new product" or "press release" copy sent by the promoters of new products. If in our judgment the information might be of interest to the personal computing experimenters and homebrewers who read BYTE, we print it in some form. We openly solicit releases and photos from manufacturers and suppliers to this marketplace. The information is printed more or less as a first-in first-out queue, subject to occasional priority modifications. While we would not knowingly print untrue or inaccurate data, or data from unreliable companies, our capacity to evaluate the products and companies appearing in the "What's New?" feature is necessarily limited. We therefore cannot be responsible for product quality or company performance.

# What's New?

## PERIPHERALS

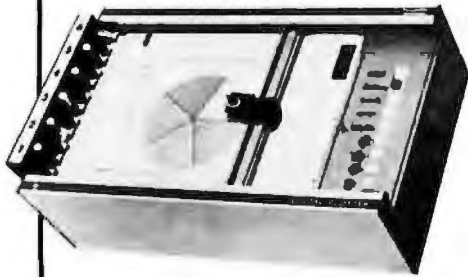

### Six-Pen Option for Hi-Plot Plotters

A six-pen plotter option is available for the Houston Instrument DMP plotters. The pens come in black, red, blue, green, violet, orange, and optional brown. They work under program control and can be retrofitted into any of the Hi-Plot plotters. The \$395 pen option can be installed by users except on the DMP-5, -6, and -7, which can be connected at the factory for \$100. A program for generating graphs and charts, Hlgraph-1, is available. For details, contact Houston Instrument, 1 Houston Sq, Austin TX 78753, (512) 837-2820. **Circle 505 on inquiry card.**

### A Clock for the Apple II

Time II is a real-time clock and calendar for the Apple II. It measures time in hours, minutes, and seconds, and provides dates with year, month, date, day of week, and leap-year information. The board features a 24-hour military format or a normal 12-hour format. Time II permits foreground and background operation of two programs simultaneously, so users can call up schedules, time events, and date listings. An on-board backup battery provides more than four months of power-off operation.

Time II is available for \$150 from Applied Engineering. POB 470301, Dallas TX 75247, (214) 492-2027.

**Circle 506 on inquiry card.**

### Smartmodem from Hayes

The Smartmodem is an FCC (Federal Communications Commission) approved direct-connect device. It has an RS-232C port and can be program-controlled in any language by ASCII (American Standard Code for Information Interchange) character strings. The modem analyzes and executes commands and can send codes in English words or decimal digits. The Smartmodem has auto-dial and auto-answer capabilities, both of which can be combined within a command.

The Hayes Stack Smartmodem can be connected to any kind of telephone. An audio monitor can alert users to wrong numbers and busy signals. If a busy signal is encountered, the Smartmodem redials the number at any time. Operation can be in full- or half-duplex with a data rate of 0 to 300 bps (bits per second). One command selects the dialing speed, escape-code characters, and number of rings to answer on. The suggested price for the modem is \$279, including a power pack, a cable, and a manual. For details, contact Hayes Microcomputer Products Inc, 5835 Peachtree Corners E, Norcross GA 30092, (404) 449-8791. **Circle 507 on inquiry card.**

### Disk Doubler

The Disk Doubler converts a single-sided 5-inch floppy disk into a double-sided floppy disk. Using the kit's tools, you can measure, mark, and punch new openings in the disk's protective sheath. The punch can't damage the disk. The Disk Doubler costs \$6.95 and is available from the Beals Agency, 4141 Fairmount Ave, San Diego CA 92105, (714) 284-1145.

**Circle 508 on inquiry card.**

### Speed-Up Board for the TRS-80

Simutek's Micro-Speed board is for the TRS-80 Model I Level II computer. The Micro-Speed increases the microprocessor clock rate to 2.66 MHz, which is almost 50% faster than the standard rate. The unit divides the system-clock signal differently to make the computer operate at this speed. Operation can be switched back and forth between regular and high speeds. The board is not software-dependent. Micro-Speed returns the computer to normal speed during access of the floppy disk or cassette; it returns to high speed upon completion of the I/O (input/output) operation. The only drawback to the device is that the Radio Shack warranty is void after installation of the unit, which requires some soldering.

The board, switch, and wires cost \$29.95. Contact Simutek, POB 13687, Tucson AZ 85732. **Circle 509 on inquiry card.**

### Microcomputer Modem

The 103J-L is a 300 bps (bits per second) modem that costs less than \$200. It operates over all rotary-telephone lines, even those that cannot be used by line-powered units. Data or talk modes are switch-selectable, and the answer and originate modes are automatic. An indicator shows transmit- and receive-data activity, and a carrier-detect indicator shows a call is established. For installation, the plug from the telephone connects to a jack in the 103J-L's rear panel. A connector from the modem accesses the telephone line.

For complete details, contact General DataComm Industries Inc, 1 Kennedy Ave, Danbury CT 06810, (203) 797-0711.

**Circle 510 on inquiry card.**

# What's New?

## PERIPHERALS

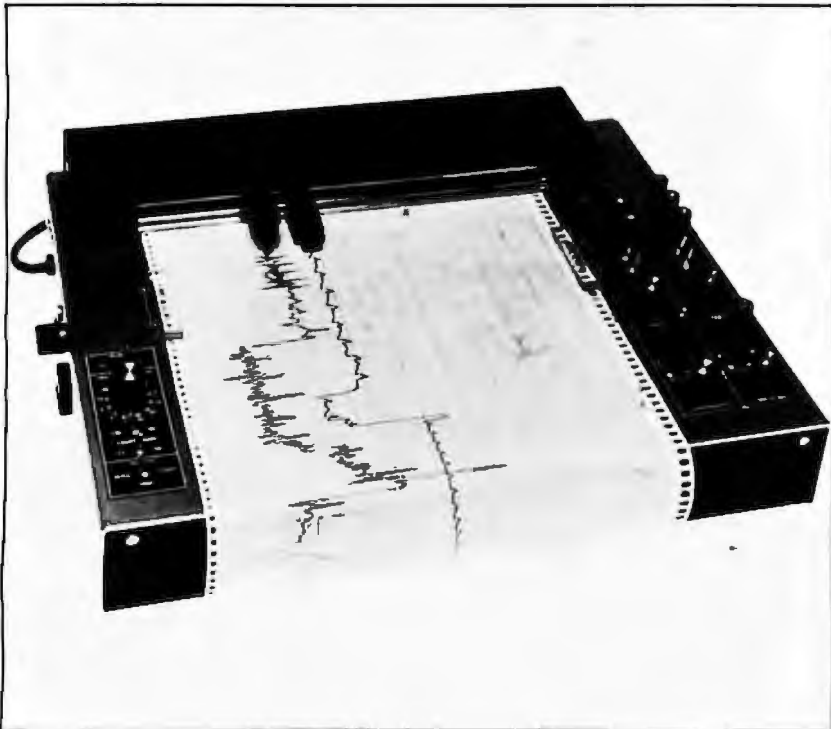

### Strip-Chart Recorders

The Series MR English/Metric strip-chart recorders in single- and dual-pen versions provide speeds of 0.05 to 20 inches per minute and per hour and 1 to 50 cm per minute and per hour. Other features of the Series MR include fifteen calibrated input ranges from 1 mV to 50 V, input on/off and positive or negative polarity reversal switches, manual chart rewind/advance, electric and remote pen lift, and automatic shutdown for over-range signals. The single-pen recorder is \$810 and the dual-pen is \$1180. Contact Pedersen Instruments, 2772 Camino Diablo, Walnut Creek CA 94596, (415) 937-3630.

Circle 511 on inquiry card.

### Interface for Analytical Instruments

SmartFact connects to the analog output of any analytical instrument and uses an RS-232C format for transmission. Two instruments can be connected simultaneously. The instrument's output is sampled at 0.1 or 1 second intervals and transmitted at one of six selectable data rates. The analog signals are converted into 16-bit words. X and Y signals from an instrument can be monitored and digitized.

Applications include peak picking in UV or AA quantitative analysis, calculation of retention time in gas or liquid chromatography, preparing peak tables for qualitative infrared comparisons, logging sample weights from an analytical balance, or determining the endpoint of an automatic titration. For information, contact Analytical Computers, POB 285, Elmhurst IL 60126.

Circle 512 on inquiry card.

### Super Keyboard

The MFJ Model MFJ-496 keyboard sends CW (continuous wave), baudot, and ASCII (American Standard Code for Information Interchange) with a 256-character buffer, 256-character programmable message memory, four automatic messages, two random-code practice modes, data-rate and buffer metering, backspace delete, buffer-memory hold, automatic serial numbering, repeat/delay, and a paddle input port. One or two keystroke combinations execute all commands. Five-level baudot is transmitted at 60 words per minute. In the ASCII mode, transmission speed is 110 bps (bits per second).

The MFJ-496 operates on 9 to 12 V DC. It costs \$339.95 and is available from MFJ Enterprises Inc, POB 494, Mississippi State MS 39762, (800) 647-1800; in Mississippi (601) 323-5869.

Circle 513 on inquiry card.

### Voice Synthesis for Heath Computers

The V-8 Voice Synthesizer for Heath H-8 and H-89 computers uses the Votrax VSL Phoneme Module, which, under program control, adds the capability of inflection or range to synthesized speech. Software for the V-8 includes a device driver and several English-speaking programs. The V-8 can be used with any computer having an available parallel port. Eight data and two handshaking lines are required.

The V-8 Voice Synthesizer costs \$149, which does not include the VSL module. A sample voice cassette is available for \$5.

For additional details, contact M.I.-8, 822 E County Rd 30, Fort Collins CO 80525, (303) 669-4116. Votrax can be contacted at 500 Stephenson Hwy, Troy MI 48084, (800) 521-1350; in Michigan (313) 588-0341.

Circle 514 on inquiry card.

# What's New?

## SOFTWARE

### Ultrasort Gives CP/M Users Fast Sorts

Ultrasort II is an 8080 and Z80 machine-language program that allows CP/M and CBASIC2 users to sort, merge, or select records from data files, or to find the number of logical records in a file. It can be used as a stand-alone utility or as a subroutine called from CBASIC2. Ultrasort II sorts on up to five keys, and fields can have a fixed or a variable length. Strings can optionally be floated as numeric fields; numeric fields are automatically floated. A select capability permits either omitting or including records that are less than, equal to, or greater than up to four independent select keys. Ultrasort II is available from Computer Control Systems Inc, 298 21st Ter SE, Largo FL 33541.

Circle 516 on Inquiry card.

### Letter Perfect for the Atari

Letter Perfect is a word-processing package for the Atari 800. It features proportional spacing, page numbering, headers, footers, and underlining. Embedded commands in text for expanded, normal, and condensed print are possible. The program is menu-driven. The user can change drive numbers; edit, load, save, merge, print, lock and unlock, and delete files; format disks; and perform a data-base merge for mailings. Printing and screen formats are programmable. Text block moves, scrolling forward and backward, scrolling speed, search, tabbing, and character and line insertion and deletion are among its features. Letter Perfect is available for \$150 from LJK Enterprise Inc, POB 10827, St Louis MO 63129, (314) 846-6124.

Circle 517 on Inquiry card.

### Tiny Pascal Plus+ for PET and Apple II

Tiny Pascal Plus+ is an enhanced version of Tiny Pascal with support for graphics. The package runs on 32 K-byte PET and Apple microcomputers. This Pascal includes a line editor, compiler, interpreter, and numerous structured programming commands. GRAPHICS, PLOT, POINT, TEXT, INKEY, ABS, and SOR are among the other command functions.

Tiny Pascal for the PET supports double-density plotting, giving 80 by 50 plot positions. The Apple version supports low- and high-resolution graphics. Tiny Pascal on floppy disk costs \$50. The PET cassette version costs \$55. Nongraphics versions are \$35 on disk and \$40 on cassette. Contact Abacus Software, POB 7211, Grand Rapids MI 49510.

Circle 518 on Inquiry card.

### Applegraph Your Business Charts

Applegraph is a software package for general-purpose data plotting in a variety of formats for the business, professional, and research decision maker. The program yields high-resolution, multi-color graphics for video display and hard-copy output. Display formats include pie charts, bar graphs, area plots, points, and solid or dashed lines, produced in any combination of overlays. Applegraph has simple commands that can be entered interactively or in advance. Data can be entered directly or supplied from other programs. Applegraph is available for \$200 from Business & Professional Software Inc, POB 11, Kendall Square Branch, 238 Main St, Cambridge MA 02142, (617) 491-3377.

Circle 519 on Inquiry card.

### APL for the Apple

APL/V80 is now available for the Apple II. It requires the Microsoft SoftCard, CP/M, and a 24 by 80 video board. Another version is available that doesn't require the video card. APL/V80 includes APL arithmetic functions, Boolean and relational functions, selection and structural functions, and nine general functions. The language has disk-based workspace and copy-object libraries, and supports arrays of up to eight dimensions. The software provides dynamic execution of system commands, canonical representation and function fix, and can use latent expression. APL/V80 allows booting directly into an application program from system power-on. A keyed ISAM (indexed-sequential access method) package, a text editor, and a check-management package are available as options for \$50 each.

APL/V80 costs \$500. It is available from Vanguard Systems Corporation, 6901 Blanco, San Antonio TX 78216, (512) 340-1978.

Circle 520 on Inquiry card.

### FORTH for SwTPC Computers

FORTH is available for SwTPC computers with Percom disk drives. This FORTH, based on fig-FORTH, comes on a single-density 5-inch floppy disk and requires 16 K bytes of memory and a Percom disk drive with Mini-DOS. The disk contains the object code, a text editor, and assorted utilities. The manual contains a description of FORTH words, a tutorial, an explanation of the screen editor, and more. The package sells for \$24.95 from Greene Software, 6169 Fawn Meadow, Victor NY 14564.

Circle 521 on Inquiry card.

# What's New?

## SOFTWARE

### Apple II Graphics System

The 3-D Graphics module is designed for 48 K-byte Apple IIs. It features a drawing module for a high-resolution screen using paddles or a joystick. The 3-D graphics module helps create, view, and manipulate 3-D objects. Color figures can be viewed simultaneously, and each figure can be individually manipulated. An upper- and lowercase character set is provided, along with a set twice as tall and wide. A character editor allows programmers to create and edit large and small fonts. A text module places text anywhere on the screen. Programming instructions are included for using pictures, shape tables, and machine-language subroutines in other programs, along with the file structure for 3-D files.

Typing can be set to overlay, reverse, or erase the background. Editing functions can move points and lines, change colors, and enter, change, and delete coordinates. A shrink utility shrinks pictures to one-quarter to one-sixty-fourth of original size.

Options include a filing routine with more than 100 blended colors, a paintbrush mode that turns the cursor into one of nine different size and shape brushes, and a shape mode that rotates, scales, and plots shapes from a shape table.

The price for this package is \$59.95. It requires a 48 K-byte Apple II and Applesoft firmware or the language system. Contact Micro Co-Op, POB 432, West Chicago IL 60185, (312) 231-0912.

Circle 522 on inquiry card.

### Two- and Three-Dimensional Hard-Copy Graphics Programs

Curve is a two-dimensional graphics package that provides users with the capability to plot Cartesian, parametric, and polar equations as well as data points. Full axes labeling and scaling are provided for linear or logarithmic plotting. Shaded-bar graphs are also included. The program works on Houston Instrument's Hi-Plot plotters and Watanabe plotters. It runs on Apple, TRS-80, PET, and North Star computers.

Another member of the Curve family is Three-D. It can plot surface functions and data or space curves and rotate them a complete 360° with scaled axes and labeling. Hidden lines are optional. The programs cost \$199 each. For more information, contact West Coast Consultants, 1775 Lincoln Blvd, Tracy CA 95376, (209) 835-1780.

Circle 524 on inquiry card.

### Collection of CP/M Programs

The CP/MUG (CP/M Users Group) has compiled more than 1000 programs for CP/M systems. On 40 floppy disks, these programs are available for a small charge.

CPM/UG.DB is a data base containing references to all the programs on these disks. Each program or collection is referenced by key words. The data base contains references to 22 assemblers and disassemblers, 138 games, 14 versions of Star-trek, 35 file-maintenance programs, and 22 languages.

CPM/UG.DB is supplied with Information Master, a data-base program from Island Cybernetics, on single-density 5- or 8-inch disks. The program costs \$20, or \$15 when ordered with Information Master at \$37.50 from ELLIAM Associates, 24000 Bessemer St, Woodland Hills CA 91367.

Circle 525 on inquiry card.

### C for Cromemco Systems

Cromemco has made the C programming language available for use on its microcomputers. C is a general-purpose language that features economy of expression, modern control-flow and data structures, and many operators. C combines the features of assembly languages with the structured-programming techniques available in higher-level languages. It is useful for writing operating systems, language systems, utilities and input/output drivers, communication software, data-base-management systems, file-management software, and fast graphics software.

C operates under Cromemco's Cromix operating system. It produces relocatable code that can be linked with other languages. It is available on 5- and 8-inch floppy disks for \$595. For additional information, contact Cromemco Inc, 280 Bernardo Ave, Mountain View CA 94043, (415) 964-7400.

Circle 523 on inquiry card.

### Data-Base System for Microcomputers

VIM (versatile information manager) is a data-base management system that aids in organizing and retrieving information. VIM can be used in keeping personnel records, inventory, mailing lists, stock transactions, property lists, or it can be used for cataloging items. VIM runs on the TRS-80 Model I and requires a minimum of 32 K bytes of programmable memory, an expansion interface, and one or more disk drives. It also requires a TRSDOS 2.2 or NEWDOS operating system.

The price for the three modules that comprise the entire package is \$99.95. Contact Microcosm Inc, POB 2034, Dearborn MI 48123.

Circle 526 on inquiry card.

# What's New?

## SOFTWARE

### Software Tools for Pascal Programmers

The Screen Handler program includes a program to create a file of prompts; a program for adding, changing, deleting, and listing prompts; a test file to include with user programs; and error checking. You can add, change, delete, or display data on a video display. It costs \$75.

The Output Formatter has tab functions, automatic page and line counters during program execution, and top-of-form routines. It allows right, left, or center justification of data to be printed and handles printing of strings, integer, and log-integer variables. The Output Formatter costs \$37.50.

The Forms Generator includes the Output Formatter and additional software for redesigning reports without programming. The user can choose any number of items from a data list and specify the column and row where they are to be printed. This \$49.50 program is useful for insurance claims, checks, invoices, and other forms.

Source code for these programs is available on Apple-compatible or 8-inch floppy disks in UCSD Pascal or Pascal/M. Contact HDP Inc, 222 E Anapamu St, Santa Barbara CA 93101, (805) 965-4477.

Circle 527 on Inquiry card.

### TRS-80 Spelling Checker

Hexspell is compatible with most of the word-processing programs available for the TRS-80. Hexspell checks words in text files against its 29,000-word vocabulary, while displaying the text for a manual proofreading. Erroneous words are shown and can be immediately replaced. The replacement word is instantly rechecked. A single keystroke teaches Hexspell a new word. Hexspell requires a 48 K-byte TRS-80 Model I with two disk drives. The program is available for \$69 from Hexagon Systems, POB 397, Station A, Vancouver, British Columbia, V6C 2N2, Canada, (604) 682-7646.

Circle 528 on Inquiry card.

### SB/E Version 4 for the SuperBrain

SB/E version 4 is a firmware and software set enhancing CP/M on the Intertec SuperBrain. Disk capacity is increased 16% and the track-to-track step rate is five times faster. With the new version, the spindle motor can be shut off when the disks are not being accessed.

SB/E Version 4 features the capability to program 35 keys, buffered I/O (input/output) on either RS-232C port, programmable handshaking modes, and automatic repeat on all keys. A real-time clock is included.

SB/E version 4 is available for standard and quad-density SuperBrains, for DOS versions 3.0 or later. The price is \$195.

For additional information, contact IE Systems Inc, 98 Main St, POB 305, Newmarket NH 03857, (603) 659-5891.

Circle 529 on Inquiry card.

### Dow Jones Service for TRS-80

Owners of TRS-80 microcomputers and Videotex equipment can now access information services from the Dow Jones Corporation. The service's data base contains current and past news stories from the Dow Jones News Service, The Wall Street Journal, and Barron's National Business and Financial Weekly (all Dow Jones Company Inc publications). The service includes price quotations on more than 6000 stocks and other securities and offers access to revenues, earnings, dividends, price-earnings ratios, and stock-price

performance on 3200 companies and 180 industries.

The package is designed for the Models I, II, III, the Color Computer, and the Videotex terminal. If you purchase the Videotex software (\$29.95), terminal (\$399), and terminal software (\$19.95), you can receive one hour of the Dow Jones service free. Previous purchasers of Radio Shack's old Videotex package are also entitled to one free hour. This package is available from Radio Shack Computer Centers. Contact Radio Shack, 1800 One Tandy Ctr, Fort Worth TX 76102, (817) 390-3568.

Circle 530 on Inquiry card.

### Pascal Programmer

The Pascal Programmer provides development modules for those knowledgeable in UCSD Pascal. Designed to lessen coding, testing, and debugging, the program provides source listings, examples, ideas and instructions for modifications, and all needed operating instructions.

It contains two floppy disks with source code, library units, and demonstration and utility programs. The Pascal Programmer costs \$90 from the Denver Software Company, 36 Steele St, Suite 19, Denver CO 80206, (303) 321-4551.

Circle 531 on Inquiry card.



### TTL

|      |        |       |        |
|------|--------|-------|--------|
| 7400 | 2/.85  | 7490  | .85    |
| 7402 | 2/.85  | 7493  | .85    |
| 7404 | 2/.85  | 74100 | 2.25   |
| 7406 | 2/1.19 | 74109 | 2/1.19 |
| 7407 | 2/1.19 | 74121 | .69    |
| 7408 | 2/.89  | 74123 | .99    |
| 7410 | 2/.85  | 74150 | 1.95   |
| 7414 | .99    | 74154 | 1.95   |
| 7417 | 2/1.10 | 74157 | .99    |
| 7420 | 2/.85  | 74161 | 1.19   |
| 7447 | 1.19   | 74164 | 1.59   |
| 7474 | .69    | 74174 | 1.59   |
| 7475 | .79    | 74175 | 1.49   |
| 7476 | .69    | 74192 | 1.19   |
| 7485 | 1.19   | 74193 | 1.19   |
| 7486 | 2/1.19 | 74367 | .99    |
| 7489 | 2.99   | 74393 | 1.95   |

### GRAB BAGS

|                          |      |                           |      |
|--------------------------|------|---------------------------|------|
| GB100 Cer. Caps. (100)   | 2.95 | GB123 Heat Sinks (30)     | 3.95 |
| GB101 Mylar Caps. (60)   | 4.95 | GB127 Transistors (100)   | 3.95 |
| GB102 Electrolytics (60) | 4.95 | GB137 Chokes (50)         | 3.95 |
| GB103 Tantalums (40)     | 4.95 | GB139 Term. Strips (40)   | 3.95 |
| GB106 TTL IC's (50)      | 4.95 | GB140 Sprc/Stdff (150)    | 2.95 |
| GB110 Asst. LEDs (100)   | 5.95 | GB141 Washers (200)       | 2.95 |
| GB113 Trimmers (30)      | 4.95 | GB145 Lugs (100)          | 2.95 |
| GB116 1/4w Resist. (200) | 2.95 | GB154 1/2w Resist. (100)  | 2.95 |
| GB117 1/2w Resist. (200) | 2.95 | GB162 7-Seg. Dsplys. (50) | 5.95 |
| GB120 Slide Switch (25)  | 3.95 | GB173 3/8" Pots. (100)    | 5.95 |

### LS Schottky

|        |      |         |      |
|--------|------|---------|------|
| 74LS00 | .55  | 74LS109 | .79  |
| 74LS02 | .55  | 74LS123 | 1.95 |
| 74LS04 | .69  | 74LS138 | 1.49 |
| 74LS08 | .55  | 74LS139 | 1.49 |
| 74LS10 | .55  | 74LS154 | 2.49 |
| 74LS14 | 1.09 | 74LS157 | 1.49 |
| 74LS30 | .55  | 74LS161 | 1.79 |
| 74LS32 | .69  | 74LS174 | 1.79 |
| 74LS38 | .69  | 74LS175 | 1.79 |
| 74LS42 | 1.49 | 74LS192 | 1.89 |
| 74LS47 | 1.49 | 74LS193 | 1.89 |
| 74LS48 | 1.79 | 74LS221 | 1.95 |
| 74LS73 | .79  | 74LS244 | 2.49 |
| 74LS74 | .79  | 74LS245 | 3.49 |
| 74LS75 | .99  | 74LS367 | 1.29 |
| 74LS85 | 1.95 | 74LS374 | 2.49 |
| 74LS90 | 1.09 | 81LS97  | 2.49 |

### POTENTIOMETERS

**2 Watt @ 70°C**  
7/8" Slotted Shaft  
Linear Taper

**3/4 Watt @ 70°C**  
15 Turn Pot.  
Linear Taper

|       |     |      |      |      |      |
|-------|-----|------|------|------|------|
| 1K    | 5K  | 10K  | 100Ω | 500Ω | 1K   |
| 25K   | 50K | 100K | 5K   | 10K  | 50K  |
| 1 Meg |     |      | 100K | 500K | 1Meg |

CMU .. \$2.95      830P .. \$1.79

### NEW! JE215 Adjustable Dual Power Supply

General Description: The JE215 is a Dual Power Supply with independent adjustable positive and negative output voltages. A separate adjustment for each of the supplies provides the user unlimited applications for IC current voltage requirements. The supply can also be used as a general all-purpose variable power supply.

**FEATURES:**

- Adjustable regulated power supplies, pos. and neg. 1.2VDC to 15VDC.
- Power Output (each supply): 5VDC @ 500mA, 10VDC @ 750mA, 12VDC @ 500mA, and 15VDC @ 175mA.
- Two, 3-terminal adj. IC regulators with thermal overload protection.
- Heat sink regulator cooling
- LED "on" indicator
- Printed Board Construction
- 120VAC input
- Size: 3-1/2" w x 5-1/16" L x 2" H

JE215 Adj. Dual Power Supply Kit (as shown) .. \$24.95

(Picture not shown but similar in construction to above)  
JE200 Reg. Power Supply Kit (5VDC, 1 amp) .. \$14.95  
JE205 Adapter Brd. (to JE200) ±5, 9 & 12V .. \$12.95  
JE210 Var. Pwr. Sply. Kit, 5-15VDC, to 1.5amp .. \$19.95

### SOCKETS

|             |        |                       |      |
|-------------|--------|-----------------------|------|
| Low Profile |        | Wire Wrap             |      |
| 8 pin LP    | 2/.59  | 14 pin WW tin         | .75  |
| 14 pin LP   | 2/.69  | 16 pin WW gold        | 1.09 |
| 16 pin LP   | 2/.79  | 16 pin WW tin         | .79  |
| 18 pin LP   | 2/.89  | 16 pin WW gold        | 1.19 |
| 20 pin LP   | 2/.99  | 24 pin WW gold        | 1.69 |
| 22 pin LP   | 2/1.09 | 40 pin WW gold        | 2.75 |
| 24 pin LP   | .79    | 14 p. plug/cover      | 1.29 |
| 28 pin LP   | .82    | 16 p. plug/cover      | 1.39 |
| 38 pin LP   | .99    | 24 p. plug/cover      | 1.95 |
| 40 pin LP   | 1.19   | Also, The Moitek Line |      |

### CMOS

|      |      |      |      |
|------|------|------|------|
| 4000 | .69  | 4030 | .79  |
| 4001 | .69  | 4040 | 1.95 |
| 4002 | .69  | 4044 | 1.39 |
| 4006 | 1.95 | 4046 | 2.49 |
| 4009 | .89  | 4047 | 2.75 |
| 4010 | .85  | 4049 | .89  |
| 4011 | .69  | 4050 | .89  |
| 4013 | .85  | 4051 | 1.95 |
| 4016 | .85  | 4056 | 1.19 |
| 4017 | 1.49 | 4059 | .79  |
| 4018 | 1.49 | 4060 | .79  |
| 4020 | 2.19 | 4071 | .79  |
| 4023 | .49  | 4081 | .69  |
| 4024 | 1.29 | 4093 | 1.19 |
| 4027 | .89  | 4511 | 1.95 |

### DIODES & TRANSISTORS

|        |        |         |        |
|--------|--------|---------|--------|
| 1N751  | 2/.59  | 2N2219A | 2/1.19 |
| 1N757  | 2/.59  | 2N2222A | 2/.89  |
| 1N1188 | 2.69   | 2N2907A | 2/.89  |
| 1N3600 | 5/.99  | 2N3055  | .99    |
| 1N4001 | 4/.59  | 2N3774  | 2.25   |
| 1N4004 | 4/.69  | 2N3902  | 2/.69  |
| 1N4007 | 4/.79  | 2N3906  | 2/.69  |
| 1N4148 | 10/.99 | 2N4401  | 2/.79  |
| 1N4733 | 2/.69  | 2N4403  | 2/.79  |
| 1N4734 | 2/.69  | 2N5129  | 2/.69  |
| 1N4735 | 2/.69  | 2N5139  | 2/.69  |
| 1N4742 | 2/.69  | 2N5210  | 2/.79  |
| 1N4744 | 2/.69  | 2N5951  | 2/1.29 |

### CONNECTORS

|          |                       |      |
|----------|-----------------------|------|
| DB25P    | D-Subminiature Plug   | 3.95 |
| DB25S    | D-Subminiature Socket | 4.95 |
| DB51226  | Cover for DB25P/S     | 2.25 |
| 22/44SE  | P.C. Edge             | 2.95 |
| UG88/U   | BNC Plug              | 2.19 |
| UG89/U   | BNC Jack              | 3.95 |
| UG175/U  | UHF Adapter           | .59  |
| SO239    | UHF Panel Recp.       | 1.49 |
| PL258    | UHF Adapter           | 1.95 |
| PL259    | UHF Plug              | 1.95 |
| UG260/U  | BNC Plug              | 2.39 |
| UG1094/U | BNC Bulkhead Recp.    | 1.49 |

### DESK TOP ENCLOSURES

DTE-8 (Pictured) .. \$31.95  
DTE-11 (Pictured) .. \$34.95  
DTE-14 .. \$36.95  
DTE-HK (Case for JE600) .. \$47.95  
DTE-AK (Case for JE610) (Pictured) .. \$52.95

### CAPACITORS

|                 |        |              |       |
|-----------------|--------|--------------|-------|
| Dipped Tantalum |        | ELECTROLYTIC |       |
| .1mf @ 35V      | 2/.89  | 1mf @ 50V    | 3/.69 |
| .47mf @ 35V     | 2/.89  | 4.7mf @ 50V  | 2/.69 |
| 1mf @ 35V       | 2/.89  | 10mf @ 50V   | 2/.69 |
| 2.2mf @ 25V     | 2/1.09 | 22mf @ 50V   | 2/.79 |
| 3.3mf @ 25V     | 2/1.19 | 47mf @ 50V   | 2/.89 |
| 4.7mf @ 25V     | 2/1.39 | 100mf @ 50V  | .59   |
| 10mf @ 25V      | 1.19   | 220mf @ 50V  | .69   |
| 33mf @ 25V      | 3.95   | 1000mf @ 25V | 1.19  |
|                 |        | 2200mf @ 16V | 1.39  |

|            |        |             |       |
|------------|--------|-------------|-------|
| 100V MYLAR |        | 50V CERAMIC |       |
| .001-.01mf | 4/.79  | 10pf-.022mf | 4/.59 |
| .022mf     | 4/.89  | .047mf      | 4/.69 |
| .047mf     | 4/.99  | .1mf        | 4/.79 |
| .1mf       | 4/1.19 |             |       |
| .22mf      | 4/1.29 |             |       |

### LINEAR

|          |      |         |      |
|----------|------|---------|------|
| LM301N   | .59  | LM7805T | 1.75 |
| LM305H   | 1.39 | LM7812T | 1.75 |
| LM307N   | .75  | LM7815T | 1.75 |
| LM308N   | 1.19 | LM380N  | 1.49 |
| LM309K   | 2.25 | LM384N  | 2.49 |
| LM310N   | 2.69 | LM555N  | .69  |
| LM311N   | 1.49 | LM556N  | 1.49 |
| LM317T   | 2.29 | LM565N  | 1.95 |
| LM318N   | 2.95 | LM566N  | 1.95 |
| LM319N   | 2.95 | LM567N  | 1.79 |
| LM320K-S | 2.25 | LM723N  | .79  |
| LM7905T  | 1.75 | LM741N  | .65  |
| LM7912T  | 1.75 | LM1310N | 2.95 |
| LM7915T  | 1.75 | LM1458N | .99  |
| LM323K   | 5.95 | LM1488N | 1.59 |
| LM324N   | 1.29 | LM1489N | 1.59 |
| LM337T   | 2.29 | LM1800N | 4.49 |
| LM339N   | 1.29 | 76477N  | 3.95 |

### JOYSTICKS

JS-100K 100K Linear Taper Pots .. \$5.49  
JVC-40 40K (2) Video Controller .. \$9.95

### MICROPROCESSORS

|           |                           |       |
|-----------|---------------------------|-------|
| Z80A      | CPU (4MHz)                | 14.95 |
| MC6800    | 8 Bit MPU                 | 14.95 |
| 8080A     | CPU                       | 6.95  |
| 8212      | 8 Bit I/O Port            | 3.95  |
| 8218      | BI-Directional Bus Driver | 4.49  |
| 2513/2140 | Character Generator       | 12.95 |
| 8T97      | Tri-State Hex Buffer      | 2.25  |
| AY-5-1013 | 30K Baud UART             | 6.95  |
| AY-5-2376 | 88-Key Keyboard Encoder   | 13.95 |
| 2114-3    | 4K Static RAM (300ns)     | 6.95  |
| MK4116    | 16K Dynamic RAM (250ns)   | 4.95  |
| 2708      | 6K EPROM                  | 6.95  |
| 2716      | 16K EPROM (+5V)           | 10.95 |

### WALL TRANSFORMERS

|        |                         |        |
|--------|-------------------------|--------|
| AC250  | 250mA 12VAC (117V/60Hz) | \$3.95 |
| DV9200 | 200mA 9VAC (117V/60Hz)  | 3.95   |

### Digital Thermometer Kit

Dual sensors - switching control for indoor/outdoor or dual monitoring. Continuous LED 8" ht. display. Range: -40°F to 199°F / -40°C to 100°C. Accuracy ±1° nominal. Bat for Fahrenheit or Celsius. Simulated walnut case. AC wall adapter included. Size: 3 1/8" x 6 5/8" w x 1 3/8" d.

**JE300 .. \$39.95**

# What's New?

## SYSTEMS

### Introducing the Ensign

The Ensign microcomputer can support up to sixteen printers or video terminals. It includes a 6 MHz Z80B, 64 K bytes of programmable memory, and two extra Z80s to handle serial I/O (input/output) and disk and tape I/O. Supported software includes MP/M, CP/M, OASIS, and MVT-FAMOS.

The Ensign microcomputer with eight serial I/O ports and 2 megabytes of hard-disk storage costs \$7000. Contact Integrated Business Computers, 22010 S Wilmington Ave, Carson CA 90745.

Circle 532 on inquiry card.

### Graphics Color System

The MicroAngelo Graphics Color System offers 512 by 480 dot resolution and a choice of up to 256 colors. The system has a user-programmable color lookup table. This Z80-based, S-100 system allows overlays using a bit-plane technology that places no load on the host computer.

With the color system, Scion includes a CP/M package and Colorpak I, which provides a high-level language interface. The price for the MicroAngelo Color System ranges between \$2495 and \$8495.

Also available is a \$400 EPROM (erasable programmable read-only memory) called the Colorpak II. The Colorpak II doubles character generation, includes split-screen editing, a self-diagnostics routine, and a light-pen interface.

Contact Scion Corporation, 8455-D Tyco Rd, Vienna VA 22180, (703) 827-0888.

Circle 533 on inquiry card.

### AIM-65/40

The AIM-65/40 microcomputer is made up of a 6502-based processor board with on-board expansion to 48 K bytes of programmable memory and 32 K bytes of ROM (read-only memory) or EPROM (erasable programmable ROM). It features a 40-column printer with a 280 by N dot matrix and an ASCII (American Standard Code for Information Interchange) keyboard with user-assignable function keys. Six-level priority-interrupt logic and six 16-bit timers are included. Other features include an RS-232C interface with data rates of up to 19 K bps (bits per second), a 20 mA current-loop TTY (teletypewriter) interface, dual audio-cassette interfaces, two user-definable 8-bit parallel ports with handshake control, and an 8-bit serial shift register. I/O (input/output) drivers are resident in ROM.

The printer contains a Centronics-compatible connector, provides upper- and lowercase

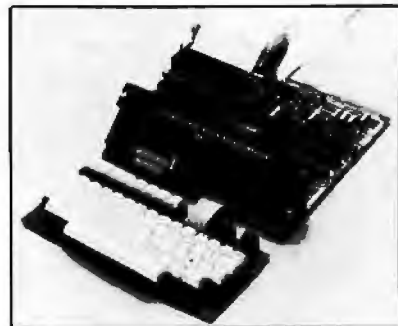

ASCII characters, graphics character font, and uses a separate microprocessor. The display module uses a vacuum fluorescent 40-character display. Assembler and other language packages are available.

The price of the AIM-65/40 Model 5000 is \$1795. In module form, the single-board computer costs \$1195, the printer is \$375, the display is \$340, and the keyboard is \$125. Contact Rockwell International, Electronic Devices Division, 3310 Miraloma Ave, POB 3669, Anaheim CA 92803, (714) 632-2321.

Circle 534 on inquiry card.

### The Expander S-100 System

The S-100 Expander microcomputer is built around a Z80 microprocessor. The system has keyboard, video and interrupt circuitry, a real-time clock, parallel printer and RS-232C interfaces, and color capabilities. There is an 80 by 24 screen format, upper- and lowercase, 4 K-byte ROM (read-only memory) monitor, 64 K bytes of programmable memory that's expandable to 512 K, and a tone generator with an internal speaker. The system comes with Microsoft's 24 K BASIC-80 on disk and 10 K BASIC-80 on cassette.

All CP/M and MP/M software



written for the Z80 and other Z80 operating systems will run on the Expander. Additional slots are provided for more S-100 boards. An external video monitor is required. The price is under \$2200 from Micro-Expander Inc, 6835 W Higgins Ave, Chicago IL 60656, (312) 792-1196.

Circle 535 on inquiry card.

# WE WILL NOT BE UNDERSOLD

## DISK DRIVES



FOR TRS-80\* Model I  
CCI-100 5 1/4", 40 Track (102K) \$314

ADD-ON DRIVES FOR ZENITH Z-89  
CCI-189 5 1/4", 40 Track (102K) \$394  
Z-87 Dual 5 1/4" system \$995

External card edge and power supply included. 90 day warranty/one year on power supply.

## RAW DRIVES

5 1/4" TEAC or TANDON \$CALL POWER SUPPLIES \$CALL

## DISKETTES — Box of 10

|  |               |         |
|--|---------------|---------|
| 5 1/4" Maxell \$40                         | BASF/Verbatim | \$26.95 |
| 8" Maxell \$45                             | BASF/Verbatim | \$36.00 |
| PLASTIC FILE BOX—Holds 50 5 1/4" diskettes |               | \$19.00 |
| PLASTIC LIBRARY CASE 5 1/4" \$3.00         | 8"            | \$ 4.00 |
| HEAD CLEANING DISKETTE                     |               | \$25.00 |
| FLOPPY SAVER \$11.95                       | RINGS         | \$ 6.95 |

## 16K RAM KITS

200 ns for TRS-80; Apple II, (specify): Jumpers 2 for \$37 \$19 \$2.50

## SYSTEM SPECIAL

Apple II Plus 48K w/drive and controller. Epson MX-80 printer and interface. SUP-R Mod RF Modulator: List \$2965 You Pay \$2299

## COMPUTERS/TERMINALS

|                                  |         |         |
|----------------------------------|---------|---------|
| ARCHIVES 64K, 2-Drives, 77 Track |         | \$ CALL |
| ALTOS ACS8000 Series             |         | \$ CALL |
| TRS-80* II-64K                   | III-16K | \$ 899  |
| ZENITH 48K, all-in-one computer  |         | \$2200  |
| ZENITH Z-19                      |         | \$ 725  |
| TELEVIDEO 920C                   | 950     | \$1039  |
| IBM 3101 Display Terminal        |         | \$1189  |
| ATARI 400                        | 800     | \$ 795  |
| MATTEL INTELLIVISION             |         | \$ 229  |
| APPLE PERIPHERALS                |         | \$ CALL |

## S-100 CALIFORNIA COMPUTER SYSTEMS



|                                    |       |
|------------------------------------|-------|
| MAINFRAME Model 2200A              | \$349 |
| Z80 CPU Model 2810                 | \$259 |
| MOTHER BOARD Model 2501            | \$106 |
| 16K STATIC RAM, 200ns Model 2116C  | \$309 |
| 32K STATIC RAM, 200ns Model 2032C  | \$619 |
| 64K DYNAMIC RAM Model 2065C        | \$580 |
| FLOPPY DISC CONTROLLER Model 2422A | \$345 |
| EXTENDER BOARD Model 2520K         | \$ 52 |
| 2P + 2S I/O Model 2718A            | \$309 |

For fast delivery, send certified checks, money orders or call to arrange direct bank wire transfers. Personal or company checks require two to three weeks to clear. All prices are mail order only and are subject to change without notice. Call for shipping charges.

## PRINTERS



NEC SPINWRITER  
Letter Quality High Speed Printer R.O. \$2395  
R.O. with tractor feed \$2555  
KSR with tractor feed \$2795

NEC SPINWRITER 3500 Series, 5 new models  
EPSON MX-70 MX-80 MX-80FT MX100 \$CALL \$CALL  
PAPER TIGER  
IDS 445 Graphics & 2K buffer \$ 695  
IDS 460 Graphics & 2k buffer \$1050  
IDS 560 Graphics \$1450  
ANADIX DP-8000 \$ 849 DP-9500/01 \$1295  
OKIDATA  
Microline 80 Friction & pin feed \$ 415  
Microline 80 Friction, and pin & tractor feed \$ 500  
Microline 82 Friction & pin feed feed \$ 615  
Microline 83 120 cps, uses up to 15" paper \$ 849  
CENTRONICS 739, new model with graphics \$ 825

## PRINTER SPECIAL

SEIKOSHA GP-80M List \$399 You Pay \$319

## MONITORS

|                               |                 |
|-------------------------------|-----------------|
| BELL & HOWELL 9" B & W BHD911 | \$195           |
| LEEDEX 12" B & W \$ 129       | 13" Color \$369 |
| SANYO 9" B & W VM4509         | \$149           |
| SANYO 12" B & W DM5012        | \$219           |
| SANYO 12" Green Screen DM5112 | \$238           |
| SANYO 13" Color DMC6013       | \$406           |
| ZENITH 13" Color              | \$349           |

## TELECOMMUNICATIONS

|  |       |
|--|-------|
| LIVERMORE STAR MODEM 2-year guarantee      | \$125 |
| UNIVERSAL DATA SYSTEMS UDS-103             | \$179 |
| D-CAT HARD WIRED DIRECT MODEM              | \$189 |
| AUTO-CAT Auto Answer, Direct Connect Modem | \$249 |
| D.C. HAYES MICRO-MODEM                     | \$295 |
| CCI Telnet Communications Package          | \$135 |

## APPLE ACCESSORIES AND SOFTWARE

|                   |          |
|-------------------|----------|
| VISICALC          | \$155.00 |
| DB MASTER         | \$159.00 |
| Z-80 SOFTCARD     | \$259.00 |
| VIDEX BOARD       | \$259.00 |
| KEYBOARD ENHANCER | \$110.00 |
| 16K CARD          | \$169.00 |
| APPLE JOYSTICK    | \$ 49.00 |
| SUP-R MOD         | \$ 25.00 |
| CCS CARDS         | \$ CALL  |



|                   |          |
|-------------------|----------|
| GALAXIAN          | \$ 22.95 |
| SPACE ALBUM       | \$ 35.00 |
| ASTEROIDS         | \$ 17.95 |
| FLIGHT SIMULATOR  | \$ 29.00 |
| WIZARD & PRINCESS | \$ 28.00 |
| SARGON 2          | \$ 29.00 |
| HI-RES FOOTBALL   | \$ 35.00 |
| MYSTERY HOUSE     | \$ 24.00 |

DEALER (NATIONAL/INTERNATIONAL) INQUIRIES INVITED

Send for FREE Catalogue

# The CPU SHOP

TO ORDER CALL TOLL FREE 1-800-343-6522

TWX: 710-348-1796 Massachusetts Residents call 617/242-3361

5 Dexter Row, Dept. B08M  
Charlestown, Massachusetts 02129  
Hours 10AM-6PM (EST) Mon.-Fri. (Sat. till 5)

Technical Information call 617/242-3361  
Massachusetts Residents add 5% Sales Tax  
Tandy Corporation Trademark® Digital Research



# What's New?

## SYSTEMS

### The Osborne Microcomputer

The Osborne 1 is a portable, briefcase-sized microcomputer. It features a Z80A microprocessor and a video terminal with a 5-inch monitor that displays 52 columns and 24 lines. There are 64 K bytes of programmable memory, serial and IEEE-488 interfaces, dual 100 K-byte floppy-disk drives, and the WordStar word-processing program with the MailMerge option, CP/M, CBASIC and MBASIC, and the SuperCalc program. The monitor is a window on a 128 by 34 row screen, which is implemented in a 4 K by 9-bit programmable memory. In addition, pockets are included for storing up to 20 floppy disks.

Options include double-density, double-sided floppy-disk drives, 9- and 12-inch monitors, a



battery pack providing three to five hours of operation, modem electronics, and an acoustic coupler.

The Osborne 1 costs \$1795.

Contact Osborne Computer Corporation, 26500 Corporate Ave, Hayward CA 94545, (415) 887-8080.

### Talking Terminals for the Blind

Triformation Systems has introduced a line of free-scan speech terminals (FSST). FSST is a talking unit with an unlimited vocabulary with both on-site and remote capabilities. It permits visually impaired operators to scan material horizontally or vertically through the use of function keys. Varying audible signals tell operators where they are on the page. FSST transmits the data audibly using full words, numerals, or letters spelling out the words. Headphones are available. Data is transmitted at rates up to 9600 bps (bits per second) and uses an RS-232C interface.

The FSST costs \$2795 and is available from Triformation Systems Inc, 3132 SE Jay St, Stuart FL 33494, (305) 283-4817.

Circle 537 on Inquiry card.



# THANDAR INSTRUMENTS

**ORDER ANY TWO INSTRUMENTS & TAKE A 3% DISCOUNT**



3 1/2 Digit LED Multimeter  
**DM 235 . . . . \$ 69.95**

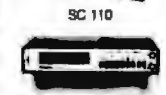

3 1/2 Digit LED Multimeter  
**DM 350 . . . . 99.95**

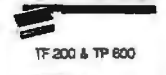

3 1/2 Digit LED Multimeter  
**PDM 35 . . . . 39.95**



8 Digit LED Hand Held Freq Meter  
**PFM 200 . . . . 99.95**



Single Trace Portable Oscilloscope  
**SC 110 . . . . 259.00**

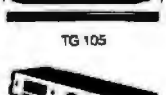

8 Digit LCD Frequency Meter  
**TF 040 . . . . 199.00**



8 Digit LCD Hand Held Freq Meter  
**TF 200 . . . . 299.00**



100 KHz Function Generator  
**TG 100 . . . . 159.00**



2 MHz Function Generator  
**TG 102 . . . . 299.00**

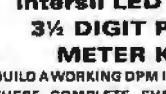

5 MHz Pulse Generator  
**TG 105 . . . . 199.00**

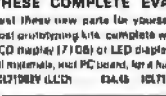

3 1/2 Digit LCD Bench Multimeter  
**TM 351 . . . . 199.00**



3 1/2 Digit LCD Bench Multimeter  
**TM 353 . . . . 159.00**

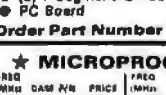

3 1/2 Digit LCD Hand Held Multimeter  
**TM 354 . . . . 79.00**



600 MHz Prescaler  
**TP 600 . . . . 79.00**

## Intersil LED or LCD 3 1/2 DIGIT PANEL METER KITS

BUILD A WORKING DPM IN 1/2 HOUR WITH THESE COMPLETE EVALUATION KITS. Each kit has your parts for yourself with Intersil's low cost prototyping kit, complete with A/D converter and LCD module (7108) or LED display (7107). Kits provide all materials, except PC board, and a functioning panel meter (EL7108BY GLCH) 63A.45 ICM7107BY ILED) 539.70



## 8 Digit - 10 MHz Universal Counter Kit

- Kit Includes:
- ICM7226A/DC IC
  - 10 MHz Quartz Crystal
  - (8) 7 Segment 3" LED Displays
  - PC Board
- Resistors
  - Capacitors
  - Diodes
  - Switches
  - IC Socket

Order Part Number ICM7226AEV..... \$74.95

## ★ MICROPROCESSOR CRYSTALS ★

| PART NO. | QTY | PRICE | QTY     | PRICE | QTY  | PRICE |
|----------|-----|-------|---------|-------|------|-------|
| 74LS10   | 100 | 1.00  | 74LS10  | 100   | 1.00 | 1.00  |
| 74LS11   | 100 | 1.00  | 74LS11  | 100   | 1.00 | 1.00  |
| 74LS12   | 100 | 1.00  | 74LS12  | 100   | 1.00 | 1.00  |
| 74LS13   | 100 | 1.00  | 74LS13  | 100   | 1.00 | 1.00  |
| 74LS14   | 100 | 1.00  | 74LS14  | 100   | 1.00 | 1.00  |
| 74LS15   | 100 | 1.00  | 74LS15  | 100   | 1.00 | 1.00  |
| 74LS16   | 100 | 1.00  | 74LS16  | 100   | 1.00 | 1.00  |
| 74LS17   | 100 | 1.00  | 74LS17  | 100   | 1.00 | 1.00  |
| 74LS18   | 100 | 1.00  | 74LS18  | 100   | 1.00 | 1.00  |
| 74LS19   | 100 | 1.00  | 74LS19  | 100   | 1.00 | 1.00  |
| 74LS20   | 100 | 1.00  | 74LS20  | 100   | 1.00 | 1.00  |
| 74LS21   | 100 | 1.00  | 74LS21  | 100   | 1.00 | 1.00  |
| 74LS22   | 100 | 1.00  | 74LS22  | 100   | 1.00 | 1.00  |
| 74LS23   | 100 | 1.00  | 74LS23  | 100   | 1.00 | 1.00  |
| 74LS24   | 100 | 1.00  | 74LS24  | 100   | 1.00 | 1.00  |
| 74LS25   | 100 | 1.00  | 74LS25  | 100   | 1.00 | 1.00  |
| 74LS26   | 100 | 1.00  | 74LS26  | 100   | 1.00 | 1.00  |
| 74LS27   | 100 | 1.00  | 74LS27  | 100   | 1.00 | 1.00  |
| 74LS28   | 100 | 1.00  | 74LS28  | 100   | 1.00 | 1.00  |
| 74LS29   | 100 | 1.00  | 74LS29  | 100   | 1.00 | 1.00  |
| 74LS30   | 100 | 1.00  | 74LS30  | 100   | 1.00 | 1.00  |
| 74LS31   | 100 | 1.00  | 74LS31  | 100   | 1.00 | 1.00  |
| 74LS32   | 100 | 1.00  | 74LS32  | 100   | 1.00 | 1.00  |
| 74LS33   | 100 | 1.00  | 74LS33  | 100   | 1.00 | 1.00  |
| 74LS34   | 100 | 1.00  | 74LS34  | 100   | 1.00 | 1.00  |
| 74LS35   | 100 | 1.00  | 74LS35  | 100   | 1.00 | 1.00  |
| 74LS36   | 100 | 1.00  | 74LS36  | 100   | 1.00 | 1.00  |
| 74LS37   | 100 | 1.00  | 74LS37  | 100   | 1.00 | 1.00  |
| 74LS38   | 100 | 1.00  | 74LS38  | 100   | 1.00 | 1.00  |
| 74LS39   | 100 | 1.00  | 74LS39  | 100   | 1.00 | 1.00  |
| 74LS40   | 100 | 1.00  | 74LS40  | 100   | 1.00 | 1.00  |
| 74LS41   | 100 | 1.00  | 74LS41  | 100   | 1.00 | 1.00  |
| 74LS42   | 100 | 1.00  | 74LS42  | 100   | 1.00 | 1.00  |
| 74LS43   | 100 | 1.00  | 74LS43  | 100   | 1.00 | 1.00  |
| 74LS44   | 100 | 1.00  | 74LS44  | 100   | 1.00 | 1.00  |
| 74LS45   | 100 | 1.00  | 74LS45  | 100   | 1.00 | 1.00  |
| 74LS46   | 100 | 1.00  | 74LS46  | 100   | 1.00 | 1.00  |
| 74LS47   | 100 | 1.00  | 74LS47  | 100   | 1.00 | 1.00  |
| 74LS48   | 100 | 1.00  | 74LS48  | 100   | 1.00 | 1.00  |
| 74LS49   | 100 | 1.00  | 74LS49  | 100   | 1.00 | 1.00  |
| 74LS50   | 100 | 1.00  | 74LS50  | 100   | 1.00 | 1.00  |
| 74LS51   | 100 | 1.00  | 74LS51  | 100   | 1.00 | 1.00  |
| 74LS52   | 100 | 1.00  | 74LS52  | 100   | 1.00 | 1.00  |
| 74LS53   | 100 | 1.00  | 74LS53  | 100   | 1.00 | 1.00  |
| 74LS54   | 100 | 1.00  | 74LS54  | 100   | 1.00 | 1.00  |
| 74LS55   | 100 | 1.00  | 74LS55  | 100   | 1.00 | 1.00  |
| 74LS56   | 100 | 1.00  | 74LS56  | 100   | 1.00 | 1.00  |
| 74LS57   | 100 | 1.00  | 74LS57  | 100   | 1.00 | 1.00  |
| 74LS58   | 100 | 1.00  | 74LS58  | 100   | 1.00 | 1.00  |
| 74LS59   | 100 | 1.00  | 74LS59  | 100   | 1.00 | 1.00  |
| 74LS60   | 100 | 1.00  | 74LS60  | 100   | 1.00 | 1.00  |
| 74LS61   | 100 | 1.00  | 74LS61  | 100   | 1.00 | 1.00  |
| 74LS62   | 100 | 1.00  | 74LS62  | 100   | 1.00 | 1.00  |
| 74LS63   | 100 | 1.00  | 74LS63  | 100   | 1.00 | 1.00  |
| 74LS64   | 100 | 1.00  | 74LS64  | 100   | 1.00 | 1.00  |
| 74LS65   | 100 | 1.00  | 74LS65  | 100   | 1.00 | 1.00  |
| 74LS66   | 100 | 1.00  | 74LS66  | 100   | 1.00 | 1.00  |
| 74LS67   | 100 | 1.00  | 74LS67  | 100   | 1.00 | 1.00  |
| 74LS68   | 100 | 1.00  | 74LS68  | 100   | 1.00 | 1.00  |
| 74LS69   | 100 | 1.00  | 74LS69  | 100   | 1.00 | 1.00  |
| 74LS70   | 100 | 1.00  | 74LS70  | 100   | 1.00 | 1.00  |
| 74LS71   | 100 | 1.00  | 74LS71  | 100   | 1.00 | 1.00  |
| 74LS72   | 100 | 1.00  | 74LS72  | 100   | 1.00 | 1.00  |
| 74LS73   | 100 | 1.00  | 74LS73  | 100   | 1.00 | 1.00  |
| 74LS74   | 100 | 1.00  | 74LS74  | 100   | 1.00 | 1.00  |
| 74LS75   | 100 | 1.00  | 74LS75  | 100   | 1.00 | 1.00  |
| 74LS76   | 100 | 1.00  | 74LS76  | 100   | 1.00 | 1.00  |
| 74LS77   | 100 | 1.00  | 74LS77  | 100   | 1.00 | 1.00  |
| 74LS78   | 100 | 1.00  | 74LS78  | 100   | 1.00 | 1.00  |
| 74LS79   | 100 | 1.00  | 74LS79  | 100   | 1.00 | 1.00  |
| 74LS80   | 100 | 1.00  | 74LS80  | 100   | 1.00 | 1.00  |
| 74LS81   | 100 | 1.00  | 74LS81  | 100   | 1.00 | 1.00  |
| 74LS82   | 100 | 1.00  | 74LS82  | 100   | 1.00 | 1.00  |
| 74LS83   | 100 | 1.00  | 74LS83  | 100   | 1.00 | 1.00  |
| 74LS84   | 100 | 1.00  | 74LS84  | 100   | 1.00 | 1.00  |
| 74LS85   | 100 | 1.00  | 74LS85  | 100   | 1.00 | 1.00  |
| 74LS86   | 100 | 1.00  | 74LS86  | 100   | 1.00 | 1.00  |
| 74LS87   | 100 | 1.00  | 74LS87  | 100   | 1.00 | 1.00  |
| 74LS88   | 100 | 1.00  | 74LS88  | 100   | 1.00 | 1.00  |
| 74LS89   | 100 | 1.00  | 74LS89  | 100   | 1.00 | 1.00  |
| 74LS90   | 100 | 1.00  | 74LS90  | 100   | 1.00 | 1.00  |
| 74LS91   | 100 | 1.00  | 74LS91  | 100   | 1.00 | 1.00  |
| 74LS92   | 100 | 1.00  | 74LS92  | 100   | 1.00 | 1.00  |
| 74LS93   | 100 | 1.00  | 74LS93  | 100   | 1.00 | 1.00  |
| 74LS94   | 100 | 1.00  | 74LS94  | 100   | 1.00 | 1.00  |
| 74LS95   | 100 | 1.00  | 74LS95  | 100   | 1.00 | 1.00  |
| 74LS96   | 100 | 1.00  | 74LS96  | 100   | 1.00 | 1.00  |
| 74LS97   | 100 | 1.00  | 74LS97  | 100   | 1.00 | 1.00  |
| 74LS98   | 100 | 1.00  | 74LS98  | 100   | 1.00 | 1.00  |
| 74LS99   | 100 | 1.00  | 74LS99  | 100   | 1.00 | 1.00  |
| 74LS100  | 100 | 1.00  | 74LS100 | 100   | 1.00 | 1.00  |

# Commodore VIC-20



Introducing the full featured, expandable color computer . . . . . \$299.95

## SILICON GENERAL

Linear IC and Voltage Regulator Databook  
214 pages \$4.60

## Motorola's Complete Opto Triac Driver

| Type    | V <sub>CE</sub> | I <sub>CE</sub> | Price  |
|---------|-----------------|-----------------|--------|
| MC03200 | 10              | 200             | \$2.30 |
| MC03210 | 8               | 200             | 2.71   |
| MC03211 | 5               | 200             | 2.88   |
| MC03220 | 10              | 400             | 3.16   |
| MC03201 | 8               | 400             | 3.92   |
| MC03202 | 15              | 200             | 3.96   |
| MC03212 | 8               | 250             | 5.22   |

## ANCRONA HAS INTERSIL IC's

| Part No.     | QTY    | Price | Part No.     | QTY   | Price |
|--------------|--------|-------|--------------|-------|-------|
| IM8100-1PL   | 813 BF | 14.45 | ICM7227-C1P1 | 12.40 |       |
| IM8102-1PL   | 14.80  |       | ICM7227-C1P1 | 14.45 |       |
| ICM7038-A1PA | 3.00   | 26.63 | ICM7240-1JE  | 4.90  |       |
| ICM7038-C1PA | 3.00   | 26.63 | ICM7241-1PA  | 3.40  |       |
| ICM7045      | 14.96  | 22.34 | ICM7242-1JA  | 2.08  |       |
| ICM7125-AC1P | 13.90  | 21.40 | ICM7260-1JE  | 6.00  |       |
| ICL7108-CPL  | 16.80  | 11.25 | ICM7260-1JE  | 5.28  |       |
| ICL7107-CPL  | 16.80  | 11.25 | ICM7270-1PL  | 8.88  |       |
| ICL7116-CPL  | 16.70  | 12.40 | ICM7555-1PA  | 1.20  |       |
| ICL7117-CPL  | 17.20  | 10.78 | ICM7556-1PD  | 2.29  |       |
| ICM7201-1DR  | 2.28   | 7.80  | ICL7600-CPA  | 3.40  |       |
| ICM7308-1PG  | 13.90  | 11.25 | ICL8038-CCJ2 | 4.70  |       |
| ICM7308-CAPE | 8.15   | 6.00  | ICL8048-CCPE | 21.80 |       |
| ICM7201-A1PD | 8.80   | 3.20  | ICM8099-CG2  | 2.40  |       |
| ICM7208-1P1  | 18.00  | 12.40 | ICL8211-CPA  | 2.60  |       |
| ICM7209-1PA  | 3.45   | 26.63 |              |       |       |
| ICM7211-1PL  | 8.80   | 10.40 |              |       |       |

## Z-80 SERIES

| Part No.    | QTY   | Price |
|-------------|-------|-------|
| Z80-CPU     | 5.895 |       |
| Z80-CPL     | 6.90  |       |
| Z80-DART    | 14.50 |       |
| Z80-DART-0  | 13.50 |       |
| Z80-SIO-D   | 34.40 |       |
| Z80-SIO-R   | 18.20 |       |
| Z80-DMA     | 20.10 |       |
| Z80A-CPU    | 5.985 |       |
| Z80A-CPL    | 7.95  |       |
| Z80A-DART   | 18.85 |       |
| Z80A-DART-0 | 16.50 |       |
| Z80A-SIO-D  | 30.50 |       |
| Z80A-SIO-R  | 23.40 |       |
| Z80A-DMA    | 24.90 |       |

| Part No. | QTY   | Price |
|----------|-------|-------|
| MC6800P  | 10.80 |       |
| MC6802P  | 11.80 |       |
| MC6875L  | 6.90  |       |
| MC6880AP | 3.14  |       |
| MC6881P  | 6.11  |       |
| MC6882AL | 8.93  |       |
| MC6886P  | 2.72  |       |
| MC6886P  | 2.72  |       |

# What's New?

## MISCELLANEOUS

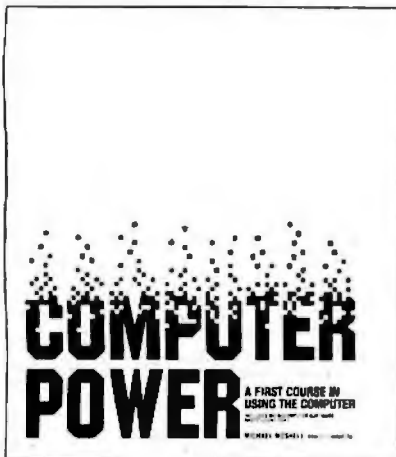

### Computer Power

Computer Power is a new computer-literacy curriculum from the Gregg Division of McGraw-Hill. Based on a unique Pascal Interpreter, the materials in each package include: Rascal, an extended version of UCSD Pascal including enhanced graphics and music commands as well as animation; INTERPAS, the Pascal interpreter which allows students to program in Pascal as easily as BASIC by providing an immediate execution mode, single-stepping of programs, extensive error-handling facilities, single-key entry of

command words, simplified editing and filing procedures, and the ability to convert debugged INTERPAS programs into standard Pascal programs; and a student text that includes program listings and materials to provide extended learning experiences for each lesson. Also included is an extensive teacher's manual written with the computer-naive teacher in mind. The manual provides complete lesson plans, a step-by-step guide to lesson objectives, instructional activities, instructions on how to use the computer in each lesson, a tutorial on using the computer and the accompanying software, and sections on classroom organization, management, and grading.

Computer Power runs on a 48 K-byte Apple II computer with the Language System, one disk drive, and a color monitor. For more information, contact Computer Power, Gregg/McGraw-Hill (29th floor), 1221 Avenue of the Americas, New York NY 10020.

Circle 538 on Inquiry card.

### Memory Board from North Star

The HRAM memory boards are designed for North Star systems. The boards feature memory-parity checking and bank-switching capabilities. The boards are Horizon-compatible, and are available in 32 K-, 48 K-, and 64 K-byte configurations.

The boards range in price from \$599 for the 32 K-byte board to \$1099 for the 64 K-byte board. For more details, contact North Star Computers Inc, 14440 Catalina St, San Leandro CA 94577, (415) 357-8500.

Circle 539 on Inquiry card.

### 8 K-Byte Memory for the VIP

The RCA VIP single-board microcomputer can now have an extra 8 K bytes of programmable memory. The VP-575 System Expansion Board uses 2114 integrated circuits, addresses each 4 K-byte block separately, plugs into the VIP expansion connector or system expansion board, and draws 600 mA from a +5 V supply. The VP-575 costs \$149 assembled and tested, and the bare board is \$49. Contact G J Krizek, 722 N Morada Ave, West Covina CA 91790.

Circle 540 on Inquiry card.

### Protecting Apple Software

The Soft Key system is a hardware-oriented antipiracy system for Apple software. The patent-pending system features a set of techniques that can be used by programmers to create their own security schemes. The custom algorithm used in the system is embodied in a non-copyable "key." The key, a custom integrated circuit, is plugged into a master security board to create a protection algorithm unique to the particular program.

The master board, which plugs into the Apple motherboard, is available in 1-, 8-, or 16-key versions, allowing the protection keys for several programs to co-reside in the computer. The company claims that its protection scheme causes no significant slowdown in execution time of a program.

The protection key can be used to protect floppy disks, hard disks, and computer-network software. Programs written in Applesoft, Integer BASIC, Pascal, FORTRAN, and the various languages used in conjunction with the Microsoft Softcard, can all be protected by the Soft Key system.

The company charges an initial fee to instruct programmers in the techniques of using the system; program details need not be disclosed to Soft Key to protect the program. The OEM (original equipment manufacturer) price of the product is approximately \$18 in quantity for a single keyboard with one custom key. Contact Soft Key Associates Inc, 44 Front St, Ashland MA 01721.

Circle 541 on Inquiry card.

# INCREDIBLE? BELIEVE IT!

## PRINTERS



150 cps bidirectional-9x9 dot matrix, quietized case, 136 col, vertical form control and many other functions

**\$1195**

We feel this printer offers the best price/performance ratio available. RS-232 serial to 19,200 baud

supporting X-ON, X-OFF or Current Loop—add \$40

Only

**Teletype 40**, 300 LPM-typewriter quality, RS-232 interface. This quality printer is available in many configurations including forms access, quietized case, etc.

from **\$2928**

**Teletype 43** from **\$995**

**NEC Spinwriter-55** cps, bidirectional, letter quality R.O. **\$2660** KSR **\$2942**

**DIABLO 630-40** cps, bidirectional, daisy wheel, plot/graph **\$2270**

**C. ITOH Starwriter**, 25 cps, daisy wheel **\$1575**

**C. ITOH Starwriter**, 45 cps, daisy wheel **\$1849**

**EPSON MX-80**, 80 cps, 9x9 dot matrix **\$515**

**ANADEX 9500/9501**, up to 200 cps, high resolution dot **\$1349**

**OKIDATA Microline 80**, 80 cps, 9x7 dot matrix **\$490**

**Microline 82**, bidirectional, friction/pin feed **\$599**

**Microline 83**, bidirectional, 120 cps, uses 15" paper **\$875**

**TI-810**, 150 cps, Basic **\$1695**

Package-Compressed print, vertical form control **\$1830**

**CENTRONICS 704-9**, 180 cps, 9x9 dot matrix, 132 col, RS-232 **\$1595**

**704-11**, 180 cps, 9x9 dot matrix, 132 col, parallel **\$1695**

**730**, 100 cps, 7x7 dot matrix, same as R.S. LPII **\$660**

**737**, 80 cps, nx9 dot matrix, same as R.S. LPIV **\$849**

proportional spacing **\$1085**

**DEC LA-34** **\$1199**

**IDS 460G**

## S-100 SPECIALTIES



We offer all of Delta's systems — from their cost effective single user system to extensive multi-user networks of computers and terminals.

Many disk, tape and Winchester configurations are available.

## Systems Group

Call us for best prices on these high quality 2nd generation boards and systems.



These high quality, reliable products have made CCS defacto industry standard for S-100 products

Assembled and tested:

**2200** H.D. Mainframe, 20 a. P.S., 12 slot MB **\$434** **\$359**

**2065C** 64K dynamic RAM/Bank Select **\$720** **\$580**

**2810A** Z-80 CPU, serial port, ROM monitor **\$310** **\$259**

**2422A** Floppy Cont, CP/M 2.2, ROM monitor **\$425** **\$345**

**SSM** **CB2 Z-80 CPU** **\$344** **\$295**

**2P + 2S I/O interface** **\$290** **\$249**

**NNC 2 board set Z-80A CPU, CP/M 2.2, floppy disc controller** **\$765**

**2 serial, 3 parallel ports, PROM, I/O cable** **Scale**

**SUPERBRAIN**

Similar savings on the full lines of **CCS, SSM, NNC, MORROW, DELTA, NORTHSTAR, ITHACA INTERSYSTEMS, GOBBOUT, NEC, TELEVIDEO, IMS and ZENITH.**

## 8" DISK DRIVE SALE

**8" SHUGART SA801R** **\$429**  
Premium double sided drives: **8" SHUGART SA851R** **\$625**  
or **QUME DATATRACK 8** 2 for **\$1199**

Enclosure, power supply for 2 8" drives A&T **\$299**

**NNC industrial grade enclosure** for 2 drives with P.S. **\$415**

**POWER 1**, power supply for 2 8" drives **\$135**

**MORROW Discus 2D + CP/M** **\$963**

**Discus 2 + 2 + CP/M** **\$1259**

## HARD DISK SPECIALS

**CORVUS 10MB and controller** List **\$5350** only **Scale**

**20MB and controller** **\$6450** **Scale**

**Constellation Network Multiplexer** **\$750** **Scale**

**Mirror Video Tape Disk Backup** **\$790** **Scale**

**MORROW 29MB + controller + CP/M 2.2** **\$4995** **\$3995**

**CAMEO cartridge drive controller** **\$1500** **\$1275**

**controller, CDC Hawk Drive (5 fix, 5 rem)** **\$6995** **\$5995**

**controller, Western Dynex (5 fix, 5 rem)** **\$5995** **\$5099**

Winchester 5 1/4 drives complete with case, cable, software, S-100 controller. Adapter avail. for use with any Z-80 system. Cartridge driver controllers avail.

**XCOMP** List **\$2898**

**5MB** **\$3398**

**10MB**

Quantity discounts available!

**ADES S-100 CONTROLLER FOR PRIAM** **\$693**

**PRIAM 8" and 4" Winchester/tape subsystems avail.**

We carry the full line of **ADES** disk and tape controllers and subsystems.

## FULLY CONFIGURED BUSINESS SYSTEMS

The following are some examples of the fully assembled and tested business and scientific computer systems which we offer. All include CP/M 2.2.

64K bytes dynamic RAM, Z-80A 4mh CPU. We offer a full line of quality, tested software.

**CCS 2210A w/floppy controller, 1 serial port** **\$1849**

**CCS 300-1A w/1.2MB floppy drives, 2 serial, 2 parallel ports** **\$4849**

**CCS 400-1A w/10MB hard disc, 2 serial, 2 parallel ports** **\$6999**

Optional CP/M for CCS 300, 400 (OASIS available) **\$150**

**NNC 80 w/1MB floppy drives, 2 serial, 3 parallel ports** **\$3799**

**NNC 80W w/.5MB floppy, 8.4MB hard disc, (OASIS optional)** **\$6693**

**ALTOS single and multi-user systems** **Scale**

**MORROW Decision 1, MICROSOFT basic, UNIX** **Scale**

## TERMINALS

**TELEVIDEO 912 C** **\$950** **\$725**

**920 C** **\$1030** **\$789**

**950C** **\$1195** **\$989**

**SOROC IQ 120** **\$995** **\$729**

**IQ 140** **\$1395** **\$1149**

**INTERTUBE III or EMULATOR (multi-terminal)** **\$895** **\$799**

**DEC VT-100** **\$2050** **\$1575**

Similar savings for our **HAZELTINE** and **LEAR SIEGLER** lines

## LOOK HERE!

Call us for ALL your software needs

**SYSTEMS HOUSES & EDUCATIONAL INSTITUTIONS**

**GIVEN SPECIAL CONSIDERATION.**

ALL OF OUR PERIPHERALS CAN BE CONFIGURED FOR RADIO SHACK® MODEL II

## DEALER and INTERNATIONAL INQUIRIES WELCOME

### WASHINGTON COMPUTER SERVICES

an affiliate of **WASHINGTON ELECTRIC COMPANY** est. 1912

CUSTOM COMPUTER ROOM WIRING SINCE 1960

97 Spring Street

New York, N.Y. 10012

Hours: 8AM-5:30PM (EST) Mon.-Fri.

TO ORDER: CALL OUR TOLL-FREE NUMBER:

★ (800) 221-5416 ★ In N.Y. State and for technical information call 1-(212) 226-2121

For fast delivery, send certified checks, money order or call to arrange direct bank wire transfers. Personal or company checks require two to three weeks to clear. All prices are mail order only. Prices subject to change without notice; call for latest prices. Prices include 2% cash discount. N.Y. residents add sales tax.

Quantex is a trademark of North Atlantic Industries, Inc.

Radio Shack® is a trademark of the Tandy Corp

CP/M® is a trademark of Digital Research



# wabash®

When it comes to  
Flexible Disks, nobody  
does it better than  
Wabash.

MasterCard, Visa Accepted.  
Call Free: (800) 235-4137



**PACIFIC EXCHANGES**  
100 Foothill Blvd  
San Luis Obispo, CA  
93401 (In Cal call  
(805) 543-1037)

Circle 292 on inquiry card.

## COMPUTER EQUIPMENT & SOFTWARE BARGAINS



EVERY MONTH

BUY, SELL OR TRADE ALL TYPES OF  
COMPUTER EQUIPMENT AND SOFT-  
WARE (pre-owned and new) among  
20,000 readers nationwide in BIG  
(11x14") pages. Classified ads are  
only 10¢ per word and are indexed for  
easy and fast location. Subscription:  
\$10 a year / 12 issues. Money back  
guarantee. Sample copy, \$1.50.

**COMPUTER SHOPPER**  
P.O. Box F-14  
Titusville, FL 32780  
(305) 269-3211

MasterCard or VISA subscription orders only.  
call TOLL FREE 1-800-528-8050 Ex. 184.

Circle 75 on inquiry card.



FULL PERFORMANCE CP/M\* computer  
\$1995 list

dealer-distributor discounts

**Alspa Computer, Inc.**  
5215 Scotts Valley Drive  
Scotts Valley, CA 95066  
(408) 438-3328

\*trademarks of Digital Research, Inc.

Circle 14 on inquiry card.

## DISCOUNT PRICES

ON

CENTRONICS • CROMEMCO  
LEAR SIGLER • NORTH STAR  
DIABLO • HAZELTINE, ETC.

- NEW, FULL WARRANTY
- QUICK DELIVERY
- Hundreds of Satisfied Customers
- Call for DISCOUNT Price List

**DIGITAL DATA SYSTEMS, Inc.**  
1551 NW 65th Avenue Plantation, FL 33313  
(305) 792-3290

OUR 8TH YEAR OF SERVICE

Circle 112 on inquiry card.

## FORTH FOR/MAT™ SCREEN EDITOR

A MUST FOR THE SERIOUS FORTH  
PROGRAMMER

- All code is Forth-79 standard. Each line of code is fully explained and flow-charted (Forth style) for easy modification
- This editor works just like the popular word processors on the market except it is written in high level forth and is confined to the 1024 byte boundary of a forth screen.
- There are over 20 different commands for cursor positioning, text modification, tabs, relocating lines, spreading lines, and moving lines to other screens
- Insert mode is toggled on and off for midstream insertions and deletions. Text ahead of CP is moved right during insertion and left during deletion if insert mode is on
- Column position is displayed at all times.
- Bomb proof — all unused control codes are trapped
- Must be used with a CRT that has cursor addressing or with a memory mapped video
- Send check or money order in the amount of \$50.00 and receive complete source code, flowcharts, documentation, and instructions for bringing up on your system.

**KV33 CORPORATION**  
P.O. BOX 27246  
TUCSON, AZ 85726  
(602) 889-5722



Circle 191 on inquiry card.

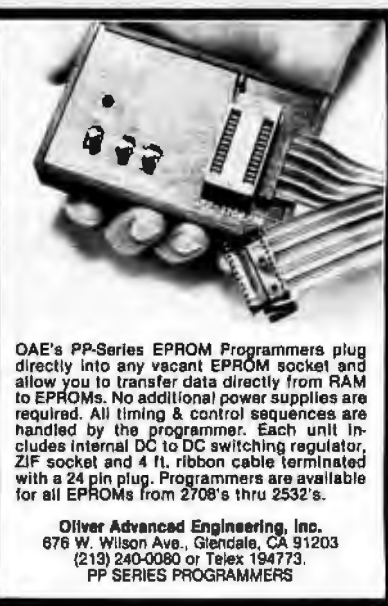

OAE's PP-Series EPROM Programmers plug directly into any vacant EPROM socket and allow you to transfer data directly from RAM to EPROMs. No additional power supplies are required. All timing & control sequences are handled by the programmer. Each unit includes internal DC to DC switching regulator, ZIF socket and 4 ft. ribbon cable terminated with a 24 pin plug. Programmers are available for all EPROMs from 2708's thru 2532's.

Oliver Advanced Engineering, Inc.  
676 W. Wilson Ave., Glendale, CA 91203  
(213) 240-0080 or Telex 194773.  
PP SERIES PROGRAMMERS

Circle 274 on inquiry card.

## ONE BOARD CP/M SYSTEM!



only \$750  
Asm., Tested  
& Burned-In  
for one week

### Features:

- 8 1/2 by 12 inches
- 10 MHZ 8085 CPU
- 64K RAM
- 3 RS-232 channels
- 8272 Floppy Disk Controller
- Handles Single/Double Density
- One to Four Drives. 801R or 850R.

Documentation \$15.  
CP/M Floppy Disk Operating System \$150  
Check or Money Order

**autocontrol**  
INCORPORATED

11744 Westline Industrial Drive  
St. Louis, MO 63141  
(314) 432-1313

Circle 29 on inquiry card.

## AC-85 CP/M® SYSTEM

Asm., Tested  
& Burned In  
for one week **\$2450**

### Features:

- One board 8085 Computer
- 2 - SA800R\* (1.2 megabytes)
- CBIOS Diskette
- Installed and wired in a cabinet with P/S and Fan ready to plug-in
- Manual
- 17 1/2" W x 17" D x 10" H
- SYSTEM with 2 SA850R (2.4 mbytes)

**\$2750.00**

CP/M Floppy Disk Operating System \$150  
Check or Money Order

**autocontrol**  
INCORPORATED

11744 Westline Industrial Drive  
St. Louis, MO 63141  
(314) 432-1313

\* CP/M is a registered trademark of  
Digital Research, Inc.

Circle 30 on inquiry card.

# EPSON

DOT MATRIX PRINTER  
**MX-80 F/T**

Friction and removable, variable width tractor

**NOW IN STOCK**  
CALL FOR DISCOUNT PRICE

Also in Stock **MX-80 \$499** Lower! Call!

NEW! Graphics ROM for MX-80. CALL!

We also stock direct connect cables for TRS-80,  
Apple, Atari, Pet or RS 232

**CALL 800-344-7493**  
(209) 667-2888 (within CA)



**MACROTRONICS, Inc.**  
1125 N. GOLDEN STATE  
TURLOCK, CA 95380

Circle 203 on inquiry card.



# COMPUTER STOP

2545 W. 237 St. Torrance, CA. 90505

ORDER BY PHONE  
MON.—SAT.  
10-6

(213) 539-7670 PST  
TELEX: 678401 TAB IRIN

## LOWEST PRICES IN THE WEST, NORTH, SOUTH & EAST



### apple computer 1-800-421-1947

Sales and Service

- APPLE III OPTION A: .....3850
  - APPLE III 96K
  - Information Analyst Package
  - 12" B/W Monitor
- APPLE III OPTION B: .....4350
  - SAME AS OPTION A PLUS:
  - DISK II for APPLE III
- APPLE III OPTION C: .....4800
  - SAME AS OPTION A PLUS:
  - DISK II FOR APPLE III
  - SILENTYPE Thermal Printer

### APPLE HARDWARE

- Parallel Printer Interface Card .....160
- Communications Card .....195
- High Speed Serial Interface .....160
- Pascal Language System .....425
- Centronics Printer Interface .....185
- Applesoft Firmware Card .....160
- Integer Firmware Card .....160
- Disk II with Controller DOS 3.3 .....529
- Disk II only .....475
- Graphics Tablet .....625

### OTHER HARDWARE

- Alf Music Synthesizer (3 Voice) .....245
- 9 voice .....175
- ABT Numeric Keypad .....119
- Micromodem II .....295
- Apple Clock .....245
- Rom Plus with Keyboard Filter .....175
- Introl/X-10 System .....250
- Romwriter .....150
- DoubleVision 80 x 24 Video Interface .....245
- CCS Arithmetic Processor .....399
- CCS Parallel Interface .....119
- 16K Ram Card .....145
- Microworks DS-65 Digisector .....339
- SVA 8 Inch Disk Controller .....335
- Sup-R-Mod .....30
- CCS Synchronous Serial Interface .....119
- CCS Asynchronous Serial Interface .....99
- Corvus 10 Meg. Hard Disk .....4395
- Corvus Constellation .....595

### MISCELLANEOUS/SUPPLIES

- 16K RAM (200-250 NS) .....29
- Verbatim Datalife Diskette (Box of 10) .....30
- Dysan Diskettes (Box of 5) .....22
- Apple Diskettes (Box of 10) .....45
- Verbatim Diskette Boxes (Holds 50 Disks) .....18
- Silentye Paper (Box of 10 rolls) .....40



### MONITORS/DISPLAYS

- Leedex Video 100 12" .....140
- Sanyo 9" Monitor .....195
- KG-12C Green Phos. Monitor .....275
- Sanyo 12" Green Phosphor. Monitor .....275
- NEC 12" Green Phosphor. Monitor .....275
- Sanyo 12" B/W Monitor .....250

### PRINTERS

- Apple Silentye with Interface .....525
- IDS 445 (Paper Tiger) with Graphics .....650
- IDS 460 with Graphics .....1049
- IDS 560 with Graphics 10) .....1199
- Centronics 737 .....795
- NEC Spinwriter (RO, Serial) .....2650

### SOFTWARE

- The Controller .....525
- Apple Post (Mailing List Program) .....40
- Easywriter Professional System .....195
- Apple Pie 2.0 .....95
- DB Master Data Management .....175
- The Cashier .....210
- Apple Writer .....65
- Visicalc .....170
- CCA Data Management System .....90
- Full Screen Mapping for CCA DMS .....59
- Pascal Interactive Terminal Software (PITS) .....29
- Basic Interactive Terminal Software (BITS) .....29
- Data Capture .....29
- Data Factory DMS .....110
- Apple Plot .....55
- Apple Pilot .....120
- Magic Wand Word Processor (Needs Z-80 Softcard) 345
- Dow Jones Portfolio Evaluator .....45
- Fortran .....140

**ORDERING INFORMATION:** Phone orders invited using VISA, MASTERCARD or bank wire transfers. VISA & MC credit card service charge of 2%.  
 Mail order may send charge card number (include expiration date), cashier's check, money order or personal check (allow 10 business days to clear.) Please include a telephone number with all orders. Foreign orders (excluding Military PO's) add 10% for shipping. All funds must be in U.S. dollars (letters of credit permitted). Shipping, Handling and insurance in U.S. add 3% (minimum \$4.00). California residents add 6% sales tax. Our low margins prohibit us to send COD or on purchase orders or open account (please send for written quotation). All equipment is subject to price change and availability. Equipment is new and complete with the manufacturer warranty. We do not guarantee merchantability of products sold. All returned equipment is subject to a 15% restocking fee. We ship most orders within 2 days.  
 WE ARE A MEMBER OF THE CHAMBER OF COMMERCE.

PLEASE SEND ORDERS TO:  
**COMPUTER STOP, 2545 W. 237 St., TORRANCE, CA 90505**

RETAIL STORE PRICES MAY DIFFER FROM MAIL ORDER PRICES.

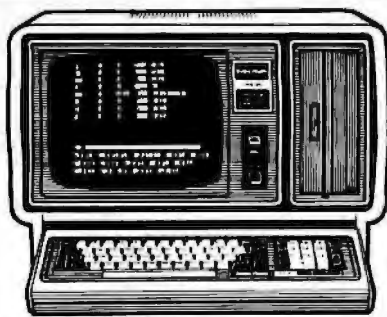

Model II

## SAVE UP TO \$459.00 NOW on TRS-80 Computers

Now you can own a great little computer at a great big discount off the manufacturer's list price. For home or office use, the Radio Shack line of computers is first in quality, performance and price:

- FREE SHIPPING in the 48 continental contiguous states.
- NO SALES TAX collected on out-of-state orders.
- CHARGE it with your MasterCard or Visa card.
- CONVENIENT ORDERING Call us TOLL FREE.

| Catalog Number                                | Description                | List Price | Charge By Phone | Cashier's Check Or Money Order | CASH PRICE YOU SAVE |
|---|----------------------------|------------|-----------------|--------------------------------|---------------------|
| Radio Shack® TRS-80 Model II<br>26-4002       | 64K 1-Disk Model II .....  | 3,899.00   | 3,579.30        | 3,440.00                       | 459.00              |
| Radio Shack® TRS-80 Model III<br>26-1061      | Model III 4K Level-I ..... | 699.00     | 629.10          | 629.10                         | 69.90               |
| 26-1062                                       | Model III 16K .....        | 999.00     | 865.00          | 865.00                         | 134.00              |
| 26-1063                                       | Model III 32K .....        | 2,495.00   | 2,243.50        | 2,199.00                       | 296.00              |
| Radio Shack® TRS-80 Color Computer<br>26-3001 | 4K Color Computer .....    | 399.00     | 359.10          | 359.10                         | 39.90               |
| 26-3002                                       | 16K Color Computer .....   | 599.00     | 539.10          | 539.10                         | 59.00               |

# Pan American Electronics

CALL TOLL FREE 800-531-7466 • Texas & Principal Number 512/581-2766 • Telex 767339  
Dept. 18 • 1117 Conway Avenue • Mission, Texas 78572

## NEW BRANCH

2912 N. Main, Fort Worth, Texas 76106 • Phone Number 817-625-6333 • Telex 794836

TRS-80 is a Trademark of Tandy Corp.

Circle 299 on Inquiry card.

### FLOPPY DISK DRIVES



Qume DT-8 .....\$599 - 2/\$1150  
Virtually the industry standard. High quality/reliability. Full featured, double-sided, double density.

Mitsubishi!!!!!! ..... \$649  
Up & coming potential giant of the double sided/double density realm.

Shugart 851R ..... \$649  
Double sided/double density

Shugart 800/801R..... \$425 - 2/\$820

Siemens FDD100-8D\$395 - 2/\$755

Tandon double sided mini-floppy.  
Shugart compatible, double density.  
.....\$350 - 2/\$640

SA400 mini-floppy. 35 track, double density.....\$299 - 2/\$525

### CONTROLLERS

Tarbell single density kit .....\$210

Tarbell single density A & T .....\$290

Tarbell double density A & T .....\$450

MDA LSI-11 floppy controller .....\$1095



**SPECIAL!!** CCS 2422A floppy disk controller with CP/M version 2.2 \$375

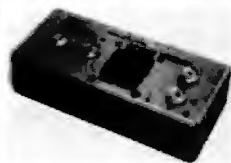

**FLOPPY POWER SUPPLY:** Handles two units with the greatest of ease.

.....\$109



### CABLE KITS:

One drive \$30

Two ..... \$35

Three ..... \$40

Four ..... \$45

Includes all wire, cable + connectors to hook up most drive systems.

**DISKETTES:** Single sided \$39/10 - Double sided \$59/10

### SPECIAL SPECIALS (very limited supply)

SBC 80/30 CPU card (used) ..... \$475.

SBC 604 ..... \$150.

SBC 614 ..... \$150.

UDS 103J modem card (used) ..... \$100.

UDS 801A dialer card (used) ..... \$100.

all used gear here comes with 90 day warranty.

### CRYSTALS ... most major values. Call for case size, etc.

\$2.75/ea. .... 25/\$2.50 ..... 100/\$2.20

3.57954/\$.99 ea - 100/\$.80

### CONNECTORS... many types in stock. IDC, etc. all connectors \$3.00 ea. 50/\$2.75 - 100/\$2.50

- call for particulars -

### Qume S/5 - Daisy Wheel Printer

Sprint 5/45 RO ..... \$2699

Sprint 5/55 RO ..... 2829

Sprint 5/45 KSR ..... 3029

Sprint 5/55 KSR ..... 3159

Forms Tractor ..... 210

Pinfeed platen ..... 155

Paper Guide ..... 30

Paper Basket ..... 50

many print wheels, ribbons, & more available.

Terms of sale: cash or checks, purchase orders from qualified firms and institutions. Minimum order \$25. CA residents add 6% tax. Prices subject to change without notice. All goods subject to prior sale. Minimum shipping/handling charge \$4.00.

## Electrolabs

POB 4436, Stanford, CA 94305 (415) 321-5601

# MICROPROCESSOR SUPPORT I.C.'S

## WE GUARANTEE FACTORY PRIME PARTS

|                   |                        |                            |                   |                        |
|-------------------|------------------------|----------------------------|-------------------|------------------------|
| <b>2716 EPROM</b> | <b>1-9 10 &amp; UP</b> | <b>2708 EPROM 3 SUPPLY</b> | <b>2732 EPROM</b> | <b>1-9 10 &amp; UP</b> |
| HITACHI +5        | 7.00 6.00              | AMERICAN MICRO DEVICES     | INTEL             | 17.00 16.00            |
| INTEL +5          | 9.50 8.00              | AM2708DC                   | MITSUBISHI        | 16.00 15.00            |
| MOTOROLA +5       | 7.00 6.00              | 1-24 25-99 100 & UP        | NEC               | 16.00 15.00            |
| NATIONAL +5       | 7.00 6.00              | 3.50 3.20 2.90             |                   |                        |
| TI                | 3 Supply 7.50 6.00     |                            |                   |                        |

|                            |                    |                         |                |                     |      |
|----------------------------|--------------------|-------------------------|----------------|---------------------|------|
| <b>16K x 1 DYNAMIC RAM</b> |                    | <b>2114L STATIC RAM</b> |                | <b>74LS SPECIAL</b> |      |
| NEC                        | UPD 416C-2 200NS   | 1K x 4                  | 31- 100 & UP   | LS175               | .75  |
| 1-31                       | 2.50 100-499 2.10  | HITACHI 200NS           | 2.85 2.60 2.35 | LS240               | 1.15 |
| 32-99                      | 2.30 500 & UP 1.90 | INTEL 200NS             | 3.00 2.85 2.70 | LS241               | 1.15 |
|                            |                    | NEC 250NS               | 3.00 2.85 2.70 | LS244               | 1.00 |
|                            |                    |                         |                | LS245               | 1.95 |
|                            |                    |                         |                | LS373               | 1.15 |

|                  |            |           |             |             |              |              |
|------------------|------------|-----------|-------------|-------------|--------------|--------------|
| Z80-P10 6.00     | 8755 49.95 | 4050 .69  | 4531 .99    | 74C925 6.95 | 74LS107 .45  | 74LS244 1.00 |
| Z80A-P10 7.10    | 4000 .35   | 4051 1.10 | 4532 1.25   | 74LS00 .35  | 74LS109 .45  | 74LS245 1.95 |
| Z80-CTC 6.00     | 4001 .35   | 4052 1.10 | 4539 .99    | 74LS01 .28  | 74LS112 .49  | 74LS247 1.10 |
| Z80ACTC 7.10     | 4002 .35   | 4053 1.10 | 4543 1.99   | 74LS02 .28  | 74LS122 .55  | 74LS248 1.10 |
| Z80-DMA 18.50    | 4006 1.39  | 4055 3.95 | 4553 3.50   | 74LS03 .28  | 74LS123 1.19 | 74LS249 1.69 |
| Z80A-DMA 22.50   | 4007 .29   | 4056 2.95 | 4555 .75    | 74LS04 .39  | 74LS125 1.35 | 74LS251 1.79 |
| Z80-S10/0 18.50  | 4008 1.39  | 4059 9.95 | 4556 .75    | 74LS05 .28  | 74LS126 .89  | 74LS253 .98  |
| Z80A-S10/0 22.50 | 4009 .49   | 4060 1.39 | 4581 1.99   | 74LS08 .39  | 74LS132 .79  | 74LS257 .98  |
| Z80-S10/1 18.50  | 4010 .49   | 4066 .75  | 4582 1.01   | 74LS09 .39  | 74LS136 .59  | 74LS268 .98  |
| Z80A-S10/1 22.50 | 4011 .35   | 4068 .35  | 4584 .55    | 74LS10 .28  | 74LS138 .89  | 74LS259 2.95 |
| Z80-S10/2 18.50  | 4012 .29   | 4069 .35  | 4585 .99    | 74LS11 .39  | 74LS139 .89  | 74LS260 .69  |
| Z80A-S10/2 22.50 | 4013 .49   | 4070 .49  | 4702 9.95   | 74LS12 .39  | 74LS145 1.25 | 74LS261 2.49 |
| 3205 3.95        | 4014 1.39  | 4071 .35  | 74C00 .39   | 74LS13 .47  | 74LS148 1.49 | 74LS266 .59  |
| 3242 10.00       | 4015 1.15  | 4072 .35  | 74C02 .39   | 74LS14 1.25 | 74LS151 .79  | 74LS273 1.75 |
| 8156 11.25       | 4016 .59   | 4073 .35  | 74C04 .39   | 74LS15 .39  | 74LS153 .79  | 74LS275 4.40 |
| 8185 29.95       | 4017 1.19  | 4075 .35  | 74C08 .49   | 74LS20 .26  | 74LS155 1.19 | 74LS279 .59  |
| 8185-2 39.95     | 4018 .99   | 4076 1.29 | 74C10 .49   | 74LS21 .38  | 74LS156 .99  | 74LS283 1.10 |
| 8202 45.00       | 4019 .49   | 4078 .35  | 74C14 1.65  | 74LS22 .38  | 74LS157 .99  | 74LS290 1.29 |
| 8205 3.95        | 4020 1.19  | 4081 .35  | 74C20 .39   | 74LS26 .39  | 74LS158 .75  | 74LS293 1.95 |
| 8212 2.00        | 4021 1.19  | 4082 .35  | 74C30 .39   | 74LS27 .39  | 74LS160 .98  | 74LS295 1.10 |
| 8214 3.95        | 4022 1.15  | 4085 1.95 | 74C32 .99   | 74LS28 .39  | 74LS161 1.15 | 74LS298 1.29 |
| 8216 1.85        | 4023 .38   | 4086 .79  | 74C42 1.85  | 74LS30 .26  | 74LS162 .98  | 74LS324 1.75 |
| 8224 2.65        | 4024 .79   | 4093 .99  | 74C48 2.39  | 74LS32 .39  | 74LS163 .98  | 74LS347 1.95 |
| 8226 1.85        | 4025 .38   | 4099 2.25 | 74C73 .85   | 74LS37 .79  | 74LS164 1.19 | 74LS348 1.95 |
| 8228 5.00        | 4026 2.50  | 4104 1.99 | 74C74 .85   | 74LS38 .39  | 74LS165 .89  | 74LS352 1.65 |
| 8238 5.45        | 4027 .65   | 4501 .39  | 74C85 2.49  | 74LS42 .79  | 74LS166 2.49 | 74LS353 1.66 |
| 8243 4.65        | 4028 .85   | 4502 1.65 | 74C89 4.95  | 74LS47 .79  | 74LS170 1.99 | 74LS363 1.49 |
| 8251A 5.55       | 4029 1.29  | 4503 .69  | 74C90 1.85  | 74LS48 .79  | 74LS173 .89  | 74LS365 .99  |
| 8253 9.85        | 4030 .45   | 4505 8.95 | 74C93 1.85  | 74LS51 .26  | 74LS174 .99  | 74LS366 .99  |
| 8255A 5.40       | 4031 3.25  | 4506 .75  | 74C95 1.85  | 74LS54 .35  | 74LS175 .75  | 74LS367 .73  |
| 8255A-5 5.40     | 4032 2.15  | 4507 .95  | 74C107 1.19 | 74LS55 .35  | 74LS181 2.20 | 74LS368 .73  |
| 8257 9.25        | 4033 2.15  | 4508 3.95 | 74C151 2.49 | 74LS73 .45  | 74LS190 1.15 | 74LS373 1.15 |
| 8257-5 9.25      | 4034 3.25  | 4510 1.39 | 74C154 3.50 | 74LS74 .59  | 74LS191 1.15 | 74LS374 2.75 |
| 8259A 7.30       | 4035 .95   | 4511 1.39 | 74C157 2.10 | 74LS75 .68  | 74LS192 .98  | 74LS375 .69  |
| 8271 60.00       | 4037 1.95  | 4512 1.39 | 74C160 2.39 | 74LS76 .45  | 74LS193 .98  | 74LS377 1.95 |
| 8275 32.95       | 4040 1.29  | 4514 3.95 | 74C161 2.30 | 74LS78 .65  | 74LS194 1.15 | 74LS385 1.95 |
| 8279 10.80       | 4041 1.25  | 4515 3.95 | 74C163 2.39 | 74LS83 .99  | 74LS195 .95  | 74LS386 .65  |
| 8279-5 10.80     | 4042 .95   | 4516 1.69 | 74C164 2.39 | 74LS85 1.19 | 74LS196 .89  | 74LS390 1.95 |
| 8282 6.70        | 4043 .85   | 4519 .99  | 74C173 2.59 | 74LS86 .45  | 74LS197 .89  | 74LS393 1.95 |
| 8283 6.70        | 4044 .85   | 4520 1.39 | 74C174 2.75 | 74LS90 .75  | 74LS221 1.49 | 74LS395 1.70 |
| 8284 5.85        | 4046 1.75  | 4522 .99  | 74C175 2.75 | 74LS92 .75  | 74LS240 1.15 | 74LS399 2.95 |
| 8286 6.70        | 4047 1.25  | 4526 1.15 | 74C192 2.39 | 74LS93 .75  | 74LS241 1.15 | 74LS424 2.95 |
| 8287 6.70        | 4048 .99   | 4527 1.75 | 74C193 2.39 | 74LS95 .88  | 74LS242 1.95 | 74LS668 1.75 |
| 8288 25.40       | 4049 .69   | 4528 .99  | 74C195 2.39 | 74LS96 .98  | 74LS243 1.85 | 74LS670 2.29 |
| 8289 49.95       |            |           |             |             |              |              |

**MINIMUM ORDER \$10.00**  
**INCLUDE \$3.00 FOR U.P.S. GROUND**  
**\$4.00 FOR UPS BLUE or 1st CLASS MAIL**  
 Washington State Add 5.4% Sales Tax  
 (800-426-2668)

**HANLEY ENGINEERING**  
 (206) 643-0792  
 13400 NORTHUP WAY #22  
 BELLEVUE, WASHINGTON 98005

**FOR THE FINEST IN MICROPROCESSOR SUPPORT I.C.'S**

# SUNNY LOW LOW COST POWER SUPPLIES FOR S-100, FLOPPY DISKS.



**KIT 1, 2 & 3** For S-100

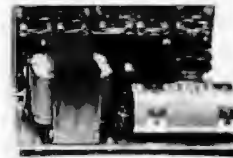

**R3** For Three 8" or 5 1/4" Disk Drives



**S3** 2 in 1 Unit for S-100 and two 8" or 5 1/4" Disk Drives. It fits most Disk System Mainframes.

## S-100 POWER SUPPLY KITS (OPEN FRAME WITH BASE PLATE, 3 HRS. ASSY. TIME)

| ITEM  | USED FOR        | @ + 8 Vdc | @ - 9 Vdc | @ + 16 Vdc | @ - 16 Vdc | @ + 28 Vdc | SIZE W x D x H    | PRICE |
|-------|-----------------|-----------|-----------|------------|------------|------------|-------------------|-------|
| KIT 1 | 15 CARDS SOURCE | 15A       |           | 2.5A       | 2.5A       |            | 12" x 5" x 4 7/8" | 52.95 |
| KIT 2 | SYSTEM SOURCE   | 25A       |           | 3A         | 3A         |            | 12" x 5" x 4 7/8" | 59.95 |
| KIT 3 | DISK SYSTEM     | 15A       | 1A        | 2A         | 2A         | 4A         | 14" x 6" x 4 7/8" | 67.95 |

## DISK DRIVE POWER SUPPLY "R3" REGULATED, OPEN FRAME, ASSY. & TESTED ..... 67.95

SPECS + 5V @ 5A OVP, -5V @ 1A + 24V @ 5A. SHORTS PROTECT 2 SIZES AVAIL 1) 9" (W) x 6 1/4" (D) x 4 3/8" (H) 2) 9" (W) x 4 7/8" (D) x 5 1/4" (H)  
OPTION 1) REPLACE + 24V BY + 12V 2) FOR SIZE 1 ONLY ADD + 12V @ 1A. AT AN ADDITIONAL \$12.00  
IDEAL FOR THREE 8" or 5 1/4" FLOPPY DISK DRIVES SUCH AS SHUGART 801/851 SIEMANS FDD 100-8/200-8 OR 100-5 ETC

## DISK SYSTEM PWR SUPPLY "S3" OPEN FRAME, ASSY & TESTED. COMPACT SIZE. 10 (W) x 6 (D) x 5" (H) 92.95

REGULATED OUTPUTS FOR DISK DRIVES + 5V @ 4A, 5V @ 1A + 24V @ 4A (OR + 12V @ 4A) SHORTS PROTECT  
UNREGULATED OUTPUTS FOR S-100 -8V @ 14A + 16V @ 3A (OPTION ADD OVP FOR +5V ADD \$5.00)  
A COMPLETE UNIT FOR DISK SYSTEM WITH THE MAINFRAME CONTAINING 12 SLOTS & TWO 8" or 5 1/4" DISK DRIVES

## POWER TRANSFORMERS (WITH MOUNTING BRACKETS)

| ITEM | PRIMARY | SECONDARY #1   | SECONDARY #2     | SECONDARY #3   | SIZE W x D x H           | PRICE |
|------|---------|----------------|------------------|----------------|--------------------------|-------|
| T1   | 110/120 | 2 x 8 Vac, 15A | 28 Vac, CT, 2.5A |                | 3 1/4" x 3 3/8" x 3 1/4" | 21.95 |
| T2   | 110/120 | 2 x 8 Vac, 25A | 28 Vac, CT, 3.5A |                | 3 1/4" x 4 3/8" x 3 1/4" | 27.95 |
| T3   | 110/120 | 2 x 8 Vac, 15A | 28 Vac, CT, 2.5A | 48 Vac, CT, 2A | 3 1/4" x 4 3/8" x 3 1/4" | 29.95 |
| T4   | 110/120 | 2 x 8 Vac, 6A  | 28 Vac, CT, 1.5A | 48 Vac, CT, 3A | 3 3/4" x 3 3/8" x 3 1/4" | 22.95 |
| T5   | 110/120 | 2 x 8 Vac, 8A  | 28 Vac, CT, 2A   |                | 3" x 3" x 2 1/4"         | 14.95 |

SHIPPING For each power supply \$5.50 in Calif., \$7.50 in other states, \$14.00 in Canada.  
For each Transformer \$5.00 in all States, \$10.00 in Canada. Calif. Residents add 6% Sales Tax

MAILING ADDRESS:  
P.O. BOX 4296  
TORRANCE, CA 90510  
TELEX: 830-5010  
ANSWER BACK FOR TELEX SUNYCO TRUC

SUNNY INTERNATIONAL  
(TRANSFORMERS MANUFACTURER)  
(213) 328-2425 MON-SAT 9-6

SHIPPING ADDRESS:  
22129 1/2 S. VERMONT AVE  
TORRANCE, CA 90502



CALIFORNIA COMPUTER SYSTEMS

- \$100**
- 2032 32K STATIC RAM A & T.
  - 450 NSEC. \$579.00, 300 NSEC. \$585.00, 200 NSEC. \$629.00
  - 2116 16K STATIC RAM A & T.
  - 450 NSEC. \$285.00, 300 NSEC. \$289.00, 200 NSEC. \$329.00
  - 2085 64K DYNAMIC RAM A & T. .... \$548.95
  - 2200 S-100 MAIN FRAM A & T. .... \$379.95
  - 2422 FLOPPY DISC WITH CP/M 2.2" .... \$329.95
  - 2802 6502 PROCESSOR A & T. .... \$282.95
  - 2810A Z80 CPU A & T. .... \$249.95
  - 2710A 4 SERIAL I/O A & T. .... \$291.95
  - 2710A 2 SERIAL, 2 PARALLEL A & T. .... \$305.95
  - 2720A 4 PARALLEL A & T. .... \$214.95
  - PROTO BOARDS WW. .... \$39.95, SOLDETAIL. .... \$29.95

**APPLE PRODUCTS**

- 7114A 12K ROM/PROM. .... \$68.50
- 7424A CALENDAR/CLOCK. .... \$106.95
- 7440A PROGRAMMABLE TIMER. .... \$98.50
- 7470A A TO O CONVERTER. .... \$105.95
- 7490A GPIB (IE 488) INTERFACE. .... \$265.95
- 7710A ASYNC SERIAL. .... \$125.95
- 7712A SYNC SERIAL. .... \$153.95
- 7720A PARALLEL STANDARD. .... \$98.95
- 7720B PARALLEL CENTRONICS. .... \$98.95
- 7811B ARITHMETIC PROCESSOR W/DISC. .... \$342.95
- 7811C ARITHMETIC PROCESSOR W/ROM. .... \$342.95
- 7500A WW BOARD. .... \$22.95
- 7610A SOLDETAIL BOARD. .... \$23.95

**SOFTWARE**

- 2810 CP/M™ MACRO ASSEMBLER ON DISK. .... \$76.95
- 2820 CP/M™ SYMBOLIC INSTRUCTION DEBUGGER. .... \$64.25
- 2830 CP/M™ TEXT FORMATER. .... \$64.25
- 2840 CP/M™ BACKGROUND PRINT UTILITY. .... \$42.95

OTHER CCS PRODUCTS ARE AVAILABLE.  
CALL FOR PRICE.



MICROCOMPUTER PRODUCTS

**\$100 PRODUCTS**

- CB1A 6080 PROCESSOR PCBD. .... \$32.95
- KIT. .... \$155.95, A & T. .... \$215.95
- CB-2 280 PROCESSOR BOARD
- KIT. .... \$198.95, A & T. .... \$269.95
- VBIC 64 x 16 VIDEO, PCBD. .... \$32.95
- KIT. .... \$153.95, A & T. .... \$199.95
- VB2 64 x 16 VIDEO, PCBD. .... \$32.95
- KIT. .... \$175.95, A & T. .... \$234.95
- VB3 80 CHARACTER VIDEO 4MHZ
- KIT. .... \$345.95, A & T. .... \$425.95
- UPGRADE RAMS FOR VB-3. .... \$42.00
- 104 2 PARALLEL, 2 SERIAL, PCBD
- KIT. .... \$155.95, A & T. .... \$194.95
- PB-1 2708, 2716 PROGRAMMER BOARD.
- KIT. .... \$135.95, A & T. .... \$185.95
- MB-10 16K STATIC RAM.
- KIT. .... \$299.95, A & T. .... \$339.95

**APPLE PRODUCTS**

- A488 IEEE 488 INTERFACE. .... \$399.95
- A10 SERIAL/PARALLEL INTERFACE
- KIT. .... \$125.95, A & T. .... \$155.95
- A810 SERIAL I/O
- KIT. .... \$87.95, A & T. .... \$97.95
- API0 PARALLEL I/O
- KIT (W/O CABLES) \$67.95, A & T (W/O CABLES) \$87.95

OTHER SSM PRODUCTS ARE AVAILABLE.  
CALL FOR PRICES.



MONDAY-FRIDAY, 8:00 TO 12:00, 1:00 TO 5:30  
THURSDAYS, 8:00 TO 8:00 P.M.  
(415) 728-9121  
P.O. BOX 955 • EL GRANADA, CA 94018  
PLEASE SEND FOR IC, XISTOR AND COMPUTER PARTS LIST

**AUG. SPECIAL SALE  
ON PREPAID ORDERS**

(CHARGE CARDS AND C.O.D. OR P.O. NOT AVAILABLE ON THESE OFFERS)

- MEM-3 KIT LESS RAM ..... \$89.95
- IOB-1 KIT ..... \$99.95



- MEM-3 32K STATIC RAM, PCBD. .... \$36.95
- KIT LESS RAM. .... \$95.95, A & T. .... \$135.95
- CPU-2 280 PROCESSOR, PCBD. .... \$32.95
- KIT LESS ROM. .... \$109.95, A & T. .... \$149.95
- EPM-2 16K/32K EPROM, PCBD. .... \$32.95
- KIT LESS ROM. .... \$65.95, A & T. .... \$98.95
- FPB-1 FRONT PANEL, PCBD. .... \$48.50
- KIT. .... \$144.95, A & T. .... \$184.95
- CPU-1 8080 PROCESSOR, PCBD. .... \$29.95
- KIT. .... \$89.95, A & T. .... \$129.95
- QMB-12 13 SLOT MOTHER BOARD, PCBD. .... \$39.95
- KIT. .... \$95.95, A & T. .... \$135.95

OTHER WAMECO PRODUCTS ARE AVAILABLE.  
CALL FOR PRICES.

MIKOS PARTS ASSORTMENTS ARE ALL FACTORY MARKED PARTS. KITS INCLUDE ALL PARTS LISTED AS REQUIRED FOR THE COMPLETE KIT LESS PARTS LISTED ALL SOCKETS INCLUDED

LARGE SELECTION OF LS TTL AVAILABLE.  
PURCHASE \$50.00 WORTH OF LS TTL AND GET 10% CREDIT TOWARD ADDITIONAL PURCHASES. PREPAID ORDERS ONLY

VISA or MASTERCARD: Send account number, interbank number, expiration date and sign your order. Approx. postage will be added. Check or money order will be sent post paid in U.S. If you are not a regular customer, please use charge, cashier's check or postal money order. Otherwise there will be a two-week delay for checks to clear. Calif. residents add 6% tax. Money back 30-day guarantee. We cannot accept returned IC's that have been soldered to. Prices subject to change without notice. \$10 minimum order. \$1.50 service charge on orders less than \$10.00.

**NEW SAVE \$1500**

**QT SYSTEM H+**



SYSTEM H+ and SYSTEM+

31 M Byte hard disk  
2 MHz Z-80A, 4 serial, 2 parallel  
32K Ram useable per user  
CP/M multi-user DOS  
Backup: 1 MByte floppy  
Soon: Optional tape cartridge

|        |          |          |
|--------|----------|----------|
|        | Let      | Now Only |
| YS H+1 | \$12,750 | \$11,250 |
| YS H+2 | 13,250   | 11,750   |
| YS H+3 | 13,750   | 12,250   |
| YS H+4 | 14,250   | 12,750   |

**QT SYSTEM+**

2 MHz Z-80A, 2 serial, 2 parallel  
8" floppies, double density  
64K Ram, EPROM monitor for RS-232  
CP/M 2.2  
Optional 6, 8, or 12 slot motherboard  
Optional single or double-sided floppies  
Burned in—just add video terminal

**QT MINI-SYSTEM+**



Above with 5 1/4" floppies

|             |       |             |       |
|-------------|-------|-------------|-------|
| YS-SS(6)    | \$395 | SYS-DS(8)   | \$445 |
| YS-SS(8)    | 395   | SYS-DS(8)   | 455   |
| YS-SS(12)   | 375   | SYS-DS(12)  | 465   |
| MSYS-SS(6)  | \$245 | MSYS-DS(6)  | \$275 |
| MSYS-SS(8)  | 255   | MSYS-DS(8)  | 285   |
| MSYS-SS(12) | 265   | MSYS-DS(12) | 295   |

Special Offer: 2 Boxes of Diskettes Free with any System+ or Mini-system+

**2 MBYTE FLOPPY FOR APPLE**



double density, double sided 8" drives  
Cabinet, power supply, cable, controller  
DOS 3.3 compatible (Pascal and CP/M optional)  
This package is best, spec for spec, price for price.  
Suggested List ... \$2550 Now Only ... \$2050  
SAVE \$500 CP/M Patch \$75 Pascal Patch \$75

**QT DISK PACKAGES**



|             |                            |        |
|-------------|----------------------------|--------|
| DC-88-2     | 2-801R, cab., ps, fan      | \$1250 |
| DC-88-22    | 2-Cuma DT-8, cab., ps, fan | 1675   |
| DC-88-3     | Cabinet, ps, fan, cables   | 325    |
| DC-88-4     | Cabinet only               | 58     |
| August 801R |                            | \$380  |
| June DT-8   |                            | 585    |
| 7 B-51      |                            | 250    |
| 7 B-52      |                            | 350    |

**ADES S-100 HARD DISK**



PRIAM 3350 8" Winchester  
31 MByte with CP/M 2.2  
With S-100 controller  
Cables, cabinet, power supply

|         |     |        |
|---------|-----|--------|
| 33 List | Now | \$3650 |
|---------|-----|--------|

**QT SBC+2/4 S-100 Single Board Computer**

2-80A, 2 or 4 MHz, switch  
16K Ram, 1 parallel, 1 serial  
EPROM monitor (specify)  
DMA, programmable timers

|     |       |     |       |
|-----|-------|-----|-------|
| Kit | \$195 | A&T | \$300 |
|-----|-------|-----|-------|

**QT Z+80 CPU**

- 2 or 4 MHz, switch
- Monitor with jump
- Serial port to 9600 baud

|     |       |     |       |
|-----|-------|-----|-------|
| Kit | \$185 | A&T | \$225 |
|-----|-------|-----|-------|

**QT CLOCK/CALENDAR+ Apple, S-100, TRS-80 (Specify)**

- Date, month, year
- Day of week, leap year
- 24 hour or AM-PM
- 4 interrupt intervals
- With software
- Now with on-board battery

|                 |       |
|-----------------|-------|
| S-100/Apple/TRS | \$150 |
|-----------------|-------|

**QT EXPANDABLE + REV II S-100 64K Dynamic RAM**

- 2 or 4 MHz, switch
- Bank switch, IEEE Standard
- On board refresh, 4 layer PC
- Burned in, tested.

|        |       |        |       |
|--------|-------|--------|-------|
| EXP+16 | \$299 | EXP+48 | \$379 |
| EXP+32 | 339   | EXP+64 | 409   |

(Less \$40—kit)

**QT RAM+16 16K Static, S-100**

- Bank switchable RAM
- Thousands of happy customers

|     |      |          |       |          |       |
|-----|------|----------|-------|----------|-------|
| Kit | \$35 | 4MHz Kit | \$180 | 4MHz A&T | \$210 |
|-----|------|----------|-------|----------|-------|

**QT I/O+ S-100 4 Parallel, 2 Serial**

- On board crystal
- Prog. baud
- 16 prog. timers
- 6 level prog. interrupt

|     |       |     |       |
|-----|-------|-----|-------|
| Kit | \$235 | A&T | \$375 |
|-----|-------|-----|-------|

**QT SILENCE+ S-100 Motherboards**

- Full ground shield network
- Specify board, kit, or assembled

|      |      |      |      |      |      |
|------|------|------|------|------|------|
| 8-B  | \$25 | 8-B  | \$27 | 12-B | \$30 |
| 8-K  | 40   | 8-K  | 55   | 12-K | 70   |
| 8-A  | 50   | 8-A  | 70   | 12-A | 90   |
| 18-B | \$50 | 22-B | \$75 |      |      |
| 18-K | 100  | 22-K | 140  |      |      |
| 18-A | 140  | 22-A | 190  |      |      |

**QT MAINFRAMES**

- 18A power supply, S-100
- Drive power supply
- Specify motherboard slots
- Specify 8", 5 1/4" or no floppy

|                               |       |
|-------------------------------|-------|
| 2-8" Floppy w/motherboard     |       |
| MF8-6                         | \$625 |
| MF8-8                         | 650   |
| MF8-12                        | 675   |
| 2-5 1/4" Floppy—w/Motherboard |       |
| MF6-6                         | \$450 |
| MF5-12                        | 500   |
| No Floppy—w/Motherboard       |       |
| MF-12                         | \$450 |
| MF-18                         | 500   |
| MF-22                         | 600   |

**QT SINGLE 8" CABINET**

- Accepts one 8" floppy
- Power supply, fan, AC filter
- 117V AC/220V AC
- Data cable, power cables

|     |       |     |       |
|-----|-------|-----|-------|
| Kit | \$195 | A&T | \$300 |
|-----|-------|-----|-------|

**QT S-100 CARD CAGES**



- 6, 8 or 12 slot
- Accepts silence 1 mother
- With card guides
- Accepts 4" fan
- Specify with mother, with fan

|                                  |      |
|----------------------------------|------|
| 6 Slot (5 1/4" x 10 1/4" x 8")   |      |
| CC+6                             | \$24 |
| CC+6M                            | 90   |
| CC+6M/F                          | 115  |
| 8 Slot (7 1/4" x 10 1/4" x 8")   |      |
| CC+8                             | \$39 |
| CC+8M                            | 99   |
| CC+8M/F                          | 134  |
| 12 Slot (11 1/4" x 10 1/4" x 8") |      |
| CC+12                            | \$61 |
| CC+12M                           | 114  |
| CC+12M/F                         | 149  |

**XYMEC HY-Q 1000 Daisywheel Printer/Typewriter**



- Bold, underline, reverse, right justify, center
- 10, 12 and 15 pitch
- Automatic error correction
- 15 character display
- Fast, nationwide service
- Save \$400

|                 |        |
|-----------------|--------|
| Parallel        | \$2450 |
| RS-232          | 2675   |
| IEEE-488 (GPIB) | 2525   |
| Tractor         | 325    |

**STARWRITER 25CPS**



- Daisywheel printer, Centronics parallel interface
- Same as Vista V-300
- Nationwide service

|                |        |          |        |
|----------------|--------|----------|--------|
| Suggested List | \$1895 | Now Only | \$1550 |
|----------------|--------|----------|--------|

SAVE \$345

**IDS PAPER TIGERS**

|       |       |
|-------|-------|
| #445  | \$710 |
| #460G | 1050  |
| #560G | 1300  |

**NEC SPINWRITER 55CPS**

- Receive only, serial interface

|      |        |
|------|--------|
| Only | \$2500 |
|------|--------|

**NEW ADDS VIEWPOINT Smart CRT Terminal**

- 80 x 24
- Detachable keyboard

The Best for Less ... \$650

**SD SYSTEMS 20%+ Discount on A&T**



All SD items available.

|       |                           |       |
|-------|---------------------------|-------|
| 38007 | Z-80 Starter Board        | \$424 |
| 38013 | VDB-8024 (80 Hz)          | 444   |
| 38020 | Expandoram II-16K         | 310   |
| 38023 | Expandoram II-84K         | 370   |
| 38025 | PROM 100                  | 248   |
| 38059 | Versafloppy II (RS-232)   | 400   |
| 38060 | Versafloppy II (VDB-8024) | 400   |
| 38061 | SBC-200 (VDB-8024)        | 376   |
| 38062 | SBC-200 (RS-232)          | 376   |

Call for kit, software, and cable prices.

**CALIFORNIA COMPUTER SYSTEMS**

15% Discount

All CCS items available

|       |                    |       |
|-------|--------------------|-------|
| S-100 | 32K Static - 2 MHz | \$551 |
| 2032A | 32K Static - 4 MHz | 841   |
| 2032B | 16K Static - 2 MHz | 297   |
| 2116A | 16K Static - 4 MHz | 331   |
| 2116B | Mainframe          | 368   |
| 2200A | System             | 1500  |
| 2210A | Floppy Controller  | 380   |
| 2422A | 4-Port Serial      | 289   |
| 2710A |                    |       |

**APPLE**

|       |                        |      |
|-------|------------------------|------|
| 7114A | 12K ROM/PROM Board     | \$69 |
| 7440A | Programmable Timer     | 97   |
| 7470A | A/D Converter          | 102  |
| 7490A | GP1B IEEE-488          | 255  |
| 7500A | Wire Wrap Board        | 20   |
| 7510A | Solder Tail Board      | 21   |
| 7520A | Extender Board         | 25   |
| 7710A | Serial Async Board     | 139  |
| 7728A | Centronics Parallel Bd | 105  |
| 7811B | Arith Processor - disk | 355  |
| 7811C | Arith Processor - ROM  | 355  |

**TELETEK**

|       |                           |       |
|-------|---------------------------|-------|
| FDC-1 | Single Board Computer     | \$685 |
| FDC-2 | Double Density Controller | 325   |

**INTEGRATED CIRCUITS**

|              |        |           |       |
|--------------|--------|-----------|-------|
| 4116 (200ns) | \$2.00 | 8257      | 17.95 |
| 2114 (450ns) | 2.00   | 8285      | 16.50 |
| 2708         | 3.50   | MC14411   | 11.00 |
| 2716 (5V)    | 6.50   | 14411Xtal | 4.95  |
| 2716 (5-12V) | 8.00   | 1771801   | 24.95 |
| 2732         | 13.00  | 1781A01   | 37.95 |
| 4164 (200ns) | 25.00  | 82350     | 7.95  |
| Z-80A        | 12.95  | N8T26     | 2.50  |
| 6080A        | 3.50   | 1488      | 1.25  |
| 8085A        | 20.00  | 1489      | 1.25  |
| 8086-4       | 60.00  | 80342     | 10.15 |
| TMS9900      | 29.95  | TMS5501   | 19.00 |
| 8212         | 3.50   | TR1802B   | 4.50  |
| 8214         | 4.50   | 8845P     | 22.00 |
| 8228         | 5.00   | 4118      | 16.95 |
| 8238         | 5.00   | DP8304BN  | 4.00  |
| 8251         | 7.00   |           |       |

**CABLES**

|                              |         |
|------------------------------|---------|
| RS-232- male/male - 9 ft.    | \$24.00 |
| RS-232 - male/male - 18 ft.  | 29.00   |
| RS-232 - male/female - 9 ft. | 29.00   |

**Floppy-Data-Card Edge Type SD • Jade**

|          |              |         |
|----------|--------------|---------|
| DSC-34-1 | Single, mini | \$24.00 |
| DSC-34-2 | Dual, Mini   | 29.00   |
| DSC-34-4 | Quad, Mini   | 34.00   |
| DSC-50-1 | Single, 8"   | 24.00   |
| DSC-50-2 | Dual, 8"     | 32.00   |
| DSC-50-4 | Quad, 8"     | 40.00   |

**Floppy-Data-Pin Type CCS • Tarbell • Teletek**

|          |              |         |
|----------|--------------|---------|
| DSP-34-1 | Single, Mini | \$24.00 |
| DSP-34-2 | Dual, Mini   | 29.00   |
| DSP-34-4 | Quad, Mini   | 34.00   |
| DSP-50-1 | Single, 8"   | 24.00   |
| DSP-50-2 | Dual, 8"     | 29.00   |
| DSP-50-4 | Quad, 8"     | 34.00   |

**8" Floppy-DG Power PDC-8 24" long \$7.00**

**ISOBAR Surge Suppressor/Power Strip**



- 4 receptacle, 16A

|         |         |
|---------|---------|
| IBAR4-6 | \$59.95 |
|---------|---------|

**CONNECTORS**

|         |        |        |        |
|---------|--------|--------|--------|
| IDD-25P | \$8.25 | DB25C  | \$1.50 |
| IDD-25S | 8.75   | IDS-20 | 2.75   |
| CEC-34  | 6.05   | IDS-26 | 3.50   |
| CEC-50  | 7.50   | IDS-34 | 4.50   |
| DB25P   | 3.50   | IDS-50 | 6.50   |
| DB25S   | 4.60   |        |        |

**ZIP DIP SOCKETS**

|        |        |
|--------|--------|
| ZIP-18 | \$5.50 |
| ZIP-24 | 7.50   |
| ZIP-40 | 10.25  |

Apple is a trademark of Apple Computer, Inc. CP/M and MP/M are trademarks of Digital Research. TRS-80 is a trademark of Radio Shack.

**BISON PRODUCTS**

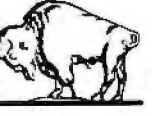

MAIL ORDER: PO Box Q, Sherman Oaks, CA 91423  
 RETAIL: 15620 S. Inglewood Ave., Lawndale, California 90260  
 (213) 970-1476 (800) 421-5150  
 TERMS OF SALE: Cash, checks, credit cards, C.O.D. Calif. residents add 6% sales tax.

Circle 35 on inquiry card.

## WRITE YOUR OWN COMPILERS IN PL/C

PL/C (Programming Language/Compilers) is the implementation a BNF superset as a high-level programming language.

Our Z80 version runs on a 32K CP/M system and generates TDL-format assembler code.

The PL/C Compiler, Runtime Library, and Compiler Source Code are shipped on an IBM-3740 format, CP/M compatible diskette. A license agreement must be completed. Lifetime single-CPU license fees are as follows:

\$1000 — PL/C Compiler, Runtime Library, Compiler PL/C Source, and PL/C Source Code for a PL/C Compiler Version which produces PROCESSOR-INDEPENDENT macro source.

\$5000 — As above, plus commented Assembler Source Code for the Compiler and Runtime Library.

A PL/C information package is available for \$25

**MRD Systems, Inc.**  
Box 147, Spring Valley, MN 55975

Circle 259 on Inquiry card.

## TRS-80 \*EPROM PROGRAMMER

|         |              |       |
|---------|--------------|-------|
| 08/16   | (bare board) | 30.95 |
| 16/32   | " "          | 30.50 |
| 16/2532 | " "          | 30.50 |

|       |            |       |
|-------|------------|-------|
| \$100 | 8088       | 44.95 |
| \$100 | Programmer | 44.95 |

\*TRS-80 is a trademark of the Tandy Corp.

**JWS ENGINEERING**  
Box 67  
Lebanon, NJ 08833

Circle 188 on Inquiry card.



## CROMEMCO USERS

**PMSI INTRODUCES**

A UNIQUE FINANCIAL REPORTING SYSTEM FOR SMALL BUSINESSES AND INDIVIDUALS

**BANKKEEPING \* REPORTER**

FOR — Offers Current Cash Flow Analysis and Complete SMALL Profit/Loss Picture for Each Month and BUSINESS Year To Date  
Adaptable to All Types of Business Forms Property Management and Investments

FOR — Provides a Unique Budget for Family INDIVIDUALS Expenditures for Current Month and Year To Date  
Supplies a Monthly Recap of Tax Deductible Items as Well as a Complete Listing of All Tax Deductible Items for the Entire Year

AVAILABLE FOR CDS05 - or CROMIK - FOR FLOPPY OR HARD DRIVE SYSTEMS

Perfect Package for CPA's, Bookkeeping Services Service Bureaus, Banks and Savings/Loans

PMSI PROVIDES SOFTWARE PACKAGES FOR CROMEMCO USERS

PRACTICAL MANAGEMENT SYSTEMS, INC.  
P O BOX 1301 2800 KING STREET  
JONESBORO, AR 72401  
501 932 8206

**DEALER DISCOUNTS AVAILABLE**

\* Registered trademark of Cromemco, Inc.  
† Registered trademark of Practical Management Systems, Inc.

Circle 313 on Inquiry card.



Agfa-Loaded  
**Cassettes**  
and Cassette Boxes  
for  
Software Producers  
& Duplicators

Ask for our Catalog  
**Poly** 312/298-5300  
1233 Rand Road • Des Plaines IL 60016

Circle 311 on Inquiry card.

## floppy disks.

100% CERTIFIED AND TESTED  
PREMIUM QUALITY



Immediate off the shelf delivery... one box or quantity orders welcome.

# SAVE UP TO 40%

WE PAY SHIPPING!

**CALL OUR ORDER DESK NOW!**

Western States: Los Angeles .. (213) 469-9661  
Phoenix ..... (602) 277-5766

Central States: Dallas ..... (214) 988-1885

All Others: ..... (805) 985-9824

MASTERCARD — VISA — C.O.D.

**NATIONAL DATA SUPPLIES, INC.**

Circle 264 on Inquiry card.

Attention "Electric Pencil 1" users

Introducing —  
**ZIP**

Mail list program. Searches for specific zip codes and zip sorts mailing lists on multiple disc files. Prints 1" x 3.5" labels. Designed to work on files created with "Electric Pencil 1" on single density drives, 8080 or Z-80 based computers. Very simple operation. Practically no list formatting required. Price: \$100. Supplied on 5 1/4" single density disc.

 **FRYE  
ELECTRONICS, INC.**

BOX 23391 • TIGARD, OREGON 97223 • U.S.A.

(503) 620-2722

Circle 142 on Inquiry card.



**200Ns**  
**16K DYNAMIC RAM SET**  
8 Chips for \$15.95  
LIMITED SUPPLY

These prime 4116's became available when a major corporation implemented a design change with several thousand in stock. These parts meet all the rigorous quality standards of one of America's most respected manufacturers and are fully guaranteed.

### DO NOT DELAY

- Expand your computer memory while supply lasts.
- Club and Quantity discounts available.
- Same day mailing when payment made with money order or cashier's check.

**Russo**  
P.O. Box 546  
Fox Lake, IL. 60020

- Include mailing address and \$2.00 per set for shipping and handling.

Circle 337 on Inquiry card.

## Convert your TRS-80 into a DEVELOPMENT SYSTEM

Z-80 In-Circuit emulation and EPROM/EEPROM programming in a single compact unit.

Debug stand-alone systems with program in TRS-80 RAM, then copy working program into PROM.

Only \$329 including personality module for 2716, 2516, 2758, 2508, 2532, 2816, 2808, 48016.

**ORION INSTRUMENTS**  
172 Otis Ave, Woodside, CA 94062  
(415) 851-1172



Circle 285 on Inquiry card.

## database manager for TRS-80 Model I

- CREATE random access disk files 15 fields or 255 bytes/record  
Files can span 4 disk drives  
Password protected file access
- Database DIRECTORY displays all user files and their attributes
- Powerful TRANSACTIONS — add, edit, read, delete & list records  
Efficient binary tree sorts
- Sophisticated QUERY with multi-key relational & logical operations
- REPORT formatter requires only for user to select desired fields  
Automatic sub & grand totals  
May be used with lower case
- Entirely MENU DRIVEN operation
- Extensive error trapping routines
- User oriented instruction manual
- Requires 32k — 2 disk drives

**Introductory price \$59.95**  
Visa and MasterCard accepted

**mentor software**  
816 McLane Ave — Morgantown, WV 26505  
Tandy Corp. Trademark

Circle 216 on Inquiry card.

## SPEECH SYNTHESIZERS

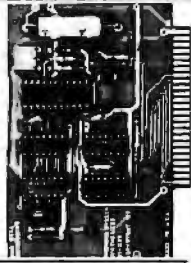

APPLE II®

**NEW**

Now you can have unlimited speech for your computer!

JBE's Speech Synthesizers use the Votrax® SC-01 Phoneme Synthesizer chip. The SC-01 phonetically synthesizes continuous speech of unlimited vocabulary. The SC-01 contains 84 different phonemes and 4 levels of inflection accessed by an 8 bit code. It requires 10 Bytes/sec. for continuous speech. Both Boards have an audio amp for direct connection to an 8Ω speaker.

### PARALLEL INPUT

Documentation includes basic user programs, a phoneme chart and a listing of coded words to help you get started.

Documentation for the Apple II® Speech Synthesizer includes a disk with many user programs.

\*Because of the high cost of the SC-01 at this time, it will be sold separately. In 10% way, as the price goes down, we can pass the savings on directly to you.

|  |                |
|--|----------------|
| 81-088 Apple II® Speech Synthesizer  | <b>\$79.95</b> |
| 81-120 Parallel Input Speech Synth. (On board power supply, Wall transformer included) | <b>\$89.95</b> |
| SC-01 Phoneme Synthesizer Chip   | <b>\$59.95</b> |

## EPROM EXPANSION CARD

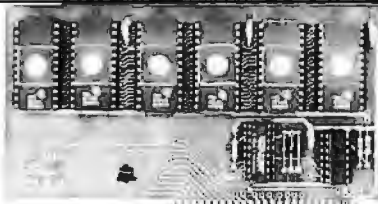

JBE EPROM Expander for the Apple II holds six 5 volt 2716s for a total of 12K bytes of ROM. This board takes the place of the on board ROM in the Apple. It is software switchable by the same technique used by the Apple® II firmware card. Solder jumpers are for reset to the Apple ROM or 2716s on the card. (EPROMs available separately). Use JBE EPROM programmer and parallel I/O cards to program your EPROMS.

|                    |                |
|--------------------|----------------|
| 81-085K Kit        | <b>\$49.95</b> |
| 81-085A Assm.      | <b>\$59.95</b> |
| 81-085B Bare Board | <b>\$39.95</b> |

## JBE I MICROCOMPUTER

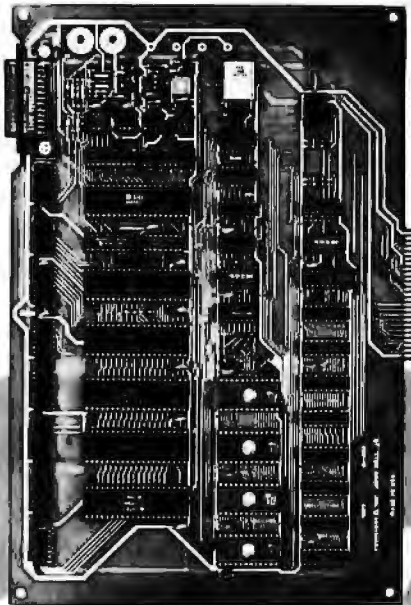

JBE's 7 3/4" x 11 3/4" 6502 base Microcomputer has the capacity for 16K of EPROM, 4K of RAM, 8 Parallel Ports and 1 Serial Port. Monitor and Tiny Basic are also available. The fully populated version includes:

- 1 6502 CPU
- 4 6522 VIA (8 Parallel I/O Ports)
- 1 AY5-1013 (Serial I/O Ports)
- 8 2114 RAM (4K)
- 2 2716 EPROM (monitor & tiny basic)

The partially populated version includes:

- 1 6502 CPU
- 1 6522 VIA (2 Parallel I/O Ports)
- 1 AY5-1013 (Serial I/O Port)
- 2 2114 RAM (1K)
- 1 2716 EPROM (with monitor)

Both versions include sockets for 4 2716s or 2732s, 8 16 pin sockets for I/O interfacing and a DB25 connector for RS232.

All address and data lines, power supply, RDY, Interrupts, DMA, phase 1 & phase 2 clock, RW, reset and NMI & IRQ are brought off the board to the 60 pin edge connector. (similar to the Apple II® bus)

This board also features power on reset and cassette interface.

Documentation includes basic programming manual & Complete doc. for the 6522 VIA. Also included is doc. for interfacing with JBE A-D & D-A Converter, Solid State Switches, EPROM Programmer & Parallel Input Speech Synthesizer.

|                                       |                 |
|---------------------------------------|-----------------|
| 81-030C Fully Populated JBE I         | <b>\$349.95</b> |
| 81-030M Partially Populated JBE I     | <b>\$249.95</b> |
| 81-030B Bare Board JBE I (Doc. Incl.) | <b>\$ 89.95</b> |
| 2716 EPROM (with monitor)             | <b>\$ 19.95</b> |
| 2716 EPROM (with tiny basic)          | <b>\$ 19.95</b> |

## A TO D CONVERTER

**NEW**

JBE's 16 channel A-D Converter plugs into your Apple II® Computer. It uses an ADC0817 which incorporates a 16 channel multiplexer and an 8 bit A-D Converter. The 16 inputs are high impedance and the voltage range is 0 to 5 volts. Conversion time is <100 μsec. The resolution is 8 bits or 256 steps, linearity is ± 1/2 step. Two 16 pin DIP sockets are used for Input, GND & reference voltage connections. There are 3 single bit TTL inputs. Doc. Includes sample program.

|                        |                |
|------------------------|----------------|
| 81-132B Bare Board     | <b>\$29.95</b> |
| 81-132K Kit            | <b>\$69.95</b> |
| 81-132A Assm. & Tested | <b>\$89.95</b> |

## REAL TIME CLOCK

**NEW**

JBE's Real Time Clock Card for the Apple II® computer has automatic leap year calculation, month & date and can time down to .1 sec. It uses an MM58174 Real Time Clock chip, has interrupt capability and has separate time intervals of 60 sec, 5 sec & .5 sec. An on board 2716 holds 8 user programs which are switch selectable. A 32768 Hz crystal is used for accuracy. On board battery will keep correct time for up to one year.

|                        |                 |
|------------------------|-----------------|
| 81-135B Bare Board     | <b>\$ 39.95</b> |
| 81-135K Kit            | <b>\$ 89.95</b> |
| 81-135A Assm. & Tested | <b>\$119.95</b> |

## EPROM SUBSTITUTION CARD

**NEW**

This board looks like RAM to the Apple® II and like an EPROM to the computer being programmed. It features 2K or 4K of RAM and emulates a 2716 or 2732. A 24 pin ribbon cable connects the computer being programmed to the EPROM sub. board. Documentation includes disk with basic & pascal utility routines including save, write, CMP, error checking. Complete Source Code User Manual also included. This board allows you to test programs without burning your EPROM. Three control lines from the board are used to control the computer being programmed (reset etc.)

|                              |                 |
|------------------------------|-----------------|
| 81-070K2 Kit - 2K RAM        | <b>\$149.95</b> |
| 81-070K4 Kit - 4K RAM        | <b>\$159.95</b> |
| 81-070A2 Assm. - 2K RAM      | <b>\$159.95</b> |
| 81-070A4 Assm. - 4K RAM      | <b>\$169.95</b> |
| Ribbon Cable with Connectors | <b>\$ 9.95</b>  |



# JOHN BELL ENGINEERING, INC.

ALL PRODUCTS ARE AVAILABLE FROM JOHN BELL ENGINEERING • P.O. BOX 338  
REDWOOD CITY, CA 94064 • ADD SALES TAX IN CALIFORNIA • ADD 5% SHIPPING & HANDLING

MC

(415) 367-1137

10% OUTSIDE U.S.A.

VISA

## SCR SUPER BUYS

**\$10<sup>00</sup> MIN. ORDER HANDLE/SHIP \$5<sup>00</sup>**

**UPS ANYWHERE IN CONTINENTAL U.S.**

- ① UHF VARACTOR-TUNER, Channels 14-83 (tunable 1/0=75 ohms. Power Gain=10-20 dB max. Complete with schematic and tech data. Brand new - surplus. **\$23<sup>95</sup>**
- ② NICAD 5 AA BATTERY PACK in shrink tube with solder tabs. Brand new - surplus. **\$6<sup>95</sup>**
- ③ CABLE TV CONVERTER. For conversion to mid-band and superband cable stations. Brand new and its LEGAL! **\$34<sup>95</sup>**
- ④ BRAND NAME POWER SUPPLIES ±5V/6A. Voltage adjustable and IC regulated. Ideal for CMOS, computer-based instruments, etc. use. Brand new - surplus. **\$23<sup>95</sup>**
- ⑤ MODULATOR. Video and sound input with 75 ohms output. Switchable to channels 3 or 4. Shielded case. Brand new - surplus. **\$16<sup>95</sup>**

**SCR ELECTRONICS INC. (714) 527-2554**  
9533 VALLEY VIEW, CYPRESS, CA 90630  
Pay by CHECK, M.O., VISA, MC, C.O.D.

Circle 341 on Inquiry card.

## EAST COAST COMPUTERS

22 ELM ST. WOBURN, MA 10801  
617-935-9309

|                             |        |
|-----------------------------|--------|
| VERBATIM 5" DISKETTES ..... | 25.00  |
| MEMOREX 5" DISKETTES .....  | 24.00  |
| SCOTCH 5" DISKETTES .....   | 27.00  |
| PLASTIC BOX .....           | 3.00   |
| LEEDEX MONITOR .....        | 129.00 |
| 16K MEMORY KIT .....        | 29.00  |
| D-CAT MODEM .....           | 179.00 |
| ATARI 400 .....             | 479.00 |
| MX-80 .....                 | 459.00 |
| MICROSOFT Z-80 CARD .....   | 289.00 |
| MICROSOFT RAM CARD .....    | 169.00 |

TERMS. MASTERCHARGE, VISA, CHECK, MONEY ORDER, U.S. FUNDS ONLY. MASS. RESIDENTS ADD SALES TAX. THE ABOVE PRICES DO NOT INCLUDE SHIPPING.

Circle 126 on Inquiry card.

## Time Machine II™

FOR YOUR 

### \$135 REAL TIME CLOCK AND CALENDAR

Introducing an intelligent real time clock and calendar peripheral for the Apple II:

- Read and set time routines in 2K EPROM driver.
- Counts seconds, minutes, hours, days, days of week, month and years.
- Six date formats including: 12-JUN-1981
- Two interrupt programs in EPROM.
- Nicad battery and applications diskette.
- Basic, Pascal, and Machine language compatible.

FOR FREE BROCHURE CALL (801) 486-4839



TRADemark OF APPLE COMPUTER CORPORATION

Circle 94 on Inquiry card.

## PASSWORD DISTRIBUTORS INC.

EVERY DAY'S A SALE DAY AT  
PASSWORD DISTRIBUTORS  
PASS THE WORD!

|   |                |
|---|----------------|
| <b>QUME DATATRAK 8</b>                                      | <b>545.00</b>  |
| <b>QUME DATATRAK 5</b>                                      | <b>315.00</b>  |
| INCLUDES EXTENDED ONE YEAR WARRANTY                         |                |
| <b>QUME SPRINT 9/45 PRINTER</b>                             | <b>2295.00</b> |
| INCLUDES 90 DAY WARRANTY FROM QUME                          |                |
| SERVICE CONTRACT AVAILABLE FROM GENERAL ELECTRIC AT 25% CO. |                |
| ACCESSORIES AVAILABLE - CALL FOR PRICING                    |                |
| <b>TELETEK FDC I CPU</b>                                    | <b>635.00</b>  |
| INCLUDES DOCUMENTATION                                      |                |
| EXTENDED ONE YEAR WARRANTY 80.00                            |                |
| SPECIALIZED BOARD CONFIGURATION 80.00                       |                |
| INCLUDES EXTENSIVE APPLICATION NOTES                        |                |
| <b>CHRISLIN 64K MEMORY BOARD</b>                            | <b>635.00</b>  |
| INCLUDES DOCUMENTATION                                      |                |
| EXTENDED ONE YEAR WARRANTY 80.00                            |                |
| <b>CABLES: PARALLEL, SERIAL, 8" &amp; 5.1" FLAT CABLES</b>  | <b>15.00</b>   |
| QUANTITY DISCOUNTS!   |                |
| IMMEDIATE DELIVERY!   |                |
| TERMS: CASH, CREDIT CARD, OR CASH ON DELIVERY               |                |
| UNTIL CREDIT IS ESTABLISHED                                 |                |
| ACTUAL PAYMENT CHARGES WILL BE ADDED TO ALL ORDERS          |                |
| GIVE US A CALL AT: (408) 425-6411                           |                |
| UNITED WINDOW REP KARADAWY LTD PHONE (925) 512-2522         |                |

1320 RIVER STREET  
SAN ANTONIO, TEXAS 78204

Circle 301 on Inquiry card.

## FULLY AUTOMATED BARCHARTS

Use the TBAR program with your CP/M system and Diablo printer to produce fully automated bar-charts. Produce professional quality charts in two colors with many special symbols and features.

Price: \$175.00

**JMCA Software, Inc.**  
4717 University Dr., NW  
Suite 106  
Huntsville, AL 35805

Circle 185 on Inquiry card.

## Heath/Zenith 89 Users

### 16K MEMORY EXPANSION CARD

to make a H/Z89 a 64K machine. Assembled and Tested **\$100.00**



### COMPUTER TABLES

|              |                 |
|--------------|-----------------|
| 60 x 28 x 28 | <b>\$186.40</b> |
| 48 x 28 x 28 | <b>\$162.40</b> |

Shelves Available

**PRINTER STAND \$75.00**



AUTHORIZED SERVICE CENTER

### SECURED COMPUTER SYSTEMS

12011 Aclaire St. • Cerritos, CA 90701  
(213) 924-6741 Shipping not included

Circle 343 on Inquiry card.

## ATARI OWNERS

### Parallel Printer Interface for the ATARI 800

connects to controller jacks 3 and 4 works with BASIC/DOS/ASSEMBLER

FOUR printer connectors available:

|                                   |       |
|-----------------------------------|-------|
| TRENDCOM 100/200                  | ABP-1 |
| ATARI 825; CENTRONICS 730/737     | ABP-2 |
| EPSON MX 80/MX 70 & other 36 pin* | ABP-3 |

\*Fits all other parallel Centronics plus Okidata, Anadex, Base 2 Microtek, etc.

I.D.S. PAPER TIGER 440/445. ABP-4

**\$69.95** 6% CA sales tax  
order by part number M C./VISA accepted

GRAPHICS PRINTING SOFTWARE & ATARI 400 printer interfaces also available

To order toll free 1-800-344-7493  
(in CA call (209) 667-2888)

**MACROTRONICS, inc.**

Circle 204 on Inquiry card.

## 8035/9 BOARDS

CPU 1K RAM, 40 I/O lines  
Parallel I/O 2 8255s, 70 mil line drivers  
Serial I/O 3 8251s, RS 232C interface  
A/D-D/A 8/1 channel  
All boards 4x7, 88 pin edge connector  
Assembled - \$125 Bare - \$20  
Hardware & Software Tools available

Make check payable to:  
**SKP ELECTRONICS**  
2211 Caper Tree Dr.  
Tustin, CA 92680  
(714) 832-1732

California residents add 6% sales tax  
Please add \$3.00 for shipping and handling  
COD charges extra

Circle 348 on Inquiry card.

## DATAPoint

1134 Diskette Systems



16k Processor with Four Diskettes (1 Megabyte), 80 CPS Matrix Printer. Nationwide maintenance available.

**\$2,645**

SOFTWARE AVAILABLE  
DISK OPERATING SYSTEM  
SORT UTILITY  
ISAM UTILITY  
ALSO AVAILABLE FOR \$250 EACH:  
A/P, A/R, GENERAL LEDGER, PAYROLL, TIME ACCOUNTING, AND INVENTORY

**AMERICAN COMPUTER EXCHANGE**  
100 N. MAIN ST. BOX 52  
CHAGRIN FALLS, OH 44022  
216-247-2100

Circle 17 on Inquiry card.





## THE STAR MODEM

From Livermore Data Systems

|                |            |
|----------------|------------|
| RS232 MODEM    | SALE \$128 |
| IEEE 488 MODEM | SALE \$199 |
| RS232 CCITT    | \$170      |
| IEEE 488 CCITT | \$280      |

STAR Modem is the price performance leader with a full 2 YEAR FACTORY WARRANTY.

### We carry Apple II+ from Bell & Howell



**PROGRAM YOUR OWN EPROMS**  
Branding Iron for PET/CBM \$79  
EPROM Programmer with software for all ROM versions. Includes all necessary hardware and software to program or copy 2716 and 2532 EPROMS.

**Paper-Mate Word Processor** \$39.95  
PET/CBM full featured 60 command system by Michael Riley. Uses either tape or disk and any printer. Includes in-text commands, floating cursor, scrolling, etc.

**FLEX-FILE Data Base for CBM/PET** \$60  
Random file handling system with Report Writer and Mail Label Handler. By Michael Riley.

|                                    |      |         |            |          |
|------------------------------------|------|---------|------------|----------|
| 6502                               | 7.45 | 10/6.95 | 50/6.55    | 100/6.15 |
| 6502A                              | 8.40 | 10/7.95 | 50/7.35    | 100/6.90 |
| 6520 PIA                           | 5.15 | 10/4.90 | 50/4.45    | 100/4.15 |
| 6522 VIA                           | 6.45 | 10/6.10 | 50/5.75    | 100/5.45 |
| 6532                               | 7.90 | 10/7.40 | 50/7.00    | 100/6.60 |
| 2114-L200 ns RAM                   | 3.75 | 25/3.50 | 100/3.25   |          |
| 2114-L300 ns RAM                   | 3.15 | 25/2.90 | 100/2.65   |          |
| 2716 EPROM                         | 7.75 | 5/7.45  | 10/6.90    |          |
| 2532 EPROM                         |      |         | 17.00      |          |
| 4116 200ns                         |      |         | 8 for \$20 |          |
| S-100 Wire Wrap                    |      |         | 2.65       |          |
| Zero Insertion Force 24 pin Socket |      |         | \$2.00     |          |

**CASSETTES - AGFA PE-611 PREMIUM**  
High output, low noise, 5 screw housing, labels  
C-10 10/5.65 50/25.00 100/48.00  
C-30 10/7.30 50/34.00 100/66.00  
All other lengths available. Write for price list.

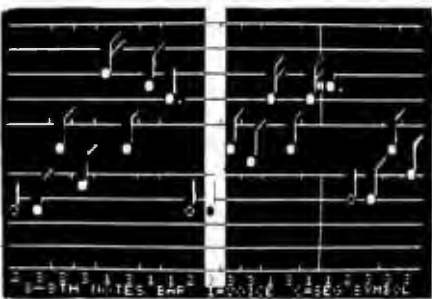

**4 PART HARMONY MUSIC SYSTEM for PET**  
The Visible Music Monitor, by Frank Levinson, allows you to easily enter, display, edit, and play 4 part harmony music. Includes whole notes thru 64ths (with dotted and triplets), tempo change, key signature, transpose, etc. The KL-4M unit includes D to A converter and amplifier (add your own speaker).  
KL-4M Music Board with VMM Program \$59.90

|   |       |
|---|-------|
| REVERSAL (Spracklen) 32K Apple              | 28.00 |
| Super FORTH 48K Apple                       | 40.00 |
| Energy Miser for PET, Apple, or Zenith      | 24.50 |
| Data Manager (Lutus) 24K Apple              | 40.00 |
| Histo-Graph (Boyd) 48K Apple                | 24.50 |
| Data-Graph (Boyd) 48K Apple                 | 40.00 |
| Apple II User's Guide (Osborne)             | 12.00 |
| Introduction to Pascal (Sybex)              | 10.30 |
| Pascal Handbook (Sybex)                     | 12.00 |
| Graphics Cookbook for Apple                 | 9.90  |
| Musical Applications of Micros (Chamberlin) | 20.00 |
| Basic FORTRAN (Coan)                        | 7.25  |

**KMMM Pascal for PET** \$75  
Subset of standard Pascal with true machine language translator for faster execution 16K with tape or disk

**EARL for PET (disk file based)** \$65  
Editor, Assembler, Relocator Linker to generate relocatable object code

**FORTH for PET/CBM or Apple** \$65  
A full-featured FORTH with extensions conforming to Forth Interest Group standards. Includes assembler, string processing capabilities, disk virtual memory multiple dimensioned arrays, floating point and integer processing



### CBM-PET SPECIALS

**FREE** Up to \$375 free merchandise with purchase of one of following CBM-PET items:

|                                  |        |     |      |
|----------------------------------|--------|-----|------|
| 8032 32K - 80 Column CRT         | \$1495 | 295 | FREE |
| 8050 Dual Disk Drive             | 1795   | 375 |      |
| 4016 Full Size Graphics Keyboard | 995    | 170 |      |
| 4032 Full Size Graphics Keyboard | 1295   | 260 |      |
| 8096 96K - 80 Column CRT         |        |     |      |
| 2040/4040 Dual Disk Drive - 340K | 1295   | 260 |      |
| 4022 Tractor Feed Printer        | 795    | 140 |      |
| CBM Voice Synthesizer            | 395    | 50  |      |
| C2N External Cassette Deck       | 95     | 12  |      |
| Used CBM/PET Computers           |        |     | CALL |
| VIC Personal Computer            | 300    | 25  |      |

WRITE FOR SYSTEM PRICES

**\*\*\* EDUCATIONAL DISCOUNTS \*\*\***  
Buy 2 PET/CBM Computers, receive 1 FREE

|   |        |
|---|--------|
| WordPro 3+ - 32K CBM, disk, printer       | 250    |
| WordPro 4+ - 8032, disk, printer          | 335    |
| OZZ Data Base System for CBM 8032         | 335    |
| VISICALC for PET or ATARI                 | 170    |
| SM-KIT - Super PET ROM Utilities          | 40     |
| Programmers Toolkit ~ PET ROM Utilities   | 34.90  |
| PET Spacemaker II ROM Switch              | 36.00  |
| 2 Meter PET to IEEE or IEEE to IEEE Cable | 40.00  |
| Dust Cover for PET                        | 6.90   |
| IEEE-Parallel Printer Interface for PET   | 110.00 |
| IEEE-RS232 Printer Interface for PET      | 120.00 |
| The PET Revealed                          | 17.00  |
| Library of PET Subroutines                | 17.00  |

Source Hookup over 1000 programs/services 88

### MILOT Intelligent Plotter by Watanabe Instruments (Digiplot)

**SPECIAL \$1195**

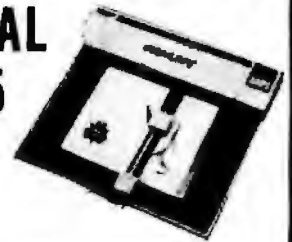

Has all intelligent functions for producing graphs and drawings including 8 vector and 4 character commands. Solid and broken lines can be specified. Character generator for alpha, numeric, and symbols. Characters can be rotated in 4 orientations, and can be 16 sizes. Coordinate axes drawn by specifying graduation interval and number of repetitions. Parallel ASCII interface, 11 x 17 paper.

### SPECIALS

|                                |      |
|--------------------------------|------|
| EPSON MX-80 Printer            |      |
| EPSON MX-80 F/T Printer        |      |
| EPSON MX-70 Printer            |      |
| EPSON MX-100 Printer           | 750  |
| Centronics 739 Printer         |      |
| STARWRITER Daisy Wheel Printer | 1445 |
| Leedex Video 100 12" Monitor   | 128  |
| ZENITH DATA SYSTEMS            |      |
| Z19 Video Terminal             | 729  |
| Z89 with 48K                   | 2150 |
| Extra 16K RAM                  | 115  |
| Z-47 Dual 8" Drive             | 2775 |

|                                      |     |
|--------------------------------------|-----|
| SYM-1                                | 209 |
| SYM BAS-1 BASIC or RAE-1/2 Assembler | 85  |
| KTM-2/80 Synertek Video Board        | 349 |

### DISK SPECIALS

|  |         |         |          |
|--|---------|---------|----------|
| SCOTCH (3M) 5 1/4"                                 | 10/2.85 | 50/2.75 | 100/2.65 |
| SCOTCH (3M) 8"                                     | 10/2.90 | 50/2.80 | 100/2.70 |
| Verbatim 5 1/4"                                    | 10/2.45 | 50/2.40 | 100/2.35 |
| (add 1.00 for 5 1/4" Verbatim plastic storage box) |         |         |          |
| Verbatim 8" Dbl. Dens.                             | 10/3.45 | 50/3.35 | 100/3.25 |
| BASF 5 1/4"  | 10/2.40 | 20/2.35 | 100/2.30 |

WRITE for prices on WABASH Disks

### WE STOCK MAXELL DISKS

|                        |                     |
|------------------------|---------------------|
| Diskette Storage Pages | 10 for 3.95         |
| Disk Library Cases     | 8" - 2.85 5" - 2.15 |

**ATARI 800 \$745**  
All Atari Modules 20% OFF

ATARI EDUCATIONAL PLAN Write for details.

**A P Products 15% OFF**  
**A P Hobby-Blox 15% OFF**



### ALL BOOK and SOFTWARE PRICES DISCOUNTED

|                                       |       |
|---------------------------------------|-------|
| The 8086 Book (Osborne)               | 14.00 |
| Z8000 Assembly Language Programming   | 16.90 |
| PET Personal Computer Guide (Osborne) | 12.75 |
| PET and the IEEE-488 Bus (Osborne)    | 13.60 |
| 6502 Assembly Language (Osborne)      | 14.45 |
| Programming the 6502 (Zaks)           | 10.45 |
| 6502 Applications Book (Zaks)         | 10.45 |
| 6502 Software Cookbook (Scelbi)       | 9.45  |
| CP/M Handbook (w/ MP/M) Zaks          | 11.85 |
| Practical BASIC Programs (Osborne)    | 13.60 |
| Some Common BASIC Programs (Osborne)  | 12.75 |

WRITE FOR CATALOG.

Add \$1.25 per order for shipping. We pay balance of UPS surface charges on all prepaid orders. Prices listed are on cash discount basis. Regular prices slightly higher.

252 Bethlehem Pike  
Colmar, PA 18915

215-822-7727 **A B Computers**

Circle 1 on inquiry card.

16-K  $\frac{1}{8}$ /\$16.75  
**M E M O R Y**  
**RAM**  
 4116 200ns 8/\$16.75 \$2.75ea.  
 2114L300ns 8/\$19.75 \$2.55ea.  
 4164 200ns \$27.00ea.  
**EPROMS**  
 2732(5V)450ns 8/\$15.00 \$16.95ea.  
 2716(5V)450ns 8/\$5.75 \$6.35ea.

All chips are fully guaranteed  
 All chips factory new  
 Call for quantity pricing  
 We are Price Competitive  
 Add \$2.50 Shipping & Handling  
 C.O.D. \$3.00, Wash. residents add  
 5.4% Sales Tax

**CHIPS & DALE**  
 P.O. Box 31607  
 Seattle, Washington  
 Zip 98103 1-206-524-9126



Circle 53 on inquiry card.

**CONTROL-Z**  
 SINGLE BOARD Z-80\* COMPUTER FOR CONTROL USES



**USES:** Industrial Test Equipment  
 Intelligent Peripheral Controller  
 Automatic Drawing Equipment  
 Solar Heating & Power Systems

**Micros Control:** Security Systems  
 3 1/2" Disc Drive Controller  
 Alpha-Pro Controller

**Features:** 4 MHz Z-80A\* (on board system) 16 RAM, sockets for 2 2716's (all PROM) 3 1/2" (4 parallel TTL) output ports, 8 1/2" (4 parallel TTL) input ports, 100 state counter timer, 8 input counter output timer (input collectors), 4 open-drain output lines, video output bit TTL output for alpha-10 Z-80 control lines brought in edge connector, video port (decoder) brought in edge connector, 1 output port decoder on bus for port expansion, on board for regulator 4 1/2" PC board uses standard 72 pin edge connector for sockets, readers - 8 to 10 volts, 300 mA

**PRICE:** \$295 Memory PROM 845F for hardware monitor program and download capability software using driver & port test feature

**TERMS:** CHECK, MC, VISA or C.O.D. Cash Price adds 6% tax  
 Fast Class Shipping Included

**COMPUTER-AID**  
 1122 DE LA VINA SANTA BARBARA, CA 93101 (805) 966-3077

Circle 66 on inquiry card.

CP/M COMMUNICATIONS  
**LYNC™**  
 THE BEST AVAILABLE PROGRAM  
 FOR CP/M COMMUNICATIONS

LYNC is extremely powerful and easy to use and a must for every computer user that wants to communicate with time-sharing systems or other CP/M computers.

**TERMINAL MODE**  
 In this mode your system acts as a terminal. Can send to or receive from a time-sharing system. When receiving data from a remote system, received data is buffered to your maximum memory, then can be saved as a disk file.

**LYNC MODE**  
 Communicate online with another computer similarly equipped. Both ends can type messages that appear simultaneously on both screens.

**SEND: AUTOMATIC ERROR DETECTION & RETRY**  
 LYNC sends block of information with 16 bit checksums. In case of error it will keep retrying until successful.

**FETCH**  
 Once both systems are in LYNC mode, either operator can FETCH files from either system.

**REMOTE AND LOCAL DIRECTORY**  
 Can display both local and remote directories.

**BAUD RATES: UP TO 9600 BAUD**  
**SELF GENERATING I/O ROUTINES REQUIRE NO PATCHING**

PRICE \$95 TERMS MONEY ORDER, CHECK, C.O.D. MC OR VISA  
 PLEASE SPECIFY DESIRED FORMAT: 8" Single Density, 5" Microfloppy TRS-80 Mod II with CP/M, North Star single or double density, Supertronic 3.0 DOS or later, Cromemco 5" single density

**COMPUTER-AID**  
 1122 DE LA VINA • SANTA BARBARA, CA 93101  
 (805) 966-3077

Circle 67 on inquiry card.

**SAVE 90%**

You CAN save up to 90% by building your own Micro or Minicomputer! If you can read - you can do it. SO DO IT!

FREE DETAILS

DIGATEK CORP  
 SUITE 20  
 2723 W. BUTLER DR.  
 PHOENIX AZ 85021

You CAN afford a Computer of your own

Circle 109 on inquiry card.

**68000**

ERG68-696 68000 CPU available and in production. Meets or exceeds all aspects of IEEE696 S-100 standard.

**\$1995**

Z-80 emulation and integrated 68000 systems also available.

Empirical Research Group, Inc.  
 PO Box 1176  
 Milton, WA 98354  
 206-631-4855

Circle 162 on inquiry card.

**Dysan CORPORATION**

Solve your disc problems, buy 100% surface tested Dysan diskettes. All orders shipped from stock, within 24 hours. Call toll FREE (800) 235-4137 for prices and information. Visa and MasterCard accepted. All orders send postage paid.



**PACIFIC EXCHANGES**  
 100 Foothill Blvd.  
 San Luis Obispo, CA 93401. (In Cal. call (805) 543-1037.)

Circle 292 on inquiry card.

**RS-232 PROBLEMS?**



LET THE RS-232 TESTER HELP YOU SOLVE YOUR COMPUTER INTERFACE PROBLEMS. DESIGNED TO CONNECT IN SERIES WITH ANY RS-232 INTERFACE, IT DISPLAYS THE STATUS OF SEVEN OF THE MOST IMPORTANT LINES: TRANSMIT DATA, RECEIVE DATA, REQUEST TO SEND, CLEAR TO SEND, DATA SET READY, CARRIER DETECT, AND DATA TERMINAL READY. THE RS-232 TESTER REQUIRES NO POWER AND MAY BE LEFT IN THE LINE PERMANENTLY.

**\$39.95 POST PAID**  
**B & B ELECTRONICS**  
 BOX 475/MENDOTA, IL 61342

Circle 32 on inquiry card.

**FACTORY PRIME STATIC RAM CHIPS**

2114 Super Low Power  
 200ns, 1Kx4 ..... \$ 2.90  
 6514 CMOS 300ns, 1Kx4 ..... \$ 6.90  
 6116 CMOS 200ns, 2Kx8 ..... \$22.50  
 Add \$5.00 Handling on Orders Under \$200.00

**FACTORY PRIME** From the same shipments used in GIMIX Professional quality boards.

**32KB STATIC RAM CARDS**  
 for the S550 and S550C BUS  
 (16KB - \$298.12), (24KB - 348.14)  
 (32KB - \$398.15)

**NEW! 64KB BATTERY BACK UP CMOS RAM CARDS**  
 Two independently addressable 32KB blocks, each with extended addressing.  
 (56KB - \$994.56), (64KB - \$1088.64)

**2MHZ 6809 56KB S550 SYSTEMS \$2498.29**

**DISK SYSTEMS AVAILABLE**

**GIMIX inc.**

1337 W. 37th Place • Chicago, IL 60609  
 (312) 927-5510 • TWX 910-221-4055  
 The Company that delivers.  
 Quality Electronic products since 1975.  
 GIMIX® and GHOST® are Registered Trademarks of GIMIX INC

Circle 146 on inquiry card.

**ZEN is HERE**

**FAST SCREEN EDITING**  
 for CP/M & NORTH STAR  
 OPEN PROGRAMS WITH SOURCE FILES

ZEN™ offers you very fast screen editing without line numbers. You are in control and ZEN may be reassembled to change or add custom features. Call system and return without losing the file. Justify even old disc files to any line length. Save, append, find, print & much more, with ease. Monitor functions are built in, extensions can be added. A 32K system with console is necessary but addressable cursor is not required.

CPM version for 1.4 thru MP/M releases, uses their assembler and file command conventions which can include multiple command lines.

North Star DOS versions have a disc assembler, an extensive monitor and some basic utilities. They use the N.S. line editing conventions.

Specify version #                   ZEN1.1 5" SD NS 2000  
 ZEN2.1 8" SD SS CPM               ZEN1.2 5" DD NS 2000  
 ZEN2.2 5" DD NS CPM               ZEN1.3 5" DD NS 0100

Disc and Manual \$75               Manual alone \$15  
 CA residents add 6%               Send check to:  
 Dawn Enterprises inc.

**ZENRAD CONTROLS CO**  
 1575 A.P.S.  
 Santa Barbara CA 93103

Circle 406 on inquiry card.

# DIGITAL RESEARCH COMPUTERS

(214) 271-3538

## 32K S-100 EPROM CARD

**NEW!**

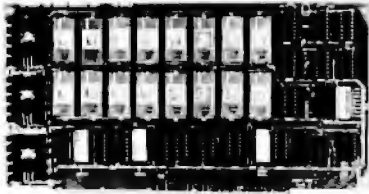

**\$79.95**  
KIT

USES 2716's

Blank PC Board - \$34

ASSEMBLED & TESTED  
ADD \$30

SPECIAL: 2716 EPROM's (450 NS) Are \$9.95 Ea. With Above Kit.

### KIT FEATURES:

1. Uses +5V only 2716 (2Kx8) EPROM's
2. Allows up to 32K of software on line!
3. IEEE S-100 Compatible.
4. Addressable as two independent 16K blocks
5. Cromemco extended or Northstar bank select
6. On board wait state circuitry if needed
7. Any or all EPROM locations can be disabled
8. Double sided PC board, solder-masked, silk-screened.
9. Gold plated contact fingers.
10. Unselected EPROM's automatically powered down for low power
11. Fully buffered and bypassed.
12. Easy and quick to assemble.

## 32K SS-50 RAM

**\$329<sup>00</sup>** KIT

For 2MHZ  
Add \$10

Blank PC Board  
\$50

For SWTPC  
6800 - 6809 Bus

Support IC's  
and Caps  
\$19.95

Complete Socket Set  
\$21.00

Fully Assembled,  
Tested, Burned In  
Add \$30

**NEW!**

At Last! An affordable 32K Static RAM with full 6809 Capability.

### FEATURES:

1. Uses proven low power 2114 Static RAMs.
2. Supports 6550C - EXTENDED ADDRESSING.
3. All parts and sockets included.
4. Dip Switch address select as a 32K block.
5. Extended addressing can be disabled.
6. Works with all existing 6800 SS50 systems.
7. Fully bypassed. PC Board is double sided, plated thru, with silk screen.

## 16K STATIC RAM KIT-S 100 BUSS

PRICE CUT!

**\$169<sup>95</sup>**  
KIT

FOR 4MHZ  
ADD \$10

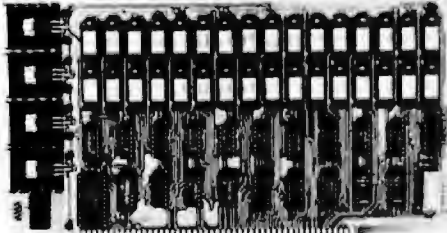

### KIT FEATURES:

1. Addressable as four separate 4K Blocks.
2. ON BOARD BANK SELECT circuitry. (Cromemco Standard) Allows up to 512K on line!
3. Uses 2114 (450NS) 4K Static Rams.
4. ON BOARD SELECTABLE WAIT STATES
5. Double sided PC Board, with solder mask and silk screened layout. Gold plated contact fingers
6. All address and data lines fully buffered
7. Kit includes ALL parts and sockets
8. PHANTOM is jumpered to PIN 67
9. LOW POWER: under 1.5 amps TYPICAL from the +5 Volt Bus
10. Blank PC Board can be populated as any multiple of 4K

BLANK PC BOARD W/DATA-\$33

LOW PROFILE SOCKET SET-\$12

SUPPORT IC'S & CAPS-\$19.95

ASSEMBLED & TESTED-ADD \$35

**OUR #1 SELLING  
RAM BOARD!**

## 16K STATIC RAM SS-50 BUSS

PRICE CUT!

**\$159** KIT

FULLY STATIC!

FOR 2MHZ  
ADD \$10

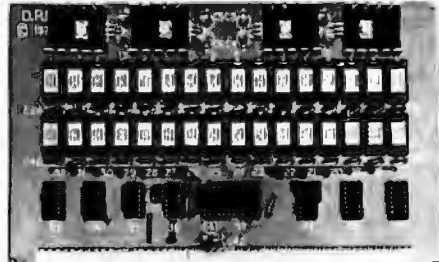

FOR SWTPC  
6800 BUSS!

ASSEMBLED AND  
TESTED - \$35

### KIT FEATURES

1. Addressable on 16K Boundaries
2. Uses 2114 Static Ram
3. Fully Bypassed
4. Double sided PC Board Solder mask and silk screened layout
5. All Parts and Sockets included
6. Low Power Under 1.5 Amps Typical

BLANK PC BOARD-\$35

COMPLETE SOCKET SET-\$12

SUPPORT IC'S AND CAPS-\$19.95

## NEW! S-100 SOUND COMPUTER BOARD NEW!

At last, an S-100 Board that unleashes the full power of two unbelievable General Instruments AY3-8910 NMOS computer sound IC's. Allows you under total computer control to generate an infinite number of special sound effects for games or any other program. Sounds can be called in BASIC, ASSEMBLY LANGUAGE, etc.

### KIT FEATURES:

- \* TWO GI SOUND COMPUTER IC'S
  - \* FOUR PARALLEL I/O PORTS ON BOARD.
  - \* USES ON BOARD AUDIO AMPS OR YOUR STEREO.
  - \* ON BOARD PROTO TYPING AREA.
  - \* ALL SOCKETS, PARTS AND HARDWARE ARE INCLUDED.
  - \* PC BOARD IS SOLDERMASKED, SILK SCREENED, WITH GOLD CONTACTS
  - \* EASY, QUICK, AND FUN TO BUILD WITH FULL INSTRUCTIONS
  - \* USES PROGRAMMED I/O FOR MAXIMUM SYSTEM FLEXIBILITY
- Both Basic and Assembly Language Programming examples are included.

### SOFTWARE:

SCL™ is now available! Our Sound Command Language makes writing Sound Effects programs a SNAP! SCL™ also includes routines for Register-Examine-Modify, Memory-Examine-Modify, and Play-Memory. SCL™ is available on CP/M™ compatible diskette or 2708 or 2716. Diskette-\$24.95 2708 - \$19.95 2716 - \$29.95. Diskette includes the source. EPROM'S are ORG at E000H

### COMPLETE KIT!

**\$84<sup>95</sup>**

(WITH DATA MANUAL)

BLANK PC  
BOARD W/DATA  
\$31

## SPECIAL PURCHASE!

## UART SALE!

TR1602B - SAME AS TMS6011,  
AY5-1013, ETC. 40 PIN DIP

**TR1602B**

**\$2<sup>95</sup>** EACH

**4 For \$10<sup>00</sup>**

### CRT CONTROLLER CHIP

SMC #CRT 5037. PROGRAMMABLE FOR 80 x 24, ETC. VERY RARE SURPLUS FIND. WITH PIN OUT. \$12.95 EACH.

## NEW! G.I. COMPUTER SOUND CHIP

AY3-8910 As featured in July, 1979 BYTE! A fantastically powerful Sound & Music Generator. Perfect for use with any 8 Bit Microprocessor. Contains: 3 Tone Channels Noise Generator, 3 Channels of Amplitude Control, 16 bit Envelope Period Control, 2-8 Bit Parallel I/O, 3 D to A Converters, plus much more! All in one 40 Pin DIP. Super easy interface to the S-100 or other busses \$11.95 PRICE CUT!  
SPECIAL OFFER: ~~\$14.95~~ each Add \$3 for 60 page Data Manual.

## 4K STATIC RAM

National Semi. MM5257. Arranged 4K x 1. +5V. 18 PIN DIP. A Lower Power, Plug in Replacement for TMS 4044. 450 NS. Several Boards on the Market Will Accept These Rams. SUPER SURPLUS PURCHASE! PRIME NEW UNITS!

8 FOR \$16 32 FOR \$59.95

**Digital Research Computers**  
(OF TEXAS)

P.O. BOX 401565 • GARLAND, TEXAS 75040 • (214) 271-3538

TERMS: Add \$2.00 postage. We pay balance. Orders under \$15 add 75¢ handling. No C.O.D. We accept Visa and MasterCard. Tex. Res. add 5% Tax. Foreign orders (except Canada) add 20% P & H. Orders over \$50, add 85¢ for insurance.

**HEADERS**



PRINTED CIRCUIT  
RIGHT ANGLE MOUNT

34 PIN HEADER  
3M 3413-1003 \$1.25 EA

40 PIN HEADER ALPHA  
\$1.50 EA

50 PIN HEADER  
3M 3433-1002 \$1.75 EA

40 PIN CONNECTOR  
3M 3417  
\$1.50 EACH

22/44 EDGE CONNECTOR  
TIN SOLDER TAIL .156" x .200"

LARGE QUANTITIES AVAILABLE  
\$1.35 each 10 for \$12.50

**8 POLE DIP SWITCH**  
\$1.50 each

**RFI LINE FILTER**  
for line to line & line to ground noise suppression  
CORCOM # 10K6  
Rated: 10 amp  
115/250 v  
50-400 Hz  
\$3.75 ea.  
10 for \$35.00

**SUB MINI L.E.D.**  
20 MA at 1.75 volt  
.075" x .098"

10 for \$1.00  
PACKAGE of 200 PCS \$16.00  
400 for \$32.00  
1000 for \$70.00

**ALL ELECTRONICS CORP.**  
905 S. Vermont Ave.  
P.O. BOX 20406  
Los Angeles, Calif. 90006  
(213) 380-8000  
Mon. - Fri. Saturday  
9 AM - 5 PM 10 AM - 3 PM  
SEND FOR FREE CATALOG

**TERMS**  
• Quantities Limited  
• Min. Order \$10.00  
• Add \$2.00 Shipping USA  
• Calif. Res. Add 4%  
• Prompt Shipping

Circle 10 on inquiry card.

**WANTED:**

APPLE, PET, TRS-80, CP/M  
**SOFTWARE**

Westico is a publisher and distributor of professional software for microcomputers. If you have a new program ready for distribution or want your existing programs to reach a larger market, contact:

Phillip Woelthof, V.P. Mktg.  
Westico, Inc.  
25 Van Zant Street  
Norwalk, CT 06855  
(203) 853-6880

To increase your profits, take advantage of Westico's worldwide promotion and distribution

**WESTICO**  
The Software Express Service

**PRO-SOFT**  
**MEDICAL BILLING**



Our software for the Apple keeps the Doctor away...  
...away from needless billing drudgery.

The Pro-soft Medical Billing System for the Apple II features:

- Up to ten physicians
- Immediate Superbill
- Over 7000 accounts
- MediCare, Medi-Cal, Other
- RVS and IDCA codes
- Menu driven, easy to use
- Support and training

For more information call or write us - today!

Professional Medical Software  
(213) 248-2884  
3604 Foothill Boulevard  
La Crescenta, CA 91214



Circle 318 on inquiry card.

**INVENTORY CONTROL SYSTEM**  
WITH PARTS EXPLOSION FOR  
FINISHED GOODS AND ASSEMBLIES  
Parts requirements forecasting & Pull Sheets  
Reorder Reports  
Economic Order Quantities  
5000 Items per 8" disk  
AVAILABLE FOR CROMEMCO, CP/M®,  
AND OASIS OPERATING SYSTEMS

Hardware requirements: 64k RAM,  
132 Column printer.  
Manual and 8" floppy disk ..... \$250.  
Multi-level explosion version ..... \$499.  
Job Costing ..... \$350.

Accounts Receivable, Accounts Payable,  
Order Entry, General Ledger, Payroll and  
Mailing List programs also available.

**FEITH SOFTWARE, INC.**  
204 MARVIN RD.  
ELKINS PARK, PA. 19117  
(215) 782-8240

Circle 139 on inquiry card.

**THIS** is only one of hundreds of unusual values.



Atari 800 16K • \$789

TOLL FREE  
1-800-343-8124

**computer plus**  
Dept. C  
245A Great Road  
Littleton, MA  
01450

**THIS** is only one of hundreds of unusual values.



Radio Shack's  
Color Computer 4K • \$310

TOLL FREE  
1-800-343-8124

**computer plus**  
Dept. I  
245A Great Road  
Littleton, MA  
01460

Circle 74 on inquiry card.

**QUARTZ CRYSTALS**

|          |          |          |          |           |           |           |
|----------|----------|----------|----------|-----------|-----------|-----------|
| 3216-0   | 5.2420-0 | 9.0330-0 | 20.000-0 | 30.7000-0 | 42.0516-0 | 60.3120-0 |
| 5200-0   | 5.6100-0 | 9.0400-0 | 20.000-0 | 30.7000-0 | 42.0516-0 | 60.3120-0 |
| 1.025-0  | 6.7140-0 | 9.0000-0 | 22.130-0 | 31.8000-0 | 42.8250-0 | 61.2600-0 |
| 1.8432-0 | 6.850-0  | 10.000-0 | 22.850-0 | 32.750-0  | 43.8250-0 | 62.000-0  |
| 1.8437-0 | 6.862-0  | 10.240-0 | 25.250-0 | 34.440-0  | 45.000-0  | 63.500-0  |
| 2.000-0  | 6.800-0  | 10.400-0 | 25.000-0 | 34.500-0  | 45.000-0  | 63.500-0  |
| 2.8911-0 | 6.164-0  | 10.775-0 | 25.070-0 | 34.925-0  | 45.270-0  | 63.700-0  |
| 2.4575-0 | 6.1900-0 | 10.825-0 | 27.000-0 | 36.120-0  | 47.100-0  | 65.000-0  |
| 2.500-0  | 6.2870-0 | 10.800-0 | 27.000-0 | 36.500-0  | 47.500-0  | 65.500-0  |
| 2.8967-0 | 6.400-0  | 11.130-0 | 27.000-0 | 36.800-0  | 47.500-0  | 65.500-0  |
| 2.8969-0 | 6.560-0  | 11.150-0 | 28.000-0 | 37.750-0  | 48.750-0  | 67.000-0  |
| 3.000-0  | 6.720-0  | 11.200-0 | 28.000-0 | 37.750-0  | 48.750-0  | 67.000-0  |
| 3.007-0  | 6.750-0  | 11.200-0 | 28.120-0 | 38.000-0  | 49.000-0  | 67.250-0  |
| 3.200-0  | 6.800-0  | 11.470-0 | 28.500-0 | 38.400-0  | 49.400-0  | 67.500-0  |
| 3.2700-0 | 6.800-0  | 11.500-0 | 28.500-0 | 38.500-0  | 49.500-0  | 67.600-0  |
| 3.500-0  | 6.800-0  | 11.800-0 | 28.000-0 | 38.000-0  | 49.000-0  | 67.000-0  |
| 3.570-0  | 6.800-0  | 12.440-0 | 28.000-0 | 38.000-0  | 49.000-0  | 67.000-0  |
| 4.000-0  | 6.700-0  | 14.310-0 | 28.000-0 | 38.000-0  | 49.000-0  | 67.000-0  |
| 4.100-0  | 6.700-0  | 14.630-0 | 28.200-0 | 38.200-0  | 49.200-0  | 67.200-0  |
| 4.3420-0 | 6.000-0  | 15.000-0 | 29.430-0 | 40.000-0  | 52.000-0  | 70.500-0  |
| 4.400-0  | 6.050-0  | 15.400-0 | 31.750-0 | 41.000-0  | 53.000-0  | 71.000-0  |
| 4.610-0  | 6.110-0  | 15.500-0 | 31.000-0 | 41.000-0  | 53.000-0  | 71.000-0  |
| 4.800-0  | 6.1810-0 | 16.000-0 | 32.000-0 | 41.370-0  | 53.500-0  | 71.000-0  |
| 4.820-0  | 6.330-0  | 16.300-0 | 32.000-0 | 41.370-0  | 53.500-0  | 71.000-0  |
| 4.810-0  | 6.400-0  | 17.200-0 | 33.500-0 | 42.000-0  | 54.000-0  | 71.500-0  |
| 5.000-0  | 6.570-0  | 17.200-0 | 34.500-0 | 42.500-0  | 54.370-0  | 71.500-0  |
| 5.000-0  | 6.600-0  | 18.000-0 | 34.750-0 | 42.750-0  | 54.750-0  | 71.500-0  |
| 5.120-0  | 6.800-0  | 18.420-0 | 34.870-0 | 42.700-0  | 54.700-0  | 71.500-0  |
| 5.100-0  | 6.800-0  | 18.400-0 | 35.000-0 | 42.750-0  | 54.750-0  | 71.500-0  |
| 5.100-0  | 6.800-0  | 18.750-0 | 35.000-0 | 42.810-0  | 54.750-0  | 71.500-0  |

ALL A - \$2.00 ALL B - \$1.00 10 MM MODEL DISTRICT 94

ADD \$1.00 SHIPPING  
CAL. RES. ADD 6% SALES TAX  
FREE OSCILLATOR SCHEMATICS  
WITH ANY ORDER

**QUALITY COMPUTER PARTS**  
P.O. BOX 743 / CHATSWORTH, CA 91311

Circle 321 on inquiry card.

**POWER**

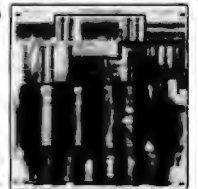

**THE AE-85 SINGLE CARD COMPUTER FOR DEDICATED CONTROL**

The AE-85 with the many features listed below is ideal for dedicated control applications since all the necessary features are provided on board. Even the interrupt control logic and space for custom electronics is provided so as to further reduce development costs. So save time with the simple solution and discover the AE-85.

**Standard**

- Standard 5 MHz 8085 MPU with serial port
- 22 programmable bidirectional I/O pins
- 256 bytes of RAM
- 14 bit crystal controlled counter/timer
- Up to 4K EPROM (accepts 2708, 2716 or 2732)
- Provisions for 190 wire wrap pins for various sockets and connectors
- On board jumper definable logic allowing easy combining of interrupt requests for the 4 hardware interrupts
- 6 by 6 inches with four 3/16 inch holes for easy mounting
- Assembled and tested \$179.00 singles

**Optional on extra**

- 22 programmable bidirectional I/O pins
- 128 bytes of RAM
- 14 bit crystal controlled counter/timer

Call today for more information. Phone: 614-221-3268  
Advent Electronics, Inc., 5 East Long Street, Suite 1812, Columbus, Ohio 43215

Circle 5 on inquiry card.

**COLOR VIDEO MONITORS**  
RGB AND COMPOSITE  
VIDEO

- TC-700 13" color video monitor/receiver, NTSC composite video. \$399.00 TC-900, 19", \$595.00. Use with Apple II and III and other computers.
- CM-19RGB: 19" screen, 3 modes: RGB, Composite video, TV. \$895.00.
- Apple III RGB Interface: Converts RGB data from Apple III to produce 16 color display on RGB monitor. \$129.00.
- Hitachi Hi-Res RGB, 13" character display, 2000, 80 x 24, 5 x 7 dot matrix, TTL inputs. \$1200.00.
- Sony TV to video monitor conversion kit, MCK 100: \$135.00.
- OEM 13" and 19" RGB color monitors, immediate delivery, prices and specs, on request.

For additional information, contact:  
**Video Marketing, Inc.**  
P.O. Box 339  
Warrington, Pa. 18976  
(215) 343-3000

Circle 395 on inquiry card.

**— Discounts Discounted —**

**We Feature**  
CP/M — Osborne — Rejas — Forth  
Micro-soft — Micro-Pro —  
Micro-AP — Fortran — S-Basic

**Special Feature Packages**  
CP/M — Peachtree Programs

**General Ledger**  
Acct. Rec. —————→ \$1250.00  
Acct. Payable —————→ Plus — Sales Tax  
Pay Roll —————→ Plus — Shipping  
Inventory —————→  
Mailing Address —————→

This sale terminates when this ad closes.  
Act Now.

Who for our free catalog

**PACIFIC DISCOUNT SOFTWARE**  
3204-A Production Avenue  
Oceanside, California 92054  
Telephone (714) 439-6201



Circle 291 on inquiry card.

# INTELLIGENT VIDEO I/O FOR S-100 BUS

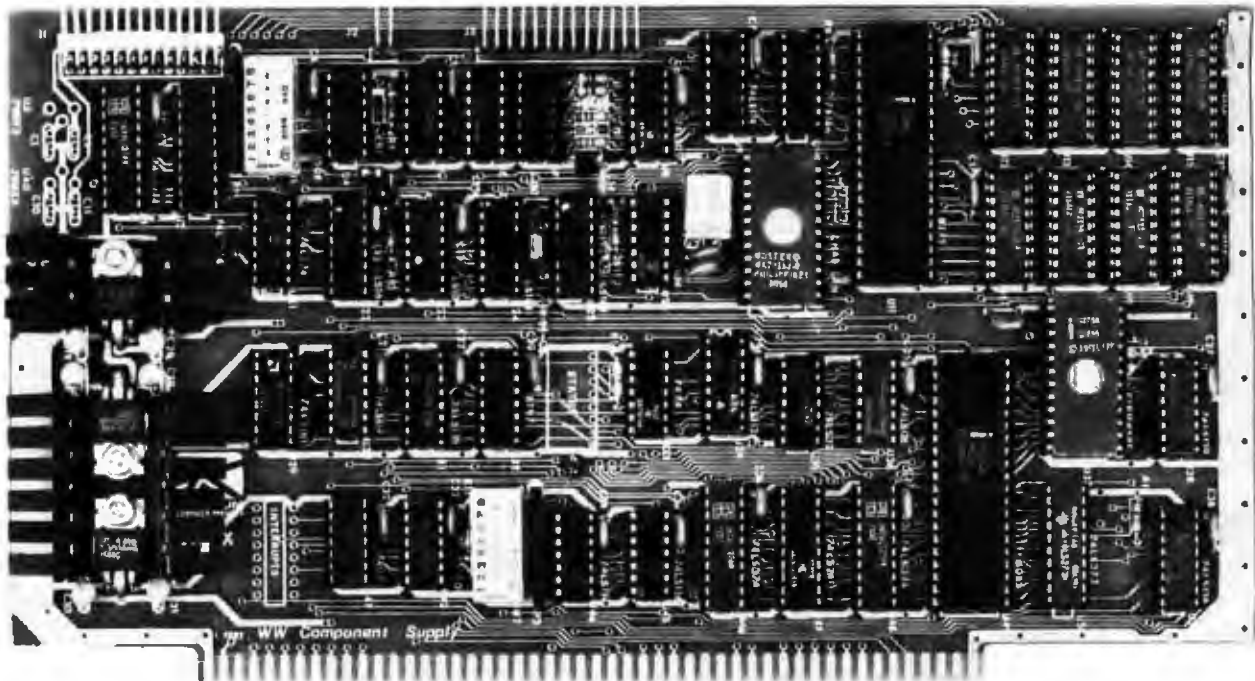

## VIO-X

The VIO-X Video I/O Interface for the S-100 bus provides features equal to most intelligent terminals both efficiently and economically. It allows the use of standard keyboards and CRT monitors in conjunction with existing hardware and software. It will operate with no additional overhead in S-100 systems regardless of processor or system speed.

Through the use of the Intel 8275 CRT controller with an onboard 8085 processor and 4k memory, the VIO-X interface operates independently of the host system and communicates via two ports, thus eliminating the need for host memory space. The screen display rate is effectively 80,000 baud.

The VIO-X1 provides an 80 character by 25 line format (24 lines plus status line) using a 5 x 7 character set in a 7 x 10 dot matrix to display the full upper and lower case ASCII alphanumeric 96 printable character set (including true descenders) with 32 special characters for escape and control characters. An optional 2732 character generator is available which allows an alternate 7 x 10 contiguous graphics character set.

The VIO-X2 also offers an 80 character by 25 line format but uses a 7 x 7 character set in a 9 x 10 dot matrix allowing high-resolution characters to be used. This model also includes expanded firmware for block mode editing and light pen location. Contiguous graphics characters are not supported.

Both models support a full set of control characters and escape sequences, including controls for video attributes, cursor location and positioning, cursor toggle, and scroll speed. An onboard Real Time Clock (RTC) is displayed in the status line and may be read or set from the host system. A checksum test is performed on power-up on the firmware EPROM.

Video attributes provided by the 8275 in the VIO-X include:

- FLASH CHARACTER
- INVERSE CHARACTER
- UNDERLINE CHARACTER or
- ALT. CHARACTER SET
- DIM CHARACTER

The above functions may be toggled together or separately.

The board may be addressed at any port pair in the IEEE 696 (S-100) host system. Status and data ports may be swapped if necessary. Inputs are provided for parallel keyboard and for light pen as well as an output for audio signalling. The interrupt structure is completely compatible with Digital Research's MP/M ®.

Additional features include:

- HIGH SPEED OPERATION
- PORT MAPPED IEEE S-100 INTERFACE
- FORWARD/REVERSE SCROLL or
- PROTECTED SCREEN FIELDS
- CONVERSATIONAL or BLOCK MODE (opt)
- INTERRUPT OPERATION
- CUSTOM CHARACTER SET
- CONTROL CHARACTERS
- ESCAPE CHARACTER COMMANDS
- INTELLIGENT TERMINAL EMULATION
- TWO PAGE SCREEN MEMORY

VIO-X1 - 80 x 25 5 x 7 A & T **\$295.00**  
*Conversational Mode*  
 VIO-X2 - 80 x 25 7 x 7 A & T **\$345.00**  
*Conversational & Block Modes*

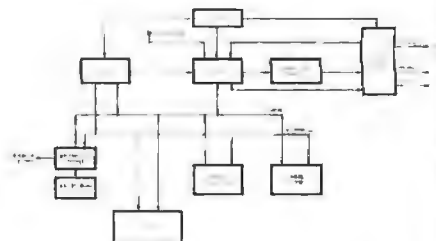

**FULCRUM**  
 COMPUTER PRODUCTS

Distributed by

WW COMPONENT SUPPLY INC. 1771 JUNCTION AVENUE • SAN JOSE, CA 95112 • (408) 295-7171

**DOUBLE YOUR LA36  
DECWRITER'S SPEED TO 60 CPS**

The ACCELEWRITER converter enables you to convert the LA36 Decwriter from 10/15/30 to 10/30/60 CPS.

Utilizes Decwriter's own built-in 60 CPS speed

Plugs into logic board

Compatible with Decwriter option boards  
Decwriter reconverts to "stock" in seconds

Thousands sold

In use for over 4 years

Full one-year warranty

\$135 includes shipping



Brochure sent promptly at your request  
Write or call us.

**LARKS ELECTRONICS & DATA**

P.O. Box 22, Skokie, IL 60077  
(312) 677-6080

Circle 488 on Inquiry card.

**SINGLE-BOARD VERSATILITY!**



**The New  
BASYS/1  
can:**

- directly drive motors and solenoids
- operate for weeks on a few flashlight batteries
- work reliably from -40 to +85°C.
- monitor 80 keys and drive 10-digit LED displays
- fit in a 4.5 x 6.5 x 1" space

...and a lot more. BASYS/1 is a CMOS single board computer for real-world control applications. It contains a COSMAC 1802 CPU, up to 2K RAM, 8K ROM, and versatile serial, parallel, and multiplexed I/O. ROM monitor supplied for machine language programming, or order optional Integer BASIC or BTH (our version of FORTH). Expansion boards also available.

**BASYS/1 with 1K RAM, .5K ROM. Kit \$185, assembled \$220**

**TECHNICAL MICRO SYSTEMS, INC.**

**TMSI** 386 Cloverdale  
Ann Arbor, MI 48105  
(313) 994-0784

Circle 228 on Inquiry card.

**PROCAP**

EAGLES ?  
COWBOYS ?

RAIDERS ?  
RAMS ?

If you'd like to know NOW before the big game

With PROCAP and your TRS-80™ you can use statistics and probability theory to predict the results of this week's big games. And more PROCAP:

- Gives offensive and defensive ratings for every National Football League team
- Predicts range of results and probable scores for each game
- Allows computer matchup of any two teams (Great for playoffs!)
- Gives up-to-the-minute standings, statistics, and ratings for each NFL Division

PROCAP is easy to use and comes with extensive documentation

Disk or cassette version is only \$49.95

To order call our toll free number NOW. Money back guarantee so you can't lose.

Dial (800) 543-3000 operator 400  
In Ohio dial (800) 562-1364 operator 400

\* Please specify TRS-80 Model I (10K or 20K cassette version only)  
or TRS-80 Model II (10K or 20K cassette or 5.25 floppy disk)



The Trinity Computer Group • Software Agent/Publisher

Circle 23 on Inquiry card.

**ANALOG ↔ DIGITAL  
DIGITAL ↔ ANALOG**

**CONVERSION MODULES**

**SOFTWARE  
GAIN CONTROL**

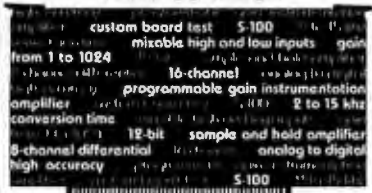

For additional details about the AD-100-4 and other fine California Data Corporation 100% individually tested, high reliability products, circle the reader service card number below or for faster response write or call us.

**CALIFORNIA DATA  
CORPORATION**

3475 Old Conajo Road, Suite C-10  
Newbury Park, CA 91320

(805) 498-3651

Circle 43 on Inquiry card.



**IPEX NEW!**

**Interface Converts  
Your Typewriter  
Into Printer**



- Finest print quality
- Easy installation
- Fits IBM SELECTRIC™ typewriter with no modification.
- For TRS-80®, Apple®, or any parallel or RS232C port.
- Write or phone for more information, today!
- Low cost
- Quick delivery

— U.S. and worldwide sales —



**IPEX INTERNATIONAL INC.**  
15140 Valerio St.  
Van Nuys, CA 91406 USA

TEL: 213/781-0020 TLX/TWX: 910-495-1767

Circle 179 on Inquiry card.

**COED**

**CRT ORIENTED EDITOR**

- For Data General Systems: RDOS (DOS) and AOS (MP/OS).
  - Easier to use, faster and more powerful than: EDIT, SPEED, LINEDIT and SED.
  - Includes limited source code, complete users manual, function key template and 1 year support.
  - Non Data General Terminal support.
- \$750 for single CPU license

Contact:



132 E. St., #3B  
Davis, CA 95616  
(916) 758-9355

Systems Programming for  
Data General Computers

Circle 229 on Inquiry card.

**CP/M ↔ 68XX**

**CROSS-SOFTWARE**

including source code in "C"

**ASSEMBLER FEATURES:**

- 2-pass absolute assembly
- Full instruction set, Motorola-compatible
- Free-format input
- Unlimited length labels
- Arithmetic expressions in operands
- Sorted symbol table output
- Intel format hex output

PACKAGE A6800 ... MC6800/MC6802/MC6808  
PACKAGE A6801 ... MC6801/MC6803  
PACKAGE A6809 ... MC6809

8" soft-sectored disk format, w/manual ... \$100.00  
5" North Star disk format, w/manual ... \$100.00  
Manual and listing alone ... \$ 85.00  
(Wisconsin residents please add 4% tax)

**introl corp.**

647 W. Virginia St.  
Milwaukee, WI 53204  
14141 276-2937

Visa and  
Master Charge  
Accepted

CP/M is a trademark of Digital Research

Circle 178 on Inquiry card.

**FULL ELIZA FOR YOUR MICRO!**

AT LAST! A FULL IMPLEMENTATION of the original ELIZA program is now available to run on your microcomputer! Created at MIT in 1966, ELIZA has become the world's most celebrated artificial intelligence demonstration program. ELIZA is a non-objective psychotherapist who analyzes each statement as you type it in and then responds with her own comment or question. Response time is virtually instantaneous and her remarks are often startlingly appropriate. Designed to run on a large mainframe, ELIZA has hitherto been unavailable to small computer users except in greatly stripped-down versions lacking the sophistication which made the original program so fascinating. Now, a new version possessing the full power and range of expression of the original is available to run on any CP/M based microcomputer system with at least 65K of RAM. Supported as a 24K COM machine language file on a standard 8" diskette, the program is being offered for a limited time at the introductory price of only \$25. And if you want to find out how she does it, let us know (or do more), we will include the complete Source program, a review in MicroWorld BASIC-49 Version 5.0, for only \$50 additional. Order your copy of ELIZA today, and you'll never again wonder how to respond when one of your friends says, "Okay, lets see what this computer of yours can actually do!"

HERE IS AN ACTUAL SAMPLE OF ELIZA'S CONVERSATIONAL ABILITY:  
(ELIZA'S comments are printed in capital letters)

AM I AN IDIOT?  
BY WHAT MEANS?  
They're always bopping us about something or other  
GAIN YOU THINK OF A SPECIFIC EXAMPLE?  
Visit my identified made me come here  
YOUR BOYFRIEND MADE YOU COME HERE THAT'S INTERESTING  
I need some help, that much seems certain  
WHAT WOULD IT MEAN TO YOU IF YOU GOT SOME HELP?  
Perhaps I could learn to get along with my brother  
TELL ME MORE ABOUT YOUR FAMILY?  
You are like my father in some ways  
WHAT RESEMBLANCE DO YOU SEE?  
You are about as big  
DOES IT PLEASE YOU TO BELIEVE I AM AFRAID OF YOU?  
My father is afraid of everybody  
WHAT ELSE COMES TO MIND WHEN YOU THINK OF YOUR FATHER?  
Business  
DOES THAT HAVE ANYTHING TO DO WITH THE FACT THAT  
YOUR BOYFRIEND MADE YOU COME HERE?

**ARTIFICIAL INTELLIGENCE RESEARCH GROUP**

821 NORTH LA JOLLA AVENUE  
LOS ANGELES, CALIFORNIA 90045  
(213) 856-7388 (213) 854-2214

MC, VISA, and CHECKS ACCEPTED

Circle 24 on Inquiry card.



NEW! for  
the '89 from

**MAGNOLIA  
MICROSYSTEMS**

**DOUBLE DENSITY  
DISK CONTROLLER**

for both 5 1/4" & 8" drives

only \$595 complete

including CP/M™ 2.2

MAGNOLIA MICROSYSTEMS, INC.  
2812 Thorndyke W., Seattle 98199  
(206) 285-7266 (800) 426-2841

CP/M is a trademark of Digital Research.

Circle 205 on Inquiry card.



## MICRO DESIGN CONSULTANTS

1 Bit through  
32-Bit Machines

We handle concept  
through production  
prototypes with  
complete documentation.

HARDWARE - 916/723-1050

David Jenkins  
7214 Springleaf Court  
Cirrus Heights, CA 95610

SOFTWARE - 916/381-1717

Richard Lerseth - LEAPAC  
8245 Mediterranean Way  
Sacramento, CA 95826

Circle 195 on inquiry card.

## ATARI® GAME OWNERS

YOU ALREADY OWN A  
POWERFUL HOBBY COMPUTER

Realize its capabilities by plugging our MagiCard module into your unaltered Video Computer System™ console. If you have ever wanted to program a computer or learn about microprocessors, our MagiCard and detailed instruction manual are an unmatched educational value. If you have ever wanted to understand and use the video and audio capabilities of your ATARI game, our MagiCard will unlock its mysteries. Features include 1K bytes of RAM and a 2K byte ROM monitor. Using your keyboard controllers, you will soon be creating your own 6502 machine language programs. To receive your MagiCard and manual (including sample programs and instructions for building a cassette interface), send check or money order for \$49.88 (in Illinois, add 6% tax) to Computer Magic, Inc., Box 3383A, Fox Valley Center, Aurora, Illinois 60506.

ATARI and Video Computer System are trademarks of ATARI Inc.

Circle 72 on inquiry card.

## North Star BASIC UTILITY SET

- EDITOR — Create & edit a Basic program using 26 commands, including GLOBAL locate & change.
- BPRT — Print & cross reference a Basic program.
- BPAK — Pack a Basic program.
- RE — Rename a disk file.

\$69 plus \$1.50 shipping,  
Calif. Res. add 6%.

Check, VISA, M/C

**SZ Software Systems**

1269 Rubio Vista Road, Altadena, Calif. 91001  
(213) 791-3202

Circle 372 on inquiry card.

## ZENITH/Heath Users



Double Your  
5 1/4" disk storage  
capacity without adding a drive.

Get twice as much from your H88 or H89 microcomputer. Our FDC-880H floppy disk controller, in conjunction with your 5 1/4" drives, for example, expands memory capacity from 256 bytes to 512 bytes per sector.

And it handles single and double-sided, single and double-density, 8" and 5 1/4" drives — simultaneously.

Call 714/275-1272 today  
or write for details.



C.O.R. Systems Inc.

Controlled Data Recording Systems, Inc.  
7687 Vickers St., San Diego, CA 92111

Circle 50 on inquiry card.

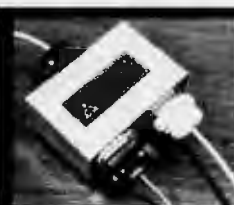

TERMINAL  
DATA  
CORPORATION

### MODEL 1200 RS-232 BI-DIRECTIONAL DATA SPLITTER

available in kit form

Model 1200K gives the terminal or micro-processor user a second interface for a printer, plotter, cassette or tape drive. It operates at any speed & isolates the two output devices from each other, while providing 2 RS-232 interfaces from the terminal or microprocessor.

The kit consists of 3 RS-232 connectors, printed circuit board, all necessary components, enclosure, mounting hardware & assembly instructions

\$69.00

write or call

TERMINAL DATA CORP.  
11878 Coakley Cir.  
Rockville, MD 20852  
(301) 881-7655

Circle 382 on inquiry card.

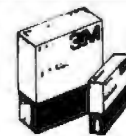

**Scotch®**  
DISKETTES

SAVE 40% Write for our  
complete list.

5 1/4" Sgl. Dens. 26.70/10  
Specify soft, 10 or 16 hard sectors

8" Sgl. Dens. 27.30/10  
8" Dbl. Dens. 35.80/10  
Specify soft or 32 hole hard

Add \$2.00 shipping - Michigan add 4% tax

LYBEN COMPUTER SYSTEMS  
27204 Harper Ave.  
St. Clair Shores, MI 48081

Authorized Distributor  
Information Processing Products



Circle 202 on inquiry card.

### D TYPE CONNECTOR MOUNTING HARDWARE

at less than 1/2 the price

- Similar to Anatek #609-003
- Standard 4-40 male and female threads
- Complete with lock washers and 4-40 small pattern nuts

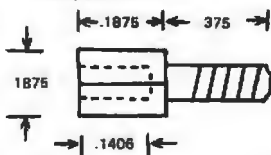

100 pc. .... \$40.00  
500 pc. .... \$35.00/c  
1000 pc. .... \$30.00/c

Over 1000 — please inquire

### CCB Machine Products

1519 Sherbrook Rd.  
Cleveland, Ohio 44121  
1-216-381-1291

Circle 9 on inquiry card.

### Serial Printer Interface



(RS232C) for  
APPLE II\*  
only \$179;  
assembled/  
tested  
burned in  
docum

- Powerful ON BOARD SOFTWARE provides:  
-TOP OF FORM & AUTO PAGING  
-LIST format for program listings (inserts 1 or 2 blank lines after any user specified program line)

-"HARD COPY" reproduces screen text on printer  
-INPUT from printers with keyboards

• 32 DIP SWITCH levers select ALL printer interface parameters (columns/line, lines/page, vertical margins, and more)

• BAUD rates between 70 and 1500

• Output functions selected via ATTRACTIVE color coded - CONTROL PANEL (fits under keyboard)

• Control panel, 7 ft cable, connector included

ORDER NOW or send for MORE INFORMATION

RADIX, Inc. †CO residents add 3% sales tax  
P.O. Box 3465 Foreign orders add 10%  
Littleton, CO 80161 MC/VISA/COD/MO  
(303) 985-4152 Personal Check (add 3 wks)

\* registered (trademark of Apple Computer, Inc.

Circle 326 on inquiry card.

## PRIAM

Drives, Smart Controllers,  
Accessories,  
SMD interface available

lowest cost and greatest established reliability for H.P., DEC, Apple, Z-80, 8085 — and so on

We can show you how to overcome  
"foreign" disk warranty worries—give us a call.

Special Opportunity:

**S-100 Power Supply Kit**  
14A @ ± 8VDC  
2A @ ± 18VDC **\$29<sup>95</sup>**

Input: 95, 115, 205, 220 VAC, 50/60 Hz.  
Includes: UL Spec. Transformer, Rectifiers, Computer Grade Capacitors, RFI line filter, and Schematics.

### ADVANCED TECHNOLOGY

735 Loma Verde, Palo Alto, CA 94303  
415-493-5930

Send 36 ct SASE for our 16 page flyer.

Circle 108 on inquiry card.



# NOBODY KNOWS MORE ABOUT ADDING MEGABYTES TO YOUR TRS-80 MODEL II\* THAN AMERICAN SMALL BUSINESS COMPUTERS

## THE CAMEO CONNECTION

The Cameo 10 Million Character Disk Drive Subsystem (pictured in foreground) is a 5 Megabyte Fixed, 5 Megabyte Removable Cartridge-Type Disk Drive. Advantages To This Unit Are Ease of Backup For Data and Program Files and Low Cost. By Attaching A Multiplexor Unit Several Model II's Can Be Attached To The Cameo Disk Drive. For Further Pricing, Availability, and Operating Systems Options, Call or Write to American Small Business Computers and ask for the CAMEO CONNECTION.



## THE CORVUS CONNECTION

The Corvus Disk Drive Subsystem (center of picture) is Available in 5, 10, and 20 Million Character Capacities. The Corvus System Is The Ultimate In The Sealed "Winchester, All-Fixed" Type Drive. The Corvus Is Designed To Operate In The Harshest Environments Such As Factories, Oil Rigs, Etc. Backup Of Data Is Accomplished Via Optional MIRROR Backup Device Whereby Data Is Written Onto A Standard Video Tape Recorder. A Great Number of Model II's May Be Attached To The Corvus Via An Optional CONSTELLATION Multiplexor. For Further Pricing, Availability, and Operating Systems, Call Or Write to American Small Business Computers and Ask for the CORVUS CONNECTION.

## THE AMERICAN SMALL BUSINESS COMPUTERS MINI-WINCHESTER SPECIAL

The MINI-5 (being held by Corporate President Robert Webster) Is American Small Business Computer's Very Own Disk Subsystem. The MINI-5 Offers Approximately 5 Million Characters of Information Storage and is Based On the Famous Seagate Technology ST-506 Micro Winchester Drive. Now You Can Own State-Of-The-Art Technology At An Affordable Price — Only \$3500 — Which Includes Drive, Controller Electronics, Power Supply, Cabinet, Cables, Documentation and Operating System Software.

**DEALER INQUIRIES INVITED**

**AMERICAN SMALL BUSINESS COMPUTERS**

\*TM TANDY CORPORATION

118 SOUTH MILL STREET

PRYOR, OK. 74361

918-825-4844

**ok PRODUCTS**



**JUST WRAP KIT**

Just Wrap tool for daisy chain wiring. Tool strips as it wraps and cuts. Includes one 50 foot spool of wire.

| Part No. | Description              | Price   |
|----------|--------------------------|---------|
| JW-1*    | Just Wrap Tool           | \$14.95 |
| JWK-8    | Tool w/4 Spools and JUW1 | 24.95   |
| R-JW*    | 50 Ft. Replacement Wire  | 3.49    |
| JUW-1    | Unwrapping Tool          | 3.49    |

\*Specify Color: Red, Blue, White or Yellow.



Regular Wrap



Modified Wrap

**HAND WRAP TOOL**

| Part No. | Description | Price  |
|----------|-------------|--------|
| WSU30    | Regular     | \$6.95 |
| WSU30M   | Modified    | 7.95   |

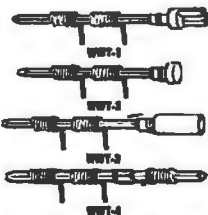

**TERMINALS**

- .025 (0,83mm) Square Post
- 3 Level Wire-Wrapping
- Gold Plated
- 25 PER PKG.

| Part No. | Description              | Price  |
|----------|--------------------------|--------|
| WWT-1    | Slotted Terminal         | \$4.98 |
| WWT-2    | Single Sided Terminal    | 2.98   |
| WWT-3    | IC Socket Term.          | 4.98   |
| WWT-4    | Double Sided Terminal    | 1.98   |
| INS 1    | Insertion Tool for above | 2.49   |

**SOCKET WRAP — ID**

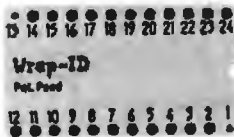

Slipped onto socket before wrapping to identify pins.

| Part # | Price   | Bulk Price | Part # | Price  | Bulk Price |
|--------|---------|------------|--------|--------|------------|
| 14ID   | 1.49/10 | 5.50/100   | 22ID   | 1.49/5 | 5.95/50    |
| 16ID   | 1.49/10 | 5.95/100   | 24ID   | 1.49/5 | 5.95/50    |
| 18ID   | 1.49/10 | 5.00/50    | 28ID   | 1.49/5 | 6.50/50    |
| 20ID   | 1.49/5  | 5.00/50    | 40ID   | 1.49/5 | 5.00/25    |



**P.C.B. TERMINAL STRIPS**

The TS strips provide positive screw activated clamping action, accommodate wire sizes 14-30 AWG (1,8-0,25mm). Pins are solder plated copper, .042 inch (1mm) diameter, on .200 inch (5mm) centers.

| Part No. | Description         | Price  |
|----------|---------------------|--------|
| TS- 4    | 4-Pole              | \$1.68 |
| TS- 8    | 8-Pole              | 2.59   |
| TS-12    | 12-Pole             | 3.49   |
| TS6MD    | 2-Pole Interlocking | 3/1.78 |



**DESOLDERING PUMP**

Easy one hand operation.

Rugged all metal construction. Replaceable TEFLON® Tip. Sell cleaning on each stroke.

Suction precisely regulated for reliable desoldering without damage to delicate circuitry.

|      |                  |        |
|------|------------------|--------|
| DSPI | Desoldering Pump | \$9.95 |
|------|------------------|--------|

**LOGIC PROBE**



Compatible with all logic families using a 4 to 15V power supply. Thresholds automatically programmed. Visual indication of logic levels to show high, low, bad level or open circuit logic pulses.

- 10 N sec. pulse responses
- 120 K input impedance.
- Automatic resetting memory.
- Includes tip with protective cap & coiled cord.

|       |         |
|-------|---------|
| PRB-1 | \$36.95 |
|-------|---------|

**LOGIC PULSER**

Superimposes a pulse train (20 pps) or a single pulse onto the circuit node under test without un-soldering IC's.

- Automatic polarity sensing
- 2 us pulse width
- Finger tip push button actuated
- Includes tip with protective cap & coiled cord.

|       |         |
|-------|---------|
| PSL-1 | \$48.95 |
|-------|---------|

**VACUUM VISE**

Unique vacuum-based light duty vise for precision handling of small components and assemblies. Rugged ABS construction. 1 1/2" (32mm) travel for maximum versatility. Also features screw lugs for permanent installation.



|     |             |        |
|-----|-------------|--------|
| VV1 | Vacuum Vise | \$3.49 |
|-----|-------------|--------|

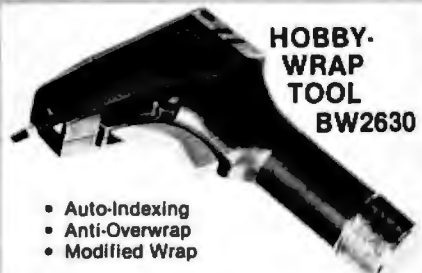

**HOBBY WRAP TOOL BW2630**

- Auto-Indexing
- Anti-Overwrap
- Modified Wrap

| Part No. | Description         | Price   |
|----------|---------------------|---------|
| BW2630   | Tool                | \$19.85 |
| BT30     | #30 Bit (not incl.) | 3.95    |
| BT2628   | #28 Bit (not incl.) | 7.95    |
| BC1      | Batteries & Charger | 14.95   |

**INSERTION/EXTRACTION TOOLS**

| Part No. | Description                 | Price  |
|----------|-----------------------------|--------|
| INS1416  | 14-16 pin inserter          | \$3.49 |
| MOS1416  | 14-16 pin MOS Safe Inserter | 7.95   |
| MOS2428  | 24-28 pin MOS Safe Inserter | 7.95   |
| MOS40    | 40 pin MOS Safe Inserter    | 7.95   |
| EX1      | 14-16 pin IC Extractor      | 1.49   |
| EX2      | 24-40 pin IC Extractor      | 7.95   |



**WK-7 IC INSERTION KIT**

Complete IC Inserter/ Extractor Kit Individual Components (listed above) \$22.95

**IC DISPENSER**

Allows IC's to be dispensed from their tube 1 at a time and picked up by insertion tools above.

- Dispenses 8-42 pin IC's • Compatible with all IC carrying tubes • Use with WK7 for MOS safe insertion. •

| Part No. | Description        | Price   |
|----------|--------------------|---------|
| MDD1     | 1 Chan. Dispenser  | \$21.85 |
| MDD5     | 5 Chan. Dispenser  | 83.43   |
| MDD10    | 10 Chan. Dispenser | 160.45  |

\*No Discount.

TOLL FREE ORDERING NUMBER 1-(800) 423-7144

## IDC CONNECTORS



### RIGHT ANGLE HEADERS

| SOLDER TAIL |          | WIRE WRAP |          |        |
|-------------|----------|-----------|----------|--------|
| Size        | Part No. | Price     | Part No. | Price  |
| 10          | IDH10SRB | \$1.20    | IDH10WRB | \$2.60 |
| 20          | IDH20SRB | 1.90      | IDH20WRB | 4.15   |
| 26          | IDH26SRB | 2.75      | IDH26WRB | 5.35   |
| 34          | IDH34SRB | 3.75      | IDH34WRB | 6.25   |
| 40          | IDH40SRB | 3.75      | IDH40WRB | 7.35   |
| 50          | IDH50SRB | 4.75      | IDH50WRB | 9.20   |

.1" Spacing. Mounts on PC Board & Mates with IDS Socket below. Ejector Bars - 4/1.00.



### EDGE CARD CONNECTORS

| Size | Part No. | Price  |
|------|----------|--------|
| 10   | IDE10B   | \$3.95 |
| 20   | IDE20B   | 4.35   |
| 26   | IDE26B   | 5.00   |
| 34   | IDE34B   | 6.05   |
| 40   | IDE40B   | 6.90   |
| 50   | IDE50B   | 7.50   |

.1" Spacing. Crimps onto cable with ordinary vise & mates with standard .062" Card Edge.

### RIBBON CABLE

| Size | Solid Color |         | Color Coded |         |
|------|-------------|---------|-------------|---------|
|      | 10 ft.      | 100 ft. | 10 ft.      | 100 ft. |
| 10   | 2.90        | 17.00   | 4.00        | 30.00   |
| 14   | 3.40        | 23.80   | 5.00        | 42.00   |
| 16   | 3.70        | 27.20   | 5.60        | 48.00   |
| 20   | 4.40        | 34.00   | 7.00        | 60.00   |
| 24   | 5.00        | 40.80   | 8.00        | 72.00   |
| 26   | 5.40        | 44.20   | 8.80        | 78.00   |
| 34   | 6.80        | 57.80   | 11.00       | 102.00  |
| 40   | 7.80        | 68.00   | 13.00       | 120.00  |
| 50   | 9.50        | 85.00   | 16.00       | 150.00  |



### 25 PIN "D" CONNECTORS

| Solder Style | Part No. | Price  |
|--------------|----------|--------|
| Male         | DB25P    | \$2.95 |
| Female       | DB25S    | 3.95   |
| Cover        | DB25C    | 1.50   |

| IDC Style | Part No. | Price |
|-----------|----------|-------|
| Male      | IDB25P   | 6.25  |
| Female    | IDB25S   | 6.60  |
| Cover     | IDB25C   | 1.60  |

Solder Style solders onto cable, IDC Style crimps onto cable with vise. 9, 15, 37 and 50 pin available also.



### CABLE PLUGS

| Size | Part No. | Price  |
|------|----------|--------|
| 14   | IDP14B   | \$1.45 |
| 16   | IDP16B   | 1.65   |
| 24   | IDP24B   | 2.50   |
| 40   | IDP40B   | 4.15   |

.1" Spacing. Crimps onto cable with ordinary vise & plugs into standard IC Socket.



### SOCKETS

| Size | Part No. | Price  |
|------|----------|--------|
| 10   | IDS10B   | \$1.88 |
| 20   | IDS20B   | 2.75   |
| 26   | IDS26B   | 3.50   |
| 34   | IDS34B   | 4.50   |
| 40   | IDS40B   | 5.40   |
| 50   | IDS50B   | 6.50   |

.1" Spacing. Crimps onto cable with ordinary vise & mounts to header sold above.

## WIRE WRAP SUPPLIES

### WIRE WRAP WIRE

#### #30 Wire Wrap Wire

| Length | 100/Bag | 500/Bag | 1K/Bag |
|--------|---------|---------|--------|
| 2.5"   | \$1.38  | \$6.81  | \$3.94 |
| 3.0"   | 1.43    | 7.46    | 4.25   |
| 3.5"   | 1.51    | 8.11    | 4.57   |
| 4.0"   | 1.56    | 8.73    | 4.88   |
| 4.5"   | 1.63    | 9.39    | 5.21   |
| 5.0"   | 1.69    | 10.04   | 5.54   |
| 5.5"   | 1.74    | 10.69   | 5.92   |
| 6.0"   | 1.82    | 11.34   | 6.23   |
| 6.5"   | 2.11    | 12.99   | 7.08   |
| 7.0"   | 2.19    | 13.68   | 7.44   |
| 7.5"   | 2.29    | 14.40   | 7.78   |
| 8.0"   | 2.35    | 15.10   | 8.12   |
| 8.5"   | 2.40    | 15.80   | 8.46   |
| 9.0"   | 2.46    | 16.51   | 8.92   |
| 9.5"   | 2.53    | 17.22   | 9.15   |
| 10.0"  | 2.63    | 17.91   | 9.58   |

All lengths are overall, including 1" strip on each end. Choose from colors; Red, Blue, Black, Yellow, White, Green, Orange, and Violet.

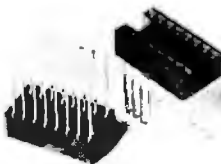

| Size | Part No.   | Each | Tube               |
|------|------------|------|--------------------|
| 08   | ICN083WBSG | .44  | 52x .39 = \$20.28  |
| 14   | ICN143WBSG | .53  | 30x .46 = \$13.80  |
| 16   | ICN163WBSG | .58  | 26x .50 = \$13.00  |
| 16   | ICN183WBSG | .78  | 23x .68 = \$15.64  |
| 20   | ICN203WBSG | 1.00 | 21x .85 = \$17.85  |
| 22   | ICN224WBSG | 1.07 | 19x .92 = \$17.48  |
| 24   | ICN246WBSG | 1.09 | 17x 1.09 = \$18.53 |
| 28   | ICN286WBSG | 1.43 | 15x 1.23 = \$18.45 |
| 40   | ICN406WBSG | 1.85 | 10x 1.60 = \$16.00 |

Selective Plating provides gold in contact where it counts. 3-level wrap. Save by buying sockets by the tube. All gold available at 1/2¢/pin extra charge.

\* \* \* No Discount

### WIRE KITS

#### Kit No. 1 - \$9.95

|     |        |     |        |
|-----|--------|-----|--------|
| 250 | 3"     | 100 | 4 1/2" |
| 200 | 3 1/2" | 100 | 5"     |
| 100 | 4"     | 100 | 6"     |

#### Kit No. 2 - \$24.95

|     |        |     |        |
|-----|--------|-----|--------|
| 250 | 2 1/2" | 250 | 5"     |
| 500 | 3"     | 100 | 5 1/2" |
| 500 | 3 1/2" | 100 | 6"     |
| 500 | 4"     | 100 | 6 1/2" |
| 250 | 4 1/2" | 100 | 7"     |

#### Kit No. 3 - \$34.95

|     |        |     |        |
|-----|--------|-----|--------|
| 250 | 2 1/2" | 500 | 4 1/2" |
| 500 | 3"     | 500 | 5"     |
| 500 | 3 1/2" | 500 | 5 1/2" |
| 500 | 4"     | 500 | 6"     |

#### Kit No. 4 - \$59.95

|      |        |      |        |
|------|--------|------|--------|
| 500  | 2 1/2" | 1000 | 4 1/2" |
| 1000 | 3"     | 1000 | 5"     |
| 1000 | 3 1/2" | 1000 | 5 1/2" |
| 1000 | 4"     | 1000 | 6"     |

## ORDERING INFORMATION

Prepaid orders over \$50 shipped prepaid via UPS. All others add \$3.00 for handling. VISA, MC, COD's and open account orders will be charged freight. \$15 minimum order. \$100 minimum open account order.

## DISCOUNT SCHEDULE

| Order Amount | Discount |
|--------------|----------|
| \$15 - 99    | Net      |
| 100 - 199    | less 10% |
| 200 - 499    | less 15% |
| 500 - 999    | less 20% |
| 1000 up      | less 25% |

Discount and the name of this magazine must be mentioned at time of order to get discount. Discount applies on all items except as noted, "No Discount."

# 16K Memory 8/\$16.95

4116 300ns

ALL MERCHANDISE 100% GUARANTEED

CALL US FOR VOLUME QUOTES

## LS SERIES

|         |      |         |      |
|---------|------|---------|------|
| 74LS00  | .25  | 74LS163 | .95  |
| 74LS01  | .25  | 74LS164 | .95  |
| 74LS02  | .25  | 74LS165 | .95  |
| 74LS03  | .25  | 74LS166 | 2.40 |
| 74LS04  | .25  | 74LS167 | 1.75 |
| 74LS05  | .25  | 74LS168 | 1.75 |
| 74LS06  | .35  | 74LS169 | 1.75 |
| 74LS09  | .25  | 74LS170 | 1.75 |
| 74LS10  | .25  | 74LS171 | .80  |
| 74LS11  | .35  | 74LS172 | .95  |
| 74LS12  | .35  | 74LS173 | .95  |
| 74LS13  | .35  | 74LS174 | .95  |
| 74LS14  | .45  | 74LS175 | .95  |
| 74LS15  | 1.00 | 74LS176 | 2.15 |
| 74LS20  | .25  | 74LS177 | 9.95 |
| 74LS21  | .25  | 74LS178 | 1.00 |
| 74LS22  | .25  | 74LS179 | 1.00 |
| 74LS23  | .25  | 74LS180 | 1.00 |
| 74LS24  | .25  | 74LS181 | 1.00 |
| 74LS25  | .25  | 74LS182 | .85  |
| 74LS26  | .35  | 74LS183 | .95  |
| 74LS27  | .35  | 74LS184 | .95  |
| 74LS28  | .35  | 74LS185 | .95  |
| 74LS29  | .35  | 74LS186 | .95  |
| 74LS30  | .25  | 74LS187 | .95  |
| 74LS31  | .35  | 74LS188 | 1.85 |
| 74LS32  | .35  | 74LS189 | .85  |
| 74LS33  | .55  | 74LS190 | .85  |
| 74LS34  | .55  | 74LS191 | .85  |
| 74LS35  | .55  | 74LS192 | .85  |
| 74LS36  | .55  | 74LS193 | .85  |
| 74LS37  | .55  | 74LS194 | 1.00 |
| 74LS38  | .55  | 74LS195 | .95  |
| 74LS39  | .55  | 74LS196 | .85  |
| 74LS40  | .25  | 74LS197 | .85  |
| 74LS41  | .55  | 74LS221 | 1.20 |
| 74LS42  | .75  | 74LS222 | 1.85 |
| 74LS43  | .75  | 74LS223 | 1.85 |
| 74LS44  | .75  | 74LS224 | 1.85 |
| 74LS45  | .75  | 74LS225 | 1.85 |
| 74LS46  | .75  | 74LS226 | 1.85 |
| 74LS47  | .75  | 74LS227 | 1.85 |
| 74LS48  | .75  | 74LS228 | 1.85 |
| 74LS49  | .75  | 74LS229 | 1.85 |
| 74LS50  | .75  | 74LS230 | 1.85 |
| 74LS51  | .25  | 74LS231 | 1.85 |
| 74LS52  | .35  | 74LS232 | 1.85 |
| 74LS53  | .35  | 74LS233 | 1.85 |
| 74LS54  | .35  | 74LS234 | 1.85 |
| 74LS55  | .35  | 74LS235 | 1.85 |
| 74LS56  | .35  | 74LS236 | 1.85 |
| 74LS57  | 1.25 | 74LS237 | 1.85 |
| 74LS58  | .40  | 74LS238 | 1.85 |
| 74LS59  | .50  | 74LS239 | 1.85 |
| 74LS60  | .50  | 74LS240 | 1.85 |
| 74LS61  | .50  | 74LS241 | 1.85 |
| 74LS62  | .50  | 74LS242 | 1.85 |
| 74LS63  | .75  | 74LS243 | 1.85 |
| 74LS64  | 1.15 | 74LS244 | 1.75 |
| 74LS65  | 1.15 | 74LS245 | 2.95 |
| 74LS66  | .40  | 74LS246 | 7.35 |
| 74LS67  | .65  | 74LS247 | 7.35 |
| 74LS68  | .65  | 74LS248 | 7.35 |
| 74LS69  | .99  | 74LS249 | 7.35 |
| 74LS70  | .99  | 74LS250 | 7.35 |
| 74LS71  | .65  | 74LS251 | 1.30 |
| 74LS72  | .65  | 74LS252 | .85  |
| 74LS73  | .65  | 74LS253 | .85  |
| 74LS74  | .65  | 74LS254 | .85  |
| 74LS75  | .65  | 74LS255 | .85  |
| 74LS76  | .40  | 74LS256 | .85  |
| 74LS77  | .50  | 74LS257 | .85  |
| 74LS78  | .50  | 74LS258 | .85  |
| 74LS79  | .50  | 74LS259 | 2.85 |
| 74LS80  | .50  | 74LS260 | .85  |
| 74LS81  | .50  | 74LS261 | .85  |
| 74LS82  | .50  | 74LS262 | .85  |
| 74LS83  | .50  | 74LS263 | .85  |
| 74LS84  | .50  | 74LS264 | .85  |
| 74LS85  | .50  | 74LS265 | .85  |
| 74LS86  | .50  | 74LS266 | .85  |
| 74LS87  | .50  | 74LS267 | .85  |
| 74LS88  | .50  | 74LS268 | .85  |
| 74LS89  | .50  | 74LS269 | .85  |
| 74LS90  | .50  | 74LS270 | .85  |
| 74LS91  | .99  | 74LS271 | .85  |
| 74LS92  | .70  | 74LS272 | 1.06 |
| 74LS93  | .65  | 74LS273 | 1.20 |
| 74LS94  | .65  | 74LS274 | 1.55 |
| 74LS95  | .65  | 74LS275 | 1.55 |
| 74LS96  | .65  | 74LS276 | 1.55 |
| 74LS97  | .65  | 74LS277 | 1.55 |
| 74LS98  | .65  | 74LS278 | 1.55 |
| 74LS99  | .65  | 74LS279 | 1.55 |
| 74LS100 | .65  | 74LS280 | 1.98 |
| 74LS101 | .40  | 74LS281 | 1.98 |
| 74LS102 | .45  | 74LS282 | 1.98 |
| 74LS103 | .45  | 74LS283 | 1.98 |
| 74LS104 | .45  | 74LS284 | 1.98 |
| 74LS105 | .45  | 74LS285 | 1.98 |
| 74LS106 | .45  | 74LS286 | 1.98 |
| 74LS107 | .40  | 74LS287 | 1.35 |
| 74LS108 | .40  | 74LS288 | 1.35 |
| 74LS109 | .40  | 74LS289 | 1.35 |
| 74LS110 | .45  | 74LS290 | 1.35 |
| 74LS111 | .45  | 74LS291 | 1.35 |
| 74LS112 | .45  | 74LS292 | 1.35 |
| 74LS113 | .45  | 74LS293 | 1.35 |
| 74LS114 | .50  | 74LS294 | 1.35 |
| 74LS115 | .50  | 74LS295 | 1.35 |
| 74LS116 | .50  | 74LS296 | 1.35 |
| 74LS117 | .50  | 74LS297 | 1.35 |
| 74LS118 | .50  | 74LS298 | 1.35 |
| 74LS119 | .50  | 74LS299 | 1.35 |
| 74LS120 | .50  | 74LS300 | 1.35 |
| 74LS121 | .50  | 74LS301 | 1.35 |
| 74LS122 | .50  | 74LS302 | 1.35 |
| 74LS123 | .50  | 74LS303 | 1.35 |
| 74LS124 | .50  | 74LS304 | 1.35 |
| 74LS125 | .50  | 74LS305 | 1.35 |
| 74LS126 | .50  | 74LS306 | 1.35 |
| 74LS127 | .50  | 74LS307 | 1.35 |
| 74LS128 | .50  | 74LS308 | 1.35 |
| 74LS129 | .50  | 74LS309 | 1.35 |
| 74LS130 | .50  | 74LS310 | 1.35 |
| 74LS131 | .50  | 74LS311 | 1.35 |
| 74LS132 | .50  | 74LS312 | 1.35 |
| 74LS133 | .50  | 74LS313 | 1.35 |
| 74LS134 | .50  | 74LS314 | 1.35 |
| 74LS135 | .50  | 74LS315 | 1.35 |
| 74LS136 | .50  | 74LS316 | 1.35 |
| 74LS137 | .50  | 74LS317 | 1.35 |
| 74LS138 | .50  | 74LS318 | 1.35 |
| 74LS139 | .50  | 74LS319 | 1.35 |
| 74LS140 | .50  | 74LS320 | 1.35 |
| 74LS141 | .50  | 74LS321 | 1.35 |
| 74LS142 | .50  | 74LS322 | 1.35 |
| 74LS143 | .50  | 74LS323 | 1.35 |
| 74LS144 | .50  | 74LS324 | 1.35 |
| 74LS145 | .50  | 74LS325 | 1.35 |
| 74LS146 | .50  | 74LS326 | 1.35 |
| 74LS147 | .50  | 74LS327 | 1.35 |
| 74LS148 | .50  | 74LS328 | 1.35 |
| 74LS149 | .50  | 74LS329 | 1.35 |
| 74LS150 | .50  | 74LS330 | 1.35 |
| 74LS151 | .75  | 74LS331 | 1.35 |
| 74LS152 | .75  | 74LS332 | 1.35 |
| 74LS153 | .75  | 74LS333 | 1.35 |
| 74LS154 | .25  | 74LS334 | 2.20 |
| 74LS155 | 1.15 | 74LS335 | 9.65 |
| 74LS156 | .95  | 74LS336 | 3.20 |
| 74LS157 | .75  | 74LS337 | 2.30 |
| 74LS158 | .75  | 74LS338 | 2.40 |
| 74LS159 | .90  | 74LS339 | 2.40 |
| 74LS160 | .95  | 74LS340 | 2.40 |
| 74LS161 | .95  | 74LS341 | 2.40 |
| 74LS162 | .95  | 74LS342 | 2.40 |

## 7400 SERIES

|       |      |       |       |
|-------|------|-------|-------|
| 7400  | .19  | 74128 | .55   |
| 7401  | .19  | 74132 | .45   |
| 7402  | .19  | 74136 | .50   |
| 7403  | .19  | 74141 | .95   |
| 7404  | .19  | 74142 | 2.95  |
| 7405  | .22  | 74143 | 2.95  |
| 7406  | .22  | 74144 | 2.95  |
| 7407  | .22  | 74145 | .90   |
| 7408  | .24  | 74147 | 1.75  |
| 7409  | .19  | 74148 | 1.20  |
| 7410  | .19  | 74150 | 1.35  |
| 7411  | .25  | 74151 | .85   |
| 7412  | .25  | 74152 | .85   |
| 7413  | .25  | 74153 | .85   |
| 7414  | .25  | 74154 | 1.40  |
| 7415  | .25  | 74155 | .75   |
| 7416  | .25  | 74156 | .85   |
| 7417  | .25  | 74157 | .85   |
| 7420  | .19  | 74157 | .55   |
| 7421  | .35  | 74159 | 1.85  |
| 7422  | .29  | 74160 | .85   |
| 7423  | .29  | 74161 | .70   |
| 7425  | .29  | 74162 | .85   |
| 7426  | .29  | 74163 | .85   |
| 7427  | .29  | 74164 | .85   |
| 7428  | .45  | 74165 | .85   |
| 7430  | .19  | 74186 | 1.00  |
| 7432  | .29  | 74187 | 1.95  |
| 7433  | .45  | 74170 | 1.65  |
| 7437  | .29  | 74172 | 5.95  |
| 7438  | .29  | 74173 | .75   |
| 7440  | .19  | 74174 | .89   |
| 7442  | .49  | 74175 | .89   |
| 7443  | .65  | 74176 | .99   |
| 7444  | .89  | 74177 | .75   |
| 7445  | .69  | 74178 | 1.15  |
| 7446  | .59  | 74179 | 1.75  |
| 7447  | .69  | 74180 | .75   |
| 7448  | .69  | 74181 | 2.25  |
| 7450  | .19  | 74182 | .75   |
| 7451  | .23  | 74184 | 2.00  |
| 7453  | .23  | 74185 | 2.00  |
| 7454  | .23  | 74186 | 18.50 |
| 7480  | .23  | 74190 | 1.15  |
| 7484  | .39  | 74191 | 1.15  |
| 7485  | .39  | 74192 | .79   |
| 7470  | .35  | 74193 | .79   |
| 7472  | .29  | 74194 | .86   |
| 7473  | .34  | 74195 | .88   |
| 7474  | .35  | 74196 | .79   |
| 7475  | .49  | 74197 | .75   |
| 7476  | .35  | 74198 | 1.35  |
| 7480  | .59  | 74199 | 1.35  |
| 7481  | 1.10 | 74221 | 1.35  |
| 7482  | .95  | 74246 | 1.35  |
| 7483  | .50  | 74247 | 1.25  |
| 7484  | .50  | 74248 | 1.85  |
| 7485  | .65  | 74249 | 1.85  |
| 7486  | .35  | 74251 | .75   |
| 7488  | .45  | 74258 | 2.25  |
| 7480  | .45  | 74255 | 1.95  |
| 7481  | .40  | 74273 | 1.95  |
| 7482  | .50  | 74278 | 1.25  |
| 7483  | .49  | 74279 | .75   |
| 7484  | .65  | 74283 | 2.00  |
| 7485  | .55  | 74284 | 3.75  |
| 7486  | .70  | 74285 | 3.75  |
| 7487  | 2.75 | 74290 | .95   |
| 74100 | 1.00 | 74293 | .75   |
| 74107 | .30  | 74298 | .85   |
| 74109 | .45  | 74351 | 2.25  |
| 74110 | .46  | 74355 | .85   |
| 74111 | .55  | 74366 | .95   |
| 74116 | 1.55 | 74367 | .85   |
| 74120 | 1.20 | 74368 | .65   |
| 74121 | .29  | 74377 | 2.20  |
| 74122 | .45  | 74390 | 1.75  |
| 74123 | .55  | 74393 | 1.95  |
| 74125 | .45  | 74425 | 3.15  |
| 74126 | .45  | 74426 | .85   |
| 74490 |      | 74490 | 2.55  |

## T.V. CIRCUITS

|        |      |
|--------|------|
| MC1330 | 1.89 |
| MC1350 | 1.29 |
| MC1358 | 1.79 |
| LM380  | 1.29 |
| LM398  | 1.50 |
| LM565  | .99  |
| LM741  | .29  |
| LM1310 | 2.90 |
| LM1800 | 2.99 |
| LM1889 | 2.49 |

## MISC.

|        |      |          |       |
|--------|------|----------|-------|
| 8T26   | 1.89 | 3242     | 9.95  |
| 8T28   | 2.49 | AY5-1013 | 3.95  |
| 8T85   | .99  | TR1602   | 4.95  |
| 8T96   | .99  | IM6402   | 7.95  |
| 8T97   | .99  | 1771     | 24.95 |
| 8T98   | .99  | 1791     | 38.95 |
| 1488   | .99  | UPD765   | 39.95 |
| 1489   | .99  | 8272     | 39.95 |
| DM8131 | 2.85 |          |       |

## CMOS

|       |      |        |       |      |      |       |       |
|-------|------|--------|-------|------|------|-------|-------|
| 74C00 | .35  | 74C373 | 2.75  | 4018 | .95  | 4093  | .95   |
| 74C02 | .35  | 74C374 | 2.75  | 4019 | .45  | 4099  | 1.95  |
| 74C04 | .35  | 74C901 | .80   | 4020 | .95  | 14409 | 8.95  |
| 74C08 | .35  | 74C902 | .85   | 4021 | .95  | 14410 | 8.95  |
| 74C10 | .35  | 74C903 | .85   | 4022 | 1.15 | 14411 | 9.95  |
| 74C14 | 1.50 | 74C905 | 10.95 | 4023 | .35  | 14412 | 12.95 |
| 74C20 | .35  | 74C906 | .95   | 4024 | .75  | 14419 | 2.95  |
| 74C30 | .35  | 74C907 | 1.00  | 4025 | .35  | 4502  | .95   |
| 74C32 | .50  | 74C908 | 2.00  | 4026 | 1.65 | 4503  | .95   |
| 74C42 | 1.75 | 74C909 | 2.75  | 4027 | .65  | 4508  | .85   |
| 74C48 | 2.10 | 74C910 | 9.95  | 4028 | .80  | 4510  | .95   |
| 74C73 | .85  | 74C911 | 10.00 | 4029 | .95  | 4511  | .95   |
| 74C74 | .85  | 74C912 | 10.00 | 4030 | .45  | 4512  | .95   |
| 74C78 | .80  | 74C914 | 1.95  | 4034 | 2.95 | 4514  | 1.25  |
| 74C83 | 1.95 | 74C915 | 2.00  | 4035 | .85  | 4515  | 2.25  |
| 74C85 | 1.95 | 74C918 | 2.75  | 4040 | .95  | 4516  | 1.55  |
| 74C88 | .95  | 74C920 | 17.95 | 4041 | 1.25 | 4518  | 1.25  |
| 74C89 | 4.50 | 74C921 | 15.95 | 4042 | .75  | 4519  | 1.25  |
| 74C90 | 1.75 | 74C922 | 5.95  |      |      |       |       |

# 4K STATIC RAMS 8/18.95

2114 LOW POWER 450ns

ALL MERCHANDISE 100% GUARANTEED

CALL US FOR VOLUME QUOTES

## 8200

|        |       |
|--------|-------|
| 8202   | 45.00 |
| 8205   | 3.50  |
| 8212   | 1.95  |
| 8214   | 3.90  |
| 8216   | 1.85  |
| 8224   | 2.50  |
| 8226   | 1.85  |
| 8228   | 4.95  |
| 8237   | 19.95 |
| 8238   | 4.95  |
| 8243   | 4.95  |
| 8250   | 14.95 |
| 8251   | 5.50  |
| 8253   | 9.85  |
| 8253-5 | 9.85  |
| 8255   | 5.25  |
| 8255-5 | 5.25  |
| 8257   | 7.00  |
| 8259   | 9.00  |
| 8272   | 39.95 |
| 8275   | 29.95 |
| 8279   | 10.50 |
| 8279-5 | 10.50 |
| 8282   | 6.65  |
| 8283   | 6.65  |
| 8284   | 5.80  |
| 8286   | 6.65  |
| 8287   | 6.65  |
| 8288   | 25.00 |
| 8289   | 49.95 |

## 6800

|      |       |
|------|-------|
| 6800 | 5.95  |
| 6802 | 11.95 |
| 6809 | 37.95 |
| 6810 | 4.60  |
| 6820 | 4.95  |
| 6821 | 4.95  |
| 6828 | 9.95  |
| 6834 | 16.95 |
| 6840 | 14.95 |
| 6843 | 42.95 |
| 6844 | 44.95 |
| 6845 | 29.95 |
| 6847 | 15.95 |
| 6850 | 4.75  |
| 6852 | 6.75  |
| 6860 | 10.95 |
| 6862 | 11.95 |
| 6871 | 25.95 |
| 6875 | 6.95  |
| 6880 | 2.95  |

## Z80

|            |       |
|------------|-------|
| Z80        | 8.95  |
| Z80A       | 9.95  |
| Z80B       | 19.95 |
| Z80-PIO    | 6.50  |
| Z80A-PIO   | 8.80  |
| Z80-CTC    | 8.50  |
| Z80A-CTC   | 8.55  |
| Z80-DART   | 15.25 |
| Z80A-DART  | 18.75 |
| Z80-DMA    | 17.50 |
| Z80A-DMA   | 27.50 |
| Z80-SIO/0  | 23.95 |
| Z80A-SIO/0 | 28.95 |
| Z80-SIO/1  | 23.95 |
| Z80A-SIO/1 | 28.95 |
| Z80-SIO/2  | 23.95 |
| Z80A-SIO/2 | 28.95 |
| Z80-SIO/9  | 17.95 |
| Z80A-SIO/9 | 22.95 |

## MPU'S

|        |       |
|--------|-------|
| 8035   | 18.95 |
| 8039   | 19.95 |
| 8080A  | 3.95  |
| 8085   | 12.95 |
| 8086   | 98.95 |
| 8088   | 39.95 |
| 8195   | 11.95 |
| 8156   | 11.95 |
| 8185   | 29.95 |
| 8185-2 | 38.95 |
| 8741   | 38.95 |
| 8748   | 69.95 |
| 8755   | 49.95 |

## 6502

|       |       |
|-------|-------|
| 6502  | 6.95  |
| 6502A | 12.95 |
| 6504  | 8.95  |
| 6505  | 8.95  |
| 6520  | 4.95  |
| 6522  | 9.95  |
| 6532  | 14.95 |
| 6551  | 14.95 |

## IC SOCKETS

1-100 100pcs

|           |     |     |
|-----------|-----|-----|
| 8 pin ST  | .13 | .11 |
| 14 pin ST | .15 | .12 |
| 16 pin ST | .17 | .13 |
| 18 pin ST | .20 | .18 |
| 20 pin ST | .29 | .27 |
| 22 pin ST | .30 | .27 |
| 24 pin ST | .30 | .27 |
| 28 pin ST | .40 | .32 |
| 40 pin ST | .48 | .39 |

ST = SOLDER TAIL

|           |      |      |
|-----------|------|------|
| 8 pin WW  | .59  | .49  |
| 14 pin WW | .69  | .52  |
| 16 pin WW | .69  | .58  |
| 18 pin WW | .99  | .90  |
| 20 pin WW | 1.09 | .96  |
| 22 pin WW | 1.39 | 1.28 |
| 24 pin WW | 1.49 | 1.35 |
| 28 pin WW | 1.89 | 1.49 |
| 40 pin WW | 1.99 | 1.80 |

WW = WIRE WRAP

BEFORE YOU BUY CALL  
JDR FOR THE BEST PRICE.

**800-538-5000**

**800-662-6233**

(CALIFORNIA RESIDENTS)

## APPLE OWNERS

EXPAND YOUR 48K COMPUTER TO 64K

### SUPER RAM • II

- PLUG IN SLOT Ⓞ
  - GOLD PLATED CONTACTS
  - INCLUDES 5 JUMPER OPTIONS
  - INCLUDES 5 RAM-ROM OPTIONS
  - ENJOY THE BEST OF BOTH WORLDS
  - 16K RAM (RANDOM ACCESS MEMORY)
  - THIS IS SOPHISTICATED FIRMWARE
  - EXPANDS YOUR 48K APPLE TO 64K OF PROGRAMMABLE MEMORY
  - ELIMINATES THE NEED FOR APPLESOFT\* OR INTEGER BASIC ROM CARD
  - ALLOWS YOU TO RUN APPLE'S NEW FORTRAN PACKAGE ALSO PASCAL AND PILOT
  - KEYBOARD CONTROL SELECTION OF RAM OR MOTHER BOARD ROM LANGUAGE
  - INCLUDES: INSTALLATION INSTRUCTIONS AND APPLICATIONS NOTES
  - THE SOFTWARE DEVELOPED BY VARIOUS VENDORS FOR YOUR (64K) SHOULD NOW WORK AS THEY ADVERTISED
  - THE MOST VERSATILE RAM EXPANSION ON THE MARKET TODAY
- UNIQUE 1 YEAR WARRANTY!! \$168.00



## SUPER FAN II

"COOL-IT"

- TAN COLOR
- SAVE DOWN TIME
- LONG LIFE MOTOR
- LOW NOISE IS A MUST
- SAVE REPAIR CHARGES
- INCREASES RELIABILITY
- CLIPS ON—NO HOLES OR SCREWS
- MINIMUM QUIETNESS IS DUE TO THE DRAW EFFECT OF AIR THROUGH YOUR COMPUTER AND A SPECIAL FAN AND MOTOR DESIGN
- THOSE EXTRA PLUG-IN CARDS CAN CAUSE EXTRA HEAT

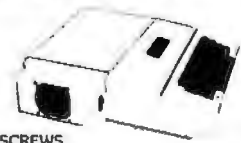

HOW TO HOOK IT UP

1. Clip it on your APPLE.
2. (Unplug your 120V cable (you won't need it))
3. Plug short 120V cable from Super Fan II to the back of your computer
4. Plug the supply cable from Super Fan II to your 120V power source
5. Turn on the rocker switch and a built-in red ready light comes on
6. You are all set "COOL IT"

UNIQUE 1 YEAR WARRANTY!! \$69.00

\*APPLE IS A TRADEMARK OF APPLE COMPUTER INC.

## LEDS

|                |         |
|----------------|---------|
| Jumbo Red      | 10/1.00 |
| Jumbo Green    | 6/1.00  |
| Jumbo Yellow   | 6/1.00  |
| 5082-7780 43°C | .79     |
| MAN74 3°C      | .99     |
| MAN72 3°C      | .99     |

## DYNAMIC RAMS

|          |         |         |        |      |
|----------|---------|---------|--------|------|
| 4027     | (250ns) | 2.50    | 100pcs | 2.00 |
| 4116-150 | (150ns) | 8/21.95 |        | 2.65 |
| 4116-200 | (200ns) | 8/19.95 |        | 2.35 |
| 4116-300 | (300ns) | 8/16.95 |        | 2.00 |
| 4164     | (200ns) | CALL    |        | CALL |

## STATIC RAMS

|         |              |         |        |      |
|---------|--------------|---------|--------|------|
| 2101    | (450ns)      | 1.95    | 100pcs | 1.85 |
| 2102-1  | (450ns)      | .89     |        | .85  |
| 21L02-1 | (LP) (450ns) | 1.29    |        | 1.15 |
| 2111    | (450ns)      | 2.99    |        | 2.49 |
| 2112    | (450ns)      | 2.99    |        | 2.79 |
| 2114    | (450ns)      | 8/18.95 |        | 2.25 |
| 2114L-2 | (LP) (200ns) | 8/22.95 |        | 2.45 |
| 2114L-3 | (300ns)      | 8/21.95 |        | 2.45 |
| 2113L-4 | (LP) (450ns) | 8/18.95 |        | 2.25 |
| 4044-4  | (450ns)      | 3.49    |        | 3.25 |
| 4044-3  | (300ns)      | 3.99    |        | 3.75 |
| TMM2016 | (200ns)      | CALL    |        | CALL |
| MB6116  | (200ns)      | CALL    |        | CALL |

LP = LOW POWER

## EPROMS

|         |                       |       |      |       |
|---------|-----------------------|-------|------|-------|
| 1702    | 256 x 8 (1us)         | 4.95  | 8pcs | 4.50  |
| 2708    | 1024 x 8 (450ns)      | 3.95  |      | 3.50  |
| 2716    | (5v) 2048 x 8 (450ns) | 6.95  |      | 5.95  |
| 2758    | (5v) 1024 x 8 (450ns) | 9.95  |      | 8.95  |
| 2716-1  | (5v) 2048 x 8 (350ns) | 12.95 |      | 11.95 |
| TMS2716 | 2048 x 8 (450ns)      | 9.95  |      | 8.95  |
| TMS2532 | (5v) 4096 x 8 (450ns) | 21.95 |      | 19.95 |
| 2732    | (5v) 4096 x 8 (450ns) | 17.95 |      | 16.95 |

## PROMS

|        |          |    |         |       |
|--------|----------|----|---------|-------|
| 74S188 | (82S23)  | OC | 32 x 8  | 3.95  |
| 74S287 | (82S129) | TS | 256 x 4 | 4.75  |
| 74S288 | (82S123) | TS | 32 x 8  | 4.45  |
| 74S387 | (82S126) | OC | 256 x 4 | 5.75  |
| 74S471 |          | TS | 256 x 8 | 9.95  |
| 74S472 | (82S147) | TS | 512 x 8 | 16.85 |
| 74S474 | (82S141) | TS | 512 x 8 | 17.85 |
| 74S570 | (82S130) | OC | 512 x 4 | 7.80  |
| 74S571 | (82S131) | TS | 512 x 4 | 7.80  |

## JDR MICRODEVICES, INC.

1101 South Winchester Blvd.  
San Jose, California 95128  
800-538-5000 800-662-6233 (Callif.)  
408-247-4852

TERMS: For shipping include \$2.00 for UPS Ground; \$3.00 for UPS Blue Label Air; \$10.00 minimum order. Bay Area Residents add 6 1/2% sales tax. Calif. Residents add 6% sales tax. We reserve the right to limit quantities and substitute manufacturer. Prices subject to change without notice.



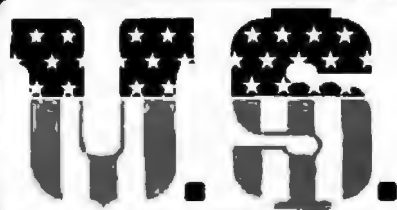

# MICRO SALES

DEALS □ DEALS □ DEALS

SHOP HERE AND  
**SAVE!**  
(MINIMUM ORDER \$10.00)

This is **ABSOLUTELY** the **LOWEST PRICE EVER**  
for a Hi Speed (300 NS) LO-LO Power 32K RAM.  
4K by 1 Chips are organized in Selectable Banks.

# \$299

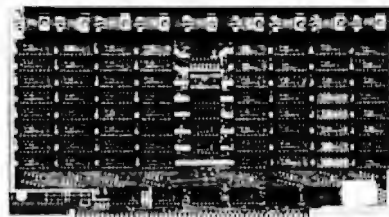

★ Extended Address Lines A16 - A17

★ Phantom Line

★ 9 Regulators

(KIT)

## SCHOOLS

| DIP SWITCHES  | POS. | PRC. |
|---|------|------|
|  | 4    | .88  |
|   | 5    | .92  |
|   | 6    | .95  |
|   | 7    | .99  |
|   | 8    | 1.05 |
|   | 9    | 1.15 |
|   | 10   | 1.19 |



AMP - Need we say more? There is a difference in sockets! These aren't the lowest prices you can find. But, if you've been "burned" before by bad connections in your computer, a few pennies for the best is worth it!

| PINS | PC  | WW  |
|------|-----|-----|
| 8    | .10 | .26 |
| 14   | .13 | .29 |
| 16   | .16 | .32 |
| 18   | .18 | .34 |
| 20   | .22 | .38 |
| 24   | .32 | .48 |
| 28   | .34 | .50 |
| 40   | .45 | .61 |

## RESISTORS .02 ea!

(100 PACK) ¼W

|     |      |      |      |      |
|-----|------|------|------|------|
| 1.0 | 75   | 2.7K | 22K  | 220K |
| 4.7 | 100  | 3.3K | 24K  | 330K |
| 6.8 | 150  | 3.9K | 27K  | 470K |
| 10  | 220  | 4.7K | 33K  | 680K |
| 15  | 330  | 6.8K | 39K  | 1M   |
| 22  | 470  | 10K  | 47K  | 1.5M |
| 27  | 680  | 12K  | 68K  | 2.2M |
| 33  | 1K   | 15K  | 100K | 4.7M |
| 47  | 1.5K | 18K  | 150K | 10M  |
| 68  | 2.2K | 20K  |      |      |

## WIRE WRAP WIRE

Packed in 500 Lot Bundles

(Length includes 2" x 1" Strip)

Color - R, Bu, G, Y, Bk, W

50 ft. \$1.65 - 100 ft. \$3.00 - 500 ft. \$9.50

|          |          |           |
|----------|----------|-----------|
| 2.5-3.25 | 4.0-3.75 | 6.0-4.75  |
| 3.0-3.35 | 4.5-4.00 | 7.0-5.00  |
| 3.5-3.50 | 5.0-4.50 | 8.0-5.50  |
|          |          | 10.0-6.50 |

## OK WIRE WRAP TOOL \$5.95



## COMPUTER GRADE ELECTROLYTICS

| Capac.  | Volt | Type  | \$    |
|---------|------|-------|-------|
| 150,000 | 15   | CAN   | 12.50 |
| 18,000  | 25   | CAN   | 5.60  |
| 6,000   | 50   | CAN   | 5.75  |
| 10,000  | 16   | AXIAL | 4.95  |
| 4,700   | 35   | AXIAL | 3.50  |

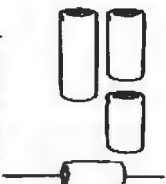

## HOBBIEST

**LM323K 5V. 3A.**  
  
REGULATOR  
**\$5.50**



## TAB MOUNT

|      |      |    |
|------|------|----|
| 7805 | +5V  | 1A |
| 7905 | -5V  | 1A |
| 7812 | +12V | 1A |
| 7912 | -12V | 1A |



HEAT SINKS  
49¢ **\$1.25**

◆ GOLD ◆

## S-100-CONNECTOR TI or Better

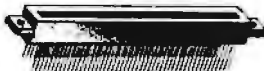

SOLDER TAIL WIRE WRAP

**\$2.50 \$3.25**

## DIP PLUGS

| PART# | PINS | PRICE |
|-------|------|-------|
| 08DP  | 8    | .40   |
| 14DP  | 14   | .55   |
| 16DP  | 16   | .58   |
| 24DP  | 24   | .95   |
| 40DP  | 40   | 1.50  |

Socket and Dip Plug priced based on gold not exceeding \$700 per ounce.

## CONNECTORS

| DUAL ROW .100 |       | CARD EDGE |       |
|---------------|-------|-----------|-------|
| PINS          | PRICE | PINS      | PRICE |
| 20            | 2.35  | 20        | 3.35  |
| 26            | 3.00  | 26        | 3.80  |
| 34            | 3.85  | 34        | 4.65  |
| 40            | 4.50  | 40        | 5.50  |
| 50            | 5.50  | 50        | 5.90  |

RIBBON - 20 to 34 @ 1.00 ft.  
40 & 50 @ 1.30 ft.

CRIMPING 2.00 / CONNECTOR

## OEM'S

### Z-80-A \$6.95

4MHZ Beastie with extra instructions!

### Z-80 SUPPORT

CTC - \$6.55

SIO - \$25.50

PIO - \$6.50

DMA - \$18.75

All 4MHZ (who wants 2MHZ?)

### 74LSXX

|             |              |              |
|-------------|--------------|--------------|
| 74LS00 .33  | 74LS107 .59  | 74LS221 2.95 |
| 74LS01 .33  | 74LS109 .59  | 74LS240 2.85 |
| 74LS02 .33  | 74LS112 .59  | 74LS241 2.49 |
| 74LS03 .33  | 74LS113 .59  | 74LS242 1.95 |
| 74LS04 .59  | 74LS114 .49  | 74LS243 1.95 |
| 74LS05 .39  | 74LS122 .59  | 74LS244 2.95 |
| 74LS06 .39  | 74LS123 1.19 | 74LS245 8.95 |
| 74LS07 .39  | 74LS124 1.49 | 74LS247 1.19 |
| 74LS08 .59  | 74LS125 .89  | 74LS248 1.19 |
| 74LS09 .39  | 74LS126 .89  | 74LS249 1.89 |
| 74LS10 .29  | 74LS132 .79  | 74LS251 1.79 |
| 74LS11 .39  | 74LS133 1.19 | 74LS253 .95  |
| 74LS12 .39  | 74LS136 .69  | 74LS257 1.95 |
| 74LS13 .69  | 74LS138 .99  | 74LS258 1.95 |
| 74LS14 1.25 | 74LS139 .99  | 74LS259 2.95 |
| 74LS15 .49  | 74LS145 1.25 | 74LS260 .75  |
| 74LS20 1.95 | 74LS148 1.49 | 74LS266 1.15 |
| 74LS21 3.7  | 74LS151 .79  | 74LS273 1.75 |
| 74LS22 .29  | 74LS154 2.49 | 74LS275 4.39 |
| 74LS26 .39  | 74LS155 1.49 | 74LS279 .79  |
| 74LS27 .49  | 74LS156 1.49 | 74LS283 1.49 |
| 74LS28 .39  | 74LS157 1.49 | 74LS289 5.75 |
| 74LS30 .49  | 74LS158 1.49 | 74LS290 1.29 |
| 74LS32 .95  | 74LS160 .75  | 74LS293 1.95 |
| 74LS33 1.95 | 74LS161 1.99 | 74LS295 1.95 |
| 74LS37 .75  | 74LS162 1.25 | 74LS298 1.29 |
| 74LS38 .39  | 74LS163 1.25 | 74LS324 1.75 |
| 74LS40 .25  | 74LS164 2.15 | 74LS352 1.65 |
| 74LS42 1.39 | 74LS165 1.49 | 74LS353 1.65 |
| 74LS47 .79  | 74LS166 2.49 | 74LS365 .95  |
| 74LS48 .79  | 74LS168 2.95 | 74LS366 .79  |
| 74LS35 .25  | 74LS169 1.95 | 74LS367 .99  |
| 74LS54 .25  | 74LS170 1.95 | 74LS368 .99  |
| 74LS55 .70  | 74LS173 1.25 | 74LS373 2.95 |
| 74LS73 .79  | 74LS174 1.49 | 74LS374 3.95 |
| 74LS74 .59  | 74LS175 1.49 | 74LS377 1.95 |
| 74LS75 .79  | 74LS181 2.15 | 74LS378 1.95 |
| 74LS76 .79  | 74LS189 6.95 | 74LS379 1.95 |
| 74LS78 .49  | 74LS190 .99  | 74LS386 .59  |
| 74LS83 .95  | 74LS191 1.95 | 74LS390 1.95 |
| 74LS85 1.49 | 74LS192 1.95 | 74LS393 1.95 |
| 74LS86 .95  | 74LS193 1.95 | 74LS395 1.95 |
| 74LS90 .75  | 74LS194 1.49 | 74LS490 4.95 |
| 74LS92 .75  | 74LS195 .95  | 74LS868 1.89 |
| 74LS93 .95  | 74LS196 .95  | 74LS669 1.89 |
| 74LS95 1.29 | 74LS197 1.95 | 74LS670 3.55 |
| 74LS96 1.29 |              |              |

**DEALS □ DEALS □ DEALS**

OUR BUYERS ARE IN CONTACT WITH EVERY MAJOR SUPPLIER AND O.E.M. BUY HERE AT 1000 PIECE



**MICRO SALES**

**QUANTITY PRICES**

ALL MERCHANDISE 100% GUARANTEED! 15 DAY FULL CASH REFUND!

11 EDISON DRIVE ★ NEW LENOX ★ ILLINOIS 60451  
CALL TOLL FREE: 1-800-435-9357 ★ MONDAY thru SATURDAY  
(ILLINOIS RESIDENTS CALL: 815-485-4002) ★ 8:00 a.m. to 6:30 p.m.

TERMS: Prepayment - C.O.D. up to \$100.00 - M/C Visa  
\$5.00 Processing and Handling added to each order PLUS  
Shipping Charges. Please allow personal check to clear before shipment.

**JUST HOT STUFF**

**POWER SUPPLIES**

If you can beat these prices we will be truly amazed. OEM's at 500 lot pay more than this. Call or write for full spec. sheets.



| DISK POWER SUPPLIES              |            |             |         |       |
|----------------------------------|------------|-------------|---------|-------|
| PRIAM-SHUGART-CENTURY-MICROPOLIS |            |             |         |       |
| +5V @ 9A                         | -5V @ .8A  | +24V @ 7A   | US-384  | 89.00 |
| SHUGART-SIEMANS-MPI 5 1/2"       |            |             |         |       |
| +5V @ .5A                        | +12V @ .9A |             | US-340  | 33.50 |
| +5V @ 2A                         | +12V @ 4A  |             | US-323  | 56.25 |
| SHUGART-SIEMANS-CDC 8"           |            |             |         |       |
| +5V @ 1A                         | -5V @ .5A  | +24V @ 1.5A | US-205  | 52.50 |
| +5V @ 2A                         | -5V @ .5A  | +24V @ 3A   | US-206  | 69.00 |
| +5V @ 3A                         | -5V @ .6A  | +24V @ 5A   | US-162  | 89.00 |
| +5V @ 1.7A                       | -5V @ 1.5A | +24V @ 2A   | US-272  | 69.00 |
| +5V @ 2A                         | +12V @ .4A | -12V @ .4A  | US-HTAA | 37.50 |

**TELEVIDEO 950**

Televideo 950 - \$950.00  
Televideo 912C - 665.00  
Televideo 920C - 720.00  
ADDS R-25 - 710.00

Also have 920C, SOROC, HAZELTINE, etc. What we don't have is room on this page. Call Toll Free 800 number for prices.



**C-ITOH PRINTER**

**\$499.00**

Look closely at the photo and see other adds in this rag at \$995.00. Perfect units, warranted. Only 500 pcs. Same story, manufacturer had too many.



**S-100 CARD EXTENDER**

**\$12.50**

(Gold Contacts)

As long as there is a price war, we will fight your battle. Compare at your local Dept. store and buy US MICRO.



**MEMOREX - VERBATUM - WABASH**

**BASF FLOPPIES**

BOX OF 10 ONLY:

|        |           |            |
|--------|-----------|------------|
| 5 1/4" | SOFT      | \$2.65 ea. |
| 5 1/4" | HARD 10   | 2.65 ea.   |
| 5 1/4" | HARD 16   | 2.65 ea.   |
| 8"     | SOFT 1D   | 3.25 ea.   |
| 8"     | SOFT 2D   | 3.85 ea.   |
| 8"     | SOFT 2DDS | 5.00 ea.   |



**SPECIAL OF THE QUARTER**

**S1-MOD (KIT)**

**\$189.00**



Complete S-100 12 Slot Computer. Ample system power with regulated power for drives. Excellent for Subsystem or Hobby use. 4 hours to build. (6 conn. incl., less fans)

**DUAL DRIVE SUBSYSTEM**

**\$995.00**

\$195.00 w/no Drives

If this looks like a Lobo Drive System, don't be fooled. Just because it looks like one, works like one, smells like one, and tastes like one (?) doesn't mean it has to cost like one!



2 SHUGART 801R

**TWIN VERTICAL DRIVES**

5" \$550.00 - 8" \$980.00

Attractive, convenient and compact Two Drive Mass Storage includes Power Supply, Drives, Cabinets and Cables. Double Sided, Double Track available too! \$145.00 Kit (Less Cable)



**Z-80 CPU (KIT)**

The first time this world popular CPU offered in Kit. 2 serial, 3 parallel, CTC, EProm Z-80 at 4 mhz. Software bued rate, etc. (less Prom & cable) \$212.00



**EXPANDABLE RAM**

★SPECIAL★SPECIAL★SPECIAL★

This is the best all around 64K board you can buy. If after you see it, you don't agree return for full refund. Bank Select by extended address lines or I.O. 40H.



★ \$389.00 A&T★

US - D\$K \$255.00

Double Density 8" and 5" Disk Controller designed for S-100 IEEE standards. Uses Western Digital 1795, 1691 2143 Chip Set.



**FANS \$14.95**

These are brand new, in the box fans. Not noisy bearing pullouts. Never again at these low prices!



3-1/8"



4-5/8"

**SPECIALS OF THE MONTH**

**4116s**

**\$2.95**

Expansion 16K Dynamic RAMs for Apple, TRS-80 S-100 systems. T.I., Mostek Intel, Call for manufacturer.

200 NS

**INTEL**

**8251 \$4.95**

**8255 \$6.50**

VERY POPULAR I.O. CHIPS BY LEADING MANUFACTURER

**2114s**

**\$3.25**

One of the world's two most popular STATIC RAMs. Factory prime tested units. Sold in lots of 8 only. FUJITSU, HITACHI, etc.



200 NS

**TMS-4044**

**\$4.25**

**MM-5257**

**INTEL 2147**

250 NS

CMOS Version \$4.50!

The other of the world's most popular STATIC RAMs. This one is 4K by 1 organization. Don't buy Gold, buy these, the price won't last!

**2716s**

**\$7.50 (450 NS)**

**2708s**

**\$6.95 (450 NS)**

Remember when 2716s were \$50.00 and hard to get? These units are so beautiful it's hard to part with them. But we will, for a small price. Guaranteed!

**SHUGART DRIVE**



**8" 801R**

**\$395.00**

Manufacturer had too many, buys at 1000 piece rate, sales dropped, so we got 'em. Fantastic buy, get them while they last! Full warranty.

**SIEMANS DRIVE**

**8" 100-8**

**\$375.00**

Very Special Price on these BRAND NEW current production units Add \$10.00 for Extended 1 Year Warrantee!

7400

Table listing various computer models and their prices, including SN7400N, SN7401N, SN7402N, etc.

74LS00

Table listing various computer models and their prices, including 74LS00N, 74LS01N, 74LS02N, etc.

CMOS

Table listing various computer models and their prices, including CD4000, CD4001, CD4002, etc.

LINEAR

Table listing various computer models and their prices, including LM105H, LM108AH, LM109H, etc.

1.8K UPGRADE ONLY \$24.95 SPECIFY COMPUTER

HP HEWLETT PACKARD HP-85 \$2695.00

HP-85 2695.00 HP-83 1885.00 HP-41V 875.00 HP-41CV 775.00

MINIMOVER-5 MICROBOT ROBOTIC ARM \$1695.00

California Computer Systems 2200 SUPER S-100 BUY!

Proto Gilps Proto Boards

Novation AUTO-CAT Automatic Answer Direct Connect 0-300 Band

D-CAT direct Connect 0-300 Band

Single Board Computers

ADVANCED COMPUTER PRODUCTS

Apple computer Sales and Service Apple II 64K

Table listing various Apple computer models and their prices, including Apple II, Apple III, etc.

Apple Triple Play! 1. Apple III 2. Apple II 3. Apple II

New Apple software Visicalc - Now Better Than Ever

Novation Vista A800 Quad Density DMA 8" Disk Controller

ATARI 800 & 400 Personal Computer System

ATARI 800 Includes: Computer Console, BASIC Lang Cartridge, BASIC Language Programming Manual, etc.



# ADVANCED COMPUTER PRODUCTS

FIRST TO OFFER PRIME PRODUCTS TO THE HOBBYIST AT FAIR PRICES!

1. Proven Quality Factory tested products only.
2. Guaranteed Satisfaction
- Call For Special School Discounts

**SALE \$164 \$19.95**

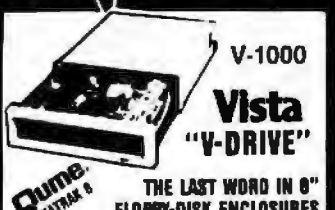

**V-1000 Vista "V-DRIVE" RAM**

THE LAST WORD IN 8" FLOPPY-DISK ENCLOSURES

THE VISTA V-1000 FLOPPY DISK DRIVE SUBSYSTEM is the most advanced and reliable system available... it features a built-in microprocessor and advanced electronics... it is designed for maximum performance and reliability... it is the only drive that meets the needs of the home user and the professional alike.

**DISCOUNT PRICES**

- CABINET... \$ 395
- CABINET with 2 drive slots... \$1495
- CABINET with 4 drive slots... \$1995

**\$24.95 TRS-80/APPLE \$24.95 MEMORY EXPANSION KITS**

4116's 16K (200/250 ns.) 8 pcs for \$24.95 Specify Computer Call For Volume Pricing

**16K RAM**

**CENTRONICS PRINTER** Model 737

- Centronics compatible printer
- The 737 has everything... check and compare the features
- New, true drive

**\$835.00**

**32K STATIC RAM BOARD**

2 or 4 MHz Expandable uses 2114L's

**S-100**

- 16K x 4 MHz Kit \$59.95
- 16K x 4 MHz AAT \$17.95
- 32K x 4 MHz AAT \$29.95
- 32K x 4 MHz AAT Bare Board \$39.95
- Bare Bd. w/ all parts less mem. \$9.95

**NEW! from Zilog**

Z-8 CPU comes with Tiny Basic & debug program on the I.C.

**\$69.95 w/dtata**

**BIPOLAR CPU SALE**

Signetics 8x300 8 bit CPU

While stock lasts 14.95 ea.

**UV "Eprom" Eraser**

Model UVs-11E \$69.95

Model S-52T... \$325.00

**NON-LINEAR SYSTEMS, INC. (NL)**

**TOUCH-TEST 20**

DIGITAL MULTIMETER \$319.95

**BECKMAN DIGITAL MULTIMETERS**

TECH 300 Digital Multimeter \$110

TECH 310 Digital Multimeter \$140

TECH 320 Digital Multimeter \$185

VG-201 Vinyl Carrying Case \$10

DC-202 Deluxe Carrying Case \$10

HV-211 High Voltage Probe \$35

TR-221 AC Current Clamp \$25

DL-231 Deluxe Test Lead Kit \$10

TL-242 Square Test Leads \$5

**INTERSYSTEMS**

The Perfected S-100 Box

The new Series II CPU Board features a 4 MHz Z-80A CPU and full-featured front panel 20-slot actively terminated motherboard, with 25 amp power supply (50/60 Hz operation, incl 68 cfm fan)

DPS-1, List \$1795

ACP Price **\$1499**

**SYSTEM 2A**

with Z-80A CPU & MHz. 8A RAM, I/O Board, 20 slots, front panel 20-slot active disk controller board Full 1-year warranty.

List \$3795 ACP Price \$2995

**NEC PC-8000 Series Microcomputer System.**

**NEW INTRODUCING \$1099.00**

- PC-8000A High Resolution Graphics Monitor \$1395.00
- PC-8000B High Resolution Graphics Monitor \$1099.00
- PC-8000C High Resolution Graphics Monitor \$999.00
- PC-8000D High Resolution Graphics Monitor \$799.00
- PC-8000E High Resolution Graphics Monitor \$599.00
- PC-8000F High Resolution Graphics Monitor \$399.00
- PC-8000G High Resolution Graphics Monitor \$199.00

**MICROPROCESSORS**

Z8001 16 bit 8080 \$170.00

Z8002 16 bit 8088 \$140.00

8080 8080 \$135.00

8085 8085 \$135.00

8088 8088 \$135.00

8088A 8088A \$135.00

8088B 8088B \$135.00

8088C 8088C \$135.00

8088D 8088D \$135.00

8088E 8088E \$135.00

8088F 8088F \$135.00

8088G 8088G \$135.00

8088H 8088H \$135.00

8088I 8088I \$135.00

8088J 8088J \$135.00

8088K 8088K \$135.00

8088L 8088L \$135.00

8088M 8088M \$135.00

8088N 8088N \$135.00

8088O 8088O \$135.00

8088P 8088P \$135.00

8088Q 8088Q \$135.00

8088R 8088R \$135.00

8088S 8088S \$135.00

8088T 8088T \$135.00

8088U 8088U \$135.00

8088V 8088V \$135.00

8088W 8088W \$135.00

8088X 8088X \$135.00

8088Y 8088Y \$135.00

8088Z 8088Z \$135.00

**ADVANCED SUPPORT**

AM5611 486 Processor \$175.00

AM5612 486 Processor \$175.00

AM5613 486 Processor \$175.00

AM5614 486 Processor \$175.00

AM5615 486 Processor \$175.00

AM5616 486 Processor \$175.00

AM5617 486 Processor \$175.00

AM5618 486 Processor \$175.00

AM5619 486 Processor \$175.00

AM5620 486 Processor \$175.00

**Z-80 SUPPORT CHIPS**

Z80-PRO 2.5 MHz \$7.95

Z80-PRO 4.0 MHz \$12.95

Z80-CTC 2.5 MHz \$7.95

Z80-CTC 4.0 MHz \$12.95

Z80-DMA 2.5 MHz \$7.95

Z80-DMA 4.0 MHz \$12.95

Z80-SIO-1 2.5 MHz \$7.95

Z80-SIO-1 4.0 MHz \$12.95

Z80-SIO-2 2.5 MHz \$7.95

Z80-SIO-2 4.0 MHz \$12.95

Z80-SIO-3 2.5 MHz \$7.95

Z80-SIO-3 4.0 MHz \$12.95

**8080/8088 SUPPORT**

8080-1 8080 \$2.95

8080-2 8080 \$2.95

8080-3 8080 \$2.95

8080-4 8080 \$2.95

8080-5 8080 \$2.95

8080-6 8080 \$2.95

8080-7 8080 \$2.95

8080-8 8080 \$2.95

8080-9 8080 \$2.95

8080-10 8080 \$2.95

**8080 SUPPORT CHIPS**

8080-1 8080 \$2.95

8080-2 8080 \$2.95

8080-3 8080 \$2.95

8080-4 8080 \$2.95

8080-5 8080 \$2.95

8080-6 8080 \$2.95

8080-7 8080 \$2.95

8080-8 8080 \$2.95

8080-9 8080 \$2.95

8080-10 8080 \$2.95

**8080 SUPPORT CHIPS**

8080-1 8080 \$2.95

8080-2 8080 \$2.95

8080-3 8080 \$2.95

8080-4 8080 \$2.95

8080-5 8080 \$2.95

8080-6 8080 \$2.95

8080-7 8080 \$2.95

8080-8 8080 \$2.95

8080-9 8080 \$2.95

8080-10 8080 \$2.95

**BIPOLAR PROMS**

Custom Programming

8253-8032 74S165 \$2.25

8253-8032 74S165 \$2.25

8253-8032 74S165 \$2.25

8253-8032 74S165 \$2.25

8253-8032 74S165 \$2.25

8253-8032 74S165 \$2.25

8253-8032 74S165 \$2.25

8253-8032 74S165 \$2.25

8253-8032 74S165 \$2.25

8253-8032 74S165 \$2.25

**MOS PROMS**

74S165 \$2.25

74S165 \$2.25

74S165 \$2.25

74S165 \$2.25

74S165 \$2.25

74S165 \$2.25

74S165 \$2.25

74S165 \$2.25

74S165 \$2.25

74S165 \$2.25

**CHARACTER GEN.**

251-001 3V Laser \$9.00

251-002 3V Laser \$9.00

251-003 3V Laser \$9.00

251-004 3V Laser \$9.00

251-005 3V Laser \$9.00

251-006 3V Laser \$9.00

251-007 3V Laser \$9.00

251-008 3V Laser \$9.00

251-009 3V Laser \$9.00

251-010 3V Laser \$9.00

**STATIC RAMS**

2114 16Kx1 \$1.25

2114 16Kx1 \$1.25

2114 16Kx1 \$1.25

2114 16Kx1 \$1.25

2114 16Kx1 \$1.25

2114 16Kx1 \$1.25

2114 16Kx1 \$1.25

2114 16Kx1 \$1.25

2114 16Kx1 \$1.25

2114 16Kx1 \$1.25

**DYNAMIC RAMS**

A16 4116 16K (16 Pin) \$2.49

Sel of 4116 x 200 NS \$24.95

4116 16Kx1 \$1.25

4050 4K x 118 Pin \$4.95

4050 4K x 118 Pin \$4.95

4050 4K x 118 Pin \$4.95

4050 4K x 118 Pin \$4.95

4050 4K x 118 Pin \$4.95

4050 4K x 118 Pin \$4.95

4050 4K x 118 Pin \$4.95

4050 4K x 118 Pin \$4.95

**SOCKETS**

| # Pins | Lo Profile | Standard | Tri | Lead |
|--------|------------|----------|-----|------|
| 18     | 14         | 14       | 14  | 14   |
| 24     | 14         | 14       | 14  | 14   |
| 30     | 14         | 14       | 14  | 14   |
| 36     | 14         | 14       | 14  | 14   |
| 42     | 14         | 14       | 14  | 14   |
| 48     | 14         | 14       | 14  | 14   |
| 54     | 14         | 14       | 14  | 14   |
| 60     | 14         | 14       | 14  | 14   |
| 66     | 14         | 14       | 14  | 14   |
| 72     | 14         | 14       | 14  | 14   |
| 78     | 14         | 14       | 14  | 14   |
| 84     | 14         | 14       | 14  | 14   |
| 90     | 14         | 14       | 14  | 14   |
| 96     | 14         | 14       | 14  | 14   |
| 102    | 14         | 14       | 14  | 14   |
| 108    | 14         | 14       | 14  | 14   |
| 114    | 14         | 14       | 14  | 14   |
| 120    | 14         | 14       | 14  | 14   |
| 126    | 14         | 14       | 14  | 14   |
| 132    | 14         | 14       | 14  | 14   |
| 138    | 14         | 14       | 14  | 14   |
| 144    | 14         | 14       | 14  | 14   |
| 150    | 14         | 14       | 14  | 14   |
| 156    | 14         | 14       | 14  | 14   |
| 162    | 14         | 14       | 14  | 14   |
| 168    | 14         | 14       | 14  | 14   |
| 174    | 14         | 14       | 14  | 14   |
| 180    | 14         | 14       | 14  | 14   |
| 186    | 14         | 14       | 14  | 14   |
| 192    | 14         | 14       | 14  | 14   |
| 198    | 14         | 14       | 14  | 14   |
| 204    | 14         | 14       | 14  | 14   |
| 210    | 14         | 14       | 14  | 14   |
| 216    | 14         | 14       | 14  | 14   |
| 222    | 14         | 14       | 14  | 14   |
| 228    | 14         | 14       | 14  | 14   |
| 234    | 14         | 14       | 14  | 14   |
| 240    | 14         | 14       | 14  | 14   |
| 246    | 14         | 14       | 14  | 14   |
| 252    | 14         | 14       | 14  | 14   |
| 258    | 14         | 14       | 14  | 14   |
| 264    | 14         | 14       | 14  | 14   |
| 270    | 14         | 14       | 14  | 14   |
| 276    | 14         | 14       | 14  | 14   |
| 282    | 14         | 14       | 14  | 14   |
| 288    | 14         | 14       | 14  | 14   |
| 294    | 14         | 14       | 14  | 14   |
| 300    | 14         | 14       | 14  | 14   |
| 306    | 14         | 14       | 14  | 14   |
| 312    | 14         | 14       | 14  | 14   |
| 318    | 14         | 14       | 14  | 14   |
| 324    | 14         | 14       | 14  | 14   |
| 330    | 14         | 14       | 14  | 14   |
| 336    | 14         | 14       | 14  | 14   |
| 342    | 14         | 14       | 14  | 14   |
| 348    | 14         | 14       | 14  | 14   |
| 354    | 14         | 14       | 14  | 14   |
| 360    | 14         | 14       | 14  | 14   |
| 366    | 14         | 14       | 14  | 14   |
| 372    | 14         | 14       | 14  | 14   |
| 378    | 14         | 14       | 14  | 14   |
| 384    | 14         | 14       | 14  | 14   |
| 390    | 14         | 14       | 14  | 14   |
| 396    | 14         | 14       | 14  | 14   |
| 402    | 14         | 14       | 14  | 14   |
| 408    | 14         | 14       | 14  | 14   |
| 414    | 14         | 14       | 14  | 14   |
| 420    | 14         | 14       | 14  | 14   |
| 426    | 14         | 14       | 14  | 14   |
| 432    | 14         | 14       | 14  | 14   |
| 438    | 14         | 14       | 14  | 14   |
| 444    | 14         | 14       | 14  | 14   |
| 450    | 14         | 14       | 14  | 14   |
| 456    | 14         | 14       | 14  | 14   |
| 462    | 14         | 14       | 14  | 14   |
| 468    | 14         | 14       | 14  | 14   |
| 474    | 14         | 14       | 14  | 14   |
| 480    | 14         | 14       | 14  | 14   |
| 486    | 14         | 14       | 14  | 14   |
| 492    | 14         | 14       | 14  | 14   |
| 498    | 14         | 14       | 14  | 14   |
| 504    | 14         | 14       | 14  | 14   |
| 510    | 14         | 14       | 14  | 14   |
| 516    | 14         | 14       | 14  | 14   |
| 522    | 14         | 14       | 14  | 14   |
| 528    | 14         | 14       | 14  | 14   |
| 534    | 14         | 14       | 14  | 14   |
| 540    | 14         | 14       | 14  | 14   |
| 546    | 14         | 14       | 14  | 14   |
| 552    | 14         | 14       | 14  | 14   |
| 558    | 14         | 14       | 14  | 14   |
| 564    | 14         | 14       | 14  | 14   |
| 570    | 14         | 14       | 14  | 14   |
| 576    | 14         | 14       | 14  | 14   |
| 582    | 14         | 14       | 14  | 14   |
| 588    | 14         | 14       | 14  | 14   |
| 594    | 14         | 14       | 14  | 14   |
| 600    | 14         | 14       | 14  | 14   |
| 606    | 14         | 14       | 14  | 14   |
| 612    | 14         | 14       | 14  | 14   |
| 618    | 14         | 14       | 14  | 14   |
| 624    | 14         | 14       | 14  | 14   |
| 630    | 14         | 14       | 14  | 14   |
| 636    | 14         | 14       | 14  | 14   |
| 642    | 14         | 14       | 14  | 14   |
| 648    | 14         | 14       | 14  | 14   |
| 654    | 14         | 14       | 14  | 14   |
| 660    | 14         | 14       | 14  | 14   |
| 666    | 14         | 14       | 14  | 14   |
| 672    | 14         | 14       | 14  | 14   |
| 678    | 14         | 14       | 14  | 14   |
| 684    | 14         | 14       | 14  | 14   |
| 690    | 14         | 14       | 14  | 14   |
| 696    | 14         | 14       | 14  | 14   |
| 702    | 14         | 14       | 14  | 14   |
| 708    | 14         | 14       | 14  | 14   |
| 714    | 14         | 14       | 14  | 14   |
| 720    | 14         | 14       | 14  | 14   |
| 726    | 14         | 14       | 14  | 14   |
| 732    | 14         | 14       | 14  | 14   |
| 738    | 14         | 14       | 14  | 14   |
| 744    | 14         | 14       | 14  | 14   |
| 750    | 14         | 14       | 14  | 14   |
| 756    | 14         | 14       | 14  | 14   |
| 762    | 14         | 14       | 14  | 14   |
| 768    | 14         | 14       | 14  | 14   |
| 774    | 14         | 14       | 14  | 14   |
| 780    | 14         | 14       | 14  | 14   |
| 786    | 14         | 14       | 14  | 14   |
| 792    | 14         | 14       | 14  | 14   |
| 798    | 14         | 14       | 14  | 14   |
| 804    | 14         | 14       | 14  | 14   |
| 810    | 14         | 14       | 14  | 14   |
| 816    | 14         | 14       | 14  | 14   |
| 822    | 14         | 14       | 14  | 14   |
| 828    | 14         | 14       | 14  | 14   |
| 834    | 14         | 14       | 14  | 14   |
| 840    | 14         | 14       | 14  | 14   |
| 846    | 14         | 14       | 14  | 14   |
| 852    | 14         | 14       | 14  | 14   |
| 858    | 14         | 14       | 14  | 14   |
| 864    | 14         | 14       | 14  | 14   |

# California Digital

Post Office Box 3097 B • Torrance, California 90503



## DISKETTES

FREE PLASTIC LIBRARY CASE INCLUDED WITH THE PURCHASE OF EVERY BOX OF DISKETTES

Private industry for California Digital is one of the most progressive producers of magnetic media. A high quality in cartridge double density 5.25 inch diskette. To insure customer value, the diskette is manufactured with a plastic case and a plastic library case is included with every lot of diskettes. Minimum order 1000 from computer or required sectors.

**\$24.95**  
BOX

Ten boxes \$22.75 One hundred boxes \$21.50

| DISKETTES | Box     | 10 boxes | Box           | 10 boxes |
|-----------|---------|----------|---------------|----------|
| 52501     | \$27.00 | \$25.00  | 52501(10)     | \$25.00  |
| 52501(10) | \$29.00 | \$27.00  | 52501(10)(10) | \$25.00  |

**5.25" DISKETTES** Search box 10 hrs. 1000 512. 3740 848. 847. 3060 3. 8. 31. Single side double den. 710-0 45. 42. 3740/4 75. 72. 2800 47. 35. Double side/Double den. 710-22 21. 42. 3740/4 75. 72. 2800 47. 35. Double side/Double den. 710-50 62. 36. 3740/4 75. 72. 2800 47. 35. SCFF/CI word hard cleaning kit. \$24.95 52501-52501(10) please specify 5 1/4" 5 1/4" Prices available on request for tape, cartridges, videotapes, volume diskettes.

## MEMORY

TRS-80 \$25  
APPLE II \$25  
16k memory (8) 4116's



Factory prime. Unconditionally guaranteed for one full year. Add \$3.00 for TRS-80 jumpers and instructions.

## DYNAMIC

|             | ea.   | 32+   | 100+ | 1K+  |
|-------------|-------|-------|------|------|
| 4116- 200ns | 3.25  | 3.00  | 2.75 | 2.50 |
| 4116 150ns  | 3.75  | 3.50  | 3.25 | 3.00 |
| 4164 4JK    | 49.50 | 45.00 |      |      |

## STATIC

|              |      |      |      |      |
|--------------|------|------|------|------|
| 21L02 450ns  | 1.18 | 1.05 | .80  |      |
| 21L02 250ns  | 1.48 | 1.45 | 1.39 |      |
| 2114L4 450ns | 4.95 | 2.95 | 2.75 | 2.50 |
| 2114L3 300ns | 4.25 | 3.75 | 3.00 | 2.75 |
| 4044-1 450ns | 4.85 | 4.50 | 4.00 | 4.00 |
| 4044-2 250ns | 5.50 | 4.95 | 4.50 | 4.35 |
| 5257-3 300ns | 4.47 | 4.25 | 4.05 | 3.75 |

## EPROM

|               |       |       |       |      |
|---------------|-------|-------|-------|------|
| 2708 450ns    | 4.95  | 4.50  | 3.75  | 3.25 |
| 2716 5V.      | 7.95  | 6.50  | 5.00  | 4.50 |
| 2716 tri-volt | 8.95  | 9.00  | 8.25  | 7.50 |
| 2732 Intel    | 18.00 | 17.60 | 16.00 |      |
| 2532 TI       | 21.50 | 19.00 |       |      |
| 2764          |       |       |       |      |



direct connect MODEM Your Choice \$169

Direct connect modem is a standard line of balance modems that are designed for use with computer terminals. Choose either of these two model units. The Universal Data System 1611P is a high selectable between answer and receive rates. It has full 102 compatibility. Direct connect to the new model 1611P unit. 100% guaranteed from the telephone line. No need to locate modem in proximity to L.C. power receptacle. 100-102LP 2 years.

UDS 103/LP AUTO ANSWER \$219

## 26 Megabyte Hard Disk Drive from GEORGE MORROW'S Thinker Toys \$3495

Other options: Additional card drive \$149.00, 1000 512 sectors \$149.00, 1000 512 sectors \$149.00, 1000 512 sectors \$149.00.

## MEMOREX 8" DISKETTES \$25

Recently the MEMOREX Corporation has a complete line of magnetic tape. A fresh line of eight inch magnetic tape. California Digital is a leader in the industry. This line of products is available in quantities of 1000 units.



The new BSR SYSTEM X-10 computer terminal. Fully compatible with your existing system. 3200 baud. 1000 512 sectors. 1000 512 sectors. 1000 512 sectors.

## S-100 Mother Board \$35



## SWITCHES

| SWITCHED | TERMINAL | PK   | 100+ |
|----------|----------|------|------|
| 100 100  | 100 100  | 1.10 | 1.10 |
| 100 100  | 100 100  | 1.10 | 1.10 |
| 100 100  | 100 100  | 1.10 | 1.10 |

## CONNECTORS



| CONNECTORS       | PK   | 100+ |
|------------------|------|------|
| 5400 1/4" center | 1.00 | 1.00 |
| 5400 1/2" center | 1.00 | 1.00 |
| 5400 3/4" center | 1.00 | 1.00 |
| 5400 1" center   | 1.00 | 1.00 |

| TERMINALS | PK   | 100+ |
|-----------|------|------|
| 100 100   | 1.10 | 1.10 |
| 100 100   | 1.10 | 1.10 |
| 100 100   | 1.10 | 1.10 |



## S-100 MAINFRAME

Mainframe includes 117/230 volt power supply and your choice of a six or twelve slot motherboard. Six slot enclosure is supplied with mounting provisions for two 5 1/4" floppy disk or Winchester drive. AC receptacle is provided for terminal or other accessory. Chassis has been punched to accept six assorted computer connectors. Shipping weight 37 lbs. ENM-CD1 \$285.00

## Shugart Associates



801/R Disk Drive 15 lbs. \$395. Shugart 801/R with CP-200 power supply, multi-format diskette, 30 pounds. Documentation included. 30 pounds. 2250-1801. Some are shown with two Shugart 801/R disk drives. \$1195. 30 pounds. 2250-2001. Disk Drive usable. 4 foot 30 conductor with edge card connector at both ends. \$22.00. Export Disk drives. 2250V. 30A115 add \$30.00 per disk drive.

## SHUGART 801R \$395

Qume Double Sided 8 1/4" Disk Drive \$75

## NEW from Shugart Technology 5 Megabyte Hard Disk Drive



Packaged in the same physical size as the industry standard 5 1/4" minifloppy disk drive. The micro-Winchester stores thirty times as much data (4.33 megabytes unformatted), accesses data twice as fast (170 milliseconds) and transfers data twenty times faster (5.0 megabits per second).

The ST508 is factory sealed to protect the media from environmental contaminants. Requires only DC voltage. Dual California Digital 5 1/4" enclosure. \$1500

Shugart Associates SA400 removable media disk drive for above package. add: \$300

## DATA INPUT TERMINAL \$49

This Regulated terminal was recently acquired from the CDC division of the Perkin Corporation. The unit was originally designed for inputting data directly onto magnetic tape. The system is comprised of a precision steel aluminum and fiberglass enclosure, about 18" x 18" x 18" in size. Thirty-character keyboard. Thirty-character large alphanumeric display. Four back load speaker. Microprocessor of data and status of pending operations. The most of all this "USER" terminal, with a little imagination, can be configured to make the perfect home for an S-100 computer and video display, or with slight modification will accept the Hewlett-Packard HP-45 micro-computer. Five volt regulated power supply is available for an additional \$20. All units are in excellent condition. Original acquisition over \$1000. 22 lbs.

## Regulated Power Supply 5 VOLT 5AMP \$1195

This USBI surplus power supply can be used for a wide variety of applications. It is a regulated power supply. It is a regulated power supply. It is a regulated power supply.

TOLL FREE ORDER LINE (800) 421-5041 TECHNICAL & CALIFORNIA (213) 679-9001 TWX 910325-6212



All merchandise sold by California Digital in premium grade. Shipping: First five pounds \$2.00; each additional add \$1.40. Foreign orders 10% shipping. Excess will be refunded. California residents add 6% sales tax. COD's discouraged. Open accounts extended to state supported educational institutions and companies with a "Strong Dan & Bradstreet". Warehouse: 15608 Inglewood Blvd. Visitors by appointment.

Circle 44 on inquiry card



# Terminals and Printers

**ZENITH** | data systems  
Z19 Video Terminal



List \$995

OUR PRICE  
**\$799**

Limited Time

Intertec

## NEW INTERTUBE III

List \$995 **ONLY \$749**

12" display, 24 x 80 format, 18-key numeric keypad, 128 upper/lower case ASCII characters. Reverse video, blinking, complete cursor addressing and control. Special user-defined control function keys, protected and unprotected fields. Line insert/delete and character insert/delete editing, eleven special line drawing symbols.

## TELEVIDEO TVI-912C



Upper and lower case, 15 baud rates: 75 to 19,000 baud, dual intensity, 24 x 80 character display, 12 x 10 resolution. Numeric pad. Programmable reversible video, auxiliary port, self-test mode, protect mode, block mode, tabbing, addressable cursor. Microprocessor controlled, programmable underline, line and character insert/delete. "C" version features typewriter-style keyboard. List \$950

CALL FOR PRICE

920C (with 11 function keys, 6 edit keys and 2 transmission mode keys, List \$1030

CALL FOR PRICE

950C List \$1195 . . . . . CALL FOR PRICE

## HAZELTINE 1500

Call For Price



1410 w/numeric keypad, List \$900 . . . . . CALL  
1420 w/lower case and numeric pad . . . . . CALL  
1510, List \$1395 . . . . . CALL  
1520, List \$1650 . . . . . CALL

## SOROC



**IQ-120**

List \$995

**SPECIAL \$729**

IQ135 \$749

IQ-140 List \$1495  
**SPECIAL \$1149**

## CENTRONICS PRINTERS

730, parallel, friction, tractor \$599  
NEW 739 w/graphics \$819  
779-2 w/tractor (same as TRS-80 Line Printer II), List \$1350 \$799  
704-9 RS232 150CPS \$1595  
704-11 Parallel 150CPS \$1695

## NEC SPINWRITER™

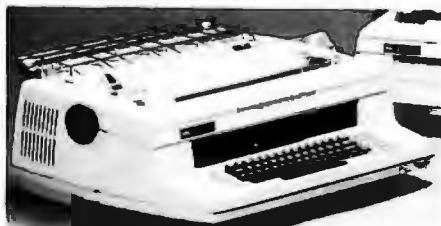

Terminal/Keyboard as well as RO Printer Only models available.

**CALL FOR PRICES!**

## PAPER TIGER®

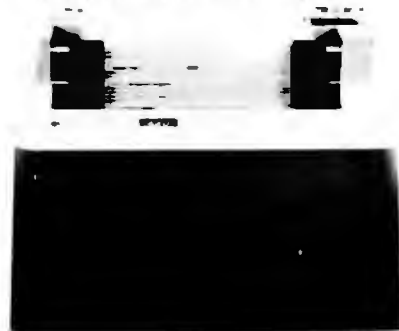

IDS 445 PAPER TIGER . . . . . \$698  
IDS 445G PAPER TIGER  
Buffer w/graphics option, incl. buffer . . \$789

NEW IDS 460/560

QUALITY PRINTING AT MATRIX  
SPEED — LOGIC SEEKING  
PROPORTIONAL SPACING

w/auto test justification

NEW IDS PAPERTIGER 460 List \$1295 . . \$1099  
NEW IDS PAPERTIGER 460G List \$1394 \$1149  
NEW IDS 560G List \$1794 . . . . . \$1499  
TRS-80 cable . . . . . \$45

## TI-810



TI-810 Basic Unit, \$1895 . . . . . \$1595  
TI-810 w/full ASCII (Lower case), vertical forms control, and compressed print \$1795  
TI-820w/lower case List \$1995 . . . \$1645  
TI-820w/full ASCII, forms control, compressed print . . . . . List \$2150 . \$1795  
TI-745 Complete printing terminal with acoustic coupler, List \$1695 . . . \$1399

## ANADEX

### DP9500 / DP9501 PRINTERS

DP-9500, List \$1650 . . . . . \$1349

DP-9501, List \$1650 . . . . . \$1349

### ANADEX DP-8000

80-Col. Dot Matrix. . . . . \$849

## OKIDATA

**Microline 80** List \$599 **ONLY \$499**

Tractor Feed Option . . . . . \$109

Serial interface . . . . . \$ 99

Microline 82 List \$799 \$679

Microline 83 List \$1260 \$1069

EpsonMX-80 FTList \$745. . . . . \$599

EpsonMX-80 List\$645. . . . . \$499

Above prices reflect a 2% cash discount (order prepaid prior to shipment). Add 2% to prices for credit card orders, C.O.D.'s, etc. Prices are f.o.b. shipping point. Prices are subject to change and offers subject to withdrawal without notice. **WRITE FOR FREE CATALOG.**

# MiniMicroMart, Inc.

1618 James Street, Syracuse NY 13203 (315) 422-4467 TWX 710-541-0431



# Computers, Disk Systems

**ZENITH** | data systems



Z89-FA  
List \$2895  
OUR PRICE  
**\$2395**



Z-89GA  
List \$2595, Less Disk . . . . . \$2149  
A-87 Two Drive  
Minifloppy System List \$1195. . . . . \$989  
Z-47DA. . . . . \$3695  
8" Two Megabyte Disk System  
List \$3695. . . . . \$3059

## INTERSYSTEMS

formerly ITHACA AUDIO

The new Series II CPU Board features a 4 MHz Z-80A CPU and a full-feature front panel. 20-slot actively terminated motherboard, with 25 amp power supply (50/60 Hz operation, incl. 68 cfm fan). DPS-1, List \$2199. **CALL FOR PRICE**

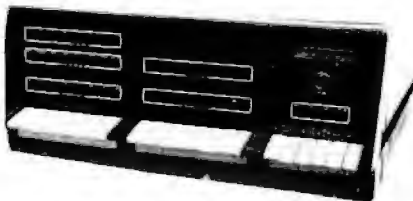

COMPLETE SYSTEM with InterSystem 64K RAM, I/O Board and double density disk controller board. Full 1 year warranty.

**CALL FOR PRICE**

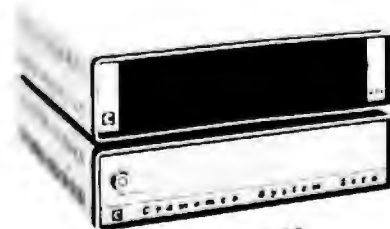

## NEW! CROMEMCO SYSTEM ZERO/D

A complete 64K Computer with Double Density Disk Controller . . . . . List \$2995

**OUR PRICE \$2545**

Companion Disk drive for above —  
Quad Density — Total of 780 Kilobytes of  
storage on the two drives. . . . . List \$1295

**OUR PRICE \$1099**

Only \$3644 for a complete 64K Disk System

## SUPERBRAIN By INTERTEC

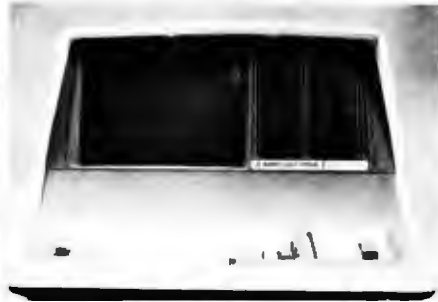

64K Double or Quad Density units available. Uses two Z-80 CPU's. Commercial-type terminal with 12" monitor. Dual double density minifloppies. Over 350 kilobytes of storage (twice that with quad density drives). Two serial RS232 ports, I/O ports standard. Expandable with optional S-100 interface. Comes with CP/M 2.2 operating system. MiniMicroMart can supply a wide range of CP/M development and application software

w/64K Double Density, List \$3495 **\$2869**  
w/64K Quad Density, List \$3995 **\$3395**



**hp** HEWLETT  
PACKARD  
HP-41CV  
**\$259.**



## DYNABYTE DB 8/1



DB 8/1 64 64K RAM SYSTEM WITH  
Z80 CPU and 2 serial and 1 parallel I/O.  
List \$3395, Disc. \$2850 **OUR PRICE \$2795**

**hp** HEWLETT  
PACKARD **HP-85A**  
List \$3250  
**\$2749**



**HP-83  
Special \$1749**

F.O.B. shipping point. All prices subject to change and all offers subject to withdrawal without notice. Advertised prices are for prepaid orders. Credit card and C.O.D. 2% higher. C.O.D. may require deposit.

## MORROW THINKER TOYS® DISCUS M26™

26 megabytes of formatted storage  
List \$4495 **NEW LOW \$3795**



## THINKER TOYS® DISK SYSTEMS

Now includes CP/M® 2.2

Discus 2D, List \$1199 . . . . . \$998  
Discus 2D, dual-drive, List \$1994 . . . . . \$1669  
Discus 2 + 2, A&T, List \$1549 . . . . . \$1299  
Dual Discus 2 + 2, A&T, List \$2748 . . . . . \$2299

All Morrow floppy disks include CP/M® 2.2 and Microsoft Basic 80

## MORROW

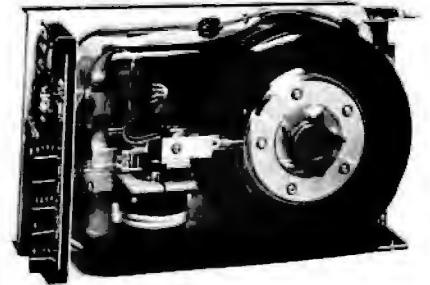

List \$3695  
DISCUS M-10 10 Megabyte  
Wirchester **OUR PRICE \$3095**

## NEW! CROMIX FROM CROMEMCO

A New UNIX Like  
Disk Operating System.

With true multi-user,  
multi-tasking capabilities

List \$295 . . . . . **OUR PRICE \$249**

## NEW! DOUBLE DENSITY CONTROLLER BOARD FROM CROMEMCO

With built-in diagnostics

16 FDC Controller, List \$595 **OUR PRICE \$505**

— WRITE FOR FREE CATALOG —

# Mini Micro Mart, Inc.

1618 James Street, Syracuse, NY 13203

(315) 422-4467 TWX 710-541-0431

Circle 249 on Inquiry card.

# If North Star or Cromemco offer it . . . WE HAVE IT!! Immediate Delivery at Discount Prices

## NORTH STAR Horizon® 2



### ASSEMBLED

|                                |        |                                |      |
|--------------------------------|--------|--------------------------------|------|
| HORIZON 1, DD . . . . .        | \$2279 | 32K, QD, List \$2995 . . . . . | 2539 |
| HORIZON 2, 32K, DD .           | \$2619 | 48K, QD, List \$4090 . . . . . | 3469 |
| 32K, QD, List \$3595 . . . . . | 3049   | 64K, DD, List \$3830 . . . . . | 3239 |
| 48K, DD, List \$3590 . . . . . | 3039   | 64K, QD, List \$4330 . . . . . | 3669 |

### NORTH STAR APPLICATIONS SOFTWARE

(Exclusive for use with North Star Disk Systems — specify Double or Quad Density)

|  |       |
|--|-------|
| NORTHWORD, List \$399 . . . . .          | \$339 |
| MAILMANAGER, List \$299 . . . . .        | 249   |
| INFOMANAGER, List \$499 . . . . .        | 419   |
| GENERALLEDGER, List \$999 . . . . .      | 799   |
| ACCOUNTSRECEIVABLE, List \$599 . . . . . | 499   |
| ACCOUNTSPAYABLE, List \$599 . . . . .    | 499   |

### NORTH STAR HARD DISK HD-18

18 megabytes, plugs into parallel port of North Star Horizon. Utilizes tried-and-proven 14" Century Data Marksman. List \$4999.

**OUR PRICE \$4199**

**NORTH STAR MDS-A** — Double (or Quad) Density Disk System, Kit, List \$799. **OUR PRICE \$669**  
Assembled and Tested, List \$899 **SPECIAL \$719**

### NORTH STAR MEMORY BOARDS

|   |       |
|---|-------|
| 16K Dynamic RAM (RAM-16-A/A), Assembled, List \$499 . . . . . | \$420 |
| 32K (RAM-32/A), Assembled, List \$739 . . . . .               | \$620 |

**NorthStar prices going up!!!**  
Check by phone for prices after May 1, 1981

## NEW System 3

by CROMEMCO

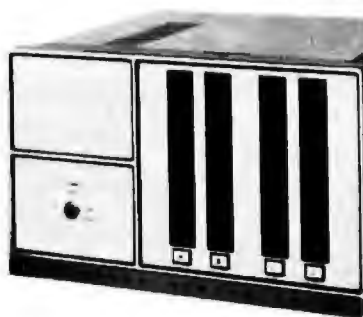

Now with Dual Double Sided Double Density (over 2 megabytes of Storage)  
64K of RAM  
List \$7995

LIMITED TIME **\$6395**

**CROMEMCO SYSTEM 2** — Now double Density with Double Sided Drives, Quad Capacity mini floppy disc drives. List \$4695 . . . . . **Only \$3899**

### CROMEMCO Z-2H

Full 11-megabyte Hard Disk

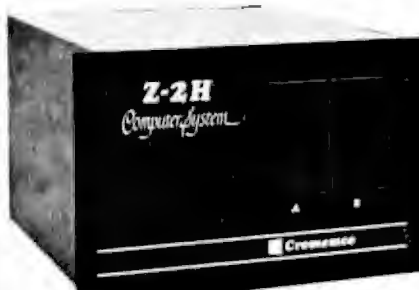

system. Fast Z-80A 4 MHz processor, two floppy disk drives, 64K RAM memory, RS232 special interface, printer interface, and extensive software available.  
List \$9995

**OUR PRICE \$8489**

Beat the price increase on many CROMEMCO Boards & Software.  
**ORDER NOW!!!**

NEW! Double Density Controller Board from Cromemco w/built-in diagnostics — 16 FDC Controller List \$595 . . . . . \$505

|   |                       |
|---|-----------------------|
| Cromemco System CS-0/D  |                       |
| Z-80 SCC CPU, 64KZ, 16 FDC . . . . .  | \$2595                |
| SINGLE CARD COMPUTER — SCC-W 4 MHz, List \$450 . . . . .  | \$382                 |
| NEW COLOR GRAPHICS INTERFACE — 80I List \$595 . . . . .   | OUR PRICE \$505       |
| CROMEMCO HDD — 11/22-megabyte Hard Disk for use with existing systems. DMA controller. Transfer rate of 5.6 megabytes/second. |                       |
| HDD-11, List \$6995 . . . . .   | OUR PRICE ONLY \$5939 |
| HDD-22, List \$11,995 . . . . .   | \$10,189              |

SHIPPING AND INSURANCE: Add \$15 or Horizons, \$2.50 for Boards and Software. Hard Disk Systems and Cromemco systems shipped freight collect. Advertised prices are for prepaid orders. Credit card and C.O.D. 2% higher. Deposit may be required on C.O.D. All prices subject to change and offers subject to withdrawal without notice.

# MiniMicroMart, Inc.

1618 James Street, Syracuse, NY 13203 (315) 422-4467

TWX 710-541-0431



# Better Products,

## JADE Double-D™ Get the Inside Track

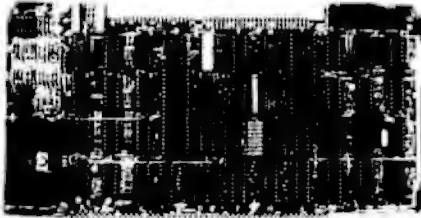

S-100 bus compatible • Reads and writes single or double density • Density is software selectable • CP/M™ 2.2 compatible in single or double density • Controls up to four 5-1/4" or 8", single or double-sided drives • Single or double-sided drives may be mixed in the same system • On-board Z-80A to assure reliable operation • EIA level serial printer interface on board, baud rates to 9600 (perfect for despooling operations) • 2K of RAM on-board • Uses IBM standard formats • Designed to meet IEEE signal disciplines • Works with 8080, 8085, and Z-80 CPU's • 4-layer PC board with internal power and ground planes provides very stable, low-noise operation.

IOD-1200B Bare board ..... \$59.95  
IOD-1200K Kit ..... \$299.95  
IOD-1200A A & T for 8" ..... \$375.95  
IOD-1205A A & T for 5 1/4" ..... \$395.00  
SFC-58001200E DD boot PROM .... \$20.00  
SFC-59002001F CP/M 2.2 for DD . \$150.00

## JADE Memory Bank™ 8 or 16 Bit Dynamic Memory

New, from JADE (naturally), an IEEE S-100 64K dynamic memory that looks toward the future. • IEEE S-100 standard pinout and signal discipline • Expandable to 16 Megabytes via switchable port OR extended address lines • 8 or 16 bit words, automatically, depending on the type of CPU on the bus • 4-layer PC board for extremely low-noise operation.

The new JADE Memory Bank™ is one of the safest places you can store your valuable program information. With its on-board refresh controller, this board allows DMA operations without regard to time factors. It will run reliably at any system clock rate up to 6 MHz—because it is clocked with the system clock itself (no one-shots are used for timing operations). Its unique IEEE design enables it to switch from a 64K by 8-bit board to a 32K by 16-bit board automatically (responds to IEEE's 16 Rqst line and, if enabled, replies with 16 Grant).

On-board M1 wait-state generator allows the use of slower memory, and a unique on-board precharge extender makes this board run reliably with any manufacturer's 4116 memory chips.

Compatible with Cromemco and other CPU systems — features enough optional strapping to enable it to run with any Z-80/Z8000 system.

MEM-99730B Bare Board ..... \$49.95  
MEM-99730K Kit, no RAM ..... \$199.95  
MEM-16730K 16K kit ..... \$219.95  
MEM-32731K 32K kit ..... \$239.95  
MEM-48732K 48K kit ..... \$259.95  
MEM-64733K 64K kit ..... \$279.95  
Assembled & Tested ..... add \$50.00

## JADE The Big Z™ Z-80A Based CPU

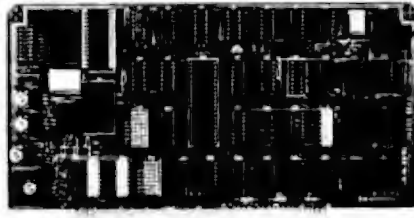

S-100 bus compatible • Switch selectable 2 or 4 MHz operation • Serial I/O port • Accommodates a 2708, 2716, or 2732 EPROM in shadow mode allowing full use of 64K RAM • MWRITE signal is generated automatically if used without front panel • On-board 8251 USART controls serial port at baud rates from 75 to 9600 baud • Switch selectable 1K, 2K, or 4K boundary fully buffered • Power-on jump to EPROM

CPU-30201K Kit ..... \$139.95  
CPU-30201A A & T ..... \$189.95  
CPU-30200B Bare board ..... \$35.00

### Memory Chips on Sale

|             | 1-9   | 10-21 | 25-49 | 50+   |
|-------------|-------|-------|-------|-------|
| 2114L 4 MHz | 3.35  | 2.99  | 2.75  | 2.49  |
| 2708 2 MHz  | 4.90  | 3.90  | 3.45  | 2.90  |
| 2532 2 MHz  | 24.90 | 19.90 | 15.90 | 12.90 |
| 2716 2 MHz  | 8.90  | 7.45  | 6.45  | 5.75  |
| 2716 4 MHz  | 19.90 | 15.45 | 13.45 | 11.75 |
| 2732 2 MHz  | 24.90 | 19.90 | 15.90 | 12.90 |
| 2732 4 MHz  | 39.90 | 29.90 | 24.90 | 19.90 |
| 2758 2 MHz  | 6.90  | 6.25  | 5.50  | 4.50  |
| 4116 200 ns | 3.25  | 2.99  | 2.49  | 1.99  |
| 4164 200 ns | 28.90 | 24.90 | 22.90 | 19.90 |

## JADE Disk Sub-Systems Shugart, Siemens, Qume



Handsome metal cabinet with proportionally balanced air flow system • Rugged dual drive power supply • Power cable kit • Power switch, line cord, fuse holder, cooling fan • Never-Mar rubber feet • All necessary hardware to mount 2-8" disk drives, power supply, and fan • Does not include signal cable

**Dual 8" Subassembly Cabinet**  
END-000420 Bare cabinet ..... \$59.95  
END-000421 Cabinet kit ..... \$225.00  
END-000431 A & T ..... \$359.95

**8" Disk Drive Subsystems**  
**Single Sided, Double Density**  
END-000423 Kit w/2 FD100-8Ds ..... \$975.00  
END-000424 A & T w/2 FD100-8Ds ..... \$1175.00  
END-000433 Kit w/2 SA-801Rs ... \$999.95  
END-000434 A & T w/2 SA-801Rs ..... \$1195.00

**8" Disk Drive Subsystems**  
**Double Sided, Double Density**  
END-000426 Kit w/2 DT-8s ..... \$1475.00  
END-000427 A & T w/2 DT-8s ... \$1675.00  
END-000436 Kit w/2 SA-851Rs ... \$1495.00  
END-000437 A & T w/2 SA-851Rs ..... \$1695.00

Circle 181 on inquiry card.

## JADE S.P.I.C. Our "SPICy" New I/O Board

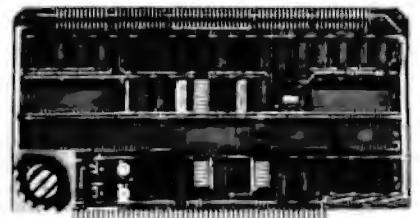

New, from JADE, one of the most advanced, technologically sophisticated Serial/Parallel Interrupt Controller systems in the world. On a single IEEE S-100 standard board, JADE has packed two bi-directional parallel ports with full handshaking, four serial channels (asynchronous, IBM-compatible bi-synch, synchronous, HDLC/SDLC) with complete modem control lines, and 16 counter-timer channels.

Utilizing the highly advanced Zilog peripheral chips, (Z-80 SIO, PIO & CTCs), the SPIC board is fully programmable to serve as the foundation for a multi-user multi-tasking system. Although the board can be operated in an 8080/8085 system, we recommend its use with a Z-80/Z8000 system utilizing the powerful Z-80/Z8000 interrupt Mode 2. Each of the seven Z-80 peripheral chips can generate its own interrupt vector, with daisy-chain priority levels. Each counter-timer channel can be programmed to monitor an interrupt vector line on the S-100 bus, to serve as an interval timer or real-time clock, and to operate as a software controllable baud rate generator. Each SIO channel can be driven independently with separate Tx/Rx clocks for each channel, so your peripherals can have varied baud rates, from 110 to 76,800 baud

In addition, this board can serve as a data concentrator link to an IBM, DEC, or Data General mainframe computer, utilizing a high-speed serial channel that is programmable to virtually any protocol.

IOI-1045B Bare board & manual ..... \$49.95  
IOI-1045K Kit, standard ..... \$179.95  
IOI-1045A A & T, standard ..... \$239.95  
IOI-1046K Kit w/full chip set ..... \$219.95  
IOI-1046A A & T w/full chip set ... \$299.95

## Jade Business Software

Now, for the first time, at an amazingly low price, CP/M and SDOS users can get an affordable business software package. Just look at these programs! All come complete with basic code (written to run under CBASIC I), for easy customizing and modification. All software is self-documenting. The package price includes a word-processing system. When printed on the system's printer, all files with the extension xxxTOT. constitute a complete manual. No manuals are supplied with the package other than as they appear on the disks. All software is supplied on 8" premium quality JADE Diskettes. Software sold as is. (Sorry, but at these low prices we can not offer our usual friendly support and handholding.)

Includes: General Ledger, Payroll, Invoicing, Inventory Control, Accounts Receivable, Cash Disbursements, Fixed Assets, Cash Receipts, & Mailing List Management.  
Special Package Price ..... \$249.95

# Lower Prices,

## Printers



### BEST BUY in PRINTERS - Epson

- MX-70** 132 column, 80 CPS, 5 x 7 dot matrix, adjustable tractor feed, & graphics  
PRM-27070 List \$459 ..... **\$399.95**
- MX-80** 132 column, 80 CPS, bi-directional/logic seeking printing, 9 x 9 dot matrix, adjustable tractor feed, & 64 graphics characters  
PRM-27080 List \$645 ..... **\$474.95**
- MX-80FT** same as MX-80 with friction feed and full graphics added  
PRM-27082 List \$745 ..... **\$574.95**
- MX-100** 233 column, correspondence quality, ultra-high resolution graphics, up to 15" paper, friction feed & removable adjustable tractor feed, 18 x 18 dot matrix, 80 CPS, programmable forms handling  
PRM-27100 List \$945 ..... **\$795.00**
- PRA-27084** Serial interface ..... **\$69.95**  
**PRA-27088** Serial intf & 2K buffer .. **\$144.95**  
**PRA-27081** Apple card ..... **\$74.95**  
**PRA-27082** Apple cable ..... **\$22.95**  
**PRA-27086** IEEE 488 card ..... **\$52.95**  
**PRA-27087** TRS-80 cable ..... **\$32.95**  
**PRA-27085** Grafrax II ..... **\$95.00**  
**PRA-27083** Extra ribbon ..... **\$14.95**

### SPINWRITER - NEC

- 65 cps, bi-directional, letter quality printer with deluxe tractor mechanism, both parallel and serial interfaces on-board, 16K buffer, ribbon, print thimble, graphics, micro-space justification, data cable, and self test diagnostic ROM.  
**PRD-55511** without 16K buffer ... **\$2795.00**  
**PRD-55512** with 16K buffer ..... **\$2895.00**

## Accessories for TRS-80

### DISK DRIVES for TRS-80

23% more storage, 4 times faster, 40 track with free patch, 120 day warranty.  
**MSM-12410C** Save \$125.00 !!! ..... **\$325.00**

### 8" DISK DRIVES for MODEL II

- 2 double density drives with cabinet, power supply, & cables  
**END-000433** Kit ..... **\$1050.00**  
**END-000434** Assembled ..... **\$1250.00**  
**WCA-5036A** Cable (required) ..... **\$29.95**

## 16K Atari ... \$359.95

### ATARI 800 - Atari

- Complete personal computer with high resolution color graphics, built-in RF modulator, 4 controller ports, internal speaker, 16K RAM & 8K ROM  
**SYO-2080A** 16K Atari 800 ..... **\$759.95**  
**Atari 800** with 32K of RAM ..... **\$799.95**  
**Atari 800** with 48K of RAM ..... **\$849.95**  
**SYO-2040A** 16K Atari 400 ..... **\$359.95**  
**MSM-330810** Disk drive ..... **\$595.00**  
**MSM-330815** Dual drive ..... **\$1395.00**  
**IOX-5050A** 850 interface ..... **\$199.95**  
**MEX-16853K** 16K RAM module ..... **\$69.95**  
**SFI-241011005** Visicalc ..... **\$184.95**

## Accessories for Apple



### 16K MEMORY UPGRADE

Add 16K of RAM to your TRS-80, Apple, or Exidy in just minutes. We've sold thousands of these 16K RAM upgrades which include the appropriate memory chips (as specified by the manufacturer), all necessary jumper blocks, fool-proof instructions, and our 1 year guarantee.  
**MEX-16100K** TRS-80 kit ..... **\$25.00**  
**MEX-16101K** Apple kit ..... **\$25.00**  
**MEX-16102K** Exidy kit ..... **\$25.00**

### 16K RAM Card - Microsoft

(There is life after 48K)

- MEX-16300A** A & T ..... **\$174.95**
- Z-80\* CARD for APPLE**  
 Two computers in one, Z-80 & 6502, more than doubles the power & potential of your Apple, includes Z-80\* CPU card, CP M 2.2, & BASIC-80  
**CPX-30800A** A & T ..... **\$279.95**

### APPLE CLOCK - Cal Comp Sys

Real time clock w/ battery back-up

- IOK-2030A** A & T ..... **\$109.95**

### DISK DRIVE for APPLE

5 1/4" disk drive with controller for your Apple

- MSM-12310C** with controller ..... **\$475.00**  
**MSM-12310I** w/out controller ..... **\$375.00**

### 8" DRIVES for APPLE

Controller, DOS, two 8" double density drives, cabinet, power supply, & cables  
**Special Package Price Kit** ..... **\$1399.95**

### PRINTER INTERFACE - C.C.S.

Centronics type I O card w/ firmware

- IOI-2041A** A & T ..... **\$99.95**

### AIO, ASIO, APIO - S.S.M.

Parallel & serial interface for your Apple (see Byte pg 11)

- IOI-2050K** Par & Ser kit ..... **\$139.95**  
**IOI-2050A** Par & Ser A & T ..... **\$189.95**  
**IOI-2052K** Serial kit ..... **\$89.95**  
**IOI-2052A** Serial A & T ..... **\$99.95**  
**IOI-2054K** Parallel kit ..... **\$69.95**  
**IOI-2054A** Parallel A & T ..... **\$89.95**

### A488 - S.S.M.

IEEE 488 controller, uses simple basic commands, includes firmware and cable, 1 year guarantee, (see April Byte pg 11)  
**IOX-7488A** A & T ..... **\$399.95**

### CPS MULTICARD - Mtn. Computer

Three cards in one! Real time clock, calendar, serial interface, & parallel interface - all on one card.  
**IOX-2300A** A & T ..... **\$229.95**

### VISICALC - Personal Sftwr

The ultimate program for your Apple II  
**SFA-24101005M** Complete package **\$139.95**  
 Circle 182 on inquiry card.

## Single Board Computers

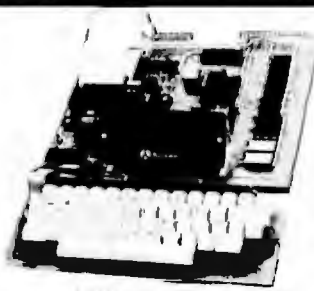

### AIM-65 - Rockwell

6502 computer with alphanumeric display, printer, & keyboard, and complete instructional manuals  
**CPK-50165** 1K AIM ..... **\$424.95**  
**CPK-50465** 4K AIM ..... **\$499.95**  
**SFK-74600008E** 8K BASIC ROM ..... **\$99.95**  
**SFK-64600004E** 4K assembler ROM ..... **\$84.95**  
**PSX-030A** Power supply ..... **\$64.95**  
**ENX-000002** Enclosure ..... **\$54.95**  
 4K AIM, 8K BASIC, power supply, & enclosure  
**Special package price** ..... **\$675.00**

### Z-80\* STARTER KIT - SD Systems

Complete Z-80\* computer with RAM, ROM I/O display, keyboard, manual, and huge area.  
**CPS-30010K** Kit ..... **\$369.95**  
**CPS-30010A** A & T ..... **\$459.95**

### SYM-1 - Synertek Systems

Single board computer with 1K of RAM, 4K of ROM, keyboard, LED display, 20mm & cassette interface on board  
**CPK-50020A** A & T ..... **\$249.95**

## Video Terminals

### VIEWPOINT - ADDS

Detachable keyboard, serial RS232C interface, baud rates from 110 to 19,200, auxiliary serial output port, 24 x 80 display, tiltable screen, international character set  
**VDT-501210** Sale Priced ..... **\$639.95**

### TELEVIDEO 950

Detachable keyboard, split screen with line lock, etched CRT, programmable function keys, on-screen status line, buffered auxiliary port, 14 x 10 dot matrix, self test, serviced nationwide by General Electric  
**VDT-901250** List \$1195.00 ..... **\$995.00**

## Video Monitors

### Leedex / Amdek

Reasonably priced video monitors

- VDM-801210** Video 100 12" B&W .. **\$149.95**  
**VDM-801230** Video 100-80 12" B&W **\$189.95**  
**VDM-801250** 12" Green Phosphor ... **\$189.95**  
**VDC-801310** 13" Color I ..... **\$399.95**

### 13" COLOR MONITOR - Zenith

The hi res color you've been promising yourself  
**VDC-201301** ..... **\$449.00**

### 12" GREEN SCREEN - NEC

20 MHz, P31 phosphor video monitor with audio, exceptionally high resolution. A fantastic monitor at a very reasonable price  
**VDM-651200** 12" monitor ..... **\$259.95**

## EPROM Erasers

### EPROM ERASERS

L.S. Engineering UV eraser for up to 48 EPROMs  
**XME-3200** A & T ..... **\$39.99**

Spectronics hi intensity industrial eraser  
**XME-3100** Without timer ..... **\$69.50**  
**XME-3101** With timer ..... **\$94.50**



# Faster Service.

## S-100 PROM Boards

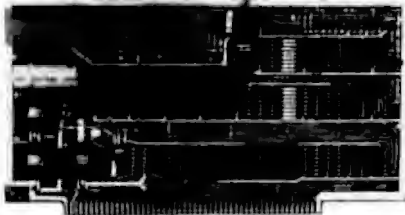

### PB-1 - S.S.M.

270K, 2716 EPROM board with built-in programmer  
**MEM-99510K Kit** ..... \$154.95  
**MEM-99510A A & T** ..... \$219.95

### PROM-100 - SD Systems

270K, 2716, 2732, 2758, & 2516 EPROM programmer  
**MEM-99520K Kit** ..... \$219.95  
**MEM-99520A Jade A & T** ..... \$269.95

### EPROM BOARD - Jade

16K or 32K uses 2708's or 2716's, 1K boundary  
**MEM-16230K Kit** ..... \$79.95  
**MEM-16230A A & T** ..... \$119.95

## S-100 Video

### VB-3 - S.S.M.

80 characters x 24 lines expandable to 80 x 48 for a full page of text, upper & lower case, 256 user defined symbols, 160 x 192 graphics matrix, memory mapped, has key board input.

**IOV-1095K 4 MHz kit** ..... \$349.95  
**IOV-1095A 4 MHz A & T** ..... \$439.95  
**IOV-1096K 80 x 48 upgrade** ..... \$39.95

### VDB-8024 - SD Systems

80 x 24 I/O mapped video board with keyboard I/O, and on-board Z-80A\*.  
**IOV-1020K Kit** ..... \$399.95  
**IOV-1020A Jade A & T** ..... \$459.95

### VIDEO BOARD - Jade

64 characters x 16 lines, 7 x 9 dot matrix, full upper/lower case ASCII character set, numbers, symbols, and greek letters, normal/reverse/blinking video, S-100.

**IOV-1050K Kit** ..... \$99.95  
**IOV-1050A A & T** ..... \$125.00  
**IOV-1050B Bare board** ..... \$29.95

## Motherboards

### ISO-BUS - Jade

Silent, simple, and on sale - a better motherboard  
 6 Slot (5 1/4" x 8 1/2")

**MBS-061B Bare board** ..... \$19.95  
**MBS-061K Kit** ..... \$39.95  
**MBS-061A A & T** ..... \$49.95

12 Slot (9 1/4" x 8 1/2")

**MBS-121B Bare board** ..... \$29.95  
**MBS-121K Kit** ..... \$69.95  
**MBS-121A A & T** ..... \$89.95

18 Slot (14 1/4" x 8 1/2")

**MBS-181B Bare board** ..... \$49.95  
**MBS-181K Kit** ..... \$99.95  
**MBS-181A A & T** ..... \$139.95

## Mainframes

### MAINFRAME - Cal Comp Sys

12 slot S-100 mainframe with 20 amp power supply

**ENC-112105 Kit** ..... \$379.95  
**ENC-112106 A & T** ..... \$409.95

### DISK MAINFRAME - N.P.C.

Holds 2 8" drives and a 12 slot S-100 system. Attractive metal cabinet with 12 slot motherboard & card cage, power supply, dual fans, lighted switch, and other professional features

**ENS-112320 with 25 amp p.s.** ..... \$699.95

## S-100 Memory

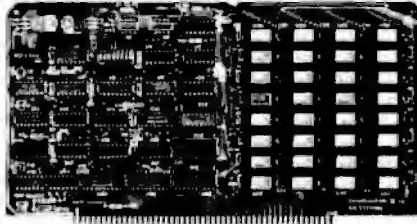

### EXPANDORAM II - S D Systems

4 MHz RAM board expandable from 16K to 64K  
**MEM-16630K 16K kit** ..... \$275.95  
**MEM-32631K 32K kit** ..... \$295.95  
**MEM-48632K 48K kit** ..... \$315.95  
**MEM-64633K 64K kit** ..... \$335.95  
 Assembled & tested ..... add \$50.00

### 64K RAM - Calif Computer Sys

4 MHz bank port - bank byte selectable, extended addressing, 16K bank selectable, PHANTOM line allows memory overlay, 8080 / Z80 / front panel compatible.  
**MEM-64565A A & T** ..... \$575.00

### 32K STATIC RAM - Jade

2 or 4 MHz expandable static RAM board uses 2114L's  
**MEM-16151K 16K 4 MHz kit** ..... \$169.95  
**MEM-32151K 32K 4 MHz kit** ..... \$299.95  
 Assembled & tested ..... add \$50.00

### 16K STATIC RAM - Mem Merchant

4 MHz 16K static RAM board, IEEE S-100, bank selectable, Phantom capability, addressable in 4K blocks, "disable-able" in 1K segments, extended addressing, low power  
**MEM-16171A A & T** ..... \$174.95

## S-100 Disk Controller

### DOUBLE DENSITY - Cal Comp Sys

5 1/4" and 8" disk controller, single or double density, with on-board boot loader ROM, and free CP/M 2.2\* and manual set.  
**IOD-1300A A & T** ..... \$369.95

### VERSAFLOPPY II - SD Systems

New double density controller for both 8" & 5 1/4"  
**IOD-1160K Kit** ..... \$339.95  
**IOD-1160A A & T** ..... \$379.95

## Disk Drives

### 8" DISK DRIVES

Highly reliable double density floppy disk drives  
 Shugart 801R single sided, double density  
**MSF-10801R SA-801R** ..... \$425.00  
**Special Sale Price** ..... 2 for \$790.00

Shugart 851R double sided, double density  
**MSF-10851R SA-851R** ..... \$595.00  
**Special Sale Price** ..... 2 for \$1150.00

Siemens FDD1100-8D2 single sided, double density  
**MSF-201120 6 mo warranty** ..... \$385.00  
**Special sale price** ..... 2 for \$750.00

Qume Datatrak 8 double sided, double density  
**MSF-750080 SA-851R compatible** .. \$599.95  
**Special sale price** ..... 2 for \$1160.00

### JADE DISK PACKAGE

Double density controller, two 8" double density floppy disk drives, CP/M 3.2 (configured for controller), hardware and software manuals, boot PROM, cabinet, power supply, fan, & cables

**Special Package Price Kit** ..... \$1395.00

**5 1/4" Diskettes Box of 10** .. \$22.00

**8" Diskettes Box of 10** .... \$24.00

## S-100 CPU



### CB-2 Z-80 CPU - S.S.M.

2 or 4 MHz Z-80 CPU board with provision for up to 8K of ROM or 4K of RAM on board, extended addressing, IEEE S-100, front panel compatible.

**CPU-30300K Kit** ..... \$239.95  
**CPU-30300A A & T** ..... \$299.95

### 2810 Z-80\* CPU - Cal Comp Sys

3 1/4 MHz Z-80A\* CPU with RS-232C serial I/O port and on-board MOSS 2.2 monitor PROM, front panel compatible.  
**CPU-30400A A & T** ..... \$269.95

### SBC-200 - SD Systems

4 MHz Z-80\* CPU with serial & parallel I/O ports, up to 8K of on-board PROM, software programmable baud rate generator, 1K of on-board RAM, Z-80 CTC.

**CPC-30200K Kit** ..... \$339.95  
**CPC-30200A Jade A & T** ..... \$399.95

## S-100 I/O

### I/O-4 - S.S.M.

2 serial I/O ports plus 2 parallel I/O ports  
**IOI-1010K Kit** ..... \$179.95  
**IOI-1010A A & T** ..... \$249.95  
**IOI-1010B Bare board** ..... \$35.00

## Novation Cat Modem

(We have only 265



available at this special price)

**IOM-5200A List price \$189.95** ..... \$139.95

D-CAT 300 baud, direct connect modem  
**IOM-5201A Special sale price** .. . \$189.00

AUTO-CAT Auto answer/originate, direct connect  
**IOM-5230A Special sale price** ..... \$239.95

## Place Orders Toll Free

Continental U.S. Inside California  
**800-421-5500 800-262-1710**

For Technical Inquiries or Customer Service call:  
**213-973-7707**

## JADE Computer Products

4901 W. Rosecrans, Hawthorne, Ca 90251

TERMS of SALE: Cash, checks, credit cards, or Purchase Orders from qualified firms and institutions. Minimum Order \$15.00. California residents add 6% tax. Minimum shipping & handling charge \$10.00. Pricing & availability subject to change

## MODEM SALE

**\$129.00**



**THE STAR  
MODEM  
from  
LIVERMORE**

**FEATURE  
FITS GTE HANDSETS!  
2 YEAR WARRANTY**

**EXCLUSIVE ACOUSTIC CHAMBERS**  
The exclusive triple seal of Livermore's new flat mounted cups locks the handset into the acoustic chamber yielding superior acoustic isolation and mechanical cushioning. Designed to adapt to most common handsets used throughout the world, the STAR offers the utmost in flexibility and transmission reliability

**Specifications:**

- Data Rate: 0 to 300 baud
- Compatibility: Bell 103 and 113, CCITT
- Frequency Stability: ±0.3 percent Crystal controlled
- Receiver Sensitivity: -50 dBm ON, -53 dBm OFF
- Modulation: Frequency shift keyed (FSK)
- Carrier Detect Delay: 1.2 seconds ON; 120 msec OFF
- EIA Terminal Interface: Compatible with RS 232 specifications
- Teletype Interface: 20 milliampere current loop
- Optional Interfaces: IEEE 488, TTL, TTY 43
- International (CCITT) frequencies available
- Switches: Originate/Off/Answer, Full Duplex/Test/Half Duplex
- Indicators: Transmit Data, Receive Data, Carrier Ready, Test
- Power: Supplied by 24 VAC/150 MA UL/CSA listed wall-mount transformer. Input 115 VAC, 2.5 watts (A 220 VAC, 50 Hz adaptor is available upon request.)
- Dimensions: 10" x 4" x 2"
- Weight: 1.74 lbs (3 lbs shipping weight including AC adaptor)
- Warranty: Two years on parts and labor, excluding the AC adaptor which carries the manufacturer's warranty



| Part No. | Description                    | List Price | SALE PRICE |
|----------|--------------------------------|------------|------------|
| LIV-STAR | RS232, TTL, 20 MA Current Loop | \$199.00   | \$129.00   |

| Part No.    | Description       | Price   |
|-------------|-------------------|---------|
| CND-RS2320F | RS232 8 Cond 8 II | \$19.95 |

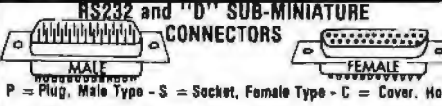

P = Plug, Male Type - S = Socket, Female Type - C = Cover, Hood

| PART NO.    | DESCRIPTION                             | 1-9     | 10-24   | 25-99   |
|-------------|---|---------|---------|---------|
| CND-069P    | 9 PIN MALE                              | \$ 2.10 | \$ 1.90 | \$ 1.70 |
| CND-069S    | 9 PIN FEMALE                            | \$ 2.70 | \$ 2.40 | \$ 2.10 |
| CND-068C    | 9 PIN COVER                             | \$ 1.50 | \$ 1.25 | \$ 1.10 |
| CND-DA15P   | 15 PIN MALE                             | \$ 2.75 | \$ 2.45 | \$ 2.15 |
| CND-DA15S   | 15 PIN FEMALE                           | \$ 3.95 | \$ 3.60 | \$ 3.20 |
| CND-DA15C   | 15 PIN COVER                            | \$ 1.50 | \$ 1.30 | \$ 1.10 |
| CND-DB25P   | 25 PIN MALE                             | \$ 3.00 | \$ 2.75 | \$ 2.60 |
| CND-DB25S   | 25 PIN FEMALE                           | \$ 4.00 | \$ 3.75 | \$ 3.50 |
| CND-DBS1212 | 1 PC GREY HOOD                          | \$ 1.60 | \$ 1.45 | \$ 1.30 |
| CND-P25H    | 2 PC GREY HOOD                          | \$ 1.50 | \$ 1.25 | \$ 1.10 |
| CND-DBS1226 | 2 PC BLACK HOOD                         | \$ 1.80 | \$ 1.65 | \$ 1.45 |
| CND-DC37P   | 37 PIN MALE                             | \$ 5.80 | \$ 5.10 | \$ 4.45 |
| CND-DC37S   | 37 PIN FEMALE                           | \$ 8.70 | \$ 7.70 | \$ 6.70 |
| CND-DC37C   | 37 PIN COVER                            | \$ 1.80 | \$ 1.55 | \$ 1.30 |
| CND-DB50P   | 50 PIN MALE                             | \$ 8.75 | \$ 7.75 | \$ 6.70 |
| CND-DB50S   | 50 PIN FEMALE                           | \$11.85 | \$10.25 | \$ 8.90 |
| CND-DB50C   | 50 PIN COVER                            | \$ 2.00 | \$ 1.80 | \$ 1.60 |
| CND-D20418  | HARDWARE SET 2 PR                       | \$ 1.00 | \$ 0.80 | \$ 0.70 |
| CND-RS2320F | RS232 DB25P EIA CLASS 1 CABLE 8 CON BFT | \$19.95 | \$17.95 | \$15.95 |
| CND-5730360 | CENT 700 SERIES PRINTER CONNECTOR       | \$ 9.00 | \$ 7.50 | \$ 6.00 |

**GOLD S-100 CONNECTORS  
SOLDER TAIL PRICE**

| Part No.  | 1-9  | 10-24 | 25-99 | 100-249 |
|-----------|------|-------|-------|---------|
| \$100 STG | 3.50 | 3.20  | 2.80  | 2.50    |

**WIRE WRAP PRICE**

| Part No.  | 1-9  | 10-24 | 25-99 | 100-249 |
|-----------|------|-------|-------|---------|
| \$100 WWG | 4.00 | 3.75  | 3.50  | 3.25    |

**2708 \$8.50 EA.**  
450ns 8K EPROM  
**8/\$32.00**

**2716 \$11.95 EA**  
450ns 5 Volt only  
16 K EPROM  
**8/\$48.00**

**2114-3L**  
4096 BIT (1024x4) 300ns  
LOW POWER STATIC RAM  
**8/\$30.00**  
**100 + \$3.00**

**2016P3**  
2K x 8 200ns  
L/P STATIC RAM  
**8/\$100.00**

**TRS-80/APPLE  
MEMORY EXPANSION KITS**  
4116's RAMS  
from Leading Manufacturers  
**100% GUARANTEED (16Kx1 200ns) 1,000's SETS SOLD**  
**8 for \$24.00**  
ADD \$3.00 FOR PROGRAMMING JUMPERS FOR TRS-80 KEYBOARD  
**4116's 100 pcs & UP \$2.75 each**  
**1000 pcs & UP \$2.50 each**

## POWERLINE INSULATOR

**GOF-IBARW3**  
SH. WT. 3 LBS  
LIST PRICE **\$59.95**  
SALE PRICE **\$29.95**  
A MUST FOR EVERY OFFICE WITH DATA PROCESSING EQUIPMENT

**PROTECT YOUR INVESTMENT  
PROTECT YOUR DATA WITH**

**ISOBAR**  
**GOF-IBAR46**  
Inductively isolated grounds  
Sockets individually filter isolated  
Each socket isolated from power line  
LIST PRICE **\$79.95**  
SALE PRICE **\$39.95**

**6 OUTLET  
MULTI USE  
CORD REEL**  
THE CONVENIENCE OF AN EXTENSION CORD AND POWER DISTRIBUTION PANEL IN ONE COMPACT, SELF-STORING UNIT!  
SIX GROUNDED 3-PRONG OUTLETS!  
CIRCUIT BREAKER FOR SAFETY'S SAKE - GUARDS AGAINST OVERLOADS ABOVE 10 AMPS  
GOF-CR21 22 Ft. - 5 lbs. .... **\$24.95**  
GOF-CR50 50 ft. - 10 lbs. .... **\$39.95**

## THE EXPANDABLE 1™



## THE UNIVERSAL IEEE-S100 DYNAMIC MEMORY CARD

THE EXPANDABLE 1™ 64K Dynamic Ram board provides your S-100 system with 64K of reliable, high-speed dynamic RAM. Compatible with most of the major S-100 systems on the market, including those with front panels, it supports DMA operations and requires no Wait states with current microprocessors.

- User expandable from 16 to 64 K
- 2 or 4 MHz operation
- North Star compatible
- Cromemco Compatible
- Designed to IEEE proposed S-100 bus standards
- Supports IMSAI-type front panels
- Operates with either an 8080 or Z-80 based S-100 system, providing processor-transparent refreshes with both
- Bank-select system allows system memory expansion and is compatible with Cromemco products
- Bank select part's address is jumper selectable
- Any 16K block can be made bank-independent
- All 64K can be made bank-enabled on power-on and reset
- Configuration as a 16K, 32K, or 48K board without the removal of RAMs
- Fully buffered address and data lines
- Fail-safe refresh circuitry for extended Wait states
- Board configuration with reliable, easy-to-configure Berg jumpers
- Supports DMA
- Jumper-selectable Phantom input
- Uses Popular 4116 RAMS
- Assembled & tested
- All ICs in sockets
- Power supply: Unregulated +8, +16, and -16 volts  
Maximum power draw: 400 mA at +8 volts  
175 mA at +16 volts  
5 mA at -16 volts

Dissipation: less than 8 watts  
Temperature: 0 to 70 degrees Celsius  
Humidity: 0 to 90% noncondensing  
PC Board  
FR-4 glass epoxy  
Solder mask on both sides  
Gold-plated connector lingers  
Silk screen component outlines, reference numbers, and part designations

**PRI-EXP1-16**  
**\$299.00**

Factory Assembled and Tested 16K Board. For additional memory order 1 set of 8 4116's at the left for each additional 16K. **PRIORITY ONE ELECTRONICS** can supply the board A&T populated to 32K, 48K, or 64K at additional cost, see our catalog or call for pricing.

**SPECIAL PURCHASE**  
**GOLD**  
16 PIN LOW PROFILE I.C.  
C-95 SOCKETS

**TIG-16LP pkg. of 100 \$16.00**  
**TIG-16LP pkg. of 1000 \$120.00**  
**OEMS Stock up at this LOW PRICE**

**PRIORITY ONE ELECTRONICS**  
9161-B DEERING AVE. • CHATSWORTH, CA 91311

Terms: U.S.: VISA, MC, BAC, Check, Money Order, U.S. Funds Only. CA. residents add 8% Sales Tax  
MINIMUM PREPAID ORDER \$15.00 Include MINIMUM SHIPPING & HANDLING of \$2.50 for the first 3 lbs., plus 25¢ for each additional pound. Orders over 50 lbs sent freight collect. Just in case... please include your phone no. Prices subject to change without notice. We will do our best to maintain prices thru AUGUST, 1991. SOCKET and CONNECTOR prices based on GOLD, not exceeding \$700.00 per oz  
Sales Prices are for prepaid orders only. Credit Card orders will be charged appropriate freight

MEMBER **MIA** **NECA**

DETACH OUR CATALOG FROM THE MAY BYTE

DETACH OUR CATALOG FROM THE MAY BYTE

# PRIORITY 1 ELECTRONICS TRUCK LOAD PURCHASE 10 MHZ 16K A&T STATIC S-100 RAM SALE

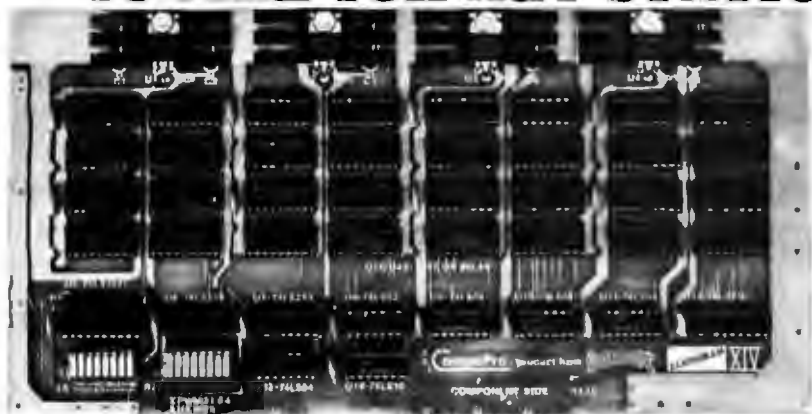

GBT-143A  
List  
\$349.00

**SAVE  
\$180.00**

**\$169.00**  
or 3 for \$450.00

The RAM 14 provides 16K X 8 of reliable, totally static RAM storage. Conforming fully to the IEEE 696/S-100 bus standard, RAM 14 not only provides 24 address lines for 16 megabyte extended addressing capability, but also includes a number of features you would only expect to find in memory boards costing considerably more. Here's a partial listing of what makes RAM 14 your best choice!

- Operates up to 10 MHZ (90 ns RAM Chips)
- Assembled & Tested
- Meets or exceeds all IEEE 696/S-100 specifications (including timing).
- Fully static design eliminates the timing problems associated with dynamic memories.
- Switch selectable choice of 24 address lines conforming to the IEEE 696/S-100 extended addressing specifications, or 16 address lines as used in older S-100 systems.
- Ideal for multi-user installations.
- Board is addressable as one 16K x 8 block on any 4K boundary
- Switch selectable PHANTOM disable and write protect.
- +5 Volt operation (requires no other supply voltages)
- Low power operation (900 mA typical, 1200 mA maximum).
- 1 year Factory Warranty.
- Don't settle for obsolete boards that use 2114's, draw twice the power, run at only 1/2 the speed . . . and cost more.
- Buy with confidence when you buy Godbout boards from P.I.E. Godbout is the world's largest manufacturer of S-100 products. When Priority 1 Electronics — the #1 distributor of S-100 products, teams up with Godbout, it makes an unbeatable combination.
- Don't settle for unknown, unproven products from unknown sources.

**CompuPro**™

division of

**GODBOUT**  
ELECTRONICS



ORDER TOLL FREE  
1-800-423-5922  
except CA., AK., HI., CALL  
(213) 709-5464



**PRIORITY ONE ELECTRONICS**  
9161-B DEERING AVE. • CHATSWORTH, CA 91311



Terms: U.S.; VISA, MC, BAC, Check, Money Order, U.S. Funds Only. CA. residents add 6% Sales Tax. MINIMUM PREPAID ORDER \$15.00. Include MINIMUM SHIPPING & HANDLING of \$2.50 for the first 3 lbs., plus 25¢ for each additional pound. Orders over 50 lbs. sent freight collect. Just in case...please include your phone no. Prices subject to change without notice. We will do our best to maintain prices thru AUG, 1981. SOCKET and CONNECTOR prices based on GOLD, not exceeding \$700.00 per oz. Sales Prices are for prepaid orders only. Credit Card orders will be charged appropriate freight.

Circle 315 on inquiry card.

**MORROW DESIGNS**  
**Qume**  
**SSM**  
**Vista**  
**CompuPro**  
**PRIORITY ONE ELECTRONICS**  
**TOLL FREE 1-800-423-5922**

**S-100 ROM**

**FBI FROM PROGRAMMER - SSM**  
 programs 2708 or 2716's, operates as a 4K/8K EPROM board as well.

|          |     |          |
|----------|-----|----------|
| SSM-PB1K | Kit | \$179.00 |
| SSM-PB1A | A&T | \$239.00 |

**ECONOROM 2708 - GODBOUT**

16K x 8 EPROM Board using 2708, Power on jump to any 256 byte

|          |       |          |
|----------|-------|----------|
| GBT 125U | UnKit | \$85.00  |
| GBT 125A | A&T   | \$120.00 |
| GBT 125C | CSC   | \$175.00 |

**S-100 DISK CONTROLLERS**

**DISK 1 - GODBOUT**

DMA, Soft Sector, Controls 8" or 5 1/4", single or double density

|           |  |          |
|-----------|--|----------|
| GBT 171A  | A&T  | \$450.00 |
| GBT 171C  | CSC  | \$555.00 |
| GBT CPM80 | CP/M 2.2 for 280/8085 with Manuals & BIOS 8" S.D. disk | \$175.00 |
| GBT CPM86 | CP/M for 8086 with manuals & BIOS 8" S/D disk          | \$300.00 |

**2422A - CA. COMP. SYST.**

I/O Mapped, controls 8" or 5 1/4", single or double density

|          |                          |          |
|----------|--------------------------|----------|
| CCS-2422 | A&T with CPM 2.2 8" S.D. | \$375.00 |
|----------|--------------------------|----------|

**DISK JOCKEY 1 - MORROW**

Single density disk controller with serial I/O, controls 8"

|           |     |          |
|-----------|-----|----------|
| MDSDJ1108 | A&T | \$219.00 |
|-----------|-----|----------|

**DISK JOCKEY 2D - MORROW**

I/O Mapped, controls 8", single or double density, serial I/O

|           |     |          |
|-----------|-----|----------|
| MDSDJ2208 | A&T | \$375.00 |
|-----------|-----|----------|

**DISK DRIVES**

**80IR - SHUGART**

Single sided double density most popular 8" drive

|            |                           |          |
|------------|---------------------------|----------|
| SHU80IR    | \$425.00 ea. or 2 or more | \$410.00 |
| SHUSA80IRM | Manual for 80IR drives    | \$10.00  |

**DT-8 - QUME**

Data track 8 double sided, double density

|         |                           |              |
|---------|---------------------------|--------------|
| QME-DT8 | \$625.00 ea. or 2 or more | \$600.00 ea. |
|---------|---------------------------|--------------|

**DISK CABINETS**

**V-100 - VISTA**

Dual 8" drive cabinet with power supply, Rack or Desk Mount

|          |                  |          |
|----------|------------------|----------|
| VIS-V100 | SINGLE 8" - Q.T. | \$395.00 |
|----------|------------------|----------|

Single 8" cabinet with power supply

|          |     |          |
|----------|-----|----------|
| QTC-DDC8 | A&T | \$195.00 |
|----------|-----|----------|

**5" CABINETS - VISTA**  
 Single 5" with P.S. \$75.00  
 Dual 5" with P.S. \$95.00

**S-100 DISK SUBSYSTEMS**

**DISCUS SINGLE SIDES MORROW**

8" DBL Density drives with cabinet, power supply controller, with CP/M 2.2 and Microsoft Basic

|          |                     |           |
|----------|---------------------|-----------|
| MDSF1216 | Single Drive System | \$950.00  |
| MDSF1226 | Dual Drive System   | \$1598.00 |

**DISCUS DOUBLE SIDED - MORROW**

8" DBL Density/sided drives with cabinet Power supply controller, with CP/M 2.2 and Microsoft Basic

|          |                     |           |
|----------|---------------------|-----------|
| MDSF2218 | Single Drive System | \$1198.00 |
| MDSF2228 | Dual Drive System   | \$2190.00 |

**26MB HARD DISK - MORROW**

Special purchase, limited stock - 26MB formatted hard disk complete with cabinet, P.S., Controller, CP/M 2.2 and Microsoft Basic

|          |                       |           |
|----------|-----------------------|-----------|
| MDS-W26S | 26 MB Subsystem List. | \$4995.00 |
|----------|-----------------------|-----------|

**SALE**

★ \$3950.00 ★

SAVE \$1,045.00!

**MICROPOLIS**

**Priority 1 Electronics is the worlds largest distributors of MICROPOLIS disk sub Systems CALL FOR PRICES**



**PRIORITY ONE ELECTRONICS**

9161-B DEERING AVE. • CHATSWORTH, CA 91311

**ORDER TOLL FREE (800) 423-5922 CA, AK, HI CALL (213) 709-5464**

Terms: U.S. VISA, MC, BAC, Check, Money Order, U.S. Funds Only. CA residents add 6% Sales Tax. MINIMUM PREPAID ORDER \$15.00. Include MINIMUM SHIPPING & HANDLING of \$2.50 for the first 3 lbs., plus 25¢ for each additional pound. Orders over 50 lbs. sent freight collect. Just in case... please include your phone no. Prices subject to change without notice. We will do our best to maintain prices thru August, 1981. SOCKET and CONNECTOR prices based on GOLD, not exceeding \$700.00 per oz. Sales Prices are for prepaid orders only. Credit Card orders will be charged appropriate freight.

**S-100 I/O BOARDS**

**SYSTEM SUPPORT 1 - GODBOUT**

Serial port (software prog baud), 4K EPROM or RAM provision, 15 levels of interrupt, real time clock, optional math processor

|          |           |          |
|----------|-----------|----------|
| GBT-162U | UnKit     | \$295.00 |
| GBT-162A | A&T       | \$360.00 |
| GBT-162C | CSC       | \$460.00 |
| GBT-9512 | Math Chip | \$195.00 |

**MPX CHANNEL BOARD - GODBOUT**

I/O Multiplexer, using 8085A-2 cpu on board

|          |     |          |
|----------|-----|----------|
| GBT-166A | A&T | \$450.00 |
| GBT-166C | CSC | \$550.00 |

**INTERFACER I - GODBOUT**

Two Serial I/O

|          |     |          |
|----------|-----|----------|
| GBT-133A | A&T | \$219.00 |
| GBT-133C | CSC | \$298.00 |

**INTERFACER II - GODBOUT**

Three parallel, one serial I/O board

|          |     |          |
|----------|-----|----------|
| GBT-150A | A&T | \$219.00 |
| GBT-150C | CSC | \$298.00 |

**MULTI I/O - MORROW DESIGNS**

Three Serial, Two parallel

|           |     |          |
|-----------|-----|----------|
| MDSMB3200 | A&T | \$309.00 |
|-----------|-----|----------|

**SWITCHBOARD-MORROW DESIGNS**

Two serial I/O, four parallel I/O, one status port, one strobe port

|          |     |          |
|----------|-----|----------|
| MDS82411 | A&T | \$239.00 |
|----------|-----|----------|

**I/O3 - SSM**

One parallel input, one parallel output, proto work area

|         |     |         |
|---------|-----|---------|
| SSM102K | Kit | \$68.00 |
| SSM102A | A&T | \$89.00 |

**I/O4 - SSM**

Two serial I/O, two parallel I/O

|         |     |          |
|---------|-----|----------|
| SSM104K | Kit | \$210.00 |
| SSM104A | A&T | \$260.00 |

**SM-SSM**

Music synthesizer board

|         |          |          |
|---------|----------|----------|
| SSMS81K | Kit      | \$249.00 |
| SSMS81A | A&T      | \$310.00 |
| SSMS81S | Software | \$ 25.00 |

**S-100 VIDEO BOARDS**

**SPECTRUM - GODBOUT**

Color Graphics board with Parallel I/O

|          |                   |          |
|----------|-------------------|----------|
| GBT-1440 | UnKit             | \$299.00 |
| GBT-144A | A&T               | \$349.00 |
| GBT-2D   | Sublogic Software | \$ 35.00 |

**VB - 3 S.S.M.**

80 x 24 or 48 character video display Memory Mapped, Parallel Keyboard port

|            |             |          |
|------------|-------------|----------|
| SSM-VB3K24 | Kit 80x24   | \$359.00 |
| SSM-VB3A24 | A&T 80x24   | \$450.00 |
| SSM-VB3K48 | Kit 80x48   | \$425.00 |
| SSM-VB3K48 | A&T 80x48   | \$495.00 |
| SSM-VB3UP  | Upgrade Kit | \$ 50.00 |

**VB2 - SSM**

I/O Mapped Video Board, with Parallel Keyboard port. 64x16

|          |     |          |
|----------|-----|----------|
| SSM-VB2K | Kit | \$169.00 |
| SSM-VB2A | A&T | \$229.00 |

**VBIC - SSM**

Memory Mapped Video Board 64x16 character display or 64x16 graphics display

|           |     |          |
|-----------|-----|----------|
| SSM-VBICK | Kit | \$169.00 |
| SSM-VBICA | A&T | \$229.00 |

**S-100 MOTHERBOARDS**

**MOTHERBOARD - GODBOUT**

Active termination, 6-12-20 slot

|          |               |          |
|----------|---------------|----------|
| GBT-153U | UnKit 6 slot  | \$ 89.00 |
| GBT-153A | A&T 6 slot    | \$119.00 |
| GBT-154U | UnKit 12 slot | \$129.00 |
| GBT-154A | A&T 12 slot   | \$149.00 |
| GBT-155U | UnKit 20 slot | \$174.00 |
| GBT-155A | A&T 20 slot   | \$189.00 |

**WUNDERBUSS - MORROW DESIGNS**

Active termination, 8-12-20 slot, peripheral power outputs (5V @ 1A, 12V @ 500ma, -12V @ 500ma)

|          |                           |          |
|----------|---------------------------|----------|
| MDS0800K | Kit 8 slot no connectors  | \$ 54.00 |
| MDS1200K | Kit 12 slot no connectors | \$ 65.00 |
| MDS2000K | Kit 20 slot no connectors | \$ 76.00 |
| MDS0800A | A&T 8 slot                | \$129.00 |
| MDS1200A | A&T 12 slot               | \$149.00 |
| MDS2000A | A&T 20 slot               | \$199.00 |

**S-100 MISC.**

**CK017 ACTIVE TERMINATOR-GODBOUT**

|          |     |          |
|----------|-----|----------|
| GBT-108U | Kit | \$ 34.95 |
|----------|-----|----------|

**ES20 - CCS**

Extender/terminator, Active and/or passive

|           |     |          |
|-----------|-----|----------|
| CCS2620AK | Kit | \$ 58.00 |
|-----------|-----|----------|

**EXTENDER/LOGIC PROBE-MULLEN**

|           |     |          |
|-----------|-----|----------|
| MUL-CK004 | Kit | \$ 58.00 |
|-----------|-----|----------|

**OB1 VECTOR JUMP - SSM**

with prototyping area

|          |     |          |
|----------|-----|----------|
| SSM-OB1K | Kit | \$ 65.00 |
| SSM-OB1A | A&T | \$ 90.00 |



# CompuPro™

division of

# GODBOUR ELECTRONICS



## TEAMS UP WITH PRIORITY ONE ELECTRONICS TO INTRODUCE THE NEXT GENERATION OF IEEE/696 S-100 COMPUTERS

### 8 BIT

There are still a lot of 8 bit machines out in the world, matched with plenty of 8 bit software — but very few of these machines are working up to their peak capacity. We want the "Big 8" system to change all that, and bring professional level computing power to all the owners of older S-100 machines. And if you're assembling an 8 bit system from the ground up, "Big 8" gets you off to the best possible start... regardless of price.

#### Here's what you get

1. CPU Z, our high speed, high performance Z80\* based CPU board. Includes a 6 MHz CPU for maximum throughput and highest operating speed.
2. Disk I DMA floppy disk controller.
3. 64K of fast static RAM with 24 bit extended addressing.
4. Interlacer I — Dual Serial I/O card or Interlacer II 3 Parallel 1 Serial I/O Card.
5. CP/M\* 80 2.2.
6. All documentation and manuals.

It all adds up to \$2712.00

**TOTAL PACKAGE PRICE**  
**\$1950.00**

**YOU SAVE \$762.00!**

ORDER PART NO. GBT-SPEC-C  
Big 8 System with Interlacer I  
ORDER PART NO. GBT-SPEC-D  
Big 8 System with Interlacer II

SAVE EVEN MORE, when you add 2 Shugart 801R disk drives, and a dual Vista Cabinet with Power Supply.

This package adds up to \$4062

**TOTAL PACKAGE PRICE**  
**\$3095.00**

**YOU SAVE \$967.00**

GBT-SPEC-EV with Interlacer I  
GBT-SPEC-FV with Interlacer II

## Ciarcia's Circuit Cellar

Micromouth for use on Apple II or other parallel ports A&T Featured in June BYTE

MMMI-94VOAPL \$149.00

Micromouth for use of TRS-80 Model I complete with cable, AC Adapter, less enclosure A&T.

MMI-94VOTRSI \$169.00

Expansion Interface for TRS-80 Model I with DATA SEPARATOR, 32K of RAM, and Centronics Printer port. A&T. Featured in MARCH BYTE.

MMI-DISK80 \$429.00

### 16 BIT

A second chance, we offered a limited number of these "BIG 16" packages 2 months ago and quickly sold out, leaving many customers disappointed. We had so many customers who wanted to get a second system, and many more who just wanted a chance to get one system, that we went back to GODBOUR, and convinced them to make another production run just for us. (They can't ignore our requests when we purchase boards by the 1,000's.) Here is your second chance to step up to the World of 16 Bit Computers and save hundreds, even thousands, of dollars if you act right now.

#### Here's what you get

1. 16 bit/8 bit Dual Processor (w/6 MHz 8088)
2. System Support I with Serial I/O, Real time clock, Interval Timers & More!
3. Disk I DMA Floppy Disk Controller (w/BIOS for CP/M \*2.2)
4. 64K of fast static RAM (w/IEEE 24 bit extended addressing)
5. Sorcin's powerful PASCAL/M\* - 8086 software on disk
7. I/O and Disk Controller cables, plus full documentation on all hardware and software

\*PASCAL M is a trademark of Sorcin; CP/M is a registered trademark of Digital Research

It all adds up to \$3430.00

**A) TOTAL PACKAGE PRICE**  
**\$2495.00**

**YOU SAVE \$935.00**

ORDER PART NO. GBT-SPEC-A

SAVE EVEN MORE, when you add 2 Shugart 801R disk drives, and a dual Vista Cabinet with Power Supply.

This package adds up to \$4780.

**B) TOTAL PACKAGE PRICE**  
**\$3650.00**

**YOU SAVE \$1130.00**

ORDER PART NO. GBT-SPEC-BV

## Ciarcia's Circuit Cellar

I/O Interface for TRS-80. Features 50-19200 baud RS-232C Serial port and Centronics printer port. Connect up to 16 COMM-80's to either Keyboard or Expansion Interface. Featured in June 80 BYTE.

MMI-COMM-80 \$179.95



From the power supply through the sturdy chassis, TEI constructs and assembles each mainframe with great care. Every TEI mainframe utilizes a constant voltage transformer (CVT) which delivers clean, regulated power at the proper level, reducing the heat in the computer cards. The output voltage on the transformer remains nearly even with the input voltage varying from approximately 85V to 140V. This means the mainframe will never notice voltage variations or even a brownout. It also provides 100 dB noise rejection to protect the computer from voltage spikes and line noise.

No need for a dedicated line or expensive noise filters. TEI was the first manufacturer to offer the CVT in its complete computer product line and is still one of few manufacturers to offer the CVT as standard equipment.

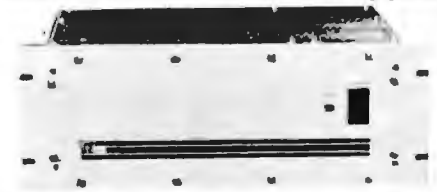

TEI 22 slot and 12 slot mainframes offer a S-100 motherboard which is grounded, shielded and actively terminated for high speed operation now or for later upgrading. Each mainframe is shipped completely assembled, tested and burned in, with fan, washable filter, all connectors and card guides. Rackmount models are available in both 22 and 12 slot mainframes. The combination of the lowest noise bus, a regulated CVT power system and a rugged chassis produces a mainframe without equal.

|                             | LIST PRICE | OUR PRICE |
|-----------------------------|------------|-----------|
| <b>S-100 MAINFRAMES</b>     |            |           |
| TEI-MCS 112 12 Slot Desk    | \$685.00   | \$616.00  |
| TEI-MCS 122 22 Slot Desk    | \$845.00   | \$760.00  |
| TEI-RM 12 12 Slot Rackmount | \$800.00   | \$720.00  |
| TEI-RM 22 22 Slot Rackmount | \$945.00   | \$850.00  |

Shipping Weight: On 12 Slot Mainframes 35 lbs.  
On 22 Slot Mainframes 50 lbs.

12 slot: +8V @ 17A, -16V @ 2A; 35 lbs.  
22 slot: +8V @ 30A, -16V @ 4A; 50 lbs.

Shipping Weight: On 12 Slot Mainframes 40 lbs.  
On 22 Slot Mainframes 55 lbs.



### S-100 MAINFRAME WITH 12 SLOT MOTHERBOARD AND CUTOUTS FOR 3 5 1/4" FLOPPY DISK DRIVES WITH INTERNAL POWER CABLES

|                            | LIST PRICE | OUR PRICE |
|----------------------------|------------|-----------|
| TEI-TF12 12 slot desk      | \$95.00    | \$25.00   |
| TEI-RF12 12 slot rackmount | \$95.00    | \$75.00   |

### DUAL 8" DISK DRIVE CHASSIS

|  | LIST PRICE | OUR PRICE |
|--|------------|-----------|
| For Shugart 800/801R with internal power cables provided |            |           |
| TEI-DF80 Desk Top  | \$69.00    | \$59.00   |
| TEI-RF80 Rack Mount                                      | \$19.00    | \$48.00   |

\*Priority 1 Electronics is a master distributor for T.E.I. Dealers & O.E.M.'s. Call for quantity pricing.



## PRIORITY ONE ELECTRONICS

9161-B DEERING AVE. CHATSWORTH, CA 91311

ORDER TOLL FREE (800) 423-5922 CA, AK, HI CALL (213) 709-5464

Terms: U.S.; VISA, MC, BAC, Check, Money Order, U.S. Funds Only. CA residents add 6% Sales Tax. MINIMUM PREPAID ORDER \$15.00. Include MINIMUM SHIPPING & HANDLING of \$2.50 for the first 3 lbs., plus 25¢ for each additional pound. Orders over 50 lbs. sent freight collect. Just in case... please include your phone no. Prices subject to change without notice. We will do our best to maintain prices thru August, 1981. SOCKET and CONNECTOR prices based on GOLD, not exceeding \$700.00 per oz. Sales Prices are for prepaid orders only. Credit Card orders will be charged appropriate freight.



**National Semiconductor** Clock Modules

**12VDC AUTOMATIC INSTRUMENT CLOCK**

**APPLICATIONS:**

- In-deck autlocks
- After-market auto/RV clocks
- Aircraft marine cks.
- 12VDC const. Instru.
- Portable/battery powered instruments.

Features: Bright 0.3" green display. Internal crystal time-base, ±0.8 sec./day accur. Auto display brightness control logic. Display color filterable to blue, blue-green, green & yellow. Complete - just add switches and lens.

**MA1003 Module . . . . . \$16.95**

**CLOCK MODULES**

MA1023 7" Low Cost Digital LED Clock Module 8.98  
 MA1026 7" Dig. LED Alarm Clock/Thermometer 16.98  
 MA5025 3" Low Cost Digital LED Clock/Timer 6.95  
 MA1002 5" LED Display Dig. Clock & Xformer 9.95

**TRANSFORMERS**

102-P20 Xformer for MA1023 Clock Modules 3.49  
 102-P22 Xformer for MA1026 Clock Modules 3.49  
 102-P20 Xformer for MA5025 Clock Modules 3.49

**8 OHM SPEAKER**

2 1/4" - 8 Ohm - .25 watt

**A0201**

\$1.25 ea. 2/\$1.95 ea. 10/\$3.95 ea.

**BATTERY HOLDER**

- Holds 2 ea. C cells
- Aluminum Case
- 5" leads

**H-801-158**

\$ .45 each 10/\$3.95

**BATTERY HOLDER**

- Holds 4 ea. C cells
- Plastic case
- 5" leads

**B2721**

\$ .48 ea. 10/\$4.25

**EPROM Erasing Lamp**

- Erases 2708, 2716, 1702A, 52030, 52040, etc.
- Erases up to 4 chips within 20 minutes.
- Maintains constant exposure distance of one inch.
- Special conductive foam liner eliminates static build-up.
- Built-in safety lock to prevent UV exposure.
- Complete with holding tray for 4 chips.

**UVS-11E . . . . . \$79.95**

**JOYSTICKS**

JS-5K 5K Linear Taper Pots . . . . . \$5.25  
 JS-100K 100K Linear Taper Pots . . . . . \$4.95  
 JVC-40 40K (2) Video Controller in case . . . \$5.95

• Bright, 300 ht. comm. cathode display  
 • Uses MM5314 clock chip  
 • Switches for hours, minutes and holds modes  
 • Hrs. easily viewable to 20 ft.  
 • Simulated walnut case  
 • 115 VAC operation  
 • 12 or 24 hr. operation  
 • Incl. all components, case & wall transformer  
 • Size: 6 1/2" x 3 1/8" x 1 3/4"

**JE701 . . . . . \$19.95**

**6-Digit Clock Kit**

**JE215 Adjustable Dual Power Supply**

General Description: The JE215 is a Dual Power Supply with independent adjustable positive and negative output voltages. A separate adjustment for each of the supplies provides the user unlimited applications for IC current voltage requirements. The supply can also be used as a general all-purpose variable power supply.

**FEATURES:**

- Adjustable regulated power supplies, pos. and neg.
- Power Output (each supply): 12VDC @ 500mA, 10VDC @ 750mA, 5VDC @ 500mA, and 5VDC @ 170mA.
- Two, 3-terminal adj. IC regulators with thermal overload protection
- Heat sink regulator coating
- LED "on" indicator
- Printed Board Construction
- 120VAC input
- Size: 3 1/2" w x 5 1/16" h x 2 1/8" d

**JE215 Adj. Dual Power Supply Kit (as shown) . . . \$24.95**  
 (Picture not shown but similar in construction to above)

JE200 Reg. Power Supply Kit (5VDC, 1 amp.) . . . \$14.95  
 JE205 Adapter Brd. (to JE200) ±5, 0 & ±12V . \$12.95  
 JE210 Var. Pwr. Sply. Kit, ±15VDC, to 1 amp. . \$19.95

**MICROPROCESSOR COMPONENTS**

| 8080A/8088 SUPPORT DEVICES |                                  | DATA ACQUISITION (CONTINUED) |                                   |
|----------------------------|----------------------------------|------------------------------|-----------------------------------|
| IN2801A                    | CPU                              | AD080CCCN                    | 8 Bit A/D Converter (8-Ch. Mult.) |
| DP222                      | 8 Bit Input/Output               | AD080CCCN                    | 8 Bit A/D Converter (8-Ch. Mult.) |
| DP211                      | Priority Interrupt Control       | DA080CCCN                    | 8 Bit D/A Converter (8-Ch. Mult.) |
| DP216                      | Bi-Directional Bus Driver        | DA080CCCN                    | 8 Bit D/A Converter (8-Ch. Mult.) |
| DP227                      | Clock Generator/Driver           | DA080CCCN                    | 8 Bit D/A Converter (8-Ch. Mult.) |
| DP228                      | Bus Driver                       | DA080CCCN                    | 8 Bit D/A Converter (8-Ch. Mult.) |
| DP229                      | System Controller/Bus Driver     | DA080CCCN                    | 8 Bit D/A Converter (8-Ch. Mult.) |
| DP230                      | System Controller                | DA080CCCN                    | 8 Bit D/A Converter (8-Ch. Mult.) |
| IN2803                     | I/O Expander (80 Series)         | DA080CCCN                    | 8 Bit D/A Converter (8-Ch. Mult.) |
| IN2805                     | Asynchronous Comm. Element       | DA080CCCN                    | 8 Bit D/A Converter (8-Ch. Mult.) |
| DP231                      | Prog. Comm. I/O (USART)          | DA080CCCN                    | 8 Bit D/A Converter (8-Ch. Mult.) |
| DP232                      | Prog. Interval Timer             | DA080CCCN                    | 8 Bit D/A Converter (8-Ch. Mult.) |
| DP233                      | Prog. Parameter I/O (PIO)        | DA080CCCN                    | 8 Bit D/A Converter (8-Ch. Mult.) |
| DP234                      | Prog. DMA Control                | DA080CCCN                    | 8 Bit D/A Converter (8-Ch. Mult.) |
| DP235                      | Prog. Interrupt Control          | DA080CCCN                    | 8 Bit D/A Converter (8-Ch. Mult.) |
| DP236                      | Prog. CPT Controller             | DA080CCCN                    | 8 Bit D/A Converter (8-Ch. Mult.) |
| DP237                      | Prog. Keyboard/Display Interface | DA080CCCN                    | 8 Bit D/A Converter (8-Ch. Mult.) |
| DP238                      | Cost Bus Receiver                | DA080CCCN                    | 8 Bit D/A Converter (8-Ch. Mult.) |
| DP239                      | System Timing Element            | DA080CCCN                    | 8 Bit D/A Converter (8-Ch. Mult.) |
| DP240                      | 8 Bit Bi-Directional Receiver    | DA080CCCN                    | 8 Bit D/A Converter (8-Ch. Mult.) |
| DP241                      | 8 Bit Bi-Directional Receiver    | DA080CCCN                    | 8 Bit D/A Converter (8-Ch. Mult.) |
| DP242                      | 8 Bit Bi-Directional Receiver    | DA080CCCN                    | 8 Bit D/A Converter (8-Ch. Mult.) |

| 8080/8088 SUPPORT DEVICES |  | PROMS/EPROMS |                              |
|---------------------------|--|--------------|------------------------------|
| MC6801                    | MPU                                    | 2708A        | 8K 1V EPROM                  |
| MC6802                    | Multiplexer with Clock and RAM         | 2708B        | 8K 1V EPROM (Single +5V)     |
| MC6803A                   | 128K Static RAM                        | 2708C        | 8K EPROM (8000) (Single +5V) |
| MC6804                    | Bi-Directional Inter. Adapter (MC6800) | 2708D        | 8K EPROM (8000) (Single +5V) |
| MC6805                    | Priority Interrupt Controller          | 2708E        | 8K EPROM (8000) (Single +5V) |
| MC6806                    | Priority Interrupt Controller          | 2708F        | 8K EPROM (8000) (Single +5V) |
| MC6807                    | Priority Interrupt Controller          | 2708G        | 8K EPROM (8000) (Single +5V) |
| MC6808                    | Asynchronous Serial Data Adapter       | 2708H        | 8K EPROM (8000) (Single +5V) |
| MC6809                    | Asynchronous Serial Data Adapter       | 2708I        | 8K EPROM (8000) (Single +5V) |
| MC6810                    | Asynchronous Serial Data Adapter       | 2708J        | 8K EPROM (8000) (Single +5V) |
| MC6811                    | Asynchronous Serial Data Adapter       | 2708K        | 8K EPROM (8000) (Single +5V) |
| MC6812                    | Asynchronous Serial Data Adapter       | 2708L        | 8K EPROM (8000) (Single +5V) |
| MC6813                    | Asynchronous Serial Data Adapter       | 2708M        | 8K EPROM (8000) (Single +5V) |
| MC6814                    | Asynchronous Serial Data Adapter       | 2708N        | 8K EPROM (8000) (Single +5V) |
| MC6815                    | Asynchronous Serial Data Adapter       | 2708P        | 8K EPROM (8000) (Single +5V) |
| MC6816                    | Asynchronous Serial Data Adapter       | 2708Q        | 8K EPROM (8000) (Single +5V) |
| MC6817                    | Asynchronous Serial Data Adapter       | 2708R        | 8K EPROM (8000) (Single +5V) |
| MC6818                    | Asynchronous Serial Data Adapter       | 2708S        | 8K EPROM (8000) (Single +5V) |
| MC6819                    | Asynchronous Serial Data Adapter       | 2708T        | 8K EPROM (8000) (Single +5V) |
| MC6820                    | Asynchronous Serial Data Adapter       | 2708U        | 8K EPROM (8000) (Single +5V) |
| MC6821                    | Asynchronous Serial Data Adapter       | 2708V        | 8K EPROM (8000) (Single +5V) |
| MC6822                    | Asynchronous Serial Data Adapter       | 2708W        | 8K EPROM (8000) (Single +5V) |
| MC6823                    | Asynchronous Serial Data Adapter       | 2708X        | 8K EPROM (8000) (Single +5V) |
| MC6824                    | Asynchronous Serial Data Adapter       | 2708Y        | 8K EPROM (8000) (Single +5V) |
| MC6825                    | Asynchronous Serial Data Adapter       | 2708Z        | 8K EPROM (8000) (Single +5V) |
| MC6826                    | Asynchronous Serial Data Adapter       | 2708AA       | 8K EPROM (8000) (Single +5V) |
| MC6827                    | Asynchronous Serial Data Adapter       | 2708AB       | 8K EPROM (8000) (Single +5V) |
| MC6828                    | Asynchronous Serial Data Adapter       | 2708AC       | 8K EPROM (8000) (Single +5V) |
| MC6829                    | Asynchronous Serial Data Adapter       | 2708AD       | 8K EPROM (8000) (Single +5V) |
| MC6830                    | Asynchronous Serial Data Adapter       | 2708AE       | 8K EPROM (8000) (Single +5V) |
| MC6831                    | Asynchronous Serial Data Adapter       | 2708AF       | 8K EPROM (8000) (Single +5V) |
| MC6832                    | Asynchronous Serial Data Adapter       | 2708AG       | 8K EPROM (8000) (Single +5V) |
| MC6833                    | Asynchronous Serial Data Adapter       | 2708AH       | 8K EPROM (8000) (Single +5V) |
| MC6834                    | Asynchronous Serial Data Adapter       | 2708AI       | 8K EPROM (8000) (Single +5V) |
| MC6835                    | Asynchronous Serial Data Adapter       | 2708AJ       | 8K EPROM (8000) (Single +5V) |
| MC6836                    | Asynchronous Serial Data Adapter       | 2708AK       | 8K EPROM (8000) (Single +5V) |
| MC6837                    | Asynchronous Serial Data Adapter       | 2708AL       | 8K EPROM (8000) (Single +5V) |
| MC6838                    | Asynchronous Serial Data Adapter       | 2708AM       | 8K EPROM (8000) (Single +5V) |
| MC6839                    | Asynchronous Serial Data Adapter       | 2708AN       | 8K EPROM (8000) (Single +5V) |
| MC6840                    | Asynchronous Serial Data Adapter       | 2708AO       | 8K EPROM (8000) (Single +5V) |
| MC6841                    | Asynchronous Serial Data Adapter       | 2708AP       | 8K EPROM (8000) (Single +5V) |
| MC6842                    | Asynchronous Serial Data Adapter       | 2708AQ       | 8K EPROM (8000) (Single +5V) |
| MC6843                    | Asynchronous Serial Data Adapter       | 2708AR       | 8K EPROM (8000) (Single +5V) |
| MC6844                    | Asynchronous Serial Data Adapter       | 2708AS       | 8K EPROM (8000) (Single +5V) |
| MC6845                    | Asynchronous Serial Data Adapter       | 2708AT       | 8K EPROM (8000) (Single +5V) |
| MC6846                    | Asynchronous Serial Data Adapter       | 2708AU       | 8K EPROM (8000) (Single +5V) |
| MC6847                    | Asynchronous Serial Data Adapter       | 2708AV       | 8K EPROM (8000) (Single +5V) |
| MC6848                    | Asynchronous Serial Data Adapter       | 2708AW       | 8K EPROM (8000) (Single +5V) |
| MC6849                    | Asynchronous Serial Data Adapter       | 2708AX       | 8K EPROM (8000) (Single +5V) |
| MC6850                    | Asynchronous Serial Data Adapter       | 2708AY       | 8K EPROM (8000) (Single +5V) |
| MC6851                    | Asynchronous Serial Data Adapter       | 2708AZ       | 8K EPROM (8000) (Single +5V) |
| MC6852                    | Asynchronous Serial Data Adapter       | 2708BA       | 8K EPROM (8000) (Single +5V) |
| MC6853                    | Asynchronous Serial Data Adapter       | 2708BB       | 8K EPROM (8000) (Single +5V) |
| MC6854                    | Asynchronous Serial Data Adapter       | 2708BC       | 8K EPROM (8000) (Single +5V) |
| MC6855                    | Asynchronous Serial Data Adapter       | 2708BD       | 8K EPROM (8000) (Single +5V) |
| MC6856                    | Asynchronous Serial Data Adapter       | 2708BE       | 8K EPROM (8000) (Single +5V) |
| MC6857                    | Asynchronous Serial Data Adapter       | 2708BF       | 8K EPROM (8000) (Single +5V) |
| MC6858                    | Asynchronous Serial Data Adapter       | 2708BG       | 8K EPROM (8000) (Single +5V) |
| MC6859                    | Asynchronous Serial Data Adapter       | 2708BH       | 8K EPROM (8000) (Single +5V) |
| MC6860                    | Asynchronous Serial Data Adapter       | 2708BI       | 8K EPROM (8000) (Single +5V) |
| MC6861                    | Asynchronous Serial Data Adapter       | 2708BJ       | 8K EPROM (8000) (Single +5V) |
| MC6862                    | Asynchronous Serial Data Adapter       | 2708BK       | 8K EPROM (8000) (Single +5V) |
| MC6863                    | Asynchronous Serial Data Adapter       | 2708BL       | 8K EPROM (8000) (Single +5V) |
| MC6864                    | Asynchronous Serial Data Adapter       | 2708BM       | 8K EPROM (8000) (Single +5V) |
| MC6865                    | Asynchronous Serial Data Adapter       | 2708BN       | 8K EPROM (8000) (Single +5V) |
| MC6866                    | Asynchronous Serial Data Adapter       | 2708BO       | 8K EPROM (8000) (Single +5V) |
| MC6867                    | Asynchronous Serial Data Adapter       | 2708BP       | 8K EPROM (8000) (Single +5V) |
| MC6868                    | Asynchronous Serial Data Adapter       | 2708BQ       | 8K EPROM (8000) (Single +5V) |
| MC6869                    | Asynchronous Serial Data Adapter       | 2708BR       | 8K EPROM (8000) (Single +5V) |
| MC6870                    | Asynchronous Serial Data Adapter       | 2708BS       | 8K EPROM (8000) (Single +5V) |
| MC6871                    | Asynchronous Serial Data Adapter       | 2708BT       | 8K EPROM (8000) (Single +5V) |
| MC6872                    | Asynchronous Serial Data Adapter       | 2708BU       | 8K EPROM (8000) (Single +5V) |
| MC6873                    | Asynchronous Serial Data Adapter       | 2708BV       | 8K EPROM (8000) (Single +5V) |
| MC6874                    | Asynchronous Serial Data Adapter       | 2708BW       | 8K EPROM (8000) (Single +5V) |
| MC6875                    | Asynchronous Serial Data Adapter       | 2708BX       | 8K EPROM (8000) (Single +5V) |
| MC6876                    | Asynchronous Serial Data Adapter       | 2708BY       | 8K EPROM (8000) (Single +5V) |
| MC6877                    | Asynchronous Serial Data Adapter       | 2708BZ       | 8K EPROM (8000) (Single +5V) |
| MC6878                    | Asynchronous Serial Data Adapter       | 2708CA       | 8K EPROM (8000) (Single +5V) |
| MC6879                    | Asynchronous Serial Data Adapter       | 2708CB       | 8K EPROM (8000) (Single +5V) |
| MC6880                    | Asynchronous Serial Data Adapter       | 2708CC       | 8K EPROM (8000) (Single +5V) |
| MC6881                    | Asynchronous Serial Data Adapter       | 2708CD       | 8K EPROM (8000) (Single +5V) |
| MC6882                    | Asynchronous Serial Data Adapter       | 2708CE       | 8K EPROM (8000) (Single +5V) |
| MC6883                    | Asynchronous Serial Data Adapter       | 2708CF       | 8K EPROM (8000) (Single +5V) |
| MC6884                    | Asynchronous Serial Data Adapter       | 2708CG       | 8K EPROM (8000) (Single +5V) |
| MC6885                    | Asynchronous Serial Data Adapter       | 2708CH       | 8K EPROM (8000) (Single +5V) |
| MC6886                    | Asynchronous Serial Data Adapter       | 2708CI       | 8K EPROM (8000) (Single +5V) |
| MC6887                    | Asynchronous Serial Data Adapter       | 2708CJ       | 8K EPROM (8000) (Single +5V) |
| MC6888                    | Asynchronous Serial Data Adapter       | 2708CK       | 8K EPROM (8000) (Single +5V) |
| MC6889                    | Asynchronous Serial Data Adapter       | 2708CL       | 8K EPROM (8000) (Single +5V) |
| MC6890                    | Asynchronous Serial Data Adapter       | 2708CM       | 8K EPROM (8000) (Single +5V) |
| MC6891                    | Asynchronous Serial Data Adapter       | 2708CN       | 8K EPROM (8000) (Single +5V) |
| MC6892                    | Asynchronous Serial Data Adapter       | 2708CO       | 8K EPROM (8000) (Single +5V) |
| MC6893                    | Asynchronous Serial Data Adapter       | 2708CP       | 8K EPROM (8000) (Single +5V) |
| MC6894                    | Asynchronous Serial Data Adapter       | 2708CQ       | 8K EPROM (8000) (Single +5V) |
| MC6895                    | Asynchronous Serial Data Adapter       | 2708CR       | 8K EPROM (8000) (Single +5V) |
| MC6896                    | Asynchronous Serial Data Adapter       | 2708CS       | 8K EPROM (8000) (Single +5V) |
| MC6897                    | Asynchronous Serial Data Adapter       | 2708CT       | 8K EPROM (8000) (Single +5V) |
| MC6898                    | Asynchronous Serial Data Adapter       | 2708CU       | 8K EPROM (8000) (Single +5V) |
| MC6899                    | Asynchronous Serial Data Adapter       | 2708CV       | 8K EPROM (8000) (Single +5V) |
| MC6900                    | Asynchronous Serial Data Adapter       | 2708CW       | 8K EPROM (8000) (Single +5V) |
| MC6901                    | Asynchronous Serial Data Adapter       | 2708CX       | 8K EPROM (8000) (Single +5V) |
| MC6902                    | Asynchronous Serial Data Adapter       | 2708CY       | 8K EPROM (8000) (Single +5V) |
| MC6903                    | Asynchronous Serial Data Adapter       | 2708CZ       | 8K EPROM (8000) (Single +5V) |
| MC6904                    | Asynchronous Serial Data Adapter       | 2708DA       | 8K EPROM (8000) (Single +5V) |
| MC6905                    | Asynchronous Serial Data Adapter       | 2708DB       | 8K EPROM (8000) (Single +5V) |
| MC6906                    | Asynchronous Serial Data Adapter       | 2708DC       | 8K EPROM (8000) (Single +5V) |
| MC6907                    | Asynchronous Serial Data Adapter       | 2708DD       | 8K EPROM (8000) (Single +5V) |
| MC6908                    | Asynchronous Serial Data Adapter       | 2708DE       | 8K EPROM (8000) (Single +5V) |
| MC6909                    | Asynchronous Serial Data Adapter       | 2708DF       | 8K EPROM (8000) (Single +5V) |
| MC6910                    | Asynchronous Serial Data Adapter       | 2708DG       | 8K EPROM (8000) (Single +5V) |
| MC6911                    | Asynchronous Serial Data Adapter       | 2708DH       | 8K EPROM (8000) (Single +5V) |
| MC6912                    | Asynchronous Serial Data Adapter       | 2708DI       | 8K EPROM (8000) (Single +5V) |
| MC6913                    | Asynchronous Serial Data Adapter       | 2708DJ       | 8K EPROM (8000) (Single +5V) |
| MC6914                    | Asynchronous Serial Data Adapter       | 2708DK       | 8K EPROM (8000) (Single +5V) |
| MC6915                    | Asynchronous Serial Data Adapter       | 2708DL       | 8K EPROM (8000) (Single +5V) |
| MC6916                    | Asynchronous Serial Data Adapter       | 2708DM       | 8K EPROM (8000) (Single +5V) |
| MC6917                    | Asynchronous Serial Data Adapter       | 2708DN       | 8K EPROM (8000) (Single +5V) |
| MC6918                    | Asynchronous Serial Data Adapter       | 2708DO       | 8K EPROM (8000) (Single +5V) |
| MC6919                    | Asynchronous Serial Data Adapter       | 2708DP       | 8K EPROM (8000) (Single +5V) |
| MC6920                    | Asynchronous Serial Data Adapter       | 2708DQ       | 8K EPROM (8000) (Single +5V) |
| MC6921                    | Asynchronous Serial Data Adapter       | 2708DR       | 8K EPROM (8000) (Single +5V) |
| MC6922                    | Asynchronous Serial Data Adapter       | 2708DS       | 8K EPROM (8000) (Single +5V) |
| MC6923                    | Asynchronous Serial Data Adapter       | 2708DT       | 8K EPROM (8000) (Single +5V) |
| MC6924                    | Asynchronous Serial Data Adapter       | 2708DU       | 8K EPROM (8000) (Single +5V) |
| MC6925                    | Asynchronous Serial Data Adapter       | 2708DV       | 8K EPROM (8000) (Single +5V) |
| MC6926                    | Asynchronous Serial Data Adapter       | 2708DW       | 8K EPROM (8000) (Single +5V) |
| MC6927                    | Asynchronous Serial Data Adapter       | 2708DX       | 8K EPROM (8000) (Single +5V) |
| MC6928                    | Asynchronous Serial Data Adapter       | 2708DY       | 8K EPROM (8000) (Single +5V) |
| MC6929                    | Asynchronous Serial Data Adapter       | 2708DZ       | 8K EPROM (8000) (Single +5V) |
| MC6930                    | Asynchronous Serial Data Adapter       | 2708EA       | 8K EPROM (8000) (Single +5V) |
| MC6931                    | Asynchronous Serial Data Adapter       | 2708EB       | 8K EPROM (8000) (Single +5V) |
| MC6932                    | Asynchronous Serial Data Adapter       | 2708EC       | 8K EPROM (8000) (Single +5V) |
| MC6933                    | Asynchronous Serial Data Adapter       | 2708ED       | 8K EPROM (8000) (Single +5V) |
| MC6934                    | Asynchronous Serial Data Adapter       | 2708EE       | 8K EPROM (8000) (Single +5V) |
| MC6935                    | Asynchronous Serial Data Adapter       | 2708EF       | 8K EPROM (8000) (Single +5V) |
| MC6936                    | Asynchronous Serial Data Adapter       | 2708EG       | 8K EPROM (8000) (Single +5V) |
| MC6937                    | Asynchronous Serial Data Adapter       | 2708EH       | 8K EPROM (8000) (Single +5V) |
| MC6938                    | Asynchronous Serial Data Adapter       | 2708EI       | 8K EPROM (8000) (Single +5V) |
| MC6939                    | Asynchronous Serial Data Adapter       | 2708EJ       | 8K EPROM (8000) (Single +5V) |
| MC6940                    | Asynchronous Serial Data Adapter       | 2708EK       | 8K EPROM (8000) (Single +5V) |
| MC6941                    | Asynchronous Serial Data Adapter       | 2708EL       | 8K EPROM (8000) (Single +5V) |
| MC6942                    | Asynchronous Serial Data Adapter       | 2708EM       | 8K EPROM (8000) (Single +5V) |
| MC6943                    | Asynchronous Serial Data Adapter       | 2708EN       | 8K EPROM (8000) (Single +5V) |
| MC6944                    | Asynchronous Serial Data Adapter       | 2708EO       | 8K EPROM (8000) (Single +5V) |
| MC6945                    | Asynchronous Serial Data Adapter       | 2708EP       | 8K EPROM (8000) (Single +5V) |
| MC6946                    | Asynchronous Serial Data Adapter       | 2708EQ       | 8K EPROM (8000) (Single +5V) |
| MC6947                    | Asynchronous Serial Data Adapter       | 2708ER       | 8K EPROM (8000) (Single +5V) |
| MC6948                    | Asynchronous Serial Data Adapter       | 2708ES       | 8K EPROM (8000) (Single +5V) |
| MC6949                    | Asynchronous Serial Data Adapter       | 2708ET       |                              |

# WHAT'S NEW FROM CONSUMER COMPUTERS

Consumer Computers announces it's lowest prices ever.

## Apple Cards and Hardware

|  |      |
|--|------|
| Language System w/Pascal               | 379  |
| Silentype Printer w/Interface          | 349  |
| Hayes Micromodem II                    | 299  |
| Novation Apple-Cat II                  | 339  |
| Videx videoterm 80 w/graphics          | 269  |
| 2-80 Microsoft Card                    | 269  |
| 16K Ram Card Microsoft                 | 159  |
| ABT Numbrnc Keypad (old or new hybrid) | 110  |
| ALF 3 Voice Music Card                 | 239  |
| ALF 9 Voice Music Card                 | 169  |
| Neuristics Speechlink 2000             | 249  |
| Alpha Syntauri Keyboard System         | 1399 |
| Convus 10MB Hard Disk                  | CALL |
| Lazer Lower Case Plus                  | 50   |
| Micro-Sci Disk Drives (A-40 & A-70)    | CALL |
| 55M A10 Serial/Parallel Card A&T       | 189  |
| Sup-R-Terminal 80 Col. Card            | 529  |
| 5VA 8 inch Floppy Disk Controller      | 345  |
| Versawriter/Digitizer Pad              | 229  |
| Digisector Camera I/f                  | 209  |
| ThunderClock Plus                      | CALL |
| Symtec Hi-Res Light Pen                | 210  |
| Integer or Applesoft II Firmware Card  | 145  |
| Graphics Tablet                        | 619  |
| Parallel Printer Interface Card        | 135  |
| Hi-Speed Serial Interface Card         | 135  |
| Smarterm 80 Column Video Card          | 299  |

We have many more accessories in stock for the Apple II. Please call toll free 800-854-6654 for a price list.

## Mountain Computer, Inc.

|                          |     |
|--------------------------|-----|
| Music System (16 voices) | 479 |
| A/D + D/A Interface      | 289 |
| Expansion Chassis        | 599 |
| Intrlok-10 Cont. Card    | 169 |
| Clock/Calendar Card      | 225 |
| Supertalker SD-200       | 239 |
| Romplus+ Card            | 135 |
| Romwriter Card           | 149 |

## CCS California Computer Systems

|                                    |      |
|------------------------------------|------|
| Clock/Calendar Module              | 99   |
| GP/IB IEEE-488 Card                | 249  |
| Asynchronous Serial Interface Card | 129  |
| Centronics Parallel Interface Card | 99   |
| Arithmetic Processor Card          | 299  |
| We carry all CCS hardware          | CALL |

## Apple II Entertainment Software

|                                 |    |
|---------------------------------|----|
| Raster Blaster                  | 29 |
| Alien Rain                      | 23 |
| Adventure by Microsoft          | 27 |
| Sargon II Chess                 | 32 |
| Reversal                        | 34 |
| Pool 1.5                        | 34 |
| Creature Venture                | 23 |
| Hi-Res Adventure #0             | 19 |
| Hi-Res Adventure #1             | 24 |
| Hi-Res Adventure #2             | 32 |
| ABM By MUSE                     | 32 |
| Zork                            | 35 |
| Pulsar II                       | 29 |
| Phantom Five                    | 29 |
| Space Eggs                      | 29 |
| Snoggle                         | 24 |
| Flight Simulator                | 34 |
| Warptactor                      | 39 |
| Olympic Decathlon               | 24 |
| Prisoner                        | 29 |
| Alien Typhoon                   | 24 |
| Missile Defense                 | 29 |
| Autobahn                        | 29 |
| Operation Apocalypse            | 55 |
| Interlude (X-rated)             | 19 |
| Odyssey                         | 30 |
| Space Raiders                   | 29 |
| Cosmos Mission (Space Invaders) | 24 |

TELEX 695-000

ANS: BETA

REF: CCMO

OPEN 7 DAYS

## Apple II Plus Computer



The versatile Apple Computer for home or business. Unmatched in flexibility.

16K  
\$1025

48K  
\$1129

We carry the Apple III  
Call for our price.



Save on Video displays.

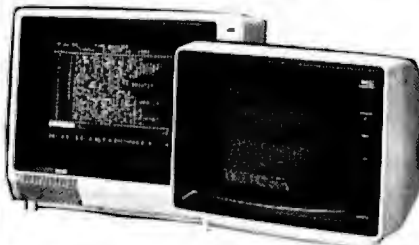

Highlights of our fine line of video monitors.

|                                |      |
|--------------------------------|------|
| Amdek/Leedex Video 100 12" B&W | 159  |
| Amdek (Hitachi) 13" Color      | 359  |
| NEC 12" P31 Green Phosphor     | CALL |
| NEC 12" RGB Hi-Res Color       | CALL |
| Panasonic 13" Color            | 449  |
| Sanyo 9" B&W                   | 159  |
| Sanyo 12" B&W                  | 239  |
| Sanyo 12" P31 Green Phosphor   | 279  |
| Sanyo 13" Color                | 419  |

Happy Birthday Leslie!

## Solution Software for the Apple II.

|                                  |      |
|----------------------------------|------|
| Visicalc 3.3                     | 169  |
| CCA Data Management              | 85   |
| DB Master                        | 169  |
| Word Star (Apple 80 col. ver.)   | 299  |
| Super Text II                    | 139  |
| Desktop Plan II                  | 169  |
| Applewriter                      | 65   |
| Infotory                         | 225  |
| Landlord Apt. Mngmnt             | 649  |
| Stock Tracker H&R                | 175  |
| Easywriter                       | 225  |
| ASCII Express                    | 59   |
| Appleplot                        | 60   |
| BPI General Ledger               | CALL |
| PFS                              | 85   |
| Apple Pie (specify version)      | 119  |
| Super-Scribe                     | 79   |
| Data Factory                     | 139  |
| Peachtree Business               | 1200 |
| Applesoft Compiler               | 185  |
| Visitem                          | 129  |
| Visitrend/Ansiplot               | 219  |
| Real Estate Analyzer             | 89   |
| Tax Preparer                     | 89   |
| Request                          | 199  |
| DOS Toolkit                      | 65   |
| Tax Planner                      | 99   |
| Dow Jones Portfolio Evaluator    | 45   |
| Dow Jones News & Quotes Reporter | 85   |
| Apple Fortran                    | 165  |
| Apple Pilot                      | 129  |
| Controller gen. Bus Package      | 519  |
| The Analyzer Dain 5              | 519  |
| Music Theory                     | 45   |

CALL TOLL FREE  
800-854-6654

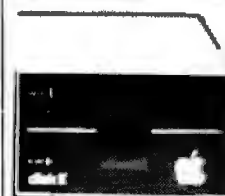

Apple  
Disk Drives

With  
Controller \$519

Without  
Controller \$439

16K Ram Cards by  
ConComp Industries

|               |     |
|---------------|-----|
| Atan 800 Card | 89  |
| Apple II Card | 130 |

Ohio Scientific  
Challenger computer.



4P

1P \$549  
MOD II \$399



# WHAT'S NEW FROM CONSUMER COMPUTERS

Buying Mail Order saves time, money and energy!

## Atari Personal Computer



Now the personal computer offering from the acknowledged leader in video arcade technology... ATARI.

**ATARI 800 16K**  
**\$749**

### Atari Accessories

|  |      |
|--|------|
| 410 Program Recorder                   | 59   |
| 810 Disk Drive                         | 449  |
| 815 Dual Disk Drive (Dbl Den)          | 1295 |
| 820 40 col. Impact Printer             | 549  |
| 822 Thermal Printer                    | 549  |
| 825 80 col. Impact Printer (Cent. 757) | 699  |
| 830 Acoust. Modem                      | 159  |
| 830 Interface Module                   | 159  |
| Atari Light Pen                        | 65   |
| 16K Ram Memory Module                  | 149  |

### Atari Software

|                         |    |
|-------------------------|----|
| Missile Command         | 35 |
| Asteroids               | 35 |
| Space Invaders          | 19 |
| Star Raiders            | 55 |
| Sunday Golf             | 9  |
| Star Trek 3 5           | 14 |
| Sands of Mars           | 59 |
| Microchess              | 19 |
| Checker King            | 19 |
| FastGammon              | 19 |
| Fantasyland 2041        | 55 |
| Family Expenses         | 24 |
| Imperial Walker         | 29 |
| Galactic Empire         | 19 |
| Lunar Lander            | 14 |
| Cypher Bowl             | 29 |
| Star Warrior            | 59 |
| Wizard and the Princess | 52 |

## Exidy Sorcerer II



Please Call for our price.

|                     |     |
|---------------------|-----|
| S-100 Unit          | 449 |
| Word Processing Pac | 179 |
| Development Pac     | 89  |

## PMC-80 Micro Computer



**\$599**

See Pages 164-165 for more discounts

## Printers, Etc.

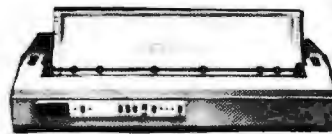

Qume  
Sprint 5145

**\$2495**

|                              |      |
|------------------------------|------|
| Anadex DP-9500/1 w/2K Buffer | 1549 |
| C. Itoh Starwriter 25 CPS    | 1649 |
| C. Itoh Starwriter 45 CPS    | 2249 |
| Centronics 737               | 699  |
| Epson MX-70                  | 539  |



Epson  
MX - 80 **\$499**

|                     |      |
|---------------------|------|
| Epson MX-80 F/T     | 649  |
| Epson MX-100        | 829  |
| Paper Tiger ID5-445 | 729  |
| Paper Tiger ID5-560 | 1450 |
| Watanabe Digiplot   | 1149 |

**AVAILABLE NOW...**  
**The NEC Microcomputer**



Please call for more details

**TOLL-FREE ORDER LINE**  
**800-854-6654**

Use your Mastercharge, Visa, American Express, Carte Blanche, or Diners Club card to charge your order by phone.

### SSM S-100 Cards at Lowest Prices Ever

The following is our fine line of S-100 cards. We will beat any currently advertised price.

|                               | MR  | Assm & Tested |
|-------------------------------|-----|---------------|
| 2-80 CPU CB-2                 | 219 | 279           |
| IDA 2 P + 25 I/O              | 189 | 249           |
| VB-3 80 x 24 VIDEO            | 329 | 379           |
| VB-3 80 x 48 VIDEO            | 369 | 429           |
| BV-2 VIDEO                    | 159 | 219           |
| PB1 PROM PROMMR & EPROM BOARD | 139 | 199           |

### CCS Calif. Comp. Systems

|                                    |     |     |
|------------------------------------|-----|-----|
| 280 CPU 2810                       | n/a | 229 |
| 64K Dynamic RAM card               | n/a | 499 |
| 16K Static RAM 2 MHz               | n/a | 249 |
| 16K Static RAM 4 MHz               | n/a | 269 |
| Dbl Density Floppy Disc Controller | n/a | 299 |
| 12 Slot S-100 Mainframe            | n/a | 549 |

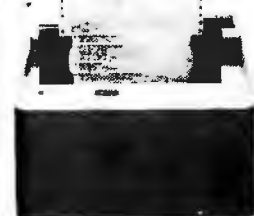

Paper Tiger  
ID5 - 460

**\$1099**

Silentype w/apple II  
Interface



**\$349**

We carry much more than listed. Please call our toll free order line to request our complete price list.

### How to Order

Ordering Information: Phone Orders invited using VISA, MASTERCARD, AMERICAN EXPRESS, DINER CLUB, CARTE BLANCHE, or bank wire transfer. Credit cards subject to service charge, 2% for account number (include expiration date), cashiers or certified check, money order, or personal check (allow 10 days to clear,) all funds must be in US dollars. Shipping, handling and insurance in US add 5% (minimum \$4.00). California residents add 6% sales tax. We accept COD's OEM's, Institutions & Corporations please send for written quotation. All equipment is subject to price change and availability without notice. All equipment is new and complete with manufacturer warranty (usually 90 days). Showroom prices may differ from mail order prices.

Send orders to:

**consumer computers**

Mail Order

8314 Parkway Drive  
La Mesa, California 92041

## Z-80 FORTH \$50.00

**Z-80 FORTH**—a complete program development system. Full fig FORTH and FORTH-79 vocabularies, plus extensions for access to all CP/M<sup>®</sup> functions. Users standard CP/M<sup>®</sup> compatible random access disk files for screen storage. Package includes: interpreter/compiler with virtual memory management, line editor, screen editor, Z-80 Assembler, decompiler, utilities, demonstration programs, and 60 page user manual. System requirements: Z-80 microcomputer, 32 k bytes RAM, CP/M<sup>®</sup> 2.2 or MP/M 1.1 \$50.00

**Z-80 FORTH WITH NAUTILUS SYSTEMS CROSS-COMPLIER.** Extend/modify the FORTH runtime system, recompile on a host computer for a different target computer, generate hardware code, generate ROMable code with initialized variables. Supports forward referencing to any word or label. Produces load map and list of unresolved symbols. 107 page manual. System requirements as for Z-80 FORTH above. \$200.00

**Z-80 FORTH WITH FULL FLOATING POINT ARITHMETIC.** Our basic program development system extended with a complete set of floating point operators and data manipulation primitives. Includes 8-100 compatible hardware serial board incorporating AMD 5811 arithmetic processor \$300.00

**MACHINE TEST PROGRAM PACKAGE** for Z-80 systems. Includes memory, floppy disk, printer, and terminal tests with all source code. Requires CP/M<sup>®</sup> 2.2. \$50.00

All software distributed on eight-inch soft sector single density diskettes. Prices include shipping by first class or UPS within USA or Canada. COD charges extra. Purchases orders accepted at our discretion. CP/M and MP/M are registered trademarks of Digital Research, Inc. Z-80 is a registered trademark of Zilog, Inc.

Laboratory Microsystems  
4147 Beethoven Street  
Los Angeles, CA 90066

Circle 182 on inquiry card.

## 68KFORTH

New SYSTEMS LANGUAGE for ERG 68-696 CPU and Motorola's KDM board. O/S, Compiler, Monitor, Assembler, Interpreter, Virtual Memory, Screen Editor, DBL Precision Arithmetic and more. FORTH-79 Standard Vocabulary.

**\$795**

Empirical Research Group, Inc.  
PO Box 1176  
Milton, WA 98354  
206-631-4855

Circle 163 on inquiry card.

## Analog and Power Control I/O.....in a Single Board Computer



6801 or 68701 MPU with 2K ROM or EROM, 128 RAM, timer, 8 12-bit analog inputs, 8-bit analog output, 8 AC or DC inputs or outputs, serial I/O, digital I/O, watchdog timer, power supply.

**WINTERK** Winter Corp.  
4801 South Street  
Lafayette, IN 47904  
317-742-8426

Circle 402 on inquiry card.

## MICRO-COMPUTER COMMUNICATORS, INC. MC<sup>2</sup>

ANNOUNCES the introduction of the Consumer Referral Index for the Micro-Computer Industry. We need additional vendors, now!

The Consumer Referral Index can help maintain and enhance your current market penetration as well as open previously undefined markets restrained by budget limitations, lack of research, distribution and/or consumer awareness.

MC<sup>2</sup> is dedicated to bringing "know-how" of Micro-Computer hardware, software and services to the general public through RESEARCH, ANALYSIS, AND REFERRAL.

In addition to the Consumer Referral Index, MC<sup>2</sup> provides other services for consumers and vendors including the development of sales and instructional aids (computer-aided and video).

For more information contact:

**MICRO COMPUTER COMMUNICATORS, INC. MC<sup>2</sup>**  
10064 Borgman

Huntington Woods, MI 48070

1-800-521-0334 Ext. 507

1-800-482-4242 Ext. 507 (Mich. only)

\*Applications for the Consumer Referral Index subject to review

Circle 295 on inquiry card.

## DISCOUNT PRICES



|                   |         |
|-------------------|---------|
|                   | only!!  |
| 16K APPLE II      | 1059.00 |
| 32K APPLE II      | 1104.00 |
| 48K APPLE II      | 1149.00 |
| DISK W/CONTROLLER | 515.00  |
| DISK ONLY         | 445.00  |
| APPLE SOFTCARD    | 129.00  |
| INTEGER CARD      | 129.00  |
| PASCAL SYSTEM     | 395.00  |
| SILENTYPE PRINTER | 495.00  |

COMPUTER ACE  
P.O. BOX 728  
ADELPHI, MD 20783  
(301) 587-7459

Circle 414 on inquiry card.

## UV EPROM ERASER



**\$49.95**

- ERASES ALL UV ERASABLE EPROMS (2708, 2716, 2532, 2664, etc.)
- QUICK FIFTEEN MINUTE ERASE TIME
- ERASES OVER FIFTEEN EPROMS AT A TIME
- LAMP LIFE, 7000 HOURS
- TIMER AND SAFETY INTERLOCK SWITCH OPTION

• DEALER-INQUIRIES INVITED •

|                       |       |                              |
|-----------------------|-------|------------------------------|
| QUV TB                | 49.95 | Send Check or COD order to:  |
| Shipping              | 2.50  | <b>LOGICAL DEVICES, INC.</b> |
| COD charges           | 1.50  | 781 W. Oakland Park Blvd.    |
| Timer & Switch option | 20.00 | Ft. Lauderdale, Fla. 33311   |
| Delivery app. 20 days |       | (305) 585-8103               |

Circle 200 on inquiry card.

## MEMOREX FLEXIBLE DISCS

WE WILL NOT BE UNDER-SOLD!! Call Free (800)235-4137 for prices and information. Dealer inquiries invited and C.O.D.'s accepted.

VISA

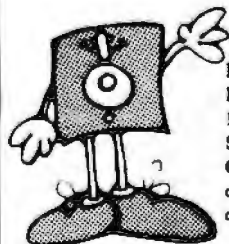

PACIFIC EXCHANGES  
100 Foothill Blvd.  
San Luis Obispo,  
CA 93401 in Cal.  
call (800) 592-5935  
or (805) 543-1037

Circle 292 on inquiry card.



- YES! Sign me up as a charter subscriber. Enclosed is my \$20.00 for 10 issues. (\$24 to Canada. \$30 elsewhere.)
- Not sure. Enclosed is \$2 for a sample issue.

Name \_\_\_\_\_  
Addr \_\_\_\_\_  
City/St \_\_\_\_\_ Zip \_\_\_\_\_

Circle 302 on inquiry card.

## CALL FOR QUALITY COMPONENTS SLIDER

GODBOUT ELECTRONICS A & T BOARDS

|                   |        |                   |        |
|-------------------|--------|-------------------|--------|
| CPU 2 4MHz        | \$221. | CPU 8085/88       | \$319. |
| Disk 1            | 371.   | CPM 80 w/DI       | 135.   |
| System Support 1  | 296.   | 4MHz 9511 (8231)  | 235.   |
| Interfacer for II | 187.   | Interfacer 3 (5)  | 467.   |
| Interfacer 3 (8)  | 547.   | CPM 86 w/DI       | 235.   |
| RAM 20 32K 10MHz  | 524.   | RAM 17 64K        | 1046.  |
| RAM 17 48K        | 786.   | DISK SYSTEM       | Call   |
| Enclosure 2 Desk  | 619.   | Enclosure 2 Rack  | 671.   |
| TELEVIDEO 910 NEW | 600.   | Televideo 920C    | 725.   |
| Televideo 950     | 975.   | Ampeq Dialogue 80 | 975.   |
| C. ITCM 25CPS. SW | 1495.  | NEC 5510 SW       | 2785.  |
| EPSON MX80 par    | 473.   | MX80 FT par       | 645.   |

Q.T. SYSTEM-1 @ \$3595. List is an exceptional Cost/Performance value Now only \$3235.

Mainframe+DD-851t 599. MF+DD-12 slot 629.

SBC 2/4 MHz 280A 265. Expandable+II 64K 599.

RAM 16 16K 4MHz 195. RAM 65 16K Bank 210.

SOFTWARE-----Registered Trademark of:

WORD STAR \$300., Mailmerge \$125. Micro Pro Data Star 250., Supersort 195. Micro Pro MAGIC HAND 300. PeachTree Milestone or Date Book II 250. Organic Software Acc. Rec. Acc. Pay. Gen. Led. Payroll, Mail., 100.

ALL PRICES SUBJECT TO CHANGE. Min. Shipping \$5.00. Outside USA \$12. to airmail boards.

CPM is a registered trademark of Digital Research, 280 is a reg. trademark of Zilog

PO BOX 951  
WESTMINSTER CA 92683  
714 545 1746

Circle 349 on inquiry card.

# If your printer is using more of your computer's time than you are...

## you need the "Fast Spooler."

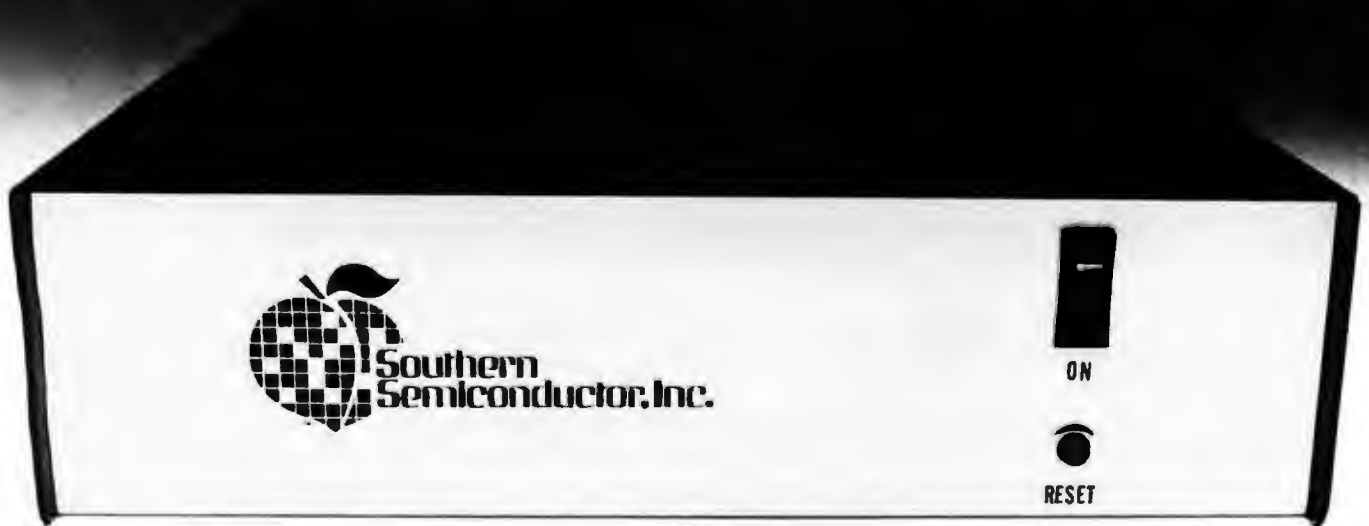

Remember the last time you waited for your printer to complete a printout so you could get down to business with your computer? Well now you can untie your computer with Southern Semiconductor's "Fast Spooler". Large blocks of data can be transmitted at high speed to the "Fast Spooler" so your computer is available for more important functions. Long printouts can be handled entirely by the spooler — a real timesaver for word and data processing.

Easy to interface, the "Fast Spooler" can be connected by either a RS-232 serial interface or a Centronics parallel interface. These interfacing capabilities provide service for virtually any computer and printer.

With its own power supply, cabinet and necessary software, the "Fast Spooler" is a complete unit. So why keep waiting. Visit your nearest Southern Semiconductor dealer today or contact us for complete details.



### Southern Semiconductor, Inc.

6030 Unity Drive, Suite J, Norcross, Georgia 30071 (404) 449-6666

# Unclassified Ads

**FOR SALE:** IMSAI 8080, \$560. Terbell interface with two PerSci 70 8-inch disk drives, case, and power supply; \$1400. VDM-1; \$190. 16 K static programmable memory; \$180. IMSAI MIO; \$100. Selectric MIO; \$650. BYTE, Keyboard Microcomputing, and Interface Ages; write for details. T. Tai, 115 Bonny Ln, Collegeville PA 19426.

**FOR SALE:** Digital Group Z80 dual Phi-Deck system with 34 K memory. Godbout memory board can be expanded from 16 K to 32 K. The system has a 64 by 16 display, 88-cab, and Phi-cab. A Sanyo 9-inch monitor and two keyboards are part of the package. A large amount of software is also included (Phimon, Hi-Phi, Business BASIC, Sargon, Super Games, etc.). \$1250. D. Reavis, 4355 Morris St, Salt Lake City UT 84119, (801) 966-0065.

**FOR SALE:** 9-inch video monitors. No case, in factory carton. 100% prime tested, but never used. Green-phosphor display, requires composite video and 13 thru 16 VDC inputs. Schematic included. I can ship COD, but I will pay shipping if you send a money order for \$60. Chris Kalmbach, 422 S Florida Ave, Joplin MO 64801.

**FOR TRADE OR SALE:** BYTE, Vol. 6, #4-1, Vol. 5, #12-3, Vol. 4, #8, Vol. 3, #11, 4. Walter Jeffries, RFD 1, Readfield ME 04355

**WANTED:** Apple II with 16 K. Must be in good to excellent condition. Marc Lenburg, 14 Meadowbrook Dr, Hadley MA 01035.

**FOR SALE:** Ohio Scientific C4P small-business computer. Includes 52 K, dual 8-inch floppy drives with 600,000 K bytes of storage, OS-65D and OS-65U operating systems, full line of related manuals, and monitor. All for \$2500. UCSD Pascal development package available at \$300 (includes FORTRAN). John F. Durcher, RD 1, Oxford NY 13830, (607) 843-9206.

**FOR SALE:** SOL-20/16 K programmable memory microcomputer, 9-inch Sanyo monitor, Diablo Hy-Type tractor-feed letter-quality printer with keyboard, cassette recorder, Electric Pencil I and II word-processing software, BASIC/S software, debugging tape, supplies, and manuals. Asking \$4000. Pete Pennington, 580 Gregory Ln, Devon PA 19333.

**FOR SALE:** Wave-Mate 6800 64 K computer, dual 8-inch floppy-disk drives, and Infoton 80-column video display. Includes software, Dynamics editor, assembler, and BASIC compiler. Asking \$3000 or best offer. Will consider selling separately. Scott Joslyn, 5411 El Jardin St, Long Beach CA 90815, (213) 597-1749.

**FOR SALE:** Seales B K memory board for 55-50 bus, \$100. SwTPC MP-A processor board less ICs, \$20. Conrac 21-inch black-and-white monitor, \$25 (pick-up locally only). Joe Dubner, 865 S Haskell St, Mountain Home ID 83647, (208) 587-9383.

**FOR SALE:** Diablo Hy-Type I/Hi-Type II or IBM Selectric printer interface. The input is Centronics-compatible (parallel). The unit is stand alone and has a 16 K FIFO print buffer. Ted Warm, POB 526, Knightdale NC 27545, (919) 266-9411.

**FOR SALE:** Quest Super ELF 1802 system in cabinet, 4 K expansion board, monitor and Tiny BASIC read-only memory, power supply, RF modulator, ASCII keyboard, manuals, magazines, and tapes. \$300. Richard Maffie, 20121 Leadwell St #3, Canoga Park CA 91306, (213) 341-6098.

**HELP:** I have an INFO 2000 with TDL monitor and piggyback intelligent controller to PerSci drives. I lost the first EPROM on the 5-100 board. Need DUMP or will buy copy of the chip. Company no longer has the information. If anyone has a similar system, please write or call collect. Edgar Alberding, POB 382, Salem IN 47167, (812) 883-2644.

**FOR SALE:** Cromemco Z2 chassis, Cromemco ZPU, Central Data 64 K twin-port SIO programmable-memory card, IMSAI twin-port SIO, Morrow second disk controller, and two Shugart 801 floppy drives. The above is up and running under CP/M 1.4 with a Hazeltine 1500 terminal. \$4200. Rick Pugsley, 1911 W Callender, Peoria IL 61604, (309) 674-4343.

**FOR SALE:** Nine female Pin D connectors, \$1.50 each. Retaining clips and mounting screws; \$0.50/set of two each. Strain-relief cases for 15-pin D connectors; \$3 each. 30-pin card-edge connectors, solder-eye, 0.156-inch spaces, gold-plated, bifurcated contacts; \$2.50 each. Limited quantity, first come, first served. 10% for shipping and handling. Money order or cashier's check only. Kurt A. Schultz, 115-1 Roxanne Ct, Walnut Creek CA 94596.

**FOR SALE:** Complete set of BYTE. Make offer on any or all issues. John Cowan, 613 Navarra Dr, Scotts Valley CA 95066, (408) 438-5116.

**WANTED:** Our nonprofit college radio station desperately needs the donation of a video terminal or Teletype. Working or nonworking is okay. We need the terminal fairly soon to secure an I/O port on the new college computer. Your donation is fully tax deductible and will be acknowledged by a Swarthmore College receipt. Steve Podell, WSRN-FM Swarthmore College, Swarthmore PA 19081, (215) 447-7340. May thru August: 90 Terrace Ln, Moss Beach CA 94038, (415) 728-3248.

**FOR SALE:** Printer 165 cps, excellent condition, variable character size, double-width characters, graphics can be added, same mechanism as the IDS printers. Best offer \$ Levine, 1802 Melville St, Ocean NJ 07712, (201) 531-8305 after 6 PM.

**FOR SALE:** Apple Silentype printer. As new and complete \$450. Al Coombe, 807 Neal Dr, Gurley AL 35748, (205) 776-2378 after 6 CT.

**FOR SALE:** 5-100 memory: SDS Expandoram II with 32 K of 4 MHz memory Bank select, expandable to 64 K. Certificate of performance by Jade. Novation CAT acoustic modem, nearly new, RS-232C compatible. Guaranteed working, \$350 and \$150. Nick Reiber, 11458 Benton St, Loma Linda CA 92354, (714) 825-7942.

**WANTED:** Daily stock prices on Pet cassettes. One cassette per issue. Hi, lo, close, volume, date 1960 to present. Don Nyre, 305 LaJolla Dr, Newport Beach CA 92663.

**FOR SALE OR SWAP:** TRS-80 Model I with upper-case/lower-case modification in keyboard. Complete with 48 K expansion interface, RS-232C and modem, Percom drives, and Centronics 730 printer. Only one year old; selling to do major hardware upgrade. Software: NEWDOS/80, Miller-FORTH and Datahandler, Pascal, FORTRAN, VisiCalc, Disk Ed/Asm, Stockpak, Scripsit, etc. \$5000 investment. Want 5-100 or STD bus 280 equipment with 8-inch drives. Alan W/Coa, POB 151, Archbald PA 18403, (717) 586-8515 before 9 PM.

**FOR SALE:** Televideo 920C terminal with second-page memory option. Used for only three months and in mint condition in its original shipping container. Will send UPS postage paid to the first person submitting a \$700 certified check or money order. G. D. Kaplan, POB 1462, Laguna Beach CA 92652, (714) 499-2724.

**WANTED:** Poor student in need of any and all 5-100 (preferred) computer boards, peripherals, software, and electronic components. Need not work. Send list of equipment and price. Jonathan A. Chandross, 14 Hunterdon Blvd, Murray Hill NJ 07974.

**FOR SALE:** Brand-new unused Apple communication card. Best offer: R. J. Crafts, POB 262, Ocean Heights, Edgarmown MA 02539, (617) 627-4707 days, 627-8867 evenings.

**FOR SALE:** Digital Group computer. Factory wired, less than five hours running time. Z80A processor, 32 K static programmable memory, keyboard, and dual Phi-Deck (early board). Complete documentation, showroom condition, \$700 or best offer. FOB Los Angeles. J. Zubrecky, 328-A Russell Ave, Monterey Park CA 91754, (213) 571-1554.

**FOR SALE:** Heath H-89 all-in-one microcomputer. Less than ten hours use, looks and works perfect. Single floppy-disk drive, 48 K programmable memory, cassette interface, cassette player, HDOS 2.0 disk operating system, and Extended Benton Harbor and Microsoft BASIC. Full documentation plus miscellaneous software. \$3000 value for \$2000. Will ship anywhere. Thomas F. Arnold, 6961 Island Rd, Clay NY 13041, (315) 699-5310.

**FOR SALE:** IMSAI MIO board and Processor Technology 3P+S board. Assembled and tested with all IC sockets and guaranteed working. MIO contains one serial port, two parallel ports, and a Terbell cassette interface for 5-100 bus systems. 3P+S contains three parallel ports and one serial port for 5-100 bus systems. \$100 each plus shipping. Will ship COD. John Dunning, 1395 Main St, Waltham MA 02154, (617) 899-7244 days only.

**FOR SALE:** Heath H-11: 32 K, two serial and one parallel boards, two extra LSI-11/2 processor modules, extended arithmetic chip, WH-27 factory-assembled floppy disk, DEC VT100 video terminal, DEC LA36 DECwriter II Accelwriter (600 bps) equipped, Heath computer desk, super software package, all accessories, many extras, running and ready to go. Will accept any bona fide offer over \$5000. Will separate. Greg Krzyzowski, 5223 Main St, Downers Grove IL 60515, (312) 963-0250 days, 964-4429 evenings.

**FOR SALE:** Apple II peripherals. Hayes Microcomputer Products micromodem and Videx 80-column board. Free interface EPROM for modem, spare EPROMs and programmer for video board. Also, Mountain Hardware clock. Everything 1/3 off current price or trade for Apple Graphic Pad. James Leatham, RD 2, Box 198, Chester NY 10918, (914) 469-4092.

**FOR SALE:** BYTE, complete set to present, in excellent condition. SwTPC 6800 complete system, cassette-based with terminal. New RS/Centronics 779 in unopened box. Make offers. Innn French, 8045 Alida St, La Mesa CA 92041.

**WANTED:** Bare printed-circuit board for D.C. Hayes B-103A modem. D. Reinebeck, 899 Fairfield Rd, North Vancouver British Columbia, V7H 2J4 Canada, (604) 929-5759.

**FOR SALE:** Assembled and working Heathkit H-8 with B K memory, H-8-5 serial interface board, Extended BASIC and regular BASIC tapes, tape recorder, and manuals. \$350 or best offer. Micro-Term serial keyboard, \$350. Sanyo 9-inch monitor, \$125. RF modulator (used with Apple computer); \$20. Bill Lofron, 5840 Sun Valley Way, Sacramento CA 95823, (916) 393-0154.

**FOR TRADE:** A Leslie Model 145 organ amplifier/speaker and preamplifier for a computer of comparable value. Like-new condition. I will deliver within a 250-mile radius. Martin Meier, 801-J Patterson Rd, Dayton OH 45419, (513) 299-7156.

**FOR SALE:** APF Imagination Machine. Only two months old. Excellent condition. Paid \$599, will sell for \$450 or offer. Also, interested in buying used Apple II with 48 K Steve Grabarczyk, 4921 W Midland Dr, Greenfield WI 53219, (414) 543-7989.

**UNCLASSIFIED POLICY:** Readers who are soliciting or giving advice, or who have equipment to buy, sell or swap should send in a clearly typed notice to that effect. To be considered for publication, an advertisement must be clearly noncommercial, typed double spaced on plain white paper, contain 75 words or less, and include complete name and address information.

These notices are free of charge and will be printed one time only on a space available basis. Notices can be accepted from individuals or bona fide computer users clubs only. We can engage in no correspondence on these and your confirmation of placement is appearance in an issue of BYTE.

Please note that it may take three or four months for an ad to appear in the magazine.

# Reader Service

| Inquiry No. | Page No.                     | Inquiry No. | Page No.                   | Inquiry No. | Page No.   | Inquiry No. | Page No.                             |
|-------------|------------------------------|-------------|----------------------------|-------------|--|-------------|--------------------------------------|
| 1           | AB COMPUTERS 443             |             |                            | 168         | INFOSOFT SYSTEMS INC 272                           | 220         | MIRO COMPUTERS 343                   |
| 2           | ABM PRODUCTS 184             | 79          | COMPUTERS ETC 202          | 167         | INMAC 355  | 252         | MORROW DESIGNS 77                    |
| 3           | ACKERMAN DIGITAL SYS 189     | 80          | COMPUTERS ETC 286          | 168         | INNOVATIVE PROD 147                                | 253         | MORROW DESIGNS 78                    |
| *           | ACTION COMPUTER 143          | 81          | COMPUTERS ETC 383          | 169         | INNOVATIVE SFTW APPL 382                           | 254         | MOSTEK CORP 179                      |
| 4           | ADAPTIVE DATA & ENERGY 127   | 82          | COMPUTERS WHOLESALE 252    | 170         | INSOFT CORP 53                                     | 255         | MOUNTAIN COMPUTER 19                 |
| 5           | ADROIT ELECTRONICS 446       | 83          | COMPUTERWARE 353           | 171         | INTEC 170  | 256         | MOUNTAIN DISTR 232                   |
| 6           | ADV COMP PROD 458, 459       | 84          | COMPUTEX CORP 30           | 172         | INTEGRAL DATA SYS 145                              | 257         | MOUNTAIN VIEW PRESS 309              |
| 7           | ADV MICRO SYS 258            | 85          | COMPUVIEW PROD INC 65      | 173         | INTEGRAND 347                                      | 258         | MPI 239                              |
| 106         | ADV TECHNOLOGY 450           | 87          | CONCOMP IND 236            | 174         | INTEGRATED BUSN COMP 372                           | 259         | MRD SYS INC 440                      |
| B           | ADVENTURE INT'L 351          | 88          | CONCORD COMP PROD 327      | 177         | INTERTEC DATA SYS 73                               | 260         | MSI DATA CORP 22                     |
| *           | ALF PRODUCTS, INC 122        | 89          | CONSUMER COMP 164, 165     | 178         | INTROL CORP 448                                    | 261         | MTI INC 216                          |
| 10          | ALL ELECTRONICS CORP 446     | 90          | CONSUMER COMP 474, 475     | 179         | IPEX INT'L 448                                     | 262         | MULLEN COMP PROD 342                 |
| 11          | ALLENBACH IND 76             | 92          | COVER CRAFT 176            | 180         | ITHACA INTERSYSTEMS 8, 9                           | 264         | NAT'L DATA SUPPLIES 440              |
| 12          | ALLISON INDUSTRIES 244       | 93          | CPU SHOP, THE 429          | 181         | JADE COMP PROD 485                                 | 265         | NATIONAL TRICOR 248                  |
| 13          | ALPHA BYTE STORAGE 51        | 207         | CREATIVE DISC SFTW 349     | 182         | JADE COMP PROD 466, 467                            | 266         | NEBS 98                              |
| 360         | ALPHA BYTE STORAGE 277       | 94          | CREATIVE SFTW DEV 442      | 183         | JAMECO ELECTR 472, 473                             | 267         | NEC AMERICA 175                      |
| 14          | ALSPA COMP SYS 434           | 95          | CREATIVE SOFTWARE 380      | 184         | JDR MICRODEVICES 454, 455                          | 268         | NECO 219                             |
| 15          | ALTOS COMP SYS 88, 89        | 96          | CROMEMCO 1, 2              | 411         | JIM-PAK 427  |             | NETRONICS 152, 154, 324              |
| 16          | AMER SMALL BUSINESS COMP 451 | 97          | CYBERNETICS INC 361        | 185         | JMCA SOFTWARE 442                                  | 269         | NORSEA DATA CORP 91                  |
| 17          | AMER COMP EXCH 442           | 98          | D & W DIGITAL 67           | 186         | JWS ENGINEERING 440                                | 407         | NORTH AMER TECH 26                   |
| 18          | AMER SQUARE COMP 211         | 99          | DAKIN 5 CORP 337           | 418         | KADAK PRODUCTS 320                                 | 408         | NORTH AMER TECH 82                   |
| 19          | ANCI LABS 282                | 293         | DATA DISCOUNT CTR 250      | 187         | KERN PUBLISHING 292                                | 270         | NOVELL DATA SYS 241                  |
| 20          | ANCRONA 431                  | 101         | DATA-ED 95                 | 190         | KRAMER SYS INT'L 356                               |             | OASIS SYSTEMS 298                    |
| 21          | APPARAT INC 23               | 102         | DATASOFT 330               | 191         | KV 33 434  | 273         | OHIO SCIENTIFIC INSTR C IV           |
| 22          | APPLE COMP INC 13            | 103         | DATASOUTH COMP CORP 34     | 192         | LABORATORY MICROSYS 478                            | 274         | OHVER ADVANCED ENGR 434              |
| 418         | APPLE COMP 13                | 104         | DATASOUTH COMP CORP 159    | 217         | LARKS ELECTR 448                                   | 275         | OLYMPIC SALES 355                    |
| *           | APPLE COMP 182               |             | DATRICON CORP 194          | 194         | LEAPAC SERVICES 355                                | 276         | OMEGA MICRO COMPUTER 308             |
| 417         | ARISTO POLKS 198             | 107         | DELTA PRODUCTS 297         | 195         | LEAPAC SERVICES 450                                | 277         | OMEGA SALES 262, 283                 |
| 24          | ARTIFICIAL INTL RESRCH 448   | 78          | DENVER SFTW CO, THE 75     | 196         | LEO ELECTRONICS 258                                | 278         | OMIKRON 63                           |
| 25          | ASAP COMP PROD INC 280, 281  | 108         | DESIGNER SOFTWARE 31       | 197         | LIFEBOAT ASSOC 203                                 | 279         | OMNI RESOURCES 109                   |
| 415         | ASAP COMP PROD INC 371       |             | DFS COMP FORMS 326         | 409         | LIFEBOAT ASSOC 221                                 | 280         | OMNITEC DATA 171                     |
| 26          | ASHTON-TATE 222, 223         | 109         | DIGATEK CORP 444           | 410         | LIFEBOAT ASSOC 307                                 | 281         | OPTIMIZED SFTW 357                   |
| 27          | ATARI PERSONAL COMP 303      | 110         | DIGIAC CORP 359            | 198         | LNW RESEARCH 243                                   | 282         | ORANGE MICRO 116                     |
| 28          | AUSTRALIAN PERS COMP 212     | 111         | DIGICOMP RESRCH CORP 381   | 199         | LO-BALL COMPUTERS 218                              | 283         | ORANGE MICRO 117                     |
| 29          | AUTOCORNTROL INC 434         | 112         | DIGITAL DATA SYS 434       | 200         | LOGICAL DEVICES 476                                | 284         | ORANGE MICRO 141                     |
| 30          | AUTOCORNTROL INC 434         | 378         | DIGITAL ELEC SYS 320       | 201         | LOMARS DATA PRODUCTS 270                           | 285         | ORION INSTRUMENTS 440                |
| 31          | AUTOMATED EQPTMNT 323        | 113         | DIGITAL GRAPHIC SYS 100    | 202         | LYBEN COMP SYS 450                                 | 286         | ORTHOCODE GROUP 234                  |
|             | AVOCET 180                   | 114         | DIGITAL MARKETING 6        | 203         | MACROTRONICS 434                                   | 287         | OSBORNE COMPUTERS 33                 |
| 32          | B & B ELECTR 444             | 115         | DIGITAL MARKETING 125      | 204         | MACROTRONICS 442                                   | 288         | OSBORNE WILSON LABS 334              |
| 33          | BASF SYSTEMS 291             | 116         | DIGITAL RESEARCH 247       | 205         | MAGNOLIA MICROSYS 448                              | 289         | OSBORNE/MCGRAW-HILL 187              |
| *           | BELL, JOHN ENGR 441          | 117         | DIGITAL RESEARCH COMP 445  | 206         | MALIBU ELECTR CORP 161                             | 290         | OWENS ASSOC 288, 289                 |
| 35          | BETA COMP DEVICES 287        | 118         | DILITHIUM PRESS 238        | 34          | MANNESMANN TALLY 377                               | 291         | PACIFIC COMP BRK 246                 |
| 36          | BISON PRODUCTS 439           | 119         | DISC3 MART INC 345         | 208         | MARATHON COMP SYS 341                              | 291         | PACIFIC DISC SFTW 446                |
| 37          | BIT BUCKET, THE 363          | 120         | DISCOUNT SFTW GRP, THE 186 | 209         | MARSHALL SYS INC 310                               | 292         | PACIFIC EXCHANGES 237, 434, 444, 478 |
| 37          | BOWER-STEWART 180            | 188         | DJ "AI" SYS LTD 196        | 207         | MAROT SFTWRE 225                                   | 296         | PAGE DIGITAL 452, 453                |
| 38          | BUSINESS OPERATING SYS 146   | 121         | DMA 276                    | 210         | MARTEC 352   | 297         | PALOMAR COMP EQUIP 261               |
| 39          | BUSINESS WEEK 285            | 122         | DUAL SYS CONTROL CORP 139  | 211         | MARTIN MARIETTA CORP 313                           |             | PAN AM WORLD AIRWAYS 130, 131        |
|             | BYTE BOOKS 207               | 123         | DYNAMARC IND 96            | 212         | MARTEL INDUSTRIES 343                              | 298         | PAN AMERICAN ELEC INC 72             |
| 40          | BYTE BOOKS 208               | 124         | DYNABYTE BUSN COMP C III   |             | MARVELL DATA PRODUCTS 305                          | 299         | PAN AMERICAN ELEC INC 438            |
| 41          | BYTE BOOKS 209               | 125         | DYNACOMP 204, 205          |             | MCGRAW-HILL BOOK 12 PG                             | 300         | PAPER TRACTOR 335                    |
| 42          | BYTE BOOKS 210               | 126         | EAST COAST COMP 442        |             | METRO INSERT—TO APPEAR IN BOSTON METRO ONLY 80, 81 | 301         | PASSWORD DISTR 442                   |
|             | BYTE BACK ISSUES 376         | 127         | ECOSOFT 349                | 213         | MEAS SYS & CONTROLS 28, 29                         | 302         | PC NEWSLETTER 476                    |
|             | BYTE SUB 362                 | 128         | ELECTROLABS 436            | 214         | MEMOREX MEDIA PROD 169                             | 303         | PC SYSTEMS INC 32                    |
|             | BYTE WATS 376                | 129         | ELECTRONIC CONTROL 104     | 215         | MEMORY MERCHANT 27                                 | 304         | PEACHTREE SOFTWARE 174               |
| 43          | CALIF DATA CORP 448          | 130         | ELECTRONIC SPLISTS 333     | 216         | MENTOR SOFTWARE 440                                | 305         | PERCOM DATA 7                        |
| 44          | CALIF DIGITAL 460, 461       | 131         | ELECTRONIC SYS FURN 373    | 218         | META TECHNOLOGIES 420                              | 306         | PERCOM DATA 15                       |
| 45          | CALIF COMP SYS 20            | 132         | ELECTRONICS CENTER 296     | 219         | MICRO AGE COMP STORE 150, 151                      | 307         | PERCOM DATA 15                       |
| 46          | CALIF COMP SYS 21            | 133         | ELLIS COMPUTING 274        | 222         | MICRO BUSINESS WORLD 341                           | 308         | PERSONAL COMPUTERS 304               |
| 47          | CALIF SOFTWARE 268           | 162         | EMPIRICAL RESRCH GRP 444   | 223         | MICRO BUSN ASSOC 329                               | 309         | PHASE ONE SYS INC 285                |
| 48          | CAMBRIDGE DEVEL LABS 357     | 163         | EMPIRICAL RESRCH GRP 476   | 224         | MICRO COM 229                                      | 310         | PICKLES & TROUT 94                   |
| 49          | CAMEO ELECTR INC 325         | 134         | EPSON AMERICA 301          | 295         | MICRO COMP COMM 476                                | 311         | POLYLINE CORP 440                    |
| 294         | CASEMAKER, THE 343           | 135         | EXATRON INC 193            |             | MICRO COMP DISC CO 375                             |             | POPULAR COMPUTING 273                |
| 9           | COB MACHINE PROD 450         | 136         | EXATRON INC 231            | 225         | MICRO DATA BASE SYS 101                            | 312         | POWER ONE INC 87                     |
| 50          | CDR 450                      | 137         | EXECUTIVE SYS INC 153      | 189         | MICRO FOCUS 57                                     | 313         | PRACTICAL MGMT SYS 440               |
| 52          | CHECKS-TO-GO 168             |             | EXPOTEK 54                 | 228         | MICRO HOUSE 316, 317                               | 315         | PRIORITY ONE 468, 469                |
| 53          | CHIPS & DALE 444             | 138         | FAIRCOM 314                | 229         | MICRO MTRIC 448                                    | 316         | PRIORITY ONE 470, 471                |
| 54          | CHRISLIN INDUSTRIES 275      | 139         | FARNSWORTH COMP CTR 331    | 227         | MICRO MINT 335, 480                                | 317         | PRIVATE IND COUNCIL 284              |
| 55          | CHRISLIN INDUSTRIES 295      | 140         | FEITH SOFTWARE 446         | 230         | MICRO PRO INT'L 68, 69                             | 318         | PROF COMP STORE 446                  |
| 56          | CMC INT'L 115                | 141         | FORETHOUGHT PRODUCTS 345   | 231         | MICRO SCI 25                                       | 319         | PURCHASING AGENT, THE 172            |
| 57          | CMS ENTERPRISES 264          | 142         | FREDERICK COMP PROD 228    | 232         | MICRO SCI 25                                       | 320         | QUALITY COMP PARTS 312               |
| 58          | COMPILER SYS INC 191         | 143         | FRYE ELECTR 440            | 233         | MICRO WORKS, THE 294                               | 321         | QUALITY COMP PARTS 446               |
| 59          | COMPONENTS EXPRESS 337       | 144         | G R ELECTRONICS 352        | 234         | MICROACE 359                                       | 322         | QUALITY SOFTWARE 110                 |
| 61          | COMPUTIME 333                | 145         | GIDDINGS & LEWIS 71        | 235         | MICROCOMP TECH INC 123                             | 323         | QUALITY SOFTWARE 328                 |
| 62          | COMPUMART 136, 137           | 146         | GIMIX INC 128              | 236         | MICROCOMPUTER APP 56                               | 324         | QUASAR DATA PROD INC 257             |
| 63          | COMPUSERVE 235               | 147         | GIMIX INC 444              | 237         | MICROCRAFT SYS 345                                 | 325         | QUAY CORP 319                        |
| 414         | COMPUTER ACE 476             | 148         | GODBOUT ELECTR 299         | 238         | MICRODASYS 201                                     | 327         | QUEST ELECTR 449                     |
| 65          | COMPUTER AGE 290             | 149         | GORDON, MARK COMPS 384     | 239         | MICROMAIL 214                                      | 328         | R K S ENTERPRISES INC 333            |
| 66          | COMPUTER AID 444             | 150         | H & E COMPUTRONICS 215     | 240         | MICROMATE ELECTR INC 351                           | 329         | RC ELECTRONICS 331                   |
| 67          | COMPUTER AID 444             | 151         | H & E COMPUTRONICS 217     | 241         | MICROSTEF (CPD) 111                                | 330         | RR SOFTWARE 351                      |
| 68          | COMPUTER CASE CO 338         | 152         | HANLEY ENGRNGR 437         | 242         | MICROTECH EXPORTS 86                               | 331         | RACET COMPUTES 363                   |
| 69          | COMPUTER CROSSROADS 351      | 153         | HAPPY HANDS 308            | 243         | MICROWARE 112                                      | 332         | RADIO SHACK ASSOC CTR 339            |
| 70          | COMP DISC OF AM 318          | 154         | HAYDEN BOOK CO INC 315     | 244         | MIDWEST COMP PERPH 350                             | 333         | RADIO SHACK-GLNW SPR 335             |
| 70          | COMPUTER EXCHANGE 253        | 155         | HAYES MICROCOMP PROD 135   | 245         | MIKOS 438  | 336         | RADIX INC 450                        |
| *           | COMPUTER FACTORY 92, 93      | 156         | HAYES MICROCOMP PROD 199   | 246         | MILLER MICROCOMP SERV 158                          | 334         | RCA 64                               |
| 71          | COMPUTER FURN & ACCSS 202    | 314         | HAYES MICROCOMP PROD 354   | 247         | MINI COMP SUPPLIERS 350                            | 335         | RCA SOLID STATE 113                  |
| 72          | COMPUTER MAGIC 450           |             | HEATH COMPANY 16, 17, 185  | 248         | MINI MICRO MART 462                                | 336         | ROBOTICS AGE 49                      |
| 73          | COMPUTER MAIL ORDER 283      | 158         | HIGH TECHNOLOGY INC 10     | 249         | MINI MICRO MART 192                                | 337         | RUSSO, M 440                         |
| 51          | COMP PER UNLTO 353           | 159         | HOBBY ROBOTICS 361         | 249         | MINI MICRO MART 463                                |             | S-100 INC 279                        |
| 74          | COMPUTER PLUS 446            | 160         | HOUSTON INSTRUMENTS 206    | 250         | MINI MICRO MART 464                                | 272         | S C DIGITAL 354                      |
| 75          | COMPUTER SHOPPER 434         | 161         | I/O TECHNOLOGY 254         | 412         | MINITMAN PRINTING 390                              | 338         | SCIENTIFIC ENGRG LABS 363            |
| 68          | COMPUTER SOCIETY 480         | 164         | IMS INTERNATIONAL 55       | 251         | MIN MICROCOMP SFTW 81                              | 339         | SCION CORP 5                         |
| 76          | COMPUTER SPLICES 84, 85      | 165         | INFOSCRIBE 103             |             |  | 340         | SCITRONICS 242                       |
| 77          | COMPUTER STOP, THE 435       |             |                            |             |  |             | SCOTTSDALE SYSTEMS 80                |

To get further information on the products advertising in BYTE, fill out the reader service card with your name and address. Then circle the appropriate numbers for the advertisers you select from the list. Add an 18-cent stamp to the card, then drop it in the mail. Not only do you gain information, but our advertisers are encouraged to use the marketplace provided by BYTE. This helps us bring you a bigger BYTE. The index is provided as an additional service by the publisher, who assumes no liability for errors or omissions. \*Correspond directly with company.

## Reader Service

| Inquiry No. | Page No.                              | Inquiry No. | Page No.                              | Inquiry No. | Page No.                 | Inquiry No. | Page No.                  |
|-------------|---------------------------------------|-------------|---------------------------------------|-------------|--------------------------|-------------|---------------------------|
| 352         | SOFTECH MICROSYS 269                  | 384         | SUNNY INT'L 438                       | 380         | TEI INC 61               | 383         | VECTOR GRAPHICS 121       |
| 351         | SOFTWARE HOWS 162                     | 385         | SUPER STAR INT'L 233                  | 381         | TEI INC 177              | 394         | VERTICAL DATA SYS INC 149 |
| 353         | SOHO GROUP, THE 349                   |             | SUPERSOFT 83, 163, 197, 220, 329, 353 | 382         | TERMINAL DATA SYS 450    | 395         | VIDEO MARKETING 446       |
|             | SOLID STATE SALES 158                 | 386         | SURVEYORS SUPPLY CO 358               | 383         | TERRAPIN INC 329         | 396         | VIDEX 181                 |
| 354         | SORCIM 78                             | 387         | SYBEX 58                              | 384         | TEXAS COMP SYS 387       | 387         | VISTA COMPUTER CO 119     |
| 365         | SORRENTO VALLEY ASSOC 337             |             | SYNCHRO SOUND 368                     |             | THUNDERWARE 245          | 388         | VOTRAX 187                |
| 413         | SOURCE TELECOMPUTING CORP AM 396, 397 | 389         | SYNERTEK SYSTEMS 173                  | 385         | TINY-C 82                | 389         | WASHINGTON COMP SERV 433  |
| 368         | SOUTHERN SEMICNDTRS 477               | 370         | SYS INTERFACE CONS 70                 | 386         | TNW CORP 347             | 400         | WESTERN BUSN ASSOC 266    |
| 357         | SOUTHWEST TECH PROD C II              | 371         | SYSTEMS PLUS 195                      | 387         | TRANSET CORP 357         |             | WESTICO INC 107, 446      |
|             | SPECIALIZED BUSN SYS 347              | 372         | SZ SOFTWARE SYSTEMS 450               | 388         | TRANSWAVE CORP 105       |             | WHITESMITHS LTD 133       |
| 358         | SPECTRUM SOFTWARE 267                 | 375         | TARBELL ELECTR 311                    | 23          | TRINITY GROUP 448        | 401         | WILD HARE COMP SYS 155    |
| 359         | SSM MICRO COMP PROD 11                | 376         | TARCO DEVELOPMT CORP 339              | 389         | US MICRO SALES 321       | 402         | WINTER CORP 476           |
|             | STATCOM INC 97                        | 377         | TEAM ELECTR 331                       | 390         | US MICRO SALES 456, 457  | 403         | WINTERHALTER & ASSOC 339  |
| 381         | STREET ELECTR CORP 336                | 226         | TECHNICAL MICRO SYS 448               | 391         | US ROBOTICS 271          | 404         | WW COMPONENT SUPPLY 447   |
| 382         | STRUCTURED SYS GRP 35                 |             | TECHNICAL SYS CONS 183                |             | UNITED SFTW OF AM 157    | 405         | X COMP 293                |
| 383         | SUBLOGIC 259                          | 379         | TECMAR INC 227                        | 392         | VAN HORN OFFICE SUPP 359 | 406         | ZENRAD CONTROLS 444       |
|             |                                       |             |                                       | 420         | VANDATA 251              |             | ZOBEX 129                 |

# BOMB

## BYTE's Ongoing Monitor Box

| Article # | Page | Article  | Author(s)                     |
|-----------|------|--|-------------------------------|
| 1         | 14   | Introducing the Smalltalk-80 System                    | Goldberg                      |
| 2         | 36   | The Smalltalk-80 System                                | Xerox Learning Research Group |
| 3         | 50   | Build a Z8-Based Control Computer with BASIC, Part 2   | Ciarcia                       |
| 4         | 74   | Object-Oriented Software Systems                       | Robson                        |
| 5         | 90   | The Smalltalk Environment                              | Tesler                        |
| 6         | 147  | User-Oriented Descriptions of Smalltalk Systems        | Reenskaug                     |
| 7         | 168  | The Smalltalk Graphics Kernel                          | Ingalls                       |
| 8         | 200  | The Japanese Computer Invasion                         | Miastkowski                   |
| 9         | 230  | Building Data Structures in the Smalltalk-80 System    | Aithoff                       |
| 10        | 286  | Design Principles Behind Smalltalk                     | Ingalls                       |
| 11        | 300  | The Smalltalk-80 Virtual Machine                       | Krasner                       |
| 12        | 322  | Building Control Structures in the Smalltalk-80 System | Deutsch                       |
| 13        | 348  | Is the Smalltalk-80 System for Children?               | Goldberg and Ross             |
| 14        | 369  | ToolBox: A Smalltalk Illustration System               | Bowman and Flegal             |
| 15        | 378  | Virtual Memory for an Object-Oriented Language         | Kaehler                       |
| 16        | 398  | Microsoft Editor/Assembler Plus                        | Carlson                       |
| 17        | 401  | BOSS: A Debugging Utility for the TRS-80 Model I       | Mitchell                      |

## May BOMB Results: Printers Top List

By one of the largest margins in BOMB's history, Kevin Cohan's article "The Epson MX-80 and MX-70 Printers" swept first place in the May contest. The \$100 first prize will be donated to charity in Kevin's name. (Kevin Cohan, a technical editor at BYTE, was killed in an automobile accident April 22.)

Steve Ciarcia's "DC Motor Controls: Build a Motorized Platform" captured second place and the \$50 prize. Third place went to senior editor Gregg Williams for his article "The Commodore VIC 20 Micro-computer: A Low-Cost, High-Performance Consumer Computer," and fourth place went to technical editor Stan Miastkowski for his article "Extended Color BASIC for the TRS-80 Color Computer."

## POPULAR BASIC LISTINGS

Back after overwhelming response to introductory offer in the March BYTE

- LAS VEGAS BINGO PINBALL \$ 5  
(game card simulation)
- Highly Acclaimed-Challenging-Habit Forming  
some people play it all night
- THE BATTLE FOR GAMMA OMICRON OUTPOST #1 \$ 3  
(Challenging space war game)
- BOTH LISTINGS \$ 6
- BLANK DISKETTES \$ 4  
state size and sectoring or machine  
We sell in single quantities. No  
need to purchase more than you want.

THE COMPUTER SOCIETY  
(a company)

P.O. Box 1056  
WASHINGTON PARK, IL. 62204

Add \$1.50 shipping and handling. Ill. residents add sales tax. Credit card customers include card number and expiration date.



## 9 TRACK TAPE DRIVES

800 BPI  
45 IPS  
FULL MANUAL  
\$4850 VALUE



\$2400  
NEW IN  
ORIGINAL  
BOXES

PERTEC Model 8840A-9-45  
INDUSTRY STANDARD INTERFACE  
CAPABLE OF IND. STD. ANSI-IBM DATA FORMAT

- READ/WRITE DATA IN STANDARD ANSI-IBM COMPATIBLE FORMAT
- DUMP WINCHESTERS AND HARD DISKS; 10 inch reels hold up to 3800' at tape - 34.56 Megabytes unblocked.
- EXCHANGE DATA & PROGRAMS WITH LARGE MAIN FRAMES AT SCHOOL, WORK, SERVICE BUREAUS ETC.
- BARGAIN PRICED MINI-COMPUTER UPGRADE. OEM List \$4850

A large OEM oversize makes these industry standard drives available at a fraction of their current list price. Full size drives handle up to 10.5 inch reels of standard inexpensive 1/2 inch mag tape. 19 inch rack mount or use right out of the box on steel shipping frame.

**SPECIFICATION SUMMARY:** 9 track, 800 BPI, dual head (read only write), 45 IPS read-write, 200 IPS rewind, BOT/EOT sensing, 110 VAC/60-Hz, solid state, recent manufacture, all I/O signals TTL/DTL compatible, tension arm tape buffering, full control panel. Call or write for full set of technical specifications.

**INTERFACES:** Electrovalue encourages the development of interfaces to popular systems. Interfaces exist for popular minis and are being developed for several hobby computers. If you'd like to develop and document an interface to a popular small system call to discuss discounts.

ELECTROVALUE INDUSTRIAL INC.

P.O. BOX 157-B  
MORRIS PLAINS, NJ 07950

Formerly Electrolog Systems

Please reservations and  
questions are welcome  
201/267-1117

## Vobrax SC-01 SPEECH SYNTHESIZER



\$70 Ea.  
Immediate  
Delivery.

### Order in Ones or Thousands

The SC-01 Speech Synthesizer is a completely self-contained solid state device. This single chip phonetically synthesizes continuous speech, of unlimited vocabulary.

The SC-01 contains 64 different phonemes which are accessed by a 6-bit code. It is the proper sequential combination of these phoneme codes that creates continuous speech.

Vobrax is a trademark of Federal Screw Works

Call 1-800-645-3479, in N.Y. 1-516-374-6793

The MicroMint Inc  
917 Midway  
Woodmere, NY 11598



The Dynabyte Difference: Unequalled price/performance with total expandability.

# Buying the powerful Dynabyte 5615 isn't only smart, it's cost efficient.



The 5615 is the sure way to get the system you need. With more power for the price. You can select memory to 400 KB on our S-100 bus architecture. Choose from 3 sizes of Winchesters to 45 MB and have diskette back-up to your system also. If it's tape back-up you need, then choose our 5700. If you need less storage, our 5 1/4" floppy 5200, our 8" floppy 5300 or our 5400 system using both floppies, with up to 3.6 MB capacity, can be yours.

The 5615 system is available with either single user CP/M or our enhanced MP/M for multi-user applications. Our MP/M operating system supports up to eight terminals, with a separate or shared spooler, and up to sixteen printers with no required partition space. Add to this multi-tasking, bank switching, record lockout, type-ahead and DMA and you have an MP/M operating system that supports a

host of existing languages and meets minicomputer standards.

No multi-user applications library is so responsive to your needs. The 5615 features Business Manager,<sup>™</sup> the fully integrated, menu-driven, well documented, easy to install accounting system that gives you file/record protection, HELP commands, multi-level security, keyed data access, internal disk management, available source code and more.

System expandability, power and price/performance are further enhanced by on-hand availability, quantity discounts, 180-day warranty and a national WATS line for support.

Whether you use or sell computer systems, you should ask about the microcomputer that puts minicomputer capability in your hands. That's the 5615. That's the Dynabyte Difference. Call Mike Seashols, V. P. Marketing (800) 227-8300. In California (415) 329-8021. Dynabyte, 115 Independence Drive, Menlo Park, California 94025.

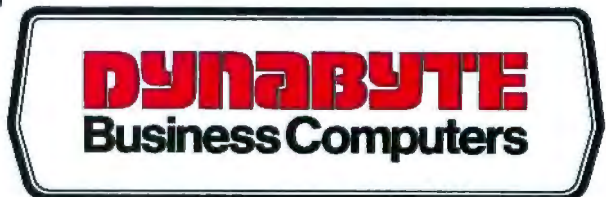

# "It's beautiful what your bucks will buy from Ohio Scientific."



Ohio Scientific was first to add Winchester hard disk drives to microcomputers. This advanced technology allows low cost microcomputers to store over 100 times as much information on line as they could before.

"Our Challenger C3-B has been running almost 24 hours a day for the last 18 months keeping track of countless details of our business. The Challenger's real time clock allows repetitive jobs to be scheduled months in advance, and runs them without operator intervention when the time comes. For example, every morning at 3 AM our Challenger knows it is time to update all the day's accounting records including the P&L, General Ledger, and Payables. It knows when it is time to file a tax return, and it makes out the quarterly reports. When it is through with all of this, it writes the checks. Periodically it does a comprehensive advertising analysis and updates any other files that are necessary."

*Holly Quarles, President, Commonwealth Capital Corp.  
Charlottesville, Virginia*



"Running our retail stores sure has been easier since our Challenger computer came to work for us. We use it for Accounts Receivable, Accounts Payable, Payroll, General Ledger. It's most important in Inventory Control. We must know what we have and haven't. Now we do, daily. Terrific! Ohio Scientific!"

*Henry Felkey, Division Manager,  
Schwartz-Klines  
New Philadelphia, Ohio*

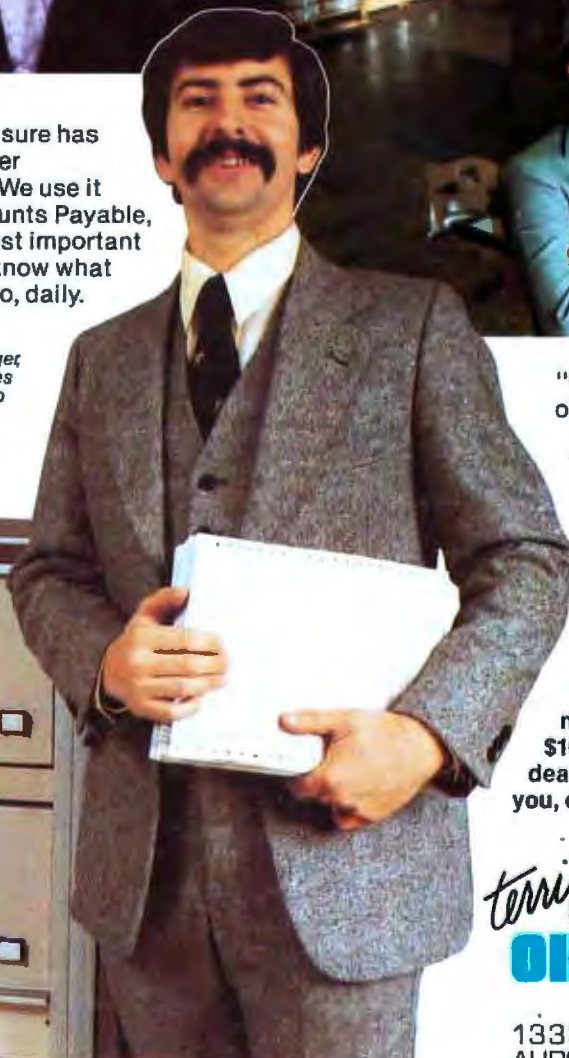

"Our Challenger gives us more control of scrap from our blown film extrusion operation. By putting shift reports through the computer, we spot waste immediately. Whether the problem is the extruder or the operator it's corrected fast. Wasted material is wasted money!"

*Wayne Johnson, Controller, Wyard  
Industries, Cambridge, Minnesota*

Ohio Scientific hard disk based microcomputers start at less than \$10,000. And are sold by more than 400 dealers nationwide. For the one nearest you, call 1-800-321-6850, TOLL FREE.

*terrific!*

Circle 273 on inquiry card.

**OHIO SCIENTIFIC**

a **MACOM** Company

1333 SOUTH CHILLICOTHE ROAD  
AURORA, OH 44202 • [216] 831-5600