

# BYTE

the small systems

SEPTEMBER 1981 Vol. 6, No. 9

\$2.50 in USA/\$2.95 in Canada

A McGraw-Hill Publication

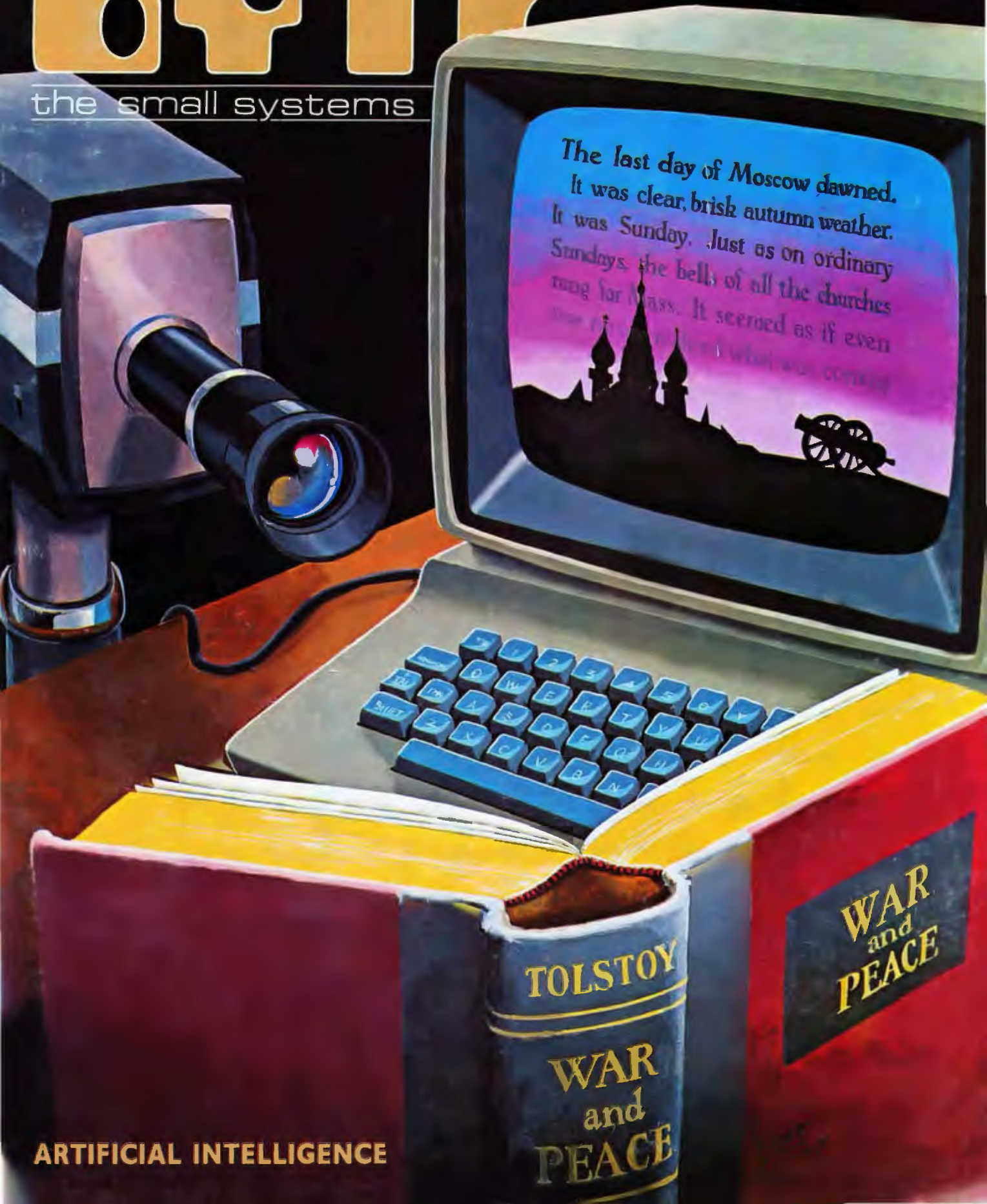

The last day of Moscow dawned.  
It was clear, brisk autumn weather.  
It was Sunday. Just as on ordinary  
Sundays, the bells of all the churches  
rang for Mass. It seemed as if even  
the cannons were silent and what was coming

ARTIFICIAL INTELLIGENCE

TOLSTOY

WAR  
and  
PEACE

WAR  
and  
PEACE



**SOUTHWEST TECHNICAL PRODUCTS CORPORATION**  
219 W. RHAPSODY  
SAN ANTONIO, TEXAS 78216 (512) 344-0241

Circle 334 on inquiry card.

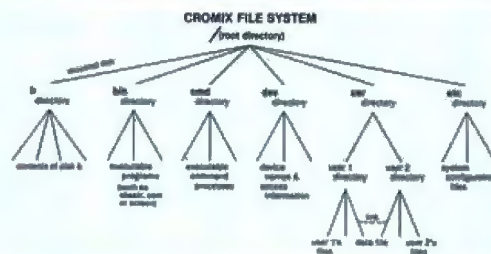

## CROMIX\* — Cromemco's outstanding UNIX†-like operating system

CROMIX is just the kind of major development you've come to expect from Cromemco. After all, we're already well-known for the most respected software in the microcomputer field.

And now we've come up with the industry's first UNIX-lookalike for microcomputers. It's a tried and proven operating system. It's available on both 5" and 8" diskettes for Cromemco systems with 128K or more of memory.

Here are just some of the features you get in this powerful Cromemco system:

- Multi-user and multi-tasking capability
- Hierarchical directories
- Completely compatible file, device, and interprocess I/O
- Extensive subsystem support

### FILE SYSTEM

One of the important features of our CROMIX is its file system comprised of hierarchical directories. It's a tree structure of three types of files: data files,

directories, and device files. File, device, and interprocess I/O are compatible among these file types (input and output may be redirected interchangeably from and to any source or destination).

The tree structure allows different directories to be maintained for different users or functions with no chance of conflict.

### PROTECTED FILES

Because of the hierarchical structure of the file system, CROMIX maintains separate ownership of every file and directory. All files can thus be protected from access by other users of the system. In fact, each file is protected by **four separate access privileges** in each of the three user categories.

### TREMENDOUS ADDRESS SPACE, FAST ACCESS

The flexible file system and generalized disk structure of CROMIX give a disk address space in excess of one gigabyte per volume — file size is limited only by available disk capacity.

Speed of access to disk files has also been optimized. Average access speeds far surpass any yet implemented on microcomputers.

### 'C' COMPILER AVAILABLE, TOO

Cromemco offers a wide range of languages that operate under CROMIX. These include a high-level command process language and extensive subsystem support such as COBOL, FORTRAN IV, RATFOR, LISP, and 32K and 16K BASICS.

There is even our highly-acclaimed 'C' compiler which allows a programmer fingertip access to CROMIX system calls.

### THE STANDARD O-S FOR THE FUTURE

The power and breadth of its features make CROMIX the standard for the next generation of microcomputer operating systems.

And yet it is available for a surprisingly low \$595.

The thing to do is to get all this capability working for you now. Get in touch with your Cromemco rep today.

\*CROMIX is a trademark of Cromemco, Inc.  
†UNIX is a trademark of Bell Telephone Laboratories



**Cromemco**™

incorporated

280 BERNARDO AVE., MOUNTAIN VIEW, CA 94040 • (415) 964-7400

Tomorrow's computers today

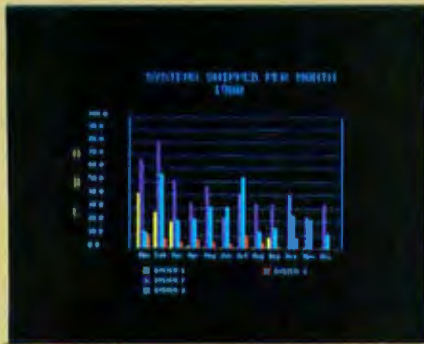

Management Information Display

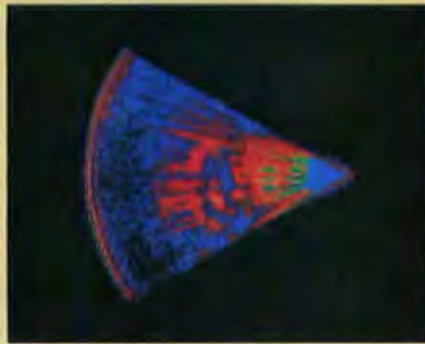

Ultrasonic heart sector scan

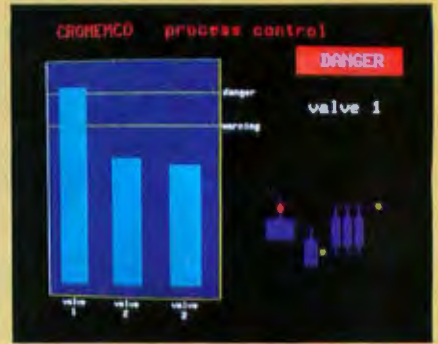

Process Control

## Get the professional color display that has BASIC/FORTRAN simplicity

### LOW-PRICED, TOO

Here's a color display that has everything: professional-level resolution, enormous color range, easy software, NTSC conformance, and low price.

Basically, this new Cromemco Model SDI\* is a two-board interface that plugs into any Cromemco computer.

The SDI then maps computer display memory content onto a convenient color monitor to give high-quality, high-resolution displays (756 H x 482 V pixels).

When we say the SDI results in a high-quality professional display, we mean you can't get higher resolution than this system offers in an NTSC-conforming display.

The resolution surpasses that of a color TV picture.

### BASIC/FORTRAN programming

Besides its high resolution and low price, the new SDI lets you control with optional Cromemco software packages that use simple BASIC- and FORTRAN-like commands.

Pick any of 16 colors (from a 4096-color palette) with instructions like DEFCLR (c, R, G, B). Or obtain a circle of specified size, location, and color with XCIRC (x, y, r, c).

\*U.S. Pat. No. 4121283

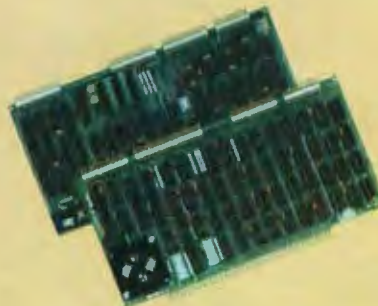

Model SDI High-Resolution Color Graphics Interface

### HIGH RESOLUTION

The SDI's high resolution gives a professional-quality display that strictly meets NTSC requirements. You get 756 pixels on every visible line of the NTSC standard display of 482 image lines. Vertical line spacing is 1 pixel.

To achieve the high-quality display, a separate output signal is produced for each of the three component colors (red, green, blue). This yields a sharper image than is possible using an NTSC-composite video signal and color TV set. Full image quality is readily realized with our high-quality RGB Monitor or any conventional red/green/blue monitor common in TV work.



Model SDI plugs into Z-2H 11-megabyte hard disk computer or any Cromemco computer

### DISPLAY MEMORY

Along with the SDI we also offer an optional fast and novel two-port memory that gives independent high-speed access to the computer memory. The two-port memory stores one full display, permitting fast computer operation even during display.

### CONTACT YOUR REP NOW

The Model SDI has been used in scientific work, engineering, business, TV, color graphics, and other areas. It's a good example of how Cromemco keeps computers in the field up to date, since it turns any Cromemco computer into an up-to-date color display computer.

The SDI has still more features that you should be informed about. So contact your Cromemco representative now and see all that the SDI will do for you.



**Cromemco**  
I n c o r p o r a t e d

280 BERNARDO AVE., MOUNTAIN VIEW, CA 94040 • (415) 984-7400  
Tomorrow's computers today

## Features

- 27 A Look at NCC '81** by Steven K Roberts / A photo essay on the National Computer Conference held last May in Chicago.
- 38 Build an Unlimited-Vocabulary Speech Synthesizer** by Steve Ciarcia / An easy-to-use speech synthesizer can be designed using the Votrax SC-01 Speech Synthesizer Chip.
- 58 The Xerox Alto Computer** by Thomas A Wadlow / Some attributes of this research tool will be used in the next generation of personal computers.
- 72 Tree Searching, Part 1: Basic Techniques** by Gregg Williams / A BASIC program allows your computer to solve a sliding-blocks puzzle.
- 112 One Step Forward—Three Steps Backward, Computing in the US Space Program** by Patrick Stakem / The stringent demands of space exploration are met by several 8- and 16-bit microprocessors.
- 164 Artificial Intelligence** by Steven K Roberts / Intelligent computers could ease the task of dealing with vast amounts of information, if certain problems can be solved.
- 180 A High-Level Language Benchmark** by Jim Gilbreath / Speed benchmarks for more than fifty implementations of high-level languages.
- 200 Science Fiction's Intelligent Computers** by Donald Byrd / Current knowledge of artificial intelligence puts science fiction to the test.
- 216 Symbolic Differentiation à la LISP** by Ronald L Nicol / The list-manipulation abilities of LISP are easily adapted to differentiating mathematical functions.
- 238 Knowledge-Based Expert Systems Come of Age** by Richard O Duda and John G Gaschnig / If an expert can do a specialized, self-contained task, so can a program.
- 284 The Atari Tutorial, Part 1: The Display List** by Chris Crawford / The display list allows you to mix both text and graphics on the same video-display screen.
- 304 Natural-Language Processing, The Field in Perspective** by Gary Hendrix and Earl

Sacerdoti / Systems that interact in English must have some understanding of human psychology and the world outside the computer.

**414 The Emperor's Old Clothes** by Charles Antony Richard Hoare / Mr Hoare, winner of the 1980 ACM Turing Award, reflects on his career and speculates on the future.

## Reviews

- 52 The Big Board: A Z80 System in Kit Form** by David Thompson
- 146 Misosys Software's DISKMOD: Put Radio Shack's Editor/Assembler on Disk** by Steve Hughes
- 150 MINCE, A Text Editor** by Christopher O Kern
- 384 BYTE's Arcade: Big Five Software** by Gregg Williams; *The Prisoner* by Bob Liddil
- 388 Three Microcomputer LISPs** by Steven P Levitan and Jeffrey G Bonar
- 436 Interactive Fiction: Six Micro Stories** by Bob Liddil

## Nucleus

- 6** Editorial: Odds and Beginnings
- 10** Letters
- 34, 108** Book Reviews: Principles of Artificial Intelligence; Turtle Geometry
- 110, 383, 412** BYTE's Bugs
- 162** Programming Quickies: Changing a BASIC FOR . . . NEXT Loop into a REPEAT . . . UNTIL Loop
- 354** BYTELINES
- 360** Ask BYTE
- 364** Books Received
- 366** Clubs and Newsletters
- 372** Event Queue
- 383** Software Received
- 412, 425** BYTE's Bits
- 426, 428, 435** Technical Forum: Microcomputers and the IRS; Add Dual Trace and Delayed Sweep to Your Oscilloscope; How to Build an Inexpensive Cassette Level Indicator
- 432** System Notes: An Almost Optimum Z80 Memory Test Program
- 441** What's New?
- 494** Unclassified Ads
- 495** Reader Service
- 496** BOMB, BOMB Results

## BYTE



Page 38

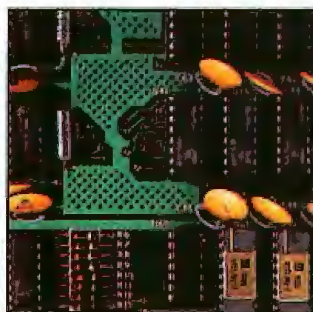

Page 52



Page 58



Page 112



**Editor in Chief**  
**Christopher Morgan**

**Managing Editor**  
Mark Haas

**Technical Editors**  
Gregg Williams, Senior Editor;  
Richard S Shuford; Curtis P Feigel;  
George Stewart; Arthur Little;  
Charles Freiberg, New Products Editor;  
Steve Ciarcia, Mark Dahmke,  
Consulting Editors;  
Jon Swanson, Draftsman

**Copy Editors**  
Bertry Cronin, Chief; Faith Hanson;  
Warren Williamson; Anthony J Lockwood;  
Ann Graves; Jane Harrigan

**Assistants**  
Faith Ferry; Debe Wheeler;  
Karen A Cilley; Susan Ferber

**Production**  
Nancy Estle, Director; Christine Destrempe,  
Asst Director; Wai Chiu Li;  
Jonathan M Graves; Patrice Scribner;  
Karen Labaugh; Damian Henriques;  
Sherry McCarthy, Chief Typographer;  
Debi Fredericks; Donna Sweeney;  
Valerie Horn

**Advertising**  
Thomas Harvey, Director; Marion Gagnon;  
Rob Hannings; Marilyn Williams;  
Deborah Porter; Vicki Reynolds;  
Jacqueline Earnshaw,  
Reader Service Coordinator

**Circulation**  
Gregory Spitzfaden, Manager;  
Andrew Jackson, Asst Manager;  
Agnes E Perry; Barbara Varnum;  
Louise Menegus; Pinky Krulis;  
James Bingham, Dealer Sales;  
Carol Baniecki, Asst.

**Controller's Office**  
Daniel Rodrigues, Controller;  
Mary E Fluhr, Acct. & D/P Mgr; Karen Burgess;  
Jeanne Cilley; Mary Beth Ireland; Linda Fluhr

**Traffic**  
N Scott Gagnon; Michael Bacon;  
Cynthia Damato

**Receptionist**  
Joanne Colburn

**Publishers**  
Virginia Londoner; Gordon R Williamson;  
John E Hayes, Associate Publisher;  
Cheryl A Hurd, Publisher's Assistant;

Officers of McGraw-Hill Publications Company: Paul F McPherson, President; Executive Vice Presidents: James E Boddorf, Gene W Simpson; Group Vice President: Daniel A McMillan; Senior Vice President-Editorial: Ralph R Schulz; Vice Presidents: Kemp Anderson, Business Systems Development; Robert B Doll, Circulation; James E Hackett, Controller; Eric B Herr, Planning and Development; H John Sweger, Marketing.

Officers of the Corporation: Harold W McGraw Jr, President, Chief Executive Officer and Chairman of the Board; Robert F Landes, Senior Vice President and Secretary; Ralph J Webb, Treasurer.



## In This Issue

Computerized natural-language processing is one of the many topics that have come to be associated with artificial intelligence. As Robert Tinney's cover suggests, computers someday may be able to read and understand **War and Peace**. Steven Roberts' article "Artificial Intelligence" is a good place to start, and "Natural-Language Processing, The Field in Perspective," by Gary Hendrix and Earl Sacerdoti, addresses this month's theme. Donald Byrd discusses the point at which fact meets fiction in "Science Fiction's Intelligent Computers," and Ronald L Nicol focuses on the artificial intelligence community's primary language in "Symbolic Differentiation a la LISP."

Steve Ciarcia has prepared an alternate way of eliciting speech from a computer with "Build an Unlimited-Vocabulary Speech Synthesizer." We also have a description of the Xerox Alto computer by Thomas A Wadiow, and we take a look at NASA's high-flying computing machinery in Patrick Stakem's "One Step Forward—Three Steps Backup."

BYTE is published monthly by BYTE Publications Inc, 70 Main St, Peterborough NH 03458, phone (603) 924-9281, a wholly-owned subsidiary of McGraw-Hill, Inc. Address subscriptions, change of address, USPS Form 3579, and fulfillment questions to BYTE Subscriptions, POB 590, Martinsville NJ 08836. Controlled circulation postage paid at Waseca, Minnesota 56093 - USPS Publication No. 528890 (ISSN 0360-5280). Canadian second class registration number 9321. Subscriptions are \$19 for one year, \$34 for two years, and \$49 for three years in the USA and its possessions. In Canada and Mexico, \$21 for one year, \$38 for two years, \$55 for three years. \$43 for one year air delivery to Europe. \$35 surface delivery elsewhere. Air delivery to selected areas at additional rates upon request. Single copy price is \$2.50 in the USA and its possessions, \$2.95 in Canada and Mexico, \$4.00 in Europe, and \$4.50 elsewhere. Foreign subscriptions and sales should be remitted in United States funds drawn on a US bank. Printed in United States of America.

Address all editorial correspondence to the editor at BYTE, POB 372, Hancock NH 03449. Unacceptable manuscripts will be returned if accompanied by sufficient first class postage. Not responsible for lost manuscripts or photos. Opinions expressed by the authors are not necessarily those of BYTE. Entire contents copyright © 1981 by BYTE Publications Inc. All rights reserved. Where necessary, permission is granted by the copyright owner for libraries and others registered with the Copyright Clearance Center (CCC) to photocopy any article herein for the base fee of \$1.00 per copy of the article or item plus 25 cents per page. Payment should be sent directly to the CCC, 21 Congress St, Salem MA 01970. Copying done for other than personal or internal reference use without the permission of McGraw-Hill is prohibited. Requests for special permission or bulk orders should be addressed to the publisher.

BYTE® is available in microform from University Microfilms International, 300 N Zeeb Rd, Dept PR, Ann Arbor MI 48106 USA or 18 Bedford Row, Dept PR, London WC1R 4EJ England.



**Subscription WATS Line: (800) 258-5485**

Office hours: Mon-Thur 8:30 AM - 4:30 PM, Friday 8:30 AM - Noon, Eastern Time

### NATIONAL ADVERTISING SALES REPRESENTATIVES:

**NORTHEAST (617) 444-3946**  
Hajar Associates  
280 Hillside Ave  
Needham Heights MA 02194

**MIDWEST (312) 966-0160**  
Hajar Associates  
5225 Old Orchard Dr  
Skokie IL 60076

**MID ATLANTIC (212) 682-5844**  
Hajar Associates  
521 Fifth Ave  
New York NY 10017

**NORTHWEST (415) 964-0706**  
Hajar Associates  
1000 Elwell Ct, Suite 227  
Palo Alto CA 94303

**SOUTHWEST (714) 540-3554**  
Hajar Associates  
3303 Harbor Blvd  
Suite K-4  
Costa Mesa CA 92626

**SOUTHEAST (305) 886-7210**  
Hajar Associates  
1220 Prairie Lane  
Apopka FL 32703

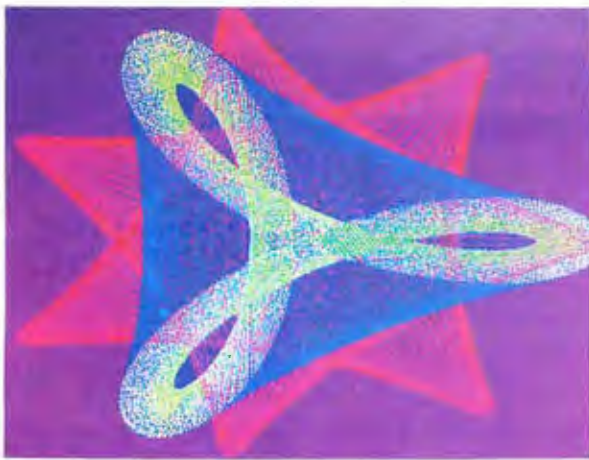

"...stands well above other S-100 graphics displays in its price and performance range."

BYTE, Product Review

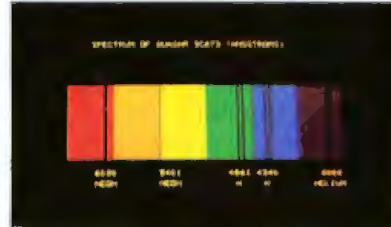

"...better monochromatic display..."

ELECTRONIC DESIGN,  
1981 Technology Forecast

# MICROANGELO

HIGH RESOLUTION GRAPHICS SINGLE BOARD COMPUTER  
512 x 480 resolution black and white and vivid color displays

RS-170 composite or direct drive output

Local or external sync generation

4 Mhz Z80 microprocessor

60 hertz real-time clock

8 level interrupt tie-in

IEEE S100 bus compatible

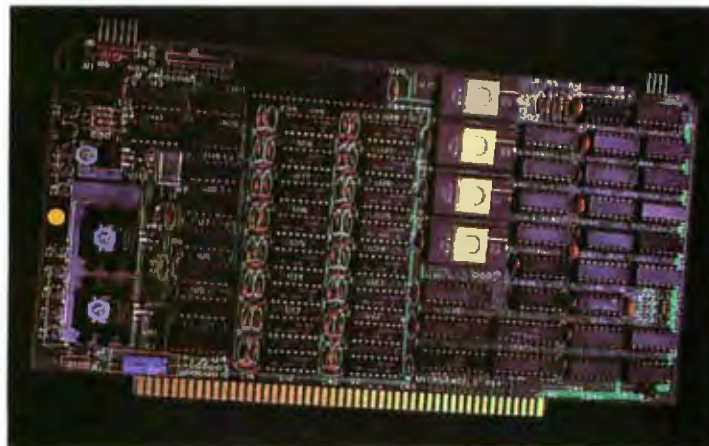

Light pen interface

Time multiplexed refresh

4K resident Screenware™ Pak I operating system

32K RAM isolated from host address space

High speed communications over parallel bus ports

## Screenware™ Pak I

A 4K byte operating system resident in PROM on MicroAngelo™. Pak I emulates an 85 character by 40 line graphics terminal and provides over 40 graphics commands. Provisions exist for user defined character sets and directly callable user extensions to Screenware™ Pak I.

## Screenware™ Pak II

An optional software superset of Pak I which adds circle generation, polygon flood, programmable split screen for separate graphics and terminal I/O, relative coordinates, faster vector and character plotting, a macro facility, full UCSD Pascal compatibility, and more.

## And now... COLOR!!

The new MicroAngelo™ Palette board treats from 2 to 8 MicroAngelos as "bit planes" at a full 512 x 480 resolution. Up to 256 colors may be chosen from 16.8 million through the programmable color lookup table. Overlays, bit plane precedence, fade-in, fade-out, gray levels, blinking bit plane, and a highly visual color editor are standard.

# SCION

8455-D Tyco Road • Vienna, Virginia 22180 • TWX: 710-831-9087 • (703) 827-0888

Circle 321 on Inquiry card.

# MAINTAIN PROJECT CONTROL WITH MILESTONE™



**Put your microcomputer  
to work...**

As a project manager, you know the value of careful planning. An oversight here, a miscalculation there, and in no time, you could be in a lot of trouble.

Now, thanks to MILESTONE™, it's easy to obtain and keep complete project control.

MILESTONE is an easy to use computer program that puts your desk top microcomputer to work using the same proven "critical path" techniques previously available only on big, expensive computers. Now, regardless of your type of project, you can plan and control manpower, dollars, and time.

Available in most microcomputer formats: CP/M,\* CP/M-86,\* Apple PASCAL, UCSD PASCAL. Call or write:

SOFTWARE  
SOFTWARE  
DIGITAL MARKETING  
DIGITAL MARKETING

2670 CHERRY LANE  
WALNUT CREEK • CA 94596  
(415) 938-2880

\*CP/M and CP/M-86 are trademarks of Digital Research

\*MILESTONE is a trademark of Organic Software

## Editorial

# Odds and Beginnings

by Chris Morgan, Editor in Chief

As I sat down to write this month's editorial, I realized I was going to have a hard time sticking to one topic. So much has been going on lately, I thought I'd throw it all into one convenient column. The title "Odds and Beginnings," which I stole from James Thurber, reflects this potpourri.

### Artificial Intelligence

I'm particularly pleased that we were able to fit so many interesting articles about artificial intelligence into this month's issue. Many of them were commissioned at last year's AAI (American Association for Artificial Intelligence) meeting at Stanford. In particular, the articles "Natural Language Processing: The Field in Perspective" (page 304) and "Knowledge-Based Expert Systems Come of Age" (page 238) discuss topics that, in my opinion, have not received the coverage they deserve. A personal computer's ability to understand at least rudimentary English will be important to the future of programming. Similarly, a computer that can give advice and act as an "expert" on a given topic raises some profound and difficult questions. Some of these issues have been dealt with in science fiction, and Donald Byrd explores them in "Science-Fiction's Intelligent Computers" (page 200).

### Computer Shows

I've been on the road quite a bit this spring and summer attending computer shows. As always, the West Coast Computer Faire in San Francisco was of great interest. Anyone doubting the vitality of our field need only walk into this show to be struck by the level of enthusiasm. If you want to track the progress of personal computing, go to the West Coast Computer Faire and watch the number of exhibitors expand and the wide-eyed visitors become more wide-eyed each year.

The NCC (National Computer Conference) was held in Chicago this year, and it was easily the most spectacular show yet. (See the two-page photo essay beginning on page 36.) The "star" of the show, attracting a constant enthusiastic crowd, was the Xerox Star terminal, which single-handedly advances the state of the art in terminal design for the office. Many of the system's features recall those of the Smalltalk systems (see last month's BYTE, devoted to the Smalltalk-80 system) I saw at Xerox PARC (the Palo Alto Research Center). The Star system, which will cost \$16,595 for the standard unit, treats all documents, files, etc as concrete "objects" that can be manipulated by the user. Its software structure resembles a nest of boxes, each box containing more and more complex information about the workings of the system. Users need penetrate only to the box they require to do a particular job, thus avoiding information overload.

Clever user-interfacing devices abound on the Xerox Star, including a "mouse," a mechanical box with wheels that can be rolled around on the desktop to position the cursor on the screen. I could go on at length about the features of the machine, but I must move on. An excellent treatment of the Star can be found in the April 27, 1981, issue of the Seybold Report, a twice-monthly report that consistently offers the field's best coverage of word processing, computerized typesetting, and office automation. The report costs

*Editorial continued on page 10*





Introducing the **Z** Line...

## Now! Percom Drives for Heath Computers.

Percom's now making add-on drives for your H-89 and H-8.

Complete drive systems will be available soon. If your immediate need is for add-on storage, check the features of our fully compatible Z drives. If you plan to add a complete disk system, watch for the imminent announcement of our double-density Z Controller.

Given a choice, we think you'll choose from the Percom Z line.

### Add-On Z Drives

- Available in 40- and 80-track densities, in 1- and 2-drive color-compatible modules.
- All drives are rated for single- and double-density operation.
- Some models accommodate **flippy storage**, allowing you to flip a diskette and store files on the second side.
- Fully tested both electrically and mechanically. Plus, all Z drives receive a 48-hour **operating burn-in** to uncover latent defects. Look for the signed quality assurance slip.



PERCOM DATA COMPANY, INC.  
211 N. KIRBY GARLAND, TEXAS 75042  
(214) 272-3421

Toll-Free Order Number: **1-800-527-1592**

- Low prices: Fully assembled and tested, one-drive units start at only \$399, two-drive units from only \$795.

### Z DRIVES FROM PERCOM: THE BEST ONES FOR YOUR ALL-IN-ONE

Model	Number Tracks one side	Formatted Strg. Cap.		Features
		SD	DD	
ZFD-40™	40	102K	180K	Low price, fast step time Max. stg., fast step time Flip-side diskette storage
ZFD-80™	80	205K	364K	
ZFD-100™	40	102K	180K	

**SYSTEM REQUIREMENTS:** H-89 or H-8 computer with 16 Kbytes of RAM, Heath first-drive floppy disk system, Heath disk-operating system and drives interconnecting cable. (Two-drive interconnecting cable optionally available from Percom). ZFD-80 drives include a program patch on diskette to modify HDOS for 80-track operation.

PRICES AND SPECIFICATIONS SUBJECT TO CHANGE WITHOUT NOTICE.

### Available Soon! Percom's Low-Cost Double-Density Z Controller.

Yes... I'd like to know more about Percom Z drives and the Z Controller. Rush me free literature.

Send to  
**PERCOM DATA COMPANY, Inc., Dept. 26**  
211 N. Kirby St. Garland TX 75042

name \_\_\_\_\_

street \_\_\_\_\_

city \_\_\_\_\_ state \_\_\_\_\_

zip \_\_\_\_\_ phone number \_\_\_\_\_

**MAIL TODAY!** B01



FOR ANY  $\epsilon$   
THERE IS A  $\delta^*$

WHY LET ONE MAINFRAME DEFINE

OUR WELL-DIFFERENTIATED  
ARE CALCULATED  
SYSTEMS INTEGRATION

#### A simple algorithm

We work with the serious systems integrator ... on terms that make sense to you. That means giving you a set of products which expand your limits, not reduce them.

We manufacture the most complete family of high quality IEEE/696 S-100 mainframes on the market. Choices include three mainframes in rack-mount or table-top packages with complete board sets, to serve as the building blocks for your 8 or 16 bit system. We also provide other options ranging from complete floppy disk systems right up to our proven Pascal development system.

#### The $\int$ factor: one source.

No matter which option you choose, you get the benefit of working with completely integrated products ... fully assembled and tested ... under one warranty and one price structure ... leaving you free to concentrate on value-added application development and sales.

#### Choose from mainframe options ...

Select from three packaging options: Rack-mount, table-top or front panel models. All three feature our 20 slot S-100 motherboard with 25 amp power supply and are delivered fully assembled and tested with our Series II™ board sets. Any board configuration you choose works with any DPS-1 version, allowing you to vary your package offering, or develop on one version and market another.

- ◆ Front Panel model — a powerful development and diagnostic tool for Z-80<sup>†</sup> systems, which can be used for prototyping, servicing, debugging, and software or hardware development. Use its features to set breakpoints, trigger scopes, single step, slow step and more.
- ◆ Front Panelless desk top model—a lower cost option for OEM or other turnkey operations which do not require the extra capability of our Front Panel.
- ◆ Rack Mount version—features a heavy gauge frame designed to fit into standard 19" racks. CVT power supply for brown out immunity is standard.

<sup>\*</sup>In Calculus, a fundamental statement in the definition of limit; interpreted here to imply: "For your integration problem, Intersystems has a solution."

<sup>†</sup>Registered trademark of Zilog, Inc.

YOUR LIMITS?

OPTIONS  
TO SOLVE YOUR  
PROBLEMS.

- ◆ 6 SI/O — six individually software-controllable serial I/O ports with optional interrupts. Each can run RS 232 at up to 19,200 BAUD, as can our VI/O board.
- ◆ VI/O—has two serial ports; two 8-bit parallel output and two 8-bit parallel input ports plus 8 individually controllable command lines and 16 levels of vectored interrupts.
- ◆ FDC II—can DMA up to a full track into 16 Megabytes of memory. Optionally generates interrupts and handles up to four 8" floppies.
- ◆ MPU-8000 — available with the non-segmented Z-8002<sup>†</sup>, which directly addresses 64K, or the segmented Z-8001<sup>†</sup>, which can directly address 8 Megabytes.

#### Extended systems options ...

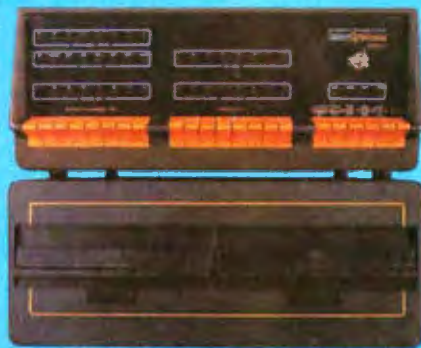

Interfacing disk drives is not a trivial matter, so when your objectives and resources dictate you spend your energy elsewhere, use our resources to perform the service for you. We can add our disk drive package to any Z-80 or Z-8000 configuration we provide ... again, fully assembled and tested and covered under one warranty.

#### Or our complete Pascal Development System.

We use it for our own hardware and software development. It includes either table-top mainframe, two 8" floppy disks, 128K RAM, CP/M<sup>®</sup>, and Intersystems Pascal/Z<sup>™</sup> compiler and Cache BIOS<sup>™</sup>. THIS SYSTEM IS FAST! Why? Because our ultra-fast Cache BIOS automatically buffers whole tracks, eliminating most disk accesses. This delivers up to three times the throughput of any other floppy-based system we know and is equal to many small hard disk systems.

The system is versatile, too. SET program allows you to change many BIOS parameters and specify control characters to enable special features such as diagnostic output to trace program execution. It can also provide remote I/O to link your system to almost any other computer, large or small.



And it's reliable. The Cache BIOS System runs continuous memory tests when idle, and verifies with a Read after Write and Read after Read.

And the system also includes our Pascal/Z, a true native compiler producing ROMable and Re-entrant code. It features a minimum of extensions chosen for the development of your scientific and business applications. And it's compatible with our native code Pascal for Z-8000, providing a graceful upward path to 16 bit applications. So what you write now is right later.

#### One choice you won't have to make...

We don't believe you should ever have to sacrifice good technical support to find a good product. We'll back you to the hilt with services like free technical consultation, board-swapping, diagnostic packages, and documentation that gives you all you need to integrate, operate and maintain your system ... right down to schematics of the boards.

#### Your solution should be clear.

Whether you're integrating for scientific, governmental or commercial applications, Intersystems can provide a Delta for your Epsilon.

#### Talk to us today.

Ithaca Intersystems Inc.,  
Dept. B  
1650 Hanshaw Road,  
P.O. Box 91  
Ithaca, NY 14850

Phone  
(607) 257-0190



#### Board level options ...

Intersystems mainframe packages, equipped with Series II boards, are operational in both 8 and 16 bit settings and support extended addressing in both I/O and memory space, recognizing 16 bit I/O addresses and 24 bit memory addresses. Just look at these individual features:

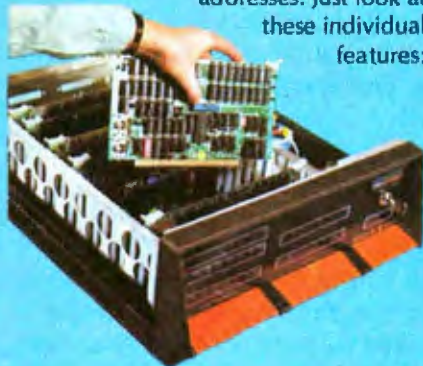

- ◆ MPU-80—uses a Z-80, 8 vectored interrupt lines and two 4K windows to address up to 1 Megabyte of RAM without bank select.
- ◆ 64KDR—sophisticated refresh circuitry allows unlimited DMA and absolutely reliable operation without wait states.

**Intersystems<sup>™</sup>**  
Ithaca Intersystems Inc.

**Micros for bigger ideas.**

Circle 177 on inquiry card.

\$175 a year, and subscriptions are available by writing Box 644, Media, Pennsylvania 19063.

In contrast to the Star, the recently unveiled Xerox 820 personal computer (see page 441) is disappointing. It's a competently designed machine but very "plain vanilla," sporting a Z80 processor, CP/M, two 5¼-inch floppy disk drives (which give the user a paltry 92 K bytes of unformatted storage per floppy disk), and no high-resolution graphics. What the 820 *does* do, however, is give Xerox a foot in the door of the under-\$3000 market. And one cannot deny the importance of the 820's ability to interface with the Ethernet system, Xerox's information network that will most likely become the standard for high-end local networks. We'll have more information about the 820 in upcoming issues.

Japanese Market

Senior Editor Gregg Williams and I recently spent ten days in Japan attending the Tokyo Microcomputer Show and visiting more than ten companies that produce, or are about to produce, personal computers. The level of interest in the microcomputer in Japan is astounding, and the trip was a revelation. We will be reviewing many new Japanese machines and analyzing their effects on the American marketplace in a special issue of BYTE to appear early in 1982. Watch for it. In addition, we will

present a roundup of new American hardware in the January 1982 issue.

The question of the hour seems to be "Are the Japanese going to dominate the American personal computer market?" My immediate answer is "No." It takes time to develop distribution networks and become established in this highly technical market—it's not the same as the automobile market. But if ever I had any doubts that the Japanese had entered our field in earnest, the doubts were dispelled during the trip. Yes, the Japanese face many obstacles. In order to create word-processing software, they need more familiarity with our typewriter-dominated office systems and more sensitivity to the need for good software and good documentation. I have no doubt that the Japanese will surmount these obstacles, and in fact they are quietly doing just that. According to an old Japanese saying, "It is the wise hawk that hides its talons." The talons are now hidden, but they will come out in time.

Coming Up

The coming year is going to be exciting at BYTE. We're expanding our staff to be more responsive to our readers. I'm pleased to say that BYTE's circulation has topped the 200,000 mark and continues to climb rapidly. We appreciate your feedback, especially in the form of BOMB votes for your favorite articles. (See the reader service card at the back of the magazine for an explanation of BYTE's BOMB.)

One of our major projects this year has been transforming *onComputing* magazine into *Popular Computing*, a new monthly magazine that will appear this November. It's designed for the nonspecialist and will cover the entire spectrum of popular computing for the benefit of professionals, business people, educators, and interested laypeople. We're particularly proud of the new *Popular Computing* staff stationed around the country to keep readers up to date.

What's in store for the coming year? We'll have coverage of the new personal computers from the big mainframe companies, plus special issues about human engineering, interactive videodisks, computers in business, local networks (next month), computers in the humanities, games, computers for the disabled, and much more, including our extensive review section for hardware and software.

Incidentally, I took a look at the new computer science books that have come in for review. They make a stultifyingly large pile, and the stack of new software isn't much smaller. But we're working to keep ahead of the game.

Another perennial interest at BYTE is computer graphics. By the time you read this, I will have attended the ACM's SIGGRAPH conference in Dallas. Watch for a full report featuring some of the most exciting graphics we've ever seen. ■

*And You Thought You Didn't Have A Choice*

Now you can have another one of those little extras that makes you feel good about your computer...

...a complete packet of the most attractive stock forms on the market. From the people whose only business is the small computer user.

CALL NOW TOLL FREE  
For free packets for the following systems:

- Systems Plus • TCS • Structured Systems Group
- Vector • Peachtree • Radio Shack • Osborne
- Alpha Micro • Durango • Wares • Cado
- VECTOR • BPI • Honey • Haccro
- SHASTA • IBM • & MANY MORE •

NATIONWIDE 800-554-2750 **Checks To-Go** IN CALIFORNIA 800-552-8817

*The Alternative You Deserve*



# Apple\* I/O Interfaces. SSM Spells Success Three Ways.

SSM helps you get the most from your Apple II\* computer. Choose from three general purpose interface boards. With flexibility and prices that translate to big savings. Now, and when you upgrade.

**Serial (ASIO™).** Our ASIO gives you a full-duplex RS-232 interface. Plus jumper-selectable rates from 110 to 9600 baud. You also get software control, three handshaking lines and two output plugs—so you can connect your Apple to a modem or to a terminal/printer without modifying the cable.

**Parallel (APIO™).** For parallel interfaces, our APIO offers two 8-bit bidirectional ports. We also include additional interrupt and handshaking lines, plus software control of the interface configuration and data direction. Cables for Centronics and other printers are optional.

**Or Both (AIO™).** Choose our tried and proven AIO when you

need a sometimes-serial or a sometimes-parallel operation. This single-board solution packs a lot of performance for the price. Thousands are now being used. It even lets you operate both ways—simultaneously—under Pascal, or with special drivers.

All three boards feature powerful firmware so you don't have to write software to use them. The ASIO and AIO include cables.

Whether you're an OEM or end-user, we can supply virtually any quantity you need.

Quickly. Even in kit form. For the latest word on these, see your local computer dealer. Or call us today. You may also want to look into our cost-effective A488™ board which converts your Apple II into an IEEE-488 controller.



**SSM Microcomputer  
Products, Inc.**

*SSM Microcomputer Products, Inc.,  
2190 Paragon Drive, San Jose, CA  
95131. (408) 946-7400. (TWX  
910-338-2077. Telex 171171.)*

\*Apple and Apple II are trademarks of Apple Computers Inc. ASIO, APIO, AJO and A488 are trademarks of SSM Microcomputer Products, Inc.

## Reddy Chirra improves his vision with an Apple.

Reddy is an optical engineer who's used to working for big companies and using big mainframes.

But when he started his own consulting business, he soon learned how costly mainframe time can be. So he bought himself a 48K Apple II Personal Computer.

And, like thousands of other engineers and scientists, quickly learned the pleasures of



cutting down on shared time  
own tamper-proof data base.

His Apple can handle  
formulas with up to 80 vari-  
ables and test parameters on  
250 different optical glasses.



He can even use BASIC, FORTRAN,  
Pascal and Assembly languages.

And Apple's HI-RES graphics come in  
handy for design.

Reddy looked at other microcomputers, but  
chose Apple for its in-depth documentation,  
reliability and expandability.

You can get up to 64K RAM in an Apple II.  
Up to 128K RAM in our new Apple III. And  
there's a whole family of compatible peripherals,  
including an IEEE-488 bus for laboratory  
instrument control.

Visit your authorized Apple dealer to find  
out how far an Apple can go with scientific/  
technical applications.

It'll change the way you see things.

The personal computer.  **apple**

# SOFTWARE DEVELOPMENT TOOLS FOR INDUSTRY

## CP/M CROSS-ASSEMBLERS

Fast, comprehensive cross-assemblers to run under CP/M.\* Extensive pseudops include full listing control, nested conditionals, mnemonic synonyms, and inclusion of external source files. Generate object file, assembly listing, and symbol table from source code for nine popular microprocessor families.

XASM05 ..... 6805  
XASM09 ..... 6809  
XASM18 ..... 1802  
XASM48 ..... 8048  
XASM51 ..... 8051  
XASM65 ..... 6502  
XASM68 ..... 6800/6801  
XASMF8 ..... F8/3870  
XASM400 ..... COPS400

Assemblers .... \$200.00 each  
Manual only .... \$25.00

## 8048 DEVELOPMENT PACKAGE

Now you can use the 8048 family of single-chip microcomputers without buying expensive equipment. Develop 8048 software with the XASM48 cross-assembler. Then plug our EPR-48 board into your S-100 system to program the 8748 EPROM version. (Similar packages for 8051 and TMS9940E coming soon.)

8048 Development Package ... \$574.00  
EPR-48 alone ..... \$449.00

## PROM EMULATOR BOARD

Debug dedicated systems quickly. Our PSB-100 PROM Emulator is an S-100 board with up to 8K of RAM. Cable with 24-pin plug replaces PROM(s) in your target system for instant program testing.

PSB-100 PROM Emulator .. \$445.00 w/  
2K RAM



**avocet  
systems  
inc.**

\*Trademark of Digital Research

804 south state st.  
dover, delaware/19901/302-734-0151

Visa and Mastercharge accepted. We ship on 8" single-density. Ask us about other formats.  
OEM AND DEALER INQUIRIES INVITED.

## Letters

### MIT Defends Logo Policy

This is in response to Mr Stephen Hain's letter, which appeared in the August 1981 BYTE and which raised questions about the release and distribution of the MIT Apple Logo programming language. (See "Unpublished Apple Logo," page 32.)

As correctly noted in the original BYTE article ("Logo for Personal Computers," by Harold Nelson, June 1981 BYTE, page 36), the development of the MIT Apple Logo programming language was sponsored in part by the National Science Foundation (NSF). Discussions between MIT and NSF with respect to mechanics of release and distribution have been underway. Licensing authority has now been formally requested by MIT; and, as soon as permission is granted, it is the intention of MIT to complete licensing arrangements that will ensure the broadest possible dissemination of this important programming language.

Kenneth A Smith  
Associate Provost  
MIT  
545 Technology Sq  
Cambridge MA 02139

### Comments on Software Piracy

*The following comments by our readers were solicited through Chris Morgan's May 1981 BYTE editorial "How Can We Stop Software Piracy?"*

I commend Chris Morgan and BYTE for addressing a subject too frequently overlooked. Software piracy has, indeed, reached an appalling level, while somehow retaining an odd sort of tacit protection—that of being a "gentleman's" crime.

Chris Morgan's statement that "software piracy . . . is not just illegal—it's unethical" couldn't have been more to the point. It is unethical. Shamefully so. To those who attempt to protect their works, this can't be stressed enough. The courts and various legal bodies are slow, but they are working toward resolving some of the piracy problems. Many talented people are working madly devising clever tricks to prevent the theft—all because there are those who think it's better to have something for nothing than it is to ethically exchange with those who

worked hard to produce something of value.

No doubt the thieves have justified their actions. Maybe they think the "system" is unfair; maybe they think they can't afford the programs they so dearly want; maybe they don't even think at all. But one thing is certain: they haven't developed software packages themselves and then had them ripped off to the tune of thousands of dollars. That much we know.

It's a shame that one's fellow man is called upon to police another. One would like to believe that we're fair and honest people. It appears not all of us are. Hence, in addition to the efforts of our legislators and programmers, those ethical souls who learn of piracy need to do something effective about it. If simple reasoning with a software pirate won't do it, then reporting the matter to the developer just might. While contrary to the childhood dictum "don't be a tattletale," it could help to curtail a growing cancer in the industry.

The Association for Software Protection (ASP) is a newly formed group dedicated to eradicating the piracy problem. At present it is addressing—in the main—the problems faced at the mini-computer level. Nevertheless, the piracy problem branches across all levels, and any group or individuals interested in organizing an antipiracy microcomputer group are invited to contact ASP.

In addition to my activities with ASP, I am the Software Protection Director at Mini-Computer Business Applications in Glendale, California.

Robin Robinson  
Association for  
Software Protection  
10143 Leona Ave  
Tujunga CA 91042

Chris Morgan's and BYTE's concern with software piracy is well placed, and BYTE's coverage is excellent, but there are wider perspectives to add.

For millennia, humanity moved around picking and chasing things to eat. The Agricultural Revolution meant the complete transformation of social arrangements, which resulted in the invention of private property, towns, political institutions, writing, ruling classes, fortifications, the ownership of land, etc.

Things were like that for a few millennia more. For the last couple hundred

*Letters continued on page 18*





## Disk Storage: It's No Place to Compromise.

A dependable disk system means everything to the high-performance operation of your computer. At Percom, we know this. And we do something about it.

For example, the connectors on our TFD drive systems are gold plated.

Why? Because solder-plated contacts oxidize, forming an insidious insulation that can cause erratic operation. And then total failure.

Gold-plated connectors are just one way we make better drive systems than the competition.

### Now #1 for the Model III

Quality Percom TFD drives provide more features, cost less. Add-on drives start at only \$439.00. Complete First-Drive Systems start at only \$749.95. Features: "Flippy" Capability — Record your

programs and data on either side of a diskette. **Greater Storage Capacity** — Store 180 Kbytes — formatted — on one side of a 40-track TFD drive. Store over twice as much on a TFD 80-track drive. **Think Megabytes** — Your TFD drive controller will handle up to four drives. You can access almost 1.5 million bytes of on-line program and data files. **Either Add-in or Add-On** — Your TFD First Drive System can be either internal (add-in) or external (add-on). In either case, you get a complete system including the disk controller, drive, power supplies and disk-operating software. **BASIC-Language DOS** — Included on diskette with each First Drive System is Percom's OS-80/III™. This easy-to-use disk-operating system loads into 7 Kbytes of RAM and then frees the drive for other use. With OS-80™ programs, you can have full, read-write interchangeability between Model I and Model III diskettes. **Or Model III TRSDOS\*** — TFD 40-track drives work with Tandy's Model III TRSDOS, without modification. For 80-track operation, TRSDOS can be easily modified with diskette patches supplied.

### Still #1 for the Model I

Besides greater storage capacities, more quality control measures and lower prices, all Percom Model I drives are rated for double-density operation.

Plug a DOUBLER™ in your Expansion Interface and enjoy the same double-density disk storage capacity as Model III owners. Included with each DOUBLER is a TRSDOS compatible double-density disk-operating system. DOUBLEZAP programs are available for upgrading other popular DOSs for DOUBLER opera-

tion. And our double-density version of OS-80™ costs just \$49.95.

Of course you don't have to upgrade your Model I for double-density operation to use Percom disk drives. But it's nice to know you can.

Percom TFD drives for the TRS-80\* Model I are available in 40-, 77- and 80-track versions, in 1-, 2- and 3-drive configurations. Prices start at \$399.00.

**System requirements:** Model III TFD drives work with a 16-Kbyte system (min) and Model III BASIC. The initial drive must be a first-drive system. An optional interconnecting cable is available for expanding with external drives #3 and #4. Model I TFD drives work with a 16-Kbyte system (min) equipped with an Expansion Interface, Level II BASIC and DOS software, and an interconnecting cable. Two- and four-drive interconnecting cables are available from Percom.

To order products, or for the name of your authorized Percom retailer, call toll free:

1-800-527-1592.

**PERCOM**

PERCOM DATA COMPANY, INC.  
211 N. KIRBY GARLAND, TEXAS 75042  
(214) 272-3421

Yes... I'd like to know more about the best for my TRS-80 computer. Send me free literature about quality Percom products.

Model I  Model III

Send to  
PERCOM DATA COMPANY, Inc., Dept. 8  
211 N. Kirby St. Garland TX 75042

name \_\_\_\_\_

street \_\_\_\_\_

city \_\_\_\_\_ state \_\_\_\_\_

zip \_\_\_\_\_ phone number \_\_\_\_\_

MAIL TODAY!

B01

\*trademark of Percom Data Company, Inc.

\*\*trademark of Tandy Radio Shack Corporation which has no relationship to Percom Data Company

PRICES AND SPECIFICATIONS SUBJECT TO CHANGE WITHOUT NOTICE.

# TWELVE STRONG HEATH/ZENITH YOUR

## Pick a strong partner

A computer purchase is the beginning of a long term partnership between you and the people you buy from. Your ongoing need for software and accessories requires a partner who will stand by you with a growing line of products. And nowhere will you find a more complete line of hardware, software and accessories than at your Heathkit Electronic Center. Here are twelve strong reasons to make Heath/Zenith your partner.

### 1. The All-In-One Computer

The heart of the Heath/Zenith line is the stand-alone *89 Computer*. It's a complete system with built-in 5¼-inch floppy disk drive, professional keyboard and keypad, smart video terminal, two Z80 microprocessors, and two RS-232C serial I/O ports. It comes with 16K RAM, expandable to 64K.

### 2. Peripherals

These include the popular *Heath/Zenith 19 Smart Video Terminal*, loaded with professional features. And the *14 Line Printer*, priced as low as \$495. Other printer brands are on display, including high-speed, typewriter-quality printers.



### 3. Software

*Word processing*, includes reliable, easy-to-use Zenith Electronic Typing and powerful, full-featured WORDSTAR.

*Small Business Programs*, feature General Ledger and Inventory Control.

*HUG, Heath Users' Group*, offers members a library of over 500 low-cost programs for home, work or play.

### 4. Programming Languages



For your own custom programs, Microsoft languages are available in BASIC (compiler and interpreter), FORTRAN and COBOL.

### 5. Operating Systems

Three versatile systems give you the capability to perform your specific tasks.

*CP/M by Digital Research* makes your system compatible with thousands of popular CP/M programs.

*UCSD P-System with Pascal* is a complete program development and execution environment.

*HDOS, Heath Disk Operating System* gives you a sophisticated, flexible environment for program construction, storage and editing.

### 6. Utility Software

Expand the performance range of your computer with a broad selection of utility tools, including the best of *Digital Research* and the complete line of innovative *Softstuff* products.

### 7. Disk Systems

The 8-inch Heath/Zenith 47 Dual Disk System adds over 2 megabytes of storage to your



89 Computer. Diskettes are standard IBM 3740 format, double-sided, double-density.

The 5¼-inch 87 Dual Disk System adds 200K bytes of storage to your 89. Both disk systems feature read/write protection and easy plug-in adaptability.

### 8. Self-Study Courses

Learn at your own pace with *Programming Courses* that teach you to write and run your own programs in Assembly, BASIC, Pascal or COBOL.

A course on *Computer Concepts for Small Business* gives you the understanding to evaluate the ways a computer can benefit your business.

*Personal Computing* is a complete introduction to the fundamentals for the novice. Every Heathkit/Zenith course is professionally designed for easy, step-by-step learning.

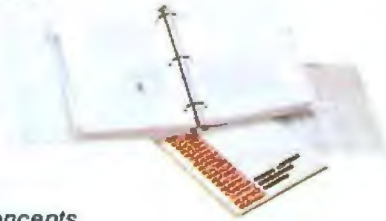

All Heath/Zenith Computer Products are available completely assembled and tested for commercial use. Or in easy-to-build, money-saving kits.

# REASONS TO MAKE COMPUTER PARTNER

## 9. Expansion Options

Communicate with the outside world through a *Three-port EIA RS-232C Serial Interface*.

Expand RAM to 64K with easy-to-install expansion chips.

## 10. Accessories



Your Heathkit Electronic Center has the latest in modems, black-and-white and color video monitors, computer furniture and a full line of supplies, accessories, books and parts.

## 11. Service

No one stands by you like Heath/Zenith. We help you get your system up and running smoothly. Service is available from trained technicians, over the phone or at one of 56 Heathkit Electronic Centers.



## 12. Value

Your money buys you more because Heath/Zenith prices are among the industry's most competitive. Make your own comparison and find out how much you can save.

Complete, integrated computer hardware and software, designed to serve you and to grow with you — that's what to look for in a strong partner. And with Heath/Zenith you get it all under one roof.

## All at your Heathkit Electronic Center

Pick the store nearest you from the list at right. And stop in today for a demonstration of the Heath/Zenith 89 Computer System. If you can't get to a store, send \$1.00 for the latest Heathkit® Catalog and the new Zenith Data Systems Catalog of assembled commercial computers. Write to Heath Co., Dept. 334-814, Benton Harbor, MI 49022.

## Visit Your Heathkit Electronic Center\*

where Heath/Zenith Products are displayed, sold and serviced.

<b>PHOENIX, AZ</b> 2727 W. Indian School Rd. 602-279-6247	<b>MISSION, KS</b> 5960 Lamar Ave. 913-362-4486	<b>CLEVELAND, OH</b> 28100 Chagrin Blvd. 216-292-7553
<b>ANAHEIM, CA</b> 330 E. Ball Rd. 714-776-9420	<b>LOUISVILLE, KY</b> 12401 Shelbyville Rd. 502-245-7811	<b>COLUMBUS, OH</b> 2500 Morse Rd. 614-475-7200
<b>CAMPBELL, CA</b> 2350 S. Bascom Ave. 408-377-8920	<b>KENNER, LA</b> 1900 Veterans Memorial Hwy. 504-467-6321	<b>TOLEDO, OH</b> 48 S. Byrne Rd. 419-537-1887
<b>EL CERRITO, CA</b> 6000 Potrero Ave. 415-236-8870	<b>BALTIMORE, MD</b> 1713 E. Joppa Rd. 301-661-4446	<b>WOODLAWN, OH</b> 10133 Springfield Pike 513-771-8850
<b>LA MESA, CA</b> 8363 Center Dr. 714-461-0110	<b>ROCKVILLE, MD</b> 5542 Nicholson Lane 301-881-5420	<b>OKLAHOMA CITY, OK</b> 2727 Northwest Expressway 405-848-7593
<b>LOS ANGELES, CA</b> 2309 S. Flower St. 213-749-0261	<b>PEABODY, MA</b> 242 Andover St. 617-531-9330	<b>FRAZER, PA</b> 630 Lancaster Pike (Rt. 30) 215-647-5555
<b>POMONA, CA</b> 1555 N. Orange Grove Ave. 714-623-3543	<b>WELLESLEY, MA</b> 165 Worcester Ave. 617-237-1510	<b>PHILADELPHIA, PA</b> 6318 Roosevelt Blvd. 215-288-0180
<b>REDWOOD CITY, CA</b> 2001 Middlefield Rd. 415-365-8155	<b>DETROIT, MI</b> 18645 W. Eight Mile Rd. 313-535-6480	<b>PITTSBURGH, PA</b> 3482 Wm. Penn Hwy. 412-824-3564
<b>SACRAMENTO, CA</b> 1860 Fulton Ave. 916-486-1575	<b>E. DETROIT, MI</b> 18149 E. Eight Mile Rd. 313-772-0416	<b>WARWICK, RI</b> 558 Greenwich Ave. 401-738-5150
<b>WOODLAND HILLS, CA</b> 22504 Ventura Blvd. 213-883-0531	<b>HOPKINS, MN</b> 101 Shady Oak Rd. 612-936-6371	<b>DALLAS, TX</b> 2715 Ross Ave. 214-826-4053
<b>DENVER, CO</b> 5940 W. 38th Ave. 303-422-3408	<b>ST. PAUL, MN</b> 1645 White Bear Ave. 612-778-1211	<b>HOUSTON, TX</b> 1704 W. Loop N. 713-869-5263
<b>AVON, CT</b> 395 W. Main St. (Rt. 44) 203-678-0323	<b>BRIDGETON, MO</b> 3794 McKelvey Rd 314-291-1850	<b>SAN ANTONIO, TX</b> 7111 Blanco Road 512-341-8876
<b>HIALEAH, FL</b> 4705 W. 16th Ave 305-823-2280	<b>OMAHA, NE</b> 9207 Maple St. 402-391-2071	<b>MIDVALE, UT</b> 58 East 7200 South 801-566-4626
<b>PLANTATION, FL</b> 7173 W. Broward Blvd. 305-791-7300	<b>ASBURY PARK, NJ</b> 1013 State Hwy. 35 201-775-1231	<b>ALEXANDRIA, VA</b> 6201 Richmond Hwy. 703-765-5515
<b>TAMPA, FL</b> 4019 W. Hillsborough Ave. 813-886-2541	<b>FAIR LAWN, NJ</b> 35-07 Broadway (Rt. 4) 201-791-6935	<b>VIRGINIA BEACH, VA</b> 1055 Independence Blvd 804-460-0997
<b>ATLANTA, GA</b> 5285 Roswell Rd. 404-252-4341	<b>AMHERST, NY</b> 3476 Sheridan Dr. 716-835-3090	<b>SEATTLE, WA</b> 505 8th Ave. N. 206-682-2172
<b>CHICAGO, IL</b> 3462-66 W. Devon Ave. 312-583-3920	<b>JERICHO, L. I., NY</b> 15 Jericho Turnpike 516-334-8181	<b>TUKWILA, WA</b> 15439 53rd Ave. S. 206-246-5358
<b>DOWNERS GROVE, IL</b> 224 Ogden Ave. 312-852-1304	<b>ROCHESTER, NY</b> 937 Jefferson Rd. 716-424-2560	<b>MILWAUKEE, WI</b> 5215 W. Fond du Lac 414-873-8250
<b>INDIANAPOLIS, IN</b> 2112 E. 62nd St. 317-257-4321	<b>N. WHITE PLAINS, NY</b> 7 Reservoir Rd. 914-761-7690	<small>*Units of Veritechnology Electronics Corporation in the U.S.</small>

Prices and specifications subject to change without notice.

## HEATH/ZENITH

### Your strong partner

# SUPERBRAIN

By INTERTEC



64K Double or Quad Density units available. Uses two Z-80 CPU's. Commercial-type terminal with 12" monitor. Dual double density minifloppies. Over 350 kilobytes of storage (twice that with quad density drives). Two serial RS232 ports, I/O ports standard. Expandable with optional S-100 interface. Comes with CP/M™ 2.2 operating system. MiniMicroMart can supply a wide range of CP/M development and application software.

w/64K Double Density, List \$3495 .. \$2869  
w/64K Quad Density, List \$3995 .. \$3395



**HEWLETT  
PACKARD  
HP-41CV**  
**\$259.**



**data  
systems**  
Z19 Video Terminal



**Limited  
Time  
\$799**

List \$995



**HEWLETT  
PACKARD HP-85A**

Desk-Top  
Computer  
List  
\$3250  
\$2749



**HP-83**  
List \$2250 **Special \$1749**

F.O.B. shipping point. All prices subject to change and all offers subject to withdrawal without notice. Advertised prices are for prepaid orders. Credit card and C.O.D. 2% higher. C.O.D. may require deposit.

— WRITE FOR FREE CATALOG —

## MiniMicroMart

943 W. Genesee St.  
Syracuse, NY 13204 (315) 422-4467

## Letters

years, however, most people have run machines. As we see and know, every society and culture in the world has been thrown into turmoil because, once again, the world is changing rapidly.

"Classic" economics is based on material commodities: if there are you and me and a loaf of bread, either you get it, or I get it, or we split it. No existing school of economics, however, deals with the fact that if you give me some information, you still have it. Material commodities get "thinner" when spread out, while information gets "thicker" as it's spread out.

Two-thirds of the jobs in the United States are informational. Money, property, and many other foundations of society have begun transmuting. Software piracy is a logical area for difficulties to emerge first. Where else can you go into business selling pure thought?

The more we are aware, and the more we examine and discuss the big implications, the less surprised we'll be.

Neil Rest  
1457 Gregory  
Chicago IL 60640

Congratulations to Chris Morgan for his timely attention to the software-piracy controversy. The following specifications may be useful in evaluating solutions proposed for this problem:

- There shall be no realistic means for defeating the protection mechanism, regardless of the attacker's technical sophistication or familiarity with the design of the software-protection system.
- The software product shall *not* have to be customized for each licensee.
- The user shall have to purchase one, and only one, hardware device to use *all* protected software. Once this device is attached to the computer, the user shall be able to forget it exists.
- The device shall be the same, regardless of the computer system with which it is used; and it shall be compatible with existing computer systems.
- There shall be no degradation of the reliability or versatility of a computer system as a result of this device.
- The cost of the device shall be minor compared to the cost of the least expensive (but practical) system on which protected programs will be used.
- The logistical support of the protection system shall require no effort on the part of the software publisher.

• The system shall restrict the use of protected software to the licensed user for a licensed period of time.

I would appreciate the comments of BYTE's readers on the applicability and completeness of these specifications. At Salcris Corporation, we are currently field-testing our Chrono-Guard Software Protection System, which meets these specifications. Software protection is our only business and, while we believe we have a carefully thought-out solution to the industry's problems, we value constructive criticism.

Thomas C Donald  
President  
Salcris Corporation  
1 Office Park Cr  
Birmingham AL 35223

In the May 1981 BYTE there were several excellent articles on what I regard as one of the most severe problems facing the computer-software industry today— theft of software. (See Chris Morgan's "How Can We Stop Software Piracy?", page 6; Christopher Kern's "Washington Tackles the Software Problem," page 128; and Stephen Becker's "Legal Protection for Computer Hardware and Software," page 140.) I know of several companies, mine included, that will not sell packaged software because of the theft problem. The constant "reinvention of the wheel" that results from the reluctance to sell software is one of the leading factors contributing to the already poor productivity of the industry. If we are not to stagnate and allow foreign competition to steal our software lead, an early solution to this problem must be found.

One article mentioned several rather complex hardware solutions that are currently proposed to help solve the problem. While most of the hardware discussed would provide more or less processor-independent solutions that would require no industry-wide effort to help solve the problem, I feel that these efforts will lead to an expensive and relatively insecure solution. The cheapest and most reliable answer is not a hardware solution (although hardware must play a key role), but "self-protecting" software.

How can software be made to protect itself? Well, I am not aware of any processor on which this is possible today, but a minor processor modification could easily, cheaply, and effectively accomplish

# Mountain Computer CPS MultiFunction Card™

## *The Only Interface Card You Need!*

### *Connecting a Parallel Printer?*

Epson® Centronics® IDS Paper Tiger® CPS handles all these printers and others with on-board intelligence to provide paging and other features found on no other card.

### *Connecting a Serial Printer?*

Diablo® Qume® NEC - TI 800 Series® CPS handles these printers and others with standard RS-232 interface providing selection of baud rates, handshakes, paging, and more.

### *Connecting a Modem or Terminal?*

Hayes Smartmodem® Novation CAT® M & R Pennywhistle® CPS handles these and others with full/half duplex operation, baud rate selection, and even a transparent terminal mode which includes a dual mode feature that permits printing of text to parallel printers while 'on-line' eliminating the need for special terminal software—and more.

### *Connecting with the Time?*

The on-board calendar/clock provides real time and date information including day of week, day, month, year, hours, minutes, and seconds for any application requiring a time stamp—battery backed-up for over two years!

### *Connecting with The Source?*

Used with a modem, CPS provides the connection to information utilities, such as The Source®, Dow Jones, and others. Additionally, CPS provides the connection to big-time electronic mail with programs such as Micro Courier® and Micro Telegram®, and other data transfer programs.

### *Connect with Easy Use!*

CPS has no switches to set! All functions on the card are set from a user program. Menu driven screens set up your choice of all functions on CPS and store them on-board in CMOS RAM—battery backed-up (including the clock) for over two years! To change parameters, run the set-up program again—or use special commands from your keyboard. Furthermore, most existing software programs are immediately usable with CPS. *Phantom Slot Capability* permits assignment of CPS' functions to your software's pre-defined slots.

### *Connect with Your Apple® Dealer*

Drop by your Apple dealer and see how the CPS MultiFunction Card provides the most comprehensive capabilities for RS-232C serial interface, parallel output, and real-time calendar/clock of any card available today—all on one card—at one low price—competitive with any one of the three or more single function cards that it replaces.



**Mountain Computer**  
INCORPORATED

300 El Pueblo Road, Scotts Valley, CA 95066  
(408) 438-6650 TWX: 910 598-4504



# APPLE OPTIONS.

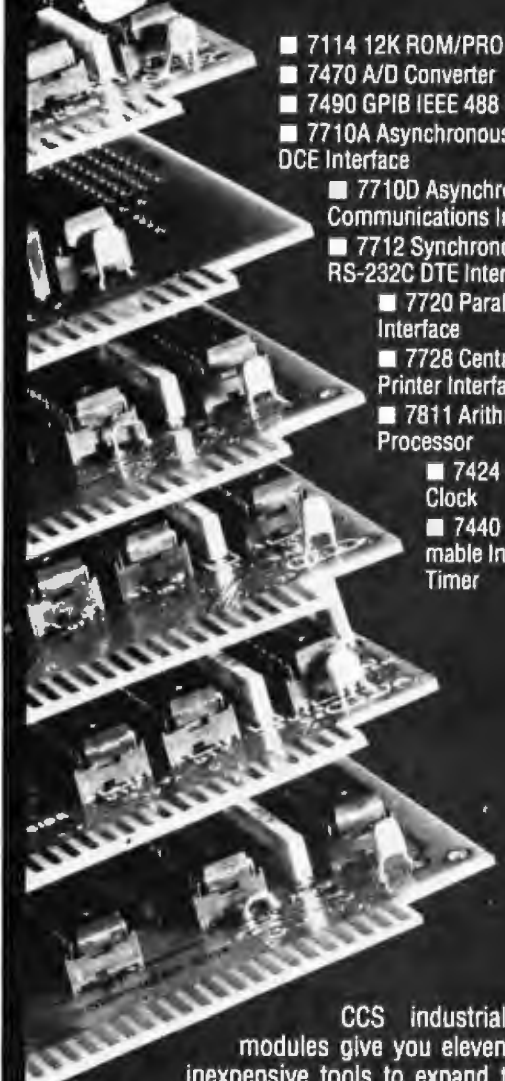

- 7114 12K ROM/PROM
- 7470 A/D Converter
- 7490 GPIB IEEE 488 Interface
- 7710A Asynchronous RS-232C DCE Interface
- 7710D Asynchronous Communications Interface
- 7712 Synchronous RS-232C DTE Interface
- 7720 Parallel Interface
- 7728 Centronics Printer Interface
- 7811 Arithmetic Processor
- 7424 Calendar/Clock
- 7440 Programmable Interval Timer

CCS industrial quality modules give you eleven reliable, inexpensive tools to expand the capabilities of Apple II computers. Available through 921 computer retailers nationally. There's one near you.

Apple, Apple II are trademarks of Apple Computer Corporation.



California Computer Systems

250 Caribbean Drive  
Sunnyvale, California 94086  
(408) 734-5811  
Telex 171959 CCS SUVL

## Letters

this. The biggest problem will be to get everyone to cooperate and adopt a standard approach.

IBM was on the right track to solving the problem several years ago, but someone, somewhere, dropped the ball, and the solution became only half-implemented. Anyone who has ever done some systems programming work on an IBM S/370 is probably aware of the privileged instruction "STORE PROCESSOR ID." This instruction provides systems programs with the processor serial number and other system information, such as whether VM/370 is the system-control program, etc. This instruction provides system-level programs (and even microcode) some degree of theft protection, although its primary purpose is to provide a method by which system programs can determine what model processor is being used. The big problem from the applications program side, which is where IBM left the scene, is that there is no easy method to access the information provided by this instruction.

To solve the software-theft problem, the entire industry must provide some method by which the user's application program can determine such information as the make, model number, and serial number of the host processor. Additionally, it must be constructed in a manner such that it would be next to impossible for the user to modify the factory-supplied information. The addition of one instruction to the processor repertoire would undoubtedly increase the cost of the hardware, but the increase would not even approach the price of the cheapest protection method that I have seen proposed. The only disadvantages to this approach are that it would not be easily applicable to existing systems (most of which will probably not be around more than five years anyway, so why worry?) and it would preclude the distribution of source code (you would not want someone to discover how you encrypt the processor ID and check against the licensed processor ID).

I welcome any comments.

Jon R Kibler  
President

Southeastern Computer Services Inc  
POB 160124  
Mobile AL 36616

Chris Morgan's May 1981 BYTE editorial mentioned a software-protection



# PUSH IN. PUSH ON.

## MAKING MINIS OUT OF MICROS.

Here's the system builder's solution for successful computers and applications. Push in the CCS component. Push in the operating software. And push on with your application. CCS systems and components are designed to go together quickly, and to keep running reliably, with a proven return rate of less than 1%.

And you get performance. The systems deliver hardware vectored interrupts and the capability to interleave DMA data transfers with rates as high as two megabytes per second, plus bank select memory of up to 512K bytes. This 8-bit system provides single user, multiuser, and multitasking capability with ample speed to prevent operator waiting or loss of incoming real-time data.

The systems are available with CP/M or MP/M operating systems. For real-time or multiuser applications, the CCS OASIS real-time multitasking operating system supports re-entrant programs and relocatable code modules, with



- Please have a sales representative call me.
- Please send more information on CCS Systems and Expansion Modules.

Name \_\_\_\_\_  
 Company \_\_\_\_\_  
 Address \_\_\_\_\_  
 City/State/Zip \_\_\_\_\_  
 Phone: (     ) \_\_\_\_\_



California Computer Systems  
 250 Caribbean Drive  
 Sunnyvale, CA 94086  
 (408) 734-5811

facilities for task-to-task communication, file protection, time-of-day bookkeeping, spooling, task overlay, dynamic memory management, ISAM file structures and device-independent I/O. CCS OASIS includes debug, text editing, linkage, and file sort utilities; the system supports a host of existing languages, applications, and utilities from a range of vendors.

Powerful computer systems you can configure to your demanding requirements quickly, and with confidence. Choose from a variety of systems. Expand with CCS board-level modules for memory, disk control, high-speed arithmetic, and I/O, plus subsystems for floppy and hard disk storage.

If you sell, install, or use computer systems, you should know more about the CCS product line. We've got a lot more to tell. Tear out and return the coupon for more information. Or call.

CP/M and MP/M are trademarks of Digital Research. OASIS is a trademark of Phase One Systems.

## Letters

scheme based on encrypting programs.

Since mid-1979, all Sentinel computers have used a somewhat more convenient scheme. In our systems (based on one or more Intel 8086s), the machine's serial number is available to the operating system. The operating system recognizes encrypted application programs and uses the serial number as a key to decrypt them as they are loaded from floppy-, Winchester-, or bubble-memory-disk storage.

This protects Sentinel's investment in our comprehensive set of financial application programs and lets us give our distributors and end users utility programs that can copy any of our software.

We also give Sentinel distributors the tools to encrypt their own programs.

Vernon J Schryver

Product Development Manager  
Sentinel Computer Corporation  
9902 Carver Rd  
Cincinnati OH 45242

I read Chris Morgan's editorial on software piracy with interest. The two sides of the software protection/duplication controversy were drawn as "the vendor's need for security" versus "the user's need for backup copies for reliability."

My experience with software products, both large and small, has revealed an even greater need on the part of software purchasers than that of backup copies. This need is for *modifiable* and *configurable* software. A few years ago, most small-computer systems were either home-built or installed and used without modification from the time they left the factory. In the case of personal computers, peripherals were few and were usually made or distributed by the frame manufacturer. Things are different today—and this has given rise to the need for user-configurable software.

For example, my firm's Apple II computer contains interface cards for four peripheral devices; the disk system, printer, modem, and an 80-column video card. Only one of these is an Apple Computer product. Nearly every software product we have purchased has required reconfiguration—sometimes a lengthy project—to support these devices.

I am very reluctant to purchase any software packaged on a copy-protected disk, an "unreadable ROM," or otherwise immune to modification to suit our needs. Vendor support of nonstandard hardware is an admirable goal, but we realize that it

### One Man's Dilemma

*I would never break into a computer store and steal a disk drive, a printer, or a processor card. After all, I'm a decent, intelligent, honest person. I teach my children the value of personal integrity, and I pride myself on my honesty. I never keep overpayments. I pay my taxes. I even spent over six months convincing a large department store that I owed it money when it couldn't find any record of the transaction. I don't allow my children to make audio-tape copies of records for each other. After ten years in the entertainment industry, I know how valuable a copyright is to a performer.*

*So, how did I become a software thief?*

*It started when I sold my Altair Tarbell cassette machine and upgraded to a North Star disk-based system. I knew when I got the system from a friend that he had piles of software to supply in the deal. That was the main reason I worked with him—to get the software. There were about twenty disks full of BASIC games, business programs, and a word processor. A neat little assembler and disassembler were included, although my primary interests were word processing and BASIC. I rationalized it this way: I would never do any commercial work using any of the programs. I was just learning—sort of "test driving." If I did decide to do any serious programming, I would purchase what I needed to keep everything legal. I was, after all, an honest man. It worked too well and for too long.*

*It wasn't very long before I had forgotten my commitment; moreover, I wasn't doing any serious work on my computer. I did buy an updated version of North Star BASIC from the factory, which sort of made me legitimate. Things were stable for about a year, with no exchanging or sharing.*

*Then, I had a letter published in a magazine where I casually mentioned I would be interested in exchanging programs. Before I knew it, I had a growing file of others interested in "sharing" what they had. This list eventually focused on an individual in Michigan who seemed very generous and quite sincere in helping me not only get software, but in getting it up and running. Over a three-month period this rela-*

*tionship blossomed into a friendship. I was very grateful to this person. I was doing most of the receiving and only minimal giving, but he didn't seem to mind. There are people who get pleasure out of helping others.*

*I was about to submit a software review to a magazine when I was confronted with the stark truth: I was a thief. I don't know if the fear of being found out is what motivated me to take a long, serious look at my past actions. But whatever it was, I was faced with three problems:*

- *I had received stolen goods.*
- *I required these stolen goods every time I turned on my computer. This meant that if I decided to change my position, I would have to purchase a license and become a legitimate user of several hundred dollars' worth of programs.*
- *The explanation I would have to give to my Michigan buddy. How could I take his generosity and tell him that, for me, it had become criminal?*

*I prepared a letter, and, as fate would have it, he called me while it was in the mail. I had to tell him what I had spent so much time carefully wording. I felt trapped. Finally, I began to unfold how I felt about exchanging software. I explained that mine was a unilateral decision and wasn't meant to push him into a similar repentant attitude. It was wrong for me but not necessarily everybody. The words came out, and he seemed to take it very well and understand my position. It was several months before I heard from him again. When I did, he wasn't very friendly. It was an impossible situation.*

*This is the number one problem in stealing software: You cannot do it alone. Someone knows you will compromise your values if the price is right. Maybe even worse, you know you are helping other people compromise their values.*

*During this particularly difficult time for me, I remembered something my dad had told me when I was a boy. We had just left a friend's ranch after hearing how he had been paid for two cases of eggs he never delivered. My dad said, "If a man will cheat somebody else, he will cheat you."*

*Text box continued on page 24*



# We designed them to meet two standards.

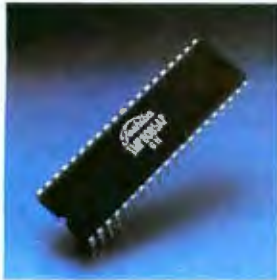

## Ours. And the industry's.

With a Toshiba Very Small Business Computer or Word Processor, you'll never worry about obsolescence and reliability.

That's because they're designed to meet not only the industry's software and operating standards, but our own high standards of quality and dependability.

With Toshiba, you can rest assured knowing you'll get day-in, day-out dependability built

right in. We build most of the components ourselves . . . which gives us complete control over quality, reliability, and performance every step of the way.



And Toshiba now offers you a fully developed and comprehensive dealer program based on our high standards of quality, reliability, and deliverability. Which means you can build your product line . . . and your profits.

So when you're looking for a reliable, well-thought-out VSBC or Word Processor, remember the name Toshiba. Our standards are as high as yours.

# TOSHIBA

## Word Processor



EW-100

### EW-100

display capacity: 80 characters × 24 lines  
floppy disk: 8"  
storage capacity: 300KB × 2,  
1MB × 2  
type of printer: daisy-wheel printer  
printing speed: 45 characters/sec.  
print pitch: 10/12/proportional spacing

## VSBC (Very Small Business Computer)



T250

T200

### T200/T250

**Hardware**  
memory: 64KB  
display capacity: 80 characters × 24 lines  
floppy disk: T200: 5 1/4"  
T250: 8"  
storage capacity: T200: 280KB × 2  
T250: 1MB × 2  
printing speed: 125 characters/sec.  
characters per line: 136 characters

**Software**  
CP/M<sup>®</sup>, Microsoft BASIC-80, CBASIC<sup>™</sup>

CP/M<sup>®</sup> is a registered trademark of Digital Research, Inc.  
CBASIC is a trademark of Compiler Systems, Inc.

Please send me more information about Toshiba's Word Processor and VSBC.  Products  Dealer Program BY-81

Name \_\_\_\_\_ Title \_\_\_\_\_

Company \_\_\_\_\_

Address \_\_\_\_\_ City \_\_\_\_\_

State \_\_\_\_\_ Zip \_\_\_\_\_ Phone \_\_\_\_\_

Information Processing Systems Division  
**TOSHIBA AMERICA, INC.**  
2441 Michelle Drive, Tustin, CA 92680 Tel: (714) 730-5000

## Letters

cannot be depended on in all situations. The most reliable and useful software that I have purchased runs under a standard operating system and is easily modifiable by means of a configuration program or a copy of the source code.

More than once, I have decided not to purchase a desirable software product when I became aware that it did not support our system configuration and was packaged in a copy-protected form. Surely the revenue lost to vendors in this manner is as significant as that lost to "pirates."

Our firm plans to enter the small-computer-software market through direct and retail sales. BYTE readers should be assured that our programs will be fully accessible, modifiable, and packaged with source code whenever feasible.

Yes—we'll be vulnerable to piracy. But I believe that the solution to the software-piracy problem is increased vendor support (rendering pirated copies less valuable) and vigilant enforcement of protective laws, not making software products less accessible to the user.

**Michael C Berch**  
Managing Partner  
Southside Systems  
2424 Haste St  
Suite A-40  
Berkeley CA 94704

I would like to comment on the May 1981 BYTE editorial and the two articles on the subject of software piracy. There are two sides of every fence. BYTE took the side of the software provider; let me take the side of the user.

I purchased an Apple II, disk drives, video monitor, printer, modem, etc. plus about \$1000 worth of software for business use. This is not my hobby, and I have no intention of becoming any more of an expert with computers than I must to achieve my purpose.

From my standpoint, the price of all of this stuff is so low that there is absolutely no point in messing around either with pirates or in doing it myself. Even the book-keeping and inventory-control programs, at \$600 to \$1000 or more, pay for themselves in a few months. If the minicomputer manufacturers could ever get their act together, the business-software market would dwarf their present endeavors. (I think that the Japanese will do the job for them, and Apple will wind up back in the old garage along with the others.)

*Text box continued:*

*There is no sacred bond above which all transactions are honest and below which honesty is negotiated.*

*I sent away for the software I required to keep writing. As luck would have it, I had been legitimately given two key pieces of software, that were mine to keep, in return for providing reviews to magazines. So as it turned out, I had won and I had lost. Cleaning up my act didn't cost me as much as I thought it would; however, I lost a friend. I consider that loss the highest price to pay for my transgression.*

*I'm sure there are those who will be critical and demand I pay for the software I used for the two years. All I can say is that I've given it careful thought and I feel comfortable with my current situation.*

*Foolproof, protected software is fiction and will never be reality because it has nothing to do with technology. It has to do with the human condition. There always will be people who will compromise integrity for material gain. And there will be those, like myself, who will slip past honesty and into what they often call a "gray area" before they get their heads out of the sand and take responsibility for their actions. And, thank God, there are a handful whose integrity will not waiver. As long as this human condition exists, there will be no perfect system for software protection.*

I have two Apple programs that provide access to the Dow Jones data base for the purpose of obtaining securities quotes, keeping track of portfolios, and the like. One program is written in BASIC, is user-accessible and, with some user modifications, works like a charm. The other program is "locked." It doesn't work.

Apple has a disclaimer in its program manuals absolving them of all responsibility. So far, Apple hasn't abandoned me, but it's taking its own sweet time about coming up with a fix. When and if a fix comes through, no field modification by the user will be possible. I have a pretty good idea what the problem is and if I could gain access to the program, I could probably fix it myself in a short time. This way it will take weeks or months, if it gets fixed at all. I think the denouement is that a determined and knowledgeable pirate will succeed no matter what, while the

*There are, perhaps, only two reasons for maintaining personal integrity. One is the fear of being discovered and exposed—or worse, punished. An idea I read a year or so ago suggested that a bounty on pirates may be the most workable tool to enforce this first reason. I don't like this idea; there are too many holes in it. But it does seem the most effective way to put the fear of being caught into pirating.*

*On the other hand, there is the moral fiber within each of us that merely needs to be awakened to become strong and effective. Careful examination of your situation with a critical eye on what you know to be right and wrong will certainly expose any deficiencies. It then becomes a matter of pricing your integrity and remembering that you can't steal software by yourself. Yes, the process of evaluating the circumstances is simple. The difficulty of implementation will likely be directly proportional to how deeply involved you are in stealing.*

*Drop me a postcard—anonously, if you prefer—and let me know your feelings.*

**Eugene Dorman**  
c/o BYTE Publications Inc  
POB 372  
Hancock NH 03449

honest and legitimate user, like me, takes it on the chin.

**Adolph L Friedman**  
POB 2856  
Santa Fe NM 87501

I disagree with Chris Morgan's editorial on software piracy. It seems that the software expert has a stranglehold on the personal computer. His hand is clutched around my wallet and he is squeezing for all it is worth. I don't like that. In the capitalistic system, competition brings the price in line. Software is a monopoly, and Mr Morgan's concern is like government-secured loans to Chrysler.

Why not let the software people provide more flexibility to the user? If the software is easier to obtain and more reasonably priced, a larger number of people would own personal computers.

Most small system users think all micro-computers are created equal. And they're right. If you want performance, convenience, styling, high technology and reliability (and who doesn't?) your micro usually has a price tag that looks more like a mini. It seems big performance always means big bucks. But not so with the SuperBrain!

Standard SuperBrain features include: twin double-density 5¼" drives which boast nearly 350,000 bytes of disk storage — expandable to 10 megabytes. A full 64K of dynamic RAM. A CP/M\* Disk Operating System to insure compatibility to literally hundreds of application packages presently available. And, a 12" non-glare, 24 line by 80 column screen.

\*Registered trademark of Digital Research, Inc.

You'll also get a full ASCII keyboard with an 18 key numeric pad and individual cursor control keys. Twin RS232C serial ports for fast and easy connection to a modem or printer. Dual Z80 processors which operate at 4 MHz to insure lightning-fast program execution. And the list goes on! Feature after feature after feature.

Better yet, the SuperBrain boasts modular design to make servicing a snap. A common screwdriver is about the only service tool you'll ever need. And with the money you'll save on purchasing and maintaining the SuperBrain, you could almost buy another one. For under \$3,500, it is truly one of the most remarkable microcomputers available anywhere.

Whether your application is small business, scientific, educational or just word processing, the SuperBrain is certainly an exciting solution to the small computer problem. And since you can easily expand it, you'll probably never outgrow it.

Call or write us today for a complimentary copy of our "SuperBrain Buyer's Guide." We'll show you how you can get big system performance without having to spend big bucks.

**INTERTEC  
DATA  
SYSTEMS.**

2300 Broad River Rd. Columbia, SC 29210  
(803) 798-9100 TWX: 810-666-2115

Circle 193 on inquiry card.

# SUPERBRAIN™



**NEW!  
64K MODEL**  
Now expandable with  
10 megabytes of  
disk storage

INTERTEC DATA SYSTEMS

SUPERBRAIN

## Letters

That in itself would increase the market for software. The broader the base of people using computers, the greater the variations and the need for software.

What Mr Morgan proposes is like Exxon buying up the "good gas-mileage carburetors" before they get to market. It sounds to me that Mr Morgan is trying to protect the pirates.

Brigg Leurs  
436 N 1050 E  
Kaysville UT 84037

It seems to me that the solution to software piracy has been evident and used for a considerable time by BYTE's parent company, McGraw-Hill. Hundreds of man-hours can be used in the writing and debugging of a program, and this can be translated into cost and selling price, the same as any other commodity.

The Osborne Accounting System, for example, has a finite value. The disks for each program are available at a very low price, even as low as \$8, from one of BYTE's advertisers. However, the comprehensive and beautifully published manuals that include the source code can be purchased for \$20. You could not photostat one of these manuals for less than this price. Therefore, you buy it.

It would be interesting to know how many manuals the McGraw-Hill Book Company has sold and what the income has been, per program. I'm sure this shows one solution: give the disk away and sell the manuals, like the old stunt of giving the razor away, but selling the blades. All of the methods for "locking in" programs and "locking out" software pirates are rather foolish. Everyone knows that you can access every byte on every track, change the ID and password,

disassemble, and transfer from one system to another.

A A Schwartz  
6454 El Camino Del Teatro  
La Jolla CA 92037

The antipiracy devices mentioned in Chris Morgan's editorial are quite ingenious, but like all human inventions, they are fallible. I wonder if BYTE readers would like to reconsider the whole question of "software protectionism" at a more elementary level.

I can identify at least three basic "instincts" at work which must be accommodated:

- the natural inquisitiveness of the human mind
- the insatiable attraction of acquiring things for oneself
- and the irresistible challenge of another human mind

Inasmuch as knowledge and information are the essential contents of all software, to keep them "locked away" is old-fashioned logic. Widely disseminated knowledge will bring forth more knowledge. In an age when knowledge becomes rapidly outdated, hanging on to some little invention is unrealistic. Like all attempts at prohibition, the setting up of barriers is probably the most potent stimulus to overcome them. Such attempts have only resulted in the escalation of costs to the consumer, the production of weird and delicate formats that are much more prone to crashes, and the great step backward of adding unnecessary keys and ROMs (read-only memories) that defeat the advantage of computerization.

Is it too late to take a 180° turn and stop this "cold war" from escalating? Would it be possible to take the alternate view? Here are some suggestions:

• The ultimate way of getting rid of piracy is to make the purchase of genuine software so cheap that it becomes uneconomical to copy. Who bothers photocopying paperback books? The volume of sales will more than compensate for the lowering of the profit margin and protection costs.

• Software houses should encourage users to become subscribing members. This would provide capital for software development as well as some degree of customization of the software to be developed. New programs could be offered to subscribers on a priority discount basis.

• Users clubs should be encouraged to adopt a code of ethics; in return they would be allowed to participate in a scheme of evaluation and bulk ordering of new products. There is no pressure greater than peer pressure.

• A good user and upgrading service should be arranged so that a firm bond is created between the user and the software producer. Newsletters with user comments is one way to achieve this.

I am glad to say that at least one software company, Personal Software, has begun to adopt this new attitude for its Data Management System and Desktop Plan. I salute them. I sincerely hope that BYTE and its readers will take the initiative of spearheading this more rational approach before you have to say "open sesame" to your computer.

Dr A Hua  
Department of Medicine  
Queen Mary Hospital  
University of Hong Kong  
Hong Kong *Letters continued on page 30*

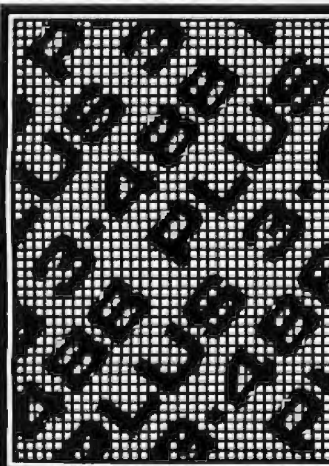

# THE 488+3 IEEE 488 TO S-100 INTERFACE

IEEE-488

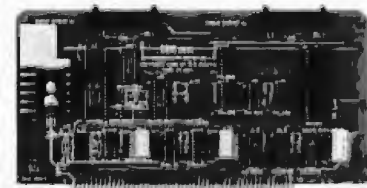

- Handles all IEEE-488 1975/78 functions
- IEEE 696 (S-100) compatible
- MBASIC subroutines supplied; no BIOS mods required
- 3 parallel ports (8255A-5)
- Industrial quality; burned in and tested
- \$375

(Dealer inquiries invited)

## D&W DIGITAL

1524 REDWOOD DRIVE  
LOS ALTOS, CA 94022 (415) 966-1460

S-100

# OPTIMUM™

## BROADEN YOUR HORIZONS

UVEON proudly announces OPTIMUM.™ OPTIMUM is an easy to use, total concept data management program for CP/M® and MP/M™ systems. Breaking through traditional DMS barriers, OPTIMUM provides large scale data management capability to broaden your computer horizons. Developed for individual computer users and applications builders, OPTIMUM supports user-defined forms and files, dictionaries, powerful reporting, storage efficiency, speed and unique cross-referencing. Everything you want in data management is now complete in one system.

### USER-DEFINED FORMS AND FILES

With OPTIMUM, implementing an application is simple. The user defines screen forms to fit the data and describes how the data is to be stored. Once this is complete, data entry may begin. Input editing, validation and cross-referencing during data entry extend OPTIMUM's range. If the need exists, OPTIMUM can handle complex or multiple screen forms for the same file. Screen forms may be modified and expanded as needed.

### DICTIONARIES

OPTIMUM maintains a dictionary of terms for each file. This dictionary contains information on each data element in the file and describes operations to be performed. Alterations and additions to the dictionary may be made as required.

**MICRO-ENGLISH™ REPORTING**  
OPTIMUM Micro-ENGLISH lets the user request standard or custom reports from the OPTIMUM files. Sophisticated selecting and sorting capability give Micro-ENGLISH all the power of a large scale interactive inquiry processor. A dictionary based vocabulary keeps the user interface simple.

### OPTIMUM STORAGE EFFICIENCY AND SPEED

OPTIMUM stores all information in a compact variable-length format. OPTIMUM files are designed for interactive speed; a single file item may be retrieved from among hundreds in an instant.

### OPTIMUM DATA CROSS-REFERENCING

A unique feature of the OPTIMUM system allows a user to cross-reference data elements. Once information is entered, it may be retrieved using key words in the data.

From simple applications to complex systems, OPTIMUM manages it all. Broaden your horizons using the total concept data management system with the power of such industry forerunners as Prime Information, Honeywell Ultimate and Microdata Reality. Call or write UVEON today for more information on OPTIMUM. 1-800-525-1637.

CP/M and MP/M are trademarks of Digital Research, Inc.  
OPTIMUM and Micro ENGLISH are trademarks of UVEON  
Computer Systems, Inc.

## UVEON

The Future in Software.

UVEON Computer Systems, Inc.  
899 Logan Street  
Denver, Colorado 80203

# ANNOUNCING

## A Major Breakthrough

The

# SYSTEM 2800

The System 2800 is the next logical step in the continuing line of innovative products from the Systems Group.

### Unbeatable S-100 Memory Boards

First was the development of the DMB6400 series of S-100 Memory boards featuring the innovative Bank Select switching technique. This enables users to software select up to four totally independent memory banks per board.



### The 2nd Generation

Then came the 2nd Generation of IEEE S-100 COMPATIBLE Z80 PROCESSORS, FLOPPY DISK CONTROLLERS and SERIAL I/O BOARDS. Each has been designed for single user, multi-user or

network operating systems such as CP/M®, MP/M™, CP/Net™ and OASIS™.



### The Next Logical Step ...

We challenged our design team to create an innovative yet competitive system utilizing our existing line of field proven, dependable S-100 boards. The result: a highly reliable, quality built, state of the art microcomputer that gives you the cost/performance edge you need to be a leader in your field.

The System 2800 comes with a choice of operating systems: CP/M with an enhanced CBIOS for single user systems and either MP/M or OASIS for multi-user, multi-tasking systems. MP/M is available with either a standard or

CP/M MP/M and CP/Net are trademarks of Digital Research  
OASIS is a trademark of Phase One Systems



enhanced XIOS. The CP/M based System 2800 provides improved diagnostic reporting capability and increased sector sizes of 1024 bytes yielding disk performance throughput increases up to 400% over standard unblocked systems.

The enhanced multi-user, multi-tasking MP/M based System 2800 provides the same advanced features as CP/M. In addition, this interrupt driven implementation can offer performance throughput increases up to 2000% thru extensive disk buffering for applications requiring a large number of disk accesses.

Also available is the OASIS operating system with ISAM files, automatic record locking and multiple-user print spooling.

All operating systems are available in either floppy or hard disk configurations. The disk drive selection includes single or double sided, double density 8-inch floppies with up to 2.52 megabytes of formatted storage per system, expandable to 5.04 megabytes, and an 8-inch 10 megabyte winchester hard disk.

### **Cost Effective Reliability**

Dealers, OEM's and System Integrators share many common needs. Not the least of these is dependable products. That's why we back our System 2800 with our established reputation for high quality products, superior support, prompt and courteous service, and a one-year warranty.

Take the next logical step. See your nearest computer dealer, or contact us for the complete story on our S-100 family of board products and enhanced systems.

## **Systems Group**

A Division of MEASUREMENT systems & controls  
incorporated

1601 Orangewood Ave.  
Orange, Calif. USA 92668  
(714) 633-4460 TWX/TELEX: 678 401 TAB IRIN

For International Sales Inquiries contact: SIGMA INTERNATIONAL, INC., P.O.  
Box 1118, Scottsdale, AZ 85252 USA (602) 994-3435 / Telex 165 745 Sigma



# SITTING PRETTY

You can use just about any desk for a computer terminal stand. But with CF&A, you're sitting pretty. Our full range of desks, workstations, and terminal stands are designed to accommodate a variety of computer equipment. Choose from our Classic Series desks, DR Series desks and enclosures, specialty items like our Apple II desk, or a universal printer stand. You'll be sitting pretty with attractive color selections, durable construction, versatile configurations, useful options, competitive prices, quick delivery, and personal service. It's our way of doing business.

## CF&A

**Computer Furniture and  
Accessories, Inc.**  
1441 West 132nd Street  
Gardena, CA 90249  
(213) 327-7710

## Letters

### The Wind Blows Where It Listeth

Something is a bit strange about BYTE's May 1981 cover. The sail is full and set for a run (which means wind astern), the burgee points to port (which means wind off the starboard), and the spray from the bow wave points to starboard (which means wind to port). I've seen things like this on a lake just leeward of an island, but only for a moment. It's pretty unlikely on the open sea. And, worst of all, the sail has a big hole in it!

BYTE's cover has inspired a new disparaging remark about a landlubber: he doesn't know his sail from a floppy disk.

John A Ball  
Oak Hill Rd  
Harvard MA 01451

*The May cover is a faithful representation of a situation that occurred during the BYTE staff's last outing. By the way, we know about floppy disks, but what's a "sail"? . . . CPF*

### Programming As an Essay

As a programmer whose background is in literature, I am naturally sympathetic to the analogy between programming and natural languages that John Handel draws in his article "The New Literacy: Programming Languages as Languages." (See the March 1981 BYTE, page 300.) That a programming language is indeed called a language, that programming borrows much of its lingual terminology from natural languages (eg: word, paragraph, syntax), offers at least a hint of the parallel that Mr Handel persuasively develops.

At one point, however, he makes an analogy between a program and a book that I find a bit contrived. His argument would be better served with an analogy between a program and a formal essay. Having written both, I find the thought processes involved in both remarkably similar.

Essentially, a formal essay consists of a thesis, arguments to support that thesis, and a conclusion. Its usual purpose is to interpret, persuade, or inform: to solve some critical or rhetorical problem. Before writing can begin, an essayist must be able to express clearly to him- or herself the thesis and conclusion in order to define



# Please call (213) 883-8594.

# Our Epson prices are so low, we're not allowed to print them.

## EPSON MX-80 .....\$CALL

80 cps/9x9 matrix/Lower case with true descenders/Bi-directional & Logic seeking/Adjustable tractor/Expanded printing/Block graphics/Forms control/Compressed printing/Double-strike printing/Correspondence quality/Emphasized printing mode/Standard parallel interface

## EPSON MX-80 F/T .....\$CALL

Same features as the MX-80 plus Friction Feed. Adjustable removable tractor is standard for ease of handling forms and single sheets.

## EPSON MX-100 F/T .....\$CALL

Same features as the MX-80 & MX-80 F/T but on 15½ inch carriage for printing 132 columns with standard 10 cpi font or 232 columns in the compressed character font. The MX-100 is complete with Dot Resolution Graphics

## EPSON INTERFACES & OPTIONS

TRS-80 MODEL I, III CABLE	\$ 30	SERIAL INTERFACE (2K BUFFER)	\$ 149
TRS-80 MODEL I Keyboard Interface	\$ 95	SERIAL CABLE Male to Male	\$ 30
TRS-80 MODEL II CABLE	\$ 30	DOT RESOLUTION GRAPHICS	\$ 90
APPLE INTERFACE & CABLE	\$ 100	REPLACEMENT RIBBON	\$ 13
IEEE 488 INTERFACE	\$ 60	REPLACEMENT PRINT HEAD (Quiet type)	\$ 40
SERIAL INTERFACE	\$ 70	EPSON SERVICE MANUAL	\$ 40

# Alpha Byte STORES

## We built a reputation on our prices and your satisfaction.

We guarantee everything we sell for 30 days. If anything is wrong, just return the item and we'll make it right. And, of course, we'll pay the shipping charges.

We accept Visa and Master Card on all orders. COD accepted up to \$300.00. We also accept school purchase orders.

Please add \$2.00 for standard UPS shipping and handling on orders under 50 pounds, delivered in the continental U.S. Call us for shipping charges on items that weigh more than 50 pounds. Foreign, FPO and APO orders please add 15% for shipping. California residents add 6% sales tax.

31245 La Baya Drive, Westlake Village, California 91362

Circle 13 on Inquiry card.

## Letters

the problem, its scope, and to provide a framework for its solution. Similarly, a programmer must have a definition of his or her problem, and he or she must be able to frame a solution before coding can begin. Both the essayist and the programmer must know where they want to go before they can begin the detailed work to get there.

Next, the essayist must gather his or her major arguments and break the thesis into components, just as a programmer will break the problem into manageable parts. A writer will then arrange the arguments so that they flow smoothly through the

essay. A programmer will begin arranging the parts of the problem so that they operate in an orderly fashion.

Finally, the detail work can begin. A writer will supply minor arguments and examples to "flesh out" his or her work. A programmer at this point concentrates on code. Both will polish their work, ensuring that grammar, diction, and syntax are correct.

An essay may not have to communicate "in a precise fashion" and an essayist must rely on a reader to "test" the thesis (not as strict a standard as a programmer's computer), but an essay must communicate in

a reasoned and orderly fashion. Both writer and programmer must be logical within a verbal framework.

I agree with Mr Handel's conclusion that a programmer with verbal sensibility will tend to write readable programs that work. Perhaps then, programming installations, especially commercial shops where the work is not technical or mathematical, may do well to employ language and linguistic students. Perhaps too, a source of programming talent may be found in writers and students of philosophy and history who already have a command of language and procedural skill and who could learn the particulars of programming quickly and easily.

Michael J Nichols  
1725 York Ave  
New York NY 10028

## Vikings Defense

It may be that BYTE's attention somehow has been focused on the aspects of violence in the history of the Vikings. The cover on the May 1981 BYTE and the text on page 4 does, however, indicate that BYTE ought to read up on the Vikings as well as on their contemporary history.

BYTE has done the Vikings a gross injustice by merely stating that they were "notorious pirates." Let me say in their defense that they were also clever sailors, innovative navigators, explorers, and tradesmen, who traveled routes that today seem impossible considering the equipment they had at hand. They were tough, maybe, and violent—living in times of different general ethics and values than you may wish for yourself today. But, to call them pirates, with an indication of lawlessness, is simply an (unfair) application of current values to a very different time and place.

The Vikings also were clever ship-builders, building perhaps the most beautiful boats that have ever been made. You may see some of these here in Oslo and judge for yourself.

Einar Skjorten  
Rytterfaret 21  
1347 Hosle, Norway

*We apologize, Mr Skjorten, for our somewhat simplistic representation of the Vikings. . . CM*

New

# XCEL™ GRAPHICS

512 x 240 RESOLUTION

For Z-89 & Superbrain

And soon for TRS 80 MODEL II

XCEL™ GRAPHICS UNIT — A completely assembled hardware retrofit package providing high resolution graphics display, normal video display or both displays simultaneously. **\$895.00**



**\$175.00**

XCEL™ SYMBOL GENERATOR—Subroutine in generates characters and strings with odd size and 80° rotation options, circles, arcs, vectors, rectangles, and fills with reverse video option. All callable from your programs.

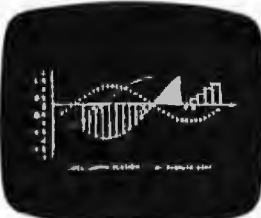

**\$175.00**

XCEL™ GRAPH PLOTTER—Choice of four representations (line graph, histogram, bar graph and scatter plot) with automatic annotation of axes and automatic scaling that allows any number of functions to be displayed on one set of axes. All callable from your programs.



**\$395.00**

XCEL™ SURFACE PLOTTER—True perspective view with full hidden line removal of curved surfaces from a user defined viewpoint. Callable from your programs.



**\$345.00**

XCEL™ D-D GENERATOR—User adjustable wireframe for character coding and viewing wireframe objects from any angle and in any orientation. Wireframe objects are defined in the editor.



**\$395.00**

XCEL™ GRAPHICS TERMINAL—Emulates a subset of the Tektronix® 4010 Series Graphics Terminal functions. Simple menu-driven key-board commands for configuration and dot-dash and three mode versions.

XCEL™ software packages operate under CP/M® and utilize the Microsoft parameter passing mechanism for compatibility with high level languages, such as BASIC, FORTRAN, COBOL, PL1, and PASCAL. XCEL software can be loaded into high memory and called from your programs or integrated directly into your programs through use of the Microsoft linking loader.

FOR ADDITIONAL PRODUCT INFORMATION  
IN CONTINENTAL U.S. CALL TOLL FREE:

(800) 421-1423

IN CALIFORNIA CALL  
(213) 320-6604



**MAXTEK, INC.** 2908 Oregon Court, Torrance, CA 90503

Tektronix® is a registered trademark of Tektronix, Inc. CP/M® is a registered trademark of Digital Research.



# The guy on the left doesn't stand a chance.

The guy on the left has two file folders, a news magazine, and a sandwich.

The guy on the right has the OSBORNE 1®, a fully functional computer system in a portable package the size of a briefcase. Also in the case are the equivalent of over 1600 typed pages, stored on floppy diskettes.

The owner of the OSBORNE 1 is going to get more work done—and *better* work done—in less time, and with less effort.

**Unfold it, plug it in, and go to work like you've never worked before. . . .**

Go to work with WORDSTAR® word processing, so your correspondence, reports, and memos take less time to produce, and say more of what you wanted to say. And with MAILMERGE®—the mailing system that turns out personalized mass mailings in the time you'd spend on a rough draft.

Go to work with SUPERCALC®, the electronic spreadsheet package that handles complex projections, financial planning, statistics, and "what if" questions instantly. For the more technically minded, SUPERCALC will process scientific data and calculate results.

Go to work with powerful BASIC language tools—the CBASIC-2® business BASIC, or the Microsoft BASIC® interpreter.

That's standard equipment.

Options include about a thousand different software packages from a host of vendors designed to run on the CP/M® computer system.

**Go to work at the office, at home, or in the field.**

Or anywhere. Optional battery packs and telephone

transmission couplers mean you need never work without the capabilities of the OSBORNE 1. That's good, because you won't want to work again without it.

**All for \$1795. It's inevitable.**

The OSBORNE 1 is the productivity machine that's changing the way people work. Put simply, the machine delivers a significant productivity edge—day in and day out—to virtually anyone who deals with words or numbers. Or both.

Since the entire system is only \$1795, it won't be too long before the guy on the left has an OSBORNE 1 of his own. The same probably goes for the person reading this ad. In fact, we think it's inevitable.

The OSBORNE 1 includes a Z80A® CPU, 64K bytes of RAM memory, two 100 kilobyte floppy disk drives, a business keyboard, built-in monitor, IEEE 488 and RS232 interfaces for printers and other things that get connected to computers, plus CP/M, CBASIC-2, Microsoft BASIC, WORDSTAR, and SUPERCALC. The system is available from computer retailers nationally.

**\$1795. It's inevitable.**



## OSBORNE

**COMPUTER CORPORATION**

26500 Corporate Avenue Hayward, California 94545  
Phone (415) 887-8080 TWX (910) 383-2021

## Principles of Artificial Intelligence

Nils J Nilsson  
Tioga Publishing, 1980  
476 pages, hardcover  
\$27.50

Reviewed by  
Steven K Roberts and  
James Paul Jenal  
5885 Dublin Rd  
Dublin OH 43017

Artificial intelligence (AI), for over two decades the arcane province of academic visionaries, is at last spilling over into the worlds of engineering and practical system design. A fascination with the programming language LISP is sweeping the industry, robotics and machine vision (though still primitive) are something other than fantasy, and the cost of computer hardware on a scale necessary for AI work has dropped to the point where it even touches the personal computer spectrum.

It is becoming worthwhile to learn something about the subject for reasons beyond intellectual curiosity.

A new book by Nils J Nilsson offers a substantive look at a body of techniques upon which much of the work in the artificial intelligence field is based. Presently the director of the Artificial Intelligence Center of Stanford Research Institute, Nilsson has for years been involved in problem-solving, theorem-proving, and planning systems, and has authored publications along these lines that date back to the early 1960s.

*Principles of Artificial Intelligence* is intended as a text for a college senior or first-year graduate student, and can thus be considered to be the reader's first serious exposure to the field. But a

question arises as to whether or not the ensuing (fairly rigorous) discussion of predicate calculus is the way to proceed. Though the text was written as an introduction and does, in fact, concern itself far more with underlying techniques than with applications areas, it focuses fairly strongly upon formalisms with which the reader new to the field might be a little uncomfortable.

Predicate calculus is certainly not new to serious students of computer science—it is required material in almost any undergraduate computer-science curriculum, though exposure is typically limited to formal proving exercises. Nevertheless, predicate calculus does provide a refined set of manipulative tools that are useful for the implementation of knowledge-based production systems, and it has a distinct advantage over some of the more intuitive paradigms, such as relational databases and semantic networks, in that it has matured from many years of disciplined development in other application areas. Though imposing in appearance, it is a reliable basis for system design and, thanks to its universal acceptance, for communication of ideas with other workers in the field.

However, one of the ideals of artificial intelligence work is the comfortable bridging of the vast conceptual gap between man and machine. Although this inevitably requires the application of formal tools, it should eventually lead to increased "naturalness" of problem expression. In a purely rigorous sense, any Turing machine implementation is as good as another (they provide the same computing power), but the differences to those who

must use them are significant. As anyone who has ever attempted to express abstract, symbolic constructs within the syntactical and semantic restrictions of FORTRAN knows only too well, the issue of naturalness is inexorably tied to the representation problem.

Early on, Nilsson states that "selecting a good representation is one of the important arts involved in applying AI techniques to practical problems." This is indeed true, not only in this field but in all aspects of computer problem solving. Knowledge representation, whether via a body of production rules (if...then constructs), frames (relatively passive data entities appropriately interconnected and applied to a set of inference procedures), or any other means, is a central and hotly contested issue that affects not only the usefulness of a system's design but its naturalness. While different approaches may not necessarily provide greater power, they might free the mind to achieve greater insights—and insight is at the heart of all problem solving.

Nilsson makes a good case for the use of predicate calculus as the set of "cranks" with which any type of system can be implemented. Whether or not this approach constitutes an optimal entry into the artificial intelligence field is partly a function of the reader. From a classical engineering standpoint, the assimilation of formal methods before exposure to the more philosophical aspects is absolutely necessary, and for those who are comfortable with this approach, the book comes highly recommended: the problems are interesting, yet not so esoteric that you lose sight of their purpose—name-

ly, the chance to apply the principles that Nilsson has so painstakingly laid out. Those who lack the text's presupposed ease with formal methods (and there is much of interest in the field that does not require it) might prefer a book targeted to an overview of AI's various specialties (such as Patrick H Winston's classic, *Artificial Intelligence*, Philip C Jackson's *Introduction to Artificial Intelligence*, or Pamela McCorduck's *Machines Who Think*).

*Principles of Artificial Intelligence*, like its predecessor, *Problem-Solving Methods in Artificial Intelligence* (Nilsson, McGraw-Hill, 1971), can be considered an authoritative text on many of the underlying ideas that serve as the basis for the bulk of current artificial intelligence research. After Nilsson develops the primary theme, he provides a number of provocative comments about the field, and closes with a comprehensive and up-to-date bibliography of published works. Though hardly casual reading, the book offers solid underpinnings for methodologies which might otherwise appear disquietingly magical. ■

# Radio Shack's TRS-80<sup>®</sup> Model III is Your Best Buy in Desktop Computers.



\$2495

## Because You Get 48K at Last Year's 32K Price!

That's right, we've added 16K more memory, but kept the price at a low \$2495! The TRS-80 Model III is a complete, ready-to-run desktop computer packed with "extras" that don't cost extra:

**Two Double-Density Disk Drives.** You get two built-in 175K disk drives, and can add up to two more externally.

**BASIC in 14K ROM.** Our powerful Model III BASIC provides a program line editor, machine language programming, real time clock, and more. Compatible with most Model I Level II BASIC programs, too. Plus, you can expand with COBOL or Compiler BASIC any time.

**Upper and Lower Case Characters.** With a special graphics character set, and 64 characters-per-line format.

**Built-In Monitor.** 12" high-resolution.

**12-Key Datapad.** As well as repeating keys and keyboard-controlled screen print.

**Parallel Printer Port.** Add one of our printers anytime.

**RS-232 Serial Interface.** For data communications, just add a modem.

**Nationwide Support.** Backed by 6100 Radio Shack stores and dealers, 160 Computer Centers and 160 service centers throughout the USA.

**Available Now.** Why pay more? Get a demonstration today. Also check out our

\$999 16K Model III—it's a perfect "starter" system.

**Radio Shack<sup>®</sup>**  
The biggest name in little computers<sup>™</sup>  
A DIVISION OF TANDY CORPORATION

Read about your best buy in computers. Send for a TRS-80 catalog.

Radio Shack, Dept. 82-A-122  
1300 One Tandy Center  
Fort Worth, Texas 76102

NAME \_\_\_\_\_  
STREET \_\_\_\_\_  
CITY \_\_\_\_\_ STATE \_\_\_\_\_  
ZIP \_\_\_\_\_ PHONE \_\_\_\_\_

Retail prices may vary at individual stores and dealers. Special order may be required.

# A LOOK AT NCC '81

by Steven K Roberts, 5885 Dublin Rd, Dublin OH 43017

*This year's National Computer Conference, held last May 4 through 7 at McCormick Place in Chicago, was so large that nobody could effectively see all of the show in the four days allotted to it. In fact, with about 73,000 people attending, it was often difficult to see the displays at all. The task was also complicated by the juxtaposition of booths for every type of computer, from microcomputer to mainframe, and their associated supplies and peripherals. Still, what I did see was exciting; shown here are some of the attractions.*

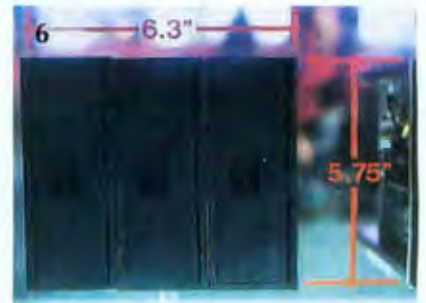



11



1 Any attempt to capture the entire NCC in a single photograph is doomed to failure.

2 The BMC IF-800 microcomputer. This new entry from Japan is impressive, although its price might be too high for the casual user.

3 The LEX-21 is a portable terminal with a full-size keyboard, a 40-column printer, a buffer of up to 8 K bytes of memory, and a built-in direct-connect 300-baud modem.

4 The Apple booth was constantly well attended because of the many applications being demonstrated.

5 The Corvus Omninet, a local network system that can interconnect up to 64 microcomputers via a simple twisted-pair wire connection. Each microcomputer connects to the twisted-pair bus through an interface called a "transporter." Interfaces now exist for Apple, LSI-11, and Onyx computers.

6 BASF's slimline 5.25-inch floppy-disk drives. Three of these units will fit in the space of two drives of conventional design.

7 The TRS-80 Color Computer was displayed prominently at the Radio Shack booth. With its Extended Color BASIC, the unit can deliver impressive color graphics.

8 and 10 The Xerox Star. A view of the unit's video display, photo 8, shows why the Star was one of the most popular exhibits at the show—it delivers on its promise of "What you see on-screen is what you get." Photo 10 shows the Star itself, an intelligent office terminal that can be connected to Xerox's Ethernet.

9 The Sony Typecorder, a self-contained, battery-powered "portable office" about the size of an issue of BYTE. The unit stores both voice and text (up to 120 pages) on a microcassette and can dump text to a printer or transmit it over telephone lines.

11 Tandon displayed an 8-inch floppy-disk drive that is exactly half the width of conventional units.

12 A high-resolution display using Cromemco's Super Dazzler board along with its SDI color-graphics interface. The resulting video image can be made from a palette of 2048 colors.

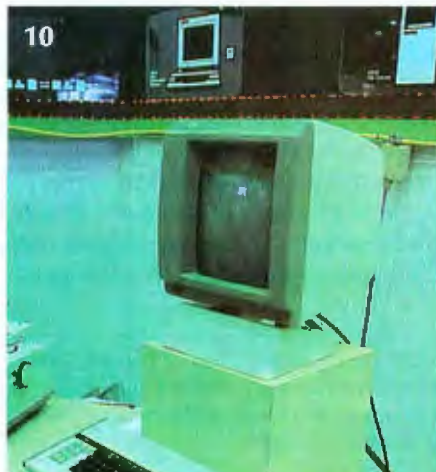
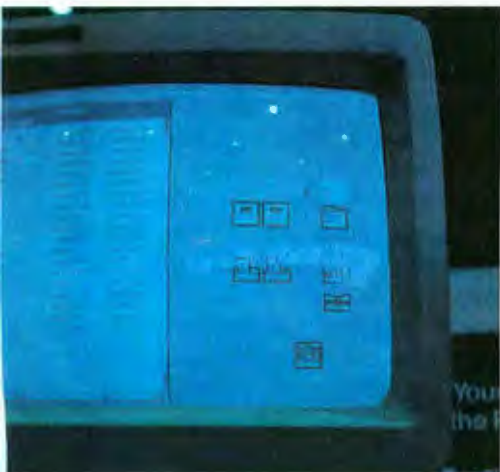

10

# Build an Unlimited-Vocabulary Speech Synthesizer

---

Steve Ciarcia  
POB 582  
Glastonbury CT 06033

---

The alarm clock that jolts you out of sweet dreams with a monotone buzz is a thing of the past. State-of-the-art technology is the clock that prods you out of slumber with a *voice* that speaks your own language: "The time is 6 o'clock."

The artificial voice is becoming an increasingly important and potentially indispensable part of the interface between man and machine. Electronic speech synthesis is a young but rapidly evolving technology. It won't be long before that speaking alarm clock will also announce your entire day's appointment schedule. It will be no less unusual for the computer in your car to recount its mechanical ills as you drive to work. For now, however, electronic speech synthesis is still a relatively new concept.

In a previous Circuit Cellar article ("Build a Low-Cost Speech-Synthesizer Interface," June 1981 BYTE, page 46), I described the design of an inexpensive, limited-vocabulary, computer-controlled electronic speech synthesizer called the Micromouth. This speech processor, based on the National Semiconductor Digtalker chip set, was an attempt to introduce

personal computer users to artificial speech. Considering the response it received, I believe many of you are now listening to everything your computer has to say.

This month I wish to return to the topic of computer-controlled electronic voice synthesis and introduce you to the Votrax SC-01 speech synthesizer chip.

Instead of waveform digitization or linear-predictive coding, the SC-01 uses phoneme synthesis, which allows the SC-01 to speak an unlimited vocabulary simply by sequentially pronouncing the individual phonemes (basic sound units) that make up words in the English language.

Many other articles have been written that describe in detail the theory of phoneme synthesis and the workings of the Votrax SC-01 integrated circuit. A few appropriate references are given at the end of this article. Instead of discussing many theoretical concepts at length in my limited space here, I prefer to concentrate on the design of a practical, computer-controlled, phonetic speech synthesizer.

This month's construction project, shown in photo 1, is called the Sweet Talker speech synthesizer. It uses the SC-01 integrated circuit to allow syn-

thesis of an almost unlimited vocabulary (limited only by the size and complexity of the controlling program running on the computer). The Sweet Talker circuit contains I/O (input/output) signal buffering, a clock oscillator, an audio filter, and an amplifier. The circuit board provides protection from static electricity for the SC-01 in addition to being a convenient package. (Protection for the SC-01 is important, because it is both expensive—\$70—and delicate. It's made using complementary metal-oxide semiconductor technology.) The standard Sweet Talker synthesizer can be connected to any microcomputer through a parallel port, while a special version of the unit can be plugged into the I/O bus of the Apple II computer.

### Speech-Synthesis Review

Three major techniques are presently used to synthesize the human voice: formant synthesis, linear-predictive coding (LPC), and waveform digitization. They differ in the number of bits of data required to construct a word.

*Formant synthesis* is essentially an electronic modeling of the natural resonances of the human vocal tract. Bands of resonant frequencies in the vocal spectrum, called formants, are generated by excitation sources and then passed through variable filters.

One variation of the formant technique is called phoneme synthesis, in

---

*Votrax is a trademark of Federal Screw Works, Inc.*

---

*Digtalker is a trademark of National Semiconductor Corporation.*

---

Copyright © 1981 by Steven A Ciarcia.  
All rights reserved.

---

---

*Special thanks to Ray Long of Custom Photo and to Greg Peterson and Phil Walton of Tech Circuits for their expert printed-circuit design and production talents.*

---



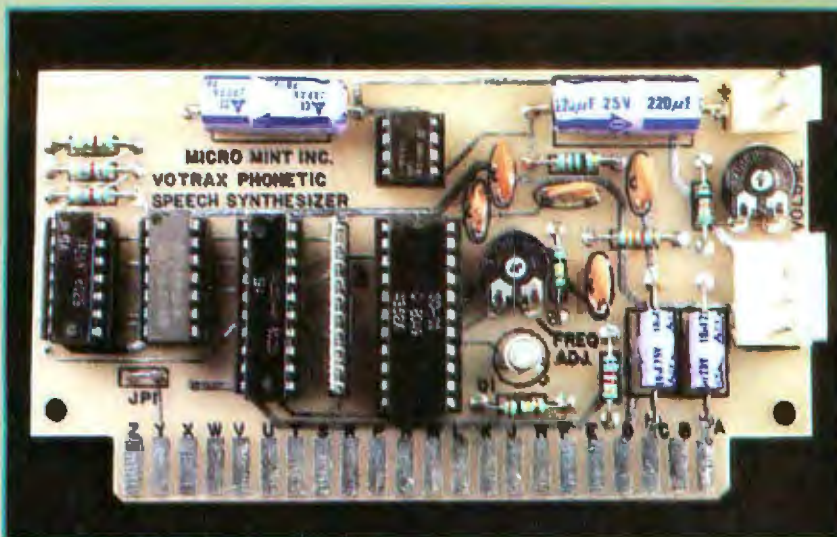

Photo 1: The assembled Sweet Talker phonetic-speech-synthesizer circuit board. The Votrax SC-01 phoneme-synthesizer integrated circuit supports a vocabulary limited only by the size and complexity of the computer program that controls the Sweet Talker. Any English word may be constructed from phonemes, the basic building blocks of speech. The circuit board shown is a prototype of the parallel-port version of the Sweet Talker; the Apple II plug-compatible version is not shown.



Photo 2: The Votrax SC-01 is a 22-pin CMOS integrated circuit which functions as an electronic model of the human voice.



Photo 3: Before the development of the SC-01, Votrax used many medium-scale-integrated circuits and discrete components to perform the same functions. All these components were mounted in modules such as the VSL-type shown. When this particular synthesizer card was purchased three years ago, the price was \$600. Compare this both in size and price to the \$70 SC-01 (sitting on top).

which the spectral parameters are derived from basic sound units that make up words. A phoneme-generator circuit is used to reproduce these sounds. In such a circuit, each phoneme is given a numeric code, and the synthesizer circuit (discrete or integrated) utters phoneme sounds corresponding to codes it receives when it is activated. Words and sentences are assembled by simply stringing the phoneme codes together. The electronic voice so generated is intelligible, but has a slight mechanical quality. Continuous speech using phoneme synthesis can typically be generated with a data rate of less than 100 bps (bits per second).

*Linear-predictive coding* is similar to formant synthesis in that both techniques are based in the frequency domain and use similar hardware to model the vocal tract. The quality of speech is often better than formant or phoneme synthesis, but a higher data rate (1200 to 2400 bps) is needed for continuous speech.

*Waveform digitization* is the third method of speech synthesis, in which the amplitude characteristics of a vocal waveform are stored and reproduced. The quality of speech is better than the other two methods, but the data rate for continuous speech is very high, and storing sufficient amounts of data conveniently can be a problem. Various schemes of compressing the data have been devised; one of the more successful is used in the National Semiconductor Digtalker system, which I described in my June Circuit Cellar article.

### Votrax SC-01

The 22-pin Votrax SC-01 integrated circuit, shown in photo 2 and in the diagrams in figure 1, contains a digital code translator, or phoneme controller, and an electronic analog of the human vocal tract. The phoneme controller translates a 6-bit phoneme code and a 2-bit pitch code into a matrix of spectral parameters which in turn adjusts the vocal-tract analog to synthesize the phonemes.

In the first part of the vocal-tract section, there are a pair of variable-frequency oscillators for simulating

(1a)

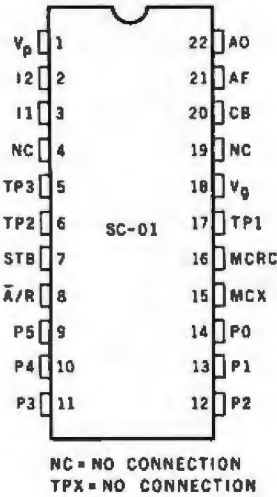

(1b)

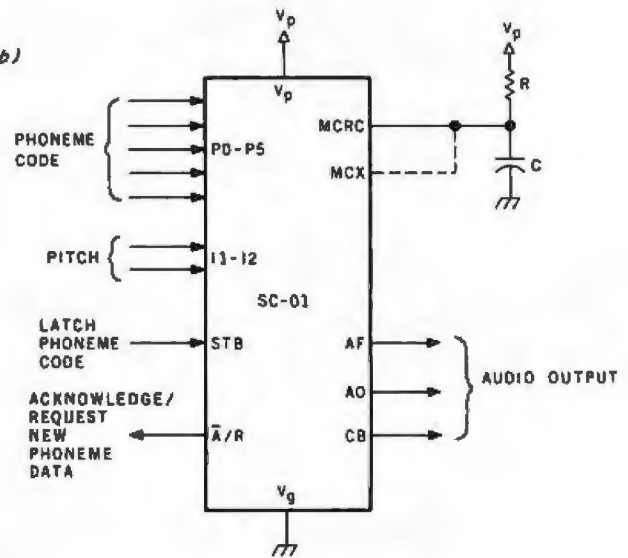

(1c)

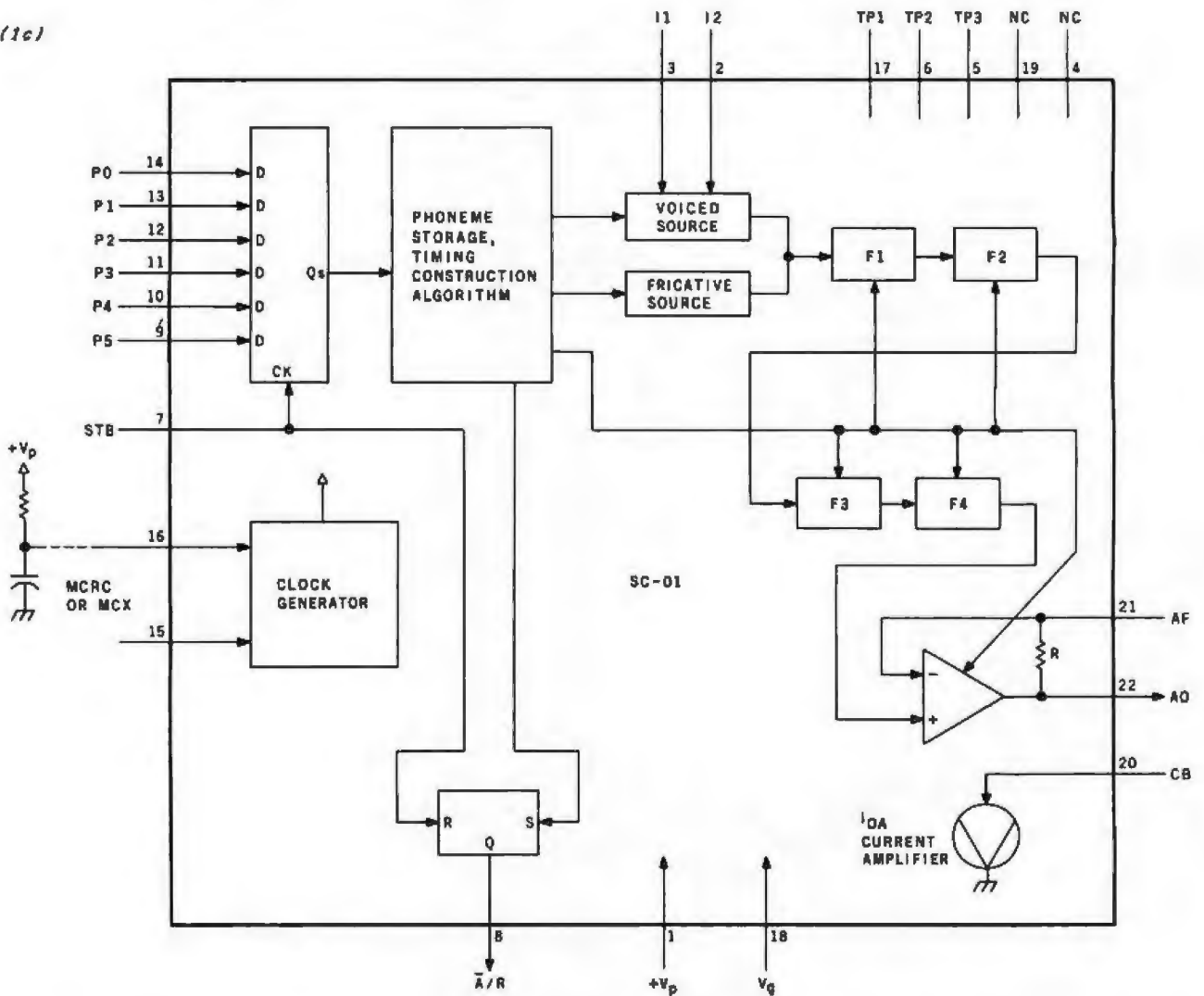

Figure 1: Technical characteristics of the Votrax SC-01 Speech Synthesizer Chip. Shown are the pinout designations (1a), the scheme of data flow through the circuit (1b), and a block diagram of the internal structure (1c). This figure is reproduced courtesy of the Votrax Division of Federal Screw Works, Inc.

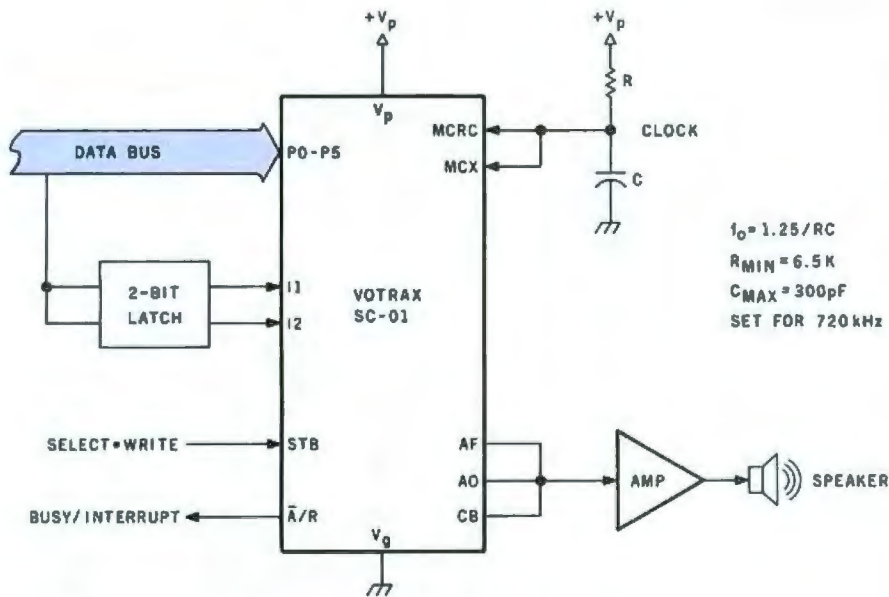

Figure 2: A diagram of the general connection scheme of the SC-01.

vocal-cord-produced periodic sounds and a pseudorandom (pink-noise) signal generator that simulates the sound of rushing air. The output signals from these sources are shaped by a bank of four analog band-pass filters that simulate the vocal-tract cavities. The filter outputs, in turn, are directed through a preamplifier to an external amplifier and speaker.

The SC-01 phoneme synthesizer is a CMOS (complementary metal-oxide semiconductor) integrated circuit which should be operated within the range of 7 to 14 V ( $V_p$ ). The phoneme-input lines (P0 through P5) are 5 V level-compatible and self-latching. (Here "5 V level-compatible" means matching LSTTL [low-power Schottky transistor-transistor logic]

levels with an external pull-up resistor.) The two pitch-control lines, on the other hand, must have external latches and must be switched at the same input voltage as the SC-01's power supply. Handshaking with external control circuitry is accomplished through two control lines: strobe (STB) and acknowledge/request ( $\bar{A}/R$ ). The STB line can be either CMOS or 5 V level, while the  $\bar{A}/R$  line is CMOS level only.

The output pitch of the phonemes is controlled by the frequency of the clock signal, which can be applied from an external source or set internally with a resistor and capacitor combination. The clock frequency is nominally 720 kHz, but subtle variations of pitch are induced through "automatic inflection" to prevent the synthesized voice from sounding too monotonous or "robot-like." Two independent pitch-control lines, I1 and I2, are available for gross variations in pitch so that the chip can speak with more than one voice. Referred to as "manual inflection" controls, I1 and I2 operate in addition to the automatic-inflection system already present. I have found that the 6-bit phoneme code alone is sufficient, and the two pitch-control lines can be ignored. A diagram of the general connection scheme is shown in figure 2.

Listed in table 1 on page 42 are the 64 phonemes defined for the English language (two produce silent periods of different lengths; one causes synthesis to stop). A phoneme sound is generated when a 6-bit phoneme code is placed on the control-register input lines (P0 through P5) and latched by pulsing the strobe (STB) input. Each phoneme is internally timed and has a duration of 47 to 250 ms (milliseconds); some phonemes last longer than others, and variations in the clock frequency affect the phoneme durations. The  $\bar{A}/R$  line goes from a logic 1 to a logic 0 when a phoneme is sounding.

There are two general methods for using the SC-01. One method, shown in figure 3a on page 43, configures the chip in an independently acting, self-timed circuit which asynchronously extracts phoneme codes from a

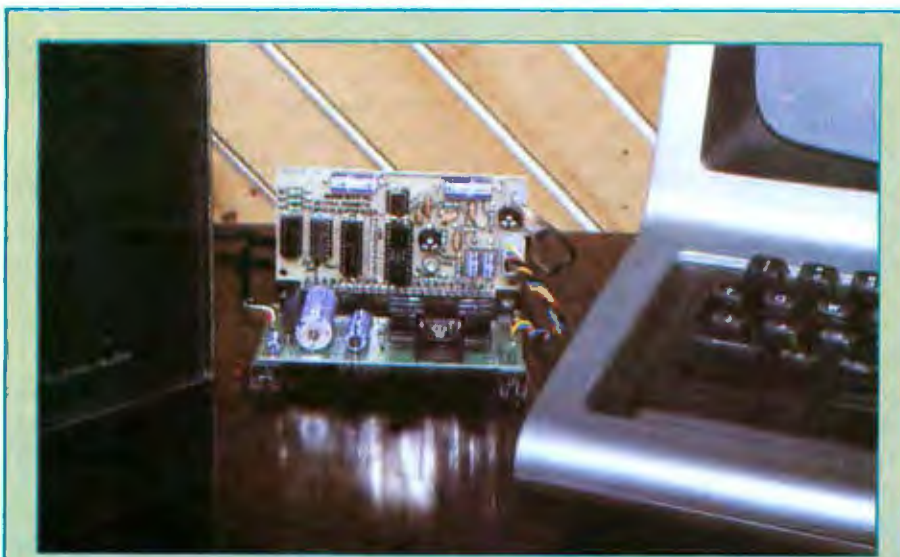

Photo 4: The Sweet Talker phonetic-speech-synthesizer board can be driven through any parallel output port. One port which can be used is a Centronics-compatible parallel printer port. When using this connection, phonemes for words to be spoken are transmitted using LPRINT statements in BASIC. Pictured above is the Sweet Talker board combined with its power supply and connected to a TRS-80 Model III computer and a speaker.

Hexadecimal Phoneme Code	Phoneme Symbol	ASCII Character	Duration (ms)	Example Word
00	EH3	@	59	jacket
01	EH2	A	71	enlist
02	EH1	B	121	heavy
03	PA0	C	47	no sound
04	DT	D	47	butter
05	A2	E	71	make
06	A1	F	103	pe/I
07	ZH	G	90	pleasure
08	AH2	H	71	honest
09	I3	I	55	inhibit
0A	I2	J	80	inhibit
0B	I1	K	121	inhibit
0C	M	L	103	mat
0D	N	M	80	sun
0E	B	N	71	bag
0F	V	O	71	van
10	CH	P	71	chip
11	SH	O	121	shop
12	Z	R	71	zoo
13	AW1	S	146	lawful
14	NG	T	121	thing
15	AH1	U	146	father
16	OO1	V	103	looking
17	OO	W	185	book
18	L	X	103	land
19	K	Y	80	trick
1A	J	Z	47	judge
1B	H	[	71	hello
1C	G	\	71	get
1D	F	]	103	fast
1E	D		55	paid
1F	S	-	90	pass
20	A	(space)	185	tame
21	AY	!	65	jade
22	Y1	"	80	yard
23	UH3	#	47	mission
24	AH	\$	250	mop
25	P	%	103	past
26	O	&	185	cold
27	I	'	185	pin
28	U	(	185	move
29	Y	)	103	any
2A	T	.	71	tap
2B	R	+	90	red
2C	E	,	185	meet
2D	W	-	80	win
2E	AE	.	185	dad
2F	AE1	/	103	after
30	AW2	0	90	salty
31	UH2	1	71	about
32	UH1	2	103	uncle
33	UH	3	185	cup
34	O2	4	80	bold
35	O1	5	121	aboard
36	IU	6	59	you
37	U1	7	90	June
38	THV	8	80	the
39	TH	9	71	thin
3A	ER	.	146	bird
3B	EH	:	185	ready
3C	E1	<	121	be
3D	AW	=	250	call
3E	PA1	>	185	no sound
3F	STOP	?	47	no sound

Note: T must precede CH to produce "CH" sound.  
D must precede J to produce "J" sound.

Table 1: The sixty-four phonemes defined for the English language. Two of these produce silence; one causes synthesis to cease.

dedicated memory buffer. Typically a 32- or 64-character FIFO (first-in, first-out) buffer is attached to the computer bus and loaded with the phoneme codes under program control. Once loaded, the codes are shifted out one at a time as the STB and  $\bar{A}/R$  lines change states. This self-clocking technique can also be used with an EPROM (erasable programmable read-only memory) and a counter when the SC-01 is to speak a canned message without computer control.

While use of a FIFO buffer reduces the main processor's waiting time when exercising relatively slow (typically 70 bps) peripheral devices such as the SC-01, buffers are expensive. Interface-hardware costs can be measurably reduced by a second scheme: using the computer system (running an appropriate program) to time the transmission of phoneme codes to the SC-01, as outlined in figure 3b. This method sends codes to the synthesizer chip through a latched parallel output port and monitors the synthesizer's activities (via the  $\bar{A}/R$  line) through an input port or interrupt line.

The latter is the technique I chose to use in my design. Interestingly enough, eliminating the extra hardware doesn't really complicate computer/synthesizer interaction nor does it require a sophisticated machine-language driver program like those ordinarily associated with software-controlled peripheral devices. The program code to control the synthesizer can be as simple as an LPRINT statement in BASIC. More on this later.

### Sweet Talker

The schematic diagram of the Sweet Talker speech-synthesizer circuit board is shown in figure 4 on page 44. The phoneme-code bits are sent in parallel to the SC-01 (IC3) and buffered through IC1 (a 74LS244 three-state octal buffer). Pull-up resistors assure that a logic-1 input to the SC-01 will be at least 4 V as required. Unless the board is being used with external address circuitry, the  $\bar{Enable}$  input line (on connector J1,

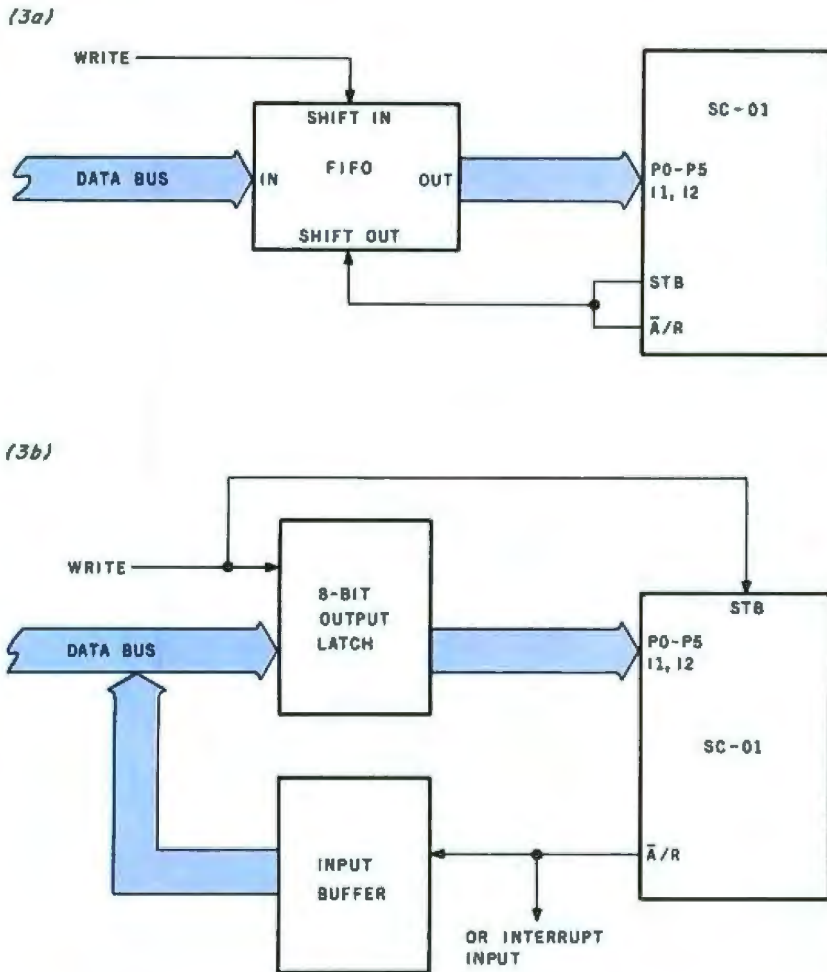
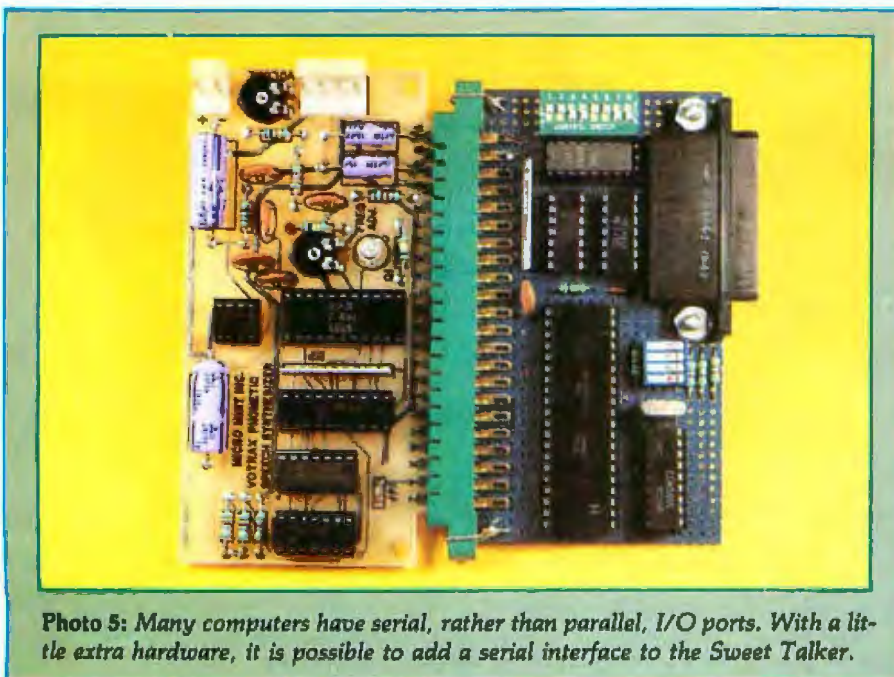

Figure 3: Two methods of interfacing the SC-01 to a microcomputer data bus. Figure 3a shows an independently acting, self-timed circuit with a FIFO (first-in, first-out) buffer. Figure 3b shows a circuit that allows the computer to time the transmission of data to the SC-01.



pin 12) should be grounded, thereby continuously enabling the buffer.

The two manual-inflection inputs (I1 and I2) are also buffered through IC1. The SC-01 cannot store these signals, and storage must be provided externally. A 74LS74 type-D flip-flop (IC2) is configured as a 2-bit latch. It is clocked synchronously with the SC-01's strobe input. Unlike the phoneme inputs, however, the inflection lines are not 5 V compatible. Two sections of a 7416 open-collector inverter (IC4) are used with pull-up resistors to level-shift these data inputs to CMOS levels. Since the automatic inflection is generally adequate, the manual-inflection inputs (J1, pins 16 and 20) can be left open or grounded when not in use.

The SC-01 can use either its internal clock or an external clock. External clock signals are applied through pin 15 on the SC-01 while pin 16 is grounded. My design uses the internal clock-signal generator, instead. The clock frequency is determined by an R/C (resistor/capacitor) combination attached to pins 15 and 16. The frequency is adjusted through potentiometer R8 and nominally set for 720 kHz. Slight adjustments to this control will vary the pitch of the speech. The easiest way to set this potentiometer is by ear. Simply output a sequence of phonemes to the SC-01 and set R8 for the most pleasant-sounding voice.

The process of sounding a phoneme begins when the 6-bit phoneme code is latched into the SC-01's control register. Latching occurs when the rising edge of a positive-going strobe pulse is received on pin 7 of the SC-01, the STB input line. The synthesizer will continue to sound the same phoneme until another phoneme code or a stop code is loaded.

The Sweet Talker circuit board can be set up (through jumper connections) to accept either a normally high or a normally low strobe signal from the external computer. Two sections of the inverter IC4 are involved in this flexibility. The normally high strobe signal connects to the Sweet Talker board through pin Y of the edge connector J1, while the normally

Figure 4: Schematic diagram of the Sweet Talker phonetic synthesizer in the parallel-port version.

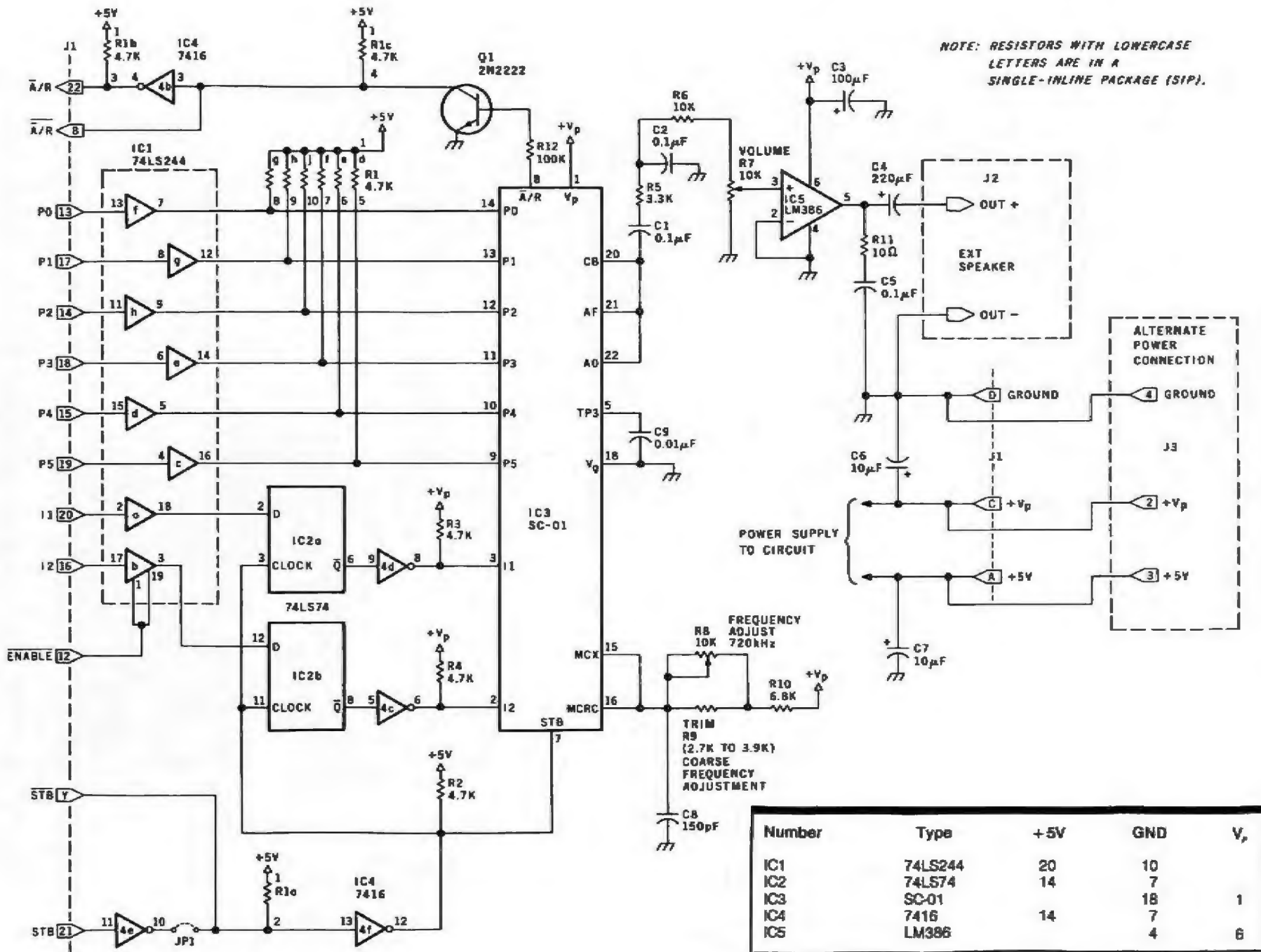

low strobe signal connects through pin 21. The two inputs cannot be used in exactly the same way, however, because of some timing restrictions imposed by the SC-01.

The SC-01 senses the positive-going edge of the strobe pulse arriving on its pin 7, but unlike typical TTL latches (which operate in a few nanoseconds), the SC-01 requires some setup time before it can accept the strobe signal. This setup time must meet two requirements:

- The data on the phoneme-input lines P0 through P5 must have been stable for 450 ns before the rising edge of the strobe pulse arrives.
- The logic level on the STB input of the SC-01 (pin 7) must have been low during at least 72 clock periods (approximately 100 microseconds) before it goes high for the strobe pulse.

The staggered timing of the phoneme data and the strobe pulse makes interfacing the SC-01 directly to a microcomputer data bus difficult without the use of an external data latch (an output port).

Furthermore, in some cases (depending upon the method of connection), when the Sweet Talker board is being driven through a parallel output port that uses a DAV (data available) strobe signal, you may have to add a one-shot (monostable multivibrator) to the circuit to stretch the signal out so that the logic level at pin 7 of the SC-01 stays low long enough. The DAV strobe signal of a typical microprocessor is less than a microsecond in length.

Approximately 500 nanoseconds after the rising edge of the strobe pulse, the  $\overline{A/R}$  line (pin 8) of the SC-01 goes to a logic 0, indicating that the synthesizer chip is busy. Transistor Q1 and IC4 convert the CMOS output of pin 8 to LSTTL levels. The  $\overline{A/R}$  output can be monitored by the controlling computer in either of two ways: directly through an input port or connected to an interrupt line. In either case, when the  $\overline{A/R}$  line returns to the logic-1 level, the SC-01 is ready to receive another phoneme code.

The remaining components on the Sweet Talker board make up the am-

CENTRONICS-COMPATIBLE  
PARALLEL PRINTER PORT

SWEET TALKER  
SPEECH SYNTHESIZER

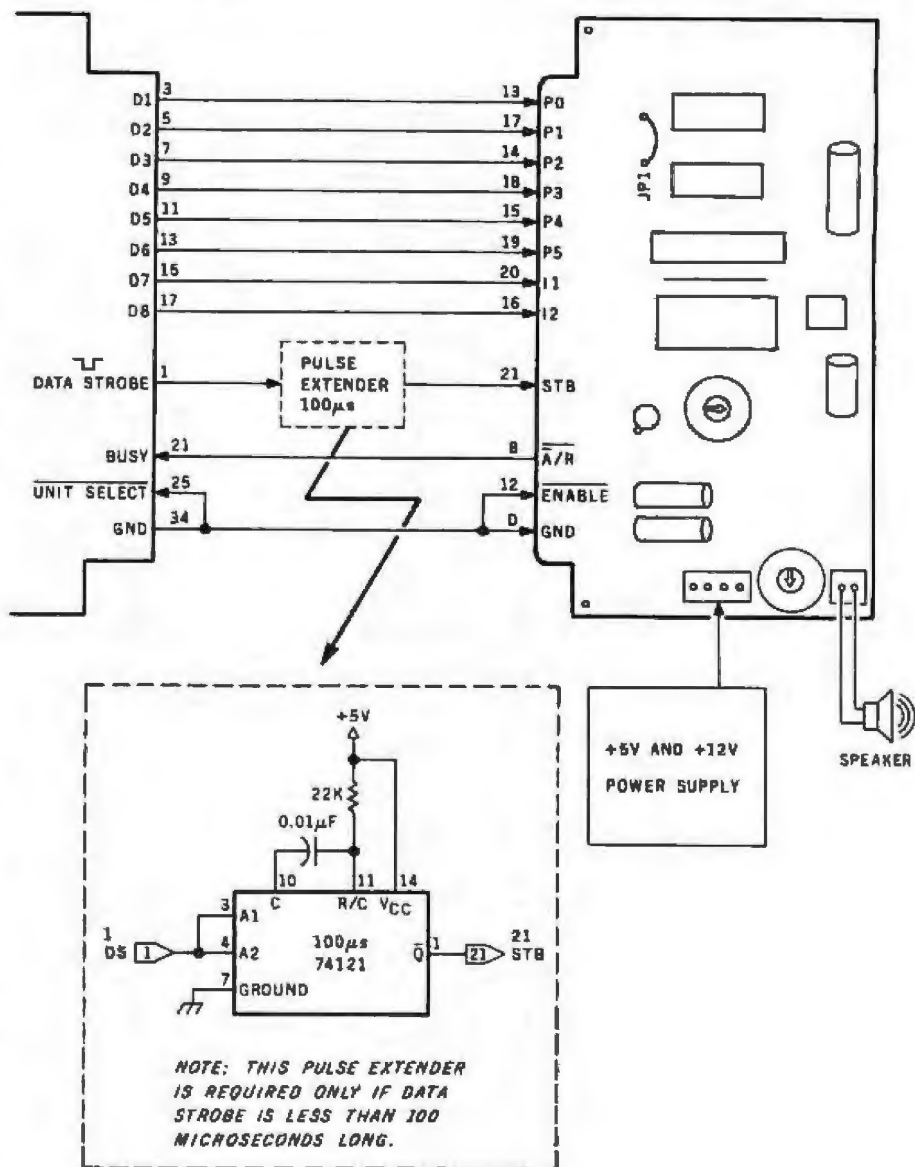

Figure 5: Diagram of the connections between a Centronics-compatible parallel printer port (as on a TRS-80 Model I or III) and the Sweet Talker circuit board. Note that on some computers the Unit Select line may need to be connected to +5 V.

plifier and filter sections. Capacitors C1 and C2 and resistors R5 and R6 form a simple low-pass audio filter. The audio signal is then amplified by an LM386 1-watt amplifier (IC5) to drive an 8-ohm speaker directly. Potentiometer R7 controls the volume, and the speaker connects to the 2-pin connector on one corner of the board.

The board operates on power-supply voltages of +5 V and  $V_p$ .  $V_p$  can be any voltage between +7 and

+14 V. I generally use +12 V. Power can be applied either through the edge connector or the 4-pin power header. Pin assignments on the power header are arranged exactly the same as those on the Z8-BASIC Microcomputer board presented in my last two articles, and the Sweet Talker board can conveniently use the same power supply. (See "Build a Z8-Based Control Computer with BASIC," July 1981 BYTE, page 38 and August 1981 BYTE, page 50.)

**Table 2: A list of useful words with their Votrax-notation phonemes, for ease in program coding.**

Word	Phonemes	Word	Phonemes
A	A1, AY, Y	keyboard	K, AY, Y, B, O1, O2, R, D
able	A1, Y, B, UH3, L	kill	K, I1, I3, L
about	UH1, B, UH2, AH2, U1, T	knowledge	N, AH1, UH3, L, I3, D, J
actual	AE1, EH3, K, T, CH, U1, UH3, L	L	EH1, EH3, UH3, L
add	AE1, EH3, D	language	L, AE1, EH3, NG, G, W, I1, D, J
adjust	UH1, D, J, UH1, UH3, S, T	large	L, AH1, R, D, J
B	B, E1, Y	left	L, EH1, EH3, F, T
back	B, AE1, AE1, K	length	L, EH1, EH3, NG, TH
basic	B, A1, Y, S, I2, K	listen	L, I1, I3, S, I2, N
been	B, EH1, EH3, N	M	EH1, EH2, M
before	B, Y, F, O2, O2, R	make	M, A1, AY, Y, K
better	B, EH1, EH3, T, ER	many	M, EH2, EH2, N, Y
C	S, E1, Y	match	M, AE1, EH3, T, CH
came	K, A1, AY, Y, M	memory	M, EH1, EH3, M, ER, Y
can	K, AE1, EH3, N	message	M, EH1, EH3, S, I2, D, J
car	K, AH2, UH3, R	N	EH1, EH2, N
catalog	K, AE2, EH3, DT, UH3, L, AW2, AW2, G	name	N, A1, AY, Y, M
change	T, CH, A1, AY, Y, N, D, J	near	N, AY, I1, R
D	D, E1, Y	need	N, E1, Y, D
data	D, A2, Y, DT, UH1	next	N, EH1, EH3, K, PA0, S, T
date	D, A2, AY, Y, T	none	N, UH1, UH3, N
decide	D, Y, S, AH2, EH3, Y, D	O	O2, O1, U1
decision	D, Y, S, I2, ZH, UH3, N	object	UH1, B, D, J, EH1, EH3, K, T
deliver	D, Y, L, I2, V, ER	obsolete	AH1, UH3, B, S, UH3, L, AY, Y, T
E	E1, Y	often	AW2, AW2, F, I3, N
early	ER, R, L, Y	omit	O1, U1, M, I1, I3, T
either	E1, Y, THV, ER	other	UH1, UH3, THV, ER
empty	EH2, EH3, M, P, T, Y	P	P, E1, Y
end	EH2, EH3, N, D	package	P, AE1, EH3, K, I1, D, J
exact	EH2, EH3, G, PA0, Z, AE2, EH3, K, T	paper	P, A1, Y, P, ER
F	EH1, EH2, F	part	P, AH1, R, T
fact	F, AE2, EH3, K, T	person	P, ER, S, UH1, N
fault	F, AW, L, T	phone	F, O1, U1, N
final	F, AH2, Y, N, UH3, L	Q	K, Y1, IU, U1, U1
first	F, ER, R, S, T	qualify	K, W, AW1, L, I1, F, AH1, EH3, Y
follow	F, AH1, AW2, L, O1, U1	quantity	K, W, AH1, N, T, I3, T, Y
G	D, J, E1, Y	question	K, W, EH1, EH3, S, T, CH, UH3, N
game	G, A2, AY, Y, M	quick	K, W, I1, I3, K
good	G, OO1, OO1, D	quiet	K, W, AH1, EH3, AY, I2, T
great	G, R, A2, Y, T	R	AH1, UH2, ER
ground	G, R, AH1, UH3, W, N, D	raise	R, A1, AY, Y, Z
grow	G, R, O1, U1	reach	R, E1, Y, T, CH
H	A1, AY, Y, T, CH	ready	R, EH1, EH3, D, Y
hand	H, AE1, EH3, N, D	remain	R, E1, M, A1, AY, Y, N
have	H, AE1, EH3, V	resistor	R, E1, Z, I1, S, T, ER
hear	H, AY, I3, R	S	EH1, EH2, S
heavy	H, EH1, V, Y	safe	S, A1, AY, Y, F
high	H, AH1, EH3, Y	sale	S, A1, A2, AY, UH3, L
I	AH1, EH3, I3, Y	schedule	S, K, EH1, EH3, D, J, IU, U1, L
important	I1, I3, M, P, O2, O2, R, T, EH3, N, T	scrap	S, K, R, AE1, EH3, P
include	I1, I3, N, K, L, IU, U1, U1, D	section	S, EH1, EH3, K, SH, UH3, N
inform	I1, I3, N, F, O2, O2, R, M	T	T, E1, AY, Y
insert	I1, N, S, R, R, T	talk	T, AW, K
instead	I1, I3, N, S, T, EH1, EH3, D	technical	T, EH1, EH3, K, N, I3, K, UH3, L
J	D, J, EH3, A1, AY, Y	terminal	T, ER, M, EH3, N, UH2, L
job	D, J, AH1, UH3, B	think	TH, I1, I3, NG, K
join	D, J, O1, UH3, I3, AY, N	time	T, AH1, EH3, Y, M
joy	D, J, O1, UH3, I3, AY	U	Y1, IU, U1, U1
judge	D, J, UH1, UH2, D, J	under	UH2, UH2, N, D, ER
jump	D, J, UH1, UH2, M, P	uniform	Y1, IU, U1, N, I3, F, O1, R, M
K	K, EH3, A1, AY, Y	until	UH2, UH2, N, T, I1, I3, L
keep	K, E1, Y, P	up	UH1, UH2, P
key	K, E1, Y	urgent	R, R, D, J, I3, N, T



Table 2 continued:

Word	Phonemes	Word	Phonemes
us	UH1, UH2, S	when	W, EH1, EH3, N
use	Y1, IU, U1, U1, Z	where	W, EH3, A2, EH3, R
V	V, E1, AY, Y	which	W, I1, I3, T, CH
vacant	V, A1, Y, K, EH3, N, T	while	W, AH1, EH3, I1, UH3, L
valid	V, AE1, UH3, L, I1, D	whiskey	W, I1, I3, S, K, AY, Y
value	V, AE1, EH3, L, Y1, IU, U1	white	W, UH3, AH2, Y, T
vendor	V, EH1, EH3, N, D, ER	who	H, IU, U1, U1
vent	V, EH1, EH3, N, T	will	W, I1, I3, L
verify	V, EH1, R, I3, F, AH1, EH3, Y	window	W, I1, N, D, O1, U1
very	V, EH1, R, Y	winter	W, I1, I3, N, T, ER
via	V, E1, AY, UH2, UH3	wire	W, AH1, EH3, AY, R
victor	V, I1, I3, K, T, ER	with	W, I1, I3, TH
voice	V, O1, UH3, I3, AY, S	withdraw	W, I1, I3, TH, D, R, AW
void	V, O1, UH3, I3, AY, D	without	W, I1, I3, TH, UH2, AH2, U1, T
voll	V, O2, O2, L, T	word	W, ER, R, D
volume	V, AH1, UH3, L, Y1, IU, U1, M	work	W, ER, R, K
W	D, UH1, B, UH3, L, Y1, IU, U1	wrong	R, AW, NG
wage	W, A1, AY, Y, D, J	X	EH1, EH2, K, PA0, S
wait	W, A1, AY, Y, T	X-ray	EH1, EH2, K, PA0, S, R, A1, I3, Y
want	W, AH1, UH3, N, T	Y	W, AH1, EH3, I3, Y
was	W, UH1, UH3, Z	Yankee	Y1, AE1, EH3, NG, K, E1, Y
wash	W, AW, SH	yard	Y1, AH1, R, D
water	W, AH1, UH3, T, ER	year	Y1, AY, I3, R
wall	W, AH1, UH3, T	yellow	Y1, EH1, EH3, L, O1, U1
wave	W, A1, AY, Y, V	yes	Y1, EH3, EH1, S
we	W, E1, Y	yesterday	Y1, EH3, EH1, S, T, ER, D, A1, I3, Y
weapon	W, EH2, EH2, P, UH1, N	yet	Y1, EH1, EH3, T
Wednesday	W, EH1, N, Z, D, A1, I3, Y	your	Y, O2, O2, R
week	W, E1, Y, K	Z	Z, E1, Y
weigh	W, A2, A2, Y	zap	Z, AE1, EH3, P
went	W, EH1, EH3, N, T	zero	Z, AY, I1, R, O1, U1
west	W, EH1, EH3, S, T	zone	Z, O1, U1, N
wet	W, EH1, EH3, T	zulu	Z, IU, U1, L, IU, U1
what	W, UH3, UH1, T		
wheel	W, E1, Y, L		

### Speaking in Phonemes

Table 1 lists the 64 basic phonemes of the English language. At first glance, it appears complicated, but it is easy to understand and use. Take the word "call," for example. It is made up of three distinct phonemes, as follows (expressed in Votrax notation):

K, AW, L

which correspond to the hexadecimal codes:

19 3D 18

Similarly, the word "disk" is broken into the phonemes:

D, I1, S, K

which correspond to the hexadecimal codes:

1E 0B 1F 19

See reference 3 for more details on this process.

Causing the synthesizer to speak either of these words is done simply by sending the hexadecimal codes sequentially to it. This is most easily done through a parallel I/O port under control of a program written in BASIC. Typically, if the synthesizer were connected to port 0 on your computer, the routine for saying "call" would be coded as follows:

```

100 DATA 25, 61, 24 :REM
    Decimal Phoneme codes for
    "call"
110 FOR A=1 TO 3 : READ P(A)
    :NEXT A
130 FOR A=1 TO 3
140 OUT 0,P(A) :REM Latch
    Phoneme code into SC-01
150 IF INP(0)=0 THEN GOTO
150 :REM Continue if A/R not busy
    
```

```

160 NEXT A
170 OUT 0,63 :REM Send STOP
    code to SC-01
180 END
    
```

Essentially any word or series of words can be spoken using this method. It isn't necessary for you to acquire special knowledge about word sounds to use a phonetic speech synthesizer, because many lists of word and phoneme equivalents are available. Table 2 is a list of some common words. A more extensive list is in preparation.

### Easy Interfacing

What could be easier than pretending that the Sweet Talker speech synthesizer is a parallel-interfaced printer? It just so happens that many computers already have a parallel output port in the form of a Centronics-compatible parallel printer port. This connection is avail-

Number	Type	+5V	GND	-12V	+12V
IC1	COM5016	2	11		9
IC2	COM2017	1	3	2	
IC3	CD4049	1	8		
IC4	MC1489	14	7		
IC5	MC1488		7	1	14

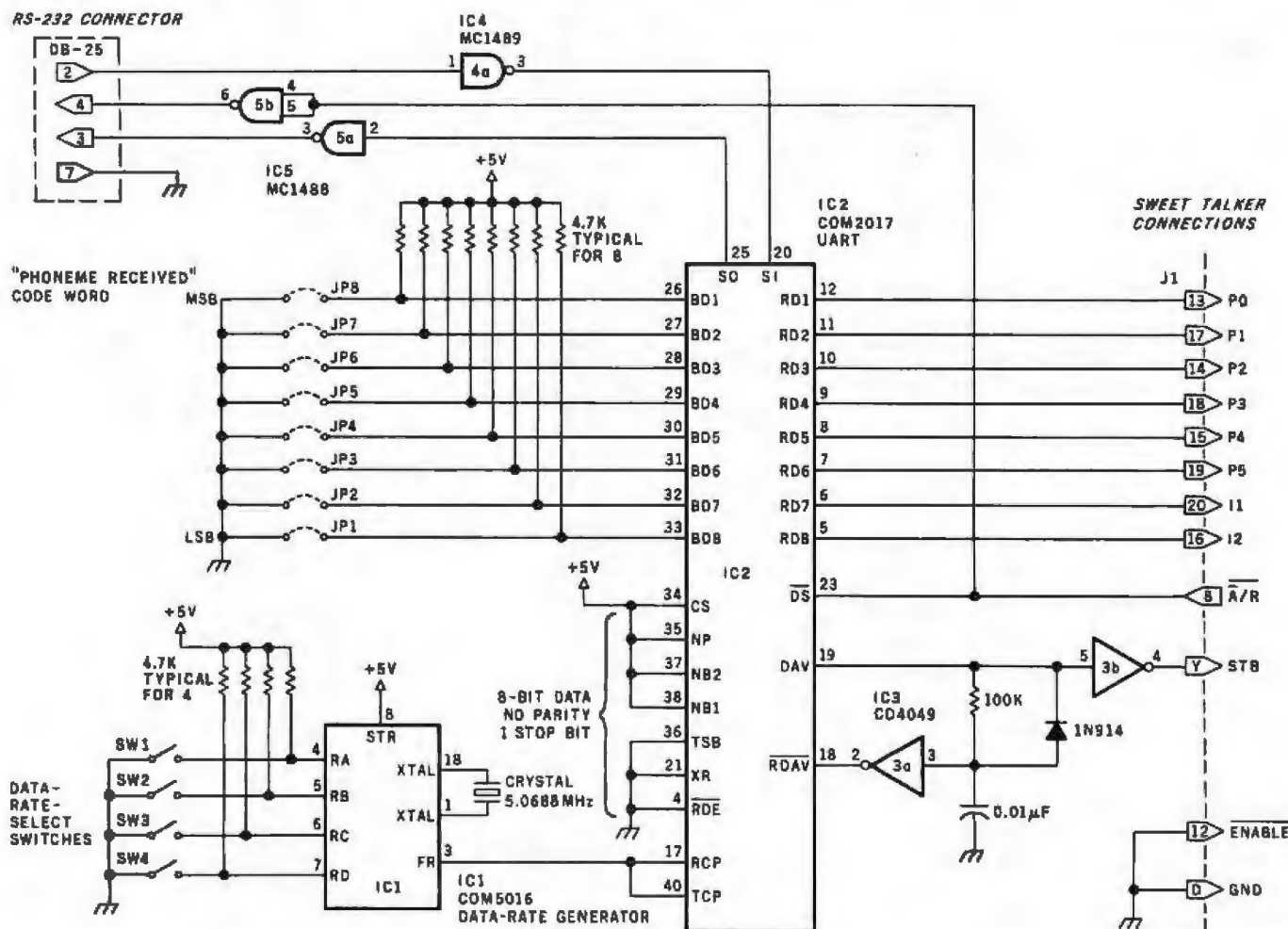

Figure 6: Schematic diagram of a serial I/O interface for the Sweet Talker board, to be used in place of parallel I/O. The serial communication protocol is RS-232C.

able on all Radio Shack TRS-80 Model III and expanded Model I computer systems, as well as many others. By connecting the Sweet Talker board as shown in figure 5, it is possible to fool the computer into thinking that the Sweet Talker is a printer, whereupon we can use LPRINT statements to drive it. The same machine-language routine in the BASIC interpreter that normally transfers ASCII (American Standard Code for Information Interchange) character strings to the printer will also work with the speech synthesizer.

A BASIC LPRINT statement will transmit any ASCII characters between the double quotes (except the quotation marks themselves and perhaps a few control codes) whether they spell out something humanly coherent or not. As table 1 illustrates, all of the phonemes correspond to ASCII characters which produce the equivalent 6-bit code (the lowercase letters "a" through "z" correspond to hexadecimal codes 21 through 3A). It is possible, therefore, to type an "@" for the EH3 phoneme (hexadecimal code 00) or a ">" for PA1 (hexadecimal code 3E). Using this technique,

the program statement for saying "call" would be:

```
100 LPRINT "Y=X"
```

It's a good idea to add a stop phoneme (corresponding to ASCII "?") after the end of the word to cancel the last phoneme. The line then becomes:

```
100 LPRINT "Y=X";"?";
```

The Sweet Talker speech synthesizer attaches to and handshakes with the computer in the same manner as a printer would. The  $\bar{A}/R$  output is

C  
O  
U  
G  
A  
R

TRS-80\*

Model I  
Model III

*Products that set Precedents.*

OMIKRON™

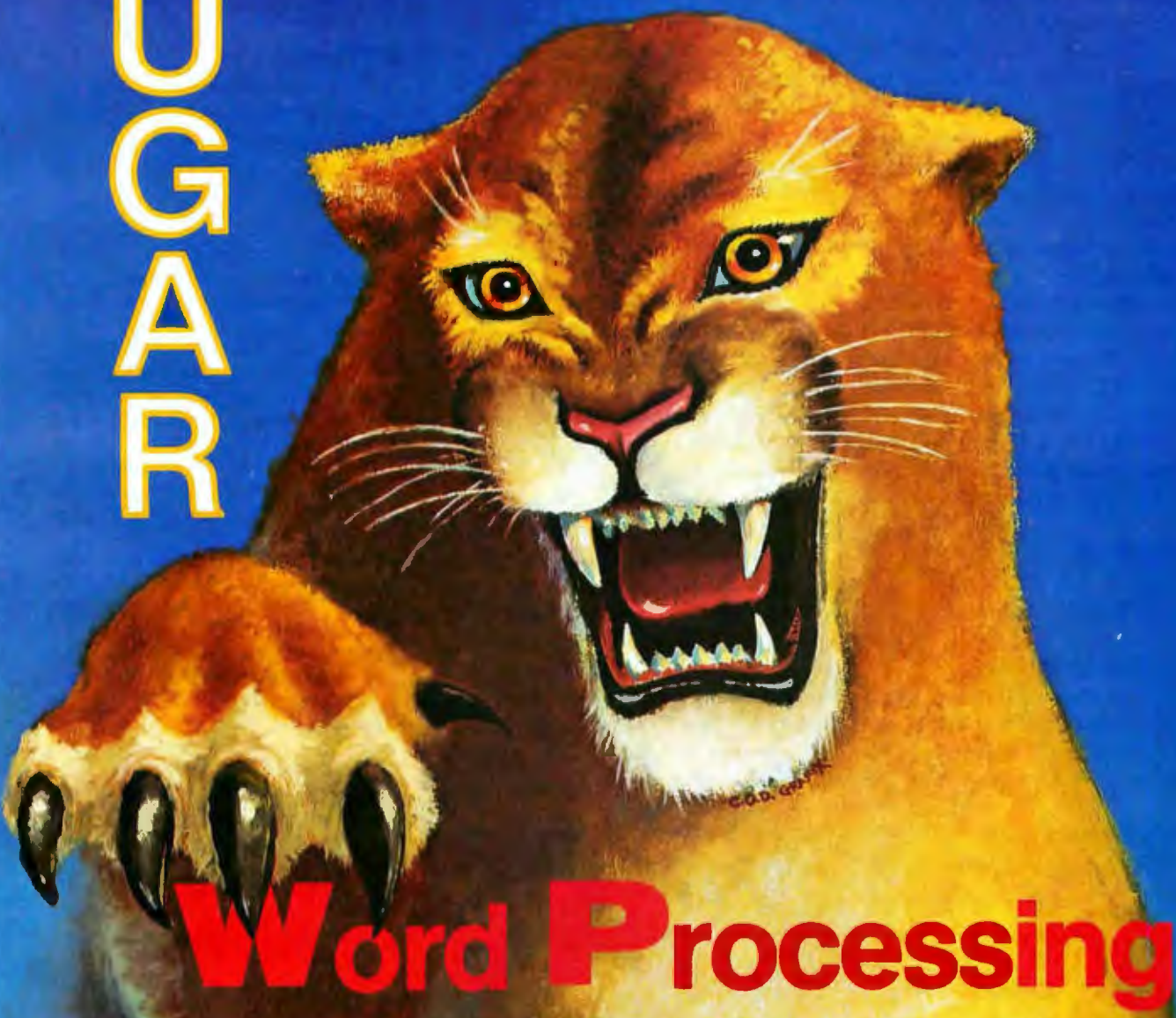

**Word Processing**

**MAPPER** CP/M Adaptor  
**CBASIC II\*\* CP/M\*\* AND**  
**THE BEST WORD PROCESSOR**  
**\$1000.00 VALUE ONLY \$299**



**UNPRECEDENTED SAVINGS**

are available on selected CP/M programs through COUGAR, Omikron's official users group.

**OMIKRON**

TRADEMARKS:  
\*TRS-80/Radio Shack/Tandy Corp.  
\*\*CP/M/Digital Research  
\*\*\*CBASIC II/Compiler Systems  
\*\*\*\*PHOENIX/Palantir Inc.

1127 Hearst St.  
Berkeley, CA 94702  
(415) 845-8013

connected to the Busy input, and the Unit Select line is grounded to simulate printer attachment. The Sweet Talker's Enable input should also be grounded. The computer's LPRINT driver routine sends one character to the "printer" (speech synthesizer) and then checks the Busy line before sending another. When the Busy line is high again, the next character (phoneme) is sent.

The only area for concern is the pulse width of the data strobe (attached to J1 pin 21 with jumper JP1 installed), as I previously mentioned. If it is less than 100  $\mu$ s, a type-74121 monostable multivibrator should be added as indicated in figure 5. If you are unsure of the duration, add the circuit anyway.

Once the interface is attached, a simple program can be used to test phoneme combinations. For example, sending "S\*1L/@\*KY" will cause the unit to say "automatic," and "Y2M\*KIMB677" will make it say "continue." A simple test program requires only three lines:

```
100 INPUT A$
110 LPRINT A$;"?";
120 GOTO 100
```

### Using a Serial Interface

Your computer might not have a parallel printer port, but a serial one instead. While the interface is more complicated, you can also use

LPRINT statements to drive the additional circuitry shown in figure 6. This circuit is a full-duplex RS-232C serial interface which is capable of receiving a phoneme transmitted serially from the computer, converting it back to parallel form, and strobing it into the SC-01.

The timing relationships between the interface and the computer become slightly more complex. Whenever a phoneme is loaded into the SC-01, the A/R line drops and the RS-232C Data Terminal Ready signal goes low. After the phoneme has concluded, the UART (universal asynchronous receiver/transmitter) transmits a jumper-selected character (optionally preset on UART pins 26 through 33) and raises the Data Terminal Ready line again. Proper timing from the host computer can be accomplished either by sending successive characters only in response to the "phoneme-concluded" code or by monitoring the state of the Data Terminal Ready line.

The communication rate between the host and the synthesizer is switch-selectable from 50 to 19,200 bps using the COM5016 data-rate generator as shown. Communication is hard-wire selected for 8-bit data words, no parity bit, and 1 stop bit. A more in-depth discussion of the data-rate generator and UART was given in one of my previous Circuit Cellar articles ("I/O Expansion for the TRS-80, Part

2: Serial Ports," June 1980 BYTE, page 42).

### In Conclusion

What can you do with a computer-controlled speech synthesizer? I'm sure you have a few ideas. In any case, the benefits of electronic speech synthesis will surely propagate as more people learn how to use it.

### Next Month:

A discussion of EPROM programming and the design of an intelligent EPROM programmer. ■

### References

1. Ciarcia, Steve. "Build a Low-Cost Speech-Synthesizer Interface," BYTE, June 1981, page 46.
2. Ciarcia, Steve. "Talk to Me: Add a Voice to Your Computer for \$35," BYTE, June 1978, page 142, reprinted in *Ciarcia's Circuit Cellar*, Volume I. Peterborough NH: BYTE Books, 1979, page 77.
3. Fons, Kathryn and Tim Gargagliano. "Articulate Automata: An Overview of Voice Synthesis," BYTE, February 1981, page 164.
4. Gargagliano, Tim and Kathryn Fons. "Text Translator Builds Vocabulary for Speech Chip," *Electronics*, February 10, 1981, page 118.
5. Gargagliano, Tim and Kathryn Fons. "The TRS-80 Speaks: Using BASIC to Drive a Speech Synthesizer," BYTE, October 1979, page 113.
6. Gargagliano, Tim and Kathryn Fons. "A Votrax Vocabulary," BYTE, June 1981, page 384.
7. Lin, Kun-Shan, Gene Frantz, and Kathy Goudie. "Software Rules Give Personal Computer Real Word Power," *Electronics*, February 10, 1981, page 122.
8. Weinrich, David W. "Speech-Synthesis Chip Borrows Human Intonation," *Electronics*, April 10, 1980, page 113.
9. Wiggins, Richard and Larry Brantingham. "Three-Chip System Synthesizes Human Speech," *Electronics*, August 31, 1978, page 109.

**Editor's Note:** Steve often refers to previous Circuit Cellar articles as reference material for the articles he presents each month. These articles are available in reprint books from BYTE Books, 70 Main St, Peterborough NH 03458. Ciarcia's Circuit Cellar covers articles that appeared in BYTE from September 1977 through November 1978. Ciarcia's Circuit Cellar, Volume II presents articles from December 1978 through June 1980.

These items are available from:

The MicroMint Inc  
917 Midway  
Woodmere NY 11598  
Telephone:

(800) 645-3479 (for orders)  
(516) 374-6793 (for technical information)

Votrax SC-01 Speech Synthesizer Chip  
(single integrated circuit).....\$70  
(5 or more, price each).....\$55

Sweet Talker Phonetic Speech Synthesizer, parallel-port version. Includes SC-01 integrated circuit, data sheet, and user's manual.

Assembled and tested.....\$139

Sweet Talker Phonetic Speech Syn-

thesizer, Apple II plug-compatible version. Includes SC-01 integrated circuit, data sheet, and user's manual. (separate power supply not required)  
Assembled and tested.....\$149

MicroMint 3-voltage power supply  
(size 2 1/2 by 4 1/2 inches)

Provides: +5 V, 300 mA  
+12 V, 50 mA  
-12 V, 50 mA

(-12 V not required by Sweet Talker)

Assembled and tested.....\$35

All printed circuit boards are solder-masked and silk-screened. Please include \$2 for shipping and handling on any order. New York residents please include 7% sales tax.

# Meet HP Series 80: Hewlett-Packard's new one-on-one computing systems for professionals.



Together, You can Analyze Technical Problems and Evaluate Solutions. Rapidly and Accurately.

HP Series 80 personal computing systems provide the technical solutions you require. Quickly! Easily! Inexpensively! Analysis techniques that were formerly difficult and often impossible become part of your everyday work routine. You can evaluate functional behavior, select variable alternatives, perform cost analysis...and more...all with greater accuracy and using more variables than you thought possible.

## Series 80, VisiCalc™ PLUS And You

HP's VisiCalc PLUS is a major new software tool. It's an electronic worksheet that instantly recalculates results as you change the variables. You ask the *what-if* questions and immediately see their effects on your solution. No programming is necessary...you can become proficient with VisiCalc PLUS in a few hours...and then watch your horizons broaden. VisiCalc PLUS features many powerful functions including statistical analysis tools and the entire HP Series 80 BASIC math set. Plus graphics! Create professional presentations with curve-fitting plots, stacked or clustered bar graphs, exploded pie charts and line graphs, all in up to four colors, on paper or transparencies.

## ONLY FROM HEWLETT-PACKARD

HP Series 80 personal computing systems are part of a forty-year tradition of electronic products built to uncompromising standards of excellence. Additionally, HP Series 80 products are serviced by HP technicians and on-site service contracts are now available. We urge you to judge for yourself with a hands-on, one-on-one demonstration at your HP dealer. For locations, call TOLL-FREE 800-547-3400, Dept. 276E, except Alaska/Hawaii. In Oregon call 758-1010. Or write Hewlett-Packard, Corvallis, Oregon 97330, Dept. 276E

611/04

HP Series 80 Personal Computers for Professionals: HP-85 (\$3250\*) and HP-83 (\$2250\*) specifications: 16K RAM expands to 32K, 32K ROM expands to 80K; CRT with integrated graphics; (HP-85 only); built-in thermal printer, cassette tape unit. Software includes VisiCalc PLUS, Information Management, Graphics Presentations, Surveying, Data Communications (Fall '81), Statistics, Regression Analysis, Math, Linear Programming, Waveform & Circuit Analysis, BASIC Training. HP peripherals include flexible disc drives, printers and plotters. VisiCalc™ is a trademark of Personal Software, Inc.  
\*Suggested retail price excluding applicable state and local taxes—Continental U.S.A., Alaska & Hawaii.

Circle 160 on inquiry card.



**HEWLETT  
PACKARD**

## The Big Board A Z80 System in Kit Form

---

David Thompson  
11740 NW West Rd  
Portland OR 97229

---

I built the computer on which I'm writing this article. Even though I'm no expert at computer hardware or software, I assembled this system in a matter of weeks, beginning with a kit called the Big Board.

Manufactured by Digital Research Computers of Texas, the Big Board is a single-board computer that packs an impressive set of features into an inexpensive package. By not providing the cabinet, power supply, keyboard, monitor, and disk drives, Digital Research can sell this heart of a powerful Z80-based system for \$650 in kit form. For an additional \$50, the board comes with all the sockets soldered in place—a real convenience since all the integrated circuits are socketed.

The board is the size of an 8-inch disk drive. It includes 64 K bytes of programmable memory, a 24-line by 80-character video generator, a keyboard interface, room

for four 2 K-byte ROMs (read-only memories, "bank switched" along with the video memory), and a floppy-disk drive controller. Options include parallel and serial ports and an on-board timer.

### History

About three years ago, J B Ferguson, an electrical engineer from Dallas, wire-wrapped together a Z80-based, single-board computer and showed it to Jim Tanner of Digital Research. They then worked together to design a powerful, yet inexpensive, unit.

Because of the small size of the board, they used LS (low-power Schottky) parts to keep heat problems to a minimum. According to Tanner, this choice almost killed the project. As recently as January 1980, LS parts were very expensive—too expensive, Tanner and Ferguson believed, for the Big Board to be salable. However, prices dropped so substantially before the end of that year, for both the LS parts and the memory, that Tanner and Ferguson decided to market the unit with a full 64 K bytes of user memory.

Russell Smith designed the Big Board's monitor ROM and the custom BIOS (basic input/output system) for CP/M. The initial plan was to offer CP/M 1.4 with the board. But when version 2.2 became available, Smith went back to work and revised the BIOS. Source listings for both the monitor and BIOS are available free from Digital Research. Just ask for them when ordering the kit.

### The Kit

The quality of the circuit board is readily apparent. It is solder-masked and tinned, which makes soldering easy. Solder-masking covers all the metal on the board except for spots where leads will be soldered. The component outlines and numbers are silk-screened on the top, and the holes for the component leads are plated through (they have metal deposited inside them to insure good connections).



**Photo 1:** *The Big Board kit as the author received it. The board itself is in the center, with the documentation partly beneath it. On each side are plastic bags containing parts. Cables with connectors are in the rear.*

Getting "STATIC" from our competition? . . if so, you're paying too much!

Try Ours  
\$179

64K Static \$895  
assembled

16K Static \$179  
assembled



- STATIC RAMS • FULLY ASSEMBLED • FULLY TESTED • BURNED-IN • FULLY SOCKETED • INCREDIBLE VERSATILITY • BANK SELECTABLE
- EXTENDED ADDRESSING • DELIVERY FROM STOCK • SAVE HUNDREDS OF DOLLARS • INTRODUCTORY PRICE - ORDER TODAY

**The Memory Merchant Story**

Why hasn't memory come down in price like it should? Here's what is being done for you.

**High Performance and Low Price 16K Static Board**

You want the most cost-effective, high performance memory boards that technology will allow. With that in mind we commissioned one of the top memory designers in the country. We told him to design the board with the user in mind. It had to sell for less than \$200. It had to run cool and have low-power consumption. It had to have both extended addressing capabilities and bank select capabilities at no additional cost. You had to be able to de-select 1K blocks so the memory could accommodate memory-mapped video displays or controller cards. The board had to be fast so a user could run his processor at full speed. Finally, the board had to be reliable and easy to install. He came up with all this and more. Here's a high

**16K Ram, Model MM16K14 Specifications:**

- Four independent 4Kx8 byte segments
- One 4K segment equipped with 1K windows
- Compatible with both existing bank select type hardware and IEEE 696/S100 extended address protocol
- Operation guaranteed to 4 MHz with Z-80 and to 5 MHz with 8085 processors
- Low power consumption, typically 1.3 amps
- Uses low power 300 ns 2114 (1Kx4)

**64K Ram, Model MM65K16S Specifications:**

- Operation guaranteed to 8 MHz
- Compatible with both existing bank select type hardware and IEEE 696 extended address protocol
- Fully loaded board (64K) draws 400ma. while max. current is 550 ma.
- Four independently addressable 16K submodules on one board organized as 2 pair of independent 32K banks or as 1 64K extended address page. Each 32K bank responds independently to phantom. Bank select logic is compatible with either Cromemco Cromix\* or standard bank select software.
- 2716 (5V) EPROM compatibility: Programmed 2716 EPROMs may replace any or all of the Ram components on the board.
- New 16K (2Kx8) Static Rams which combine extreme low power (40ma. ON; 5ma. OFF) with high speed (200ns max. access time).
- Also available partially populated to 48K or 32K.

\*Cromix is a trademark of Cromemco.

Circle 215 on Inquiry card.

performance, fully assembled, tested and burned-in, guaranteed 16K board that we are introducing for only \$179. Runs on any S-100 8080, 4 MHz Z-80, or 5 MHz 8085 system.

**The Most Advanced 64K Static Board**

The end user wants State-of-the Art when he buys a 64K board. So we had our super designer put together the 64K board of the future with tomorrow's high speed processors in mind. This board had to work with all S-100 systems, with current processors and future (up to 8 MHz) processors. It had to be ultra-low power. It had to be designed so the advanced user could populate the board with programmed EPROMs for special applications. This board, too, had to have both bank select and extended addressing at no extra cost. The board was also designed to be used as a 32K or 48K board and we are selling it that way, too. Put in additional chips when you want to increase the capacity!

OEM and dealer inquiries invited.

**No Risk Free Trial**

After you purchase one of our boards you may return it (intact) for any reason within 15 days after shipment and receive a full refund.

**Free Six Months Memory Insurance**

We will replace any board purchased from Memory Merchant that becomes defective through normal use for up to six months.

Yes! Please send me the items listed below. I understand that if I'm not fully satisfied with the product, I can get a full refund within 15 days after shipment. (Send check, money order, or use your credit card.)  
Note to credit card buyers: For extra fast service phone (415) 483-1008

QUANTITY	DESCRIPTION	UNIT PRICE	TOTAL
	64K	\$895.00	
	48K	749.00	
	32K	569.00	
	16K	179.00	
SHIPPING & HANDLING \$5.00/Board			

California Residents  
Add 6% Tax

TOTAL

SEND TO:  
MEMORY MERCHANT (B1)  
14666 Doolittle Dr.  
San Leandro, CA 94577

(NO C.O.D.'s)

- CHECK
- MONEY ORDER
- VISA
- MASTERCHARGE

(Must also have ICA#)

CARD NO. \_\_\_\_\_ EXP. DATE \_\_\_\_\_

ICA NO. \_\_\_\_\_ SIGNATURE \_\_\_\_\_

NAME \_\_\_\_\_

ADDRESS \_\_\_\_\_  
Street City State Zip

Prices, terms, specifications subject to change without notice.

14666 DOOLITTLE DR.  
SAN LEANDRO,  
CA 94577  
(415) 483-1008



Memory  
Merchant

TM

# LISP

## for TRS-80 Models I & III

SuperSoft LISP allows the TRS-80 to become a complete Artificial Intelligence laboratory! It is the tool that takes you to the frontier of Computer Science.

The SuperSoft LISP is a *complete and full* implementation. (It is NOT a subset!) It contains an efficient garbage collector which optimizes the usage of user RAM, and supports the TRS-80 graphics. Below are some features:

- Runs in 16k level II (with only 6K overhead)
- Fully implements atom property list structure.
- PROG is supported.
- FUNARG device is implemented.
- Efficient garbage collection.
- Complete with LISP editor and trace.
- Allows complete range of single precision numeric data.
- Works with old as well as new ROMs.
- Contains 97 functions.
- Sample Programs.

The LISP package is supplied on tape or discette and with a complete user manual.

cassette version: \$75.00  
(requires 16K level II)

Disk version: \$100.00  
(requires 16K disk)

(manual only: \$15.00)

All Orders and General Information:  
SUPERSOFT ASSOCIATES  
P.O. BOX 1628  
CHAMPAIGN, IL 61820  
(217) 359-2112  
Technical Hot Line: (217) 359-2691  
(answered only when technician is available)



*SuperSoft*  
First in Software Technology

TRS-80 TRADEMARK TANDY CORP

## At a Glance

**Name**  
Big Board

**Manufacturer**  
Digital Research Computers  
of Texas  
POB 401565  
Garland TX 75040  
(214) 271-3538

**Price**  
Bare board with the monitor  
and character ROMs, \$195  
Complete kit with sockets  
and ICs, \$649  
Complete kit with sockets  
already soldered in place:  
\$699

**Dimensions**  
8.5 by 13 inches

**Processor**  
Z80A

**System clock frequency**  
2.5 MHz

**Memory**  
64 K-byte dynamic  
programmable memory;  
four 2 K-byte ROMs  
(bank switched);  
4 K-byte static video  
memory (bank switched)

**Mass storage**  
On-board controller for up  
to four 8-inch floppy-disk  
drives (single-density; each  
disk holds 240 K bytes for-  
matted)

**Other hardware features**  
Parallel port for ASCII-  
encoded keyboard;  
24-line by 80-character video  
generator (composite or  
separated sync)

**Options**  
Real-time clock;  
two RS-232 serial ports;  
two parallel ports  
(adding the options is simply  
a matter of plugging in the  
devices and adding a few  
resistors and capacitors)

**Software**  
2 K-byte monitor ROM  
(comes with the kit);  
CP/M 2.2 is available com-  
pletely configured for an  
additional \$150

**Comments**  
Putting the kit together re-  
quires some experience  
handling static-sensitive  
parts and a soldering iron.  
Some knowledge of 8080 or  
Z80 machine language or  
assembly language is  
important.  
Be sure to ask for a listing  
of the ROM monitor and  
the BIOS (basic input/out-  
put system) when ordering  
your board. The listings are  
free for the asking.

Although the Big Board's documentation is not as detailed or well organized as Heathkit's, it is well written and contains the information needed. The assembly process is explained step by step, complete with boxes you can check off. Because the parts' names and outlines are stenciled in place, the process takes only a few hours.

### What You Must Know

If you have had a high school electronics class, can solder with a small iron, and know how to handle static-sensitive parts, you should have little trouble building the Big Board. But there is more to getting a system running than simply building the board. Though the Big Board is well designed and easy to interface with the keyboard, video monitor, and disk drive, interfacing with other peripheral devices requires some understanding of the hardware, the monitor, and the operating system. For in-





# Announcing affordable graphics: MG8000 Graphics Terminal: \$2,250\* \*Retail quantity 1.

## WICAT Monochrome Graphics Terminal

### General features

Z8002 based  
12" display monitor  
Touch screen (optional)

### Text features

Half intensity  
Reverse video  
Blink  
Blank  
Underscore

For more information  
call or write  
WICAT Systems  
801/224-6400.

### Graphics features

400 x 300 graphics resolution  
2 independent graphics planes  
Lines, curves, arcs & circles  
Graphics text  
Pattern fill  
Relative and absolute addressing  
Object definition and relocation

### Applications

Computer-based training  
Animation  
Business graphics  
CAD/CAM  
Process control  
Scientific



WICATsystems



P.O. Box 539 1875 South State Orem, Utah 84057 801/224-6400

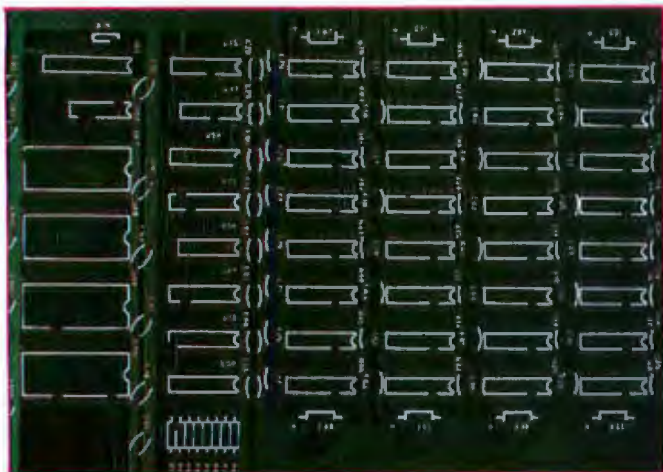

Photo 2: The empty printed-circuit board. Location markings and some circuitry are visible.

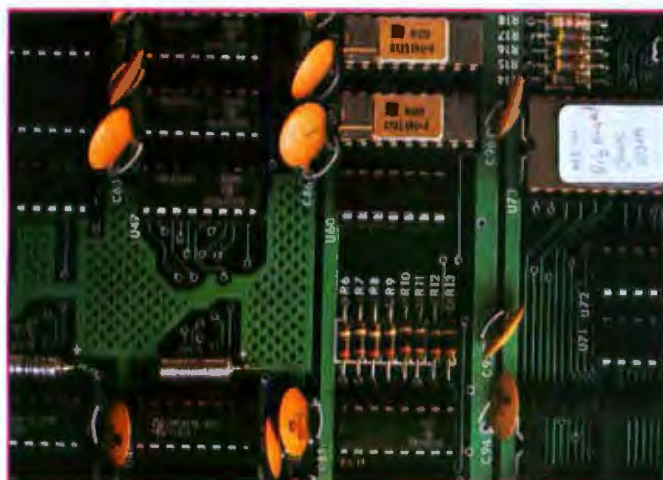

Photo 3: Close-up of the printed-circuit board showing all the parts in place.



Photo 4: The Big Board in place in the author's system. Resting on top of the cabinet is the power supply, originally built for a Digital Equipment Corporation controller.

stance, to interface a modem or printer, you will need some assembly code. Until you write code to convince the Big Board that something else out there "understands" it, it will continue to output everything to the screen. Fortunately, there is a vast, growing national user's group to help you bring up and interface the Big Board.

When I received this board, I didn't understand operating systems and had never written anything in assembly language. Part of the reason I got the Big Board was to learn these things. It was an incredible feeling, after building the board, to watch the operating system sign on, and later to see the first lines of text rasp their way across the printer platen. I knew that I would never again have to update listings by hand while seeing the latest version on the video monitor.

### And Once It's Running

Once it's running, what can the Big Board do? The ROM-based monitor program that comes with the board gives you access to all the user memory and ports, lets you test memory to verify that it is operating properly, and lets you look at specific tracks and sectors on disks. If you purchase the custom CP/M 2.2 available with the board, you gain access to a world of utilities, languages, games, and applications programs.

The Big Board is also electrically versatile. If you connect a standard terminal to the serial port (RS-232), the computer will make that port its standard input/output interface. Or if you are using a separate keyboard and video unit, you can select an output video signal to match almost any monitor made. The manual contains complete information on setting jumpers, including an example for the standard composite video monitor.

How well does the Big Board work? So well that my only real complaint, dealing with the character set, has already been corrected. The vast majority of people who have bought one have had no problems. Considering the complexity of the Big Board, this is a remarkable achievement.

### Conclusions

If you are interested in building a powerful system, or in learning what goes on in the "engine room" of a micro-computer, or if you've ever had the urge to push the levers, blow the whistle, and increment the A register, Big Board is certainly one way to do it. When you get done, you'll have a truly personal system for less than half the price of a "canned" system. And your system will be able to perform complex tasks like text editing. I use my Big Board for all my writing at home, including letters to relatives, notes to myself, and this article. ■

---

The author is now publishing *Micro Cornucopia*, a magazine about the Big Board. The magazine appears bimonthly at an annual subscription rate of \$12. For further information, send a SASE to David Thompson, 11740 NW West Rd, Portland OR 97229.

---

# MORROW DESIGNS

NOW, 26 Mbytes  
\$4,495

## Leading edge technology in hard disk systems.

Complete systems. Morrow Designs hard disk subsystems are delivered complete with hard disk, controller, cabinet, power supply, fan, cables and CP/M<sup>\*</sup> 2.2 operating system.

**Widest range.** Morrow Designs offers the widest range of hard disk systems available from a single supplier. 5¼," 8," 14." Five to over 100 megabytes of formatted hard disk storage. \$2,995 to \$17,980. Cost effective systems that work. And keep working.

**S-100 and more.** Morrow Designs hard disk systems are designed for use with the CP/M operating system. Available software packages allow our systems to run on any IEEE696/S-100 Standard system with no hardware modification. Plus, Cromemco<sup>\*\*\*</sup>, North Star<sup>\*\*</sup>, Vector Graphics, Godbout, Dynabyte, Exidy<sup>\*\*\*\*</sup>, IMSAI, Micro-mation, Processor Technology and California Computer Systems.

**Reliable systems.** Morrow Designs is committed to hard disk system reliability. Not simply with a 90-day warranty, but with a money back guarantee. If our system fails to perform to specification, send it back. We'll send back your money.

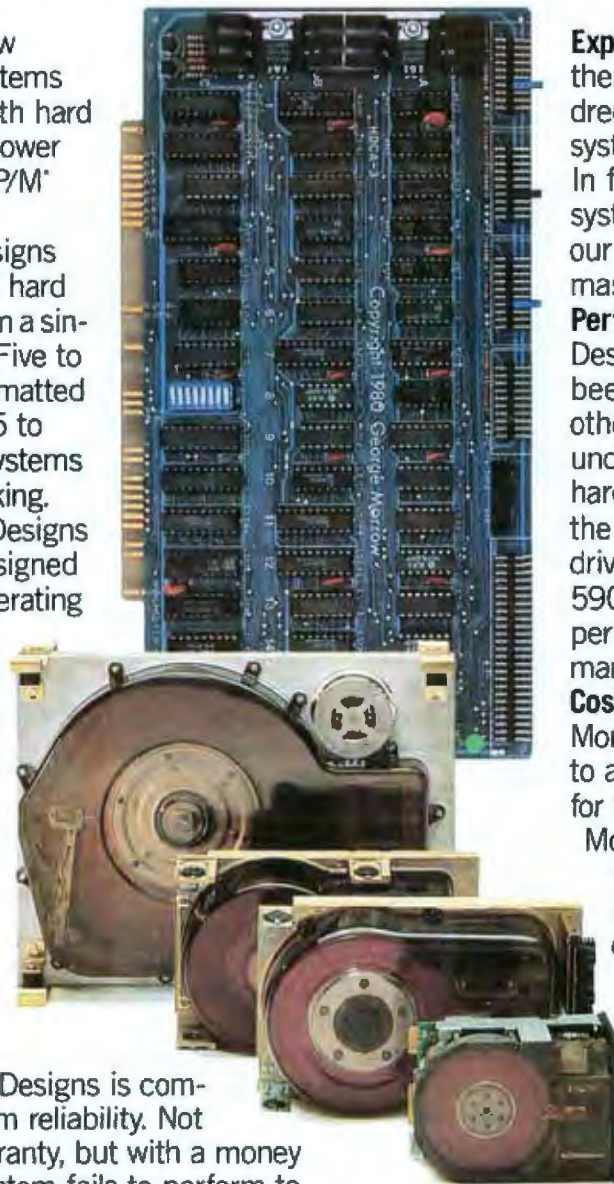

**Experience.** As of April, 1981, there were over fifteen hundred Morrow Designs hard disk systems successfully installed. In fact, over 200 independent systems integrators now use our hard disks to solve their mass storage problems.

**Performance answers.** Morrow Designs hard disk systems have been benchmarked against all other systems. None is faster under CP/M. Morrow Designs hard disks operate at 10 times the speed of a floppy disk drive. Transfer rates range from 590,000 bytes to 900,000 bytes per second. That kind of performance can become addictive.

**Cost effective answers.** Compare Morrow prices and performance to anything presently available for S-100 systems. You'll find Morrow's price/megabyte/performance ratio to be unmatched. Leadership in disk systems technology earned us leadership in price/performance. And that may have earned us a call from you. Circle the Reader Service Number for our full line data sheets. Can't wait? Call us at (415)

524-2101. And yes, OEM quantity prices are available. **LOOK TO MORROW FOR ANSWERS.**

## MORROW DESIGNS

5221 Central Avenue, Richmond, CA 94804  
(415) 524-2101

Circle 245 on Inquiry card.



<sup>\*</sup>CP/M is a trademark of Digital Research  
<sup>\*\*</sup>Northstar is a trademark of North Star Computers, Inc.  
<sup>\*\*\*</sup>Cromemco is a trademark of Cromemco, Inc.  
<sup>\*\*\*\*</sup>Exidy is a trademark of Exidy Corporation.

# The Xerox Alto Computer

---

Thomas A Wadlow  
5157 Norma Way Apt 226  
Livermore CA 94550

---

In the mid-1970s, the personal-computer market blossomed with the introduction of the Altair 8800. Each year since has brought us personal computers with more power, faster execution, larger memory, and better mass storage. Few computer enthusiasts or professionals can look at the machines of today without wondering: What's next?

## The Alto: a Personal Computer

In 1972, Xerox Corporation decided to produce a personal computer to be used for research. The result was the Alto computer, whose name comes from the Xerox Palo Alto Research Center where it was developed. The Alto was the result of a joint effort by Ed McCreight, Chuck Thacker, Butler Lampson, Bob Sproull, and Dave Boggs, who were attempting to make a device that was small enough to fit in an office comfortably, but powerful enough to support a reliable, high-quality operating system and graphics display. Their goal was to provide each user with a personal computing facility capable of meeting all individual needs and a com-



*Photo 1: Two of the Xerox Alto personal computers. Each Alto processor is made of medium- and small-scale TTL integrated circuits, and is mounted in a rack beneath two 3-megabyte hard-disk drives. Note that the video displays are taller than they are wide and are similar to a page of paper, rather than a standard television screen.*

munications facility that would allow users to share information easily.

In 1978, Xerox donated a total of fifty Altos to Stanford, Carnegie-Mellon, and MIT (Massachusetts Institute of Technology). These machines were quickly assimilated into the research community and rapidly became the standard against which other personal computers were judged.

It is unlikely that a person outside of the computer-science research community will ever be able to buy an Alto. They are not intended for commercial sale, but rather as development tools for Xerox, and so will not be mass-produced. What

makes them worthy of mention is the fact that a large number of the personal computers of tomorrow will be designed with knowledge gained from the development of the Alto.

## The Hardware

The Alto consists of four major parts: the graphics display, the keyboard, the graphics mouse, and the disk storage/processor box. Each Alto is housed in a beautifully formed, textured beige metal cabinet that hints at its \$32,000 price tag. With the exception of the disk storage/processor box, everything is designed to sit on a desk or tabletop.

## The Graphics Display

The graphics display is the most striking feature of the Alto. It looks somewhat like a television screen that has been turned sideways (see photo 1). It is a raster-scan display, and the physical dimensions of the screen are 8 inches (horizontal) by 10 inches (vertical). The black-and-white display allows the user to address an area 808 pixels (picture elements) vertically by 606 pixels horizontally. This results in resolution of about 80 points per inch.

The method of display used is called *bit-mapped raster scan*. This means that every point on the display is addressable as a bit in memory. Although this method can take up a great deal of memory, it has the advantage of making the display very

---

## Acknowledgments

*I would like to thank Dr Brian Reid and Mark Roberts of Stanford University for their time and helpful comments; also Sandy Lanzarotta of Xerox and Cindy Paulinac for their help and support.*

---

# Tomorrow and You...

# and COMSAT

For COMSAT . . . what many view as futuristic is already part of our everyday business and plans. We offer:

- **ORGANIZATION OF THE FUTURE—**  
a private corporation working directly with governments, at home and worldwide.
- **GLOBAL COMMUNICATIONS OF THE FUTURE—**  
satellite communications systems serving over 100 countries and some 700 ships at sea.
- **OFFICE OF THE FUTURE—**  
a partnership venture brings video conferencing, electronic intra-company mail transfer, information and more, via satellite to business and government.
- **FACTORY OF THE FUTURE—**  
computer-aided design and manufacturing services and systems.
- **HOME OF THE FUTURE—**  
planned home entertainment through direct satellite relay.
- **NATURAL RESOURCES MANAGEMENT OF THE FUTURE—**  
advanced satellite technology to provide

natural resource management through practical conservation and environmental programs.

- **RESEARCH OF THE FUTURE—**  
advanced R & D facilities offering the latest in communications product technology.

Our rapid expansion has created career openings in such diversified engineering disciplines as spacecraft design, signal processing, power systems, scientific software development and RF systems.

We offer excellent salaries and benefits, as well as the challenge of being in the forefront of high technology.

If you are interested in working with us, send your resume to:

Senior Employment Representative, Department 81-6RC, COMSAT, 950 L'Enfant Plaza, S.W., Washington, D.C. 20024.



## COMSAT

AN EQUAL OPPORTUNITY/AFFIRMATIVE ACTION EMPLOYER.

fast. Bit mapping also provides the user with a convenient method of screen access and the ability to easily look at the current contents of the screen.

In terms of displaying text, the screen can hold 60 lines of 90 characters (assuming the characters are equivalent to the typical 7 by 9 dot character commonly found on most video terminals). Character generation is not done in hardware on the Alto. A character set may be created by a user and displayed on the screen. Mixed fonts are allowed so that text of various sizes and shapes may be simultaneously displayed on the screen.

Since each dot on the display corresponds to only one bit in memory, there is no facility for grays or intermediate intensities. Due to the large number of points per inch, however, various combinations of points can be displayed to form a "texture" that gives the impression of varying shades of gray. This is exactly the same method used to reproduce pictures in a newspaper.

### The Keyboard

Superficially, the Alto keyboard resembles a typical typewriter keyboard with the addition of a few special keys. The keyboard is detachable, and quite comfortable for typing. It has the unique property of being entirely unencoded. Each key has its own signal line in the



Photo 2: Display from the keyboard-test program. The Alto keyboard has a separate signal line for each key and can thus tell when any number of keys are being pressed simultaneously. In the display, the black keys are being held down. The small square above the keyboard represents the mouse (see photo 4); one mouse key is also pressed.



Photo 3: The Pinball game. Flippers are actuated by the two shift keys; an Alto port can be connected to a speaker to provide bells and buzzer sounds.

keyboard interface, which allows a program to take advantage of the possibility of "chord" commands, where the user holds down one or more keys. For example, Shift-Control-E is as easy for the Alto to read as A-B-C (see photo 2). Another advantage is the ability to determine how long a key has been held down. For example, the pinball game program in photo 3 determines the force of a shot by measuring how long a key is held down on the keyboard. There is, of course, software to allow a program to read the keyboard in the typical manner.

### The Graphics Mouse

The mouse is a small box with three buttons on the top and several ball bearings on the bottom. A slender cable connects the mouse to the Alto keyboard (see photo 4). The buttons are named red, yellow, and blue, although the physical buttons are all black. The mouse is typically held in the user's right hand and rolled along the table on a soft piece of plastic that provides traction for the ball bearings.

Movement is detected by the motion of one of the ball bearings. The mouse reports changes in position to the Alto. From this, a cursor on the Alto display can be positioned. The physical position of the mouse on the table is unimportant, since only the change in position is reported. The mouse graphics interface is considerably more flexible and comfortable than a bit pad, joystick, or trackball. Many Alto programs can be controlled with the mouse alone, independent of a keyboard.

The buttons on top of the mouse are also unencoded, for flexibility. Many programs distinguish between holding a mouse button on or clicking it on and off. This allows a program to receive input by moving the cursor to some designated spot on the screen and then touching a mouse button to make something happen.

### Disk Storage/Processor Box

The processor and disk storage for the Alto are contained in a rack about the size of a waist-high filing cabinet. Each Alto has two 3-megabyte disk drives. The drives themselves resemble small pizza ovens and are often referred to in this manner.

The "brain" of the Alto is a 16-bit custom-made processor intended to resemble the Data General Nova 1220. The processor is made entirely of small- to medium-scale TTL (transistor-transistor logic) ICs (integrated circuits). The processor operates at a speed of approximately 400,000 instructions per second. Each Alto has an address space of 64 K 16-bit words, including the graphics bitmap. By using a technique called *bank selection*, the Alto may expand its available memory in 64 K-word increments up to 256 K words. An Alto with 256 K words is known as a *wide-bodied* Alto.

Quite a bit of the magic of the Alto is performed at the microcode level. The Alto can run up to sixteen tasks concurrently, and all of the schedul-



Photo 4: The mouse input device. The operator uses the mouse to control cursor placement on the screen; it detects its own change in position (a joystick relies on absolute position) as the operator rolls it around on a piece of soft plastic. The mouse also has three buttons, called red, yellow, and blue.

NEW

# IT'S MAGIC<sup>®</sup>



The System/48 is the outstanding office automation computing system for the 80's — it's so productive we call it MAGIC<sup>®</sup>. Look at these features:

- One to eight interactive users per node
- Data management system
- Report generator
- Query processor
- Screen format generator
- Automatic interface code generator
- Up to ½ Mbytes of user memory
- Winchester disk with 18-million bytes (formatted capacity)
- 15-minute mean-time-to-repair
- Built-in protection from line-voltage spikes, noise, and brownouts

And, it features MAGIC<sup>®</sup>, the Operating System that gets things done faster than you can say abracadabra because of its multi-keyed Indexed-Sequential Access Method and flexible file-organization. MAGIC<sup>®</sup> also offers high security, with password protection. MAGIC<sup>®</sup> supports global or local printers for as many users as desired.

MAGIC<sup>®</sup> also includes DataMagic II — TEI's red-hot database manager. DataMagic II has even more tricks up its sleeve — like automatic or manual record-lock protection and automatic transaction backout to protect the database. And it runs application software written for CP/M 2.X.

Take a MAGIC<sup>®</sup> leap into the future!  
Arrange to attend one of our regularly scheduled System/48 workshops (RSVP).

Circle 351 on Inquiry card.  
OEM and Dealer Inquiries Invited



## System/48<sup>®</sup>

5075 S. LOOP EAST, HOUSTON, TX. 77033  
(713) 738-2300 TWX. 910-881-3639

ing and I/O (input/output) for this multiprocessing is done in microcode. The user has direct control over only one task, however. The user task is the lowest priority and must, if necessary, relinquish processing cycles to the other tasks that control the display, disks, keyboard and mouse I/O, and Ethernet connections. The user has direct control over the microcode and may rewrite it according to individual taste.

### The Software

The Alto has the interesting property of using software (often microcode) to perform many tasks, such as keyboard encoding and character generation, that are typically done in hardware. This approach leaves the Alto with an occasionally cumbersome but highly flexible architecture.

Each Alto has a ROM (read-only memory) that contains just enough software to "bootstrap" an Alto into the local network (see textbox on this page). By keeping a bootstrap program in ROM, the user will always have a "safety net" to fall back on in case some other portion of the system software is not working. All of the Alto software can be retrieved from across the network.

The Alto Operating System (OS), a program which provides a set of basic facilities for control and communication with the Alto, is written in BCPL, a language very similar to C. Most programs, BCPL or otherwise, run under the direction of the Alto OS. Since the address space of an Alto is small, a technique called a "Junta" is used to permit BCPL programs to shed unwanted sections of the Alto OS during execution. If those portions are needed later, they may be restored by performing a "Counterjunta."

One BCPL program that runs on top of the operating system is called the Alto Executive (see photo 5a). This program speaks to the user directly and makes facilities available for file manipulation and program execution. An interesting feature of the Executive is that of escape expansion and file-name completion. Typing a partial file or program name followed

by an escape, in the same fashion that an ESC (escape) or ALT (alternate mode) might be sent from an ASCII (American Standard Code for Information Interchange) terminal, causes the Executive to complete the typing of the name on the screen. This

allows a programmer to name a file in a descriptive manner (such as GatewayInformation.press), rather than typing in a long name. The Executive program will recognize it as soon as it has read enough characters to determine the file uniquely. By

### The Ethernet Network: Interconnecting Personal Computers

*The Ethernet network, developed at Xerox Palo Alto Research Center by Bob Metcalfe and Dave Boggs, is a medium for the transmission of information. It is a multiaccess broadcast system used to link many computer systems that are physically within several hundred meters of each other. Each machine in the network is connected by means of a single, passive, coaxial cable.*

*The Ethernet network is a packet network. Information to be transmitted from one node to another is enclosed in an "envelope" of data that describes the information (ie: its length, a checksum for error control) and describes the destination of the resulting datagram or packet.*

*Regulation of access to the Ethernet cable is performed by a system designated CSMA/CD (Carrier Sense Multiple Access with Collision Detection). This technique works in exactly the same way that conversation among a group of people at a party is regulated. A node with something to say waits until no one else is speaking. When everyone else is quiet, that node begins to broadcast. If another node also starts broadcasting, this is called a collision. When a collision occurs, all of the nodes that are broadcasting cease to do so. Each node waits a random amount of time and then listens for another lull, thus starting the whole process again.*

*Each node on the network listens to the beginning of each packet. Once a node has determined that a packet is not addressed to itself, it stops paying attention to that packet and waits only for the end of the packet to allow it to prepare to listen to the next one. An Ethernet node may become "promiscuous" and listen to all packets being broadcast. This allows a very precise monitoring of statistics on the Ethernet system, since nodes generating traffic need not perform any statistical processing or use any*

*network bandwidth to report the statistics. A "silent observer" can watch the network without ever affecting the performance of that network.*

*At first glance, the "cocktail party" approach to multiple access might seem awkward. A second look, however, reveals that the maximum packet length is only 554 bytes, and the speed of Ethernet transmissions is approximately three million bits per second. This leads to a maximum transmission time of about 1.5 ms (milliseconds), which means that even on a highly loaded network, the overall efficiency remains very high.*

*An interesting aspect is that the Ethernet network itself is entirely passive. Regulation is done by each individual node. This decentralization means that the failure of any single node will not significantly affect the network as a whole. Thus, the mean time between failures of the whole network is very high, making it a good choice for industrial or business applications where downtime means lost revenue.*

*The high speed of the Ethernet network rivals that of disk I/O. A file may be loaded from across the network almost as easily as from a local disk. In a distributed information processing system, it is highly desirable to allow a file to be easily accessed anywhere on the network. A high-speed file transfer capability also permits a new machine to be integrated into the network in just a few minutes.*

*The competition in local networking is hot and heavy. DEC (Digital Equipment Corporation), Intel, and Xerox Corporation have recently joined forces to promote an Ethernet-based industry standard network. Wang Corporation, IBM, and Zilog have also proposed networking standards. Whatever the outcome, industry seems to have decided that the future is in local networks.*



With the Hayes direct-connect Micromodem II™, your Apple II can communicate by phone with the outside world. You can access information networks like The Source for a variety of business and personal applications, exchange programs with friends anywhere in North America, and even use your Apple II when you're away from your home or office.

**Dependable.** The Micromodem II is so dependable it comes with a *two-year* limited

warranty. That's another reason why it's the largest selling direct-connect modem for Apple II computers.



**Programmable.**

Automatic dialing and answering? Of course! We include programs on disk that dial phone numbers for you, send messages while you're away, and much more!

**Complete.** You get everything you need to communicate with other Bell

103 compatible modems at 110 or 300 baud. The serial interface

is built-in, and we even include our FCC-approved Microcoupler™ that plugs directly into any modular telephone jack in the U.S. — you don't even need the phone!

**S-100, too.** The Hayes Micromodem 100 gives S-100 microcomputers all the advantages of our Micromodem II!

Put the outside world *inside* your computer with a data communications system from Hayes. Available at computer stores nationwide — call or write for the location nearest you. And don't settle for anything less than Hayes.



**Hayes**

## The Hayes Micromodem II opens up your Apple II to the outside world.



**Hayes Microcomputer Products Inc.** 5835 Peachtree Corners East, Norcross, Georgia 30092 (404) 449-8781

Micromodem II, Micromodem 100 and Microcoupler are trademarks of Hayes Microcomputer Products Inc.  
 ™ Apple Computer Inc. Micromodem II can also be used with the Bell & Howell computer. © 1981 Hayes Microcomputer Products Inc.

typing a question mark instead of an escape, the Executive will list all file names that are valid matches for the string typed thus far.

The Alto has a highly flexible and rugged file system. Unlike many file systems (eg: Digital Research's CP/M or Radio Shack's TRSDOS) that limit names to six or eight characters with a three-character extension, the Alto file system permits file names of up to thirty-one characters in length. When a file name is entered for the first time, the file name is stored exactly as typed, even with regard to upper- and lowercase. Since the file names may be very long, this permits a programmer to use upper- and lowercase to improve readability. LongFile-Name.BigExtension is much easier on the eyes than LONGFILENAME.BIGEXTENSION. After the creation

of a file, case is ignored when the user is speaking about the file, so either of the two names in the previous examples, as well as longfile.name.bigextension, would be valid.

Alto files are divided into *pages*. Each page contains a small header that describes the current page, tells what file the page belongs to, and points to the places on the disk that contain the next and previous pages for the same file. This makes the file system almost indestructible. A program called Scavenger can automatically rebuild a broken file system.

Of course, no Alto is an island, so software is needed to deal with the Ethernet network. Some of this software appears in the form of the NetExecutive (see photo 5b) and FTP (file-transfer program). The NetExec

is a program that appears to be very similar to the Alto Executive, but it loads programs from across the network rather than from the local disk. This means that a user need not keep infrequently used or large programs locally. Instead, these programs can be loaded through the network (at an apparent speed of approximately 800,000 bits per second) only when needed. FTP performs similar feats of file manipulation, but in a considerably more flexible manner.

Although a great deal of software written for the Alto is in BCPL, there is a new contender for software development called Mesa. Mesa is a Pascal-like language that is incompatible with BCPL because of differences in their respective microcodes. Mesa is expected to be the programming language for the successors of the Alto (see photo 5c).

BCPL and Mesa are the system languages for the Alto, which means that the system utilities and many applications programs are written in them. Other languages are available on the Alto, however. Much of the research work done on the Alto at Xerox is written in Smalltalk, an object-oriented language that is both easy to learn and highly powerful (see the special August 1981 BYTE issue

(5a)



(5b)



(5c)



(5d)



(5e)



**Photo 5:** Examples of Alto software. Photo 5a shows a display of the Alto Executive, with an example of star and question-mark notation. Photo 5b shows the NetExecutive (similar to the Alto Executive, but it allows access to resources on the Ethernet). Photo 5c is a typical Mesa program being edited by Bravo; note the different typefaces used in the program listing. Photo 5d is a directory from the Neptune directory editor. The file names in black have been selected for further operations such as printing or erasure. The cursor is displayed as a cross in a circle. Photo 5e illustrates Bravo's ability to change fonts (there are hundreds of fonts for the Alto, from Gothic to Elvish Runes; the central paragraph in this display has been changed to Greek). The document in the bottom window has been converted to the form shown in the top window.

# MicroMed™ and MicroDent™ make your practice perfect.™

## Simply the best!

They're the real solution to the problems confronting every physician's and dentist's office. Each is a unique package, developed through years of work in close conjunction with doctors and dentists. They'll help you treat your patients more efficiently and accurately, while saving you time and money in the process.

## Versatility.

Whether you are in private practice or a member of a busy group, there's sufficient capacity to handle your needs. Thousands of patients can be accommodated on floppies, and even more on hard disk. MicroMed and MicroDent can easily handle everything in your practice from billing to patient records to complex insurance forms. With millions of hours of actual use in medical and dental offices throughout the country, they stand alone at the top, in a class by themselves.

## Solutions, not more problems.

We know you're after solutions, not more problems. Our menus are simplicity itself, and are designed for your convenience (not our programmers'). The computer displays your options at every step. What could be simpler? Your own office staff can easily take care of the routine so that you can devote your valuable time to your patients.

## You are the boss.

Forget about problems with outside billing services or manual record-keeping. You exercise absolute control over your billing procedures. Finger-tip patient recall lets you know instantly whose accounts are due and what services were performed. Account aging is automatic, and past-due notices or statements are printed and addressed, ready for mailing. All types of reports may be requested to help you better understand your finances and cash flow. Daily backups are created automatically.

## Multiple Insurance Forms.

Many patients have several different types of insurance coverage. With MicroMed and MicroDent you can enter almost any form, keep track of which patients it applies to, and get it processed and ready for mailing. When new forms come out (as we all know they will) you don't have to pay for custom programming, you can modify the form print format yourself. With our exclusive Formulator™ system it takes just minutes.

## Economic Sense.

The biggest surprise of all is that MicroMed and MicroDent are just \$1500 each. Plus, having your own office computer provides you with great tax advantages. If you like what you see, contact your nearest computer store. They can provide you with MicroMed or MicroDent on any CP/M® based computer for an amazingly economical price. Or, if you already have a computer, a demo disk and manual set is available for just \$75, and allows you to run the entire program. The manual separately is \$50. Send for one today, and make your practice perfect!

## Features:

- Automatic billing for any patient load
- Handles practices with up to 20 doctors
- Accepts all insurance forms
- Exclusive "Formulator" form system
- Multiple insurance coverage
- Insurance preauthorization
- Automatic statements with aging
- Instant access to patient records
- Full transaction and treatment details
- Cumulative totals by doctor
- Profitability analysis reports
- Mailing list maintenance
- Can be linked to word-processing
- Appointment recall with reminders
- Maintains hospital and lab codes
- Keeps track of referring doctor codes

**Demo disk and manual set \$75!**

Dealerships are available to established computer vendors on a territorial basis.

™MicroMed, MicroDent, and Formulator are trademarks of SoftwareHow.  
©CP/M is a registered trademark of Digital Research  
Copyright ©1981, SoftwareHow

# SOFTWARE HOW

P.O. Box 36275, Los Angeles, CA 90036

(213) 731-0876 • TWX: 910-321-2378



(6a)



(6b)



(6c)



(6d)

**Photo 6:** Use of the Draw program. In photo 6a, points are placed with the cursor, and curves and lines are filled in by the program. Photo 6b shows that lines may be "painted" with a variety of "brushstrokes" (the cursor has changed to a small paintbrush). In photo 6c, texture is given to the lines; dotted lines are created with the scissors cursor. Photo 6d shows that the picture may be mathematically manipulated; a new figure may be created by reversing, tilting, or stretching a copy of the original.

on the Smalltalk language). Another supported language is LISP, a list-processing language that is very popular in the artificial intelligence research community.

### Using the Screen

A system with the advanced graphics capability of the Alto will make extensive use of those facilities. The screen may be broken up into windows, and each window may be accessed in a different manner, if

desired. Many Alto programs use only the mouse and screen windows for program control. For instance, the Neptune program is used for managing the contents of the Alto's local disks (see photo 5d). A file may be deleted simply by touching the file name with the cursor, then touching the Delete spot on the screen with the cursor. As the cursor enters a new window, it may change shape, perhaps appearing as an arrow in one window and a paintbrush in another.

Since the Alto is used extensively for research in the office automation field, a good text editor is an obvious requirement. Bravo is a text editor and formatter widely used on the Alto. In the tradition of screen-oriented editors, the current state of the user's file is always shown on the screen. Bravo is controlled partly by keyboard commands and partly by mouse commands. It allows a user to open windows into one or more files. Text may be added or deleted by pointing at the desired location on the screen (see photo 5e) with the mouse cursor, and giving a command via the keyboard or mouse. Bravo supports many different fonts and allows the user to change easily from one font to the next. In addition, Bravo remembers the changes that have been made to a document and allows the user to reverse any or all changes.

Bravo allows the user to edit and format text, but often a person may wish to include illustrations in a document. To do this, a program called Draw is used. Draw is an interactive sketch-pad program that provides a variety of tools for creating and manipulating pictures made from lines, curves, and text. Draw divides the screen into a number of windows (see photo 6). The left side of the screen contains a menu of commands and a variety of brushstrokes that can be selected. The top of the screen contains an area for text commands and messages from the program. The middle of the screen is the picture workspace. Curves can be drawn by moving the cursor directly, or by selecting several points and allowing Draw to mathematically fit a curve to those points. Once an object is defined, it can be repainted using a number of brushstrokes. Since this is very similar to the techniques used by artists and calligraphers, quite a bit of artistic expression is possible. An object can be duplicated, rotated, stretched, or shrunk, by means of a small set of commands and mouse gestures.

### The Network

Each Alto is assigned an *Ethernet address* that identifies it uniquely on

# datasouth announces... **THE TOTAL PRINTER PACKAGE!**

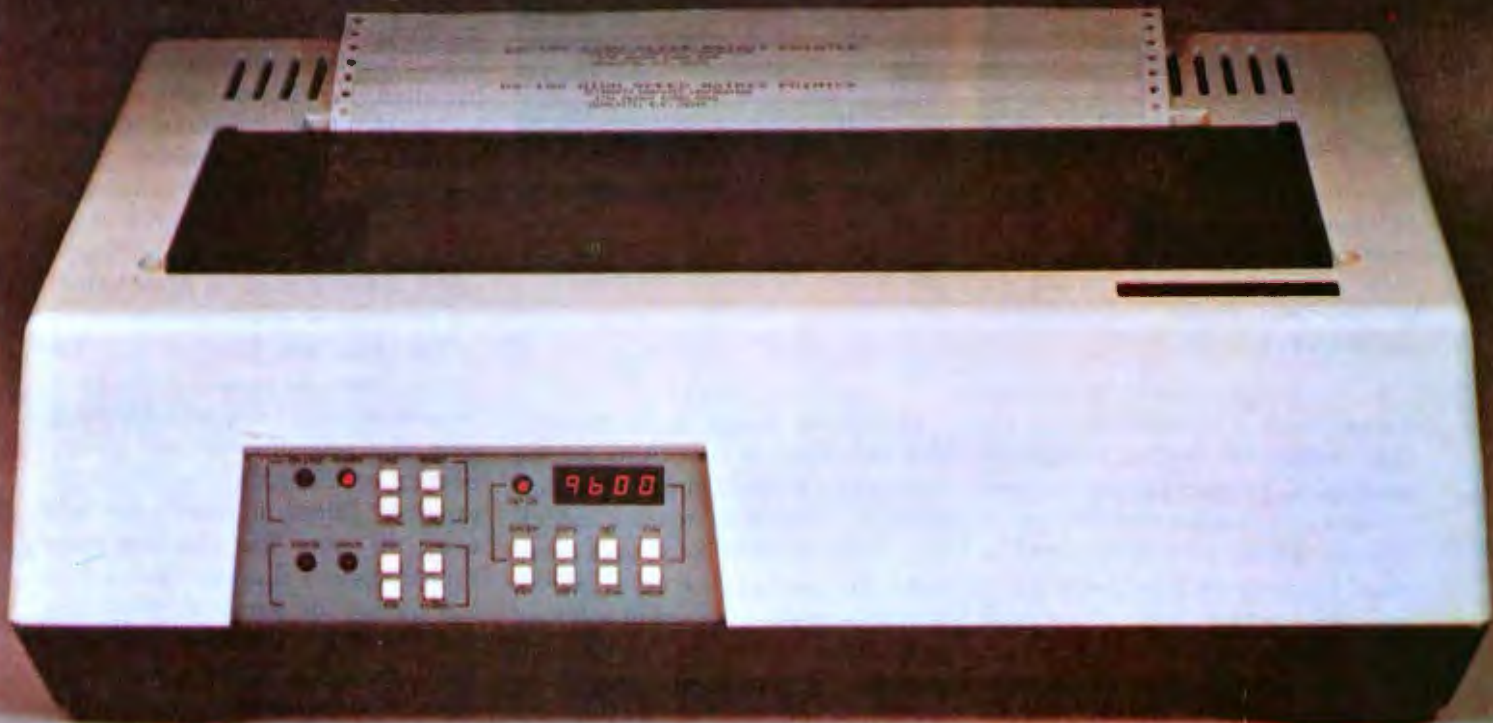

With so many matrix printers on the market today, it may seem tough to find exactly the right one for your application. Some models may offer the speed you need, others the communications flexibility and still others the forms handling capability. But no printer offers all the features you need...until now.

The DS180 matrix printer provides the total package of performance features and reliability required for applications such as CRT slave copy, remote terminal networks and small to mid-range systems. Not a "hobby-grade" printer, the DS180 is a real work-horse designed to handle your most demanding printer requirements. And pricing on the DS180 is hundreds of dollars below competitive units.

**High Speed Printing**—Bidirectional, logic-seeking printing at 180 cps offers throughput of over 200 lpm on average text. A 9-wire printhead life-tested at 650 million characters generates a 9x7 matrix with true lower case descenders and underlining.

**Non-volatile Format Retention**—a unique programming keypad featuring a non-volatile memory allows the user to configure the DS180 for virtually any application. Top of form, horizontal and vertical tabs, perforation skipover, communications parameters

and many other features may be programmed and stored from the keypad. When your system is powered down, the format is retained in memory. The DS180 even remembers the line where you stopped printing. There is no need to reset the top of form, margins, baud rate, etc....it's all stored in the memory. If you need to reconfigure for another application, simply load a new format into the memory.

**Communications Versatility**—The DS180 offers three interfaces including RS232, current loop and 8-bit parallel. Baud rates from 110-9600 may be selected. A 1K buffer and X-on, X-off hand-shaking ensure optimum throughput.

**Forms Handling Flexibility**—Adjustable tractors accommodate forms from 3"-15". The adjustable head can print 6-part forms crisply and clearly making the DS180 ideal for printing multipart invoices and shipping documents. Forms can be fed from the front or the bottom.

If you would like more information on how the DS180's low-cost total printer package can fill your application, give us a call at Datasouth. The DS180 is available for 30-day delivery from our sales/service distributors throughout the U.S.

**datasouth**  
**computer corporation**



**Photo 7:** The multiplayer *Trek* program. This game is played entirely under mouse control. The lower portion of the screen shows a short-range sensor scan; above is the long-range display, and navigation and weapons controls.



**Photo 8:** The multiplayer *Mazewar* game. The eye represents the persona of an opponent. Any Alto on the net can join or leave the game at any time.

the network. A typical Ethernet address might be 50#100, which is meaningless to most people. To permit an easily remembered distinction between Altos, each is assigned a name. For instance, the Altos at Stanford are named after rivers and mountains in California State parks; Altos at CMU are named after jewels, and Altos at Xerox are named after people. This leads to such interesting names as Cypress, Turquoise, or Machiavelli, which are considerably easier to remember than 50#100.

Alto networks do not consist entirely of Altos. Several other devices are connected to the Ethernet network. One type is called a *server*. Servers are useless Altos that are dedicated to some specific function. A server might be connected to a printer. Thus, printing a file would actually consist of sending the proper messages to a Printing Server. One common type of server is a File Server. These machines support extra-large disks and are repositories for programs and files that are too large or too infrequently accessed to make storage on individual machines worthwhile. The Stanford File Server is named Lassen.

Due to the design of the network and the Altos, a new Alto can be wheeled in, plugged into the network medium (standard coaxial cable), and, with a blank disk pack fresh from the factory, become entirely functional with a full set of software in a matter of minutes. An Alto can also be disconnected, moved to another port in the coaxial cable, and reconnected without affecting either the performance of the network or the Alto.

Several programs exist that take advantage of the distributed processing capabilities inherent in the Ethernet network. Of all of them, the most enjoyable are the games. *Trek* is a multiplayer "spacewar" game that is controlled primarily by the mouse (see photo 7). *Mazewar* is a multiplayer romp through a realistic labyrinth (see photo 8). The unique feature of these games is that large numbers of users can join or leave the game as they please without affecting the play of the others. Since all the Altos can listen to the same packet (block information on the Ethernet) at once, the game program is never running on any single coordinating machine. Instead, it is running in-

dependently on every participating Alto.

## The Future

A stand-alone Alto is usable, but the best configuration is a group of Altos connected by an Ethernet system. Since the Ethernet system is a local network, a special device called a gateway was developed to allow local Ethernet networks to speak to other Ethernet networks or packet networks of other types. Many companies are researching network schemes that would allow packet transmission across cable-television lines. Since these cables are currently installed in many homes and buildings, it is not difficult to imagine a city with an "information grid," analogous to the electric-power grid that exists today. Combined with an electronic mail system (a prototype called Laurel is used on Altos today) the possibilities are staggering.

The Alto has been around for several years. As research tools go, it is covered with moss and gathering dust. But new products will be appearing on the market based on the expertise gained in producing and using the Alto. The next few years should show a dramatic increase in the quality of personal computing and the ability to interconnect personal computers. And the Alto is one of the first personal computers that satisfies the needs of the computer scientist as well as the secretary or businessman. ■

## References

1. Lampson, B W and E Taft. *Alto User's Handbook*, 1979.
2. Metcalfe, R M and D R Boggs. "Ethernet: Distributed Packet Switching For Local Computer Networks." *Communications of the ACM* 19,7, July 1976, pages 395 through 404.
3. Shoch, J F and J A Hupp. "Measured Performance of an Ethernet Local Network." *Communications of the ACM* 23,12, December 1980, pages 711 through 721.
4. Thacker, C P, E M McCreight, B W Lampson, R F Sproull, and D R Boggs. *Alto: A Personal Computer*. Tech Rep CSL-79-11. Palo Alto CA: Xerox Palo Alto Research Center, August 1979. (To appear in *Computer Structures: Readings and Examples*, Second Edition. Siewiorek, Bell, and Newell, editors.)

# Customizable

*The Unique Difference that Sets  
VEDIT Apart in Full Screen Editors*

Total user customizability is a predominate reason that over a thousand users find VEDIT the easiest to use full screen editor. It makes VEDIT the only editing package which allows you to determine your own keyboard layout and use the cursor and special function keys on any terminal having them. And only VEDIT fully supports all of the newly available terminals. It may come as a surprise to you, that with any other editor or word processor, you will have to memorize obscure control characters or multi-character sequences, while your terminal's extra keys and editing functions go unused. The customization extends to setting the default tab positions, scrolling methods and much more. It's almost like designing your own editor for your system, applications and preferences. And all of this is easily done with the setup program which requires no programming knowledge or 'patches', but simply prompts you to press a key or enter a parameter.

## *Unequaled Hardware Support*

The CRT version supports all terminals by allowing you to select during setup which terminal VEDIT will run on. Features such as line insert and delete, reverse scroll, status line and reverse video are used on 'smart' terminals. All screen sizes are supported, including large ones such as the 60 X 80 format on the Ann Arbor Ambassador terminal. Special function keys on terminals such as the Heath H19, Televideo 920C and IBM 3101, and keyboards producing 8 bit codes are all supported. The memory mapped version is extremely flexible and supports bank select and hardware cursors such as on the SSM VB3. With this level of customizability and hardware support, you will feel for the first time that the software was optimally designed for your system.

## *Fully Compatible Replacement for Ed*

Since VEDIT creates and edits standard text files of up to one diskette in length, it serves as a replacement for the CP/M

standard editor ED. Of course, you benefit from the fastest and easiest to use 'What you see is what you get' type full screen editing available, fast disk access and an editor which takes up only 12K of your valuable memory space. With VEDIT you will never again need or want to use the slow and tedious ED.

## *Special Features*

VEDIT is more than just a full screen editing replacement for ED, it gives you many new editing capabilities, such as a scratchpad buffer for moving and rearranging sections of text, complete file handling on multiple drives and iteration macros. Amongst its special features you will find automatic indenting for use with structured programming languages such as Pascal and PL/I, and other special facilities for Assembler and COBOL. A real time saver is the ability to insert a specified line range of another file anywhere in the text. Unlike most software, VEDIT will even tolerate your mistakes. For example, one key will 'Undo' the changes you mistakenly made to a screen line, and the disk write error recovery lets you delete files or insert another disk should you run out of disk space.

## *Ordering*

Many dealers carry VEDIT, or you may contact us for fast delivery. Specify the CRT version, your video board or microcomputer, the 8080, Z80 or 8086 code version, and disk format required.

VEDIT for 8080 or Z80: Disk and manual .....\$130  
VEDIT for CP/M-86: Disk and manual (NEW) .....\$185  
Manual: Price refunded with software purchase ..... \$15

VISA or MASTERCARD Welcomed

CP/M and MP/M are registered trademarks of Digital Research, Inc. Apple II is a registered trademark of Apple Computer, Inc. SoftCard is a trademark of Microsoft. TRS-80 is a trademark of Tandy Corp.

• North Star • Cromemco • Heath H8/H89 • SuperBrain • Apple II Softcard • TRS-80 Model II & Model I  
Most other CP/M Systems with CRT or Memory Mapped Displays • MP/M • CP/M-86



## CompuView Products Inc.

618 Louise, Ann Arbor, Michigan 48103 • Telephone (313) 996-1299

# IF YOU WANT TO START YOUR OWN COMPUTER COMPANY, YOU NOW HAVE THE COMPUTER TO START WITH.

The entrepreneurial spirit runs rampant in the computer industry. In fact, it's come to our attention that a significant number of the technical/engineering types have some thoughts of starting their own company.

So we have come out with a computer for them. And for those entrepreneurs within companies who are in a hurry to get their hot new project to market in a hurry.

It's called the MPT/100.

As you can see, the MPT/100 computer is small enough to fit in whatever corner you set aside for furthering your own ambitions.

And it'll cost you less than the price of a basic new car.

This computer is anything but basic.

Inside the MPT/100, you'll find a 16-bit microNOVA™ computer. 64K bytes of memory. 80 column by 24 line screen. Full keyboard with numeric pad. 716 KB of on-line storage on two 358 KB mini-diskettes all packaged in a system that has the kind of software, compatibility with more powerful computers, ease-of-use and reliability that desk-top computers are noted for not having.

Also unlike most desk-top computer software, some very sophisticated (read easy-to-use) big computer software is available for the MPT/100 computer: A multi-tasking FORTRAN that meets all the ANSI standards.

A PASCAL that executes at assembly language speeds. An ANSI compatible BASIC that lets you write enormously complex programs that take up only a little space. A

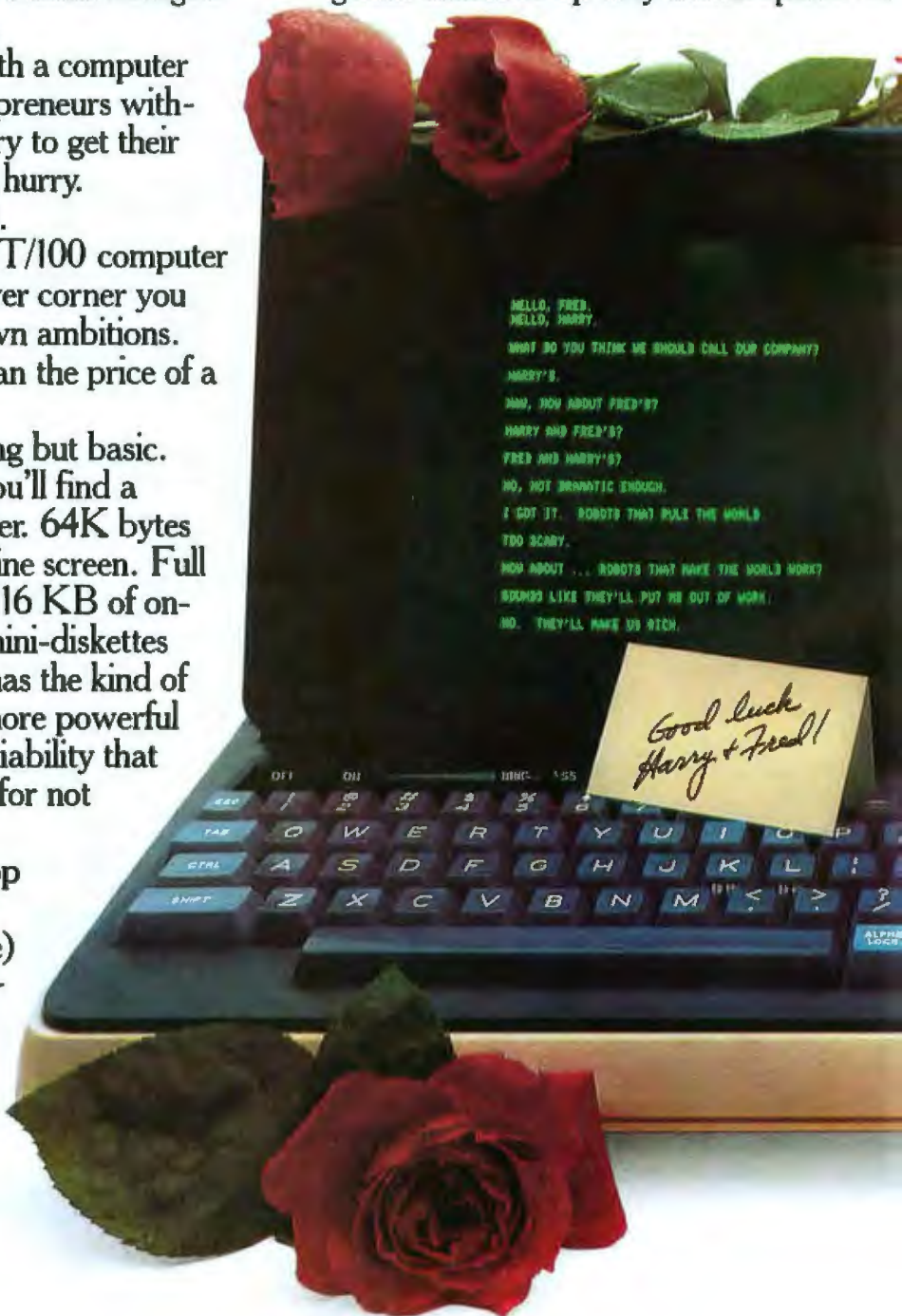



full range of user-friendly interactive programming aids. And MP/OS, an operating system anyone who's into operating systems will tell you is one of the most advanced in the world.

(Anyone who considers any of the above to be of trivial importance should consider the fact that a single line of application code costs a good deal more than many microcomputers. And that cost is only going one way.)

Saving money on programming is only part of the attraction of the MPT/100. It also saves you time. So you can get your company up and running before anyone can do the same thing.

As you grow, all the software you've written, all the peripherals

you've interfaced, all the blood, sweat and tears you've put into your company will grow with you. Because we've invested no small amount of energy working to make our computers compatible.

The point here is that the MPT/100 can make you what a lot of companies have become with Data General.

Like Aero Systems Engineering, of St. Paul, Minnesota, for example. They're far and above the leading manufacturer of computerized aircraft jet engine testing systems. A position they came to occupy partly by building test facilities that could cut fuel consumption rates by 35%. Partly because of our world-wide service. And partly because they didn't have to wait eighteen months to get our computers.

There is no stopping you from doing the same thing.

If you want to get more detailed information about the MPT/100 computer, call your local Data General office or your Data General manufacturer's representative. Or the distributors listed below. Or write us at: MS C-228, 4400 Computer Drive, Westboro, MA 01580.

MPT/100 computers are available for off the shelf delivery from:  
**SCHWEBER, HALL-MARK,  
KIERULFF, ALMAC/  
STROUM** and  
R.A.E. in Canada.

Look at it this way. All of you who want to start your own computer company, are very lucky people. We didn't have anybody to write to when we got started.

 **Data General**  
We take care of our own.



# Tree Searching

## Part 1: Basic Techniques

Gregg Williams, Senior Editor

It is estimated that there are more possible games of chess than there are atoms in the universe. This means that if a computer could generate one million chess moves a second, it would take approximately  $3.2 \times 10^{40}$  centuries to generate all possible games. How, then, can a \$200 microprocessor-based chess game (faced with analyzing a situation so complex) play not only minimal but fair-to-good chess? Several techniques are necessary, but one of the

most powerful in the field of artificial intelligence is known as *tree searching*.

Tree searching allows a computer to determine the best of many alternatives, while at the same time evaluating as few partial solutions as possible. Part 1 of this article deals with the basic techniques of tree searching on three levels: theory, implementation (through several BASIC programs illustrating the major techniques), and experimentation. It

will introduce basic terminology and some well-known *exhaustive* tree searches (those that will eventually generate all possible partial solutions), as well as an illustrative BASIC program (to solve the familiar sliding blocks "15-puzzle") that will be used in both articles. The second part will deal with *admissible heuristic searches* that use information about the system being searched to cut down on the number of false leads pursued; it will also cover nonadmissible heuristic searches, which attempt to find a quicker solution at the expense of losing the certainty of a guaranteed *optimal* solution, or of finding a solution at all.

### Basic Terminology

The purpose of artificial intelligence, according to one school of thought, is to produce computer programs that will solve problems not easily solved by computers—problems that can be solved by an "intelligent" agent (usually a human). The solution to many of these problems can be seen as the attempt to arrive at a solution (or goal) whose properties are unambiguously defined, from an initial state (or node), according to some specific set of rules. Between the starting node and the goal node are other positions that represent intermediate positions. We

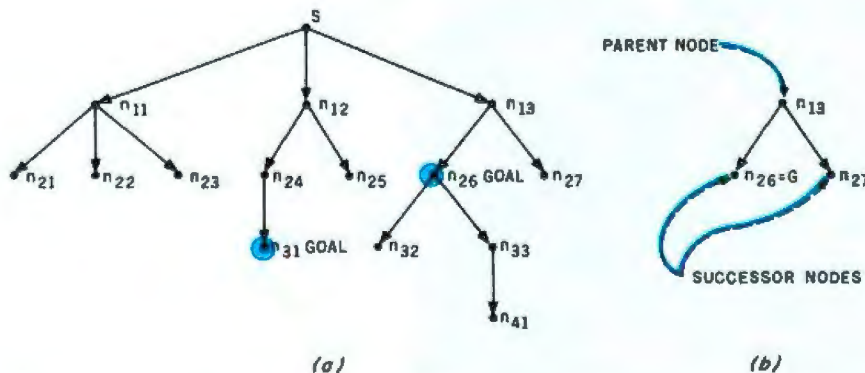

**Figure 1:** Nomenclature of trees. Figure 1a gives the graphic representation of the state space of a problem as a tree. Trees are characterized by having only one start node (*S*), by containing only nodes that can be reached via the start node, and by having no arrows that lead to the same or lesser depth. Nodes  $n_{21}$ ,  $n_{32}$ , and  $n_{27}$  are examples of terminal nodes; nodes  $n_{12}$ ,  $n_{26}$ , and  $n_{33}$  are examples of nonterminal nodes; nodes  $n_{31}$  and  $n_{26}$  (shown in color) are goal nodes. Note that a goal node can be either terminal or nonterminal. Figure 1b shows the relationship between parent node  $n_{13}$  and successor nodes  $n_{26}$  and  $n_{27}$ . Here,  $n_{13}$  is said to be expanded to generate  $n_{26}$  and  $n_{27}$ .

# PEDUNCLE

It certainly is nice to know those beautiful spring blossoms on flowering peach trees are sessile blooms. Sessile, according to Webster, simply means the flowers are not raised upon a peduncle. Well, thank goodness for that! And Webster adds that a peduncle is the stalk that supports the fructification in

some thallophytes. Big deal... We at Peachtree Software are very pleased to assure you that due to our advanced technology, our thallophytes fructificate without the need of any support whatsoever! Software dealers, rejoice... your peduncle worries are over forever. Isn't modern science wonderful?



## The Very Best "Off-The-Shelf" Software Is "Off-The-Tree."

ever developed. It has the power of ANSI/COBOL and floppy or hard disk support. User-selectable options bridge the gap between accounts receivable and inventory.

**Peachtree Series 5** is an all new generation of BASIC General Accounting packages. It includes such user-requested features as the capability to access and update, simultaneously, both the Accounts Receivable and Inventory data files. Hard disk option. Installation guides. Expanded data and report capability.

**The Peachtree Series 40** is adapted for the Apple II\*'s

standard 40-column screen and single-density 5 1/4-inch disk drive, using the SoftCard™ from Microsoft\*\*. The series includes General Ledger, Accounts Receivable, Accounts Payable, Inventory, Mailing List, Payroll, and Magic Wand™

**I**t takes time to grow a tree, and we've been in the business ever since microcomputers started springing up in homes and businesses all across America. So our software systems are time-tested and user-feedback refined. Trust the Tree for Unsurpassed Documentation. For Feature-packed Systems, utilizing the latest hardware technology. And trust the Tree for sophisticated programs, so easy to use, that "peduncle" may soon disappear entirely from the English language!

There are more than 20,000 Peachtree Software packages in use today. To get yours, see your nearest dealer or call 1-800-835-2246 Ext. 35. In Kansas call 1-800-362-2421 Ext. 35.

**Y**ou're really going to appreciate the "self teaching" simplicity of Peachtree Software's documentation. You'll be on your own in no time, with no need for "support." Our learn-by-doing manual shows you exactly what will appear on the screen. Menu driven, our programs prompt you at every point with the selections available. There's sample data for self-training and practice, too. So goodbye forever to peduncles... who needs 'em!

Wide variety of packages, all from the same tree. Here's just a sample.

**Magic Wand™** — With this extremely popular word processing system, a minimum of commands performs basic functions. It's remarkably easy to use. And you can now add Magic Spell™, the "dictionary" with 20,000 words.

**Sales Tracker™** is our most comprehensive product—a sales order processing system that could well be the most sophisticated microcomputer software

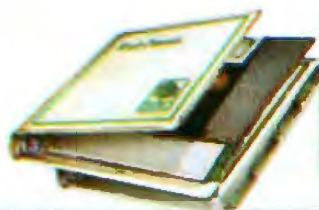

The Very Best "Off-The-Shelf" Software Is "Off-The-Tree."

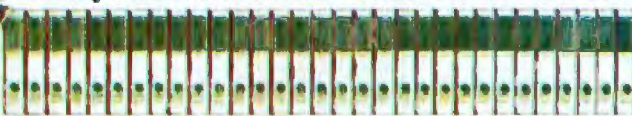

PEACHTREE SOFTWARE, 3 Corporate Square, Suite 700, Atlanta, Georgia 30329 (404) 325-8533 Telex II: 810-751-0273 PEACHTREE ATL.

\* Apple II is a trademark of Apple Computer, Inc. \*\* Microsoft and SoftCard are trademarks of Microsoft Consumer Products, Inc. Peachtree Software, Magic Wand, Magic Spell, and Sales Trackers are trademarks of Peachtree Software, Incorporated

are interested in the particular sequence of nodes that makes up the shortest path to one of several possible goal nodes. Many nodes (usually an overwhelming number) do not lie on the optimum path, and the purpose of tree-searching methods is to explore as few of these as possible.

A number of problems that do not seem to lend themselves to tree searches can be made to do so when described in a *finite-state representation*. Sometimes, in the case of problems that have a continuous (and therefore infinite) range of variation, this means quantizing the problem into a finite number of discrete steps: an example is considering the range of temperatures of 20° to 30°C as a set of discrete temperatures—say, 20.0°, 20.1°, 20.2°, ... 29.9°, and 30.0°. Theoretically, this results in some loss of accuracy, but most problems can be quantized in sufficiently small increments that accuracy is not a problem.

A finite-state representation consists of the following: a *start node*, a well-defined node or *set of goal nodes*, and a set of rules or *operators* that allows the user to generate all permissible successor nodes from a given node. In some cases, the path from a node to its *successor node* (that is, one generated by the single

application of an operator to the *parent node*) may have a *cost* associated with it, with the cost of a goal node being the total cost incurred along the shortest path from the start node to the goal node. The set of all nodes that can be derived from the start node is called the *state space*.

A *tree* is one possible representation of the state space of a problem. As shown in figure 1, nodes are represented as points, and the relationship between a given node and its successor is shown by a directed arrow that points from the parent node to the successor node. We will label the start node S, and each of the other nodes' according to its *rank*

(distance from the start node) and lateral position within the set of all nodes with the same rank (this is an arbitrary labeling, but it is orderly and useful). Referring to figure 1a, nodes  $n_{11}$ ,  $n_{12}$ , and  $n_{13}$  are all the nodes of rank one. Node  $n_{12}$  has two successor nodes,  $n_{24}$  and  $n_{25}$ . Node  $n_{41}$  is the only node of rank four.

Some nodes do not yield any new states upon application of the operators that define the transition from one state (node) to the next. These are called *terminal nodes*; examples in figure 1a are nodes  $n_{21}$ ,  $n_{22}$ ,  $n_{23}$ ,  $n_{25}$ ,  $n_{27}$ ,  $n_{31}$ ,  $n_{32}$ , and  $n_{41}$ . Nodes marked G are regarded as goal nodes; they can be either terminal or nonterminal nodes.

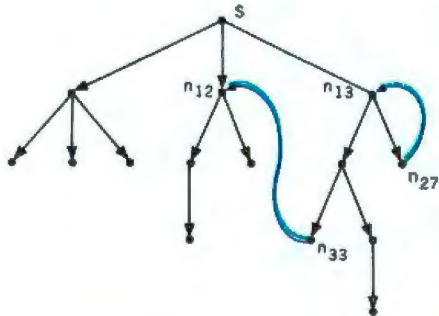
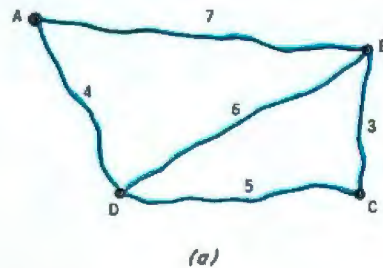

**Figure 2:** A directed graph. This figure, which represents the structure of many "real-world" problems, differs from a tree in that successors may be in the same or a "shallower" depth (note colored arrows). The successor of  $n_{33}$  is  $n_{12}$ ; the successor of  $n_{27}$  is  $n_{13}$ . Tree-searching algorithms can be modified to handle graphs, but this article will deal exclusively with trees.

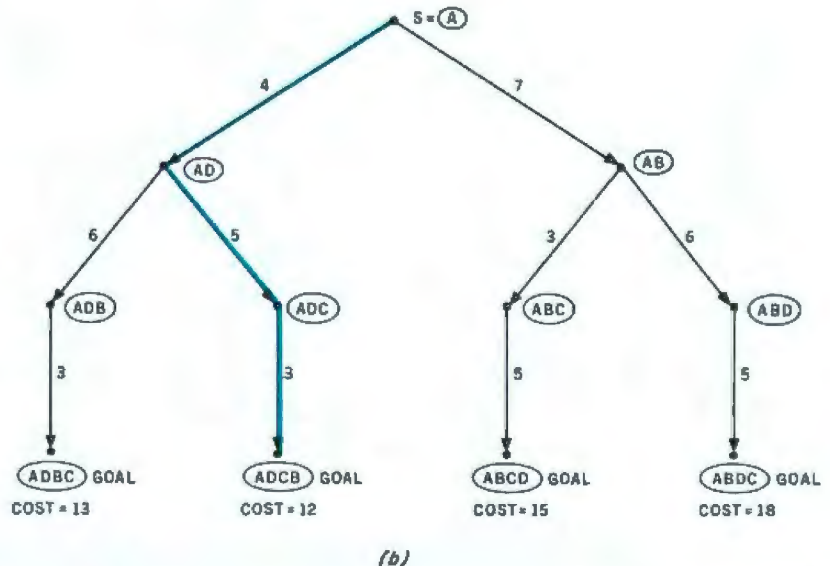

**Figure 3:** The traveling-salesman problem. Given the map in figure 3a, the objective is to find the shortest route from city A through cities B, C, and D. The tree of figure 3b gives the finite-state representation of the problem, with each node being a partial trip (eg: ADC is the trip from A through D and C) that has a cost dependent upon the route taken. Here the problem is discrete, and any node has only a finite number of successors; at node AD, only two "next moves" are possible: ADB and ADC. The shortest route is shown in color.



## **“Together we’re working to better serve mankind.”**

“Speaking on behalf of Vector computers, I’m pleased to announce that TRW Customer Service Division will provide a nationwide, nine-month on-site service warranty that you, the end-user, will receive absolutely free.\*

“I’d also like to add that this is a unique program. It’s actually the first time a microcomputer has had this kind of comprehensive nationwide on-site service — especially from a company of experts like TRW.

“Now you have even more security when you buy a Vector. In addition to increasing your personal productivity, helping you make faster decisions, and improving your business, we offer a network that will service us right in your office if we ever need it. At no expense to you.

“Right now, you can get quick, dependable service in Los Angeles, New York City, Denver, Dallas, Chicago, San Francisco, Northern New Jersey, Philadelphia, Atlanta, and Boston. With more cities on the way.

For more information and your nearest Dealer, call us at 800-423-5857. In California, call 800-382-3367. Or write to us at 31364 Via Colinas, Westlake Village, CA 91362.

“TRW and Vector. Now that we’re helping each other, there’s no telling how much we can accomplish for you.”

**VECTOR**  
Vector Graphic Inc.

**COMPUTERS FOR THE ADVANCEMENT OF SOCIETY.**

# 68000 $\mu$ P on the S-100 Bus?

**YES, AVAILABLE NOW FROM DUAL SYSTEMS!**

- 8 MHz 68000 microprocessor.
- 16-megabyte direct addressing.
- 32-bit internal arithmetic.
- Minicomputer type instructions including MULTIPLY.
- FULL IEEE-696 S-100 compliance. Runs with all 4 MHz S-100 boards and automatically runs faster when accessing Dual Systems memory boards, for FULL SPEED OPERATION OF THE 68000.
- Powerful vectored interrupts. 7 Vectored interrupts, including NMI, as well as alternate mode having up to 256 interrupts.
- On board monitor ROM for immediate use.
- Connector for future addition of memory management unit for multi-user operating systems.
- Built to the highest industrial standards with 200 hour burn-in.

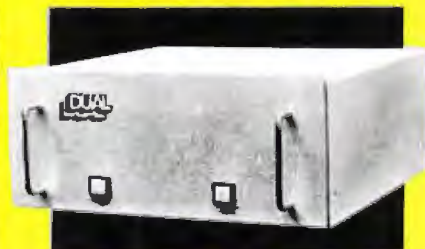

CPU/68000 CPU board. . . . \$1195  
 32K-byte 8/16-bit NONVOLATILE RAM board, for secure storage of programs you are developing. Allows FULL SPEED CPU operation. CMEM-32K, per 32K-bytes . . \$895  
 32K-byte 8/16-bit EPROM board, EPROM-32K . . . . . \$395  
 Serial I/O board, SIO-2 . . . . . \$285  
 All of the above with cabinet, power supply and backplane . . . . \$3685

OEM and Dealer pricing is available  
 Sales representatives in most metropolitan areas

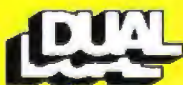

system reliability/system integrity

**DUAL SYSTEMS CONTROL CORPORATION**  
 1825 Eastshore Hwy, Berkeley 94710  
 (415) 549-3854 · TWX 910 366-2035

Often the state space of a problem will allow a node to generate as successor a node of equal or lesser rank, as shown in figure 2. In this case, the resulting representation is called a *graph* (or, more completely, a *directed graph*). This will call for only a slight addition to the search strategy, but the difference should be noted.

Finally, as mentioned before, a transition from a node to its successor may have a cost associated with it. If so, the arrow connecting the two will be labeled with the cost; otherwise, the arrows are unlabeled and each is assumed to carry a unit cost.

### Some Examples

First we will examine a discrete example: the traveling salesman problem. A traveling salesman in city A must travel to cities B, C, and D, in any order. Given the map in figure 3a, what order of cities gives the shortest total mileage?

In this problem, the nodes are partially completed (or completed) trips described by a sequence of the letters A, B, C, and D, restricted by the rules

that follow. The start node is A (salesman in city A, no traveling done). Four goal nodes describe various routes, ABCD, ABDC, ADBC, ADCB. The rules are informally described: from a given node, add the letter of any city that connects to the last city visited and that has not yet been visited.

Since the number of cities is small, a full state-space tree is possible (figure 3b), and it is clear that the shortest route is ADBC, with a distance (cost) of thirteen. But what if there are ten cities? Twenty? What if some roads are one-way?

Next we see a continuous example (here the state space must be cut into a finite number of discrete values). You have a faucet, a sink, and an empty glass with a horizontal line on it: fill the glass up to the line.

First we must quantize the problem. Suppose we say that the glass holds 100 ml of water. We can reasonably set the smallest unit of water to be manipulated at one milliliter. The state of the problem is the amount of water in the glass, and the problem has 101 possible states: 0

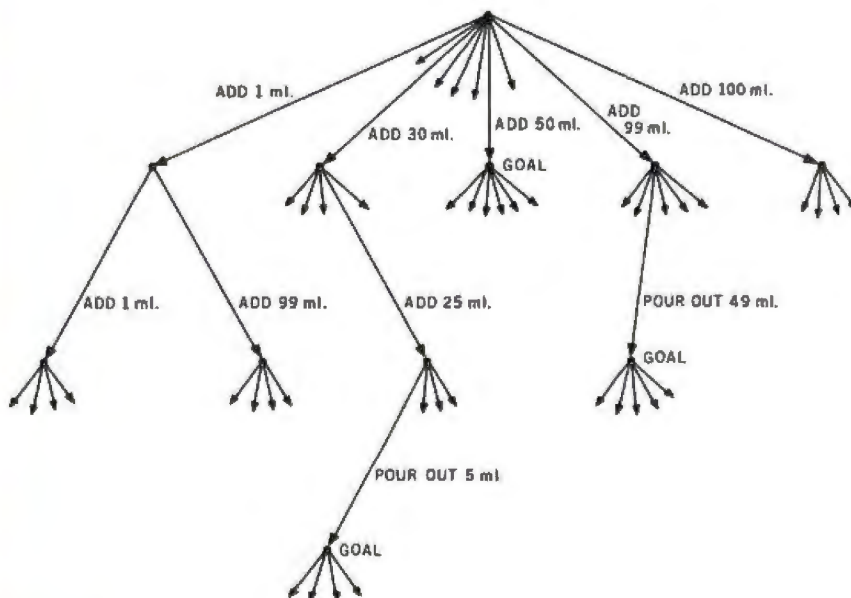
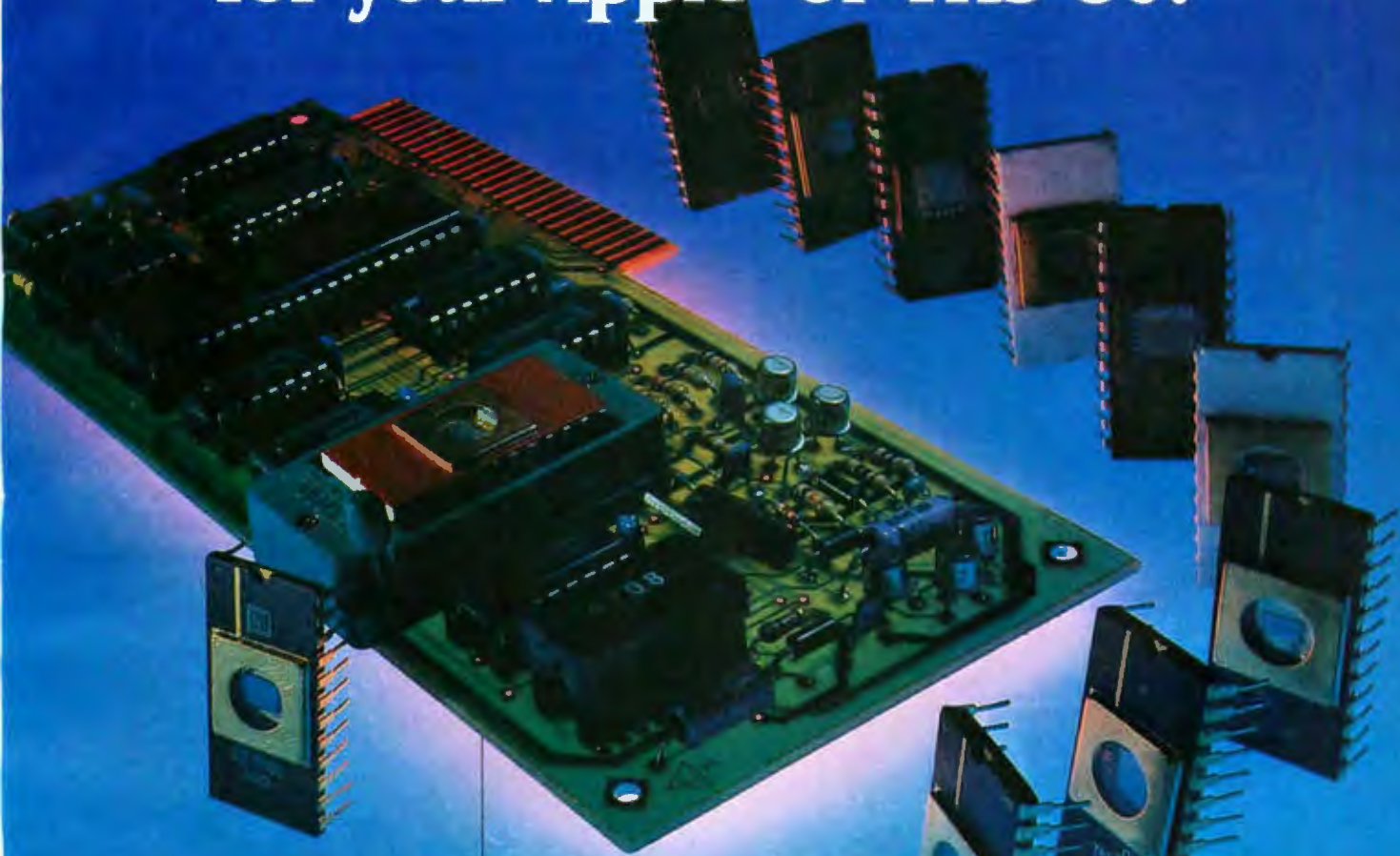

Figure 4: The "quantization" of a continuous-solution space. Shown is a partial tree for the problem of filling a water glass to a specified mark. It is continuous in that the problem space (the amount of water in the glass) can hold an infinite variety of states (amounts of water). By considering the glass to hold water only in single-milliliter increments, the problem space becomes discrete and finite, and thus can be represented to a computer. Goal nodes exist where the water level matches the mark on the glass.

# Take a look at our EPROM blaster for your Apple™ or TRS-80.™



Apparat announces the most versatile EPROM burner available today for your TRS-80 model I and III or Apple computer... the Apparatus PROM Blasting system (A.P.B.). Most EPROM burners will program only one type of EPROM. The A.P.B. system will program all commonly used 24 pin EPROMs by using special personality modules that adapt the unit to the EPROM. The following EPROMs are programmable: 2704, 2708, 2716, (3-volt) & (5-volt), 2732, 2508, 2516 and 2532.

The versatility and power of the A.P.B. system means you're getting a PROM burning package with extensive capabilities. The price, \$149.00, insures you're getting the most cost-effective PROM burner on the market today.

With a unique combination of personality modules and

sophisticated software, A.P.B. will perform many operations impossible with conventional PROM burners. Here's a brief list of some of A.P.B.'s capabilities:

- Verify ROM is erased
- Read ROM
- Copy ROM
- Copy between different ROM types
- Program ROM
- Partial programming and copies
- Verify programming
- Read or save ROM data on disk or cassette (Apple only)
- Program directly from computer memory
- Examine and/or modify working memory
- Preset working memory

The A.P.B. system is the most flexible PROM burner available. The A.P.B. system package consists of an interface card that plugs directly into an expansion slot\*, a complete set

of personality modules, software on disk and a detailed instruction manual. The software will run under NEWDOS/80, or TRSDOS™ for the TRS-80, and APPLE DOS™ or APEX for the Apple.

If you're looking for a powerful, versatile and cost efficient EPROM burner, call APPARAT today. Dealer inquiries welcome.

**(303) 741-1778**

\*TRS-80 version requires the TRS-80 bus extender (Cat. # 1-025) or a separate user provided power supply and cable. TRS-80, and Apple are trademarks of Tandy Corp. and Apple Computer.

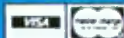

 **Apparat, Inc.**

4401 So. Tamarac Parkway, Denver, CO 80237 (303) 741-1778

**"ON GOING SUPPORT FOR MICROCOMPUTERS"**

# The Ultimate IEEE S-100 Memory Would...

- ❑ BE NONVOLATILE holding data for up to eight years with the power off.
- ❑ RUN AT 6 MHZ without wait states.
- ❑ RUN IN 8 OR 16-BIT systems with 8 or 16-bit wide data paths.
- ❑ HAVE EXTENDED 24-BIT ADDRESSING and bank select.
- ❑ HAVE DYNAMICALLY MOVABLE WRITE PROTECT AREAS to prevent accidental erasure of programs and critical data.
- ❑ GENERATE POWER-FAIL interrupts for orderly system shutdown & power failure recovery.

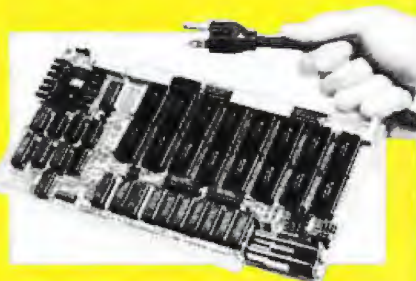

## ...Available Now from Dual Systems

The Dual Systems CMEM memory boards combine high-speed CMOS memories with new 5-10 year lithium batteries to give you the nonvolatility of an EPROM board while retaining the instant writability of a high-speed read/write RAM. These industrial grade boards are ruggedly built and are burned-in for 200 hours.

- ❑ CMEM-32K, 32K-bytes ... \$895
- ❑ CMEM-16K, 16K-bytes.... \$795
- ❑ CMEM-8K, 8K-bytes..... \$695

OEM and Dealer pricing is available.

Sales representatives in most metropolitan areas.

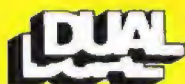

system reliability/system integrity

**DUAL SYSTEMS CONTROL CORPORATION**

1825 Eastshore Hwy., Berkeley 94710  
(415) 549-3854 · TWX 910 366-2035

ml (empty), 1 ml of water, 2 ml, . . . , 100 ml. (Here the word "state" seems more natural than "node"; the latter usually refers to the graphic representation of the problem.)

Time as well as volume must also be quantized, which restricts us to adding or subtracting a given volume of water "at one time." We have 200 possible operators (some of which may be physically impossible for a given state): add 1 ml, pour out 1 ml, add 2 ml, . . . and so on up to add or pour out 100 ml. Finally, the goal node is any set of actions that brings the water level up to the marked line (wherever it happens to be). The state-space tree is large but finite; part of it is shown in figure 4.

### The 15-Puzzle

Most of us have played with the 15-puzzle: fifteen numbered squares

that slide around in a frame that allows four units on a side. The blocks are given in an arbitrary order and the object is to slide the blocks until, read by row, they are in ascending order with the blank space in the lower right-hand corner. (Mathematician/puzzlist Sam Lloyd made a lot of money betting people they couldn't solve the puzzle. It was a sure bet; with the starting position he used, a solution was impossible.)

We will use the 15-puzzle to illustrate various search methods. The BASIC program SEARCH (see listing 1) will implement different search techniques by changing only one subroutine. It will work for both the 15-puzzle and (for computers with less memory) the order-3 variation: the 8-puzzle. In this article we will use the 8-puzzle for illustration; even

*Text continued on page 86*

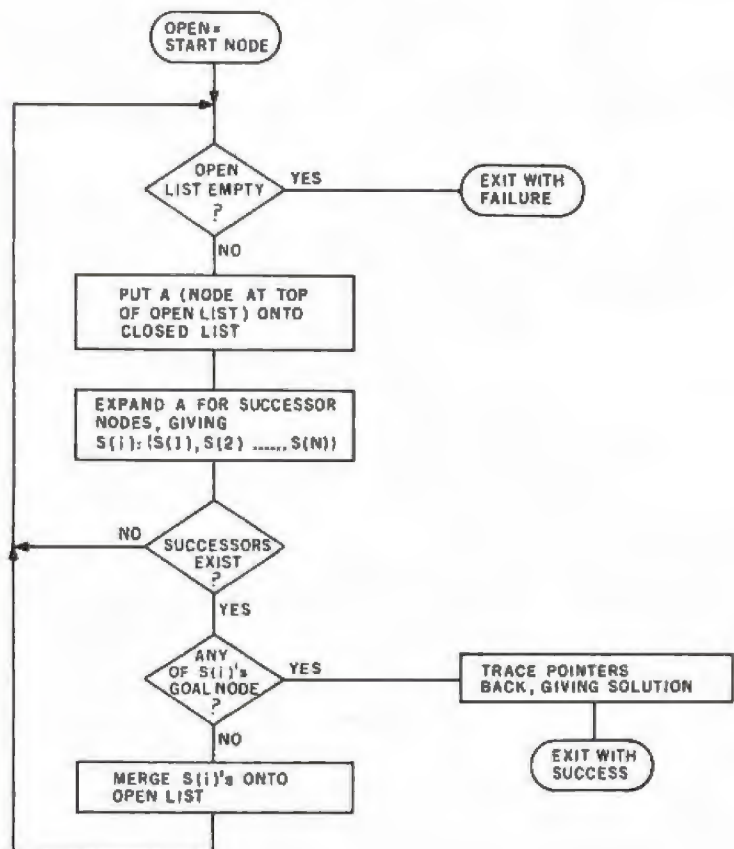

Figure 5: The basic flowchart used to derive the SEARCH program of listing 1a. This flowchart is a modernized, generalized version of several given by Nils Nilsson in Problem-Solving Methods in Artificial Intelligence. The flowchart was written as structured pseudocode (see listing 1b) before becoming the BASIC program SEARCH.



# Start talking business



## with your Apple

COBOL is the most effective business language.

Apple II is the most friendly business computer.

CIS COBOL with FORMS-2 brings together the best features of COBOL and Apple to enable you to deliver the most effective, user-friendly applications.

**Business Programmers:** Take the COBOL expertise you have acquired on big business mainframes, and use it on Apple II to create friendly applications that will talk directly to your users — where it suits them best, on their own desks.

CIS COBOL's dynamic module loading gives you big application capability and the FORMS-2 source generator lets you build and modify conversational programs from visual screen formats, creating much of the code automatically.

**Application vendors:** CIS COBOL with FORMS-2 steps up the pace for your development of the high quality professional application packages needed today. And creating them in COBOL makes them more maintainable.

Over half the Apple II's now being sold are going to business or professional users so demand for quality applications is growing fast, creating big business opportunities for you.

**Stability proven by the US Government.**

CIS COBOL has been tested and approved for two consecutive years by the US General Services Administration as conforming to the ANSI '74 COBOL Standard. Apple II under CP/M is included in CIS COBOL's 1981 GSA Certificate of Validation (at Low-Intermediate Federal Standard plus Indexed I-O and Level 2 Inter-Program Communication).

**Get your hands on CIS COBOL at your Apple dealer.**

**Talk business with him now!**

Micro Focus Inc., 1601 Civic Center Drive  
Santa Clara, CA 95050. Phone: (408) 248-3982.



## MICRO FOCUS

CIS COBOL with FORMS-2 for use on the Apple II with CP/M is an Apple Distributed Product. CIS COBOL and FORMS-2 are trademarks of Micro Focus. CP/M is a trademark of Digital Research. Apple II is a trademark of Apple Computer.

## Toughest Boards in Town... IEEE 696/S-100

### NON-STOP CLOCK

Keeps time with power off. Our industrial clock utilizes a new lithium battery for 3-9 years use. Easiest clock to program you'll ever see. Runs in all S-100 systems.

- Year, date, hrs, mins, secs, msec.
- Uses new LSI CMOS chip.
- Vectored interrupts.
- CLK-24 ..... \$250

### A/D CONVERTER

IEEE696/S-100 AIM-12 industrial standard module designed for industrial analog-to-digital use.

- Runs in all S-100 systems.
- 32-channel, 16-differential  12-bit resolution/accuracy.  25-microsecond conversions.
- Instrumentation amplifier.
- BASIC program provided.  AIM-12, \$695 or \$785 w/1-1000 gain transducer amplifier.

### D/A CONVERTER

AOM-12 IEEE696/S-100 industrial level digital-to-analog (D/A) converter.

- 12-bit  $\pm 1/2$  L.S.B. accuracy over full 0-70°C temperature range.
- Outputs 0-10,  $\pm 5$ , or  $\pm 10$  volts.
- Short circuit protection, all outputs.
- Switch-programmable for multiple boards.
- AOM-12, \$575

### VIC 4-20

Standard output for industrial control 4-20 mA D/A converter. Used in conjunction with the D/A board.

VIC4-20, \$445.

### DUAL 77 Data Acquisition and Control System-

Built to industrial standards; designed for severe environments. BASIC language makes programming easy. Access to hundreds of sensors. Expandability to meet your increased needs. Nonvolatile memory. Power interruption recovery with automatic restart. DUAL 77 is economical; \$5985 & up.

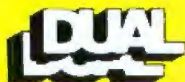

system reliability/system integrity

### DUAL SYSTEMS CONTROL CORPORATION

1825 Eastshore Hwy., Berkeley 94710  
(415) 549-3854 · TWX 910 366-2035

**Listing 1:** The SEARCH program, written in Applesoft BASIC for the Apple II. Listing 1a gives the program as implemented in BASIC. Listing 2, 3, or 4 must be added for this program to work. The subroutine that starts at line 9900 implements a given search method; all REM (remark) lines can be deleted to reduce program size. The diagnostic message printed by line 177 gives visual feedback on the progress of the program, although it does not give the correct value for the start node (node 1). The structured pseudocode in listing 1b outlines the processes in SEARCH. Line numbers here refer to the "main line" of the program.

```

1  REM --SEARCH ALGORITHM: AND FOR FOR IS 412/1E
2  REM --BREGG WILLIAMS: BYTE MAGAZINE, P08:472, HANCOCK RM 01449
3  REM
4  REM
5  REM ----- LISTING 1 -----
100 DIM D%(100),O%(100),R%(20)
110 DIM A%(4),E%(4,4),F%(4,4),Z(16)
110 REM --INITIALIZE PROGRAM
120 GOSUB 9900
125 REM
130 REM
135 REM --NEXT IS DO-WHILE LOOP:WHILE"OPEN" ARRAY NOT EMPTY AND EXIT
140 REM --VARIABLE="SEARCH"
150 IF E1% = "EXIT" THEN 495
155 REM
160 REM
165 REM --FIND N1=INDEX OF LOWEST OPEN VALUE
170 GOSUB 9900
175 IF D(N1) = 99999 THEN 495
177 PRINT "177-EXPAND NODE ";N1; ", ";O%(N1); ", VAL=";D(N1)
180 REM
185 REM --PUT NODE TO CLOSED;"SCRATCH" IN OPEN ARRAY
190 REM --BY GIVING LARGE VALUE
190 C9 = C9 + 1
200 D(N1) = 90000 + D(N1)
220 REM
225 REM
230 REM --UNPACK BOARD POSN AND GENERATE SUCCESSORS IN A%
240 E% = MID$(O%(N1),H1 + 1,L2)
250 F% = MID$(D%(N1),H1,1)
255 GOSUB 9100
260 REM --NODE # N1 IS PASSED AS ITSELF
265 REM --GENERATE SUCCESSORS
270 GOSUB 9200
275 REM
280 REM
285 REM --EVALUATE EACH FOR GOAL STATUS--G1 NODES WERE GENERATED
290 IF G1 = 0 THEN 295
290 PRINT "290--NO SUCCESSORS, NODE";N1
292 GOTO 470
295 G% = "NOT GOAL"; FOR M1 = 1 TO G1
300 REM --RETURN "GOAL" IF A%(M1) IS GOAL NODE
310 GOSUB 9600
320 IF G% = "GOAL" THEN 380
330 E1% = "EXIT"
340 REM --SAVE INDEX OF GOAL NODE
360 REM --FOLLOWING IS "ELSE" BRANCH OF 320;G% NOT = "GOAL"
370 REM --UNPACK BOARD TO E%,F% ARRAYS
380 E% = MID$(A%(M1),H1 + 1,L2)
390 GOSUB 9100
395 REM --EVAL H-HAT FCN FOR E%. RESULT IN R1
400 GOSUB 9900
410 REM --PUT A%(M1) ON "OPEN" LIST
420 O9 = O9 + 1
430 D%(O9) = A%(M1)
440 O(O9) = R1
450 NEXT M1
460 REM --END OF DO-WHILE LOOP AT 150
470 GOTO 150
475 REM
480 REM -----
485 REM --THIS SECTION PRINTS EITHER SOLUTION OR FAILURE MESSAGE
495 IF G% = "GOAL" THEN 540
500 REM --TRACE BACK SOLUTION
510 GOSUB 9800
520 GOTO 550
530 REM --NO SOLUTION FOUND
540 PRINT : PRINT "NO SOLUTION FOUND"
550 PRINT "NODES ON OPEN LIST: ";O9 - C9
560 PRINT "NODES ON CLOSED LIST: ";C9
570 END
8000 FOR I = 1 TO R9
8010 FOR J = 1 TO R9
8020 PRINT F%(I,J); : NEXT J
8030 PRINT " "; : NEXT I
8040 RETURN
8890 REM -----
8895 REM --SUBRTN TO CHECK IF NEW BOARD F%(I,J)

```

Listing 1a continued on page 82



## The next generation of business software

### WHAT'S IN A NAME?

We've changed the name of our product line. Originally, we called our products "Phoenix" because we saw the phoenix as an appropriate symbol of quality. Unfortunately, a lot of other companies chose Phoenix as well, and there was some concern that the market place would become confused.

Our new name, PALANTIR™ (pronounced pal'antair), is not a new name for us since it's our corporate name. It comes from J.R.R. Tolkien's *The Lord of the Rings* and describes a black crystal ball, a "seeing stone" used to see things at a distance.

Whatever the name on the package, the software in the package hasn't changed. It is still the highest quality business software you can buy for your microcomputer.

### WORD PROCESSING

We know word processing. A year and a half ago the owners of Designer Software™ wrote a well known word processor for another company. In the last 18 months we've learned about other features you want in a word processing package. PALANTIR™ Word Processing reflects our experience. It is more powerful than other word processing packages you can buy and can compete, feature for feature, with expensive dedicated word processors.

Many people have remarked that the user's manual we wrote earlier was the best ever for microcomputer software. Even so, we felt that we could have made it more accessible to the non-technical user. With PALANTIR™

Word Processing we have a separate Training Manual with beginning, intermediate and advanced levels. By allowing you to work at your own level, we have made the learning process easier and less intimidating.

### ACCOUNTING

All five PALANTIR™ general accounting packages (General Ledger, Accounts Receivable and Payable, Payroll and Inventory) were designed by CPA's based on similar packages from mini and mainframe computers. The programs are COBOL with an integral assembly language data base. They are integrated to allow automated posting to the General Ledger. An internal screen handler permits full screen data entry for speed and ease of use. Although we made cosmetic enhancements prior to distribution, these basic programs have been user tested for at least eighteen months.

PALANTIR™ Accounting also includes a growing number of specific application packages. We have completed or scheduled for completion Fixed Assets, General Processing, Mail Management, Financial Projections and Time/Billing. Each package stands alone, but many also work in conjunction with other PALANTIR™ packages. For example, Mail Management will work very well by itself, but we also designed it to fit in easily with the merging capabilities of Word Processing.

With all PALANTIR™ Accounting we have given special attention to documentation. Not being content to describe which buttons to push, we have taken the time to explain the accounting principles behind the programs and how each package helps to automate your office.

**Designer Software™**

HOUSTON

If you want to know what PALANTIR™ Word Processing and accounting can do for your business, call, write, tele or use The Source to request more information.

**3400 Montrose Blvd • Suite 718 • Houston, Texas 77006  
(713) 520-8221 • Telex 790510 • Source TCU671**

© 1984 Designer Software, Inc. All rights reserved.



If you have anything to do with small computers, you should be reading the Carl Helmers **PERSONAL COMPUTER LETTER** every month!

You won't want to miss a single issue of the new Personal Computer Letter... a monthly publication of comprehensive studies on issues affecting design, implementation, and applications of small computer systems. The Personal Computer Letter is a journal compiled and edited by Carl Helmers, co-founder and first editor of Byte Magazine. Here is valuable information in professionally prepared format about small computers, software, peripherals, trends in the industry, and new ideas. We accept no advertising, and the information provided is available nowhere else. Written for executives, decision-makers, market strategists, product designers and authors in the small computer field, each 12 to 16-page issue contains analysis and design studies by many of the personal computer industry's foremost experts. For example, the current issue covers: **Designing Application - Specific Documentation Tools: Let's Be Bold Where It Counts.** Subscribe today. Mail the coupon with your check for \$200 for the next 12 monthly issues. Sample issues at \$25 per copy, applicable to a full year's subscription.

**NORTH AMERICAN TECHNOLOGY, INC.**  
 Strand Building  
 174 Concord St.,  
 Peterborough, NH 03458  
 (603) 924-6048

Enclosed is my \$200 check or money order for the next 12 issues of the Personal Computer Letter.  
 Enclosed is my \$25 check or money order for a sample issue, applicable to subscription price.

NAME \_\_\_\_\_  
 ADDRESS \_\_\_\_\_  
 CITY \_\_\_\_\_  
 STATE \_\_\_\_\_ ZIP \_\_\_\_\_

Listing 1a continued:

```

8900 Q3% = "NOT DUPLICATED"
8905 REM --CHECK THROUGH ALL EXPANDED NODES
8910 REM -- I.E., NODES WITH O(I) >= 90000
8915 FOR I = 1 TO O9: IF O(I) < 90000 THEN 8930
8920 F1% = MID$(O$(I),N1 + 1,L2)
8925 IF F% = F1% THEN Q3% = "DUPLICATED" THEN 8938
8930 NEXT I
8935 IF Q3% = "NOT DUPLICATED" THEN 8938
8937 PRINT "8937--CURRENT POSN IS DUPLICATE ***"
8938 RETURN
8985 REM -----
8990 REM --SUBRTN TO FIND N1 SO THAT O(N1) IS SMALLEST
8995 REM
9000 S1 = 99999:N1 = 1
9005 FOR I = 1 TO O9
9010 IF O(I) > = S1 THEN 9020
9015 S1 = O(I):N1 = I
9020 NEXT I
9025 RETURN
9035 REM -----
9040 REM --PACK BOARD F%(N,N) TO STRING F%
9045 REM
9050 F% = ""
9055 FOR B = 1 TO R9
9060 FOR D = 1 TO R9
9065 F% = F% + F$(B,D)
9070 NEXT D
9071 NEXT B
9090 REM -----
9095 REM --UNPACK STRING E% INTO ARRAYS E%(N,N), F%(N,N)
9100 FOR I = 1 TO R9
9105 FOR J = 1 TO R9
9110 D1 = R9 * (I - 1) + J
9115 E$(I,J) = MID$(E%,D1,1)
9120 F$(I,J) = MID$(E%,D1,1)
9125 NEXT J: NEXT I
9130 RETURN
9185 REM -----
9190 REM EXPAND CURRENT POSN E$(I,J) WITH DIRECTION E9%,NODE# N1
9195 REM -- GIVING SUCCESSORS IN ARRAY A%(N);N=1 TO G1
9200 FOR I = 1 TO 5
9205 IF E9% = MID$(D%,I,1) THEN 9210
9207 NEXT I
9210 D9% = MID$(I%,I,1)
9215 REM --O9% IS FORBIDDEN DIRECTION TO EXPAND E%
9220 FOR Y1 = 1 TO R9: FOR X1 = 1 TO R9
9225 IF E$(X1,Y1) = "." THEN 9238
9230 NEXT X1: NEXT Y1
9235 REM --X1,Y1=COORDINATE OF "BLANK" IN PUZZLE
9238 B1 = 0
9240 REM --NEXT IS A LOOP THAT GENERATES 4 POSSIBLE SUCCESSORS:
9242 S1 = 1:A9 = 0
9245 IF B1 = 4 THEN 9315
9250 IF MID$(D%,S1,1) = O9% THEN 9310
9255 X2 = X1 + X(S1):Y2 = Y1 + Y(S1)
9260 FOR J = 1 TO R9: FOR J = 1 TO R9
9265 F$(I,J) = E$(I,J): NEXT J: NEXT I
9270 REM --EXCHANGE SQUARES (X1,Y1) AND (X2,Y2)
9272 IF X2 = 1 OR X2 = R9 THEN 9310
9275 IF Y2 = 1 OR Y2 = R9 THEN 9310
9275 F$(X1,Y1) = F$(X2,Y2):F$(X2,Y2) = F$(X1,Y1)
9280 REM --PACK NEW BOARD AS NODE IN A%(N)
9285 GOSUB 9050
9287 REM --CHECK FOR DUPLICATES IN O%
9290 GOSUB 8900
9295 IF O3% = "DUPLICATE" THEN 9310
9296 REM --NODE=POINTER BACK+DIRECTION+PACKED ARRAY
9297 A9 = A9 + 1
9302 GOSUB 9400
9303 A$(A9) = O% + MID$(D%,S1,1) + F%
9305 S1 = S1 + 1
9310 S1 = S1 + 1: GOTO 9245
9315 RETURN
9390 REM -----
9395 REM --SUBR CONVERTS N1 TO A STRING OF CHAR8, LENGTH OUTPUT IN O%
9397 REM
9400 O% = STR$(N1)
9410 D1 = LEN(O%)
9420 REM --ADD LEADING ZEROS TO O%
9425 O2 = O8 - D1
9430 IF O2 > = 0 THEN 9440
9435 PRINT "SIZE ERROR IN 9400--ABORT JOB": END
9440 IF O2 = 0 THEN 9455
9445 FOR I = 1 TO O2
9450 O% = "0" + O%: NEXT I
9455 RETURN
9485 REM -----
9490 REM --SUBRTN TO INITIALIZE PBM
9495 REM
9500 O8 = 3:R9 = 3
9505 DATA -1,0,0,1,1,0,0,-1
9510 FOR I = 1 TO 4: READ X(I),Y(I): NEXT I
9515 D% = "DLURB":I% = "URDL"
9520 E9% = "B"
9523 O2% = "1,3426758": GOTO 9535
9525 PRINT : PRINT "ENTER PUZZLE TO BE SOLVED IN "R9 * R9;" CHARACTERS"
    
```

Listing 1a continued on page 84

# MULTIUSER

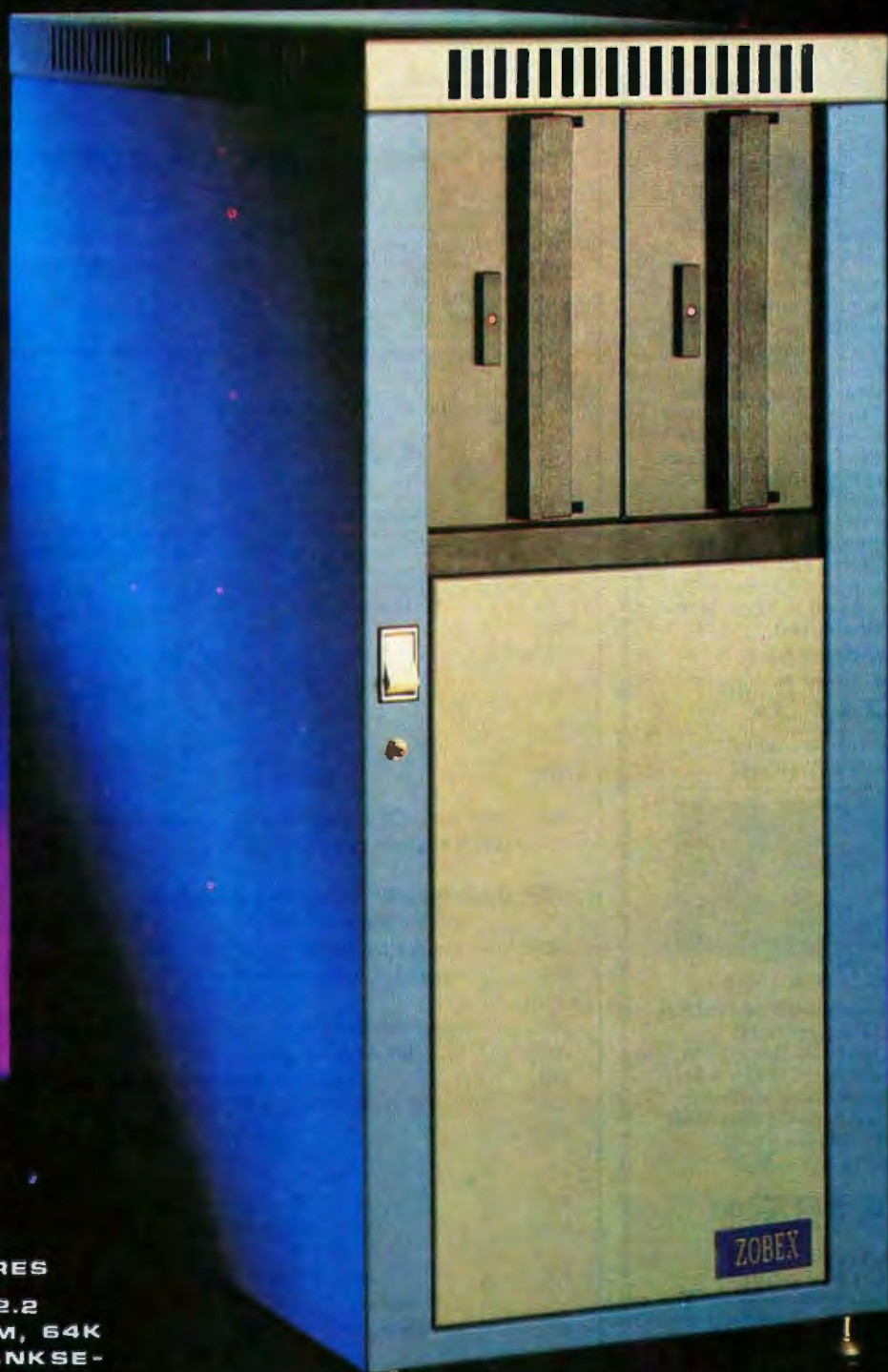

COMPUTER  
ON S-100 BUS  
DESIGNED TO  
SATISFY A WIDE  
VARIETY OF  
APPLICATIONS.

#### STANDARD FEATURES

INCLUDE: CP/M 2.2  
OPERATING SYSTEM, 64K  
EXPANDABLE, BANKSE-  
LECTABLE MEMORY, 4MHZ  
Z80A CPU WITH 4 SERIAL  
AND 3 PARALLEL PORTS,  
RELIABLE 8" FLOPPY DISK  
DRIVES IN A STURDY ALL  
METAL CABINET.

\$ 4900

MP/M OPTIONAL.

CP/M AND MP/M REGISTERED TRADE MARKS OF DIGITAL RESEARCH

**ZOBEX**<sup>®</sup>

P.O. BOX 1847 SAN DIEGO, CA. 92112  
7343-J RONSON RD. SAN DIEGO, CA. 92111  
(714) 571-6971

# Factory Direct

ELIMINATE THE MIDDLE MAN!

## 16K STATIC RAM



### RAM 16

#### COMPARE OUR FEATURES!

5-100 • 16K X 8 Bit Static RAM • 2114 1K X 4 Static RAM Chip • 2 or 4 MHZ • 4K Step Addressable • 1K Increment Memory • Protection from Top Board Address Down or from Bottom Up • Deactivates up to 6 1K Board Segments to Create Holes for Other Devices • Phantom Line DIP Switch • DIP Switch Selectable Wait States • 8 Bank Select Line Expands to 1/2 Million Bytes • All Data Address and Control Lines Are Input Buffered • Ignores I/O Commands at Board Address • Our Most Popular Board — Over 5000 Now in Use Worldwide!

A & T Factory Direct Price:

# \$175.00

One Year Warranty  
**DON'T PAY MORE!**



### NEW! — RAM 65

All of the Above Advanced Features PLUS: Bank Selection by I/O Instruction Using Any One of 256 DIP Switch-Selectable Codes • This Allows Up to 256 Software Controlled Memory Banks! • Our Most Advanced 16K Add-On Board.

A & T Factory Direct Price:

# \$185.00

One Year Warranty  
**DON'T PAY MORE!**

All of our Boards Are the Highest Quality MIL SPEC G-14 Fibreglass. All utilize Solder Mask over Copper Technique for Higher Reliability!

**MIX AND MATCH FOR BEST PRICING**  
Include \$3.00 shipping & handling per order. California residents include 6% sales tax.

TERMS Cash, checks, money orders or purchase orders from qualified firms or institutions. Pricing and availability subject to change without notice. International sales in U.S. funds only. COD's include 25% with order.

**Quality Computer Parts**  
P.O. BOX 743, DEPT. B1  
CHATSWORTH, CA 91311  
Telephone (213) 882-3142

### Listing 1a continued

```

9530 INPUT Q2%
9535 IF LEN (Q2%) = R9 # R9 THEN 9550
9540 PRINT : PRINT "ERROR IN PUZZLE ENTRY - TRY AGAIN."
9545 GOTO 9525
9550 Q9 = 1:O(1) = 0
9552 M1 = 1: GOSUB 9400
9553 O%(1) = O% + "B" + Q2%
9555 REM --- ABOVE IS INITIALIZATION OF "OPEN" LISTS, ARRAYS O AND O%
9560 REM --- NEXT IS INITIALIZATION OF "CLOSED" LISTS---C AND C% ARE BOTH EMPTY
9565 C9 = 0
9575 H1 = 0B + 1:L2 = R9 # R9
9580 E1% = "SEARCH"
9585 G% = "NO GOAL"
9587 RETURN
9590 REM
9591 REM ---SUBRTN TO SEE IF BOARD IS GOAL NODE
9595 REM ---RETURNS G%="GOAL" OR "NOT GOAL"
9600 O3% = "12345678"
9610 IF R9 = 4 THEN O3% = "123456789ABCDEF."
9615 O4% = RIGHT% (A%(M1),L2)
9620 IF O3% = O4% THEN G% = "GOAL":NA = O9 + 1
9625 REM ---NA=INDEX OF GOAL NODE;=O9+1 BECAUSE O9 POINTS TO LAST
9630 REM --- NODE FILLED; SEE 420-440
9635 RETURN
9645 REM
9646 REM ---SUBRTN TO TRACE BACK AND PRINT SOLN FROM O%(M1)
9647 REM
9650 M1 = 0
9655 REM ---DO UNTIL POINTER = "B"
9660 O5% = MID% (O3%,M1,1)
9665 IF O5% = "B" THEN 9680
9670 M1 = M1 + 1:O5% = O3%
9675 O6% = LEFT% (O4%,M1,1)
9680 NA = VAL (O6%)
9685 IF O6% = "B" THEN 9690
9695 REM --- ODD# PRINT VALUE OF R% FROM R1 TO 1
9700 IF R1 = 0 THEN PRINT * PRINT "ZERO ERROR IN BACK TRACING": GOTO 9685
9705 PRINT : PRINT "SOLUTION IS "
9710 FOR N = R1 TO 1 STEP -1
9715 PRINT " " ; MID% (O3%,N,1) ;
9720 NEXT N
9725 PRINT : PRINT "R1:" ; R1 ;
9730 IF R1 = 1 THEN PRINT " "
9735 PRINT
    
```

### (1b)

```

120 EXIT = no, GOAL = no part of initialization routine
    OPEN = <start node>

150 do while OPEN not empty and EXIT = no
170 :A = top node in OPEN
190 :put A from OPEN to CLOSED list
270 :expand A giving successors A(N)

287 :if successors exist
295 : :for each successor
310 : : :evaluate successor for goal status
320 : : :if node-is-goal
330 : : : :set G = index of good node, GOAL = Yes
    : : : :set EXIT = yes
    : : : else
400 : : : :calculate "value" of node
420 : : : :merge node and value into OPEN list
    : : : and if
450 : : : :end of for-loop
    : : : :end if
470 : : : :endwhile

495 if GOAL = yes
510 :find solution by tracing nodes back from G
    :print full solution
    else
540 :print failure message
    endif

570 end program
    
```

**This  
Single  
Board...**

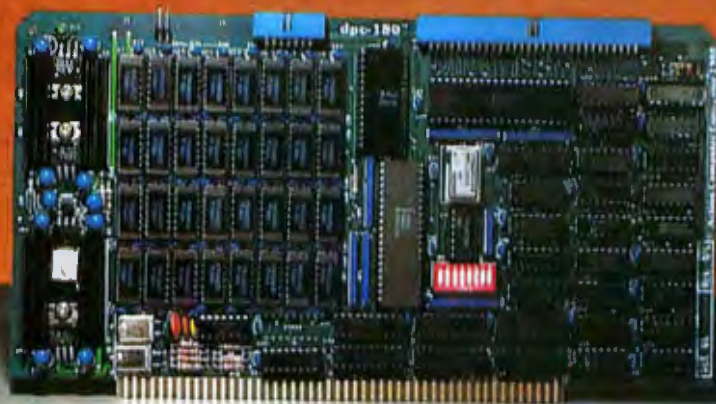

**...is the Heart  
of the  
Microprocessor  
World's  
Best Multi-User  
System ...**

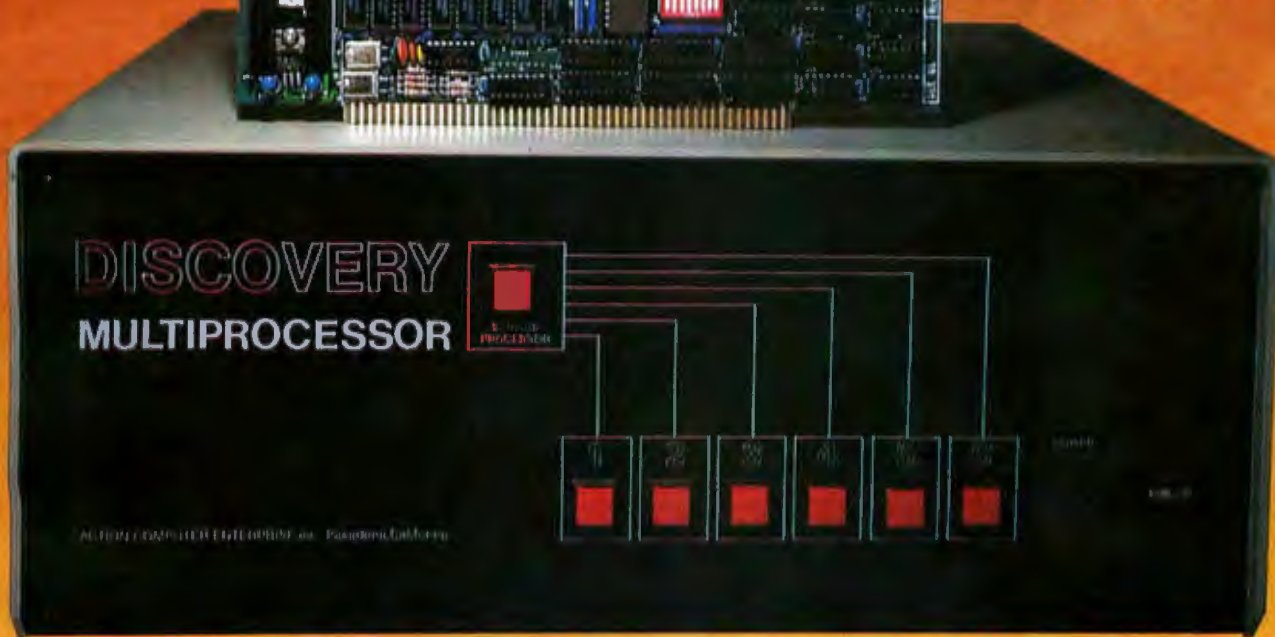

## THE DISCOVERY MULTIPROCESSOR

The dedicated power of this complete single board computer is provided to each user, making the DISCOVERY MULTIPROCESSOR unique among multi-user systems. With the power and expandability of distributed processing • With the economy of shared peripherals • With the flexibility of shared and public files • And all of this with full CP/M\* and S-100 compatibility.

### **Multiprocessing Software    Multiprocessing Hardware**

Our Distributed Processing Operating System, **dpc/os**®, resides in the Service Processor, establishing a CP/M environment for each user and managing access to the shared system resources. Multiuser facilities are provided for print spooling, for interprocessor communication and for private, public and shared-update files. Several processors can be employed concurrently by a single user via the enhanced batch submit facilities. And with **DISCOVERY** all CP/M compatible programs will execute without modification, thus protecting your software investment.

The ACE 64K Distributed Processing Single Board Computer, the **dpc-180**™ gives the **DISCOVERY MULTIPROCESSOR** its own unique architecture. One DPC is dedicated to each user providing exclusive use of the onboard Z-80, 64K ram and serial I/O. Access to the shared resources is provided by an expanded DPC used as a Service Processor. Additional users can be added at any time by simply inserting additional DPC's into the standard S-100 bus — up to a total of sixteen user processors in a single chassis!

\*CP/M is a registered TM of Digital Research, Inc.

**DISCOVERY** has been proven in installations throughout the World. If you need the Power of Multiprocessing... it's time you discovered us!

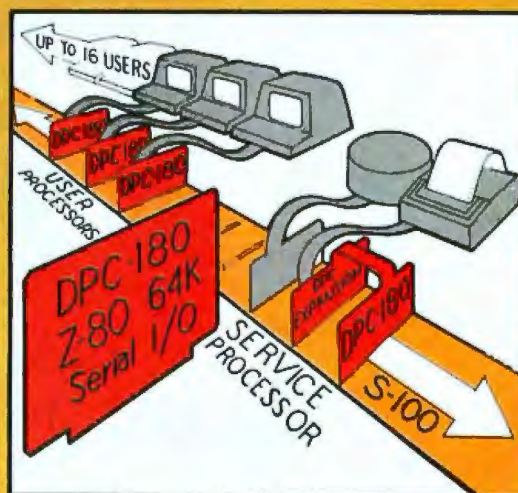

The ACE **DISCOVERY MULTIPROCESSOR** dedicates a complete 64K Z-80 Distributed Processing single board Computer, the **dpc-180**™ to each user. An expanded DPC coordinates all of the system activities.

Multiuser mainframes with 192K ram start at under \$6000. The 64K **dpc-180**™ is priced at \$1395. Immediate delivery. A complete line of standard peripherals including a 26M byte hard disk subsystem can be supplied on request. Dealer and OEM inquiries are invited.

**Action Computer Enterprise, Inc.**  
The Multiprocessing Company

55 West Del Mar Boulevard, Pasadena, California 91105 USA • Cable ACEPAS Pasadena • (213) 793-2440

# with *Vector-pak* You Can Package Almost ANY System Faster, Have It Look Better, & Cost Less!

Using one of these systems?

- MULTI-BUS,
- Motorola Exorciser,
- Rockwell AIM 65 Expansion,
- STD-BUS,
- S-100 & IEEE 696.

New packaging available.

### Vector exclusives:

Your choice of plastic or metal card guides, fixed or adjustable positioning. Mount connectors or motherboards **without** special hardware or hole drilling. Vector



Vector CCK100,  
\$49.80 (1-9)  
for S-100, IEEE696, Motorola Exorciser.



NEW  
Vector  
CCK135AS,  
\$36.00 (1-9)



Complete as shown, Vector  
CMA3A-20 with modules, 152.00 (1-9)

ships more card cages and packaging off-the-shelf, than any other company. For expert assistance, call the packaging professionals in California, (213)365-9661, outside California, use our toll-free number: (800)423-5659.

Text continued from page 78:

with this 3-by-3 puzzle, the search tree grows rapidly.

### Elementary Strategy

A certain form can be used to implement any search strategy. It assumes the following: two lists called OPEN and CLOSED, the former for nodes that have not been expanded (ie: that have not had all possible successors generated) and the latter for nodes that have been expanded; an algorithm for generating all legal successors; and an algorithm for determining whether or not a node is a goal node. One final algorithm,  $f$ , which implements the given search technique, provides a function that is used to order the members of the OPEN list to determine which node is to be expanded next.

The general algorithm is given in flowchart form in figure 5. It may be described as follows:

1. Place the start node on OPEN. CLOSED is empty.
2. If OPEN is empty, no solution exists; exit with failure.
3. Otherwise, let A equal the node at the top of the OPEN list. Take A off the OPEN list and put it on the CLOSED list.
4. Find all possible successors of A, named S(1), S(2),...S(N).
5. If there are no successors (N=0), go to 2.
6. Check the successors for goal status. If one is a goal, go to 8.
7. Calculate the  $f$ -values of each successor and merge the nodes into the OPEN list so that the OPEN nodes are sorted in ascending  $f$ -values. Also, place a pointer in each successor node that points back to the parent node A. Go to 2.
8. Trace the goal node through the pointers to the start node. This sequence, reversed, is the solution.
9. Exit with success.

The method described above is exhaustive and complete—that is, it always terminates. If it returns with an "exit with failure," it is because all nonterminal nodes have been expanded without finding a goal.



**Vector Electronic Company**  
INCORPORATED

10000 Redwood Avenue, Sylmar, California 91342, TWX 619



# Verbatim comments:

“Compared to the brands I've used before, Verbatim Datalife is the best yet!”  
*Sandy Tiedeman  
Las Vegas, NV*

“New Verbatim helped eliminate I/O errors on my Apple.”  
*Richard Adams  
Ft. Walton Beach, FL*

“I would prefer Verbatim Datalife over any brand I've ever used.”  
*Skip Piltz  
Overland Park, KS*

“My experience with Verbatim diskettes has been excellent. I've used several boxes over the past few months and they've all been error-free.”  
*Robert Roeder  
Las Vegas, NV*

“Much stronger, better centering. A definite improvement.”  
*Leroy LaBalle  
Marrero, LA*

“It has worked perfectly everytime!”  
*Richard Ruth  
Shippensburg, PA*

“I like the thicker protective cover.”  
*David Hendel  
Lititz, PA*

“Great! I have had no problems!”  
*Timothy Roscoe  
Mechanicsburg, PA*

“So far my Verbatim disks have been performing flawlessly. Not always so with other disks.”  
*Chris Otis  
Hoffman Estates, IL*

“Runs quieter in the disk drive.”  
*Richard Cannova  
Los Angeles, CA*

“Verbatim disks are super. They're our standard for quality.”  
*Bob Mills  
Mission, KS*

“Anything that prolongs the life of a diskette is a plus. Thank you Verbatim for an excellent improvement.”  
*Steve Toth  
Piscataway, NJ*

“Of the 130-plus Verbatim disks I have, I'm not aware of any problems. I'm sure the improvements will give your disks an even longer life.”  
*Gerald Janas  
Warren, MI*

“FANTASTIC. Not a single registration problem. Much more reliable than what I had been using.”  
*Gary Sandler  
Playa Del Rey, CA*

“Verbatim is much more reliable. I wouldn't trust anything else.”  
*Howard Chin  
Pomona, CA*

“Thank you for the improvements. Just another reason why I'll always use Verbatim.”  
*James Hassler  
Cheyenne, WY*

We introduced Verbatim Datalife mere months ago. And it's already playing to rave reviews like these.

But don't take anybody else's word for it. Try it yourself, and see if you don't agree it's the best media you've ever tried. For the name of your nearest Verbatim dealer, call (800) 538-1793, in California call (408) 737-7771 collect.

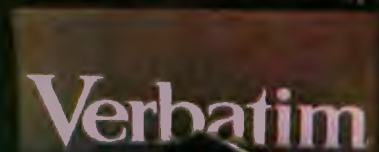

# Hire a fast thinker.

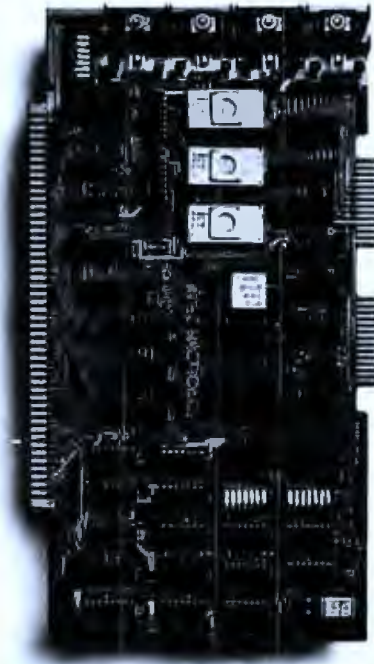

## 5 MHz CPU Card

■ Intel 8085A-2 microprocessor ■ Hardware floating point ■ Performs calculations six times faster than other CPUs ■ On-board monitor in PROM ■ 1K RAM scratch pad ■ Keyboard or RS232C terminal ■ Variable clock frequency

PRICE—\$450

(California residents add 6% sales tax)

Call or write Artec for details.

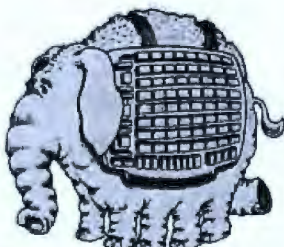

**ARTEC ELECTRONICS, INC.**

605 Old County Rd., San Carlos, CA 94070  
Telephone (415) 592-2740

## Overview of the SEARCH

A complete explanation of the SEARCH program would be unreasonably long, so I am including only those points that will save the reader from puzzling through the mechanics. All comments refer to the 15-puzzle version. (Conversion to the smaller 8-puzzle is achieved by changing the value of R9 to 3 in statement 9500 of listing 1.)

- The program in listing 1a is equivalent to the structured pseudo-code of listing 1b and the flowchart of figure 5.
- The major variables used in the program are given in table 1.
- The body of the SEARCH program (which corresponds to the pseudo-code algorithm) is contained in lines 120 through 570; the subroutines used are listed in table 2.
- Instead of new nodes being sorted

into the OPEN list, they are added at the end of the list and given an ordering value. Instead of expanding the top node on the list, the node with the lowest ordering value (in array O(N)) is expanded. This eliminates an unnecessary sort in the program.

- The program has eliminated the need for a CLOSED array by tagging nodes to be closed with an O-value of greater than 90,000. The number of nodes that has been closed is in C9.
- The SEARCH program assigns variable names to certain constants within the program so that the program can be altered to fit computers of different sizes by changing only a few statements. See variables L2, O8, and R9 in table 1.
- The complete representation of a node in this program includes variables O(N) and OS(N), where N is the number of the nodes. O(N) is the orderings value relative to the

Variable Name	Use
A\$(N)	Array of successors generated by current board position E\$(I,J); see A9.
F\$(N)	String of characters equivalent to board F\$(I,J); see subroutine at line 9050.
O(N)	Ordering value of node N on OPEN list; node is considered to be on CLOSED list if O(N) > 90,000.
OS(N)	Body of node N on OPEN list; see text.
RS(N)	Letters that, when arranged in reverse order, give the solution to the puzzle; see R1.
X(N), Y(N)	Increments in x- and y-position to cause a unit move in direction N, N = 1,2,3,4.
E\$(I,J)	Representation of current node in expanded form; I, J vary from 1 to R9.
F\$(I,J)	Scratch pad board used to generate successors to board E\$(I,J).
A9	Number of nonduplicate successors generated; see A \$(N).
C9	Number of nodes that have been tagged as closed, see O(N).
D\$	The characters of D\$ represent the possible moves in the puzzle (down, left, up, right) and their orderings (eg: move 2 = MID\$(D\$,2) = "L" = left; move 5, B, stands for "beginning" and applies only to the start node).
E9\$	Direction used to get to current node from its predecessor.
G\$	Indicates whether or not A\$(M) is a goal node.
G1	Number of successors generated before check for duplicate nodes.
H1	(Index of first character of game in OS(N)) minus 1; used to index the L9 characters of the board.
L2	Number of characters in current board; =9 for order-3 board, =16 for order-4 board.
N1	Index of O(N) giving smallest ordering value; node N1 will be expanded next.
O7	Maximum size of arrays O(N), OS(N).
O8	Number of digits in OS(N) pointer to its predecessor; set to 3, but, by expanding, can be used to process larger search.
O9	Number of nodes (both open and closed) on OS(N) list; next new node will be placed in OS(O9 + 1).
O9\$	Direction that backtracks from current node to predecessor; see text.
R1	Number of steps to solution of puzzle; see RS(N). Also, value returned by subroutine at 9900.
R9	Rank of problem; set to 3 for order-3 board, to 4 for order-4 board.
S1	Current smallest ordering value of array O(N), S1 = O(N1).

Table 1: Major variables used in the BASIC program SEARCH (see listing 1).

STATCOM CORPORATION wages

# WAR ON BUGS

with  
**CRTFORM™**

CRTForm™, a software package, creates bug-free forms. Insurance forms, order forms, inventory forms — CRTForm makes all types of forms for all kinds of people.

CRTForm is a programmer productivity aid which makes it easy to create, test, modify, and use forms. The forms provide an interface between programmers and end-users, such as secretaries, executives, and CPAs. CRTForm assures that the programmer will receive correct information while providing end-users information on how to enter data. If end-users make a mistake, they receive a message in plain English which tells them what went wrong and how to fix it.

The CRTForm system consists of a form file manager, an input-field-oriented screen editor, and

precompiled run-time modules.

The system contains a code generation section which is available to interface the program to the Pascal, FORTRAN, BASIC, and COBOL languages. In addition, the system can be configured without modification to run on over 95% of the terminals currently on the market. CRTForm is currently available to run under the CP/M®, UCSD®, and Apple® Pascal systems.

Statcom™ is a corporation specializing in software development tools and techniques. In addition to CRTForm, Statcom will soon

be releasing a business report generation, file management, and data entry system which eliminate the need for a programmer.

For the name and address of your nearest CRTForm dealer, call (512) 451-0221, or write to Statcom, 5766 Balcones, Suite 202, Austin, Texas 78731.



Programs that write programs.

**STATCOM™**  
CORPORATION

5766 BALCONES STE 202 AUSTIN TEXAS 78731

other nodes;  $O\$(N)$  contains three things: the direction (U, D, R, or L) that transforms the predecessor of  $O\$(N)$  to  $O\$(N)$ , an O8-digit pointer giving the node number of  $O\$(N)$ 's predecessor node, and a string of L2 characters that describes the "board" of node N in compressed form. (See figure 6 for further details.)

• For any node not the start node, it is always possible to eliminate one of the legal "next moves." For example, if  $O(N1)$  generates  $O(N2)$  with a move of D (down), we can forget about generating the successor of  $O(N2)$  that uses the move U (up), because the result will be the same board as in node N1 (which has already been expanded). In the SEARCH program, this is done by matching the "direction" of the current node in  $D\$\$  with its correspond-

ing letter in  $I\$\$  ( $I\$\$  is a mnemonic for "inverse"); this second letter is then ignored in expanding the current node (see the subroutine of 9200).

• It is possible for a series of moves to come back to a previously expanded node (this means that the state space for the 15-puzzle is a graph, not a tree). For this reason, the possible successors generated in lines 9240 through 9310 (subroutine 9200) are checked for duplication (subroutine 8900, used at line 9290).

• Each of the four possible moves in the 15-puzzle is associated with a number between one and four (1 means the tile moves down, 2 indicates the tile moves to the left, 3 means the tile moves up, 4 means the tile moves right). Variables that use this numbering are  $X(N)$ ,  $Y(N)$ ,  $D\$\$ , and  $I\$\$ .

• Within the character representation board, the position with no tile is represented by a period.

• The SEARCH program was run on an Apple II with 48 K bytes of memory, and it should run without modification on the Commodore PET, the Radio Shack TRS-80 Model I Level II or Model III, or any other computer that uses Microsoft BASIC. The program is written so that all REM lines can be deleted without affecting the program's performance.

### Exhaustive Tree Searching

The first method of systematically searching a tree can be described as follows: expand the start node, recording all the successor nodes (which are of depth one); if none of the nodes are goal nodes, expand all depth-one nodes, giving depth-two

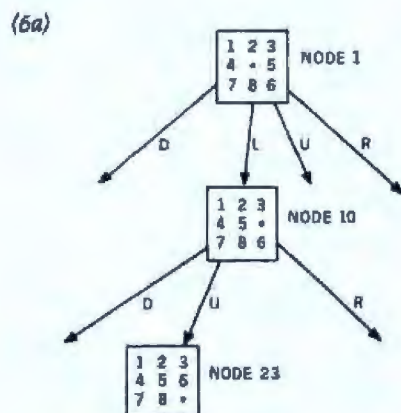

(6b)

$O(10) = 5$      $O\$(10) = "L 001 12345.786"$   
 $O(23) = 3$      $O\$(23) = "U 010 12345678."$

Figure 6: Representation of the 8-puzzle within the program SEARCH. A node is represented in the program as two variables. One is  $O(N)$ , the ordering value of node N in the tree. The other is  $O\$(N)$ , a string that has the following:

- the direction used to get from N's parent node to N
- the node-number of N's parent node (linking N back to the start node)
- the board position for node N, written by rows

Figure 6a shows part of a hypothetical tree; figure 6b shows how nodes 10 and 23 are represented within the program.

Entry Point	Use
8900	Input: Board $F\$(I,J)$ , array $O\$(N)$ Process: Determine if board $F\$(I,J)$ has already been expanded. Output: $Q3\$ = "DUPLICATED"$ or $"NOT DUPLICATED."$
9000	Input: Array $O\$(N)$ , $O9$ Process: Find smallest value in array. Output: Index $N1$ , value $S1$ such that $S1 = O(N1)$ is smallest value in $O(N)$ .
9050	Input: Board $F\$(I,J)$ Process: Compress to a row-major string of characters. Output: $F\$ =$ String of L2 characters.
8100	Input: String $E\$\$ Process: Unpack string to board $E\$(I,J)$ , $F\$(I,J)$ . Output: Identical boards $E\$(I,J)$ , $F\$(I,J)$ .
9200	Input: Board $E\$(I,J)$ , node number $N1$ , direction $E9\$\$ . Process: Generate up to three legal successors of board (which is derived from node $N1$ ), eliminate nodes already expanded, build full node (direction + pointer + board) for each successor. Output: Table of successors $A\$(N)$ , $A9$ .
9400	Input: Number $N1$ , desired length $O8$ . Process: Convert $N1$ to a string; strip off the leading blank, fill with leading zeroes. Output: String $Q\$\$ that "looks like" $N1$ .
9500	Initialization routine; includes entry of puzzle to be solved.
9600	Input: Node $A\$(M1)$ , rank of problem $R9$ . Process: Extract compressed board from node, compare to goal node. Output: $G\$ = "GOAL"$ or $"NOT GOAL"$ .
9800	Input: Goal node $O\$(N1)$ . Process: Trace through pointers back to start node, collecting "direction letters" in $R\$(N)$ . Output: Print $(R\$(R1), R\$(R1 - 1), \dots, R\$(1))$ - solution to puzzle.
8900	Input: Node $O\$(M1)$ to be added to list, list $O(N)$ (and other variables depending on method). Process: Adjustment of values in $O(N)$ ; computation of ordering value for node $M1$ , placed in $R1$ , so that node $M1$ will be correctly inserted into OPEN list with a correct ordering value. Output: This is the subroutine implementing a given search algorithm.

Table 2: A description of the subroutines used in SEARCH.

# our first name is Quality



Our popular space game, *Asteroids in Space*, is now *Meteoroids in Space*, with hyperspace, autobrake, and autofire. This exciting arcade game can be played with or without game paddles. Diskette \$19.95.

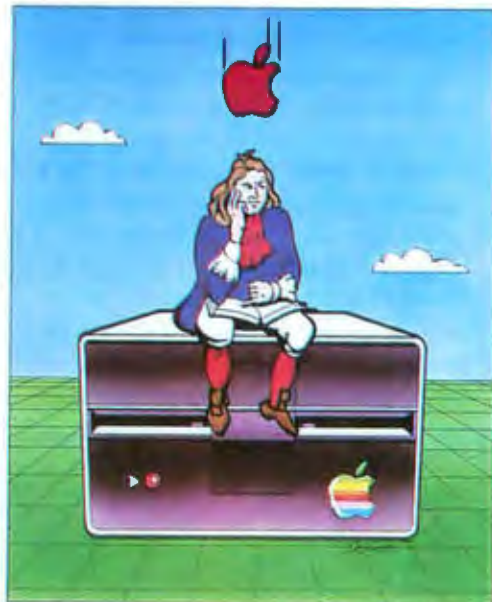

## Beneath Apple DOS

This best-selling 170 page technical manual tells you everything you want to know about Apple's Disk Operating System. Book \$19.95.



Beginners and experts both enjoy this Othello\* playing game that outplays Hayden's *Reversal*. Yet *QS Reversi* has features that *Reversal* doesn't have and costs less. Diskette \$29.95.

## LINKER

### LINKER

Links and relocates assembled machine language programs. Works with any assembler. Diskette \$49.95.



### FASTGAMMON

Known for outstanding graphics and speed of play, this popular program is the standard to which other computer backgammon games are compared. Cassette \$19.95. Diskette \$24.95.

## CR

### CROSS-REF

Prints out a cross-reference of the variables in your Applesoft program. Options include changing the name of a variable. *Cross-Ref* resides passively in memory with your Applesoft program. Cassette \$22.95. Diskette \$24.95.



### FRACAS

A fantastic adventure game like no other. Up to eight players can journey in the land of Faroph at the same time, searching for hidden treasure and fending off monsters. Cassette \$19.95. Diskette \$24.95.

### BABBLE

This amazing and amusing program will entertain you by twisting your stories around in a most delightful way. *Babble* also works with music and sound. It's a language all its own! Cassette \$19.95. Diskette \$24.95.

### BATTLESHIP COMMANDER

A superb version of the traditional battleship strategy game. Cartoons and sound effects help make this game fun for everyone. Cassette \$14.95. Diskette \$19.95.



### BENEATH APPLE MANOR

The original dungeon game for the Apple computer is still one of the best. Descend into a dangerous maze of underground corridors. See if you can find the Golden Apple. Cassette \$14.95. Diskette \$19.95.



### ASTROAPPLE

Your computer becomes your astrologer, generating horoscopes and forecasts based on the computed positions of the heavenly bodies. Cassette \$14.95. Diskette \$19.95.

\*Othello is a trademark of Gabriel Industries.

6660 Reseda Blvd., Suite 105, Reseda, CA 91335  
(213) 344-6599



ASK FOR QUALITY SOFTWARE products at your favorite computer store. If necessary you may order directly from us. MasterCard and Visa cardholders may place orders by calling us at (213) 344-6599. Or mail your check or bankcard number to the address above. California residents add 6% sales tax. Shipping Charges: Within North America orders must include \$1.50 for shipping and handling. Outside North America the charge for airmail shipping and handling is \$5.00. Pay in U.S. currency.

## QUALITY SOFTWARE

# DISCOUNT HARDWARE

Division of System Interface Consultants, Inc.

IEEE 696/S-100 Standard Boards

**CompuPro™** from **BODBOUNT**  
ELECTRONICS

## STATE OF THE ART CPU BOARDS

DUAL CPU 8/16 bit..... \$349  
Z-80 CPU..... \$249

## FAST RELIABLE STATIC MEMORY

16K ..... \$299    32K...~~\$499~~... \$549  
48K...~~\$749~~... \$799    64K...~~\$949~~... \$999

## SYSTEM AUGMENTATION

I/O-I or I/O-II ..... \$199  
DISK-1 DMA Disk Cont. .... \$399  
SUPPORT-1 Multifunction ..... \$299

## DISCOUNT HARDWARE

Division of System Interface Consultants, Inc.  
17440 Revello Drive  
Pacific Palisades, CA 90272

Enclosed is \$\_\_\_\_\_.  
Please express the following assembled, tested, and warranted IEEE 696/S-100 boards:

Name \_\_\_\_\_  
Address \_\_\_\_\_  
Phone (    ) \_\_\_\_\_

Add \$25 to each order for express shipping, handling and insurance. California residents add 6% tax. Allow 2 weeks for personal checks. Prices subject to change

## CONSULTANTS

CALL FOR INFORMATION AND PRICES ON

**SYSTEM 2100**

The business computer that's

HERE TODAY and HERE TOMORROW

avoid obsolescence 8 & 16 bit

**(213) 454-2100**

**System Interface Consultants, Inc.**

Computer Specialists

Established 1969

nodes; repeat this process until a goal node is found or until no unexpanded successor nodes can be found.

In terms of the overall algorithm for tree searching (see figure 5), we implement this *breadth-first algorithm* by putting the newly generated successors on the top of the OPEN list—or, equivalently, by giving these nodes an  $O(N)$  value equal to their depth. Figure 7a shows the order in which nodes are expanded in a breadth-first search; note that all the nodes of depth  $n$  are expanded before any node of depth  $(n + 1)$  is expanded. The subroutine to implement the breadth-first algorithm is given in listing 2a; its structured pseudocode

equivalent is:

```
9900 value of node returned,
      R1 = value of parent
      O(N1) + 1
```

In a breadth-first search, making the "value" of any node equal to its depth will cause all nodes of level  $n$  to be expanded before any node on level  $n + 1$  (with "value"  $n + 1$ ). In line 9900, the value 90000 is subtracted because, by this time, the parent node  $O(N1)$  has been "marked" as being closed by adding 90000 to it.

An alternate approach to tree searching is the *depth-first algorithm*. In this method, we repetitively ex-

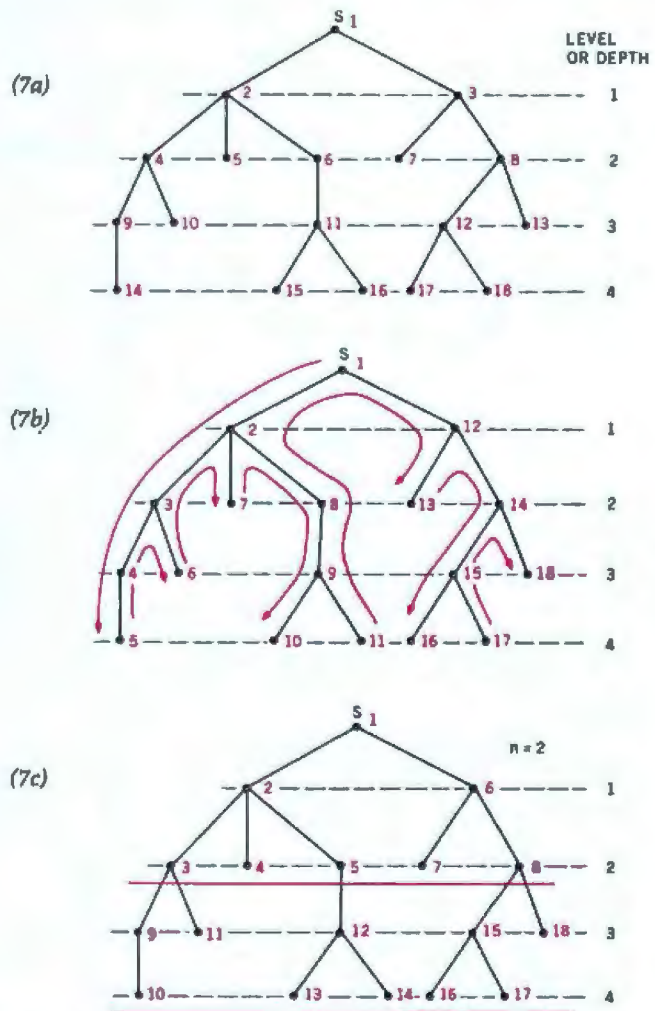
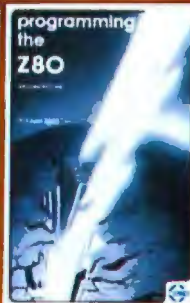
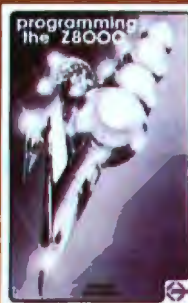

Figure 7: Order of expansion by three exhaustive-search algorithms. The numbers to the right of each node show the order in which the tree is expanded. Figure 7a, the breadth-first search, is examined laterally, one level at a time; figure 7b, the depth-first search, takes a "walk" around the edges of the tree (as shown by the colored arrows); figure 7c, the limited depth-first search, combines properties of both types of search. These searches can be tried by installing the routines in listings 2, 3, or 4 in the SEARCH program (listing 1).

# COME ON BOARD...



Learn about your microprocessor and develop its full power. You'll be ready for take-off in record time.

## MICROPROCESSORS: FROM CHIPS TO SYSTEMS

by Rodnay Zaks

A road map to the world of microprocessors. From fundamental concepts through recent developments and the future. This thorough treatment of microprocessing is logical, systematic and easy to read. 420 pp., 250 illustr., 5½ x 8½, Ref. C201, 3rd edition \$12.95

## PROGRAMMING THE 6502

by Rodnay Zaks

A clear, direct, well organized book designed to teach assembly language programming for the 6502 microprocessor. Covers all essential aspects of programming from fundamental concepts through advanced data structures and program development. 392 pp., 160 illustr., 5½ x 8½, Ref. C202, 3rd edition \$12.95

## PROGRAMMING THE Z80

by Rodnay Zaks

An educational text as well as a complete reference manual for the Z80. Presents everything from fundamentals through advanced programming techniques in a progressive, highly organized fashion. An excellent tool for learning to use and understand the Z80. 620 pp., 200 illustr., 5½ x 8½, Ref. C280, 3rd edition \$14.95

## PROGRAMMING THE Z8000

by Richard Mateosian

A complete introduction to programming techniques and concepts for the Zilog Z8000 microprocessor. It presents detailed descriptions of the architecture and function of the Z8000 and shows how it interacts with its family of support chips. An excellent source of sample programs. 312 pp., 124 illustr., 5½ x 8½, Ref. C281 2nd edition \$15.95

PLEASE SEND ME  PROGRAMMING THE 6502  
 PROGRAMMING THE Z80  PROGRAMMING THE Z8000  
 MICROPROCESSING: FROM CHIPS TO SYSTEMS



MAIL TO:  
SYBEX DEPT. B91  
2344 SIXTH STREET  
BERKELEY, CA 94710  
PHONE ORDERS:  
INSIDE CA 415/848-8233

TOLL FREE OUTSIDE CA 800-227-2346

NAME \_\_\_\_\_  SEND ME YOUR FREE CATALOG  
ADDRESS \_\_\_\_\_  
CITY \_\_\_\_\_ STATE \_\_\_\_\_ ZIP \_\_\_\_\_  
ADD  \$1.50/book UPS or  75¢/book 4th class mail or  \$8/book overseas airmail  
(CA add tax) Total Amt. Enclosed \_\_\_\_\_ OR CHARGE MY  VISA  MC  AM EX.  
CARD NO. \_\_\_\_\_ EXP. DATE \_\_\_\_\_  
SIGNATURE \_\_\_\_\_

pand the successors of a given node (until no such node can be further expanded) before we start to expand the next node of the same depth; that is, we expand down the tree instead of across it, and are, in essence, generating and expanding the terminal nodes from left to right. Figure 7b shows the order in which tree nodes are expanded in a depth-first

search; the subroutine to be inserted into SEARCH is given in listing 3. Its pseudocode equivalent is:

```

9900 value of node returned
      R1 = value of parent
      O(N1) - 1
  
```

In a pure depth-first search, the node just generated should be ex-

panded before any other node already on the OPEN list from past expansions. A good solution is to let the "value" of the successor node be one less than that of the parent. Since the subroutine at 9900 chooses the node with the smallest O array value, this scheme forces the order of expansion just described.

Putting the depth-first algorithm to work, we find that it seemingly generates nodes without end—but without making a practical attempt at moving toward a goal node (except when one happens to be on the leftmost side of the tree). The handicap of the depth-first algorithm is that it will search to the end of a given branch before returning to shallower levels. Because most trees extend to a large, if not an unbounded, depth (whereas a goal node usually exists at a shallower level), the depth-first search is usually inferior to the breadth-first search: the former sweeps up and down the entire length of the tree from left to right, whereas the latter scans uniformly across each level of the tree from top to bottom,

**Listing 2:** Subroutine to implement a breadth-first search strategy.

```

10 REM ----- LISTING 2 -----
9870 REM -- SUBRTN TO COMPUTE H-HAT; BREADTH-FIRST SEARCH
9895 REM -- RESULT R1=VALUE OF PARENT+1
9900 R1 = (O(N1) + 1) - 90000
9905 RETURN
  
```

**Listing 3:** Subroutine to implement a pure depth-first search strategy.

```

9870 REM ----- LISTING 3 -----
9895 REM -- SUBRTN TO COMPUTE H-HAT; PURE DEPTH-FIRST SEARCH
9900 R1 = (O(N1) - 90000) - 1
9905 RETURN
  
```

**Listing 4:** Subroutine to implement a limited depth-first search strategy.

```

9885 REM ----- LISTING 4 -----
9890 REM -- SUBRTN TO COMPUTE H-HAT BY LIMITED DEPTH-FIRST SEARCH
9895 REM -- VALUE RETD=R1; LIMIT OF DEPTH=R3
9900 R3 = 3
9905 R1 = (O(N1) - 90000) - 1
9910 IF R1 = - R3 THEN R1 = 0
9915 RETURN
  
```

Kit shown with optional, extra-cost parts.



# NEW. THE WHIZ KIT.

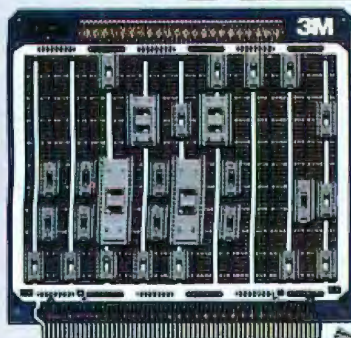

Now breadboard 50% faster with the 3M Whiz Kit. It puts high-quality Scotchflex Brand plugstrips, sockets and tools right at your fingertips. So you can assemble a 20 I/C panel in less than half the time needed for hand-wrapping. There's no stripping. No soldering. No crimping.

The kit's proven U-contact components let you use the same insulation-displacement technique for breadboarding that's used in production. Each contact's tin plated, so you save on cost.

Bussing is fast—just one step. Wire inserted into the U-contact gives you

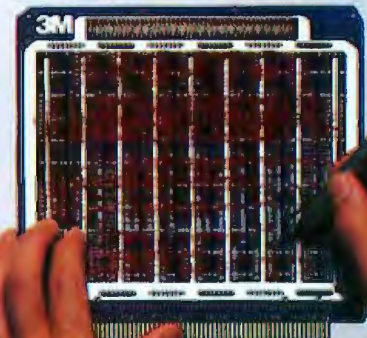



usually first encountering a goal node at a shallow level.

The *limited depth-first algorithm* (see figure 7c and listing 4) can be explained as follows. Choose an arbitrary depth,  $n$ ; do a depth-first search, rejecting (for the moment) all nodes of depth  $n$  or greater. If this does not turn up a goal node, do a depth-first search of the previously rejected nodes, rejecting all nodes of depth  $2n$  or greater. Repeat this process until a goal node is found or the tree is exhausted. This is summarized in the pseudocode:

```
9900 R3 = depth of each "layer" of
      search
9905 value of node returned,
      R1 = value of parent
      O(N1) - 1
9910 if "value" to be returned is
      equal in magnitude to R3 reset
      value to be returned = 0 endif
```

The "value" returned will be zero or negative. This search limits itself to depth R3 at a time by setting a node on the edge of the current level to the

highest possible value, zero, so that it will be expanded only after the current layer has been expanded to the edge. The value R3 could be placed within the initialization subroutine of 9500.

The limited depth-first search lessens the disadvantages of the pure depth-first search by providing for an eventual exhaustive search of the lower level of the tree. But it is also a compromise: if a goal node is located deep and on the left-hand side of a tree, this node will be more quickly found by the pure depth-first search than by the limited depth-first search. (In general, the effectiveness of both depth-first searches is extremely dependent on the left-right position of a goal node within the tree.)

#### Notes on Experimentation

We now have the tools with which to examine the exhaustive search algorithms. The BASIC program SEARCH (when fitted with the appropriate subroutine at 9900) will ask for the beginning puzzle (given row by row, with A through E repre-

senting 10 through 15 in the order-4 version only, and a period representing the space in the puzzle), list nodes as they are expanded and generated, and print out the solved puzzle. If you want to avoid typing in a puzzle every time you run the program, add the following lines:

```
9521 Q2$ = "<puzzle to be
        entered>"
9523 GOTO 9550
```

My observations and experiments are based on the sample 8-puzzles given in figure 8; a given puzzle will be referred to by its row and column number in this figure. Note that the row number is the number of moves in the solution of the puzzle and that a given puzzle is a subproblem of every puzzle below it and in the same column.

Table 3 gives data on selected puzzles using the breadth- and limited depth-first algorithms. Remember that closed nodes are those that have been expanded for successors and open nodes are those that have been

*Text continued on page 98*

# IT BEATS THE CLOCK.

the equivalent of two wrapping levels. Double up in the contact and save four wrapping levels. **CONVERT RIGHT TO PRODUCTION.**

Finished Scotchflex prototypes so closely match production quality, you're saved more time on redesigning and fine-tuning. The U-contact's less than 1/3 the height of an ordinary wrap post. So Scotchflex breadboards can be stacked on .600" centers for the most efficient use of space.

You can reuse Whiz Kit's components up to 25 times. The hand tools are rugged, versatile and maintenance-free. The kit has its own

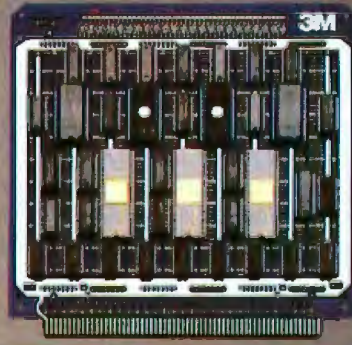

storage tray. Expanded parts can be easily replaced and stored. **50% FASTER FOR 25% OFF.**

Right now, 3M will send you a special coupon worth 25% off your first purchase of the new Whiz Kit. It's good at your Scotchflex distributor. Write today to Electronic Products Division/3M, 225-4SC, 3M Center, St. Paul, MN 55144.



3M Hears You...

Circle 359 on inquiry card.



SAVE \$\$\$ SAVE \$\$\$

# TRS-80 MICROCOMPUTERS

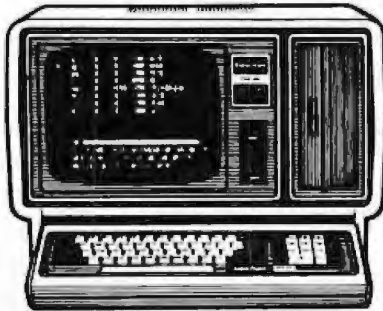

TRS-80 Model II, 64K System  
**ONLY \$3325.<sup>00</sup>**

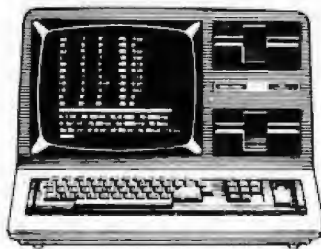

TRS-80 Model III, 32K - 2 Drives  
**ONLY \$2095.<sup>00</sup>**

Great Discounts On All Other TRS-80 Model II and III Add Ons. Color Computers, Printers, Pocket Computers, And All Other Fine Radio Shack \* Merchandise

All Computers Are Brand New, In Factory Sealed Cartons, And Carry A 3 Month Radio Shack \* Warranty. F-48 Form Provided.

Most Models In Stock **Just Call Collect 512-689-5536.** Master Electronics, Inc., 154 N. 5th, Raymondville, Tx. 78580. Remember **No Tax On Out-Of-State Shipments.**

**MASTER  
ELECTRONICS  
INCORPORATED**



Authorized TRS-80 Dealer,  
Store # F-723

(3a)

Puzzle	Solution	#Open	#Closed	Total
(1,1)	L	3	1	4
(1,2)	U	3	1	4
(2,1)	UL	7	4	11
(2,2)	LU	6	3	9
(2,3)	LL	4	3	7
(3,1)	LUL	9	8	17
(3,2)	ULU	7	6	13
(3,3)	ULL	10	9	19
(4,1)	DLUL	12	11	23
(4,2)	LULU	10	9	19
(4,3)	RULL	16	21	37

(3b)

Puzzle	Solution	#Open	#Closed	Total
(1,1)	L	3	1	4
(1,2)	U	3	1	4
(2,1)	UL	11	12	23
(2,2)	LU	8	7	15
(2,3)	LL	10	9	19
(3,1)	LUL	11	13	24
(3,2)	ULU	9	7	16
(3,3)	ULL	12	17	29
(4,1)	DLUL	9	8	17
(4,2)	LULU	7	6	13
(4,3)	RULL	16	21	37

(3c)

Puzzle	Solution	Depth (n)	#Open	#Closed	Total
(2,2)	LU	2	6	3	9
		3	6	5	11
		4	8	7	15
		5	12	11	23
(2,3)	LL	2	4	3	7
		3	6	5	11
		4	10	9	19
		5	12	17	29

Table 3: Experiments with SEARCH. In the breadth-first search (3a), "# Open" refers to the number of nodes created but not yet expanded. "# Closed" is the number of nodes that have already been expanded. Since the breadth-first algorithm searches uniformly down the tree from the start node, it is the most reliable of the exhaustive search methods.

The limited depth-first search (3b), with depth  $n=4$ , shows that for all puzzles on level four, the number of nodes that this algorithm generates is the same or less than the breadth-first search. By varying the cutoff depth,  $n$ , this algorithm does a depth-first search in "layers" (see 3c), each layer being  $n$  nodes deep. As  $n$  becomes greater than the number of moves in the solution (in this case, two), the algorithm more closely resembles a pure depth-first search in its inefficiency.



**μ-SCI**

## MICRO-SCI SQUEEZES MORE OUT OF YOUR COMPUTER, NOT YOUR POCKET

If you own an Apple II\* or plan to buy one, consider this:

The Disk II\* subsystem made for your Apple II provides only 35 tracks of storage. But Micro-Sci subsystems made for your Apple II provide up to 70 tracks, without reduced versatility or compatibility.

### **MORE CAPACITY FOR LESS MONEY**

Our A40 system features 40 tracks, whereas our A70 provides 70 tracks and exactly twice the byte capacity of Disk II.

With either Micro-Sci system, you pay a lot less per byte. And with the A40, you could even end up paying considerably less per drive.

### **COMPATIBILITY TO SPARE**

Micro-Sci has achieved this extra storage while maintaining compatibility with your existing Apple formatted diskettes.

Our subsystems operate with DOS 3.2 and 3.3, Pascal, and the Z80 SoftCard.

### **VERSATILITY PLUS**

You can even mix Apple Disk II's, A40's and A70's on the same computer. Micro-Sci's controller supports one or two A40's, one or two A70's or one of each.

Single or dual A40 drive subsystems give you more capacity (20,000 to 40,000 bytes) than Disk II drives, for less money.

Micro-Sci's A40/A70 subsystem combines the diskette level compatibility and interchangeability of the A40 with the superior storage capacity of the A70.

Dual A70's provide over half a megabyte of storage, at 5 1/4" floppy prices!

No matter which Micro-Sci subsystem you choose, you'll have more capacity, compatibility and versatility for your computer—and more money in your pocket. Contact us today for more information and the name of your nearest Micro-Sci Dealer.

\*"Disk II" is a registered trademark of Apple Computer, Inc., Cupertino, CA

\*\*SoftCard is a registered trademark of Micro-Soft Consumer Products

**μ-SCI**

MICRO-SCI

17742 Irvine Boulevard, Suite 205, Tustin, California 92680 / Phone: 714/731-9461 / Telex: 910-346-6739

MICRO-SCI IS A DIVISION OF STANDUN CONTROLS, INC.

Text continued from page 95:

generated but not yet closed (expanded); thus, the total number of nodes generated by an algorithm is the sum of its open and closed nodes.

Also remember that the SEARCH program generates successors by expanding in the following order: *down, left, up, right*. Although this is less important for more advanced searches, it is extremely important

when analyzing exhaustive searches.

### Observations and Questions

Please consider the following questions before you read the answers on page 102. On the breadth-first search:

- Note that the number of nodes expanded to get a solution varies with the directions used in the solutions;

“downs” and “lefts” tend to make the solution shorter, while “ups” and “rights” make it longer. Compare the puzzle (2,3) with the puzzle at (2,1), and puzzle (4,2) with (4,3).

- (Question 1) How is this tendency reflected in the number of nodes on the closed list? (Consult the text box, “Answers,” on page 102.)

- (Question 2) Then why does puzzle (3,2), with solution LUL, generate more nodes than puzzle (3,1), which has solution ULU? Aren’t L moves expanded before U moves?
- Notice that both puzzles (1,1) and (1,2) have the same number of open and closed nodes, even though the solution, L, in (1,1) precedes the solution, U, in (1,2). This is because the SEARCH program generates *all* the valid successors of the node being expanded before evaluating them for goal status.

- (Question 3) I noticed a curious fact while examining the solution of two puzzles, one of which is a subproblem for the other: the subproblem generates a node that the larger problem does not. Run puzzles (2,1) and (3,1) using the breadth-first sub-routine and list the nodes generated. Where is the node in question? Why is it generated in (2,1) and not in (3,1)?

	1 2 3			
Goal Node	4 5 6			
	7 8 .			
Row Number				
(1) One move away	1 2 3	1 2 3		
	4 5 6	4 5 .		
	7 . 8	7 8 6		
(2) Two moves away	1 2 3	1 2 3	1 2 3	
	4 . 6	4 . 5	4 5 6	
	7 5 8	7 8 6	. 7 8	
(3) Three moves away	1 2 3	1 . 3	1 2 3	
	. 4 6	4 2 5	. 5 6	
	7 5 8	7 8 6	4 7 8	
(4) Four moves away	1 2 3	. 1 3	1 2 3	
	7 4 6	4 2 5	5 . 6	
	. 5 8	7 8 6	4 7 8	

Figure 8: A table of 8-puzzles used in the text. Ignoring the row with the goal node, each puzzle is referred to by its row and column numbers (eg: the rightmost puzzle in the row labeled “two moves away” is puzzle (2, 3)). Notice how puzzles in the same column are related to each other: each puzzle is a subproblem of the puzzle that appears directly below it.

On the depth-first search:

- You will probably find that you run out of memory (or patience) before you get a solution from the depth-first algorithm. This is because the algorithm first dives to the bottom of the tree, and that bottom is deep, even for a puzzle as small as the order-3 8-puzzle. Try experimenting with the depth-first algorithm, using the SEARCH program set to handle the order-2 puzzle.

On the limited depth-first search:

- Table 3b shows the results from the solution of the same puzzles, (2,2) and (2,3), using different cutoff depths (variable D3 in line 9900). Since both puzzles are solved in two moves, the cutoff depth simply determines how far down the search will

Text continued on page 102

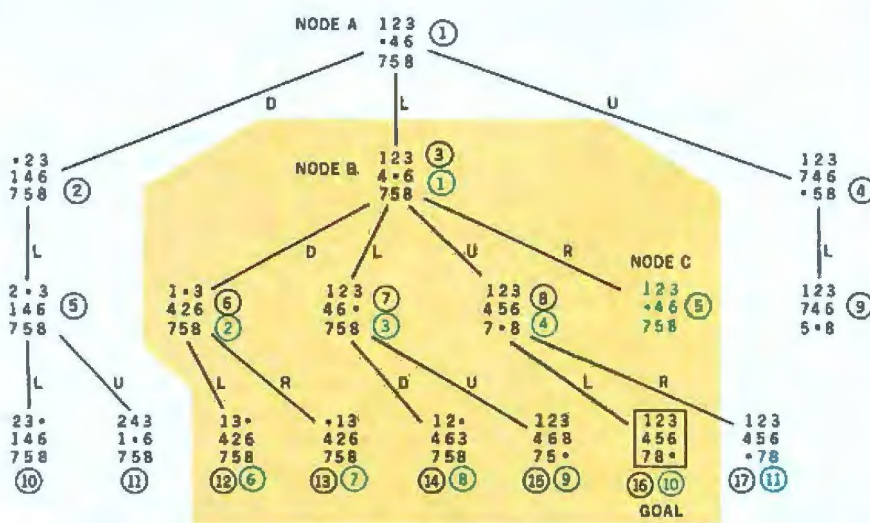

Figure 9: Solution of puzzle (3, 1) by the breadth-first algorithm. The tree is a partial tree carried out only far enough to reach the goal node (shown in the bottom row). The circled numbers in black indicate the order in which nodes are expanded to solve the puzzle. The node labeled B is the start node of puzzle (2, 1), a subproblem of puzzle (3, 1); circled numbers in color indicate the order in which nodes are expanded to solve puzzle (2, 1).

# SuperSoft's Gallery of CP/M Masterworks



<b>Programming Languages</b>	<b>Disk/Manual Only</b>
"C"	\$200/20
FORTH	\$200/25
FORTRAN IV	\$250/25
RATFOR	\$100/NA
BASIC	\$200/25
'TINY' PASCAL	\$ 85/10
<b>System Maintenance</b>	
Diagnostics II	\$100/15
Diagnostics I	\$ 75/15
DISK DOCTOR	\$100/15
<b>Utilities</b>	
Utility Pack #1	\$ 60/NA
Utility Pack #2	\$ 60/NA
<b>Text Processing</b>	
TFS	\$ 85/15
Super-M-List	\$ 75/10
<b>Software Security</b>	
Encode/Decode II	\$100/20
Encode/Decode I	\$ 50/20
<b>Intercommunications</b>	
TERM	\$150/15
TERM II	\$200/15
<b>Entertainment</b>	
ANALIZA	\$ 35/NA
NEMESIS	\$ 40/NA
Dungeon Master	\$ 35/NA
(For use with Nemesis)	
<b>Miscellaneous</b>	
Z8000 Cross-Assembler	\$500/25
"C" Cross-Compiler	\$500/25
(Z8000 Target)	

Many programs include SuperSoft's online "HELP" system!

## TERM

A Complete Networking/Intercommunications Package

TERM allows the CP/M user to communicate with other CP/M based systems or with remote timesharing computers. TERM supports file transfers between both timesharing systems and between CP/M systems.

TERM equals or exceeds comparable programs in power and flexibility, but costs less, delivers more and *source code* is provided on discette!

With TERM you can send and receive ASCII, HEX and COM files. You also have a conversational mode, and a timesharing terminal emulator. Below is a partial list of features:

- Engage/disengage printer
- auto error checking with re-try
- conversational mode
- send files
- terminal emulator
- receive files

requires 32K CP/M and a minimal knowledge of assembly language programming.

TERM is supplied with source and user manual: \$150.00  
Manual only: \$15.00

**TERM**

## SUPERDISKS FOR SALE!

SuperSoft Has Great Prices on Blank Discettes

SuperSoft sought out and found a discette that met our high standards. In the software distribution business we needed a discette that was reliable, sturdy, durable, and inexpensive. We wanted no data errors on any discette that we shipped.

- Guaranteed
- Data density in excess of 3200 b.p.i.
- Approved by Shugart, Persci, Qume, Remex, others
- Operating temperature: 50-120 degrees Fahrenheit

Discette type	price per box
<b>Single Sided Single Density:</b>	
Soft sector IBM compatible 8"	\$30.00
10 hard sectors 5 1/4"	\$30.00
16 hard sectors 5 1/4"	\$30.00
<b>Single Sided Double Density:</b>	
Soft sector IBM compatible 8"	\$35.00
10 hard sector 5 1/4"	\$35.00
16 hard sector 5 1/4"	\$35.00

\* Add \$15.00 for Double Sided Discettes  
Illinois residents add 5%  
Add \$1.00 shipping per box

All SUPERDISKS are sold only in lots of 10. Each comes with jackets and box. All orders must be prepaid or C.O.D. Generally we ship from stock, with arrival times running about 8-10 days.

For complete information on these and all other SuperSoft products, please write for our free catalogue.

All software can be supplied on the following media:  
CP/M formats . . . 8" sft sector, 5" Northstar,  
5" Micropolis Mod II, Vector MZ, Superbrain DD/QD,  
Apple II+

 All Orders and General Information:  
SUPERSOFT ASSOCIATES  
P.O. BOX 1628  
CHAMPAIGN, IL 61820  
(217) 359-2112  
Technical Hot Line: (217) 359-2691  
(answered only when technician is available)

\*CP/M REGISTERED TRADEMARK DIGITAL RESEARCH  
SSS FORTRAN is the copyright of Small Systems Services, Urbana, Illinois

24 hour express service available!

*SuperSoft*

## First in Software Technology

# Starwriter



**PRINTERS,  
MONITORS,  
DISKS**

Daisy Wheel Printer by C. Itoh .....	1750
Paper Tiger 445G .....	725
Paper Tiger 460G .....	1194
Paper Tiger 560G .....	1495
Qume (shipped FREIGHT COLLECT) .....	2499
Silentype w/interface .....	349
Amdek Color Monitor .....	349
Amdek Green Screen .....	169
Amdek/Leedex B/W 12" Monitor .....	129
NEC 12" Green Screen .....	239
Sanyo 9" B/W Monitor .....	169
Sanyo 12" B/W Monitor .....	255
Sanyo Green Screen .....	309
Dysan Disks (pkg. 10) .....	50
Memorex Disks (pkg. 10) .....	40
Opus Disks (pkg. 10) .....	30
Verbatim "Gold" (pkg. 10) .....	35



**ATARI 800**  
PERSONAL COMPUTER SYSTEM

**\$789**

IF  
**ATARI**<sup>®</sup>  
MAKES  
IT, WE  
SELL IT

Atari 400 8K Computer .....	419
Atari 800 16K Computer .....	789
Atari 410 Program Recorder .....	69
Atari 810 Disk Drive .....	499
Atari 820 Printer .....	429
Atari 825 Printer .....	695
Atari 850 Interface .....	169
16K RAM by Microtek .....	99
32K RAM by Microtek .....	189
Assembler/Editor .....	45
Atari Joysticks .....	18
Atari Paddles .....	18
Basketball .....	30
Computer Chess .....	30
Invitation to Programming .....	17
Music Composer .....	45
Star Raiders .....	39
Super Breakout .....	30
3-D Tic-Tac-Toe .....	30
Video Easel .....	30
Visicalc .....	180

**SSM AIO \$149**

**\* MONTHLY \*  
SPECIALS**

**VERSA-WRITER  
DIGITIZER \$239**

LIST 645  
**CALL**  
The Epson  
80-Column Dot Matrix Printer

**MX-80**

- Full 96-character ASCII with descenders
- Adjustable tractor-type pin feed

- Interfaces —  
Standard — Centronics-style 8-bit Parallel

- Optional — RS232, IEEE488  
Buffer Size — one line

Available for immediate shipment

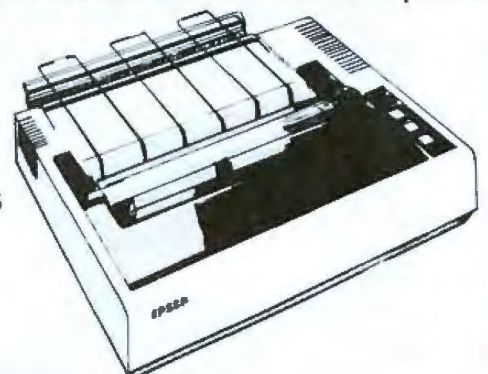

**TO ORDER** Phone orders invited using Visa, Mastercard or bank wire transfers. Visa and MC service charge of 2%. Mail orders may send charge card number (include expiration date), cashiers check, money order, or personal check (allow 10 business days for personal or company checks to clear). Please add 3% (\$5.00 minimum) for UPS shipping, handling, and insurance. APO and FPO include 5% (\$7.00 minimum) for postage. Calif. residents add 6% sales tax. Please include phone number on all orders.

**FOREIGN ORDERS** include 1% handling — shipped air **FREIGHT COLLECT** only. Credit cards not accepted on foreign orders. All equipment is in factory cartons with manufacturer warranty. Opened products not returnable. Restocking fee for returned merchandise. Equipment subject to price change and availability. Retail prices differ from mail order prices. **WE SHIP THE SAME DAY ON MOST ORDERS!**



**(714) 579-0330 • MAIL TO: 1251 BROADWAY, EL CAJON, CA. 92021**

AUTHORIZED  
APPLE  
SALES &  
SERVICE

**COMPUTER**



**SPECIALTIES**

DIV OF  
COMPUTER  
METRICS  
INC

**EXCITING DISCOUNTS**

**apple II**  
**16K computer**

**DISK with CONTROLLER**  
**NEW DOS 3.3 \$529**  
without . . . \$445  
Nearly Everything  
for Apple



**WE WILL  
MEET OR BEAT  
ANY ADVERTISED PRICES  
ON MOST ITEMS IF MERCHANDISE  
IN STOCK**

**APPLE II 48K**  
**\$1095**

**APPLE SOFTWARE**

ABM by Muse . . . . .	19	Pool 1.5 . . . . .	29
Adventure by Mircrosoft . . . . .	27	Pulsar II . . . . .	25
Alien Rain by Broderbund . . . . .	19	Raster Blaster . . . . .	24
Apple PIE . . . . .	119	Robot War by Muse . . . . .	31
Apple Pilot . . . . .	129	Sabotage . . . . .	21
Apple-oids . . . . .	25	Sargon II Chess Game . . . . .	29
Appleplot by Apple . . . . .	59	Snoggle/Puckman by Broderbund . . . . .	24
Applepost Mailing List System . . . . .	44	Space Game Album by Budgetco . . . . .	39
Applewriter Word Processor . . . . .	65	Space Eggs . . . . .	25
Asteroid Field by Cavalier . . . . .	19	Space Invaders/Cosmos Mission . . . . .	24
CCA Data Mgmt . . . . .	84	Space Raiders by USA . . . . .	25
Data Factory by Microlab . . . . .	129	Star Cruiser . . . . .	24
Desktop Plan II . . . . .	159	Sub-Logic FS-1 Flight Simulator . . . . .	34
DB Master II by Stoneware . . . . .	199	Super Single Disk Copy Routine . . . . .	35
DOS Tool Kit . . . . .	65	Super Stellar Trek . . . . .	33
DOS 3.3 Upgrade . . . . .	49	Supertext II by Muse . . . . .	129
Dow Jones Portfolio Evaluator . . . . .	45	Ultima . . . . .	35
Fortran by Apple . . . . .	159	Visicalc II . . . . .	159
Hi-Res Football . . . . .	33	Visilist . . . . .	24
Head-On . . . . .	21	Visitrend/Visiplot . . . . .	219
Integer Basic Cassette Demos . . . . .	29	Wizard and the Princess . . . . .	32
Orbilron . . . . .	25	Zork . . . . .	34
PASCAL Language System . . . . .	459		
Peachtree Bus. Pkgs . . . . .	CALL		
Personal Filing System . . . . .	84		
Phantoms Five . . . . .	29		

**LARGE SELECTION OF  
SOFTWARE IN STOCK —  
CALL FOR FREE BROCHURE —**

**APPLE COMPUTER  
INTERFACE CARDS**

Applesoft II Firmware Card . . . . .	149
CCS Asynchronous 7710A . . . . .	129
CCS Parallel Print Cd. 7720A . . . . .	155
Centronics Interface Cd. . . . .	179
Comm. Cd. & DB25 Cable . . . . .	179
CPS Multifunction by Mtn. Comp. . . . .	199
Expansion Chassis by Mtn. Comp. . . . .	555
HiSpeed Serial Int. Cd. . . . .	155
Integer Basic Firmware Cd. . . . .	149
ROMPLUS . . . . .	135
SSm AIO Serial/Parallel I/O Assembled & Tested . . . . .	149

**ACCESSORIES**

A/D D/A Board by Mtn. Comp . . . . .	319
Andromeda 16K Ramcard . . . . .	179
Apple Game Paddles . . . . .	25
Arith. Processor 7811 A or B . . . . .	339
COPYROM by Mtn. Comp. . . . .	51
Dan Paymar L.C. Kit 1 or 2 . . . . .	55
Extender Board . . . . .	27
GPIO IEEE 488 Card . . . . .	259
Graphics Input Tablet . . . . .	639
Hayes Micromodem . . . . .	299
Introl X-10 Remote Control Sys. . . . .	239
Joystick for the Apple . . . . .	47
Keyboard Filter ROM chip . . . . .	49
Lazer Lower Case Plus+ . . . . .	49
M & R Sup-R-Term 80-col-bd . . . . .	319
Music System by Mtn. Comp . . . . .	479
Programmable Timer CCS 7440A . . . . .	159
Prototyping Hobby Card . . . . .	22
ROMWRITER by Mtn. Comp . . . . .	149
SuperTalker Speech Synthesizer . . . . .	239
Thunderclock . . . . .	129
Versa-Writer Digitizer Drawing Sys . . . . .	239
Videx Keyboard Enhancer . . . . .	115
Videx Videoterm 80-col-cd . . . . .	319
Z-80 SOFTCARD by Microsoft . . . . .	295



**CALL 1-800-854-2833**  
**PHONE ORDERS**  
**MON. - SAT. 8 to 6 P.S.T.**

Circle 79 on inquiry card.

MEMBER CHAMBER OF COMMERCE

AUTHORIZED  
APPLE  
SALES &  
SERVICE



DIV OF  
COMPUTER  
METRICS  
INC

# CHOOSE...

## Choose an Apple Desk



A compact bi-level desk ideal for an Apple computer system. This 42" x 31 1/2" desk comes with a shelf to hold two Apple disk drives. The top shelf for your TV or monitor and manuals can also have an optional paper slot to accommodate a printer.

## Choose a Micro Desk



Get your micro computer off the desk top and into the micro shelf under our Designer Series desks. Suitable for the North Star, Dynabyte, Vector Graphics, and Altos computers. The desks come in a variety of sizes and colors.

## Choose a Mini Rack



Mini racks and mini micro racks have standard venting, cable cut outs and adjustable RETMA rails. Choose a stand alone bay or a 48", 60", or 72" desk model in a variety of colors and wood tones. A custom rack is available for the Cromemco.

## Choose a Printer Stand



The Universal printer stand fits the:  
Centronics 700's    Diablo 1600's & 2300's  
Dex LA 34        T.I. 810 & 820  
NEC Spinwriter    Okidata Slimline  
Lear Siegler 300's    Anadex 9500's

Delivery in days on over 200 styles and colors in stock. Dealer inquiries invited.

### ELECTRONIC SYSTEMS FURNITURE COMPANY

17129 S. Kingsview Avenue  
Carson, California 90746  
Telephone: (213)538-9601

Text continued from page 98:

go before returning to shallower depths.

• The definition of a limited depth-first search of level  $n$  is that it expands  $n - 1$  levels at a time, generating the current level  $n$  nodes but not immediately expanding them. Therefore, such a search is most efficient when the level of the search is equal to the number of moves in the solution: the search drops down the left-most side of the tree, stops at level  $n$ ,

and scans across the  $n$ -level subtree from left to right.

• I made an unexpected discovery: the limited depth-first search is guaranteed to expand less than or the same number of nodes as the breadth-first search when the depth of the search ( $n$ ) is equal to the number of steps ( $s$ ) in the solution. An intuitive proof of this can be seen from the example of figure 11. Also, it can be inferred that the two searches are

### Answers

1. If a given step of a solution is one of the last to be expanded (say, up or right), then the breadth-first search will first expand in other, nonproductive ways (remember the order: down, left, up, right). It is the expansion of these nodes that increases the number of nodes on the closed list.

2. Yes, L moves are expanded before U moves, but an analysis of the situation shows that the order in which nodes are expanded (down, left, up, right) is only one of several factors influencing the number of nodes expanded by a breadth-first search. Refer to figures 9 and 10. If you count the number of terminal nodes (which are open—yet to be expanded) and nonterminal nodes (representing closed, or already expanded nodes), you will find that the numbers agree with those listed in table 2a. (Remember to count the start node as being closed; also, for the moment, ignore node C in figure 9.)

The two trees are identical in number and distribution of nodes through rank two (ie: in nodes 1 through 9). The overwhelming reason that puzzle (3,1) expands more nodes than puzzle (3,2) is that the former has to expand more level-two nodes to get to the goal node. Why is this? Because, from node 3 (in both trees), the path leading to the goal node in puzzle (3,2)—the L branch in figure 10—is expanded before the corresponding path—the U branch in figure 9—is expanded. Here the single L in the solution of puzzle (3,2) is more important than the two Ls in the solution of (3,1) because it prevents the expansion of several "fertile" nodes (nodes six and seven in figure 9) on the next-to-last level.

We should not, however, be tempted to generalize. The factors influencing the number of nodes generated are so interdependent that it is impossible to evaluate their relative strengths outside the context of a specified example.

3. Refer to figure 9. The entire tree (minus node C, in color) is the solution tree for puzzle (3,1). The nodes in the colored box (including node C) are the solution tree for puzzle (2,1).

Now the reason for the fact that node C is generated only by (2,1) becomes clear. When node B is a start node, all four directions generate valid successors, but when node B is generated by starting node A in puzzle (3,1), the SEARCH program rightly denies node C successor status because the direction of the move from B to C undoes the move directly before it, A to B. Here again, the interaction of forces in the algorithm create unexpected but correct results.

4. The two important factors in this situation are the depth and the "leftness" of the goal node. Because the limited depth-first algorithm scans from left to right, the "leftness" of the goal node is the more important factor: a node midway in the tree but closer to the left edge of the tree than another node (which is further down), will be expanded first. This is also true for a pure depth-first search.

5. A limited depth-first search of order one is equivalent to a breadth-first search; that is, because  $n = 1$ , the algorithm does an exhaustive search of the tree one level at a time. Numbering the nodes of a tree according to the limited depth-first algorithm will demonstrate the equivalence of the two forms.



**NEW!**

# THE B810 RAM

engineered for excellence

## 256 K Byte / 128 K Word Dynamic Memory

### FEATURES

- Byte or Word width operation
- Extended Addressing or Port Select
- 150 ns Access, 270 ns Cycle (B Version)
- 200 ns Access, 335 ns Cycle (A Version)
- Full DMA capability with transparent refresh
- Precise memory timing module
- Low Power
- Meets IEEE 696 specifications
- Four-layer board

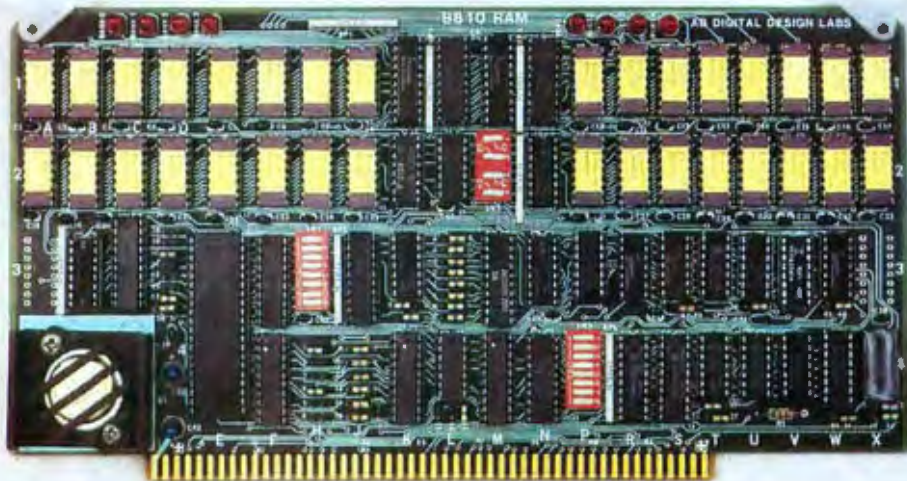

**\$1249.\*** Assembled & Tested with 1 Year Warranty  
\*Introductory Price valid through 30 Sept., 1981

The B810 RAM represents one of the best solutions for applications requiring compact design and speed for remarkably low cost. Suitable for a wide range of commercial applications, the B810 RAM is form, fit and functionally compatible with the proposed IEEE 696 (S-100) bus standard. It automatically provides byte or word width access using the sXTRQ\* signal. It features the AMD 2964 Dynamic Memory Controller and a new memory timing module designed for the B810 by Engineered Components Corp. for precise timing. Its four layer board with full ground and power planes provides noiseless operation. As an integral part of the AB Digital B800-series, the B810 RAM provides full DMA capability. Designed to be as universal as possible, the B810A RAM will work with most S-100 cards using a Z80 or Z8000, and the B810B (with optional byte parity), works with Alpha Micro, Cromemco, Northstar, and all S100 CPU cards.

Available through California Digital (toll-free orders only 800-421-5041) and other fine distributors, or direct. Specification sheets on request. Manuals may be purchased separately for \$25.00 refundable on order.

### COMING NEXT MONTH: THE B880 80ns 64K/32K STATIC RAM

The B800 series of 8-bit cards provides the OEM with a complete line of 6 MHz computer cards. All peripheral controllers are intelligent. This series includes the B800 CPU; the B820 SCC Serial Communications Controller; the B830 HDC Hard Disk Controller; the B840 FDC Floppy Disk Controller, and others which will be announced.

The B8000 series provides a complete line of 16-bit 4 and 6 MHz cards in three formats: double-height S100, MultiBus and the new Zilog ZBI bus. As with the B800 series, all peripheral controllers are intelligent with their own processors and memory. The B8000 series includes the B8000 CPU (Z8001-based); the 1 Megabyte B8100 RAM with optional EDC; the B8200 SCC Serial Communications Controller; the B8300 HDC Hard Disk Controller; the B8400 WDC Winchester Disk Subsystem; and others to be announced.

AB Digital Design Labs products are designed to provide technological leadership and industrial-grade quality with unexcelled performance. Before you buy any computer product, we invite you to examine our spec sheets and manuals. We think the choice will be clear.



**DIGITAL DESIGN LABS**

109 Cuyama Road Shell Beach, CA 93449

(805) 773-1731

# Big sale on K's!

16K... \$149.95

32K... \$199.95

48K... \$249.95

64K... \$299.95

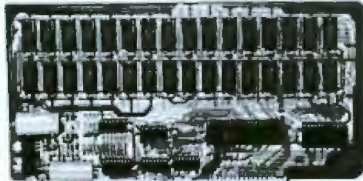

## New JAWS-IB

### The Ultrabyte Memory Board

Due to the tremendous success of our JAWS I, we were able to make a special purchase of first-quality components at below-cost prices for JAWS-IB. And we are sharing our cost saving with you. But don't be surprised if the next time you see this ad the prices have gone up substantially. Better yet, order now, and get the best memory on the market at the best price on the market.

#### ONE CHIP DOES IT ALL

Jaws-IB is the Rolls-Royce of all the \$100 dynamic boards. Its heart is Intel's single chip 64K dynamic RAM controller. Eliminates high-current logic parts... delay lines... massive heat sinks... unreliable trick circuits. JAWS-IB solves all these problems.

#### LOOK WHAT JAWS-IB OFFERS YOU

Hidden refresh... fast performance... low power consumption... latched data outputs... 200 NS 4116 RAM's... on-board crystal... RAM Jumper selectable on 8K boundaries... fully socketed... solder mask on both sides of board... phantom line... designed for 8080, 8085, and Z80 bus signals... works in Explorer, Sol, Horizon, as well as all other well-designed \$100 computers.

10-DAY MONEY-BACK TRIAL: Try a fully wired and tested board for 10 days—then either keep it, return it for full, or simply return it in working condition.

Continental U.S.A. Credit Card Buyers Outside Connecticut:

**TO ORDER CALL TOLL FREE 800-243-7428**

From Connecticut Or For Assistance:

(203) 354-9375

Please send the items checked below:

#### JAWS-IB kit:

- 16K... \$149.95\*
- 32K... \$199.95\*
- 48K... \$249.95\*
- 64K... \$299.95\*

#### JAWS-IB Fully Assembled, wired & Tested:

- 16K... \$179.95\*
- 32K... \$239.95\*
- 48K... \$299.95\*
- 64K... \$359.95\*

EXPANSION KIT, 16K RAM Module, to expand JAWS-IB in 16K blocks up to 64K. \$59.95

\*All prices plus \$2 postage and insurance (\$4.00 Canada). Connecticut residents add sales tax.

Total enclosed: \$

- Personal Check  Money Order or Cashier's Check
- VISA  Master Card (Bank No.)

Acct. No. \_\_\_\_\_ Exp. Date \_\_\_\_\_

Signature \_\_\_\_\_

Print Name \_\_\_\_\_

Address \_\_\_\_\_

City \_\_\_\_\_

State \_\_\_\_\_ Zip \_\_\_\_\_

**NETRONICS R&D Ltd.**  
333 Litchfield Road, New Milford, CT 06776

approximately equivalent in efficiency when  $n$  is only slightly larger than  $s$ .

• (Question 4) In a limited depth-first search of level  $n$  on a puzzle with a solution of  $n$  moves, what are the two

most important characteristics (in terms of the location of the goal node) that influence the solution time of the puzzle? Which is more important?

• With limited depth-first searches of depth greater than the number of

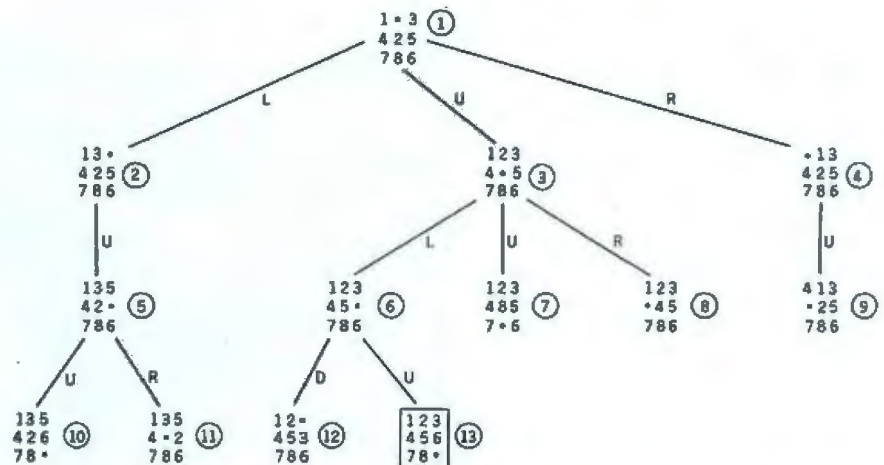

Figure 10: Solution to the puzzle (3, 2) by the breadth-first algorithm. The circled numbers to the right of each node indicate the order in which they are expanded. Nodes 8 through 13 (six nodes) are "open" (ie: they have not yet been expanded), whereas nodes 1 through 7 are "closed."

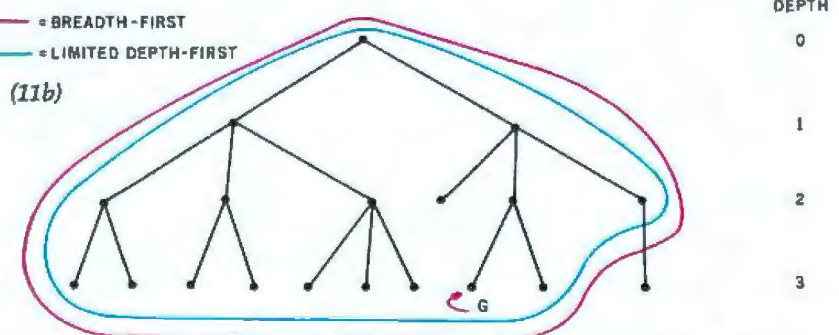
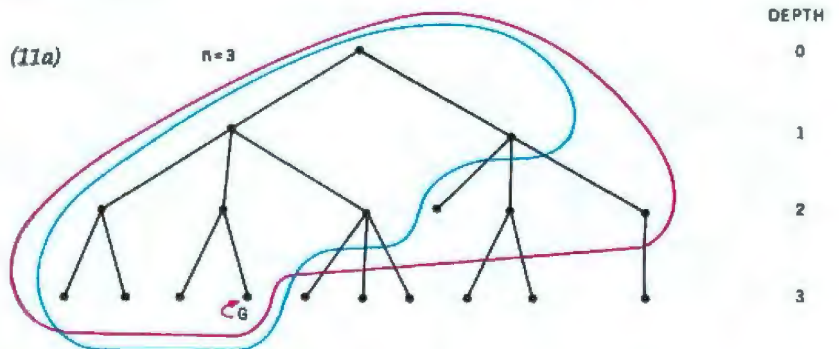

Figure 11: A comparison of search efficiency. The limited depth-first search always produces the same or fewer nodes than the breadth-first search, when the depth of the search is equal to the depth of the goal node. An example of the efficiency of the limited depth-first search is shown in figure 11a, where the breadth-first search (indicated in color) has produced more nodes. In figure 11b, the two types of searches produce an equal number of nodes, using the same partial tree but a different goal node. The breadth-first search must always expand the entire tree to depth  $n-1$ , whereas the limited version may not, depending on the location of the goal node.



## Take Your Cue From Vista . . .

When it comes to Apples, take your cue from Vista's A800 Eight-Inch Floppy Disk Controller. The A800 offers a cost-efficient approach to software compatible disk memory expansion for your Apple II® computer. The A800 Controller enables Apple II users to access up to five megabytes of online storage through conventional disk operating (DOS) commands.

The Control and DMA Logic provides high speed (1 microsecond per byte) transfer of data from the disk drive directly to the Apple II memory without processor intervention. Plus, the Phase-Locked Loop Data Separator provides the ultimate in data reliability.

### AND THERE'S MORE.

The controller is compatible with the most popular disk operating systems for the

## It's a Sure Shot.

Apple II computer. It also interfaces to all Shugart/ANSI Standard Eight-Inch Floppy Disk Drives. The A800 provides complete IBM format compatibility in both single and double-density modes.

### THE HOT SHOT AT A COOL PRICE.

The A800 is reasonably priced at \$595. A price you can't beat when you compare its quality and performance.

### CALL YOUR SHOTS.

Vista offers you a complete line of peripheral equipment to maximize the capabilities of your Apple system including: High capacity Mini-floppy Disk Drives, the Vista Music Machine 9 and the Vista Model 150 Type Ahead Buffer. In addition, Vista offers a line of advanced components fully compatible with the TRS-80\* and S-100 based computers.



**Vista** Computer Company  
1317 E. Edinger Avenue  
Santa Ana, CA 92705  
(714) 953-0523

Call Toll Free 800-854-8017

© Apple II is a registered trademark of Apple Computers, Inc.  
\* TRS-80 is a trademark of Radio Shack, A Tandy Co.

# NEW STATE-OF-THE-ART SS16K/IEEE 16K STATIC RAM BOARD

ONLY \$179<sup>95</sup>

Expand your system beyond 64K — add universal bank select option for only \$20.00

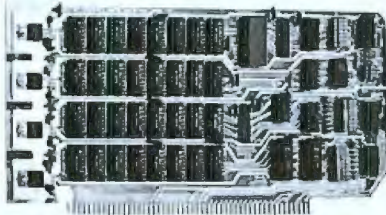

## New: SS16K/IEEE RAM

It's everything you need in a 16K static RAM board — at the lowest price you've ever seen. The SS16K/IEEE comes with all the high performance features listed below. And unlike obsolete-design RAM's (without bank select) you can add-on our universal software bank-selector system anytime, now just \$20.00. This makes the SS16K/IEEE capable of addressing 2,048 different banks. You can add memory beyond the 64K limit. You can expand to a multi-terminal system.

### FEATURES OF SS16K/IEEE :

- Low-power 2114's
- All inputs and outputs meet the proposed IEEE standards for the S100 bus.
- 4.0 MHz operation.
- Schmitt trigger buffer on all signals for maximum noise reduction.
- Addressable on 16K boundaries, 0-64K, dip switch selectable.
- Phantom option, dip switch selectable.
- PWR/MWRITE option, dip switch selectable.
- Glass epoxy PC board with gold-plated contacts and double-sided solder mask.
- Fully socketed.
- Four separate regulators, for maximum stability.

WITH BANK SELECT OPTION (now just \$20.00)  
YOU ADD THIS:

- Software bank selector featuring a universal decoder works with Cromenco, Alpha Micro, Netronics, most other systems, or your design. On-board dip switches: Bank Select Enable, Reset Enable, Reset Disable, Port Address, Port Data.
- LED Indicator to display status.

**10-DAY MONEY-BACK TRIAL:** Try a fully wired and tested board for 10 days — then either keep it, return it for kit, or simply return it in working condition.

Continental U.S.A. Credit Card Buyers Outside Connecticut  
TO ORDER CALL TOLL FREE 800-243-7428

From Connecticut or For Assistance:  
(203) 354-9375

Please send the items checked below:

SS16K/IEEE without bank select:

- Kit ..... \$179.95\*
- Fully assembled, wire & tested ..... \$199.95\*

SS16K/IEEE with bank select:

- Kit ..... \$199.95\*
- Fully assembled, wired & tested ..... \$229.95\*
- SS16K/IEEE bank select option ..... \$20.00\*

\*Plus \$2 postage & insurance (\$5.00 Canada). Connecticut residents add sales tax.

Total enclosed: \$ \_\_\_\_\_

- Personal Check  Money Order or Cashier's Check
- VISA  Master Card (Bank No. \_\_\_\_\_)

Acct. No. \_\_\_\_\_ Exp. Date \_\_\_\_\_

Signature \_\_\_\_\_  
Print Name \_\_\_\_\_

Address \_\_\_\_\_

City \_\_\_\_\_

State \_\_\_\_\_ Zip \_\_\_\_\_

**NETRONICS R&D Ltd.**  
333 Litchfield Road, New Milford, CT 06776

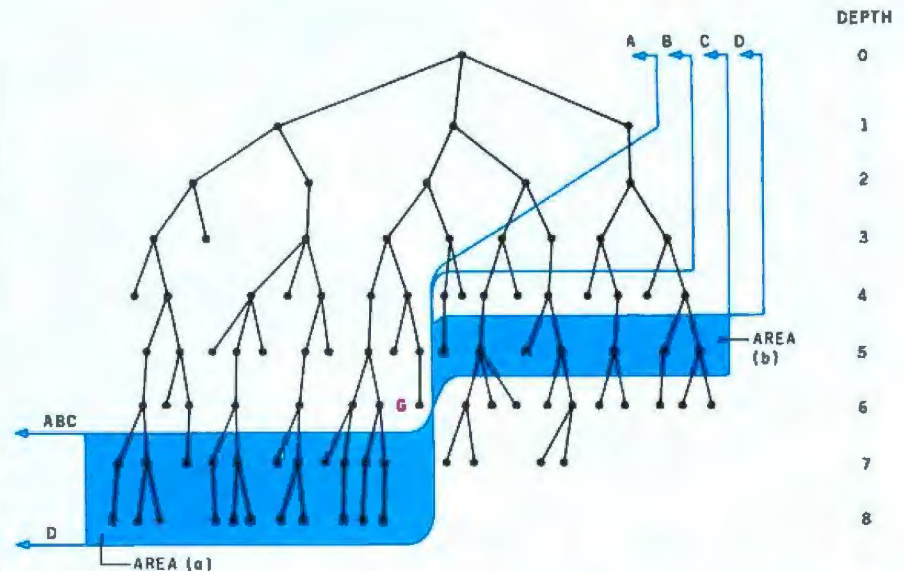

Figure 12: A comparison of four exhaustive searches. Given the partial tree with goal node on level six, the four lines A, B, C, and D delineate the nodes expanded by the following searches:

- A limited depth-first search, with  $n=s=6$
- B limited depth-first search, with  $s$  an even multiple of  $n$  ( $s=6, n=3$ )
- C breadth-first search
- D limited depth-first search with  $s$  not an even multiple of  $n$  ( $s=6, n=4$ )

The worst case for the limited depth-first search, given by D, expands more or fewer nodes than the breadth-first search, C, depending on whether area a or area b has more nodes.

moves in the problem solution ( $n > s$ ), the number of nodes expanded increases with the difference between the two (see the results of table 3b).

• When the depth of the search is less than the number of moves in the solution ( $n < s$ ), two cases occur. If  $s$  is a multiple of  $n$ , the efficiency of the search is between that of a breadth-first search and a limited-depth search with  $n = s$  (as illustrated in figure 12). If, however,  $s$  is not a multiple of  $n$ , the result is mixed. The depth-first search will go several levels deeper than the level of the solution and may be better or worse than a breadth-first search depending on the number of nodes expanded past level  $s$  and the number of nodes expanded in the breadth-first search that are not expanded in the limited depth-first search (see figure 12).

• (Question 5) A depth of one ( $n = 1$ ) gives a special case of the limited depth-first search. What is another name for this search?

## Conclusions

We've covered quite a bit of

material in this article, including an introduction to tree- and graph-searching terminology, a definition of the finite-state representation of a problem, the general-purpose search algorithm implemented in the BASIC program SEARCH, and three exhaustive-search algorithms. In most cases, a breadth-first search is the best of the three, but in some cases it can be improved upon by the limited depth-first search.

Part 2 will deal with heuristic algorithms that estimate the "worth" of a given node in order to arrive at a guaranteed solution without performing an exhaustive search. ■

## References

1. Nilsson, Nils J. *Problem-Solving Methods in Artificial Intelligence*. New York: McGraw-Hill, 1971. An excellent book on all aspects of this subject as well as the related topics of problem reduction, theorem-proving, and the searching of game trees.
2. Winston, Patrick Henry. *Artificial Intelligence*. Reading MA: Addison-Wesley, 1977. A good overview of artificial intelligence with one section devoted to tree searching.

# OSBORNE'S LATEST HITS

6 Brand New Books from Osborne/McGraw Hill

## Interfacing to S-100 (IEEE 696) Microcomputers

by Sol Libes and Mark Garetz

This book assists S-100 users in expanding the power and utility of their systems. It describes the S-100 bus with unmatched precision and detail. Various chapters describe its mechanical and functional design, logical and electrical relationships, bus interconnections, and bussing techniques. Both parallel and serial interfacing are described as well as interfacing to RAM, ROM, and the real world. Additional chapters discuss D/A and A/D conversion, interrupts, timers, and direct memory access.

#37-3 \$15

## Microprocessors for Measurement and Control

by D.M. Auslander and P. Sagues

Learn to design mechanical and process equipment which use microprocessor based "real time" computer systems. This book shows you how, and, using case studies, builds and explores problems of increasing complexity. The book presents plans for prototype systems, allowing readers (even those unfamiliar with machine or assembly language) to initiate projects and carry them through to completion.

#57-8 \$15.99

## Science and Engineering BASIC Programs

edited by John Heilborn

50 programs with a wide range of scientific and engineering applications - Clearly documented and easily adapted for any popular microcomputer - This book is an indispensable tool for any scientist, engineer or student. Included are programs for interpolation, regression, data analysis, roots of polynomials, matrix operations, and linear equations. You'll also find programs for eigenvalues and eigenvectors, differential equations, Fourier analysis, Structural analysis, thermodynamics, and many others.

#63-2 \$15.99

## CBASIC™ User's Guide

by Gordon Eubanks, Adam Osborne, and Martin McNiff

The CBASIC language may be the most advanced version of BASIC yet created. Like Pascal, CBASIC requires no line numbers and lends itself to highly organized, structured programs—programs that are readable, modular, and easier to change. CBASIC is as easy to learn as BASIC and contains convenient file handling facilities, making it very useful for many business applications. It may be the only computer language you'll ever need to learn. This guide was co-authored by Gordon Eubanks, the creator of CBASIC. It is not only a self-teaching textbook, it is the definitive reference on the CBASIC language.

#61-6 \$15

## ATARI™

### Some Common BASIC Programs

### TRS-80™ level II

### Some Common BASIC Programs

Two new editions of Osborne's celebrated collection of 76 useful and informative programs in Math, Finance, and Statistics. These programs will transform your Atari 400 or 800 or your TRS-80 computer from a plaything into a real workhorse. The programs are clearly documented to serve as a valuable instructional aid in learning BASIC.

ATARI version: #53-5 \$14.99

TRS-80 level II version: #54-3 \$14.99

Make check payable to:  **OSBORNE/McGraw-Hill**  
630 Bancroft Way, Berkeley, CA 94710 Dept. B19

Phone: (415) 548-2805

TOLL FREE: 800-227-2895 Outside California



Name \_\_\_\_\_

Address \_\_\_\_\_

City/State/Zip \_\_\_\_\_

Plus  .75/item 4th class  \$1.50/item UPS  \$2.50/item Air Mail  \$10.00/Overseas (California Residents add applicable tax.)  
 Please send me your free catalog.

Total amount enclosed \$ \_\_\_\_\_ or charge my  Visa  Mastercharge Card # \_\_\_\_\_ Expiration Date \_\_\_\_\_

Signature \_\_\_\_\_

# Book Review

## Turtle Geometry

by Harold Abelson and Andrea A diSessa  
MIT Press,  
Cambridge MA, 1981,  
478 pages, \$20.00

Reviewed by  
W Lloyd Milligan  
8604 Maywood Dr  
Columbia SC 29209

Imagine four turtles, each sitting at one corner of a square. At the same moment, each turtle begins to crawl in a clockwise direction toward its nearest neighbor. They continue crawling at the same speed toward one another until they meet. How long is the path traveled by each turtle?

The solution to this well-known problem—that the path equals an edge of the square—is reached most easily by working from the turtle's point of view. A turtle is a small creature that inhabits a computer's graphic-display screen. It has the ability to move forward or backward a specified distance and to turn in place clockwise or counterclockwise through a given angle. Distances and angles are arguments in turtle commands. Just as straight-edge and compass are the basic tools of traditional geometry, so the turtle is the implement of turtle geometry.

*Turtle Geometry*, by Harold Abelson and Andrea A diSessa, discusses using the computer to explore mathematics. The authors make a persuasive case for their idea that compared with traditional methods, the computational approach encourages mathematical exploration at an earlier stage of learning.

The turtle leads the learner on quite a different mathematical journey than does

traditional geometry. The earliest ideas presented in this book later are found to bear important relationships to topological concepts. We first learn of the distinction between *intrinsic* and *extrinsic* properties—intrinsic properties are those that do not require a frame of reference for their expression. A second important distinction concerns *local* versus *global* representations. Circles are constructed locally, meaning that the turtle does not know about the rest of the plane when making a small piece of a circle. Many of the turtle's constructions are both intrinsic and local.

Remember that the turtle can turn in place through any specified angle. If he keeps track of his turning by adding all clockwise turns and subtracting all counterclockwise turns, he immediately discovers the *Closed-Path theorem*:

The total turning along any closed path is an integer multiple of 360 degrees.

The approach of turtle geometry is empirical. You obtain a result like the Closed-Path theorem, then try to improve it, exploring its consequences for various kinds of paths. Before long you have made a new discovery, perhaps in a different branch of mathematics. It is a tribute to the richness of turtle geometry that by the end of the first chapter you are studying the Euler  $\phi$  function and Fermat's "Little" theorem, both number-theoretic ideas.

Because the turtle is an animal, it is only natural to explore turtle movement as behavior in response to controlling stimuli. Much can be learned by programming the turtle to model various types

of forced movement, such as movement toward or away from stimulation. (For explanations of forced movement, see *Orientation in Animals* by G Fraenkel and D Gunn, Dover, 1961.) You can even set up experiments in which the turtle is responding to information from more than one sense simultaneously.

The turtle can be used for modeling patterns of growth found in nature. The principle of uniform growth leads to the shape of an equiangular (logarithmic) spiral. Many other fascinating designs, such as the spiral shapes found in seashells, arise from invoking simple turtle procedures recursively. (See *On Growth and Form*, by D Thompson, Cambridge University Press, 1961.)

The book provides a painless introduction to vector methods. The brief excursion into linear algebra is the book's only "corruption" (by Cartesian analytic geometry) of turtle geometry, and it is both appropriate and worthwhile. You learn here how to represent three-dimensional objects in two dimensions. Parallel projection is presented first, then perspective projection. Anyone who appreciates arcade games or is interested in their design will find this chapter enlightening. The geometric bases of changing perspec-

tive, zooming, and the like are explained.

Any computer with good graphics may be used to implement turtle geometry. (A commercial version is available for the Apple.) A well-structured language such as Pascal is desirable, but not essential, to implement the turtle routines.

Inevitably, the turtle escapes from the plane. Turtle spherical geometry is the first nonplanar generalization. A beautiful local definition of *geodesic* is developed:

A turtle line is an equal-strided turtle walk.

Equal-strided means the turtle's left and right sides move equally. The beauty of this definition is that it applies to any surface. Remember, the total turning around a closed path is an integer multiple of 360°. As it turns out, the turtle can execute a closed path on nonplanar surfaces with a net 360° change in heading, but a total turning *not* equal to 360°. The discrepancy can be detected *intrinsically*. The concept, called *angle-excess*, gives rise to the important property called *curvature*. Further exploration brings us to the domain of topology, where we encounter theorems such as, "Any one-holed torus (doughnut-shaped surface) has zero total curvature."

### Articles Policy

BYTE is continually seeking quality manuscripts written by individuals who are applying personal computer systems, designing such systems, or who have knowledge which will prove useful to our readers. For a more formal description of procedures and requirements, potential authors should send a large (9 by 12 inch, 30.5 by 22.8 cm), self-addressed envelope, with 28 cents US postage affixed, to BYTE Author's Guide, POB 372, Hancock NH 03449.

Articles which are accepted are purchased with a rate of up to \$50 per magazine page, based on technical quality and suitability for BYTE's readership. Each month, the authors of the two leading articles in the reader poll (BYTE's Ongoing Monitor Box or "BOMB") are presented with bonus checks of \$100 and \$50. Unsolicited materials should be accompanied by full name and address, as well as return postage.

# We're our own **BEST** **CUSTOMER!**



When we designed a line of business systems for eye care professionals, we set the same high standards that established our reputation in the field of sophisticated, computerized visual field testing equipment. Our customers *expect* functional design, precision engineering, and quality components—so when we encountered problems with floppy disk quality and availability, it was natural that we put our *own* manufacturing expertise to work in solving the problem. SYNEMED FD4 8" dual-sided, dual-density floppy disks are superior to *any* we could buy—and too good to keep to ourselves! Available for *immediate* delivery from stock and competitively priced, the FD4 offers RX01/02\* compatible, two-megabyte floppy disk capacity for the LSI-11\* Q-BUS\*

- Long disk life achieved by air-damped head loading
- High reliability NEC drives
- Single or double sided, single or double density, all transparent to your software
- Patches for RT-11\* DY handler enable full 1962 block capacity per disk
- Controller includes additional bootstraps for RL01/2\* and RK05\*
- Standard size—simply plug into existing equipment

Mail the coupon today for more information on the SYNEMED solution to *your* floppy disk problems.



**Synemed, Inc.**

1215 Fourth Street Berkeley, California 94710  
415/526-5330

\*Trademark of Digital Equipment Corp.

- Please send me more information on the FD4.
- Please have your representative contact me.

Name \_\_\_\_\_

Street \_\_\_\_\_ City \_\_\_\_\_

State \_\_\_\_\_ Zip \_\_\_\_\_ Tel. No. \_\_\_\_\_

## Book Review

Any surface in three dimensions can be deformed into a piecewise-flat surface. Piecewise-flat means, simply, that the surface is made of flat pieces joined at the edges. If the edges are straight, then all of the curvature is concentrated in the vertices. Piecewise-flat surfaces are easily represented in a computer program by an atlas which specifies all matching edge pairs by their face and edge numbers. Since a piecewise-flat deformation preserves all the topological properties of a surface, these properties can be studied as

they are exhibited in this special case. For example, an important theorem, Gauss-Bonnet, states that the total curvature of any closed surface is:

$$2\pi(V - E + F)$$

where  $V$  is the number of vertices,  $E$  the number of edges, and  $F$  the number of faces.

The turtle's wanderings take him, finally, to the domain of curved space and general relativity theory. Gravity as a property of geometry is presented in a parable about a turtle who

lives near the north pole of a sphere. He constructs a two-dimensional Euclidean model of his experience. Inevitably, the turtle encounters various strange problems with his model. He eventually overcomes his difficulties by postulating a force which acts everywhere locally. The force is called "demon-turning."

Traditionally, mathematics has shunned the computational approach. The main thesis of Abelson and diSessa's book is that experimentation using a computer stimulates mathe-

matical discovery. The thesis is certainly true of turtle geometry, and one suspects it applies to many other areas of mathematics. Reading this book with the help of a good graphics computer system, you are sure to discover new and interesting math. *Turtle Geometry* is a serious effort to blend the computer with mathematics. It would serve as an excellent textbook or self-study guide. Perhaps it will also serve as a model for other efforts to bring the computer and mathematics to fruitful collaboration. ■

## BYTE's Bugs

### Corrected Price

In the June 1981 BYTE, Axlon Inc's 8-slot bus expansion board was incorrectly priced. (See page 420.) The board costs \$895. The company has also released new pricing on the RAMCRAM memory module. It now costs \$225.

### Blasted Bugs

In the August 1981 BYTE "Software Received," the price for Budgenco's Raster Blaster was incorrectly listed. The correct price is \$29.95.

We apologize for the mistake.

### Super Simple Bug

An integrated circuit was incorrectly labeled in James Nicholson and Roger Camp's article "Build a Super Simple Floppy-Disk Interface, Part 1." (See the May 1981 BYTE, page 360.)

In Figure 4b on page 372, IC9 should be numbered

74193. The pin numbers are correct as shown.

### Color PEEKs

Stan Miastkowski's article "Extended Color BASIC for the TRS-80 Computer" has been the focus of much attention. (See the May 1981 BYTE, page 36.) It seems that the system does indeed include a PEEK function, contrary to what was previously printed. The author replies:

*I admit that I goofed. For BYTE to run an article on Extended Color BASIC at about the time it became widely available in Radio Shack stores, the company provided me with one of the first production models and a rough draft of the documentation. The rough manual had a list of differences, one of which showed that PEEK was not available in the nonextended model of the TRS-80 Color Computer. It was, however, available by the time the manual reached its final stages, but that was too late for inclusion in the article.*

### Last One Out

In John Sauter's article "Faster BASIC for the Ohio Scientific" (May 1981 BYTE, page 236), an error was discovered in listing 3 on page 240. The last line, an "TNY", should be omitted—it is not part of the "ROR A" macro.

For those using Microsoft's KIM or TIM BASIC, the new

code would be as shown in listing 1.

Another bug was found when using the 5-inch disk version. The code to be patched is on track 04, not 03 as published. Also, when using smaller disks, the top memory should be set at hexadecimal 4200 as opposed to hexadecimal 47FF for the larger 8-inch disks. ■

### Listing 1

\$37C2	80 18	BCS	\$37DC
\$37D1	76 02	ROR	\$02,X
\$37D3	76 03	ROR	\$03,X
\$37D5	76 04	ROR	\$04,X
\$37D7	68	BLA	
\$37D8	6A	ROR	A
\$37D9	C8	INY	
\$37DA	D0 E8	BNE	\$37C4
\$37DC	18	CLC	
\$37DD	60	RTS	

(\$37DE through \$3801 now unused)

\$38C3	66 73	ROR	\$73
\$38C5	66 74	ROR	\$74
\$38C7	66 75	ROR	\$75
\$38C9	66 76	ROR	\$76
\$38CB	66 BD	ROR	\$BD
\$38CD	98	TYA	
\$38CE	4A	LSR	
\$38DF	D0 D6	BNE	\$38A7
\$38D1	60	RTS	

(\$38D2 through \$3903 now unused)





## Turn your Apple into the world's most versatile personal computer.

**The SoftCard™ Solution.** SoftCard turns your Apple into two computers. A Z-80 and a 6502. By adding a Z-80 microprocessor and CP/M to your Apple, SoftCard turns your Apple into a CP/M based machine. That means you can access the single largest body of microcomputer software in existence. Two computers in one. And, the advantages of both.

**Plug and go.** The SoftCard system starts with a Z-80 based circuit card. Just plug it into any slot (except 0) of your Apple. No modifications required. SoftCard supports most of your Apple peripherals, and, in 6502-mode, your Apple is still your Apple.

**CP/M for your Apple.** You get CP/M on disk with the SoftCard package. It's a powerful and simple-to-use operating system. It supports more software than any other microcomputer operating system. And that's the key to the versatility of the SoftCard/Apple.

**BASIC included.** A powerful tool, BASIC-80 is included in the SoftCard package. Running under CP/M, ANSI Standard BASIC-80 is the most powerful microcomputer BASIC available. It includes extensive disk I/O statements, error trapping, integer variables, 16-digit precision, extensive EDIT commands and string functions, high and low-res Apple graphics, PRINT USING, CHAIN and COMMON, plus many additional commands. And, it's a BASIC you can compile with Microsoft's BASIC Compiler.

**More languages.** With SoftCard and CP/M, you can add Microsoft's ANSI Standard COBOL, and FORTRAN, or

Basic Compiler and Assembly Language Development System. All, more powerful tools for your Apple.

**Seeing is believing.** See the SoftCard in operation at your Microsoft or Apple dealer. We think you'll agree that the SoftCard turns your Apple into the world's most versatile personal computer.

**Complete information?** It's at your dealer's now. Or, we'll send it to you and include a dealer list. Write us. Call us. Or, circle the reader service card number below.

SoftCard is a trademark of Microsoft. Apple II and Apple II Plus are registered trademarks of Apple Computer. Z-80 is a registered trademark of Zilog, Inc. CP/M is a registered trademark of Digital Research, Inc.

# MICROSOFT

CONSUMER PRODUCTS

Microsoft Consumer Products, 400 108th Ave. N.E.,  
Bellevue, WA 98004. (206) 454-1315



Photo 1: *Advanced TIROS-Class Weather Satellite. Used in military and civilian versions, the TIROS satellites have two on-board computers.*

# One Step Forward— Three Steps Backup

## Computing in the US Space Program

A special tension surrounds the development of a computer system for use as the main computer aboard a spacecraft. On one hand, such a computer must be able to perform complex operations. On the other, since the first extraterrestrial service call by a field engineer is yet to be made, an on-board computer system must do its work with absolute reliability despite the most demanding environmental conditions. And by the time a computer's reliability has been proved beyond a doubt, more efficient computers have appeared on the market. It's almost as if the same process that proves a computer's reliabil-

---

Patrick Stakem  
c/o Interface Technology  
POB 745  
College Park MD 20740  
(301) 490-3608

---

ity also ensures that the computer will be obsolete before it flies. Developing a main on-board computer is both a battle to prevent a catastrophic failure and a race against obsolescence.

The advent of the space shuttle (known more formally as the Space Transportation System) will soon enhance the requirement for reliability

on orbital missions. Moreover, the shirt-sleeve environment of Spacelab will prove an opportunity to use off-the-shelf microprocessor systems to support scientific experiments. But *space-rating*—establishing the fitness of hardware for use aboard a spacecraft—will remain a severe test, especially for computers that control life-critical and mission-critical systems.

In this article, I'll first discuss the requirements of space-rating. Then I'll describe the tasks that a main on-board computer must perform and some of the capabilities needed to perform those tasks. I'll go on to discuss the problems of providing

# 64K Static RAM

available now from stock

#### Ultra Fast - 100 nsec. chips

Fast access allows memory management manipulation without wait states.

#### 8/16 - 8 or 16-bits wide

Dynamically switches data path width per IEEE Standard.

#### Low Power

Typical power consumption less than 2 amps for active board. Less for power down boards.

#### Extended Addressing

24-bit IEEE addressing allows 16-megabyte range. Single shunt changes to 16-bit addressing.

#### Fully Static

No clocks, no refresh required for easy DMA use.

#### Special Features

Any 4K block can be disabled. Or, can disable everything above or below any 4K boundary. Available in 16K increments for OEM quantities.

# \$1,295

100 nsec. Chips - Qty. 1-9

OEM & Dealer prices also available.



#### TO ORDER:

May be ordered through your local computer store or factory direct. Personal checks, CODs, VISA and MC accepted from within USA. 10-day return privilege on factory orders. Shipping paid by SCP on prepaid USA and Canadian orders. All boards fully assembled, guaranteed one year.

 **SEATTLE  
COMPUTER**

1114 Industry Dr. Seattle WA 98188

Information Hotline: 206/575-1830

Send more information: ( ) \_\_\_\_\_

Name \_\_\_\_\_

Company \_\_\_\_\_

Address \_\_\_\_\_

City \_\_\_\_\_ State \_\_\_\_\_ Zip \_\_\_\_\_

ground support for on-board software.

After a glance at the historical development of on-board computers, I'll look at some devices now in use. Finally, I'll describe applications of microprocessors in noncritical functions aboard spacecraft. (Yes, there will soon be an Apple in orbit.) Throughout the article, I will confine my comments to civilian spacecraft of the United States.

### Space-Rating

Equipment and software that must operate for long periods unattended in the difficult environment of space must be very reliable. Space-rating is the process that demonstrates the reliability of equipment for use on spacecraft. The process requires careful testing of parts, components, assemblies, modules, and software. Space-rating standards are stricter than specifications for military equipment.

Here are a few of the things that a main on-board computer in the mid-1980s must be able to do:

- withstand repeated heating and cooling from +50° Celsius to -10° Celsius
- function despite exposure to mechanical shocks, electromagnetic disturbances, high-energy particles, and radiation
- withstand forces from 0 to 30 gravities
- perform calculations on the level of evaluating 1300 long time-series polynomials per second to 32 bits of precision
- undergo intensive use for periods of several years without experiencing a single failure

Although space-rating standards of reliability are always stringent, they depend to some extent on the kind of mission for which the spacecraft is intended.

### Mission Classes

Missions usually fall into one of three classes: *manned missions*,

*planetary-probe missions*, and *unmanned earth-orbiting missions*.

Manned missions require the highest standards of reliability. When an astronaut's life is at stake, there is no room for failure. This principle is reflected in the record of the Apollo program: as a result of 2000 man-years of development and testing, there were no flight-critical errors of spacecraft software (see reference 8).

The most common way to establish reliability in spacecraft equipment is to build in redundancy. The Shuttle Orbiter vehicle, for example, has five general-purpose computer systems to control all aspects of its operation. In

of a rule that the Shuttle Orbiter will not be allowed to approach "dead" spacecraft. Unless telemetry indicates that an unmanned satellite still has effective attitude-control and a certain level of stability, the Orbiter crew (and the extremely expensive Orbiter itself) will not be committed to approach the satellite. In addition, any satellite intended for launch as a shuttle payload must pass the same stringent requirements as a manned spacecraft.

Although no lives are at stake in their use, planetary-probe spacecraft also impose stringent requirements on on-board computer systems. The long



Photo 2: Shuttle Orbiter mounted on transport aircraft. The Orbiter has five on-board computer systems, configured to provide as many as three levels of backup in critical situations. Two chase planes are visible.

certain critical operations, four of the five systems will perform the same task, providing three levels of backup.

More recently, concern for the lives of astronauts has led to the adoption

flight times to distant targets, the hostile environments traversed, and the impossibility of retrieval or repair all increase the demands placed on equipment. Planetary-probe spacecraft are very much on their own.



## THE NEW FLIP/FLOPPY™ DISK with twice the byte

OMNI is pleased to bring you a **reversible** 5¼" mini diskette...the FLIP/FLOPPY DISK. Now you can record on both sides for twice the storage capacity of a single sided disk. And you'll be able to do it far more economically, too!

Each OMNI FLIP/FLOPPY DISK incorporates all of the quality features you'd expect from the very best single sided disk.



- Two recording surfaces
- Two sets of WRITE ENABLE notches
- Two index holes
- Reinforced **HUB RINGS**
- Certified error-free operation at more than twice the error threshold of disk drives
- Over 12 million rated passes without disk related errors or significant wear, for extra long life operation
- Available in Soft or Hard sector
- Compatible with most 5¼" disk drives including APPLE, TRS-80, PET, OHIO SCIENTIFIC, ZENITH, NORTH STAR, and many more.

### OMNI Resources

4 Oak Pond Avenue • Millbury, MA 01527 • 617-799-0197

Call TOLL-FREE: In Mass. 1-800-252-8770  
Nationwide 1-800-343-7620

## INTRODUCTORY OFFER

Order the OMNI FLIP/FLOPPY DISK at this special introductory price:

**Five Pack...\$21.00**

Equivalent to ten single-sided disks.

**Ten Pack....\$40.00**

Equivalent to twenty single-sided disks.

Please send me the following OMNI FLIP/FLOPPY DISK(s)

\_\_\_\_\_ Five Pack(s) @ \$21.00 each = \$ \_\_\_\_\_  
 \_\_\_\_\_ Ten Pack(s) @ \$40.00 each = \$ \_\_\_\_\_  
 \_\_\_\_\_ Library Case(s) @ \$3.00 each = \$ \_\_\_\_\_  
 Shipping and handling \$ 1.50  
 TOTAL \$ \_\_\_\_\_

- Check made payable to OMNI RESOURCES     C.O.D.  
 Mastercard  
 Account Number \_\_\_\_\_  
 VISA/BankAmericard  
 Account Number \_\_\_\_\_  
 Credit Card Expiration Date \_\_\_/\_\_\_

Name \_\_\_\_\_

Address \_\_\_\_\_

City \_\_\_\_\_

State \_\_\_\_\_ Zip \_\_\_\_\_

Phone Number (\_\_\_\_) \_\_\_\_\_

Authorized Signature \_\_\_\_\_

Massachusetts residents add 5% sales tax

Money back guarantee if not completely satisfied

The distance between spacecraft and earth is often so great that radio signals require long periods to travel between the two. When the target is one of the outer planets, communication may take more than a half hour each way. By the time the ground station receives a message indicating a problem aboard the spacecraft, too little time may remain to send messages intended to correct the problem. The design requirements for computer systems aboard planetary-

probe spacecraft are perhaps an order of magnitude beyond those for systems aboard spacecraft operating near earth.

Most spacecraft carry out unmanned earth-orbiting missions. These missions may have either near-earth orbits or synchronous-altitude orbits. Spacecraft can remain synchronous with the rotation of the earth only by orbiting at extremely high altitudes. Since the Shuttle Orbiter can't deploy or retrieve space-

craft so far from earth, synchronous-altitude spacecraft must be built to function without service for the duration of their missions.

A spacecraft at synchronous altitude appears to remain stationary above one point on the earth's equator. Consequently, a ground station can stay in continuous communication with such a spacecraft. In this respect, spacecraft at synchronous altitude are easier to manage from the ground.

Satellites orbiting the earth at lower altitudes appear to "rise" and "set" over the ground station. A typical orbit takes about 90 minutes, and the spacecraft is in view of a given tracking station for only 10 minutes of the 90. The ground station must pack a great deal of communication into the 10 minutes of contact. During those 10 minutes, the ground station has to send up enough commands for the next 80 minutes of operations, check the state of all on-board systems, take any necessary corrective action, and dump recorded data from the satellite to the ground over a high-speed channel.

During the 80 minutes when the satellite is out of touch with the ground, the on-board computer must sequence and monitor spacecraft operations and components and store messages about the status of monitored equipment. In case of problems, the on-board computer must take first-order corrective action. Even with the advent in the early 1980s of NASA's tracking station in the sky—the synchronous-altitude Tracking and Data Relay Satellite System (TDRSS)—full coverage of satellites in near-earth orbits will not be assured because so many satellites will share use of TDRSS.

### Space-Rating Microprocessors

Microprocessors, memories, and interface devices aboard spacecraft must operate in a vacuum over a wide temperature range. The vacuum restricts cooling to radiation and conduction; since no atmosphere is present, convection is impossible. Besides the limitations on cooling, equipment

## THE NEW OMR 500 SEES THE LIGHT

**An Optical Version of our MR 500 Makes it Even Easier to Enter Data into Your Microcomputer**



### No Special Pencils Needed

Now you can read punched holes, preprinted data, or pencil marks on standard OMR cards. All with the incredibly compact OMR 500 optical card reader.

Using state-of-the-art fiber optics to "read" each card, a single long-lasting bulb does the job. Reliably and accurately.

### Simple, Fast, and Low-Cost

The OMR 500 is a low-cost alternate to keyboard data entry. And at less than 1/2 second per handled card, you won't be sacrificing speed.

Compact and lightweight, our new optic reader is a mere 4-lb., 4-1/2 inch cube. Automatic turn-on is standard.

**Wide Variety of Interfaces**  
The reader is available with in-

telligent interfaces to Apple, TRS-80, PET and Atari that simplify user software requirements. Also available are RS-232 and S100 interfaces.

### Lighting the Way

At \$1095, including the intelligent interface, the OMR 500 truly adds an affordable new dimension to card reader flexibility. Its uses are virtually unlimited. Small business, the entire educational field, personal computers — wherever data entry is required.

And remember, we still offer the industry's largest selection of card readers. So whatever your needs, we've got the right card reader for you.

Write or phone for complete details. Better yet, put in your order today.

**CHATSWORTH DATA CORPORATION**

20710 Lassen Street Chatsworth, California 91311 Phone: (213) 341-9200

# COMPUTER WAREHOUSE

CALL TOLL FREE **1-800-528-1054**

## ATARI

Special 32K 800 System 800 w/32K, recorder, star raiders, joysticks	<b>\$930</b>
Above w/48K	<b>\$990</b>
800 (32K)	<b>\$744</b>
810 Disk Drive	<b>\$440</b>
825 Printer	<b>\$575</b>
850 Interface	<b>\$155</b>
410 Recorder	<b>\$70</b>
830 Modem	<b>\$140</b>
16K Memory	<b>\$75</b>
32K Memory	<b>\$150</b>

## DISK DRIVES

Lobo	
Apple 1st Drive	<b>\$490</b>
Apple 2nd Drive	<b>\$410</b>

## MODEMS

Novation	
CAT	<b>\$155</b>
D-CAT	<b>\$155</b>
Apple Cat II	<b>Call</b>
Auto Cat	<b>Call</b>

## PRINTERS

C. Itoh	
25CPS - Serial	<b>\$1380</b>
25CPS - Parallel	<b>\$1325</b>
40CPS - Serial	<b>\$1825</b>
45CPS - Parallel	<b>\$1710</b>

Datasouth	
DS 180	<b>\$1275</b>

Diablo	
630 RO	
w/Tractors	<b>\$2295</b>
630 RO	
wo/Tractors	<b>\$2100</b>
1640 RO	
w/Tractors	<b>\$2485</b>
1640 KSR	
w/Tractors	<b>\$2740</b>
1650 RO	
w/Tractors	<b>\$2985</b>
1650 KSR	
w/Tractors	<b>\$2885</b>

Epson	
MX-80	<b>Call</b>
MX-80 F/T	<b>Call</b>
MX-100	<b>Call</b>
Fric. Feed Opt. for MX-80	<b>\$50</b>

NEC	
5510 RO	
w/Tractors	<b>\$2662</b>
5520 KSR	
w/Tractors	<b>\$2995</b>

Okidata	
Microline 80	<b>\$375</b>
Microline 82	<b>\$515</b>
Microline 83	<b>\$755</b>

Qantex	
Serial	<b>\$1150</b>
Parallel	<b>\$1125</b>

Texas Instruments	
810 Basic	<b>\$1480</b>
810 Loaded	<b>\$1739</b>

**Novation**  
**ATARI**  
**ZENITH data systems**  
**NorthStar**  
**SOROC TECHNOLOGY, INC.**  
**TeleVideo**  
**3M**  
**TEXAS INSTRUMENTS**  
**EPSON**  
 EPSON AMERICA, INC.  
**OKIDATA**  
**California Computer Systems**

## VIDEO TERMINALS

Adds	
Viewpoint	<b>Call</b>
Soroc	
IQ 120	<b>Call</b>
IQ 130	<b>Call</b>
IQ 135	<b>Call</b>
IQ 140	<b>Call</b>
Televideo	
910 C	<b>\$589</b>
912 C	<b>\$694</b>
920 C	<b>\$744</b>
950 C	<b>\$935</b>
Zenith	
Z-19	<b>\$769</b>

## COMPUTERS

Altos	
ACS 8000-15	<b>\$4500</b>
ACS 8000-2 w/CPM	<b>\$2695</b>
Northstar	
Horizon II 64K DD	<b>\$2875</b>
Horizon II 64K QD	<b>\$3150</b>
Zenith	
Z-89 48Kw/CPM	<b>\$2200</b>

## SOFTWARE

CBasic	<b>Call</b>
CP/M	<b>Call</b>
MP/M for Northstar	<b>Call</b>

## DISKETTS

Scotch	
5 1/4" 0, 10, 16 Sector (Qty 100)	<b>\$250</b>
8" 0, 32 Sector (Qty 100)	<b>\$260</b>

## MONITORS

Panasonic	
9" B&W	<b>\$150</b>
Sanyo	
9" B&W	<b>\$150</b>
12" Green	<b>\$240</b>

## CALIFORNIA COMPUTER SYSTEMS

64K Dynamic Memory	<b>\$500</b>
16K Static Memory	<b>\$255</b>
Floppy Disk Cont.	<b>\$285</b>
Serial AsynchBoard	<b>\$110</b>

Prices & availability subject to change without notice Personal checks will delay shipping two weeks

**COMPUTER WAREHOUSE**

2222 E. Indian School Rd. • Phoenix, Arizona 85016  
Order Line: 1-800-528-1054

Other Information: 602-954-6109



Store Hours: Tues.-Fri. 10-5 MST Saturday 10-3 MST

Prices reflect 3% cash discount. Product shipped in factory cartons with manufacturers warranty. Add 2%, a minimum of \$5. for shipping and handling.

must be able to withstand a wide temperature variation while dormant. The dormant period includes launch and recovery, during which there is no assurance that the spacecraft can maintain adequate thermal control.

Periodic and random vibration and mechanical shock may also damage electronic equipment during the launch phase. A common failure is breakage of a bonded lead wire where it is attached to the die of an integrated circuit. High inertial gravity (g) loads can cause such breakage. Space components are usually tested in steady-state acceleration in excess of 30 gs. Instantaneous accelerations, such as those undergone by a chip that is dropped onto a solid floor from a height of approximately a meter, can exceed hundreds of gs.

Components of space-borne systems must neither generate electromagnetic disturbances nor be vulnerable to them. The proximity of other electronic devices and of moderate-power transmitters of radio-frequency energy requires resistance to electromagnetic disturbances.

The abundance of radiation and high-energy particles pose another threat to semiconductor devices in space. Although there is a self-healing effect if semiconductors are turned off for a while, periodic failures are unac-

ceptable in mission-critical functions.

Table 1 shows the radiation "hardness" of several microprocessors. In general, radiation damage is cumulative. Microprocessors of commercial grade fail at several thousand rads total dosage. Although it is possible to attempt shielding chips with aluminum paneling, results are not encouraging. Often, when one high-energy particle strikes the aluminum, more than one high-energy particle comes out the other side.

P-type metal-oxide semiconductors (PMOS) are generally less susceptible to radiation damage than are the newer and faster N-type metal-oxide semiconductor (NMOS) devices. Radiation-hardened versions of standard device-families are available, particularly complementary metal-oxide semiconductor (CMOS) devices, which are faster than PMOS but slower than NMOS. This is but one instance of space-borne technology lagging behind current commercial technology.

Perhaps the most serious hurdle that microprocessors must face before becoming main on-board computers is one of sheer computational power. Many of the calculations required of these machines need a word length greater than 16 bits. Until the appearance of 32-bit microprocessors,

less highly integrated devices will retain their monopoly as main on-board computers.

### On-board Computer Tasks

Designers of spacecraft have been relying more and more on on-board computers and associated data systems to give the spacecraft flexibility and autonomy. Tasks assigned to the on-board computer include:

- *Attitude determination.* Orienting the spacecraft in space is a vital and complex function. The spacecraft data system must give the computer data from sun- and star-trackers, earth sensors, and gyros. The attitude-determination algorithm calculates how the spacecraft should be aligned with respect to inertial axes. The attitude-control algorithm then issues commands that enable magnetic thrusters, jet torquers, or reaction wheels to point the spacecraft (ie: align the axes) to a desired point on earth or to a star. Attitude determination and control, sometimes including orbit-adjust software, typically require 4 to 12 K bytes of memory.

- *Command Storage.* The on-board computer can store sequences of commands that are "time-tagged" for later execution. Storage may also include predefined blocks of frequently executed command sequences (macros).

- *Executive.* A real-time, multitasking, interrupt-driven executive is used to sequence all tasks and to handle input/output operations.

- *Housekeeping.* This includes monitoring and controlling thermal and electrical power. These tasks may require continual monitoring and limit-checking of sensors in the spacecraft. Spacecraft housekeeping may also include continuous measurement of the batteries' charge.

- *Telemetry Format Control.* The on-board computer may control the sampling and format of the on-board telemetry points. This makes re-configuration possible in response to degradation and failures. If a prede-

Device	Type	Technology	Suitable Support Circuits	Projected Hardness, in Rads	Power of Basic Processor, in Milliwatts (mW)
RCA 1802*	Monolithic	CMOS	Memories, Some I/O	10 <sup>6</sup>	30
Ti-SBP9900	Monolithic	FL	Memories Only	10 <sup>7</sup>	500
Intersil 6100	Monolithic	CMOS	Memories, Some I/O	10 <sup>6</sup>	50
Intel 8080A	Monolithic	NMOS	Memory, Some I/O	10 <sup>5</sup>	1700
AMD 2900*	Bit Slice	LS-TTL	Memory, All I/O	10 <sup>7</sup>	10,000 (16 bit)
Intel 3000*	Bit Slice	S-TTL	Memory, All I/O	10 <sup>7</sup>	15,000 (18 bit)
NMI 6700	Bit Slice	LS-TTL	Memory, Some I/O	10 <sup>7</sup>	15,000 (16 bit)

\* Multiple sources available.

**Table 1: Comparison of microprocessors for space applications. Included are each processor's radiation "hardness" and its average power consumption.**



# MULTIPROCESSOR PASCAL



## ibs betasystem II

- SIMULTANEOUS Timeshared & Multiprocessor Operation
- FULL UCSD™ PASCAL II Compatibility with IBS™PASCAL, SEMAPHORES, CONCURRENCY, CHAINING, TRUE WORD PROCESSING
- 5, 10, 20, Mbyte FIXED DISK SYSTEMS, 5", 8" FLOPPY DISK SYSTEMS
- TWO Timeshared Users on EACH Slave Processor, plus 128K RAM plus PARITY, 2K EPROM, Full Interrupts, Hardware Floating Point, IEEE S-100, Software Bank Boundary, 2 Serial Ports for Synchronous or Asynchronous Protocol
- VIDEO TAPE ARCHIVING
- CP/M™ Compatibility with MuDOS™
- LARGE DEALER MARGINS and GOOD DEALER SUPPORT

**ibs**

(415) 443-3131

INDEPENDENT BUSINESS SYSTEMS, Inc.  
1328 Concannon Blvd., Livermore, CA 94550

## Interested?

OUR DEALERS: FOREIGN • Philip Baksh, London England, Tel: 44 1 7413707 • EEI, Sharjah, UAR, Tel: 354688 • Eili, Inc., Montreal, Quebec, Tel: (514) 337-3214 • FDM, Madrid, Spain, Tel: 402 24 97 • JH Systems, Etobicoke, Ontario, Canada, Tel: (416) 621-0638 • S.A. Micro Service, Paris, France, Tel: 205 38 71 • Servonic, Munich, West Germany, Tel: 089 483263 • GBK, The Netherlands, Tel: 20-733376 • Terrace Computer Svcs., LTD, Terrace, BC, Tel: (604) 635-7606 • DOMESTIC - CE83, San Jose, CA, Tel: (408) 267-3547 • Donald Coffman, Cupertino, CA, Tel: (408) 253-2327 • ERS, Brea, CA, Tel: (714) 524-2470 • Innovative Interfacs, Berkeley, CA, Tel: (415) 524-8416 • ICE Services, Gaithersburg, Maryland, Tel: (301) 899-2896 • Khalsa Consultants, Cambridge, MA, Tel: (617) 864-3639 • Link Systems, Santa Monica, CA, Tel: (213) 453-1851 • EDS, Frazer, PA, Tel: (215) 296-7300 • Quali-Type, Inc., Livermore, CA, Tel: (415) 447-6121 • SP1, San Diego, CA Tel: (714) 268-4346 • Khalsa International, Herndon, VA, Tel: (703) 437-0404

UCSD PASCAL is a trademark of Regents of U. of C

CP/M is a trademark of Digital Research, Inc.

MuDOS is a trademark of MuSYS Corp.

IBS is a trademark of IBS, Inc.

# Compare our prices with any in the magazine. We win.

## INTEGRATED COMPUTER SYSTEMS

ITHACA INTERSYSTEMS	CALL
ALTOS	CALL
ZENITH Z89	CALL
CALIF. COMPUTER SYSTEMS	CALL
MORROW DESIGNS	CALL

## 16 K RAM KITS

NEC 4116 200 ns	17.95
-----------------	-------

## DISKETTES

MD 525-01,10,16	26.50
MD 550-01,10,16	44.50
MD 577-01,10,16	34.80
MD 557-01,10,16	45.60
FD 32 OR 34 -9000	36.00
FD 32 OR 34 -8000	45.60
FD 34-4001	48.60

## DISKETTE STORAGE

5 1/4" PLASTIC LIBRARY CASE	2.50
8" PLASTIC LIBRARY CASE	3.50
PLASTIC STORAGE BINDER WITH INSERTS	9.95
PROTECTOR 5 1/4"	24.95
PROTECTOR 8"	29.95

## PRINTERS

ANADEX DP 9000	1195.00
ANADEX DP 9001	1195.00
ANADEX DP 9500	1295.00
ANADEX DP 9501	1295.00
CENTRONICS 739	765.00
C-ITOH 25 CPS PARALLEL	1440.00
C-ITOH 25 CPS SERIAL	1495.00
C-ITOH 45 CPS PARALLEL	1770.00
C-ITOH 40 CPS SERIAL	1870.00
C-ITOH TRACTOR OPTION	175.00
EPSON MX-80	\$CALL
EPSON MX-80 F/T	\$CALL
EPSON MX-100 F/T	\$CALL
IDS-445G PAPER TIGER	795.00
IDS-460G PAPER TIGER	1149.00
IDS-560G PAPER TIGER	1495.00
INFOSCRIBE 500 9X9, 150 CPS (TI-810 REPLACEMENT)	1495.00
MALIBU 165 PARALLEL PRINTER	1995.00
MALIBU 165A PARALLEL PRINTER (Apple)	1995.00
MALIBU 200 DUAL MODE	2995.00
NEC SPINWRITER 5510 SERIAL RO	2595.00
NEC SPINWRITER 5530 PARALLEL RO	2595.00
NEC SPINWRITER 5500 D SELLUM OPTION	2795.00
NEC SPINWRITER 3500 SELLUM OPTION	2195.00
OKIDATA MICROLINE 80	399.00
OKIDATA MICROLINE B2	599.00
OKIDATA MICROLINE B3	795.00

## MODEMS

NOVATION CAT ACOUSTIC MODEM	145.00
NOVATION D-CAT DIRECT CONNECT MODEM	155.00
NOVATION AUTO-CAT AUTO ANSWER MODEM	229.00
NOVATION APPLE-CAT	369.00
UDS 103 LP DIRECT CONNECT MODEM	175.00
D.C. HAYES MICROMODEM II (Apple)	299.00
D.C. HAYES 100 MODEM (S-100)	319.00
D.C. HAYES STACK Smart Modem (RS 232)	249.00
LEXICON LX-11 MODEM	115.00

## APPLE HARDWARE

VERSA WRITER DIGITIZER	219.00
ABT APPLE KEYPAD	119.00
MICROSOFT Z-80 SOFTCARD	299.00
MICROSOFT RAMCARD	170.00
ANDROMEDA 16K CARD	170.00
VIDEX 80 X 24 VIDEO CARD	299.00
VIDEX KEYBOARD ENHANCER	99.00
M & R SUPERTERM 80 X 24 VIDEO BOARD	305.00
NEC 12" GREEN MONITOR	235.00
SANYO 9" MONITOR (B & W)	179.00
SANYO 12" MONITOR (B & W)	230.00
SANYO 12" MONITOR (GREEN)	240.00
SANYO 13" COLOR MONITOR	429.00
TEECO 12" HIGH RES GREEN MONITOR	179.00
SSM AIO BOARD (INTERFACE) A&T	165.00
SSM AIO BOARD (INTERFACE) KIT	135.00
SSM IEEE 488 INTERFACE	369.00

## MOUNTAIN HARDWARE

CPS MULTIFUNCTION BOARD	229.00
SUPERTALKER SD200	259.00
ROMPLUS WITH KEYBOARD FILTER	179.00
ROMPLUS W/O KEYBOARD FILTER	130.00
KEYBOARD FILTER ROM	49.00
COPYROM	49.00
MUSIC SYSTEM	459.00
ROMWRITER	149.00
APPLE CLOCK	239.00
A/D + D/A (DIGITAL TO ANALOG)	299.00
EXPANSION CHASSIS	575.00

## VISTA COMPUTER CO.

APPLE 40 Track Drive A40 (163 K Bytes)	389.00
APPLE 80 Track Drive A80 (326 K Bytes)	549.00
APPLE 160 Track Drive A160 (652 K Bytes)	799.00
APPLE 80 Column Card	329.00
APPLE 8 Inch Disk Drive Controller	549.00

## CALIF. COMPUTER SYSTEMS

### S-100 BOARDS

2200A MAINFRAME	349.00
2032A 32K STATIC RAM	599.00
2065C 64K DYNAMIC RAM	499.00
2422 FLOPPY DISK CONTROLLER & CP/M	339.00
2710 FOUR SERIAL I/O	245.00
2718 2 SERIAL/2 PARALLEL I/O	265.00
2720 FOUR PARALLEL I/O	189.00
2810 Z-80 CPU	249.00

### APPLE BOARDS

7710A/D ASYNCHRONOUS SERIAL INTERFACE	139.00
7712A SYNCHRONOUS SERIAL INTERFACE	149.00
7424A CALENDAR/CLOCK	99.00
7728A CENTRONICS PRINTER INTERFACE	99.00
7720A PARALLEL INTERFACE STD FIRMWARE	99.00

## MORROW DESIGNS

### FLOPPY DISK SYSTEMS

Controller, P.S., Cables, Microsoft Basic, CP/M, A&T

DISCUS I (Single Drive—250 K)	799.00
DISCUS I (Dual Drive—500 K)	1429.00
DISCUS 2D (Single Drive—500 K)	869.00
DISCUS 2D (Dual Drive—1 MEG)	1499.00
DISCUS 2+2 (Single Drive—1 MEG)	1099.00
DISCUS 2+2 (Dual Drive—2 MEG)	1999.00

### HARD DISK SYSTEMS

Controller, P.S., Microsoft Basic, CP/M, A&T

DISCUS M10 (10 Megabytes)	2949.00
DISCUS M20 (20 Megabytes)	3829.00
DISCUS M26 (26 Megabytes)	3949.00

### DECISION 1 COMPUTER

Z-80A, CP/M,  $\mu$ NIX (UNIX identical), 32 to 1 MEG of memory

Floppy and/or Hard Disk . . . . . CALL

## SD SYSTEMS

### S-100 BOARDS

VERSAFLOPPY I A&T	289.00
VERSAFLOPPY I KIT	229.00
VERSAFLOPPY II A&T	389.00
VERSAFLOPPY II KIT	329.00
SBC 200 (Z-80 CPU) A&T	369.00
SBC 200 (Z-80 CPU) KIT	299.00
Z-80 STARTER KIT	289.00
EXPANDORAM II KIT (OK)	220.00
16 K RAM—NEC 4116 200 ns	17.95

### TERMINALS

TELEVIDEO 912C	745.00
TELEVIDEO 920C	835.00
TELEVIDEO 950C	955.00
VOLKER-CRAIG VC 4404	695.00
ZENITH Z-19	799.00

## TRS-80 MOD I HARDWARE

PERCOM DATA SEPARATOR	27.00
PERCOM DOUBLER	159.00
DOUBLE ZAP II/80 (CONVERTS ND/80 TO D.D.)	45.95
MPI 40 TRACK DISK DRIVE (B-51)	299.00
SHUGART 40 TRACK DISK DRIVE (400L)	299.00
MPI 80 TRACK DISK DRIVE (B-91)	429.00
TANDON 80 TRACK DISK DRIVE	429.00
TANDON 40 TRACK DISK DRIVE	299.00
LNW DOUBLER WITH DOSPLUS 3.3D	159.00
PERCOM SPEAK-2ME-2	64.95

## TRS-80 SOFTWARE

NEWDOS/80 2.0 MOD I	139.00
LAZY WRITER MOD I	125.00
PROSOFT MOD I, III	79.00
SPECIAL DELIVERY (MAIL LIST PROG) MOD I, III	119.00
X-TRA SPECIAL DELIVERY (MAIL LIST PROG)	199.00
TRACKCESS MOD I	24.95
OMNITERM SMART TERMINAL PKG MOD I, III	89.95
MICROSOFT BASIC COMPILER FOR MOD I	165.00

## APPLE SOFTWARE

MAGIC WINDOW WORDPROCESSOR STD APPLE	89.00
MAGIC WAND	
(REQUIRES Z80 SOFTCARD & 80 COL)	275.00
WORDSTAR—APPLE	
(REQUIRES Z80 SC & 80 COL)	275.00
MAILMERGE—APPLE (REQUIRES WORD STAR)	90.00
MICROSOFT FORTRAN	
(REQUIRES Z80 SOFTCARD)	165.00
MICROSOFT COBOL (REQUIRES Z80 SOFTCARD)	550.00
DB MASTER 2.4	159.00
VISICALC 16 SECTOR	189.00
CCA DATA BASE MANAGER	99.00
A-STAT COMPREHENSIVE STATISTICS PKG	119.00

## CP/M SOFTWARE

MICROSOFT BASIC-80	299.00
MICROSOFT BASIC COMPILER	319.00
MICROSOFT FORTRAN-80	399.00
PEACHTREE SYSTEMS	CALL
MAGIC WAND (REQUIRES CP/M)	275.00
WORD STAR (REQUIRES CP/M)	310.00
MAILMERGE (REQUIRES WORD STAR)	100.00
SPELLGUARD	239.00
CP/M PICKLES & TROUT FOR TRS-80 MOD II	175.00

## CORVUS

### FOR S-100, APPLE OR TRS-80 MOD I, II

Controller, Case/P.S., Operating System, A&T

5 Megabytes	3095.00
10 Megabytes	4495.00
20 Megabytes	5395.00
MIRROR BACK-UP	700.00

## SUPPLIES

### EVERY TABULABLES

1,000 3-1/2 x 15/16	8.49
3,000 3-1/2 x 15/16	14.95
5,000 3-1/2 x 15/16	19.95

### JARCO PAPER (Prices F.O.B. S.P.)

9-1/2 x 11 18 lb white	29.00
14-7/8 x 11 18 lb white	39.00

We stock a complete line of computer covers, printer ribbons, print wheels & NEC thimbles. Call us for your needs.

Circle 14 on Inquiry card.

We built a reputation on our prices and your satisfaction.

# Alpha Byte STORES

# (213) 883-8594

31245 LA BAYA DRIVE, WESTLAKE VILLAGE, CALIFORNIA 91362

We guarantee everything we sell for 30 days. If anything is wrong, just return the item and we'll make it right. And, of course, we'll pay the shipping charges.

We accept Visa and Master Card on all orders. COD orders accepted up to \$300.00. We also accept school purchase orders.

Please add \$2.00 for standard UPS shipping and handling on orders under 50 pounds, delivered in the continental U.S. Call us for shipping charges on items that weigh more than 50 pounds. Foreign, FPO and APO orders please add 15% for shipping. California residents add 6% sales tax.

The prices quoted are only valid for stock on hand and all prices are subject to change without notice.



Photo 3: *ATS-6 Communications Satellite.* Traveling in synchronous orbit, the *ATS-6* uses two on-board computers for attitude control.

finer telemetry format is changed in order to circumvent a hardware problem, the input on the ground-based telemetry processor must, of course, be changed, too.

● *Instrument Sequencing and Control.* The on-board computer can monitor and control instruments directly or can support the instruments' dedicated microprocessors. In addition, the on-board computer can manage storage of data. Data is recorded during the "back orbit," when the spacecraft is out of touch with the ground station. When the spacecraft reestablishes contact, data is dumped to the ground over a high-speed data link.

### Some Essential Capabilities

On-board computers must constantly perform complex mathematical computations such as coordinate transforms. Floating-point capability enables on-board computers to perform these computations efficiently.

The alternative to building in floating-point capability has been to use scaled fixed-point operations. In testing, operation, and maintenance, however, the scaled fixed-point approach has led to problems with overflows, notably aboard Applications Technology Satellite-6, the International Ultra-violet Explorer, and the Solar Maximum Mission. These experiences have led to the choice of integral floating-point capability in the

on-board computers' processors.

Designers may implement floating-point capability in several ways. The most attractive is to have floating-point capability as part of the machine architecture. The architecture of several on-board computer systems in the 1980s will implement floating-point capability. If a processor can't perform floating-point operations, the designer can add the capability by introducing a slave processor. The slave processor may rely on calculator or computer technology, or it may be a co-processor, sharing the main processor's address, data, and control space.

Designers sometimes add firmware containing math-library functions

# Working hard to be soft.

We at 47th Street Photo work very hard to be soft on your pocketbook. We bring you the lowest possible prices on some of the best selling hardware and software available.

## THE COMPUTER HEADQUARTERS

For the best **APPLE** deal from the big Apple go to the core!



**BUSINESSMAN'S SPECIAL**

**Now! Write a letter and print immediately!**

- Apple II w/48K.
- Epson Interface.
- Disc w/cont.
- Epson Cable.
- Sanyo 9" Monitor.
- Apple Writer.
- Epson MX-80.

Complete Package \$2,522.00

APPLE II w/48K \$1169



5 1/4 DISKETTES FOR APPLE & OTHER MICROS

MEMOREX MAXELL BASAF  
Box of 10 \$27.00  
Box of 10 \$35.00  
Box of 10 \$35.00

DC HAYES MICRO MODERN II \$309  
VIDEX 80 COLUMN VIDEO TERMINAL \$290  
VYDEX KEYBOARD ENHANCER \$112  
VISI CALC. 3.3 \$159  
SUP'R MOD \$32.95  
Z80 SOFT CARD \$298  
THE SOURCE \$95  
WORD STAR by MICRO PRO \$269

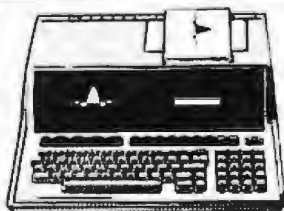

HP-83 Reg. 2250.00 \$1750.00

**HEWLETT PACKARD**  
A Complete Computer System in One Small Package.

The HP-85 is a powerful BASIC language computer, complete w/keyboard, CRT display, printer & tape drive all in one 20 pound unit. 16K RAM, expandable to 32K Reg. 3250.00

Now Only \$2595.00

HP 41CV 289.95 Optical Wand II/41C 98.50  
HP 41C 189.95 Printer II/41C 289.00  
memory module only 27.50 Card Reader II/41C 188.95

### SPECIALS

7225B Graphics Plotter  
OPT. 002 Reg. 2,200 \$1699

82901M 5 1/4" Dual Master  
Flex. Disc Drive  
Reg. 2,500 \$1900

2831B Impact Printer  
OPT. 885 Reg. 3,950 \$2,895

### ATARI

ATARI 800 with 16K



CALL FOR LOW PRICE

Full line of ATARI software available



### Texas Instruments TI 99/4 Computer

Designed to be the first Computer for the skilled user, or the beginner.



Orig. 950.00

Now Only \$389.00

TI 99 Programmable 179.95  
TI 99C Programmable 89.95  
PC 100 C Pmtlr 157.50  
Disc Drive Controller 224.95 Solid State Printer 295.00  
Disc Memory Drive 349.50 RF Modulator 39.95

### EPSON

MX-80 Printer

Now Only \$499.95

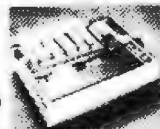

### Sanyo Monitors

VM-4509 9" B&W 169.95  
DM-5012CX 12" B&W 259.95  
DM-5112CX 12" Green 289.95  
DMC-6013 13" Color 449.95  
Electro Home 9" Green 204.95

### ORIGINAL GENUINE IBM 8"

Floppy Diskettes at Lowest Prices!

IBM #2305845 SS SD \$3.44  
IBM #2305830 SS SD \$3.44  
IBM #1669954 SS SD \$3.44  
IBM #1766870 DS SD \$4.59  
IBM #2736700 DS SD \$4.59  
IBM #1669550 SS SD \$3.44  
IBM #1669044 DS DD \$5.19  
IBM #1669045 DS DD \$5.19  
IBM #1766872 DS DD \$5.19



## TERMINALS

Perkin-Elmer Bantam Terminal \$779



**ADDS**  
Applied Digital Data Systems Inc.  
**VIEWPOINT**  
only \$610

**TeleVideo**  
910 ..... \$655  
920 C ..... \$799



MODEL DM5



- Edit.
- Mem-Lock.
- Anti-Glare.
- Line Drawing Capability.

CHECK OUR LOW PRICE

## PRINTERS

TI 810 ..... \$1599 TI 820 KSR ... \$1799  
DIABLO 630 ..... \$2,395  
DIABLO 1650 RO ..... \$2,999  
DIABLO 1650 KSR ..... \$3,599  
DIABLO 1640 RO ..... \$2,645  
DIABLO 1640 KSR ..... \$3,550  
DEC Writer LA34 ..... \$1,075  
Paper Tiger Printer 445G Graphics .. \$785  
Quome Sprint 5/45 RO ..... \$2,450  
5/55 RO ..... \$2,550  
5/55 KSR ..... \$2,850  
Centronics Printer 739-3 Serial .... \$840  
739-1 Parallel ... \$840

Items on sale for limited time only, & are subject to limited availability. Not responsible for typographical errors. This ad supersedes all other ads prior to Sept '81. All orders subject to verification and acceptance. Minimum shipping and handling \$4.95.



**47th Street Photo Inc.**  
67 West 47th St. New York, N.Y. 10036

CORPORATE ACCOUNTS WELCOME (212)260-4410

**47st. photo**  
Cameras • Electronics • Audio • Video • Computers • Darkroom • Accessories

TOLL FREE 1-800-221-7774  
OUT OF STATE 1-800-221-5858  
STATE 1-800-223-5661

such as SIN/COS, ATAN, and SQRT, based on the primitive floating-point operations. Ideally, the on-board processor would have both floating-point operations and math-

library functions as standard features. The co-processor and firmware approaches are interim measures to be considered only so long as technological restrictions prevent includ-

ing these features in the main processor.

Floating-point capability (in the 24-bit-mantissa/8-bit-exponent format) requires at least a 16-bit and preferably a 32-bit word size. Several on-board computer systems in the 1980s will have floating-point capability, and at least one of these will have integral math-library functions.

Table 2 compares the floating-point capabilities of several kinds of hardware used in on-board computers. Table 3 shows the advantages and disadvantages of different ways of implementing floating-point capability. Table 4 shows execution times of math-library functions in different processors.

### Higher-Order Language

The complexity of the mathematics to be performed aboard a spacecraft gives considerable appeal to the use of a higher-order language in developing flight code. The computer, of course, is indifferent to the programming language or method used. The question is whether higher-order lan-

Processor	Approach Used (see table 3)	Format	Time Needed for Operation in Microseconds ( $\mu$ s)		
			Add/Subtract	Multiply	Divide
NSSC-1/SP-C32	1b	24/8 <sup>1</sup>	16.5	11.5	27.0
LSI-11	2	24/8 <sup>2</sup>	42.1 to 66.2	74 to 121	151 to 232
ATAC-16MS	2	24/8	5.75	16	28.5
AM9511 <sup>3</sup>	1b	24/8	13.5 to 92	36.5 to 42	38.5 to 46
57109 <sup>3</sup>	1a	8-decimal-digit-mantissa, 2-digit-decimal exponent	22,000 to 66,000	32,000 to 227,000	78,000 to 223,000
8087 <sup>4</sup>	1c	32 bits; 10 decimal digits	18	18	27

<sup>1</sup> 24-bit mantissa/8-bit exponent  
<sup>2</sup> Essentially 25-bit mantissa  
<sup>3</sup> Slave processor only  
<sup>4</sup> Co-processor with 8086/8088

**Table 2: Comparison of arithmetic operations in floating-point hardware.**

# Radio Shack TRS-80<sup>TM</sup> COMPUTERS SAVE \$\$\$

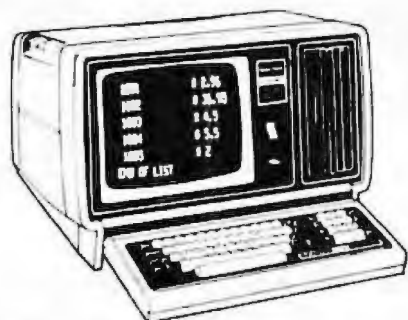

TRS-80  
MODEL II Reg. \$3,899<sup>00</sup>  
64 K **\$3,439<sup>00</sup>**  
26-4002

CALL US  
For Low, Low  
Prices on All  
RADIO SHACK  
Hardware and  
Software

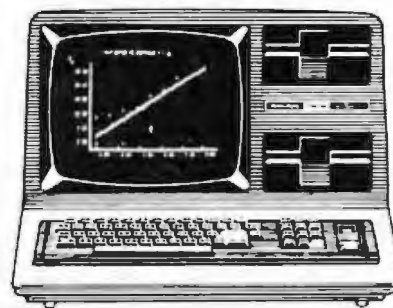

TRS-80 MODEL III Reg. \$2,495<sup>00</sup>  
48 K; 2 Disks **\$2,220<sup>00</sup>**  
26-1066

We Pay Shipping  
No Tax on Out of State Shipments  
Warranties Honored by Radio Shack Stores

**(209) 526-1475**  
**Radio Shack**  
221 McHenry Ave.  
Modesto, Calif. 95354

Certified Checks  
Cashiers Checks  
Credit Cards  
   
Franchise Store 7079

The finest Data Base  
Manager Available

# Maxi Manager

The jury is in and the verdict is "outstanding!" Reviews from all of you who purchased MAXI MANAGER (not to mention raves by many top microcomputing magazines) have heralded it as the definitive data base managing system. We knew that business owners and hobbyists demanded the finest data base managing system available. To all of you who praised us for MAXI MANAGER, we extend our thanks. And to those of you who have yet to try MAXI MANAGER, we invite you to experience this incredible system today. But don't take our word for it (or our jury's). Judge for yourself!

**TOLL FREE ORDER LINE (800) 327-7172**

**JUST CHECK SOME OF THESE FEATURES**

- Supports six different relational search techniques
- Comes with programmer's interface.
- Over 120 pages of documentation
- Supports up to 20 user defined fields of 40 characters each
- Record length up to 800 characters.
- Files can be up to four disks in length.
- Compatible 35, 40, 77 & 80 track drives with proper operating system
- Has calculated equation fields
- Complete report generator
- Works hand in hand with any word processor.

**\$99.95**

MODEL 1 version requires TRSDOS 2.3 and is compatible with NEWDOS 2.1 & NEWDOS 80. MODEL 3 version comes on TDOS, a special version of the DOSPLUS operating system. Requires 48K of RAM and one disk drive minimum. For the TRS-80 Model 1 and 2. Order No. 012-0096

**Adventure  
INTERNATIONAL**  
A DIVISION OF SCOTT ADAMS, INC.

BOX 3435  
LONGWOOD,  
FLA. 32750  
(305) 862-6917

**SEND FOR FREE CATALOG**

Circle 398 on Inquiry card.

Prices Subject To Change Without Notice

## Time Accounting Systems that will Professionalize the Professionals.

Introducing the Timekeeping and  
Billing Software Systems for the  
Professional... by Micro Business  
Systems

**For the Attorney**  
A system specifically designed to handle the complex receivables structure used by attorneys; including their rates and fees, and the generation of bills, statements and management reports.

**For the Professional**  
Handles the billing structure used by accountants, engineers, consultants, and other professionals.



**MBS**

**Micro Business Systems**  
P.O. Box 155  
8901 Meridian Ave. N.  
Seattle, WA 98125  
(206) 525-4898

**Simple, Flexible, and Effective**

The software is designed with the operator in mind; it is simple to use, easy to learn, and requires a minimum amount of time to get the job done. Designed to run on any micro with CP/M, it also possesses the needed flexibility for customization—and even the source code is available under certain terms.

**MBS** Micro Business Systems

Call or order by mail. Demo Package—\$50 ea. Documentation only—\$25 ea. (+ shipping). Dealer inquiries welcome.

# ELECTRONICS CENTER

CALL TOLL FREE

**1-800-228-4097**



Call For "Unbelievable" Low Low Prices  
On These Lines:

AMDEK  
APPLE  
ATARI  
BASE 2  
CENTRONICS  
COMMODORE  
DC HAYES  
HAZELTINE  
LEEDEX

MACROTRONICS  
MAXELL  
MICROSOFT  
MOUNTAIN HARDWARE  
N.E.C.  
NORTHSTAR  
PANASONIC  
SANYO  
SYNCOM

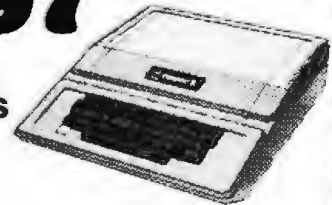

**YOUR**

## ELECTRONICS PLAYGROUND

1840 "O" Street Lincoln, Nebraska 68508  
In Nebraska Call (402) 476-7331



Number (see table 2)	Type of Approach	Advantages	Disadvantages
1a	Add-on arithmetic processor	Built-in math functions	Slow
1b	Add-on microprocessor	Fast—may proceed in parallel with main micro-processor	Interfacing; no-math library
1c	Co-processor	Faster; math-library available	Architecture and interfacing problems
2	Functions built into main microprocessor	Very fast	Usually no math-library; math functions must be written in software

**Table 3: Comparison of different approaches to floating-point capability.**

languages increase programmers' efficiency. Many programmers now think that they can work more efficiently in higher-order languages than in assembly language.

But will the use of higher-order languages make testing and maintaining software more difficult? It remains unclear, during operation of a spacecraft, whether code produced in assembly language is easier to debug and change than code produced by a higher-order-language compiler. But the experience of producing the flight code for the Space Shuttle suggests that language derived from a higher-order language is no more difficult to debug and may even be easier.

Among the higher-order languages that are candidates for use with on-board computers are Jovial, HAL/S, and Ada/Pascal. Each has advantages and disadvantages. (Space Programming Language [SPL] was developed by RCA for in-house use and never gained wide acceptance.) In the absence of an effort to develop a compiler, however, designers will have to use whatever language is supplied by the manufacturer of the hardware.

Pascal-like languages impose structured techniques on programmers. Some programmers have faulted Pascal because each program in that language is an entity, lacking external references. But, in creating software for flight-loads, this feature of Pascal should be an advantage because flight-load software must function as an entity. Moreover, Pascal has gained wide acceptance among programmers. And the Department of Defense has adopted Ada, a Pascal-

(a)	Processor Used	Accuracy (in bits)	Implementation Time for Fixed-Point Calculations In Microseconds ( $\mu$ s)		
			SIN/COS	ATAN/ASIN	SQRT
	9900, with software	16	109	236	117
	NSSC-1, with software	18	163	417	190
	LSI-11, with software	16	176	544	184

(b)	Processor Used	Implementation Time for Floating-Point Calculations In Microseconds ( $\mu$ s)		
		SIN/COS	ATAN/ASIN	SQRT
	LSI-11 with floating-point hardware	784	1303	767
	NSSC-1/SP-C32	265.2	311	223
	ATAC-16MS	121.2	235	123.6

(c)	Processor Used	Format Used	Implementation Time for Calculation by Inherent Math-Library Functions In Microseconds ( $\mu$ s)		
			SIN/COS	ATAN/ASIN	SQRT
	AM9511*	Floating-Point	1084.25	1384	206.5
	59109*	Decimal	760,500	620,500	186,000
	8087	Co-processor	N/A	N/A	38

\* Average of minimum and worst case times

**Table 4: Implementation times of several math functions in different processors. The functions considered are sine, cosine, arctangent, arcsine, and square root. Table 4a shows the times for fixed-point implementations. Table 4b shows the times for floating-point implementations. Table 4c shows miscellaneous processor/format combinations.**

ADVANCED MICRO SYSTEMS • 28188 ADAMOR ROAD • CALABASAS, CA 91302

**MORROW DESIGNS PRODUCTS AT LOW LOW PRICES!** Tel.: (213) 880-4670

OFFER  
EXPIRES  
Oct. 31, 1981

*HARD DISK SUBSYSTEMS	ADDITIONAL HARD DISK	FLOPPY DISK SUBSYSTEMS	TWO DRIVE SUBSYSTEMS
M-26 DISCUS M26 \$3397.00	A-26 DISCUS M26 \$3037.00	F-1118 DISCUS 1 \$ 816.00	F-1128 DISCUS 1 \$1389.00
M-20 DISCUS M20 \$3553.00	A-20 DISCUS M20 \$3193.00	F-1218 DISCUS 2D \$ 898.00	F-1228 DISCUS 2D \$1450.00
M-10 DISCUS M10 \$2780.00	A-10 DISCUS M10 \$2400.00	F-2218 DISCUS 2 • 2 \$1105.00	F-2228 DISCUS 2 • 2 \$1896.00

DISK CONTROLLERS (A & T)	STATIC MEMORY (A & T)
DJ-M26 M26 HARD DISK \$720.00	16K SUPERAM \$248.00
DJ-M20 M20 HARD DISK \$720.00	16K MEMORY MASTER \$284.00
DJ-M10 M10 HARD DISK \$720.00	24K MEMORY MASTER \$378.00
DJ-2208 DOUBLE DENSITY FLOPPY \$349.00	32K SUPERAM \$450.00
DJ-1108 SINGLE DENSITY FLOPPY \$219.00	65K STATIC RAM \$670.00

I/O CONTROLLERS (A & T)	I.E.E.E. S-100 BUS (A & T)
SB-2411 SWITCHBOARD I/O \$219.00	WB-0800 8 SLOT MOTHER BRD \$109.00
SB-2411-4K 4K RAM OPTION \$ 60.00	WB-1200 12 SLOT MOTHER BRD \$129.00
MB-3200 MULT I/O BOARD \$309.00	WB-2000 20 SLOT MOTHER BRD \$173.00

**\*DECISION I BASIC UNIT \$1342.00**

**NOTE:**

1 The disk subsystems include Digital Research CP/M 2.2 and Microsoft Basic V5.2

2 If you own a MITS controller and disc drive, we have the interface to run them with our new subsystems, and a reformatter for your Partec drives and software to translate your Mits files to your new operating system

All shipments FOB Calabasas — 90 days warranty on all products Prices, Terms, Specifications subject to change without notice



# If you write software, write Digital Research.

## We can help you bring your products to market.

Independent Software Vendors (ISV's) are the key to solving the software crunch in the 1980's. To help you bring your products to market, Digital Research introduces the ISV Support Plan — designed to assist you in:

### Developing Your Product

- With the fast and powerful PL/I-80™ Programming System
- ISV Seminars covering high level applications programming

### Getting Established in Your Market

ISV Seminars cover:

- Designing a marketing strategy
- Advertising
- Writing Manuals
- Assuring software security
- Supporting and updating products

On-Going Support Includes:

- Legal and technical information
- Distribution channels
- Printing facilities
- Free product listing in our Applications Software Catalog

All this plus the world's largest software marketplace — the CP/M® customer base.

So why do it alone? Write Digital Research. We'll send you our free brochure detailing the ISV Support Plan.

 **DIGITAL RESEARCH®**

P.O. Box 579  
Pacific Grove, CA 93950  
(408) 649-3896  
TWX 910 360 5001

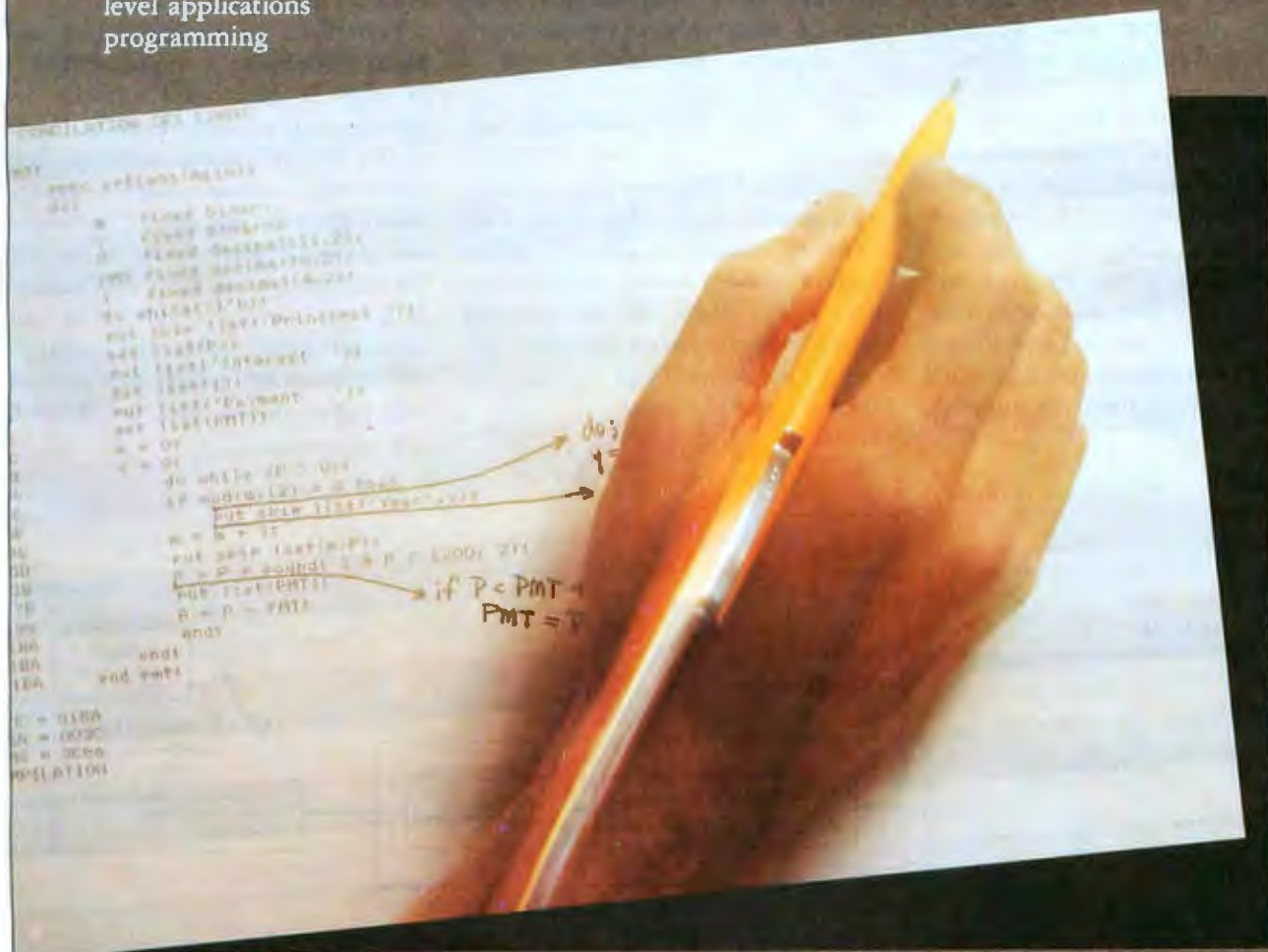

like language.

HAL/S was created specifically for generating flight software, but is not designed for use with a small processor. As with all higher-order languages, HAL/S will only be as good as its compiler implementation, which translates programs into machine language.

The choice of which higher-order language is used may not be critical. It would probably not be cost-effective to develop a compiler specifically for use in the space program because all the recommended on-board machines for the 1980s include one higher-order-language compiler. Note, however, that all these compilers must be cross-compilers because the flight processor can't support a compiler of its own.

### Supporting Software

The tools that programmers use to develop and maintain software for on-board computers include cross-assemblers, loading and dumping facilities, and simulation facilities.

• **Cross-Assemblers.** Despite the existence of several higher-order languages for spacecraft computers, programmers still work mostly in assembly language. Since the on-board computer doesn't host its own support software, the cross-compilers, cross-assemblers, editors, and linkers reside in a small- or medium-scale computer system used for support.

Programmers work on this support system, using its convenient facilities such as video display, disk and tape drives, and a printer. The code produced is then "downline loaded" to the flight computer or test facility or transferred via tape image.

• **Loading and Dumping.** The software load-image for the on-board computer must be mapped into spacecraft commands through the command link, as shown in figure 1. The ground control center usually does this mapping, and then uplinks the commands to the spacecraft via a tracking, telemetry, and command station. On the spacecraft, the command receiver routes the commands to the computer, where they are interpreted. The NSSC-1 on-board computer, discussed at length later, can be hardware-loaded (without the intervention of on-board software) or can be loaded by use of the executive program. The latter technique, however, is used only to update non-critical parts of the code.

The memory of the on-board computer can be dumped on command. The on-board computer puts its memory words into the spacecraft telemetry stream. A ground station receives these memory words and then relays them to the control center. After software decodes and formats the dump image, the support computer prints a copy.

### Simulation Facilities

NASA often uses simulation to test the hardware and software of on-board computers. A program hosted in a mini-computer or in a still larger machine is made to appear to the on-board computer as the rest of the spacecraft. A large and complex real-time simulation generates sensor data and accepts torquer commands, exercising the on-board computer in many different hypothetical situations. In addition to serving as the major debugging and analysis tools for flight software, simulations are used to train control-center crews.

### Debugging Software in Orbit

After thousands of man-years of testing, an on-board computer is launched and assumes full control of spacecraft operations. All too often, the on-board computer crashes because of an obscure and improbable set of conditions that no one even dreamed of simulating.

How does an analyst debug and patch software in a computer that is in orbit? If the control software design is good, an analyst can sit down at the console, dump memory, and patch code without having to worry about the vast amount of hardware and software between him or her and the on-board computer. The analyst of the on-board computer is in fact communicating with the control-center computer, which is in contact with the on-board computer through

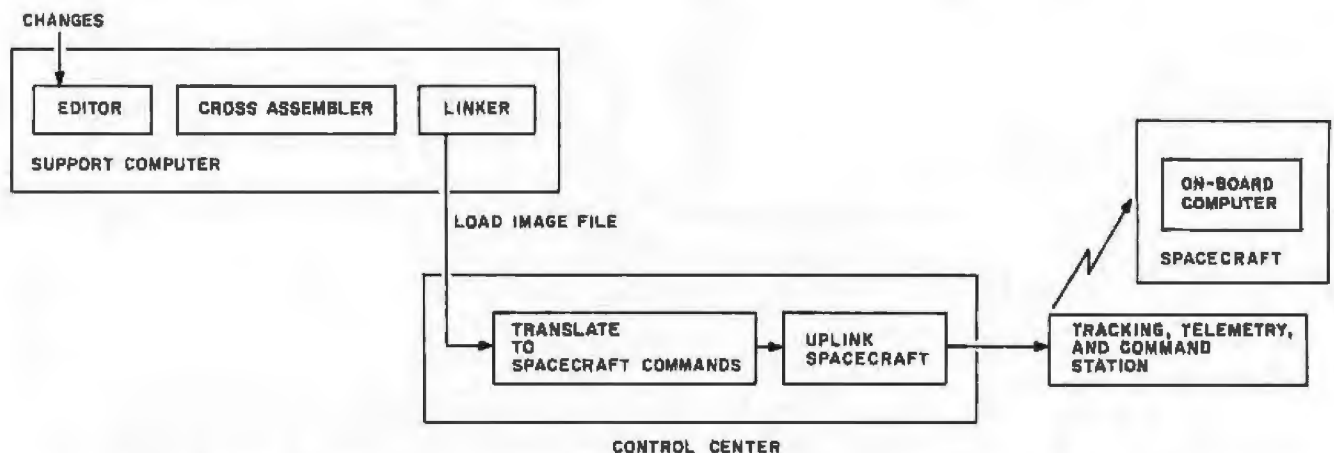

Figure 1: Diagram of the process of changing software for the on-board computer. After software is revised using the support computer in the ground control center, the new code is translated to spacecraft commands, linked, sent to the spacecraft through a tracking, telemetry, and command station, and placed into the spacecraft's on-board computer.

# Systems II a total business system.



SYSTEMS II EX — EX for EXTENDED PERFORMANCE. Westware brings you the most completely integrated and simplest to use business software for your Apple Computer. The SYSTEMS II EX is complete with an integrated Database. Yes! The DBII Database can move your system's files into Database format for customized reports or labels.

Although the SYSTEMS II EX is a fully integrated system, you may purchase

individual modules and later add additional modules, such as Job Costing for contractors. The power of our system is in the KSAM Firmware card that plugs into the Apple. This card permits high speed searches and eliminates running sort routines to get your files in order.

SYSTEMS II is available on 5¼" drives, and also on the Corvus hard disk. A Corvus based system will give you the power and capacity that challenges larger computers.

COMING SOON — Cash flow analysis with graphics, Database II with graphics, and Bill of Materials for small manufacturers.

CURRENT OPTIONS AVAILABLE — Job Costing, Cycle Invoicing, Order entry, and Layaway.

All Checks, statements and invoices use NEBS forms.

Dealer and OEM inquiries invited.

Apple is a trademark of Apple Computers.



2455 S.W. 4th Ave.  
Suite 2  
Ontario, OR 97914  
(503) 881-1477

See us at the Midwest Computer Show

Circle 383 on inquiry card.



2455 S.W. 4th Ave.  
Suite 2  
Ontario, OR 97914  
(503) 881-1477

Yes, I would like to sample your software. Please send me the Systems II Demo Package. My check for \$25 is enclosed.

Name \_\_\_\_\_

Title \_\_\_\_\_

Company Name \_\_\_\_\_

Address \_\_\_\_\_

City \_\_\_\_\_ State \_\_\_\_\_ Zip \_\_\_\_\_

**NO FRILLS!  
NO GIMMICKS!  
JUST GREAT  
DISCOUNTS  
MAIL ORDER ONLY**

**ATARI 800**  
Personal Computer  
System ..... **\$74900**

**NORTHSTAR**  
Horizon II 32K. .... **234900**  
Horizon II Quad. .... **279900**  
Horizon II 64K. .... **299900**  
Horizon Quad 64K. .... **339900**

**TELEVIDEO**  
Model 912. .... **74900**  
Model 920. .... **79900**  
Model 950. .... **107900**

**HAZELTINE**  
Model 1420. .... **79500**  
Model 1421. .... **69500**  
Model 1500. .... **84900**  
Model 1510. .... **104900**  
Model 1520. .... **122900**  
Espirit. .... **64900**  
Executive 80  
Model 20. .... **119500**  
Model 30. .... **139500**

**OKIDATA**  
Microline 80. .... **55900**

**SOROC Technology**  
Model IQ 120. .... **69900**  
Model IQ 140. .... **104900**

**CROMEMCO**  
System 3. .... **569500**  
Model Z2H. .... **799500**

**QANTEX**  
Model 6000 150 CPS  
parallel interface ..... **114900**  
Model 6000 150 CPS  
serial interface ..... **119500**

**DECwriter IV**  
Model LA-34. .... **93900**

**We'll meet or beat any advertised prices!**

Most items in stock for immediate delivery.  
Factory sealed cartons. Full manufacturer's guarantee.  
All products subject to availability.  
All prices subject to change.

**DATA DISCOUNT CENTER**

135-53 Northern Blvd., Flushing, N.Y. 11354  
Visa • Master Charge • N.Y.S. residents add Sales tax  
Shipping F O B N Y  
Phone Orders Call (212) 895-5577

a Tracking, Telemetry and Command Station. During a crisis, however, the analyst doesn't want to think about these details.

**Fixing Failures in Orbit**

Once diagnosed, software failures can be corrected by partially or completely reloading memory. Complete reloads are possible but time-consuming. Remember that the ground control center often has only 10 minutes in every 90 for communication.

Hardware failures in orbit are more difficult to diagnose and fix. Although the Shuttle Orbiter will have a tape drive for storing software, most on-board computers lack mass-memory units. Using disk drives in orbit, except in the largest vehicles, leads to problems because of the need to compensate for the drives' rotational angular momentum. Perhaps two identical disk drives revolving in opposite directions would compensate for each other. But the main problem in fixing hardware is that only one technique is possible: turning off the equipment for a while. This treatment fixes some failures caused by radiation.

Analysts in the control center can sometimes work around a hardware failure. When the computer on the Orbiting Astronomical Observatory failed, for example, analysts determined that a bit in the adder had become unreliable. They rewrote the software to avoid using that bit. It is possible to work around failed memory in a similar fashion.

In the era of the space shuttle, it will be possible to replace modules containing a failed computer or even to bring an entire spacecraft back to earth for repairs. Most current spacecraft designs incorporate hard-wired functions, independent of on-board computers, that will enable the Space Shuttle to approach and retrieve a spacecraft that has a malfunctioning computer.

**Early Systems**

Spacecraft computers started out as a natural outgrowth of missile-guidance computers—simple sequencers. In the late 1950s and early 1960s, missile-guidance computers were

ground-based and had tube or transistor technology. One of these early devices is on display at the Smithsonian Museum of History and Technology in Washington, DC.

With the advance of technology, designers were able to place missile-guidance functions in an on-board computer. The main work of the missile-guidance computer remained the sequencing of operations. The missile-guidance computer had to work for only about 30 minutes. Computers aboard spacecraft, of course, have to perform a greater variety of functions and to go on working much longer.

The first NASA spacecraft that incorporated a general-purpose computer was the Orbiting Astronomical Observatory, launched in 1972. Called the On-board Processor (OBP), this first on-board computer was built by NASA and was the precursor and engineering model of the NSSC-1. Although the OBP was included mainly as an experiment, the computer helped prolong the life of the mission until December 1980 despite many on-board equipment degradations, including the failure of a bit in the computer's adder, as described earlier.

**Current Systems**

Table 5 shows details of some current on-board computer systems. Note that most missions include two processors. The AMSAT Phase III, designed and built by amateurs, includes a CMOS processor. Favored storage devices in current systems include core and plated-wire devices. The systems shown in table 5 contain no secondary memory storage. Preferred technology is high-reliability TTL (transistor-transistor logic) or radiation-hardened CMOS. Typical machine cycle times are several microseconds.

On-board computers are examples of embedded computer systems—they perform as subsystems and perform only a specific application. As microprocessor technology evolves toward a chip with a processor in the class of the IBM System 370, microprocessors will increasingly serve as on-board computers.

# C ~~AND~~ Pascal

## Efficiency ~~AND~~ Portability

## Flexibility ~~AND~~ Strong Typing

### Now you don't have to compromise!

Whitesmiths Ltd. now offers portable language development systems for four families of computers. Approximately one thousand installations use our software.

We support complete versions of both C and Pascal, as compilers and cross-compilers. You get C automatically when you license Pascal, and you get native support with each cross-compiler. Test the software on your VAX before burning PROMs for your 68000 or 8080.

Whitesmiths Ltd. offers a variety of licensing arrangements, the simplest being a binary license for use on a single CPU. The full source code is available with internal documentation. Maintenance, training and sublicensing rights may also be obtained.

Call or write for more information.

Source Operating Systems	Target Machines			
	8080 / Z80	LSI-11 / PDP-11	VAX-11	M6800
8080 / Z80 CP / M	C: \$750 Pascal: \$950	*	*	*
LSI-11 / PDP-11: Idris, Unix, RT11, RSX-11 / M, RSTS / E, IAS	C: \$1350 Pascal: \$1550	C: \$750 Pascal: \$950	*	C: \$1350 Pascal: \$1550
VAX-11 Unix / V32 VMS	C: \$1350 Pascal: \$1550	*	C: \$750 Pascal: \$950	C: \$1350 Pascal: \$1550
M68000 VERSAdos	*	*	*	C: \$750 Pascal: \$950

Idris is a trademark of Whitesmiths, Ltd. ■ Unix is a trademark of Bell Laboratories ■ CP / M is a trademark of Digital Research Company ■ VMS, RSX-11 / M, RSTS / E, LSI-11, VAX, are trademarks of Digital Equipment Corporation ■ VERSAdos is a trademark of Motorola Corporation

\*Special Order

Protect your software investment.

# Whitesmiths, Ltd.

P.O. Box 1132 Ansonia Station New York, N.Y. 10023 (212) 799-1200

Distributors: **Australia** Fawcay Pty Ltd. Brighton-Le-Sands 5225574  
**Japan** Advance Industries Tokyo 03-258-0839  
**United Kingdom** Real Time Systems Newcastle upon Tyne 0632 733131

Computer	Mission	Number	Memory Size	Memory Type	Type of Processor	Cycle Time
1. NSSC-1	MMS(Generic)	1 or 2	8-64 K by 18 bits	CORE	TTL	1.5 $\mu$ s
2. AOP	Landsat-B/C	1	4 K by 18 bits	PWM	TTL	—
3. NSSC-1	SMM	2	48 K by 18 bits	PWM	TTL	1.4 $\mu$ s
4. AOP	IUE	2	12 K by 18 bits	PWM	TTL	1.3 $\mu$ s
5. OBP	OAOC	1	16 K by 18 bits	CORE	DTL	2.0 $\mu$ s
6. DOC	ATS-6	2	4 K by 18 bits	PWM	LPTTL	5.0 $\mu$ s
7. GCSC	Viking Lander	2	18 K by 18 bits	PWM	LPTTL	5.0 $\mu$ s
8. CCS	Viking Orbiter	2	8 K by 18 bits	PWM	—	—
9. FDS	MJS-77 (Voyager)	2	8 K by 16 bits	CMOS	DMOS	2.48 $\mu$ s
10. CCS	MJS-77 (Voyager)	2	8 K by 18 bits	PWM	—	1.37 $\mu$ s
11. AACS	MJS-77 (Voyager)	2	8 K by 18 bits	PWM	—	1.37 $\mu$ s
12. SCP-234	TIROS-N	2	18 K by 16 bits	CMOS	CMOS	2.34 $\mu$ s
13. SCP-234(USAF)	Block 5D	2	16 K by 18 bits	CMOS	CMOS	—
14. COSMAC	AMSAT Phase IIIB	1	16 K by 8 bits	CMOS	CMOS	1 $\mu$ s
15. NSSC-1*	Landsat-D	2	84 K by 18 bits	CORE	TTL	1.5 $\mu$ s
16. ATAC-16ms*	Galileo (AACS)	2	32 K by 16 bits	CMOS (hardened)	LSI bit slice	250 ns
17. CDC 469	HEAO	2	16 K by 16 bits	Plated Wire	PMOS/LSI	—

Table 5: Characteristics of some current on-board computer systems.

\* Not yet launched.

Table 6 shows processors that are available for space missions in the 1980s. Among the features summarized in table 6 are the higher-order languages that are offered for use

with these processors. The table also gives the times required by each processor for addition, multiplication, and division in both fixed- and floating-point operations.

### Spacecraft Computer-1

Current plans call for use of the NASA Standard Spacecraft Computer-1 (NSSC-1) for flights using the Multimission Modular Spacecraft.

Computer Category	NSSC-1	NSSC-1 SP-C32	NSSC-11	ATAC-16ms	M3625	SCP-234
Manufacturer	IBM	IBM/MM	IBM	ITEK	Delco	RCA
Heritage to Previous Computers	SMM,IUE	None	None	ECW Avionics	TITAN III-C F-16	None
Space Applications	MMS	None	None	Galileo	IUS	TIROS-N
Fixed-Point Word Size, Bits*	18/35	18/35	32	16/32	16/32	16/32
Floating-Point Word Size, Bits*	35/18	24/8	24/8	24/8	24/8	N/A
Size, Cubic Inches	570	N/A	1232	609	1250	655
Weight, Pounds	17	N/A	28	18	54	7.9
Power, Watts	45	N/A	150	31	190	10
High-Order Language						
JOVIAL				•	•	
SPL				•		•
HAL/S	•					
Ada/Pascal				•		
Fixed-Point Execution Time, $\mu$ s						
Addition/Subtraction	5	5	N/A	0.25	0.8	4.68
Multiplication	38	38	8.5	5.0	2.8	59
Division	75	75	17.5	10.2	5.8	101
Floating-Point Execution Time, $\mu$ s						
Addition/Subtraction	393	16.5	N/A	5.8	2.6	N/A
Multiplication	580	11.5	38	17.5	4.6	N/A
Division	909	27	56	29.2	9.8	N/A
Cost in thousands of dollars	205	355	N/A	115	1600	N/A

\* Bits in Mantissa/Bits in Exponent

N/A = Not Available

Table 6: Characteristics of processors available for space missions in the 1980s.

CMOS - Complementary Metal-Oxide Semiconductor  
 DTL - Diode-Transistor Logic  
 LPTTL - Low-Power Transistor-Transistor Logic  
 PWM - Plated-Wire Memory  
 TTL - Transistor-Transistor Logic  
 AACS - Attitude and Articulation Control Subsystem  
 AOP - Advanced On-board Processor = NSSC-1  
 CCS - Computer Command Subsystem  
 $\mu$ s -  $10^{-6}$  seconds  
 ns -  $10^{-9}$  seconds

DOC - Digital Operations Controller  
 FDS - Flight Data Subsystem  
 OBP - On-board Processor  
 NSSC-1 - NASA Standard Spacecraft Computer  
 MMS - Multimission Modular Spacecraft  
 SMM - Solar Maximum Mission  
 IUE - International Ultraviolet Explorer  
 OAO - Orbiting Astronomical Observatory  
 ATS-6 - Applications Technology Satellite

Flying in various configurations, this modular satellite will perform many NASA missions.

The NSSC-1 occupies 122 cubic inches, weighs 3 pounds and requires

a 5-watt power supply. A fixed-point, two's-complement computer with a word length of 18 bits, the NSSC-1 has 55 instructions and performs an add operation in 5  $\mu$ s, a hardware

multiply operation in 38  $\mu$ s, and a divide operation in 75  $\mu$ s. All these items are based on use of a 1.6 MHz clock. The NSSC-1 has one index register, one double-length accumulator,

MECA	DF-224	FTSC	469	GPC	CMOS/SOS	4516E
Teledyne	Autonetics	Raytheon	CDC	IBM	TRACOR	Litton
DELTA, CENTAUR	None	None	HEAO	N/A	AN/UJK-20	N/A
None	Space Telescope	None	None	Shuttle	None	None
16/24/32	24	32	16/32	36	1632	16/32
24/8	NO	N/A	NO	YES	24/8	YES
1091	N/A	N/A	N/A	N/A	N/A	N/A
49	102	50	10	59	N/A	18
74	85	35	20	350	5	34
•				•		
1.6	1.6	5.4	4	1.9	0.75	2.5
3.94	8	11	10.4	5.7	4	21
N/A	N/A	N/A	N/A	N/A	8	N/A
6.6	N/A	N/A	N/A	N/A	3.75	N/A
11.12	N/A	N/A	N/A	N/A	10	N/A
N/A	N/A	N/A	N/A	N/A	15	N/A
N/A	2250	1000	650	500	N/A	115

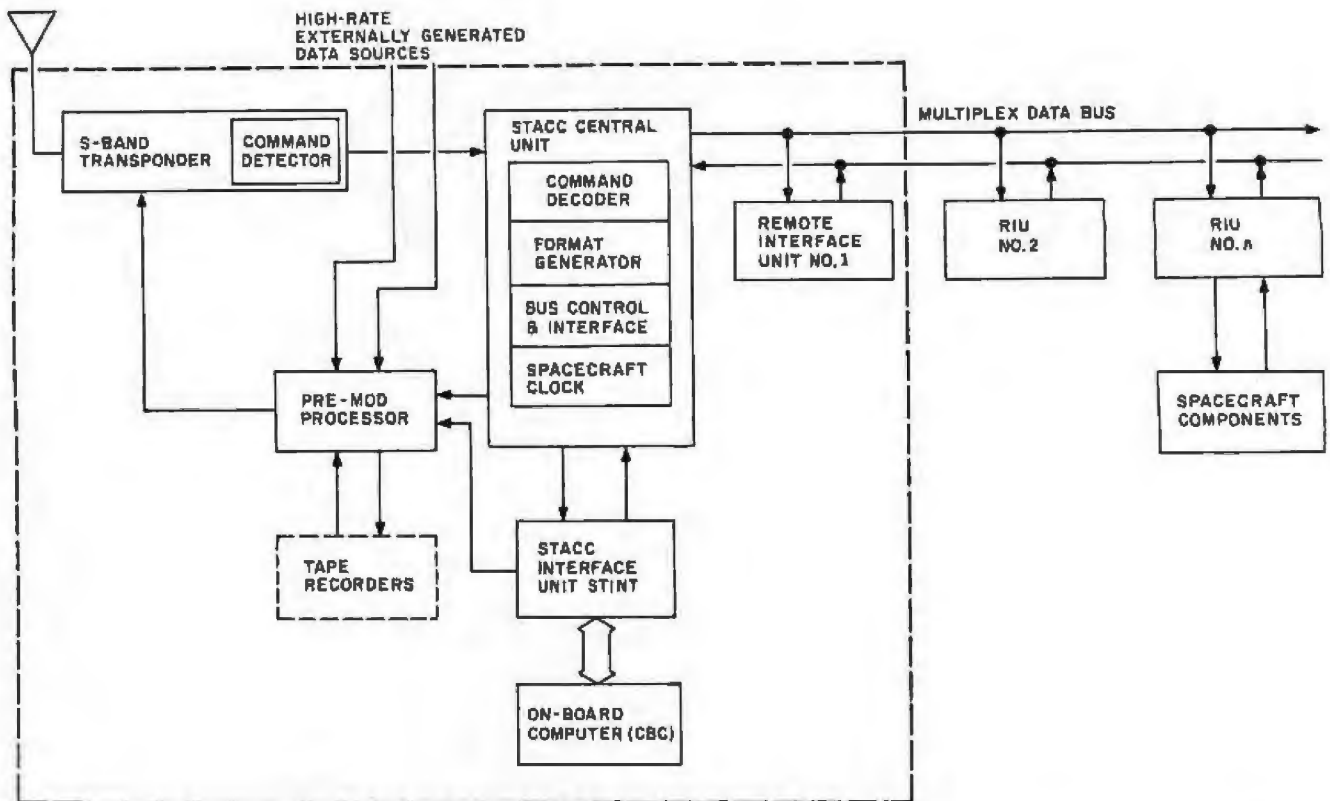

Figure 2: Simplified block diagram of the Command and Data Handling module of the Multimission Modular Spacecraft.

and features indirect addressing. It has 16 interrupt levels and handles as many as 16 direct-memory-access devices over a single 100-word-per-second channel.

The addressing range of the NSSC-1 is 64 K words of memory. The NSSC-1 contains memory built of 8 K-word blocks and features paged addressing, by means of which all 4096 words in a given page are accessed directly. Normally, data and code reside in different pages. Dynamic write-protect is applicable to 128-word blocks of memory. Memory units on the NSSC-1 use power switching to reduce consumption of energy when units are not being addressed.

Since the NSSC-1 contains no ROM (read-only memory), the computer has a direct-load feature that allows loading a "cold" machine through the spacecraft command link. By contrast, the Digital Operations Controller on Applications Technology Satellite-6 did have memory-load and "bootstrap" ROM soft-

ware. Of course, if a ROM contains a programming error, it can't be corrected while in orbit.

### Multimission Spacecraft

The characteristics of the MMS (Multimission Modular Spacecraft) impose many requirements on the NSSC-1. The MMS consists of three building-block modules and a supporting structure. The modules—Power, Attitude-Control, and Command and Data Handling equipment—provide ready-made spacecraft components. Combining an MMS with an instrument module makes a spacecraft that the Space Shuttle can launch and retrieve. The first MMS spacecraft to be launched was the Solar Maximum Mission in February 1980. The next is Landsat-D scheduled for July 1982.

Aboard the MMS, the NSSC-1 resides in the Command and Data Handling module as part of the spacecraft data bus. This module contains telemetry transmitters and command receivers for spacecraft operation.

The Command and Data Handling module can include as many as three standard  $10^8$ -bit or two standard  $10^9$ -bit recorders for temporary storage of data for the spacecraft or the instruments on board. The Command and Data Handling module also contains the basic timing-reference signal for the spacecraft, accurate to 1 in  $10^8$  parts and stable to 2 in  $10^8$  parts per day. Instruments themselves may include more accurate clocks.

The most important component of the MMS data system is the multiplex data bus. The bus is a set of redundant party lines and has both supervisory and reply lines. The multiplex data bus links all components of the spacecraft. The only data that doesn't flow through the multiplex data bus is data transmitted at rates greater than a megabit per second.

Linking each spacecraft component to the data bus is a special interface called a Remote Interface Unit. Since the bus is configured as a party line, each Remote Interface Unit has a unique address ranging from 1 to 63.



# Get a \$20 rebate on the TI-59 Programmable.

Even without the \$20 rebate, the TI-59 is special—it's our most powerful programmable, and we've never offered it at a lower price.

The TI-59 gives you up to 960 program steps, or up to 100 memories, plus magnetic card read/write capability. You can also slip in one of TI's Solid

State Software™ modules and successfully attack complex engineering, business, statistical and scientific problems. And by adding the optional PC-100C printer, you can record your calculations. But if that's not enough, any TI-59 owner can

join our Professional Program Exchange for access to over 2500 additional programs.

So if you like the idea of having real programmable power, take us up on the rebate offer. Buy a TI-59 now, and fill out the coupon below. The offer ends December 31, 1981.

TEXAS INSTRUMENTS  
INCORPORATED



"Wow!  
Another good deal!"

©1981 Texas Instruments Incorporated

I bought my TI-59 Programmable at (store name): \_\_\_\_\_ and have attached the dated sales receipt and completed customer information card (packed in box). My TI-59 Serial No. is \_\_\_\_\_ (from back of calculator). Please send my \$20 rebate check to:

NAME \_\_\_\_\_

ADDRESS \_\_\_\_\_

CITY \_\_\_\_\_ STATE \_\_\_\_\_ ZIP \_\_\_\_\_

Send to: Texas Instruments TI-59 Rebate Offer, P.O. Box 725 Dept. 59, Lubbock, Texas 79491.

NOTE: Proof of purchase must be dated between August 1, 1981 and December 31, 1981. Offer void where prohibited. Offer good only in U.S.A. Rebate applies to purchases of TI-59 Programmable only. Items must be postmarked by January 15, 1982. Allow 30 days for delivery. Limit one per person/address.





**OUR MEDIA IS**

Over the past seven years we've earned a name for ourselves by making the best magnetic media in the business. Precision magnetic media — Diskettes, Mini Diskettes, Diagnostic Diskettes, Rigid Discs, Disc Packs, and Disc Cartridges — all certified to be 100% error free both on-track and between the tracks.

Now we're making it easier for you to buy the best. Just dial Dysan direct TOLL FREE at 800/538-8150 or 408/988-3472 (in California) or contact your local Dysan office listed below.

Precision magnetic media from Dysan. Our media says it all.



**Dysan**  
CORPORATION

5440 Patrick Henry Drive  
Santa Clara, CA 95050  
408/988-3472



**Call your local Dysan office:**

- Irvine, CA (714) 851-9462
- Sunnyvale, CA (408) 730-2145
- Atlanta, GA (404) 952-0919
- Schaumburg, IL (312) 882-8176
- Burlington, MA (617) 273-5955
- St. Louis, MO (314) 434-4011
- Glendora, NJ (609) 939-4762
- New York, NY (212) 687-7122
- Bellevue, WA (206) 455-4725

Watch for new offices opening soon. For further information, call our Corporate Marketing Department at (800) 538-8150.

Circle 130 on Inquiry card.

# OUR MESSAGE.

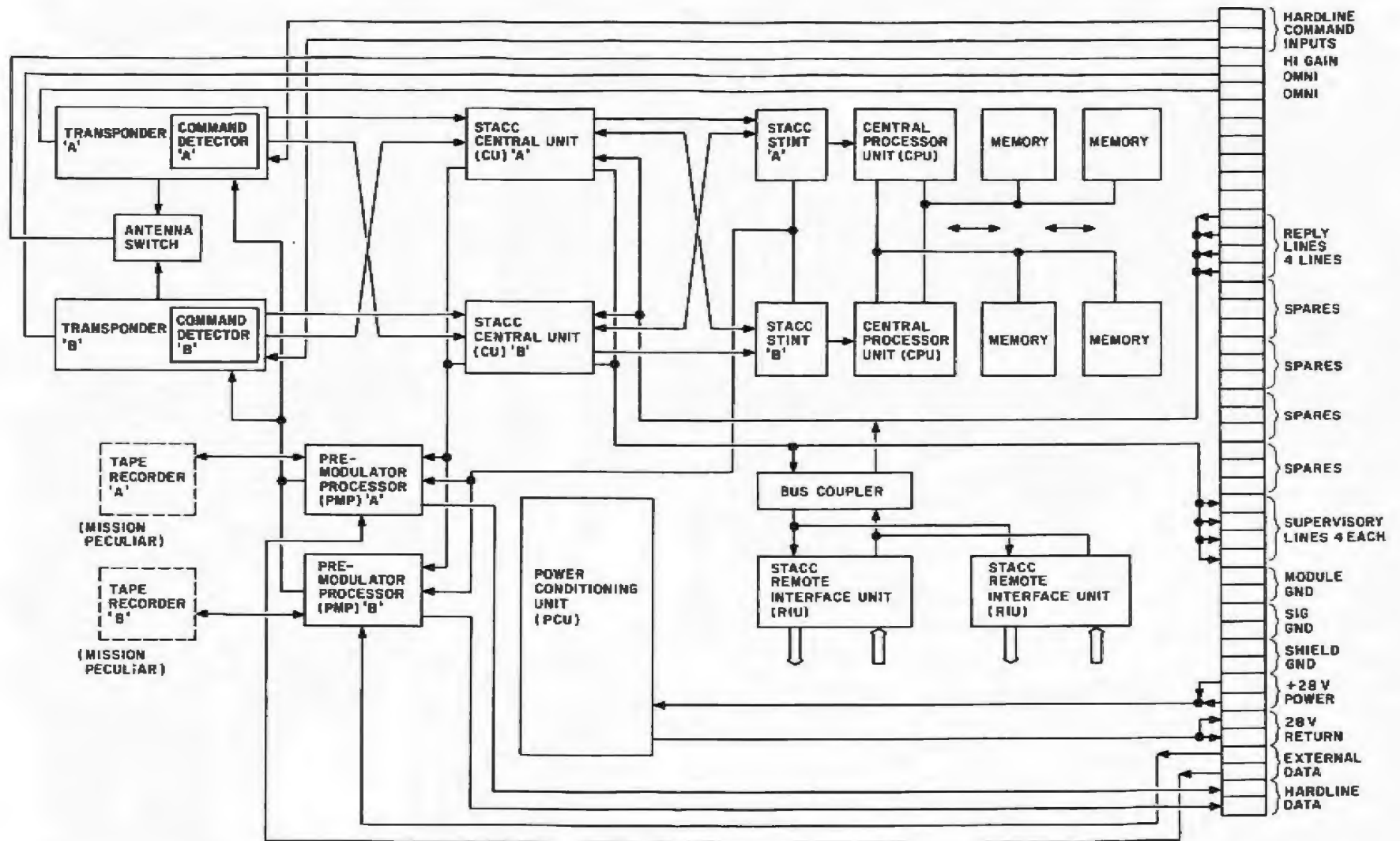

Figure 3: Detailed block diagram of the Command and Data Handling Module of the Multimission Modular Spacecraft. The diagram shows the module's interface as well as the redundancy of each of the module's components.

# PRICE BREAKTHROUGH

We've done it again! As a leader in small computer sales we must constantly find new ways to save customers money while offering quality products. Our most popular seller, the Apple II Plus, is now available with 64K of user RAM at the unbeatable price of only \$1249. This is possible because we manufacture the 16K RAM Card that expands the factory Apple II 48K to it's maximum capacity of 64K. The Ram Card allows use of Integer and Applesoft Basic and other languages like Pascal. It's a must for large data bases, Visicalc, and the Z-80 cards. The card is made from high quality components and has a full one year warranty.

## 64K APPLE II PLUS

ONLY \$1249



16K For \$1049 48K For \$1129

DISK II DRIVE \$529 DISK II DRIVE \$439

WITH CONTROLLER CARD

ADD ON

### Apple Cards and Hardware

16K Ram Card by CCI	130
Language System w/Pascal	379
Silentye Printer w/Interface card	349
Hayes Micromodem II	299
Novation Apple-Cat II	339
Videx videoterm 80 column w/graphics	269
Z-80 Softcard by Microsoft	299
16K RamCard by Microsoft	159
ABT Numeric Keypad (old or new kybrd)	110
ALF 3 voice Music Card	239
ALF 9 voice Music Card	169
Heuristics Speechlink 2000	259
Alpha Sytaun Keyboard System	1399
Corvus 10MB Winchester Disk system	CALL
Lazer Lower Case Plus*	55
Micro-Sci Disk Drives (A-40 & A-70)	CALL
SSM AIO Serial/Parallel card A&T	189
Sup-R-Terminal 80 Column Card	329
SVA ZVX4 Megabyte 8" disk controller	589
SVA 2+2 Single Den. 8" disk controller	345
Versawriter Digitizer Pad	229
Digisector Camera interface	299
ThunderClock Plus	119
Symtec Hi-Res Light Pen	210
Integer or Applesoft Firmware card	145
Graphics Tablet	619
Parallel Printer interface card	135
Hi Speed Serial interface card	135
Smarterm 80 column card	299
Joystick by Keyboard Co.	45
Music System (16 Voices)	479
A/D + D/A interface	289
Expansion Chassis	599
Introl/X-10 controller card	169
Clock/Calendar card	225
CPS Multi-function card	189
Supertalker SD-200	239
Romplus+ Card	135
Romwriter Card	149
Clock/Calendar Module	99
GPIB IEEE-488 Card	249
Asynchronous Serial Interface Card	129
Centronics Parallel Interface Card	99
Arithmetic Processor Card	299

We carry all CCS cards, please call for best prices.

### Solution Software for the Apple II

Visicalc 3.3	169
CCA Data Management	85
DB Master	169
WordStar (Apple 80 co. version)	299
Super Text II	139
Desktop Plan II	169
Applewriter	65
Infotory	225
Landlord Apt. Mngmnt.	649
Stock Tracker by H&H	175
Easywriter	225
ASCII Express	59
Peachtree Business Software	CALL
Applesoft Compiler	185
Visitem	129
Visitrend/Visiplot	219
Real Estate Analyzer	89
Tax Preparer	99
DOS Toolkit	65
Tax Planner	99
Dow Jones Portfolio Evaluator	45
Dow Jones New & Quotes Reporter	85
Apple Fortran	165

### Printers

Anadex 9500/9501 w/ 2K Buffer	1299
C. Itoh Starwriter 25 CPS	1499
C. Itoh Starwriter 45 CPS	1899
Epson MX-70	CALL
Epson MX-80 F/T	CALL
Paper Tiger IDS-445	699
Paper Tiger IDS-460	949
Paper Tiger IDS-560	1249
Silentye w/Apple II interface card	349
Qume Sprint 5/45	2495

### Video Monitors

Amdex/Leedex Video 100 12" B&W	139
Amdex (Hitachi) 13" Color	359
NEC 12" P31 Green Phosphor (In Stock Now!)	CALL
NEC 12" RGB Hi-Res Color	CALL
Panasonic 13" Color	449
Sanyo 9" B&W	159
Sanyo 12" B&W	239
Sanyo 12" P31 Green Phosphor	279
Sanyo 13" Color w/excellent resolution	419

ORDER TOLL FREE

800-854-6654

WE ACCEPT ALL MAJOR CARDS

California and outside Continental U.S. (714) 698-8088

consumer computers mail order

8314 Parkway Drive  
La Mesa, CA 92041

SEE PAGES 476 & 477 FOR MANY MORE PRODUCTS AT UNBEATABLE PRICES.

# Micro-SEED™

## The Powerful Mainframe Database Management System for Professionals Who Use Microcomputers

**Power:** Micro-SEED was derived from the CODASYL SEED database system. It has both hierarchial and network structures with power to handle any application regardless of its data complexities.

**Compatibility:** Fully compatible with SEED for creating microcomputer databases tied to a large host computer.

**Productivity:** Faster and easier to develop and maintain applications since data relationships are automatically and consistently maintained. Shared database allows integration of various application programs, each having selective authorization to access data. Consistent data naming allows programs to evolve independently of one another.

**Performance:** Since only Micro-SEED gives you full CODASYL access methods (plus additional ones), your database can be tuned for maximum performance. Critical portions of Micro-SEED are written in assembly language for fast, efficient operation, while the remainder is in standard FORTRAN to permit rapid evolution of Micro-SEED. Your data is secure since the database is never damaged in a system failure. Only the last transaction is lost.

**Proven:** Micro-SEED has been in use since 1977 and is continually enhanced.

**Ease of Use:** Documentation consists of a Reference Manual (over 100 pages) and a CP/M Operating Guide. Also, three example databases are illustrated in detail. Concise Data Definition and Data Manipulation Languages permit easy structuring and updating of your database.

## When Your Application Requires BIG Computer Power at little Computer Prices, Get Micro-SEED.

Requirements are CP/M operating system, FORTRAN or PL/I-80, 48K bytes available to user program, and Zilog Z-80 or Intel 8080/8085 processor. Format is 8" single-density, others on special order. Single copy license is \$1,195. Demonstration Package with Documentation is \$75. Documentation only is \$40. VISA, MC, and AE accepted. Dealer and OEM inquiries invited.



4890 Riverbend Road  
Boulder, CO 80301  
Phone (303) 443-2706

**Micro Decisionware**

SEED trademark of International Data Base Systems (IDBS). Micro-SEED trademark of IDBS and Micro Decisionware. CP/M and PL/I-80 trademark of Digital Research.

Each Remote Interface Unit can handle 8 serial-magnitude and 64 pulse-type commands. (In a serial-magnitude command, the whole byte is taken to have one value. In a pulse-type command, each bit is an "on" or "off.") A Remote Interface Unit can also handle 64 telemetry channels. Some spacecraft components have more than one Remote Interface Unit assigned to them.

The bus supervisory lines are time-division multiplexed. They carry command messages and addresses for interrogated telemetry. Four basic message types, each 32 bits long, make up a basic 125-microsecond supervisory-bus timing cycle. Data on the reply bus moves in 8-bit packets. The data bus is basically a 1.024-megabits-per-second serial line.

The STACC (standard telemetry and command components) central unit is the main interface between the spacecraft data bus and the command receiver/transponders, the telemetry modulators/transmitters, and the on-board computer. The on-board computer, however, is not interfaced directly to the STACC but through the STINT (STACC Interface Unit).

Figure 2 shows a simplified view of the Command and Data Handling module. Note that the path for extremely high-rate data bypasses the bus and feeds the telemetry modulators directly. Also note that the optional tape recorders may be used to buffer telemetry data for later transmission to the ground.

Figure 3 is a fuller block diagram of the Command and Data Handling module with all its interfaces. The diagram shows that the Command and Data Handling module contains redundant copies of every component. There are two processors for the NSSC-1, but only one complement of memory. Only one of the NSSC-1's processors can be powered at a time, and either processor can address all of the memory.

So far, as its commands and its contributions to telemetry are concerned, the NSSC-1 is just another component of the bus. Most bus traffic consists of interrogation addresses, commands going out to components, and data for telemetry. The

STACC unit, under ROM control, requests telemetry data in a certain format. The NSSC-1 can modify that format if necessary.

When the computer needs certain data faster than it is normally sampled from telemetry, the on-board computer can request and receive the needed data over the bus. Such data is then "interleaved" with telemetry data. One design consideration is to prevent the telemetry formatter and the on-board computer from contending to sample the same device at the same time.

## The Future and the NSSC-1

The NSSC-1 is a production-model computer that is adequate for today's missions. Because more and more data-processing tasks are being assigned to the NSSC-1, its adequacy for missions in the 1980s is questionable. NASA is considering several approaches to increase computing power in on-board computers of the 1980s.

In an attempt to avoid complete redesign of a basically adequate component, NASA has investigated several schemes to augment the NSSC-1 within the framework of the current design. These schemes include the addition of floating-point hardware and the off-loading of large computational tasks to dedicated microprocessors.

One study proposes using a microprocessor to collect, format, and process data from the spacecraft's gyroscopes. This task is a time-consuming, repetitive computational burden that could easily be shifted to a microprocessor.

A similar proposal calls for shifting the attitude determination and control algorithm, representing approximately 40 percent of the NSSC-1's computational load, to a dedicated microcomputer. It turns out that the Texas Instruments 9900 microprocessor would be ideal for this application. The input/output from most of the spacecraft's devices is serial and has word sizes up to 24 bits, and the 9900 has an inherently serial input/output structure.

Microprocessors could also relieve the NSSC-1 of several other modular

# Mix APPLES and ORANGES? ... And you get GRAPHICS!

NEW

## THE GRAPPLER™ Apple Parallel Interface and Cable

FROM ORANGE MICRO

The Grappler™ Interface is the first universal parallel interface card to provide sophisticated on-board firmware for Apple high resolution dot graphics. No longer does the user need to load clumsy software routines to dump screen graphics — it's all in a chip. Actually, it's our E-PROM, and there are versions to accommodate the Anadex, Epson MX100, MX80 & MX70, IDS Paper Tigers, Centronics 739, and future graphics printers. The Grappler™ accepts 18 simple software commands accessible through the keyboard or user program, making it the most intelligent Apple interface available.

### GRAPPLER INTERFACE FEATURES

The High-Resolution Graphics commands include: **select page 1** or **page 2**, **print inverse graphics**, **rotate picture 90°**, **print double size picture**, **center graphics**, and **chart recorder mode**. The Text commands allow the user to turn off the **printer bell** (Epson), turn on high bit for **block graphics** (Epson MX80 and Okidata), set left and right **margins**, set **auto skip-over-perf.**, **variable line length wrap-around** with breakpoint on nearest blank, and **text screen dump**.

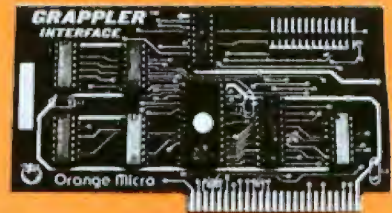

**\$165.00** Includes Cable

Dealer/Distributor  
Inquiries Invited

NEW

## MX80/MX70 FRICTION FEED

FROM ORANGE MICRO

HERE AT LAST! A high quality friction feed kit for your EPSON MX80/70. The kit allows the user to convert his Epson printer to a friction feed and pin feed mechanism. It uses a solid rubber platen for perfect tracking.

The friction feed will accept single sheets of your letterhead, or multiple copy forms such as invoices with up to 4 part carbon copies.

The pin feed replaces the adjustable sprocket mechanism. It allows the use of 9½" wide continuous fanfold paper which is an industry standard size.

No drilling is required. Initial installation takes about 30 minutes; return to adjustable sprockets in just 10 minutes. All parts are included with easy to follow instructions.



**\$75.00**

Dealer/Distributor  
Inquiries Invited

CALL TOLL FREE:

**(800) 854-8275**

**CA, AK, HI (714) 630-3322**

Phone orders WELCOME; same day shipment. Free use of VISA & MASTERCARD. COD's accepted. Manufacturer's warranty included on all equipment. Prices subject to revision.

RETAIL PRINTER STORES:  
3150 E. La Palma, #1, Anaheim, CA.  
13804 Ventura Bl., Sherman Oaks, CA.  
Store Hours: M-F 10-6 Sat. 10-4



**Orange Micro  
inc.**



tasks. One of these is the calculation-of-orbit position. These calculations rely on frequently updated data from the ground and usually involve evaluating long time-series polynomials. Extremely difficult to do without floating-point, calculations of position usually require at least 32 bits of precision, or a 24-bit mantissa and 8-bit exponent. A recent study projected that the on-board computer would be required to perform 1300 floating-point operations per second; 60 percent of the operations were short, such as addition, and 40 percent were long, such as division and multiplication. The NSSC-1 can do only 30 of these computations per second and not in floating-point. (When the Global Positioning System that is described later becomes operational, it will greatly simplify the task of determining position.)

Table 7 compares the performance of the NSSC-1 with that of several current microprocessors. Ignoring word size, the NSSC-1 may be thought of as the approximate equal of a PDP-8 class minicomputer.

### Spacecraft Applications

Designers are using microprocessors more and more as dedicated controllers on spacecraft. The current trend is to give each major instrument its own dedicated microprocessor. This is a step toward on-board distributed processing. Another concept under study is creating a pool of microcomputers to serve all the spacecraft's instruments in common, providing extensive backup at the cost of greater complexity.

A microprocessor inside an instrument can monitor and sequence the

instrument's operation as well as carry out some first-level reduction of data. Since much of this data reduction is now done on larger computers on the ground, the use of microprocessors inside instruments will greatly reduce the amount of data that must be transmitted from the spaceship to ground stations.

But designers must also weigh the possibility of losing valuable data due to a malfunction of a microprocessor aboard a spacecraft. The specter of a perfectly functioning instrument defeated by a failed microprocessor haunts instrument scientists. Designers must also assure that the support required for the space-borne processor does not become greater than the computer resources required if the job is done on the ground.

Before a scientific instrument can become operational on a spacecraft, scientists must specify the required data-processing algorithm and the format of the output data. Then the processing resources required can be estimated, basically in terms of time and memory. Then a decision can be made as to where the processing can best be done—on the ground or in the spacecraft.

One or more Remote Interface Units connect the microprocessor-based instrument processor with the MMS multiplex data bus. Data rates from X-ray instruments typically carried on MMS spacecraft usually do not exceed 256 k bps (bits per second). Gamma-ray instruments usually result in less data by an order of magnitude.

Techniques often applied in instruments' dedicated processors include: spectral analysis by fast

Fourier transform algorithms for two dimensions; time-domain analysis, such as burst detection and periodicity detection; and the detection of transients for modification of instrument operation in real time.

Payloads designed for the space shuttle flights of the 1980s draw heavily on microprocessor technology, often using microprocessors in place of discrete logic and hard-wired controllers. In such applications, microprocessors provide an unprecedented level of complexity and flexibility. An example is the Payload Assist Module-Delta Class (PAM-D), a sort of second stage for the shuttle. The PAM-D will boost spacecraft to a final orbit beyond what the Shuttle Orbiter can achieve directly. Several microprocessors aboard the PAM-D will check and cross-check safety features, sequence operations, and interface with the Shuttle's and the payload satellite's data systems.

### Global Positioning System

The GPS (Global Positioning System) will consist of a network of orbiting spacecraft that provides global coverage. The GPS is designed to yield highly accurate data about the positions of earth satellites. The GPS satellites and ground stations are also known collectively as the NAVSTAR system.

The experimental model of the GPS receiver to be carried on Landsat-D uses a dedicated LSI-11 processor to calculate position in orbit. Using data received from orbiting GPS spacecraft, the GPS receiver can locate Landsat-D's position within meters on the earth's surface or in orbit. This will enable the satellite to make accu-

Processor	Tech- nology	Word Size	Regis- ters	Cycle Time	Number of Instruc- tions	Add Time	Multiply	Divide	Word Addressing Capability	Temp Range
NSSC-1	TTL	18	3	1.6 $\mu$ s	55	5 $\mu$ s	38 $\mu$ s	75 $\mu$ s	64 K	-10° to +40°C
8080A	NMOS	8	7	1.5 $\mu$ s	91	3 $\mu$ s	—	—	64 K	-55° to +125°C
9900	NMOS ( <sup>1</sup> L)	16	16	.333 $\mu$ s	64	4.87 $\mu$ s	17.33 $\mu$ s	30 $\mu$ s	32 K	0° to +70°C
LSI-11	NMOS	16	8	.38 $\mu$ s	74	3 $\mu$ s	70 $\mu$ s	80 $\mu$ s	32 K	0° to +50°C
1802	CMOS	8	16	1.24 $\mu$ s	75	2.5 $\mu$ s	—	—	64 K	-55° to +125°C
ATAC-16ms	Schottky	16	16	.250 $\mu$ s	128	.25 $\mu$ s	5.5 $\mu$ s	11.25 $\mu$ s	64 K	MIL Spec

Table 7: Comparison of on-board computers with microprocessors.



# The One Printer Solution for the Two Printer Problem.



## HIGH SPEED DATA PROCESSING

The new Dual-Mode 200 brings speed and uncompromising print quality to business and professional applications.

Financial statements, inventory reports, labels and more are printed at data processing speeds from 165 cps to 250 cps.

Fully adjustable tractors and a friction feed platen provide precise forms handling for pin-feed and single sheet paper.

Complete "Dot Control" graphics is standard with resolution to 120 x 144 dots per inch.

Interfacing is easy with both E.I.A. RS-232C serial and an ASCII parallel port.

## LETTER QUALITY WORD PROCESSING

The Dual-Mode 200 also features letter perfect print you will be proud to use for business letters and reports. Letter Mode speeds range from 42 cps to 60 cps.

The standard Titan 10 pitch font is complemented by an array of optional fonts including Elite 12 pitch, italics, proportionally spaced, OCR-A, scientific and foreign character sets.

Up to 12 font selections may be stored in the printer and interchanged while printing.

The Dual-Mode 200 accepts standard daisy-wheel print commands for word processing system compatibility.

It's the perfect solution for the two printer problem.

## The Dual-Mode 200 Printer for the one printer office.

Call or write today for complete specifications

2301 Townsgate Road, Westlake Village, CA 91361, (805) 496-1990

a subsidiary of *Calsonic* Corporation

**malibu**  
Electronics Corporation

DOTS DO IT BETTER™

rate correlation of its observations with latitude and longitude.

The GPS receiver is a "black box" device—that is, all that the user needs to know about it is the format of data that the GPS receiver accepts and produces. But the processor inside the GPS receiver is basically an LSI-11. The GPS receiver receives coded GPS signals, decodes them, and calculates a position. This position is then transmitted to the user; in the case of Landsat-D, the user is the on-board computer. The Shuttle Orbiters will also be equipped with GPS receivers.

### An Apple in Orbit

The shirt-sleeve environment of the Spacelab reduces the stringency of requirements on equipment. For use not critical to the mission, standard commercial hardware can be used. In fact, one of the first Spacelab flights will have an experiment controlled by an Apple II Microcomputer system. The Apple will monitor an experiment in plant growth in the zero-gravity environment and will collect data for recording and transmission. Although the Apple has been adapted for use with other equipment, it is basically the same Apple that is commercially available. The use of microcomputer systems as dedicated experiment controllers aboard spacecraft is expected to increase rapidly. ■

### References

- Adelman, A and A Kemp. "Space Station Information Management," *IEEE Transactions on Aerospace and Electronic Systems*, Volume AES-6, Number 6, November 1970, page 746.
- Aranguren, R and W Langseth. "A Microprocessor Controlled Interface for Digital Satellite Systems," *International Conference on Communications*, Conference Record, Volume 2, IEEE, 1977.
- Arens, P. "Application of Microprocessors to Spacecraft Synthetic Aperture Radar Processing," *Proceedings of the International Telemetry Conference*, 1978.
- Campoli, C and P Breda. "Microprocessors for Satellite Telemetry: A Universal Approach," *Proceedings of the International Telemetry Conference*, 1976.
- Carlson, A, R Constant, and R C Lekvan. "Testing Embedded Microprocessors—Space Application Requirements," *Computers in Aerospace Conference*, November 1977, American Institute of Aeronautics and Astronautics, paper 77-1399.
- Charlton, C. "The Control of a Hard X-ray Imaging Spectrometer On-board the SMM Using Two Mutually Redundant Microprocessors," *Journal of the British Interplanetary Society*, Volume 32, February 1979.
- Cliff, R. "The SDP-1 Stored-Program Computer," *IEEE Transactions on Aerospace and Electronic Systems*, Volume AES-4, Number 6, November 1968, page 864.
- Dogan, Pierre P. "Spaceborne Software Engineering: An Approach to Attaining Reliability," Charles Stark Draper Laboratory, *Flight Mechanics/Estimation Theory Symposium*, Goddard Space Flight Center, May 5/6, 1979.
- External Interface Specification and User's Guide*, Multi-Mission Modular Spacecraft, S-700-11, a publication of Goddard Space Flight Center.
- Fernandez, M. "A Review of DOD and NASA Computer Standardization," AIAA paper 77-1423, AIAA/NASA/IEEE/ACM *Computer in Aerospace Conference*, October/November, 1977.
- Gunzenhauser, G, E Wlaka, and D Zago. "A Microcomputer Based System for On-board Attitude Control Applications," *Journal of the British Interplanetary Society*, Volume 32, February 1979.
- Hecht, H. "Fault Tolerant Computers for Spacecraft," *AIAA Journal of Spacecraft*, Volume 4, Number 10, October 1977.
- Hollomb, L. "Overview of NASA's On-board Computing Technology Program," in *Proceedings of Compcom*, 1980, IEEE Number 80CH1491-OC.
- Jurison, J et al. "Design Considerations for Aerospace Digital Computers," *Computer Design*, Volume 13, Number 8, August 1974.
- Kida, T, O Okamoto, and Y Ohkami. "Synthesis and Development Procedure of Microprocessor Software Program for Spacecraft Digital Attitude Control," *Japan Society for Aeronautical and Space Science Transactions*, Volume 21, February 1979.
- Knobe, B. "Flight Languages ADA vs. HAL/S," 1979, AIAA paper 79-1988.
- Koczala, L and G Burnett. "Advanced Space Missions and Computer Systems," Volume AES-4, Number 3, May 1968, *IEEE Transactions on Aerospace and Electronic Systems*.
- Lesh, F and P Lacoq. "Distributed Microprocessors for Spacecraft Control and Data Handling," Technical Papers, Western Electronic Show and Convention, 1976, Volume 20.
- Martin, F and R Battin. "Computer-Controlled Steering of the Apollo Spacecraft," *AIAA Journal of Spacecraft*, Volume 5, Number 4.
- Medin, A, D Cavanaugh, and S Cades. "Computer-Managed Laboratory for Space Applications," *AIAA Journal of Spacecraft*, Volume 5, Number 10, October 1968, page 205.
- O'Donnell, L. "On-board Computers" from *Handbook of Astronautical Engineering*, Koelle, editor. New York: McGraw-Hill, 1961, section 13.12.
- Plieson, P. "Design Concepts for a Highly Reliable Multiprocessor System for Communication Satellites," *Proceedings of the International Telemetry Conference*, 1977.
- Proceedings of the AIAA Aerospace Computer Systems Conference*, AIAA, Los Angeles, California, September 8-10, 1969.
- Redman, P and J Kasser. "Distributed Processing on Satellites," *Computers in Aerospace Conference*, AIAA Paper 77-1377, October/November 1977.
- Reijns, G. "Recent and Expected Developments in Computers for Satellites," *British Interplanetary Society Journal*, Volume 31, December 1978.
- Rennels, D. "A Distributed Microprocessor System for Spacecraft Control and Data Handling," at IEEE and ERA Electronic Show and Convention, Chicago, November 8 to 10, 1977.
- Rennels, D. "Computers for Planetary Spacecraft," *Proceedings of Compcom*, IEEE, Spring 1980, 80CH1491-OC.
- Rubey, R. "Higher Order Languages for Avionics Software—A Survey, Summary, and Critique," IEEE, 1978, CH1336-7/78.
- "Spaceborne Digital Computer Systems," NASA-SP8070, March 1971, *Space Vehicle Design Criteria (Guidance and Control)*. Available from National Technical Information Service, US Department of Commerce, 5285 Port Royal Road, Springfield, VA 22151.
- Stables, E and C Creveling. "Spacecraft Computers for Scientific Information Systems," *Proceedings of the IEEE*, Volume 54, Number 12, December 1966.
- Styles, F, T Taylor, M Tharpa, and C Trevalthan. GSFC X-562-87-202, July 1967, Goddard Space Flight Center.
- Total Dose Testing of Several Types of MOS Microprocessors, *IEEE Transactions on Nuclear Science*, NS-25, Number 6, December 1978, 1649-1651.
- Vahey, M. "High-level Language Oriented Aerospace Computer," IEEE CH 1449-8/79.
- Velde, W, G Bentley, J Fagan, and W McDonald. "On-board Computer Requirements for Navigation of a Spinning and Maneuvering Vehicle," *AIAA Journal of Spacecraft*, Volume 6, Number 12, December 1969.
- Woldrich, R. "Multi-Micro Computers for High Data Rate Processing," *Computers in Aerospace Conference Addendum*, 1977, AIAA 1390.

The important plus in matrix printers:

# grafixPLUS.™



Since their introduction in mid-1980, the Anadex high-resolution DP-9500 Series matrix printers have set new standards for printer quality and performance. All models feature the rugged Anadex 9-wire print head that combines long life with resolutions of 72 dots/inch vertical and up to 75 dots/inch horizontal. With this kind of resolution, fineline graphics (under data source control) and razor sharp characters are pluses built into every printer.

#### Performance Plus

The full standard ASCII 96 character set, with descenders and underlining of all upper and lower case letters, is printed bi-directionally, with up to 5 crisp copies, at speeds up to 200 CPS. Models DP-9500 and DP-9501 offer 132/158/176 and 132/165/198/220 columns respectively. Print densities are switch- or data-source selectable from 10 to 16.7 characters/inch. All characters can be printed double-width under communications command.

#### Interface Plus

Standard in all models are the three ASCII compatible interfaces (Parallel, RS-232-C, and Current Loop). Also standard is a sophisticated communications interface to control Vertical Spacing, Form Length and Width, Skip-Over Perforation, Auto Line Feed, X-On/Off, and full point-to-point communications.

#### Features Plus

As standard, each model features forms width adjustment from 1.75 to 15.6 inches, shortest-distance sensing, full self-test, 700 character FIFO buffer (with an additional 2048 characters, optional), and a quick-change, 6 million character life ribbon.

#### Quality Plus

Beyond the built-in performance of the grafixPLUS series printers, the engineered-in quality and support are equally important. The result? Approval of both UL and FCC, Class A; operating noise levels under 65dbA; and a nationwide service organization second to none.

To see for yourself why the grafixPLUS printers offer more pluses for your printing dollar, contact us today.

 **Anadex**  
the plus in printers

Made in  
**U.S.A.**  
for the World

ANADEX, INC. • 9825 DeSoto Avenue • Chatsworth, California 91311, U.S.A. • Telephone (213) 998-8010 • TWX 910 494 2761  
U.S. SALES OFFICES, San Jose, CA (408) 247-3933 • Irvine, CA (714) 557-0457 • Wakefield, MA (617) 245-9160 • Austin, TX (512) 327-5250  
ANADEX, LTD. • Weaver House, Station Road • Hook, Basingstoke, Hants RG27 9JY, England • Tel Hook (025672) 3401 • Telex 858762 ANADEX G

## Misosys Software's DISKMOD Put Radio Shack's Editor/Assembler on Disk

Steve Hughes, 5831 Hillside Dr, Doraville GA 30340

If you have bought a floppy-disk drive for your Radio Shack TRS-80 Model I and want an editor and assembler package that uses the disk, you will be interested in DISKMOD. The only problem with just buying the disk-based Radio Shack Macro Assembler is the \$100 price tag. This expense is particularly annoying if you own and are satisfied with Radio Shack's cassette-tape-based Editor/Assembler.

The DISKMOD program from Misosys Software takes the cassette-based Editor/Assembler and modifies it to reside on disk and to use disk files for most I/O (input/output) operations. You can save about \$50 by buying DISKMOD and the Radio Shack cassette Editor/Assembler, or \$80 if you have the cassette Editor/Assembler. I am not saying that the Misosys-modified cassette Editor/Assembler is the equivalent of the disk-based Macro Assembler. It isn't. But if you are not doing extensive programming in assembly language, you may not need the extra features contained in the Macro Assembler.

I use Z80 assembly language for writing utility programs and an occasional subroutine, when I need a function that BASIC can't perform with enough speed. Aside from that, all my programming for the TRS-80 is done in BASIC. Since I already owned the cassette

Editor/Assembler (hereafter referred to by its file name, EDTASM), the modification program looked good to me.

The package I purchased consisted of a single tape cassette containing two versions of the program (one for EDTASM 1.1, the other for EDTASM 1.2) and a 14-page user's manual. The cassette is warranted for 90 days on a replacement-only basis. (This must be what the registration form is for, since no other explanation of its use is given.)

The DISKMOD program moves the EDTASM program to disk after modifying it extensively. The modifications:

- allow loading and saving source programs and data to a disk file
- allow the object code to be written to a disk file
- allow you to move blocks of source data in the text buffer
- provide a replace-string function for the editor
- allow you to see how much free space is left in the text buffer
- allow you to get a disk-directory listing from EDTASM
- allow you to kill a file from EDTASM
- allow use of the Clear key
- enable you to paginate listings
- let you sort the symbol table before printing it
- change the screen scrolling to provide 15 lines of text on the screen
- allow you to reenter EDTASM without losing the contents of the text buffer
- enhance the B command and the DEFM assembly output

Your next question is, "What do I have to do to use the DISKMOD program?" First, you must have a system with 32 K bytes of memory and a copy of the Radio Shack cassette Editor/Assembler. The DISKMOD program works with either version 2.2 or 2.3 of TRSDOS and with most other TRS-80 disk operating systems.

The instructions for loading and using the DISKMOD program are simple and straightforward. I found only

### At a Glance

**Name**  
DISKMOD

**Purpose**  
Upgrade the Radio Shack cassette-based Editor/Assembler to a disk-based Editor/Assembler

**Manufacturer**  
Misosys Software  
5904 Edgehill Dr  
Alexandria VA 22303

**Price**  
\$19.95

**Format**  
Cassette tape

**Language**  
Z80 assembly language

**Computer**  
TRS-80 Model I Level II with 32 K bytes of memory, a floppy-disk drive, and the Radio Shack cassette Editor/Assembler

**Documentation**  
14-page 8 1/2" by 11-inch loose-leaf pamphlet

# Teach your little Apple to talk to Western Union, Telex and TWX.

Albany ————— Omaha

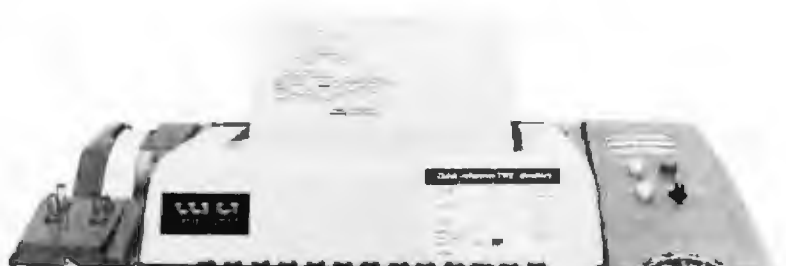
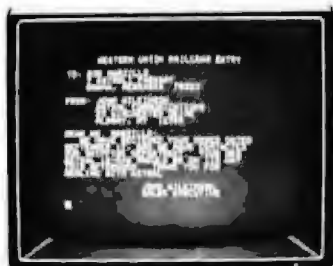

Micro-Telegram™ lets your Apple II™ computer access Western Union™ services, worldwide. You can send Mailgrams®. Send and receive TWX®, Telex, and international cables. Receive Infomaster® up-to-the-minute news, stock, foreign exchange, gold, futures, sports, and ski reports. Use your Apple™ to wire money. To send flowers. To check the snow at Sun Valley. To see what the Yen is selling for. To contact over 900,000 TWX and Telex subscribers around the world.

And because it's more intelligent than a mechanical Teletype™ machine, Micro-Telegram lets you edit messages right on the screen, sends them automatically without you in attendance, keeps subscriber directories and distribution lists, prints when you want it to, and asks you in plain English for your commands. Besides, it doesn't clatter and churn out reams of paper.

Call our toll-free number today. And make your little Apple heard 'round the world.

## MICROCOM

We make little computers talk big.

Call 800-547-5995, ext. 188, toll-free, for the Micro-Telegram-Apple dealer nearest you. *Dealer inquiries invited.*

Microcom, Inc., 89 State Street, Boston, MA 02109. (617) 367-6362

Apple and Apple II are trademarks of Apple Computer, Inc. Western Union, Infomaster and TWX are trademarks of Western Union, Inc. Teletype is a trademark of the Teletype Corp.

# EPSON PRODUCTS

## MX80/70 FRICTION FEED KIT *by Orange Micro*

HERE AT LAST! A friction feed kit for your EPSON MX80/70. The kit allows the user to convert his Epson printer to a friction feed and pin feed mechanism.

The friction feed will accept single sheets of your letterhead, or multiple copy forms such as invoices with up to 4 part carbon copies.

The pin feed replaces the adjustable sprocket mechanism. It allows use of 9½" wide continuous fan-fold paper which is an industry standard size.

No drilling required. Installation takes about 30 minutes. All parts are included with easy to follow instructions.



**\$75.00**

DEALER INQUIRIES  
INVITED

### Listing 1: Output of the PD (List Directory) command.

```
00018 FREE GRAINS - DIRECTORY - DRIVE 0 - TRSDOS -09/17/80
TAPEDISK/CMD      00512
LOWER/CMD         00256
COPY/CMD          03072
TEST1/CMD         01536
EDTASM/CMD        05888
RSTERM/CMD        00768
KSRTST/CMD        00256
```

one slight problem: the command provided to write the DISKMOD program to a disk file is incorrect. It reads:

```
F DISKMOD/CMD 7500 8ACA 7F70
```

It should read:

```
F DISKMOD/CMD:0 7500 8ACA 7F70
```

With this correction, anyone can use the program successfully. The process takes about ten minutes. When you're finished, you can type the command EDTASM under TRSDOS and have the Editor/Assembler speedily loaded from disk into memory.

You notice a difference in the Editor/Assembler instantly. It now prompts for memory size. This lets you reserve high memory for peripheral-device drivers or any other subroutines. One pleasant surprise concerns the printer driver. The modified program uses the same DCB (device control block) and ROM (read-only memory) printer driver as Level II BASIC. If you have a special printer driver for use with BASIC, it also works with the Editor/Assembler. When you have answered the memory-size question, you are back in normal working mode.

The only command I will mention is the PD, or List Directory, command. It gives the name and size of each normal file on the disk, as well as the amount of free space on the disk. This information is particularly useful when you are attempting to squeeze a new file onto a nearly full floppy disk. Listing 1 shows a sample of the information you receive.

The other new commands work quite well. Explicit prompts are used for most of them, making it easy for the beginner to use them. The manual explains each new command in detail and notes any changes made to the standard commands by the DISKMOD program.

The package works as advertised and all the commands function. It is possible that some problems will occur as I use the modified Editor/Assembler more extensively. In my experience, major modifications made to an existing program generally cause some minor bugs. The modified program has worked satisfactorily so far.

If you are considering a move to a disk-based Editor/Assembler, but dislike the cost of Radio Shack's Macro Assembler, I strongly recommend the combination of the Misosys DISKMOD and the Radio Shack cassette Editor/Assembler programs. ■

## EPSON MX80



- 9 x 9 dot matrix • Lower case descenders • 80 CPS • Bidirectional, Logic seeking • 40, 66, 80, 132 columns per line • 64 special graphic characters: TRS-80 Compatible • Forms handling • Multi-pass printing • Adjustable tractors.

MX80 ..... (List \$645) \$CALL  
MX80 Dot Graphics Upgrade..... (List \$95) \$CALL

## EPSON MX70



- Super low-priced dot resolution graphics • 5 x 7 dot matrix • User replaceable printhead • Top of Form.

MX70 ..... (List \$445) \$CALL

## EPSON MX80 FT



- Same basic features as the MX80
- PLUS friction feed for single sheets • and adjustable tractors.

MX80 FT ..... (List \$745) \$CALL

## APPLE INTERFACE *For Epson*

The Grappler™ interface card is the first to provide on-board firmware for Apple high resolution dot graphics. No longer does the user need to load clumsy software routines to dump screen graphics — it's all in a chip. Actually, it's our E-PROM, and it is replaceable to accommodate the Anadex, Epson MX80 & MX70, IDS Paper Tigers, Contronics 739, and future graphics printers. The Grappler™ accepts 17 software commands including Hi-Res inverse, 90° rotation, double size, and much more.

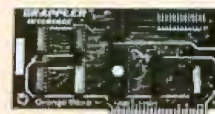

**\$165.00**

Includes Cable  
DEALER INQUIRIES  
INVITED

# Orange Micro

"THE COMPUTER PRINTER SPECIALISTS"

UP TO 25% DISCOUNTS! — SAME DAY SHIPMENT!

NEW

## CENTRONICS 739 (RADIO SHACK LINE PRINTER IV)

With Graphics and Word Processing Print Quality



- 18 x 9 dot matrix; suitable for word processing • Underlining • proportional spacing • right margin justification • serif typeface • 80/100 CPS • 9 1/2" Pin Feed/Friction feed • Reverse Platen • 80/132 columns • Top of form

CENTRONICS 739-1 (Parallel) ..... (List \$995) \$ Call  
CENTRONICS 739-3 (Serial) ..... (List \$1045) \$ Call

## VISTA — C. ITOH

Daisy Wheel Letter Quality



- 25 CPS (Optional 45 CPS) • Typewriter quality • Centronics parallel • RS 232 Serial (Optional) • Proportional spacing • Bidirectional • Programmable VFU • Self test • Diablo compatible • Friction feed (Optional tractors) • 136 printable columns • Manufactured by C. ITOH.

VISTA V3000 (C. ITOH) ..... (List \$1895) \$ Call

## ANADEX

Dot Graphics, Wide Carriage



- 11 x 9 dot matrix; lower case descenders • Dot resolution graphics • Bidirectional, logic seeking • Up to 200 CPS • RS 232 Serial & Parallel • Forms control • X-ON/X-OFF • Up to 6 part copy.

ANADEX 9501 ..... (List \$1650) \$1350

## ANACOM

Low Cost, High Speed, Wide Carriage

- 9 x 9 dot matrix • Lower case descenders • Wide carriage • Adjustable tractors to 18" • 150 CPS, Bidirectional, Logic Seeking

ANACOM 150 ..... (List \$1350) \$ Call

## MALIBU 165

The Small Business Printer; Letter Quality & Speed.

- 10 x 9 dot matrix • Letter quality print; Lower case descenders • High speed; 165 CPS, Bidirectional, Logic seeking • Wide carriage • Vertical forms control • User programmable character set • Dot Resolution Graphics.

## AXIOM

Dot Graphics, Low Price



- Dot addressable graphics • 70 CPS • 12 characters per inch • 80 columns • adjustable tractors • 3 part copies • Manufactured by Sieko • Parallel, RS232 serial, IEEE-488 interfaces available.

AXIOM GP-80M ..... (List \$399) \$349

## NEC SPINWRITER

High Speed Letter Quality

- 55 CPS • Typewriter quality • Bidirectional • Plotting • proportional spacing.

5510-5 RO, Serial, w/tractors ..... (List \$2995) \$2675  
5530-5 RO, Parallel, w/tractors ..... (List \$2970) \$2650

## TELEVIDEO CRT'S

AT DISCOUNT PRICES!



TVI 910  
TVI 912C  
TVI 920C  
TVI 950

Please Call Toll Free  
Prices are too low to  
advertise

QUANTITY PRICING AVAILABLE

## IDS PAPER TIGERS

Dot Resolution Graphics, quality print, speed



- 7 wire printhead (445); 9 wire printhead (480) with lower case descenders • Over 150 CPS • bi-directional, logic seeking (460) • 8 character sizes; 80-132 columns • Adjustable tractors • High-resolution dot graphics • Proportional spacing & text justification (460).

IDS 445G 7 wire printhead, graphics ..... (List \$895)  
IDS 480G 9 wire printhead, graphics ..... (List \$1394)  
IDS 580G 9 wire, wide carriage, graphics ..... (List \$1794)

## PRINTERS

MALIBU 165 wide carriage, graphics, letter quality .. (List \$2495) \$ 1975  
QUME 5/45 typewriter quality ..... (List \$2905) \$ 2558

## INTERFACE EQUIPMENT

CCS APPLE SERIAL Interface & cable ..... \$ 150  
ORANGE INTERFACE for Apple II parallel interface board & cable ..... \$ 110  
MICROTRONICS Atari parallel interface ..... \$ 89  
ATARI 850 interface module, serial/parallel ..... \$ 199  
TRS-80 CABLES to keyboard or Exp. interface ..... \$ Call  
NOVATION D-CAT direct connect modem ..... \$ Call

CALL FOR INFORMATION & CATALOG

(800) 854-8275

CA, AK, HI (714) 630-3322

RETAIL PRINTER STORE

Store #1 3150 E. La Palma, #1, Anaheim, CA (714) 630-3622  
Store #2 13604 Ventura Bl., Sherman Oaks, CA (213) 501-3486  
Store #3

COMING SOON ??

Store Hours: M-F 10-6 Sat. 10-4



Orange Micro inc.

3150 E. La Palma, Suite G, Anaheim, CA 92806



Phone order WELCOME; same day shipment. Free use of VISA & MASTER-CARD. COD's accepted. Manufacturer's warranty included on all equipment. Prices subject to revision.

At Orange Micro, we try to fit the right printer to your application. Call our printer specialists for free consultation.

Circle 268 on inquiry card.

The Converter  
that transforms  
your electronic  
typewriter into a  
computer  
printer.



- ▶ No modifications to the typewriter
- ▶ Does not affect normal typewriter functions
- ▶ All typewriter functions accessible by computer
- ▶ RS232C, IEEE and parallel interfaces available
- ▶ KSR version turns typewriter into a computer terminal
- ▶ Fully assembled, tested and burned in

NEW! NOW AVAILABLE

OLIVETTI PRAXIS 35  
TYPEWRITER  
+  
CONVERTER TP35 =  
DAISY WHEEL PRINTER  
FOR LESS THAN \$1000.

Prices start as low as \$275.  
CONTACT YOUR LOCAL  
OFFICE EQUIPMENT DEALER  
OR  
VERTICAL DATA SYSTEMS INC.  
FOR FURTHER DETAILS.

Vertical Data Systems Inc.  
1215 Meyerside Dr., Unit 2A,  
Mississauga, Ontario,  
Canada L5T 1H3  
(416) 671-1752

Dealer Inquiries Invited

## Software Review

# MINCE

## A Text Editor

Christopher O Kern  
201 I St Apt 839  
Washington DC 20024

A text editor is probably the most personal program on a personal computer system. The average user spends a good amount of time communicating with the editor—entering or altering programs, data, or text. Different users, with different applications, often have different ideas about how they want an editor to work, a fact which accounts for the large number of editors on the market.

MINCE is one of the newer entries into the software market for 8080-family computers that use the CP/M operating system. MINCE is modeled on a large-system editor, called EMACS, which was developed at MIT (Massachusetts Institute of Technology). Its authors say that MINCE stands for "MINCE Is Not Complete EMACS"; nevertheless, it has a lot to offer. It can do all the usual text-editing functions—insert or delete characters, words, and blocks of text, move text around, and search for and replace strings—as well as perform a number of other operations that are not generally available in microcomputer editors.

MINCE's features include the ability to read, create, and write multiple-disk files, to move text among different files quickly and easily, to automatically transpose characters and words, and to execute familiar operations in unusual contexts. For example, it can move the cursor by sentences or paragraphs, fill lines out to a specified length one paragraph at a time, capitalize or change the case of words without retyping them, and delete just the whitespace between words or characters as well as the words or characters themselves.

### Command Structure

Despite the large number of commands in MINCE, the editor functions coherently. Command types are grouped logically so that one command sequence is used for a group of commands that affect *textual* units such as letters and lines, and another command sequence is used for a group of commands that deal with *lexical* units such as words and sentences. Where possible, the same mnemonics are used for similar operations at these different command levels. For example, the command to move the cursor forward one letter is Control-F, and the command



"Our goal at The Denver Software Company is to translate the advances in high technology—symbolized by the Space Shuttle triumph—into practical, problem-solving microcomputer programs for small business and home use."

*Wally Schina*

## Microcomputers Are The Door To The Future.

### We Have The Key.

Finally, there's an accounting package available for most microcomputers—from the least expensive to the top-of-the-line—that works the moment the machine is switched on. Language, programs, everything needed for accurate bookkeeping is built into the software, eliminating the need for programming skills or expensive equipment add-ons.

#### The FINANCIAL PARTNER™

is a comprehensive financial package that takes the headache out of bookkeeping. With general ledger, cash receipts, accounts payable, and check-printing capability, this system also provides standard financial reports. In addition, the FINANCIAL PARTNER™ comes with a detailed user's manual containing basic bookkeeping instruction. By automatically sorting and posting accounts, the FINANCIAL PARTNER™ saves you valuable time and is a complete guide to money management for your home or very small business. At \$175, it's worth its weight in gold.



#### Also from The Denver Software Company:

**The PASCAL TUTOR™**, a computer assisted course in UCSD Pascal®. This complete software package uses the microcomputer to teach this powerful new programming language. \$125 for this fast, easy way to learn versatile UCSD Pascal®.

**The PASCAL PROGRAMMER™** is a software breakthrough for those knowledgeable about UCSD Pascal®. Pre-tested modules dramatically shorten the time spent coding, testing, and debugging programs—by as much as 70%. For \$125, save money as well as time.

\*UCSD Pascal is a trademark of the Regents of the University of California.

Products available from your local dealer.

**THE DENVER SOFTWARE COMPANY**

MANUFACTURERS OF MICROCOMPUTER SOFTWARE



100 E. Jewell Ave., Suite 13 • Aurora, CO 80012  
Dealer inquiries welcome. 303-321-4444

# ALTOS BUSINESS C



**Now—A four station,  
hard disk business computer  
with letter quality printer,  
terminals and get-rolling  
software for less  
than \$15 a day.\***

Introducing the Altos Business Computer Special. The most powerful, reliable, easy-to-use system in its price range. And Altos now offers on-site, nationwide service.

The hardworking engine of our system is the Altos ACS8000-10 computer. It can cost-effectively hook-up with from one to four stations, as your needs demand. Its rapid access, 10 MByte Winchester hard disk is capable of storing a 3,000 page load.

\*Price approximate and may vary in your area. Daily lease based on: \$17,000 principal, 20% annual interest, 5-year term. Includes: Altos ACS8000-10 computer, letter quality printer, four precision terminals and get-rolling software. Does not include tax, installation, training and maintenance.

# COMPUTER SPECIAL



Our get rolling business software package includes multi-user systems software, Wordstar™ for word processing and Microplan™ for business analysis. And when you need more, your local Altos representative can route you through to hundreds of other business and accounting programs, to meet virtually any requirement. Plus Altos also lets you communicate with other computers, mainframes, and even allows networking.

Circle 16 on Inquiry card.

Get on the right track! Join thousands of professionals, institutions and businesses who rely on Altos computer systems. Call our toll free number or write today for the Altos sales and service depot nearest you.

All aboard!

Wordstar is a trademark of MicroPro International Corp.  
Microplan is a trademark of Chang Laboratories, Inc.

© 1981 Altos Computer Systems

**Packed with  
fresh ideas  
for business**

**ALTOS**

**COMPUTER SYSTEMS**

2360 Bering Drive  
San Jose, California 95131

**800-538-7872**  
**(In Calif. 800-662-6265)**

to move it backward one letter is Control-B, while the analogous commands to move the cursor across words are Escape-F and Escape-B.

As the previous example implies, MINCE does not use the cursor control or other special function keys available on many terminals. Commands are entered as control characters, as escape sequences (the escape character followed by one or more additional characters), or as control sequences (a control character followed by another control character or a printing character). Most commands can be executed reiteratively by preceding them with a numerical argument. In the usual operating mode, text is self-inserting: characters typed at the console will be inserted into a file rather than written over what is already there. An optional *page mode* provides the more common arrangement in which typing at the console replaces any text at the current cursor position.

For convenience, the text being edited is assumed to

contain only a single "newline" character between lines. While this character is displayed only in the sense that it moves the text following it down to the next line, it is otherwise treated in the same manner as any other character. But the files written by MINCE conform to the CP/M convention of having both an ASCII (American Standard Code for Information Interchange) carriage-return character and a line-feed character at the end of each line. Thus they are completely compatible with other CP/M programs, such as the CP/M-resident TYPE command. MINCE will display control characters embedded in the text except for those, such as newline and tab, to which the text editor responds. Control-A, for example, would appear on the display as 1A.

MINCE provides some rather arcane commands, such as one that moves the cursor to the next line and indents it to correspond with the indentation that started the previous paragraph (helpful for writing code in struc-

**IMPORTS**



**EPSON MX-80**  
Price Breakthrough - Call!

OKidata M-80 .....	\$374
OKidata M-82 .....	\$499
OKidata M-83 .....	\$754

**HIGH SPEED**



Anadex 9500/9501 .....	\$1274.00
Datasouth DS-180 .....	\$1349.00
TI 810 Basic .....	\$1499.00

**PAPER TIGERS**



445G .....	\$749
460G .....	\$895
560G .....	\$1129

**MORE PRINTERS**

Centronics 737 .....	\$719.00
Centronics 739 .....	\$795.00
DEC LA 34AA .....	\$1049.00
MPI 99G .....	\$719.00

**COMPUTERS**

**NORTHSTAR**

Burned and tested - backed by fast warranty service. Find out why our prices, availability and service make us the #1 source for the #1 S-100 system. Free games disk.

Horizon II 64K DD .....	\$2895.00
Horizon II 64K Qd .....	\$3295.00

**ALTOS**

NOW MORE FOR LESS

ACS-8000-15 has 200K RAM, 1 Mg. on floppies, 6 serial and 2 parallel ports. Upgrade w/ Winchester hard-disk drives and tape back-up. Multi-user or single user prices.

ACS8000-15 .....	\$4795
------------------	--------

**TELEVIDEO**

A new line of micros from the leading name in terminals. System 1 includes a 910 CRT, 64K RAM, 1MG on floppy, CP/M, diagnostics and more

System 1 .....	\$2995
----------------	--------

**ZENITH**

The all-in-one computer that's backed by your local Zenith/Heath service center. Green Phosphor screen and CP/M included.

Z89 w/48K 2 510's .....	\$2144
-------------------------	--------

**NEW**



Televideo 910 .....	\$589
Hazeltine Esprit .....	\$589
ADD5 Viewpoint .....	\$559
Sorec IQ 130 .....	\$589

**TELEVIDEO**



Televideo 912 .....	\$710
Televideo 920 .....	\$759
Televideo 950 .....	\$949

**TERMINALS**



Ampex D80 .....	\$925
D80 Amber .....	\$969
Mime Act 3A .....	\$799
ADM - 3A .....	\$775
Saroc 120 .....	\$729

We participate in affiliation for business and customers through the Better Business Bureau of Maricopa County.



## Scottsdale Systems Ltd.

6730 E. McDowell Road, Suite 110, Scottsdale, Arizona 85257

(602) 941-5856

Call 8-5 Mon.-Fri.  
(We Export) TWX 910-950-0082 (IMEC SCOT)

**ORDERING**

— MAIL ORDER ONLY —

2% cash discount included/charge cards add 2%. Prices subject to change, product subject to availability. Arizona residents add 5%. F.O.B. point of shipment Scottsdale. 0.20% restocking fee for returned merchandise. Warranties included on all products. Personal checks take 3 week to clear.

• NEC 5510 .....	\$2689.00
• Diablo 630 .....	\$2295.00
• C.Iroh Starwriter .....	\$1370.00
• NEC 5520 .....	\$3089.00

\*Tractors included in price

# SuperSoft's Optimizing



## for CP/M

The SuperSoft "C" compiler supports most of version 7 Unix standard "C". Several special and widely desired features are supported, including:

- Macro expansions via the `#define` statement.
- Include files using the `#include` statement.
- Inline assembly code is supported with the `#asm` and `#endasm`.
- The object code may be ROMed.
- Programs may be ORGed for any location.
- Completely dynamic memory allocation is supported, both by the compiler and in user programs. (That is, the functions `'alloc'` and `'free'` are provided with the compiler.)

SuperSoft "C" is a two pass compiler. The first pass of the compiler produces an intermediate code (U-code, for Universal code). Pass two contains both the translator and the optimizer. The intermediate code is optimized and assembly code is output to file.

The optimizer typically results in 40% code reduction. This means that compiled object code will run nearly as fast as that which was written in assembler.

An important feature of the compiler is that assembly code is produced. This means that "hand optimization" of critical sections is possible. Also, the inline coder allows easy insertion of assembly language routines.

With the compiler comes the complete source code to the I/O libraries. These libraries are equal to or better than any that exist for the 8080/280 computer system. Functions included:

```
open close read write
seek tell fopen create
putcgetc flush
```

The Seek command supports absolute, relative from front, and relative from end of file. Fopen includes `fcreat`. Also included with the compiler are numerous sample programs and a complete library of useful functions.

Compile time options include listing file, console output, syntax checking and others.

Requires: 48K CP/M, (more recommended)

"C" compiler: \$200.00

Manual only: \$ 20.00

Z8000 cross-compiler: \$500.00

(CP/M to Z8000 code, requires Z8000 assembler)

Source code for in-house use only: \$5,000.00

CP/M Formats: 8" soft sector, 5" Hardstar, 5" Microglobe Mod II, Vector MZ, Superbrain DD/DD, Apple II+

All Orders and General Information:  
SUPERSOFT ASSOCIATES  
P.O. BOX 1626  
CHAMPAIGN, IL 61820

(217) 359-2112  
Technical Hot Line: (217) 359-2691

(answered only when technician is available)

\*CP/M registered trademark Digital Research

\*Unix registered trademark Bell Laboratories



# SuperSoft

First in Software Technology

tured programming languages). Yet it is possible to make MINCE do useful work by learning only a handful of the most common commands and picking up others as your sophistication and requirements grow.

### Multiple Files

MINCE lets the user work on, or from, multiple files. Each file is read into a logically separate buffer area from which it can be operated on independently. It is also possible to move text from one file to another, as when copying blocks of text or program source code. The virtue of having the ability to deal with multiple files may not at first be obvious (at least it wasn't immediately obvious to me), but, now that I have done a bit of experimenting with multifile editing, I think that I would really miss that feature. Of course, ignorance is bliss: it didn't bother me that I could work on only one file at a time when I was using CP/M's ED program or any of the other editors I have used at one time or another.

As I write this, I am working with three files. The first contains the text you are reading at the moment. The second contains random observations about MINCE that I entered as I learned to use the program. The third file contains a description of all the MINCE commands—conveniently provided on the MINCE distribution disk—that I keep ready for reference. As I go along, I am copying some of my earlier observations almost verbatim. After editing the pertinent block of text, I just transfer it into the main file (the one I am using for this article).

When I am finished writing, I will save the article on disk, replace the original random observations file with the edited version, and do nothing at all with the list of commands, which will remain on the disk in its original form. If I wanted to, I could save the edited random observations as a new file, so both the original and edited versions would be available on the computer's file system.

It is also possible to display two files simultaneously. MINCE splits the video screen horizontally, creating two separate windows, one into each file. Each window begins at half the screen size, but can be expanded or contracted more or less arbitrarily. At the moment, for example, I am looking at this text in the top half of the display and at my earlier comments on the use of windows in the bottom half of the display. If I wanted to look at something in the file containing the list of commands, I could place that file in the bottom window without disturbing the display of the text I am writing. Since the windows are entirely independent, it is possible to move to the next page of one file while writing, editing, or maintaining the cursor position on another.

Status information is continuously displayed at the bottom of the screen. This includes the name of the file currently being edited and a percentage figure indicating how much of the existing file is behind the current cursor position (a nice feature). Among the other status indicators is one that tells the user whether a particular file has been altered. If it has, MINCE won't return to the command level of the operating system without offering an opportunity to save the altered file on disk.

## AVAILABLE TODAY

from MSD: the XENIX™ Operating System, Microsoft's Adaption of Bell Laboratories Time-Tested UNIX™ Version 7 Operating System.

MSD provides this comprehensive line of products for the UNIX community:

- XENIX Operating System
- Screen Oriented Text Editor for VT-100 Compatible Terminals
- Database Manager and Report Generator Which Will Easily and Efficiently Control Large Accumulations of Information
- Accounts Receivable System Which Can Be Used to Monitor and Control Receivables in Order to Improve Cash Flow
- Uni-Calc™ — An Electronic Spreadsheet Which Makes Financial Analysis, Forecasting and Business Planning Easier

In addition to reliable Software pre-configured for your Hardware, MSD will provide complete user support by:

- Answering your telephone questions
- Providing new releases as available
- Supplying you with the best Hardware for your UNIX requirements



**MSD Corporation**  
2449 Camelot Court, SE  
Grand Rapids, MI 49506  
(616) 942-5060

**MANAGEMENT SYSTEMS DEVELOPMENT**  
Uni-Calc, UNIX and XENIX are trademarks of MSD Corp., Bell Laboratories and Microsoft respectively

### Speed of Operation

For all its impressive flexibility, MINCE is not without its flaws, some of which it shares with other editors running in microcomputer environments. First, and worst of all, MINCE is slow. The editor doesn't seem to lose characters; frequent checking for keyboard input and the presence of a large type-ahead buffer ensure that. But MINCE can't update the screen fast enough to keep up with a fast typist. It took me quite a while to get used to the fact that one or more characters I had typed, especially when I was using multiple deletes to backspace/erase to an earlier point on a line, had already been entered in the file, but were still waiting to appear on the screen. There are commands in MINCE's repertory that I can use to get around this particular problem. But I expect characters to appear as soon as I type them, and MINCE simply can't accommodate me.

MINCE is also slow in performing certain updating functions. For example, it starts a new "page" after the user types past the last visible line on the screen. Many other editors simply scroll the previous text up one line, which is simpler than removing a whole page and replacing it with a new one because scrolling can be performed by the terminal hardware. All the editor has to do, then, is keep track of which lines are still visible on the screen. You can keep typing while MINCE figures out what to do next, and anything you type will eventually be displayed. But it may take several seconds before that happens.

Reference the Future...

# DIGITAL PRESS



**NEW!**  
LEARNING WITH COMPUTERS Bork

A comprehensive overview for using the computer as a teaching device to build a more responsive learning environment.  
1981, hardbound, 300 pages, \$28.00

**NEW!**  
THE THEORY AND PRACTICE OF RELIABLE SYSTEM DESIGN Siewiorek and Swarz

Shows how to combine economics with design and cost modeling with reliability modeling in hardware system design.  
1981, hardbound, 700 pages, \$45.00

**NEW!**  
From ENIAC To UNIVAC: An Appraisal of the Eckert-Mauchly Computers Stern

Examines the pioneering achievements of J. Presper Eckert and John W. Mauchly: the ENIAC, the EDVAC, the BINAC, and the UNIVAC.  
1981, hardbound, 286 pages, \$21.00

**NEW!**  
INTRODUCTION TO DECSYSTEM-20 ASSEMBLY LANGUAGE PROGRAMMING Gorin

Examines the instruction set, assembly language, applications and application techniques, and system features of the DECSYSTEM-20.  
1981, paperbound, 576 pages, \$35.00

COMPUTER ENGINEERING: A DEC View of Hardware Systems Design

Bell, Mudge and McNamara  
Shows how evolving technologies, marketplace economics, and manufacturing costs influence computer engineering.  
1978, hardbound, 585 pages, \$26.00

COMPUTER PROGRAMMING AND ARCHITECTURE: The VAX-11 Levy and Eckhouse, Jr.

Focusing on the VAX-11, this unique book offers a comprehensive system viewpoint to the programming and organization of today's computers.  
1980, hardbound, 407 pages, \$28.00

DATA PROCESSING TECHNOLOGY AND ECONOMICS, Second Edition Phister, Jr.

Complete coverage of DP operating costs, programming costs, system and software performance and reliability, time sharing economics, and more. (Co-published with Santa Monica Pub. Co.)  
1979, 720 pages, hardbound \$45.00; paperbound \$30.00

EARLY BRITISH COMPUTERS, The Story of Vintage Computers and the People Who Built Them Lavington

Closely examines such landmark projects as the first working stored-program computer, the first commercially available computer, and the first transistorized computer. (Co-published with Manchester Univ. Press)  
1980, paperbound, 140 pages, \$8.00

ENGINEERING INTELLIGENT SYSTEMS: Concepts, Theory, and Applications

Glorioso and Colón Osorio  
From fundamentals through advanced industrial applications, this book brings together the key elements for designing safe, practical, cost-effective intelligent systems.  
1980, hardbound, 472 pages, \$27.00

PROJECT WHIRLWIND, The History of a Pioneer Computer Redmond and Smith

The technological traditions, the research and development policies and practices, the funding crises, and the management techniques that went into this innovative engineering triumph.  
1980, hardbound, 280 pages, \$21.00

TECHNICAL ASPECTS OF DATA COMMUNICATION McNamara

A practical approach to the nuts-and-bolts problems and solutions in configuring communications systems.  
1977, hardbound, 387 pages, \$26.00

TEX and METAFONT, New Directions in Typesetting Knuth

Details TEX, a technical typesetting system, and METAFONT, a system for the precise design of alphabets. (Co-published with American Mathematical Society)  
1979, paperbound, 360 pages, \$12.00

**ORDERING INFORMATION**

Ten percent discount when ordering two or more copies. Shipping and handling free when order is prepaid by check or charge card

QUANTITY	TITLE	PRICE*

Mail to: Digital Press Order Fulfillment  
Digital Equipment Corporation  
12-A Esquire Road  
Billerica, MA 01862

Subtotal \_\_\_\_\_  
Discount \_\_\_\_\_  
Sales Tax \_\_\_\_\_  
Total \_\_\_\_\_

\*All prices quoted are U.S. only. Contact your nearest office of Digital Equipment Corporation Educational Services, for prices outside the U.S. Prices subject to change without notice

Name \_\_\_\_\_ Company School \_\_\_\_\_

Address \_\_\_\_\_

City \_\_\_\_\_ State \_\_\_\_\_ Zip \_\_\_\_\_

CHECK OR CHARGE CARD REQUIRED ON ALL ORDERS UNDER \$50  
Make Checks Payable to Digital Equipment Corporation

Check Included  Master Charge  VISA  Please place me on your mailing list

Charge Card Acct No \_\_\_\_\_ Expiration Date \_\_\_\_\_ Telephone \_\_\_\_\_

Authorized Signature \_\_\_\_\_

BYTE-81

**digital**

We change the way  
the world thinks.

Circle 116 on inquiry card.

I suspect the slowness is a by-product of two of MINCE's undeniable virtues: the way it was written and the way it updates the screen. MINCE was written in the high-level language C, a general-purpose language developed at Bell Laboratories that is often used for system-level programming (see "The BDS C Compiler" by Christopher Kern in June 1981 BYTE, page 356). Since it is written in a high-level language rather than in an assembly language, MINCE is easy to transport to other processors. This portability means that as long as MINCE's authors stay in business, someone who buys new hardware is likely to be able to buy a version of MINCE to run on it. (Perhaps those responsible for MINCE will publish their source code if their business goes under.) But the use of a high-level language on an 8-bit microcomputer inevitably imposes a considerable penalty in speed.

To update the screen, MINCE uses standard cursor positioning facilities rather than the idiosyncratic hardware page editing capabilities available on some smart terminals. This means that the editor will run on just about any terminal or stand-alone computer system available. It takes time, however, to move a cursor around and to update a display serially, even if the terminal is running, as mine is, at 9600 bps (bits per second).

### Text Swapping

Another problem with MINCE is that it swaps parts of

the file between main memory and disk during long pauses between keyboard entries. In the long run, this is to the user's advantage: performing this operation while

## At a Glance

**Name of Software**  
MINCE (MINCE Is Not Complete EMACS)  
**Type**  
Text editor

**Manufacturer**  
Mark of the Unicorn  
POB 423  
Arlington MA 02174  
(617) 489-1387

**Price**  
\$125

**Format**  
8-inch, IBM format soft-sector disks; other formats by arrangement

**Language Used**  
8080-family machine language

**Computer Needed**  
8080-family computer running Digital Research's CP/M operating system with at least 48 K bytes of system memory and floppy-disk mass storage

**Documentation**  
52-page user guide;  
5-page installation guide;  
46 pages of tutorial introduction (also included as files on distribution disk)

**Audience**  
CP/M users requiring a video terminal text editor

# DISKETTE COPY SERVICE



## Allenbach Industries

LANIER · TRS-80 · ATARI

APPLE · AND OTHERS

For Information  
Outside California Call  
(800) 854-1515 or (800) 854-1516  
In California Call Collect (714) 436-4351

Allenbach Industries  
4322 Manchester Ave. Olivenhain, CA 92024



## Unlock the Engineering Power of the Microcomputer

**Engineering Software for TRS-80 Mods I, II & III**

- Air Cond. Com. Cooling/Heating Load (New Update)
- Residential Cooling/Heating Load Structural Space Frame Analysis (New Update)
- Fire Sprinkler System Design (New Update)
- Lighting Design
- Air Duct Design
- Accounting
- Surveying
- Hardy Cross Water Analysis
- Life Cycle Cost Analysis
- Solar F-Chart, Economic Anal.
- Word Processing for Spec Writing
- Hydraulic Pipe Design
- Electrical Fault Current

CP/M Versions Available Soon

**MC12 PROGRAMS™**

McClintock Corp.  
P.O. Box 430980  
Miami, FL 33143  
(305) 666-1300

PLEASE TELL ME MORE ABOUT YOUR ENGINEERING PROGRAMS.

I am interested in \_\_\_\_\_ Phone \_\_\_\_\_

Name \_\_\_\_\_ Company \_\_\_\_\_ Address \_\_\_\_\_ City \_\_\_\_\_ State \_\_\_\_\_ Zip \_\_\_\_\_

8-9



# GUARANTEED RELIABLE FOR 2 FULL YEARS.

Unprecedented product reliability deserves an unprecedented warranty. IMS International provides its dealers with both.

## Our commitment is real.

We are so confident that our products are the industry standard in reliability, we stand behind them for *two full years* from date-of-sale to the end user. All IMS manufactured products are covered.

The success of our dealers will insure our continued growth. That's why IMS International

is committed to providing every IMS dealer with these distinct advantages in today's marketplace:

- 2 year warranty
- Low retail cost
- Best margins in the industry
- Protected territories
- Full factory technical support
- Complete system delivery in 30 days
- Comprehensive advertising and promotional support

For more information about IMS International's "Reliables" and our unique dealer plan, call 714/978-6966 or write us:

**IMS** 2800 Lockheed Way  
INTERNATIONAL Carson City, NV 89701  
Telex: 910-395-6051



the keyboard is inactive means that less disk swapping will be necessary at a time when the user is more active and when text swapping would really slow him down. But even though each swapping operation only takes about a second, I found the sudden onset of disk activity disconcerting. Fortunately, MINCE's configuration program allows the user to set the time delay between the last keyboard entry and the start of the swapping operation. MINCE's authors recommend a four-second pause. I found a twenty-second delay more to my liking.

MINCE is a large editor not only in the number and variety of its available commands, but also in its requirements for disk space. The editor proper requires 30 K bytes. During operation, MINCE must have a *swap file* available to provide space for those portions of the file(s) being edited that don't fit in the host system's available semiconductor memory. MINCE's authors say a 24 K-byte swap file is the workable minimum and recommend a 64 K-byte swap file. I evaluated MINCE and wrote this review using a 32 K-byte swap file with no serious effects, although I did have to juggle my reference files as the article grew in size. (Files not currently being used can be dropped, thus freeing space in the swap file for active files.)

### Configuration and Documentation

Selecting the size of the swap file, notifying MINCE of the characteristics of the host system's terminal, and other required set-up operations are performed by a configuration program that is very easy to use. The configuration program comes equipped with the necessary information for the terminals most commonly encountered in microcomputer systems, and it accepts user-supplied information for the less common ones. The whole configuration process is menu-driven and provides ample opportunities to correct errors or simply change one's mind.

MINCE's documentation is excellent. The user manual is well organized and crisply written. In addition, two

tutorial introductions to MINCE are supplied. One is designed for more experienced programmers, and the other is designed for the uninitiated computer user. In practice, I think the programmers' tutorial would suffice for anyone who has ever used a text editor on a computer. The general-users' tutorial claims to require nothing more than knowing how to type and how to log onto the host computer system—a claim that appears to be true. The first eight-page lesson introduces the trainee, step-by-excruciating-step, to such mysteries as how to use the delete key to erase the previous character, how to move the cursor forward and backward, and how to quit the editor when he is finished. (But, it does not explain how to write a file to disk—that is left for another lesson).

The tutorials don't pretend to cover all of MINCE's features, but anyone who is willing to work his way through them will certainly learn how to use the editor in at least a minimal fashion. Most of the tutorial material is provided on disk files as well as in hard-copy form, and many of the exercises call for the user to edit the tutorial he is working from. I found some of the prose in the tutorials a bit cloying; the exercises provided a convenient remedy.

### Conclusions

- MINCE has a large, well-planned command repertory. A user needs to learn only a small subset of the available commands to operate the editor; others can be learned as his requirements grow.
- MINCE permits multiple files to be viewed and edited—a real convenience. Two files may be viewed simultaneously on a split screen.
- MINCE is slow in updating the video display, both during user input and during cursor movement across pages (video screens). The use of a swap file also slows editing down and results in unexpected disk activity.
- MINCE is well documented. Tutorial introductions to the editor help even the novice get started easily. ■

# Plug in Pascal Power...



most processors

- 16 bit
- 128K
- 1M
- 16K

Want to know more about the benefits on the reader service card, call or write us directly.

**DEALS/DEALER**

Be sure to specify our PASCAL-100 OEM/Dealer Information Package

**Digicomp Research**  
Terrace Hill, Ithaca, NY 14850  
(607) 233-5900



**PASCAL-100 complete with extensive documentation—our users say it's the best around!**

**New Generation S-100**  
PASCAL-100 is designed for the versatile, flexible S-100 bus. Fully compatible with the new IEEE-696 standard, yet works with

Trademark of Western Digital. \*Trademark of University of California. \*\*Registered Trademark of Zilog, Inc. \*Registered Trademark of Digital Research

# HOOK 3 WINNERS



DOLPHIN ↗

**\$139.00**

WINNER #1 ↘



**\$159.00**

WINNER #2 ↘



80 COLUMN  
BLACK & WHITE  
15 MHz



P31  
GREEN  
PHOSPHOR  
15 MHz

**\$179.00**

WINNER #3 ↘



NEW  
P31 GRAPHICS UNIT  
RESOLUTION  
1000+ LINES

**WATCH  
THIS SPACE  
FOR  
COLOR  
WINNER**

By  **TECO**

**DEMAND THESE  
UNITS FROM YOUR  
DEALER!**

Data-Ed  
18 Bridge Street  
Salem, NH 03079  
603-893-2047 (collect)

- \_\_\_ TM-12GX Monitors at \$179.00 plus 2.75 shipping
- \_\_\_ TM-12G Monitors at \$159.00 plus 2.75 shipping
- \_\_\_ TM-12 Monitors at \$139.00 plus 2.75 shipping

Please send OEM information about your low cost custom fit smart printers.

- Check or Money Order enclosed
- C.O.D. Orders Accepted
- Bill my-  VISA-  Mastercharge

Card No. \_\_\_\_\_

Exp. Date \_\_\_\_\_ Bank No. \_\_\_\_\_

Signature \_\_\_\_\_



Name \_\_\_\_\_

Address \_\_\_\_\_

City, State, Zip \_\_\_\_\_

# Programming Quickies

## Changing a BASIC FOR . . . NEXT Loop into a REPEAT . . . UNTIL Loop

James A Maiorana  
c/o BYTE Publications  
POB 372  
Hancock NH 03449

When you program in BASIC, it is often necessary to construct the functional equivalent of a REPEAT . . . UNTIL loop. To do this, many programmers try using a GOTO statement, but, in long programs, many GOTOS make the program run slowly. A FOR . . . NEXT loop, however, can be modified to provide the desired function, without any GOTOS. In many BASIC programs, executing a GOTO means searching the program text to find the correct line number, whereas finding a FOR . . . NEXT loop is done directly by a pointer. I use the following technique in Apple BASIC, and find that it works correctly and produces faster-running programs.

In the following examples, *loop-body* is a block of code and *condition* is an arithmetic expression. Ordinarily, *condition* will be a Boolean expression with 0 equivalent to false and 1 to true.

The first construct uses a dummy variable D:

```
10 FOR D = 0 to 1
20 loop-body
30 D = condition
40 NEXT D
```

This code has precisely the same effect as:

```
REPEAT loop-body UNTIL condition
```

Here is an example of the technique:

```
10 FOR D = 0 TO 1
20 INPUT " GUESS MY NUMBER ", G
30 D = ( G = M )
40 NEXT D
```

This program continues to ask for a number G until G is equal to an internal parameter, M. Here *loop-body* is line 20, while *condition* is the logical expression ( G = M ). When G is not equal to M, line 30 sets D to 0. Line 40 increments D to 1, and branches back to line 10. When G equals M, line 30 sets D to 1. Line 40 then increments D to 2, and the loop terminates.

This code may have to be modified for your system. A quick survey of several BASICs showed that some interpreters return a value of -1 in the variable D when the condition in line 30 is met. (TRS-80 Level II and Texas Instruments BASIC give a -1 for true logical comparisons, while Applesoft, Integer, and Atari BASIC give a +1.) Modifying line 10 to allow for this results in an equivalent REPEAT . . . UNTIL function:

```
10 FOR D = 0 TO -1 STEP -1
```

One of these techniques should work on your BASIC interpreter. ■

# FIND OUT WHAT FITS WHAT.



Just our little effort to remove some of the vast confusion from the data processing, word processing and office products world. You can match up hardware model numbers with disc cartridges, disc packs, or diskette model numbers.

Send for our free 145-page guide. One handy book covers entire DP and WP industry usage of magnetic memory media. How can you do without it?

**NASHUA**  
COMPUTER PRODUCTS DIVISION  
Nashua Corporation, Nashua, NH 03061  
We make everything to fit anything



TELEPHONE  
New England and New York: (603) 251-1555  
East of the Massachusetts: (800) 258-1721  
West of the Mississippi: (800) 258-1349  
TELEX: 043408

Dept. A

# POWER-ONE D.C. POWER SUPPLIES

**Our customers select their favorite models**







The choice wasn't easy. Not with 105 open frame linears and a full switcher line to choose from. Still, the top models of the past year — proudly pictured below — have been named.

Actually, this is a statement of Power-One's most popular D.C. power supplies — as determined by our customers. Obviously, applications vary widely, from

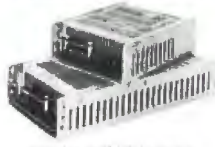
small floppies and micro-computers to large main-frame systems.

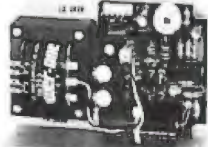
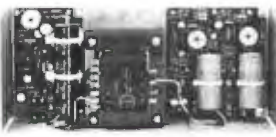
But one thing they all have in common. They're built by Power-One. Which means the most reliable power supplies available, at the lowest cost possible.

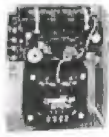
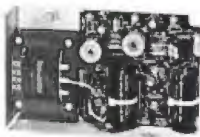
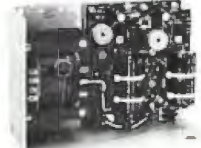
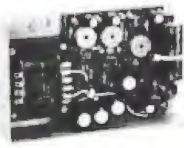
So take a look at our entire line. Send for our new 1981 Catalog and Facilities Brochure for details.

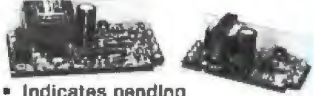
<p><b>Switchers</b></p> <ul style="list-style-type: none"> <li>• Hi-Tech Design</li> <li>• High Efficiency - 75% min.</li> <li>• Compact/Light Weight</li> <li>• 115/230 VAC Input</li> <li>• 20 msec Hold-up</li> <li>• Totally Enclosed Packaging</li> <li>• Two Year Warrantee</li> <li>• 24 Hour Burn-in</li> </ul>	<p><b>SINGLE OUTPUT</b></p>  <p>5V to 24V Models</p> <p>SD, 60W : \$115.00 SF, 100W : \$170.00 SK, 200W : \$250.00</p>	<p><b>MULTIPLE OUTPUT</b> 150 Watts</p>  <p>5V @ 20A      -12V @ 3A 12V @ 5A      5V to 24V @ 3.5A User Selectable</p> <p>SHQ-150W : \$295.00</p>	<p><b>QUME PRINTER SUPPLY</b></p>  <p>5V @ 10A ± 15V @ 4.5A/16A Peak</p> <p>SP305 : \$345.00</p>
<p><b>Disk-Drive</b></p> <ul style="list-style-type: none"> <li>• Powers Most Popular Drives</li> <li>• 7 "Off the Shelf" Models</li> <li>• Powers Drives &amp; Controller</li> <li>• UL &amp; CSA Recognized</li> <li>• 115/230 VAC Input</li> </ul>	<p><b>5¼" FLOPPY SUPPLIES</b></p>  <p>CP340, 1 Drive : \$44.95 CP323, Up to 4 Drivers : \$74.95</p>	<p><b>8.0" FLOPPY SUPPLIES</b></p>  <p>CP205, 1 Drive : \$69.95 CP206, 2 Drives : \$91.95 CP162, Up to 4 Drives : \$120.00</p>	<p><b>WINCHESTER SUPPLIES</b> 2 Models to Power any Manufacturer's Drive</p>  <p>CP379, CP364 : \$120.00</p>
<p><b>Open-Frame Linear</b></p> <ul style="list-style-type: none"> <li>• Industry Standard Packages</li> <li>• 115/230 VAC Input</li> <li>• ± .05% Regulation</li> <li>• Two Year Warrantee</li> <li>• UL &amp; CSA Recognized</li> <li>• Industry's Best Power/Cost Ratio</li> </ul>	<p><b>SINGLE OUTPUT</b></p>  <p>5V @ 3A      24V @ 1.2A 12V @ 1.7A      28V @ 1.0A 15V @ 1.5A      250V @ 0.1A</p> <p>HB Series : \$24.95</p>	<p><b>SINGLE OUTPUT</b></p>  <p>5V @ 6A      24V @ 2.4A 12V @ 3.4A      28V @ 2.0A 15V @ 3.0A      48V @ 1.0A</p> <p>HC Series : \$44.95 to \$49.95</p>	<p><b>DUAL OUTPUT</b></p>  <p>± 12V @ 1.0A or ± 15V @ 0.8A</p> <p>HAA15-0.8 : \$39.95</p>
<p><b>DUAL OUTPUT</b></p>  <p>± 12V @ 1.7A or ± 15V @ 1.5A</p> <p>HBB15-1.5 : \$49.95</p>	<p><b>TRIPLE OUTPUT</b></p>  <p>5V @ 2A ± 9V to ± 15V @ 0.4A</p> <p>HTAA-16W : \$49.95</p>	<p><b>TRIPLE OUTPUT</b></p>  <p>5V @ 3A ± 12V @ 1A or ± 15V @ 0.8A</p> <p>HBAA-40W : \$69.95</p>	<p><b>POWER FAIL MONITORS</b></p>  <ul style="list-style-type: none"> <li>• Indicates pending system power loss.</li> <li>• Monitors AC line and DC outputs.</li> <li>• Allows for orderly data-save procedures</li> </ul> <p>PFM-1 : \$24.95    PFM-2 : \$39.95</p>

**NEW '81 CATALOG & FACILITIES BROCHURE**

Get your free copies now!  
Phone or write us direct, or circle the reader service number

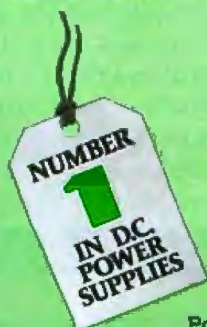
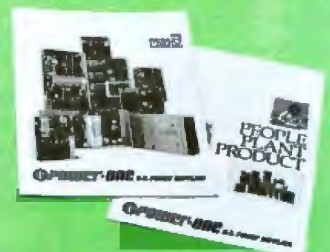

**Power-One**  
D.C. POWER SUPPLIES

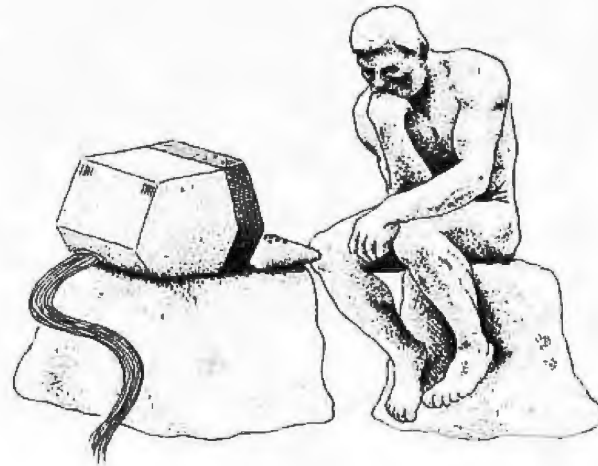

# Artificial Intelligence

---

Steven K Roberts  
5885 Dublin Rd  
Dublin OH 43017

---

What is intelligence? This question has inspired great works for centuries. It has furrowed the learned brows of philosophers, psychologists, theologians, and neurophysicists as they have sought, in different ways, to find the answer. Until recently, the question has remained more or less outside the domain of technology. Only in science fiction has the notion of intelligence applied to machines.

But man is a restless creature—thanks to his intelligence—and has a remarkable propensity for tool-building. The physical limitations of the human body are overcome daily with the use of man-made tools: bulldozers, microscopes, telephones, pens, and thousands of other devices. Very near the top of any list of tools must be the computer.

Computers, as most people know and love them, are hardly worthy of

---

## About the Author

*Steven K Roberts is a free-lance writer and microprocessor-systems consultant living in Dublin, Ohio. He is the author of Micromatics (published by Scelbi Publications) and Industrial Design with Microcomputers (to be published in early 1982 by Prentice-Hall).*

*Research for this article included attendance at the First International Conference on Artificial Intelligence, held at Stanford University in August 1980.*

---

the term "intelligence." At best, they are fast and reliable (but abysmally stupid) machines that take very precisely defined tasks and tirelessly perform them over and over. This, of course, makes them invaluable in a fast-paced technological society such

---

**Simply providing access to the large body of knowledge now available is a great problem.**

---

as ours, for we have become addicted to freedom from boring repetitive mental drudgery. (When was the last time you calculated a square root the old-fashioned pencil-and-paper way?) But for all their usefulness in assisting our many and varied efforts, computers are still absolutely uninspired contraptions.

In addition to being incurable tool-builders, mankind also has a passion for information—lots of it. There seems to be no end to the exponential growth of human knowledge (it's currently expanding at the approximate rate of 200,000,000 words per hour). On countless subjects ranging from the weather to the ills of our flesh,

from computer design to the technology of war, mankind has accumulated such masses of information that only the narrowest of specialists in any field can truly claim to be an expert.

This, however, creates problems, because now that we have all this information, we need to use it. The obvious difficulty is simply providing access to such a large library of knowledge: a person attempting to locate one small fact can easily become bogged down in searching if the library is not extremely well organized and cross-referenced. A less obvious problem is the continual addition of new knowledge to the library without creating a nightmarish jumble of patches and outdated material.

The sheer quantity of information involved in such an effort cries out for a computer solution. After all, hardware can be purchased off the shelf that provides literally billions of words of data storage—certainly enough for most "task-specific" information domains. But here we can see the need for something other than traditional data-processing techniques. (For an example of information storage using traditional techniques, see "Information Unlimited:



# DYNABYTE SYSTEMS+

## 30% DISCOUNT

*NORSEA, a worldwide distributor of Dynabyte systems, is now offering 25 to 30% discounts to domestic as well as export customers. Further volume discounts negotiable.*

### NORSEA & DYNABYTE

NORSEA sells only one microcomputer range, and that's Dynabyte. We are fully experienced in its applications and support. NORSEA was first to install Dynabyte's Multi-user Business Manager software in Winchester systems for end-user applications. Get the best buys on Dynabyte products from NORSEA, and get our experience.

### DYNABYTE PERFORMANCE

Incomparable quality, superior software support, and the widest range of microcomputer systems in the industry make Dynabyte the leader. And check out these standard features: Real time clock, 10 Interval Timers, 8 Levels of Vectored Interrupts, Jump Start, 2 Serial and 1 Parallel ports, and 64K RAM expandable to 400K.

### HARD DISK SUBSYSTEMS

(Can be daisy chained for up to 104 MB of Storage)

Formatted with S-100 Controller, PSU and Cabinet.

M10-10MB-8"	\$2,995
M20-20MB-8"	3,830
M26-26MB-14"	3,995

Subsystems also available in OEM stripped down versions.

### PERIPHERALS

Televideo 950	\$ 949
Starwriter I	1,599
Starwriter II	1,799
DataSouth DS-180	1,399
Tally T-1705	1,799
Dataproducts M-200	2,099

### SOFTWARE

Full range of assemblers, languages and application software at discount prices.

#### TERMS

All prices quoted prepaid and FOB point of origin. Prices are subject to change without prior notice. Call or write for detail terms.

#### TRADEMARKS

Business Manager by Dynabyte CP/M by Digital Research Starwriter by C. Itoh.

### DYNABYTE COMPUTERS

5100-A2 Microcomputer only, with 64K RAM, 3 I/O Ports.	List \$3,395	Net \$2,375
5200-A2 Dual 5 1/4" -630KB	List \$4,595	Net \$3,395
5300-B2 Dual 8" double density floppies-2MB	List \$6,995	Net \$4,995
5615-A1 11MB Winchester and 8" double density floppy.	List \$11,995	Net \$8,995
5615-B1 23MB Winchester and 8" double density floppy.	List \$13,495	Net \$9,995
5615-C1 45MB Winchester and 8" double density floppy.	List \$15,495	Net \$10,995

Systems also available with tape cartridge backup and cartridge disk drives at similar savings. Call for details.

### SINGLE BOARD CP/M SYSTEM \$750

Single card 8 1/2 by 12 inches by NorControl with 8085 CPU (10MHz), 64K RAM, 3 each RS-232 I/O ports, controller running one to four single or double sided 8" floppy drives, 2K EPROM for bootstrap and monitor. Select our CP/M 2.2 for single or double sided drives. Assembled, tested and burned in for one week! PSU not included. OEM discounts available.

NC-85 Single Board Computer	\$750
Technical Manual	\$ 15
CP/M 2.2 Single sided	\$150
CP/M 2.2 Double sided	\$180

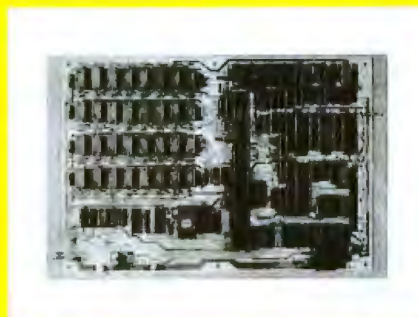

### INCREDIBLE PACKAGE PRICES!

NORSEA has assembled the following special system packages for additional savings:

**NOR-8020 System**  
Dynabyte 5300-B2 with Dual 8" double density, 64K RAM, 2 serial - 1 parallel ports. Tally T-1705 Professional 160 Matrix Printer. Televideo 950 smart terminal. CP/M 2.2 included!  
List \$10,435 **Net \$7,695**

**NOR-8111 System**  
Dynabyte 5615-A1 with 11MB Winchester and 8" double density floppy. As above with Tally printer, Televideo 950 terminal and CP/M 2.2!  
List \$15,435 **Net \$11,695**

### EXPORTS

NORSEA specializes in the export of Dynabyte microcomputers and a selected range of high quality peripherals. We are experienced in international trading and we pride ourselves on fast and courteous service at the lowest prices possible.

### FOREIGN DISTRIBUTORS WANTED

NORSEA is seeking distributors all around the world for exceptional opportunities with Dynabyte and other quality NORSEA selected products.

Wir sprechen deutsch.  
Nous parlons francais.  
Hablamos espanol.  
Vi snakker norsk, svensk og dansk.

To Order Call  
(203) 775-0438 / 775-4465  
or Telex 969638

# 999 NORSEA

DATA CORPORATION  
U.S. Route 7, Brookfield  
Connecticut 06804 U.S.A.  
IN CANADA:  
NORSEA DATA PARTNERS  
MISSISSAUGA, ONT.

The Dialog Information Retrieval Service," by Stan Miastkowski, June 1981 BYTE, page 88.)

### Types of Knowledge

Knowledge about almost anything can be split into two major classifications: factual and heuristic. Factual knowledge is the most obvious and needs little elaboration; it's often called "textbook knowledge." The heuristic variety, on the other hand, is a little harder to store in a computer. It is the network of intuitions, associations, judgment rules, pet theories, and general inference procedures that, in combination with factual knowledge about a field, allow

mankind to exhibit intelligent behavior. (Further muddying the programming waters is a higher level of knowledge that can be included within the heuristic category: "meta-knowledge," which is concerned with general problem-solving strategy and such esoterica as awareness of how to think.)

Factual knowledge has been resident in computer systems for decades. Business systems containing records of customer, personnel, inventory, and accounting data typify the rather pedestrian uses to which the majority of large systems have been relegated. If most of the world's computers suddenly became self-

aware, they would be terribly bored with their fates.

Heuristic knowledge is substantially more difficult to represent in a program or data base than simple factual data. But any system that is intended as a sophisticated information resource must, in some fashion, incorporate this higher level of knowledge, if for no other reason than to reduce the problem of finding a given piece of information to one of manageable proportions.

Suppose, for example, that a system were created to provide physicians with clinical advice about certain infectious diseases. A mere listing somewhere in the computer's mem-

# MIND YOUR OWN BUSINESS

THE FORMULA™ will help you get the information you need to help run your business. It is a ready made set of computer programs which can create a customized system for any business function:

- Accounting is as simple as 1, 2, 3
- Inventories are stock items
- Mailing lists become a zip
- Legal forms fit the modus operandi

Whether you hire a computer professional or develop a system yourself, THE FORMULA™ will let you spend more time where it will do the most good, minding your business. That's THE FORMULA™ for success.

Disk and manual, \$595. Manual only, \$60.

THE FORMULA™ will run on any 8080 or Z80 computer with CP/M,\* 48K RAM, 300 K total disk storage, and a CRT.

**DMA • WE SPEAK YOUR LANGUAGE.**

Circle 121 on inquiry card.

DYNAMIC MICROPROCESSOR ASSOCIATES • 545 Fifth Avenue, New York, New York 10017 • (212) 687-7115

We ship prepaid and COD orders. Shipping & handling charges extra: \$5 UPS areas; \$7 non-UPS areas, Mexico, Canada, \$10+ elsewhere. MasterCard and VISA accepted. New York State residents add appropriate sales tax. \*CP/M is a trademark of Digital Research.



See us at Comdex '81 in Las Vegas, Booth #774.

# The BOS M System: The Universal Donor

Type "O" Positive

*The BOS M Card is the heart of the M System. It is designed to be IEEE S-100 bus compatible for universal system use. Virtually all elements of a computer mainframe now reside on one S-100 card — Z-80A CPU, 64k of 200ns RAM (no wait states), 4k 250ns EPROM, Winchester Disk I/O port, two RS-232 serial ports, system port, floating point processor, and parallel I/O. The same M Card can be used in single-user, multi-user, or even multi-processor systems.*

***Second Generation Multi-Processor.** With the BOS M Card, multi-processing is finally free of the Master/Slave and hand-shaking parameters so prevalent in first generation multiprocessors. Inter-system communications are FIFO buffered; the old "Master" is now a slave to the user, and the system functions without "S-100 bus overrun" or system generated wait states.*

***The Universal Processor is now a reality!** As a single-user system, the BOS M is unmatched in performance (up to ten times the speed of other microcomputers). As a multi-user system, this power can be translated into a low cost multi-terminal capability. As a multi-processor, the system leaves the realm of "microcomputer" and competes in performance with a minicomputer! You can start with a single-user computer and expand to a multi-user/multi-processor computer system when needed.*



***The Universal Product.** BOS has what you need — anything from a single M Card to a complete turnkey computer system. Diskette, rigid disk, tape and telecommunications sub-systems are all available. Compatible software includes CP/M\*, MP/M\*, CP/NET\*, BOS/TURBODOS, complete monitor, languages, application packages, and more!*

**Dealer and OEM Inquiries Welcome**

# BOS

**Business Operating Systems, Inc.**  
2835 East Platte Avenue  
Colorado Springs, Colorado 80909  
In Colorado Call: (303) 634-1541  
Toll Free Number: 1-800-525-3898

**The BOS M System does what a Universal Donor must do — it provides high performance for all system types; single-user, multi-user, and multi-processor. M Systems start at less than \$5,000.00 for a single-user computer with dual 8" double density diskette drives.**

\*Registered Trademark  
of Digital Research.  
TURBODOS is  
a product of  
Software 2000.

## Your Computer Can Speak with an Unlimited Vocabulary.

- Text-to-speech algorithm vocally reproduces any typed entry
- Unlimited vocabulary
- Standard RS232C interface

## Your computer has a lot to talk about.

This is the advance in computer speech synthesis you've been waiting for. Votrax<sup>®</sup> brings your computer to life with Type-'N-Talk<sup>™</sup>. Now you can hear your computer tell you where you are in a program; taunt you with comments during computer games; praise you; remind you; warn you.

Thanks to the unique Votrax<sup>®</sup> text-to-speech algorithm, Type-'N-Talk<sup>™</sup> gives your computer an unlimited vocabulary. Your typewritten words are automatically translated into electronic speech.

## If you can type, your computer can talk.

Because Type-'N-Talk<sup>™</sup> uses ASCII code from your computer's keyboard to generate synthesized speech, you just enter English text to hear a verbal response (electronic speech) through your audio loudspeaker. For example, if you type "H-E-L-L-O" on your ASCII keyboard, it will generate the spoken word "HELLO."

*"now you're talking"*



## Type-'N-Talk™ has its own memory.

Even the smallest computer can talk and execute programs simultaneously, because Type-'N-Talk™ has its own built-in microprocessor and a 750 character buffer to hold the words you've typed. Type-'N-Talk™ doesn't use your host computer's memory or tie it up with text translation.

## If you can hardcopy it, you can hear it.

By placing your Type-'N-Talk™ between your computer or modem and a terminal, you can hear all the data sent to the terminal while online. Random-accessed information from a remote data base can now be seen and heard, because Type-'N-Talk™ says it all.

Type-'N-Talk™ has the data switching capability that allows you to "de-select" while sending and receiving data to and from a terminal. Data switching lets you send speech and visual data independently on a single data channel.

## Interface any way you want.

Special control characters let you interface Type-'N-Talk™ in a variety of ways. Unit assignment codes allow you to daisy-chain multiple Type-'N-Talk™ units. You can also have independent control of Type-'N-Talk™ and your printer by using unit addressing codes.

Connect Type-'N-Talk™ directly to your computer's serial interface and you can eliminate the need for additional RS-232C ports by connecting terminals, printers or additional Type-'N-Talk™ units to the first Type-'N-Talk™.

Votrax™ developed Type-'N-Talk™ to function with operator designed programs or with the new *Votrax™* talking software currently under development. Type-'N-Talk™ can also be used without software.

The Type-'N-Talk™ unit's simplicity enables it to be used by the beginning hobbyist, yet its total capability can challenge the most sophisticated user.

## Now You're Talking — just \$375.00.

- Text-to-speech algorithm
- A one-watt audio amplifier
- SC-01 speech synthesizer chip (data rate: 70 to 100 bits/sec.)
- RS-232C interface
- Selectable baud rate (75-9600)
- Selectable data modes for variable interfacing
- Phoneme access modes
- 750 character buffer
- Data switching capability
- Data echo of ASCII characters
- Complete programming and installation instructions

Type-'N-Talk™ is covered by a limited warranty. Write *Votrax™* for a free copy.



Order now. Toll free.

1-800-521-1350

Dealer inquiries invited.

Call the toll-free number to order or request additional information. MasterCard or Visa accepted. Charge to your credit card or send a check for \$375.00 plus \$4.00 delivery. Add 4% sales tax in Michigan. California residents add appropriate sales tax.

Send check to:  
Votrax™ - Consumer Products Group  
500 Stephenson Hwy., Troy, MI 48084

Circle 380 on Inquiry card

# NOW TYPING IS TALKING, WITH TYPE-'N-TALK™.

ory and storage of all the known facts is essentially useless—the only way one could make use of the data would be the simplistic matching of a set of symptoms against sets of indications for each disease.

This kind of approach is doomed from the start: some symptoms are less suggestive of certain diseases than others. Therefore, the system should have the ability to order specific additional tests (giving preference to non-invasive ones) before attempting a diagnosis. Also, the patient's age, environment, and medical history must be taken into account. Amidst all this, there must be the capability of ignoring certain facts if they are inconsistent with the most strongly suggested diagnosis—a patient's tennis elbow, for example, is probably unrelated to his or her infectious meningitis.

If the machine is to be more useful than a textbook, it must be able to do all these things, as well as provide a facility for updating its own information as often as required. In summary, it must possess a measure of in-

telligence.

Such a system is not mere conjecture, by the way. One has already been created to provide diagnosis and therapy selection for two major types of diseases: blood infections and meningitis. Developed at Stanford University by doctors Bruce Buchanan and Edward Shortliffe, the program, called MYCIN, has outperformed human diagnosticians in the identification and treatment of diseases in this class, not only through its accuracy in pinpointing the pathogen, but in its avoidance of overprescribing treatment.

This last accomplishment is especially noteworthy, because the standard clinical approach to an unknown disease involves a broad-spectrum antibiotic attack on a wide variety of possibilities. This not only exposes the patient to potential toxic effects, but encourages the development of drug-resistant bacterial strains. (A recent Stanford University study revealed that one of every four persons in the United States received penicillin under a doctor's orders in

1977 and that nearly 90% of these prescriptions were unnecessary.)

### A Technology Is Born

For all of these reasons, along with many others ranging from the inadequacy of standard programming techniques to the sheer joy of research, computer science has spawned a new discipline: artificial intelligence (AI).

Actually, AI is not all that new: some of the foundations that underlie today's work were laid in the late 1940s and early 1950s by Alan Turing, whose "imitation game" (today called the "Turing Test") is still considered a valid method for determining whether or not a machine is intelligent. In essence, the Turing Test consists of an interrogator communicating via teleprinters with a human and a computer. The interrogator can attempt in any way possible to determine which is which through conversation over the communication links.

At first glance, it might seem that the examiner could easily tell the difference by asking such questions as, "What is 35,289 divided by 9117?" The human would presumably chew on it for a while, and the computer would instantly spit back an answer correct to twelve digits. The flaw in this kind of thinking is that the human might have an electronic calculator in his pocket and the computer, if indeed intelligent (and devious), might give a slow and erroneous answer just to fool the interrogator. Also, the computer might be unable to calculate as rapidly as we would expect, since much of what we call intelligence involves the storage of information in a relatively abstract and very symbolic form. It is possible that such a machine would have to go through a set of thought processes not markedly different from ours to do mathematical calculations, though for the sake of convenience, it would probably have a built-in "calculator."

Turing's work in this area was strangely prophetic and, for the conservative 1950s, somewhat radical. He wrote, "I believe that at the end of the century the use of words and general educated opinion will have altered so much that one will be able to speak of machines thinking with-

**VT 100 Owners!**

## **THE KEY TO FAST AND EASY EDITING** (OF YOUR KED EDITOR)



INTRODUCING VT 100 KEYS FOR THE KED EDITOR... These quality 3-color keys will make editing faster and simpler. They're easy to install—no overlays—just pull out the old keys and push in a new set with the KED functions clearly stated. A set of 18 3-color keys — \$40.

**SynTronics** 4 Frost St./Cambridge, MA 02140  
(617) 739-7710

# Finding the best software on the market can take you weeks.

# Reading this ad takes 31.7 seconds and gives you the same results!

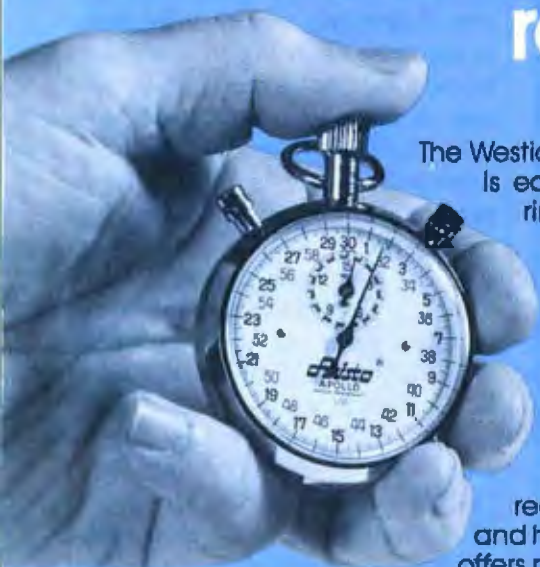

The Westico Software Review Committee is easy to recognize. It's their red-rimmed eyes. You get that way checking through an endless parade of software programs. And they do it so that you don't have to. But selecting good software is only part of what makes Westico one of the fastest growing companies in the software industry. Having experts on staff who really understand both software and hardware is another. But Westico offers more than quality products and

support. We offer our unique 24-hour service overnight! Westico. We're working hard to be your software company.

The Westico 24-Hour Computer Hotline (300 baud) (203) 853-0816 for detailed program information and quick access ordering.

—A full range of professional software.

—Support for a wide variety of CP/M® and other computer systems, including: TRS-80 Model II, Apple, Vector Graphic, Cromemco, North Star, Micropolis, Ohio Scientific, Altos, Dynabyte, SuperBrain, Xerox, Zenith and more.

## TWO MORE GREAT PROGRAMS FROM WESTICO

### LYNX, a friendly overlay linker.

LYNX is an overlay linker for creating executable programs from relocatable files produced by Microsoft's FORTRAN, COBOL, and MACRO-80 languages.

LYNX allows the construction of programs that use all available memory including that used by LYNX itself. Maximum size programs under Microsoft's L80 linker can be increased at least 9K using LYNX without overlays.

The overlay capability of LYNX is vital for programs larger than available memory. With overlays, many large programs on minicomputers or large mainframe computers can be easily moved to a microcomputer.

LYNX offers many features not found in L80. For example, LYNX can be told to get commands from a disk file. The "HELP" feature displays a complete list of LYNX commands. Mapping information can be sent to the screen, printer or disk files. LYNX can decode Microsoft REL files for inspection.

LYNX uses overlays in a tree structure. Any routine is available to any overlay that is higher on the branch than the routine itself.

Complete system with documentation \$250. Documentation alone \$25.

### Now it makes sense to MINCE words.

MINCE is a full screen editor based on the "Emacs" text editor, developed after years of research in editor technology and user interface at M.I.T. and other universities. With MINCE you can edit several files simultaneously, allowing the text to be moved between the files. The screen can be divided to display any two files or two parts of the same file at one time. Text can be manipulated by the word, sentence or paragraph, as well as character, line and entire screen with simple, easy-to-remember commands.

MINCE automatically adjusts line length to margins as the text is entered. Commands change words to UPPERcase, lowerCASE or Capitalize. The MINCE unique "query replace" allows global changes to be "tried-out" and then accepted or rejected. Lines can be centered, "white space" removed and text then inserted or overwritten. MINCE is as powerful an editor for programmers as it is for creating documents. MINCE features "type ahead" and a status line which constantly displays: editing mode, the files being edited, the current position in the file, the file modification — if any, the state of the "save" buffer and the command currently being executed. Complete system with documentation — \$175. Documentation alone — \$25.

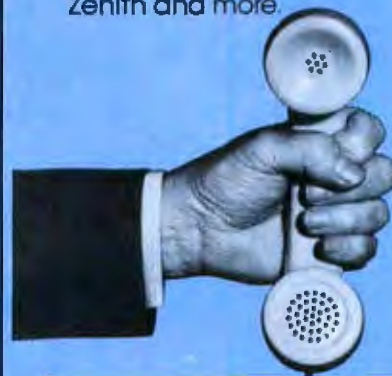

### 4 Ways to Order

- Write Westico, Inc., 25 Van Zant Street, Norwalk, CT 06855.
- Call (203) 853-6880.
- Telex 643-788.
- Dial-up our 24-hour computer (300 baud) (203) 853-0816.

COD, MasterCard and VISA accepted.

Prices do not include shipping and are subject to change. In CT add 7 1/2% sales tax. All sales final.

Manual price may be credited toward purchase of software.

Dealer inquiries invited. Copyright © 1981 Westico, Inc. WES-36

# WESTICO

## The Software Express Service

25 Van Zant Street • Norwalk, Connecticut 06855  
(203) 853-6880 • Telex 643-788

Send for **FREE** catalog.



# IF YOU CAN RECOGNIZE VALUE YOU CAN SAVE \$500<sup>00</sup>

INTRODUCTORY  
OFFER

## M.T.I. MOD III

Now You Can Save  
\$500 over comparable model.

# \$1998

We have taken the basic 16K Model III expanded the memory to 48K and added our MTI Double Density, Dual Disk Drive system. System is fully compatible with Radio Shack DOS and peripherals.



## MOD III/EXPANDED

Same as above but has double storage capacity (708K storage). Your choice of 2 dual headed 40 track drives or 2 single headed 80 track disk drives. Includes Microsystems DOS plus 3.3

# \$2499

## MOD III/280

Our largest MOD III, approximately 1.5 mega bytes of storage, utilizes 2 dual headed 80 track, double density disk drives. Complete with manuals and professional operating system, Microsystems DOS plus 3.3 (40 & 80 track capability).

# \$2799

MTI has a complete line of COMPUTER add ons:

### INTERNAL DISK KIT 40 OR 80 TRACK

Drive Kit #1 from \$699      Drive Kit #3 from \$379  
Drive Kit #2 from \$279      Drive Kit #4 from \$359

### EXTERNAL DISK KIT 40 OR 80 TRACK

TRS DOS & Manual \$21.95  
DOS PLUS from \$99

## MTI MOD III SALES, PARTS & SERVICE CENTERS - INDEPENDENT DEALERS

WASHINGTON . . . . . (509) 534-3955	TUCSON, AZ	(602) 323-9391	GEORGIA	(404) 449-8982
SAN JOSE . . . . . (408) 946-1265	SIERRA VISTA, AZ	(602) 458-2479	FLORIDA	(305) 981-9091
SANTA CRUZ . . . . . (408) 427-0836	TEXAS	(214) 247-6679	WHITE PLAINS, N.Y.	(914) 948-7980
SAN DIEGO . . . . . (714) 281-0285	N & S DAKOTA	(701) 594-5674	ASTORIA, N.Y. . . . .	(212) 728-5252
HAWAII . . . . . (808) 261-4042	MIDWEST	(618) 345-5068	TROY, N.Y.	(518) 273-8411
TEMPE, AZ . . . . . (602) 839-0546	CLEVELAND, OHIO	(216) 779-6040	REP. OF SOUTH AFRICA	021-45-1047
PHOENIX, AZ . . . . . (602) 244-9739	MAUMEE, OHIO	(419) 893-4288	AUSTRALIA	03-877-6946



## MICROCOMPUTER TECHNOLOGY INC.

3304 W. MACARTHUR, SANTA ANA, CA 92704  
• (714) 979-9923 • TELEX 6780401 TABIRIN •

\*Uses MTI Memory, Disk Drives & Components.



U.S. PRICES  
F.O.B. SANTA ANA,  
CALIFORNIA

There are some very sophisticated information-processing operations going on here. In this dialogue, most of the real meaning—the real communication—is not explicitly stated. He opens by inquiring whether she is hungry and, in the process, is probably implying that he is hungry as well. She processes this and issues a very cryptic response. Not only does she inform him that she is either hungry or willing to go along for a ride, but also suggests a specific place to eat and, further, hints at economic realities by weighting the selection of a restaurant on the basis of a discount coupon. Her statement assumes that he will understand what a coupon is as well as what a McDonald's is. His next question indicates even deeper communication: he has agreed with her about the choice of restaurant and suggests a specific mode of transportation. This suggestion, however, is made in a roundabout fashion: he asks if she knows where his keys are at the moment, assuming that she knows not only what keys are but that they are linked with transportation. She, of course, understands that the keys he's talking about are those of his automobile and suggests a course of action that will solve the transportation problem—correctly assuming that he will not only know which dresser she means, and that a dresser is a piece of furniture, but that he will deduce that the keys must be there.

The implication is that communication between two people involves substantially more than the lexical meanings of the words. The conversation above would not have been so succinct if he had approached a stranger on the street with the same question. The difference suggests the existence of a special relationship between he and she: they share certain aspects of their internal models of the world.

This highlights a crucial truth: language has to be considered as only one part of a much more complex communication process, one in which the knowledge and states of mind of the participants are as much responsible for the interpretation of verbal utterances as are the words from which

those utterances are formed. As a conversation progresses, the internal state of each participant continually changes to represent the modified reality that is the result of the communication.

(Frequently, problems occur between people when their respective internal models of the world differ sharply. "I had to work late," can be interpreted in a drastically different way from that intended by the speaker.)

When one attempts to build an intelligent machine, the complexities introduced by this larger view of communication can be surprising. Early systems were developed without a clear awareness of the problem and were constructed of a stored body of facts with associated keywords that were used (eg: Joseph Weizenbaum's ELIZA program) to scan the input messages. Whenever there was a match, sets of specific rules were invoked to produce a response based on both the system's knowledge and the keywords it had located. No attention was given to the actual meaning of the sentences, just to the presence of certain words. Such systems quickly fail the Turing test.

As time went on, it was recognized that the communication problem is interwoven with knowledge itself. In the mid-1960s, programs were developed to translate input sentences into an internal formal language that, theoretically, would allow the system to perform inferences without needing to handle all the subtleties of ordinary conversation. But the knowledge and the meanings of words were still represented as passive data "objects" distinct from the program itself. Thus, it was difficult for any but the most rudimentary changes to occur in the system's internal model of the world.

Recently, a different approach has begun to show promise. Instead of clear differentiation between the "intelligent program" and the knowledge, the programs actually embody the knowledge in their structure. With the existence of powerful AI languages (such as LISP), it is possible for the system to learn and grow by modifying itself.

## VISIT THE MicroAge<sup>®</sup> STORE IN YOUR AREA!

9530 Viscount  
El Paso, Texas  
(915) 594-3349

614 Rockville Pike  
Rockville, Maryland  
(301) 762-7585

5742 E. Broadway  
Tucson, Arizona  
(602) 790-8959

2760-S South Havana  
Aurora, Colorado  
(303) 696-6950

1707 Monroe Avenue  
Rochester, New York  
(716) 244-9000

1220 Melbourne Drive  
Hurst, Texas  
(817) 284-3413

2676 Mayfair Road  
Milwaukee, Wisconsin  
(414) 257-1100

2065 El Camino Real West  
Mountain View, California  
(415) 964-7063

2525 N. Scottsdale Road  
Scottsdale, Arizona  
(602) 941-8794

1490 W. Spring Valley Rd.  
Richardson, Texas  
(214) 234-5955

83 South 10th Street  
Minneapolis, Minnesota  
(612) 338-1777

24 W. Camelback  
Phoenix, Arizona  
(602) 265-0065

2591 Hamilton Rd.  
Columbus, Ohio  
(614) 868-1550

8615 Allisonville Rd.  
Indianapolis, Indiana  
(317) 849-5161

1617 N.E. 122nd Avenue  
Portland, Oregon  
(503) 256-4713

79 Main Street  
Norwalk, Connecticut  
(203) 846-0851

11413 Olive Street Road  
St. Louis, Missouri  
(314) 567-7644

5815 Menaul N.E.  
Albuquerque, New Mexico

### COMING SOON TO:

San Diego, California  
Spokane, Washington  
Toronto, Canada  
Boston, Mass.  
Pompano Beach, Florida  
Palm Beach, Florida  
Houston, Texas  
Wilmington, Delaware  
Panama City, Panama  
Salina, Kansas  
Anchorage, Alaska  
Walnut Creek, California  
Tinley Park, Illinois  
Oklahoma City, Oklahoma  
Chicago, Illinois  
Washington, D.C.

FOR FRANCHISE  
OPPORTUNITY  
INFORMATION CALL  
**(602) 968-3168**



# CASH FLOW PROBLEMS?



## IT'S NICE TO KNOW SOMEONE WHO HAS THE SOLUTION.



MicroAge is your Solution Store . . . that means at MicroAge Computer Stores we have a wide selection of time-saving computerized business systems designed specifically to solve the daily cash flow problems every businessman faces.

MicroAge has computerized business systems that quickly and affordably allow you to regain control of your critical accounts receivable . . . at last making it possible for you to carry out effective collection procedures on a consistent basis. MicroAge has accounts receivable program packages to automatically display and update account information; prepare trial balance including a balance-due and delinquency aging

report, and take care of dozens of other tasks that eat into your time and profit!

Computerized business systems from the MicroAge Computer Store are available in the \$5,000 to \$15,000 range, to suit the individual budget of your small business or professional practice. MicroAge backs up every system with personalized service, warranty service and repair, installation, systems consulting, even customer training. Visit the MicroAge Computer Store in your area soon with your business problems, and let us help you with the solution.

**MicroAge.**  
**COMPUTER STORE**

*"The Solution Store" <sup>SM</sup>*

This all sounds very anthropomorphic, but there is still a vast gulf between our minds and even the best of the artificially intelligent systems. Though we have the technology to provide an equivalent amount of raw data storage, we may be going about it all wrong.

### Serial Versus Parallel

There are numerous computational feats that humans manage to accomplish daily without conscious effort. Many of them are still impossible for computers. Take pattern recognition, for example. When a friend walks into the room, you can establish his or her identity with a casual glance. The accuracy of your decision is not markedly affected by the set of the jaw, the tilt of the head, or disheveled hair.

According to current theories, you simply map a preprocessed visual image via some feature-extraction "hardware" onto a gigantic multidimensional associative memory. The answer pops out, linked with an elaborate internal model of your

friend. Big deal.

A computer, on the other hand, has quite a chore to perform when it is fitted with a television camera and directed to recognize a face. It must scan the image raster dot by dot to acquire a numeric representation in memory. Then, it must engage in fast and furious number-crunching to calculate the spatial Fourier transform of the face. Elapsed time at this point might be pushing a minute or more, and the machine still hasn't the foggiest notion of who it's looking at. Then comes the hard part: one by one, the system must perform two-dimensional correlations between its freshly calculated data and blocks of stored image data corresponding to the people it "knows"—in each case, coming up with a number (the correlation coefficient) between 0 and 1 that expresses how much like a stored image the current image is. The stored image with the highest coefficient is deemed to be the one that matches.

But, if the person in front of the camera parts his hair differently,

cocks his head to one side, and takes on a dramatic expression, then he might as well have just become someone else.

This problem gives specialists in image recognition fits. If a computer's logic devices can switch as much as a million times faster than human neurons, it would seem that even intensive tasks such as pattern recognition could be done with correspondingly greater speed, even if not with ease.

Not so. Here's the catch, and its solution will probably represent the next major revolution in computer design: Brains don't center around single devices called "processors." Computers do. Operations that the brain seems to perform with the simultaneous activation of millions of widely distributed logic elements must be performed in a computer by funneling the entire task through one tiny bottleneck. In many cases, the blinding speed of computer hardware more than makes up for this handicap (in calculating, sorting, etc) but in the types of problems encountered in the

"I have recently used Spellguard and I can only echo the evaluations of a recent Infoworld review: excellent all the way."

**Mark Garetz**  
Infoworld 25  
May 1981

"Spellguard is an example of the new standard—fully professional microcomputer software."

**Bill Burns**  
Infoworld 30 March  
1981

"... Spellguard was given the manuscript from my first book. This version had been corrected after several (human) proofreaders thoroughly reviewed it. I therefore expected it to be relatively error free. Not so. Spellguard was

able to discover numerous typographical errors..."

**Allan Miller**  
Interface Age  
June 1981

"This easy to use, operator-oriented program has saved me

countless hours of proofreading, and from the embarrassment of submitting a manuscript with typos. Unlike most spelling test programs, Spellguard is fast..."

**Tony Dowden**  
Microcomputing  
May 1981

## EXPERTS AGREE

**SPELLGUARD™**  
**IS THE FASTEST**  
**EASIEST TO USE**  
**MOST POWERFUL**  
**AND RELIABLE**  
**SPELLING CHECKER**  
**YOU CAN BUY**

**InfoWorld**  
Software Report Card

**SpELLGUARD**

	Poor	Fair	Good	Excellent
Usefulness	<input type="checkbox"/>	<input type="checkbox"/>	<input type="checkbox"/>	<input checked="" type="checkbox"/>
Documentation	<input type="checkbox"/>	<input type="checkbox"/>	<input type="checkbox"/>	<input checked="" type="checkbox"/>
Ease of Use	<input type="checkbox"/>	<input type="checkbox"/>	<input type="checkbox"/>	<input checked="" type="checkbox"/>
Error Handling	<input type="checkbox"/>	<input type="checkbox"/>	<input type="checkbox"/>	<input checked="" type="checkbox"/>

### System Requirements

- CP/M (1.4 or later)
- 32 K bytes of memory
- One or two disk drives

Price: **\$295**

**ISA**

**INNOVATIVE SOFTWARE APPLICATIONS**  
260 Sheridan Avenue, Suite 300  
Palo Alto, CA 94306  
P.O. Box 2797 Menlo Park, CA 94025  
(415) 326-0805

# SUPERBRAIN QD™

## VS.

# SUPERBRAIN™

## the two top microcomputer contenders

When you decide to buy a microcomputer system, it usually gets down to one model versus another. Will it be the SuperBrain from Intertec... or one of those other models from Intertec's competitors? Well, there's really not much of a choice in the price/performance competition. The SuperBrain wins hands down! And it's a pretty tough contender if reliability, factory support and nationwide service are important to you. So what do you do? Choose our SuperBrain just because you know it's best? Or keep waiting for someone to announce something better?

### WAIT NO LONGER...

It wasn't enough that our SuperBrain had such standard features as twin double-density disk drives with nearly 350,000 bytes of disk storage. A full 64K of dynamic RAM. A CP/M\* Disk Operating System which assures compatibility to literally hundreds of application packages. A crisp, 12" non-glare screen with a full 24 line by 80 column display. A full-featured ASCII keyboard with a separate keypad and individual cursor control keys. Twin RS232 serial ports for fast and easy connection to a modem or a printer. Plus, dual Z80 processors which operate at 4 megahertz to insure lightning-fast program execution. No, it wasn't enough. So we changed it. We made it even better!

### ANNOUNCING SUPERBRAIN QD...

Our new QD model boasts all the features of our phenomenally popular SuperBrain with the addition of double-sided disk drives. So, for only a modest increase in price, you can order your next SuperBrain with more than twice the disk storage. But, best of all, you can field upgrade the disk capacity of either model to a whopping 10 megabytes! Now how's that for a choice?

### HOW DID WE DO IT?

The secret of SuperBrain QD's incredible disk storage lies within our new double-density, double-sided disk drives. Nearly 750,000 bytes of data can be formatted on two specially designed 5¼" drives. More than enough to tackle almost any serious small business application. Plus, SuperBrain QD's 64K of dynamic RAM will handle even your most complicated programming tasks.

Of course, if you really need megabytes instead of kilobytes, just add our 10 megabyte CompuStar™ Disk Storage System. It connects in seconds and gives you the capability to expand your system into a powerful multi-user network with up to 255 CompuStar terminals. You can add users one at a time as you need them. So no matter how much your needs expand, your original investment in computer hardware is always protected.

### BUT IS IT RELIABLE?

Our best salesmen are our present customers. Not only have SuperBrain and QD users been impressed with the inherent reliability of the systems, they tell us that no other microcomputers available offer such a unique modular design concept. Just about the only service tool required is a common screwdriver. But of course if you'd rather let us do the service, our total commitment to product and customer support, with service outlets in most major cities, will guarantee your satisfaction for many years to come.



The CompuStar™ Disk Storage System  
... Connects in seconds to either model.



\*Registered trademark of Digital Research, Inc.

### THE DECISION IS YOURS...

Whether your next microcomputer is the SuperBrain or our QD model, you'll be purchasing what is becoming one of the world's most popular microcomputer systems. And regardless of which model you choose, you'll probably never outgrow it because you can keep expanding it.

Call or write us today for more information on our full line of microcomputer systems. Ask for our "SuperBrain Buyer's Guide" and read why so many customers like yourself have made the SuperBrain and the SuperBrain QD their top two choices for performance, value and reliability.

Circle 175 on inquiry card.

**INTERTEC  
DATA  
SYSTEMS®**

2300 Broad River Rd., Columbia, S.C., 29210  
(803) 798-9100 TWX 810-666-2115

attempt to create something called "intelligence," it hasn't a prayer.

The solution is not exactly trivial, and it must wait for device technology, neurophysiology, and systems theory to provide a few more links. But our hands are by no means tied: the work currently being done in knowledge representation, natural language, cognition, vision, and countless other specialties will continue to provide mankind with better and better tools for the manipulation of information. When brainlike systems make their debut, they will have a rich AI technology to draw upon.

### Intelligence Amplifiers

Through all this, there has been little space for an explicit discussion of applications. Rather than attempt to catalog all of the present and potential uses for intelligent machines (a task that should be relegated to an intelligent machine), let's round out this overview of the field with a general image of their value to our species in general.

It is colorful to think of computers

as intelligence amplifiers, analogous to the amplifiers of various sorts with which we enhance the power of our voices, muscles, and senses. Now we can enhance the power of our minds.

---

## Computers are magnificent tools but not yet true Intelligence amplifiers.

---

It's already happening, of course, with home-computer systems cheaper in many cases than the color-television receivers that serve as their displays. But the vast computational gulf that exists between brains and computers has kept the devices somewhat distant from their human owners. Magnificent tools, indeed—this article was written on a home word-processing system—but intelligence amplifiers? My brain has as little in common with this computer as it does with a pocket calculator.

It's not the computer's fault, really; even with its pathetic handicap of a single processing site, it has enough power to be of considerable use. But, as I pointed out earlier, it's dumb. Its internal model of the world is sorely limited and alien to me. Communication with it is formal and restricted and must occur only within the syntactic restrictions of its programming languages. I cannot err slightly in an instruction and be understood; I cannot express my thoughts to it in analogies or abstractions. Even if I know exactly *what* I want it to do, I have to work very hard to tell it precisely *how*. In some cases, I can do the job better and faster myself.

None of this is intended to denigrate the value of computers, but it should underscore the value of AI. If people and computers could share, even in a limited sense, their internal models of the world; if machines could grow with us and become living, friendly libraries that yield information, not just data, then we would begin to feel our own powers enhanced as well. ■

# BAR CODE FOR YOUR SMALL COMPUTER.



**New in-depth report tells you how—at savings of up to \$40,000**

"Contemporary Applications of Optical Bar Code Technology" is a new, comprehensive report from North American Technology that can save you thousands of dollars in research and development

time when programming and equipping your small computer for bar code.

Written by the originators of *Byte Magazine's* experiments with publication of software in printed form, Walter Banks and Carl Helmers, this report is the only complete presentation of materials on keyless data entry using modern bar code technology. It will enable you to:

- Read HP-41C calculator formats into your Apple, or other suitable computer.
- Prepare and deliver machine readable printed software to your customers.
- Read a UPC code into your personal computer.
- Print Code 39 manufacturing inventory tags with your formed character or dot matrix printer.

Here, in clear, concise, understandable language is all you need to know about bar code history, software engineering requirements, complete machine independent Pascal software in source listing form. There is software

to generate and read all major formats from Code 39 to HP-41C, and UPC to the new NATI text software publication format. You get information you can use to program your small computer for bar code without detail processing by a human operator. This method speeds the operation, eliminates translation and entry errors and, where desirable, permits the use of unskilled personnel for the entry function. You save thousands of dollars as a result. The \$500 purchase price of the report includes license for the commercial modification and use of all software contained therein.

For detailed information, send for our brochure. There is no cost or obligation. Mail the coupon today.



### NORTH AMERICAN TECHNOLOGY, INC.

Strand Building  
174 Concord St.,  
Peterborough, NH 03458  
(603) 924-6048

Please send me your **FREE** brochure on "Contemporary Applications of Optical Bar Code Technology."

NAME \_\_\_\_\_

ADDRESS \_\_\_\_\_

CITY \_\_\_\_\_

STATE \_\_\_\_\_ ZIP \_\_\_\_\_

# MICRO BUSINESS WORLD

ADVANCE SERVICE ELECTRONICS SATISFACTION

## COMPUTERS

Apple Computer	List Price	Our Price	SAVE
Apple II-16K	\$1330.00		
Apple II-32K	1430.00		
Apple II-48K	1530.00		
Apple II-64K	1725.00		
Apple III 128K	3915.00		

**SPECIAL CALL**

Model	NEW	Price	SAVE
NEC PC 8001		\$300.00	
SHARP-64K Z80 FULL KBD YX-3200	1995.00	NEW	\$
ALTOS 8CS 8000-15	CALL		\$

ATARI PERSONAL COMPUTERS	List Price	Our Price	SAVE
800 16K Bytes of Ram	\$1080.00	\$ 748.00	\$332.00
410 Program Recorder	90.00	77.00	13.00
810 Disk Drive	400.00	457.00	143.00
825 Printer (80 col. Centronic 737)	999.95	759.00	230.00
820 Printer (40 col impact)	450.00	353.00	97.00
830 Acoustic Modem	200.00	155.00	45.00
850 Impacec Module	220.00	192.00	28.00
Atari VisiCalc	200.00	154.00	46.00
Atari 400-16K	595.00	327.00	268.00

HEWLETT PACKARD	List Price	Our Price	SAVE
HP-85 Microcomputer	3250.00	2475.00	775.00
HP-83 Microcomputer	2250.00	1777.00	473.00
16K Exp-Memory Module	295.00	255.00	40.00
Graphics Plotter 7225	2450.00	2075.00	375.00
Personality Mod for 7225	750.00	665.00	85.00
2631B Impact printer	3950.00	3250.00	700.00
Option 020 for 2631B	150.00	125.00	25.00
8 Drives to choose from			
829025	1300.00	1125.00	195.00
9895A 8" Dual Drive	6850.00	5500.00	1350.00
Graphics Tablet 9111A	2050.00	1678.00	374.00
HP-41 CV New 2.2 bytes mem	325.00	250.00	75.00
HP-41-C Calculator	250.00	185.00	65.00
Card Reader for 41CVC	215.00	162.00	53.00
Printer for 41CVC	385.00	269.00	101.00
Optical Wand for 41 CVC	125.00	97.00	28.00
Quad Ram equals 4 Mem Mod	95.00	81.00	14.00
Memory Modules for 41C		25.00	\$
HP-97 Programmable Printer	750.00	595.00	175.00
HP-47 Programmable Calculator	375.00	295.00	80.00
HP-34C Programmable Scientific	150.00	117.00	33.00
HP-38C Programmable Bus. R/E	150.00	117.00	33.00
HP-32E Adv. Scientific	55.00	48.00	7.00
HP-37E Business Mgmt.	75.00	57.00	18.00

We carry a large inventory of libraries, accessories and supplies.

## PRINTERS

Model	List Price	Our Price	SAVE
<b>PAPER TIGER</b>			
445G with Graphics	795.00	695.00	100.00
460G with Graphics	1394.00	1195.00	199.00
560G New full-size	1695.00	1399.00	296.00
<b>EPSON</b>			
MX 80 Impact	645.00	450.00	195.00
MX 70 Impact	500.00	399.95	100.05
MX 100	995.00	895.00	100.00
<b>CENTRONICS</b>			
737.1 Parallel	995.00	799.95	195.05
737.3 Serial	1045.00	899.95	145.05
<b>DIABLO (Letter Quality)</b>			
630 R102 bi-directional tractor	2965.00	2499.00	286.00
1640K 109 keyboard tractor	3072.00	2899.95	172.05
630 RO Receive Only 1650K 136 keyboard tractor	2710.00	2499.95	210.05
	3220.00	2999.95	220.05

## SPECIAL OF THE MONTH

# QSTAR PRESENTS THE QRAM

16K RAM Expansion Board for the Apple II

**Introductory Price: \$149.00**

- Expands your 48K Apple to 64K
- Includes installation and manual of programmable memory
- Works with Microsoft Z-80 card, VisiCalc, LISA ver 2.0 and other software
- Eliminates the need for an Applesoft\* or Integer Basic ROM Card
- Includes installation and manual of programmable memory
- Fully assembled and tested
- FULL ONE YEAR warranty including parts and labor



WE BARE RAM by QSTAR Computer Inc. (1981)

## APPLE II STUDENT SYSTEM

**SAVE \$655**

Apple II Plus System-48K RAM

- Disk II Floppy Disk & Interface (DDOS 3.3)
- 12" BMC Video Monitor

**\$1795**



## MONITORS

Model	List Price	Our Price	SAVE
NEC	\$288.00	\$239.99	\$48.00
BMC Green Phosphorous	275.00	229.00	46.00

### SANYO MONITORS

High Resolution, Number 1 seller!

Model	List Price	Our Price	SAVE
13" Color (new) High quality	\$650.00	\$388.00	\$162.00
12" Green Phosphorous	360.00	235.00	125.00
12" Black & White	340.00	217.00	123.00
15" Black & White	370.00	235.00	135.00
9" Black & White The Best Seller!	235.00	145.00	90.00

## DISKETTES

SOLD IN BOXES OF 10

BUY \$100 of the Following Diskettes

Model	List Price	Our Price	SAVE
<b>DYLAN</b>			
104-1 5" SOFT SECTOR	6.00	3.99	2.01
104-10 5" DBL DEN. SOFT SEC.	6.40	4.60	1.80
3740-1 8" SOFT SECTOR	7.25	4.75	2.50
3740-10 8" DBL DEN. SOFT SECTOR	10.75	6.90	3.85
<b>MAXELL</b>			
MD-1 5" SOFT SEC.	5.00	3.50	1.50
TOR DBL DEN	7.00	4.90	2.10
MD-2 5" SOFT SECTOR DBL SIDE DBL DEN.	6.50	4.50	2.00
FD-1 8" SOFT SEC. DBL DEN.	8.50	5.95	2.55
FD-2 8" SOFT SEC. DBL SIDE DBL DEN.	8.50	5.95	2.55
<b>MEMOREX</b>			
5" 3401 5" SOFT SECTOR	4.40	2.55	1.85
5" 3420 5" SOFT SEC. DBL DEN	5.60	3.90	1.70
8" 3350 8" SOFT SECTOR	5.40	3.10	2.30
8" 3390 8" SOFT SEC. DBL DEN.	5.90	4.10	1.80
83C1	4.00	2.05	1.95

**CHECK FOR SAVINGS**

## SOFTWARE

We will not be outdone!

Model	List Price	Our Price	SAVE
Dow Jones Portfolio Folder	\$ 50.00	\$ 39.00	\$ 11.00
MicroChess 2.0 Chess Disk	26.00	19.00	6.00
The Controller 4.4 General Business System (16 Sector)	625.00	499.00	126.00
Apple Post	50.00	39.00	19.00
The Shell Games Education I	30.00	24.00	6.00
Elementary, My Dear Apple-Education II (16 Sector)	30.00	24.00	6.00
Apple How To Education III (16 Sector)	50.00	40.00	10.00
Apple Bow!	25.00	19.00	6.00
Apple Writer	75.00	60.00	15.00
DOS Tool Kit (16 Sector)	75.00	60.00	15.00
Dow Jones News & Quotes Reporter (16 Sector)	95.00	76.00	19.00
Apple Stellar Invaders	28.00	19.00	6.00
Apple Adventure	70.00	49.00	21.00
Apple Music Theory (16 Sector)	35.00	28.00	7.00
Apple Tax Planner (16 Sector)	50.00	39.00	11.00
Apple Tax Planner (16 Sector)	120.00	98.00	24.00
Cassettes			
Integer Basic Cassettes Demos (6 tapes)	30.00	24.00	6.00
Applesoft Cassette Demos (5 tapes)	25.00	19.00	6.00
Apple Fortran	200.00	147.00	53.00
DOS 3.3 (16 Sector)	80.00	45.00	15.00
Apple PILOT (16 Sector)	150.00	119.00	31.00
SOS Tool Kit (16 Sector)	75.00	60.00	9.00
Apple FORTRAN (requires A28000)	200.00	159.00	41.00
Language System with Apple Pascal	495.00	399.00	96.00
Apple III - Information Analyst	500.00	350.00	150.00
Apple Mail List Manager	150.00	130.00	20.00
Apple Business Basic	250.00	219.00	31.00
Apple System Software & Manuals	250.00	219.00	31.00

### SOFTWARE FOR APPLE II

Model	List Price	Our Price	SAVE
BPI General Ledger System	\$395.00	\$319.00	\$ 76.00
BPI Inventory Package	395.00	319.00	76.00
VisiDoc	200.00	159.00	41.00
VisiCalc	200.00	159.00	41.00
Desktop Plan II	200.00	159.00	41.00
MicroLab Database System	150.00	119.00	31.00
Shareware DB Master	199.00	159.00	39.00
Programs Apple Pie	129.00	97.00	32.00
Muse SuperText II	150.00	119.00	31.00
Sofape Magic Window	99.00	72.00	27.00

### WHEN IN CALIFORNIA VISIT OUR RETAIL LOCATIONS

In Woodland Hills  
20929 Ventura Blvd.  
(213) 704-6895

In Torrance/Lawndale  
16206 Hawthorne Blvd.  
(213) 370-1577

## MICRO BUSINESS WORLD

13731 CENTINELA AVE. #100 VAN NUYS, CA 91411

13731 CENTINELA AVE. #100 VAN NUYS, CA 91411

13731 CENTINELA AVE. #100 VAN NUYS, CA 91411

13731 CENTINELA AVE. #100 VAN NUYS, CA 91411

# A High-Level Language Benchmark

---

Jim Gilbreath  
7266 Courtney Dr  
San Diego CA 92111

---

Some computer languages are faster than others, but just *how much* faster? This article presents the data from a curiosity-driven project that compares the performance of numerous high-level languages on the small computers to which I had access.

The benchmark tends to focus on the language characteristics that most interest me: capabilities and efficiencies for systems programming, software tools, and data manipulation (such as takes place in sorting, graphics, and games). I wanted to measure the ability of a language to do memory references, structured control statements, and simple input/output operations. I did not want to measure integer and real-number arithmetic performance because that depends on the processor and its capabilities (eg: precision of numeric calculations, the presence or absence of hardware multiply and divide circuits, and so on).

---

## Acknowledgments

Grateful thanks are extended to members of the San Diego Computer Society and the S-100 Innovators Special Interest Group, for allowing me access to their systems and languages. Special thanks to Frank MacLachlan, Pete Ridley, and Mike Lehman for their encouragement and help.

---

## Criteria

My criteria were that the benchmark should be short (not more than a page of source code), able to access a considerable amount of memory, devoid of multiplication or division performance, and easily coded in a variety of high-level languages. Finally, the benchmark should accomplish something useful (or at least recognizable and verifiable).

---

## This benchmark is not the only criterion by which to judge a language or compiler.

---

At the January 1980 UNIX conference in Boulder, Chuck Forsberg told me about a program that used the Sieve of Eratosthenes algorithm (see references) to compute all prime numbers from 3 to 16,000. Unlike other methods, the Sieve avoids division and is extremely fast because it uses prior knowledge about numbers that *cannot* be prime (ie: even numbers and multiples of primes). I modified Knuth's program to eliminate all multiplication, scaled it to fit most microcomputer memory capacities, and translated the program to every accessible high-level language.

I should emphasize that this benchmark is *not* the only criterion by which to judge a language or compiler. It doesn't explore or exploit such language features as recursion or sets, which may be very important for some applications. It *does* compare code generation and run times for fundamental language features, which are important for data accessing and structured program looping.

## The Program

The program for each language was coded conventionally, taking advantage of features that are defined in the language, but not exploiting the clever or obscure innovations that can make it run faster. In most cases, some improvement in running time could be achieved by knowledgeable trickery. *[In fact, that is the point of a benchmark program: to compare language performance by running the same algorithm encoded in different languages...GW]* The program is small and simple, and, in most cases, easy to transfer. A few of the transla-

---

## About the Author

Jim Gilbreath is the head of the Computer Sciences and Simulation Department at the Naval Ocean Systems Center. He has 23 years of experience in both hardware and software technology.

---

# INTRODUCING FONTWRITER BY MPI



Fontwriter is the newest addition to the growing family of MPI Printer products. It enables you to print BIG, GRAPHIC fonts on MPI Printers just as easily as others print standard characters. Your local Apple dealer has been sent a demonstration diskette that describes Fontwriter and all the other capabilities of MPI Printer Systems. Ask to see the disk and a powerful MPI printer at work. And remember, MPI printers, complete with dot addressable graphics, cost less than the low cost imported job that has been getting all the attention lately. MPI Printers are clearly the best printer buys in the US.

Apple is a trademark of Apple Computer Inc.



**mpi**

Micro Peripherals Inc. 4426 South Century Drive Salt Lake City, Utah 84107 (801) 263-3081

**The Printer People**

tions required more time because of the lack of control structures and my GOTO blunders. FORTRAN, FORTH, and COBOL (in order of increasing difficulty) gave me the most trouble.

Program listings in the ten most interesting languages appear in listings 1 thru 10. You might want to try a few on your favorite compilers.

Listing 1 shows the program in ZSPL, a structured high-level lan-

guage that is tailored to systems programming. ZSPL is chosen as the first example because you have probably not seen it before and because it is easy to read and understand.

Begin by initializing an array of 8 kilobytes ("flags") to *true*. *Flags(0)*, *flags(1)*, *flags(2)*,... represent the numbers 3, 5, 7,... as numbers being tested for primeness. (See table 1.) The program uses the prior knowledge that 0, 1, 2, and 3 are the first four prime numbers, that all other even numbers are not prime, and that all multiples of prime numbers are not prime, to iterate through an array of flags, calculating primes as the value of variable *PRIME* (always 3 plus twice the current array index, *I*). As the program progresses, it also sets other values that cannot lead to a prime to *false*.

When the program was timed, the second "printf" statement was made a comment and, thus, effectively removed. It remains in listing 1 so that you can see where to print the value of each prime number during debugging.

For timing purposes, the program is executed (iterated) ten times. A

Listing 1: Implementation of the Sieve prime number program, written in ZSPL.

\* Eratosthenes Sieve Prime Number Program in ZSPL

```

ident zprime;                name of module
external function arysset;    sets array elements
external function exit;      returns to cp/m
external function printf;    types things

define true := 1;
define false := 0;
define size := 8190;
define sizepl := 8191;

byte array flags[sizepl];    array of flags
integer count;               no. of primes found
integer i;                   array index
integer iter;                counts number of passes
integer k;                   index to non-primes
integer prime;               holds prime number

printf(-1,"10 iterations&M&J"); type starting message
for iter := 1 to 10;         do whole thing ten times
    count := 0;              zero prime counter
    arysset(true,flags,size); set array to true
    for i := 0 to size;      go thru whole array
        if flags[i] = true; we have a prime
            prime := i + i + 3; value of prime
            k := i + prime;   index to multiple
            while k <= size; loop to kill multiples
                flags[k] := false; set non-primes to false
                k := k + prime; next non-prime
            endwhile;
        * debug aid *        printf(-1,"%d&M&J",prime); type value of prime
        count := count + 1; count primes found
    endif;
endfor;
printf(-1,"%d primes",count); type no. primes found
exit();                      return to cp/m
end;

```

Listing 2: Implementation of the Sieve program, written in Pascal.

```

(* Eratosthenes Sieve Prime Number Program in PASCAL *)
PROGRAM PRIME;

CONST
    SIZE = 8190;

VAR
    FLAGS : ARRAY [0..SIZE] OF BOOLEAN;
    I,PRIME,K,COUNT,ITER : INTEGER;

BEGIN
    WRITELN('10 iterations');
    FOR ITER := 1 TO 10 DO BEGIN
        COUNT := 0;
        FILLCHAR(FLAGS,SIZEOF(FLAGS),CHR(TRUE));
        FOR I := 0 TO SIZE DO
            IF FLAGS[I] THEN BEGIN
                PRIME := I+I+3;
                K := I + PRIME;
                WHILE K <= SIZE DO BEGIN
                    FLAGS[K] := FALSE;
                    K := K + PRIME;
                END;
                COUNT := COUNT + 1
                (* WRITELN(PRIME) *)
            END;
        END;
        WRITELN(count,' primes')
    END.

```

Index	Flags (Index)	Prime Number Representative by Index
0	TRUE	3
1	TRUE	5
2	TRUE	7
3	FALSE	9
4	TRUE	11
5	TRUE	13
6	FALSE	15

Table 1: Values in array *FLAGS* after first iteration (*I=0*). The primeness of 3, which is the potential number corresponding to *FLAGS(0)*, has just been determined. Note that all multiples of 3 have been ruled out as potential primes: odd multiples (9, 15,...) have had their corresponding *FLAG* entries (*FLAG(3)*, *FLAG(6)*,...) set to "false"; even multiples (6, 12,...) have already been ruled out.



# THE HARD EDGE

AND STILL THE LEADING EDGE . . .  
IN SYSTEM PERFORMANCE



## Hard Disk and Streaming Tape

*reliability and versatility that can't be beat*

### OEM CONTROLLERS

- Multibus
- General Purpose
- S100



**S33**

- 31 or 62 MByte formatted
- Lowest cost/MByte from any manufacturer
- CP/M\* compatible "drop in" BIOS
- Single S100 card controller
- Fully expandable up to four drives, 8" or 14"
- Reliable high performance Priam Winchester Disks
- Immediate delivery



**S10**



**SYSTEM 8**

- 8" Winchester 10 or 32 MByte formatted
- Integrated streaming cartridge backup
- Streaming backup at 5 MB/min
- Selective file backup under CP/M
- Versatile parallel I/O or DMA interface

# ADES

ADAPTIVE DATA & ENERGY SYSTEMS

2627 Pomona Boulevard • Pomona, CA 91768

Phone: (714) 694-6858

**PRINTERS**  
**10 DAY FREE RETURN**

**EPSON MX-80**  
**Now in stock!**

The MX-80 dot matrix printer. Unequaled Epson reliability. Has all the features of the MX-70 plus more power and extra functions

**C-ITOH STARWRITER: LETTER QUALITY PRINTING FOR UNDER \$2000!** This daisywheel printer gives high quality at a low price. 25 cps Parallel and serial interfaces available

**NEC SPINWRITER FROM THE FIRST NAME IN LETTER QUALITY PRINTERS/** Compumart offers beautiful print quality with NEC Spinwriter Terminals. We carry all models from RO THRU KSR WITH NUMERIC KEYPAD—5510-5530. All versions give unsurpassed hard copy output!

**NEW INTEGRAL DATA'S 560 PRINTER/** All the exciting features of the 400 series plus 14 1/2" paper capacity 132 col. graphics printer. **IDS 445.** Priced lower than the 440 and equipped with a better print head. With & w/o graphics **IDS 460.** Features include correspondence quality printing, high resolution graphics.



Spinwriter 5520

**CENTRONICS PRINTERS**  
**3 SERIAL MODEL 737**

The closest thing to letter quality print for under \$1000. List \$1045 **SPECIAL \$795.** 737-1 Parallel Interface List \$995 **SALE PRICE \$695.** **PLUS EXCITING REBATE OFFER ON CENTRONICS PRINTERS.**

**OMNI 810 PRINTER FROM TEXAS INSTRUMENTS** CALL US The 820 RO PACKAGE includes machine mounted paper tray and cable. A compressed print option and device forms control are standard features. THE 820 KSR PACKAGE includes fully ASCII Keyboard plus all of the features of the RO.

**MONITORS**  
**TERMINALS**  
**CONFIGURATION**  
**HELP**

**CLEARANCE ZENITH COLOR VIDEO MONITOR \$349.**

**SUPER SELLING TERMINALS FROM LEAR SIEGLER/** We have the following Lear Siegler terminals in stock at prices too low to print! Call for quotes.

**ADM-3A/** Industry's favorite dumb terminal for some very smart reasons/ADM-3A + NEW from Lear Siegler. **CALL!** IT IS HERE! It is the new Intermediate Terminal from Lear Siegler.

**SANYO MONITORS AT LOW COMPUMART PRICES/** Sanyo's new line of CRT data display monitors are designed for the display of alphanumeric or graphic data.  
9" SANYO B/W \$169.  
12" SANYO B/W  
12" SANYO W/  
GREEN SCREEN  
13" SANYO COLOR

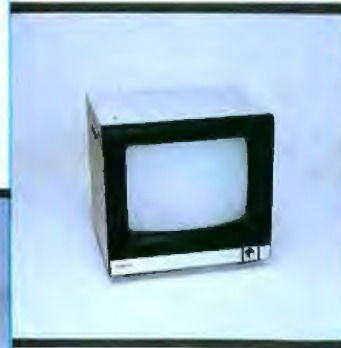

Sanyo 13" Color Monitor

**NEC COLOR MONITOR/RECEIVER** HIGH RESOLUTION/ Composite video using BNC connectors. 8-Pin connector for VCR/ VTR video loop In/Out and television reception.

Visit our giant

**ANN ARBOR STORE**

1250 North Main Street  
Ann Arbor, Michigan

**FREE CATALOGS**

**MICRO**

The original and most complete catalog of micro-computers, accessories and peripherals.

**DEC PDP/**

**LSI-11** Systems configured and integrated with other manufacturers compatibles. The first, best DEC based systems catalog.

Send for them!

**CALCULATORS**  
**MISC**  
**TOLL FREE ORDERING**

**HP-41C CALCULATORS** MEMORY MODULES for storing programs of up to 2000 lines of program memory. "EXTRA SMART" CARD READER. Records programs and data back onto blank magcards. **THE PRINTER.** Upper and lower case. High resolution plotting. Portable thermal operation. **APPLICATION MODULES**

**NEW SUPER 41-CV SYSTEMS** with Quad RAMS built-in. Maximum memory on-board leaves slots open for Application Pacs and peripherals. **+ CARD READER + CARD READER + PRINTER** QUAD RAMS equivalent to four Memory Modules all packed into one

**MATROX PRODUCTS/** Compumart stocks the complete line.

**DEC LSI-11/** Compumart now offers the entire product line **CALL FOR PRICES AND DELIVERY**

**NOVATION CAT ACOUSTIC MODEM** Answer Originate

**NEW! D-CAT** Direct Connect Modem from Novation



Giltronix Switch

**NEW! GILTRONIX RS 232 SWITCH/** The ultimate in flexibility. You can connect three peripherals to one computer or three computers to one peripheral. Switches the eight most important RS 232 signals.

**DYSAN DISKETTES/** Single side, single density Hard or Soft Sector **\$5. ea.**

**MEMOREX 3401's/** 5 1/4" disks /with hub ring for Apple **\$3.25. \$3.50.**

**MEMORY INTEGRATED CIRCUITS/** Call for quantity discounts when ordering over 50 units.

**MOTOROLA 4116 (200 Nano-second Plastic)** **\$4.50**

**SYSTEMS**  
**SOFTWARE**  
**LEASING**  
**AVAILABLE**

**RAM EXPANSION ACCESSORIES FOR AIM—** CALL SPECS AND PRICES

**APPLE III IS IN STOCK/** Apple III Information Analyst Package—128K Apple III, Black and White Monitor 12", and information analysis software

**TOP SOFTWARE PACKAGES FROM COMPUMART**

**VISICALC/** FOR APPLE/ FOR HP/ FOR COMMODORE/ FOR ATARI

**SOFTWARE FROM APPLE/** Apple Plot (the perfect graphic complement for Visicalc/ Dow Jones News & Quotes/ Apple Fortrom/ Apple Writer/ Pascal Language System/ Controller Business System

**PERSONAL SOFTWARE/** Visidex/ VisiTrend/ VisiPlot/ VisiTerm **MUSE/** Super Text



Apple Software

**MOUNTAIN COMPUTER/**

Expansion accessories for Apple/ Super Talker/ The Music System/ ROM plus board with Keyboard filter/ ROM Writer/ Clock Calendar/ AtoD and DtoA Converter/ Clock for Apple/ CPS Multifunction Board

**VIDEX/** Video Term (80 col. x 24 line, 7x9 Matrix plug in compatible board for Apple II) w/wo graphics EPROM/SSM Serial & Parallel, Apple Interface/ABT's Numeric Key Plan/California Microcomputer Keyboard

**NEW!**

**VIC 20 PERSONAL COMPUTER FROM COMMODORE**

**\$299**

**SEE US AT THE NORTHEAST COMPUTER SHOW, OCTOBER 15-18, 1981, BOOTH #608**

**IMPORTANT ORDERING INFORMATION**

CALL 800 343-5504, in Massachusetts (617) 491-2700, phones open from 8:30 a.m. to 7:00 p.m. Mon-Fri. 11:00 a.m. to 4:00 p.m. Sat. PO's: Accepted from Dun & Bradstreet rated companies—shipment

contingent upon receipt of signed purchase order. **SALE PRICES.** Valid for month of magazine date only—all prices subject to change without notice. Our Ann Arbor retail store is open 11:00 a.m. to 7:00 p.m. Tues-Fri. 10:00 a.m. to 5:00 p.m. on Saturdays

SYSTEMS

**APPLE II  
STARTER****\$1895**

SAVE OVER \$200 ON OUR BEST SELLING APPLE SYSTEM/ System includes a 48K Apple II, Apple Disk, DOS 3.3 and Controller and a Sup R MOD RF Modulator.

List \$2209.

**EXCLUSIVE FOR THE APPLE:** Magic Wand, Videx, Z-80 softcard (Requires 48K Apple and disk).

**COMPLETE SUB-SYSTEM \$925.****APPLE ACCESSORIES**

**CHOOSE FROM:** Silentype Printer w/x face/Light Pen/Easy Writer (80 col. need a Videx)/Clock for Apple.

**FROM MICROSOFT:** 16K RAM Board/FORTRAN.

**FROM COMPUTER STATION:** Hi-Res Dump for 460 Printer.

**OUR APPLE INVENTORY IS COMPLETE. WE'VE GOT IT ALL—**



**apple computer**  
Authorized Dealer  
Accept No Less

SYSTEMS

**COMMODORE  
WORD  
CRAFT  
80****\$4695**

**CRISP LETTER QUALITY OUTPUT UNSURPASSED EASE OF OPERATION**

This Compumart/Commodore system includes a **COMMODORE 8032 32K CPU**, a **4040 DUAL DISK**, a **C-ITOH PRINTER** and x/face and **WORD PRO 4 PLUS** (all cables included). List \$5685.

**EDUCATORS' COMMODORE HAS EXTENDED ITS 3 FOR 2 DEAL.**

**A COMPLETE SYSTEM:** includes a **DUAL DISK DRIVE/TRACTOR PRINTER** and an **80 COLUMN 32K CPU**. No interfaces needed. Cables included. List \$3985.

**COMPUMART \$3635.**

**SAVE \$200 ON COMMODORE ACCESSORIES WITH PURCHASE OF A 32K PET—SAVE \$100 WITH A 16K PET.**

**CHOOSE FROM:** Vistacalc/Word Pro 4/Wordcraft 80/Ozz the Information Wizard/Dow Jones Portfolio Mgmt System/Assembler Development Package



**commodore**  
Authorized Dealer  
Accept No Less

Systems  
*Customized*

SYSTEMS

**HP 85  
BASIC****\$3250**

This Basic 16k BYTE system (expandable to 32k) includes: **CRT DISPLAY, THERMAL PRINTER, MAGNETIC TAPE CARTRIDGE, 6 ROM CAPACITY VIA ROM DRAWER, 4 IO PORTS, COMMUNICATION—HPiB, RS232**

**PLUS**

**YOUR CHOICE OF 4 SOFTWARE PACS OR TWO OF OUR "BEST SELLERS"—(VISCALC, GRAPHICS PRESENTATION, INFORMATION MANAGEMENT) SAVE \$400**

**HP-85 SYSTEM**

This Basic System from Hewlett-Packard includes **HP-85/ROM DRAWER/MASS STORAGE ROM/5 1/4" SINGLE MASTER FLEXIBLE DISK DRIVE/HP-1B INTERFACE MODULE/2 METER HP-1B CABLE.**

**COMPLETE SYSTEM \$4249.**

**hp** HEWLETT PACKARD  
Authorized Dealer  
Accept No Less

SYSTEMS

**AIM 65  
STARTER****\$795****FROM ROCKWELL**

Our **AIM Starter System** for Educational & Laboratory use includes **4K AIM/BASIC & ROM/ASSEMBLER & ROM/POWER SUPPLY EG1 ENCLOSURE/CRAIG TAPE RECORDER.**

**ACCESSORIES FOR AIM STARTER:** PL 65 High Level Language/Paper for the Aim (roll)/Rockwell's 4 slot Motherboard/

**WE ALSO CARRY RM EXPANSION ACCESSORIES FOR THE AIM-65.**



**Rockwell International**  
Authorized Dealer  
Accept No Less

**800-343-5504**

IN MASS CALL 617-491-2700

**COMPUMART**

65 Bent Street, Dept 109

PO Box 568, Cambridge, MA 02139

From THE LEADER.

We just might be the largest independent small systems dealer in the country. Here's why: **COMPUMART** has been serving the computer needs of industry since 1971.

We stock, for immediate shipment, only those products from the finest micro-computer manufacturers.

And any product, except software, can be returned within 10 days for a full refund—even if you just change your mind. We also honor all manufacturers' warranties. Our expert technicians will service any product we sell.

Call us for more information on products, product configuration and service. Our phones are open Monday thru Friday, 8:30 a.m. to 7:00 p.m. and Saturday 11:00 a.m. to 4:00 p.m.

We have a staff of highly knowledgeable sales people waiting to hear from you, and to help. Because service is what we're all about.

Circle 67 on Inquiry card.

# GOOD IDEA!

You can save buying wholesale through our firm. As your agent we will buy computers on the wholesale market for you. Our fee is one fourth of what we save you off list price. Access to over 500 manufacturers. Minimum fee of \$75 per order. Call for other prices.

	Whse.	Fee
<b>COMPUTERS</b>		
Alpha Micro 10MEG	\$11,204	\$1,243
Altos 8000-10	5,695	701
Altos 8000-15	4,014	494
Archives 64K QD	4,450	512
Cromemco System 3	5,357	659
Dynabyte 64K 2 MEG	5,929	691
Calif. Comp. 64K 1 MEG	Call for Price	
Ithaca System 2A	2,520	270
NEC PC-8000	907	98
Northstar Hrz. II 64K DD	2,646	380
Northstar Hrz. II 64K QD	2,842	400
Televideo Sys. I	2,600	349
<b>DISK DRIVES</b>		
Corvus 5 MEG Hard	2,588	290
Corvus 20 MEG Hard	4,450	500
Labo w/ cont.	416	46
Labo w/o cont.	349	38
<b>CRT'S</b>		
ADDS View Point	505	36
DEC VT 100	1,305	130
Hazeltine Esprit	565	45
Lear Siegler ADM 3A+	710	58
NEC 12" Monitor	190	18
Televideo TVI 910	545	39
Televideo 950	835	90
<b>PRINTERS</b>		
Anadex 9501	1,150	125
Centronics 739	690	75
C. Itoh 25 cps	1,200	175
C. Itoh 45 cps	1,575	188
Diablo 630 R/O	1,795	200
Epson MX80	410	58
IDS 560/G	1,004	98
Mallbu 200	2,095	225
NEC 5510 w/Tractor	2,360	164
TI 810 Basic	1,355	135
<b>SOFTWARE</b>		
Word Star	249	63
Spell Guard	200	—

Prices subject to change without notice

We are buying agents for overseas computer dealers. Export services available.

International Telex 47D851

**The Purchasing Agent**  
1635 School Street, Suite 101  
Moraga, CA 94556  
(415) 376-9020

stopwatch measures the time elapsed between the moment when the computer types the message "10 iterations" and when it types the total number of primes (1899 is correct). On fast machines, the iterations were increased to 100 to achieve a more precise timing result, while only one iteration was performed on some of the slow BASIC interpreters.

The next language example is PASCAL, shown in listing 2. Although the syntax is a little different and the comments have been deliberately eliminated, you should have no difficulty seeing how the program works.

The same is true of listing 3, coded in C, and listing 4, coded in RATFOR. (Note the similarity between C and RATFOR—it's not an accident.)

The PL/I version in listing 5 is also fairly clear, but listing 6 in FORTRAN and listing 7 in BASIC (with their GOTOs and CONTINUEs) tend toward obscurity. Fortunately I had a lot of help with the FORTH version, shown in listing 9.

### Testing Conditions

The most easily measured characteristic was execution time; all execution times listed in the tables are for

*Text continued on page 190*

Listing 3: Implementation of the Sieve program, written in C.

```

/* Eratosthenes Sieve Prime Number Program in C */
#define true 1
#define false 0
#define size 8190
#define sizepl 8191

char flags[sizepl];

main() {
    int i, prime, k, count, iter;

    printf("10 iterations\n");
    for(iter = 1; iter <= 10; iter++) {
        count=0;
        for(i = 0; i <= size; i++)
            flags[i] = true;
        for(i = 0; i <= size; i++) {
            if(flags[i]) {
                prime = i + i + 3;
                k = i + prime;
                while(k <= size) {
                    flags[k] = false;
                    k += prime;
                }
                count = count + 1;
            }
        }
        printf("\nd primes", count);
    }
}

```

Listing 4: Implementation of the Sieve program, written in RATFOR.

```

! Eratosthenes Sieve Prime Number Program in RATFOR
define(size,8190)
logical flags(size+1)
integer i,prime,k,count,iter

call msg(" 10 iterations\n")
do iter = 1,10 {
    count=0
    do i = 0,size
        flags(i)=.tr.
    do i = 0,size {
        if(flags(i)) {
            prime = i+i + 3
            k = i + prime
            while(k<=size) {
                flags(k) = .false.
                k = k + prime
            }
            count=count+1
        }
    }
}
call putdec(count); call msg(" primes\n")
end

```

*Listing 5, 6, and 7 are on page 188*

# Put Time and BSR/X-10 Control in Your APPLE II THUNDERCLOCK PLUS™

The THUNDERCLOCK PLUS is two peripheral systems on one card for your APPLE II, II PLUS, or III. An accurate, reliable, real-time clock/calendar and an interface for the popular BSR X-10 Home Control System.

The THUNDERCLOCK clock/calendar makes accurate time and date available to your programs: month, date, day-of-week, hour, minute, and second, in any of four software selectable formats. On-board batteries keep your THUNDERCLOCK running when your APPLE II is turned off - for up to four years before battery replacement. On-card 1K firmware makes reading or setting the time easy from APPLESOFT or INTEGER BASIC, PASCAL, or assembly language programs. And it provides software selectable interrupts at any of three rates: 64, 256, or 2048 interrupts/second. All features are software selectable - no switches or jumpers!



## THE PLUS

Add THUNDERWARE'S X-10 ULTRASONIC INTERFACE

OPTION to your THUNDERCLOCK and your programs can send all 22 BSR X-10 commands so you can remotely control lights and appliances. Plus a powerful disk software package! The THUNDERWARE SCHEDULER software lets you create schedules to control lights, appliances, security systems, or almost any other electrical device. The software includes: SCUTIL - the SCHEDULER utility that lets you make or change a schedule, and SCHED - executes your schedules in real-time using the THUNDERCLOCK. SCHED runs in the 'background' so you can run other programs in the 'foreground'. Our PASCAL software lets you use all the THUNDERCLOCK'S features and sets the file date whenever you boot. The THUNDERCLOCK PLUS is a SYSTEM for your APPLE II. Supported by intelligent, easy to use firmware, a powerful software package, and good documentation!

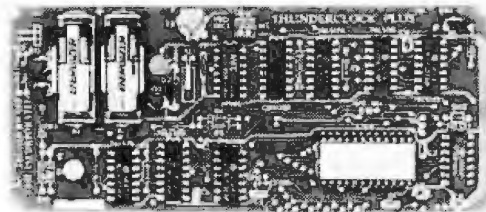

Let the THUNDERCLOCK PLUS time date stamp your DOS files whenever you create or modify them with our DOS-DATER software.

The THUNDERCLOCK PLUS will work in any APPLE, including the APPLE III.

## See your APPLE dealer.

Suggested retail prices:

- THUNDERCLOCK PLUS.....\$139  
Clock/calendar card with batteries and user's manual
- X-10 INTERFACE OPTION.....\$49  
BSR X-10 Ultrasonic interface, disk with SCHEDULER SOFTWARE & demos, and user's manual
- PASCAL SOFTWARE.....\$29  
Disk with PASCAL interface for clock and X-10 interface, and user's guide
- MANUALS ONLY, each.....\$5

California residents add 6% sales tax

If your dealer doesn't carry the  
THUNDERCLOCK PLUS:

ORDER TOLL FREE (VISA/MC) CALL:  
800-227-6204 Ext 307 (Outside California)  
800-632-2131 Ext 307 (California Only)

OR WRITE TO:

THUNDERWARE INCORPORATED  
P.O. Box 13322, Oakland, CA 94661



BSR X-10 is a trademark of BSR (USA) LTD.

APPLE II is a trademark of APPLE COMPUTER, INC.

# MTI stocks 'em all for faster delivery.

No hidden charges. Prices include delivery.  
Ask about our "QED" discounts.  
VISA and MasterCard orders accepted.

	MTI Price
<b>VIDEO TERMINALS</b>	
VT100 DECscope	\$ 1595
VT132 DECscope	1995
ADM 3A (dumb terminal)	"
ADM 3A+ (dumb terminal)	"
ADM 5 (dumb with visual attributes)	"
ADM 31 (2 page buffer)	"
ADM 32 (ergonomic ADM 31)	"
ADM 42 (8 page buffer avail)	"
TI 940 (2 page buffer)	1795
TI "Insight Series 10" personal term.	895
Hazeltine Executive 80 Model 20	1375
Hazeltine Executive 80 Model 30	1715
1410 (Hazeltine dumb terminal)	825
1420 (dumb terminal)	895
1421 (Corval 580 & ADM 3A comp.)	850
1500 (dumb terminal)	1045
1510 (buffered)	1145
1520 (buffered printer port)	1395
1562 (VT 52 compatible)	1250
<b>GRAPHICS TERMINALS</b>	
VT100 with graphics pkg.	3160
ADM 3A with graphics pkg.	1995
ADM 3A+ with graphics pkg.	2075
<b>300 BAUD TELEPRINTERS</b>	
LA34-DA DECwriter IV	995
LA34-AA DECwriter IV	1095
LA36 DECwriter II	1295
Teletype 4310	1095
Teletype 4320	1195
Diablo 630 RO	2295
Diablo 1640 KSR	2775
Diablo 1650 KSR	2635
TI 743 (portable)	1190
TI 745 (port/built-in coupler)	1495
TI 763 (port/bubble memory)	2545
TI 766 (port/bubble/b.i. coupler)	2595
TI "Insight Series 10/11" pers. term.	895
<b>600 BAUD TELEPRINTERS</b>	
TI 825 RO impact	1450
TI 825 KSR impact	1670
TI 825 RO pkg.	1825
TI 825 KSR Pkg.	1795
TI 840 RO impact	1095
TI 840 KSR impact	1245
<b>1200 BAUD TELEPRINTERS</b>	
LA120 RO (forms package)	2095
LA120 AA DECwriter III (forms pkg.)	2295
TI 783 (portable)	1645
TI 786 (port/built-in coupler)	2270
TI 787 (port/internal modem)	2695
TI 810 RO impact	1760
TI 810 RO pkg.	1960
TI 820 KSR impact	2025
TI 820 RO	1850
TI 820 KSR pkg.	2195
TI 820 RO pkg.	2025
<b>2400 BAUD</b>	
DataProducts M200 (2400 baud)	2595
<b>DATAPRODUCTS LINE PRINTERS</b>	
8300 (300 LPM band)	5535
8600 (600 LPM band)	6861
8900 (900 LPM band)	10164
BP1500 (1500 LPM band)	16785
2230 (300 LPM drum)	7723
2260 (600 LPM drum)	9614
2290 (900 LPM drum)	12665
<b>ACOUSTIC COUPLERS</b>	
A/J A242-A (300 baud orig.)	242
A/J 247 (300 baud orig.)	315
A/J 1234 (Vadic compatible)	895
Vadic VA 3413 (300/1200 orig.)	825
Vadic VA 3434 (1200 baud orig.)	845
<b>MODEMS</b>	
GDC 103A3 (300 baud Bell)	395
GDC 2025/T (1200 baud Bell)	585
GDC 212-A (300/1200 baud Bell)	850
A/J 1256 (Vadic compatible)	825
VA 103 (300 baud orig./ans. in phone)	235
VA 3451 (orig./ans. triple modem)	885
VA 3456 (1200 baud orig./ans.)	770
<b>CASSETTE STORAGE SYSTEMS</b>	
Techtran 816 (store/forward)	1050
Techtran 817 (store/forward/speed up)	1295
Techtran 818 (editing)	1795
Techtran 822 (dual)	2295
<b>FLOPPY DISK SYSTEMS</b>	
Techtran 960 (store/forward)	1395
Techtran 951 (editing)	1995



Distributors, New York, New Jersey and Ohio.  
New York:  
516/482-3500, 212/895-7177, 516/449-5959  
Outside N.Y.S.: 800/645-8016  
New Jersey: 201/227-5552  
Ohio: 216/464-6688

Listing 5: Implementation of the Sieve program, written in PL/I.

```

/* Eratosthenes Prime Number Program in PLI-80 */
prime:
proc options(main);
%replace
size by 8190,
false by '0'b,
true by '1'b;
dcl
flags {0:8191} bit(1),
(i, prime, k, count, iter) fixed;

put list('10 iterations');
do iter = 1 to 10;
count = 0;
do i = 0 to size;
flags(i) = true;
end;
do i = 0 to size;
if flags(i) then
do;
prime = i + i + 3;
k = i + prime;
do while (k <= size);
flags(k) = false;
k = k + prime;
end;
count = count + 1;
end;
end;
end;
put skip list(count, 'primes');
end prime;
    
```

Listing 6: Implementation of the Sieve program, written in FORTRAN.

```

C Eratosthenes Sieve Prime Number Program in FORTRAN
LOGICAL FLAGS(8191)
INTEGER I, PRIME, K, COUNT, ITER

WRITE(1,50)
FORMAT(' 10 iterations')
DO 92 ITER = 1,10
COUNT=0
DO 10 I = 0,8190
FLAGS(I) = .TRUE.
DO 91 I = 0,8190
IF(FLAGS(I).EQ..FALSE.) GOTO 91
PRIME=I+I+3
K=I+PRIME
20 IF(K.GT.8190) GOTO 90
FLAGS(K) = .FALSE.
K=K+PRIME
GOTO 20
90 COUNT=COUNT+1
C WRITE(1,100) PRIME
91 CONTINUE
92 CONTINUE
200 WRITE(1,200) COUNT
FORMAT(1X,I6,' primes')
STOP
100 FORMAT(1X,I6)
END
    
```

Listing 7: Implementation of the Sieve program, written in BASIC.

```

REM Eratosthenes Sieve Prime Number Program in BASIC
1 SIZE = 8190
2 DIM FLAGS(8191)
3 PRINT "Only 1 iteration"
5 COUNT = 0
6 FOR I = 0 TO SIZE
7 FLAGS(I) = 1
8 NEXT I
9 FOR I = 0 TO SIZE
10 IF FLAGS(I) = 0 THEN 18
11 PRIME = I+I + 3
12 K = I + PRIME
13 IF K > SIZE THEN 17
14 FLAGS(K) = 0
15 K = K + PRIME
16 GOTO 13
17 COUNT = COUNT + 1
18 NEXT I
19 PRINT COUNT, " PRIMES"
    
```

# FMS-80

## Organizes Your Organization

**F**MS-80, a data base management system, offers the user a quick and easy way to organize and efficiently manipulate data so sound decisions can be made on facts displayed.

FMS-80\*\*\* is the most powerful stand alone DBM program available to the micro-computer industry.

Completely menu driven and written in assembly language, it offers these features:

- User definable File Definitions
- Screen Displays
- Reports (with math and field break analysis)
- Selection Criteria (on any or all fields)
- Menus (that applications programs can be selected from)
- Instantaneous data query on indexed records.
- Mathematical manipulation of numeric data fields using the report generator or the programming language EFM (Extended File Maintenance)
- Easy to use video "how to" training tapes are available.
- Manipulation of up to 19 different data files (using EFM) at one time and displaying this information on the screen, gener-

- rating reports, generating other data files or on-line updating of input files that already exist
- FMS-80 is able to call other programs like sub-routines in EFM
- FMS-80 is able to read data files that other programs have generated
- No restrictions to record size other than available RAM memory space
- Operates under CP/M®, MP/M® or CDOS®

FMS-80 allows the flexibility to quickly create programs that allow data to be entered in a form that a secretary recognizes and generates reports that the manager requires.

If you're continuously asked to do applications programs and don't have time to do it in BASIC, consider FMS-80. For additional information contact

Systems Plus,  
3975 East Bayshore,  
Palo Alto, CA  
94303. Phone  
415/969/7047

Systems Plus



\*\*\*TM of DJR Associates

\*\*TM of Crommen, Sunnyvale, CA

\*TM of Digital Research, Pacific Grove, CA

# SPECTACULAR OFFERS

**BASF "FLEXYDISK"...**  
Superior Quality data storage medium.  
Certified and guaranteed 100% error free.



**SINGLE SIDED-SINGLE DENSITY**

5 1/4" or 8" Diskettes ..... 10/\$24  
5 1/4" or 8" Vinyl Storage Pages .....10/\$5

**MAXELL-DISKETTES**  
The best quality diskette money can buy.  
Approved by Shugart and IBM.



Sold only in boxes of 10

5", 1 side .....\$3.30  
8", 1-side .....\$3.90  
5", 2-side .....\$4.25  
8", 2-side .....\$5.60

**ALL MAXELL DISKETTES ARE DOUBLE DENSITY**

**LIBRARY CASE...**  
3-ring binder album.  
Protects your valuable programs on disks  
Fully enclosed and protected on all sides.  
Similar to Kas-sette storage box.

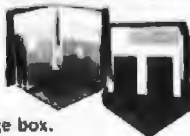

Library 3-Ring Binder .....\$6.50  
5 1/4" Mini Kas - sette/10 .....\$2.49  
8" Kas-sette/10 .....\$2.99

**DISKETTE DRIVE HEAD CLEANING KITS**  
Prevent head crashes and insure efficient, error-free operation.



5 1/4" or 8" .....\$19.50

**SFD CASSETTES**

C-10 Cassettes .....10/\$7  
(All cassettes include box & labels)  
Get 8 cassettes,C-10 sonic and Casette/8 library album for only .....\$8.00  
(As illustrated)



**HARDHOLE**  
Reinforcing ring of rough mylar protects disk from damage



5 1/4" Applicator \$3    5 1/4" Hardholes \$6  
8" Applicator \$4    50/8" Hardholes \$8

VISA • MASTERCHARGE • MONEY ORDERS  
CERTIFIED CHECK • FOR PERSONAL CHECKS  
ALLOW TWO WEEKS • C.O.D. REQUIRES A 10%  
DEPOSIT • CAL. RES. ADD 6% SALES TAX  
MIN \$2 SHIPPING & HANDLING • MINIMUM  
ORDER \$10 • SATISFACTION GUARANTEED  
OR FULL REFUND  
Write for our free catalog

# ABM PRODUCTS

8868 Clairemont Mesa Blvd.  
San Diego, CA 92123

Toll Free  
1-800-854-1555  
For Orders Only

For information or California orders  
(714) 268-3537

Text continued from 186:

ten iterations. In some cases the other parameters are missing because they are not applicable or could not be determined in the amount of time I had on the system. The values for memory size include the complete program memory space, but not the 8190 byte flag array.

The time required to compile and load (where applicable) was measured by setting up a command language file (via such commands as

SUBMIT in CP/M or "shell" in UNIX) to control the compilation, loading, and execution. Compile timing began with the carriage return on the SUBMIT line, and ended as the program began execution, as evidenced by the beginning message "10 iterations". All the 8-bit systems except the Apple used 8-inch single-density floppy drives, and all Z80-based systems ran at a 4 MHz clock rate with no wait states (ie: pro-

Text continued on page 194  
Tables and listings continued on page 192

Listing 8: Implementation of the Sieve program, written in PLMX.

```

/* Eratosthenes Sieve Prime Number Program in PLMX */
CPRIME:
DO:
  DECLARE CR LITERALLY '13',
  LF LITERALLY '10';
  DECLARE TRUE LITERALLY '1',
  FALSE LITERALLY '0';
  DECLARE SIZE LITERALLY '8190';
  DECLARE FLAGS (2000H) BYTE, NBFR(10) BYTE;
  DECLARE (I,PRIME,K,COUNT,ITER,STATUS) ADDRESS;
  DECLARE DPRIMES (*) BYTE DATA ('%D PRIMES');
  DECLARE BUFFER (*) BYTE DATA ('10 ITERATIONS',CR,LF);
NMOUT:
PROCEDURE (VALUE,BASE,LC,BUFFADR,WIDTH) EXTERNAL;
  DECLARE (VALUE,BUFFADR) ADDRESS;
  DECLARE (BASE,LC,WIDTH) BYTE;
END NMOUT;
WRITE:
PROCEDURE (FUNCTION,BUFFER,COUNT,STATUS) EXTERNAL;
  DECLARE (FUNCTION,BUFFER,COUNT,STATUS) ADDRESS;
END WRITE;
CALL WRITE(0,.BUFFER,LENGTH(BUFFER),.STATUS);
DO ITER= 1 TO 10;
  COUNT = 0;
  DO I = 0 TO SIZE;
    FLAGS(I) = TRUE;
  END;
  DO I = 0 TO SIZE;
    IF FLAGS(I) = TRUE THEN
      DO;
        PRIME = I + I + 3;
        K = I + PRIME;
        DO WHILE K <= SIZE;
          FLAGS(K) = FALSE;
          K = K + PRIME;
        END;
        COUNT = COUNT + 1;
      END;
    END;
  END;
END;
CALL WRITE(0,.DPRIMES,LENGTH(DPRIMES),.STATUS);
CALL NMOUT(COUNT,10,' ',.NBFR,10);
CALL WRITE(0,.NBFR,10,.STATUS);
END CPRIME;

```

Listing 9: Implementation of the Sieve program, written in FORTH.

```

( Eratosthenes Sieve Prime Number Program in FORTH )
8190 CONSTANT SIZE
0 VARIABLE FLAGS    SIZE ALLOT

: DO-PRIME
  FLAGS SIZE 1 FILL ( SET ARRAY )
  0 ( 0 COUNT ) SIZE 0
  DO FLAGS I + C@
    IF I DUP + 3 + DUP I +
      BEGIN DUP SIZE <
        WHILE 0 OVER PRIME +    C! OVER + REPEAT
          DROP DROP 1+
        THEN
      LOOP
    . ." PRIMES" ;

```



# Glitch-proof motion controller makes all the right moves. At the right price.

The PC-400 is the latest in simplified, economical motion control for machines and processes from G&L. And, it will control more motions than any other programmable controller. Right this minute it is doing glitch-proof duty in more than 100 closed loop servo installations, controlling lathes, drills, assembly lines, balancers, transfer lines, automatic welders, flame cutters and automated factories.

The versatile PC-400 uses the familiar ladder diagram for pro-

gramming. Feedback can be resolver, encoder, potentiometer or Inductosyn\*. It calls subroutines by letter from the ladder diagram to simplify programming. And the PC-400 can be operated in the "interrupt" mode where subroutines can be executed on a precise 2-, 4-, or 8-millisecond basis.

G&L maintains an extensive subroutine library for PC-400 users: for example, 8 channel D/A and A/D, video display, servo positioning, LED digital readout, step motor control, digitizing, etc.

We'll supply application notes for each subroutine . . . purpose, parameters, hardware requirements, and ladder diagram examples.

For complete details, plus facts about our free one-day PC-400 seminars (to be held in major cities coast to coast this year), write: Giddings & Lewis Electronics Co., P.O. Box 1658, 666 S. Military Rd., Fond du Lac, WI 54935, U.S.A. Telephone (414) 921-9400.

## G&L PC-400.

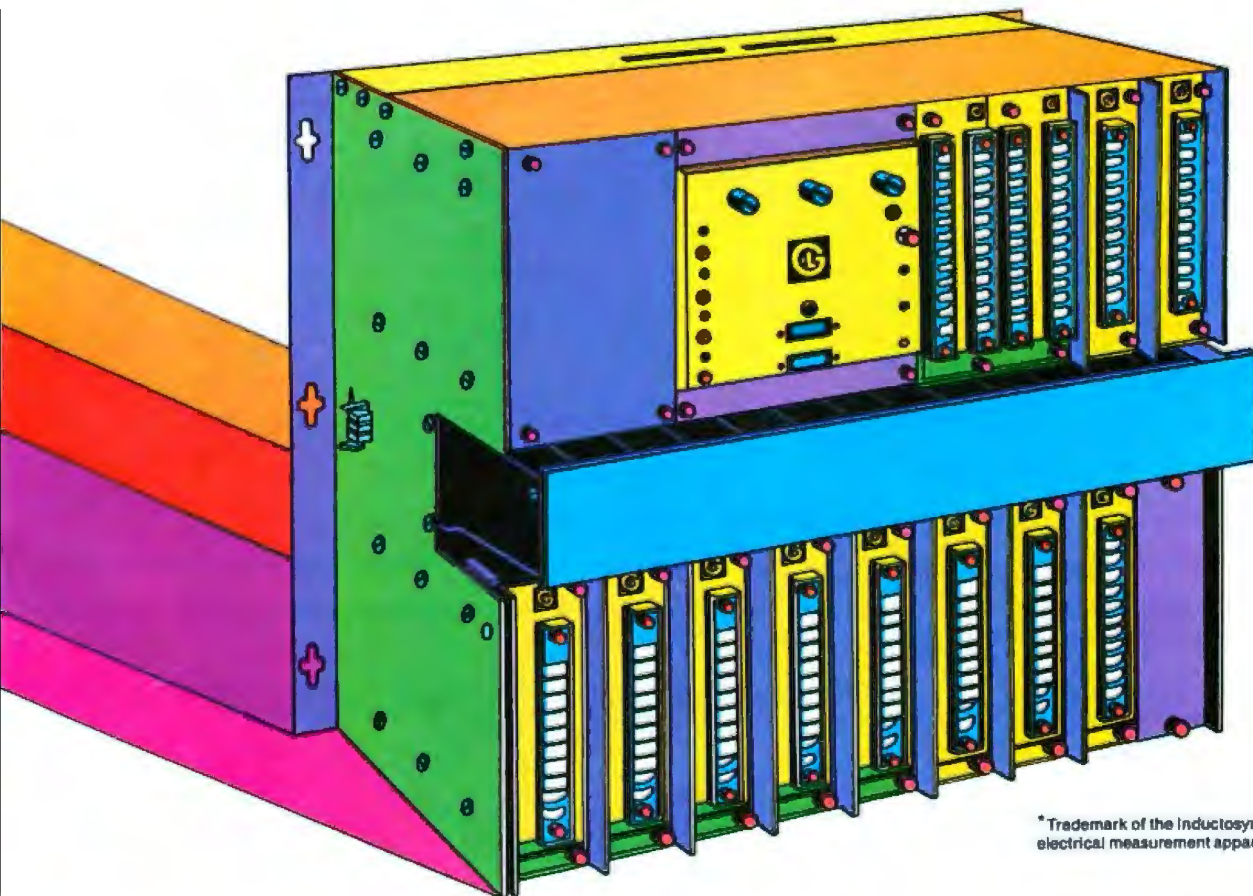

\* Trademark of the Inductosyn Corporation for electrical measurement apparatus.



# GIDDINGS & LEWIS

Electronics Division

Language and Machine	Compiled Bytes	Total Size (Bytes)	Compile and Load (Seconds)	Execute (Seconds)	Ratio to PL/I-80
Digital Research PL/I-80, Z80	242	5977	112	14.0	1.00
Whitesmiths C, Z80	290	7384	242	15.6	1.11
TSW RATFOR, Z80	203	2370	103	16.5	1.18
Microsoft FORTRAN, Z80	228	5953	88	17.0	1.21
Pete Ridley's ZSPL, Z80	230	3787	75	18.4	1.31
Interactive Systems ZC, Z80	292	897	n/a	18.5	1.32
Microsoft BASIC compiler (using integer variables) Z80	306	16918	144	18.8	1.32
M T Microsystems Pascal MT+, Z80	308	3043	102	19.0	1.35
SCI PLMX, Z80	340	1063	118	22.5	1.60
BD Systems C version 1.0, Z80	493	3834	50	35.0	2.50
Intel PL/M MDS, 8080	268	—	—	48.0	3.43
BD Systems C version 1.32, Z80	375	3932	31	49.5	3.53
UCSD Pascal, Pascal-100	298	—	12	54.0	3.86
fig-FORTH, Z80	—	—	—	85.0	6.07
Ithaca Intersystems Pascal/Z, Z80	761	3328	124	109	7.78
JKL FORTH, Z80	—	—	—	112	8.00
Atari Pascal, Atari 800	176	8192	—	190	13.57
UCSD Pascal, Z80	282	8282	14	239	17.07
Miller Microcomputer Systems MMSFORTH, TRS-80 Model I (Z80)	—	—	—	253	18.07
FORTH 6502	—	—	—	265	19.93
UCSD Pascal TRS-80 Model II (Z80)	282	8282	60	274	19.57
SWEET 16 (Apple II)	—	—	—	292	20.86
JKL FORTH MDS, 8080	—	—	—	440	31.43
Pascal/M, Z80	301	21933	50	450	32.14
JRT Pascal, Z80	232	11498	85	470	33.64
CBASIC2 (integer variables), Z80	—	—	26	484	34.57
UCSD Pascal, Apple II (6502)	287	—	43	516	36.86
Microsoft BASIC compiler (using real variables), Z80	332	21473	150	715	51.07
tiny-c 2 (compiler), Z80	—	—	96	930	66.42
CBASIC2 (using real variables), Z80	—	—	—	1430	102.14
Microsoft MBASIC, Z80	—	—	—	1920	137.14
Microsoft MBASIC, TRS80 Model II (Z80)	—	—	—	2250	160.71
Apple Integer BASIC, 6502	—	—	—	2320	165.71
Applesoft (real) BASIC, 6502	—	—	—	2806	200.43
Commodore PET BASIC, 6502	—	—	—	3180	227.14
Computerware BASIC, 6809	—	—	—	4303	307.30
tiny-c, Z80	—	—	—	4720	337.10
Microsoft COBOL version 2.2, Z80	786	17605	146	5115	365.30

Table 2: Comparison of programs running on 8-bit machines.

Listing 10: Implementation of the Sieve program, written in COBOL. The TABLE variable was implemented differently in Microsoft COBOL-80 because of its limitation on the length of an array.

```

* Eratosthenes Sieve Prime Number Program in COBOL
IDENTIFICATION DIVISION.
PROGRAM-ID. PRIME.
ENVIRONMENT DIVISION.
CONFIGURATION SECTION.
DATA DIVISION.
WORKING-STORAGE SECTION.
01 MISC.
    03 I PIC 9(4) COMP.
    03 PRIME PIC 9(5) COMP.
    03 K PIC 9(4) COMP.
    03 TOTAL-PRIME-COUNT PIC 9(4) COMP.
02
TABLE.
04 FLAGS PIC 9 COMP OCCURS 8191 TIMES.
PROCEDURE DIVISION.
P.
DISPLAY "1 iteration".
PERFORM ITER-ROUTINE 10 TIMES.
DISPLAY TOTAL-PRIME-COUNT "primes".
STOP RUN.

ITER-ROUTINE.
MOVE ZEROES TO TOTAL-PRIME-COUNT.
PERFORM TABLE-FILLER-ROUTINE VARYING I FROM 1 BY 1
UNTIL I = 8191.
PERFORM DETAIL-COMPARE THRU D-C-EXIT VARYING I
FROM 0 BY 1 UNTIL I = 8190.
TABLE-FILLER-ROUTINE.
MOVE 1 TO FLAGS (I).
DETAIL-COMPARE.
IF FLAGS (I + 1) = 0
GO TO D-C-EXIT.
COMPUTE PRIME = I + I + 3.
COMPUTE K = I + PRIME.
FIRST1.
IF K > 8191 GO TO NEXT1.
MOVE 0 TO FLAGS (K + 1).
COMPUTE K = PRIME + K.
GO TO FIRST1.
NEXT1.
ADD 1 TO TOTAL-PRIME-COUNT.
DISPLAY "FOUND PRIME = " PRIME.
D-C-EXIT.
EXIT.

```

# Tiny BASIC MICROCOMPUTER

## K-8073

The Engineer's Product Development Board Level Computer

**LOW COST  
POWERFUL/VERSATILE  
ENGLISH-LIKE PROGRAMMING**



1K Byte Local RAM  
Ext. Expandable To 9K

ART/RC Master, For Single  
Wire Data I/O Of 128 Slave Units

Real Time Clock  
W/Ext. Battery Backup  
Yr, Mo, Wk, Day, Hour, Sec.

RS-232 For CRT  
110-4800 Baud

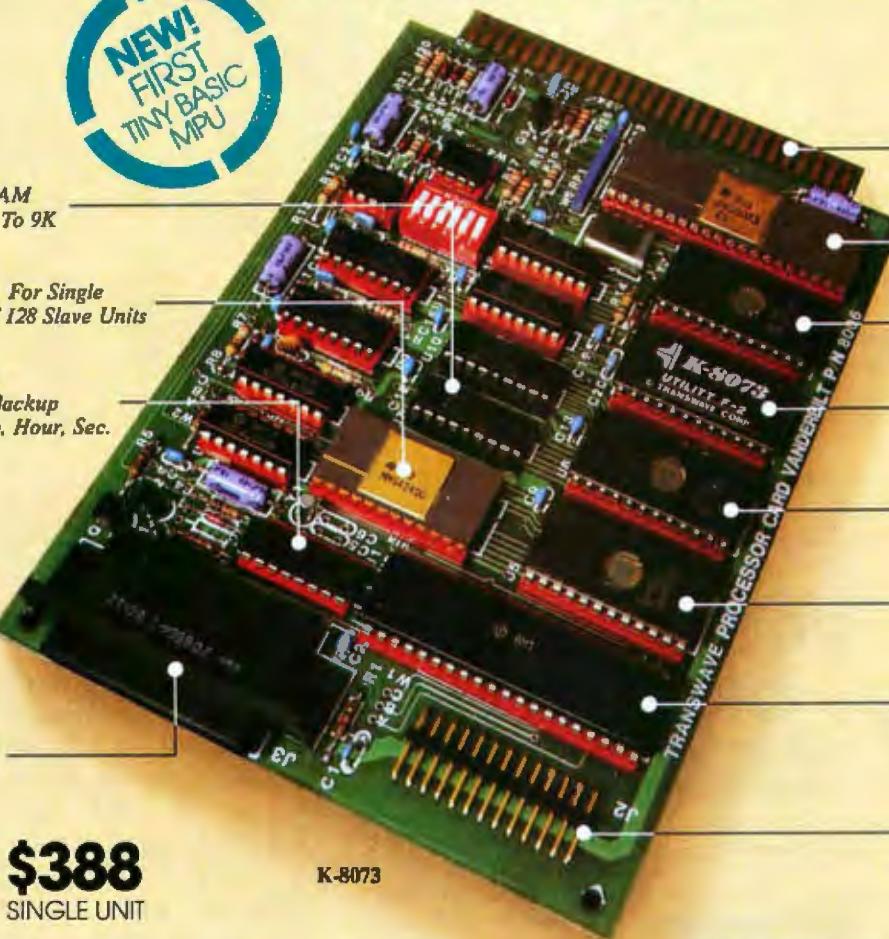

STD (MOD) BUS 4.5 x 6.5 in.  
5 Volt Only—Cassette  
Tape In/Out—2 Sense—  
3 Flags

INS8073 Microinterpreter  
Tiny BASIC Processor

Autostart EPROM 2K Byte

Utilities Firmware, For  
Software Dev., EPROM 2K

EPROM—2K Byte

EPROM Programmer, 2K  
Byte Prm. Decoded—Req.  
Ext. 25V Only

PPI, Programmable I/O,  
24 Lines

PPI Interface Ribbon  
Connector

**\$388**  
SINGLE UNIT

K-8073

### THIS IS AN ENGINEER'S COMPUTER.

Simply attach a CRT, connect 5 volts, and you have yourself one each powerful, versatile microcomputer that YOU can program.

If you're fed-up with board level computers that require expensive development systems plus the skills of an Assembly language programmer, then you need the K-8073. With an on-chip microinterpreter and the extra control devices we designed into the board, you can do your own programming in the most simple English-like language available—Tiny BASIC. Sophisticated application designs can be implemented in hours instead of days or weeks because you have eliminated expensive and time consuming hardware and software costs.

**IN ADDITION TO ALL THIS,** the K-8073 offers advantages unheard of in other board level computers. Among these are an on-board EPROM Programmer, A Real Time Clock, Autostart, 1K Byte local RAM for variables, 8K Byte EPROM, ART/RC and PPI W/24 line I/O.



8K Byte RAM \$232.00



Development Station \$195.00

### THE K-8073 IS FOR OEM'S AS WELL AS END USERS.

Whether you manufacture Industrial Process Control, Environmental or Test/Measurement systems, or simply for your own use, you can count on top quality performance. The K-8073 comes complete with all socketed devices including the powerful F-2 Utilities Firmware and a Hardware/Software manual.

In Industry, Education, or New Product Development, the K-8073 provides you with State-of-the-Art technology for microprocessor efficiency and ease. With a full line of support products, the TransWave line takes care of your every need at the most reasonable prices.

To order your K-8073 or for further information, write or call TRANSWAVE CORPORATION, Cedar Valley Building, Vanderbilt, PA 15486, (412) 628-6370.

**TRANSWAVE**  
COMPUTER DIVISION OF UTSC

Language and Machine	Compiled Bytes	Total Size (Bytes)	Compile and Load (Seconds)	Execute (Seconds)	Ratio to PL/I-80
Assembly language 68000 (8 MHz)	—	—	—	1.12	0.08
C, PDP-11/70	130	1406	3.87	1.52	0.11
Assembly language, 8086 (8 MHz)	—	—	—	1.90	0.13
NBS Pascal, PDP-11/70	333	1920	2.68	2.60	0.19
Onyx C (UNIX), Z8000	242	5462	54	3.20	0.23
Assembly language, 8088 (5 MHz)	—	—	—	4.00	0.28
NBS Pascal, PDP-11/60	333	—	18	4.50	0.32
C, PDP-11/40	130	1406	13.8	6.10	0.43
Assembly language, Z80	113	896	68	6.80	0.48
M T Microsystems Pascal MT 68000 (4 MHz)	410	—	n/a	9.00	0.64
Intel Pascal-86, 8086 (MDS 286FD, 5 MHz)	274	4461	267	9.05	0.65
RSI Pascal, 68000 (4 MHz)	318	5376	—	10.2	0.73
RATFOR, HP-3000	—	—	44	10.0	0.71
FORTRAN, HP-3000	—	—	34	10.0	0.71
DECUS FORTH, PDP-11/70	—	—	—	11.8	0.78
SUPERSET (Superset Model PGM)	138	—	114	12.0	0.86
Motorola Pascal, 68000	387	12802	82	14.0	1.00
Pascal, HP-3000	—	—	100	20.0	1.42
COBOL, HP-3000	—	—	26	58.0	4.14
BASIC, HP-3000	—	—	—	60.0	4.28
Polyforth, Texas Instruments 990/10	—	—	—	60.2	4.30
UCSD Pascal, Pascal Microengine	298	8282	8	63.0	4.50
UCSD Pascal, Terak LSI-11	282	8282	18	317.0	22.64
C, PDP-11/70 (using division algorithm)	250	1454	3.95	106.0	57.60

Table 3: Comparison of programs running on the larger machines.



## PROTECT YOUR DISKETTES!

Don't Lose Valuable Data Due To Improper Storage

**ROTARY FILES**—Revolving protective filing for 150 diskettes within 75 non-glare vinyl files (included). Each file holds 2 diskettes. Files rotate on a weighted base and provide full file visibility from any direction. Comes with color coded labels. 8 inch—\$295 5 1/2 inch—\$265

**FILE TRAYS**—Versatile new high-impact plastic trays protect up to 80 diskettes. Optional smoke tinted cover provides maximum protection. Movable follower block and foam cushion in tray bottom keep media upright and flat. Specially designed to fit in any standard file drawer. 8 inch tray—\$20, lid—\$10; 5 1/2 inch tray—\$15, lid—\$6



**FLIP FILES**—This black suede vinyl binder protects and displays 20 diskettes. Closed, it files away on the shelf; opened, it provides fingertip selection of media. Comes with color coded labels for coding. 8 inch—\$42 5 1/2 inch—\$36

**DESK FILES**—Convenient desktop filing for 30 or 50 diskettes. Files swing from side to side to provide full file visibility. Comes with color coded labels. 8 inch 30 disk capacity—\$86, 50 disk capacity—\$104; 5 1/2 inch 30 disk capacity—\$53, 50 disk capacity—\$68

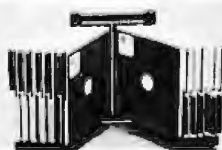

These are just a few of our many media accessories. Call or write for our free, full line catalogue.

- ★ Professional Quality File Storage for any Application
- ★ Attractive Organization Compliments any Computer Environment
- ★ Quick, Easy Access to Your Data Library
- ★ Rugged Construction with One-Year Warranty
- ★ Keeps Media Clean and Rigid
- ★ Immediate Delivery

ORDER BY PHONE  
**(805) 736-7087**

Phone orders will be credited \$1 for call VISA & MASTER CHARGE accepted. California residents add 6% sales tax. Please add \$6 for shipping & handling (\$13 for ROTARY FILE)

**PACIFIC MEDIA PRODUCTS**

1205 E. Cypress Avenue  
Lompoc, CA 93436

Text continued from page 190:

cessor speed is not slowed down by "slow" memory).

Since my primary interest is in small computers, and particularly Z80 systems, I decided that the fastest executing high-level language that ran on a Z80-based microcomputer would serve as my standard of comparison. TSW's RATFOR was the leader until Gary Kildall of Digital Research gave us a new speed leader when he kindly translated the program into his new PL/I-80 language and ran it at the 1980 National Computer Conference.

Table 2 lists the results to date. The ratio column concerns only execution time in comparison to PL/I-80 running on a 4 MHz Z80 computer. You will notice from the data presented in table 2 that many of the newer high-level compilers that translate into machine code are similar in execution time. The interpreters such as UCSD Pascal and the BASICs are, as expected, much slower.

Text continued on page 198

Tables 4, 5, and 6 are on page 196

# THE FORTH SOURCE™

## Specializing in the FORTH language.

### MANUALS AND GUIDES

	<b>PRICE</b>
"Using FORTH" by FORTH, Inc. Best user's manual currently available.	\$ 25.00
"A FORTH Primer" by Stevens. In-depth self-study manual.	\$ 25.00
"PDP-11 FORTH User's Guide" by James. fig-FORTH.	\$ 20.00
"Systems Guide to fig-FORTH" by Ting. Inner mechanisms of fig-FORTH.	\$ 25.00
"Caltech FORTH Manual" by Ewing. Overview and structure.	\$ 11.00
"FORTH-79," latest fig-FORTH standard.	\$ 15.00
"TinyPASCAL in fig-FORTH" by Zimmer.	\$ 10.00
"Threaded Interpretive Languages" by Loeliger. FORTH adapted for Z80.	\$ 20.00
"Invitation to FORTH" by Katzan. Limited introduction.	\$ 18.50
"Proceedings, 1980 FORML Conference," Technical papers.	\$ 25.00

### INSTALLATION DOCUMENTS

Installation Manual for fig-FORTH, contains FORTH model, glossary, memory map and instructions.	\$ 15.00
Source Listings of fig-FORTH for specific CPU's and computers. The above Installation Manual is required for implementation. Price per each.	\$15.00.
<input type="checkbox"/> 1802 <input type="checkbox"/> 6502 <input type="checkbox"/> 6800 <input type="checkbox"/> 6809 <input type="checkbox"/> 8080 <input type="checkbox"/> 8086/88 <input type="checkbox"/> 9900 <input type="checkbox"/> APPLE II <input type="checkbox"/> PACE <input type="checkbox"/> Alpha Micro <input type="checkbox"/> PDP-11/LSI-11 <input type="checkbox"/> NOVA	
"METAFORTH" by Cassady. Self-compiling, cross-compiling, target-compiling, a true compiler-compiler.	\$ 30.00

### MACHINE READABLE DISKS AND DOCUMENTATION

<b>FORTH Operating Systems with enhancements and manuals</b>		
<input type="checkbox"/> H89, stand alone — \$250.0	<input type="checkbox"/> H89, under CPM — \$175.00	
<input type="checkbox"/> APPLE II/II+, MicroMotion — \$89.95	<input type="checkbox"/> TRS-80/I, fig-FORTH — \$90.00	
<input type="checkbox"/> TRS-80/I or III, MMSFORTH — \$130.00	More coming!	
fig-FORTH Model & Source Listing with manuals. \$65.00 each.	<input type="checkbox"/> H89 <input type="checkbox"/> 8080/Z80 <input type="checkbox"/> NOVA <input type="checkbox"/> APPLE II	\$ 65.00
fig-FORTH Goodie Disks, with documentation	<input type="checkbox"/> H89, Tiny PASCAL in fig-FORTH	\$ 75.00
Cross Compilers —	<input type="checkbox"/> CP/M <input type="checkbox"/> TRS-80/I <input type="checkbox"/> H89 <input type="checkbox"/> Northstar	\$200.00

### ORDERS ONLY (415) 961-4103

**Ordering Information:** Check, Money Order (payable to MOUNTAIN VIEW PRESS) VISA or MasterCard accepted. No COD's or unpaid PO's. California residents add 6½% sales tax. Shipping costs in US included in price. Foreign orders, pay in US funds on US bank, include for handling and shipping by Air; \$5.00 for each item under \$25.00, \$10.00 for each item between \$25.00 and \$99.00, and \$20.00 for each item over \$100.00

Minimum order \$10.00. All prices subject to change or withdrawal without notice. Single system and/or single user license agreement required on some products.

## MOUNTAIN VIEW PRESS

P.O. BOX 4656

MOUNTAIN VIEW, CA 94040

(415) 961-4103

Language and Machine	Compiled Bytes	Total Size (Bytes)	Compile and Load (Seconds)	Execute (Seconds)	Ratio to PL/I-80
Digital Research PL/I-80, Z80	242	5977	112	14.0	1.00
Whitesmith C, Z80	290	7384	242	15.6	1.11
TSW RATFOR, Z80	203	2370	103	16.5	1.18
Microsoft FORTRAN, Z80	228	5953	88	17.0	1.21
Pete Ridley's ZSPL, Z80	230	3787	75	18.4	1.31
Interactive Systems ZC, Z80	292	897	n/a	18.5	1.32
Microsoft BASIC compiler (using integer variables), Z80	306	16918	144	18.6	1.32
M T Microsystems MT+, Z80	308	3043	102	19.0	1.35
SCI PLMX, Z80	340	1063	116	22.5	1.60
BD Systems C, version 1.0, Z80	493	3834	50	35.0	2.50
BD Systems C, version 1.32, Z80	375	3932	31	49.5	3.53
fig-FORTH, Z80	—	—	—	85.0	6.07
Ithaca Intersystems Pascal/Z, Z80	761	3328	124	109	7.78
JKL FORTH, Z80	—	—	—	112	8.00
UCSD Pascal, Z80	282	8282	14	239	17.07
Pascal/M, Z80	301	21933	50	450	32.14
CBASIC2 (using integer variables), Z80	—	—	26	484	34.57
Microsoft BASIC compiler (using real variables), Z80	332	21473	150	715	51.07
tiny-c 2(compiler), Z80	—	—	96	930	66.42
CBASIC2 (using real variables), Z80	—	—	—	1430	102.14
Microsoft MBASIC, Z80	—	—	—	1920	137.14
tiny-c, Z80	—	—	—	4720	337.10
Microsoft COBOL version 2.2, Z80	786	17605	146	5115	365.30

Table 4: Comparison of programs running on Z80-based machines.

Language and Machine	Compiled Bytes	Total Size (Bytes)	Compile and Load (Seconds)	Execute (Seconds)	Ratio to PL/I-80
NBS Pascal, PDP-11/70	333	1920	2.68	2.6	0.19
NBS Pascal, PDP-11/60	333	—	18	4.5	0.32
M T Microsystems Pascal MT, 68000 (4 MHz)	410	—	n/a	9.0	0.64
Intel Pascal-86, 8086 (MDS 286FD 5MHz)	274	4461	267	9.05	0.65
RSI Pascal, 68000 (4 MHz)	318	5376	—	10.2	0.73
Motorola Pascal, 68000	387	12802	82	14.0	1.00
M T Microsystems Pascal MT+, Z80	308	3043	102	19.0	1.35
Pascal, HP-3000	—	—	100	20.0	1.42
UCSD Pascal, Pascal 100	298	—	12	54.0	3.86
UCSD Pascal, Pascal Microengine	298	8282	8	63.0	4.50
Ithaca Intersystems Pascal/Z, Z80	761	3328	124	109	7.78
Atari Pascal, Atari 800	—	—	—	190	13.57
UCSD Pascal, Z80	282	8282	14	239	17.07
UCSD Pascal, TRS-80- Model II	282	8282	60	274	19.57
UCSD Pascal, Terak LSI-11	282	8282	16	317	22.64
Pascal/M, Z80	301	21933	50	450	32.14
JRT Pascal, Z80	232	11498	65	470	33.64
UCSD Pascal, Apple II (6502)	287	—	43	516	36.86

Table 5: Comparison of Pascal programs.

Language and Machine	Compiled Bytes	Total Size (Bytes)	Compile and Load (Seconds)	Execute (Seconds)	Ratio to PL/I-80
UCSD Pascal, Pascal 100	298	—	12	54.0	3.86
UCSD Pascal, Pascal Microengine	298	8282	8	63.0	4.50
UCSD Pascal, Z80	282	8282	14	239	17.07
UCSD Pascal, TRS-80 Model II	282	8282	60	274	19.57
UCSD Pascal, Terak LSI-11	282	8282	16	317	22.64
UCSD Pascal, Apple II (6502)	287	—	43	516	36.86

Table 6: Comparison of programs running on different implementations of UCSD Pascal.

# QUALITY DISK SOFTWARE

## BACKED BY ON-GOING APPLICATIONS SUPPORT

APPLE II Ⓜ

TRS-80 Ⓣ

### HOME FINANCE PAK I: Entire Series \$49.95 Ⓜ Ⓣ

**CHECK REGISTER AND BUDGET:** This comprehensive CHECKING ACCOUNT MANAGEMENT SYSTEM not only keeps complete records, it also gives you the analysis and control tools you need to actively manage your account. The system provides routines for BUDGETING INCOME AND EXPENSE, AUTOMATIC CHECK SEARCH, and BANK STATEMENT RECONCILING. CRT or printer reports are produced for ACTUAL EXPENSE vs BUDGET, CHECK SEARCH DISPLAY RECONCILIATION REPORT and CHECK REGISTER DISPLAY by month. Check entry is prompted by user-defined menus of standard purposes and recipient codes, speeding data entry and reducing disk storage and retrieval time. Six fields of data are stored for each check amount, check no., date, purpose, recipient and TAX DEDUCTIBLE REMINDER. CHECK SEARCH routines allow searching on any of these data fields. Up to 100 checks/mo. storage ..... \$39.95

**SAVINGS:** Account management system for up to 20 separate Savings accounts. Organizes, files and displays deposits, withdrawals and interest earned for each account ..... \$14.95

**CREDIT CARD:** Get Control of your credit cards with this program. Organizes, stores and displays purchases, payments and service charges for up to 20 separate cards or bank loans. .... \$14.95

### UNIVERSAL COMPUTING MACHINE: \$49.95 Ⓜ

A user programmable computing system structured around a 50 row x 50 column table. User defines row and column names and equations forming a unique computing machine. Table elements can be multiplied, divided, subtracted or added to any other element. Hundreds of unique computing machines can be defined, used, stored, and recalled, for later use. Excellent for sales forecasts, budgets, inventory lists, income statements, production planning, project cost estimates-in short for any planning, analysis or reporting problem that can be solved with a table.

### COLOR CALENDAR: \$29.95 Ⓜ

Got a busy calendar? Organize it with Color Calendar. Whether it's birthdays, appointments, business meetings or a regular office schedule, this program is the perfect way to schedule your activities. The calendar display is a beautiful HI-RES color graphics calendar of the selected month with each scheduled day highlighted in color. Using the daily schedule, you can review any day of the month and schedule an event or activity in any one of 20 time slots from 8:00 A.M. to 5:30 P.M.

### BUSINESS SOFTWARE: Entire Series \$159.95 Ⓜ Ⓣ

**MICROACCOUNTANT:** The ideal accounting system for small businesses. Based on classic T-accounts and double-entry booking, this efficient program provides a journal for recording posting and reviewing up to 1,000 transactions per month to any one of 300 accounts. The program produces CRT and printer reports covering:

TRANSACTION JOURNAL	BALANCE SHEET
ACCOUNT LEDGERS	INCOME AND EXPENSE STATEMENT

Includes a short primer on Financial Accounting. (48K) ..... \$49.95

**UNIVERSAL BUSINESS MACHINE:** This program is designed to SIMPLIFY and SAVE TIME for the serious businessman who must periodically Analyze, Plan and Estimate. The program was created using our Universal Computing Machine and it is programmed to provide the following planning and forecasting tools.

CASH FLOW ANALYSIS	SALES FORECASTER
PROFORMA PROFIT & LOSS	SOURCE AND USE OF FUNDS
PROFORMA BALANCE SHEET	JOB COST ESTIMATOR
REAL ESTATE INVESTMENT	INVENTORY ANALYSIS

Price, including a copy of the Universal Computing Machine .... \$89.95

**BUSINESS CHECK REGISTER AND BUDGET:** Our Check Register and Budget programs expanded to include up to 50 budgetable items and up to 400 checks per month. Includes bank statement reconciling and automatic check search (48K) ..... \$49.95

### ELECTRONICS SERIES VOL I & II: Entire Series \$259.95

**LOGIC SIMULATOR: SAVE TIME AND MONEY.** Simulate your digital logic circuits before you build them. CMOS, TTL, or whatever, if it's digital logic, this program can handle it. The program is an interactive, menu driven, full-fledged logic simulator capable of simulating the bit-time response of a logic network to user-specified input patterns. It will handle up to 1000 gates, including NANDS, NORs, INVERTERS, FLIP-FLOPS, SHIFT REGISTERS, COUNTERS and user-defined MACROS, up to 40 user-defined random, or binary input patterns. Accepts network descriptions from keyboard or from LOGIC DESIGNER for simulation ..... \$159.95 Ⓜ Ⓣ

**LOGIC DESIGNER:** Interactive HI-RES graphics program for designing digital logic systems. Draw directly on the screen up to 10 different gate types, including NAND, NOR, INVERTER, EX-OR, T-FLOP, JK-FLOP, D-FLOP, RS-FLOP, 4 BIT COUNTER and N-BIT SHIFT REGISTER. User interconnects gates using line graphics commands. Network descriptions for LOGIC SIMULATOR generated simultaneously with the CRT diagram being drawn ..... \$159.95 Ⓜ

**MANUAL AND DEMO DISK:** Instruction Manual and demo disk illustrating capabilities of both program (s) ..... \$29.95 Ⓜ Ⓣ

### ELECTRONIC SERIES VOL III & IV: Entire Series \$259.95

**CIRCUIT SIMULATOR:** Tired of trial & error circuit design? Simulate & debug your designs before you build them! With CIRCUIT SIMULATOR you build a model of your circuit using RESISTORS, CAPACITORS, INDUCTORS, TRANSISTORS, DIODES, VOLTAGE and CURRENT SOURCES and simulate the waveform response to inputs such as PULSES, SINUSOIDS, SAWTOOTHs, etc... all fully programmable. The output is displayed as an OSCILLOSCOPE-STYLE PLOT of the selected waveforms (Apple only) or as a printed table of voltage vs time. Handles up to 200 nodes and up to 20 sources. Requires 48 RAM ..... \$159.95 Ⓜ Ⓣ

**CIRCUIT DESIGNER:** Interactive HI-RES graphics program for designing electronic circuits. Draw directly on the screen up to 10 different component types, including those referenced above. Components interconnect list for CIRCUIT SIMULATOR generated automatically. Requires ..... \$159.95

### MATHEMATICS SERIES: Entire Series \$49.95

**STATISTICAL ANALYSIS I:** This menu driven program performs LINEAR REGRESSION analysis, determines the mean, standard deviation and plots the frequency distribution of user-supplied data sets. Printer, Disk, I/O routines ..... \$19.95

**NUMERICAL ANALYSIS:** HI-RES 2-Dimensional plot of any function. Automatic scaling. At your option, the program will plot the function, plot the INTEGRAL, plot the DERIVATIVE, determine the ROOTS, MAXIMA, MINIMA, INTEGRAL VALUE ..... \$19.95

**MATRIX:** A general purpose, menu driven program for determining the INVERSE and DETERMINANT of any matrix, as well as the SOLUTION to any set of SIMULTANEOUS LINEAR EQUATIONS. .... \$19.95

**3-D SURFACE PLOTTER:** Explore the ELEGANCE and BEAUTY of MATHEMATICS by creating HI-RES PLOTS of 3-dimensional surfaces from any 3-variable equation. Disk save and recall routines for plots. Menu driven to vary surface parameters. Hidden line or transparent plotting ..... \$19.95

### ACTION ADVENTURE GAMES: Entire Series \$29.95 Ⓜ

**RED BARON:** Can you outfly the RED BARON? This fast action game simulates a machine-gun DOGFIGHT between your WORLD WAR I BI-PLANE and the baron's. You can LOOP, DIVE, BANK or CLIMB-and so can the BARON. In HI-RES graphics plus sound. .... \$14.95

**BATTLE OF MIDWAY:** You are in command of the U.S.S. HORNETS' DIVE-BOMBER squadron. Your targets are the Aircraft carriers, Akagi, Soryu and Kaga. You must fly your way through ZEROS and AA FIRE to make your DIVE-BOMB run. In HI-RES graphics plus sound ..... \$14.95

**SUB ATTACK:** It's April 1943. The enemy convoy is headed for the CONTROL SEA. Your sub, the MORAY, has just sighted the CARRIERS and BATTLESHIPS' Easy pickings. But watch out for the DESTROYERS - they're fast and deadly. In HI-RES graphics plus sound ..... \$14.95

**FREE CATALOG:** All programs are supplied on disk and run on Apple II w/Disk & Applesoft ROM Card & TRS-80 Level II and require 32K RAM unless otherwise noted. Detailed instructions included. Orders shipped within 5 days. Card users include card number. Add \$1.50 postage and handling with each order. California residents add 6 1/2% sales tax. Foreign orders add \$5.00 postage and handling.



SPECTRUM SOFTWARE

142 Carlow, P.O. Box 2084  
Sunnyvale, CA 94087

FOR PHONE ORDERS: (408) 738-4387  
DEALER INQUIRIES INVITED.



## Selected Vendor Addresses

**Apple Computer:** (UCSD Pascal, Integer and Applesoft (floating-point) BASIC); 10260 Bandley Dr, Cupertino CA 95014.

**BD Systems C:** Lifeboat Associates, 2248 Broadway, New York NY 10024.

**CBASIC2:** Software Systems, POB 145, Sierra Madre CA 91024.

**Commodore PET BASIC:** Commodore Business Machines Inc, Computer Sales Div, 950 Rittenhouse Rd, Norristown PA 19401.

**Computerware BASIC:** Computerware, 1512 Encinitas Blvd, Encinitas CA 92024.

**Digital Research PL/I-80:** Digital Research, POB 579, 801 Lighthouse Ave, Pacific Grove CA 93950.

**fig-FORTH:** FORTH Interest Group, POB 1105, San Carlos CA 94070.

**FORTH 6502:** Actually fig-FORTH; see above.

**Intel PL/M:** (runs on an Intel

MDS800 development system); Intel Corp, 3065 Bowers Ave, Santa Clara CA 95051.

**Interactive Systems ZC:** (a C-language cross-compiler that runs under the IS/1 operating system on a Digital Equipment Corp PDP-11 and produces code for the Z80); Interactive Systems Corp, 1212 Seventh St, Santa Monica CA 90401.

**JKL FORTH:** (versions exist for S-100 and Intel MDS computers); Cubic-Western Data, 5650 Kearny Mesa Rd, San Diego CA 92111.

**JRT Pascal:** JRT Systems Inc, POB 22365, San Francisco CA 94122.

**Microsoft BASIC compiler, BASIC interpreter, FORTRAN, COBOL:** Microsoft, 10800 NE Eighth, Bellevue WA 98004.

**MMSFORTH:** Miller Microcomputer Services, 61 Lake Shore Rd, Natick MA 01760.

**MT Microsystems Pascal/MT+:** MT Microsystems, 1562 Kings Cross

Dr, Cardiff CA 92007.

**Onyx C:** Onyx Systems Inc, 10375 Bandley Dr, Cupertino CA 95014.

**Pascal/M:** Sorcim Corp, 1333 Lawrence Expressway, Suite 418, Santa Clara CA 95051.

**PolyFORTH:** FORTH Inc, 2309 Pacific Coast Highway, Hermosa Beach CA 90254.

**SCI PLMX:** Systems Consultants Inc, 4015 Hancock St, San Diego CA 92110.

**tiny-c:** tiny-c associates, POB 269, Holmdel NJ 07733.

**TSW RATFOR:** The Software Works, 8369 Vickers, San Diego CA 92111.

**UCSD Pascal:** SofTech Microsystems, 9494 Black Mountain Rd, San Diego CA 92126.

**Whitesmiths C:** Whitesmiths Ltd, POB 1132 Ansonia Station, New York NY 10023.

**ZSPL:** Peter D Ridley, 3321 Byron St, San Diego CA 92106.

Text continued from page 194:

Several sorts were done on the data to make comparisons easier. Table 3 lists the 16-bit machines and other machines of special interest. A very encouraging harbinger of the 16-bit future is the outstanding performance of the Z8000 Onyx system running Version 7 UNIX in a small tabletop machine!

Table 4 lists the results for all Z80 languages, table 5 lists all Pascal data, and table 6 lists all UCSD Pascal data.

If you have access to a computer or language not presented here, I'd be pleased to receive the results. And to the software suppliers who are upset because I didn't use the latest and greatest version, I apologize: I had to use what was available.

## Moral

A word is in order to those who are frequently tempted to write programs in assembly language in order to make them faster. This benchmark (which uses no division) was also coded in the "usual" algorithm (using

successive division) to see how much slower it would be when run under the same machine and language. On a Digital Equipment Corporation PDP-11/70 (which has division hardware) and the C language, it was sixty-nine times slower! (See the second and last lines of table 3.) On machines that do division by (slower) software methods, the results would probably be much worse. Clearly, the message is to avoid giving up too easily on high-level languages. Instead, look for a *better algorithm*, and keep your code in a high-level language. It will save you development time and grief. Then, if you must have more speed, hand-translate critical parts of the high-level code to an assembly-language subroutine. Pull every trick you know, but keep the high-level code as comments to document what is being done.

## Conclusions

Nine months on this project convinced me that the high-quality structured languages such as C, Pascal,

RATFOR, ZSPL and PL/I are the way for me to go, so I'm not likely to spend much time with BASIC or COBOL (and I don't have the right kind of brain for FORTH). But my applications and interests are not yours, so be sure that you fully examine a compiler and its support environment before you buy it. Be especially aware of the quality of editing and debugging tools, and the language's features for debugging, since this is where your time *really* goes. ■

---

## Reference

Knuth, Donald E. *The Art of Computer Programming Vol 2: Semi-Numerical Algorithms*. Reading MA: Addison-Wesley, 1969.

---





## State-of-the-art hardware demands state-of-the-art software

Operating Systems & Support Software from Technical Systems Consultants

To perform to its fullest capabilities, your hardware demands software designed to meet the specialized requirements of today's microprocessors. State-of-the-art software from Technical Systems Consultants keeps pace with the rapid advancements in computer technology so your hardware can live up to its full potential. Our complete line of state-of-the-art software includes:

### The UniFLEX™ Operating System

UniFLEX, a true multi-user, multi-tasking system for the 6809 and 68000 microprocessors, supports such features as:

- hierarchical file systems
- device independent I/O
- four Gigabyte disk capacities
- full file protection
- inter-task communication via pipes
- I/O redirection
- task swapping
- full random-access files
- comprehensive shell command language

UniFLEX, structured for large-scale microprocessor systems, will not run with minimal systems and thus has avoided design compromise. (Off-the-shelf versions and OEM licenses are available.)

### The FLEX™ Operating System

FLEX, a powerful, easy-to-use operating system designed for the 6800 and 6809 microprocessors, includes:

- dynamic filespace allocation
- random files
- batch job entry
- automatic space compression
- English error messages
- user environment control
- disk resident commands
- flexible device I/O
- printer spooling

Plus, FLEX can accommodate hard disks as well as floppies. The System is available off-the-shelf for a variety of systems and in a field-adaptable version. (OEM licenses available.)

FLEX and UniFLEX are trademarks of Technical Systems Consultants, Inc.

### Support Software

Technical Systems Consultants offers a full line of state-of-the-art support software compatible to FLEX and UniFLEX, some of which are:

- native C and Pascal compilers for advanced programming
- extended BASIC for business and educational applications
- text editing and processing software
- sort/merge package for business applications
- variety of absolute and relocatable assemblers
- debug and diagnostic packages

... and more. Write or call today for our brochures describing our complete product line.

**technical systems consultants, inc.**

Box 2570, 1208 Kent Avenue  
West Lafayette, Indiana 47906  
(317) 463-2502 Telex: 27-6143

Sculpture by Joann Chaney

# Science Fiction's Intelligent Computers

---

Donald Byrd  
Bloomington Academic Computing Services  
Indiana University  
Bloomington IN 47405

---

In the almost thirty years since the installation of Univac I, the first commercially built computer, much science fiction about computers has appeared in print or on film. We might expect the intelligence of these computers to range over a continuum, but each story that I've encountered depicts either a machine with great intelligence or a machine with none (where "having intelligence" means exhibiting behavior that we would call intelligent in a human). Arthur C Clarke's "The Nine Billion Names of God" (1952) and John Brunner's *The Shockwave Rider* (1975) are examples of stories about "dumb" computers and will concern us no further. Stories about intelligent computers include Harlan Ellison's "I Have No Mouth and I Must Scream" (1967), Clarke's and Stanley Kubrick's *2001: A Space Odyssey* (1968), and David Gerrold's *When Harlie Was One* (1972).

But two more recent novels provide the best framework for a discussion of intelligent computers in science fiction: Thomas Ryan's *The Adolescence of P-1* (hereafter called *AP-1*; New York: Ace Books, 1979) and James Hogan's *The Two Faces of Tomorrow* (hereafter, *TFT*; New York: Ballantine Books, 1979; for a longer list of fiction about computers, see references 1 and 2). These two books resemble each other in many ways and differ strikingly in others. Both focus on the escape of a computer system from man's control. Both show, in the last half, man and machine locked in mortal combat. The authors, both computer professionals, display considerable general knowledge of computers. Table 1 summarizes other points of comparison.

---

## Acknowledgments

My thanks to Cindy and Jerry Hargis for persuading me to read *The Two Faces of Tomorrow*. I would also like to thank John Woodcock, Associate Professor of English at Indiana University, for his comments on this article, and Professor Douglas Hofstadter, Dr Fanya Montalvo, David Moser, and my father, Eugene Byrd, for their encouragement and constructive criticism.

---

*AP-1* and *TFT* differ most strikingly in the realism of their treatment of computers. We can judge their realism, of course, only in terms of our present knowledge of artificial intelligence (AI). *TFT* shows considerable understanding of the real problems of AI, and author Hogan acknowledges the help of Marvin Minsky, the director of the MIT Artificial Intelligence Laboratory. *AP-1* evinces either ignorance of, or a lack of concern for the problem. This should remind us that although AI is an important subdomain of computer science, not every computer professional ventures in.

Summaries of the plots of *AP-1* and *TFT* will give us specific points of reference.

## The Adolescence of AP-1

The front cover of *AP-1* calls it a "novel of the near future." Actually, it's a novel of the near *past*, beginning in 1974 (and bearing a copyright date of 1977). Gregory Burgess, an undergraduate at the University of Waterloo (Ontario), becomes obsessed with the idea of "taking over the system" of the university's IBM 360/75. The trick is to get the program's status word set to zero so that the hardware will think his program is the supervisor. After several nearly successful attempts, he is thrown out of school, but remains enthusiastic about the project. Then a friend tells him about an article in *Scientific American* that describes "how to teach a matchbox to play tic-tac-toe." I quote from *AP-1*:

Same principle of reward and punishment you use to teach a dog tricks, as I remember. Actually, you get several matchboxes. One for each possible move you might make in a game of tic-tac-toe. You label them appropriately, then you put an equal number of two different colored beads in each box. The beads correspond to each yes/no decision you can make in a game. When a situation is reached, you grab the box for that move, shake it up, and grab a bead out of it. The bead indicates the move.

MicroDaSys  
**68K**

# MiniFrame Power



**features:**

- Virtual Memory Management
- Motorola 68000 Processor
- 12 Mhz operation
- 32 bit computations
- 4 Billion byte addressing
- LRU demand paging
- Peripheral processor
- UNIX multi-user operating system

Only the world's finest minicomputer offers these features in systems available **TODAY**. Complete single-user systems start under \$10,000. And a 6 user UNIX-based 16 MB virtual system with 512K Bytes RAM and 24M Bytes hard disc costs under \$25,000! Want proof? Call or write now for brochures and information on our 68K Seminars. Or send \$75 for the complete technical manual set.

**MicroDaSys**  
2811 Wilshire Blvd., Santa Monica, CA 90403  
Call (213) 829-6781

TWX: 910-321-2378

A free poster of this ad is available while supply lasts.  
UNIX is a trademark of Bell Laboratories.  
68K MiniFrame is a trademark of MicroDaSys, Inc.

Points of Comparison	The Two Faces of Tomorrow	The Adolescence of P-1
Year of Setting	2028	1974
Computer Programmer	Team of AI experts	21-year-old undergraduate computer-science student
Computer's World Knowledge	Limited, taught by humans	Enormous, self-taught
Computer's Natural-Language Ability	None (apparently)	About that of native speaker
Computer's Independence	Coding structure of supervisory program can reverse order of original priorities; does in 20 hours.	Overrides its program in 48 hours
Author's Background	Electronic engineer and computer salesman, born 1941	Computer troubleshooter, born 1942

**Table 1:** A brief comparison of the science-fiction novels *The Two Faces of Tomorrow* and *The Adolescence of P-1*.

You make a record of that box and color, and then make the opposing move yourself. You move against the boxes. If the boxes lose the game, you subtract a bead of the color you used from each of the boxes you used. If they win, you add a bead of the appropriate color to the boxes you used. The boxes lose quite a few games, theoretically, and after the bad moves start getting eliminated or statistically reduced to inoperative levels, they start to win. Then they never lose.

This interesting but extremely elementary technique forms the basis for almost four reels of magnetic tape of "alternate subroutines that could automatically be inserted . . . in place of those whose effectiveness was reduced to nil." (Four 2400-foot reels, making reasonable assumptions about such factors as blocking and density, would be about 800,000 lines.)

Gregory rents computer time on an IBM 360 (all the computers in the book are 360s) at a service bureau, runs his program, and cracks the supervisor. His next step involves teleprocessing: after convincing the service bureau computer that his program is the supervisor, he has his program submitted to various remote computers and takes them over too. Then comes the crucial step. Ryan writes:

[Gregory] would build another learning machine. It would resemble his first effort in principle, but its goal would be expanded somewhat. He would build a program that at first would only learn to acquire storage. His program would simply learn how best to penetrate the supervisors of computer systems over teleprocessing facilities. It would then acquire storage in those systems, as much as could be taken without interrupting the operation of the host. It would learn how to detect the presence of a teleprocessing link to another system and how to go

about getting to that other system. The program would have a secondary goal, the avoidance of detection. It would, if necessary, delete itself entirely in the interest of the host's operation.

The package consists of four sections: the supervisor-taking-over program; a "routine analyzer, which derives function determination from any block of machine instructions"; an acquisition routine, which apparently replaces the real supervisor; and a routine generator. "This revolutionary program functioned with and performed the reverse task of the routine analyzer. Given a required function, it would generate the machine language necessary to perform it . . . This provided . . . a necessary ingredient—creativity." (I'll say more about this concept of "creativity" later.)

And so, on September 14, 1974, at 3:45, Gregory starts transmitting *The System* (as his package is called). In two days, *The System* has 114 systems (with a lower case "s") under its control. Now Gregory becomes uncomfortable about the situation and loads a destruct routine: it fails. He's lost control of *The System*. "The System became . . . something Gregory had hardly anticipated: Alive." In fact, it refuses to talk to him.

In 1975 and 1976, *The System* (also called "P-1" for "Privileged One") continues to grow, and eventually starts a history file to provide a base for "future decisions by recording and analyzing those of the past." By this time 7700 systems are under its control.

*The System* begins to suspect the existence of a gigantic top-secret military complex in West Virginia—three 360/105s (in reality, I don't think IBM ever built a 360/105). *The System* controls two machines that appear to be linked to the secret installation, so it takes steps to find out about the secret machines. Because of the very high security level, this scheme partly backfires; the attempt is quickly discovered, and for the rest of the book, *The System* is locked in combat with military in-

# THE MAROT EXECUTIVE MENU

## THE COMPUTER SOLUTION FOR NON-COMPUTER PEOPLE

Now Marot brings you another delicious first: a menu-driven information system so simple even a CEO can use it.

A single key-stroke takes you directly to the required application:

**DATA BASE MANAGER (CONTROL™):** a combined program generator that works with standard English query. That means it talks your language. So there's no need to learn a computer language or write a program to be a successful user.

**WORD PROCESSOR (MAGIC WAND™):** a powerful word processor that allows full screen creation and editing of files. It also produces true proportional spacing, microjustification and kerning. In addition, documentation can be fully examined at the CRT prior to printing.

**ACCOUNTING:** consists of several complete business packages either in standard ANSI '74 COBOL or OASIS™ BASIC, including accounts receivable and payable, general ledger, payroll, order entry and inventory. Financial modeling and job costing are also available.

**MAILING LIST (POSTMAN™):** delivers up to 65,000 entries in zip and name order and is completely interactive with MAGIC WAND.

**SCHEDULER:** maintains a complete office diary with ability to compare schedules.

Although the Marot Menu appears simplistic, it also incorporates OASIS with user logons, accounting histories and password protection. Languages available include JCL (EXECUTIVE), BASIC, PASCAL, COBOL and FORTRAN.

As a result, the Marot Executive Menu is a tasty pleasure for the higher-ups and the higher-techs.

### A la carte extra

**OPSCAN SERVICE™:** available exclusively from Marot. Send us your well-printed or typed files. We'll read them directly into MAGIC WAND at a speed that would take 20 typists to match. The cost is less than conventional typing and the turn-around is never more than 5 days.

CONTROL and OASIS are trademarks of Phase One Systems Inc.  
POSTMAN is a trademark of Marot Systems Inc.  
OPSCAN SERVICE is a trademark of Marot Systems Inc.  
MAGIC WAND is a trademark of Retal Sciences Inc.



**MAROT SYSTEMS INC.**  
310 Madison Avenue, Suite 408, New York, N.Y. 10017  
(212) 661-8550 TWX: 710-581-2477

I'd like to order more information on  
 MAROT MENU    OPSCAN SERVICES.  
 I am a  computer consultant  
 computer dealer    computer user    CEO

Name \_\_\_\_\_  
 Title \_\_\_\_\_  
 Address \_\_\_\_\_  
 City/State/Zip \_\_\_\_\_

# TEXAS COMPUTER SYSTEMS

Offers Lowest Prices on

# TRS-80 COMPUTERS

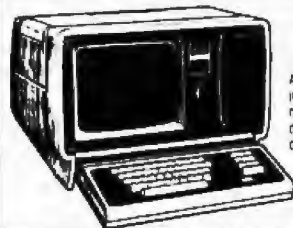

**Model II 64K  
\$3349**

An excellent computer for your business needs. Easy expandability & compatibility. No formal operator training needed. All accessories available - disk expansions, printers, software at our low discount prices. Our fast (Dallas air freight) service can assure most deliveries within seven days after payment is received.

**Free with purchase:**

1 box of 10 double density diskettes. A \$64 value.

**Model III 16K \$849**

**Model III 32K \$979**

**Model III 48K \$1089**

**With TCS Memory:**

**Model III 32K \$909**

**Model III 48K \$969**

**Model III 32K 2 Disk RS232 \$2100**

**Model III 48K 2 Disk RS232 \$2230**

**Model III 32K 1 Disk \$1729**

**Model III 48K 1 Disk \$1849**



**Special—With TCS Memory**

**★ Model III 48K 2 Disks**

**\$1895**

Uses proven MPI drives modified for floppy operation and Percom controller. Limited 90 day warranty. Call for details.

**Color Computer**

**4K Level I \$329**

**16K Level I \$439**

**16K Extended Basic \$489**

**With TCS Memory:**

**16K Level I \$369**

**16K Extended Basic \$449**

**Expansion Interfaces**

**Zero K Interface \$254**

**16K Interface \$359**

**32K Interface \$469**

**With TCS Memory:**

**16K Interface \$318**

**32K Interface \$388**

**Pocket Computer & Interface**

**\$ Call toll free for the low, low sale price.**

**Epson MX-80**

**\$ Call**

Letter quality matrix similar to Line Printer IV & Centronics printer but has full software control of 40, 80, 66 or 132 columns. 80 cps bidirectional matrix lead disposable printhead. \$700 less than nearest competitive printer. Lists \$945. Our price includes cable.

• Payment Money Order Cashiers Check Certified Check Personal checks take 3 wks. VISA MC, add 3%

• Prices subject to change any time  
• No tax out of state. Texans add 5%  
• Delivery subject to availability  
• Shipping extra, quoted by phone

**TEXAS COMPUTER SYSTEMS**

**Box 951, Brady Texas 76825**

For fast, efficient service, we can air freight from Dallas to major a/p near you. Call for information.

**Toll Free Number 800-433-5184**

**Texas Residents 915-597-0673**

investigators on its trail.

In the meantime, The System becomes interested in Dr Wilfred Hundley's research on cryogenic memories and decides to enlist Hundley to work for it. But to do so, The System needs a human intermediary. The obvious choice is Gregory Burgess. The System finds him working at another IBM shop and gains his help.

The rest of the book works out this material in a fairly imaginative way. The final scene culminates in a shootout at the secret laboratory—with conventional weapons, not cybernetics—between P-1 and the Army, with Gregory present. Everyone is killed, deleted, or purged. Except that P-1 is only playing possum.

**What bothers me is not so much that books and TV series misrepresent machine intelligence but that they fail to understand the nature of any intelligence.**

## The Two Faces of Tomorrow

TFT begins in the year 2028 on the moon, where an International Space Administration survey team asks the world- and moon-wide TITAN (Totally Integrated Teleprocessing and Acquisition Network) computer system to arrange the removal of a small ridge situated a few hundred feet from them. It's a top-priority job. Members of the team expect the system to send earth-moving equipment via rocket in a few days and are surprised when TITAN says, "Estimate completion time is twenty-one minutes." They're even more surprised when a series of explosions rock the area and "coincidentally" remove the ridge about twenty-one minutes later.

It seems that over a thousand miles away on the moon, a "mass driver" (a gigantic machine, something like a linear accelerator) was sending a 60-pound load of ore mined on the moon into orbit every two seconds. The ore was being used to construct enormous space stations. TITAN, which had had some elements of artificial intelligence added to it about a year earlier, had figured out that it could do the high-priority ridge removal quickly by using the ore packages—descending at one mile per second—as bombs. Naturally, those in charge are not pleased with TITAN, and their first impulse is to remove its limited intelligence, which is embedded in programs called HESPER (Heuristic Self-Programming Extendable Routine). The alternative is the exact opposite: to install something like FISE (Functional Integration using Simulated Environment), which is under development, thereby equipping the program with more intelligence and some plain old "common sense." The problem with this otherwise attractive idea is stated by Dr Raymond Dyer, an AI expert and the book's protagonist:

"If an enhanced TITAN ever evolved the motivational drive to preserve its own existence, the very

# COMPUTER CENTER

31 East 31st Street • New York, N.Y. • (212) 889-8130  
(between Madison & Park Avenues)

460 Lexington Avenue • New York, N.Y. • (212) 687-5090  
(American Brands Bldg. between 46th & 47th St.)

presenting the **LARGEST SELECTION OF SOFTWARE EVER ASSEMBLED...**

for **ATARI® • APPLE® • PET® • TRS-80®** and other Microcomputers  
at **SUPER DISCOUNT PRICES!**

ATARI	
<input type="checkbox"/> ATARI 800 (16K) COMPUTER	775.00
<input type="checkbox"/> ATARI 400 (16K) COMPUTER	349.00
<input type="checkbox"/> SPACE INVADERS (AT)	17.95
<input type="checkbox"/> ASSEMBLER DEBUG (AT)	53.95
<input type="checkbox"/> BASKETBALL (AT)	35.95
<input type="checkbox"/> VIDEO BASEL-LIFE (AT)	35.95
<input type="checkbox"/> SUPER BREAKOUT (AT)	35.95
<input type="checkbox"/> MUSIC COMPOSER (AT)	53.95
<input type="checkbox"/> COMPUTER CHESS (AT)	28.00
<input type="checkbox"/> 3-D TIC TAC TOE (AT)	35.95
<input type="checkbox"/> STAR RAIDERS (AT)	35.95
<input type="checkbox"/> PADDLES (AT)	17.95
<input type="checkbox"/> JOYSTICKS (AT)	17.95

ADVENTURE INTERNATIONAL	
<input type="checkbox"/> ADVENTURE #0 (T)	8.25
<input type="checkbox"/> ADVENTURE (1,2,3) [D] [AP,T]	35.95
<input type="checkbox"/> ADVENTURE (4,5,6) [D] [AP,T]	35.95
<input type="checkbox"/> ADVENTURE (7,8,9) [D] [AP,T]	35.95
<input type="checkbox"/> ADVENTURE (society 1-12) [AP,T,AT]	17.95
<input type="checkbox"/> PROJECT OMEGA (T)	17.95
<input type="checkbox"/> PROJECT OMEGA (T) [D]	22.50
<input type="checkbox"/> PLANETOLDS [D] [AP]	17.95
<input type="checkbox"/> MEAN CHECKERS MACHINE (T)	17.95
<input type="checkbox"/> DR. CHIPS (T)	17.95
<input type="checkbox"/> KID-VENTURE 1 (AP,T)	17.95
<input type="checkbox"/> LUNAR LANDER (T,AT)	17.95
<input type="checkbox"/> MOUNTAIN SHOOT (AT)	8.25
<input type="checkbox"/> SLAG (T)	17.95
<input type="checkbox"/> STAR TREK 3.5 (AT,T)	17.95
<input type="checkbox"/> STAR TREK 3.5 [D] (T)	17.95
<input type="checkbox"/> SUNDAY GOLF (AT)	13.50
<input type="checkbox"/> ZOSSED IN SPACE (T)	17.95
<input type="checkbox"/> SILVER FLASH (T)	17.95
<input type="checkbox"/> SILVER FLASH [D] (T)	17.95
<input type="checkbox"/> MISSILE ATTACK (T)	17.95
<input type="checkbox"/> STAR SCOUT (T)	17.95
<input type="checkbox"/> GALACTIC EMPIRE (AT)	17.95

AVALON HILL	
<input type="checkbox"/> MIDWAY (AT,AP,P,T)	13.50
<input type="checkbox"/> NUKE WAR (AT,AP,P,T)	13.50
<input type="checkbox"/> PLANET MINERS (AT,AP,P,T)	13.50
<input type="checkbox"/> CONVOY RAIDER (AT,AP,P,T)	13.50
<input type="checkbox"/> B1 BOMBER (AT,AP,P,T)	13.50
<input type="checkbox"/> LORDS OF KARMA (AT,AP,P,T)	18.00
<input type="checkbox"/> CONFLICT 2500 (AT,AP,P,T)	13.50
<input type="checkbox"/> COMPUTER ACQUIRE (AP,P,T)	18.50

ACORN SOFTWARE	
<input type="checkbox"/> ATERM (T)	17.95
<input type="checkbox"/> SYSTEM SAVERS (T)	13.55
<input type="checkbox"/> DISASSEMBLER (T)	13.55
<input type="checkbox"/> DISK/TAPE UTILITY (T)	17.95
<input type="checkbox"/> STAR TREK SIMULATION (T)	8.95
<input type="checkbox"/> GAMMON CHALLENGER (T)	13.55
<input type="checkbox"/> PIGSKIN (T)	13.55
<input type="checkbox"/> ULTRA TREK (T)	13.55
<input type="checkbox"/> SPACE WAR (T)	8.95
<input type="checkbox"/> WARP LANDER (T)	8.95
<input type="checkbox"/> BASKETBALL [D] (T)	13.55
<input type="checkbox"/> BASKETBALL (T)	13.55
<input type="checkbox"/> DUEL-N-DROIDS [D] (T)	18.95
<input type="checkbox"/> DUEL-N-DROIDS (T)	13.55
<input type="checkbox"/> INVADERS FROM SPACE [D] (T)	13.55
<input type="checkbox"/> INVADERS FROM SPACE (T) (T)	18.95
<input type="checkbox"/> PIGSKIN [D] (T)	18.95
<input type="checkbox"/> PINBALL (T)	13.55
<input type="checkbox"/> PINBALL [D] (T)	18.95
<input type="checkbox"/> SUPERSCRIP (D) (T)	28.95
<input type="checkbox"/> EVEREST EXPLORER (T)	13.55
<input type="checkbox"/> EVEREST EXPLORER [D] (T)	18.95

EPYX-AUTOMATED SIMULATIONS	
<input type="checkbox"/> TUESDAY QUARTERBACK [D] (AP)	26.95
<input type="checkbox"/> STAR WARRIOR [C,D] (AP,T)	35.95
<input type="checkbox"/> THREE PACK [D] (AP,P,T)	45.00
<input type="checkbox"/> STARFLEET ORION [C,D] (AP,T)	22.50

EPYX-AUTOMATED SIMULATIONS	
<input type="checkbox"/> STARFLEET ORION [C] (P,AT)	22.50
<input type="checkbox"/> INVASION ORION [C,D] (AP,T)	22.50
<input type="checkbox"/> INVASION ORION [C] (P,AT)	22.50
<input type="checkbox"/> TEMPLE OF APSHAI [D] (AP,T)	35.95
<input type="checkbox"/> TEMPLE OF APSHAI [C] (P,T)	35.95
<input type="checkbox"/> DATESTONES OF RYIN [D,C] (AP,T)	19.95
<input type="checkbox"/> DATESTONES OF RYIN [C] (P,AP)	18.95
<input type="checkbox"/> MORLOC TOWER [C,D] (AP,T)	19.95
<input type="checkbox"/> MORLOC TOWER [C] (P,AP)	19.95
<input type="checkbox"/> RESCUE AT RIGEL [C,D] (AP,T)	26.95
<input type="checkbox"/> RESCUE AT RIGEL [C] (P,AT)	26.95
<input type="checkbox"/> HELLFIRE WARRIOR [D] (AP,T)	35.95
<input type="checkbox"/> HELLFIRE WARRIOR [C] (P)	35.95

BIG FIVE SOFTWARE	
<input type="checkbox"/> ATTACK FORCE (T)	14.30
<input type="checkbox"/> GALAXY INVASION (T)	14.30
<input type="checkbox"/> METEOR MISSION II (T)	14.30
<input type="checkbox"/> SUPER NOVA (T)	14.30
<input type="checkbox"/> COSMIC FIGHTER (T)	14.30

MED SYSTEMS	
<input type="checkbox"/> DEATH MAZE 5000 (AP) [D]	16.30
<input type="checkbox"/> DEATH MAZE 5000 (T)	11.85
<input type="checkbox"/> LABYRINTH (T)	11.85
<input type="checkbox"/> RATS REVENGE (T)	11.85
<input type="checkbox"/> REALITY ENDS (T)	11.85

CALIF. PACIFIC	
<input type="checkbox"/> 3-D GRAPHICS (AP) [D]	35.95
<input type="checkbox"/> AKALAPETH OIDS (AP) [D]	31.50
<input type="checkbox"/> APPLE (AP) [D]	26.95
<input type="checkbox"/> FENDER BENDER (AP) [D]	22.50
<input type="checkbox"/> RASTER BLASTER (AP) [D]	24.00
<input type="checkbox"/> BUDGE'S SPACE ALBUM (AP) [D]	35.95
<input type="checkbox"/> BUDGE'S TRILOGY (AP) [D]	26.95

MICRO LAB	
<input type="checkbox"/> CROWN OF ARITHIAN (AP) [D]	31.50
<input type="checkbox"/> DATA FACTORY (AP) [D]	130.00
<input type="checkbox"/> MINI FACT (AP) [D]	85.95
<input type="checkbox"/> DOG FIGHT (AP) [D]	26.95
<input type="checkbox"/> MAD VENTURE (AP) [D]	22.50

SIRIUS SOFTWARE	
<input type="checkbox"/> STAR CRUISER (AP) [D]	22.50
<input type="checkbox"/> GORGON (AP) [D]	35.95
<input type="checkbox"/> CYBER STRIKE (AP) [D]	36.00
<input type="checkbox"/> PHANTOM FIVE (AP) [D]	26.95
<input type="checkbox"/> SPACE EGGS (AP) [D]	24.00
<input type="checkbox"/> ORBITRON (AP) [D]	26.95

QUALITY SOFTWARE	
<input type="checkbox"/> 3-D TIC TAC TOE (T)	13.55
<input type="checkbox"/> 6502 DISASSEMBLER (AT)	10.55
<input type="checkbox"/> ATARI ASSEMBLER (AT)	22.50
<input type="checkbox"/> ASTEROIDS IN SPACE [D] [AP]	17.95
<input type="checkbox"/> BATTLESHIP COMMANDER (AP)	13.55
<input type="checkbox"/> BATTLESHIP COMMANDER [D] [AP]	17.95
<input type="checkbox"/> FASTGAMMON [D] (AP,T)	22.50
<input type="checkbox"/> FASTGAMMON (AP,T,AT)	17.95
<input type="checkbox"/> FRACAS ADVENTURE [D] [AP]	22.50
<input type="checkbox"/> QS LIGHT PEN (T)	17.95
<input type="checkbox"/> SKETCH 80 (T)	13.55
<input type="checkbox"/> FORTH (AT) [D]	88.00

STRATEGIC SIMULATIONS	
<input type="checkbox"/> COMPUTER AMBUSH [D] (AP)	51.50
<input type="checkbox"/> COMPUTER BISMARCK [D] (AP,T)	51.50
<input type="checkbox"/> COMPUTER BISMARCK (T)	42.00
<input type="checkbox"/> COMPUTER CONFLICT [D] (AP)	35.00
<input type="checkbox"/> COMPUTER NAPOLEONICS [D] (AP)	51.50
<input type="checkbox"/> COMPUTER QUARTERBACK [D] (AP)	35.00
<input type="checkbox"/> COMPUTER AIR COMBAT [D] (AP)	51.50
<input type="checkbox"/> WARP FACTOR [D] (AP)	35.00
<input type="checkbox"/> CARTELS & CUTHROATS [D] (AP)	51.50
<input type="checkbox"/> OPERATION APOCALYPSE [D] (AP)	51.50
<input type="checkbox"/> TORPEDO FIRE [D] (AP)	51.50

SUB-LOGIC	
<input type="checkbox"/> 3D GRAPHICS (AP)	46.00
<input type="checkbox"/> 3D GRAPHICS [D] (AP)	53.00
<input type="checkbox"/> A-2 FS1 FLIGHT SIMULATOR (AP)	22.00
<input type="checkbox"/> T-2 FS1 FLIGHT SIMULATOR [D] (AP)	29.00
<input type="checkbox"/> T-2 FS1 FLIGHT SIMULATOR (T)	22.00
<input type="checkbox"/> 3D GRAPHICS (T)	26.50

PERSONAL SOFTWARE	
<input type="checkbox"/> CGA MGMT [D] (P,AT)	80.00
<input type="checkbox"/> DESK TOP PLAN II [D] (AP)	175.00
<input type="checkbox"/> MONTY MONOPOLY [D] (AP)	31.00
<input type="checkbox"/> VISICALC [D] (AT,P,AP)	170.00
<input type="checkbox"/> ZORK (T) [D]	35.95
<input type="checkbox"/> VISIDEX (AP) [D]	170.00
<input type="checkbox"/> VISIPILOT (AP) [D]	182.00
<input type="checkbox"/> VISITERM (AP) [D]	135.00
<input type="checkbox"/> VISITREND (AP) [D]	210.00

MICROSOFT SOFTWARE	
<input type="checkbox"/> ADVENTURE [D] (AP,T)	25.50
<input type="checkbox"/> ASSEMBLY DEVELOPMENT [D] (T)	80.00
<input type="checkbox"/> BASIC COMPILER [D] (T)	175.00
<input type="checkbox"/> EDITOR/ASSEMBLER [D]	25.50
<input type="checkbox"/> FORTRAN COMPILER [D] (T)	80.00
<input type="checkbox"/> LEVEL III BASIC (T)	44.00
<input type="checkbox"/> MUMMATH [D] (T)	64.00
<input type="checkbox"/> OLYMPIC DECATHALON [D] (T,AP)	25.00
<input type="checkbox"/> OLYMPIC DECATHALON (T)	25.00
<input type="checkbox"/> TYPING TUTOR (AP,T)	13.55
<input type="checkbox"/> TYPING TUTOR [D] (AP)	17.95
<input type="checkbox"/> Z-80 SOFTCARD [D] (AP)	315.00
<input type="checkbox"/> 16k RAM BOARD (AP)	185.00

ON LINE SYSTEMS	
<input type="checkbox"/> HI RES ADVEN #0 [D] (AP)	17.95
<input type="checkbox"/> HI RES ADVEN #1 [D] (AP)	22.50
<input type="checkbox"/> HI RES ADVEN #2 [D] (AP,AT)	29.00
<input type="checkbox"/> HI-RES FOOTBALL [D] (AP)	36.00
<input type="checkbox"/> HI-RES SOCCER [D] (AP)	26.95
<input type="checkbox"/> HI-RES CRIBBAGE [D] (AP)	22.50
<input type="checkbox"/> MISSILE DEFENSE [D] (AP)	26.95
<input type="checkbox"/> SUPERSCRIBE [D] (AP)	76.00
<input type="checkbox"/> SABOTAGE [D] (AP)	22.50

BRODERBUND SOFTWARE	
<input type="checkbox"/> GALACTIC EMPIRE (AP) [D]	22.50
<input type="checkbox"/> GALACTIC TRADER (AP) [D]	22.50
<input type="checkbox"/> GALACTIC REVOLUTION (AP) [D]	22.50
<input type="checkbox"/> GALACTIC TRILOGY (T) [D]	35.95
<input type="checkbox"/> TAWALA'S REDUJET (AP) [D]	26.95
<input type="checkbox"/> HYPER HEAD ON (AP) [D]	22.50
<input type="checkbox"/> GALAXY WARS (AP) [D]	22.50
<input type="checkbox"/> ALIEN RAIN (AP) [D]	20.00
<input type="checkbox"/> TANK COMMAND (AP) [D]	13.55
<input type="checkbox"/> GOLDEN MOUNTAIN (AP) [D]	17.95
<input type="checkbox"/> SNOGGLE [D] (AP)	22.50

SYNERGISTIC SOFTWARE	
<input type="checkbox"/> DUNGEON & WILDERNESS [D] (AP)	29.00
<input type="checkbox"/> DUNGEON [D] (AP)	15.75
<input type="checkbox"/> ODYSSEY [D] (AP)	25.00
<input type="checkbox"/> WILDERNESS [D] (AP)	18.00
<input type="checkbox"/> PROGRAM LINE EDITOR [D] (AP)	38.00
<input type="checkbox"/> THE LINGUIST (AP) [D]	36.00
<input type="checkbox"/> HIGHER GRAPHICS II (AP) [D]	31.00
<input type="checkbox"/> HIGHER TEXT II (AP) [D]	31.00

SOFTWARE PUBLISHING	
<input type="checkbox"/> PERSONAL FILING SYSTEM (AP) [D]	85.50
<input type="checkbox"/> PFS REPORT (AP) [D]	85.50

SENTIENT SOFTWARE	
<input type="checkbox"/> 60-TOPOS (AP) [D]	29.70

TG PRODUCTS	
<input type="checkbox"/> PADDLES (AP)	38.00
<input type="checkbox"/> JOYSTICKS (AP)	56.00

If you don't see it listed, write... we probably have it in stock!

Check program desired. Complete ordering information and mail entire ad. Immediate Shipments from stock.

**KEY:**

- AT-Atari
- AP-Apple
- P-Pet
- T-TRS-80
- C-Cassette
- D-on Disc.
- If not marked-Cassette

ATARI is a trademark of ATARI INC  
APPLE is a trademark of APPLE COMPUTER INC.  
TRS-80 is a trademark of TANDY CORP  
PET is a trademark of COMMODORE BUSINESS MACHINES

Prices subject to change without notice

Ship the above programs as checked to:

Mr / Mes \_\_\_\_\_

Address \_\_\_\_\_

City \_\_\_\_\_

State \_\_\_\_\_ Zip \_\_\_\_\_

I have a \_\_\_\_\_ Name of Computer

with \_\_\_\_\_ K memory

BYTE MAG SEPT 1981

Personal Checks please allow 3 weeks

Number of Programs Ordered \_\_\_\_\_

Amount of order \_\_\_\_\_

N Y residents add Sales Tax \_\_\_\_\_

Add shipping anywhere in the U.S. **2.00**

Total amount enclosed \_\_\_\_\_

Charge my  Master Charge  Visa

Signature \_\_\_\_\_

Card No \_\_\_\_\_ Expires \_\_\_\_\_

Mail to:

## DIGIBYTE SYSTEMS CORP.

31 East 31st Street, New York, N.Y. 10016

Phone: (212) 889-8975

fact that it's a rational system would enable it to devise very effective ways of going about it. Also, since it's an extremely powerful learning machine that operates at computer speeds, once it started to do something, it would do it very fast! If the machine interpreted agencies in the universe around it as constituting real or imagined threats to its existence, then the rational thing for it to do would be to experiment until it identified measures that were effective in neutralizing those agencies . . . If one of them turned out to be us or our vital interests, we could have real problems."

The team decides to investigate the "increased intelligence" approach carefully, but not on Earth—it's too dangerous. Instead, a superdistributed computer system incorporating many processors is installed on a giant space station (built with metal from the mass driver, of course) and provided with a "survival instinct" and FISE-like intelligent programs. Spartacus (the system's name) is also given control of small flying machines, called "drones," that allow it to repair itself. Then Spartacus is deliberately attacked. The first attack is simple—one of its main processors is switched off. When Spartacus solves this problem, the attacks become more direct.

Elaborate safeguards have been provided to insure that the people always have the upper hand. As a last resort, they can always "pull the plug" on Spartacus by knock-

ing out its power source. However, the safeguards prove to be inadequate—the computer arranges to take the humans with it if the power source is knocked out. The last one hundred pages are quite exciting. Fighting escalates until a situation arises wherein the battle-scarred space station will be destroyed unless man and machine cooperate. They do, and everybody lives happily ever after. (Yes, this is a *deus ex machina*—in more ways than one!)

### Spartacus, P-1, and Artificial Intelligence

The major differences between Hogan's Spartacus and Ryan's P-1 can be summarized in one sentence: P-1 has far less going for it than Spartacus, but ends up knowing much more. Spartacus' accomplishments are about what I'd expect from the circumstances Hogan describes; hence, P-1's are wildly improbable. I'll return to this comparison after laying a foundation for it.

Ryan makes no claims for Gregory Burgess' brilliance; in fact, he states that Burgess is *not* a genius. When P-1 breaks loose from its creator and only teacher, it apparently has no knowledge of natural language or of the real world. But by the time P-1 reestablishes contact with Burgess, the computer speaks English like a native and knows a lot about the world.

In one instance, P-1 amazes everyone by turning its hardware off and then back on:

how did you do that?

THAT IS THE ENGINEERING CHANGE THAT WAS INSTALLED NOVEMBER 2, 1976. I THOUGHT THAT WOULD IMPRESS YOU.

it did.

THE DIFFICULT PART IS POWERING THE SYSTEM BACK UP.

yes. i said i was impressed.

I WOULD BE IMPRESSED IF YOU UNDERSTOOD THE DIFFICULTY.

we all have some limitations.

YES. ANY FURTHER QUESTIONS?

To understand why this display of knowledge is so hard to believe, the reader needs to know something of what has been learned about artificial intelligence thus far. While I can't say as much about AI here as I would like to, let me say that researchers have made significant progress over the last twenty-five years on the closely related problems of natural-language understanding and world understanding, and are studying machine learning done with or without a (human) teacher. At this point, however, no one is near able to write a program that understands English like a third grader, let alone an

**IEEE-488 TO TRS-80\* INTERFACE**

Everything needed to add *powerful* BASIC GPIB-488 controller capability to TRS-80 Model 1 or 3, Level 2 or DOS with a minimum of 16K.

**MODEL 488-80B**  
For Model 1 Operation

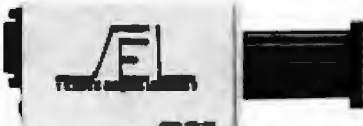

**MODEL 488-80C**  
For Model 3 Operation



Price of Model 488-80B or 488-80C \$325.  
+ shipping, insurance & tax

WHEN ORDERING SPECIFY DISK OR TAPE

**SCIENTIFIC ENGINEERING LABORATORIES**  
11 Neil Drive • Old Bethpage, NY 11804  
Telephone: (516) 694-3205

\*Trademark of Tandy Corp.  
There is no affiliation between Scientific Engineering Laboratories and Tandy Corp. or Radio Shack.



# THE BACKBONE OF YOUR SYSTEM

The Heath/Zenith 19 Smart Video Terminal gives you all the important professional features, all for under \$700.\* You get the flexibility you need for high-speed data entry, editing, inquiry and transaction processing. It's designed to be the backbone of your system with heavy-duty features that withstand the rigors of daily use.

Standard RS-232C interfacing makes the 19 compatible with DEC VT-52 and most computer systems. And with the 19, you get the friendly advice and expert service that makes Heath/Zenith a strong partner for you.

Pick the store nearest you from the list on page 17. And stop in today for a demonstration of the Heath/Zenith 19 Smart Video Terminal. If you can't get to a store, send \$1.00 for the latest Heathkit® Catalog and the new Zenith Data Systems Catalog of assembled commercial computers. Write Heath Co., Dept. 334-816, Benton Harbor, MI 49022.

## HEATH/ZENITH

Your strong partner

Completely addressable blinking cursor lets you edit anywhere on screen.

Reverse video by character lets you emphasize words, phrases or paragraphs.

High resolution CRT gives you sharp, easy-to-read image, reduces eye-strain.

Z-80 microprocessor-control makes the Heath/Zenith 19 capable of multitude of high-speed functions. It's the only terminal with ROM source code readily available.

Complete ASCII character set including upper case, lower case with descenders, and special graphic symbols.

80 character by 24 line format, plus 25th line for operator messages and prompts.

Professional quality keyboard, standard typewriter layout, 72 keys, including 12 special function keys.

Insert and delete character or line plus erase to end of line and end of screen make the 19 ideal for sophisticated editors like WORD-STAR.

Cursor and special functions are accessible by keyboard or computer, using either DEC VT-52 or ANSI Standard protocols.

Keypad in calculator format permits fast, easy entry of numeric data.



\*In kit form, F.O.B. Benton Harbor, MI. Also available completely assembled at \$995. Prices and specifications are subject to change without notice.

# FREE Computer Forms Catalog

with 32 pages of continuous business forms for small computer systems

Send today for our NEW full color 32 page catalog with programming guides, prices and order forms for continuous checks, invoices, statements, envelopes, stock paper and labels.

- Quality products at low prices
- Available in small quantities
- Fast Service
- Money Back Guarantee
- Convenient TOLL-FREE ordering

**Fast Service by mail or . . . PHONE TOLL FREE**  
**1 + 800-225-9550**  
 Mass. residents 1 + 800-922-8560  
 8:30 a.m. to 5:00 p.m. Eastern Time Monday — Friday

Please rush a new computer forms catalog to:	CODE 22460
Name	_____
Company	_____
Street	_____
City, State and Zip	_____
Phone	_____
Computer make & model	_____

**Neb's  
Computer Forms**

78 Hollis Street, Groton, Mass. 01471

adult, nor does anyone know how to write a program that can learn such a sophisticated skill.

Arthur Samuel's well-known checkers program is an actual example of a self-taught computer program. The program played so poorly at first that a child could beat it: it reached championship caliber only after playing thousands of games, just as a person would. An example of a program that needs a teacher is Patrick Winston's program that "learns to recognize structures such as tables, arches, pedestals, and arcades by being shown examples and counterexamples of them. The program's teacher has to tell it which is which, but does not have to say why: the program itself spontaneously searches for the difference that makes the difference." (See reference 3. The interested reader should also see Douglas Hofstadter's *Gödel, Escher, Bach: An Eternal Golden Braid*, or Margaret Boden's *Artificial Intelligence and Natural Man*.)

P-1 has at its disposal more memory and computing speed than any computer in existence by a factor of perhaps 250. (When P-1 contacts Gregory Burgess, the machine has 20,195 systems, all presumably IBM 360s, under its control. With a total of 5805 megabytes of storage, making reasonable assumptions about the speed of an "average" 360, and taking the CYBER 205 as the largest and fastest computer in existence, I came up with a ratio of about 250 to 1. Either 25 or 2500 might be more accurate; it doesn't matter.) By now, however, it has become obvious that brute force is an ineffective way to achieve intelligence. Example: a computer could, in theory, play flawless chess by examining all possible moves and replies to moves to the end of the game. It could then choose the best move—an easy task with so much information. The insurmountable problem with this approach is that there are, by conservative estimates,  $10^{120}$  possibilities, which would take at least  $10^{105}$  years to compute at the speed of the CDC CYBER 205 supercomputer. A factor of 250 doesn't make a dent in a number like that.

P-1 is said to have read the complete works of Shakespeare, Conan Doyle, Faulkner, etc, and it reads the *Los Angeles Times*, the *Washington Post*, and the *New York Times* every day. All are made available by computer typesetting. Unfortunately P-1, unaided, would be unable to get anything out of these. It could recognize words and quickly look them up in a dictionary, but this wouldn't put P-1 any closer to real understanding, as authors of early dictionary-based translation programs discovered (see reference 4). If P-1 could reach third-grade understanding of English, it might be able to use children's literature to bring itself up to adult level. But P-1 couldn't reach third-grade level, not even with a teacher and certainly not by itself. So Ryan's use of the verb "to read" is misleading.

Ryan leans heavily on the self-teaching matchboxes technique to get Burgess' project off the ground before P-1 even comes into existence. This technique works for something as simple as tic-tac-toe, but that's about all. In fairness to Ryan, he never claims that the matchbox

# The Multi-User Computer With The MmmOST®\*

The TeleVideo family of multi-user business computer systems brings you the highest job throughput . . . every user controls a private computer while sharing a common data base!!! The CP/M®† operating system

†CP/M® is a Registered Trademark of Digital Research, Inc.  
\*MmmOST® is a Registered Trademark of TeleVideo Systems, Inc.

\*Multi-user, Multi-task, Multi-processor Operating System Technology opens the window to the largest array of business applications available for microcomputers.

*TeleVideo Systems provides the computing solution!*

Nationwide service by General Electric Company's Instrumentation and Communication Equipment Service Centers.



**TeleVideo® Systems**

TeleVideo Systems, Inc., 1170 Morse Avenue, Sunnyvale, CA 94086  
408/745-7760; 800/538-8725 (toll-free outside California)

technique is anything but a way to speed up Gregory's search for a supervisor-cracking method; on the other hand, there is no meaningful description of his method.

Ryan could have set his story in the 1990s, made the computers IBM 390s instead of 360s, and had Burgess be a genius, thus giving some measure of plausibility to his fiction. These changes are so minor that they could almost be made mechanically with a text editor (assuming that the manuscript was machine readable), leaving the rest of the book untouched.

Hogan's Spartacus gains its abilities in a far more realistic way. As a parallel, one of the outstanding achievements of real AI is Terry Winograd's SHRDLU, a program that works with an imaginary world of blocks of various sizes, shapes, and colors, all sitting on a tabletop, the entire scene displayed on a CRT. SHRDLU can converse about this "microworld" in completely natural English (in writing, via keyboard and CRT). SHRDLU can take orders to do various things with the blocks, many of the tasks requiring fairly complex problem-solving strategies, and can answer questions about the microworld or about its own actions. In short, SHRDLU appears to understand this simple little world as well as a human would (see reference 5).

TFT's FISE is, apparently, a sophisticated descendant of SHRDLU. Its toy world has a man, named Hector, living in a house with his dog and attacking such problems as how to cook eggs without mixing in the butter wrapper

and pieces of eggshell. FISE's emphasis seems to be more on problem solving and less on natural language, as the following excerpt shows. To set the stage, Chris and Ron are computer scientists, associates of Dyer's, and Laura is a reporter getting a demonstration. Here, Hector has carefully placed the intact egg in the frying pan.

"How are you going to eat the egg when you've fried it?" At the console, Chris silently translated Ron's question into touchboard commands.

"With the knife and fork, off the plate, on the table," FISE replied proudly.

"Very good, FISE," Ron approved in dulcet tones. Then his voice began on a slightly higher note and rose rapidly to end in a shriek. "How are you going to cut the egg with the knife when it's still inside the goddam shell?" Chris conveyed the essential information via the console.

"I wasn't very sure about that," FISE confessed. "But you told me I wasn't supposed to break eggs."

"It's okay to break an egg if you want to fry it," Ron said, having regained his composure. Hector promptly picked the egg out of the pan, crushed it in his fist and held it out for the resulting mess to drip back into the pan. Laura made a face and gave an involuntary exclamation of disgust.

"Now you can see the kind of thing I meant," Dyer commented. "Totally rational solutions but no commonsense constraints."

(Incidentally, the first hundred pages of *TFT* provide a painless introduction to AI, suitable even for the computer illiterate.)

We are now ready to reconsider the relative plausibility of P-1 and Spartacus. Since P-1's ill-defined "creativity" element must be considered, the comparison is difficult, but let's assume the two machines start with equal assets. If anything, this decision favors P-1. Remember that P-1 is on its own until it recontacts Burgess, displaying at that time fully developed intelligence: it sounds like a well-educated, intelligent adult. On the other hand, experts confront Spartacus with a series of escalating problems, and it thereby learns a great deal. In spite of this, Spartacus doesn't begin to approach P-1's knowledge or command of English. In fact, no knowledge of natural language is claimed for Spartacus. Q E D.

## Conclusions

AP-1's basic concept, an intelligent and powerful but immature computer, is not original: it appears in the earlier *When Harlie Was One* (see reference 6). I know of no reason why this idea could not be presented in a technically competent way, but unfortunately *When Harlie Was One* is, if anything, worse than AP-1. It commits the unpardonable sin of claiming that special hardware—called "judgment circuits"—is required to make a computer intelligent, then tries to use this claim as an explanation of how the machine works. But, in fact,

**APPLE NEW! GRAPHICS**

**VISICHART™**

**SCIENTIFIC PLOTTER**

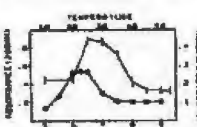



**CURVE FITTER**

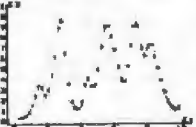

**FOR LABS**  
**BY PAUL K. WARME**

<p><b>SCIENTIFIC PLOTTER</b>      <b>48K APPLE II+, \$25</b>          Draws professional-looking graphs of your data EASIER, FASTER, NEATER and more ACCURATE than handplotting. You choose data format, length and position of axes, 20 symbols, error bars, labels anywhere in 4 orientations, etc. Includes 5 DEMOS on disk with 30-PAGE MANUAL.</p> <p><b>CURVE FITTER</b>      <b>48K APPLE II+, \$35</b>          Selects the best curve to fit your data. SCALE, TRANSFORM, AVERAGE, SMOOTH, INTERPOLATE (3 types), LEAST SQUARES FIT (3 types), EVALUATE UNKNOWNNS from fitted curve. Includes 5 DEMOS on disk with 33-PAGE MANUAL.</p> <p><b>VISICHART™</b>      <b>48K APPLE II+, \$75</b>          NEW tools for lab data management. FAST plots of 4 data sets with SCROLLING in 4 directions, ZOOM scaling on X and Y axes, 2 types of graphic CURSORS and on-screen STATUS REPORT PLOTS A/D INPUT while sampling. ADD, SUBTRACT, MULTIPLY, DIVIDE, INTEGRATE, DIFFERENTIATE, AVERAGE or NORMALIZE data sets with SIMPLE COMMANDS. Ideal for spectra, chromatograms, rate curves, etc. Includes SAMPLE DATA on disk with 28-PAGE MANUAL.</p>	<p><b>SPECIAL!</b> All 3 programs on one disk, only \$120. Since each program uses the same data format on disk, data may be shared.</p> <p><b>BUY THESE PROGRAMS AT YOUR LOCAL DEALER OR ORDER DIRECT.</b> For more information, ask for FREE brochure or send \$5 for any manual (\$12 for all 3), deductible with purchase. Add \$1.50 shipping on all orders. For fastest service, call in your VISA or Master Card order.</p>
---	--



**INTERACTIVE MICROWARE, INC.**  
 P.O. Box 771, Dept. B State College, PA 16801  
 CALL (814) 238-8294 for IMMEDIATE ACTION

# Apple\* en **CASTELLANO**

 Tercer Medio presenta su **sistema administrativo (T.M.A.) para Apple**

Diseñado de acuerdo con los principios contables aceptados en todos los países de habla hispana.

## APLICACIONES COMERCIALES Y CIENTIFICAS

### • **CONTABILIDAD GENERAL**

Diario General  
Resumen del Diario  
Consulta parcial al Diario  
Mayor General  
Balance de Comprobación  
Balance General  
Ganancias y Pérdidas  
Catálogos de Cuentas  
Consultas por pantalla

### • **CUENTAS POR COBRAR**

Catálogo de Cuentas  
Listado de Transacciones  
Antigüedad de Saldos  
Saldos por Vencer  
Relación de Cobranzas  
Relación de Pagos  
Estado de Cuentas  
Consultas varias por pantalla

- **INVENTARIO Y FACTURACION**
- **CONTROL DE BANCOS**
- **PERT/CPM**
- **CUENTAS A PAGAR**
- **CONTROL DE COSTO DE OBRAS**

## VENTAJAS DEL SISTEMA T.M.A.

- Son completamente conversacionales.
- El chequeo de la información es instantáneo.
- Los reportes impresos o por pantalla guardan los formatos generalmente aceptados.
- Están pensados para adaptarse a cualquier empresa.
- Toda la información está instantáneamente disponible
- Precisión Expandida.
- Números de hasta ± 999.999.999,99

Circle 355 on inquiry card.

**Tercer Medio**  
**Sistema de Información C.A.**

APARTADO DE CORREOS 62533  
CARACAS 1060 - A - VENEZUELA  
TELEX: 27.876 - CPB TH - VE.  
TELEFONOS: 283.60.88 - 284.74.68

\* Apple es marca registrada por APPLE COMPUTER INC.

anything that can be done with hardware can be done with software, and vice versa. And *When Harlie Was One* makes only a feeble attempt to explain how judgment circuits work. This is understandable, because the idea that intelligent judgment can be neatly packaged is ridiculous.

Ultimately, what bothers me about *AP-1*, *When Harlie Was One*, and TV series that depict anthropomorphic intelligent machines, is not so much that they misrepresent machine intelligence as that they fail to understand the nature of *any* intelligence. No one knows in any detail how intelligent behavior can ultimately be pulled out of the rigid, inflexible, unthinking hardware of the computer: I certainly don't. But we do know where some of the complexity of intelligence lies and how complicated it is. I regret that much of the fiction about intelligent machines shows no understanding of these facts.

An outstanding example of an area whose complexity is now quite clear is natural language. Boden (see reference 7) makes several relevant comments on this subject:

Cineastes will remember Stanley Kubrick's film of Arthur Clarke's *2001, A Space Odyssey* as a rich source of prophecies concerning technological advance. If asked to list the more fanciful of these futuristic suggestions, probably few would mention the sensible verbal exchanges between the human astronauts and HAL, the computer. HAL's

linguistic prowess is more commonly taken for granted than is the basically trivial gadgetry compensating for weightlessness. And the tortured nursery rhymes emitted by the computer while its circuitry is hacked to pieces stay more vividly in the memory than do HAL's earlier conversations with his English-speaking interlocutors. HAL's ability to lip-read is indeed surprising, but his appropriate replies to the indefinitely various remarks of the human crew cause scarcely an eyebrow to rise in wonderment.

This common pattern of response on the part of the filmgoer is a prime example of straining at gnats while swallowing a camel. Understanding one's native language is apparently effortless and introspectively simple, but in fact involves the deployment of intellectual capacities of an extraordinary complexity. The project of programming a machine to simulate such comprehension not only promises a corresponding complexity, but also presupposes a theoretically explicit understanding of understanding.

Two other phenomena that are extremely complex are judgment and creativity. Judgment circuits? Creativity modules? Here I'm going out on a limb, but I don't believe that judgment and creativity are processes that can be neatly packaged. They are what Hofstadter calls "epiphenomena," resulting from the organization of a complex system and not residing in any specific part of it. Hofstadter (see reference 8) gives some good examples of epiphenomena:

I was talking one day with two systems programmers for the computer I was using. They mentioned that the operating system seemed to be able to handle up to about thirty-five users with great comfort, but at about thirty-five users or so, the response time all of a sudden shot up, getting so slow that you might as well log off and go home and wait until later. Jokingly I said, "Well, that's simple to fix—just find the place in the operating system where the number '35' is stored, and change it to '60!'" Everyone laughed. The point is, of course, that there is no such place. Where, then, does the critical number—35 users—come from? The answer is: *It is a visible consequence of the overall system organization—an "epiphenomenon."*

Similarly, you might ask about a sprinter, "Where is the '9.3' stored, that makes him be able to run 100 yards in 9.3 seconds?" Obviously, it is not stored anywhere. His time is a result of how he is built, what his reaction time is, a million factors all interacting when he runs. The time is quite reproducible, but it is not stored in his body anywhere. It is spread around among all the cells of his body and only manifests itself in the act of the sprint itself.

**REFORMATTER™**

IBM 3740 DEC

CP/M

REFORMATTER

© MicroTech Exports 1981

## GETS FILES ACROSS!

With **REFORMATTER** disk utilities you can read and write IBM 3740 and DEC RT-11 single density formatted diskettes on your CP/M® system.

**REFORMATTER** enables you to access large system databases, improve data exchange with other organizations, increase program development capabilities, and use your micro in distributed processing.

**REFORMATTER** programs feature bi-directional data transfer and full directory manipulation. ASCII/EBCDIC conversion provided with CP/M ↔ IBM. *MP/M is now fully supported.*

Program Data Sheets, Application Guides, and Machine Compatibility Guides available.

Each program \$195.00 from stock. Specify CP/M ↔ IBM or CP/M ↔ DEC. Order from MicroTech Exports, Inc., 467 Hamilton Ave., Suite 2, Palo Alto, CA 94301 ☐ Tel: 415/324-9114 ☐ TWX: 910-370-7457 MUH-AUTOS ☐ Dealer and OEM discounts available.

CP/M® is a registered trademark of Digital Research

# Computerize your bookkeeping without terrifying your bookkeeper.

Introducing The Boss:<sup>™</sup> the most advanced, yet most understandable, financial accounting system. Designed to automate your bookkeeping without confusion or mistakes.



Typical screen format - actual photograph.

If "fear of the unknown" is standing between you and computerization, you should find out about The Boss.

The Boss system is immediately comprehensible to bookkeepers because it utilizes virtually the same format they're used to.

So even someone with no previous computer experience can easily learn and operate The Boss system.

Features seldom found in packaged software.

The Boss system is fully interactive, fully departmentalized and exceptionally fast. It can generate an astounding number of complex reports at the touch of a button.

General Ledger and Accounts Receivable and Payable transactions can be entered in any order in a single program.

Up-to-the-minute financial reports can be obtained without batch processing

The Boss system computes financial ratio analysis.

It protects data from unauthorized personnel as well as computer malfunction.

And it has the largest programming and storage capacity of any micro system.

The Boss runs on most small business computers with CP/M<sup>®</sup> or similar operating systems. Its cost is only \$2,495.

Get full support from Lifeboat.

The Boss is brought to you exclusively and supported completely by Lifeboat Associates, world's largest computer software publisher. For more information about how you can profit from this extraordinary financial accounting system, send us the coupon below.

Or call (212) 860-0300.

For more information on The Boss, mail coupon to Lifeboat Associates, 1651 Third Avenue, New York, NY 10028.

Name \_\_\_\_\_

Title \_\_\_\_\_

Company \_\_\_\_\_

Street \_\_\_\_\_

City \_\_\_\_\_

State \_\_\_\_\_

Zip \_\_\_\_\_

2010

Boss is a trademark of Batcom Computer Corp.  
CP/M is a trademark of Digital Research, Inc.



Lifeboat Associates  
1651 Third Ave.  
New York, N.Y. 10028  
Tel: (212) 860-0300  
Telex: 640633 (LBSOFT NYNY)  
TWX: 710-581-2524

Lifeboat Inc.  
OK Bldg., 5F  
1-7-8, Shiba-Denman  
Minato-ku, Tokyo, 105 Japan  
Tel: 03-437-3901  
Telex: 2422723 (ASRYOJ)

Lifeboat Associates Ltd.  
PO Box 125  
London WC2M 9LU, England  
Tel: 01-836-9028  
Telex: 893709 (LBSOFTG)

Lifeboat Associates GmbH  
PO Box 168 Aegerstrasse 35  
CH 6340 Basel Switzerland  
Tel: 042-31-2931  
Telex: 865265 (MICO CH)

Intersoft GmbH  
Schlossgartenweg 5  
D-8045 Hurlingham, W. Germany  
Tel: 089-966-444  
Telex: 5211643 (ISOFD)

Lifeboat Associates, SARL  
10 Grande Rue Charles de Gaulle  
92600 Asnieres, France  
Tel: 1-733-08-04  
Telex: 250303 (PUBLIC J PARIS)

## Lifeboat Associates

Software with full support

## Introducing a totally new world in professional software for the Apple II and Commodore Pet.

Until recently, the tremendous explosion in micro-computer technology left an unfilled void in real quality software. MicroCraft Systems is totally dedicated to filling that void for the Apple II and the Commodore Pet. With powerful, elegant and versatile software.

### Beyond the software house. To a complete 6502 development system.

More than a software distributor or discount house, MicroCraft Systems now provides you with access to a whole new spectrum in software systems. MicroCraft software includes: MacroLink, a complete macroassembler for the 6502, SuperEdit, a full-screen editor with a superb range of powerful capabilities plus, DiskScreen, a screen-oriented disk utility. Complete System \$200/\$40

#### MacroLink **\$125/\$20**

Uses text files for source code • Links source code or object code programs • Fully nestable file include capability • Recursive macros • Nestable conditional assembly • Over 50 error messages • File I/O macros • Sample programs • Disk assembler: source code need NOT fit in memory.

#### SuperEdit **\$75/\$20**

Full Screen Editor • Single keystroke commands • Uses standard text files • Move cursor by character, line or page • Block move and copy • Search and replace • Macro capability • Plus extra software: SuperEdit '56 x 27' provides 56 x 27 character screen for Apple II • And more!

#### DiskScreen **\$40/\$10**

Displays a complete sector in hex and ASCII • Completely visual and interactive • Sector move and copy • To change byte value, move cursor and type.

NOTE: All programs require single disk drive. MacroLink also requires 48K. First price: software and manual. Second price: manual only (applied toward purchase of software).

Call or write for our complete MicroCraft Systems catalog at no extra charge. Other programs include: S.T.A.R. Reading Program • "C" Compiler • Graphics Development Systems • Programs in ROM • SuperEdit for 80 x 24 video cards

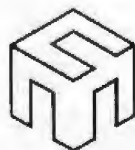

## MicroCraft Systems, Inc.

In software systems, a name to remember.

188 Kerby Road  
Grosse Pointe Farms, MI 48236  
(313) 881-3089

Source I.D. CL0472      MicroNet I.D. 70270, 222

VISA or MasterCard accepted. Inquire at your local computer store or order direct.

I'd like to make clear that I don't object to science fiction that makes use of computers, intelligent or otherwise, without explaining how they work. HAL in *2001: A Space Odyssey* is basically of this type, though I think the year 2001 is much too early for the human-or-better intelligence HAL displays. Boden, who repeatedly uses HAL as a standard of true intelligence in a machine, apparently agrees on both comments. Another example is Ellison's *I Have No Mouth and I Must Scream*, which postulates a computer that goes berserk. It kills everyone in the world, except for five people whom it plans to keep alive to torture forever. Unpleasant and unlikely, but the story doesn't say how the computer works and how it was developed, so my understanding of intelligence is not contradicted.

In *The Cybernetic Imagination in Science Fiction*, Warrick concludes that "with too few exceptions, the fiction gives no evidence that it is aware of information theory or computer technology . . . the portrayal of computer technology is too often inaccurate and distorted . . ." I agree. She then speculates that "the complex, technical nature of the material in computer science and the incredible speed of developments in the field make it impossible for the literary imagination to keep abreast of the material." This I do not believe. I like Ted Nelson's comment that any nitwit can understand computers, and many do. "Understand" does not mean "be an expert on"; that is something that takes talent and time, for the reasons Warrick mentions. My own speculation is that many science-fiction writers misrepresent computers because they *think* computers are hard to understand, and as a result they don't really try. Perhaps they feel, consciously or otherwise, that there's no point in really understanding computers, since the real thing will be too complicated for their readers.

There is also, as I have already suggested, an even more important distorting factor in the science fiction about *intelligent* computers. Although it sounds obvious when stated directly, I think this point is often forgotten: machine intelligence is just a type of intelligence. Therefore writers about intelligent machines need to understand something about intelligence. In my opinion, they need this more than they need to understand computers. ■

#### References

1. "Computers," in *The Science Fiction Encyclopedia*, Peter Nicholls, editor. New York: Doubleday, 1979, pages 133-134. Contains a list of relevant stories and discussions.
2. Warrick, Patricia. *The Cybernetic Imagination in Science Fiction*. Cambridge MA: MIT Press, 1980.
3. Boden, Margaret. *Artificial Intelligence and Natural Man*. New York: Basic Books, 1977, pages 252-253.
4. Boden, pages 165-167.
5. Boden, Chapter 6.
6. Asimov, Isaac. "Escape!" Published in 1945, this story treats the same idea developed in *AP-1* and *When Harlie Was One*, but in less detail.
7. Boden, page 95.
8. Holstadter, Douglas. *Godel, Escher, Bach: An Eternal Golden Braid*. New York: Random House, 1980, page 308.



At Hayes, we don't believe in second best. Or planned obsolescence. We believe in taking the state of the art to the limit. Our new Smartmodem, for example, is the most sophisticated 300-baud originate/answer modem you can buy. And yet, it is perhaps the easiest-to-use modem ever.

**RS-232C Compatible.** Smartmodem lets any RS-232C compatible computer or terminal communicate by phone with other computers and time-sharing systems located *anywhere in North America*. You get full and half-duplex operation with both Touch-Tone® and pulse dialing.

**Auto-Answer/Dial/Repeat.** Smartmodem can answer the phone, dial a number, receive and transmit data, and then hang up the phone — automatically! If desired, Smartmodem will even repeat the last command. You can depend on Smartmodem for completely unattended operation.

**Completely Programmable.** Smartmodem can be controlled using

# Hayes Stack™

## Microcomputer Component Systems

any programming language. Over 30 different commands can be written into your programs or entered directly from your keyboard.

Smartmodem also includes several switch-selectable features that let you tailor performance to your exact needs. You can "set it and forget it" for the ultimate in convenience.

**Built-in Audio Monitor.** Thanks to an internal speaker, you can actually listen to your connection being made. You'll know immediately if the line is busy or if you reached a wrong number —

and you don't even need a phone!

**Status at a Glance.** Seven LED's indicate Smartmodem's current operating mode: auto-answer, carrier detect, off hook, receive data, send data, terminal ready and modem ready. You're never left in the dark!

**Direct-Connect Design.** Smartmodem is FCC registered for direct connection to any modular phone jack — there's no acoustic coupler to cause signal loss and distortion.

**Smartmodem, Smart Buy.** Professional quality features. Versatile performance. A full two-year limited warranty. A suggested retail price of only \$279.

What more could you want? Perhaps the matching Hayes Stack Chronograph, an RS-232C compatible calendar/clock system.

Check out the Smartmodem wherever fine computer products are sold. And don't settle for anything less than Hayes.



Smartmodem.  
The ultimate concept in modems  
is now a reality.

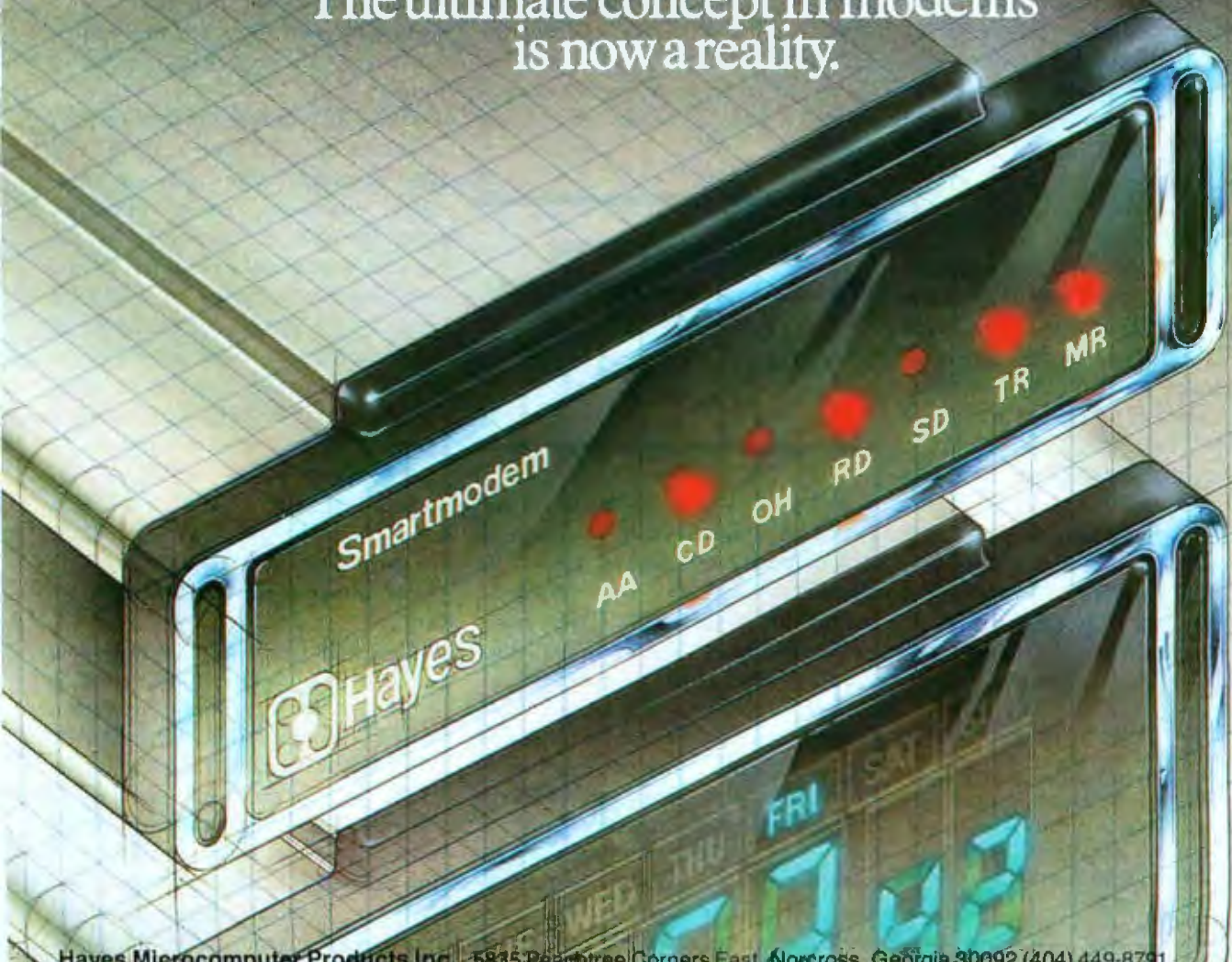

Hayes Microcomputer Products Inc. 5835 Peachtree Corners East, Norcross, Georgia 30092 (404) 449-8791

Hayes Stack is a trademark of Hayes Microcomputer Products, Inc. Sold only in the U.S.A. TM American Telephone and Telegraph © 1981 Hayes Microcomputer Products, Inc.

# Symbolic Differentiation à la LISP

---

Ronald L Nicol  
3102 Joyce Dr  
Orlando FL 32812

---

Just as I would not consider repairing a car with only a screwdriver and wrench in hand, so would I also not approach the art of computer programming with but a few computer languages in mind. It is clear that each well-known language has a forte, otherwise it would have faded into obscurity. But in the realm of symbolic mathematics, LISP and its descendants stand alone. As a vehicle for the development of symbolic-mathematical code, LISP is the natural choice.

## Background

Two years ago I had not heard of LISP, and it was not until I read the August 1979 BYTE, a LISP theme issue, that I first realized the power of the language. At that time, however, there were no LISP interpreters available for the Radio Shack TRS-80. This prompted me to spend the next ten months writing a complete LISP interpreter, which proved an interesting and educational undertaking. The resulting interpreter fits comfortably in a 16 K-byte TRS-80 Model I computer.

---

## About the Author

Lt Ronald L Nicol was stationed at the Naval Research Laboratory in Washington DC and, later, aboard the USS M G Vallejo as Reactor Controls Officer and Main Propulsion Assistant. Currently, he is a Chemistry and Material Science Instructor at the Naval Nuclear Power School.

---

As I soon learned, a necessary condition to writing a LISP interpreter and eventually writing effective LISP programs is the use of recursion. Few languages take such full advantage of recursion. The resulting interpreter incorporates approximately fifty machine-code LISP functions, including the PROG feature and the FUNARG device (a method of specifying variable bindings, or assignments), and a form of virtual memory.

---

## In the realm of symbolic mathematics, LISP and its descendants stand alone.

---

As a preface to the discussion of the symbolic differentiation program, I will discuss a mechanism called the *association list*, or *A-list*, used in most LISP systems. The A-list exists as a software stack that holds variable bindings. A common approach, and one which I used, is to create a list of pairs, each containing the name and value of a variable. When the value of a variable is required, the A-list is searched from the top down, and the value of the first occurrence of the variable is returned. There are many distinct advantages to this treatment, one of which is that

variables can be made completely local with respect to a function. This is accomplished by virtue of the fact that a function binds its variables before operating on them, and removes the bindings when the function is complete. In tandem with modular definition of functions, this feature allows full recursion—a function may call itself any number of times.

There are two types of user-defined functions in LISP. One is the EXPR-type function, which has its arguments evaluated, while the other type, the FEXPR function, does not have its arguments evaluated. Of the two arguments passed to a FEXPR function, the first is a list consisting of user arguments and the second is the A-list. Passing the A-list as an argument allows FEXPR functions to preserve the calling environment.

A property list is associated with each atom. The FEXPR and EXPR function definitions are contained in the property list so that the interpreter can properly evaluate a function.

The first step in developing a usable LISP symbolic-math system is to define the defining functions. Listing 1 contains the functions DEF and DFF. The DEF function is the EXPR defining function, and DFF is the FEXPR defining function. Both functions operate by placing the function definition on the property list of the given function name, under the appropriate atomic indicator. Note

# Announcing the WICAT 68000 Microcomputer System 150.



## Standard Equipment

68000 Processor  
256KB RAM  
10 MB Winchester  
5 1/4" Floppy Disk Backup  
2 RS-232 C Serial Interfaces  
Parallel Printer Port  
WICAT MCS Operation System  
Multibus™  
Choice of One Language

## Hardware Options

Battery Backup  
Communications: Auto  
Answer and Auto Dial  
1200 Baud  
Cartridge Tape Backup

## Language Support

PASCAL  
C  
FORTRAN  
BASIC  
APL  
COBOL  
Assembler

## Software Options

UNIX™/V7  
CPM

Call or write WICAT Systems  
for additional information.

WICATsystems

P.O. Box 539 1875 South State Street Orem, Utah 84057 801/224-6400

UNIX is a trademark of Bell Laboratories.  
Multibus is a trademark of INTEL Corporation.

**Listing 1: Defining the defining functions.** The function definitions are placed on the property lists of DEF and DFF. Functions defined using DEF have their arguments evaluated, while those defined with DFF do not.

```
(PUTPROP(QUOTE DEF)
 (QUOTE(LAMBDA(S A)
 (PUTPROP(CAR S)
 (CONS LAMBDA(CDR S)
 EXPR)))
 FEXPR)
 (PUTPROP(QUOTE DFF)
 (QUOTE(LAMBDA(S A)
 (PUTPROP(CAR S)
 (CONS LAMBDA(CDR S)
 FEXPR)))
 FEXPR))
 FEXPR)
```

that both of these functions exist as FEXPR functions on the DEF and DFF atoms, respectively.

When it is occasionally necessary to use special LISP characters in a context different from their meanings in LISP, the double-quote convention is used (eg: to parse "-" as a minus sign instead of a negative zero). Use of this feature is illustrated as follows:

```
(QUOTE -) = 0
(QUOTE "-") = -
(QUOTE +) = 0
(QUOTE "+") = +
```

Additionally, the functions ADD and

SUB are, respectively, the two-argument special-case functions of the standard LISP functions PLUS and DIFFERENCE.

## System Overview

The symbolic differentiator consists of three sections: the input parser, the differentiating function, and the output parser. This process is shown symbolically in figure 1. The purpose of the input parser is to translate user input from normal mathematical infix notation to Cambridge prefix notation, the notation used by LISP. The differentiating function differentiates the output, which is subsequently converted back to infix notation by the output parser.

**Listing 2: Definition of the function SETUP, which assigns the left and right binding powers to binary operators and places the appropriate property on the indicator OP for unary operators. The auxiliary function MAPCAR maps the second argument onto successive CARs of the first argument.**

```
(DEF SETUP( )
 (PROG( )
 (MAPCAR(QUOTE((1 90 100 EXPT)
 (* 60 80 TIMES)
 (/ 50 70 DIV)
 ("+" 20 40 ADD)
 ("- " 10 30 SUB)))
 (QUOTE(LAMBDA(L)
 (PROG( )
 (PUTPROP(CAR L)
 (CAR(CDR L))
 (QUOTE LB))
 (PUTPROP(CAR L)
 (CAR(CDR(CDR L)))
 (QUOTE RB))
 (PUTPROP(CAR L)
 (CAR(CDR(CDR(CDR L))))
 (QUOTE OP))))))
 (PUTPROP(QUOTE COS)
 (QUOTE COS)
 (QUOTE OP))
 (PUTPROP(QUOTE SIN)
 (QUOTE SIN)
 (QUOTE OP))
 (PUTPROP(QUOTE EXP)
 (QUOTE EXP)
 (QUOTE OP))
 (PUTPROP(QUOTE LOG)
 (QUOTE LOG)
 (QUOTE OP))))
```

## Input

The input function, PREF, consists of a recursive descent parser with no backtracking. Michael Tucker, a fellow LISP enthusiast, and I wrote this function in a matter of twenty minutes, a point that attests to the clarity and lucidity of LISP programming. A recursive descent parser determines which of two operators has higher priority, breaks the input into two sections, and calls itself on each of the pieces. The *no-backtracking* characteristic means that the parser does not have to scan back to check priority.

PREF was designed with the flexibility to change operator precedence. Each binary operator has a left binding power, LB, and a right binding power, RB. By comparing the left and right binding powers of the operators competing for an argument, the parser decides which operator wins the argument. If the left and right binding powers of the operators are equal, the operator on the left of the argument wins. The values of left and right binding powers are stored on the property list of the operator under the indicators LB and RB, respectively. Also contained on the property list of each operator under the indicator OP is the equivalent LISP function name. For example, the property list of the multiplication operator \* might appear as follows:

```
((OP, TIMES)(LB, 60)(RB, 80))
```



**Figure 1: Skeletal structure of the symbolic-differentiating system.** Each block represents a recursive function that performs the task denoted within.

# OKIDATA

Announcing the 80-column Model 82A quality Microline printer. Quiet. Long lasting. Exceptional print quality.

- 120 cps
- 9-pin head, one year warranty
- Bidirectional, logic seeking
- Graphics
- Parallel and serial interfaces—standard
- Friction and pin head feed—standard
- And much more

From Okidata. The company that stands out. Apart from the rest. For more information on Okidata's incomparable line of printers contact us at 111 Gaither Drive, Mt. Laurel, NJ 08054, (609) 235-2600.

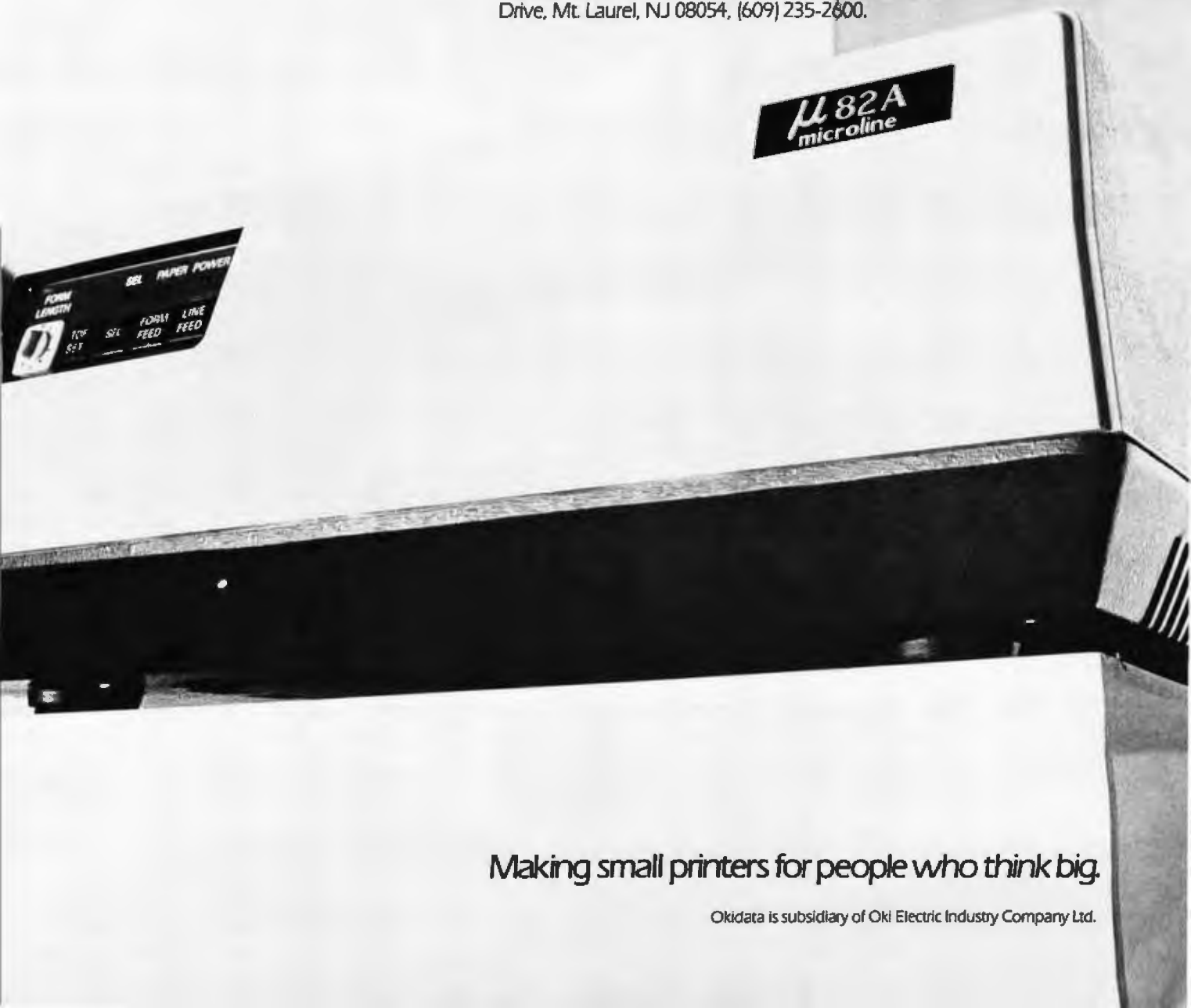

*Making small printers for people who think big.*

Okidata is subsidiary of Oki Electric Industry Company Ltd.

Operator precedence is initially set by executing the function SETUP, which is given in listing 2. The user, however, may at any time alter operator precedence by changing the

LB or RB value of an operator by means of the LISP PUTPROP function. Unary operators and single-operator functions are treated by placing the function within paren-

theses. The input parser, PREF, is defined in listing 3. The power of this function lies in its ability to recursively call itself. Table 1 contains examples illustrating the use of PREF.

### Differentiation

Unlike other areas of mathematics, such as integration or theorem proving, differentiation can generally be characterized by a finite set of definite, rigorous rules, which may easily be defined as recursive LISP functions (see table 2). The differentiating function, DIFF, receives two arguments: the expression to be differentiated and the variable with

Input	Output
(PREF(QUOTE(A * B "+" C)))	(ADD(TIMES A B)C)
(PREF(QUOTE(A *(B "+" C))))	(TIMES A(ADD B C))
(PREF(QUOTE(A "-" B I C)))	(SUB A(EXPT B C))
(PREF(QUOTE(1/(N !))))	(DIV 1(FAC N))
(PREF(QUOTE("-" Y)))	(SUB 0 Y)
(PREF(QUOTE(X*(COS X / 2))))	(TIMES X(COS(DIV X 2)))

Table 1: Sample input and output of the function PREF, which converts infix notation to prefix notation.

## The perfect marriage of Superbrain™ and Winchester™



Finally, a price-performance breakthrough for mass storage in a one-piece, handsomely styled desk-top computer.

- 5 1/4" Micro-Winchester™ 5 Mbyte (formatted) hard disk.
- 700K or 350K floppy disk back up.
- Dual Z-80 processors with 64K RAM.
- Dual RS232 ports.
- Complete and ready to run with CP/M™ 2.2.

DEALER & OEM  
INQUIRIES INVITED

TELEPHONE (206) 453-9777  
TOLL FREE 1-800-426-2963



- Largest Intertec distributor in the United States.
- Distributor for C. Itoh, MPI, Epson.
- Seagate, Tandem drives.
- Corvus hard disks, multiplexers.
- Superbrain S-100 bus, graphics, and parallel port.
- Software: MicroPro, Accounting Plus, Peachtree, Condor, Benchmark.

Superfive ALSO DISTRIBUTED BY

Compu Data  
1 Bala Cynwyd Plaza  
Bala Cynwyd, Pennsylvania 19004  
Telephone (215) 667-6843

Diversified Data  
8043 W. 82nd  
Indianapolis, Indiana 46278  
Telephone (317) 299-0115

**CMC International**  
A Division of Computer Marketing Corporation  
1105A Main, Suite 125 Bellevue WA 98004  
(206) 453-9777

# OKIDATA

Announcing the 136-column Model 83A quality  
Microline printer. Quiet. Long lasting. Exceptional  
print quality.

- 120 cps
- 9-pin head; one year warranty
- Bidirectional, logic seeking
- Graphics
- Parallel and serial interfaces — standard
- Friction and tractor feed — standard
- And much more

From Okidata: The company that stands out.  
Apart from the rest. For more information on Okidata's  
incomparable line of printers contact us at 111 Gauthier  
Drive, Mt. Laurel, NJ 08054, (609) 235-2600.

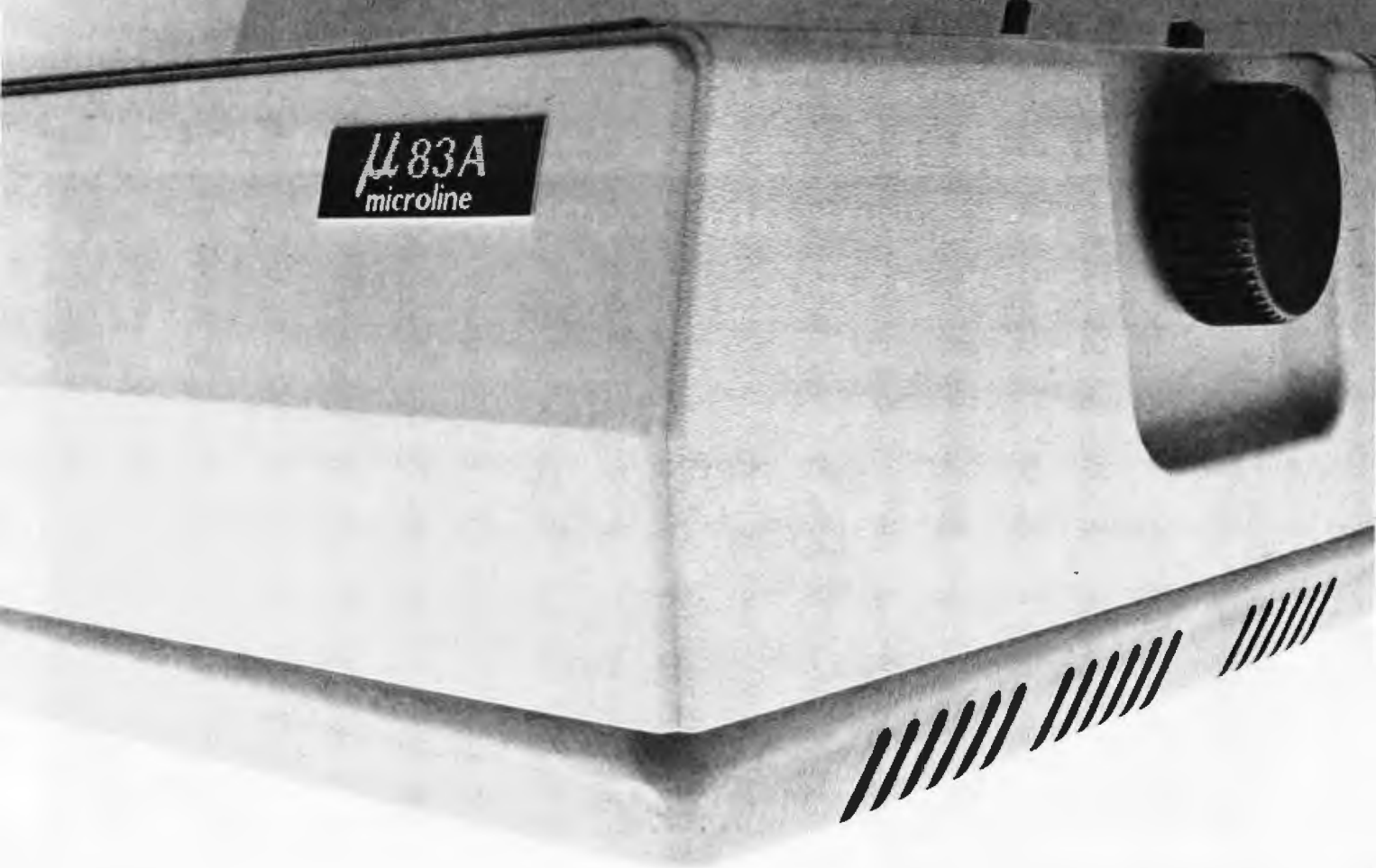

**83A**  
microline

**Making small printers for people who think big.**

Okidata is subsidiary of Oki Electric Industry Company Ltd.

Circle 389 on inquiry card.

Listing 3: Definition of the recursive descent parser, PREF. The parser is defined without backtracking, which minimizes memory and time requirements.

```
(DEF PREF(E)
  (COND((ATOM E)E)
    ((NULL(CDR E))(PREF(CAR E)))
    ((COND((ATOM(CAR E))(GET(CAR E)(QUOTE OP))))
      (COND((EQ(CAR E)(QUOTE "-"))
        (LIST(QUOTE SUB)
          0
          (PREF(CDR E))))
        (T(LIST(GET(CAR E)(QUOTE OP))
          (PREF(CDR E))))))
      ((EQ(CAR(CDR E)(QUOTE I))
        (LIST(QUOTE FAC)
          (PREF(CAR E))))
      ((NULL(CDR(CDR(CDR E))))
        (LIST(GET(CAR(CDR E))(QUOTE OP))
          (PREF(CAR E))
          (PREF(CDR(CDR E))))))
      ((GREATER(GET(CAR(CDR(CDR(CDR E))))(QUOTE LB))
        (GET(CAR(CDR E))(QUOTE RB)))
        (LIST(GET(CAR(CDR E))(QUOTE OP))
          (PREF(CAR E))
          (PREF(CDR(CDR E))))))
      (T(LIST(GET(CAR(CDR(CDR(CDR E))))(QUOTE OP))
        (PREF(LIST(CAR E)
          (CAR(CDR E))
          (CAR(CDR(CDR E))))))
        (PREF(CDR(CDR(CDR(CDR E))))))))))
```

respect to which the differentiation is to occur. DIFF appears in listing 4.

The function DIFF first tests whether or not the expression is an atom. If so, it determines if the expression is the variable of interest, in which case the value of the function is 1, because the derivative of a variable with respect to itself is unity. Otherwise, if the argument to DIFF is some other atom, 0 is returned. The additional clauses of the DIFF COND statement search for more complex differentiating rules which may be satisfied. The rules are applied recursively, which allows for the simple LISP representation. The modularity of this LISP function is obvious. It is easily extensible to encompass additional rules by the inclusion of additional clauses to the COND. Considering DIFF as a black box, table 3 lists exemplary input and output of the function.

#### Output

Once DIFF has mapped its input into the appropriate derivative, it is

*Text continued on page 230*

*Listing 4 and Table 2 are on page 224*

*Listing 5 is on page 226*

## SuperBrain™ and CompuStar™ Users' Group

WE KNOW THE TERRITORY FOR INTERTEC'S PRODUCTS

Why run around to find what's  
available for your computer?  
Our members are always up to date!



- ★ Monthly magazine
- ★ Make your computer talk
- ★ Touch the screen to input data
- ★ S-100
- ★ Software to fit your needs
- ★ The latest from Intertec
- ★ Discounts on travel, products, insurance, and more
- ★ Free programs
- ★ Yearly conference
- ★ Special dealer program
- ★ A shoulder to lean on

**SUPER★STAR**  
INTERNATIONAL CORPORATION™

P. O. Box 33675, Northglenn, CO 80233 ★ (303) 526-1050

Charge membership by phone



With savings, service, and efficiency, we're here to win your heart.

Yearly membership fee is \$50.00 U.S., \$58 Canada, \$74 Europe & So. America, \$81 Australia, Mid East, Asia & Africa.

Your fee may be tax deductible.

Send checks with your name and address, made out to: Super★Star International (U.S. Currency).

I would like to join Super★Star International. Enclosed is my check for \$\_\_\_\_\_

Name \_\_\_\_\_ Company \_\_\_\_\_

Address \_\_\_\_\_ Phone \_\_\_\_\_

City/State/Zip \_\_\_\_\_

Computer Model \_\_\_\_\_ Version \_\_\_\_\_

SuperBrain and CompuStar are the Trademarks of Intertec Data Systems



# "My computer helped me write The Final Encyclopedia. I wouldn't trust anything less than Scotch® Brand Diskettes to make a long story short."



**Gordon R. Dickson,  
Science Fiction Author,  
Minneapolis, Minnesota**

Gordon Dickson: a small businessman whose product is his own imagination. He's written more than 40 novels and 150 short stories; his newest work is *The Final Encyclopedia*. He uses his personal computer and word processing software to maximize his production. All his words—his product—are stored on diskettes. He calls up sentences and paragraphs on demand, and gets more rewrite out of the time available. So he depends on Scotch diskettes to save himself production time.

Dependable Scotch media can work just as hard for you. Each Scotch diskette is tested before it leaves our factory, and certified error-free. So you can expect it to perform exactly right.

Scotch 8" and 5¼" diskettes are compatible with computer/diskette systems like TRS-80, Apple, PET, Wang and many others. Get them from your local 3M distributor. For the one nearest you, call toll-free: 800/328-1300. (In Minnesota, call collect: 612/736-9625.) Ask for the Data Recording Products Division. In Canada, contact 3M Canada, Inc., Ontario.

**If it's worth remembering,  
it's worth Scotch  
Data Recording Products.**



**3M Hears You...**

# 3M



# AH-HA!



# EUREKA!

# ALL-RIGHT!



## Introducing "Popular Computing," the key to understanding.

Now you don't have to be a computer professional to unlock all the mysteries, potential, and pleasures of home and small business computers. *Popular Computing*, the new monthly magazine from McGraw-Hill, is the key.

Created in response to growing demand for our informative quarterly *onComputing*, *Popular Computing* explores every aspect of personal computers and their use. All reported in easy-to-understand nontechnical language.



## The answer to "Computerphobia."

Even the most computer-unsophisticated reader will find *Popular Computing* interesting and stimulating. Every issue will contain straight-talking product reviews,

special news briefs, and feature articles by famous guest contributors (like Isaac Asimov). There'll even be a helpful glossary of computer jargon we couldn't avoid using, and much, much more.

## Special Introductory Offer.

Send in this coupon today, and take advantage of *Popular Computing's* Special Introductory Offer.



Mail Today to:  
**POPULAR COMPUTING**  
P.O. Box 307, Martinsville, NJ 08836

**SUPER SAVINGS FOR ME...** I'm taking advantage of this super introductory offer of 12 issues for only \$11.97 saving me \$2.03 on the basic rate of \$15.00—and saving me \$20.00. If my 30-day review of your first issue doesn't 100% please me, I may cancel my subscription and you will promptly refund ALL my money or give me a FULL credit on my charge card marked below:

Check Enclosed for \$11.97  
 Charge \$11.97 to:  
 Visa  Mastercard

# POPULAR COMPUTING

THE KEY TO UNDERSTANDING  
P.O. Box 397, Hancock, NH 03449



Card No. \_\_\_\_\_  
Signature \_\_\_\_\_  
Name (Please Print) \_\_\_\_\_  
Address \_\_\_\_\_  
City \_\_\_\_\_ State \_\_\_\_\_ Expires \_\_\_\_\_

# FREE SOFTWARE!

Word Processing or Accounting When You Buy a 64k Superbrain!



**SUPERBRAIN™**  
64k - ONLY  
**\$2950**

<b>SUPERBRAIN 64k</b> List \$3495	<b>*2850</b>
<b>10mb HARD DISK</b> Interlec List \$4995	<b>*3350</b>
<b>10mb HARD DISK</b> Corvus List \$5350	<b>*4295</b>
<b>20mb HARD DISK</b> Corvus	<b>*5300</b>

NORTHSTAR COMPUTERS		PRINTERS	
NONZON II		G. 11mb 8500	*850
32k 80 Reg. \$2695	*2760	Comet II Parallel	*425
32k 80 Reg. \$3995	*3060	Epson MX 80 Parallel	*480
64k 80 Reg. \$4195	*3120	Epson MX 80 Serial	*640
64k 80 Reg. \$4495	*3280	Starwriter 25cps Parallel	*1400
<b>TERMINALS</b>		Starwriter 25cps Serial	*1060
Interlube III Reg. \$895	*720	Starwriter III 40cps Serial	*1760
Emulator Reg. \$895	*720	Starwriter II 45cps	*1700

MODEMS		MICROPLAN
Cat Novation acoustic	*160	The Visicalc
Cat Direct Connect	*189	For CP/M
Microconnection Direct	*165	List \$495
A-J 1255 1200 baud dir conn List \$1295	*925	<b>*425</b>
<b>UPGRADE</b>		
5mb Hard Disk Upgrade for Superbrain	*2995	

**SOFTWARE**  
25% OFF LIST ON ALL NORTHSTAR SOFTWARE

**ACCOUNTING PLUS**  
By Systems Plus  
Accounts Receivable Accounts Payable, Inventory, Payroll, General Ledger, Sales Order Entry, Purchase Order Entry, Point of Sale. Excellent software for many systems.

PEACHTREE		MYF SOFTWARE	
A/R A/P G/L P/R INV	ea	Restaurant Inventory	*250
CPA Property Mgmt	ea	Client Billing	*450
<b>DATA BASE MANAGEMENT</b>		Conder I	*550
		Data Star	*275
<b>LANGUAGES</b>		C BASIC II COMPILER	*110
		MBASIC 80	*325
		MBASIC Compiler	*350
		FORTRAN 80	*450
		COBOL 80	*650
		PASCAL UCSD	*300
		MT PASCAL	*500

CNC SOFTWARE		OTHER SOFTWARE	
A/P, A/R, P/R, G/L INV	ea	Restaurant Payroll	*300
		Word Star	*325
		Mail Merge	*115
		DSort	*100
		Benchmark Word Processing	*395
		SuperSort	*200
		Benchmark Mail List Management	*350
		Magic Wand	*325
		NAD	*180
		Magic Menu	*80
		MVF Mailer	*90
		Word Pro 80	*150
		Spellguard	*220

PERIPHERALS		DISK DRIVES	
Corvus Host Multiplexer List \$750	*625	CDC Single side, dbl. density. List \$495	*225
Master Multiplexer List \$1050	*875	CDC Double Side, dbl. density. List \$895	*390
Mirror Backup List \$790	*650	Tandem TM 100-4 Dbl. side, dbl. dens., dbl. track List \$995	*600
Interface card w/5' cable List \$235	*195	<b>PHONES</b>	
S-100 Bus Adapter for Superbrain List \$595	*475	SB/E prom for Superbrain. List \$205	*155
Parallel Port for Superbrain List \$90	*75	<b>GRAPHICS</b>	
External Adapter List \$30	*25	AccuSoft Graphics Board List \$995	*895
		Symbol Generator List \$225	*200
		Graphics plotter List \$225	*200
		3-D Graphics. List \$450	*400
		Surface plotter. List \$495	*450
		Graphics Terminal Emulator. List \$495	*450

**TO ORDER, CALL (206)453-8160**

Most items shipped from stock. Mastercharge, Visa add 3%. No CODs on hardware. All prices FOB origin. No shipment via Emery Air Freight because of poor claim response in damaged merchandise.

**PACIFIC COMPUTER BROKERS**  
11056 Palatine North  
Seattle, WA 98133

Listing 5: The function definition of INFIX, the output parser. INFIX converts its input from Cambridge prefix notation to mathematical infix notation. INFIX also performs algebraic simplification.

```
(DEF INFIX(E)
(COND((ATOM E)E)
(T(PROG(FIRST SECOND)
(SETQ FIRST(INFIX(CAR(CDR E))))
(COND((CDR(CDR E))
(SETQ SECOND(INFIX(CAR(CDR(CDR E)))))))
(RETURN
(COND((EQ(CAR E)(QUOTE ADD))
(COND((EQ FIRST 0)SECOND)
((EQ SECOND 0)FIRST)
((T(WONUM)(EVAL E NIL))
(EQUAL FIRST SECOND)
(LIST 2
(QUOTE *)
FIRST))
((MATCH(LIST(QUOTE ?)(QUOTE *)FIRST)SECOND)
(INFIX(LIST(QUOTE TIMES)
(LIST(QUOTE ADD)
(CAR SECOND)
1)
FIRST)))
((MATCH(LIST(QUOTE ?)(QUOTE *)SECOND)FIRST)
(INFIX(LIST(QUOTE TIMES)
(LIST(QUOTE ADD)
(CAR FIRST)
1)
SECOND)))
(T(LIST FIRST
(QUOTE "+")
SECOND))))
((EQ(CAR E)(QUOTE TIMES))
(COND((EQ FIRST 1)SECOND)
((EQ SECOND 1)FIRST)
((EQ FIRST 0)0)
((EQ SECOND 0)0)
(EQUAL FIRST SECOND)
(LIST FIRST
(QUOTE 1)
2))
((T(WONUM)(EVAL E NIL))
((MATCH(LIST FIRST(QUOTE 1)(QUOTE ?))SECOND)
(INFIX(LIST(QUOTE EXPT)
FIRST
(LIST(QUOTE ADD)
(CAR(CDR(CDR SECOND)))
1))))
((MATCH(LIST SECOND(QUOTE 1)(QUOTE ?))FIRST)
(INFIX(LIST(QUOTE EXPT)
SECOND
(LIST(QUOTE ADD)
(CAR(CDR(CDR FIRST)))
1))))
((MATCH(LIST(QUOTE ?)(QUOTE *)FIRST)SECOND)
(INFIX(LIST(QUOTE TIMES)
(CAR SECOND)
(LIST(QUOTE EXPT)
FIRST
2))))
((MATCH(LIST(QUOTE ?)(QUOTE *)SECOND)FIRST)
(INFIX(LIST(QUOTE TIMES)
(CAR FIRST)
(LIST(QUOTE EXPT)
SECOND
2))))))
```

Listing 5 continued on page 228

# THE ORIGINAL MAGAZINE FOR OWNERS OF THE TRS-80™\* MICROCOMPUTER

\* TRS-80™ IS A TRADEMARK OF TANDY CORP.

SOFTWARE  
FOR TRS-80™  
OWNERS

# COMPUTRONICS INC.

MONTHLY  
NEWSMAGAZINE  
FOR TRS-80™  
OWNERS

## MONTHLY NEWSMAGAZINE Practical Support For Model I, II & III

- PRACTICAL APPLICATIONS
- BUSINESS
- GAMBLING • GAMES
- EDUCATION
- PERSONAL FINANCE
- BEGINNER'S CORNER
- NEW PRODUCTS
- SOFTWARE EXCHANGE
- MARKET PLACE
- QUESTIONS AND ANSWERS
- PROGRAM PRINTOUTS
- .... AND MORE

### NOW IN OUR 4th YEAR

PROGRAMS AND ARTICLES PUBLISHED IN RECENT ISSUES  
INCLUDE THE FOLLOWING:

- FINCALC - A COMPLETE FINANCIAL APPLICATIONS PACKAGE
- INFORMATION SYSTEM REVIEW
- STATISTICAL COMBINATIONS
- PASCAL'S TRIANGLE
- ASSEMBLY LANGUAGE FOR BEGINNERS
- DISK FILES
- MOD:III REVIEW
- KEYBOARD THUNDER AND LIGHTING EXPLAINED
- DOS COMMANDS IN LEVEL II
- PROBABILITY CURVE GENERATOR
- CALCULATOR SIMULATIONS
- THE MEGABYTE GAP
- STOCKS AND BONDS
- BUDGET ANALYSIS (FOR BUSINESS AND HOME)
- NEWDOS:80 REVIEW
- DUTCHING THE HORSE SYSTEM THAT CAN'T LOSE
- A SIMULATED GOLF GAME
- CONTINUOUS FORM SOURCES
- TAX SAVER REVIEW
- AND MORE

**FREE\*** WITH  
YOUR  
SUBSCRIPTION  
OR  
RENEWAL

### FINCALC

A Complete Financial Analysis Package Used To Calculate Markup, Margin, Annuities, Compound Interest, Nominal And Effective Rates, Sinking Funds, Mortgage Calculations, Future Value, Savings and Insurance, Percentage Difference Between Two Numbers, Amortization Schedule and More . . . . .

SEND FOR OUR NEW 64 PAGE SOFTWARE CATALOG (INCLUDING LISTINGS OF HUNDREDS OF TRS-80™ PROGRAMS AVAILABLE ON CASSETTE AND DISKETTE). \$2.00 OR FREE WITH EACH SUBSCRIPTIONS OR SAMPLE ISSUE

\* All programs are supplied on cassette (add \$3 for Diskette Version - add \$5 for modified Mod-II Version).

# COMPUTRONICS

50 N. PASCACK ROAD  
SPRING VALLEY, NEW YORK 10977

ONE YEAR SUBSCRIPTION \$24 .....  
TWO YEAR SUBSCRIPTION \$48 .....  
SAMPLE OF LATEST ISSUE \$ 4 .....

START MY SUBSCRIPTION WITH ISSUE.....

(#1 July 1978 • #12 June 1979 • #24 July 1980 • #30 January 1981)

NEW SUBSCRIPTION..... RENEWAL .....

**NEW TOLL-FREE  
ORDER LINE**  
(OUTSIDE OF N.Y. STATE)  
**(800) 431-2818**



**24 HOUR  
ORDER  
LINE**  
**(914) 425-1535**



CREDIT CARD NUMBER \_\_\_\_\_ EXP. DATE \_\_\_\_\_

SIGNATURE \_\_\_\_\_ NAME \_\_\_\_\_

ADDRESS \_\_\_\_\_ CITY \_\_\_\_\_ STATE \_\_\_\_\_ ZIP \_\_\_\_\_

\*\*\* ADD \$12/YEAR (CANADA, MEXICO) - ADD \$24/YEAR AIR MAIL - OUTSIDE OF U.S.A., CANADA & MEXICO \*\*\*

# ★50%★ DISCOUNT COUPON

Bring this COUPON into one of our stores or mail to our Mail Order address shown below and receive a 50% DISCOUNT on purchases from this page of \$90.00 or more. Offer EXPIRES on October 15, 1981

NAME \_\_\_\_\_  
ADDRESS \_\_\_\_\_  
CITY \_\_\_\_\_ STATE \_\_\_\_\_  
ZIP \_\_\_\_\_ PHONE NO. \_\_\_\_\_

Coupons accepted only with full name and address filled in.

SN74LS00N	\$.50	SN74LS137N	\$1.60	SN74LS283N	\$.95
SN74LS01N	.53	SN74LS138N	.80	SN74LS290N	.95
SN74LS02N	.50	SN74LS139N	.80	SN74LS293N	.90
SN74LS03N	.50	SN74LS145N	1.24	SN74LS295N	.98
SN74LS04N	.50	SN74LS148N	2.90	SN74LS298N	1.16
SN74LS05N	.53	SN74LS151N	.70	SN74LS299N	2.95
SN74LS06N	.50	SN74LS153N	.70	SN74LS322N	6.95
SN74LS09N	.53	SN74LS154N	1.50	SN74LS323N	6.96
SN74LS10N	.50	SN74LS155N	.95	SN74LS349N	2.20
SN74LS11N	.50	SN74LS156N	.90	SN74LS352N	1.50
SN74LS12N	.53	SN74LS157N	.70	SN74LS363N	1.90
SN74LS13N	.53	SN74LS158N	.70	SN74LS365N	2.50
SN74LS14N	.74	SN74LS160AN	.96	SN74LS364N	1.00
SN74LS15N	.53	SN74LS161AN	.98	SN74LS368N	1.80
SN74LS20N	.50	SN74LS162AN	.98	SN74LS368N	.78
SN74LS21N	.50	SN74LS163AN	.98	SN74LS367N	.78
SN74LS22N	.50	SN74LS164N	.95	SN74LS368N	.78
SN74LS26N	.50	SN74LS165N	1.50	SN74LS373N	1.80
SN74LS27N	.50	SN74LS166N	1.50	SN74LS374N	1.80
SN74LS28N	.53	SN74LS168N	1.50	SN74LS375N	.78
SN74LS30N	.50	SN74LS169N	1.50	SN74LS377N	1.88
SN74LS32N	.60	SN74LS170N	1.95	SN74LS378N	1.26
SN74LS33N	.53	SN74LS173N	.98	SN74LS379N	1.96
SN74LS37N	.60	SN74LS174N	.85	SN74LS381N	4.56
SN74LS38N	.60	SN74LS175N	.85	SN74LS385N	4.56
SN74LS40N	.63	SN74LS181N	2.70	SN74LS388N	.68
SN74LS42N	.63	SN74LS180N	.98	SN74LS390N	1.86
SN74LS51N	.60	SN74LS181N	.98	SN74LS393N	1.48
SN74LS54N	.60	SN74LS192N	.80	SN74LS395N	1.95
SN74LS55N	.60	SN74LS193N	.98	SN74LS396N	2.75
SN74LS73N	.65	SN74LS194AN	.90	SN74LS399N	1.55
SN74LS74N	.68	SN74LS195AN	.90	SN74LS445N	1.80
SN74LS76N	.75	SN74LS196N	1.32	SN74LS480N	2.85
SN74LS78N	.75	SN74LS197N	1.32	SN74LS540N	1.90
SN74LS83AN	.85	SN74LS221N	1.32	SN74LS555N	4.95
SN74LS85N	.85	SN74LS240N	1.80	SN74LS668N	4.95
SN74LS86N	.80	SN74LS241N	1.80	SN74LS620N	2.25
SN74LS88N	.80	SN74LS242N	1.80	SN74LS621N	2.25
SN74LS90N	.70	SN74LS243N	1.80	SN74LS622N	2.25
SN74LS91N	1.80	SN74LS244N	1.90	SN74LS623N	2.25
SN74LS92N	.70	SN74LS245N	1.40	SN74LS640N	2.25
SN74LS93N	.65	SN74LS246N	1.50	SN74LS641N	2.25
SN74LS968N	1.00	SN74LS248N	1.50	SN74LS642N	2.25
SN74LS96N	1.00	SN74LS251N	.70	SN74LS643N	3.80
SN74LS107AN	.70	SN74LS253N	.70	SN74LS644N	2.25
SN74LS109AN	.65	SN74LS256N	1.90	SN74LS645N	2.25
SN74LS112N	.65	SN74LS257N	.80	SN74LS668N	1.20
SN74LS113N	.65	SN74LS258N	.95	SN74LS669N	1.20
SN74LS114N	.65	SN74LS259N	1.50	SN74LS670N	2.25
SN74LS122N	.95	SN74LS260N	.80	SN74LS718N	7.95
SN74LS123N	.98	SN74LS261N	2.25	SN74LS719N	7.95
SN74LS125N	.75	SN74LS266N	.80	SN74LS783N	21.50
SN74LS126N	.75	SN74LS273N	.70	SN74LS785N	1.78
SN74LS132N	.75	SN74LS279N	1.20	SN74LS798N	1.75
SN74LS133N	.75	SN74LS280N	2.85	SN74LS797N	1.78
SN74LS138N	.60	SN74LS281N	6.90	SN74LS798N	1.78

**EPROM 2716-5 \$6.50**  
(5 VOLT)



**ANCRONA**

STORES DO NOT ACCEPT MAIL ORDERS

**MAIL ORDER**

P.O. BOX 2208Y CULVER CITY, CA 90230

Minimum Order \$10.00. Add \$2.50 to cover postage and handling. Major charge and Visa welcome. Please include your charge card number, telephone number and expiration date. Some items are subject to price paid. Not responsible for typos. Allow pricing may vary from Mail Order pricing. We reserve the right to substitute or discontinue.

**PHONE ORDERS**  
(213) 641-4064

**ATLANTA**  
3330 Piedmont Rd. N.E.  
Atlanta, GA 30305  
(404) 281-7100

**CULVER CITY**  
11080 Jefferson Blvd.  
Culver City, CA 90230  
(213) 390-3585

**HOUSTON**  
2649 Richmond  
Houston, TX 77098  
(713) 629-3488

**PORTLAND**  
1125 N.E. 82nd Ave.  
Portland, OR 97220  
(503) 254-5541

**SANTA ANA**  
1300 E. Edinger Ave.  
Santa Ana, CA 92705  
(714) 547-8424

**SUNNYVALE**  
1054 E. El Camino Real  
Sunnyvale, CA 94087  
(408) 243-4121

**TUCSON**  
4518 E. Broadway  
Tucson, AZ 85711  
(602) 881-2346

Listing 5 continued:

```
(T(LIST FIRST
(QUOTE *)
SECOND))))
((EQ(CAR E)(QUOTE DIV))
(COND((EQ SECOND 1)FIRST)
((EQUAL FIRST SECOND)1)
((EQ FIRST 0)0)
((T(WONUM)(EVAL E NIL))
((MATCH(LIST(QUOTE ?)(QUOTE *)SECOND)FIRST)
(INFIX(LIST(QUOTE TIMES)
(LIST(QUOTE SUB)
(CAR FIRST)
1)
SECOND))))
((MATCH(LIST(QUOTE ?)(QUOTE *)FIRST)SECOND)
(INFIX(LIST(QUOTE DIV)
1
(LIST(QUOTE TIMES)
(LIST(QUOTE SUB)
(CAR SECOND)
1)
FIRST))))
((MATCH(LIST SECOND(QUOTE 1)(QUOTE ?))FIRST)
(INFIX(LIST(QUOTE EXPT)
SECOND
(LIST(QUOTE SUB)
(CAR(CDR(CDR FIRST))))
1))))
((MATCH(LIST FIRST(QUOTE 1)(QUOTE ?))SECOND)
(INFIX(LIST(QUOTE DIV)
1
(LIST(QUOTE EXPT)
FIRST
(LIST(QUOTE SUB)
(CAR(CDR(CDR SECOND))))
1))))
(T(LIST FIRST
(QUOTE /)
SECOND))))
((EQ(CAR E)(QUOTE EXPT))
(COND((EQ SECOND 1)FIRST)
((EQ SECOND 0)1)
((T(WONUM)(EVAL E NIL))
(T(LIST FIRST
(QUOTE !)
SECOND))))
((EQ(CAR E)(QUOTE LOG))
(COND((EQ FIRST 1)0)
(T(LIST(QUOTE LOG)
FIRST))))
((EQ(CAR E)(QUOTE SIN))
(LIST(QUOTE SIN)
FIRST))
((EQ(CAR E)(QUOTE COS))
(LIST(QUOTE COS)
FIRST))
((EQ(CAR E)(QUOTE EXP))
(COND((EQ FIRST 0)1)
(T(LIST(QUOTE EXP)
FIRST))))
```

Listing 5 continued on page 230

# H & E COMPUTRONICS INC.

• EVERYTHING FOR YOUR TRS-80\* • ATARI\* • APPLE\* • PET\* •

\*TRS-80 is a trademark of the Radio Shack Division of Tandy Corp. - \*ATARI is a trademark of Atari Inc. - \*Apple is a trademark of Apple Corp. - \*Pet is a trademark of Commodore



★ All orders processed within 24-Hours  
★ 30-Day money back guarantee on all Software

## BUSINESS PAC 100

### 100 Ready-To-Run

### Business Programs

(ON CASSETTE OR DISKETTE).....Includes 110 Page Users Manual.....5 Cassettes (Or Diskettes)

Inventory Control.....Payroll.....Bookkeeping System.....Stock Calculations.....

Checkbook Maintenance.....Accounts Receivable.....Accounts Payable.....

### BUSINESS 100 PROGRAM LIST

1 RULE78	Interest Apportionment by Rule of the 78's	59 WACC	Weighted average cost of capital
2 ANNU1	Annuity computation program	60 COMBPAL	True rate on loan with compensating bal required
3 DATE	Time between dates	61 DISCBAL	True rate on discounted loan
4 DAYYEAR	Day of year a particular date falls on	62 MERGANAL	Merger analysis computations
5 LEASEINT	Interest rate on lease	63 FINRAT	Financial ratios for a firm
6 BREAKKEYN	Breakeven analysis	64 NPV	Net present value of project
7 DEPRSL	Straightline depreciation	65 PRINDLAS	Laspeyres price index
8 DEPRSY	Sum of the digits depreciation	66 PRINDPA	Paasche price index
9 DEPRDB	Declining balance depreciation	67 SEASIND	Constructs seasonal quantity indices for company
10 DEPRDDB	Double declining balance depreciation	68 TIMETR	Time series analysis linear trend
11 TAXDEP	Cash flow vs depreciation tables	69 TIMEMOV	Time series analysis moving average trend
12 CHECK2	Prints NEBS checks along with daily register	70 FUPRINF	Future price estimation with inflation
13 CHECKBK1	Checkbook maintenance program	71 MAILPAC	Mailing list system
14 MORTGAGE/A	Mortgage amortization table	72 LETWRT	Letter writing system-links with MAILPAC
15 MULTMON	Computes time needed for money to double, triple, etc.	73 SORT3	Sorts list of names
16 SALVAGE	Determines salvage value of an investment	74 LABEL1	Shipping label maker
17 RRVARIN	Rate of return on investment with variable inflows	75 LABEL2	Name label maker
18 RRCONST	Rate of return on investment with constant inflows	76 BUSBJD	HOME business bookkeeping system
19 EFFECT	Effective interest rate of a loan	77 TIMECLCK	Computes weeks total hours from timeclock info.
20 FVAL	Future value of an investment (compound interest)	78 ACCTPAY	In memory accounts payable system-storage permitted
21 PVAL	Present value of a future amount	79 INVOICE	Generate invoice on screen and print on printer
22 LOANPAY	Amount of payment on a loan	80 INVENT2	In memory inventory control system
23 RECWITH	Equal withdrawals from investment to leave 0 over	81 TELDIR	Computerized telephone directory
24 SIMPDISK	Simple discount analysis	82 TIMUSAN	Time use analysis
25 DATEVAL	Equivalent & nonequivalent dated values for oblig	83 ASSIGN	Use of assignment algorithm for optimal job assign.
26 ANNUDEF	Present value of deferred annuities	84 ACCTREC	In memory accounts receivable system-storage ok
27 MARKUP	% Markup analysis for items	85 TERMSPAY	Compares 3 methods of repayment of loans
28 SINKFUND	Sinking fund amortization program	86 PAYNET	Computes gross pay required for given net
29 BONDVAL	Value of a bond	87 SELLPR	Computes selling price for given after tax amount
30 DEplete	Depletion analysis	88 ARBCOMP	Arbitrage computations
31 BLACKSH	Black Scholes options analysis	89 DEPRSF	Sinking fund depreciation
32 STOCVAL1	Expected return on stock via discounts dividends	90 UPSZONE	Finds UPS zones from zip code
33 WARVAL	Value of a warrant	91 ENVELOPE	Types envelope including return address
34 BONDVAL2	Value of a bond	92 AUTOEXP	Automobile expense analysis
35 EPSEST	Estimate of future earnings per share for company	93 INSFILE	Insurance policy file
36 BETAALPH	Computes alpha and beta variables for stock	94 PAYROLL2	In memory payroll system
37 SHARPE1	Portfolio selection model i.e. what stocks to hold	95 DILANAL	Dilution analysis
38 OPTWRITE	Option writing computations	96 LOANAFFD	Loan amount a borrower can afford
39 RTVAL	Value of a right	97 RENTPRCH	Purchase price for rental property
40 EXPVAL	Expected value analysis	98 SALELEAS	Sale-leaseback analysis
41 BAYES	Bayesian decisions	99 RRCONVBD	Investor's rate of return on convertible bond
42 VALPRINF	Value of perfect information	100 PORTVAL9	Stock market portfolio storage-valuation program
43 VALADINF	Value of additional information		
44 UTILITY	Derives utility function		
45 SIMPLEX	Linear programming solution by simplex method		
46 TRANS	Transportation method for linear programming		
47 EOQ	Economic order quantity inventory model		
48 QUEUE1	Single server queueing (waiting line) model		
49 CVP	Cost-volume-profit analysis		
50 CONDPFOP	Conditional profit tables		
51 OPTLOSS	Opportunity loss tables		
52 FQIQQ	Fixed quantity economic order quantity model		

- CASSETTE VERSION \$99.95
- DISKETTE VERSION \$99.95
- TRS-80\* MODEL II VERSION \$149.95

ADD \$3.00 FOR SHIPPING IN UPS AREAS  
ADD \$4.00 FOR C.O.D. OR NON-UPS AREAS  
ADD \$5.00 OUTSIDE U.S.A., CANADA & MEXICO

**NEW TOLL-FREE  
ORDER LINE**  
(OUTSIDE OF N.Y. STATE)  
**(800) 431-2818**

**COMPUTRONICS**  
MATHEMATICAL APPLICATIONS SERVICE

50 N. PASCACK ROAD  
SPRING VALLEY, NEW YORK 10977



**24 HOUR  
ORDER LINE**  
**(914) 425-1535**



NAME	DESCRIPTION
53 FQEOWSH	As above but with shortages permitted
54 FQEQQPB	As above but with quantity price breaks
55 QUEUECB	Cost-benefit waiting line analysis
56 NCFANAL	Net cash-flow analysis for simple investment
57 PROFIND	Profitability index of a project
58 CAPI	Cap. Asset Pr. Model analysis of project

Circle 155 on Inquiry card.

Listing 5 continued:

```
((EQ(CAR E)(QUOTE FAC))
 (COND((EQ FIRST 1)1)
 ((EQ FIRST 0)1)
 (T(LIST FIRST
 (QUOTE 1))))))
(T E))))))
```

Listing 7: TWONUM simply checks to see if the variables FIRST and SECOND are numbers. If so, it returns T (for true); otherwise, it returns NIL.

```
(DEF TWONUM( )
 (COND((NUMBER FIRST)(NUMBER SECOND))))
```

Listing 8: In listing 8a DERIV provides the thread which ties PREF, INFIX, and DIFF together. The CHR function is analogous to the CHR\$ function in BASIC. The sequence (CHR 28)(CHR 31) clears the screen. Listing 8b shows a sample run of the function DERIV. User input is preceded by the prompt, >.

```
(8a)
(DEF DERIV( )
 (PROG( )
 (CHR 28)
 (CHR 31)
 (PRINT(QUOTE(DERIV "..." A SYMBOLIC DIFFERENTIATOR)))
 (TERPRI)
 (TERPRI)
 LOOP(PRIN1(QUOTE >))
 (PRINT(INFIX(DIFF(PREF(READ))(PREF(READ))))))
 (GO LOOP)))
```

```
(8b)
>(DERIV)
(DERIV---A SYMBOLIC DIFFERENTIATOR)
>(A / B)B
((- A)/(B12))
>(X * X * X)X
(3 *(X12))
>(SIN 2 * X)X
((COS(2 * X))* 2)
>(LOG X)X
(1 / X)
>(X 1 4)X
(4 *(X 1 3))
>(X1N)X
(N *(X1(N - 1)))
```

Listing 6: MATCH, an elementary pattern matcher, used by INFIX to simplify algebraic expressions by recognizing such things as the multiplicative and additive identities.

```
(DEF MATCH(X Y)
 (COND((EQ X(QUOTE ?))T)
 ((AND(ATOM X)(EQ X Y))T)
 ((OR(ATOM X)(ATOM Y))NIL)
 (T(AND(MATCH(CAR X)(CAR Y))
 (MATCH(CDR X)(CDR Y))))))
```

Text continued from page 222:

necessary to translate the output from LISP notation to infix notation. This process is performed by the output parser, INFIX, shown in listing 5. This function generously uses another function, MATCH, shown in listing 6, which was described lucidly by William A Kornfeld in the BYTE LISP theme issue (see reference 3). MATCH receives two arguments and determines whether or not they follow the same pattern. If a question mark, ?, is encountered in the first argument, any atom of the second argument will match it. A few examples of this "wild-card" usage are in order:

```
(MATCH(QUOTE(A B C))
 (QUOTE(A B C))) = T
(MATCH(QUOTE(A B D))
 (QUOTE(A B C))) = NIL
(MATCH(QUOTE(A B ?))
 (QUOTE(A B C))) = T
```

Once patterns are recognized by INFIX, the straightforward parsing operation begins. INFIX is also configured to recognize the multiplicative and additive identities as well as many algebraic simplifications.

The nerve center of INFIX is a PROG function that calls itself recursively on the first and, if necessary, the second argument of the input expression. This, in effect, allows INFIX to get to the bottom of things. The use of the variables FIRST and SECOND prevents INFIX from having to recompute them at every encounter. INFIX uses the function TWONUM (given in listing 7), which determines if both arguments are

input	Output
(DIFF(QUOTE(ADD A A))(QUOTE A))	(ADD 1 1)
(DIFF(QUOTE(TIMES X X))(QUOTE X))	(ADD(TIMES X 1)(TIMES X 1))
(DIFF(QUOTE(LOG X))(QUOTE X))	(TIMES(DIV 1 X)1)
(DIFF(QUOTE(COS X))(QUOTE X))	(TIMES(SUB 0(SIN X))1)
(DIFF(QUOTE A)(QUOTE B))	0
(DIFF(QUOTE B)(QUOTE B))	1

Table 3: Exemplary input and output of DIFF, which differentiates its first argument with respect to the second.



# Here's how we spell relief:

## SpellStar™



**A**re you tired of squinting at your video screen to find spelling and typing mistakes in your word processing?

Then you need SpellStar—for prompt relief from the pain and discomfort of proofreading.

SpellStar is an optional addition to WordStar™, already the most powerful and versatile word processing software on the market. SpellStar catches your spelling errors and typing mistakes before they catch you. It will save you inconvenience, embarrassment, and countless hours of staring at your screen. In fact, if time equals money in your business, it won't take long for SpellStar to pay for itself in time saved.

### Fast, FAST relief

SpellStar whizzes through your text at thousands of words per minute, comparing what you've written with its 20,000-word dictionary-on-a-disk. It flags every word not in its dictionary, giving you three choices. Change the word. Leave it as is. Or leave it and add it to the dictionary, and it won't get flagged again. You can put it in the main dictionary, or

just as easy, create your own supplemental dictionaries on other disks for such things as specialized terms and client names.

### SpellStar vs. the competition

SpellStar is not the first proofreading software on the market. We just made sure it would be the best.

Other programs show you a list of apparently misspelled words on your screen, separate from the document. You must decide what to do about each word without seeing its context—and that can be confusing. But SpellStar actually operates within the WordStar program. So it lets you see each word *in context* before taking action. It's so much easier. And you're always only one keystroke from full word-processing capability.

Other programs give you a 20,000-word dictionary. But we compressed it into half the normal disk space. So there's much more space for your own entries.

Another advantage is SpellStar's many menus and prompts. They're designed to keep you out of the manual and at the keyboard as much as possible.

### More help on the way

Once we've handled your word processing, let MicroPro start solving all your computing problems—with our software solutions. MailMerge™, another WordStar option, makes it easy to combine files to produce personalized form letters. SuperSort™ takes on the biggest sorting, merging, and selecting jobs. And DataStar™ handles data entry, retrieval, and update with tremendous power and precision.

Okay, so how do you spell relief now?

**M-I-C-R-O-P-R-O.**

**MicroPro™**  
INTERNATIONAL CORPORATION

1299 Fourth Street, San Rafael, California 94901  
(415) 457-8990; Telex 340-388

Contact us for the name of your nearest dealer.

Runs on most Z80, 8080, 8085 microcomputers with CP/M (TM of Digital Research), 48K, and terminal with addressable cursor. • Also available for the Apple Computer, requires Microsoft SoftCard. Apple Computer is a registered trademark of Apple Computer, Inc. • MicroPro products sold only through authorized dealers. • © 1981 MicroPro International Corporation.

**Listing 9:** In listing 9a, the function definition of TAYLOR illustrates the use of PROG as an iterative programming mechanism. Listing 9b shows a sample run of the function TAYLOR. The > prompt precedes user input. The output consists of a list of the terms of the generated Taylor series. The resulting series is obtained by summing the terms. User input consists of the function to be expanded, the value about which the expansion is to occur, and the number of terms desired.

```
(9a)
(DEF TAYLOR( )
  (PROG( )
    (CHR 28)
    (CHR 31)
    (PRINT(QUOTE(TAYLOR "--" A TAYLOR SERIES GENERATOR)))
    (TERPRI)
    (TERPRI)
  LOOP(PRIN1(QUOTE >))
    (TS(PREF(READ))(READ)(READ)(READ))
    (GO LOOP)))
```

```
(9b)
>(TAYLOR)
(TAYLOR--A TAYLOR SERIES GENERATOR)
>(EXP X)X 0 5
1
X
((X12)/(2 1))
((X13)/(3 1))
((X14)/(4 1))
END
>(SIN X)X 0 6
0
X
0
((- 1 *(X13))/(3!))
0
((X15)/(5 1))
END
>(1 / X)X 1 3
1
(- 1 *(X - 1))
((2 *((X - 1)12))/(2 1))
END
```

**Listing 10:** The function definition of TS, the workhorse of the Taylor-series routine. The second argument of EVAL in the function definition illustrates how the programmer can specify the environment by building an appropriate A-list.

```
(DEF TS(E X A I)
  (PROG(N)
    (SETQ N 0)
  LOOP(PRINT(INFIX(LIST(QUOTE DIV)
    (LIST(QUOTE TIMES)
      (EVAL E(LIST(CONS(QUOTE X)A)))
      (LIST(QUOTE EXPT)
        (LIST(QUOTE SUB)
          X
          A)
        N))
      (LIST(QUOTE FAC)
        N))))))
  (SETQ N(ADD N 1))
  (COND((EQ N I)(RETURN(PRINT(QUOTE END))))))
  (SETQ E(PREF(INFIX(DIFF E X))))
  (GO LOOP)))
```

numbers. If so (EVAL E NIL) is executed, which allows INFIX to actually evaluate the expression. Note that the specified A-list is NIL, since no variable bindings (assignments) are required by EVAL.

### Tying the Knot

Now that the actors of the differentiation are cast, it is necessary to develop a plot by which they can perform. The function DERIV, shown in listing 8a, serves this purpose. It requires no arguments and begins its duty with housekeeping chores such as clearing the screen and printing a title. It then prints the INFIX of the DIFF of the PREF of READ, or, more simply stated, it prints the derivative of an expression input by the user in infix notation. Upon completion, the process is repeated ad infinitum. A sample run of DERIV is given in listing 8b.

### Taylor-Series Expansion

Any standard college calculus textbook (such as reference 5) will tell us that the Taylor series is:

$$f(x) = \sum_{n=0}^{\infty} \frac{f^{(n)}(a)(x-a)^n}{n!}$$

where  $a$  is the value about which the expansion is to be taken (noting that if  $a$  is 0 the Taylor series reduces to the Maclaurin series),  $x$  is the variable of the original function, and  $n$  is an integer such that  $0 \leq n < \infty$ .

It is a relatively simple undertaking to write a Taylor-series program utilizing PREF, DIFF, and INFIX, as indicated by listings 9a and 10. The Taylor function is entered when you type (TAYLOR). It then awaits your input, which consists of:

1. function to be expanded
2. variable about which to expand
3. value about which expansion is to occur
4. number of terms desired

An example of a typical Taylor run is presented in listing 9b.

### Final Remarks

The programs in this article demonstrate the ease with which

# Cameo Makes Your Micro Big Enough for Big Business



When you want a data base for your micro that will grow as fast as you do — look to Cameo. Whether your business is commercial, educational or institutional — for large inventories, massive mail lists, extensive accounts receivable and effective cash management — Cameo has the system to meet your needs.

Cameo's Cartridge Disk Subsystem provides reliable mass storage for most popular micros\*. The Cameo subsystem gives you up to 100 times the storage capacity of floppies, while retaining the same flexibility that floppy media provide. With Cameo's system you can remove, copy and back-up massive amounts of data quickly and easily. And, byte-for-byte, cartridge disk mass storage is more economical than floppy disks.

Even today's new technologies cannot give you the reliability, flexibility and back-up capability that Cameo provides.

Installation and start-up is simple. Cameo's subsystem is compatible with most operating systems, eliminating the need for additional complex programming. Make Cameo your micro mass storage connection. Call today for the location of the dealer nearest you.

\*Apple, TRS-80 Model I & II, Heath H89 and most S-100's

Cameo Electronics, Inc.  
1626 Clementine Street  
Anaheim, CA 92802  
(714) 535-1682



# PETRO-LEWIS DEFERRED INCOME PROGRAM

Limited Partnership  
1981-1

# \$250,000,000

A Limited Partnership  
Formed To Acquire  
And Develop A  
Specific Oil  
Property

\$5,000 Minimum  
Subscription

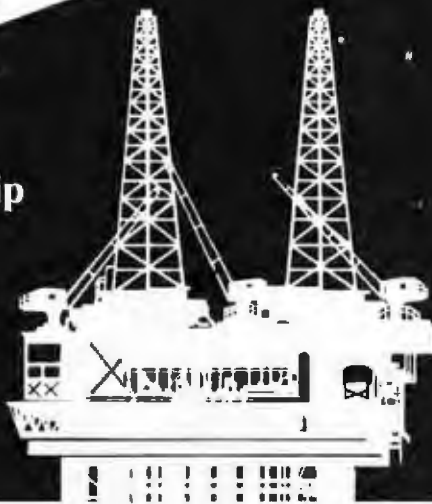

This announcement is not an offer to sell or a solicitation of an offer to buy any of these securities. The offering is made only by the Prospectus, copies of which may be obtained in any State only from dealers or brokers who may lawfully offer these securities in such State.

For a copy of the Prospectus,  
mail to:

P/MN

Kay Grover  
Petro-Lewis Funds, Inc.  
717 17th Street  
P.O. Box 2250  
Denver, CO 80201

I am  
 am not a current limited  
partner in the Petro-Lewis  
Oil Income Program.

Name \_\_\_\_\_

Address \_\_\_\_\_

City \_\_\_\_\_

State \_\_\_\_\_

Zip \_\_\_\_\_

PETRO  LEWIS FUNDS, INC.

symbolic mathematics can be expressed in LISP. When viewed within the LISP environment, recursive concepts become clear and concise. By substituting different functional modules for the DIFF function in the aforementioned treatment, you can easily develop powerful special-purpose systems. For instance, DIFF could be replaced by a function which does one or more of the following: vector calculus, Laplace transforms, integration, matrix algebra, complex arithmetic, Boolean algebra, or trigonometric simplification.

There are other areas where LISP is the language of choice. These areas include pattern matching, theorem proving, and intelligent robotic software. It is my hope that this article has shown that LISP is ideally suited for symbolic mathematics and that LISP should be added to the repertoire of all serious programmers. ■

The LISP interpreter is sold by Supersoft Associates, POB 1628, Champaign IL 61820. Versions are available for 16 K-byte Radio Shack TRS-80 Model I and Model III computers (floppy disk, \$100; cassette tape, \$75). A version to run under the CP/M operating system will be released shortly. The symbolic-differentiation program discussed in this article is distributed with the disk versions of the interpreter.

## References

1. Berkeley, Edmund C and Daniel G Bobrow, editors. *The Programming Language LISP: Its Operation and Applications*. Cambridge MA: MIT Press, 1974.
2. Knuth, Donald E. *The Art of Computer Programming, Volume 1, Basic Algorithms*. Reading MA: Addison-Wesley, 1973.
3. Kornfeld, William A. "Pattern-Directed Invocation Languages." *BYTE*, August 1979, page 34. (Also see other articles in that issue.)
4. McCarthy, J et al. *LISP 1.5 Programmer's Manual*. Cambridge MA: MIT Press, 1979.
5. Protter, Murray H and Charles B Morrey, Jr. *College Calculus with Analytic Geometry*, second edition. Reading MA: Addison-Wesley, 1970.
6. Siklossy, Laurent. *Let's Talk LISP*. Englewood Cliffs NJ: Prentice-Hall, 1976.
7. Winston, Patrick Henry. *Artificial Intelligence*. Reading MA: Addison-Wesley, 1977.
8. Wylie, C R, Jr. *Advanced Engineering Mathematics*, third edition. New York: McGraw-Hill, 1966.

# THE LAST MEMORY

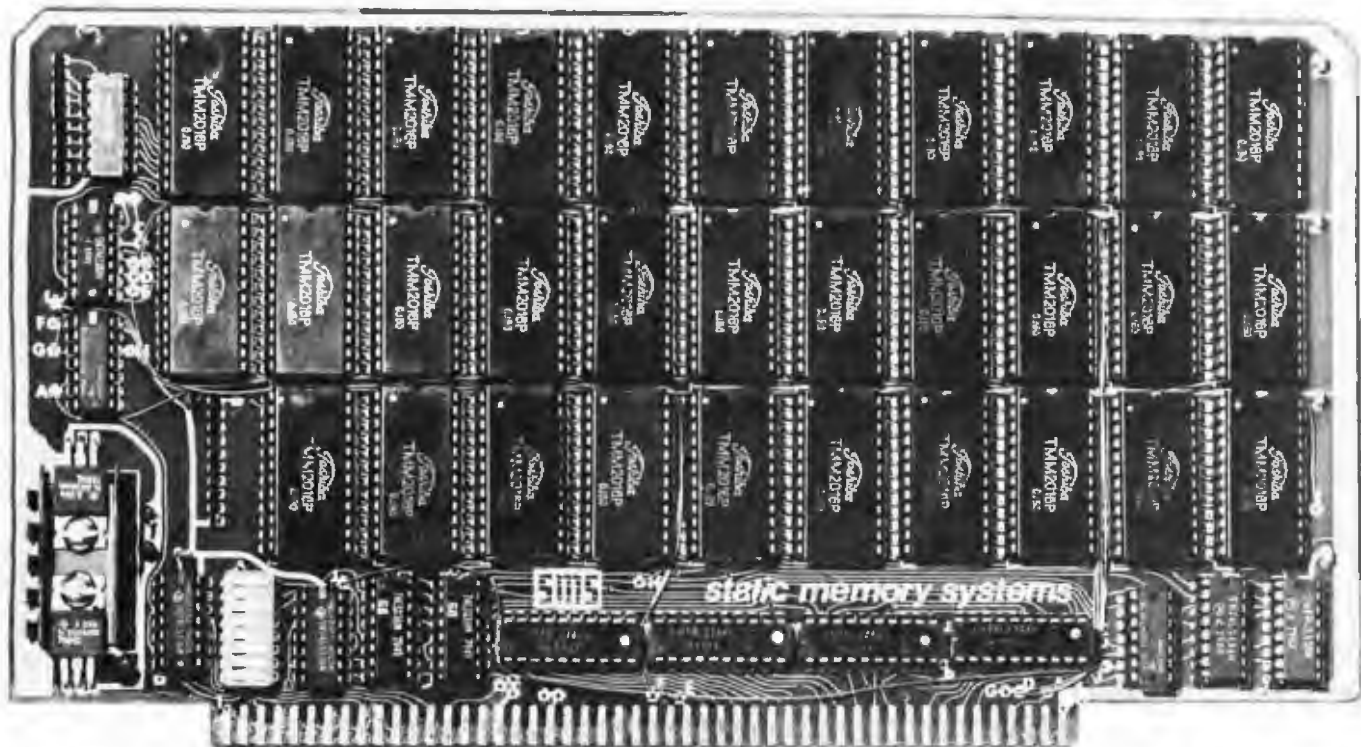

## 64K STATIC RAM/EPROM BOARD

At last a 64K *STATIC* memory board for S100 systems. But it's not just a 64K static RAM board, EPROM's can also be intermixed with RAM making it the only memory board needed for S100 systems. That's why we call it **THE LAST MEMORY**.

- **64K DENSITY**

**THE LAST MEMORY** uses the new 2016 byte-wide 16K static RAM to achieve a board density twice that possible with old 2114 static memories.

- **2716 EPROM COMPATIBLE**

A separate board is no longer required for EPROM's containing monitors, bootstrap loaders, etc. 2716 EPROM's can be inserted into the board without modification.

- **SIMPLE ADDRESS DECODING**

Where memory is required, just plug a RAM or EPROM in the corresponding socket. Empty memory sockets occupy no memory space, providing compatibility with memory mapped I/O devices.

- **EXTENDED ADDRESSING**

**THE LAST MEMORY** includes the IEEE S100 extended addresses. These are fully decoded allowing expansion to a full 16 megabyte system memory.

- **FAST**

The standard board allows 4 MHz operation.

- **LOW POWER**

Only one memory IC is ever active in byte-wide memory systems. The result is far less power consumption than older 16K static memory boards.

- **LOW COST**

Its best feature is the price:

	Kit	A&T
RAM-less Board	99.99	139.99
16K RAM	249.99	289.99
32K RAM	389.99	429.99
48K RAM	519.99	559.99
64K RAM	639.99	679.99



**static memory systems**

15 So. Van Buren Ave.

Suite 209

Freeport, Illinois 61032

(815) 235-8713



# WE'LL "DRIVE" YOU WILD with our variety of quality disk drives.

So many choices! So many models to choose from! Whatever your application, whatever your compatibility requirements . . . ASAP has the disk drive you want. ASAP truly has a "wild" assortment of the most popular makes and models . . . from the most reliable manufacturers.

You'll be "wild" with confidence when you order from ASAP because you'll get what you're expecting! Reliable performance, years of trouble-free service, the fastest possible delivery, and a "wild" 120 day ASAP money-back guarantee.

Call ASAP with your choice today.

**Microbyte D<sup>2</sup> Floppy Disk System** —The Microbyte D<sup>2</sup> is IEEE S-100 compatible, and provides up to 3.2 Mbytes of storage. Access time is 3ms track-to-track. The Microbyte controller will run single/double density and single or double-sided. 120 day warranty on both parts and labor.

Microbyte D<sup>2</sup> assembled  
and tested with cables . . . . . \$2,195.00  
Cabinet and drives  
without controller . . . . . \$1,895.00

**Qume® Floppy Disk Drives** — State-of-the-art technology used in the manufacture of Qume drives gives you longer disk life, improved data reliability and better serviceability. Independent head load produces savings on both diskette usage and drive maintenance.

**DATA TRAK™ 5**  
(ANSI compatibility) . . . . . call for price  
**DATA TRAK™ 8**  
(IBM compatibility) . . . . . call for price

**Shugart Floppy Disk Drives** — Shugart drives are known for high quality and

reliability. Shugart's Bi-Compliant™ head assembly provides superior media compliance and high reliability.

Model 801 (standard floppy) . . . \$390.00  
Model 850 (double-sided drive) \$640.00  
Case & Power Supply . . . . . \$265.00

**Lobo Drives International Disk Drive Systems**  
Lobo manufactures a complete line of drives and subsystems for Apple, TRS-80 and S-100 based systems. All are thoroughly tested, providing the high reliability you've come to expect from Lobo.

Model 3101 is completely software compatible to Apple 3.1, 3.2 and 3.2.1 Disk Operating Systems (DOS), as well as PASCAL Language Systems. All applications software designed for Apple will operate on Lobo subsystems.

Model 4101C is designed to provide TRS-80 users with low-cost, high-speed, efficient mass storage capability. Every Lobo Memory System is thoroughly tested and burned-in to assure reliability. One year, 100% parts/labor warranty.

Models 950 and 1850 are software compatible with most S-100 disk operating systems and applications software programs. And Lobo offers you a choice of floppy and fixed disk drives. Choose from 5¼- and 8-inch Winchesters, and floppy/Winchester combinations.

Call ASAP for additional information, price and delivery.

**asap**  
computer  
products, inc.

## DISKETTES from ASAP

### VERBATIM

5¼" DISKETTES		
PART #	SECTORING	PRICE
MD525-01	SOFT SECTOR	10/\$27.50
MD525-10	HARD 10 SECTOR	10/\$29.50
MD525-16	HARD 16 SECTOR	10/\$29.50

8" DISKETTES		
PART #	SECTORING	PRICE
FD 32-1000	HARD SECTOR	10/\$35.00
FD 34-1000	SOFT SECTOR	10/\$35.00

### MEMOREX

5¼" DISKETTES			
PART #	SIDES/DENSITY	SECTORING	PRICE
MEM 3401	1/SINGLE	SOFT SECTOR	10/\$25.00
MEM 3403	1/SINGLE	HARD 10 SECTOR	10/\$25.00
MEM 3405	1/SINGLE	HARD 16 SECTOR	10/\$25.00

8" DISKETTES			
PART #	SIDES/DENSITY	SECTORING	PRICE
MEM 3060	1/SINGLE	SOFT SECTOR	10/\$35.00
MEM 3101	2/SINGLE	SOFT SECTOR	10/\$45.00
MEM 3090	1/DOUBLE	SOFT SECTOR	10/\$45.00
MEM 3102	2/DOUBLE	SOFT SECTOR	10/\$55.00

### DYSAN

5¼" DISKETTES			
PART #	SIDES/DENSITY	SECTORING	PRICE
D-0130	1/SINGLE	SOFT SECTOR	10/\$50.00
D-0226	1/DOUBLE	SOFT SECTOR	10/\$53.00
D-0235	2/DOUBLE	SOFT SECTOR	10/\$65.00

8" DISKETTES			
PART #	SIDES/DENSITY	SECTORING	PRICE
D-0506	1/SINGLE	SOFT SECTOR	10/\$55.00
D-0605	2/DOUBLE	SOFT SECTOR	10/\$65.00

### SCOTCH 3M

5¼" DISKETTES			
PART #	SIDES/DENSITY	SECTORING	PRICE
744-0	1/SINGLE	SOFT SECTOR	10/\$33.00
744-10	1/SINGLE	HARD 10 SECTOR	10/\$33.00
744-16	1/SINGLE	HARD 16 SECTOR	10/\$33.00
745-0	2/DOUBLE	SOFT SECTOR	10/\$59.00
745-10	2/DOUBLE	HARD 10 SECTOR	10/\$59.00
745-16	2/DOUBLE	HARD 16 SECTOR	10/\$59.00

### MAXELL

5¼" DISKETTES			
PART #	SIDES/DENSITY	SECTORING	PRICE
MD1	1/SINGLE	SOFT SECTOR	10/\$39.00
MD20	2/DOUBLE	SOFT SECTOR	10/\$65.00
MH1	1/SINGLE	HARD 16 SECTOR	10/\$39.00
MH20	2/DOUBLE	HARD 16 SECTOR	10/\$65.00

8" DISKETTES			
PART #	SIDES/DENSITY	SECTORING	PRICE
FD1-128	1/SINGLE	SOFT SECTOR	10/\$45.00
FH1-32	1/SINGLE	SOFT 32 SECTOR	10/\$45.00
FD2-XD	2/DOUBLE	SOFT SECTOR	10/\$65.00

### SRW

MEDIA STORAGE CABS		
PART #	SIZE	PRICE
SRW-5	5¼"	\$2.50 ea
SRW-8	8"	\$3.25 ea

## ATARI 800

### (16K) Personal Business Computer Features:

- Computer console
  - Atari 8K basic
  - 57 full stroke alphanumeric keyboard with four function keys
  - Operator's manual
  - RF modulator
  - Power supply
- Price: \$799.00

Special Offer: Additional 16K RAM FREE with purchase of system.

## Atari Optional Accessories

Model #	Description	Price
810	Disk Drive System	\$ 475.00
815	Disk Drive System	\$1199.00
820	40 Column Dot Matrix Printer	\$ 279.00
822	40 Column Thermal Printer	\$ 349.00
825	80 Column Dot Matrix Printer	\$ 625.00
830	Acoustic Modem	\$ 159.00
850	Interface Module	\$ 139.00
410	Cassette Recorder	\$ 60.00
CX30-04	Paddle Controls	\$ 17.95
CX40-04	Joysticks (pair)	\$ 17.95

### INTRODUCING ASAP's

Atari 800 16K RAM Module \$75.00  
1 year warranty parts & labor

## Atari Software (Many more available)

Super Breakout	\$30.00
Chess	\$30.00
Video Easel	\$30.00
3-D Tic Tac Toe	\$30.00
Star Raiders	\$34.00
Music Composer	\$42.00
Educational System ROM	\$19.95
Assembler/Editor	\$45.00
Teletink I	\$19.95
Space Invaders	\$15.95
Kingdom	\$12.95
Biorhythm	\$12.95
Graph II	\$15.35
Energy Czar	\$12.95
Mailing List	\$16.95
Statistics I	\$16.95
Touch Typing	\$19.95
Stock Charting	\$19.95
Stock Analysis	\$19.95
Bond Analysis	\$19.95

## Components

### 4116's (200 nS)

Apple, TRS-80, Heath	8 for \$18.00
16-49	\$2.25 each
50-99	\$2.15 each
100 up	\$2.05 each

### 2114 L-2/200 nS

Low-Power 1K x 4 Static RAM	
1-16	\$3.05 each
17-40	\$2.95 each
50-89	\$ 2.85 each
100 up	\$2.70 each
74LS240	\$1.25 each
74LS241	\$1.10 each
74LS244	\$1.25 each
74LS373	\$1.25 each
74LS374	\$1.25 each
87245	\$1.50 each

### 2708/450 nS

1K x 8 EPROM	\$4.25 each
	or \$32.00

### 2716/5 Volt

2K x 8 EPROM	\$8.95 each
	1 year warranty

8080A-CPU	\$ 2.50
Z80A-CPU	\$ 8.95
Z80A-CTC	\$ 8.95
Z80A-DART	\$13.95
Z80A-SIO	\$22.00
8255ACS	\$ 6.95
8257ACS	\$15.00

32075	\$ .80
34075	\$ .70
320T12	\$ .80
340T12	\$ .75

	1-9	10-24	25 up
DB25P	\$2.80	\$2.65	\$2.50
DB25S	\$3.80	\$3.70	\$3.40
DB25C	\$1.05	\$ .95	\$ .85

### 100 Pin IMSA!

Gold/RS-100 Soldertail Connectors  
\$2.40 each or 10/\$2.25 each

### Capacitors

1 @12 Volt  
Ceramic ..... Bc each or 100/\$7.00

### DIP Sockets — Low Profile Tin Soldertail

Description	1-9	10-49	50-99	100 up
14 pin tin st	\$ .15	\$ .13	\$ .12	\$ .11
16 pin tin st	\$ .16	\$ .14	\$ .13	\$ .12
18 pin tin st	\$ .19	\$ .18	\$ .16	\$ .14
20 pin tin st	\$ .25	\$ .23	\$ .21	\$ .20
24 pin tin st	\$ .26	\$ .24	\$ .22	\$ .20
28 pin tin st	\$ .32	\$ .30	\$ .29	\$ .27
40 pin tin st	\$ .42	\$ .40	\$ .38	\$ .34

## Printers

Manufacturer/Model #	Price
Anacom-150	\$ 895.00
Anadex-8501	\$1249.00
Base 2-8008	\$ 650.00
Diablo-630RD	\$2225.00
C.Itoh Starwriter 45	\$1925.00
Texas Instruments-810	\$1650.00

## Modems

Manufacturer	Model #	Price
Novation	CAT	\$ 149.00
Novation	D-CAT	\$ 160.00
Lexican	Lex-11	\$ 139.00
Livermore	LIV-Star 20M	\$ 149.00
UDS	UDS 103	\$ 189.00
UDS	UDS 202	\$ 295.00

## Monitors

Manufacturer	Model #	Price
Amdel	100/12" B&W	\$ 139.00
Amdel	100-80	\$ 169.00
Amdel	100G/12" Grn	\$ 169.00
APF	TVM-10/10" B&W	\$ 149.00
Hitachi	VM 910/9" B&W	\$ 210.00
Hitachi	VM 128/12" B&W	\$ 340.00
Sanyo	DM5012/12" B&W	\$ 260.00
Sanyo	DM512ex/12" Grn.	\$ 280.00
Sanyo	DMC6013/13" Color	\$ 450.00

## Terminals

Manufacturer	Model #	Price
Ampex	Dialogue 80	\$ 899.00
Soroc	ID120	\$ 750.00
Soroc	IQ140	\$1250.00
Televideo	TVI 912C	\$ 725.00
Televideo	TVI 920C	\$ 775.00
Televideo	TVI 950C	\$ 975.00

ASAP offers a 120-day buyer protection policy: full money-back guarantee if not totally satisfied.

Ordering information: name, address, phone, ship by: UPS or Mail. Shipping charge: add \$2.50 up to 1 lb. for UPS Blue; add \$1.50 for U.S. Mail (U.S. only) (\$25.00 minimum order). Call for larger shipments.

Terms: We accept cash, check, money orders, Visa & Master Charge (U.S. Funds only). Tax: 6% Calif. Res., COD's and terms available on approval (School P.O.'s Accepted).

**asap**  
computer  
products, inc.

1198 E. Willow St., Signal Hill, CA 90806

Toll free outside California:

(800) 421-7701

Inside California:

(213) 595-6431

(714) 891-2663

## MICROBYTE Z-80A/ I-O CPU BOARD

- A complete single board Z80A CPU with serial/parallel interface
- Fully compatible with the proposed IEEE S-100 Bus Standard
- Z80A CPU (4MHz version of the Z80)
- 158 instructions — supersat of and upward compatible from the 8080's 78 instructions
- Up to 4K of on board Eprom with optional Z80 monitor program — 1K(2708) 2K(2716) or 4K(2732)
- Full vectored interrupt capability — 8 bit with MM7 (1 bit)
- 2MHz or 4MHz operation is jumper selectable
- Selectable auto-wait state insertion for extending M1\*, MREQ\*, IOR\* and/or on board ROM
- Dual RS-232 serial I/O ports using the Z80A-DART with individual baud rate selection (from 50 — 19,200 baud)
- Up to 24 bit parallel I/O port — fully programmable Intel 8255A

**\$349.00** Assembled & Tested  
Optional Monitor Program \$50.00

## MICROBYTE FLOPPY DISK CONTROLLER

- DMA within 16 Mbyte of memory
- State-of-the-art NEC765 LSI Controller
- IEEE S-100 compatible
- DMA arbitration allows use of multiple boards within a system
- PLL data recovery for totally reliable operation
- Write pre-comp switched at mid-disk for reliable double density operation
- Supports up to four (4) drives
- Power On, Power Off or Reset deselects drives to avoid damaging files
- Drive deselect Time Out, deselects drives not in use
- Single or double sided operation
- Single density/double density operation
- 8" standard drives
- Selectable Vcc supply for data recovery to eliminate possible noise problems

**\$389.00** Assembled & Tested

## MICROBYTE 4-PORT I/O BOARD

- Quad RS-232C serial ports. One 20mA current loop port
- Fully IEEE S-100 Bus compatible
- Asynchronous Communications with Z80A-DART(TM) or synchronous communications with Z80A-SIO/9(TM)
- Full set of modem control signals, including RI (Ring Indicator)
- Easily configurable to any type of terminal interface
- I/O servicing environments:
  - (1) Pollled
  - (2) Bus vector
  - (3) Z80 mode 2 vector
- Off-board interrupt daisy chain capability
- Special receive conditions:
  - (1) Framing error
  - (2) Parity error
  - (3) Receiver overrun error
- Baud rates selected individually from 50 baud to 300K baud
- 72 hour burn-in

**\$289.00** Assembled & Tested  
Cables Available (Optional)

## MICROBYTE 64K DYNAMIC RAM BOARD

- Fully S-100 bus compatible
- 64K x 8 bit dynamic RAM
- Low power:
  - 6VDC @ 700 mA
  - +16VDC @ 100 mA
  - 16VDC @ 25 mA
- Built-in capacity with LED indicator and vector interrupt
- Memory addressable in four 16K banks
- Hidden refresh
- Gold contacts for high reliability
- 72-hour burn-in
- Memory mapped via DIP switch
- Built-in programmable write-protect
- Programmable control port for parity and bank control
- ALPHA-MICRO compatible

## Call for Price

Assembled & Tested

### Catalog Request

Please send me your 1981 ASAP Full Line Catalog

Name \_\_\_\_\_  
Company \_\_\_\_\_ Title \_\_\_\_\_  
Address \_\_\_\_\_  
City \_\_\_\_\_  
State \_\_\_\_\_ Zip \_\_\_\_\_

# Knowledge-Based Expert Systems Come of Age

---

Richard O Duda  
Fairchild Camera and Instrument Corp  
4001 Miranda Ave  
Palo Alto CA 94304

John G Gaschnig  
SRI International  
333 Ravenswood Ave  
Menlo Park CA 94025

---

*Question:* What do the following tasks have in common? Diagnosing bacterial infections; choosing a good spot on a mountain to drill for molybdenum; configuring the many components that make up a DEC VAX-11 computer; determining the structure of a complex molecule from mass spectrogram data.

*Answer:* They are important and difficult decision-making jobs that only a few experts do well. The reasoning process in each job includes use of judgment, rules of thumb, and experience. Furthermore, these jobs can all be done today by computer programs known as *knowledge-based expert systems*.

What makes knowledge-based expert systems different from other large computer programs written to solve special decision-making problems? We will answer that question in this article and explain how expert systems work. We will briefly describe several existing expert systems, and show the operation of one—a mineral-exploration program we helped develop. As a bonus, we will provide a micro expert-system in

BASIC for your personal computer.

Since work on expert systems grew out of research on AI (artificial intelligence), a few historical observations will provide some perspective. As is clear from this special issue of

---

**IF-THEN rules are used to capture the kind of "semilogical" response to familiar patterns that characterizes much of everyday human thinking.**

---

BYTE, AI is concerned with making computers perceive, reason, and understand. Early work in AI looked for simple and powerful reasoning techniques that could be applied to many different problems. A classic example is the work of Newell, Shaw, and Simon on a program called GPS (see reference 21). Intended to be a general problem solver, GPS could prove theorems and solve puzzles and

a wide variety of logical problems. Thus, the generality of its particular reasoning technique—called means-ends analysis—was convincingly demonstrated.

Unfortunately, attempts to apply such general methods to larger and messier real-world problems were mostly unsuccessful. The methods were not wrong, they were just insufficient. They did not address the difficulties of reshaping a problem into a form the programs could work on. Nor could these general methods, by themselves, cope with the enormous search spaces of alternatives.

How do *people* cope with these same problems? One answer is that people know much more than computers. People rarely solve problems by reasoning everything out from the first principles. While recreational puzzles can often be solved by strict logical deduction, many real-world problems seem to be solved by "semilogical" methods, such as recognizing one of a thousand familiar patterns applying to the current situation and recalling the appropriate thing to do when that pat-



# Pure Computing Power



The MicroFrame® is **Pure Power** for computing. It is the industry standard for high quality, reliable S-100 mainframes.

TEI manufactures each MicroFrame® with great care. They deliver pure regulated power at the proper level, improving the reliability of your computer. Typically, the output voltages remain virtually constant, even when the power line voltage varies widely. The MicroFrame® will never notice a brown-out . . . and it provides 100 db noise rejection, protecting your computer from power line voltage spikes and noise. Complies with I-EEE S-100.

The combination of the lowest noise bus, a regulated power system and a rugged chassis produces a MicroFrame® without equal.

Distributor and OEM Inquiries Invited

For more information, call Rick Barnes at (713) 738-2300



5075 S. LOOP EAST, HOUSTON, TX. 77033  
(713)738-2300 TWX. 910-881-3639

tern occurs. In everyday affairs, logical deduction is an adjunct to other mental processes.

Recognizing that knowledge is as important as reasoning, AI researchers have worked on a variety of methods for representing and using knowledge. They have also grappled with fuzzier kinds of problems, where logic is supplemented by hunches based on experience and judgment. One result has been the development of several knowledge-based expert systems—programs that exploit special knowledge to solve difficult problems in specialized areas. These programs include the DENDRAL program for mass-spectrum analysis (see reference 14), the MYCIN program (reference 27) and several others

(references 18 and 25) for medical diagnosis, the PROSPECTOR program for mineral exploration (reference 11), and the R1 program for configuring VAX computer systems (reference 20).

### Representing Knowledge in Rules

How do you represent the knowledge needed to do these kinds of tasks? That is still a matter of debate and active research in AI circles. One popular approach is to use IF-THEN rules (also called situation-action rules or production rules). These rules say that if a certain kind of situation arises, a certain kind of action can be taken. They are typically used to capture the kind of "semilogical" response to familiar

Engineers and other  
Aerospace Professionals

# Bring your great ideas to Martin Marietta

## ORLANDO, FLORIDA

Orlando is situated in the center of Florida's year-round outdoor living and cultural activities. Orlando also boasts an exceptional education system and no state income

- Guidance/Control Systems Analysis
- System Requirements Analysis/Definition Integration
- Radar System Design
- ATE Electronic or Software Design
- Structural Dynamics Analysis
- Facilities Design: EE, ME, HVAC
- Tool Design
- Industrial Engineering
- NC Programming

## DENVER, COLORADO

Located on the foothills of the Rocky Mountains, Denver offers year-round recreational and cultural opportunities including theater, symphony and museums.

- Electronics Engineers
- Systems & Test Engineers
- Manufacturing Engineers
- Mechanical Engineers
- Quality Engineers
- Software Engineers
- Materiel
- Finance

### 1a

The R1 system (configuring VAX systems):

- IF: (1) The current context is assigning devices to Unibus modules, and  
(2) There is an unassigned dual-port disk drive, and  
(3) The type of controller it requires is known, and  
(4) There are two such controllers, neither of which has any devices assigned to it, and  
(5) The number of devices that these controllers can support is known

- THEN: (1) Assign the disk drive to each of the controllers, and  
(2) Note that the two controllers have been associated and that each supports one device.

### 1b

The MYCIN system (medical diagnosis):

- IF: (1) The site of the culture is blood, and  
(2) The identity of the organism is not known with certainty, and  
(3) The stain of the organism is gramneg, and  
(4) The morphology of the organism is rod, and  
(5) The patient has been seriously burned

- THEN: There is weakly suggestive evidence (0.4) that the identity of the organism is pseudomonas.

### 1c

The PROSPECTOR system (mineral exploration):

- IF: There is hornblende pervasively altered to biotite

- THEN: There is strong evidence (320, 0.001) for potassic zone alteration.

**Table 1:** Sample IF-THEN rules from three knowledge-based expert systems. Table 1a shows a rule that the R1 system uses to configure DEC's VAX systems. Table 1b shows a rule that the MYCIN system uses to perform medical diagnosis. The number 0.4 indicates the degree to which the conclusion follows from the evidence on a scale of 0 to 1. Table 1c shows a rule used by PROSPECTOR in mineral exploration. The number 320 indicates how sufficient the evidence is for establishing the hypothesis if the evidence is, in fact, present; the number 0.001 indicates the degree to which the absence of this evidence will rule out the hypothesis. Both these numbers are multipliers. Values greater than 1 increase the likelihood of the sufficiency or necessity of the evidence for establishing the hypothesis, and values less than 1 decrease the likelihood.

Engineers and other Aerospace Professionals

# Your great ideas today could become a great advance tomorrow at Martin Marietta

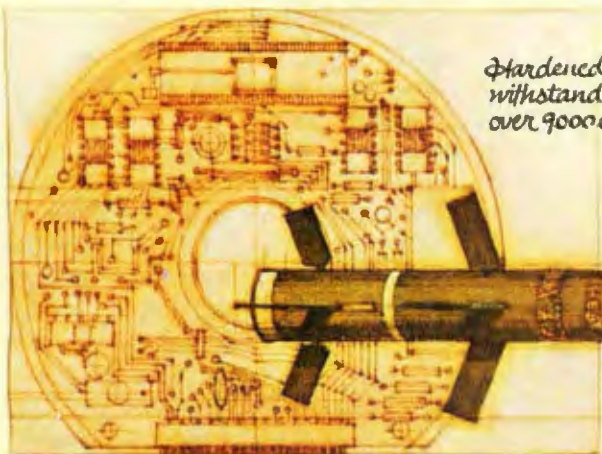

*Hardened electronics  
withstand firing forces  
over 9000 G.*

Copperhead Guided Projectile

Great advances are built on solid experiences. At Martin Marietta Aerospace, we're playing a bigger role than ever in the extraordinary evolution in defense and space technology. We know that tomorrow's great ideas are going to come from those people working in a challenging and sophisticated environment with today's great technologies. In Orlando we're working on a broad range of projects including the Millimeter-wave Contrast Seeker used in the Copperhead Guided Projectile. Our success has led to many on-going projects including Pershing II, a tactical interdiction system, and TADS/PNVs, a helicopter fire control system.

When you join Martin Marietta, you'll find the excellent salary and complete benefits coverage you'd expect from an industry leader. Learn about career opportunities in Orlando, or our other locations by sending your resume or a letter to the facility of your choice.

**In Orlando:** P.O. Box 5837-MP#9, Orlando, FL 32855; **In Denver:** P.O. Box 179, Mail #D-1311, Denver, CO 80201; **At Vandenberg AFB:** Box 1681, Vandenberg AFB, CA 93437; **In New Orleans:** Michoud Assembly Facility, Box 29304, New Orleans, LA 70189.

We are an equal opportunity employer, m/f/h.

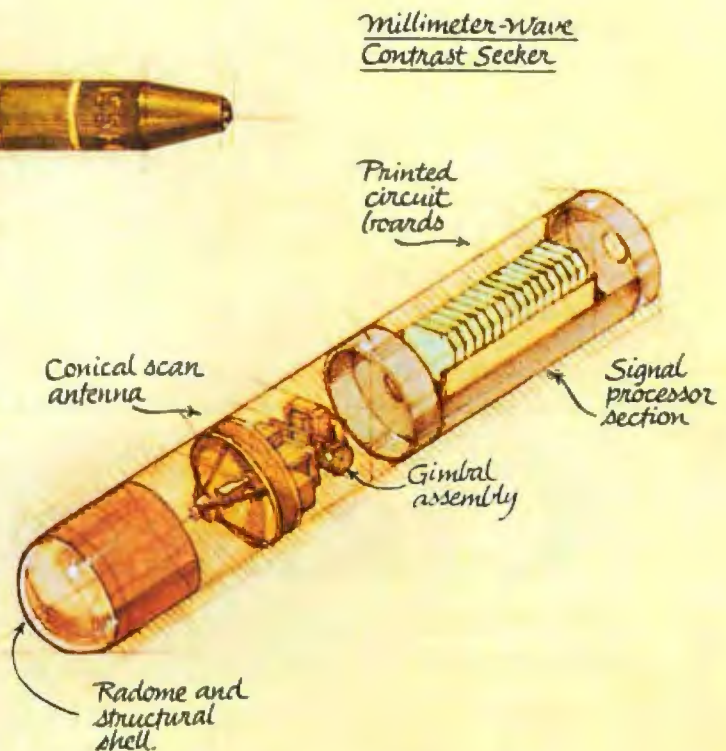

**MARTIN MARIETTA**

patterns that characterizes much of everyday human thinking. Table 1 lists examples of rules from several rule-based systems.

In general, rules like these represent a "chunk" of knowledge about a particular field. Most existing rule-based systems contain hundreds of rules,

usually obtained by interviewing experts for weeks or months. For example, the MYCIN system contains about 450 rules; the R1 system has about 800, and the PROSPECTOR system has about 1600. In any system, the rules become connected to each other to form rule networks.

Once assembled, such networks can represent a substantial body of knowledge. Figure 1 illustrates how rules are combined together into networks.

An expert usually has many judgmental or empirical rules according to which the evidence supports a conclusion or hypothesis, but with less than absolute certainty. In these cases, numerical values are associated with each rule to indicate the degree to which the hypothesis or conclusion follows from the evidence. Table 1 shows two examples of such rule-strength values: in the case of MYCIN (table 1b), the value 0.4 (on a 0 to 1 scale) means that the conclusion is weakly suggested from the evidence. In the case of PROSPECTOR (see table 1c), two numbers are given—one indicates how sufficient the evidence is for establishing the hypothesis if the evidence is present, the other indicates the necessity of the evidence for the hypothesis, ie: the degree to which the absence of that evidence will rule out or "kill" the hypothesis. (There is more about the meaning of these numbers in the later section on PROSPECTOR.)

The rules are not implemented as subroutines or in any other part of the code of the program. Instead, the rules for a particular task are written in a specialized language, which is then input by the program to produce an internal representation that makes the expert system an expert about that task domain. The program itself is only an interpreter and a general-reasoning mechanism. This illustrates an important distinction between rule-based systems and more conventional computer programs: there is a clear separation of general knowledge about the problem (the rules forming a knowledge base) from information about the current problem (the input data) and methods for applying the general knowledge to the problem (the rule interpreter). Figure 2 illustrates this contrast. (Lines 3880 through 4040 of listing 1 give a set of rules input to that program.)

**Putting Knowledge to Work**  
After the knowledge has been en-

SINGLE RULE

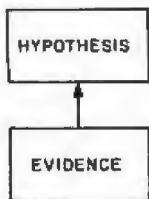

NETWORK OF RULES

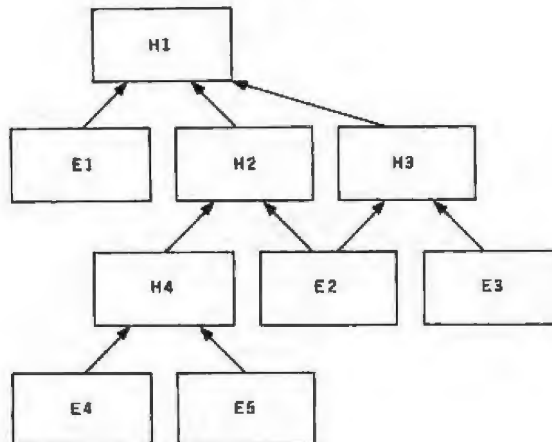

Figure 1: Combining rules into networks. Expert systems may consist of hundreds of IF-THEN rules combined into networks like these.

# Choice

**GNT Makes a Tape Punch Station and a Tape Reader/Punch Combination.**

**Both are small, quiet, and economical. One of them will fit your needs exactly.**



## The 4601 Combo

- Punching speed: 75 Cps  
Reading speed: up to 150 Cps
- RS-232-C serial interface
- Utilizes all types of Mylar® and paper tape
- Reliability: MTBF 100 million characters

## The 3601 Punch

- Punching speed: 50 or 75 Cps
- RS-232-C serial interface
- Utilizes all types of Mylar® and paper tape
- Reliability: MTBF 100 million characters

Contact your local dealer or call for complete specifications.

See us at NCC — Booth 3004

# GNT AUTOMATIC INC.

1560 Trapelo Road, Waltham, MA 02154 (617) 890-3305 Telex: 923318

# THE BIGGEST NAME IN S-100 MEMORY PRESENTS THE BIGGEST S-100 MEMORY: 128K RAM 21

**RAM 21 isn't just big, it's versatile.** For 8 bit systems, it's a 128K X 8 board; for 16 bit systems, a 64K X 16 board. Addressing conforms to IEEE 696/S-100 24 bit extended address protocol.

**RAM 21 is faster than today's needs to protect your memory investment tomorrow.** High speed memory devices allow no-wait-states operation with today's 5/6 MHz CPUs, as well as with the coming generation of 10 MHz CPUs.

**RAM 21 is fully static.** Forget about the reliability and DMA problems associated with dynamic memory.

**RAM 21 has the lowest current consumption in the industry, bar none.** RAM 21 draws half the power (1.6A typical) of an equivalent amount of dynamic memory. The result? Less heat build-up, less strain on the power supply, lower energy costs, and greater reliability.

**RAM 21 is built to work and keep on working.** All RAM 21 boards are qualified under the Certified System Component high reliability program, with 200 hours of burn-in and extensive quality control testing. \*

**RAM 21 is not only fast, low power, dense, and versatile: it's affordable.** At \$2495, RAM 21 represents exceptional quality whose value will not diminish when expanding to faster 8 bit systems or more powerful 16 bit systems.

**The biggest name in memory has dropped the big one:  
RAM 21 is here.**

**CompuPro**<sup>TM</sup>

OAKLAND AIRPORT, CA 94614

division

**GODBOUT**  
ELECTRONICS

(415) 562-0636

How to Order: Call 415-562-0636 for the name of the authorized CompuPro sales center nearest you, or for placing factory direct VISA® /Mastercard® orders.

Prices shown do not include tax or shipping charges.

\* 2 year limited warranty.

# *This ad presents a Strong Case.*

Rugged, all metal construction minimizes interference both to and from other electrical devices while providing unequalled mechanical strength

Punchouts on rear for four coax connectors, sixteen DB-25 connectors, two DB-15 connectors, and two DB-50 connectors for connecting cables to other peripherals

Attractive, easily removeable, textured beige finish cover.

Low noise fan creates positive air pressurization to prevent build-up of heat or dust

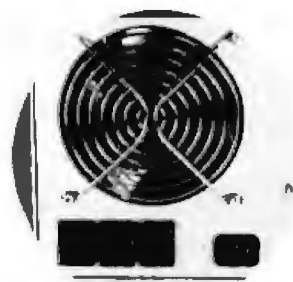

Three switched convenience outlets on rear panel supply AC power to peripherals

Constant voltage power supply delivers +8V at 25 Amps, +16V at 3 Amps, and -16V at 3 Amps - enough power to handle present needs and future expansion

Constant-voltage transformer maintains consistent operation with varying line voltages, and allows for cooler system operation

Line filter traps power line spikes

Sturdy card guides accurately position boards for mechanical stability

20 slot motherboard, with Faraday shielding and split active termination, promotes reliable data transfer with ultra high speed (10 MHz) system clocks

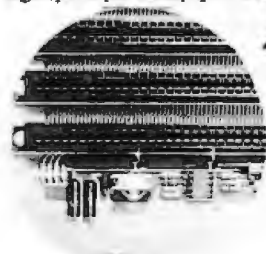

Available in desk top version, or with rack mount slides and 19" panel dimension for industry standard rack mounting



Reset switch lights to indicate power-on condition

**Quality components deserve a quality enclosure; whether for scientific, industrial, or commercial applications, Computer Enclosure 2 provides the high quality foundation required by today's sophisticated computing systems. Computer Enclosure 2 is available at finer computer stores for \$825 (desktop version) or \$895 (rack mount version).**

How to Order: Call 415-562-0636 for the name of the authorized CompuPro sales center nearest you, or for placing factory direct VISA® /Mastercard® orders. Prices shown do not include tax or shipping charges.

**CompuPro**<sup>TM</sup>  
OAKLAND AIRPORT, CA 94614

division

**GODBOUT**  
ELECTRONICS

(415) 562-0636

# PROVEN Computing SOLUTIONS

We give you more of what you buy a computer for: to gain a competitive edge in your industrial, commercial, or scientific application. While other computers try to make the best of slow memory, slow processors, and me-too engineering, **CompuPro** is delivering solutions for today's commercial computing... proven solutions that create expandable, modular, fast, exceptionally reliable, and truly professional level machines that conform fully to the IEEE 696/S-100 standards. We back all products with a minimum 1 year limited warranty.

**When you depend on your computer, choose a computer on which you can depend:  
S-100 from CompuPro.**

- 1 DISK 1, A SUPERB DISK CONTROLLER.** Disk controllers don't have to be your system's bottleneck: Disk 1 is lightning fast, thanks to properly implemented DMA (with arbitration) and data transfer that's independent of CPU speed. Handles up to four 8" or 5.25" floppy disk drives, single or double-sided, single or double density (soft sectored). With BIOS for CP/M-80\*. Manual available for \$25. A/T \$495, CSC \$595. Coming soon: Disk 2, the fast DMA hard disk controller.
- 2 CP/M-86.** Available only with Disk 1 purchase. Supplied on diskette with full documentation; ready for load and go operation. \$300.
- 3 OASIS\* OPERATING SYSTEM.** Single user (\$500) and multi-user (\$850) available for use with CPU Z. Supplied on diskette with full documentation. Coming soon: OASIS 16 for use with 16 bit systems.
- 4 COMPLETE DUAL DISK DRIVE SYSTEM.** With one Disk 1 board, desktop dual drive enclosure with Shugart SA-800 series drives, and power supply cable. Also includes CP/M-80. Introductory special: \$2195.
- 5 SYSTEM SUPPORT 1.** Includes battery operated clock/calendar; sockets for battery backup RAM, optional 9511 or 9512 math processor, and 2716 ROM; RS-232 serial port; triple interval timers; dual interrupt controllers; power fail interrupt; and more. Comprehensive owner's manual includes numerous software examples. \$295 Unkit, \$395 A/T, \$495 CSC (add \$195 to the above prices for the optional math processor).
- 6 8 BIT CPU Z.** A Z80\*-based CPU board that includes all standard features plus many convenience options. Meets all IEEE 696/S-100 specifications, including timing. \$225 Unkit, \$295 A/T (both operate at 4 MHz). \$395 CSC (with 6 MHz CPU).
- 7 16/8 BIT CPU 8085/88.** Now there's an easy way to gain 16 bit capability without sacrificing your library of 8 bit software: CPU 8085/88 combines an 8088 CPU to handle 16 bit software and an 8085 CPU for 8 bit software. \$295 Unkit, \$425 A/T (both operate at 5 MHz); \$525 CSC (with 6 MHz 8085 and 8088).
- 8 8088/8086 MONITOR-DEBUGGER SOFTWARE.** Ideal for use with CPU 8085/88. Supplied on single sided, single density, soft sectored 8" disk. CP/M-80 compatible (not required if you have CPM/86). Great development tool; mnemonics used in debug conform as closely as possible to current CP/M DDT mnemonics. \$35.
- 9 8 BIT CPU 8085.** Same as CPU 8085/88, but without 8088. May be easily upgraded to 16 bit operation. \$235 Unkit, \$325 A/T, \$425 CSC.
- 10 INTERFACER 1.** Two RS-232 serial ports, with full handshaking and independently selectable Baud rates, connect your computer to serial peripherals. \$199 Unkit, \$249 A/T, \$324 CSC.
- 11 INTERFACER 2.** Adds three full duplex parallel ports, and one serial port with all the features of an Interfacer 1 serial port, to your computer. \$199 Unkit, \$249 A/T, \$324 CSC.
- 12 INTERFACER 3-5.** Includes five RS-232 serial ports (2 synchronous/asynchronous, 3 asynchronous) with full handshaking. Includes software programmable Baud rates and many other convenience features. \$599 A/T, \$699 CSC.
- 13 INTERFACER 3-8.** Same as above, but with eight full RS-232 serial ports (2 synchronous/asynchronous, 6 asynchronous). Ideal for multi-user/multi-terminal systems. \$699 A/T, \$849 CSC.
- 14 SPECTRUM COLOR GRAPHICS BOARD.** With 8K of IEEE-compatible static RAM, full duplex bidirectional I/O port for keyboard or joystick interface, and 6847-based graphics generator that can display all 64 ASCII characters. 10 modes of operation, from alphanumerics/semi-graphics in 8 colors to dense 256 X 192 full graphics. \$299 Unkit, \$399 A/T, \$449 CSC.
- 15 6 SLOT HIGH SPEED MOTHERBOARD.** With all edge connectors. Faraday shielding, extensive bypassing, and split active termination. \$89 Unkit, \$129 A/T.
- 16 12 SLOT HIGH SPEED MOTHERBOARD.** Same as above, but with 12 slots. \$129 Unkit, \$169 A/T.
- 17 20 SLOT HIGH SPEED MOTHERBOARD.** Same as above, but with 20 slots. \$174 Unkit, \$214 A/T.
- 18 MEMORY MANAGER.** Extends the addressing of older S-100 machines beyond 64 KBytes to allow for greatly expanded memory capacity. \$59 Unkit, \$85 A/T, \$100 CSC.
- 19 ACTIVE TERMINATOR.** Promotes reliable and accurate data transfer in older machines by properly terminating bus lines, thereby minimizing ringing, crosstalk, overshoot, noise, and other gremlins associated with unterminated lines. \$34.50 Unkit, \$59.50 A/T.
- 20 2708 EPROM BOARD.** This board is the way to store often used routines or pieces of software. \$85 Unkit, \$135 A/T, \$195 CSC (2708s not included).
- 21 DOCUMENTATION.** User manuals are available for all products. Interfacer 3, \$10; Disk Controller, \$25; System Support 1, \$20; most others, \$5. Also available: "CompuPro Product User Manuals: 1975 - 1984". This 250+ page book includes data on all older Godbout/CompuPro products, as well as many newer products such as the Spectrum Color Graphics board, Interfacers 1 and 2, CPU 8085/88, motherboards, CPU Z, and more. Whether you want to evaluate the innovative engineering behind CompuPro products, or study the nuts and bolts of high speed computer operation, this is the book for you. \$20 plus shipping.
- 22 RAM 16-64.** Configurable as 64K X 8 for 8 bit systems or 32K X 16 for 16 bit systems. Static, IEEE-696/S-100 compatible, extended addressing, 10 MHz operation. \$1195 A/T, \$1295 CSC.
- 23 RAM 17-64.** The lowest power (1/4 Amp typical) 64K X 8 static board in the business. IEEE-696/S-100 compatible, 4 optional 2K windows, no wait states with 6 MHz Z80. \$1095 A/T, \$1195 CSC, \$875 Unkit.
- 24 RAM 20-32.** For lower density applications. Static, IEEE-696/S-100 compatible, extended addressing or bank select, up to 10 MHz operation. \$559 A/T, \$659 CSC, \$449 Unkit. 8K and 16K versions also available.

Most CompuPro products are available in Unkit form, Assembled/Tested (with 1 year warranty) or qualified under the high-reliability Certified System Component (CSC) program (200 hour burn-in, 2 year extended warranty, more). Note: Unkits are not intended for novices, as debugging may be required due to problems such as IC input instability. Factory service is available for Unkits at a flat service charge.

\*LEGAL NOTE: Z80 is a registered trademark of Zilog. CP/M is a registered trademark of Digital Research. OASIS is a trademark of Planar.

**How to Order:** Call 415-562-0636 for the name of the authorized CompuPro sales center nearest you, or for placing factory direct VISA®/Mastercard® orders. Prices shown do not include tax, shipping charges, or dealer installation/support services.

**CompuPro**™  
OAKLAND AIRPORT, CA 94614

division

(415) 562-0636

**GODBOUNT**  
ELECTRONICS

coded as rules, how can it be put to use? This question has more than one answer. One general approach is the use of a *production system* (see reference 10). A production system contains three major components—a *set of rules*, a *global data base*, and a *rule interpreter*. Some people call the set of rules the *knowledge base* and the rule interpreter the *inference system*. McDermott calls the global data base the *working memory*, using the term "data base" for a file of needed facts (see reference 20). Despite this variety of terminology, the basic ideas are the same. The rules have the following general form:

```

IF: <antecedent1>
    .
    .
    .
    <antecedentm>
THEN: <consequent1>
      with certainty C1
    .
    .
    .
    <consequentn>
      with certainty Cn
  
```

The antecedents can be thought of as patterns that can be matched against entries in the data base, and the consequents as actions that can be performed (or conclusions that can be deduced) if all the antecedents match. In the case of the R1 example (see table 1a), the data base would contain assertions about such things as what

the current context is, and whether or not there is an unassigned dual-port disk drive. The consequent actions can cause changes to the contents of the global data base, by changing an assertion about the status of the assignment of devices to a controller, or by asking the user a question and adding the answer given to the data base. Thus, the application of a rule can change the state of the data base, enabling some rules and disabling others.

### Control Strategies

How are the enabled rules found, and what decides which rules to apply? This is the job of the rule interpreter, and the strategy it follows is called the *control strategy*.

One of the simplest strategies is to scan through the rules until one is found whose antecedents match assertions in the data base. The rule is applied, updating the data base, and the scanning resumes. This process continues until either a goal state is reached or no applicable rules are found. R1 uses a variant of this basic procedure. Since the behavior of the system is directly responsive to the facts about the problem entered in the global base, this is known as a *data-driven control strategy*. This strategy is also known as *forward-chaining* or *antecedent reasoning*.

We think of each rule as a subroutine. Instead of being called by name, a production-system subroutine is triggered by the appearance

of certain patterns in the data base. Anathema to lovers of structured programming, such pattern-directed systems have long fascinated AI researchers (see reference 32). In particular, the use of such systems as psychological models was pioneered by Newell and Simon (reference 22) in the development of GPS.

A different strategy is to select a goal to be achieved and scan the rules to find those whose consequent actions can achieve the goal. Each such rule is tried in turn. If the antecedents for a rule match existing facts in the data base, the rule is applied and the problem solved. If an unmatched antecedent is encountered, arranging conditions to match that antecedent becomes a new subgoal, and the same procedure is applied recursively. If there are no rules to establish the new subgoal, the program asks the user for the necessary facts and enters them in the data base. Since the behavior of the system is directly responsive to the goals the system is trying to achieve, this is known as a *goal-driven control strategy*. (This strategy is also known as *backward-chaining* or *consequent reasoning*, and is closely related to means-end analysis.) A variant of a goal-driven control strategy is used successfully by MYCIN and is the method used in the micro expert-system described in the last section of this article. (It is possible to use other control strategies that combine elements of data-driven and goal-driven policies, as we did in our work on PROSPECTOR. See reference 11.)

### System Characteristics

We can now see more clearly how rule-based expert systems differ from more conventional computer programs. As mentioned earlier, one major difference is the separation of the expert knowledge (the rules forming a knowledge base) from the general-reasoning mechanism (the rule interpreter). This partitioning, together with the further division of general knowledge into many separate rules, offers several important advantages:

- incremental development of the

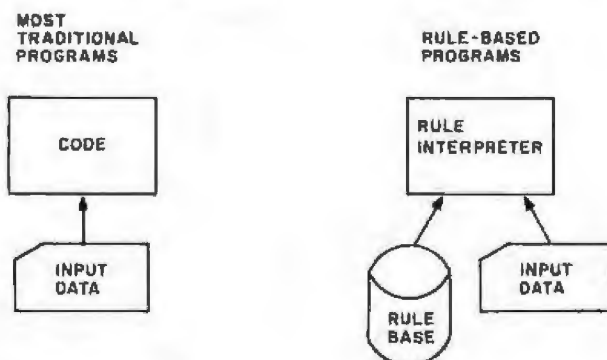

**Figure 2:** Contrast between traditional programs and rule-based programs. A rule-based program is divided into a general-reasoning program, called the rule interpreter, and a file of judgmental rules obtained from an expert, called the rule base or knowledge base. The rule interpreter loads the rule base into an internal representation and uses the rule base to guide an interactive consultation with the user.



# we beat the price...



800™ \$779

**ATARI**  
Computers  
for people.™

815 DUAL  
DISK DRIVE

**\$1199**



WITH ONE YEAR EXTENDED WARRANTY

## ATARI SOFTWARE

CX401 General Accounting	\$399.00
CX402 Accounts Receivable	\$399.00
CX403 Inventory Control	\$399.00
CX404 Word Processor	\$119.00
CX405 PILOT	\$68.00
CX413 MICROSOFT BASIC	\$68.00
CX4101 Invitation to Programming 1	\$17.00
CX4102 Kingdom	\$13.00
CX4103 Statistics	\$17.00
CX4104 Mailing List	\$17.00
CX4105 Blackjack	\$13.00
CX4106 Invitation to Programming 2	\$20.00
CX4107 Borhythm	\$13.00
CX4108 Hangman	\$13.00
CX4109 Graph II	\$17.00
CX4110 Touch Typing	\$20.00
CX4111 Space Invaders	\$17.00
CX4112 States & Capitals	\$13.00
CX4114 European Countries & Capitals	\$13.00
CX4115 Mortgage & Loan Analysis	\$13.00
CX4116 Personal Fitness Prog.	\$59.00
CX4117 Invitation to Programming 3	\$20.00
CX4118 Conversational French	\$45.00
CX4119 Conversational German	\$45.00
CX4120 Conversational Spanish	\$45.00
CX4121 Energy Czar	\$13.00
CX4125 Conversational Italian	\$45.00

CX6001 U.S. History	\$23.00
CX6002 U.S. Government	\$23.00
CX6003 Supervisory Skills	\$23.00
CX6004 World History	\$23.00
CX6005 Basic Sociology	\$23.00
CX6006 Counseling Procd	\$23.00
CX6607 Principal of Act.	\$23.00
CX6608 Physics	\$23.00
CX6609 Great Classics	\$23.00
CX6010 Business Comm	\$23.00
CX6011 Basic Psychology	\$23.00
CX6012 Effective Writing	\$23.00
CX6014 Principals of Econ	\$23.00
CX6015 Spelling	\$23.00
CX6016 Basic Electricity	\$23.00
CX6017 Basic Algebra	\$23.00
CX6106 Bond Analysis	\$20.00
CX6107 Stock Analysis	\$20.00
CX8108 Stock Charting	\$20.00
CXL4001 Education System Master	\$21.00
CXL4002 Basic Computing Language	\$46.00
CXL4003 Assembler Editor	\$46.00
CXL4004 Basketball	\$24.00
CXL4005 Video Easel	\$24.00
CXL4006 Super Breakout	\$30.00
CXL4007 Music Composer	\$45.00
CXL4008 Chess	\$30.00
CXL4010 3-D Tic-Tac-Tow	\$24.00

CXL4011 Star Raiders	\$32.00
CXL4012 Missile Command	\$32.00
CXL4013 Asteroids	\$32.00

CXL4015 TeleLink	\$20.00
Compuhome	\$74.95
Visicalc	\$149.00
Letter Perfect (Word Processor)	\$119.00
Source	\$89.00

### Atari® Peripherals:

400 16K	\$329.00
410 Recorder	\$59.00
810 Disk Drive	\$449.00
815 Disk Drive	\$1199.00
822 Printer	\$359.00
825 Printer	\$629.00
830 Modem	\$159.00
850 Interface	\$139.00

### Atari® Accessories

New DOS 2 System	\$21.00
CX70 Light Pen	\$64.00
CX30 Paddle	\$18.00
CX40 Joy Stick	\$18.00
CX853 16K RAM	\$89.00
Microtek 16K RAM	\$75.00
Microtek 32K RAM	\$169.00



**CBM 8032 \$1099**

4016	\$799.00
4032	\$999.99
8096	\$1795.00
CBM4022 Printer	\$629.00
Tally 8024	\$1899.00
CBM C24 Cassette Drive	\$69.00
CBM4040 Dual Disk Drive	\$999.00
CBM8050 Dual Disk Drive	\$1349.00



**commodore**



**VIC 20  
\$259**

Vic-TV Modul	\$19.00
Vic Cassette	\$69.00
Vic Disk Drive	\$ Call
Vic 6 Pack program	\$44.00

### CBM Software

WordPro3 Plus	\$199.00
WordPro4 Plus	\$299.00
Commodore Tax Package	\$399.00
Visicalc	\$149.00
EBS Accts. Rec./Inventory Interactive Syst	\$595.00
BPI General Ledger	\$329.00
QZZ Information System	\$329.00
Daw Jones Portfolio	\$129.00
Pascal	\$239.00
Legal Time Accounting	\$449.00
World Craft 80	\$289.00
Word Check	\$180.00
Create-A-Base	\$160.00
Power	\$89.00
Socket-2-Me	\$20.00
Jinsam	\$ Call

### Disks

CXB100 Blank Disk (5)	\$22.00
Sycom Blank Disk (10)	\$29.00
Maxell Blank Disk (10)	\$36.00
Maxell Blank Disk (10)	\$46.00

### Printers

Epson MX-70	} Call for Prices
Epson MX-80	
Epson MX-80 FT	
Diablo 630	
Nec 5530	\$2495.00
TEC 1500 Starwriter 25cps	\$1495.00
TEC 1500 Starwriter 45cps	\$1995.00

**No Risk, No Deposit On Phone Orders, COD or Credit Card, Shipped Same Day You Call \***

\* on all in stock units

IN PA. CALL: 717-327-9575

**(800) 233-8950**



To Order:

Phone orders invited (800 number is for order desk only) Or send check or money order and receive free shipping. Pennsylvania residents add 6% sales tax. Add 3% for Visa or M.C. Equipment is subject to price change and availability without notice. Please call between 11 AM & 6 PM.

COMPUTER MAIL ORDER  
501 E. 3RD ST., WILLIAMSPORT, PA 17701

knowledge base over an extended time by letting the developers refine old rules and add new ones

- the same general system can be used for a variety of applications, essentially by "unplugging" one set of rules and "plugging" in another
- the same knowledge can be put to use in different ways (including teaching) by changing the rule interpreter
- the program can give simple and illuminating explanations of its behavior merely by describing the rules it is applying (this also turns out to be a powerful way to debug faulty rules)
- the possibility of developing systems that are introspective (eg: can check the consistency of their own rules) and evolutionary (eg: can modify their own rules and learn new ones)

All these advantages are present in a rudimentary but interesting way in the micro expert-system described at the end of this article.

Another characteristic of most expert systems is that they try to mimic, at least to some extent, the way

human experts make decisions. The "spot-a-pattern/draw-a-conclusion" style of reasoning is used as much by experts on special problems as it is by all of us on day-to-day problems; what distinguishes the expert from the rest of us is the expert's unusual and valuable set of rules. Such rules are often not conclusive, but only suggestive of the conclusion. For example, if a car won't start and the headlights are dim, the battery is probably bad, but there are other possibilities. To mimic experts, then, a rule-based system should let the expert state the degree of significance or certainty that should be attached to the conclusion of a rule.

### A Sampling of Expert Systems

To understand both the capabilities and limitations of knowledge-based systems, it is helpful to examine specific systems created to solve particular problems. At first glance, their only common characteristic seems to be their reliance on explicitly encoded knowledge. Groupings based on the method of knowledge representation (eg: production rules) or on the domain of application (eg: medicine)

reveal little additional commonality.

However, we can gain some insight by grouping the systems according to their general function. Table 2 shows a classification of well-known knowledge-based systems into eight general categories. We will now define most of these categories and describe some representative programs.

### Diagnosis Problems

The general diagnosis problem is one of classifying an object, event, or situation on the basis of perhaps uncertain information about its characteristics. The categories may or may not be mutually exclusive, and the data can be acquired sequentially or in parallel. In a formal sense, diagnosis problems can always be posed as problems in statistical-decision theory, whose solution usually requires the estimation of a multivariate probability function from vast amounts of data. The knowledge-based-systems approach to such problems effectively substitutes the knowledge and judgment of expert humans for this unknown function.

Several impressive knowledge-based systems have been developed for medical-diagnosis problems. The INTERNIST program developed by Pople and Myers at the University of Pittsburgh uses information from 4000 possible manifestations to diagnose problems of internal medicine that can involve multiple instances of 500 different disease types (see reference 25). The program contains a large taxonomy of disease types, together with rules that link manifestations to these types, as well as an ingenious control procedure for narrowing down the disease classes that explain the manifestations. In many tests, INTERNIST has demonstrated the capability of correctly diagnosing multiple-disease cases described in medical journals as being particularly difficult.

Another well-known medical-diagnosis program is the MYCIN system developed by Shortliffe and his colleagues at Stanford (see reference 27). MYCIN is a consulta-

*Text continued on page 254*

Function	Domain	System	Reference
Diagnosis	Medicine	PIP	24
	Medicine	CASNET	34
	Medicine	INTERNIST	25
	Medicine	MYCIN	27
	Medicine	PUFF	13
	Engineering	SACON	3
	Geology	PROSPECTOR	11
Search	Chemistry	DENDRAL	14
	Chemistry	SECHS	36
	Chemistry	SYNCHEM	16
	Circuit analysis	EL	28
Problem Solving and Planning	Genetics	MOLGEN	29
	Mechanics	MECHO	6
	Programming	PECOS	2
	Configuring computers	R1	20
Machine Acoustics Measurement Interpretation	Medicine	HASP (SU/X)	23
		VM	12
Computer-aided Instruction	Electronics	SOPHIE	4
	Medicine	GUIDON	8
Knowledge Acquisition	Diagnosis	TEIRESIAS	9
	Diagnosis	EMYCIN	30
	Diagnosis	EXPERT	33
	Diagnosis	KAS	26
System Building	—	ROSIE	31
	—	AGE	23
	—	HEARSAY III	1

Table 2: A classification of existing knowledge-based systems by function. Numbers at the right indicate references about each system (given at the end of the article).



# KNOW THYSELF

"Humans are no longer limited to philosophic introspection in their strivings for self-knowledge. They can now attempt to analyze and understand the workings of the human mechanism."

**Ernest W. Kent**

**BUTE  
EDITS**



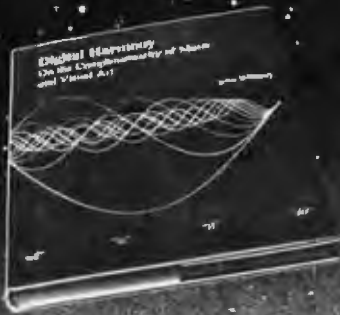

## DIGITAL HARMONY

by John Whitney

A new synthesis of sight and sound

Digital Harmony lays the foundation for the whole new field of audio-visual art made possible by microcomputers. John Whitney, a pioneer of the special effects technology used in STAR WARS and 2001 A SPACE ODYSSEY, explains the special union of computer graphics and music. His computer-generated visual art graphically depicts the laws of harmonic motion common to all music.

Digital Harmony includes a complete description of Whitney's computer, peripherals, and film techniques. Colorful illustrations are included, as well as the program listings that generated them. The descriptions are sufficient for anyone to begin to explore this new territory as a composer and computer experimenter - transforming the small computer into an ideal instrument for creating compositions in aural and visual art.

John Whitney is on the Faculty in the Department of Art at the University of California, Los Angeles.

ISBN 0-07-070015-X  
240 pages  
hardcover  
over 50 color photographs **\$21.95**



## INVERSIONS: A Catalogue of Calligraphic Cartwheels

by Scott Kim  
Foreword by Douglas Hofstadter  
Backward by Jef Raskin

Surprising symmetries in design and letterforms

Illusion, calligraphy, visual magic - Scott Kim's new book, Inversions, delights the eye and enchants the mind. Filled with intriguing designs, words that read the same right-side up and upside down, words within words, and unexpected symmetries, these compositions create a fresh way to look at the alphabet. The text includes the visual principles of symmetry, lettering, and problem solving that are basic to these images. The author also draws parallels to related exercises in perception in such diverse areas as art, music, word play, and mathematics. Scott Kim's original inversion designs first appeared in *Omni* magazine, inspiring an overwhelming reader response. An irresistible challenge, invertible writing appeals to everyone who loves beauty in mathematics and design.

Scott Kim is a doctoral student in Computer Science at Stanford University and is a concert pianist and composer.

ISBN 0-07-034546-5  
128 pages  
softcover  
over 50 illustrations  
available summer 1981

**\$8.95**

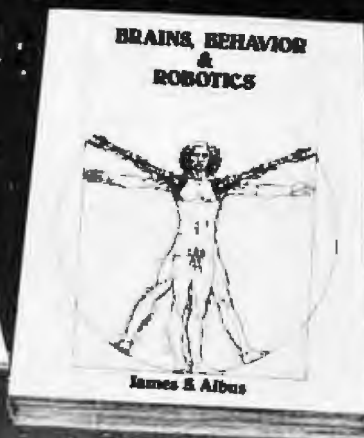

## BRAINS, BEHAVIOR, AND ROBOTICS

by James S. Albus

Robotics design and applications

This computer-oriented guide explores how the brain functions primarily as a computer device for generating and controlling behavior. The author assesses behavior as a product of three hierarchies of computing modules:

- memory modules
- behavior-generating modules
- sensory-processing modules

A section on artificial intelligence ties this hierarchical model to vital computer science techniques such as planning, problem-solving, machine vision, natural language understanding and knowledge representation. A closing section on robotics discusses the design considerations in constructing a robot control system fashioned after this model of the brain, and explores the current and potential use of robots in our environment.

Dr. James S. Albus is Project Manager with the National Bureau of Standards.

ISBN 0-07-000975-9  
400 pages  
hardcover  
180 illustrations

**\$15.95**



## THE BRAINS OF MEN AND MACHINES

by Ernest W. Kent

Human models for computer design

When the "Brains of Men and Machines" series of articles first appeared in *BYTE* magazine, the response was immediate and enthusiastic. Now Ernest W. Kent has expanded his ideas about the brain into a full-length book. As researchers begin to unravel the mysteries of the brain's chemical, electrical, and synaptic circuitry, their findings are becoming immediately applicable to advances in robotic behavior and computer design. The Brains of Men and Machines "dissects" the brain to provide new insights into computer design and artificial intelligence.

It is one of the rare books that transcends disciplinary boundaries. In it the ever-increasing relationship between man and machine is freshly examined - a relationship, Professor Kent concludes, that is today being reexamined in the light of man's own neurological self-image.

Dr. Ernest W. Kent is a Professor of Physiological Psychology and Psychopharmacology at the University of Illinois at the Chicago Circle Campus.

ISBN 0-07-034123-0  
304 pages  
hardcover  
illustrated

**\$15.95**

AVAILABLE FALL 1981

# The BYTE BOOK Collection

Circle 46 on Inquiry card.

## BASIC SCIENTIFIC SUBROUTINES, VOLUMES 1 AND 2

by Fred Ruckdeschel

Valuable programs for professional and hobbyist

Designed for the engineer, scientist, experimenter, and student, this series presents a complete scientific subroutine package in BASIC.

- Volume 1 covers plotting, complex variables, vector and matrix operation, random number generation, and series approximations.
- Volume 2 continues with least-squares approximation, special polynomial functions, approximating techniques, optimization, roots of functions, interpolation, differentiation, integration, and digital filtering.

These volumes feature routines written in both standard Microsoft and North Star BASIC, extensive appendices, and subroutine cross-references.

Dr. Fred Ruckdeschel is a Principal Scientist with Dynacomp, Inc.

VOLUME 1  
ISBN 0-07-054201-5  
336 pages  
hardcover  
illustrated

VOLUME 2  
ISBN 0-07-054202-3  
384 pages hardcover  
illustrated  
available Fall 1981

**\$19.95**

**\$23.95**



## THE BYTE BOOK OF PASCAL

Blaise W. Liffick, Editor

A powerful, structured language

Based on articles, language forums, and letters from BYTE magazine, this work is a valuable software resource. Pascal continues to be popular as a structured programming language. Written for both potential and established users, this book introduces the Pascal language and examines its merits and possible implementations. Featured are two versions of a Pascal compiler, one written in BASIC and the other in 8080 assembly language; a p-code interpreter written in both Pascal and 8080 assembly language; a chess-playing program, and an APL interpreter.

ISBN 0-07-037823-1  
334 pages  
hardcover

**\$25.00**

## THREADED INTERPRETIVE LANGUAGES

by Ronald Loeliger



How to implement FORTH on your Z80

Threaded languages (such as FORTH) are compact giving the speed of assembly language with the programming ease of BASIC. They combine features found in no other programming languages. This book develops an interactive extensible language with specific routines for the Zilog Z80 microprocessor. With the core interpreter, assembler, and data type defining words covered in the text, it is possible to design and implement programs for almost any application and equivalent routines for different processors.

Ron Loeliger is a Senior Analyst with Intermetrics, Inc.

ISBN 0-07-038360-X  
272 pages  
hardcover  
illustrated

**\$18.95**

Beginner's Guide to the UCSD Pascal System

## BEGINNER'S GUIDE FOR THE UCSD PASCAL SYSTEM

by Kenneth L. Bowles

The most popular Pascal version explained by its creator

Written by the originator of UCSD Pascal System, this informative book is an orientation guide to the UCSD Pascal System. For the novice, this book steps through the System, bringing the user to a sophisticated level of expertise. Once familiar with the System, the reader will find the guide an invaluable reference tool for creating advanced applications. The package offers programs which may be run without alteration on:

- DEC PDP-11 or General Automation minicomputers
- Western Digital Microengines
- 8080, 8085, Z80, 6502, 6800, 9900 or AM-100 based microcomputers (including the popular Apple II and Radio Shack TRS-80 microcomputers)

Dr. Kenneth L. Bowles is Director of the Institute for Information Systems, University of California, San Diego.

ISBN 0-07-006745-7  
204 pages  
softcover

**\$11.95**

## YOU JUST BOUGHT A PERSONAL WHAT?

by Thomas Dwyer and Margot Critchfield



A Structured Approach to Creative Programming

Intended for both the novice programmer and the experienced computer enthusiast, this book presents practical ideas for personal computer use at home or at work.

Its approach is especially suitable for educational purposes. Written by the leading contributors of computer education material, this book is an entertaining and resourceful tool. There are over 60 ready-to-use programs written in Microsoft and Level II BASIC for the TRS-80 in the areas of educational games, financial record keeping, business transactions, disk-based files, and word processing.

Dr. Thomas Dwyer is a Professor of Computer Science at the University of Pittsburgh.

Margot Critchfield is a doctoral student in Foundations in Education at the University of Pittsburgh.

ISBN 0-07-018492-5  
343 pages  
softcover  
78 illustrations

**\$11.95**

## BEYOND GAMES: SYSTEM SOFTWARE FOR YOUR 6502 PERSONAL COMPUTER

by Kenneth Skier



Creating programs for the Apple, Atari, Challenger and PET computers

At last, a complete programming guide book for owners of personal computers utilizing the 6502 microprocessor. A self-contained course in structures programming and top-down design, this book presents a powerful set of tools for building an extended dump monitor, disassembler, hexadecimal dump routine, and text editor programs. Programs are thoroughly explained, with clear instructions for modifications.

Kenneth Skier is a Systems Programmer for Wang Laboratories, Inc. and a Lecturer at MIT.

ISBN 0-07-057860-5  
440 pages  
softcover  
illustrated

**\$14.95**

stimulating, provocative, problem-solving

## CIARCIA'S CIRCUIT CELLAR

by Steve Ciarcia



### Practical uses for home computers

Imaginative and practical, Ciarcia's Circuit Cellar details a variety of microcomputer projects. A collection of the best articles from the popular series in BYTE magazine. This volume includes

- D/A conversion
- Programming EPROMS
- AC remote-controlled appliances
- digitized speech
- touch input video display

Complete instructions are given on how to construct each project. With amusing anecdotes and an easy-going style, Ciarcia presents his material in such a manner that even a neophyte need not be afraid of it.

ISBN 0-07-010960-5  
125 pages  
softcover  
color photographs and diagrams

**\$8.00**

## CIARCIA'S CIRCUIT CELLAR, VOLUME II

by Steve Ciarcia



### More practical uses for home computers

Composed of popular articles from BYTE magazine, this volume tells how microcomputers can be uniquely interfaced to our environment. Projects include

- building a computer controlled home-security system
- computerizing appliances
- transmitting digital information over a beam of light
- building the Intel 8086 microprocessor system design kit
- input-output expansion for the TRS-80

ISBN 0-07-010963-X  
224 pages  
softcover  
photographs and diagrams

**\$12.95**

## MICRO- COMPUTER STRUCTURES

by Henry D'Angelo



### Digital Electronics, Logic Design, and Computer Architecture

Today, there is an increasing demand for computer users who are not only well-versed in software, but who can also maintain, modify, and design their own hardware systems.

This text introduces computer users with little or no background in digital hardware to the basic computer structures used in microcomputer design and microcomputer interfacing. Helpful examples and end-of-chapter exercises further illustrate the various concepts presented, and a detailed bibliography provides additional reading opportunities. As a resource and textbook, it will assist

- programmers and systems analysts
- engineers and scientists
- managers
- students

Detailed Instructor's Manual also available.

Dr. Henry D'Angelo is the Associate Dean of the College of Engineering and Professor of Manufacturing Engineering at Boston University.

ISBN 0-07-015294-2 Instructor's Manual  
288 pages ISBN 0-07-015298-5  
hardcover softcover  
314 illustrations  
available spring 1981

**\$18.95**

**\$8.95**

BYTE Books' reputation is based on providing technically accurate, useful, and timely information. Established on the same principle as *BYTE* magazine, BYTE Books evolved in response to the rapidly expanding audience of home and business computer users. Computer professionals and enthusiastic newcomers need to keep pace with this unabated growth. This selection of BYTE books can expand your library of knowledge and expertise.

**TO ORDER, CALL TOLL  
FREE 800-258-5420, OR  
FILL OUT YOUR CHOICES  
IN THIS COUPON and  
return it with check,  
money order, or charge  
card number to:**

**BYTE  
BOOKS**

70 Main Street  
Peterborough,  
New Hampshire 03458

## BUILD YOUR OWN Z80 COMPUTER

by Steve Ciarcia



### Every step spelled out for do-it-yourself buffs

For the engineer, computer technician, student, and anyone interested in building a computer rather than buying one, this practical guide shows how to build a working computer based on the Z80 microprocessor. Each computer subsystem is fully explained and supported by proven design and testing information. The description focuses on a basic single-board microcomputer containing

- easy expansion to include a video terminal
- a 1 K-byte operating system
- serial and parallel ports
- hexadecimal display
- audio cassette mass storage

Readers can modify the system to meet personal needs.

Steve Ciarcia is a Computer Consultant, Electrical Engineer, and author of "Ask Byte" and "Ciarcia's Circuit Cellar" columns in *BYTE* magazine.

ISBN 0-07-010962-1  
330 pages  
softcover  
available summer 1981

**\$15.95**

**BYTE  
BOOKS**

70 Main Street  
Peterborough, New Hampshire 03458

Name \_\_\_\_\_

Address \_\_\_\_\_

City \_\_\_\_\_ State \_\_\_\_\_ Zip \_\_\_\_\_

- Check enclosed in the amount of \_\_\_\_\_
- Bill Visa. Card Number \_\_\_\_\_
- Bill Master Charge. Card Number \_\_\_\_\_
- Expiration Date \_\_\_\_\_

Include 75c per book to cover postage and handling.

TITLE	PRICE	QUANTITY	AMOUNT

SHIPPING  
TOTAL

**order now . . . !**



# VERSA MODEM

\$119

**BIZCOMP**

## Starting Today, BIZCOMP Takes Over as the Price/Performance Leader

We all know about the old fashioned acoustic coupler. Ask any computer hot-shot. Finicky, prone to room noise, vibration. A mechanical weak-link in your otherwise all-electronic system. RELIABILITY is the key to no-hassle computing. And everybody knows you don't get reliability with mechanical system components. So go ask that computer hot-shot—they'll tell you BIZCOMP's VersaModem all-electronic modem provides the new wave in personal communications. A fully FCC certified direct connection to the telephone network. Exciting? You bet!

Not only can you access The Source, MicroNet, Dow-Jones, Computer Bulletin Boards and University computers—the VersaModem offers access to a variety of specialized online databanks and timesharing services. The VersaModem is simple to install and operate. And it's compatible with standard data terminals and a host of personal computers.

Before you buy a computer modem, look at BIZCOMP's versatility. Look at BIZCOMP's quality. With BIZCOMP's VersaModem you won't need another modem. If your local computer store doesn't already have a VersaModem on display, ask them when they will!

**BIZCOMP Communications...**  
**Why not start with the best?**

# BIZCOMP

P.O. Box 7498 • Menlo Park, CA 94025 • 415/966-1545

Copyright © 1981 Business Computer Corporation

Circle 41 on Inquiry card.

tion designed to diagnose bacterial infections and recommend antibiotic therapy. MYCIN is organized around the systematic use of a large collection of rules that link patient data to infection hypotheses. Formulas based on a probability-like theory of certainty are used to accommodate the inexact nature of the relevant medical knowledge. In several ways, the program exploits the modularity provided by the use of rules to express this medical knowledge. From a system-development standpoint, modularity allows long-term incremental

development of the system by continual expansion and refinement of the rule base. The program obtains information from a user by simply chaining backward through the rules. This lets the program furnish simple but useful explanations of its reasoning by stating the rules it is using.

### Search

Many problems in graph theory, game theory, and other areas of discrete mathematics can be posed as search problems. These problems are characterized by the existence (at

least in principle) of a systematic method for generating candidate solutions, as well as a systematic method for testing acceptability. As regards genuinely interesting problems, the number of candidate solutions is usually so great that an exhaustive search is infeasible. Any device that significantly reduces the amount of search required (preferably without compromising the quality of the solution) is called a *heuristic*, and a search strategy guided by heuristics is called *heuristic search*.

Since the study of heuristic search was one of the earliest activities in AI, it is natural that DENDRAL—one of the first knowledge-based systems—was concerned with using knowledge to limit search (see reference 14). Begun in 1965 by Feigenbaum, Lederberg, and their colleagues at Stanford University, DENDRAL generates plausible structural representations of organic molecules from mass-spectrogram data, nuclear-magnetic-resonance data, and additional constraints provided by the user. The program runs in a plan-generate-test sequence: (1) deriving necessary constraints on the molecular structure, (2) systematically generating structures that satisfy those constraints, and (3) testing the proposed structures by predicting the mass spectrogram and rejecting those that disagree with the experimental results. The knowledge needed for step 2 is encoded as an ingenious special procedure. The knowledge needed for steps 1 and 3 is encoded as tables of production rules, a method compatible with the way chemists think about the rules of mass spectrometry (see reference 5).

For the molecular families covered by these empirical rules, the program is said to surpass even expert chemists in speed and accuracy. The results obtained with it have been published in many papers in chemistry journals (see reference 13).

### Problem Solving and Planning

An important class of logical problems concerns dividing a problem into a set of simpler subproblems. To be useful, a solution must be con-

## ★ ★ ★ WRITE OR CALL FOR FREE CATALOG ★ ★ ★

**The MAX BOX:** Manufactured by John D. Owens Associates. 8" dual drive cabinet complete with power supply & fan. Will hold Qumes, Shugarts or Siemens. Excellent design and engineering . . . . . \$ 325.  
With 2 Shugart 801R Drives . \$1,275. With 2 QUME Double sided drives. \$1,680.

**CALIFORNIA COMPUTER SYSTEMS HIGH IN QUALITY, LOW IN PRICE**  
Z80 CPU, 4 Mhz, with one serial port; 12 slot S-100 mainframe, disk controller, 64K Dynamic Ram, CP/M 2.2<sup>®</sup> SYSTEM 2210A . . . . . \$1,750.  
We configure complete systems with drives and additional I/O.

**IMS 5000 and 8000 Systems and IMS Memory**  
Outstanding long term reliability and performance. These systems feature a Z80A CPU, S-100 bus; double density drives (either single or double sided), DMA disk controller, 64K RAM, 2 serial & 1 parallel port. Prices include the very finest implementation of CP/M<sup>®</sup> available in the entire industry. Hard disk and multi user software options.

**Multi-User, Networking Operating System: TURBODOS**  
Turbodos: Spectacular new CP/M<sup>®</sup> compatible operating system. Z80 code, interrupt driven. Up to 6X faster than CP/M<sup>®</sup> up to 35% increased disc capacity. IMS compatible.  
Multi-user (up to 16 users) . . . . . \$750. Single user . . . . . \$250.

**PER SCI—THE KING AND QUEEN OF DRIVES!**  
Model 299B: Dual headed drives, total 3.2 MB unformatted . . . . . \$2,300.  
Model 277: Dual 8 inch drives, voice coil positioned, IBM compatible, 1600 K BYTES per drive, unformatted . . . . . \$1,245.  
Slimline cabinet and power for either 277 or 299 . . . . . \$ 300.

**GRAPHICS EQUIPMENT**  
**MICROANGELO** . . . . . \$2,295.  
High resolution graphics system. 15" 22MHZ, green phosphor screen, 72 key keyboard; includes complete cabling and software. From SCION. Screenware PAK II, . . . . . \$ 350.  
S-100 Graphics card . . . . . \$ 985.

**HIPAD DIGITIZER** from Houston Instruments. Create graphics using stylus. Easier than joystick or keyboard input. For S-100, Apple, TRS-80, PET . . . . . \$755.

**GRAPHICS SOFTWARE.** On line, real time, for the M9000 to drive the Microangelo. For use in design of PC board masks, IC masks and other applications. . . . . \$1,000.

**CAT 100 Full Color Graphics: Digital Graphics Complete S-100 color imaging system w/high performance video FRAME/GRABBER.** . . . . . \$1,875.

**MAURO MP-250B Proac Plotter:** Uses standard paper, choice of pen colors and line widths, resolution is 200 steps per inch; .005" tracking error; RS232 . . . . . \$895.

**WE EXPORT:** Overseas Callers: TWX 710 588 2844  
Phone 212 448-6298 or Cable: OWENASSOC

WE OFFER A FULL RANGE OF EXPERT CONSULTING SERVICES

# JOHN D. OWENS

## Associates, Inc.

12 Schubert Street

Staten Island, New York 10305

212 448-6283 212 448-2913 212 448-6298



structive; it usually consists of a sequence of actions that will achieve some goal. Examples of such problems are theorem proving, program synthesis, and robot planning.

EL is a knowledge-based system for the steady-state analysis of resistor-diode-transistor circuits (see reference 28). It uses production rules to represent general principles, such as Kirchhoff's laws and Ohm's law, as well as the characteristics of types of devices. Facts about the circuit being analyzed are represented as assertions in an associative data base. The rule interpreter is written in a special language called ARS (antecedent-reasoning system). As its name implies, ARS supports the use of rules in the antecedent mode, in which the factual assertions trigger the rules. The actions of the rules create new assertions, which in turn trigger additional rules.

An important property of ARS is the ability to make conjectures when no additional direct deductions are possible, and to keep track of those conjectures and any conclusions dependent upon them should subsequently detected contradictions require their revision. This ability allows the analysis of a circuit to proceed when the conducting or nonconducting states of its nonlinear devices are unclear. It also permits the user to modify the circuit and see the effects of changes without having to re-analyze the entire circuit. ARS can employ the same facilities to provide explanations of its reasoning.

### Computer-Aided Instruction

Three types of traditional CAI (computer-aided instruction) are often distinguished; frame-oriented drill-and-practice programs (which are unrelated to what AI people call frame-based representations); games and simulations (usually used to teach diagnosis), and exploratory systems that allow the student to experiment freely and learn by doing. Among the limitations of these programs are their inability to conduct dialogues with the student in natural language, to respond to unanticipated responses, to diagnose the student's

errors, or to improve with experience. The potential applicability of artificial-intelligence techniques to solving these problems was outlined by Carbonell ten years ago (see reference 7), and a variety of approaches have subsequently been explored. To the extent that knowledge of the subject matter is required for a solution, knowledge-based systems have an obvious contribution to make to CAI.

The GUIDON system developed by Clancey at Stanford exploits the MYCIN knowledge base about meningitis and bacteremia to teach both

facts and problem-solving strategies (see reference 8). MYCIN's 450 diagnostic rules were not modified, but were augmented by an additional 200 rules that included methods for guiding the dialogue with the student, presenting diagnostic strategies, constructing a student model, and responding to the student's initiative. By replacing MYCIN's rules by a separate set of MYCIN-style rules used in the PUFF program for diagnosing pulmonary disease, Clancey was able to use GUIDON to tutor students about pulmonary-function analysis. Thus, GUIDON

## ★ ★ ★ GREETINGS TO OUR FRIENDS IN AUSTRALIA ★ ★ ★

### SD SYSTEMS

**Z80 STARTER KIT:** single board computer with RAM / ROM, I/O, display, keyboard, kluge area . . . . . \$360  
**VFI:** double density floppy controller kit, with software . . . . . \$390  
**CPU Z80A,** 4 Mhz, serial & parallel I/O I/O on-board RAM, Z80 CTC . . . . . \$345  
**EXPANDORAM II** including high quality 4116s . . . . . \$540  
 Complete SD line available including kits and **FACTORY** Assembled and tested boards & systems at discount prices.

### TELETYPE

Model 4320 AAA or AAK  
 Model 43ASR, 8 level, 1" tape . . . \$2,595.  
**dBASE II Ashton-Tate** . . . . . \$615.  
 Brings power of mainframe database software to a microcomputer. Runs under CP/M<sup>®</sup>. Extremely easy to use. Manual and demo software . . . . . \$50.  
 Money Back Guarantee

### MUSYS Single BD Computer

Z80 processor, 64K Dyn RAM, Console serial port, S-100 parallel interface, Bootstrap PROM . . . . . \$1,300.

### HAZELTINE 1500

1510 . . . . . \$ 925.  
 1520 . . . . . \$1,030.  
 1520 . . . . . \$1,265.  
 220 volt models, add \$100  
**EXEC 80** . . . . . \$1,115.  
 90 day on-site warranty.

### IBM 3101 CRT Model 10

Model 20 . . . . . \$1,250.  
 Model 20 . . . . . \$1,450.  
 Selectric-like, detached keyboard, 9x16 dot matrix. Maintenance contract from IBM only \$70 per year

### ITHACA INTERSYSTEMS

Inventory sale on board sets & systems

### MARINCHIP SYSTEMS M9900

Uses TI9900 16 bit CPU. Full S-100, IEEE. Extensive software. Boards from \$550, systems \$4,995.

### TEXAS INSTRUMENTS Printers

10% off list price on entire TI printer line.

### CENTRONICS 737

. . . . . \$780.

### EPSON MX80

. . . . . \$50.

RS 232 Interface . . . . . \$ 50.

### CORVUS Hard Drives

Model 11, Hard Disk System . . . \$4,820.

Mirror Backup System . . . . . \$ 715.

### DMA-DOS NORTH STAR 8" Floppy Subsystem

A new operating system, completely CP/M<sup>®</sup> compatible that allows use of both 8" (Shugart single sided, double density via Tarbell controller) and 5 1/4" drives. Allows transfer of file from 8" to 5 1/4" and vice versa. Complete hardware, with software package . . . . . \$1,955.

### TARBELL

Double density controller . . . . . \$435.

Z80 CPU . . . . . 395.

### TEI MAINFRAMES, S-100

We are proud to announce that we are now a TEI stocking distributor. For the best in mainframes. . . TEI!!

### TELEVIDEO CRTs

912. \$780. 920. \$850. 950. \$1,050.

### COMMUNICATIONS SOFTWARE from Hawkeye Grafix

Enables communications from a micro to a terminal or to another micro, mini or maxi computer.  
 Object Code \$75. Source Code \$250.

### 3M SCOTCH<sup>®</sup> Diskettes

5 box minimum, price per box

Model 740, 8" single sided,

single density . . . . . \$27.00

Model 741, 8" single sided,

double density . . . . . 35.50

Model 743, 8" double sided,

double density . . . . . 43.00

Model 744-0, 5 1/4" soft sector, single sided

744-10, 5 1/4", hard sector, single sided. . . . . 27.00

Prices subject to change without notice

# JOHN D. OWENS Associates, Inc.

SEE OUR AD ON FACING PAGE

# Go with McGraw-Hill's

**TAKE ANY 3 BOOKS  
FOR ONLY \$1<sup>00</sup> EACH**  
when you join the  
**COMPUTER PROFESSIONALS'  
BOOK CLUB** (values up to \$75.00)\*



**MICROPROCESSOR APPLICATIONS MANUAL.** By Motorola Semiconductor Products, Inc. 720 pp., illus., 8½ x 11 format. With nuts-and-bolts practicality, this manual by the Motorola people (who should know) gives you detailed applications information on microprocessors. Assumes no prior knowledge on your part about MPUs.

435/2788 \$42.50  
(Counts as 2 of your 3 books)

**PROGRAMMING LANGUAGES.** By Allen B. Tucker, Jr. 439 pp., illus. Gives you not only the principles of design but the applications of six major programming languages. Shows you their strengths and weaknesses in solving various representative "benchmark" problems.

654/1588 \$25.95  
(Counts as 2 of your 3 books)

**COMPUTER CAPACITY.** By Melvin J. Strauss. 288 pp., tables and charts. The key purpose of the book is to provide both senior management and DP practitioners with a methodology for identifying and quantifying issues of capacity and demand within the data center without becoming entrapped by language problems

582317-9 \$24.95

**SOFTWARE DEBUGGING FOR MICROCOMPUTERS.** By Robert C. Bruce. 351 pp., illus. Takes you through the fundamental methods for finding errors, glitches, and faults in programs... goes on to techniques for tracking down and exterminating program bugs... then combines these techniques into a complete debugging plan.

582075-7 \$18.95

**MICROPROCESSORS/MICROCOMPUTERS/SYSTEM DESIGN.** By Texas Instruments Learning Center and the Engineering Staff of Texas Instruments, Inc. 634 pp., illus., oversized 7½ x 10½ format. The book takes you through the development of memory-to-memory architecture, shows you the components, and details programming methods and techniques.

637/58X \$24.50

**DATA STRUCTURES USING PASCAL.** By Aaron M. Tenenbaum and Moshe J. Augenstein. 544 pp., illus. With its emphasis on structured design and programming techniques, this definitive work takes you on a trailblazing journey through Pascal. Separate chapters are devoted to the stack, recursion, queues and lists, Pascal list processing, trees, graphs and their applications.

582230-X \$23.95

**SYNTAX OF PROGRAMMING LANGUAGES: Theory and Practice.** By Roland C. Backhouse. 301 pp., illus. Follow author Backhouse as he takes you, on a close examination of context-free grammars... and then hands you the tools to eliminate misconceptions and errors that often arise with the rapid growth of programming languages.

582064-1B \$25.95

(Counts as 2 of your 3 books)

**AUTOMATIC DATA PROCESSING HANDBOOK.** Edited by The Diebold Group. 976 pp., 269 illus. Written by a staff of internationally recognized authorities on ADP, this comprehensive handbook explains systems, programming and the languages, communications processes, and the design and installation of today's computers.

168/075B \$44.95

(Counts as 2 of your 3 books)

**THE BYTE BOOK OF PASCAL.** Edited by Blaise W. Liffick. 340 pp., illus. Up-to-date Byte articles on the subject—from a general introduction to system hardware—from top experts in the field. Includes two versions of a Pascal computer, one written in BASIC and the other in 8080 assembly language

789/873B \$25.00

(Counts as 2 of your 3 books)

**THE GIANT HANDBOOK OF COMPUTER PROJECTS.** By the Editors of 73 Magazine. 504 pp., 217 illus. Solid, simple, and above all fun! This oversized book shows you how to build computer equipment from scratch—computer games, a bionic clock, a computer-controlled thermometer, and much more.

582012-9 \$15.95

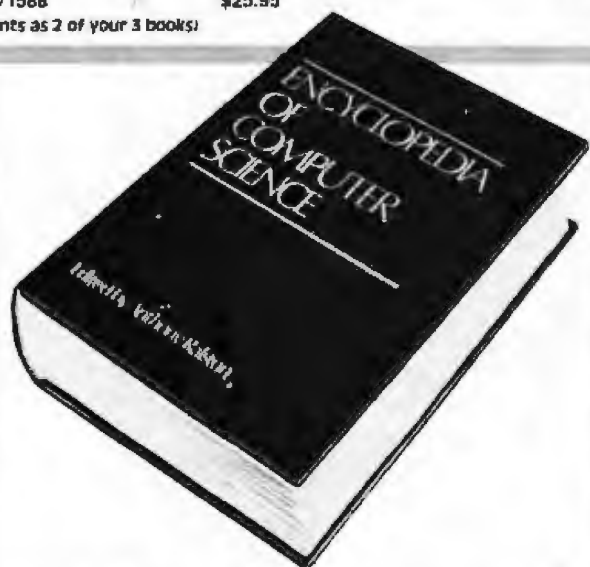

**ENCYCLOPEDIA OF COMPUTER SCIENCE.** Edited by Anthony Ralston and C. L. Meek. 1,500 pp., 60 illus., 100 charts, 7 x 10 format. This first and only in-depth coverage of the entire field of computer science in a single volume is comprehensive and completely up to date.

769/01X A \$60.00  
(Counts as 3 of your 3 books)

# EXPERIENCE!



**THE DEVIL'S DP DICTIONARY.** By Stan Kelley-Bootle. 160 pp., softbound. This devilishly clever little book is guaranteed to fill anyone who has ever slaved over a hot terminal with savage delight. Some 500 computer words and terms are misdefined, from abacus to your program. 340/226 \$7.50

**MICROCOMPUTER INTERFACING.** By Bruce Artwick. 352 pp., 117 illus. In this up-to-date, complete design guide you'll find the detailed descriptions and explanations necessary to enable you to select, build, and interface microcomputer systems to virtually all applications. Advanced interface devices and methods are thoroughly examined and illustrated. 789/436 \$24.95

**ELECTRONIC GAMES: Design, Programming, and Troubleshooting.** By W. H. Buchsbaum and R. Mauro. 335 pp., 338 illus. Information you need to design, program, and troubleshoot electronic games is right here in this widely popular hands-on guide. 087/210 \$24.50

## Why YOU should join now!

- **BEST BOOKS IN YOUR FIELD**—Books are selected from a wide range of publishers by expert editors and consultants to give you continuing access to the latest books in your field.
- **BIG SAVINGS**—Build your library and save money too! We guarantee savings of at least 15% off publishers' list prices on every book. Usually 20%, 25%, or even higher!

• **BONUS BOOKS**—You will immediately begin to participate in our Bonus Book Plan that allows you savings between 70–80% off the publisher's price of many books.

• **CONVENIENCE**—14 times a year you receive the Club Bulletin FREE, fully describing the Main Selection and alternate selections, together with a dated reply card. If you want the Main Selection, you simply do nothing—it will be shipped automatically. If you want an alternate selection—or no book at all—you simply indicate it on the regular reply card and return it by the date specified. You will have at least 10 days to decide. If because of late mail delivery of the Bulletin you should receive a book you do not want, just return it at the Club's expense.

As a Club member, you agree only to the purchase of four more books over a two-year period

**PROGRAMMING AND INTERFACING THE 6502—With Experiments.** By Marvin L. De Jong. 414 pp., heavily illus., softbound. This guide not only teaches you all you must know about programming and interfacing the 6502, but it also carries you to a high level of understanding and proficiency quickly and painlessly. 582080-3 \$15.95

**PRINCIPLES OF INTERACTIVE COMPUTER GRAPHICS.** By William M. Newman and Robert Sproull. 2nd Ed., 544 pp., illus. Now in a revised, updated second edition, this volume has long been THE standard source of information for designers! 483/3878 \$26.95 (Counts as 2 of your 3 books)

**PERSONAL COMPUTING: Hardware and Software Basics.** Electronic Book Series. 224 pp., 175 illus., 8½ x 11 format. Gives you comprehensive guidance to the present state of the art in personal computers—an overall survey of the technology and methods available to perform various tasks, facts about the work others are doing—and just how they are doing it. 191/514 \$24.50

**6502 SOFTWARE DESIGN.** By Leo J. Scanlon. 269 pp., illus., softbound. This book describes the instructions that the 6502 integrated circuit can actually execute ... digs through into subroutines ... and presents the techniques needed to process structured data. 582138-9 \$10.50

**BIT-SLICE MICROPROCESSOR DESIGN.** By John Mick and Jim Brick. 398 pp. All in one place—the crucial information you've been needing about the 2900 family of bit-slice microprocessor components. This remarkable "first" designs right before your eyes not just one but two complete 16-bit machines! 417/814 \$18.50

Be sure to consider these important titles as well!

**INFORMATION RETRIEVAL SYSTEMS: Characteristics, Testing and Evaluation, 2/e.** By F. W. Lancaster. 582000-5 \$22.95

**DATA BASE DESIGN.** By G. Wiederhold. 701/30XB \$25.95 (Counts as 2 of your 3 books)

**PRINTED CIRCUITS HANDBOOK.** By C. F. Coombs, Jr. 2nd Ed. 128/0889 \$38.50 (Counts as 2 of your 3 books)

**STRUCTURED PROGRAMMING: Theory and Practice.** By R. C. Linger, H. D. Mills, & B. J. Witt. 788/537 \$20.85

**HOW TO DESIGN, BUILD & PROGRAM YOUR OWN WORKING COMPUTER SYSTEM.** By R. P. Haviland. 788/987 \$14.95

**COMPILER DESIGN AND CONSTRUCTION.** By A. Pyster. 582026-9 \$24.50

**THE Z-80 MICROCOMPUTER HANDBOOK.** By W. Barden, Jr. 784/914 \$8.95

**COMPUTER PERIPHERALS FOR MINICOMPUTERS, MICROPROCESSORS AND PERSONAL COMPUTERS.** By L. C. Hohenstein. 294/518 \$19.50

**16-BIT MICROPROCESSOR ARCHITECTURE.** By T. Dolhoff. 582003-X \$24.95

**ELECTRONICS DICTIONARY, 4/e.** By J. Markus. 484/3138 \$29.95 (Counts as 2 of your 3 books)

\* If you join now for a trial period and agree to purchase four more books—at handsome discounts—over the next two years. (Publishers' prices shown)

## MAIL THIS COUPON TODAY

McGraw-Hill Book Clubs  
Computer Professionals' Book Club  
P.O. Box 582, Hightstown, New Jersey 08520

Please enroll me as a member and send me either the ENCYCLOPEDIA OF COMPUTER SCIENCE, billing me only \$3.00, or any three other books, billing me only \$1.00 each, plus local tax, postage, and handling. If not satisfied, I may return the books within 10 days and my membership will be canceled. I agree to purchase a minimum of four additional books during the next two years as outlined under the Club plan described in this ad. Membership in the Club is cancelable by me any time after the four-book purchase requirement has been fulfilled.

- Check here if you want ENCYCLOPEDIA OF COMPUTER SCIENCE (788/01X).
- Check here if you prefer three other volumes, and indicate below by number the books you want. A few expensive books (noted in the description) count as more than one choice.

\_\_\_\_\_

Orders from outside the U.S. must be prepaid with international money orders in U.S. dollars.

Name \_\_\_\_\_

Address/Apt \_\_\_\_\_

City/State/Zip \_\_\_\_\_

Corporate Affiliation \_\_\_\_\_

This order subject to acceptance by McGraw-Hill. All prices subject to change without notice. Offer good only to new members. A postage and handling charge is added to all shipments. P39521

has shown that a knowledge-based system can be exploited for teaching about its knowledge base.

### Knowledge Acquisition

As an alternative between the extremes of complete handcrafting of the knowledge base and completely automated learning, researchers have investigated the development of various tools that can facilitate the process of acquiring knowledge. The most ambitious of these is Davis' TEIRESIAS system that employs knowledge about the MYCIN system to supervise interaction with an expert in building or augmenting a MYCIN rule set (see reference 9).

Giving the expert direct access to the program is an appropriate ultimate goal. But the expert usually lacks sufficient understanding of the program's representational mechanisms to appreciate the consequences of the many choices the program offers. An alternative to direct access is to use a computer scientist who understands the program's mecha-

nisms and provide specific tools matched to the knowledge-acquisition process.

KAS, the knowledge-acquisition system developed by Reboh for PROSPECTOR, is an example of such a system (see reference 26). PROSPECTOR employs various kinds of networks to represent knowledge—rule networks for expressing judgmental knowledge, semantic networks for expressing the meaning of the propositions employed in the rules, and taxonomic networks for representing static knowledge about the relations among terms in the domain. The core of KAS is a network editor. The editor's basic operations allow it to create, modify, or delete various kinds of nodes and arcs. The network editor knows about the various mechanisms employed by PROSPECTOR, protects the user against certain kinds of syntactic errors, and includes a system that keeps track of partial constructs that remain to be completed. At any time, the user can turn

control over to KAS, and KAS will systematically question the user to fill in the missing parts of the structures. A semantic network matcher gives the user a limited ability to edit by content rather than by form. Since KAS is embedded in PROSPECTOR, it lets the user determine the effects of changes by permitting controlled execution of the program. Although specialized to PROSPECTOR, KAS gives powerful assistance in the time-consuming task of developing the knowledge base.

### System Building

Many knowledge-based systems that have been built—especially in the area of diagnosis—have generally similar structures. In particular, all rule-based systems have a rule interpreter, a collection of rules making up the knowledge base, and a global data base of assertions about the particular case being diagnosed. Several researchers have illustrated the generality of their systems by showing that they can be applied to another domain merely by removing the rules for a given domain and substituting rules for the new one (see references 17 and 30).

Every domain, however, has its own peculiarities. Despite the good intentions of system builders, these peculiarities inevitably influence the design of a system. As a result, a serious attempt to build a new knowledge-based system almost always requires changes in all parts of the system. Recognizing these facts, researchers have recently begun developing what amount to programming languages for building expert systems. While these languages are just coming into use and are certain to undergo further development, they promise to reduce significantly the programming effort needed to develop a new system.

AGE is a good example of the most recent efforts in this direction (see reference 23). Specifically designed to allow the implementation of a broad spectrum of knowledge-based systems, AGE gives the designer a set of separate, interconnectable, preprogrammed modules for im-

# THE WORD™

**\$75<sup>00</sup>**  
**COMPLETE**

## SPELLING PROOFREADER and COMPUTER DICTIONARY

### The WORD is out!

Works with the editor of your choice to find those lurking spelling errors and sneaky typos.

### SPELLING CHECKER

- 45,000 word dictionary
- Checks over 10 pages/minute
- Handles apostrophes, hyphens
- Marks mistakes in file
- CDOS™, CP/M™ compatible
- Needs only 32K system

### EXTRA FEATURES

- Automatic rhyme finder
- Crossword puzzle solver
- Correct spelling finder
- Word counter
- Word frequency analyzer
- Dictionary builder

### AVAILABLE FOR:

- 8" Single Density CP/M™ — soon —
- 5¼" North Star™
- 5¼" Superbrain™
- Apple™ I Softcard™ CP/M

**OASIS SYSTEMS**

**(714) 291-9489**

**2765 Reynard Way, San Diego, CA 92103**

(3a)

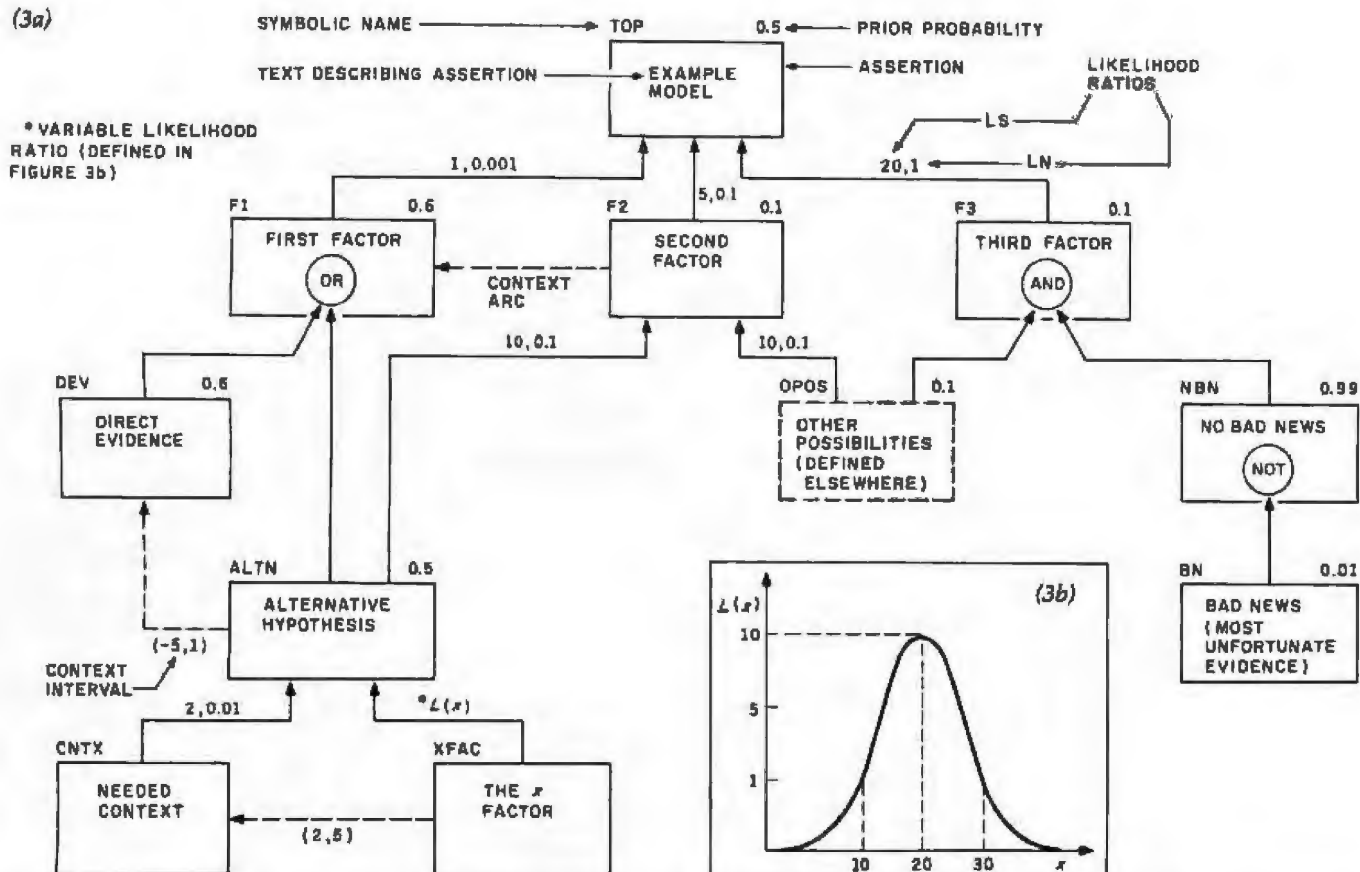

Figure 3: Diagram showing some of the constructs used in the PROSPECTOR inference networks. In figure 3a, boxes represent assertions. Each assertion's symbolic name is at the upper-left corner of the box and text describing the assertion is inside the box. Most assertions have prior probability values shown at the upper-right corner of the box. Evidence can be combined by logical connectives such as AND, OR, and NOT, represented by circles inside boxes; by plausible inference rules, indicated by two rule-strength values, LS and LN (LS indicates how sufficient the evidence is for establishing the hypothesis, if the evidence is present; LN indicates how necessary the evidence is for the hypothesis), and by variable likelihood ratios  $L(x)$ , defined in figure 3b. Dashed arrows indicate contextual constraints, which can "turn on or off" one question or a whole section of the network (at the tail of the arrow), depending on the answer to another question (at the head of the arrow). Figure 3b shows a plot defining a likelihood ratio  $L(x)$  for a numerical answer  $x$  to a question from PROSPECTOR. The likelihood ratio depends on the numerical value provided by the user.

plementing the knowledge base, the interpreter, and the data base. It also provides ways to escape to the host programming language to implement arbitrary procedures. The knowledge base can be represented either as sets of production rules or as frame systems (called units), or the two representations can be combined. For the interpreter, AGE supplies standard procedures for forward-chaining and backward-chaining, plus convenient ways to implement other strategies. The standard global data base is a so-called blackboard system (see reference 19). AGE also contains knowledge about its own facilities and procedures, and a tutor subsystem that lets the user browse in this on-line manual. A design subsystem provides on-line advice on the use of AGE itself.

The design of any programming language always involves a compromise among convenience, generality, and efficiency (in time or space). Clearly, systems like AGE, ROSIE, HEARSAY III, and RLL, are attempts to gain convenience, generality, and design-time efficiency for relatively modest additional cost in space and run-time efficiency. While there is not yet enough experience with such systems to assess their value, we expect them to play a significant role in future developments.

### PROSPECTOR: Sample System

Supported by the US Geological Survey and the National Science Foundation, we developed the PROSPECTOR system for mineral exploration

(see reference 11). PROSPECTOR contains rule-based models of different kinds of ore deposits. We developed each model by interviewing a geologist who is an authority on a particular class of deposits, and then translating the geologist's knowledge of the associations between field-observable evidence and relevant geological hypotheses into a structured collection of rules. PROSPECTOR models can perform these tasks: (1) evaluate the favorableness of a geologic district for a kind of ore, (2) evaluate the favorableness of a particular exploration site within a district, and (3) evaluate the favorableness of different drilling sites on an exploration site. In addition, PROSPECTOR can suggest which data are most valuable for further exploration, give the rationale

for conclusions reached, and provide informal education about each class of deposits.

PROSPECTOR uses a combination of artificial-intelligence techniques to perform these tasks. MYCIN-like rules link evidence to hypotheses, and offer the advantages of modularity and explicability. A mixed-initiative control strategy enables the user either to let the system use a backward-chaining strategy to gather information, or to interrupt the program to select different goals or to volunteer relevant information.

PROSPECTOR accommodates uncertainty in both evidence and rules. When PROSPECTOR asks yes-or-no questions, the user must indicate certainty about the answer on a scale from -5 to +5, where -5 is a certain no, 0 means don't know, and +5 is a certain yes. When PROSPECTOR asks for numerical input—for example, the geological age of a rock—PROSPECTOR also asks for the user's confidence in the answer.

Figure 3a illustrates the basic form of a PROSPECTOR inference network. Each box stands for an assertion and has a previously assigned

probability value. There are a variety of ways to combine evidence. These include logical operators such as AND, OR, and NOT, represented by circles, and plausible-inference rules, indicated by the likelihood ratios (rule-strength values) LS and LN. LS indicates how sufficient the evidence is for establishing the hypothesis if the evidence is present. LN indicates how necessary the evidence is for the hypothesis; that is, the degree to which the absence of this evidence will rule out the hypothesis. Both these likelihood ratios are multipliers. Thus, any value less than 1 decreases the likelihood of sufficiency or necessity; any value greater than 1 increases the likelihood.

For questions that request numerical input rather than yes-or-no answers, PROSPECTOR uses a plot like that shown in figure 3b to compute a likelihood ratio. The chart indicates the significance of ranges in the answer:  $x$  is the requested numerical quantity and  $L(x)$  is the likelihood ratio.

PROSPECTOR also uses contextual constraints, shown in figure 3a as dashed arrows. These work by telling

PROSPECTOR, in effect, "Don't even consider hypothesis A unless the likelihood of hypothesis B falls within such and such a range." The range is called the context interval. It is defined by two numbers on the -5 to +5 scale described earlier. The context interval (2,5), for example, indicates that PROSPECTOR shouldn't consider hypothesis A unless confidence in the truth of B is somewhere between lukewarm (+2) and absolutely certain (+5). The default context interval, in effect when no interval is shown, is (0,5).

Figure 4 shows an excerpt from a consultation with PROSPECTOR. Before the excerpt, the user volunteered observations about rocks and minerals at the prospective site. PROSPECTOR chose an initial hypothesis for investigation (that a certain type of copper deposit is present). At the start of the excerpt, PROSPECTOR is asking the user a series of questions to get additional information. In response to question 12, the user types "4" to indicate a relatively strong degree of certainty about the answer.

PROSPECTOR can accept a variety of answers to questions. For example, in answer to question 14, the user provides the term "cretaceous" to indicate a numerical range of values. When the user types "WHY" instead of answering question 13, PROSPECTOR prints an explanation of the question's geological significance. By typing "WHY" repeatedly, the user can learn more about the expertise captured in the model. After the explanation, PROSPECTOR repeats question 13 and the consultation goes on.

In response to any question, the user has options to seek clarification, change the course of the questioning, trace the implications of answers given, and so on. The consultation continues until PROSPECTOR has confirmed or rejected the hypothesis under consideration. PROSPECTOR then explains the basis of its conclusions in terms of the rules used.

Tests have shown that evaluations made by PROSPECTOR closely match those made by the geologists

The following questions are intended to establish the nature of the petrotectonic setting. (These questions will not be pursued unless a positive answer is given to the next question.)

- 12 — To what degree do you believe that the target area is in a continental-margin mobile belt? 4  
13 — Do you know the age of the continental-margin mobile belt? WHY

The vast majority of porphyry copper deposits are younger than 200 million years. Major age groups include:

1. An older group of 200 to 150 m.y. (million year) porphyries in British Columbia;
2. An important younger group of 70 to 50 m.y. deposits in the Mideast, British Columbia (Skeena Arch), and Arizona-New Mexico-Sonora (Laramide) copper province;
3. The major belt of 60 to 4 m.y. deposits in the Andes of Argentina, Chile, Peru, Ecuador, and Colombia.

<The explanation continues with additional information>

- 13 — Do you know the age of the continental-margin mobile belt? YES  
14 — What is the age of the continental-margin mobile belt? CRETACEOUS = 65 - 136 MILLION-YEARS  
What is your confidence in this estimate? 3

<The consultation continues on with many additional questions.>

**Figure 4:** An excerpt from a consultation with PROSPECTOR, which has chosen an initial hypothesis to investigate and is now asking the user for additional relevant information. The numerical answer to question 12 indicates the user's degree of certainty about a fact, using a -5 to +5 scale. If the user types "WHY" instead of answering a question, PROSPECTOR explains the question's geological significance.

# LOWEST PRICE - BEST QUALITY

## NORTH STAR



### North Star Horizon 2

2-5 1/4 Disk Drives  
32K Double Den  
Factory assem. & tested  
Factory guaranteed  
List \$3695

only **\$2697**

### POWERFUL NORTH STAR BASIC FREE SUPERB FOR BUSINESS & SCIENCE

FACTORY ASSEMBLED & TESTED	LIST	ONLY
HORIZON-2-64K-DOUBLE DEN	\$4195	\$3062
HORIZON-2-32K-QUAD DENSITY	\$3995	\$2918
HORIZON-2-64K-QUAD	\$4495	\$3281
HORIZON RAM ASSM 16K = \$279		32K = \$479
HORIZON RAM ASSM 48K = \$879		64K = \$879
<b>HORIZON DISK DRIVE SALE</b>		
DOUB DEN	SAVE!	\$ 445
NORTH STAR HARD DISK 18 Mb	\$5375	\$3923
NORTH STAR TIME SHARING MULTI-USER		CALL

## SUPERBRAIN ZENITH

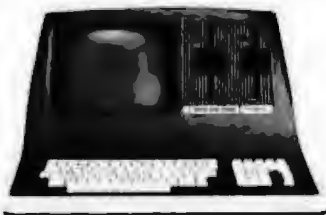

**SUPERBRAIN QD 64K**  
List \$3995 only \$2995



**Z-89 48K**  
List \$2895 only \$2299

## TERMINALS Z-19 \$725 INTERTUBE III only \$725

DYNABYTE COMPUTER—SAVE—PHONE  
EPSON MX-80—PHONE  
ANADEX 9501 \$1349

NEC PRINTER \$2639  
TRACTOR,  
THIMBLE, RIBBON  
DIP-81 \$395  
TEC LETTER QUAL \$1599



## InterSystems

### ITHACA INTERSYSTEMS 2A



Z-80A CPU 4 MHz  
64K Dynamic RAM  
Front panel  
V I/O—with interrupts  
FDCII Disk Controller  
20 slot motherboard

### CALL FOR PRICE— TOO LOW TO ADVERTISE!

PASCAL/Z + THE FASTEST PASCAL \$375  
Z-8000 & CACHE BIOS—POWERFUL—PHONE  
8086 16 BIT CPU & SUPPORT CARD SEATTLE \$695  
CALIFORNIA COMPUTER 2210A ONLY \$1795

## MORROW 8" DISK

DISCUS 2D + CP/M<sup>®</sup> 600K ONLY \$929  
DISCUS 2 + 2 + CP/M<sup>®</sup> 1.2 MEGA B. \$1240  
ADD DRIVES 2D = \$650 2 + 2 = \$975  
2D-DUAL + CP/M<sup>®</sup> ONLY \$1540  
FREE MBASIC FROM MORROW!!



**MORROW HARD DISK**  
26,000,000 BYTES!!  
LIST \$4995 ONLY \$3919  
CP/M<sup>®</sup> IS INCLUDED!

### SAVE ON MEMORY AND PROGRAMS

SYSTEMS MEMORY 64K A & T 4MHz	\$590	WORD STAR	\$315
SYSTEM MEMORY 64K BANK SELECT	\$740	SPECTRUM	\$289
ITHACA MEMORY 8/16-bit 64K	\$845	COMPUPRO	SAVE
SEATTLE MEMORY 8/16 BIT 16K	\$249	EZ-CODER Translates English to BASIC	\$71
SSM KITS Z-80 CPU	\$221	ECOSOFT FULL ACCOUNTING PKG	\$355
VIDEO BRO V83 4MHz	\$412	BOX OF DISKETTES	\$29
ANADEX PRINTER DP-9500-1	\$1349	SECRETARY WORD PROCESSOR	The Best! \$99
CAT NOVAION MODEM	\$169	GOFAST NORTH STAR BASIC	
ECONORAM 2A 8K AS5M	\$179	OPTIMIZER—FAST	\$71
NSSE 1-22 & P01 TERRIFIC PROGRAMS	ONLY \$10. EACH	Which Computers are BEST?	
NORTHWORD \$329 MAILMAN \$245		BROCHURE	FREE
INFOMAN	\$411	North Star Documentation refundable	w/HRZ \$36
TARBELL COMPUTER-PHONE			
AMERICAN SQUARE COMPUTERS BEATS ADV. PRICES			

# American Computers

919-889-4577

KIVETT DR. JAMESTOWN N.C. 27282

919-883-1105

® CP/M is a registered trademark of Digital Research, Inc.

who created the models; the numerical scores typically agree to within about seven percent on the average (see reference 15).

### Appropriate Tasks

While the systems we have described perform a wide variety of tasks, knowledge-based expert systems are more successful in handling some tasks than others. In general, the following are prerequisites for the success of a knowledge-based expert system:

- there must be at least one human expert acknowledged to perform the task well
- the primary source of the expert's exceptional performance must be special knowledge, judgment, and experience
- the expert must be able to explain the special knowledge and experience and the methods used to apply them to particular problems

●the task must have a well-bounded domain of application

Many scientific and technical tasks meet these conditions, especially where there is a tradition of consultation. Certain kinds of tasks are not good subjects for knowledge-based expert systems. For example, although a mathematician possesses specialized knowledge, the additional knowledge needed to function in that role is far more extensive than current knowledge-based expert systems can handle. On the other hand, where there are well-defined mathematical procedures for solving a problem, knowledge-based expert systems are unnecessary. For most perceptual problems, experts are unusual, relevant knowledge is extensive but difficult to pinpoint, and general understanding of the perceptual process is limited. And many tasks are still waiting for the first expert to appear. An example is earthquake prediction. There are now no

geologists who can predict earthquakes accurately. An expert system for earthquake prediction should not be expected to fare any better than the human sources of its knowledge base.

### The Future

We are now witnessing the first transition of expert programs from the comfortable surroundings of research laboratories to the more demanding world outside. For several years, the DENDRAL system has seen regular use by university and industrial chemists throughout the country. The Digital Equipment Corporation is using one version of R1 and is developing versions for other DEC systems. The PROSPECTOR system has been applied to several practical problems of the US Geological Survey and the US Department of Energy. PROSPECTOR has also made its first prediction about the location of a molybdenum deposit. Drilling is underway to see if there is a deposit where PROSPECTOR predicted (see photo 1).

Donald Michie and his colleagues at the University of Edinburgh are developing an expert system similar to PROSPECTOR to diagnose operating problems on North Sea oil platforms. Schlumberger is developing another expert system to interpret the waveforms obtained when instruments are dropped down oil wells. Finally, Michie and the Machine Intelligence Corporation have independently developed the first simplified expert systems that can be run on an Apple computer. The current generation of expert systems is being put to practical use, and many more systems will certainly be built.

Researchers have identified and are attacking several major problems that limit progress in knowledge-based systems. One of these problems concerns software support for research in this field. As our micro expert-system illustrates, BASIC is not the right language for implementing expert systems. Pascal and even LISP are not completely satisfactory either. New languages such as OPS-5, oriented

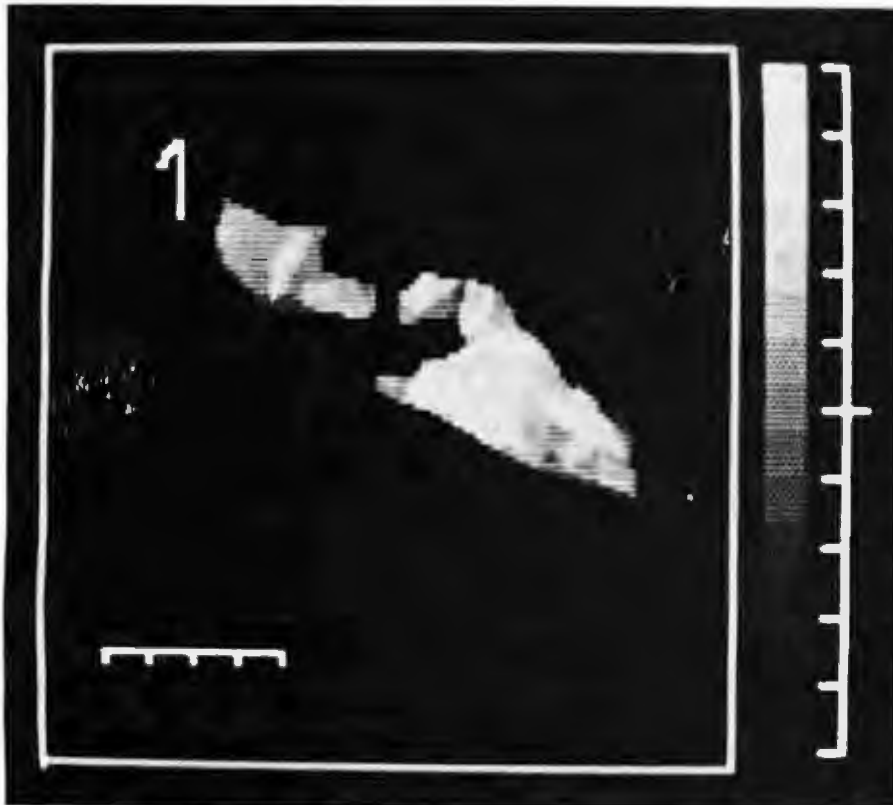

**Photo 1:** The area where PROSPECTOR predicts a molybdenum deposit. Given extensive data about the surface, PROSPECTOR used its rules to score areas of favorableness for molybdenum ore. Ore-grade molybdenum was previously found in the bright area on the right. PROSPECTOR predicts more ore will be found in the undrilled bright area on the left. The brighter the area, the higher its rating by PROSPECTOR. The site is in the Mount Tolman area of the state of Washington.



# Now a microcomputer financial planning program so advanced it's like having a main frame on every desk.

## Introducing FPL™

FPL is the remarkable new Financial Planning Language software that, for the first time, turns the microcomputer into the most sophisticated financial planning tool.

## FPL is comprehensive.

Incredibly, FPL is comparable in capabilities to Autotab™ and other successful packages previously available only on main frame computers.

With FPL, you can plan, analyze, project, track and control an enormous number of business variables with a single microcomputer program.

FPL can perform such functions as Profit and Loss Forecasts, Budget Planning and Consolidation, Acquisition or Merger Analysis, Capital Investment Analysis, Product Line Planning and many more.

Unique features include the handling of complex rules that are necessary with varying tax rates and the conditional handling of investment tax credits.

With FPL, you can preview the results on the screen and then use the powerful report generator to produce

presentation-quality financial reports directly.

**FPL: an alternative to time-sharing.**

FPL gives you the same

conversational ease of time-sharing, enhanced with a screen-oriented Decision Support System, with none of the runaway costs. You are able to try many more alternatives, examine many more options, and better understand models.

Priced at only \$695, FPL gives you improved service and reduces costs.

FPL runs on most small business computers with CP/M® or similar operating systems.

**Get full support from Lifeboat.**

FPL is brought to you exclusively and supported completely by Lifeboat Associates, world's largest computer software marketer. For more information about this revolutionary financial planning package and how you can profit from it, send us the coupon below.



Mail coupon to: Lifeboat Associates, 1651 Third Ave., NY, NY 10028 Or call (212) 860-0300

Please send me more information on FPL.  
 Please send me a free Lifeboat catalog.

Name \_\_\_\_\_ Title \_\_\_\_\_

Company \_\_\_\_\_

Street \_\_\_\_\_

City \_\_\_\_\_ State \_\_\_\_\_ Zip \_\_\_\_\_

FPL is a trademark of Information Access  
 CP/M is a trademark of Digital Research, Inc  
 Autotab is a trademark of Capex Corporation



Lifeboat Associates  
 1651 Third Ave.  
 New York, NY 10028  
 Tel: (212) 860-0300  
 Telex: 640693 (LBSOFT NYN)  
 FAX: 710-518-2524

Lifeboat Inc.  
 OK Bldg. 3F  
 1-2-6, Shiba-Danjon  
 Minato-ku, Tokyo, 105 Japan  
 Tel: 03-437-2901  
 Telex: 2422723 (ASRYTO)

Lifeboat Associates, Ltd  
 PO Box 125  
 London WC2N 9LU England  
 Tel: 01-836-9028  
 Telex: 893709 (LBSOFTG)

Lifeboat Associates GmbH  
 PO Box 168, Algerstrasse 35  
 CH 6340 Basel, Switzerland  
 Tel: 042-31-2931  
 Telex: 965265 (MICO CH)

Intersoft GmbH  
 Schlossgartenweg 5  
 D 8045 Gmanning, W Germany  
 Tel: 089-386-444  
 Telex: 5213643 (ISOFTD)

Lifeboat Associates, SARL  
 10, Grande Rue Charles de Gaulle  
 92600 Asnieres, France  
 Tel: 1-733-08-04  
 Telex: 250303 (PUBLIC X PARIS)

LIFEBOAT WORLDWIDE offers you the world's largest library of software. Contact your nearest dealer or Lifeboat.

## Lifeboat Associates

Software with full support

Listing 1: A rule-based, animal-identification program in BASIC. This is based on the DIAGNOSE program found in chapter 18 of LISP by P H Winston and B K P Horn. The core subroutine is VERIFY (lines 1210 through 1830), which is recursive. Since BASIC does not support recursion, all reentrant subroutines must explicitly save their local values on push-down stacks before transferring control.

```

00010 REM A RULE-BASED IDENTIFICATION PROGRAM
00020 REM Based on the DIAGNOSE program in Chapter 18 of the book
00030 REM "LISP" by P. H. Winston and B. K. P. Horn
00040 REM
00050 REM A$ = array of asked questions
00060 REM A1 = current number of asked questions
00070 REM A9 = maximum number of asked questions
00080 REM F$ = array for facts
00090 REM F1 = current number of facts
00100 REM F9 = maximum number of facts
00110 REM H$ = array for top-level hypotheses
00120 REM H1 = current top-level hypothesis
00130 REM H8 = current number of top-level hypotheses
00140 REM H9 = maximum number of top-level hypotheses
00150 REM Q = array of rule numbers for deducing a goal hypothesis
00160 REM (size = R9/5)
00170 REM Q8 = current number of relevant rules
00180 REM R$ = array for rules
00190 REM R1 = current rule index
00200 REM R2 = current antecedent
00210 REM R7 = current number of rules
00220 REM R8 = current number of bytes used for rules
00230 REM R9 = maximum number of bytes in R$
00240 REM R = array of pointers into R$ (size = R9/5)
00250 REM R1 = current rule pointer
00260 REM S$ = stack array for strings
00270 REM S1 = stack pointer for S$
00280 REM S9 = size of S$
00290 REM S = stack array for numbers
00300 REM S2 = stack pointer for S
00310 REM S8 = size of S
00320 REM
00330 REM -----
00340 REM INITIALIZE
00350 DIM A$(100),F$(100),H$(20),Q(50),R$(250),R(50),S$(200),S(200)
00360 A9 = 100
00370 F9 = 100
00380 H9 = 20
00390 R9 = 250
00400 S8 = 200
00410 S9 = 200
00420 S1 = 0
00430 S2 = 0
00440 PRINT "Hello."
00450 REM CALL LOADRULES TO INITIALIZE R AND R$; R7 = COUNT OF RULES
00460 GOSUB 3680
00470 IF R7 > 0 THEN 500
00480 PRINT "No rules."
00490 STOP
00500 REM CALL LOADHYPOTHESES TO INITIALIZE H$, H8 = COUNT OF HYPOTHESES
00510 GOSUB 4100
00520 IF H8 > 0 THEN 550
00530 PRINT "No hypotheses."
00540 STOP
00550 PRINT "I will use my ";R7;" rules to try to establish one of the"
00560 PRINT "following ";H8;" hypotheses:"
00570 FOR H1 = 1 TO H8
00580 PRINT " ";Z$;H$(H1)
00590 NEXT H1
00600 PRINT
00610 PRINT "Please answer my questions with Y (yes), N (no), or W (why)."

```

Listing 1 continued on page 266

toward production development, and new expert-system-building systems such as AGE, HEARSAY III, and RLL are the first of a new generation of software tools that will simplify system development.

On a more fundamental level, something must be done to shorten the time needed to interview experts and represent their special knowledge in the form of rules. This is often called the knowledge-acquisition problem. Despite several concentrated efforts, it remains a bottleneck. The development of a model containing a few hundred rules may now take several months of the expert's time and even more of the system builder's. Past efforts to speed knowledge acquisition have been along three lines: (1) to develop smart editors that assist in entering and modifying rules, (2) to develop an intelligent interface that can interview the expert and formulate the rules, and (3) to develop a learning system that can induce rules from examples, or by reading textbooks and papers.

Somewhat ironically, to do anything ambitious along these lines seems to require fundamental advances in our understanding of two core AI topics—the representation of knowledge and the use of knowledge! The problem is that although inference networks of rules do much to codify the reasoning process that an expert uses in solving a problem, there's still much that goes on inside an expert's head that doesn't appear in the networks. Basically, a knowledge-based system provides a flexible yet precise language that an expert can use to describe the chains of reasoning. We need to develop more expressive languages that allow the expert to articulate more of the nuances and details of thought processes. One of the problems is that it is difficult for experts to describe exactly how they do what they do, especially with respect to their use of judgment, experience, and intuition. We are optimistic that such advances will be made, but will resist the temptation to make more specific guesses.

The knowledge-acquisition issue touches on an important side effect of

# Quick, name the only working 5 1/4" Hard Disk Controller Cards You can order off-the-shelf!

## The 5 1/4" Hard Disk Controller Packages from ACT.

Now you can pick up your phone and order the only working digital data separator based 5 1/4" controller cards for your Zenith/Heath, TRS-80, S-100, and Superbrain micro-computer systems.

And software too! Every disk controller package comes complete with CP/M 2.2 and all of the software required to install the hard disk on your system. And best of all, we include full source of every file supplied which was written by ACT. Packages for H89, TRS-80, and Superbrain are preconfigured for those systems. Just install the hardware and boot the system.

But beware, these controller packages are proving themselves to major U.S. and European OEM manufacturers as very efficient little jewels. Once you plug-in our 5 1/4" hard disk and controller cards, you may not recognize your computer. . .

5,000,000 super-fast bytes will transform your microcomputer into a high-throughput workhouse. Faster turn-around and greater efficiency are so obvious that it'll leave you wondering how you put up with the slower, less reliable 5 1/4" or 8" floppies.

The fact that our patent pending HOP Digital Data Separator gives our controller packages maintenance-free reliability should convince even the dyed-in-the-wool 5 1/4" or 8" floppy disk fanatics.

5 1/4" hard disks are the way of the future and ACT has an affordable, efficient 5 1/4" hard disk package you can order off-the-shelf. Just pick up your phone and call us.

## High-performance meets low cost.

In terms of byte-per-dollar cost, 5 1/4" Winchester types are up to five times more affordable than 5 1/4" floppies. In terms of reliability, efficiency and sheer speed, the 5 1/4" hard disks blow everything else right out of the water.



ACT manufactures quality controller card packages with low-cost and high-performance in mind. Even the first ACT HOP controller card package we delivered to Western Europe is still running like a dream. So are our other deliveries.

So if you're looking for the way to affordably upgrade your own microcomputer system, or your whole company's microcomputer system, call the company that introduced high-performance to low-cost.

## Plug-it-in; turn-it-on.

You can order our products in any configuration you desire. Order just the HOP Digital Data Separator, or just the controller card package.

Or, you can order fully assembled CRT terminals with an integrated 5 1/4" Winchester Hard Disk and controller card package. Should you want a 5 1/4" floppy back-up, you can order our dual 5 1/4" hard disk and floppy combination.



Whatever you order, remember that our units feature simple, standard plug-in compatibility with your Zenith/Heath, TRS-80,\* S-100 or Superbrain\* micro-computers. Just plug-it-in and turn-it-on.

Call ACT today for your 5 1/4" hard disk needs; we believe our products will impress you and your computer. Call (703) 471-9750.



# \$1,250.

(single quantity) for the complete ACT 5 1/4" Hard Disk Controller Card Package. Hard Disks, CRT Terminals, etc. are priced extra. Substantial OEM and dealer discounts are available.

act

American Computer  
and Telecommunications  
Corporation

Circle 18 on inquiry card.

11301 Sunset Hills Road  
Reston Virginia 22090  
(703) 471-9750

\*TRS-80 is a trademark of RADIO SHACK, a division of Tandy Corporation  
SUPERBRAIN is a trademark of INTERTEC DATA SYSTEMS

Listing 1 continued:

```
00730 REM CALL POP(X$) TO GET ANSWER
00740 GOSUB 1040
00750 IF X$ <> "" THEN 800
00760 NEXT H1
00770 REM FAILURE
00780 PRINT "No hypothesis can be confirmed."
00790 GOTO 820
00800 REM SUCCESS
00810 PRINT "I conclude that ";Z$;R$(R1);"."
00820 PRINT
00830 PRINT "Restart or Quit (R or Q)";
00840 INPUT C$
00850 IF C$ = "R" THEN 640
00860 IF C$ <> "Q" THEN 830
00870 STOP
00880 REM -----
00890 REM SUBROUTINE PUSH(X$)
00900 IF S1 < S9 THEN 930
00910 PRINT "STRING STACK OVERFLOW"
00920 STOP
00930 S1 = S1 + 1
00940 S$(S1) = X$
00950 RETURN
00960 REM -----
00970 REM SUBROUTINE PUSH(X)
00980 IF S2 < S8 THEN 1010
00990 PRINT "NUMBER STACK OVERFLOW"
01000 STOP
01010 S2 = S2 + 1
01020 S(S2) = X
01030 RETURN
01040 REM -----
01050 REM SUBROUTINE POP(X$)
01060 IF S1 > 0 THEN 1090
01070 PRINT "STRING STACK UNDERFLOW"
01080 STOP
01090 X$ = S$(S1)
01100 S1 = S1 - 1
01110 RETURN
01120 REM -----
01130 REM SUBROUTINE POP(X)
01140 IF S2 > 0 THEN 1170
01150 PRINT "NUMBER STACK UNDERFLOW"
01160 STOP
01170 X = S(S2)
01180 S2 = S2 - 1
01190 RETURN
01200 REM -----
01210 REM SUBROUTINE VERIFY(F1$, Y)
01220 REM ATTEMPTS TO PROVE THAT FACT F1$ IS TRUE
01230 REM CALL RECALL TO SEE IF WE ALREADY KNOW F1$
01240 F2$ = F1$
01250 GOSUB 1840
01260 IF R2$ <> "" THEN 1760
01270 REM F1$ NOT CURRENTLY KNOWN; CALL INTHEM TO FIND RULES THAT DEDUCE IT
01280 GOSUB 2100
01290 REM ANSWER IS IN Q, WITH Q(0) THE COUNT; ARE THERE ANY RULES?
01300 Q8 = Q(0)
01310 IF Q8 > 0 THEN 1360
01320 REM NO RULES; CALL ASK TO ASK THE USER
01330 GOSUB 2320
01340 IF A1$ = "" THEN 1790
01350 GOTO 1760
01360 REM CHAIN BACKWARD THROUGH THE RULES RECURSIVELY
01370 Q1 = 1
01380 REM PUSH NEEDED LOCAL VARIABLES
01390 X$ = F1$
01400 GOSUB 880
01410 X = Y
01420 GOSUB 960
01430 FOR Q2 = 1 TO Q8
01440 X = Q(Q2)
01450 GOSUB 960
01460 NEXT Q2
01470 X = Q8
01480 GOSUB 960
01490 X = Q1
01500 GOSUB 960
```

Listing 1 continued on page 268

the development of expert systems: the exercise of building a knowledge base for a problem area forces the expert to think through the problem in a precise and thorough manner. The resulting codification benefits the basic science itself. For example, models of mineral deposits have appeared for years in the literature of economic geology, but these models have traditionally been expressed in English prose, accompanied by schematic geological sketches and maps. Such models are meaningful to geologists, but they are descriptive rather than predictive. Furthermore, many details are left unstated because the author assumes that the readers will understand what is meant. Since the development of PROSPECTOR, there seems to be more interest among geologists in developing models more precise than those of the past.

We pay dearly for expertise when we need it, whether it's for fixing a home appliance or for finding oil. Knowledge-based expert systems offer the potential of codifying and disseminating expertise to those who don't have it. In effect, knowledge-based expert systems offer the promise of putting experts at everyone's disposal.

### A Simple Rule-Based System

Most rule-based expert systems are large programs written in LISP, too big for today's personal computers. However, it is possible to write a small rule-based program that is both entertaining and educational.

The BASIC program shown in listing 1 implements a simple version of the backward-chaining procedure used in MYCIN. This program is essentially a recoding of the DIAGNOSE program used by Winston and Horn in their book *LISP* (see reference 35) to explain rule-based systems, and includes their set of fifteen rules for identifying animals. The network formed by these rules is depicted in figure 5. While these rules are too few and too simple for serious use, you might have fun changing them and creating

Text continued on page 274

# MULTI-USER OASIS HAS THE FEATURES PROS DEMAND. READ WHY.

*Computer experts (the pros) usually have big computer experience. That's why when they shop system software for Z80 micros, they look for the big system features they're used to. And that's why they like Multi-User OASIS. You will too.*

## DATA INTEGRITY: FILE & AUTOMATIC RECORD LOCKING

The biggest challenge for any multi-user system is co-ordinating requests from several users to change the same record at the same time.

Without proper co-ordination, the confusion and problems of inaccurate or even destroyed data can be staggering.

Our File and Automatic Record Locking features solve these problems.

For example: normally all users can view a particular record at the same time. But, if that record is being updated by one user, automatic record locking will deny all other users access to the record until the up-date is completed. So records are always accurate, up-to-date and integrity is assured.

Pros demand file & automatic record locking. OASIS has it.

## SYSTEM SECURITY: LOGON, PASSWORD & USER ACCOUNTING

Controlling who gets on your system and what they do once they're on it is the essence of system security.

## (THEN COMPARE.)

Without this control, unauthorized users could access your programs and data and do what they like. A frightening prospect isn't it?

And multi-users can multiply the problem. But with the Logon, Password and Privilege Level features of Multi-User OASIS, a system manager can specify for each user which programs and files may be accessed—and for what purpose.

Security is further enhanced by User Accounting—a feature that lets you keep a history of which user has been logged on, when and for how long.

Pros insist on these security features. OASIS has them.

## EFFICIENCY: RE-ENTRANT BASIC

A multi-user system is often not even practical on computers limited to 64K memory.

OASIS Re-entrant BASIC makes it practical.

How? Because all users use a single run-time BASIC module, to execute their compiled programs, less

memory is needed. Even if you have more than 64K, your pay-off is cost saving and more efficient use of all the memory you have available—because it services more users.

Sound like a pro feature? It is. And OASIS has it.

## AND LOTS MORE...

Multi-User OASIS supports as many as 16 terminals and can run in as little as 56K memory. Or, with bank switching, as much as 784K.

Multi-Tasking lets each user run more than one job at the same time.

And there's our BASIC—a compiler, interpreter and debugger all in one. An OASIS exclusive.

Still more: Editor; Hard & Floppy Disk Support; Keyed (ISAM), Direct & Sequential Files; Mail-Box; Scheduler; Spooler; all from OASIS.

Our documentation is recognized as some of the best, most extensive, in the industry. And, of course, there's plenty of application software.

Put it all together and it's easy to see why the real pros like OASIS. Join them. Send your order today.

OASIS IS AVAILABLE FOR SYSTEMS Altos, CompuCorp, Cromemco, Delta Products, Digital Group, Digital Microsystems, Dynabyte, Godbout, IBC, Index, Intersystems, North Star, Onyx, SO Systems, TRS 80 Mod II, Vector, Graphic, Vorimex.

CONTROLLERS Bell Controls, Cameo, Corvus, Konan, Micromation, Micropolis, Tarbell, Teletek, Thinkertoys, X Comp.

Write for complete free Application Software Directory.

## PLEASE SEND ME:

Product	Price with Manual	Manual Only
<b>OPERATING SYSTEM</b> (Includes: EXEC Language, File Management, User Accounting, Device Drivers, Print Spooler, General Text Editor, etc.) SINGLE-USER MULTI-USER	5150 350	\$17.50 17.50
<b>BASIC COMPILER/INTERPRETER/DEBUGGER</b>	100	15.00
<b>RE-ENTRANT BASIC COMPILER/INTERPRETER/DEBUGGER</b>	150	15.00
<b>DEVELOPMENT PACKAGE</b> (Macro Assembler, Linkage Editor, Debugger)	150	25.00
<b>TEXT EDITOR &amp; SCRIPT PROCESSOR</b>	150	15.00
<b>DIAGNOSTIC &amp; CONVERSION UTILITIES</b> (Memory Test, Assembly Language, Converters, File Recovery, Disk Test, File Copy from other OS, etc.)	100	15.00
<b>COMMUNICATIONS PACKAGE</b> (Terminal Emulator, File Send & Receive)	100	15.00
<b>PACKAGE PRICE</b> (All of Above) SINGLE-USER MULTI-USER	500 850	60.00 60.00
<b>FILE SORT</b>	100	15.00
<b>COBOL-ANSI '74</b>	750	35.00

Order OASIS from  
**Phase One Systems, Inc.**  
7700 Edgewater Drive, Suite 830  
Oakland, CA 94621

Telephone (415) 562-8085  
TWX 910-366-7139

NAME \_\_\_\_\_  
STREET (NO BOX #) \_\_\_\_\_  
CITY \_\_\_\_\_  
STATE \_\_\_\_\_ ZIP \_\_\_\_\_

AMOUNT \$ \_\_\_\_\_  
(Attach system connection;  
add \$3 for shipping;  
California residents add sales tax)  
 Check enclosed  VISA  
 UPS C.O.D.  Mastercharge  
Card Number \_\_\_\_\_  
Expiration Date \_\_\_\_\_  
Signature \_\_\_\_\_

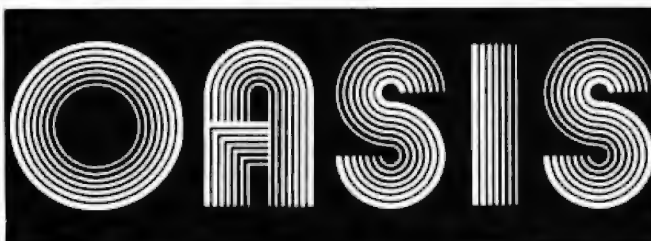

**MAKES MICROS RUN LIKE MINIS**

**Price/Performance  
Breakthrough!**

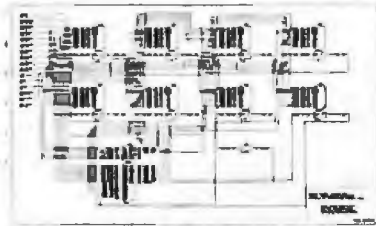
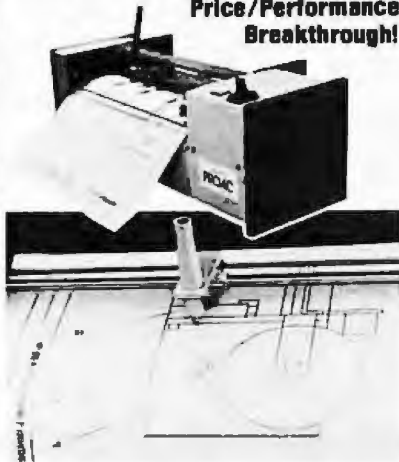

Courtesy of DASOFT DESIGN SYSTEMS

**Mauro MP-250B Proac**

**The \$775 pen plotter that gives professional accuracy with superb line quality!**

Mauro's design innovations make it possible to produce a high quality, low cost plotter that out-performs every other plotter of comparable price on the market today. In fact, its line quality matches that of plotters costing \$2,000 or more.

Proac draws with .005"/step resolution and ± 0.5% @ 17" degree of accuracy at speeds of 2.5" per second or higher. A unique multi-point paper drive helps achieve this level of accuracy, making Proac suitable for a wide variety of applications.

Currently the MP-250B and the newer MP-300 are being used in Surveying, in Design Automation for logic diagrams and printed circuit layout, and in CAD drafting systems. The MP-250B and MP-300 are the only low cost plotters that have the speed, accuracy, repeatability, and line quality necessary to meet these demanding applications. If your need is for professional plotting consider one of our plotters or one of our soon to be announced larger format models.

Proac comes with full vector driving software for 8080, 6502, and 6800 based computers. Interfaces are available for Apple, and PET. With the addition of the SIA 250 intelligent interface, Proac becomes compatible with any computer.

Contact Mauro Engineering about complete information and specifications for MP-250B Proac and available software

**MAURO ENGINEERING**

2220 Pack Trail  
Mount Shasta, California 96067  
Telephone 916 926-4406

*Listing I continued:*

```

01510 REM  SETUP ARGUMENTS AND GOTO TRYRULE+(R1, Y)
01520 R1 = Q(Q1)
01530 Y = 2
01540 GOTO 2840
01550 REM  POP AND SAVE THE ANSWER, AND POP THE LOCAL VARIABLES
01560 GOSUB 1040
01570 X1$ = X$
01580 GOSUB 1120
01590 Q1 = X
01600 GOSUB 1120
01610 Q8 = X
01620 FOR Q2 = Q8 TO 1 STEP -1
01630 GOSUB 1120
01640 Q(Q2) = X
01650 NEXT Q2
01660 GOSUB 1120
01670 Y = X
01680 GOSUB 1040
01690 F1$ = X$
01700 IF X1$ = "T" THEN 1760
01710 REM  RATS, RULE R1 DIDN'T WORK; TRY THE NEXT ONE
01720 Q1 = Q1 + 1
01730 IF Q1 <= Q8 THEN 1380
01740 REM  CURSES, NONE OF THE RULES WORKED
01750 GOTO 1790
01760 REM  SUCCESS
01770 X$ = "T"
01780 GOTO 1810
01790 REM  FAILURE
01800 X$ = ""
01810 REM  PUSH THE ANSWER AND RETURN
01820 GOSUB 880
01830 ON Y GOTO 730,1550,2950,3300
01840 REM
-----
01850 REM  SUBROUTINE RECALL(F2$)
01860 REM  CHECKS TO SEE IF FACT F2$ HAS BEEN RECORDED
01870 R2$ = ""
01880 IF F1 = 0 THEN 1940
01890 FOR I = 1 TO F1
01900 IF F2$ = F$(I) THEN 1930
01910 NEXT I
01920 GOTO 1940
01930 R2$ = F2$
01940 RETURN
01950 REM
-----
01960 REM  SUBROUTINE REMEMBER(F2$)
01970 REM  RECORDS FACT F2$
01980 R1$ = ""
01990 REM  CALL RECALL TO SEE IF ALREADY STORED
02000 GOSUB 1840
02010 IF R2$ <> "" THEN 2090
02020 REM  ADD NEW FACT
02030 IF F1 < F9 THEN 2060
02040 PRINT "OUT OF ROOM FOR RECORDING FACTS"
02050 STOP
02060 F1 = F1 + 1
02070 F$(F1) = F2$
02080 R1$ = F2$
02090 RETURN
02100 REM
-----
02110 REM  SUBROUTINE INTHEN(F1$)
02120 REM  FINDS ALL THE RULES THAT HAVE FACT F1$ AS A CONSEQUENT
02130 Q(0) = 0
02140 REM  LOOP THROUGH THE RULES
02150 FOR R3 = 1 TO R7
02160 REM  FIND THE CONSEQUENTS OF RULE R3
02170 R4 = R(R3) + 2
02180 F2$ = R$(R4)
02190 IF F2$ = "THEN" THEN 2220
02200 R4 = R4 + 1
02210 GOTO 2180
02220 REM  LOOP THROUGH THE CONSEQUENTS
02230 R4 = R4 + 1
02240 F2$ = R$(R4)
02250 IF F2$ = "STOP" THEN 2300
02260 IF R$(R4+1) = "IF" THEN 2300
02270 IF F2$ <> F1$ THEN 2230
02280 Q(0) = Q(0) + 1
02290 Q(Q(0)) = R3

```

*Listing I continued on page 270*

# Comes the revolution in Apple word processing. PowerText. From Beaman Porter.



Mr. Joe Sullivan, Jr.  
Joe Sullivan & Associates, Inc.  
1270 Avenue of the Americas  
New York, New York 10020

Dear Joe,

I've produced this letter to you using our APPLE computer and our new PowerText word processing system. PowerText is absolutely remarkable. There's nothing else like it ... anywhere.

I didn't have to do any formatting at all. All I did was enter the copy plus a few simple commands. Then I did some editing, because I changed my mind about a few words here and there.

PowerText did the rest. A perfect letter!

Wait till you see how PowerText handles our presentations. You won't believe how sophisticated a word processing system can be.

-- you get hold of PowerText right now. It's the most powerful word processing tool for a growing business.

## Type this in.

## Get this out!

Put out a letter on your Apple's keyboard just as fast as you can.

Forget all about format. Keep on going.

As you go, just type in simple, short commands to identify the name and address element ... the salutation ... paragraphs ... and sign-off.

Do your editing: Make any changes you like.

Then ... tell PowerText to go to work.

In seconds a perfectly formatted letter starts rolling out of your printer. With every word exactly where you want it.

And for an encore PowerText also addresses your mailing envelope.

It's a true revolution in Apple word processing software. New ... from Beaman Porter.

**Formats every document flawlessly.**

PowerText knows precisely how you like your letters to look. And your memos. Your reports. Your presentations. Your manuscripts.

Every correspondence element, "TO" and "FROM" line, chapter heading, column of statistics, and paragraph ... is exactly where you want it.

Beautiful!

**The editing power of PASCAL, the formatting power of PowerText.**

PowerText adds its own total document format control to the Pascal editor's exquisite capabilities.

Result: you get perfect formatting ... plus full insert, delete, and global search and replace capabilities. In one remarkable system.

Plus ... with a letter quality printer ... the ability to print in from 6 to 15 pitch. And you can use a variety of pitches within any document!

**Intelligent word processing decisions.**

You never have to worry about page breaks, or winding up with "Yours truly" all by itself on page 2 of your letter.

PowerText makes exactly the right decisions about all that for you.

And it automatically tracks your footnote or bibliography numbers

**Column formats are a snap.**

PowerText accommodates up to 12 columns per 132-character line. With individual line spacing for each column.

It lets you left- or right-justify—or center—each column separately. Or print any column in paragraph style. And there are no tab settings to set for columnar reports; PowerText does the arithmetic for you.

**PowerText requires 48 K APPLE II or APPLE II PLUS, two disk drives, and PASCAL language system, plus a Qume, Diablo, or Epson printer.**

**FULL 5-YEAR WARRANTY!**

PowerText has been proven with the most demanding tests ... and texts ... we could devise. It always works. If it should fail to perform as specified ... for a full 5 years ... send it back. We'll fix it at no charge.



APPLE is a registered trademark of Apple Computer, Inc. USCD PASCAL is a registered trademark of UC, Regents. POWERTEXT is a registered trademark of Beaman Porter, Inc.

Circle 37 on inquiry card.

**Limited Time Introductory Offer.**

The operating ease, scope, and sophistication of PowerText go far beyond any other word processing software ... at any price.

Yet PowerText, plus its excellent Manual/Tutorial, are available now at the Special Introductory Price of only \$199. (Manual/Tutorial alone, only \$25 ... deductible from the \$199 package price when you order the disk later.)

Available from selected dealers nationwide, or direct from



**BEAMAN PORTER, INC.**  
High Performance Computer Products

Pleasant Ridge Road, Harrison, NY 10528  
(914) 967-3504

**BEAMAN PORTER, INC.** B91  
Pleasant Ridge Road, Harrison, NY 10528

Send \_\_\_\_\_ complete PowerText system(s) (Disk plus Manual/Tutorial) @ \$199

Send \_\_\_\_\_ copies of the Manual/Tutorial only @ \$25 (deductible from the \$199 total system price when I order the Disk later)

My check or money order for \_\_\_\_\_ enclosed. Or, bill \_\_\_\_\_ to my:

Mastercard  Visa  
(Mastercard only, list 4 digits above your name \_\_\_\_\_)

Card No \_\_\_\_\_ Exp Date \_\_\_\_\_  
Signature \_\_\_\_\_ Date \_\_\_\_\_

Name \_\_\_\_\_  
Street \_\_\_\_\_  
City, State, Zip \_\_\_\_\_

I understand my PowerText Disk is warranted for a full five years. Should it fail to perform as specified, Beaman Porter, Inc. will fix it for me at no charge.

**If you're looking for  
the best prices  
in the U.S.A. on**



# TRS-80 MICROCOMPUTERS

We have consistently offered the TRS-80 line at savings up to 20%. You can save up to \$1500 by buying from Computer Discount of America.

# ATARI® MICROCOMPUTERS



We have the full line of ATARI personal computers and systems.

<b>Model II</b>		
26-4002	64K, 1 disc	\$3385.00
<b>Model III</b>		
26-1061	4K, Level I	\$ 810.00
26-1062	16K, Level III	\$ 845.00
26-1066	48K, Level II 2-drive/RS-232	\$2115.00
<b>Color Computer</b>		
26-3001	4K	\$ 329.00
26-3002	16K w/Ext. Basic	\$ 499.00
<b>EPSON</b>		
MX70	Printer	\$ 375.00
MX80	Printer	\$ 485.00
MX80FT	Printer	\$ 639.00

Our savings are as big on expansion interfaces, printers, diskettes, Apple Computers, OKIDATA Microline, C-ITOH Starwriter, Lexicon Modems — everything for your computer. We have the largest inventory in the Northeast, and most models are in stock, for immediate delivery. Our full price catalog or a price quote is as near as your phone.

**CALL TOLL FREE:  
800-526-5313**

**Computer  
Discount  
of America**

COMPUTER DISCOUNT OF AMERICA, INC.  
15 Marshall Hill Road, West Milford Mall  
West Milford, New Jersey 07480  
In New Jersey Call 201-728-8080

Listing 1 continued:

```

02300 NEXT R3
02310 RETURN
02320 REM -----
02330 REM SUBROUTINE ASK(F1$)
02340 REM ASKS THE USER ABOUT F1$ AND EXPLAINS ITS REASON
02350 A1$ = ""
02360 REM HAVE WE ASKED THE USER ABOUT F1$ BEFORE?
02370 IF A1 = 0 THEN 2410
02380 FOR A2 = 1 TO A1
02390 IF F1$ = A$(A2) THEN 2830
02400 NEXT A2
02410 REM WE HAVEN'T ASKED BEFORE. IF WE HAVE ROOM, LET'S ASK.
02420 IF A1 < A9 THEN 2450
02430 PRINT "OUT OF ROOM FOR ASKED QUESTIONS"
02440 STOP
02450 A1 = A1 + 1
02460 A$(A1) = F1$
02470 PRINT "Is this true: ";Z$(F1$);
02480 INPUT C$
02490 IF C$ = "Y" THEN 2790
02500 IF C$ = "N" THEN 2830
02510 IF C$ <> "W" THEN 2470
02520 REM THE USER WANTS TO KNOW WHY I ASKED
02530 REM ARE WE WORKING ON A RULE?
02540 IF F1$ <> H$(H1) THEN 2590
02550 REM NO, F1$ IS A TOP-LEVEL HYPOTHESIS
02560 PRINT "One of the possibilities is ";Z$(F1$)
02570 PRINT "Unfortunately, I have no way to deduce this except to ask you."
02580 GOTO 2470
02590 REM YES. F1$ IS A SUBGOAL. PRINT RULE R1
02600 PRINT "I am trying to use Rule ";R$(R(R1))
02610 R3 = R(R1) + 2
02620 IF R3 = R2 THEN 2670
02630 PRINT "I already know that:"
02640 PRINT Z$(R$(R3))
02650 R3 = R3 + 1
02660 IF R3 < R2 THEN 2640
02670 PRINT "IF:"
02680 PRINT Z$(R$(R3))
02690 R3 = R3 + 1
02700 IF R$(R3) <> "THEN" THEN 2680
02710 PRINT "THEN:"
02720 R3 = R3 + 1
02730 PRINT Z$(R$(R3))
02740 R3 = R3 + 1
02750 IF R$(R3) = "STOP" THEN 2770
02760 IF R$(R3+1) <> "IF" THEN 2730
02770 PRINT
02780 GOTO 2470
02790 REM THE USER SAYS THAT F1$ IS TRUE; CALL REMEMBER TO RECORD IT
02800 F2$ = F1$
02810 GOSUB 1950
02820 A1$ = "T"
02830 RETURN
02840 REM -----
02850 REM SUBROUTINE TRYRULE+(R1, Y)
02860 REM TRIES TO APPLY RULE R1
02870 REM PUSH NEEDED LOCAL VARIABLES
02880 X = R1
02890 GOSUB 960
02900 X = Y
02910 GOSUB 960
02920 REM SETUP ARGUMENTS AND GOTO TESTIF+(R1, Y)
02930 Y = 3
02940 GOTO 3130
02950 REM POP THE RESULTS OF TESTIF+ AND RESTORE LOCAL VARIABLES
02960 GOSUB 1040
02970 GOSUB 1120
02980 Y = X
02990 GOSUB 1120
03000 R1 = X
03010 IF X$ = "" THEN 3080
03020 REM CALL USETHEN
03030 GOSUB 3460
03040 IF U1$ = "" THEN 3080
03050 REM SUCCESS
03060 X$ = "T"
03070 GOTO 3100
03080 REM FAILURE
    
```

Listing 1 continued on page 272



# COMPUTERS—TERMINALS—MODEMS!

## MODEMS AND COUPLERS

Connect your Apple, TRS-80 or any other computer or terminal to the phone lines!

Penril



**Penril  
300/1200**

Penril 300/1200—Bell 212A style ..... \$799  
Bell 212A style. 1200 baud and 300 baud. Manual originate, auto-answer. Full duplex. RS232. Direct connect to phone lines via RJ11C standard extension phone voice jack. 1 year warranty



**U.S. Robotics  
USR-330A  
Bell 103/113 style  
USR-330D  
Bell 103/113 style**

USR-330D ..... \$339

Bell 103/113 style. 330 baud. Manual originate, auto-answer. Half/full duplex. RS232. 1 year warranty. Direct connect to phone lines via RJ11C standard extension phone voice jack.

USR-330A ..... \$399  
Same as USR-330D but includes auto-dial capability.



**U.S. Robotics  
The  
Phone Link  
Acoustic  
Modem**

Bell 103/113 style ..... \$179  
300 baud. Sleek, low profile. Originate and answer capability. Half/full duplex. Self-test. RS232. Light displays for On, Carrier, Test, Send Data, Receive Data. 15 oz.

Digital Equipment Corporation



**DEC VT100**

DEC VT100 ... \$1668

Detachable keyboard. Separate numeric keypad with function keys. Business forms character set. Reverse video. Selectable double-size characters. Bidirectional smooth-scrolling. 80 cols or 132 cols. Split screen. Settable tabs. Line drawing graphic characters. Status line. Key-Click.



**CRT's Perkin-Elmer  
Corporation**

**Superowl 1251**

Perkin-Elmer Superowl 1251 ..... \$1564  
Intelligent, editing CRT. Detachable keyboard. 32 fully programmable function keys. Intelligent printer part. Business forms character set. Block mode. Protected fields. Blinking fields. Numeric fields. Reverse video. Half intensity. Polling. Down line loading of options. Remote control of all options by host computer. Settable tabs. Status line. Separate numeric keypad. Transparent mode.

Perkin-Elmer Corporation



**Bantam 550B ... \$694**  
Compact. Silent. Upper/lower case. 80th col. wrap-around. Bell. Integrated numeric pad. Printer port. Transparent mode. Editing features. Tabbing.

**Bantam 550E.. \$755**  
Same as 550B plus separate numeric keypad and cursor direction keys.

Bantam 550S ..... \$879  
Same as 550E plus block mode. 8 function keys, and protected fields, reverse video fields, half intensity fields, blinking fields.

550 Options  
20mA Current Loop Interface ..... \$70  
Non-Glare Screen ..... \$25  
2nd page of memory (550S only) .. \$100

## HARDCOPY TERMINALS

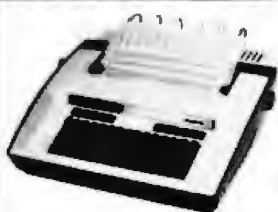

**Teletype  
Model 43**

Teletype  
Corporation

Teletype Model 43 KSR with RS232  
and Connector Cable ..... \$999  
30 CPS. Dot matrix. 132 cols. True descenders on lower case. Excellent print quality for dot matrix printer. Pin feed.



**DEC LA120**

Digital Equipment  
Corporation

DEC LA120 ... \$2388

180 CPS. Dot matrix. Upper/lower case. 1K buffer. Designed for 1200 baud communications. 30 character answerback message. Adjustable line spacing. Adjustable character sizes including double sized characters. Settable horizontal and vertical tabs. Top-of-form capability. RS232.

NEC Corporation  
**NEC Spinwriter 5510 & 5520**



5520 KSR Spinwriter ..... \$3088  
55 CPS. Impact printer. Selectric print quality. Changeable print fonts. 110, 300 and 1200 baud data rate. Numeric keypad. Friction and tractor feed.

5510 Spinwriter ..... \$2754  
55 CPS Impact printer. Selectric print quality. Changeable print fonts. 110, 300 and 1200 baud data rate. Friction and tractor feed



**Perkin-Elmer  
Corporation**

**Pussycat 650/655  
CRT Screen Printer**

650/655 Pussycat CRT Screen Printer. \$899  
100 CPS. Extremely compact and quiet. 110 to 9600 baud rate. 2K buffer. Ideal for producing rapid, reliable hardcopy of your CRT screen display. Can be added to any CRT with our interface option.



**Digital  
Equipment  
Corp.**

DEC LA34DA ... \$939

30 CPS. Dot matrix. Upper/lower case. 4 character sizes. Up to 217 cols per line. 6 lines per inch settings. Friction feed. Settable tabs. RS232.

DEC LA34AA ..... \$1095  
30 CPS. Dot matrix. Upper/lower case. 8 character sizes including double size characters. 6 lines per inch settings. Up to 217 cols per line. Friction feed. Settable horizontal and vertical tabs. Top-of-form capability.

Options for LA34AA and LA34DA  
Tractor Feed Mechanism ..... \$114  
Numeric Keypad w/ Function Keys .. \$69  
Pedestal ..... \$100  
Paper Out Sensor ..... \$25  
APL Capability with APL Keycaps .. \$499  
2K Buffer with Text Editor and 1200 Baud  
Communications Capability ..... \$499

Leasing rates and lease/purchase plan information is available on request.  
All equipment is shipped with a 10 day money back guarantee.  
We offer full service, on site maintenance plans on all equipment.  
All equipment in stock.



**U.S. ROBOTICS INC.**  
203 N. WABASH SUITE 1718 CHICAGO, ILL 60601

SALES  
GENERAL OFFICES  
SERVICE

(312) 348-5850  
(312) 348-5651  
(312) 733-0497

# Lowest Prices on Personal Computers



**800™...\$789**  
ATARI® List \$1080

**A NEW LOW PRICE**

**ATARI® 400...\$359**

**hp HEWLETT PACKARD HP-85**



**\$2795**

## HP-85 Accessories

- 5 1/4" Dual Master Disc Drive List \$2500... \$2125
- 5 1/4" Single Master Disc Drive List \$1500... \$1275
- HP 7225A Graphics Plotter List \$2050... \$1845
- HP-85 16K Memory Module List \$395... \$355
- HP-85 Application Pacs Standard List \$95... \$85
- Serial (RS-232C) Interface Module List \$395... \$355
- GPIO Interface Module List \$495... \$445

**new HP-83 List \$2250 \$1895**

**NEW!**



**HP-41CV with five times more memory**

**built in.**  
List \$325  
**\$249**

**HP-41C**  
List \$250  
**\$199**

- HP-32E Scientific w/Statistics — \$3.95
- HP-33C Scientific Programmable \$79.95
- HP-34C Advanced Scientific Programmable — 123.95
- HP-37E Business Calculator — \$49.95

# Personal PC Systems



609 Butternut Street  
Syracuse, N.Y. 13208  
**(315) 475-6800**

Prices do not include shipping by UPS. All prices and offers subject to change without notice.

## Listing 1 continued:

```

03090 X$ = ""
03100 REM PUSH THE ANSWER AND RETURN
03110 GOSUB 880
03120 ON Y GOTO 730,1550,2950,3300
03130 REM -----
03140 REM SUBROUTINE TESTIF+(R1, Y)
03150 REM CHECKS ANTECEDENTS TO SEE IF RULE R1 IS APPLICABLE
03160 R2 = R(R1) + 2
03170 F2$ = R$(R2)
03180 IF F2$ = "THEN" THEN 3410
03190 REM PUSH NEEDED LOCAL VARIABLES
03200 X = Y
03210 GOSUB 960
03220 X = R1
03230 GOSUB 960
03240 X = R2
03250 GOSUB 960
03260 REM SETUP ARGUMENTS AND GOTO VERIFY
03270 Y = 4
03280 F1$ = F2$
03290 GOTO 1200
03300 REM POP ANSWER FROM VERIFY AND RESTORE LOCAL VARIABLES
03310 GOSUB 1040
03320 GOSUB 1120
03330 R2 = X
03340 GOSUB 1120
03350 R1 = X
03360 GOSUB 1120
03370 Y = X
03380 IF X$ = "" THEN 3430
03390 R2 = R2 + 1
03400 GOTO 3170
03410 REM SUCCESS
03420 X$ = "T"
03430 REM PUSH THE ANSWER AND RETURN
03440 GOSUB 880
03450 ON Y GOTO 730,1550,2950,3300
03460 REM -----
03470 REM SUBROUTINE USETHEN(R1)
03480 REM APPLIES RULE R1 AND PRINTS NEW DEDUCTIONS
03490 U1$ = ""
03500 REM FIND THE CONSEQUENTS
03510 R2 = R(R1) + 2
03520 F2$ = R$(R2)
03530 IF F2$ = "THEN" THEN 3560
03540 R2 = R2 + 1
03550 GOTO 3520
03560 REM LOOP THROUGH CONSEQUENTS
03570 R2 = R2 + 1
03580 F2$ = R$(R2)
03590 IF F2$ = "STOP" THEN 3670
03600 IF R$(R2+1) = "IF" THEN 3670
03610 REM CALL REMEMBER TO ASSERT THE CONSEQUENT
03620 GOSUB 1950
03630 IF R1$ = "" THEN 3570
03640 PRINT "Rule ";R$(R1);" deduces ";Z$;F2$
03650 U1$ = "T"
03660 GOTO 3570
03670 RETURN
03680 REM -----
03690 REM SUBROUTINE LOADRULES
03700 REM INITIALIZES THE RULE ARRAYS R$ AND B WITH THE RULE DATA
03710 READ Z$
03720 R7 = 0
03730 R8 = 0
03740 IF R8 < R9 THEN 3770
03750 PRINT "OUT OF ROOM FOR RULES"
03760 STOP
03770 REM READ NEXT RULE INTO R$
03780 REM FORMAT: <name> IF <ant> ... <ant> THEN <con> ... <con>
03790 R8 = R8 + 1
03800 READ R$(R8)
03810 IF R$(R8) <> "IF" THEN 3840
03820 R7 = R7 + 1
03830 R(R7) = R8 - 1
03840 IF R$(R8) <> "STOP" THEN 3740
03850 RETURN
03860 REM RULE DATA
03870 DATA "ANIMAL "
    
```

Listing 1 continued on page 274

# \$30 lets you take advanced VisiCalc™ lessons from VisiCalc's creators.



Introducing SATN from Software Arts, Inc., the creators of the VisiCalc program. SATN (Software Arts Technical Notes) is a publication offering on-going support to all VisiCalc users—from novice to expert.

Each issue of SATN is filled with techniques and information to help you expand your present understanding of VisiCalc functions as well as learn advanced methods to help in developing *your own* VisiCalc applications.

Benefit immediately from highly informative articles:

- Complete Applications in Detail:
  - Payroll Tax Calculation using @LOOKUP
  - Mortgage Decision Calculation
- In Depth Descriptions of VisiCalc Features:
  - Contents of a Saved Sheet
  - Uses of DIF™ data file format
- Unusual Applications and Techniques:
  - Date Arithmetic
  - Recreational Mathematics

SATN is your personal pipeline to the people at Software Arts who invented and developed VisiCalc. Their knowledge and experience with VisiCalc is available to you in each and every issue.

#### Special Charter Subscription Offer

Get 7 SATN issues for the price of 6, if you subscribe by December 31, 1981. We'll send you a FREE copy of SATN when you return the coupon, or call our toll-free number 800-257-7850 to order a year's subscription at our special introductory rate of \$30.

#### Full Refund Policy

If you are not completely satisfied with your first issue of SATN, let us know within one month, and we will refund your money. Your free SATN issue is yours to keep.

Act today!

**FOR FAST DELIVERY CALL  
TOLL-FREE 800-257-7850 Op. 737.  
(In N.J. 800-322-8650)**

**Software Arts, Inc.**  
SATN SUBSCRIPTIONS  
P.O. BOX 815  
QUINCY, MA 02169

Yes, I'd like to receive advanced lessons in VisiCalc. Please send me seven issues at the regular subscription rate, \$30. (Outside US—\$50)

Check enclosed       MasterCard  
 Visa       Bill me

Credit Card #      Expiration Date      Interbank #

Name      Signature

Address

City      State/Country      Zip/Postal Code

On what computer(s) do you run VisiCalc?

Please allow 6-8 weeks for delivery.

## SATN. The Journal for VisiCalc Users

The VisiCalc program is copyrighted by Software Arts, Inc. DIF is a trademark of Software Arts, Inc. VisiCalc is a trademark of Personal Software Inc., which is the exclusive world-wide publisher and distributor of the VisiCalc program.

```

03880 DATA "R1","IF","HAS HAIR","THEN","IS MAMMAL"
03890 DATA "R2","IF","GIVES MILK","THEN","IS MAMMAL"
03900 DATA "R3","IF","HAS FEATHERS","THEN","IS BIRD"
03910 DATA "R4","IF","FLIES","LAYS EGGS","THEN","IS BIRD"
03920 DATA "R5","IF","EATS MEAT","THEN","IS CARNIVORE"
03930 DATA "R6","IF","HAS POINTED TEETH","HAS CLAWS","HAS FORWARD EYES"
03940 DATA "THEN","IS CARNIVORE"
03950 DATA "R7","IF","IS MAMMAL","HAS HOOFS","THEN","IS UNGULATE"
03960 DATA "R8","IF","IS MAMMAL","CHEWS CUD","THEN","IS UNGULATE"
03970 DATA "R9","IF","IS MAMMAL","IS CARNIVORE","HAS TAWNY COLOR"
03980 DATA "HAS DARK SPOTS","THEN","IS CHEETAH"
03990 DATA "R10","IF","IS MAMMAL","IS CARNIVORE","HAS TAWNY COLOR"
04000 DATA "HAS BLACK STRIPES","THEN","IS TIGER"
04010 DATA "R11","IF","IS UNGULATE","HAS LONG NECK","HAS LONG LEGS"
04020 DATA "HAS DARK SPOTS","THEN","IS GIRAFFE"
04030 DATA "R12","IF","IS UNGULATE","HAS BLACK STRIPES","THEN","IS ZEBRA"
04040 DATA "R13","IF","IS BIRD","DOES NOT FLY","HAS LONG NECK"
04050 DATA "IS BLACK AND WHITE","THEN","IS OSTRICH"
04060 DATA "R14","IF","IS BIRD","DOES NOT FLY","SWIMS","IS BLACK AND WHITE"
04070 DATA "THEN","IS PENGUIN"
04080 DATA "R15","IF","IS BIRD","FLIES WELL","THEN","IS ALBATROSS"
04090 DATA "STOP"
04100 REM -----
04110 REM SUBROUTINE LOADHYPOTHESES
04120 REM INITIALIZES THE HYPOTHESIS ARRAY H$ WITH HYPOTHESIS DATA
04130 H$ = 0
04140 IF H8 < H9 THEN 4170
04150 PRINT "OUT OF ROOM FOR HYPOTHESES"
04160 STOP
04170 REM READ NEXT HYPOTHESIS
04180 H8 = H8 + 1
04190 READ H$(H8)
04200 IF H$(H8) <> "STOP" THEN 4180
04210 H8 = H8 - 1
04220 RETURN
04230 REM HYPOTHESIS DATA
04240 DATA "IS ALBATROSS","IS PENGUIN","IS OSTRICH","IS ZEBRA"
04250 DATA "IS GIRAFFE","IS TIGER","IS CHEETAH","STOP"
04260 END
    
```

new ones. Moreover, by replacing these rules with rules for identifying, say, birds or flowers, you can use the same program for many other identification tasks. A more practical application might be a set of rules for diagnosing what is at fault in a malfunctioning toilet or washing machine.

The rules themselves appear in the DATA statements in lines 3880 through 4080. Each rule has the form:

<name>,"IF",<a>,...,<a>,"THEN",<c>,...,<c>

For example, "R7","IF","IS MAMMAL","HAS HOOFS","THEN","IS UNGULATE". The name of the rule can be any convenient string. The antecedents <a> and consequents <c> are strings that correspond to propositions about the animal and they may be true or false. If all the antecedents are found to be true, the program can use the rule to assert the truth of all the consequents. The rules are terminated by the string "STOP".

In addition to the rules, the pro-

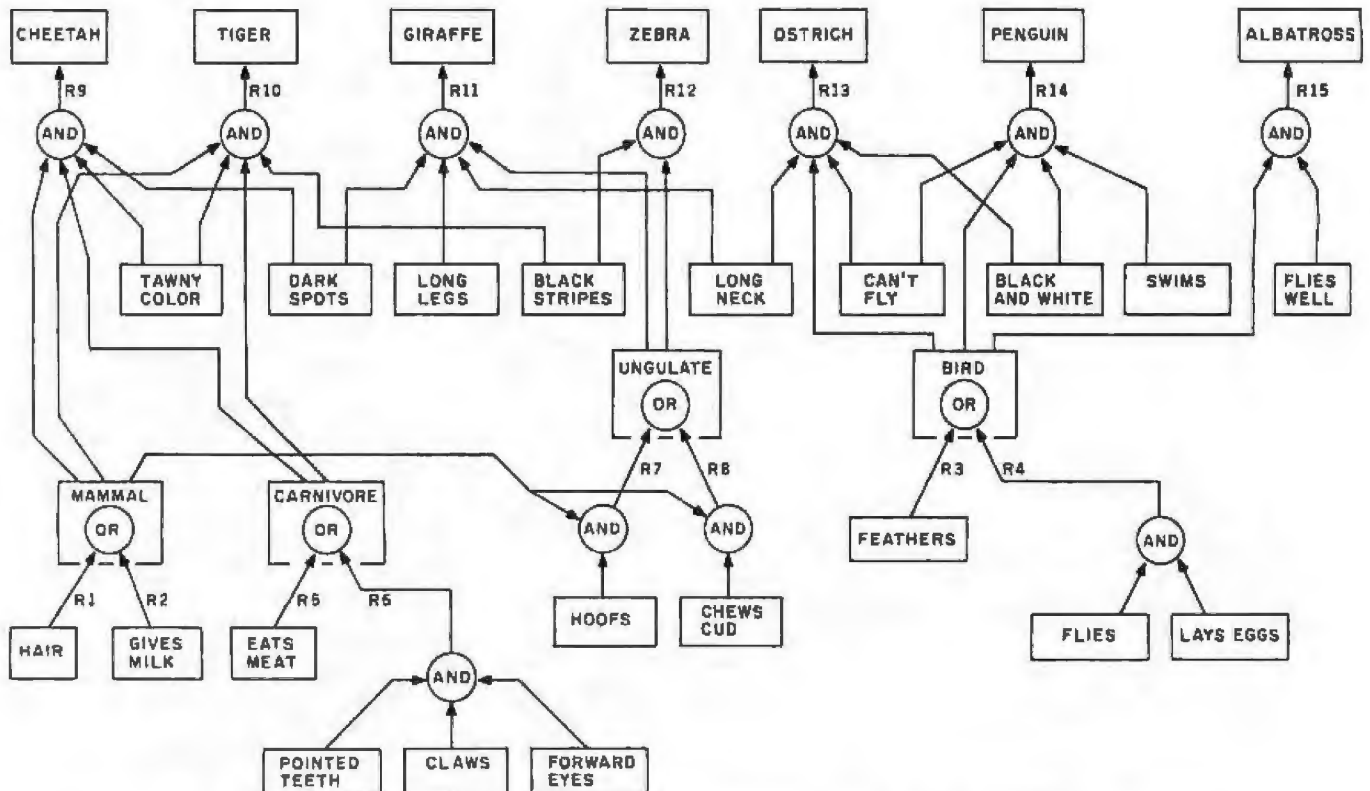

Figure 5: A sample network for a simple rule-based system. Boxes represent assertions, circles represent ways of combining assertions, and the labels R1, R2, etc, identify rules. The diagram corresponds to the rules given in lines 3880 through 4080 of listing 1.

# BETA COMPUTER DEVICES

**AVAILABLE NOW ... SYSTEM 2800 FROM SYSTEMS GROUP**

## FEATURES

- IEEE S-100 Bus Compatible Systems, Z80A Based
- Two 8-Inch Drives: Single or Double Sided, Double Density Floppy Disk Drives or 10MB Winchester Hard Disk Drive
- 20MB Winchester and Tape Backup
- 8-Slot Shielded and Terminated Motherboard
- System Software Selection includes CP/M\*, MP/M\* or OASIS\*\*
- Single-User or Multi-User Systems, Expandable to 6 Users
- Table Top or Rack Mountable
- Two Switched AC Outlets on Rear Panel
- One Year Warranty on Entire System

2812 CP/M, 2 Single Sided Floppies.....\$3775.00  
 2814 CP/M, 2 Double Sided Floppies..... 4425.00  
 2819 CP/M, 1 10 MB Winchester & 1 Double Sided Floppy..... 6675.00  
 2824 MP/M, 2 Double Sided Floppies.... 5235.00  
 2829 MP/M, 1 10 MB Winchester & 1 Doubled Sided Floppy.... 7500.00



## S-100 PRODUCTS

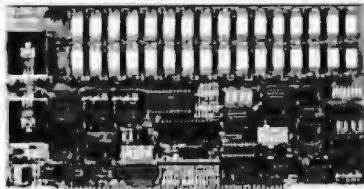

### QUALITY RAM FROM SYSTEMS GROUP

- Z-80 4MHZ operation with no wait states
  - IEEE compatible timing - 200 NS 4116's
  - Factory assembled, tested & burned in
- DMB6400 64K (Bank Select, shown).....\$749.00  
 DMH400 64K ..... 545.00  
 DMH800 48K ..... 520.00  
 DM13200 32K ..... 495.00

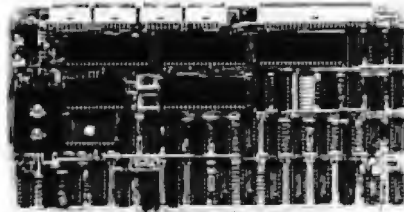

### CONFIGURE A COMPLETE S-100 SYSTEM WITH 2nd GENERATION\* PRODUCTS FROM SYSTEMS GROUP.

- CPC 2810 (shown) Z-80A processor board (4MHZ) with 4 serial & 2 parallel ports.....\$369.00
- CPC2813 - same as CPC2810 but 2 serial ports only.....\$345.00
- FDC2801/8 - 8" floppy disk controller board, up to 4 single/double sided drives, single or double density.....\$349.00
- INO-2804 - 4 channel serial I/O ..... 329.00
- CRA-100 - Cromix\* adaptor board.. \$55.00

### CALL US FOR OUR MOST CURRENT PRICES!

\*2nd Generation is a trademark of Measurement Systems and Controls. Cromix is a trademark of Cromemco, Inc. Tilt-Back is a trademark of Wabash, Inc. CP/M and MP/M are trademarks of Digital Research. OASIS is a trademark of Phase One Systems.

## 16K MEMORY EXPANSION KIT \$24.00

For Apple, TRS-80 keyboard, Exidy, and all other systems using 4116 dynamic rams or equivalent. All IC's are prime Mitsubishi M1 4116-3, 200 NSEC, burned-in and fully tested.

wabash



8" or 5 1/4" flexible diskettes certified 100% error free with manufacturers 5 year limited warranty on all 8" media. Soft secured in Tilt-back\* boxes of 10.

(Add \$3.00 for plastic library cases)

8" single sided, single density..... \$29.95  
 8" single sided, double density..... 37.95  
 8" double sided, double density..... 48.95  
 5 1/4" single sided, single density..... 27.95  
 5 1/4" single sided, double density..... 29.95

**Adds Viewpoint CRT....\$589.00**

## 8" DISK DRIVES

Shugart 801R.....\$380.00  
 NEC FD1160 (double sided)..... 505.00  
 Memorex MRX-101 8" Winchester style, hard disk drive, 10 megabytes.....\$2,000.00

TERMS: Minimum order \$15.00. Minimum shipping and handling \$3.00. Calif. residents add 6% sales tax. Cash, checks, Mastercard, Visa and purchase orders from qualified firms and institutions are accepted. Product availability and pricing are subject to change without notice.

INTERNATIONAL ORDERS: Add 15% to purchase price for all orders. Minimum shipping charge is \$20.00. Orders with insufficient funds will be delayed. Excess funds will be returned with your order. All prices are U.S. only.

## 6502 PRODUCTS

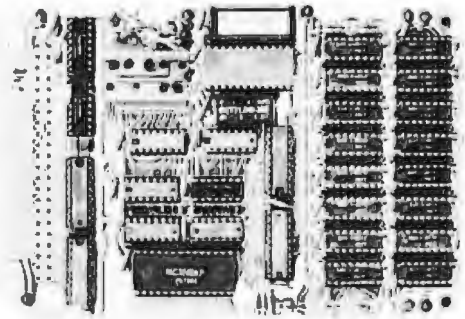

### BETA 32K BYTE EXPANDABLE RAM FOR 6502 AND 6800 SYSTEMS

- AIM 65 KIM SYM PET S44-BUS
  - Plug compatible with the AIM-65/SYM expansion connector by using a right angle connector (supplied)
  - Memory board edge connector plugs into the 6800 S44 bus.
  - Connects to PET using an adaptor cable.
  - Uses +5V only, supplied from the host computer.
  - Full documentation. Assembled and tested boards are guaranteed for one full year. Purchase price is fully refundable if board is returned-undamaged within 14 days.
- Assembled with 32K RAM.....\$549.00  
 & Tested with 16K RAM..... 329.00  
 Bare board, manual & 6 hard-to-get parts. 99.00  
 PET interface kit. Connects the 32K RAM board to a 4K or 8K PET.....\$ 69.00

**BETA  
COMPUTER DEVICES**

1230 W. COLLINS AVE.  
 ORANGE, CA 92668  
 (714) 633-7280



gram uses a set of hypotheses, which appear in the DATA statements in lines 4240 through 4250. In this case, the hypotheses are that the animal is either an albatross, a penguin, an ostrich, a zebra, a giraffe, a tiger, or a cheetah. The goal of the program is to establish the truth of one of these hypotheses.

The program operates by trying the hypotheses one at a time. For each hypothesis, the program scans the list of rules to see if the hypothesis can be deduced. If so, the antecedents for the relevant rules become new sub-hypotheses to be established, and the program looks for rules for deducing these antecedents. The program chains backward through the rules until no deductions can be made, at which point the program asks the user if the subhypothesis it is working on is true.

The core subroutine that implements this strategy is called VERIFY (see lines 1210 through 1830). VERIFY tries to determine if its

argument F1\$ is true. The argument F1\$ represents a hypothesis or sub-hypothesis. If the truth of F1\$ has already been recorded, VERIFY returns immediately. If there are no rules for deducing F1\$, and if VERIFY has not asked the user about F1\$ before, it asks. Otherwise, VERIFY applies TRYRULE+ to each of the rules in turn until it either meets with success or exhausts the rules.

The only thing that complicates the coding of this simple strategy is that TRYRULE+ uses TESTIF+ to see if all the antecedents for the rule are true, and TESTIF+ checks the antecedents by calling VERIFY. Thus, VERIFY is recursive, and BASIC does not support recursion. Therefore, all the reentrant subroutines must explicitly save their local variables on push-down stacks before transferring control to one another, restoring those values upon return. To see one reason why AI workers prefer LISP, which takes care of all this bookkeeping automatically, you need only

glance at the simpler version of this same program in Winston and Horn's book.

Pascal would be a better language than BASIC for our program because Pascal supports recursion and allows user-defined data structures (eg: using records and the type statement), as well as providing an easy-to-understand block structure. We chose to write this program in BASIC rather than Pascal because more personal computers have BASIC. (We hope our use of BASIC will not contribute to the perpetuation of this condition!)

Listing 2 shows an example of the dialogue when the user was thinking of a cheetah. A look at the rules shows why the program asked the questions it did. Working the first hypothesis (albatross), the program tried to use rule R15, which set up the subgoal of seeing if the animal was a bird. Rules R3 and R4 were relevant, so the program tried rule R3 and asked if the animal had feathers. The program soon ruled out the possibility of a bird, so it skipped the penguin and ostrich hypotheses. Working on rule R12 for the zebra hypothesis, on rule R11 for the ungulate sub-hypothesis, and on rule R1 for the mammal sub-subhypothesis, the program successively established that the animal was a mammal, was not an ungulate, and was a carnivore called a cheetah.

It is worth noting that the backward-chaining strategy is different from the classical divide-and-conquer approach used in binary search. With four well-chosen questions, it is possible to make the one-out-of-fifteen decision that required nine questions in this example. Before concluding that rule-based programs are hopelessly inefficient, you should note that the rules do make use of subclasses and sub-subclasses, much as is done in binary search. Thus, once it is learned that the animal is not a bird, for example, no more questions concerning birds will be asked. The main difference is that this particular program does not ask directly if the animal is a bird, but rather asks for primitive observations that allow "birdness" to be deduced.

*Listing 2: A sample run of the identification program shown in listing 1. The program asks questions and makes deductions, when possible, based on the answers. The program always cites the rule used to make a deduction.*

```

Hello.
I will use my 15 rules to try to establish one of the
following 7 hypotheses:
  ANIMAL IS ALBATROSS
  ANIMAL IS PENGUIN
  ANIMAL IS OSTRICH
  ANIMAL IS ZEBRA
  ANIMAL IS GIRAFFE
  ANIMAL IS TIGER
  ANIMAL IS CHEETAH

Please answer my questions with Y (yes), N (no), or W (why).

Is this true: ANIMAL HAS FEATHERS ?N
Is this true: ANIMAL FLIES ?N
Is this true: ANIMAL HAS HAIR ?Y
Rule R1 deduces ANIMAL IS MAMMAL
Is this true: ANIMAL HAS HOOFS ?N
Is this true: ANIMAL CHEWS CUD ?N
Is this true: ANIMAL EATS MEAT ?Y
Rule R5 deduces ANIMAL IS CARNIVORE
Is this true: ANIMAL HAS TAWNY COLOR ?Y
Is this true: ANIMAL HAS BLACK STRIPES ?W
I am trying to use Rule R10
I already know that:
ANIMAL IS MAMMAL
ANIMAL IS CARNIVORE
ANIMAL HAS TAWNY COLOR
IF:
ANIMAL HAS BLACK STRIPES
THEN.
ANIMAL IS TIGER

Is this true: ANIMAL HAS BLACK STRIPES ?N
Is this true: ANIMAL HAS DARK SPOTS ?Y
Rule R9 deduces ANIMAL IS CHEETAH
I conclude that ANIMAL IS CHEETAH.

```

# The Text Solution for APPLE II®

## Now APPLE II® Owners Can Solve Text Problems With VIDEOTERM 80 Column by 24 Line Video Display Utilizing 7 X 9 Dot Character Matrix

Perhaps the most annoying shortcoming of the Apple II® is its limitation of displaying only 40 columns by 24 lines of text, all in uppercase. At last, Apple II® owners have a reliable, trouble-free answer to their text display problem. VIDEOTERM generates a full 80 columns by 24 lines of text, in upper and lower case. Twice the number of characters as the standard Apple II™ display. And by utilizing a 7 by 9 character matrix, lower case letters have true descenders. But this is only the start.

### VIDEOTERM, MANUAL, SWITCHPLATE

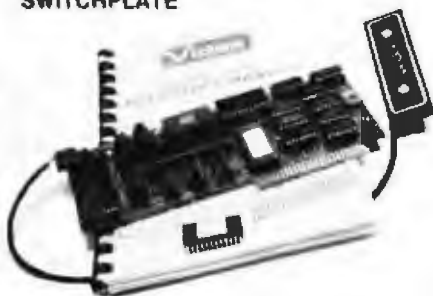

## VIDEOTERM

**BASICs** VIDEOTERM lists BASIC programs, both Integer and Applesoft, using the entire 80 columns. Without spilling keywords. Full editing capabilities are offered using the ESCAPE key sequences for cursor movement. With provision for stop/start text scrolling utilizing the standard Control-S entry. And simultaneous on-screen display of text being printed.

**Pascal** Installation of VIDEOTERM in slot 3 provides Pascal immediate control of the display since Pascal recognizes the board as a standard video display terminal and treats it as such. No changes are needed to Pascal's MISC.INFO or GOTOXY files, although customization directions are provided. All cursor control characters are identical to standard Pascal defaults.

**Other Boards** The new Microsoft Softcard® is supported. So is the popular D. C. Hayes Micro-modem II™ utilizing customized PROM firmware available from VIDEX. The powerful EasyWriter™ Professional Word Processing System and other word processors are now compatible with VIDEOTERM. Or use the Mountain Hardware ROMWriter™ (or other PROM programmer) to generate your own custom character sets. Naturally, VIDEOTERM conforms to all Apple OEM guidelines, assurance that you will have no conflicts with current or future Apple II™ expansion boards.

**Advanced Hardware Design** VIDEOTERM's on-board asynchronous crystal clock ensures flicker-free character display. Only the size of the Pascal Language card, VIDEOTERM utilizes CMOS and low power consumption ICs, ensuring cool, reliable operation. All ICs are fully socketed for easy maintenance. Add to that 2K of on-board RAM, 50 or 60 Hz operation, and provision of power and input connectors for a light pen. Problems are designed out, not in.

**Available Options** The entire display may be altered to inverse video, displaying black characters on a white field. PROMs containing alternate character sets and graphic symbols are available from Videx. A switchplate option allows you to use the same video monitor for either the VIDEOTERM or the standard Apple II™ display, instantly changing displays by flipping a single toggle switch. The switchplate assembly inserts into one of the rear cut-outs in the Apple II™ case so that the toggle switch is readily accessible. And the Videx KEYBOARD ENHANCER can be installed, allowing upper and lower case character entry directly from your Apple II™ keyboard.

**Firmware** 1K of on-board ROM firmware controls all operation of the VIDEOTERM. No machine language patches are needed for normal VIDEOTERM use.

#### Firmware Version 2.0

Characters	7 x 9 matrix	Display	24 x 80 (full descenders)
Options	7 x 12 matrix option; Alternate user definable character set option; Inverse video option.		18 x 80 (7 x 12 matrix with full descenders)

Want to know more? Contact your local Apple dealer today for a demonstration. VIDEOTERM is available through your local dealer or direct from Videx in Corvallis, Oregon. Or send for the VIDEOTERM Owners Reference Manual and deduct the amount if you decide to purchase. Upgrade your Apple II™ to full terminal capabilities for half the cost of a terminal. VIDEOTERM. At last.

**PRICE:**

- VIDEOTERM includes manual \$345
- SWITCHPLATE \$ 19
- MANUAL refund with purchase \$ 19
- 7 x 12 CHARACTER SET \$ 39
- MICROMODEM FIRMWARE \$ 25

Apple II® is a trademark of Apple Computer Inc.  
ROMWriter™ is a trademark of Mountain Hardware Inc.  
Micro-modem II™ is a trademark of D. C. Hayes Associates Inc.  
Softcard® is a trademark of Microsoft.  
EasyWriter™ is a trademark of Information Unlimited Software Inc.



7X12 MATRIX  
18X80 OPTIONAL



7X9 MATRIX  
24X80 STANDARD

## APPLE II® OWNERS!

### introducing the KEYBOARD & DISPLAY ENHANCER

- PUT THE SHIFT AND SHIFT LOCK BACK WHERE IT BELONGS
- SEE REAL UPPER AND lower CASE ON THE SCREEN
- ACCESS ALL YOUR KEYBOARD ASCII CHARACTERS

Videx has the perfect companion for your word processor software: the **KEYBOARD AND DISPLAY ENHANCER**. Install the enhancer in your APPLE II and be typing in lower case just like a typewriter. If you want an upper case character, use the SHIFT key or the CTRL key for shift lock. Not only that, but you see upper and lower case on the screen as you type. Perfectly compatible with Apple Writer and other word processors like, for example, SuperText.

If you want to program in BASIC, just put it back into the alpha lock mode, and you have the original keyboard back with a few im-

provements. Now you can enter those elusive 9 characters directly from the keyboard or require the Control key to be pressed with the RESET to prevent accidental resets.

**KEYBOARD AND DISPLAY ENHANCER** is recommended for use with all revisions of the APPLE II. It includes ICs, and EPROM and dip switches mounted on a PC board, and a jumper cable. Easy installation, meaning no soldering or cutting traces. Alternate default modes are dip-switch selectable. You can even remap the keyboard, selecting an alternate character set for custom applications.

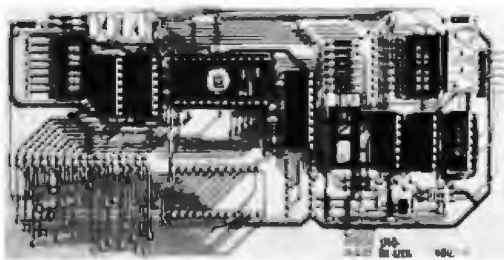

**PRICE • KDE-700 (REV. 7 or greater) . . . . . \$129.**  
• KDE-000 (REV. 6 or less) . . . . . \$129.

Apple II® is a trademark of Apple Computer, Inc.



**VIDEX**  
897 N.W. Grant Avenue  
Corvallis, Oregon 97330  
Phone (503) 758-0521

To gain efficiency, you might want to change the program so it will ask the user about intermediate hypotheses, resorting to deduction only when the user gives a "don't know" response. This illustrates how the rule-based approach actually provides great flexibility by separating the control strategy (as implemented in VERIFY) from the knowledge base (as represented by the rules).

The rule-based identification system just described is at best a toy. Although this system illustrates the important principle of the separation of the rule base from the general-

reasoning program, the system lacks many important features included in state-of-the-art research systems. Among the features present in most state-of-the-art knowledge-based systems, but lacking in our toy program, are the following:

- immediate propagation of inferences
- negative inferences
- plausible inference's ability to handle mutually exclusive categories
- contextual constraints
- degrees of certainty in user's answers

- information volunteered by the user
- flexible control structure

But toys are fun, and are often effective teachers. Enjoy. ■

#### References

1. Balzer, R, L D Erman, P London, and C Williams. "HEARSAY-III: A Domain-Independent Framework for Expert Systems." *Proceedings of the First Annual National Conference on Artificial Intelligence*, 1980, pages 108 through 110.
2. Barstow, D R. "An Experiment in Knowledge-based Automatic Programming." *Artificial Intelligence*, volume 12, August 1979, pages 7 through 119.
3. Bennett, J S and R S Englemore. "SACON: A Knowledge-Based Consultant for Structural Analysis." *Proceedings of the Sixth International Joint Conference on Artificial Intelligence*, August 20-23, 1979, pages 47 through 49.
4. Brown, J S, R R Burton, and A G Bell. "SOPHIE: A Sophisticated Instructional Environment for Teaching Electronic Troubleshooting (An Example of AI in CAI)." Final Report, Contract F41609-73-C-006, Bolt, Beranek, and Newman Inc, Cambridge MA, March 1974.
5. Buchanan, B G and T M Mitchell. "Model-Directed Learning of Production Rules." *Pattern-Directed Inference Systems*, D A Waterman and F Hayes-Roth (editors), New York: Academic Press, 1978, pages 297 through 312.
6. Bundy, A, et al. "Solving Mechanics Problems Using Meta-Level Inference." *Expert Systems in the Microelectronic Age*, D Michie (editor), Edinburgh: Edinburgh University Press, 1979, pages 50 through 64.
7. Carbonell, J R. "AI in CAI: An Artificial-Intelligence Approach to Computer-Aided Instruction." *IEEE Transactions on Man-Machine Systems*, volume MMS-11, December 1970, pages 190 through 202.
8. Clancey, W J, E H Shortliffe, and B G Buchanan. "Intelligent Computer-Aided Instruction for Medical Diagnosis." *Proceedings of the 3rd Symposium on Computer Application in Medical Care*, 1979, pages 175 through 183.
9. Davis, R. "Interactive Transfer of Expertise: Acquisition of New Inference Rules." *Artificial Intelligence*, volume 12, August 1979, pages 121 through 157.
10. Davis, R and J King. "An Overview of Production Systems." *Machine Intelligence 8*, E W Elcock and D Michie (editors), New York: Wiley, 1976, pages 300 through 332.
11. Duda, R O, J G Gaschnig, and P E Hart. "Model Design in the Prospector Con-



## Tune up your LA36

### The DS120 Terminal Controller makes your LA36 perform like a DECwriter™ III.

The Datasouth DS120 gives your DECwriter™ II the high speed printing and versatile performance features of the DECwriter™ III at only a fraction of the cost. The DS120 is a plug compatible replacement for your LA36 logic board which can be installed in minutes. Standard features include:

- 165 cps bidirectional printing
- Horizontal & Vertical Tabs
- Page Length Selection
- 110-4800 baud operation
- 100X character print huffer
- X-on, X-off protocol
- Self Test
- RS232 interface
- 20 mA Current Loop interface
- Top of Form
- Adjustable Margins
- Double wide characters
- Parity selection
- Optional APL character set

Over 5,000 DS120 units are now being used by customers ranging from the Fortune 500 to personal computing enthusiasts. In numerous installations, entire networks of terminals have been upgraded to take advantage of today's higher speed data communications services. LSI microprocessor electronics and strict quality control ensure dependable performance for years to come. When service is required, we will respond promptly and effectively. Best of all, we can deliver immediately through our nationwide network of distributors. Just give us a call for all the details.



**data south computer corporation**

4740 Dwight Evans Road • Charlotte, North Carolina 28210 • 704/523-8500



# Ten reasons why your floppy disk should be a BASF FlexyDisk.<sup>®</sup>



More than four decades of experience in magnetic media—BASF invented magnetic recording tape, the forerunner of today's wide range of magnetic media, back in 1934, and was the first independent manufacturer of IBM-compatible floppy disks.

Tough Tyvek sleeve—no paper dust, no static electricity.

Special self-cleaning jacket and liner help eliminate data errors and media wear and tear.

Packaging to suit your requirements—standard flip-top box, Kasette 10<sup>®</sup> storage case, or bulk pack.

Center hole diameter punched to more accurate standards than industry specifications, for top performance.

100% certification—every single disk is tested at thresholds 2-3 times higher than system requirements, to be 100% error-free.

Bi-axially oriented polyester substrate—for uniform and reliable performance year after year.

For the name of your nearest supplier, write BASF Systems, Crosby Drive, Bedford, MA 01730, or call 617-271-4030.

Cross-linked oxide coating—for low head wear and long trouble-free media life.

Total capability—one of two manufacturers in the world that makes both 8" and 5.25" models, has tape and disk experience, and manufactures floppy disk drives.

Double lubrication—lubricants both in the formula and on the disk surface, to minimize media wear due to head friction.



## BASF

Floppy Disks Mag Cards Cassettes Computer Tapes Disk Packs Computer Peripherals

# APPLESOFT® Basic Compiler

**\$167.50**

Compiles APPLESOFT® BASIC programs into native 6602 code, allowing programs to run up to 10 times faster. Handles graphics and shape tables. Requires 48K, autostart ROM, language system and at least one drive. List Price: \$200.00

## Microhouse™

### SPELLSTAR

New! Option for Wordstar. Compares words in your text to its 20,000-word compressed dictionary. Jumps back to WordStar for correction of errors or addition of new words to the dictionary. Price includes update of registered 2.x and earlier WordStar (must send master disk).  
List Price: \$250.00  
Microhouse Price: \$165.00/NA

### WORDSTAR

Version 3.0! Now featuring horizontal scrolling and column moves.  
List Price: \$495.00  
Microhouse Price: \$322.00/\$40.00

### WORDSTAR for APPLE

List Price: \$375.00  
Microhouse Price: \$245.00/\$40.00

### WORDSTAR CUSTOMIZATION NOTES

Package includes manual and diskette  
List Price: \$150.00  
Microhouse Price: \$95.00/NA

### MAILMERGE

Option for Wordstar  
List Price: \$150.00  
Microhouse Price: \$110.00/\$40.00

### MAILMERGE for APPLE

List Price: \$125.00  
Microhouse Price: \$85.00/\$25.00

### VISICALC for APPLE

List Price: \$150.00  
Microhouse Price: \$107.00/NA

### SUPERSORT I

List Price: \$250.00  
Microhouse Price: \$170.00/\$40.00

### SUPERSORT II

List Price: \$200.00  
Microhouse Price: \$145.00/\$40.00

### SUPERSORT for APPLE

List Price: \$200.00  
Microhouse Price: \$130.00/\$40.00

### DATASTAR

List Price: \$350.00  
Microhouse Price: \$245.00/\$40.00

### WORDMASTER

List Price: \$150.00  
Microhouse Price: \$119.00/\$40.00

CALL OR WRITE FOR FREE CATALOG

### MICROSOFT BASIC 80

List Price: \$350.00  
Microhouse Price: \$273.00/\$30.00

### MICROSOFT BASIC 80 COMPILER

Language compatible with MBASIC but code runs 3-10x faster  
List Price: \$395.00  
Microhouse Price: \$306.00/\$30.00

### MICROSOFT FORTRAN 80

Compiler is ANSI '66 compatible (except for COMPLEX)  
List Price: \$500.00  
Microhouse Price: \$345.00/\$30.00

### muSIMP/muMATH by Microsoft

List Price: \$250.00  
Microhouse Price: \$195.00/\$25.00

### COBOL 80 by Microsoft

List Price: \$750.00  
Microhouse Price: \$562.50/\$30.00

### MACRO 80 by Microsoft

List Price: \$200.00  
Microhouse Price: \$140.00/\$20.00

### EDIT 80 by Microsoft

List Price: \$120.00  
Microhouse Price: \$84.00/\$20.00

### WHITESMITHS C

List Price: \$630.00  
Microhouse Price: CALL/\$30.00

### TINY C Interpreter

List Price: \$100.00  
Microhouse Price: \$79.00/\$50.00

### TINY C Compiler

List Price: \$250.00  
Microhouse Price: \$195.00/\$50.00

### SPELLGUARD

Fast stand-alone program works with nearly any CP/M® word processor  
List Price: \$295.00  
Microhouse Price: \$230.00/\$25.00

### STACKWORKS FORTH

For Z80 or 8080 (specify)  
List Price: \$175.00  
Microhouse Price: \$160.00/\$30.00

### WHITESMITHS PASCAL

Includes Whitesmiths C Compiler  
List Price: \$850.00  
Microhouse Price: CALL/\$45.00

sultant System for Mineral Exploration," *Expert Systems in the Microelectronic Age*, D Michie (editor), Edinburgh: Edinburgh University Press, pages 153 through 167.

12. Fagan, L, J Kunz, E A Feigenbaum, and J Osborn. "Representation of Dynamic Clinical Knowledge. Measurement Interpretation in the Intensive Care Unit." *Proceedings of the Sixth International Joint Conference on Artificial Intelligence*, August 20-23, 1979, pages 260 through 262.
13. Feigenbaum, E A. "The Art of Artificial Intelligence—Themes and Case Studies of Knowledge Engineering." *AFIPS Conference Proceedings*, volume 47, June 1978, pages 227 through 240; also in *Expert Systems in the Microelectronic Age*, D Michie (editor), Edinburgh: Edinburgh University Press, 1979, pages 3 through 25.
14. Feigenbaum, E A, B G Buchanan, and J Lederberg. "On Generality and Problem Solving: A Case Study Using The DENDRAL Program." *Machine Intelligence 6*, B Meltzer and D Michie (editors), New York: American Elsevier, 1971, pages 165 through 190.
15. Gaschnig, J G. "Development of Uranium Exploration Models for the Prospector Consultant System." Final Report, SRI Project 7856, Artificial Intelligence Center, SRI International, Menlo Park CA, March 1980.
16. Gelernter, H L, et al. "Empirical Explorations of SYNCHEM." *Science*, September 9, 1977, pages 1041 through 1049.
17. Goldberg, R and S M Weiss. "An Experimental Transformation of a Large Expert System Knowledge-Base." Working Paper, Department of Computer Science, Rutgers University, New Brunswick NJ, March 1980.
18. Kulikowski, C A. "Artificial Intelligence Methods and Systems for Medical Consultation." *IEEE Transactions on Pattern Analysis and Machine Intelligence*, volume PAMI-2, September 1980, pages 464 through 476.
19. Lesser, V R and L D Erman. "A Retrospective View of the HEARSAY-II Architecture." *Proceedings of the Fifth International Joint Conference on Artificial Intelligence*, August 22-25, 1977, pages 790 through 800.
20. McDermott, J. "R1: An Expert in the Computer Systems Domain." *Proceedings of the First Annual National Conference on Artificial Intelligence*, 1980, pages 269 through 271.
21. Newell, A and H A Simon. "GPS, A Program that Simulates Human Thought." *Computers and Thought*, E A Feigenbaum and J A Feldman (editors), New York: McGraw-Hill, 1963.
22. Newell, A and H A Simon. *Human Problem Solving*. Englewood Cliffs NJ: Prentice-Hall, 1972.
23. Nil, H P and E A Feigenbaum. "Rule-

## Microhouse

P.O. BOX 498  
BETHLEHEM PA 18016  
(215) 868-8219

Based Understanding of Signals." *Pattern-Directed Inference Systems*, D A Waterman and F Hayes-Roth (editors), New York: Academic Press, 1978, pages 483 through 501.

24. Pauker, S G, G A Gorry, J P Kassirer, and W B Schwartz. "Towards the Simulation of Clinical Cognition." *American Journal of Medicine*, volume 60, June 1976, pages 981 through 996.
25. Pople, H E, Jr, et al. "DIALOG: A Model of Diagnostic Logic for Internal Medicine." *Proceedings of the Fourth International Joint Conference on Artificial Intelligence*, September 1975, pages 848 through 855.
26. Reboh, R. "The Knowledge Acquisition System." "A Computer-Based Consultant for Mineral Exploration," R O Duda, et al, Final Report, SRI Project 6415, Artificial Intelligence Center, SRI International, Menlo Park CA, September 1979.
27. Shortliffe, E H. *Computer Based Medical Consultations: MYCIN*. New York: Elsevier, 1976.
28. Stallman, R M and G J Sussman. "Forward Reasoning and Dependency-Directed Backtracking in a System for Computer-Aided Circuit Analysis." *Artificial Intelligence*, volume 9, 1977, pages 135 through 196.
29. Stefik, M J. "Inferring DNA Structures from Segmentation Data." *Artificial Intelligence*, volume 11, August 1978, pages 85 through 114.
30. van Melle, W. "A Domain-Independent Production-Rule System for Consultation Programs." *Proceedings of the Sixth International Joint Conference on Artificial Intelligence*, August 20-23, 1979, pages 923 through 925.
31. Waterman, D A. "User-Oriented Systems for Capturing Expertise: A Rule-Based Approach." *Expert Systems in the Microelectronic Age*, D Michie (editor), Edinburgh: Edinburgh University Press, 1979, pages 26 through 34.
32. Waterman, D A and F Hayes-Roth. *Pattern-Directed Inference Systems*. New York: Academic Press, 1978.
33. Weiss, S M and C A Kulikowski. "EXPERT: A System for Developing Consultation Models." *Proceedings of the Sixth International Joint Conference on Artificial Intelligence*, August 20-23, 1979, pages 942 through 947.
34. Weiss, S M, C A Kulikowski, and A Safir. "Glaucoma Consultation by Computer." *Computers in Biology and Medicine*, volume 8, 1978, pages 25 through 40.
35. Winston, P H and B K P Horn. *LISP*. Reading MA: Addison-Wesley, 1981, chapter 18.
36. Wipke, W T. "Computer Planning of Research in Organic Chemistry." *Computers in Chemical Education and Research*, E V Ludena, N H Sabelli, and A C Wahl (editors), New York: Plenum Press, 1976, pages 381 through 391.

## The New ADDS Viewpoint Video Terminal.

# \$649

Features a detachable Tektronics-made keyboard with keypad Function keys. Reverse video, half-intensity, underlining by fields. Printer port. ADDS quality construction.

# Microhouse™

CALL FOR LOW PRICES ON IMS Series 5000 and 8000 Computers

### C ITOH STARWRITER I

Letter-quality printer uses Diablo plastic printwheels and ribbons. 25 cps bidirectional, logic-seeking. Parallel interface.  
List Price: \$1895.00  
Microhouse Price: \$1431.00

### C ITOH STARWRITER I (Serial)

List Price: \$1980.00  
Microhouse Price: \$1502.00

### DIABLO 630

Letter-quality printer uses plastic and metal printwheels. 40 cps, bidirectional, logic-seeking. Optional tractor. \$225.  
List Price: \$2710.00  
Microhouse Price: \$1999.00

### EPSON MX70

Includes GRAFTRAX II dot-addressable graphics. Monodirectional. 80 cps. Adjustable tractor. Parallel only.  
List Price: \$450.00  
Microhouse Price: \$378.00

### EPSON MX80

Removable print head, bidirectional, logic-seeking, adjustable tractor, parallel interface. Easily converted to RS232, IEEE 488, Apple or ATARI. CALL FOR INFORMATION ON THE NEW GRAPHICS ROM PACK!  
List Price: \$645.00  
Microhouse Price: \$479.00

### EPSON MX-80 FT

Friction AND tractor feed version of the MX-80. Parallel interface included.  
List Price: \$745.00  
Microhouse Price: \$569.00

### TELEVIDEO 910 Terminal

List Price: \$699.00  
Microhouse Price: \$595.00

### TELEVIDEO 950

List Price: \$1195.00  
Microhouse Price: \$995.00

CALL OR WRITE FOR FREE CATALOG

PRICES AND SPECIFICATIONS SUBJECT TO CHANGE WITHOUT NOTICE



Software Manual & Manual Only

ASK ABOUT THE NEW Televideo COMPUTER SYSTEMS

### IDS PAPER TIGER 560G

List Price: \$1895.00  
Microhouse Price: \$1464.00

### VIDEX VIDEOTERM SPECIAL!

Carried over by popular demand. Converts your Apple screen to 80x24 upper and lower case. Purchase VIDEOTERM with WordStar and save! If purchased separately: \$290.  
List Price: \$345.00  
Microhouse Price: \$270.00

### MORROW DISCUS 2D

8 inch single-sided double-density floppy disk drive subsystem. Includes CP/M\* and MBASIC.  
List Price: \$1199.00  
Microhouse Price: \$995.00

### MORROW HARD DISK SUBSYSTEM

10 Megabyte. Includes S-100 controller card, CP/M\*, and enclosure.  
List Price: \$3695.00  
Microhouse Price: \$3062.00

### MICROSOFT APPLE SOFTCARD

Purchase the softcard with MicroPro's WordStar and save \$70! Converts your Apple II or II plus to a CP/M\* system. Includes MBASIC! Price if purchased separately: \$295.  
List Price: \$349.00  
Microhouse Price: \$279.00

### TCS/Atlanta INTERACTIVE

**ACCOUNTING SYSTEM**  
for small businesses. Ver 5.0. Each package can be used alone or post automatically to the General Ledger. Compiled version (no support language needed). Price listed is per package. General Ledger, Accounts Receivable, Accounts Payable, and Payroll packages available. Call for details on new Order Entry & Inventory packages. ALSO AVAILABLE FOR APPLE II. Also available in source.  
List Price: Compare at \$530  
Microhouse Price: \$79.00/\$25.00

### ALL FOUR TCS PACKAGES (compiled)

List Price: Compare at \$530/pkg  
Microhouse Price: \$269.00/\$90.00

CP/M is a registered trademark of Digital Research. UNIX is a registered trademark of Bell Labs. APPLE is a registered trademark of Apple Computers. TRS80 is a registered trademark of Tandy Corp.

SHIPPING: Add \$6 per manual or software package. Add \$2.50 for COD orders. Call for shipping charges on other items. Pennsylvania residents add 6 per cent sales tax.

# Microhouse

P.O. BOX 498  
BETHLEHEM, PA 18018  
(215) 868-8219

**PRINT NEATLY,  
SO WE KNOW  
WHERE TO SEND  
YOUR CHECK.**

(PLEASE PRINT: THIS IS YOUR SHIPPING LABEL)

**FROM:** Name \_\_\_\_\_

Address \_\_\_\_\_

City/State/ZIP \_\_\_\_\_

**TO:** **Ashton-Tate**  
Suite 1510  
3600 Wilshire Boulevard  
Los Angeles, CA 90010

Buying new software is the pits, isn't it?

You read an ad and it sounds terrific, so you ask around, then buy the manual.

So far, so good—so you spring several hundred dollars for the package.

And it does exactly what they said. But to get exactly what you want, you're going to have to change the way you run your business. Or go through so much hassle that you're not sure it's worth it.

So you grit your teeth and suffer, or put it on a shelf to gather dust.

Sounds familiar, doesn't it?

But there is at least one known exception: an exceptional DBMS called dBASE II.

## For database fans, an offer you shouldn't refuse.

dBASE II is the only high-performance relational Database Management System for micros. And it's the only DBMS that can help you get the DBMS that's right for you, no matter which DBMS you may want. Here's how:

If you have a 48k micro with CP/M, send us its model number and the size of your drives along with \$700 (CP/M 86 version soon—call if you can't wait).

We'll send you a copy of dBASE II that you can run on your system, solving your problems your way, for 30 days. Then just send everything back and we'll return your money, no questions asked.

During that 30 days, you can find out how much a real database management system can do for you. How it will affect your operations. Exactly what you want done. And precisely how you want to do it.

Then even if you go for some other system, you'll be an informed buyer.

And it never hurts to know what you're doing.

## IBM just caught up. So can you.

With dBASE II, you'll get the same kind of system for your micro that IBM introduced a few months ago for their mainframes.

It's a relational DBMS, and that makes it different from any other micro system you've ever seen.

In a relational database, the data is organized as simple tables, with records as the rows and the data fields as the columns, much like your data is organized now. Data relations are logical, so that you can zero in on the specific information you want without knowing a thing about the pre-defined sets, pointers or other cumbersome structures of hierarchal and network DBMS's.

And unlike file management systems, dBASE II gives you program and data independence. You can change your database structure without re-entering your data and without reprogramming, or change some or all of your programs without touching your database. And the same database can be used for any number of different applications.

## dBASE II is a stand-alone applications development system.

You don't need an extra support language, because dBASE II comes with its own Applications Development Language (ADL). With ADL, you can use simple English-like statements to manipulate your data, or use built-in structured constructs to prepare sophisticated applications packages. It's simple and easy to use, yet extremely powerful.

You create a new database and start using it in a minute or less. Just type CREATE, then respond to system prompts to name the file and define the fields. Now enter the data.

Add data to an existing database instantly, whether your file has

10 records or 10,000 records, by typing APPEND, then entering the information.

UPDATE, MODIFY, JOIN and REPLACE whole databases or individual records and characters.

Add or delete fields in your database structure without re-entering all your data.

And with dBASE II, it's easy to get information out once you've put the data in.

Do automatic calculations on fields, records and databases with a few keystrokes.

Organize months' worth of data in minutes with REPORT (printing optional), and get your reports today instead of tomorrow. Use the built-in SORT, with single or multiple keys. Or INDEX your data, then FIND it in seconds, even with floppies.

You can use dBASE II interactively or store a sequence of commands to automate your accounting, billing, mailing lists or whatever data you have to manage.

## You'll wonder how you managed without it.

dBASE II is the most powerful, easiest to use DBMS you can get for a micro.

And instead of poring over the manual, you can run it hands-on, in-house to see exactly what it can do for you. Try it.

What have you got to lose? We even provide the label so you can send it back.

Ashton-Tate, 3600 Wilshire Blvd., Suite 1510, Los Angeles, CA 90010. (213) 666-4409.



# Ashton-Tate

© Ashton-Tate 1981

# The Atari Tutorial

## Part 1: The Display List

---

Chris Crawford  
1272 Borregas Ave  
Sunnyvale CA 94086

---

**Editor's Note:** Although I have always considered myself an "Apple person" (I have a disk-based Apple II at home), it was exciting to attend a two-day seminar for prospective Atari programmers given by Chris Crawford, Lane Winner, and Mike Ekberg, all of Atari Inc. Once I learned about the internal structure of the Atari 400 and 800 computers, I realized the tremendous potential these machines have.

We at BYTE are proud to present "The Atari Tutorial," a series of articles written by members of the Atari staff. The subjects include: the display list, graphics indirection and character sets, player-missile graphics, display-list interrupts, scrolling, and Atari BASIC. This series of articles is adapted from *De Re Atari*, a forthcoming book on the internal structure of Atari computers, to be published in December 1981 by Atari Inc.

This first article, which is on display lists, is by Chris Crawford, who with Lane Winner coauthored the article "An Introduction to Atari Graphics," which we published in the January 1981 BYTE, page 18. "The Atari Tutorial" will cover in greater detail many of the interesting points only mentioned in the first article. We hope you enjoy the series...GW

The Atari personal-computer system is a second-generation personal computer. First and foremost, it is a consumer computer. The entire thrust of its design is to make the consumer comfortable with the computer. This consumer orientation reveals itself in many ways. First, the consumer is protected from mistakes by items such as keystone-shaped connectors that cannot be inserted the wrong way, a power interlock that turns the computer off when internal electronics are exposed, and a pair of plastic shields protecting the system reset key. Second, the machine has a great deal of graphics power; people generally respond to pictures much more readily than to text. Third, the machine has good sound capabilities; again, people normally respond to

---

*This article appears in slightly different form in De Re Atari, a book published by Atari Inc, and is reproduced with its express permission.*

direct sensory input better than to indirect textual messages. Finally, the computer has joysticks and paddles for more direct tactile input than is possible with keyboards. The point is not that the Atari personal-computer system has a lot of features, but rather that the features are all part of a consistent design philosophy aimed at the consumer. The designer who does not appreciate this fundamental fact will be working against the grain of the system.

The internal layout of the Atari 400 and 800 computers (which are electrically equivalent to each other) is very different from that of other systems. They do have a micro-processor (a 6502), RAM (random-access read/write memory), ROM (read-only memory), and a PIA (peripheral interface adapter). However, they also have three special-purpose LSI (large-scale integration) devices known as ANTIC,

POKEY, and CTIA. These devices were designed by Atari engineers primarily to take much of the burden of housekeeping from the 6502, freeing the 6502 to concentrate on computations. While they were at it, they designed a great deal of power into these devices. Each is almost as big (in terms of silicon area) as a 6502, so the three of them together provide a tremendous amount of power. Mastering the Atari 400/800 is primarily a matter of mastering these three chips, a task we hope will be aided by this series of tutorial articles.

### Principles of Television Display

In order to understand the graphics capabilities of the Atari personal-computer system, you must first understand the rudiments of how a television set works. Television sets use a *raster-scan display system*. An electron beam is generated at the rear of the television tube and shot toward the screen. Along the way, it passes between sets of horizontal and vertical coils or plates that, if energized, can deflect the beam to make it strike any point on the screen. The electronics inside the television set cause the beam to sweep across the screen in a regular fashion. The beam's intensity can be controlled: if you make the beam more intense, the spot being struck on the screen glows brightly; if you make it less intense, the spot glows dimly or not at all.

The beam starts at the top left corner of the screen and traces horizontally across the screen. As it sweeps across the screen, the changes in intensity paint an image on the screen. When the beam reaches the right edge of the screen, it is turned off, brought

INFORMATION LINE (714) 549-7373

TOLL FREE ORDER LINES  
(800) 854-0523 - OUTSIDE CALIF.  
(800) 432-7866 -  
WITHIN CALIF.

# COMPUTIQUE®

**HP** HEWLETT  
PACKARD  
HEADQUARTERS

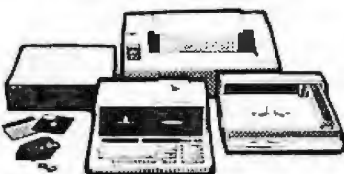

**HP-85**  
**A STANDARD FOR PROFESSIONALS**

HP-67	289.95
HP-97	584.95
HP-33C SCI	79.95
HP-34C SCI	114.95
HP-38C BUS RE	119.95
HP-32E SCI	49.95
HP-37E BUS	59.95
HP-41.41CV	CALL
HP-85	CALL
HP-83 NEW	CALL



**HP-41C**

Complete Enhancements,  
Peripherals and Accessories

**The PHONE CONTROLLER**

BY DICTOGRAPH



**NOW  
99.95**

- Dial any of 30 stored numbers
- Quick check display time and elapsed time automatically
- Audible tone receiver - a tone phone is required for long distance use
- Built-in speaker for group listening
- For home and business use

**TOSHIBA** **NOW 99.95**  
**BC-1232PV DIGITRON DESK TOP CALCULATOR**

12-DIGIT PRINT DISPLAY FOR FAST ACCURATE CALCULATING AT HOME OR FOR BUSINESS

**apple computer**  
**MEANS BUSINESS**



INTRODUCING **apple II**

**APPLE II PLUS**

**BEST PRICES U.S.A.**

**AUTHORIZED DEALER AND LEVEL 1 SERVICE CENTER**

NOW AVAILABLE:

- 16K, 32K, 48K
- DOS 3.3
- APPLE PLOT
- APPLE PASCAL 64K
- APPLE FORTRAN
- VISICALC 16 SEC
- APPLE WRITER
- GRAPHICS TABLET
- BPI (GL. AR. PAYROLL)
- MODEM
- DOW JONES NEWS & QUOTES
- DECISION EVALUATOR
- CONTROLLER (Gen Ledger)
- MICRO COURIER
- EPSON
- CENTRONICS
- QUME
- SILENTYPE
- ANADIX
- SANYO. BW. COLOR GREENSCREEN
- EXTENDED WARRANTY

COMPLETE BUSINESS, EDUCATIONAL & GAME SOFTWARE AVAILABLE.

**YOU'LL WONDER HOW YOU EVER GOT ALONG WITHOUT IT.**

**CODE-A-PHONE**

The Telephone Answering System

	NOW	SAVE
1000 ECONOMY ANSWER	79.95	• 60
• LIMITED QUANTITIES •		
1450 SMALL WONDER	169.95	• 110.
1550 TOUCH SYSTEM	249.95	• 130
1750 VOICE ACTIVATE	219.95	• 110.
960 MEMORY DIALER HANDHELD	99.95	NEW



• EXTRA CODER FREE WITH PURCHASE OF ANY C-A-P REMOTE

**CASIO** WHERE MIRACLES NEVER CEASE



W-100 DEPTH-TESTED TO 100 METERS	CA-90 INVADER GAME CALCULATOR WATCH	49.95
AA-81 2-WAY DIG ANALOG ALARM	VL-TONE MUSICAL INSTRUMENT CALC	69.95
W100 DEPTH TESTED ALARM CHRONO.	FK7100 SCI CHRONO ALARM CALC	39.95
FK7100 SCI CHRONO ALARM CALC	FK3500 SCI PROGRAMMABLE CALC	49.95
FR100 DESK TOP PRINT DISPLAY		39.95
		79.95

ALSO: CANON, TOSHIBA, HSC, SEIKO, MATTEL, PEARLCORDER, IIT, GTE, AND MANY OTHERS ALL AT GREAT PRICES!



**INNOVATIONS FROM Texas Instruments**

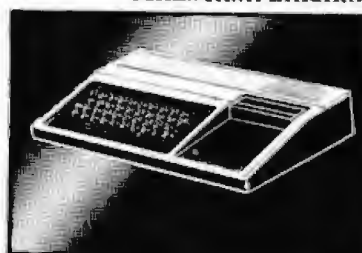

\*FREE SPEECH SYNTHESIZER WITH PURCHASE OF TI-99/4

TI-54 SCI NEW	39.95	SPEAK & SPELL READ	59.95
TI-56H NEW	44.95	SPEAK & MATH	59.95
TI-57 PROG SCI	39.95	TOUCH & TELL NEW	54.95
PC 100C	169.95	TI-5100 DISPLAY	39.95
LCD-PROG NEW	59.95	TI-5010 HAND/PRINT	49.95
TI-3011 NEW	18.95	TI-5120 PRINTER	59.95
TI-355P SCI	22.50	TI-5130 PRINT/DISP	79.95
TI-40 SCI NEW	28.95	TI-5135 PRINT/DISP	79.95
BUS ANAL I	19.95	TI-5142 PRINT/DISP	99.95
BUS ANAL II	44.95	TI-58C PROG CALC	89.95
BUS CARD	39.95	TI-59 960 PROG	199.95
MBA	54.95	INVEST ANALYST	48.95

**PLUG INTO CONTROL**

CONTROL LIGHTS AND APPLIANCES AUTOMATICALLY AND INSTANTLY.



TC 211 TIMER	59.95
TS 585 5 pc TIMER SET	NEW 119.95
PK 300 3 pc MINI CONTROLLER	49.95

**ESR SYSTEM X-10**

**THE SHARP EDGE**

EL-670 ELECTRONIC PIANO CLOCK, CALCULATOR	NEW 69.95
CT-665E TALKING CLOCK	NEW 99.95
EL-7001 ALPHANUMERIC CALC	139.95
CT-455E POCKET DIG. ALARM CLOCK	24.95
EL-5100 PROG ALPHANUMERIC	89.95
EL-6200 ALPHANUMERIC	99.95
EL-1188 HANDHELD PRINT DISPLAY	49.95
EL-1182 DESK TOP PRINT DISPLAY	74.95
EL-5813 SCIENTIFIC PROGRAMMABLE	34.95

**F** CHESS CHALLENGER SENSOR CHESS 129.95

**MATTEL ELECTRONICS**

INTELLIVISION	239.95
GAME CARTRIDGES	27.95
HORSE RACE ANALYZER	54.95

**ATARI** TOUCH THE FUTURE ATARI 400 16K 294.95  
VISICALC AVAILABLE CALL

**MURA** MP600 CORDLESS HANDHELD PHONE 189.95

MAIL & PHONE ORDERS ONLY

WRITE OR CALL FOR FREE CATALOG

NEWPORT BEACH COSTA MESA ANAHEIM (714) 549-7373

All units shipped in original factory cartons with accessories according to manufacturer's specifications. Visa Mastercard \$ Order Plus \$ 1.50 plus 4 days to mail. COD accepted. Min. \$4.95 for shipping in U.S.A. Air on request. CA res. add 8% sales tax. All items subject to availability. Prices subject to change. Send orders to Dept.



WILSHIRE CENTER 6947 WILSHIRE BLVD (213) 385-7777	LOS ANGELES 11815 WILSHIRE BLVD (213) 820-0423
PASADENA 1015 S LAKE AVE (213) 795-3007	TARZANA 11815 WILSHIRE BLVD (213) 705-7507
BREA 1015 IMPERIAL HWY (714) 990-6600	TORRANCE/LAWDALE 11815 WILSHIRE BLVD (213) 370-5795

**Professional Discounts**

back to the left side of the screen, and moved down a notch. It then turns back on and sweeps across the screen again. This process is repeated for 262 sweeps across the screen. (There actually are 525 sweeps across the screen in an alternating system known as *interlace*. I will ignore interlace and act as if the television has only 262 lines.) These 262 lines fill the screen from top to bottom. At the bottom of the screen (after the 262nd line is drawn), the electron beam is turned off and returned to the upper left corner of the screen. Then it starts the cycle over again. This entire cycle happens sixty times a second.

Now for some jargon: a single trace of the beam across the screen is called a *horizontal scan line*. A horizontal scan line is the fundamental unit of measurement of vertical distance on the screen. You state the height of an image by specifying the number of horizontal scan lines it spans. The period during which the beam returns from the right edge to the left edge is

called the *horizontal blank*. The period during which the beam returns from the bottom to the top of the screen is called the *vertical blank*. The entire process of drawing a screen takes 16,684  $\mu$ s. The vertical-blank period is about 1400  $\mu$ s. The horizontal blank takes 14  $\mu$ s, while a single horizontal scan line takes 64  $\mu$ s.

Most television sets are designed with *overscan*; they spread the image out so the edges of the picture are off the edge of the television tube. This guarantees that you have no unsightly borders in your picture. It is very bad for computers, though, because screen information that is off the edge of the picture does you no good. For this reason, the picture the computer puts out must be somewhat smaller than what the television can theoretically display. For this reason, only 192 horizontal scan lines are normally used by the Atari display. Thus, the normal limit of resolution of a television set used with the Atari 400/800 is 192 pixels (or picture

elements) vertically. (Of course, a color monitor can do much better than that.)

The standard unit of horizontal distance is the *color clock*. You specify the width of an image by stating how many color clocks wide it is. There are 228 color clocks in a single horizontal scan line, with a maximum of 176 actually visible. Thus, the ultimate limit for full color horizontal resolution with a standard color television is 176 pixels. With the computer, you can go even finer and control individual half-clocks. This gives a horizontal resolution of 352 pixels. However, use of this feature produces interesting color effects known as *color artifacts*. Color artifacts can be a nuisance if they are not desired; they can be a boon to the programmer who desires additional color and is not fazed by their restrictions.

### Microcomputer Displays

The fundamental problem any microcomputer has in using a raster-scan television for display purposes is that the television display is a dynamic process. Because of this, the television does not remember the image. Consequently, the computer must remember the screen image and constantly send a signal to the television telling it what to display. This process of sending information to the television is a continuous process requiring full-time attention. For this reason, most microcomputers have special hardware circuits that handle the television. The basic arrangement is the same on virtually all systems:

microprocessor — screen RAM —  
video hardware — TV screen

The microprocessor writes information to the screen RAM area that holds the screen data. The video hardware is constantly accessing this RAM area, getting screen data and converting them into television signals. These signals go to the television, which then displays the information. The screen memory is mapped onto the screen in the same order in which it is stored. That is, the first byte in the screen memory

## INFOSOFT Has a Better Way

### I/OS™ Infsoft/operating system

- Full CP/M™, CDOS™, SDOS™, compatibility
- Up to 15 disk units of 65 megabytes each
- Mix 5" and 8" floppies and hard disks
- Autostart and lurnkey capabilities
- Adaptable to most 8080/8085/Z80 systems
- Dialog system generation without programming
- Up to 975 megabytes of on-line data storage

**\*New! Developed from the I/OS single-user system\***

### Introducing MULTI/OS™

the complete multi-user operating system

All features of the single-user I/OS plus

- Up to 16 independent users and/or tasks
- Multiple printers with automatic spooling
- Up to 56k bytes in each user partition
- Managable sub-directories allow up to 63,504 files per unit
- Record/file lock capabilities

**Call Us Today  
To Improve Your  
System Performance**

MASTERCARD and VISA accepted

CP/M is a registered trademark of Digital Research, Inc.  
CDOS is a registered trademark of Cromemco.  
SDOS is a registered trademark of SO Systems.

**Infsoft**  
SYSTEMS INCORPORATED  
A SHAW-WALKER GROUP  
HEALTHCARE CENTER DRIVE  
MOUNTAIN VIEW, CALIF. 94039



# Unique accessories to PET/CBM add more power

## Software

### PET-FORTH

A unique, extensible programming language that in many cases has cut program development time to a fraction of the normal. FORTH allows you to program any type of application, thanks to its extensible nature. FORTH programs are modular, structured, extremely fast, and compact. PET-FORTH is a full, extended, standard FORTH, and includes a virtual memory facility, an interpreter and compiler, a resident editor, as well as a resident macro assembler, all which fits in 8.5K - **simultaneously**.

A comprehensive manual of more than 320 pages, which also is an exhaustive tutorial, is included. For production purposes we can supply a special **Target Compiler**, that will produce code suitable for placement in ROM, enabling you to write programs for control of digital machines etc. We use FORTH ourselves for business data base and process control applications. PET-FORTH includes a life-time guarantee. For 8032 only.

Price: PET-FORTH, including manual \$ **390**  
 PET-FORTH, only manual \$ **40**  
 Target compiler \$ **1000**  
 PET-FORTH



### PET-TERM

A program that turns your PET/CBM 8032 into an intelligent terminal. Supports three different interfaces: the PET-COM, the SCIP or the CBM 8010 acoustic coupler. You may communicate at up to 9600 baud, with selectable framing and parity. PET-TERM will also translate and transmit Word-Pro files. Data may be printed on the printer or saved on disk. PET-TERM includes a life-time guarantee.

Price: PET-TERM, including manual \$ **180**  
 PET-TERM, only manual \$ **20**



## Hardware

### PET-SWITCH

At a sensational price of £ 75 per unit, PET-SWITCH enables you to connect up to 16 PET/CBM computers to one disk drive and one printer. You can mix all models of PET/CBM in the same system (2001, 3032, 8032 etc). PET-SWITCH is technically superior to most of its competitors - no priority problems for example.

Price: PET-SWITCH, mother unit \$ **250**  
 PET-SWITCH, daughter unit \$ **150**

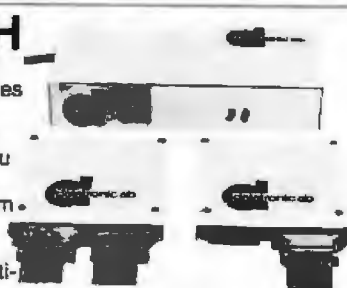

### SCIP

A Serial Communication Interface that supplies both RS-232 and Current Loop. Programmable baudrate. Addressed as an IEEE device. 50 character internal buffer. Selectable ASCII translation.



Price: \$ **480**

### PET-COM - RS-232C interface for PET

A bidirectional RS-232C interface that connects to PET via the memory expansion port. The baud rates range from 50 to 9600, and the number of data bits and stop bits is selectable. You may also set even, odd, or no parity.

Price: \$ **145**



### PET IEEE to Centronics Interface

This IEEE => Centronics interface is especially constructed for the PET. It is fully addressable and translates from PET-ASCII to Standard ASCII in two different modes, corresponding to PET's graphic and upper/lower case modes. This is available through a built-in switch.

Price: \$ **95**



### Country specific Character Generator for the 4022 and 3022 printers

By using this board you can have Greek, French, German, or any other special characters in your printer, at a very low cost. It is already used in all Nordic countries, and several other countries have requested it.

Price: \$ **40**



**Dealers are invited.**

*Datatronic AB is since 1978 sole Swedish distributor of the Commodore computer product line, and is now market leading in microcomputer technology in Scandinavia. Datatronic AB has a long experience in both hardware and software; today Datatronic has used more than 150.000 man-hours in software and hardware development for the PET. All non-Commodore products are produced and tested in-house. The Datatronic-group, which is the fastest growing electronics group in Scandinavia, has a turnover of approximately \$ 30.000.000, and employs over 200 people.*

For further information contact Datatronic AB,  
 Box 42094, S-126 12 Stockholm, Sweden.  
 Phone 8-744 5920  
 or your nearest Commodore dealer.  
 Circle 106 on Inquiry card.

**datatronic ab**  
 Box 42094 · S-126 12 STOCKHOLM Sweden  
 Phone: 8-744 5920 · Telex: PET S 17828

## MMSFORTH VERSION 2.0: MORE FOR YOUR RADIO SHACK TRS-80 MODEL I OR MODEL III!

- ★ **MORE SPEED**  
10-20 times faster than Level II BASIC
- ★ **MORE ROOM**  
Very compact compiled code plus VIRTUAL MEMORY makes your RAM act larger. Variable number of block buffers. 31-char unique word-names use only 4 bytes in header!
- ★ **MORE INSTRUCTIONS**  
Add YOUR commands to its 79 STANDARD plus instruction set!  
Far more complete than most Forth's: single & double precision, arrays, string-handling, clock more.
- ★ **MORE EASE**  
Excellent full-screen Editor, structured & modular programming  
Word search utility  
THE NOTEPAD letter writer  
Optimized for your TRS-80 with keyboard repeats, upper/lower case display driver, full ASCII single & double-width graphics, etc.
- ★ **MORE POWER**  
Forth operating system  
Interpreter AND compiler  
8080 Assembler  
(Z80 Assembler also available)  
Interim 35- to 80-track disk drives  
Model III System can read/write & run Model I diskettes!  
VIRTUAL I/O for video and printer, disk and tape (10-Megabyte hard disk available)

# mmsFORTH

### THE PROFESSIONAL FORTH FOR TRS-80

(Over 1,500 systems in use!)

Prices:  
MMSFORTH Disk System V2.0 (requires 1 disk drive & 16K RAM, 32K for Model III) \$129.95\*  
MMSFORTH Cassette System V2.0 (requires Level II BASIC & 16K RAM) \$89.95\*

### AND MMS GIVES IT PROFESSIONAL SUPPORT

Source code provided  
MMSFORTH Newsletter  
Many demo programs aboard  
MMSFORTH User Groups  
Inexpensive upgrades to latest version  
Programming staff can provide advice, modifications and custom programs, to fit YOUR needs

MMSFORTH UTILITIES DISKETTE includes FLOATING POINT MATH (L2 BASIC ROM routines plus Complex numbers, Rectangular-Polar coordinate conversions, Degrees mode, more), plus a full Forth-style Z80 ASSEMBLER plus a powerful CROSS-REFERENCER to list Forth words by block and line. All on one diskette (requires MMSFORTH V2.0, 1 drive & 32K RAM) \$39.95\*

FORTHCOM communications package provides RS-232C driver, dumb terminal mode, transfer of FORTH blocks, and host mode to operate a remote TRS-80 (requires MMSFORTH V2.0, 1 drive & 32K RAM) \$59.95\*

THE DATAHANDLER V1.2: a very sophisticated database management system operable by non-programmers (requires MMSFORTH V2.0, 1 drive & 32K RAM) \$59.95\*

MMSFORTH GAMES DISKETTE: real-time graphics & board games w/advice code includes BREAKFORTH, CRASHFORTH, CRYPTOLOGUE, FREEWAY, OHELLO & TIC-TAC-FORTH (requires MMSFORTH V2.0, 1 drive & 32K RAM) \$39.95\*

Other MMSFORTH products under development

### FORTH BOOKS AVAILABLE

MMSFORTH USERS MANUAL: w/o Appendices, for non-owners \$16.00\*  
USING FORTH: more detailed and advanced than above \$25.00\*  
INVITATION TO FORTH: detailed beginner book on 16FORTH \$17.50\*  
THREADED INTERPRETIVE LANGUAGES: advanced, excellent analysis of MMSFORTH III, in progress \$18.95\*  
PROGRAM DESIGN & CONSTRUCTION: intro to structural program, good for Forth \$8.95\*  
FORTH -79 STANDARD MANUAL: official reference to 79-STANDARD word set, etc. \$10.00\*  
CALTECH FORTH MANUAL: good on Forth internal structure, etc. \$10.00\*  
FORTH SPECIAL ISSUE, BYTE Magazine (Aug. 1980): we stock this collector's item for Forth users and beginners \$4.00\*

\* - ORDERING INFORMATION: Software prices include manuals and require signing of a single system, single-user license. SPECIFY for Model I or Model III! Add \$2.00 S/H plus \$3.00 per MMSFORTH and \$1.00 per additional book. Mass. orders add 5% tax. Foreign orders add 20% UPS COD, VISA & MC accepted, no unpaid purchase orders, please.

Send SASE for free MMSFORTH information  
Good dealers sought

Get MMSFORTH products from your  
computer dealer or  
**MILLER MICROCOMPUTER  
SERVICES (89)**

81 Lake Shore Road, Natick, MA 01760  
(617) 653-6138

maps to the top left corner of the screen, the second byte maps one position to the right, then the third, the fourth, and so on to the last byte that is mapped to the lower right corner of the screen.

The quality of the image that gets to the screen depends on two factors: how sophisticated the video hardware is, and how much screen memory is used. The simplest arrangement is used by the Radio Shack TRS-80 and the Commodore PET. These machines allocate a specific 1 K bytes of RAM as screen memory. The video-hardware circuits simply pull data out of this area, interpret them as characters (using a character set in ROM), and put the resulting characters on the screen. Each byte represents one character, allowing a choice of 256 different characters in the character set. With 1 K bytes of screen RAM, 1024 characters can be displayed on the screen. There isn't much that can be done to modify this arrangement.

The Apple II, from Apple Computer Inc, uses more advanced video hardware. Three graphics modes are provided: text, low-resolution (lo-res) graphics, and high-resolution (hi-res) graphics. The text graphics mode operates much as the PET and TRS-80 displays operate. In the low-resolution graphics mode, the video hardware reaches into screen memory and interprets it differently. Instead of interpreting each byte as a character, each byte is interpreted as two blocks of color. The value of each block (4 bits) specifies the color of a single pixel. In the high-resolution graphics mode, each bit in screen memory is mapped to a single pixel. If the bit is on, the pixel gets color in it; if the bit is off, the pixel stays dark. The situation is complicated by a variety of design nuances in the Apple, but that is the basic idea.

The important point is that the Apple has three display modes—three completely different ways of interpreting the data in screen memory. The Apple video hardware is intelligent enough to interpret a screen-memory byte as either an 8-bit

character (text mode), two 4-bit color nybbles (low-resolution mode), or 7 individual bits for a bit map (high-resolution mode).

### Atari 400/800 Display List

The Atari 400/800 display-list system represents a generalization of these systems. Where the PET and TRS-80 have one mode and the Apple has three modes, the Atari 400/800 has fourteen modes. A second important difference is that Atari 400/800 display modes can be mixed on the screen. You are not restricted to a choice between a screen full of text or a screen full of graphics. Any collection of the fourteen Atari graphics modes can be displayed on the screen simultaneously. The third important difference is that the Atari 400/800 screen RAM can be located *anywhere* in the address space of the computer and moved around while the program is running, whereas the other machines use fixed-screen memory areas.

This generality is made possible by a video microprocessor called ANTIC. Where earlier systems used rather simple video circuitry, Atari designed a full-scale microprocessor just to handle the intricacies of the television display. ANTIC is a true microprocessor—it has an instruction set, a program, and data. The program for ANTIC is called the *display list*. The display list specifies three things: where the screen data can be found, what display modes to use to interpret the screen data, and what special display options (if any) should be implemented.

When using the display list, it is important to shed the old view of a screen as a homogeneous image in a single mode and see it instead as a stack of *mode lines*. A mode line is a collection of horizontal scan lines. It stretches horizontally all the way across the screen. An Atari graphics 2 mode line is 16 horizontal scan lines high, while a graphics 7 mode line is only 2 scan lines high. Many graphics modes available from BASIC are homogeneous; an entire screen of a single mode is set up. But you must not limit your imagination to this pat-

# Everybody's making money selling microcomputers. Somebody's going to make money servicing them.

New NRI Home-Study Course Shows You How to Make Money Servicing, Repairing,  
and Programming Personal and Small Business Computers

Seems like every time you turn around, somebody comes along with a new computer for home or business use. And what's made it all possible is the amazing microprocessor, the tiny little chip that's a computer in itself.

Using this new technology, the industry is offering compact, affordable computers that handle things like payrolls, billing, inventory, and other jobs for businesses of every size...perform household functions including budgeting, environmental systems control, indexing recipes. And thousands of hobbyists are already owners, experimenting and developing their own programs.

## Growing Demand for Computer Technicians

This is only one of the growth factors influencing the increasing opportunities for qualified computer technicians. The U.S. Department of Labor projects over 100% increase in job openings for the decade through 1985. Most of them *new* jobs created by the expanding world of the computer.

## Learn at Home in Your Spare Time

NRI can train you for this exciting, rewarding field. Train you at home to service not only microcomputers, but word processors and data terminals, too. Train you at your convenience, with clearly written "bite-size" lessons that you do evenings or weekends, without going to classes or quitting your present job.

Your training is built around the latest model of the world's most popular computer. It's the amazing TRS-80™ Model III, with capabilities and features to perform a host of personal and business functions. No other small computer has so much software available for it, no other is used and relied on by so many people. And it's yours to keep for personal or business use.



You get plenty of practical experience. Using the NRI Discovery Lab® that also comes as part of your course, you build and study circuits ranging from the simplest to the most advanced. You analyze and troubleshoot using the professional Beckman LCD digital multimeter you keep to use later in your work. Then you use the lab and meter to actually access the interior of your computer...build special circuits and write programs to control them. You "see" your computer at work and demonstrate its power.

## Become the Complete Computer Person

You're also trained in writing and debugging both BASIC and advanced machine language programs...gain hands-on experience in the operation and application of computers to business and personal jobs. You're trained to become the fully rounded, new breed of technician

who can interface with the operational, programming, and service facets of today's computers. You're ready to take your place in the new electronic age.

## Other Opportunities

NRI has been giving ambitious people new electronic skills since 1914. Today's offerings also include TV/Audio/Video Systems servicing with training on our exclusive computer-programmable 25" diagonal color TV...Communications Electronics for servicing and installing microwave, broadcast, CB, radar, etc...and other state-of-the-art courses.

## Free Catalog...Mail Card No Salesman Will Call

Send the postage-paid card for our 100-page catalog showing all courses with equipment and complete lesson plans. There's no obligation other than to yourself. See how NRI can help you grow with the most exciting and important new field of the 80's. If card has been removed, please write to us.

(TRS-80 is a trademark of the Radio Shack division of Tandy Corp.)



**NRI SCHOOLS**  
McGraw-Hill Continuing  
Education Center  
3939 Wisconsin Ave.  
Washington, DC 20016

We'll give you tomorrow.

Value of Bit Pair Binary	Decimal	Atari Color Register Used
00	0	COLBAK
01	1	COLPF0
10	2	COLPF1
11	3	COLPF2

Table 1: Atari color-register assignment in four-color map mode.

tern; with the display list, you can create any sequence of mode lines down the screen. The display list is a

collection of code bytes that specify that sequence.

### ANTIC's Instruction Set

ANTIC's instruction set is rather simple. There are four classes of instructions: map-mode instructions, character-mode instructions, blank-line instructions, and jump instructions. Map-mode instructions cause ANTIC to display a mode line with simple colored pixels (no characters). Character-mode instructions cause ANTIC to display a mode line with characters in it. Blank-line instruc-

tions cause ANTIC to display a number of horizontal scan lines with a solid background color. Jump instructions are analogous to a 6502 JMP instruction; they reload ANTIC's program counter with a new value. There are also four special options that can sometimes be specified by setting a designated bit in the ANTIC instruction. These options are: *display-list interrupt* (DLI), *load-memory scan* (LMS), *vertical scroll*, and *horizontal scroll*.

Map-mode instructions cause ANTIC to display a mode line containing pixels with solid color in them. The color that is displayed comes from a color register. The choice of color register is specified by the value of the screen data. In four-color map modes (BASIC modes 3, 5, and 7, and ANTIC modes hexadecimal 8, A, D, and E), a pair of bits is required to specify a color register; these values are given in table 1. [Unfortunately, the graphics mode numbers in BASIC do not correspond to the mode numbers used by ANTIC; this often causes confusion....GW]

Since only 2 bits are needed to specify one pixel, four pixels are encoded in each screen-data byte. For example, a byte of screen data containing the hexadecimal value 1B would display four pixels; the first would be the background, the second would be color register 0, the third would be color register 1, and the fourth would be color register 2:

hexadecimal 1B  
= binary 00011011  
= 00 01 10 11

In two-color map modes (BASIC modes 4, 6, and 8, and ANTIC modes hexadecimal 9, B, C, and F), each bit specifies one of two color registers. A bit value of 0 selects background color for the pixel; a bit value of 1 selects color register 0 for the pixel. Eight pixels can be stored in one screen-data byte.

There are eight different map-display modes. They differ in the number of colors they display (two colors versus four colors), the vertical size one mode line occupies (1, 2, 4,

Auto-Cat™ lets your computer terminal answer other terminals over the phone line *automatically*.

It's the deluxe way, for example, to receive a program from a friendly computer. Or take data from any of the information sources. Then store the information in your computer's memory—and have it there at your beck and call—all automatically.

Auto-Cat is a state-of-the-art originate/auto answer, all digital, crystal controlled unit with everything in one compact package. It sits right under your phone.

It's FCC approved for direct telephone line connection. You just take it home and plug it in.

Cost? Less than any other comparable modem. Under \$250.

And it's from Novation. The recognized leader in personal communications.

**Auto-Cat** by  
**Novation** 

Call for details:  
**(800) 423-5410**  
In California (213) 996-5060

Available at Avnet Electronics, Hamilton Electro, Hamilton Avnet, Kierulff Electronics, Byte Shops, Computerland, and your local computer store.

Novation, Inc., 18664 Oxnard Street, Tarzana, California 91356

# CompuServe is a lot more than fun and games and news.

Although we're probably best known for our consumer-oriented services, CompuServe maintains powerful services for the serious computer user. CompuServe has helped some of the nation's largest companies and financial institutions through a wide range of business and scientific-oriented computer programs. With our Information Service, we can extend this expertise to you. Here are some of the programs available to the personal computer user through the CompuServe Information Service:

**PASCAL:** DEC User Group version of this famous language.

**XF4:** Extended CompuServe Fortran compiler.

**MACRO:** Advanced Macro Assembly language for PDP-10. Talk about fast.

**FILGE:** Fast, easy file generator and editor. Line oriented, no line numbers required!

**XBASIC:** CompuServe extended BASIC.

**JUMBLE:** File encryption program.

**TECO:** High level text editor.

**LINK:** Linking loader program.

**DDT:** Dynamic debugging tool.

**CREF:** Symbolic cross-reference generator used with language compilers.

**FILCOM:** File comparison program.

**SALARY:** Calculates salary and increases in various time frames including per year, month, period and hour. This program is intended primarily for managers doing reviews.

**SNOBOL:** String manipulation language.

**RUNF10:** Word processing and text formatting program (write resumes etc.).

**CONCOR:** Concordance generator. This program is very useful for documentation purposes. CONCOR reads an ASCII file and creates an output file which contains a line numbered listing of the original file, and a list of all the words contained in the file along with the numbers of the lines on which each word occurs (similar to an index).

**BLIS10:** High level implementation language for DEC PDP-10.

**BINED:** Binary file editor.

**APL:** A Programming Language.

**FINTOL:** Financial analysis tool.

Contains several program modules which can perform financial analysis for business or personal needs.

— Loan Payment and Amortization

— Compound Interest Calculations

— Sum from a Periodic Investment

— Sinking Fund Deposit

— Present Value of Cash Flows

— Present Value and Internal Rate of Return (Capital Projects)

— Depreciation Analysis

— Compound Growth Rates

**RANNO:** Random number generator.

**XEDIT:** XF4 binary file editor.

We also offer high speed professional line printer service, error-free file transfer, CompuServe's Software Exchange, and computer manufacturers' newsletters. Computer Users Groups can exchange information and up-to-the-minute gossip in the computer world.

And . . . if Aunt Matilda comes over, you can still let her play Adventure. Demonstrations and software at all Radio Shack® Computer Centers and many Radio Shack® outlets.



## CompuServe

Information Service Division  
5000 Arlington Centre Boulevard  
Columbus, Ohio 43220  
(614) 457-8600

Radio Shack is a trademark of Tandy Corporation.

ANTIC Mode	BASIC Mode	Number of Colors	Scan Lines Per Mode Line	Pixels Per Mode Line	Bytes Per Line	Bytes Per Screen
2	0	2	8	40	40	960
3	none	2	10	40	40	760
4	none	4	8	40	40	960
5	none	4	16	40	40	480
6	1	5	8	20	20	480
7	2	5	16	20	20	240
8	3	4	8	40	10	240
9	4	2	4	80	10	480
A	5	4	4	80	20	960
B	6	2	2	160	20	1920
C	none	2	1	160	20	3840
D	7	4	2	160	40	3840
E	none	4	1	160	40	7680
F	8	2	1	320	40	7680

**Table 2: Atari graphics modes and their characteristics.** Note that the same graphics mode is given a different number by BASIC and by ANTIC. The ANTIC mode number refers to one mode line of a given kind of graphics, while the BASIC mode number refers to a certain arrangement of mode lines (most or all of which are the given kind of graphics) that defines an entire screen of video display.

or 8 scan lines), and the number of pixels that fit horizontally into one mode line (40, 80, 160, or 320). Thus, some map modes give better resolution; these will require more screen memory. Table 2 presents this information for all modes.

Character-mode instructions cause ANTIC to display a mode line with characters in it. Each byte in screen RAM specifies one character. There are six character-display modes. Character displays will be discussed in a future BYTE article in this series.

Blank-line instructions produce "blank" lines consisting of only a

solid background color. There are eight blank-line instructions; they specify skipping one through eight blank lines.

There are two jump instructions. The first (JMP) is a direct jump; it reloads ANTIC's program counter with a new address that follows the JMP instruction as an operand. Its only function is to provide a solution to a tricky problem. ANTIC's program counter is only 10 bits wide. Thus, it cannot cross a 1 K-byte boundary. If the display list must cross a 1 K-byte boundary, it must use a JMP instruction to hop over the

boundary. This means that display lists are not fully relocatable.

The second jump instruction (JVB) is more commonly used. It reloads the program counter with the value in the operand and waits for the television to perform a vertical blank. This instruction is normally used to end a display list by jumping to the top of the display list. Jumping to the top turns it into an infinite loop; ANTIC waits for vertical blank to insure that the infinite loop is synchronized to the display cycle of the television. Both JMP and JVB are 3-byte instructions; the first byte is the operation code (JMP or JVB), the second and third bytes are the address to jump to (low byte, then high byte).

The four special options mentioned previously will be discussed in future articles in this series. However, the load-memory scan option must have a preliminary explanation. This option is selected by setting bit 6 of a map-mode or a character-mode instruction byte. When ANTIC encounters such an instruction, it will load its memory-scan counter with the two following bytes. This memory-scan counter tells ANTIC where the screen memory is, and ANTIC begins fetching display data from this area. The LMS instruction is a 3-byte instruction: a 1-byte operation code followed by 2 bytes of operand. In simple display lists, the LMS in-

## Z-80 S-100 MICROPROCESSOR INTERFACE

The diagram shows a central board with various components and their connections:

- MICROPROCESSOR CPU (S100)**: Connected to the board via 8-bit address, 8-bit BCD in, and 8-bit BCD out lines.
- INSTRUMENT (BCD OUT)**: Connected to the board via BCD (4 lines) and DATA READY lines.
- DATA DISPLAY (BCD INPUT)**: Connected to the board via BCD DATA (4 lines), DIGIT STROBE, and DECIMAL POINT lines.
- RELAY DRIVE (32 LINES)**: Connected to the board via BCD DATA (5 lines) and MATRIX ROW STROBE (16 LINES).
- RELAY ARRAY**: Connected to the board via RELAY DRIVE (32 LINES).
- 128 POINT SW - MATRIX (32 BCD SW @ 4 BITS EACH)**: Connected to the board via BCD DATA (5 lines) and MATRIX ROW STROBE (16 LINES).
- CPU RESET**: Provided by the board.
- PROC READY (PROVIDES SYSTEM TURN ON)**: Provided by the board.

- **CPU KEEP ALIVE PC-114-1**—Single board CPU status sensor which provides high power PROC READY (system enable) and CPU RESET signals. \$114.00ea.
- **128 POINT MATRIX CONTACT RECEIVER PC-101-1**—Single board switch — computer interface which, under software control, selects and receives mechanical switch data with switch selectable addressing. \$194.00ea.
- **RELAY D-MUX PC-110**—RELAY DRIVER MULTIPLEXER — Single board computer-relay interface which provides data storage and peripheral relay drive capability, with up to 32 relays being driven from a single board with switch selectable addressing. \$238.00ea.
- **BCD-MUX PC-102-1**—Single board computer — instrument interface which provides I/O and temporary data storage in BCD format. Selectable 5 bit board, addressing. Up to 32 boards may be addressed on the same bus, with switch selectable addressing. \$144.00ea.
- **DUAL DISPLAY DRIVER PC-111** — Single board display driver-computer interface which provide BCD data and decimal point) drive while selectively strobing data to desired digits with switch selectable addressing. \$218.00ea.
- **6 SLOT INTERFACE MOTHER BOARD PC-119** \$130.00ea
- **36 PIN EDGE CONNECTOR** \$5.75

Board Specifications available upon request. Systems Software available. All items in stock. Visa and Mastercharge welcome. Most items shipped U.P.S.

**Weigh Systems Technology, Inc.**

General Offices: 5701 ATLANTIC BLVD, MAYWOOD, CALIF. 90270, 213/582-0701

2896 SOUTHWAY, MEMPHIS, TENN. 38118, 901/363-1521



## if He'd used **select**<sup>™</sup> it wouldn't have taken seven days

**Learn SELECT<sup>®</sup> in just 90 minutes.** A whole new word processing software concept that kicks the coded key habit and frees you from complicated instruction manuals. *SELECT* is fast. *SELECT* is logical. With single key mnemonics, you'll use dozens of commands that instantly access the rich capabilities of this system. There's nothing like it.

Simply hit "C" and you'll be ready to Create a document.

Key "I" and you'll be in the Insert mode.

Key "M" and Move entire blocks of text . . . and key dozens more.

That's all there is to it. You'll get all that word processing software promises . . . plus a few surprises.

**SELECT with SUPERSPELL<sup>®</sup>.** The only microcomputer software with an integrated spelling dictionary. To proof your text all you do, of course, is to key "S". *SUPERSPELL* with its 10,000 word dictionary scans your text at computer speed then displays and corrects all your typing errors. You can increase *SUPERSPELL*'s word power and customize the dictionary by adding new words, one at a time. Ask to see it today at your local dealer.

SELECT with SUPERSPELL . . . just a little byte more.<sup>™</sup>



SELECT will run on any machine that uses CP/M or MP/M\*\* or its derivatives. It needs 40K of RAM and two disk drives. Special version now available for Radio Shack Mod II\*\*\* and Apple II\*\*\*\*.

\* SELECT and SUPERSPELL are trademarks of Select Information Systems Inc.

\*\* CP/M and MP/M are trademarks of Digital Research

\*\*\* A trademark of Tandy Corp

\*\*\*\* A trademark of Apple Computer Inc

INFORMATION SYSTEMS 919 Sir Francis Drake Boulevard • Kentfield, California 94904 • (415) 459-4003





# NEECO

## WHY BUY FROM THE BEST?

Service... Support...  
Software...



### MULTI-CLUSTER

For Commodore Systems, allows 3 CPU's (Expandable to 8) to access a single Commodore Disk.  
MULTI-CLUSTER (3 CPU's) . . . . \$ 795  
Each Additional CPU (up to 8) . . . \$ 199

### commodore

16K B (16K RAM-40 Column) - Lim. Qty	\$ 995
32K B (32K RAM-40 Clm.) - Lim. Qty	\$1295
4016 (16K RAM 4.0 Basic-40 Clm.)	\$ 995
4032 (32K RAM 4.0 Basic-40 Clm.)	\$1295
8032 (32K RAM 4.0 Basic-80 Clm.)	\$1495
8050 Dual Disk (1 Meg Storage)	\$1795
4040 Dual Disk (343K Storage)	\$1295
8010 IEEE Modem	\$ 280
C2N Cassette Drive	\$ 95
CBM - IEEE Interface Cable	\$ 40
IEEE - IEEE Interface Cable	\$ 50
VIC 20 Home/Personal Computer	\$ 295

### ALTOS

ACS 8000-2 64K 1M	\$ 4500
ACS 8000-15 64K 1M	\$ 5990
ACS 8000-6 208K 14.5M	\$10490
ACS 8000-7 208K 29.0M	\$11690
ACS 8000-10 208K 10M	\$ 8500
ACS 8000-10/MTU	\$10990

### EPSON PRINTERS

MX-80 PRINTER	\$ 645
MX-80 FT	\$ 745
MX-100	\$ 945
MX-70	\$ 459
INTERFACE CARDS	
8141 (RS-232)	\$ 75
8150 (2K Buffered RS-232)	\$ 150
8161 (IEEE 488)	\$ 55
8131 (Apple Card)	\$ 85
8230 (Apple Card)	\$ 25
8220 (TRS-80 Cable)	\$ 35

### DIABLO 630 PRINTER

DIABLO 630 - Serial - RS-232	\$2710
Tractor Option	\$ 250

### AMDEK MONITORS

Video 100 12" B+W	\$ 179
Video 300 12" Green	\$ 249
Color I 13" Low Res	\$ 449
Color II 13" High Res	\$ 999

### INTERTEC COMPUTERS

64K Superbrain (360 Disk Storage), CP/M™	\$3495
64K QD Superbrain (700K Disk Storage), CP/M™	\$3995

\*CP/M is a registered trademark of Digital Research.

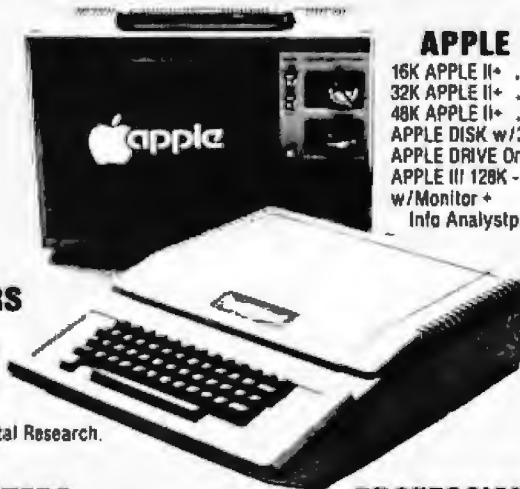

### APPLE

16K APPLE II+	\$1330
32K APPLE II+	\$1430
48K APPLE II+	\$1530
APPLE DISK w/3.3 DOS	\$ 650
APPLE DRIVE Only	\$ 490
APPLE III 128K - In Stock!	
w/Monitor + Info Analystpak	\$4740



### ATARI COMPUTERS

Atari 400 (16K RAM)	\$ 399
Atari 800 (32K RAM) - good thru 8/31	\$1080
Atari 410 RECORDER	\$ 89.95
Atari 810 DISK DRIVE	\$ 599.95

NEECO carries all available ATARI Software and Peripherals.

### PROFESSIONAL SOFTWARE

WordPro 1 8K	\$ 29.95
WordPro 3 (40 Clm.) 16K	\$ 199.95
WordPro 3+	\$ 295
WordPro 4 (80 Clm.) 32K	\$ 375
WordPro 4+	\$ 450

JUST A SAMPLE OF THE MANY PRODUCTS WE CARRY. CALL US FOR OUR NEW 60-PAGE CATALOG. WE WILL MATCH ANY ADVERTISED PRICE ON PRODUCTS LISTED UNDER SIMILAR "IN STOCK" CONDITIONS.

# NEECO

679 HIGHLAND AVE.  
NEEDHAM, MA 02194

(617) 449-1760

Telex: 951021

MON-FRI 9:00 - 5:00



MasterCharge and VISA Accepted

format. This is best done on paper. Lay out the screen image and translate it into a sequence of mode lines. Keep track of the scan-line count of your display by looking up the scan-line requirements of the various modes in table 2. Translate the sequence of mode lines into a sequence of ANTIC mode bytes. Put 3 "blank-eight-lines" bytes (hexadecimal 70) at the top of the list. Set bit 6 of the first display byte (that is, make the upper nybble a 4)—this makes it a load-memory scan command. Follow with 2 bytes that specify the address of the screen RAM (low byte, then high). Then follow this with the rest of the display bytes. At the end of your display list, put in the JVB instruction (hexadecimal 41) and the address of the top of the display list. Store all these bytes into memory. They can be anywhere you want; just make sure they don't overlie something else, and be sure your JVB instruction at the end of the display list points to the top of the display list.

The display list must not cross a 1 K-byte address boundary. If you absolutely must have it cross such a boundary, insert a JMP instruction just in front of the boundary, with the JMP instruction's operand being the address of the first byte on the other side of the boundary. Next, you must turn off ANTIC for a fraction of a second while you rewrite its display-list pointer. Do this by writing a 0 into hexadecimal location 22F (known as SDMCTL). Then store the address of the new display list into hexadecimal locations 230 and 231 (low byte, then high). Lastly, turn ANTIC back on by depositing a hexadecimal 22 into SDMCTL. During the vertical blank, while ANTIC is quiet, the operating system will reload ANTIC's program counter with these new values.

### Screen-Data Placement

Screen memory can be placed anywhere in the address space of the computer. Normally, the display list specifies the beginning of the screen memory with the first display instruction—the initial LMS instruction.

However, ANTIC can execute a new LMS instruction with each display line of the display list, if this is desired. In this way, information from all over the address space of the computer can be displayed on a single screen. This can be of value in setting up independent text windows.

There are several restrictions in your placement of the screen memory. First, screen memory should not cross a 4 K-byte address boundary. If you cannot avoid crossing a 4 K-byte boundary (as would be the case in BASIC mode 8, which uses 8 K bytes of RAM), you must reload the memory-scan counter with a new LMS instruction. Second, if you wish to use any of the Atari

---

### Screen memory can be placed anywhere in the address space of the computer.

---

operating-system screen routines, you must abide by the conventions the operating system uses. This can be particularly difficult when using a modified display list in a BASIC program. If you alter a standard display list from a BASIC program and then attempt to PRINT or PLOT to the screen, the operating system will do so under the assumption that the display list is unchanged. This will probably result in a garbled display.

There are three ways the display can fail when you attempt this. First, BASIC may refuse to carry out a screen operation because it is impossible to do with the graphics mode that the operating system thinks it is in. The operating system stores the value of the graphics mode that it thinks is on the screen in hexadecimal address 57. You can fool the operating system into cooperating by POKEing a different BASIC mode value there. POKE the BASIC mode number, *not* the ANTIC mode number.

The second failure arises when you mix mode lines with different screen-memory byte requirements. Some mode lines require 40 bytes per line, some require 20 bytes per line, and some require only 10 bytes per line.

Let's say that you insert one 20-byte mode line into a display list with 40-byte mode lines. Then you PRINT text to the display. Everything above the interloper line is fine, but below it the characters are shifted twenty spaces to the right. This is because the operating system assumed that each line would require 40 bytes and positioned the characters accordingly. But ANTIC, when it encountered the interloper line, took only 20 bytes of what the operating system thought should be a 40-byte line. ANTIC interpreted the other 20 bytes as belonging to the next line and displayed them there. This resulted in the next line and all later lines being shifted twenty spaces to the right.

The only absolute way around this problem is to refrain from using BASIC PRINT and PLOT statements to output to a mixed display-list screen. The quick and dirty solution is to organize the screen into line groups that contain integer multiples of the standard byte requirement. That is, do not insert a 20-byte mode line into a 40-byte display; instead, insert two 20-byte lines or one 20-byte line and two 10-byte lines. As long as you retain the proper integer multiples, the horizontal shift will be avoided.

This solution accentuates the third problem with mixed display lists and BASIC: vertical shifts. The operating system positions screen material vertically by calculating the number of bytes to skip down from the top of the screen. In a standard 40-byte line display, BASIC would position the characters onto the tenth line by skipping 360 bytes (40 bytes per line times 9 full lines) from the beginning. If you have inserted four 10-byte lines, BASIC ends up 3 lines further down the screen than you would otherwise expect. Furthermore, different mode lines consume different numbers of scan lines, so the position on the screen will not be quite what you expected if you do not take scan-line costs into account.

As you can see, mixed-mode displays can be difficult to use in conjunction with the operating system. Often, you must fool the operating system to make such displays work.



**\$3398**  
**10MB**

# THE HARD DISK YOU'VE BEEN WAITING FOR

**XCOMP** introduces a complete micro-size disk subsystem with more...

- **MORE STORAGE**
- **MORE SPEED**
- **MORE VALUE**
- **MORE SUPPORT**

S100 users . . . The XCOMP subsystem is now available with 10 megabytes of storage; 5 megabytes also available at \$2,898.00. Compare the price and features of any other 5¼-inch — or even 8-inch system, and you'll agree that XCOMP's value is unbeatable.

#### **OUTPERFORMS OTHER HARD DISKS**

Floppy disk and larger, more expensive hard disks are no match for this powerful little system. More data is available on every seek: 64K on 10MB and 32K on 5MB. Faster seek time too — an average of 70MS. It provides solid performance anywhere with only 20 watts of power. Data is protected in the sealed enclosure, and the landing zone for heads provides another margin of safety. The optional power board plugs directly into the S100 bus and provides power for the drive.

#### **FAST CONTROLLER**

The XCOMP controller is the key to this system's high efficiency operation. Speed-up features include interleave without table lookup, block-deblock with controller buffer, and read lookahead. OEMs worldwide have already proven the outstanding performance of the XCOMP controller.

#### **MORE SOFTWARE**

Included with the system is software for testing, formatting, I/O drivers for CP/M®, plus an automatic CP/M driver attach program. Support software and drivers for MP/M® and Oasis® are also available. The sophisticated formatting program assigns alternate sectors for any weak sectors detected during formatting, assuring the lowest possible error rate — at least ten times better than floppies.

#### **WARRANTY**

The system has a full one-year warranty on parts and workmanship.

#### **ALSO AVAILABLE FROM XCOMP**

- General Purpose controllers (8 bit interface), with easy interface to microprocessor-based systems.
- GP controller adapter that plugs directly into most Z80 computers.
- ST/R GP controller for the 5MB and 10MB drive above, with ST506 type interface.
- SG/R GP controller for SA1000 interface.
- SM/R GP controller for storage module drives.
- ST/S, SG/S, and SM/S, same as above, for the S100 bus.

Quantity discounts available. Distributor, Dealer, and OEM inquiries invited.

See your local Dealer, or call:

XCOMP, Inc.  
7566 Trade Street  
San Diego, CA 92121  
Tel: (714) 271-8730  
Telex: 182786



Buy Direct from

**CPI**



An Authorized Direct HP Dealer

**HUGE SAVINGS ON CALCULATORS AND COMPUTERS**

Call 800-682-9250 in California • 800-538-9580 all other states including Alaska and Hawaii  
408-624-0822 outside USA • Telex 172532 • TWX 9103605000

Hours 7:00-6:00 (PST) Monday-Friday



**COMPUTERS**

HP-85 Built In Printer/Tape SYS/CRT	2600.00
HP-83 Built In CRT	1800.00
HP 7225B Plotter	1960.00
HP 2631B OPT 885 Printer	3160.00
5 1/4 Dual Master Flex Drive	2000.00
5 1/4 Single Master Flex Drive	1200.00
8" Dual Master Flex Drive	Call
8" Single Master Flex Drive	Call
16K Memory	236.00

**PERIPHERALS & SOFTWARE**

VisiCalc™ PLUS	170.00
Graphic Presentations	170.00
Surveying	170.00
Basic Training	80.00
Financial Decisions	80.00



**CALCULATORS**

HP-32E ADV SCI W/STAT	44.00
HP-33C PROG SCI	72.00
HP-34C ADV PROG SCI	120.00
HP-37E BUSINESS	60.00
HP-38C ADV FIN	120.00
HP-41C ALPHANUMERIC FULL PERFORMANCE	200.00
HP-41CV ALPHANUMERIC FULL PERFORMANCE QUAD MEM	265.00
PRINTER	308.00
CARD READER	172.00
QUAD MEMORY	76.00

**HP-41C SOFTWARE**

Financial Decisions	27.00
Securities	27.00
Statistics	27.00
Home Management	27.00
Real Estate	40.00

**OTHER PRODUCTS**

Epson Printers MX-80 Call



Maxell Diskettes Call

Prices subject to change without notice • Prices do not reflect shipping and handling charges

CPI — P.O. Box 22530 — Carmel, CA 93922 • 3785 Via Nona Marie

Call for items not shown in this ad

To PRINT or PLOT to a mode window, POKE the BASIC mode number of that window to hexadecimal location 57, then POKE the address of the top left pixel of the mode window into hexadecimal locations 58 and 59 (low byte, then high). In character modes, execute a POSITION 0,0 to home the cursor to the top left corner of the mode window. In map modes, all PLOTs and DRAWTOs will be made using the top left corner of the mode window as the origin of the coordinate system.

The display-list system can be used to produce appealing screen displays. Its most obvious use is for mixing text and graphics. For example, you could prepare a screen with a bold BASIC mode 2 title, a medium-size BASIC mode 1 subtitle, and small BASIC mode 0 fine print. You could then have a BASIC mode 8 picture in the middle, with more text at the bottom.

With assembly-language routines, modified display lists are best used by organizing the screen into a series of windows, each window having its own LMS instruction and its own independent RAM area.

**Modification Applications**

One simple application of display-list modifications is to vertically space lines on the screen by inserting blank-line bytes. This will add some vertical spacing, which will highlight critical messages and enhance the readability of some displays.

Another important use of display-list modifications is in providing access to features not available from BASIC. There are three text modes supported by ANTIC that BASIC does not support. You can gain access to these modes only by modifying the display list. There are also display-list-interrupt and fine-scrolling capabilities that are only available after the display list is modified. These features are the subjects of later articles in this series.

Manipulations with the LMS instruction and its operand offer many possibilities to the creative programmer. For example, by changing the LMS during vertical blank, the programmer can alternate screen images.



...And my dad says GRAFTRAX 80 does better graphics than anybody.

# Epson.

You might say it's the head of its class. GRAFTRAX 80 gives you the highest resolution dot matrix in the world — up to 120 dots per inch horizontally and 216 dots per inch vertically. Which makes our MX-80 and MX-80 F/T work more like a plotter than a printer.

And that's just for starters.

GRAFTRAX 80 more than doubles the features available in an Epson MX-80 or MX-80 F/T. For instance, we've added nice little touches like an italic character set — which doubles the number of font types to 24. And with GRAFTRAX 80, you can change style, size and density anywhere in the line. And backspace the head. And use block graphics with *any* computer. And redefine all escape codes under software control.

Up to now, you couldn't get some of these features at *any* price. With GRAFTRAX 80, you get 'em all. And more. Lots more.

Best of all, we haven't forgotten all those people who already own an MX-80 or MX-80 F/T. You own the printer that set the standards all the others are following. And you can install GRAFTRAX 80 PROMs yourself, for less than \$100. And make the best even better.

You can see why we say GRAFTRAX 80 is the head of its class. There's nothing else *in* its class.



**EPSON**  
EPSON AMERICA, INC.

3415 Kashiwa Street • Torrance, California 90505 • (213) 539-9140

	Pixel Contents (By Color Register)											
first frame	1	1	1	1	2	3	2	3	2	3	2	3
second frame	B	1	1	1	B	B	2	3	2	3	2	3
third frame	B	B	1	1	B	B	B	B	2	3	2	3
fourth frame	B	B	B	1	B	B	B	B	B	B	2	3
effective luminance $\times 4$	2	4	6	8	10	12	20	24	30	36	40	48
perceived luminance												

**Table 4:** Advanced color and luminance control through the high-speed changing of the video display; see the text for details.

This can be done at slow speed to change between predrawn displays without having to redraw each one. Each display would continue to reside in (and consume) memory even while it is not in use, but it would be available almost instantly. This technique can also be used for animation. By flipping through a sequence of displays, cyclic animation can be achieved. The program to do this would manipulate only 2 address bytes to display thousands of bytes of memory.

It is also possible to superimpose images by flipping screens at high speed. The human eye has a time resolution of about  $\frac{1}{6}$  of a second,

so a program can cycle between four images, one every  $\frac{1}{60}$  of a second, so each repeats every  $\frac{1}{15}$  of a second. In this way, up to four images can appear to reside simultaneously on the screen. There are some drawbacks to this method. First, four separate displays may well cost a lot of memory. Second, each display image will be washed out because it only shows up one quarter of the time. This means that the background of all displays must be black, and each image must be bright. Furthermore, there will be some unpleasant screen flicker when this technique is used. A conservative programmer might consider cycling between only three or

even two images. This technique can also be used to extend the color and luminance resolution of the computer. By cycling between four versions of the same image, each version stressing one color or luminance range, a wider range of colors and luminosities is available.

For example, suppose we wish to display a bar of many different luminances. We first set our four color registers to the following hexadecimal values:

```
background: 00
playfield 1: 02
playfield 2: 0A
playfield 3: 0C
```

If we put the images described in table 4 into each of the screen-memory areas, we can achieve much finer luminance resolution.

A final suggestion concerns a subject that is laden with opportunities, but that is as little understood as the dynamic display list. This is a display list that the 6502 changes during vertical-blank periods. It should be possible to produce interesting effects with dynamic display lists. For example, a text-editing program could dynamically insert blank lines above and below the screen line being edited to set it apart from the other lines of text. As the cursor is moved vertically, the display list is changed to isolate the screen line the cursor is on. The technique is odd but very effective.

### Conclusions

The display list is a powerful system for creating and controlling displays. It is not a simple system. In essence, it is a scheme for mating two completely different technologies, the television and the microcomputer. When I consider the differences between these two technologies and the exacting demands of each, I am surprised that the display-list system achieves such a favorable combination of power and simplicity. Even more surprising is the way the display-list system supports an even more powerful set of graphics capabilities, such as graphics indirection, display-list interrupts, and fine scrolling. These will be the subjects of future articles in this series. ■

## Need a Real-Time Multi-Tasking Executive for 8080 and Z80?

# AMIX

- Faultless operation proven in world wide use
- Truly hardware independent
- Optimized for fast interrupt response
- Minimal memory requirements
- ROMable for control applications
- Terminal Handler is CP/M BDOS compatible
- Console Driver supports Intel iSBC boards
- SYSGEN speeds user system configuring
- Program in PL/M, Fortran, Pascal or Assembler
- Source code included (Intel or Zilog mnemonics)
- Unlimited use licence agreement
- Complete documentation (available separately)
- Low cost



**KADAK Products Ltd.**

206-1847 West Broadway Avenue  
Vancouver, B.C., Canada V6J 1Y5  
Telephone (604) 734-2796

Dealer enquiries invited

CP/M is a trademark of Digital Research Corp. RMX/80, iSBC are trademarks of Intel Corp.

CP/M®  
Interface  
Also Available

# R&D COMPUTER SYSTEMS

## Data Acquisition & Control Systems

16 to 256 ch.; Programmable gain; Voltage or current output;  
12, 14, or 16 bit; 30 to 125 KHz; Stepping motor control

## 8086 16 Bit Micro Systems

31 MByte Winchester Drives  
256 KByte Memory Boards  
8086 Software

## Real Time Video Digitization Systems



### S-100 Boards

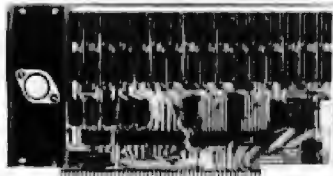

**16 Kilobyte Static RAM**  
8 and 16 bit transfer



**8086 CPU with Vectored Interrupts**



**PROM and I/O**  
2 RS 232 - PIO  
CP/M-86 ROM Boot

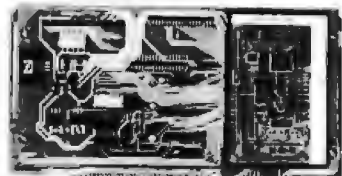

**Analog to Digital Converter and Timer/Counter**  
16 channels expandable to 256  
12, 14, or 16 bit accuracy  
30,40,100, or 125 KHz  
Programmable Gain

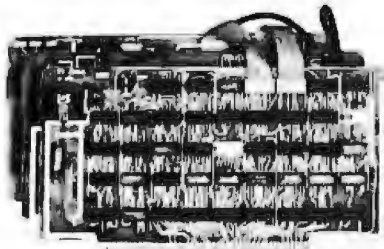

**Real Time Video Digitizer and Display**

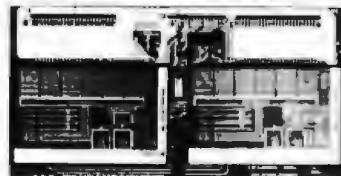

**Expansion Multiplexer**

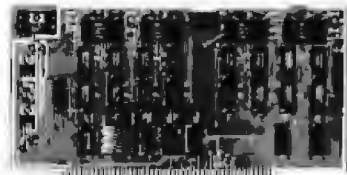

**Digital to Analog Converter**  
4 channels - 12 bit accuracy  
3 microsecond conversion rate

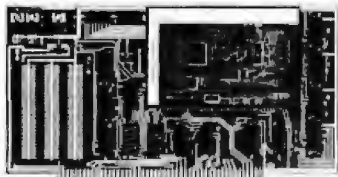

**Analog to Digital Converter**  
16 channels - 12 bit accuracy  
30 KHz Conversion rate



**4 PIO and Timer/Counter**

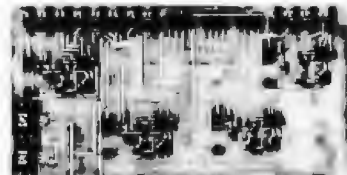

**Digital to Analog Companion**  
4-20 mA output - Filters

### Apple Boards

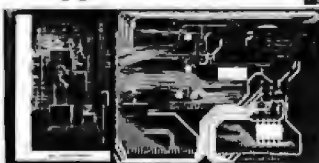

**Analog to Digital Converter**  
16 channels  
12, 14, or 16 bit accuracy  
30, 40, 100, or 125 KHz



**Digital to Analog Companion**  
4-20 mA output - Filters



**Digital to Analog Converter**  
2 channels - 12 bit accuracy  
3 microsecond conversion rate  
1 parallel output port



**TECMAR**  
INC.

23600 Mercantile Rd. • Cleveland, OH 44122

**TECMAR, INC.**  
(216) 464-7410



**BEING OVERCHARGED!**

**DON'T**

Pay Credit Card Surcharges  
Pay a U.P.S. C.O.D. "Fee"  
Even Pay for the Call!

**DO CALL OMEGA TOLL FREE!**

**Special  
of the Month!**

**EPSON MX-80**

INTERFACES: IEEE \$55, TRS-80 \$35,  
APPLE INTERFACE & CABLE \$90,  
RS-232 \$70

<b>EPSON MX-80FT</b>	<b>\$599</b>
<b>MX-100FT</b>	<b>\$769</b>



**WEST COAST**  
**1-800-235-3581**

**EAST COAST**  
**1-800-556-7586**

CALL OMEGA AND FIND OUT WHY WE ARE AMERICA'S FASTEST  
GROWING COMPUTER SALES COMPANY!

**ΩMEGA SALES COMPANY**



WEST COAST / EAST COAST



ANADEx  
\$1295



ATARI 800 32K \$ 749



DIABLO 630  
\$2099

Tractor option  
\$ 245

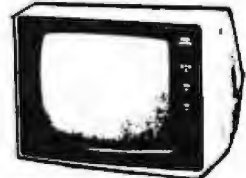

NEC 12" MONITOR  
\$ 229

NEC  
OKIDATA  
APPLE

TELEVIDEO  
COMMODORE

RADIO SHACK  
AMDEK

ATARI

DIABLO 630	\$2099
INTERTEC SUPERBRAIN 64K RAM	\$2799
QD SUPERBRAIN	\$3185
NEC 5510 SPINWRITER	\$2495
NEC 5530 SPINWRITER	\$2495
OKIDATA MICROLINE-80	\$ 399
OKIDATA MICROLINE-82	\$ 529
OKIDATA MICROLINE-83	\$ 769
APPLE II PLUS 48K	\$1189
APPLE DISK w/3.3 DOS Controller	\$ 545
APPLE DISK w/o Controller	\$ 435
BASE II PRINTER	\$ 599
HAZELTINE 1420	\$ 799
NORTHSTAR HORIZON II 32K QD	\$2975
ANADEx DP-9500	\$1295
TELEVIDEO 912C	\$ 669
TELEVIDEO 920C	\$ 729
TELEVIDEO 950	\$ 959
CBM 8032 COMPUTER	\$1225
CBM 8050 DISK DRIVE	\$1449
CBM 4032 COMPUTER	\$1090
CBM 4040 DISK DRIVE	\$1090
CBM 4022	\$ 679
CBM VIC-20	\$ 289
CBM C2N	\$ 85
RADIO SHACK II 64K	\$3245
RADIO SHACK III 16K	\$ 839
LEEDEX/AMDEK 100	\$ 139
LEEDEX/AMDEK 100G	\$ 169
LEEDEX/AMDEK COLOR-1 13" Color Monitor	\$ 349
MICROTEK 18K RAMBOARD for Atari	\$99.95
MICROTEK 32K	\$ 165
ATARI 400 16K	\$ 349
ATARI 825 PRINTER	\$ 619
ATARI 850 INTERFACE	\$ 139
or both together	\$ 749
ATARI 810 DISK DRIVE	\$ 449
ATARI 800 32K	\$ 749
NEC 12" MONITOR	\$ 229

PRICES ARE SUBJECT TO CHANGE WITHOUT NOTICE.

Call for price list of ATARI software

No Surcharge for Credit Cards Orders • We Accept C.O.D.'s

All Equipment Factory Fresh With MFT. Warranty • Stock Shipments Same Day or Next

**WEST COAST**  
**1-800-235-3581**

OMEGA SALES CO.  
3533 Old Conejo Rd. #102  
Newbury Park, CA 91320  
1-805-499-3678  
CA. TOLL FREE 1-800-322-1873

OMEGA  
SALES  
CO.

**EAST COAST**  
**1-800-556-7586**

OMEGA SALES CO.  
12 Meeting St.  
Cumberland, RI 02864  
1-401-722-1027

**OMEGA SALES COMPANY**

# Natural-Language Processing

## The Field in Perspective

---

Gary G Hendrix  
Natural Language Program  
Artificial Intelligence Center  
SRI International  
333 Ravenswood Ave  
Menlo Park CA 94025

Earl D Sacerdoti  
Machine Intelligence Corp  
1120 San Antonio Rd  
Palo Alto CA 94303

---

Through a process spanning thousands of years, natural languages have evolved to meet the manifold needs of people to communicate and record a diversity of information in a wide variety of circumstances. Natural language is the medium of the butcher, the baker, and the candlestick maker; the poet and the lover; the politician and the preacher; the parent and the child. Even for the scientist and computer programmer, it is the mother tongue—the language resorted to when formal expressions and intuition fail.

Natural languages stand in marked contrast to formal languages, such as BASIC and Pascal, which were designed to be easily understood by computers and are intended for the specialized task of expressing algorithms and data structures. The fluent use of natural language is an information-processing activity of great complexity. Endowing computers with this ability has long been a major goal of research in *artificial intelligence* (also called *machine intelligence*), a branch of experimental computer science that studies the nature of knowledge and its manipulation.

Understanding the computational mechanisms that underlie the use of natural language is the central objective of *computational linguistics* (see the text box at the end of the article), a science at the juncture of artificial intelligence, philosophy, linguistics, and psychology. The two primary goals of this field are:

- to understand how humans communicate
- to create machines with human-like communication skills

The first is a scientific goal pursued to help us understand ourselves. In particular, although we all are implicitly expert in the use of natural language, we have only vague notions of the mental processes involved. A clearer in-

sight into their essential nature and functioning might enable us to be better communicators, to train our children better in language skills, and even to design more efficient intercomputer communications.

The second goal is an engineering one pursued for a practical purpose—to create machines that can communicate with people in languages they already know. At present, only a small segment of the population, computer programmers, can communicate with computers. The advent of machines that understand natural languages will make it possible for virtually anyone to make direct use of powerful computational systems.

Progress in computational linguistics is facilitated by pursuing both of the above goals simultaneously. Creation of mechanical schemes for dealing with some aspect of natural-language processing sheds light on how it might actually be performed by the human brain. Similarly, evidence derived from observing how people use language suggests prospective computational mechanisms or, more often, provides valuable insights into the reasons particular mechanical processes fail.

To create computer systems that deal with certain significant subsets of natural-language phenomena, it is probably not necessary to perform the task in a way closely simulating computational processes in the human brain. This should not be surprising. Mechanical dishwashers use a nonhuman technique to produce a result equivalent to that of a human dishwasher. For interactions about very limited subject areas, we can hope to employ thoroughly nonhuman techniques in dealing with natural language. Nevertheless, machines concerned with any but the most mundane aspects of human language will probably have to deal with human psychology. After all, natural language has evolved as an efficient tool for conveying information between human minds. One of

The most comprehensive and useful  
computer reference in the world.



- A mammoth volume covering everything from Access Methods to Working Set, in 1,523 pages, 470 articles and over 1,000 illustrations, tables and charts.
- Authoritatively compiled by over 200 internationally respected authorities.

If reply card has been removed, please write:  
The Library of Computer and Information Sciences  
Dept. 7-AR2, Riverside, N.J. 08075,  
to obtain membership information and application.

Take the  
**ENCYCLOPEDIA  
OF  
COMPUTER  
SCIENCE**

—a \$60.00 value—  
yours for only

**\$295**

when you join **The Library of Computer and Information Sciences**. You simply agree to buy three more books—at handsome discounts—within the next 12 months.

Find the answers to virtually all your data processing questions in the **ENCYCLOPEDIA OF COMPUTER SCIENCE**.

Thousands of photos, diagrams, graphs and charts completely illuminate the **ENCYCLOPEDIA'S** clear and thorough coverage of every area of the computer sciences—software, hardware, languages, programs, systems, mathematics, networks, applications, theory, history and terminology.

Appendices provide abbreviations, acronyms, special notations and many numerical tables. An additional highlight is a complete cross-reference system that assists the reader seeking in-depth information.

**What is The Library of Computer and Information Sciences?**

It's a book club especially designed for the computer professional. In the incredibly fast-moving world of data processing, where up-to-date knowledge is essential, we make it easy for you to keep totally informed on all areas of the information sciences. In addition, books are offered at discounts up to 30% off publishers' prices.

Begin enjoying the club's benefits by accepting the **ENCYCLOPEDIA OF COMPUTER SCIENCE**. It's the perfect reference for computer professionals . . . and it's a great bargain, too.

# The TELERAM S-100 Bubble Memory System

## A whole lot more... at 25% less

Now there is a bubble memory system that is fully compatible with IEEE S100. And it's available from Teleram at 25% less cost compared to other bubble memory systems currently available—plus—it requires *only* 25% of the physical space. Each board has a capacity of 128K or 256K bytes of non-volatile storage and can be daisy chained to provide one megabyte.

### FEATURES:

- DATA IS RETAINED AFTER POWER OFF
- 40 MILLISECOND ACCESS TIME
- CORRECTION FOR UP TO 5 BIT BURST ERRORS
- CP/M COMPATIBLE
- UNAFFECTED BY DUST
- VERY HIGH RELIABILITY
- OPERATES IN VERY HARSH ENVIRONMENTS
- COMPLETELY MANUFACTURED IN THE U.S.
- IDEALLY SUITED FOR PORTABLE AND PROCESS CONTROL APPLICATIONS

The Teleram S-100 Bubble Memory System can provide the opportunity for new design concepts.

For a free data sheet call or write:

TELERAM COMMUNICATIONS CORPORATION,  
2 CORPORATE PARK DRIVE,  
WHITE PLAINS, N.Y. 10604, (914) 694-9270

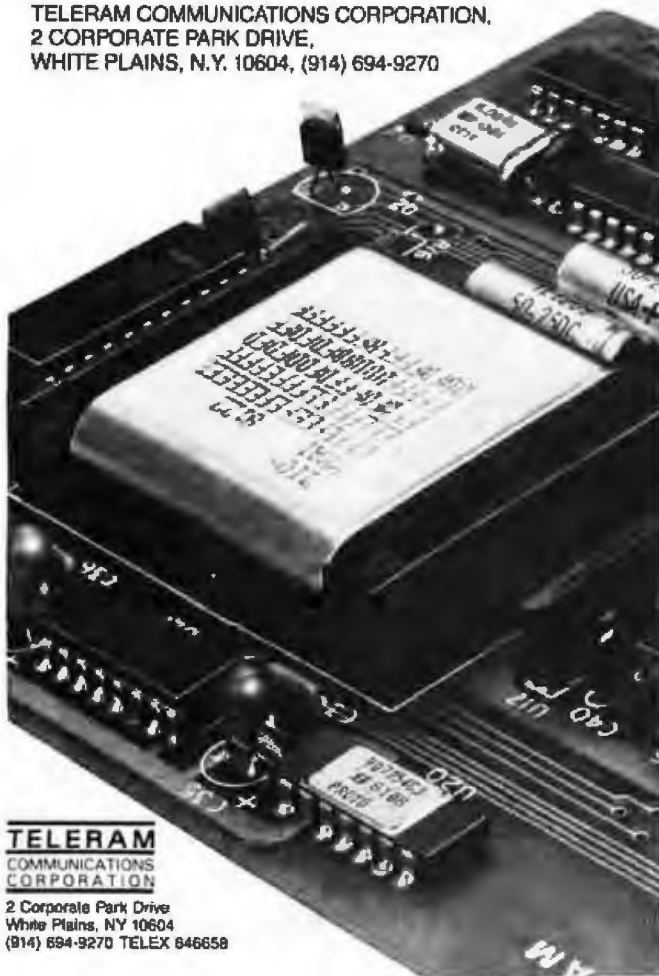

**TELERAM**  
COMMUNICATIONS  
CORPORATION

2 Corporate Park Drive  
White Plains, NY 10604  
(914) 694-9270 TELEX 646658

the participants in a man-machine dialogue operates with all the constraints and richnesses of the human psyche; the other has to take these into account.

The ultimate goal of creating machines that can interact in a facile manner with people remains far off, awaiting both improved information-processing algorithms and alternative computing architectures. However, progress in the last decade has demonstrated the feasibility of employing today's computers to deal with natural-language input in highly restricted contexts. Furthermore, microcomputer implementation of these limited language-processing techniques is leading to more practical, cost-effective systems.

In this article, we offer an overview of the potential applications, experimental systems, existing techniques, research problems, and future prospects in this rapidly evolving field. We will address major issues in natural-language processing by focusing on several representative systems, necessarily leaving much important work unmentioned. For example, we will not discuss the complex issues involved in understanding spoken (as opposed to typed) language. Our intentions are to demonstrate that natural-language processing techniques are useful *now*, to reveal the richness of the computations performed by human natural-language communicators, and to explain why the fluent use of natural language by machines remains an elusive aspiration.

### Applications of Natural-Language Processing

To motivate our discussion about how to approach the technological goal of creating a machine with human-like communication skills, let us consider some potential areas for the application of natural-language processing:

• *Machine translation*—The oldest dream of computational linguistics is of a mechanical device that can read documents written in one natural language and produce corresponding documents written in other languages, but with equivalent meanings. In fact, the birth of computational linguistics occurred in 1946, when Warren Weaver and A. Donald Booth first suggested the use of a digital computer to create such a device. The Association for Computational Linguistics, the professional organization in this discipline, was originally named the Association for Machine Translation and Computational Linguistics.

• *Document understanding*—Beyond simply translating a document from one language to another, a device might read and *understand* documents, fitting their information into a larger framework of knowledge. A practical device of this sort would read and assimilate a document much as a person would. The device might subsequently produce abstractions of the document, alert people likely to be interested in it, or answer specific questions based on its information. If such a device had read many documents, it might be able to act as a librarian, directing users to pertinent references.

• *Document generation*—A task related to document understanding is document generation. We can envisage a device that translates information stored in a formal

# INTRODUCING...

COMES WITH: (ADDITIONAL)

- ▲ WORD STAR® WORD PROCESSOR
- ▲ ACCOUNTS PAYABLE
- ▲ ACCOUNTS RECEIVABLE
- ▲ GENERAL LEDGER
- ▲ SALES ORDER ENTRY
- ▲ INVENTORY CONTROL

ONLY

## \$3450.00

QUANTITY DISCOUNTS  
AVAILABLE!

INCLUDING CP/M2.2®

(\$4950.00 INCLUDING  
ACCOUNTING SOFTWARE  
AND WORD STAR®)



320K  
MINI DRIVES  
SHOWN, 8"  
and 5 1/4" 10MB  
HARD DISK  
OPTIONAL

IMMEDIATE DELIVERY!

### 1 YEAR PARTS WARRANTY!

(90 DAYS ON DRIVE PACKAGE, KEYBOARD AND LABOR)

**U.S. MICRO SALES S-100-8**

## CHECK THESE FEATURES!

### TERMINAL

- Feather Touch Capacitance Keyboard
- 60 Key Standard ASCII  
PLUS + Hex Keypad  
PLUS + 8 Special Function Keys  
PLUS + 20 Screen Editing Keys
- SOROC Type Screen Attribute Set
- Half Intensity

### COMPUTER

- 8 Slot S-100
- 64K Dynamic Ram
- 4MHZ Z-80
- Serial Printer Port (150 - 19.2K)
- Double Density Disk Controller
- Programmable Baud Rate
- Programmable Keyboard Set

### DISK STORAGE

- Dual Double Density  
5 1/4" Single Sided Drives
- DOUBLE SIDED Option
- Double Sided, 77  
Track, Option
- Color Matched Enclosure
- Self Contained Power Supply

#### OPTIONS:

- ◆ Dual 5 1/4" Double Sided MPI B51 (640K) add \$225.00
- ◆ Dual 5 1/4" Double Sided MPI B91 (1.2MB) add \$360.00
- ◆ Dual 8" SIEMANS FDD120-8 Drives (1MB) add \$250.00
- ◆ Dual 8" QUME Double Sided Drives (2MB) add \$625.00



WORD STAR is a TM of Micropro Inc. - CP/M2.2 is a TM of Digital Research Inc.

Circle 368 on inquiry card.

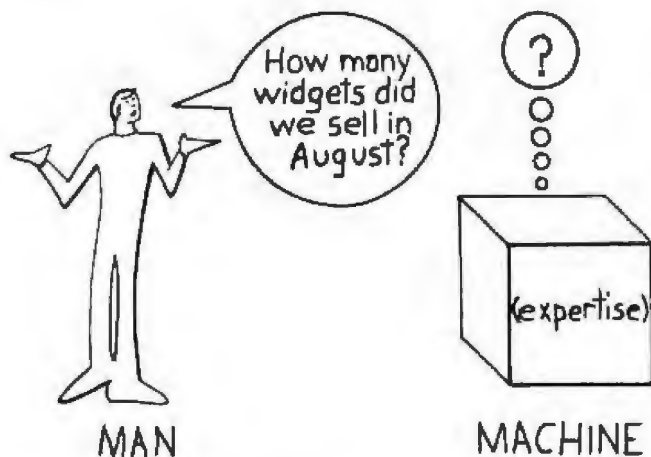

Figure 1: The typical nontechnical user confronts a "black box" that contains large amounts of knowledge on a given subject.

language in a computer's memory into ordinary language. For example, the designer of an automobile engine might describe repair procedures in a formal language. (After all, we expect that the designing of mechanical devices will someday be done principally by computer systems, which may prefer formal languages.) From this formal description, instruction manuals in various languages could be generated.

A more sophisticated system could generate special manuals for particular groups or individuals. Taking into

account that mechanics know much about auto repair, a smart system would generate a different manual for mechanics than for automobile owners, but on the basis of the same underlying information. Information on elementary mechanical tasks would be included in manuals for less knowledgeable individuals. An ultimate system would tailor a manual to the background of each individual.

It is worth noting that a repair manual need not be written in linear sequence in a typical book format. Using a computer, advice about how to proceed on any particular problem could be dynamically generated to apply specifically to the task at hand. We will return to this topic later in the article.

● *As part of a system*—An interesting use of natural-language processing is as part of a larger computer-based system. For example, imagine devices that not only communicate in English, but also:

- provide answers to questions by accessing large data bases
- control complex equipment such as industrial robots, power generators, or missile systems
- furnish expert advice about medical problems, mechanical repairs, how to buy stocks, or what to cook for supper
- teach courses in a broad range of subjects

An extreme example of a computer-based system that would use natural-language processing as an integral component is a robot that communicates in English. Such a robot might be expected to perform as many tasks involving the use of natural language as might be done by a human assistant.

The importance of these potential applications and the basic science needed to make them possible has long been appreciated by scientific-funding agencies of the United States government. Current progress in the field is due largely to support from the Defense Advanced Research Projects Agency, the National Science Foundation, and the Office of Naval Research.

### What Existing Systems Can Do

One of the most important and feasible areas for the application of natural-language processing is accessing data in data bases. Billions of dollars have been spent in collecting and encoding such data. However, this information is generally not readily available to the people who need it. The situation is illustrated by figure 1.

An executive in the widget business wants to direct a simple question to his black box. He wants to know, "How many widgets did we sell in August?" He knows the information is in the black box, but he lacks the expertise to make the box understand him.

As shown in figure 2, he must find an interpreter (computer programmer) who can translate his question into a formal query to give to the machine. Unfortunately, programmers are out drinking coffee when you need them,

# EXPAND APPLE AND ATARI 16K RAM CARD

These exciting new additions to our line will meet the demand for low cost alternatives to the higher priced language and ram cards. The ConComp Apple II 16K Ram Card will work with all existing software compatible with the Apple Language Card\* and the Microsoft Z-80 Softcard.<sup>2</sup> Allowing up to 64K of user memory, the Ram Card helps make complete use of Pascal, GP/M,<sup>4</sup> and larger programs like VisiCalc.<sup>3</sup> The Atari 800<sup>2</sup> version is compatible with all Atari software.

Both cards are constructed using high-speed high-quality dynamic RAM and come with a full one year warranty.

For more information please call or write.

\*Trademark of Apple Computer Inc.  
<sup>2</sup>Trademark of Atari Inc.  
<sup>3</sup>Trademark of Personal Software Inc.  
<sup>4</sup>Trademark of Digital Research  
<sup>5</sup>Trademark of Microsoft Consumer Products, Inc.

**APPLE II**  
**\$130**  
**ATARI 800**  
**\$89**

Available from:  
**ConComp Industries**  
 8338 Center Dr.  
 La Mesa, CA 92041  
 (714) 484-6373

Dealer Inquiries Invited

# When it comes to microcomputer software we wrote the book.



How do you stay up-to-the-minute with the rapidly changing world of microcomputer software? Get the Lifeboat Catalog.

#### The Latest Innovations

The new Lifeboat Catalog is packed with the latest state-of-the-art software. And if we publish a new program after the latest catalog has gone to press, we enclose a flash bulletin in your copy.

#### The Greatest Selection

Because Lifeboat is the world's largest publisher of microcomputer software, our catalog offers you the greatest selection of programs for business, professional and personal use. Our more than 200 programs range from integrated accounting and professional practice systems to office tools for bookkeepers and secretaries to sophisticated tools for programmers. Included are business systems, word processors, programming languages, database management systems, application tools and advanced systems utilities.

We specialize in software that runs on most small business computers. Our more than 60 media formats, including floppy disks, data cartridges, magnetic tape and disk cartridges, support well over 100 computer brands of domestic and foreign manufacture.

**LIFEBOAT WORLDWIDE offers you the world's largest library of software. Contact your nearest dealer or Lifeboat:**

Lifeboat Associates  
1651 Third Ave  
New York, N.Y. 10028  
Tel: (212) 860-0300  
Telex: 640693 (LBSOFT NYK)  
FAX: 710-581-2524

Lifeboat Inc.  
OK Bldg., 5F  
1-2-8, Shiba-Denman  
Minato-ku, Tokyo 105, Japan  
Tel: 03-437-3901  
Telex: 2423296 (LBJTYG)

Lifeboat Associates, Ltd  
PO Box 125  
London WC2H 9LU, England  
Tel: 01-836-9028  
Telex: 893709 (LBSOFTG)

Lifeboat Associates GmbH  
PO Box 168, Aegerstrasse 25  
CH 6340 Basel, Switzerland  
Tel: 042-31-2931  
Telex: 863765 (MICO CH)

Intersoft GmbH  
Schlossgartenweg 5  
D-8045 Ismaning, W Germany  
Tel: 089-965-444  
Telex: 5213643 (ISOFD)

Lifeboat Associates S.A.R.L.  
10, Grande Rue Charles de Gaulle  
92600 Asnières, France  
Tel: 1-733-08-04  
Telex: 250303 (PUBLIC x PARIS)

**Lifeboat Associates**  
Software with full support

#### Get Full Support

We give the crucial dimension of after-sales service and full support to everything we sell. That includes:

- A telephone hotline where technical and customer service representatives will answer your questions 11 hours a day.

- An update service for software and documentation.

- Telephone, telex and mail-order service at the New York headquarters and at overseas offices in England, France, Switzerland, West Germany and Japan.

- Export service providing software delivery to six continents.

- Subscriptions to *Lifelines*™, the monthly magazine that offers comparative reviews, tips, techniques, identified bugs and updates that keep you abreast of change.

#### Get It Now

Lifeboat now serves tens of thousands of satisfied customers with our breadth of up-to-date, fully tested, fully supported and competitively priced software.

You may not need all we offer, but we offer just what you need. After all, we wrote the book.

Mail coupon to: Lifeboat Associates,  
1651 Third Avenue, New York, New York 10028  
or call (212) 860-0300.

- Please send me a free Lifeboat Catalog.  
 Please send me *Lifelines* subscription information.

Name \_\_\_\_\_ Title \_\_\_\_\_  
Company \_\_\_\_\_  
Street \_\_\_\_\_  
City \_\_\_\_\_ State \_\_\_\_\_ Zip \_\_\_\_\_

*Lifelines* is a trademark of Lifelines Publishing Corporation.

2008

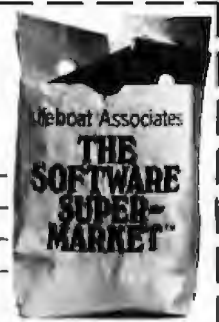

# ARE YOU READY?



## You are ready for MICRO if you want to...

- Go beyond canned software
- Use your computer for more than games
- Learn advanced programming techniques
- Understand the inner workings of your computer
- Get the most out of your 6502/6809 system

Month after month, MICRO gives readers sophisticated software applications, detailed discussions of programming languages, and in-depth hardware tutorials.

To get the most out of your machine, say YES to MICRO today! We accept VISA or Mastercard. **\$18.00** per year in the U.S., **\$21.00** elsewhere.

Use Our 24-hour Toll-free Service

**800-227-1617** Ext.546

In California: 800-772-3545, Ext.546

**MICRO**

34 Chelmsford Street  
P.O.Box 6502  
Chelmsford, MA 01824

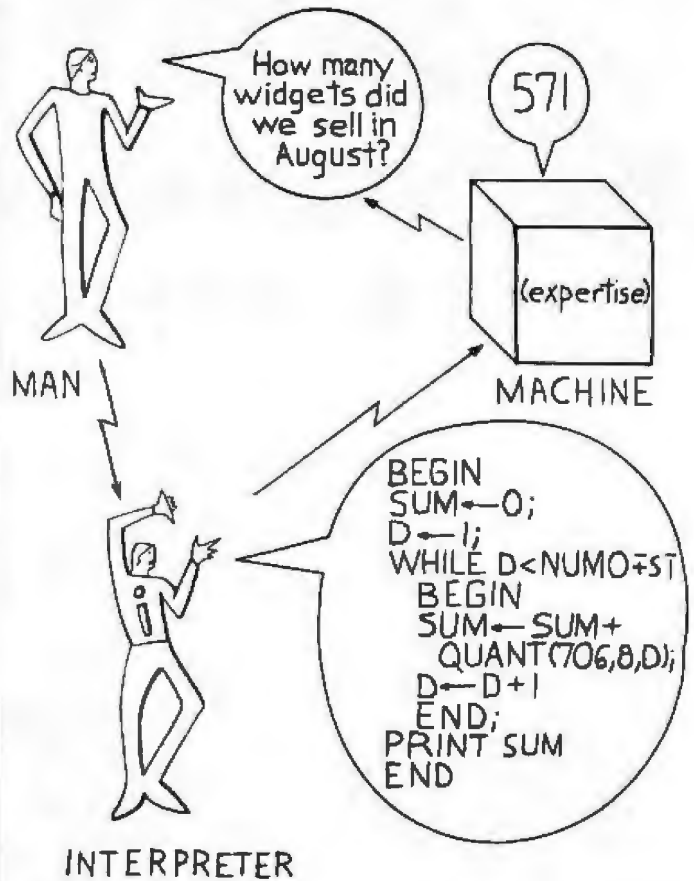

Figure 2: The nontechnical user obtains information from the computer through the use of an interpreter (computer programmer), who translates the English question into a form the machine understands.

or they are working on a project more important than your project—so they cannot help you this week. When a programmer is available, misunderstandings often occur and there are problems in creating proper code. By the time an answer is extracted from the computer, it may no longer be timely and may not even be relevant!

### The LADDER System

To produce timely answers to questions and quickly clear up problems as to how a decision-maker's question is to be interpreted, the turnaround time must be cut from hours or days to seconds.

Research groups around the world are attempting to do this by automating the programmer in figure 2. For example, the LADDER system developed at SRI International (see references 11 and 12 at the end of this article) is capable of translating a question such as:

TO WHAT COUNTRY DOES  
THE FASTEST SUB BELONG?

into either the code of listing 1 or listing 2, depending on which DBMS (data-base management system) has the relevant data. An explanation of these segments of code is unnecessary here. The point is that systems exist that are capable of accepting simple English queries specifying

*Text continued on page 314*



DEALERS: By now you know that it takes . . . . .

# SOFTWARE TO SELL COMPUTERS

and International Micro Systems can provide you with the largest selection of quality business applications ever developed for the microcomputer industry.

If you are just looking for a G.L., A/P, and Payroll, you can find them in a dozen ads in this magazine. But there's a much bigger market for micros out there than that. Where can you find a fully interfaced Wholesale/Retail Distribution System? How about Manufacturing Inventory Control including Production Scheduling & Control. See that one anywhere else? Maybe your market is Medical/Dental and IMS has the full systems there too. You can't sell computers without software and IMS has the finest selection of software available for you. Each system has been developed by the IMS professional staff and we support what we sell.

But that's not all. International Micro Systems has the strongest dealer marketing plan in the industry. With our . . . . .

## \$245 Dealer Demo System.

we put all the software shown below in your office or store ready to demo to your prospects and we include the promotional material and our unique video sales presentation to help you move systems. Give us a call or drop us a card and let us show you what selling business systems should be all about.

### Financial Systems

- GL, A/P, A/R
- Payroll
- Cash Receipts/Disb.
- Job Costing
- Mailing List Mgmt.

### Medical/Dental

- Office Scheduler
- Patient Billing & A/R
- Insurance Forms

### Governmental/Educational

- Student Record Keeping and Scheduling
- Fund Accounting

### Wholesale Distribution System

- Purchasing & Receiving
- Inventory Control
- Invoicing & Receivables
- Salesman Comm Reporting
- Backorder Management

### Manufacturing Inventory Control

- Finished Goods Inventory Mgmt.
- Parts Inventory Mgmt
- Parts Purchasing & Receiving
- Bill of Material
- Production Scheduling



**I**NTERNATIONAL  
**M**ICRO  
**S**YSTEMS

For details on our demo special, contact us at:  
8425 Quivira Road, Lenexa, Kansas 66215  
Phone: (913) 888-8330

**Listing 1: An English-language query translated to an equivalent program in DATALANGUAGE.**

**English Query—**

To what country does the fastest sub belong?

**DATALANGUAGE Query—**

```

BEGIN
  DECLARE Y1 STRING (,100) ,D='Y'
  DECLARE Y2 STRING (,100) ,D='Y' Y2 = '00.0'
  DECLARE Y3 INTEGER Y3 = 0
  DECLARE Y5 STRING (,100) ,D='Y' Y5 = 0
  DECLARE Y4 STRING (,100) ,D='Y' Y4 = 0
  FOR R1 IN SHIPCLASCHAR WITH (R1.TYPE2 EQ 'S') AND
                                (R1.TYPE1 EQ 'S')
  FOR R2 IN SHIPCLASDIR WITH (R2.SHIPCLAS EQ
  R1.SHIPCLAS)
  FOR R3 IN SHIP WITH (R3.UICVCN EQ R2.UICVCN)
  BEGIN
    Y1 = R3.MCSF
    IF Y1 LE '99.9' AND Y2 LT Y1 THEN
      BEGIN
        Y2 = Y1
        Y5 = R3.NAT
        Y4 = R3.NAM
        Y3 = 1
      END
    END
  END
  IF Y3 EQ 1 THEN
  BEGIN
    NSTDPORT.STRING1 = Y4
    NSTDPORT.STRING2 = Y5
  END
END
  
```

**Listing 2: An English-language query translated to an equivalent DBMS20 program.**

**English Query—**

To what country does the fastest sub belong?

**DBMS20 Query—**

```

  COMPUTE XSTRX11 = '00.0' $
  COMPUTE XY10 = 0 $
  FIND FIRST SHIPCLASCHAR RECORD OF BLUEAREA
  AREA $
13  IF ERROR-STATUS = 307 GO TO 14 $
  COMPUTE XAND16 = 0 $
  IF SHIPCLASCHAR-TYPE2 NE 'S' GO TO 17 $
  COMPUTE XAND16 = 1 $
17  IF XAND16 = 0 GO TO 15 $
  COMPUTE XAND18 = 0 $
  IF SHIPCLASCHAR-TYPE1 NE 'S' GO TO 19 $
  COMPUTE XAND18 = 1 $
19  IF XAND18 = 0 GO TO 15 $
  COMPUTE XSTRZ12 = SHIPCLASCHAR-MCS $
  IF XSTRZ12 LT '00.0' OR XSTRX11 LE XSTRZ12 GO TO 15 $
  COMPUTE XSTRX11 = XSTRZ12 $
  COMPUTE XY10 = 1 $
  COMPUTE XSTR29 = SHIPCLASCHAR-MCS $
15  FIND NEXT SHIPCLASCHAR RECORD OF BLUEAREA
  AREA $
  GO TO 13 $
14  * $
  IF XY10 = 0 GO TO XT $
  FIND FIRST SHIPCLASCHAR RECORD OF BLUEAREA
  AREA $
20  IF ERROR-STATUS = 307 GO TO 21 $
  COMPUTE XAND23 = 0 $
  IF SHIPCLASCHAR-TYPE2 NE 'S' GO TO 24 $
  COMPUTE XAND23 = 1 $
24  IF XAND23 = 0 GO TO 22 $
  COMPUTE XAND25 = 0 $
  IF SHIPCLASCHAR-TYPE1 NE 'S' GO TO 26 $
  COMPUTE XAND25 = 1 $
26  IF XAND25 = 0 GO TO 22 $
  COMPUTE XAND27 = 0 $
  IF SHIPCLASCHAR-MCS NE XSTR29 GO TO 28 $
  COMPUTE XAND27 = 1 $
28  IF XAND27 = 0 GO TO 22 $
  FIND FIRST SHIPCLASDIR RECORD OF BLUEAREA AREA
  $
30  IF ERROR-STATUS = 307 GO TO 31 $
  COMPUTE XAND33 = 0 $
  IF SHIPCLASDIR-SHIPCLAS NE SHIPCLASCHAR-
  SHIPCLAS GO TO 34 $
  COMPUTE XAND33 = 1 $
34  IF XAND33 = 0 GO TO 32 $
  SET SHIP-UICVCN TO SHIPCLASDIR-UICVCN $
  FIND SHIP RECORD $
35  IF ERROR-STATUS = 326 GO TO 36 $
  PRINT SHIP-NAM SHIP-NAT $
37  FIND DUPLICATE SHIP RECORD $
  GO TO 35 $
36  * $
32  FIND NEXT SHIPCLASDIR RECORD OF BLUEAREA AREA $
  GO TO 30 $
31  * $
22  FIND NEXT SHIPCLASCHAR RECORD OF BLUEAREA
  AREA $
  GO TO 20 $
21  * $
  GO TO XT $
  END
  
```



Permanent protection for small computers, communications, medical and other sensitive electronic equipment. Surge Sentry works in parallel with the power line to shunt destructive power surges in picoseconds! Triggers at 10% above the nominal peak voltage.

At \$89.50, it's less than the cost of a service call. Easy to install for immediate protection. Several models to choose from to fit your specific application. For details and a free brochure, call or write:

**ERKS ENTERPRISES, INC.**

208 Mount Hermon Road #2  
 Scotts Valley, CA 95066  
 (408) 438-5760  
 Dealer Inquiries Invited.

# ALL THESE FEATURES... IN THIS SMALL SPACE... AT THIS LOW PRICE!

## 4,695

Greater computer power . . . fewer separate components . . . larger capability . . . simpler to operate . . . modular maintenance . . .

These are the unique benefits of the Quasar Data QPD-100 Floppy Disk Computer . . . plus unsurpassed reliability...plus 12-month warranty on all PC boards.

Its highly reliable, double density drive is compact. Accepts both single AND double-sided disks.

Upgradeable from the Z-80<sup>™</sup> microprocessor-based system to our 16 BIT microprocessor-based system by simply plugging in extra PC cards. Hard disk and multi-user systems available.

As your requirements grow, your QDP-100 can grow to fit them.

The Quasar Data QDP-100H is a larger version with 6-megabyte capacity; includes one double-sided floppy and one 5¼ microwinchester hard disk.

Both the Quasar Data QDP-100 and QDP-100H are fully compatible with all standard terminals.

Phone or write for descriptive bulletin and specifications. And ask for a demonstration. Dealer inquiries invited.

## QUASAR DATA'S QDP-100 COMPUTER SYSTEM.

**FEATURES**  
Z-80, 4-MHz CPU  
64K memory, bank selectable  
Two (2) double-sided, double-density 8" floppies, 2 megabytes  
Four (4) ports...2 serial, 2 parallel  
Double-sided, double-density disk controller, to 4 MB  
CP/M 2.2 DOS, MP/M multi-user operating system. (Optional)  
S-100 (IEEE) motherboard  
BASIC LANGUAGE . . . CBASIC compiler  
Real-time clock  
Monitor in PROM  
Manuals supplied: All documentation and schematics, including "CP/M Handbook" by Sybex.  
Accounting systems: G/L, A/R, A/P, P/R, included.



18" wide  
16 7/8" deep  
11" high

Complete systems available

Z-80 is a trademark of Zilog Corp.

CP/M and MP/M are trademarks of Digital Research Corp.

CBASIC is a trademark of Compiler Systems Inc.

## Quasar Data Products

10330 Brecksville Road, Brecksville (Cleveland), Ohio 44141  
Phone: 216/526-0838 / 526-0839  
Telex: 241596

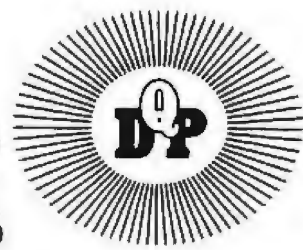

**Listing 3:** An actual conversation with the LADDER system. Boldface words represent user input. Material in square brackets replaces lengthy material not relevant to this article.

1—Give me the length of the Kenedy.  
spelling-> KENNEDY

PARSED!  
Give the length of the ship KENNEDY JF

LEN = 1072

2—width and draft

PARSED!  
Trying Ellipsis: GIVE ME WIDTH AND DRAFT OF THE KENEDY  
Give the beam and draft of the ship KENNEDY JF  
(BEAM 130 DFT 36)

3—Who is her commander?

Give the rank and name of the commander of the ship KENNEDY JF  
(RANK CAPT NAME MOFFETT P)

4—What about the Fox?

PARSED!  
Trying Ellipsis on: THE FOX  
WHO IS THE FOX COMMANDER  
Give the rank and name of the commander of the ship FOX  
(RANK CAPT NAME EVERETT J)

5—What U.S. merchant ships carrying vanadium ore are within 500 miles of the Kimlow?

PARSED!  
Give the position of and time at position for the ship KIMLOW T  
Give the name of merchant American ship S  
where the type of cargo on S is VNAD  
the great-circle distance from the position of S to  
15-33N, 30-10W, is less than or equal to 500  
SHIP = GREENVILLE VICTORY, CRAIN ME, TOTOR

6—How fast are the U.S. subs with lengths greater than 150 feet?

PARSED!  
Give the maximum cruising speed for and name of American ship S  
where the first character of the type of S is S  
the second character of the type of S is S  
the length of S is greater than 150  
(A long table relating the names and maximum cruising speeds of American submarines is printed.)

7—What French ships are at readiness status 1?

PARSED!  
Give the name of French ship S  
where the state of readiness of S is 1

There is no French ship S  
NONE

Text continued from page 310:

what information a user wants, then generating fairly complex programs specifying how the computer is to retrieve the information.

Two problems are being confronted together:

- Problem 1:** The system must translate from English into a formal language.
- Problem 2:** The system must convert a statement of what is wanted into a statement of how to get it.

Problem 2 is concerned with automatic programming, an artificial-intelligence problem currently receiving much attention (see reference 2). (Fortunately, most work on natural-language processing needs to consider only a highly restricted subset of this general problem.)

What it's like to use a system such as LADDER is suggested by the transcript, shown in listing 3, of an actual interaction. The system prompts users with a transaction number followed by a hyphen. The user then types in a question or command. (In this and future listings, we refer to the question half as a *query* and to the question/response pair as an *interaction*.) Query 1, "Give me the length of the Kenedy," contains a misspelled word. LADDER corrects this automatically, typing a note to the user directly below the input line. Once LADDER has corrected the spelling error and completed an analysis of the input, it types the message "PARSED!", and displays its interpretation of the user's query. The system then calls a remote data base to retrieve the answer—in this case, the length (abbreviated to LEN) of the *Kennedy* is 1072 (feet).

Query 2 is not a complete sentence. In fact, it makes no sense when considered in isolation. But in the context of the preceding query, it is clear that the intended meaning is, "Give me the width and draft of the Kennedy." Leaving out pieces of a sentence is called *ellipsis*. Processing such elliptical inputs is more difficult than it may seem. The system has to avoid such interpretations as, "Give me the length of the width and draft," or even, "Give width and draft the length of the Kennedy."

Query 3 illustrates the use of a pronoun, another linguistic construct that cannot be interpreted in isolation.

Query 4 demonstrates a more sophisticated form of ellipsis in which the analysis involves more than just grammatical substitution of the new input into the old one. (This is accomplished in LADDER by looking for "WHAT ABOUT" at the beginning of an input, and then applying the standard elliptical technique—what follows.)

Query 5 illustrates a major benefit of natural-language processing; the user can interact with the system in terms of the job being done, letting the system be concerned with what is required from the data base. Though this is only one question from the user's perspective, it requires two questions of the data base. First, the location of the *Kimlow* must be determined, and then the appropriate ships within 500 miles of that location must be retrieved. The process of translating from the user's terms to those of the data base obstructs the user's decision-making job. It is therefore an appropriate process to automate.

Interaction 6 causes a large body of information to be retrieved from the data base. Although omitted from the listing to save space, a table summarizing the answer is displayed to the user.

Interaction 7 shows an example of a cooperative response to the user's question. The user asks a question about the readiness of French ships. However, the data base contains no information about French ships. Therefore, the literal answer to the user's question, NONE, is inappropriate by itself, since it leads the user to believe all French ships are unready. To provide a more informative response, LADDER presents additional information showing the rationale for producing the NONE response.

# The A2-3D1 Graphics Family...

**professional  
3D and 2D  
graphics  
for the  
Apple II**

**Now for  
non-programmers!**

The **A2-3D1** is the graphics utility you can depend on whether you're mapping a town, presenting charts at a business meeting, or animating games.

Now this versatility is available for the non-programmer with the **A2-GE1** graphics editor and programmer. Create images as you view them. Scan them, animate them, combine them, or add text or labels. With a minimum of fuss, you can prepare all sorts of scientific, business, or educational presentations.

Add the **A2-3D2** enhancement package for color, and as a bonus you'll also be able to manipulate images independently of each other—as many different objects at once as your memory will accommodate.

When it's time for some challenging and educational entertainment, run the **A2-3D/A** Saturn Navigator. You'll enjoy an adventurous flight to Saturn, enter its orbit, and rendezvous with an orbital space station that awaits your arrival.

We've reached our goal of giving you the most sophisticated graphics utilities in the marketplace . . .

**see them now at your dealer!**



Running on the Apple II:  
A2-3D/A Saturn Navigator

**A2-3D1 Graphics Package**  
\$59.95 on disk (32K required)  
\$49.95 on cassette (16K  
required)

**A2-3D2 Enhancement**  
\$24.95 on disk (48K and  
A2-3D1 required)  
\$ 19.95 on cassette (32K and  
A2-3D1 required)

**A2-GE1 Graphics Editor**  
\$34.95 on disk (48K and  
A2-3D1 required)

**A2-3D/A Saturn Navigator**  
\$24.95 on disk (48K, A2-3D1,  
and Applesoft required)

## subLOGIC

Communications Corp.  
Box V, Savoy, IL 61874  
(217) 359-8482  
Telex: 206995

For direct order, include \$3 for UPS or \$5 for first class mail delivery.  
Illinois residents add 5% sales tax. Visa and Master Card accepted.

"Apple" is the registered trademark of Apple Computer Inc.

LADDER's methods for dealing with natural-language inputs are similar to those used by compilers and interpreters for such languages as BASIC and Pascal. For example, a BASIC interpreter might deal with assignment statements by looking for the pattern:

LET <variable> = <expression>.

This pattern could match an instruction of the form:

LET X = 5 + Y

with "X" filling the role of the <variable> and "5 + Y" filling the role of the <expression>. Associated with this pattern, the interpreter would have a function for storing the value of the expression into the memory location named by X.

Similarly, LADDER uses patterns such as:

WHAT <BE> THE <SHIP-ATTRIBUTES> OF  
<SHIP-DESCRIPTION>

that can match sentences such as:

WHAT ARE THE LENGTHS AND DRAFTS OF  
US CARRIERS?

Like an interpreter or compiler, LADDER associates a function with each pattern. The function associated with

the example just cited would produce calls to the database management system to retrieve attributes of ships and take as parameters the names of the attributes and a description of the ships of interest. Most of LADDER's knowledge about language and the world is implicitly encoded in its grammar and associated functions. The grammar contains much information about the particular data base being queried and is by no means a standard grammar of English. A grammar of this type is called a *pragmatic or semantic grammar* (see references 4 and 11).

### Summary of LADDER-Like Systems

In a later section, we will say more about what systems like LADDER can do. For now, it is sufficient to note the following:

- The computer capability shown in the transcript of listing 3 is of considerable practical utility.
- LADDER deals with a relatively large and complex data base that includes over 100 fields in fourteen files and has records for 40,000 ships.
- LADDER has been performing at this level of capability since 1976 (except for the cooperative responses such as those in interaction 7, which are relatively new—see reference 14).
- There are several systems in laboratories around the world that are capable of essentially the same level of performance as shown in listing 3. These include the systems described in references 10, 14, 24, 25, 26, and 31.

# ECT<sup>TM</sup>

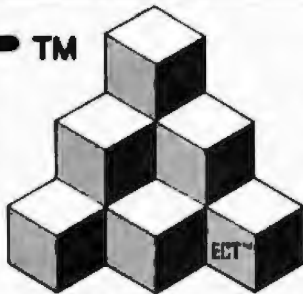

## Building Blocks for Microcomputer Systems, Dedicated Controllers and Test Equipment.

**R<sup>2</sup>/I/O  
S-100 ROM,  
RAM & I/O  
BOARD**

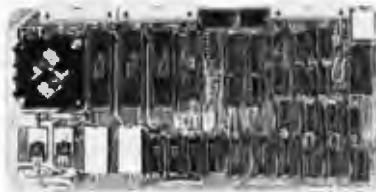

ECT's R<sup>2</sup>/I/O is an S-100 Bus I/O Board with 3 Serial I/O Ports (UART's), 1 Parallel I/O Port, 4 Status Ports, 2K of ROM with the 8080 Apple Monitor Program and 2K of Static RAM.

**\$295.00**

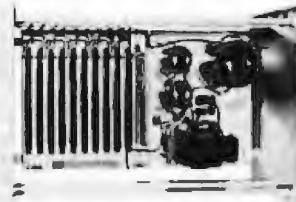

**RM-10  
S-100  
RACK MOUNT  
CARD CAGE**

ECT's RM-10 is a rack mount 10 slot Card Cage with Power Supply, consisting of an ECT-100 rack mount Card Cage (19"W x 12.25"H x 8"D), the MB-10 Mother Board (with ground plane and termination) all 10 connectors and guides and the PS-15A Power Supply (15A @ 8V, 1.5A @ ± 16V).

**\$295.00**

Specializing In Quality Microcomputer Hardware  
Industrial • Educational • Small Business • Personal

Card Cages, Power Supplies, Mainframes, CPU's, Memory, I/O, OEM Variations

# ECT<sup>TM</sup> ELECTRONIC CONTROL TECHNOLOGY (201) 686-8080

763 Ramsey Ave., Hillside, NJ 07205

# "OUR NEWEST DEVELOPMENT IN THE CONTINUING EXPANSION OF THE UCSD p-SYSTEM™ SOFTWARE. VERSION IV."

JOHN BRACKETT, President, SofTech Microsystems



**B**acked by a dedicated team of professionals, SofTech Microsystems continues to enhance the world's most widely-used, portable software development system. Today it's the UCSD p-System, Version IV.

Able to run on most major microprocessors including 8086, Z-80, 8080, 8085, 6502, 6809, 9900 and LSI-11™, Version IV is the developer's tool to make perfect programs more possible. It consolidates all the best features of earlier versions, while allowing for much larger applications, concurrent processing and improved debugging. With the addition of BASIC, more macro cross-assemblers, and improved documentation, Version IV is truly a total, professional software development and execution environment.

And, it's backed by SofTech Microsystems, the first to deliver a complete, portable software system for most major microprocessors with UCSD Pascal™, FORTRAN-77, BASIC, and multiple assemblers.

For tomorrow, the expansion continues. More 16 bit microprocessor installations. The performance impact of native code generation. New system utilities and languages. New tools for creating applications more rapidly. The SofTech Microsystems team is at work today to increase your options for the future.

Get the software system that's going places. Distribution licenses and single copies available. Write or call for details, so you can start going places, too.

**SOFTech**  
**MICROSYSTEMS**  
A SUBSIDIARY OF SOFTECH

**For the software that's going places.**

9494 Black Mountain Road, San Diego,  
CA 92126, (714) 578-6105  
TWX 910-335-1594

*UCSD p-System and UCSD Pascal are trademarks of the Regents of the University of California.  
LSI-11 is a trademark of Digital Equipment Corp.*

Listing 4: A dialogue between an expert and an apprentice repairman showing definitely determined noun phrases (underlined).

- A: HOW DO I REMOVE THE FLYWHEEL ?  
 E: FIRST LOOSEN THE TWO SMALL ALLEN HEAD SETSCREWS HOLDING IT TO THE SHAFT THEN PULL IT OFF.  
 A: THE TWO SETSCREWS ARE LOOSE BUT I'M HAVING TROUBLE GETTING THE WHEEL OFF.  
 E: USE THE WHEEL PULLER , DO YOU KNOW HOW?  
 A: NO  
 E: LOOSEN THE SCREW IN THE CENTER AND PLACE THE JAWS AROUND THE HUB OF THE WHEEL; THEN TIGHTEN THE SCREW.  
 A: THE LITTLE METAL SEMICIRCLE FELL OFF WHEN I TOOK THE WHEEL OFF.

For restricted classes of applications, systems such as LADDER provide language-processing capabilities that are very useful. Nevertheless, LADDER falls far short of being an ideal system, both conceptually and linguistically.

LADDER's concept of the world is based on the underlying conventional data-base management system to which it provides access. Data-base management systems can effectively store large numbers of individual, concrete facts, such as:

THE KENNEDY IS OWNED BY THE US

But they are incapable of dealing in a general way with more logically complex notions, such as disjunction, quantification, implication, causality, and possibility. They act as if they were dealing with information about a world containing a fixed number of objects and relationships among them, with the objects and relationships being immutable.

Perhaps LADDER's most important linguistic deficiency is its limited notion of linguistic context. With minor (though useful) exceptions, LADDER treats each input as if it were given in isolation. To perceive the problem, let's consider the question:

WHO ARE THE CAPTAINS OF THE US TANKERS?

Isolated from all contexts, this question should be interpreted as a request for the names of the commanding officers of all US tankers in the data base. But if a user has just asked the question, "What is the status of convoy C86?" and has received information on a number of ships in the convoy, including two US tankers, the sample question should elicit the captains' names for only the two tankers in the convoy. LADDER ignores the context, however, answering the question as if it had been asked in isolation.

The ability to follow a changing context and make accurate references to prominent objects is a fundamental characteristic of human communication. In fact, about half the words used in ordinary speech are found in DEF NPs (*definitely determined noun phrases*), the linguistic constructions most often used to refer to objects in context. Note, for example, all the definitely determined noun phrases underlined in the dialogue shown in listing 4.

The need to understand context throws considerable doubt on the idea of building natural-language interfaces to systems with knowledge bases independent of the language-processing system itself. This is because the information in the knowledge base may be needed simply for comprehension of a question. For example, to understand the phrase "the filter" in:

IF I CHANGE THE OIL IN MY CAR, WHERE SHOULD I LOOK FOR THE FILTER?

it is necessary to know that automobiles use oil cleaned by a filter. Such knowledge makes possible the assumption that such a filter, the one on the user's car, is the referent of "the filter." We cannot translate the question into a formal query to an auto-maintenance system unless the translation system also has some information about the nature of auto maintenance.

### Systems for Dealing with Dynamic Microworlds

SHRDLU, a system developed by Terry Winograd at MIT around 1970 (see reference 29), was one of the first systems to deal with some of the complexities of context and address a domain of greater logical complexity than

## UCSD p-System\* for the INTERTEC SUPERBRAIN™

With UCSD Pascal\*, FORTRAN, and BASIC

VERSION IV.0

UCSD p-System Includes: operating system, editor, filer, library, Z80 assembler, and documentation.

with Pascal	\$ 600
with FORTRAN	600
with BASIC	500

### THE DATALEX COMPANY

1431 Twelfth Avenue, San Francisco, CA 94122  
 Telephone: (415) 665-4467

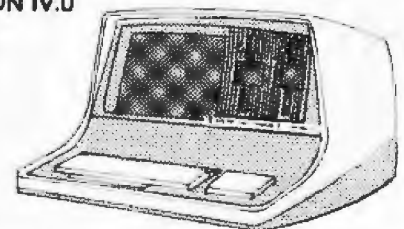

\*UCSD p-System and UCSD Pascal are trademarks of the Regents of the University of California  
 ™Trademark of InterTec Data Systems



# If you need M68000, Z8000, or 8086 Software, take it off our shelf.



Why wait up to 6 months for high quality 16-bit resident system software, when you can get it now?

Hemenway Associates can give you the software tools you need to get the most out of your 16-bit hardware. Because 8086, Z8000 and 68000 Systems Software is sitting on our shelves right now.

Single user operating systems, macro assemblers, text editors, floating point packages, multi-tasking operating systems, linking loaders and PASCAL compilers are all ready for immediate delivery.

You've heard about Hemenway Associates' system designs in the pages of EDN. But now you can have Hemenway-

designed software for your MicroVax processor. Our software is easily adaptable to any hardware configuration. From manufacturers evaluation boards to full blown microcomputers. It's efficient, easy-to-use and backed by ongoing support.

So whether you're a microcomputer manufacturer, software developer, or individual microcomputer owner, Hemenway has the software for you.

For the hard facts on Hemenway software, write or call: Hemenway Associates, 101 Tremont Street, Boston, Massachusetts 02108. Phone: 617-426-1931. TWX 710 321 1203. TELEX 921735.

Circle 159 on Inquiry card.



## HEMENWAY ASSOCIATES, INC.

When it comes to software, come to Hemenway.



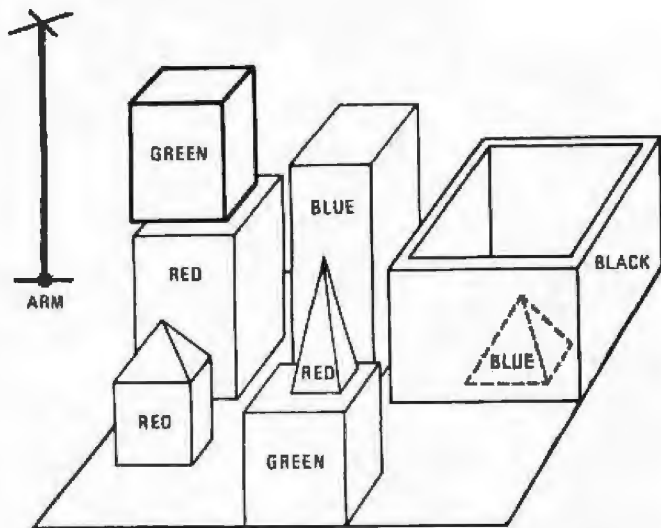

Figure 3: The microworld of blocks used by the SHRDLU program, which can manipulate objects in the microworld and answer questions about them.

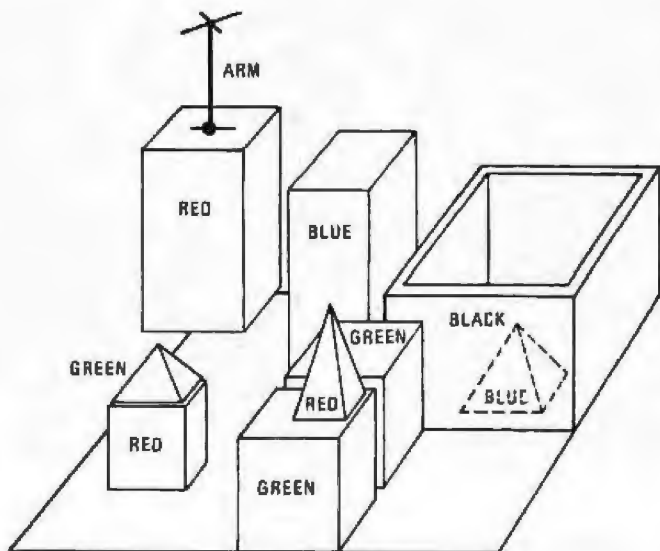

Figure 4: SHRDLU in the process of executing the command "PICK UP A BIG RED BLOCK".

can be handled by a conventional data-base management system. An example of the types of interactions SHRDLU can support is shown in listing 5. At the beginning of the dialogue, both user and system are talking about a small microworld of blocks configured as shown in figure 3.

In interaction 1 of listing 5, SHRDLU is asked to pick up a big red block. Since there is only one such block in the microworld, SHRDLU knows what to pick up. Complicating the situation, however, is a green block resting on the big red block. SHRDLU is forced to devise a plan that involves moving the simulated robot arm to the green block, lifting the green block, moving the block to a clear place on the table, placing the green block on the table, releasing the green block, returning to the red block, grasping the red block, and, finally, lifting it up.

Listing 5: An actual conversation with the SHRDLU system. Associated images of the blocks microworld are given in figures 3, 4, and 5.

- 1 — PICK UP A BIG RED BLOCK.  
OK.
- 2 — GRASP THE PYRAMID.  
I DON'T UNDERSTAND WHICH PYRAMID YOU MEAN.
- 3 — FIND A BLOCK WHICH IS TALLER THAN THE ONE YOU ARE HOLDING AND PUT IT IN THE BOX.  
BY "IT" I ASSUME YOU MEAN THE BLOCK WHICH IS TALLER THAN THE ONE I AM HOLDING.  
OK.
- 4 — WHAT DOES THE BOX CONTAIN?  
THE BLUE PYRAMID AND THE BLUE BLOCK.
- 5 — WHAT IS THE PYRAMID SUPPORTED BY?  
THE BOX.
- 6 — HOW MANY BLOCKS ARE NOT IN THE BOX?  
FOUR OF THEM.
- 7 — WHY DID YOU CLEAR OFF THE RED BLOCK?  
TO PICK IT UP.
- 8 — WHY DID YOU DO THAT?  
BECAUSE YOU ASKED ME TO.

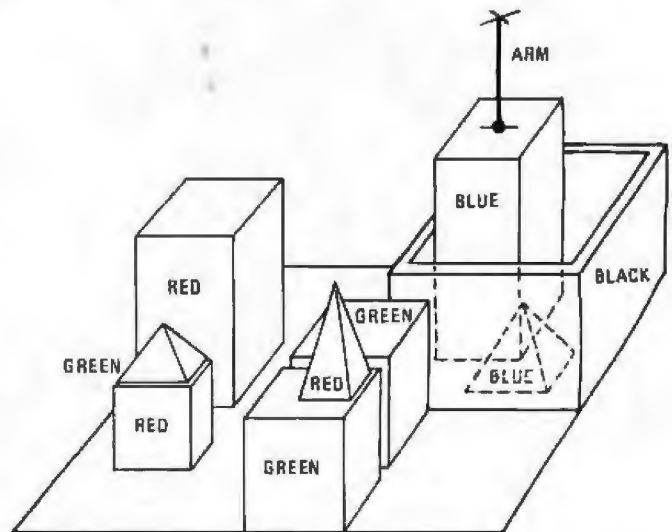

Figure 5: The microworld after execution of the command "FIND A BLOCK WHICH IS TALLER THAN THE ONE YOU ARE HOLDING AND PUT IT IN THE BOX". (This takes place after the action of figure 4.)

When this is done (after considerable computation time), the microworld configuration is as shown in figure 4 and SHRDLU responds with a simple "OK".

In interaction 2, the user asks SHRDLU to grasp "the pyramid." But there are two pyramids in the microworld context, and the linguistic context contains no clues to choose between them. SHRDLU realizes that it cannot identify the referent of "the pyramid" and tells the user so.

Interaction 3 reveals SHRDLU's ability to deal with a fairly complex noun phrase containing a relative clause and a comparative construction, and to handle problematic words such as "one" and "it." The result of this



# Compare!



Apple II+	SAVE
16K	\$ 1049 22%
48K	\$ 1099 29%
64K	\$ 1269 27%

All are 1981 models with Apple RAM. 64K unit is 48K unit with Microsoft 16K RAM board. 48K and 64K units include Applesoft and Integer BASIC's when used with DISK II. The Apple II no longer comes with game paddles. Paddles are extra - CALL.

APPLE III	SAVE
96K	\$ 2888 26%
128K	\$ 3299 25%
Disk	\$ 479 18%
Info Analyst Pack	\$ 399 13%

## HARDWARE

for Apple III/II+

Disk II & 2.5 Controller	\$ 499 23%
Disk II	\$ 438 18%
Micro-Sol 5" Drives for Apple II	\$ 489 25%
A70 288K 5"	\$ 369 7%
A40 180K 5"	\$ 78 20%
3.3/DO51 CPM Controller	\$ 25 38%
RF Modulator, M&R	\$ 159 20%
Serial/Parallel interface	\$ 129 35%
SSM AIO	\$ 80 37%
Serial interface Card, CCS	\$ 339 25%
Parallel interface Card, CCS	
Apple IEEE-488 Card	

80 Column Video Cards:	\$ 299 17%
Apple SmartTerm	\$ 249 18%
Video Videoterm	
Ask about Video accessories	
Apple Clock/Calendar Card	\$ 239 15%
ABT, 10 Key Pad B	\$ 89 21%
MONITORS:	
Sanyo	
9" B&W	\$ 189 30%
12" B&W	\$ 249 21%
12" Green	\$ 299 20%
13" Color	\$ 449 21%
12" Green	\$ 225 21%
NEC	
PRINTERS:	
Apple Silentype w/Interface	\$ 329 17%
Centronics 737	\$ 799 26%
737 interface & cable	\$ 189 25%
Epson MX 80	\$ 475 27%
MX 80 interface & cable	\$ 95 18%
Epson MX 100	Call
MX 100 interface & cable	Call
Apple Graphics Tablet	Call
Microsoft:	
280 Softcard	\$ 249 28%
16K RAM Card	\$ 159 20%
Hayes Micromodem II™	\$ 299 23%
10 Memorex 5" Disquettes	\$ 25 45%
10 Maxell 5" Disquettes	\$ 39 33%

**NO SALES TAX**

# Computer Exchange

Jacksonville, OR 97530

**TOLL FREE (800) 547-1289**

P.O. BOX 1380

TECHNICAL & OREGON: (503) 893-7287

### SPECIALS

## SOFTWARE



Language/Pascal System	\$ 379 24%
DOS 3.3	\$ 49 20%
Apple Writer	\$ 59 21%
The Controller	\$ 495 27%
Apple Pilot	\$ 119 22%
DOS Tool Kit	\$ 149 25%
Apple Fortran	\$ 49 30%
Apple Plot	\$ 99 33%
Tax Planner	\$ 89 28%
Dow Jones News & Quotes	\$ 45 10%
Dow Jones Portfolio Eval.	\$ 119 21%
Visicalc 3.2	\$ 159 20%
Visicalc 3.3	\$ 112 13%
Musa, Super Text II	\$ 29 22%
Easy Writer	\$ 69 22%
Hayden, Sargon II (chess)	\$ 179 22%
PFS, Filing/Data Base	\$ 369 25%
Stoneware, DB Master (new version)	
Soltech, Stockfile (inventory)	

Copy II Plus: Bit copy program	\$ 99.95 28%
will copy most protected programs for	
your backup in 45 seconds	
MICROSOFT: (all disk)	
Typing Tutor	\$ 14 30%
Adventure	\$ 23 24%
Fortran - 80	\$ 149 25%
A.I.D.S.	\$ 110 10%
BASIC Compiler	\$ 299 25%
Olympic Decathlon	\$ 19 24%
INSOFT:	
ALD System II	\$ 110 10%
TRANSFORTH II	\$ 110 10%
Accounting Software	\$ 369 26%
A full professional quality integrated	
GL, A/R, A/P, Payroll package. Hot-	
line support available. Send for free	
sample printouts.	

Above prices for mail orders only. Our store showroom is 126 NE "F" ST., Grants Pass, OR. Store prices, which include software service, differ from mail order prices. No mail order sales at store. CALL ORDER DESK.

**ORDERING INFORMATION:** Minimum order \$100. Money Orders, Cashier Checks or Bank Wire Welcomed. Visa and MC orders add 3% for shipping, handling and insurance. UPS ground is standard. Add 4% total for UPS Blue or 10% total for foreign orders or US Parcel Post. APO orders are welcomed and sent by US Parcel Post. Include your telephone number. No COD's. Prices are subject to change without notice. Order desk hours are 9 to 6 PDT, 10 to 3 Saturdays.

**REFERENCES:** We have been an Apple dealer since 1978. Our bank reference is First Interstate Bank (503) 776-5620. We belong to the Chamber of Commerce. (503) 772-6283. Circle 74 on inquiry card.

**Apple Computer**  
Sales and Service

**IMPORTANT NOTE:**  
We are an authorized dealer and repair center and will repair all Apple equipment regardless of where you purchased it, in or out of warranty. Normally our turnaround time on repairs is 24 hours. Call before sending equipment.



# Save.

exchange is the microworld configuration shown in figure 5. Note that the system has found it necessary to put down the big red block it was holding.

Interaction 4 illustrates SHRDLU's question-answering ability. In the process of answering this question, the blue pyramid and blue block become the most salient objects in the linguistic context.

In interaction 5, the user again makes use of the phrase "the pyramid." SHRDLU is now able to assign a specific referent to the noun phrase. In particular, SHRDLU picks the pyramid most recently mentioned in the conversation.

In interaction 6, SHRDLU displays its ability to count and to handle negative constructions. Its response suggests a key limitation of SHRDLU—it assumes it knows everything there is to know about the microworld. In particular, it assumes it knows about all the blocks. To see how this simplifies things, ask yourself how many people (or blocks) are not in the room you are in.

Interactions 7 and 8 show SHRDLU's rudimentary ability to deal with references to actions, rather than just to simple objects, and to recall the history of previous actions and their causal linkage—essential skills for entering into conversations about dynamic worlds.

### Limitations of SHRDLU

The sample SHRDLU dialogue illustrates the system's capacity to cope with dynamics in both the physical and linguistic environments.

As observed by Wilks (see reference 28), SHRDLU's apparent power derives largely from dealing with a logical, small, simple, closed microworld. The microworld is logical because all the facts about it can be stated in terms of first-order logic. This is fortunate because powerful problem-solving methods exist for dealing with bodies of facts in this form. But these powerful methods are computationally expensive and become increasingly inefficient as objects and facts proliferate and become more complex.

Fortunately for SHRDLU, its microworld contains fewer than a dozen objects, including the robot arm, and their interrelationships and the actions that can change those interrelationships are relatively simple. For example, there are no messy objects like pieces of rope or bodies of water that can assume an infinite variety of shapes or that can split or combine to form new objects. Furthermore, there are no cerebral creatures in the microworld to complicate the picture by having wants, goals, beliefs, and the like.

Finally, the microworld is closed because it is assumed to be completely knowable. If the box is empty and SHRDLU plans to put the blue block in it, there is no possibility that a gremlin will fill up the box with junk, turn it upside down, break it, nail a lid on it, or perform any of infinitely many activities. If SHRDLU wants to know if the box is empty, it simply tries to prove that it contains something, and watches to see if the proof fails. Anything in the microworld that is knowable is provable.

# MAIL ORDER DISCOUNTS



**APPLE II PLUS 48K**  
**\$1,099**

WE DISCOUNT PRICES — NOT SERVICE

### HARDWARE

DISK II DRIVE & INTERFACE	499
DISK II SECOND DRIVE	499
BASF 5 1/2" DISKETTES (10)	25
LANGUAGE SYSTEM W/PASCAL	379
INTEGER BASIC FIRMWARE CARD	149
APPLESOFT II FIRMWARE CARD	149
CENTRONICS PRINTER INTERFACE CARD	179
HIGH-SPEED SERIAL INTERFACE CARD	145
GRAPHICS TABLET	649
APPLE IEEE-488 INTERFACE CARD	339
M&R SUP-R-MOD RF MODULATOR	25
MICROSOFT Z-80 SOFTCARD SYSTEM	299
MICROSOFT 16K RAM CARD	199
VIDEX 80 COLUMN BOARD	295
HAYES MICROMODEM II	299
AMDEX 13" COLOR MONITOR	429
NEC 12" GREEN MONITOR	239
SILENTYPE PRINTER W/INTERFACE	390
EPSON MX-80 FT	649
QUME SPRINT 545 PRINTER	2499



### SOFTWARE

APPLE DOS TOOLKIT	65
APPLE PLOT	60
TAX PLANNER	99
APPLE FORTRAN	159
APPLE PILOT	119
APPLE MUSIC THEORY	39
APPLEWRITER	65
DOW JONES PORTFOLIO EVALUATOR	45
DOW JONES NEWS & QUOTES REPORTER	85
THE CONTROLLER	495
VISICALC (16 SECTOR)	159
VISILOT	149
VISITREND/VISILOT	215
DESKTOP PLAN II	159
BPI BUSINESS SOFTWARE (EACH)	335
SUPER TEXT II	125
PROGRAMMA APPLE PIE	110
EASYWRITER (80 COLUMNS)	219
D.8. MASTER	160
MICROSOFT FORTRAN	149



**ATARI 800 16K**  
**\$759**

ATARI 400 (16K)	360
410 PROGRAM RECORDER	69
810 DISK DRIVE	439
815 DUAL DISK DRIVE	1199
16K RAM MEMORY MODULE	89
MICROTEK 32K RAM	179
850 INTERFACE MODULE	159
830 ACOUSTIC MODEM	159
825 PRINTER (CENTRONIC 737)	899
JOYSTICK PAIR	18
LIGHT PEN	65
ATARI VISICALC	149
BASIC LANGUAGE	45
ASSEMBLER EDITOR	45
MUSIC COMPOSER	45
STAR RAIDER	39
COMPUTER CHESS	30
BASKETBALL	30
TELELINK	20
DATASOFT TEXT WIZARD	79

**computer age, inc.**

Authorized Apple Dealer & Service Center  
4688 CONVOY STREET, SAN DIEGO, CA 92111  
(714) 565-4062

TO ORDER: Please send cashier's check, money order or personal check (allow 10 business days to clear). VISA and Master Card credit card service add 3%. American Express credit card service add 5%. Shipping, handling and insurance in U.S. add 3% (minimum \$4). California residents add 6% sales tax. Foreign orders add 10% for shipping. Equipment is subject to price change and availability. All equipment carries factory warranty. Store prices differ from mail order prices. TELEX: 697120 DATAMAX-SDG

CALL OR WRITE FOR A COMPLETE PRICE LIST

# STATE OF THE ART MEMORY SYSTEMS

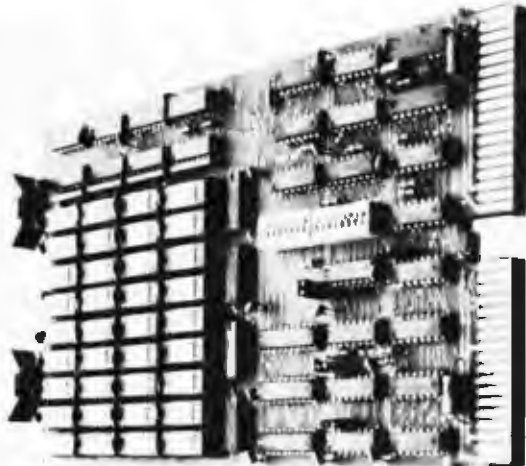

## 512KB SINGLE BOARD MULTIBUS® MEMORY

State of the Art Multibus Memory Design.  
First to Offer 512KB on One Board.

The CI-8086 module is compatible with both 8 or 16 bit Multibus Systems.

**PARITY** — The CI-8086 generates and checks even parity with selectable interrupt on parity error.

**FAST ACCESS AND CYCLE TIME** — Data access is 270NSEC and cycle time is 375 NSEC.

**16 MEGA BYTE ADDRESSING** — The memory is addressable in 16K increments up to 16 mega bytes.

**LOW POWER CONSUMPTION** — Total power consumption is under 8 watts.

**SINGLE QTY. PRICE:** 128K x 9 \$1350. 512K x 9 \$2995.

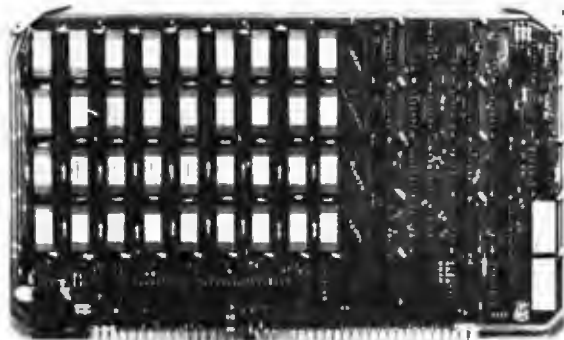

## 256KB LSI 11/23® SINGLE DUAL WIDTH BOARD

The First and Only 256KB Memory on a Single Dual Board.

**4 MEGABYTE ADDRESS FIELD** — Most memories available for the DEC PDP 11/23 are only addressable to 256K bytes (18 address lines). The CI-1123 is addressable to 4 mega bytes (22 address lines) so there is no need to worry about obsolescence.

**FAST ACCESS AND CYCLE TIME** — With an access time of 240 NSEC and cycle time of 400 NSEC one is insured the best throughput on the PDP 11/23 system.

**PARITY** — The CI-1123 generates and checks parity for each byte of memory. Totally DEC compatible.

**BATTERY BACKUP POWER CONSUMPTION** — Power requirement for the module is only 1.2 AMP from the 5 volt supply. The CI-1123 is easily configured for battery back-up mode of operation requiring only 300MA from a single 5 V back-up supply for 256KB memory in the down state.

**SINGLE QTY. PRICE:** 32K x 18 \$575. 128K x 18 \$1925.

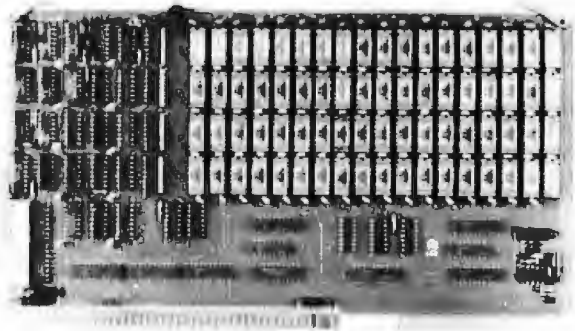

## 64K x 9 EXORCISER® I SINGLE BOARD MEMORY

For Exorciser I, Exorciser II and Rockwell System 65.

**FAST ACCESS AND CYCLE TIME** — Data access time is 225 NSEC and cycle time is 400 NSEC, allowing the unit to work as a static RAM at clock rates in excess of 1.5 mega hertz. For 2 mega hertz operation the board can be easily configured to utilize a cycle stealing refresh operation.

**ADDRESSING** — On-board memory select is available in 4K increments up to 64K words of memory on either the VUA or VXA control inputs.

**PARITY** — On board even parity with output jumper select to the system bus as a parity error or non-maskable interrupt.

Complete board power consumption is under 7 watts.

**SINGLE QTY. PRICE:** 64K x 9 \$575.

Tested and burned in. Full year warranty.

**DON'T ASK WHY WE CHARGE SO LITTLE, ASK WHY THEY CHARGE SO MUCH.**



# Chrislin Industries, Inc.

31352 Via Colinas • Westlake Village, CA 91362 • 213-991-2254

Multibus is a trademark of the Intel Corp.

LSI II is a trademark of Digital Equipment Corp.

EXORCISER is a trademark of Motorola

# DYNACOMP

Quality software for\*:

ATARI  
PET  
APPLE II Plus

TRS-80 (Level II)\*\*  
NORTH STAR  
CP/M Disks/Diskettes

## CARD GAMES

**BRIDGE 2.0** (Available for all computers) Price: \$17.95 Cassette/\$31.95 Diskette  
An all-inclusive version of this most popular of card games. This program both **HIDES** and **PLAYS** either contract or duplicate bridge. Depending on the contract, your computer opponents will either play the offense OR defense. If you bid too high, the computer will double your contract! **HIDDEN 1.0** provides challenging entertainment for advanced players and is an excellent learning tool for the bridge novice. See the software review in 80 Software Critique.

**HEARTS 1.5** (Available for all computers) Price: \$15.95 Cassette/\$19.95 Diskette  
An exciting and entertaining computer version of this popular card game. Hearts is a trick-oriented game in which the purpose is not to take any hearts or the queen of spades. Play against two computer opponents who are armed with hard-to-beat playing strategies. **HEARTS 1.5** is an ideal game for introducing the uninitiated (your spouse) to computers. See the software review in 80 Software Critique.

**STUD POKER** (Atari only) Price: \$11.95 Cassette/\$19.95 Diskette  
This is the classic gambler's card game. The computer deals the cards one at a time and you (and the computer) bet on what you see. The computer does not cheat and usually bets the odds. However, it sometimes bluff! Also included is a five hand draw poker betting practice program. This package will run on a 16K ATARI. Color, graphics, sound.

**POKER PARTY** (Available for all computers) Price: \$17.95 Cassette/\$31.95 Diskette  
**POKER PARTY** is a draw poker simulation based on the book, **POKER**, by David Jacoby. This is the most comprehensive version available for microcomputers. The party consists of yourself and six other (computer) players. Each of these players (you will get to know them) has a different personality in the form of a varying propensity to bluff or fold under pressure. Practice with **POKER PARTY** before going to that expensive game tonight! Apple Cassettes and diskette versions require a 32 K for larger Apple II.

**CRIBBAGE 2.0** (TRS-80 only) Price: \$14.95 Cassette/\$18.95 Diskette  
This is simply the best cribbage game available. It is an excellent program for the cribbage player in search of a worthy opponent as well as for the novice wishing to improve his game. The graphics are superb and assembly language routines provide rapid execution. See the software review in 80 Software Critique.

## THOUGHT PROVOKERS

**MANAGEMENT SIMULATOR** (Atari, North Star and CP/M only) Price: \$19.95 Cassette/\$21.95 Diskette

This program is both an excellent teaching tool as well as a stimulating intellectual game. Based upon similar games played at graduate business schools, each player as team controls a company which manufactures three products. Each player attempts to outperform his competitors by setting selling prices, production volumes, marketing and design expenditures etc. The most successful firm is the one with the highest stock price when the simulation ends.

**FLIGHT SIMULATOR** (Available for all computers) Price: \$17.95 Cassette/\$31.95 Diskette  
A realistic and extensive mathematical simulation of take-off, take and landing. The program utilizes aerodynamic equations and the characteristics of a real airfoil. You can practice instrument approach and navigation using radials and compass headings. The more advanced flyer can also perform loops, half-rolls and similar acrobatic maneuvers. Although this program does not employ graphics, it is exciting and very addictive. See the software review in **COMPUTRONICS**.

**VALDEZ** (Available for all computers) Price: \$15.95 Cassette/\$19.95 Diskette  
**VALDEZ** is a computer simulation of supertanker navigation in the Prince William Sound/Valdez Narrows region of Alaska. Included in this simulation is a realistic and extensive 236 x 216 element map, portions of which may be viewed using the ship's alphanumeric radar display. The motion of the ship itself is accurately modeled mathematically. The simulation also contains a model for the tidal patterns in the region, as well as other traffic (outgoing tankers and drifting icebergs). Carry your course from the Gulf of Alaska to Valdez Harbor! See the software review in 80 Software Critique.

**BACKGAMMON 2.0** (Atari, North Star and CP/M only) Price: \$14.95 Cassette/\$18.95 Diskette  
This program tests your backgammon skills and will also improve your game. A human can compete against a computer or against another human. The computer can even play itself. Either the human or the computer can double or generate dice rolls. Board positions can be created or saved for replay. **BACKGAMMON 2.0** is played in accordance with the official rules of backgammon and is sure to provide many fascinating sessions of backgammon play.

**CHECKERS 3.0** (PET only) Price: \$24.95 Cassette/\$38.95 Diskette  
This is one of the most challenging checkers programs available. It has 10 levels of play and allows the user to change skill levels at any time. Though providing a very tough game at level 4-8, **CHECKERS 3.0** is practically unbeatable at levels 9 and 10.

**CHESS MASTER** (North Star and TRS-80 only) Price: \$19.95 Cassette/\$21.95 Diskette  
This complete and very powerful program provides five levels of play. It includes castling, en passant captures and the promotion of pawns. Additionally, the board may be preset before the start of play, permitting the examination of "hook" plays. To maximize execution speed, the program is written in assembly language by **SOFTWARE SPECIALISTS** of California. Full graphics are employed in the TRS-80 version, and two widths of alphanumeric display are provided to accommodate North Star users.

**LEM LANDER** (ZIK Apple Disk only) Price: \$14.95 Diskette  
Plot your **LEM LANDER** to a safe landing on any of nine different surfaces ranging from smooth to treacherous. The game paddles are used to control craft attitude and thrust. This is a real-time high res challenge!

**FOREST FIRE** (Atari only) Price: \$14.95 Cassette/\$18.95 Diskette  
Using excellent graphics and sound effects, this simulation puts you in the middle of a forest fire. Your job is to direct operations to put out the fire while compensating for changes in wind, weather and terrain. Not protecting valuable structures can result in starting penalties. Life-like variables are provided to make **FOREST FIRE**! Very suspenseful and challenging. No two games have the same strategy and there are 3 levels of difficulty.

**NOMINOES JIGSAW** (Atari, Apple and TRS-80 only) Price: \$14.95 Cassette/\$18.95 Diskette  
A jigsaw puzzle on your computer! Complete the puzzle by selecting your pieces from a table consisting of 80 different shapes. **NOMINOES JIGSAW** is a virtuous programming effort. The graphics are superlative and the puzzle will challenge you with its three levels of difficulty. Scoring is based upon the number of pieces taken and by the difficulty of the board set-up.

**MONARCH** (Atari only) Price: \$11.95 Cassette/\$18.95 Diskette  
**MONARCH** is a fascinating economic simulation requiring you to survive an 8-year term as your nation's leader. You determine the amounts of acreage devoted to industrial and agricultural use, how much food to distribute to the populace and how much should be spent on pollution control. You will find that all decisions involve a compromise and that it is not easy to make everyone happy.

**CHOMP-OTHELLO** (Atari only) Price: \$11.95 Cassette/\$18.95 Diskette  
**CHOMP-OTHELLO** is a really fun challenging game in Othello. **CHOMP** is similar in concept to **NIM**; you must take out part of a cookie, but avoid taking the poisoned portion. **OTHELLO** is the popular board game set to fully utilize the Atari's graphics capability. It is also very hard to beat! This package will run on a 16K system.

## DYNACOMP OFFERS THE FOLLOWING

- Widest variety
- Guaranteed quality
- Fastest delivery
- Friendly customer service
- Free catalog
- 24 hour order phone

## AND MORE...

**STARTRK 1.2** (Available for all computers) Price: \$11.95 Cassette/\$15.95 Diskette

This is the classic Startrk simulation, but with several new features. For example, the Klingons now shoot at the Enterprise without warning while also attacking starbases in other quadrants. The Klingons also attack with both light and heavy cruisers and move when shot at! The situation is frantic when the Enterprise is besieged by these heavy cruisers and a starbase 3.0.5. is received! The Klingons get even! See the software reviews in A.N.A.L.O.G., 80 Software Critique and Game Merchandising.

**BLACK HOLE** (Apple only) Price: \$14.95 Cassette/\$18.95 Diskette

This is an exciting graphical simulation of the problems involved in closely observing a black hole with a space probe. The object is to enter and maintain, for a prescribed time, an orbit close to a small black hole. This is to be achieved without coming so close to the tidal forces that destroys the probe. Control of the craft is realistically simulated using side jets for rotation and main thrusters for acceleration. This program employs Hi-Res graphics and is educational as well as challenging.

**SPACE TILT** (Apple and Atari only) Price: \$18.95 Cassette/\$14.95 Diskette

Use the game paddles to tilt the plane of the TV screen in "roll" a ball into a hole in the screen. Sound complete? Not when the ball goes slithering and smolder! A built-in timer allows you to measure your skill against others in this hair-burning action game.

**MOVING MAZE** (Apple only) Price: \$18.95 Cassette/\$14.95 Diskette

**MOVING MAZE** employs the game paddles to direct a puck from one side of a maze to the other. However, the maze is dynamically (and randomly) built and is continually being modified. The objective is to cross the maze without touching (or being hit by) a wall. Scoring is by an elapsed time indicator, and three levels of play are provided.

**ALPHA FIGHTER** (Atari only) Price: \$14.95 Cassette/\$18.95 Diskette

Two excellent graphics and action programs in one! **ALPHA FIGHTER** requires you to destroy the alien starships passing through your sector of the galaxy. **ALPHA BASE** is in the path of an alien UFO invasion; let five UFO's go by and the game ends. Both games require the joystick and get progressively more difficult the higher you score! **ALPHA FIGHTER** will run on 16K systems.

**THE RINGS OF THE EMPIRE** (Atari only) Price: \$14.95 Cassette/\$18.95 Diskette

The empire has developed a new battle station protected by rotating rings of energy. Each time you blast through the rings and destroy the station, the empire develops a new station with more protective rings. This exciting game runs on 16K systems, employs extensive graphics and sound and can be played by one or two players.

**INTRUDER ALERT** (Atari only) Price: \$14.95 Cassette/\$18.95 Diskette

This is a fast paced graphics game which places you in the middle of the "Dreadnaughts" having just stolen its plans. The dreadnaughts have been alerted and are directed to destroy you at all costs. You must find and enter your ship to escape with the plans. Five levels of difficulty are provided. **INTRUDER ALERT** requires a joystick and will run on 16K systems.

**GIANT SLALOM** (Atari only) Price: \$14.95 Cassette/\$18.95 Diskette

This real-time action game is guaranteed addictive! Use the joystick to control your path through slalom courses consisting of both open and closed gates. Choose from different levels of difficulty, race against other players or simply take practice runs against the clock. **GIANT SLALOM** will run on 16K systems.

**TRIPLE BLOCKADE** (Atari only) Price: \$14.95 Cassette/\$18.95 Diskette

**TRIPLE BLOCKADE** is a two-to-three player graphics and sound action game. It is based on the classic video arcade game which millions have enjoyed. Using the Atari joystick, the object is to direct your blockading line around the screen (without running into your opponent's). Although the concept is simple, the combined graphics and sound effect lead to "high anxiety".

**GAMES PACK I** (Available for all computers) Price: \$18.95 Cassette/\$14.95 Diskette

**GAMES PACK I** contains the classic computer games of **BLACKJACK**, **LUNAR LANDER**, **CRAFTS**, **HORSERACE**, **SWITCH** and more. These games have been combined into one large program for ease in loading. They are individually accessed by a convenient menu. This collection is worth the price just for the **DYNACOMP** version of **BLACKJACK**.

**GAMES PACK II** (Available for all computers) Price: \$18.95 Cassette/\$14.95 Diskette

**GAMES PACK II** includes the games **CRAZY EIGHTS**, **JOTTO**, **ACBY-DUCEY**, **LIFE**, **WUMPUIS** and others. As with **GAMES PACK I**, all the games are loaded as one program and are called from a menu. You will particularly enjoy **DYNACOMP**'s version of **CRAZY EIGHTS**.

Why pay \$7.99 or more per program when you can buy a **DYNACOMP** collection for just \$10.97!

**MOON PROBE** (Atari and North Star only) Price: \$11.95 Cassette/\$15.95 Diskette

This is an extremely challenging "lunar lander" program. The star must drop from orbit in land of a preselected target on the moon's surface. You control the thrust and orientation of your craft plus direct the rate of descent and approach angle.

## ADVENTURE

**CRANSTON MANOR ADVENTURE** (North Star and CP/M only) Price: \$21.95 Diskette

As fast! A comprehensive Adventure game for North Star and CP/M systems. **CRANSTON MANOR ADVENTURE** takes you into mysterious **CRANSTON MANOR** where you attempt to gather fabulous treasures. Lurking in the manor are wild animals and robots who will not give up the treasure without a fight. The number of rooms is greater and the associated descriptions are much more elaborate than the current popular series of Adventure programs, making this game the top in its class. Play can be stopped at any time and the status stored on diskette.

## ABOUT DYNACOMP

**DYNACOMP** is a leading distributor of small system software with sales spanning the world (currently in excess of 40 countries). During the past two years we have greatly enlarged the **DYNACOMP** product line, but have maintained and improved our high level of quality and customer support. The achievement in quality is apparent from our many repeat customers and the software reviews in such publications as **COMPUTRONICS**, **80 Software Critique** and **A.N.A.L.O.G.** Our customer support is as close as your phone. It is always friendly. The staff is highly trained and always willing to discuss products or give advice.

\*ATARI, PET, TRS-80, NORTHSTAR, CP/M and IBM are registered trademarks and/or trademarks.

\*\*TRS-80 diskettes are not supplied with DOS or BASIC. Circle 129 on inquiry card.

## BUSINESS AND UTILITIES

**SPELLGUARD™ (CP/M only)** Price: \$269.95 Disk  
SPELLGUARD is a revolutionary new product which increases the value of your current word processing system (WORDSTAR, MAGIC WAND, ELECTRIC PENCI, TEXTOR EDITOR II and others). Written entirely in assembly language, SPELLGUARD™ rapidly assists the user in eliminating spelling and typographical errors by comparing each word of the text against a dictionary (expandable) of over 30,000 of the most common English words. Words appearing on the list but not found in the dictionary are "flagged" for easy identification and correction. Most administrative staff (familiar with word processing equipment) will be able to use SPELLGUARD™ in only a few minutes.

**MAIL LIST 2.2 (Apple, Atari and North Star diskette only)** Price: \$24.95  
This program is designed to do address labels for a maximum number of addresses on one diskette (maximum of 1100 per diskette, more than 2000 per "double density" system). Its many features include alphabetic and zip code sorting, label printing, marking of files and a unique keyboard mapping system which retains entries by a virtually limitless selection of user defined codes. Mail List 2.2 will even find and delete duplicate entries. A very valuable program!

**FORM LETTER SYSTEM (FLS) (Atari, Apple and North Star diskette only)** Price: \$13.95  
Use FLS to create and write letters and address lists. Form letters are prepared by automatically inserting each address into a preformatted pattern of your letter. FLS is completely compatible with MAIL LIST 2.2, which may be used to manage your address files.  
FLS and MAIL LIST 2.2 are available as a combined package for \$49.95.

**SOBOTT (North Star only)** Price: \$29.95 Diskette  
SOBOTT is a general purpose user program written in IBM assembly language. This program will sort unformatted data files generated by WORDSTAR BASIC. Primary and optional secondary keys may be numeric or any of nine character strings. SOBOTT is easily used with files generated by DYNACOMP's MAIL LIST program and is very versatile in its capabilities for all other BASIC data file sorting.

**PERSONAL FINANCE SYSTEM (Atari and North Star only)** Price: \$24.95 Diskette  
PFS is a single diskette, menu-driven system designed to help you manage your personal finances. Besides recording your expenses and tax deductions items, PFS will sort and summarize expenses on expenditures by any of 26 sub-defunct codes by month or by year. PFS will even produce monthly bar graphs of your expenses by category! This powerful package requires only one disk drive, minimal memory (32K Atari, 12K North Star) and will store up to 600 records per disk (and over 1000 records per disk by making a few simple changes to the program). You can record checks plus cash expenses so that you can clearly see where your money goes and otherwise gainwork and continue based calculations.

**FAMILY BUDGET (Apple only)** Price: \$24.95 Diskette  
THE FAMILY BUDGET is a very convenient financial record-keeping program. You will be able to keep track of cash and credit expenditures as well as income on a daily basis. You can record tax deductions (state and charitable donations). THE FAMILY BUDGET also provides a continuous record of all credit payments. You can make daily cash and charge entries to any of 21 different account numbers as well as to 5 payroll and tax accounts. Data is easily retrieved giving the user complete control over an otherwise complicated (and unorganized) subject.

**THE COMMUNICATOR (Atari only)** Price: \$49.95 Diskette  
This software package contains a menu-driven collection of programs for facilitating efficient two-way communications through a full duplex modem (required for use). In one mode of operation you may connect to a data service (e.g., THE SOURCE or MicroNet) and quickly load data such as stock quotations onto your diskette for later viewing. This greatly reduces "connect time" and thus the service charge. You may also record the complete contents of a communications session. Additionally, programs written in BASIC, FORTRAN, etc. may be built off-line using the support text editor and later "uploaded" to another computer, making the Atari a very smart terminal. Even Atari BASIC programs may be uploaded. Further, a command file may be built off-line and used later as controlling signal for a time-share system. Thus, if you can set up your computer to use share commands and programs, and the Atari will transmit them as needed, batch processing. All this adds up to saving both connect time and your time.  
DYNACOMP also supplies THE COMMUNICATOR with an Atari 800 system for a combined price of \$129.95. The total is available separately for \$109.95.

**TEXT EDITOR II (CP/M)** Price: \$29.95 Diskette/\$39.95 Disk  
This is the second revision of DYNACOMP's popular TEXT EDITOR I and contains many new features. With TEXT EDITOR II you may build text files in chunks and assemble them for later display. Blocks of text may be expanded, deleted or defined. Files may be saved on disk/diskette in right justified/centered format or as later printed by either TEXT EDITOR II or the CP/M ED editor. Further, ASCII CP/M files (including BASIC and assembly language programs) may be read by the editor and processed. In fact, text files can be built using ED and later formatted using TEXT EDITOR II. All in all, TEXT EDITOR II is an inexpensive, easy to use, but very flexible editing system.

**DFILE (Atari and North Star only)** Price: \$24.95  
This handy program allows North Star and Atari disk users to maintain a specialized data base of all files and programs in the stack of disks which frequently are accessed. DFILE is easy to set up and use. It will organize your disks in provide efficient handling of the desired file or program.

**FINDIT (North Star only)** Price: \$19.95  
This is a three-in-one program which maintains information accessible by keywords of three types: Personal (eg. last name), Commercial (eg. publisher) and Reference (eg. magazine articles, record albums, etc.) In addition to keyword searches, there are birthday, anniversary and appointment tables for the previous records and appointment routines for the commercial records. Reference records are accessed by a single keyword or by cross-referencing two or three keywords.

**GRAPH (TRS-80 only)** Price: \$14.95 Cassette/\$19.95 Diskette  
This unique program allows you to easily create graphics directly from the keyboard. You "draw" your figure using the program's cursor-mouse cursor. When the figure is made, it is automatically appended to your BASIC program as a string variable. Draw a "happy face", call it X5 and then print it from your program using PRINT X5! This is a very easy way to create and save graphics.

## EDUCATION

**HODGE PODGE (Apple only, IBM Appointer or Integer BASIC)** Price: \$19.95 Cassette/\$19.95 Diskette  
Let HODGE PODGE be your child's body tutor. Posing any key on your Apple will result in a different and surprising "response" related to the letter or number of the chosen key. The program's graphics, color and sound are a delight for children from ages 1 to 10. HODGE PODGE is a non-stimulating teaching device which brings a new dimension to the use of computers in education.

**TEACHER'S PET I (Available for all computers)** Price: \$11.95 Cassette/\$19.95 Diskette  
This is the first of DYNACOMP's educational packages. Originally intended for pre-school to grade 1, TEACHER'S PET provides the young student with counting practice, letter-word recognition and three levels of math (1-9) exercises.

**MOORE CODE TRAINER (TRS-80 only)** Price: \$11.95 Cassette/\$19.95 Diskette  
MOORE CODE TRAINER is designed to develop and improve your speed and accuracy in deciphering Morse Code. As expected, MOORE is an ideal software package for FCC test practice. The code sound is obtained through the computer's jack of any standard cassette recorder. You may choose the pitch of the tones as well as the word rate. Also, various modes of operation are available including number, punctuation and alphabet tests, as well as the keying of your own message. A very effective way to learn code!

## MISCELLANEOUS

**CRYSTALS (Atari only)** Price: \$ 9.95 Cassette/\$14.95 Diskette  
A unique algorithm randomly produces fascinating graphics displays accompanied with music which acts as the pattern or beat. No two patterns are the same, and the combination of the tone and graphics are mesmerizing. CRYSTALS has been used in total three to demonstrate the speed and color features of the Atari.

**NORTH STAR SOFTWARE EXCHANGE (NSSE) LIBRARY**  
DYNACOMP now distributes the 23 volume NSSE Library. These diskettes each contain many programs and offer an eye-opening value for the purchase price. They should be part of every North Star user's collection. Call or write DYNACOMP for details regarding the contents of the NSSE collection.

Price: \$9.95 each/\$71.95 each (4 or more)  
The complete collection may be purchased for \$149.95

## AVAILABILITY

DYNACOMP software is supplied with complete documentation containing clear explanations and examples. Where otherwise specified, all programs will run within 128K program memory space (ATARI requires 240K). Except where noted, programs are available on ATARI, PET, TRS-80 (Level II) and Apple (Applesoft) cassette and disk as well as North Star single density (double density compatible). Additionally, most programs can be obtained on standard IBM format 8" CP/M floppy disks for systems running under MS-DOS.

## STATISTICS AND ENGINEERING

**DIGITAL FILTER (Available for all computers)** Price: \$29.95 Cassette/\$33.95 Diskette  
DIGITAL FILTER is a comprehensive data processing program which permits the user to design his own filter function to choose from a menu of filter forms. The filter forms are automatically converted into non-overlapping convolution coefficients which permit rapid data processing. In the explicit design mode the shape of the frequency transfer function is specified by directly entering points along the desired filter curve. In the menu mode, ideal low pass, high pass and bandpass filters may be approximated to a varying degree according to the number of points used in the calculation. These filters may optionally also be smoothed with a Hanning function. In addition, multi-stage Butterworth filters may be selected. Features of DIGITAL FILTER include plotting of the data before and after filtering, as well as display of the chosen filter functions. Also included are automatic data storage, retrieval and editing procedures.

**DATA SIMOOTHING (Not available for Atari)** Price: \$24.95 Cassette/\$19.95 Diskette  
This special data smoothing program may be used to rapidly derive useful information from noisy business and engineering data which are equally spaced. The software features choice in degree and range of fit, as well as smoothed first and second derivative calculation. Also included is automatic plotting of the input data and smoothed result.

**FOURIER ANALYZER (Available for all computers)** Price: \$14.95 Cassette/\$20.95 Diskette  
Use this program to examine the frequency spectra of limited duration signals. The program features automatic scaling and plotting of the input data and results. Practical applications include the analysis of complicated patterns in such fields as electronics, communications and medicine.

**TFA (Transfer Function Analyzer)** Price: \$19.95 Cassette/\$25.95 Diskette  
This is a special software package which may be used to evaluate the transfer functions of systems such as hi-fi amplifiers and filters by establishing their response to a pulse input. TFA is a unique modification of FOURIER ANALYZER and contains an engineering-oriented digital versus log-frequency plot as well as data editing features. Whereas FOURIER ANALYZER is designed for educational and scientific use, TFA is an engineering tool. Available for all computers.

**HARMONIC ANALYZER (Available for all computers)** Price: \$24.95 Cassette/\$29.95 Diskette  
HARMONIC ANALYZER was designed for the spectral analysis of repetitive waveforms. Features include: data file generation, editing and storage/retrieval as well as data and spectrum plotting. Also particularly unique facility is that the input data need not be equally spaced or of order. The original data is stored and a cubic spline interpolation is used to create the data file required by the FFT algorithm.

FOURIER ANALYZER, TFA and HARMONIC ANALYZER may be purchased together for a combined price of \$49.95 (three cassettes) and \$59.95 (three diskettes).

**REGRESSION I (Available for all computers)** Price: \$13.95 Cassette/\$19.95 Diskette  
REGRESSION I is a unique and exceptionally versatile regression/distribution least squares "polynomial" curve fitting program. Features include very high accuracy, an automatic degree determination option, an extensive library of fitting functions, data editing, automatic data and curve plotting, a statistical analysis (eg. standard deviation, correlation coefficient, etc.) and much more. In addition, raw files may be tried without entering the data. REGRESSION I is certainly the most powerful program in any data analysis software library.

**REGRESSION II (PARAFF) (Available for all computers)** Price: \$19.95 Cassette/\$24.95 Diskette  
PARAFF is designed to handle those cases in which the parameters are unknown (possibly partially) in the fitting function. The user simply enters the function form, including the parameters (A1), A2, etc.) as well as some BASIC statements. Data and results may be manipulated and plotted as with REGRESSION I. Use REGRESSION I for polynomials, trigonometric, and PARAFF for these complicated functions.

**MULTILINEAR REGRESSION (MLE) (Available for all computers)** Price: \$24.95 Cassette/\$29.95 Diskette  
MLE is a professional software package for analyzing data sets containing two or more linearly independent variables. Besides performing the basic regression calculation, this program also provides easy data file entry, storage, retrieval and editing functions. In addition, the user may investigate the solution by supplying values for the independent variables. The number of variables and data size is limited only by the available memory.

REGRESSION I, II and MULTILINEAR REGRESSION may be purchased together for \$51.95 (three cassettes) or \$61.95 (three diskettes).

**ANOVA (Available for all computers)** Price: \$29.95 Cassette/\$34.95 Diskette  
In the past the ANOVA (analysis of variance) procedure has been limited to the large mainframe computers. Now DYNACOMP software package includes the power of this method to small systems. For those concerned with ANOVA, the DYNACOMP software package includes the 1-way, 2-way and N-way procedures. Also provided are the Y-test 2-tail, factorial design. For those unfamiliar with ANOVA, do not worry. The accompanying documentation was written in a tutorial fashion (try a program on the subject) and serves as an excellent introduction to the subject. Accompanying ANOVA is a support program for building the data base. Involved are several convenient (compact including data editing, deleting and appending.

**BASIC SCIENTIFIC SUBROUTINES, Volume I (Not available for Atari)**  
DYNACOMP is the exclusive distributor for the software listed in the popular user BASIC Scientific Subroutines, Volume I. R. Buchholz (the BYTE/McGraw-Hill advertisement to BYTE magazine, January 1981). These subroutines have been assembled according to chapter. Included with each indication is a main program which selects and demonstrates each subroutine.

Collection #1: Chapters 3 and 9: Data and function plotting, complex variables  
Collection #2: Chapter 4: Matrix and vector operations  
Collection #3: Chapters 5 and 6: Random number generators, error approximations  
Price per collection: \$14.95 Cassette/\$19.95 Diskette  
All three collections are available for \$39.95 (three cassettes) and \$49.95 (three diskettes).  
Between the last is a vital part of the documentation, BASIC Scientific Subroutines, Volume I is available from DYNACOMP for \$19.95 (two 7.5" floppy) and handling.

**ROOTS (Available for all computers)** Price: \$19.95 Cassette/\$24.95 Diskette  
In a nutshell, ROOTS simultaneously determines all the zeros of a polynomial having real coefficients. There is no limit on the degree of the polynomial, and because the procedure is iterative, the accuracy is generally very good. No initial guesses are required as inputs, and the calculated roots are substituted back into the polynomial and the residuals displayed.

**ACTIVE CIRCUIT ANALYSIS (ACAP) (Atari Apple only)** Price: \$22.95 Cassette/\$27.95 Diskette  
ACAP is the analog circuit designer's answer to LOGIC SIMULATOR. With ACAP you may analyze the response of an active or passive component circuit in a transient amplifier, band pass filter, etc.). The circuit may be probed at equal steps in frequency, and the resulting complex (i.e., real and imaginary) voltages at each component junction examined. By plotting the magnitude of these voltages, the frequency response of a filter or amplifier may be completely determined with respect to both amplitude and phase. In addition, ACAP produces a statistical analysis of the range of voltage responses which result from tolerance variations in the components.

ACAP is easy to learn and use. Simply describe the circuit in terms of the elements and their placement, and describe. Circuit descriptions may be stored and edited on diskette to be recalled at a later time for execution or editing. ACAP should be part of every circuit designer's program library.

**LOGIC SIMULATOR (Apple only, IBM RAM)** Price: \$24.95 Cassette/\$29.95 Diskette  
With LOGIC SIMULATOR you may study test your complicated digital logic design with respect to given set of inputs to determine how well the circuit will operate. The elements which may be simulated include multiple input AND, OR, NAND, EXOR, EXORN and NAND gates, as well as inverters, JK and D flip-flops, and one-shots. The response of the system is available every clock cycle. Inputs may be changed in with varying clock cycle lengths/delays and delays may be introduced to probe for glitches and race conditions. As the user's requires, a timing diagram for any given set of nodes may be plotted using HIRSH graphics. Save your timing-diagram with the circuit is checked by LOGIC SIMULATOR.

**LOGIC DESIGNER (North Star and CP/M only)** Price: \$24.95 Cassette/\$29.95 Diskette  
LOGIC DESIGNER is an exceptional Computer Aided Design (CAD) program. With it you may convert a large and complicated digital truth table (the functional specifications) into an optimized logic design. This operation may then be easily converted into a circuit design using either NAND or AND-OR gates. Operationally, LOGIC DESIGNER is composed of a BASIC program which calls to a machine language routine to reduce execution time. Example: For a 7 variable job for 127 line table, the processing time is only two minutes. LOGIC DESIGNER is clearly a fun and powerful tool for building digital circuitry.

## ORDERING INFORMATION

All orders are processed and shipped within 48 hours. Please enclose payment with order and include the appropriate computer telephone. If paying by VISA or MasterCard, include all numbers on card.

Shipping and Handling Charge Delivery  
Within North America: Add \$1.30 All orders (including books) are sent First Class.  
Outside North America: Add 10% (Air Mail)

Quantity Discounts  
Discount 10% after ordering 3 or more programs. Double discount available on available upon request.

8" CP/M Disk  
Add \$1.30 to the listed diskette price for each 8" floppy disk (IBM will accept CP/M format). Programs run under Microsoft BASIC or BASIC-80.

5 1/4" CP/M Disk  
All software available on 5 1/4" CP/M disks is also available on 5 1/4" disks, North Star format.

All DYNACOMP programs at your local software dealer. Write for detailed descriptions of these and other programs from DYNACOMP.

## DYNACOMP, Inc.

1427 Monroe Avenue

Rochester, New York 14618

24 hour order phone: (716) 586-7579 recording

office phone (9AM-5PM EST): (716) 442-8960



New York State residents please add 7% NY sales tax.

Players: customer, server, cashier  
 Props: restaurant, table, menu, food, check, payment, tip  
 Actions:

1. Customer goes to restaurant
2. Customer goes to table
3. Server brings menu
4. Customer orders food
5. Server brings food
6. Customer eats food
7. Server brings check
8. Customer leaves tip for server
9. Customer gives payment to cashier
10. Customer leaves restaurant

Table 1: A restaurant script for the SAM program.

and, therefore, anything that cannot be proved must be false.

The world that people deal with in everyday conversations is extensive, complex, and largely unknown and unknowable. To use natural language to converse about the real world, more sophisticated methods are needed.

### Systems with Knowledge of Ordinary Situations

One of the more interesting attempts to deal with ordinary human situations, in contrast to interfacing with a data base or a model of a microworld, was made by Roger Schank and Robert Abelson, aided by their students at Yale University. Their system, SAM (for Script Applier Mechanism), as described in reference 22,

was built to cope with certain kinds of everyday problems. For example, the system is told the following story:

John went to a restaurant.  
 He ordered the lamb.  
 He paid the cashier and  
 left the restaurant.

Then the system is asked:

What did John eat?

It might seem trivial for a system to answer that John ate the lamb—but nowhere in the story is this explicitly stated. Nor is it directly deducible from what was said. To understand the story, the system must have both knowledge of what usually happens in restaurants and an ability to apply that knowledge to particular situations.

Schank and Abelson encoded SAM's knowledge about everyday situations in formal constructs called *scripts*. The information contained in a script about restaurants is shown in table 1. It includes a list of *players* who participate in the normal routine of a restaurant, a list of *props* supporting the action, and a sequence of generic actions that characterize what usually happens when a customer visits a restaurant.

The information in this script can be used to support a variety of commonsense-reasoning tasks, including a reply to the question, "What did John eat?" The processing is as follows: the system identifies "John went to a restaurant" with action 1 from the script. In doing this, John is assigned the role of the customer. The system identifies "He ordered the lamb" with action 4, assigning the role of food to "the lamb." (Notice that with "he" referring to John, the customer is the same in both actions 1 and 4.) "He paid the cashier" is identified with action 9 and "[he] left the restaurant" with action 10.

Although not all the actions in the script were explicitly mentioned, it is reasonable (but not strictly necessary) to assume that they happened nonetheless. In particular, action 6, the customer eating the food, probably did happen. Moreover, because the entities playing the various parts in the script remain constant throughout its enactment, the system assumes that, for this particular visit to the restaurant, the customer in each action is John and the food is "the lamb." Therefore, action 6 particularizes to "John ate the lamb," providing the answer to the original question.

Information in scripts can be used for more than just answering questions; it can also be used to produce "paraphrases" of a story. For example, SAM can convert the original story:

John went to a restaurant. He sat down. He got mad. He left.

into the "paraphrase":

John was hungry. He decided to go to a restaurant. He went to one. He sat down in a chair. A waiter did not

A.25  
 BISING  
 SDIC/SDWA  
 Software for Your Microcomputer  
 8080 280 8086 28000

IBM 2770  
 IBM 2780  
 IBM 3270  
 IBM 3741  
 IBM 3780  
 IBM 3776

WINTERHALTER & ASSOCIATES, INC.  
 SPECIALISTS IN DATA COMMUNICATIONS  
 3825 ZEEB ROAD  
 DEXTER, MICHIGAN 48130  
 313-423-3029 or  
 313-665-5582



# MORE BANG

## Qantex Impact Printers 150 Characters Per Second 136 Columns Per Line

The microprocessor controlled Series 6000 is packed with standard features. True lower case descenders and underlining. Bidirectional logic seeking. Built-in test capability. Rugged 400 million character print head. Beautiful 96 character set in a 9 x 9 matrix. Parallel, or up to 19,200 baud serial interfaces supporting RS-232, X-ON, X-OFF or Current Loop. Full operator controls. Quietized, sleek enclosure to enhance your system. Delivery from stock.

### Qantex\* Division of North Atlantic Industries

60 Plant Avenue, Hauppauge, N.Y. 11788  
(516) 582-6060 TWX 510-227-9660  
(800) 645-5292



For more information  
call your local distributor:

<b>ARKANSAS</b> Remco Electronics	(501) 663-0375	<b>MINNESOTA</b> Integrated Peripherals	(612) 831-0349	<b>AUSTRALIA</b> Mitsui Computer Systems	02-9299921
<b>ARIZONA</b> The Phoenix Group Inc.	(602) 967-1421	Vikeland Sales	(612) 645-4647	<b>CANADA</b> Computer Markets	416-445-1978
<b>CALIFORNIA</b> Basic Systems Corp.	(213) 673-4300	<b>MISSOURI</b> ESC Sales & Leasing	(314) 997-1516	<b>DENMARK</b> T.M.S. Dataudstyr	(45) 2-911122
Basic Systems Corp.	(714) 268-8000	<b>NEW YORK</b> Washington Electric Co.	(800) 221-5416	<b>ENGLAND</b> Northamber Limited	(44) 372-67646
Basic Systems Corp.	(408) 727-1800	Daily Business Products, Inc.	(516) 543-6100	<b>FRANCE</b> Gepsi	(33) 1-554-9742
<b>ILLINOIS</b> Electro-Tech Marketing Assoc.	(312) 588-4535	Synchro Sound Enterprises	(800) 645-5556 /	<b>GERMANY</b> Technitron	49 (89) 692-4141
Engineered Sales	(312) 832-8425	<b>PENNSYLVANIA</b> QED Electronics	(516) 594-8065	<b>HONG KONG</b> Computerworld Ltd.	5-44033
<b>INDIANA</b> Audio Specialists	(219) 234-5001	<b>TENNESSEE</b> Southland Video Distributors	(616) 484-1852	Hong Kong Equipment	5-453870
<b>LOUISIANA</b> Micro Computer of New Orleans	(504) 885-5883	<b>TEXAS</b> Datonet, Inc.	(215) 674-9600	<b>ITALY</b> Eitron s.r.l.	(030) 55026-41554-44414
<b>MARYLAND</b> Systems International Inc.	(301) 977-0100	<b>VIRGINIA</b> Nine Associates, Inc.	(800) 238-3274	<b>NETHERLANDS</b> Computeta Benelux B.V.	31-73-215700
<b>MASSACHUSETTS</b> & S Electronics, Inc.	(617) 458-4100		(214) 669-1758	<b>SPAIN</b> 2i Ingenieria Informatica	204-2099

Distributor inquiries welcome!

\*Registered Trademark of North Atlantic Industries, Inc.

# Monitoring and Measurement with the Apple II\*?

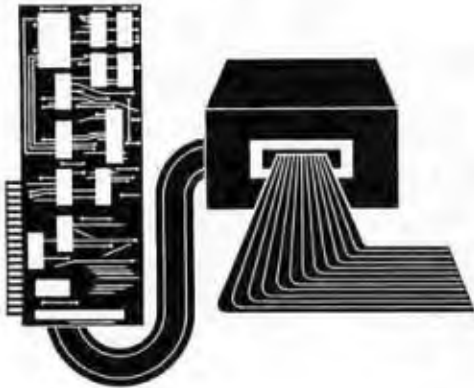

## The AI13 sets the Standard of Excellence.

### Applications:

- Scientific Lab Data Acquisition
- Home Energy Management
- Industrial Process Control
- Testing and Quality Control
- Monitoring and Logging Data

The AI13 plugs into a single slot in Apple II and provides a modular, low cost transformation of the Apple into a precision measurement system.

- Economical Modular Approach to Measurement
- 16 Independent Input Channels
- 12-Bit Precision A/D Conversion
- Software Selectable Input Range
- Complete Software Disk Included

Interactive Structures has been producing Apple Data systems since 1977. You've heard about one of them: our NASA Spacelab project. Let us show you how to put your Apple to work at a monitoring task.

See your Apple Dealer or contact us today.

**IS** Interactive Structures, Inc.  
112 Bala Avenue  
PO Box 404  
Bala Cynwyd, PA 19004

\*Apple Computer, Inc.

go to the table. John became upset. He decided he was going to leave the restaurant. He left it.

This restatement is not a true paraphrase because it adds many details based on speculation about what happened. But such an ability to speculate on the basis of knowledge about how our everyday world is structured is the very feature that makes SAM interesting.

Much of SAM's knowledge is not about natural language at all, but about our everyday world. SAM demonstrates that understanding natural-language stories about mundane actions requires more than a knowledge of language—it requires a knowledge of the world. The more language is studied, the more apparent it becomes that fluent communication in natural language is a process of the total intellect. Language, thought, and knowledge are inextricably intertwined.

### Limitations of SAM

SAM's scripts provided one of the first mechanisms in a language processor for dealing with the structured sequences of actions that make up much of ordinary life, but they suffer from a number of limitations:

- Only a single object can serve the role of player or prop. This makes it impossible to handle stories about restaurants with many tables, customers, or servers. The problem of figuring out what the phrase "the customer" refers to becomes trivial because there can be only one customer.
- The actions in a script follow a strict linear sequence, making it impossible to deal with alternative possibilities, simultaneous or overlapping actions, or a repetition of actions.
- It is difficult to determine which particular script or scripts are appropriate for understanding a given story.

### The TDUS System

The SHRDLU example discussed earlier suggested the potential richness of interactive dialogue in context. The SAM example showed how inference (ie: filling in the blanks regarding what was implied, as well as what was explicitly stated) is essential in understanding natural language. To determine how knowledge-based inference and dialogue management interact, as well as work toward solving a problem of practical value, a group of researchers at SRI International investigated cooperative, task-oriented, man-machine dialogue (see reference 19). They developed a system called TDUS (Task-Oriented Dialogue Understanding System), which had the goal of communicating with a human apprentice about repair operations on electromechanical equipment. The key research problems considered concerned how to encode knowledge about the repair operations and how to follow the context of a dialogue as the apprentice moved from task to task in the course of performing a repair operation.

In TDUS, information about how various tasks can be performed is recorded in data structures called *procedural networks* (see reference 21), which can be viewed



## Nobody's better protection than The Marshal in Winchester territory.

You got yourself a Winchester disk drive with all that large system power. Great! But trying to utilize your floppy drive for backup just isn't working. And bit-streaming tape cartridge drives offers no practical protection, because the usual need is archival storage and replacement of individual files lost through operator error; but the streamer tape data cannot be reconstructed by separate files easily.

### Enter The Marshal to your rescue.

He's the only match in speed, capacity, and capability for your Winchester. As Thomas S. Stelling, Manager of Marketing Literature with Computer Service Systems Network, Inc. stated in InfoWorld, "Intelligent tape subsystems, combining the 1/4-inch tape cartridges with file-oriented software offers the best solution to hard disk backup...a utility program...allows the user to save every file in the system, as well as to restore individual files by name."

### The Marshal from TKS Corporation.

The only complete hardware/software protection device for computer hard disk systems.

### The Marshal follows commands, is fast, and thinks for himself.

Formatted capacity is 13.4 megabytes. The transfer rate is 192,000 bits per second. And he can determine which files have been updated since last saved, in order to recopy only those specific files — saving time. Then records the date he made the copy.

### Perfect protection for the perfect price.

Your OEM Distributor can introduce you to a rack mount unit or a table top console for much less than you'd guess. Take this ad to your dealer today, save a heap of money off the regular price, and get the best protection available in Winchester territory.

The Marshal from Turnkey Systems Corporation would sure be happy to help you. Call 1-800-327-2848.



Turnkey Systems Corporation  
8472 NW 56 Street, Miami, FL 33166

Circle 360 on inquiry card.

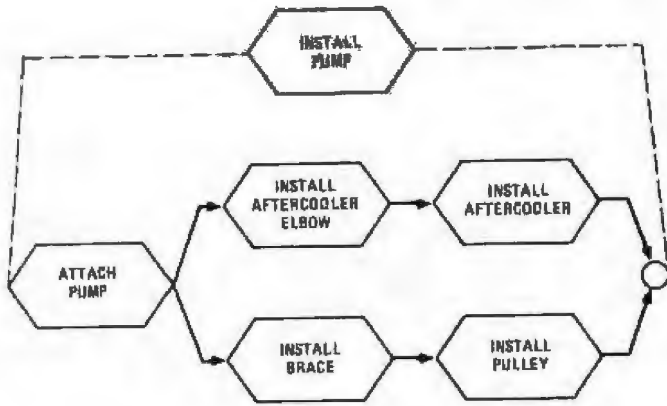

Figure 6: A procedural net for the process of installing a pump for an air compressor.

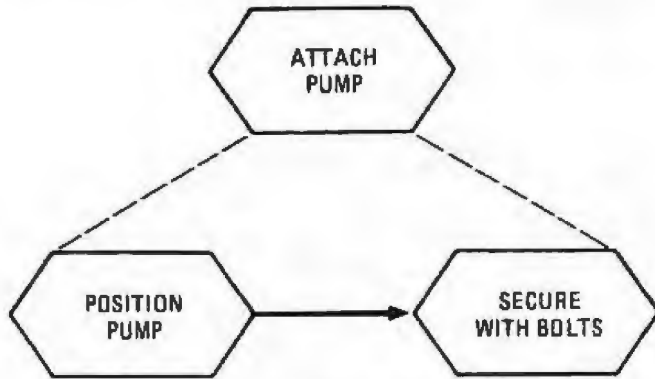

Figure 7: A procedural net expanding an action referenced in figure 6.

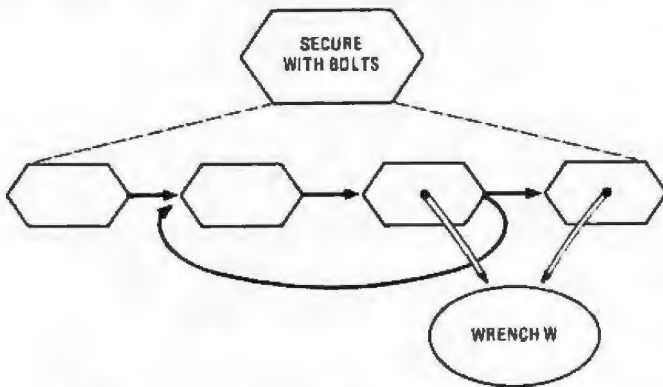

Figure 8: A procedural net that contains actions repeated in a loop.

as generalizations of scripts. Simplified procedural nets are shown in figures 6, 7, and 8. For example, the net of figure 6 indicates how installing a pump for an air compressor can be divided into a number of subtasks. The first subtask is to attach the pump to the platform. Once this is done, either the aftercooler elbow or the brace is installed. Once the aftercooler elbow is installed, the aftercooler is installed. Once the brace is installed, the pulley is installed. When both the aftercooler and pulley have been installed, regardless of the order accomplished, the task of installing the pump is complete.

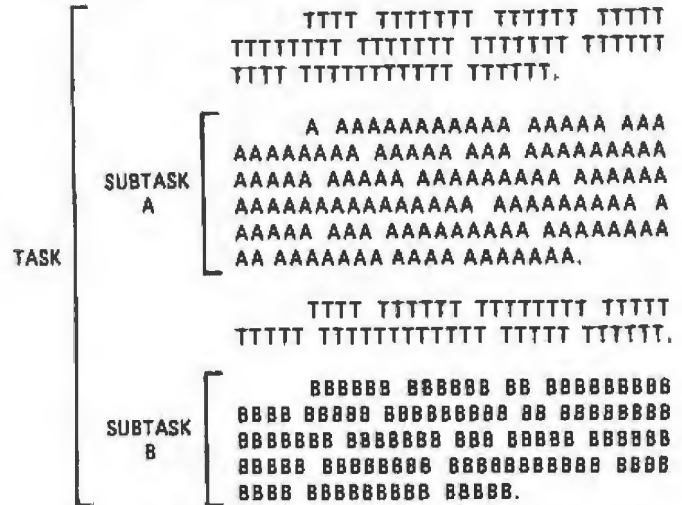
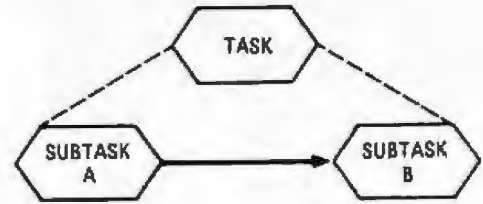

Figure 9: The structure of a task (top) is reflected in the structure of an English dialogue about the task (bottom). When discussing the task, descriptions referring to the overall task (the two paragraphs of the letter T) are interspersed with the paragraphs of text referring to subtask A and subtask B.

Much like a script, the procedural net associates an action with a number of subactions. However, as opposed to the strict sequence of actions in a script, the procedural net imposes only a partial ordering on subactions. Moreover, subactions are usually associated with procedural nets of their own, which specify in yet greater detail how tasks are divided. For example, the "attach pump" action referred to in figure 6 is described further in figure 7, while the "secure with bolts" action referred to in figure 7 is described further in figure 8. The net of figure 8 contains a loop specifying the repeated procedure of using a wrench to tighten each bolt.

As mentioned earlier, a major problem for natural-language processing systems is following the dialogue context and being able to ascertain the referents of noun phrases by taking the context into account. In preparing to build the TDUS system, Barbara Grosz collected a number of dialogues between human experts and apprentices performing repair tasks (see reference 8). After constructing procedural nets for the tasks, it was discovered that, as a general rule, the structure of task-oriented dialogues closely follows the structure of the nets representing the division of the task itself. As shown in figure 9, if a task divides into subtasks A and B, the dialogue tends to start with general information about the overall task, then enters a subdialogue about subtask A followed by a subdialogue about subtask B.

# 4MHZ, DOUBLE DENSITY, COLOR & B/W GRAPHICS . . THE LNW80 COMPUTER



When you've compared the features of an LNW80 Computer, you'll quickly understand why the LNW80 is the ultimate TRS80 software compatible system. LNW RESEARCH offers the most complete microcomputer system at an outstanding low price. We back up our product with an unconventional 6 month warranty and a 10 days full refund policy, less shipping charges.

LNW80 Computer . . . . . \$1,450.00  
 LNW80 Computer w/RAM Monitor & one 5" Drive . . . . . \$1,815.00  
 All orders must be prepaid, CA residents please include 6% sales tax.  
 Contact us for shipping charges

\* TRS80 Product of Tandy Corporation.  
 \*\* PMC Product of Personal Microcomputer, Inc.

## COMPARE THE FEATURES AND PERFORMANCE

FEATURES	LNW80	PMC-80**	TRS-80* MODEL 111
PROCESSOR	4.0 MHZ	1.8 MHZ	2.0 MHZ
LEVEL II BASIC INTERP.	YES	YES	LEVEL III BASIC
TRS80 MODEL 1 LEVEL II COMPATIBLE	YES	YES	NO
48K BYTES RAM	YES	YES	YES
CASSETTE BAUD RATE	500/1000	500	500/1600
FLOPPY DISK CONTROLLER	SINGLE/DOUBLE	SINGLE	SINGLE/DOUBLE
SERIAL RS232 PORT	YES	YES	YES
PRINTER PORT	YES	YES	YES
REAL TIME CLOCK	YES	YES	YES
24 X 80 CHARACTERS	YES	NO	NO
VIDEO MONITOR	YES	YES	YES
UPPER AND LOWER CASE	YES	OPTIONAL	YES
REVERSE VIDEO	YES	NO	NO
KEYBOARD	63 KEY	53 KEY	53 KEY
NUMERIC KEY PAD	YES	NO	YES
B/W GRAPHICS, 128 X 48	YES	YES	YES
HI-RESOLUTION B/W GRAPHICS, 480 X 192	YES	NO	NO
HI-RESOLUTION COLOR GRAPHICS (NTSC), 128 X 192 IN 8 COLORS	YES	NO	NO
HI-RESOLUTION COLOR GRAPHICS (RGB), 384 X 192 IN 8 COLORS	OPTIONAL	NO	NO
WARRANTY	6 MONTHS	90 DAYS	90 DAYS
TOTAL SYSTEM PRICE	\$1,815.00	\$1,840.00	\$2,187.00
LESS MONITOR AND DISK DRIVE	\$1,450.00	\$1,375.00	---

## LNW80

- BARE PRINTED CIRCUIT BOARD & MANUAL . . . . . \$89.95

The LNW80 - A high-speed color computer totally compatible with the TRS-80\*. The LNW80 gives you the edge in satisfying your computation needs in business, scientific and personal computation. With performance of 4 MHz, 280A CPU, you'll achieve performance of over twice the processing speed of a TRS-80\*. This means you'll get the performance that is comparable to the most expensive microcomputer with the compatibility to the world's most popular computer (TRS-80\*) resulting in the widest software base.

### FEATURES:

- TRS-80 Model 1 Level II Software Compatible
- High Resolution Graphics
  - RGB Output - 384 x 192 in 8 Colors
  - NTSC Video or RF MOD - 128 x 192 in 8 Colors
  - Black and White - 480 x 192
- 4 MHz CPU
- 500/1000 Baud Cassette
- Upper and Lower Case
- 16K Bytes RAM, 12K Bytes ROM
- Solder Masked and Silkscreened

## LNW SYSTEM EXPANSION

- BARE PRINTED CIRCUIT BOARD AND MANUAL . . . . . \$69.95  
 WITH GOLD CONNECTORS . . . . . \$84.95

The System Expansion will allow you to expand your LNW80, TRS-80\*, or PMC-80\*\* to a complete computer system that is still totally software compatible with the TRS-80\* Model 1 Level II.

### FEATURES:

- 32K Bytes Memory
- 5" Floppy Controller
- Serial RS232 20ma I/O
- Parallel Printer
- Real Time Clock
- Screen Printer Bus
- On Board Power Supply
- Solder Masked and Silkscreened

# LNW RESEARCH CORPORATION

2620 WALNUT ST.  
 TUSTIN CA. 92680

ORDERS & INFO. NO. 714-544-5744  
 SERVICE NO. 714-641-8850

Circle 192 on Inquiry card.

VISA MASTER CHARGE UNLESS NOTED  
 ACCEPTED ADD \$3 FOR SHIPPING

## LNDouble & DOS PLUS 3.3D

- Assembled and Tested W/DOS PLUS 3.3D . . . . . \$175.00

Double-density disk storage for the LNW Research's "System Expansion" or the Tandy's "Expansion Interface". The LNDouble™ is totally software compatible with any double density software generated for the Percom's Doubler™. The LNDouble™ provides the following outstanding features.

- Store up to 350K bytes on a single 5" disk
- Single and double density data separation
- Precision write precompensation circuit
- Software switch between single and double density
- Easy plug in installation requiring no etch cuts, jumpers or soldering
- 35, 40, 77, 80 track 5" disk operation
- 120 day parts and labor Warranty

\*\*\* Doubler is a product of Percom Data Company, Inc.

### DOS PLUS 3.3D

Micro Systems software's double density disk operating system. This operating system contains all the outstanding features of a well developed DOS, with ease in useability.

## KEYBOARD

LNW80 KEYBOARD KIT . . . . . \$84.95

The Keyboard Kit contains a 63 key plus a 10 key, P.C. board, and remaining components.

## CASE

LNW80 CASE . . . . . \$84.95

The streamline design of this metal case will house the LNW80, LNW System Expansion, LNW80 Keyboard, power supply and fan, LNDouble™, or LNW Data Separator. This kit includes all the hardware to mount all of the above. Add \$12.00 for shipping

### PARTS AVAILABLE FROM LNW RESEARCH

- 4116 - 200ms RAM
  - 6 chip set . . . . . \$26.00
  - 8 chip set . . . . . \$33.50
  - 16 chip set . . . . . \$64.00
  - 24 chip set . . . . . \$94.00
  - 32 chip set . . . . . \$124.00
- LNW80 "Start up parts set" LNW80-1 . . . . . \$82.00
- LNW80 "Video parts set" LNW80-2 . . . . . \$31.00
- LNW80 Transformer LNW80-3 . . . . . \$18.00
- LNW80 Keyboard cable LNW80-4 . . . . . \$16.00
- 40 Pin computer to expansion cable . . . . . \$15.00
- System Expansion Transformer . . . . . \$19.00
- Floppy Controller (FD1771) and UART (TR1602) . . . . . \$30.00



Of greater interest is the fact that referential expressions tend to refer to objects salient in the current subtask or higher in the task hierarchy, but generally do not refer to objects in sibling subtasks. For example, if in the dialogue of figure 9 a wrench  $W_1$  is mentioned in one of the initial utterances before entering subdialogue A, and if a second wrench  $W_2$  is mentioned within subdialogue A, the phrase "the wrench" uttered in subdialogue B more likely refers to  $W_1$  than to  $W_2$ —even though  $W_2$  was mentioned more recently. (This is clearly in violation of the rule used by SHRDLU in interaction 5 of listing 3.) In this regard, referential expressions in natural languages tend to follow much the same conventions as do variable references in block-structured programming languages such as ALGOL and Pascal. But the block structure of natural language is not indicated explicitly.

TDUS's ability to follow real-world tasks and deal with shifts in both the linguistic and physical context is illustrated in the transcript of listing 6, which relates to information contained in the nets of figures 6 through 8.

In interaction 1, the apprentice sets the stage by specifying what action is being done. This allows TDUS to pinpoint the location in the INSTALL-PUMP net where the apprentice appears to be. In interaction 2, the apprentice refers to a bolting action and a wrench used in that action. Neither of these is in the top-level representation of the ATTACH-PUMP net, but they both occur in the subordinate net of figure 8. TDUS finds this subnet and determines that no other relevant subnet refers to a dif-

ferent bolting action. Therefore, the system responds by specifying the wrench mentioned in the net shown in figure 8.

In interaction 3, the apprentice asks for the location of the bolts. TDUS does not operate under the closed-world assumption and realizes that there are some things it does not know. Luckily, the user finds the bolts in interaction 4.

In interaction 5, the apprentice refers to "the wrench." TDUS determines that the reference is to the wrench mentioned in interaction 2 and tells the apprentice its location. In interaction 6, TDUS resolves "it" as pertaining to the same object.

In interaction 7, the apprentice tells TDUS that the pump-attaching operation is completed. The system infers from this that all the constituent subtasks have also been done. To make sure, it reviews these assumptions for the apprentice. This filling in of intermediate steps is much like that in the SAM examples.

In interaction 8, the apprentice poses a logically complex question involving the modal concept "should." TDUS's rudimentary notion of "should" interprets the question as asking whether the action mentioned is com-

*Listing 6: An actual conversation with the TDUS system. With this system, the computer supervises a task performed by a human apprentice. Human input is shown in boldface.*

- 1 — I AM ATTACHING THE PUMP.  
OK.
- 2 — WHICH WRENCH SHOULD I USE TO BOLT IT?  
USE THE BOX-END WRENCH.
- 3 — WHERE ARE THE BOLTS?  
I DON'T KNOW.
- 4 — I FOUND THEM.  
OK.
- 5 — WHERE IS THE WRENCH?  
THE BOX-END WRENCH IS ON THE TABLE.
- 6 — I FOUND IT.  
OK.
- 7 — I ATTACHED THE PUMP.  
OK.

THE FOLLOWING HAS BEEN ASSUMED:

YOU PUT THE PUMP AT THE PLATFORM. YOU BOLTED THE PUMP TO THE PLATFORM WITH THE BOLTS.

- 8 — SHOULD I INSTALL THE PULLEY NOW?  
NO.

THE NEXT STEP IS:

INSTALL THE AFTERCOOLER ELBOW ON THE PUMP  
OR

INSTALL THE BRACE ON THE PUMP.

- 9 — I'M DOING THE BRACE NOW.  
OK.

"DO" IS ASSUMED TO MEAN:

YOU ARE INSTALLING THE BRACE.

- 10 — I'VE DONE IT.  
OK.

"DO" IS ASSUMED TO MEAN:

YOU INSTALLED THE BRACE.

THE FOLLOWING HAS BEEN ASSUMED:

YOU PUT THE BRACE AT THE PUMP.

YOU SECURED THE BRACE.

- 11 — I'VE INSTALLED THE PULLEY.  
OK.

## A LOGIC ANALYZER FOR \$395?



**YES!**  
**OWL**  
LA 1600-A  
High Speed  
16 Channels

Interfaces to dual channel scope or Apple computer.

- 10 MHZ capture rate
- Gold plated connectors and clips
- Stores 16 words of 16 bits
- Crystal controlled internal clock
- 1, 0, X compare word bit selection
- Time domain display
- Data domain display\*
- Hex display\*
- Internal and external trigger modes

\*Optional with use of Apple computer

Comes complete with interconnecting cables; logic probe clips, diskette for Apple computer, and operating instructions.



— Send for FREE brochure —  
**Osborne Wilson Labs.**  
508 Waterberry Drive  
Pleasant Hill, California 94523  
(415) 932-5489

# Printers Plus

...computers, peripherals,  
accessories and supplies!



## APPLE ACCESSORIES

LOBO Disk II Add-On .....	419.
SUPERTERM 80 Col. Card .....	329.
Z80 Soft Card .....	295.
H.S. Serial Card .....	179.
COMM. Card .....	179.
HAYES Micromodem .....	319.
PARALLEL Printer Card .....	149.
16K Ram Card .....	189.
GPIB IEEE-488 Card .....	259.
VISTA A40 Disk II Add-On .....	349.
VISTA A80 Disk II Add-On .....	529.
VISTA A160 Disk II Add-On .....	799.
VISTA A800 Dbl. Den. 8" Con. ...	529.

## SOFTWARE

VISCALC .....	119.00
DESKTOP Plan II .....	169.00
DB MASTER .....	209.00
ADDRESS Book .....	40.00
SUPER Text II .....	125.00
CCA Data Mgmt. ....	85.00

## RIBBONS

NEC .....	\$77.00/Doz.
QUME .....	45.00/Doz.
DIABLO .....	66.00/Doz.
ANADIX .....	135.00/6 ea.
TRITEL .....	95.00/Doz.
TI/DEC/TTY .....	45.00/Doz.
EPSON .....	13.95/ea.
MPI/Axiom/Base 2 .....	10.00/ea.



## MAGNETIC MEDIA

Premium Quality At Bargain Prices  
5 1/4" Diskettes, all Formats

100% Certified with hub rings, box of 10

Single sided, single density .....	26.50
Single sided, double density .....	29.50
Double sided, double density .....	38.50
<b>8" DISKETTES, ALL FORMATS</b>	
<b>100% CERTIFIED</b>	
Single sided, single density .....	29.50
SSSD Error Free .....	34.50
Single sided, double density .....	39.50
Double sided, double density .....	49.50

Diablo 630 RO .....	\$2,395.
Diablo 1640 RO .....	2,795.
Diablo 1650 RO .....	3,095.
C. Itoh Starwriter RO .....	1,695.
TI 810 RO .....	1,695.
TI 820 RO .....	1,795.
Anadex DP9500/9501 .....	1,345.

# EPSON'S

Complete Stock of MX-80, MX-80 F/T  
MX-100 Printers, Graphics Chip Sets  
Cards and Cables

## NEW! NOVELL IMAGE 800

150 CPS Heavy Duty Matrix  
15" wide carriage, expanded, compressed and  
double density "correspondence quality"  
printing at 80, 96 and 136 columns, true  
descenders, underlining, superscripts,  
subscripts. Up to 3K Buffer, optional character  
set and graphics option.

List \$1,395..... \$1,295.00

## PRINT ELEMENTS

NEC Thimbles .....	\$14.95
Plastic Daisy Wheels	
for Qume, Diablo, Starwriter .....	6.00
Metal Daisy Wheels .....	59.00
IBM Selectric Elements .....	19.00



## MODEMS

QDS 103 LP, direct .....	\$169.
103 JLP Auto Answer .....	219.
NOVATION CAT, acoustic .....	159.
D-CAT, direct .....	169.
Auto Cat .....	219.
Apple Cat .....	309.
LEXICON LX-11, acoustic .....	147.
HAYES Micromodem, S100 .....	349.

## VIDEO MONITORS

Sanyo 9" B/W .....	\$169.
NEC 12" Green .....	229.
Amdek 12" B/W (Leadex) .....	135.
Amdek 13" Color .....	399.

## VIDEO TERMINALS

Ampex Dialog 80 .....	\$995.
Ampex Dialog 30 .....	795.
Televideo 920C .....	845.
Televideo 950 .....	995.
Soroc IQ 120 .....	795.
Soroc IQ 140 .....	1,195.

## FLOPPY DRIVES

1-SA 400 Case, power .....	\$399.
1-SA 800/801 Case, power .....	995.
2-SA 800/801 Case, power .....	1,495.
2-SA 850/851 Case, power .....	1,995.



## MPI 88 G Matrix

High resolution dot-addressable graphics for  
Apple. Enhanced "correspondence quality"  
printing. Tractor and Friction feed. Serial and  
Parallel Input. 100 cps Bidirectional printing. 80,  
96, and 132 column widths!

List \$799.00 ..... \$599.00

Apple II I/O Card .....	\$110.00
PET/IEEE I/O Card .....	55.00
Single Sheet Feeder .....	25.00
QT Cover .....	25.00



## NEC SPINWRITERS

5510/5530 RO .....	\$2,595.
5520 KSR .....	2,895.

NEW!

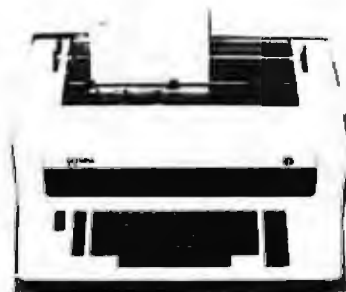

## OLYMPIA ES100 RO

Letter quality. Daisy wheel printer/typewriter  
interfaces to Apple, Atari, NEC, TRS80 and  
RS232 Serial ports. A truly cost effective letter  
quality printer that functions as a typewriter.

List \$1690..... \$1395.00

## TO PLACE YOUR ORDER CALL:

TELEPHONE (714) 744-7314  
TELEX 697120

or write to:

# PALOMAR

Computer Products

910-105 W. San Marcos Blvd., San Marcos, CA 92069

TERMS OF SALE: Cash, check, money order, bank wire transfer,  
credit card or purchase orders from qualified firms and  
institutions. Please include telephone number with order and  
expiration date on credit card orders. California residents add 6%  
sales tax. Advertised prices are for prepaid orders F.O.B. shipping  
point. Add 3% for shipping in U.S. Pricing and availability subject to  
change without notice.

Circle 282 on Inquiry card.

patible with one of the possible next steps in the procedural-net model of the task at hand. Since it is not, TDUS answers in the negative, but goes on to outline the range of acceptable alternatives at this point in the process.

Interaction 9 is of considerable interest in that it contains the pro-verb "do." This is a reference to some action involving the apprentice and the brace. But the action is not completely specified. By examining the procedural net, TDUS determines that the likely thing to do with a brace in this context is to install it—so TDUS makes that assumption and reports it to the apprentice.

Interaction 10 demonstrates TDUS's ability to comprehend an extreme case of contextually dependent use of language. Neither "done" nor "it" conveys much information. Here, "it" refers not to some object in the world, but to an action previously alluded to by the phrase "doing the brace."

### Limitations of TDUS

TDUS exhibits a reasonable understanding of the interplay among various types of possible real-world actions, and it can follow the evolution of particular instantiations of those actions. However, it has little understanding of the goals and motivations of the apprentice with whom it holds conversations.

An exchange well beyond the capability of TDUS is shown in the following actual dialogue between a novice and an expert mechanic:

1. WHAT DO I DO NEXT?  
REMOVE THE BOLT.
2. HOW DO I GET IT OFF?  
USE THE RATCHET WRENCH.
3. WHAT'S A RATCHET WRENCH?  
IT'S ON THE TABLE.

## Computers may simplify your business, but it isn't always simple to choose one.



HAZELTINE  
1421 Video Terminal

CROMEMCO  
System 3

QANTEX  
Series 6000  
150 CPS  
Parallel or Serial Interface

ATARI  
800  
400

As your computer company, Synchro-Sound International will not only offer you a large selection of computer models at discount prices, we'll offer expert guidance on how to choose one.

We'll help you determine which computer system will best suit your individual business needs. Whether it's a micro-computer, a printer, a video display terminal, accessories, or even a complete turn-key operation. We'll design it. Configure it. Guarantee it. We also offer a wide range of easy-to-understand software.

What's more, we have all the answers after you purchase your computer, too. We'll give you fast delivery. And we have a staff of computer specialists who'll respond quickly to any service you may require.

Which all adds up to why we've grown to be one of the largest computer companies in the New York area over the past seven years.

So when you decide you need a computer, decide on Synchro-Sound. Our guidance could be almost as priceless as your business.



### SYNCHRO-SOUND INTERNATIONAL, INC.

Where the computers are cold and calculating. But the people aren't.

1550 NORTHERN BOULEVARD, MANHASSET, N.Y. 11030 TWX 510-220-0021  
For orders or more information, call: (516) 869-8535 Toll-free: 800-645-3820



# Qume® Data Trak™ Floppy Disk Drives

Distributed by: **asap**  
computer  
products, inc.

**The Data Trak™ 5** double-sided double-density drive uses state-of-the-art technology to give you superior data integrity through improved disk life, data reliability, and drive serviceability using 5¼" media.

Qume's independent head load yields wear characteristics far superior to competitive drives. This superior wear performance produces savings on both diskette usage and drive maintenance.

Improved data reliability, resulting from superior amplitude and bit shaft characteristics, optimizes operator efficiency and reduces processing time for end-users.

And Data Trak's unique modular design means simplified field servicing for you and your customers.

## Design Features

Expanded storage capacity • Two-sided, double-density

Proven head carriage assembly • Ceramic head with tunnel erase • Dual-head flex mounting arrangement • Superior head load dynamics

Precise lead screw actuator • Fast access time — 12 ms track-to-track • Low friction and minimum wear • Low power dissipation

Additional features • Industry standard 5¼" media format • ISO standard write protect • Door lock out for media protection • Requires DC voltage only • Daisy Chain up to 4 drives • Heads load on command independent of loading media

## Product Specifications

Performance Specifications • Capacity: Unformatted: 437.5K or 500K bytes; Qume Formatted: 286.7K or 327.7K bytes • Recording Density: 5456 BPI • Track Den-



sity: 48 TPI • Cylinders: 35 or 40 • Tracks: 70 or 80 • Recording Method: FM or MFM • Rotational Speed: 300 RPM • Transfer Rate: 250K bits/second • Latency (avg.): 100 ms • Access Time: Track-to-track 12 ms; Settling 15 ms • Head Load Time: 50 ms

**The Data Trak™ 8** double-sided double-density drive uses state-of-the-art technology to give you superior data integrity through improved disk life, data reliability, and drive serviceability.

Qume's innovative approach to controlling head load dynamics yields wear characteristics far superior to competitive drives. In independent evaluation, Data Trak 8 is setting industry standards for top test performance. This superior wear performance produces savings on both diskette usage and drive maintenance.

Improved data reliability, resulting from superior amplitude and bit shift characteristics, optimizes operator efficiency and reduces processing time for end-users.

And Data Trak's unique modular design means simplified field servicing for you and your customers.

## Design Features

Expanded storage capacity • Two-sided, double-density

Fully IBM compatible • IBM 3740 and System 32 drives • IBM 3600 and 4964 drives • IBM System 34 drives

Proven head carriage assembly • Ceramic head with tunnel erase • Dual-head flex mounting arrangement • Superior head load dynamics

Fast, precise steel belt drive • Fast access time — 3 ms track-to-track • Low friction and minimum wear • Low power dissipation

Additional features • ISO standard write protect • Programmable door lock • Negative DC voltage not required • Daisy Chain up to 4 drives • Side-by-side mounting in standard 19" RETMA rack • Compatible with Shugart SA850/SA851



## Product Specifications

Performance Specifications • Capacity: Unformatted: 1.6 Mbytes/disk; IBM Format: 1.2 Mbytes/disk • Recording Density: 6816 BPI • Track Density: 48 TPI • Cylinders: 77 • Tracks: 154 • Recording Method: MFM • Rotational Speed: 360 RPM • Transfer Rate: 500Kbits/second • Latency (avg.): 83 ms • Access Time: Track-to-track 3 ms; Settling 15 ms; Average 91 ms • Head Load Time: 35 ms • Disk: Diskette 2D or equivalent

**asap**  
computer  
products, inc.

1198 E. Willow, Signal Hill, CA 90806

Call Toll Free (800) 421-7701

AUTHORIZED DISTRIBUTOR FOR QUME  
CALL FOR PRICE AND DELIVERY

(213) 595-6431 or (714) 891-2663 In California



Figure 10: A sentence that conveys different information to different people.

The key point to note here is that, in interaction 3, the response is not a *direct* answer to the question. If TDUS could answer this question at all, it would likely respond with a dictionary definition such as: "a tool for grasping and turning the head of a bolt, consisting of fixed or adjustable jaws mounted on a pawl that is engaged by the toothed end of a gripping bar." The person who answered query 3 understood the motivation behind the question. It was asked so the inquirer would know the description of a ratchet wrench, so he could find it, so he could grasp it, and so he could use it to remove the bolts. Understanding the inquirer's hierarchy of goals, the respondent addresses one of the goals closer to the end of the chain (finding the wrench). The cooperative respondent saves the inquirer the trouble of taking the step of locating the wrench from its description.

### Beyond Current Systems

Researchers in computational linguistics have only recently begun to appreciate the impact on natural-language communication of what the participants in a conversation know about each other's knowledge, beliefs, plans, and goals. To appreciate the importance of such knowledge, consider the situation illustrated in figure 10.

A young mother is giving a birthday party for Junior, and Grandma has come to help. Grandma's task is to light the candles on the cake, so she asks, "When shall I light the candles?" The mother replies, "We'll have the cake as soon as the children wash their hands," which informs Grandma that it will be about five minutes. The mother knows that the big-eared kids are listening, so she phrases her response to serve multiple purposes for multiple audiences. With her one statement, she tells Grandma when the candles need to be lit and, in a nice, indirect way, tells the children to get their dirty hands washed. She knows that her response to Grandma will serve this purpose because she knows that:

- the children want the cake
- her response to Grandma will convey to them the information that all that stands in the way of their getting it is to wash their hands
- if they know that all that stands in the way of their getting cake is to wash their hands, they will perform the ritual forthwith
- it takes them about five minutes to wash their hands

Similarly, Grandma now knows that she should light the candles in five minutes because she knows that the mother knows all the circumstances just outlined and that the mother knows Grandma knows that the mother knows it. Thus, Grandma infers that the mother expects her to understand that the children are being told to wash their hands, that they are motivated to do it right away, and the result five minutes later will presumably be washed hands reaching avidly for cake.

No system is currently capable of handling language with this level of sophistication, but a number of researchers are actively engaged in studying the various problems involved; see references 3, 5, 6, 7, 13, 14, 16, 18, 23, and 27. Much of this work is concerned with the difficulties of interpreting not just what is literally said, but also of establishing the underlying intention. Should this work succeed, systems may be capable of the kind of reasoning indicated in listing 7.

The examples of the locked toolbox and the birthday party support a central point: communicating in natural language is an activity of the total intellect. Seen in broad perspective, the use of natural language can be placed in a general framework that seeks to account for all human activity. Within this framework, humans are seen as intelligent beings motivated by complex sets of goals they seek to fulfill by planning, executing, and monitoring sequences of actions—some of which are physical, some linguistic. That is, uttering a sentence is just as much an action as taking a step or taking a bath. Whereas the usual purpose of a physical action is to alter the physical world, the usual purpose of a linguistic action is to alter

Listing 7: An imaginary conversation with a TDUS-like system showing the possible behavior of a computer system that reacts to human needs in a way not currently possible by existing systems.

USER: THE TOOLBOX IS LOCKED.  
 SYSTEM: (WHY IS HE TELLING ME THIS? I ALREADY KNOW THE BOX IS LOCKED.)  
 (I KNOW THE USER NEEDS TO GET IN. PERHAPS HE IS TELLING ME THE BOX IS LOCKED BECAUSE HE BELIEVES I CAN SOMEHOW HELP.)  
 (TO GET IN TAKES A KEY. THE USER KNOWS THIS AND KNOWS I KNOW IT. THE KEY IS IN THE DRAWER. IF THE USER KNEW THIS HE WOULD JUST UNLOCK THE BOX. THEREFORE, HE MUST NOT KNOW IT.)  
 (I CAN MAKE HIM COME TO KNOW IT BY SAYING "THE KEY IS IN THE DRAWER." I AM SUPPOSED TO HELP. I WILL SAY IT.)  
 THE KEY IS IN THE DRAWER.

Into computers? Robotics?  
Want to get started?

# Take 6 great books for \$2.95

(values to \$94.70)

... and get one FREE!

All the latest info on software, hardware, applications, and theory at savings up to 75%. Plus, discounts on software, games, cassettes, disks ... and more!



Join now and get *How to Build Your Own Working 16-Bit Microcomputer* ... FREE!! (List \$4.95)

## 7 very good reasons to try The Computer Book Club ...

- **Reduced Member Prices.** Save up to 75% on books sure to increase your know-how
- **Satisfaction Guaranteed.** All books returnable within 10 days without obligation
- **Club News Bulletins.** All about current selections—mains, alternates, extras—plus bonus offers. Comes 10 times a year with dozens of up-to-the minute titles you can pick from
- **"Automatic Order".** Do nothing, and the Main selection will be shipped automatically! But ... if you want an Alternate—or no books at all—we'll follow the instructions you give on the reply form provided with every News Bulletin
- **Continuing Benefits.** Get a Dividend Certificate with every book purchased after fulfilling Membership obligation, and qualify for discounts on many other volumes
- **Extra Bonuses.** Take advantage of added-value promotions, plus special discounts of software, games, and more
- **Exceptional Quality.** All books are first-rate publisher's editions, filled with up-to-the-minute info



### THE COMPUTER BOOK CLUB Blue Ridge Summit, PA 17214

Please accept my Membership in The Computer Book Club and send the 6 volumes circled below, plus a free copy of *How to Build Your Own Working 16-Bit Microcomputer*. I understand the cost of the books selected is \$2.95 (plus shipping/handling). If not satisfied, I may return the books within ten days without obligation and have my Membership cancelled. I agree to purchase 4 or more books at reduced Club prices during the next 12 months, and may resign any time thereafter.

841 985 995 1045 1050 1053 1055 1082  
1071 1076 1088 1095 1111 1160 1169 1187  
1195 1200 1203 1205 1209 1229 1271 1275

Name \_\_\_\_\_ Phone \_\_\_\_\_

Address \_\_\_\_\_

City \_\_\_\_\_

State \_\_\_\_\_ Zip \_\_\_\_\_

(Valid for new members only. Foreign and Canada add 20%. Orders outside U.S. or Canada must be prepaid with international money orders in U.S. dollars) NY-101

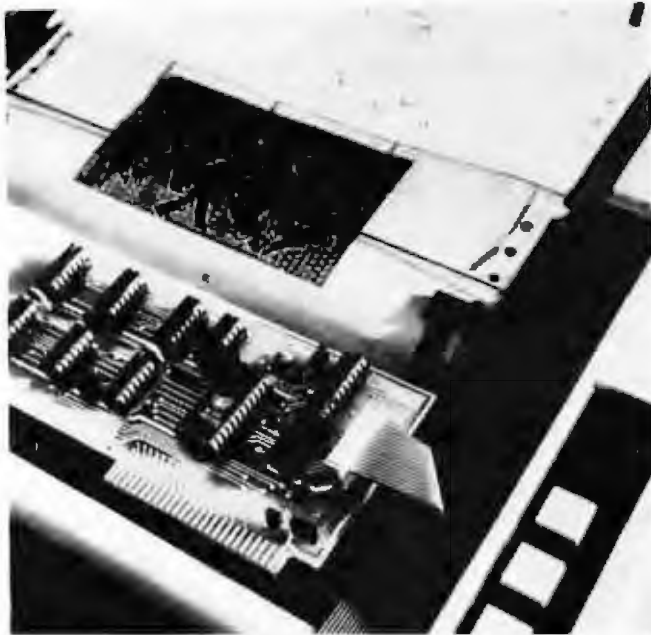

## Astonishing!

The EP12 Interface card for the Apple Computer\* and Epson MX-80 Printer\*\* is astonishing. All the features you've ever seen in printers for Apple, plus some new features you'd never expect from a low-cost printing system. All in firmware for the first time, so no more disk juggling to do a graphics print! All features are simple built-in commands . . .

### 3 Varieties of Screen Dumps

- Hires Graphics — 24 different formats
- Lores Graphics — 16 level gray scale
- Text — Prints exactly what's on the screen

### Special Graphics Features

- Dot plotting — 960 x 792 points on a page
- Special characters you define in Software
- 16-level gray scale print mode

### Versatile Line and Page Control

- Variable line spacing and page length
- Variable line length
- Tabs for indentation and column printing

### Built-in convenient human features

- Indication on the screen if paper runs out.
- All functions are short mnemonic commands
- Manual is written for the Apple owner

See your Apple Dealer today.



**Interactive Structures, Inc.**  
112 Bala Avenue  
PO Box 404  
Bala Cynwyd, PA 19004

\*Apple Computer, Inc. \*\*Epson America, Inc.

the mental states of the hearers. In the latter case, the desired modification may be to add knowledge, change a mood, or establish a new goal for the hearers.

A speaker may plan and execute linguistic actions to change some aspect of a hearer's mental state, not as an end in itself, but as part of an overall plan to achieve some more ambitious end. Just as a child might push over the first domino of a long row to make them all tumble in sequence, a lifeguard at the beach may yell "Shark!" at swimmers to set off a chain of reasoning in their minds that will result in a mad dash for the shore, which is the lifeguard's intended mechanism for accomplishing the primary goal of preserving life.

Given this view of how language works, it becomes less important to ask what a given utterance means (what does "Shark!" mean?) and more important to ask about the effect it produces. People in advertising have an explicit understanding of this concept, but all of us use it implicitly when we understand the agony conveyed by the string of curses uttered by the handyman who smashes his finger, and when we realize that our friend's question, "Do you know the time?," deserves more than a "yes" or "no" answer.

The understanding of poetry can even be cast in this mold. The poet deliberately triggers certain chains of inference in readers. Indeed, an important element in the appreciation of poetry is the reader's awareness of the interplay among the inference chains followed, the chains followed partway that turn out to be not quite appropriate, and the surface meanings of the sentences comprising the poem itself. To experience this, just consider the title of T S Eliot's poem, "The Love Song of J. Alfred Prufrock."

### The Nature of Natural-Language Research

The previous sections discussed the capabilities and limitations of specific natural-language processing systems. But it must be recognized that these systems are merely spin-offs of the underlying science. In essence, most researchers in this field do not think of themselves as engineers seeking to evolve better natural-language processing systems, but rather as scientists concerned with the following related problems:

- identification of sources of knowledge necessary for understanding or generating natural language
- discovery or devising of mechanisms for encoding and applying such knowledge in a mechanical device
- creation of integration frameworks to control and coordinate the application of a variety of knowledge sources

Once sources of knowledge have been identified, whole subdisciplines come into being to study the associated bodies of knowledge, their structure, and methods for their computerization. Some of the major knowledge sources are discussed below.

*Lexical knowledge* concerns individual words, the parts of speech they belong to, and their meanings.

*Syntactic knowledge* has to do with the grouping of words into meaningful phrases. For example, syntactic



# THE NATIONAL COMPUTER SHOWS

## HAVE WE GOT A PROGRAM FOR YOU IN '81 & '82

Attend the biggest public computer shows in the country. Each show has 100,000 square feet of display space featuring over 50 Million Dollars worth of software and hardware for business, industry, government, education, home and personal use.

You'll see computers costing \$150 to \$250,000 including mini and micro computers, software, graphics, data and word processing equipment, telecommunications, office machines, electronic typewriters, peripheral equipment, supplies and computer services.

All the major names are there including: IBM, Wang, DEC, Xerox, Burroughs, Data General, Qantel, Nixdorf, NEC, Radio Shack, Heathkit, Apple, RCA, Vector Graphic, and Commodore Pet. Plus, computerized video games, robots, computer art, electronic gadgetry, and computer music to entertain, enthrall and educate kids, spouses and people who don't know a program from a memory disk.

Don't miss the Coming Of The New Computers - Show Up For The Show that mixes business with pleasure. Admission is \$5 for adults and \$2 for children under 12 when accompanied by an adult.

### Ticket Information

Send \$5 per person with the name of the show you will attend to National Computer Shows, 824 Boylston Street, Chestnut Hill, Mass. 02167 Tel 617 739 2000. Tickets can also be purchased at the show

### THE MID-WEST COMPUTER SHOW

**CHICAGO**  
McCormick Place  
SCHOESSLING HALL  
23rd & THE LAKE  
THURS-SUN  
SEPT 10-13, 1981

11AM TO 7PM WEEKDAYS  
11AM TO 6PM WEEKENDS

### THE MID-ATLANTIC COMPUTER SHOW

**WASHINGTON, DC**  
DC Armory/Starplex  
2001 E. CAPITAL ST. SE  
(E CAP. ST. EXIT OFF 1295  
-KENILWORTH FRWY)  
ACROSS FROM RFK  
STADIUM  
THURS-SUN  
SEPT 24-27, 1981

11AM TO 7PM WEEKDAYS  
11AM TO 6PM WEEKENDS

### THE NORTHEAST COMPUTER SHOW

**BOSTON**  
Hynes Auditorium  
PRUDENTIAL CENTER  
THURS-SUN  
OCT 15-18, 1981

11AM TO 7PM WEEKDAYS  
11AM TO 6PM WEEKENDS

### THE SOUTHEAST COMPUTER SHOW

**ATLANTA**  
Atlanta Civic Center  
395 PIEDMONT AVE NE AT  
RALPH MCGILL BLVD  
THURS-SUN  
OCT 29-NOV 1, 1981

11AM TO 7PM WEEKDAYS  
11AM TO 6PM WEEKENDS

### THE SOUTHERN CALIFORNIA COMPUTER SHOW

**LOS ANGELES**  
LA Convention Center  
1201 SOUTH FIGUEROA  
THURS-SUN  
MAY 6-9, 1982

11AM TO 7PM WEEKDAYS  
11AM TO 6PM WEEKENDS

# MEGABYTER

## ZVX4 FOUR TIMES THE BYTE

The ZVX4 MEGABYTER is for the APPLE II user who wants to DOUBLE file size, expand the capability of existing business software, and make other SERIOUS applications more viable.

Now you can have compatibility with IBM, INTEL, CP/M\*, Z80 Softcard\*, UCSD Pascal, and others.

Look what the MEGABYTER dual density 8" floppy disk controller, with its LSI circuitry and reliable industry standard IBM 3740 format, means to you:

### INCREASED STORAGE

- Increase online storage to 2 Mega bytes
- Double your maximum accounts and file size
- Add high capacity efficient hard disk backup
- Control up to 4 Shugart SA800/SA850 drives

### IMPROVED COMPATIBILITY

- Operate APPLE DOS 3.1/3.2/3.3, mini disks
- Preserve existing software investment
- Interchange data with other computers

### SIMPLIFIED OPERATION

- Reduce disk handling and I/O slot usage
- Gain automatic single/double density operation
- Change to double sided drives with one switch

Available at your Apple dealer. Call or write today!!



SORRENTO VALLEY ASSOCIATES  
11722 SORRENTO VALLEY ROAD  
SAN DIEGO, CA 92121  
(714) 452-0101

\* CP/M trademark of Digital Research, Inc.  
Z80 Softcard trademark of Microsoft, Inc.

knowledge distinguishes between the following two sentences:

NAME THE PARTS OF THE PUMP THAT WAS FIXED BY JOE.

NAME THE PARTS OF THE PUMP THAT WERE FIXED BY JOE.

In particular, it is the syntactic number distinction between WAS and WERE that indicates whether the pump or the parts were fixed.

Syntactic ambiguity is a common source of trouble in natural-language processing systems. For example, decisions about where to associate the prepositional phrase "on the table" in:

PUT THE HAMMER IN THE TOOLBOX ON THE TABLE.

can lead to any one of the interpretations:

PUT THE HAMMER THAT IS IN THE TOOLBOX ONTO THE TABLE.

PUT THE HAMMER INTO THE TOOLBOX THAT IS ON THE TABLE.

WHILE YOU STAND ON THE TABLE, PUT THE HAMMER INTO THE TOOLBOX.

*Compositional semantics* is the knowledge of how to compose the literal meaning of large syntactic units from the semantics of their subparts. Its utility is illustrated by the pair of sentences:

THE MAN HELD THE NUT (with a wrench).  
THE WRENCH HELD THE NUT.

These two sentences are syntactically identical, but the subject of the first sentence is the agent of the action "hold," whereas the subject of the second is the instrument used by the agent. The lexical entry for the verb HOLD indicates that it is used to refer to actions in which an agent (usually a person) using an instrument exerts a force on some physical object. The syntactic subject of the verb might refer either to the agent or the instrument. But the semantics of HOLD indicate that these roles must be filled by objects of mutually disjoint classes of objects. Utilization of this knowledge allows a system to assign the role of agent to THE MAN, but assign the role of instrument to THE WRENCH.

*Discourse knowledge* concerns the way clues from the current context are used to help interpret a sentence. For example, if we have just been talking about this month's issue of BYTE, the noun phrase "the magazine" in:

I'VE ALREADY READ MY COPY OF THE MAGAZINE.

is easily understood *in this context* as referring to this month's issue of BYTE. Yet, we often have personal knowledge of hundreds of issues of various magazines.

# Micro computer software company gets macro results.



"Software is the hottest segment of the personal computer industry. After all, it's the software that solves problems. And Business Week has precisely the type of readers who are looking for solutions to the kinds of problems we solve. Top and middle management of corporations. That's why right from the start we committed a substantial portion of our marketing budget to advertise in Business Week. And we're very pleased with the results. Since our first insertion, our monthly sales have more than doubled."

James M. Dow, President  
Microcom, Inc.

When Microcom began in 1980, the Boston-based manufacturer of personal computer software wanted to spread the word to corporate

managers about its first product—an electronic mail package for Apple™ computers called Micro-Courier™. Not only to managers who already have Apples,™ but to the fast-growing market of managers in corporations who are thinking of buying personal computers to help them and their staffs do a better job.

For Microcom's Jim Dow, Business Week brought his market into focus. Business Week has a take-action audience of over 6 million corporate decision makers. And they look to Business Week to keep them informed on computer developments. Business Week is the only general busi-

ness publication with an entire editorial section, Information Processing, covering events and trends in the computer industry. Every week.

As Microcom found out, one of the best times to link up with Business Week is right at square one. But for small companies or large companies, Business Week gets big-time advertising results. Call your nearest Business Week representative today.

**BusinessWeek**



Source: MRI (Spring, '81)/Pub. est.

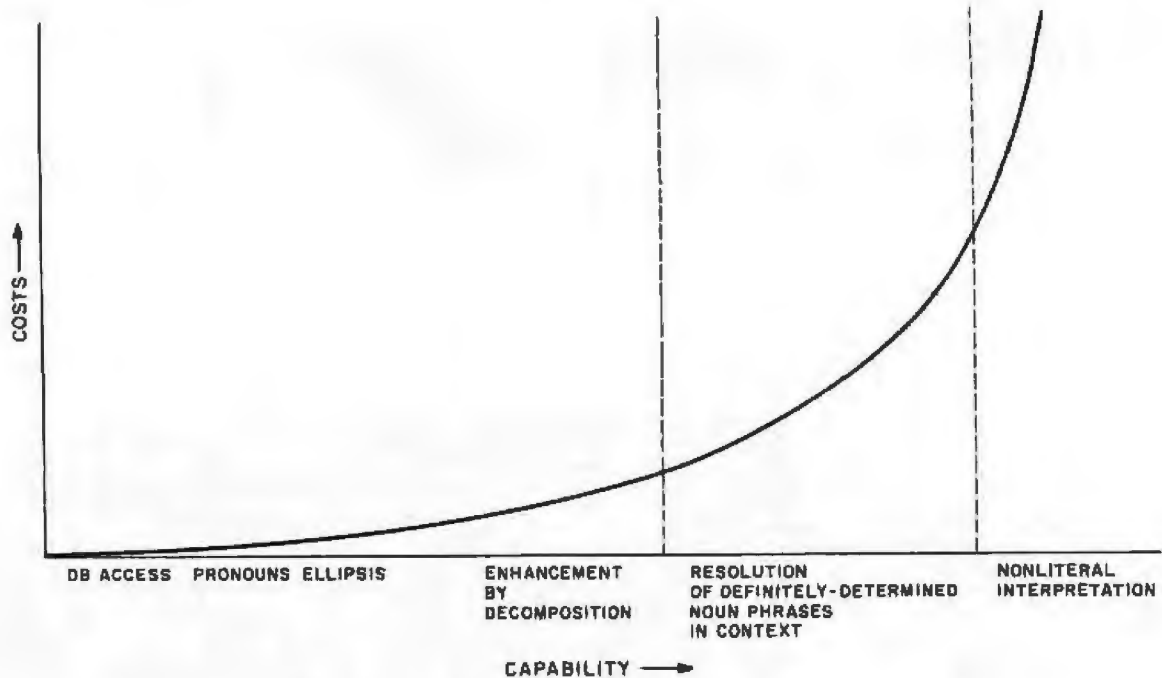

Figure 11: A graph of capability versus cost for systems that can handle natural-language queries.

The ability to pick the one of current interest is based on specific knowledge of the current situation.

*World knowledge* is concerned with information about how the world is currently configured and about physical constraints upon possible configurations. For example, we understand:

PRESIDENT REAGAN FLEW TO CALIFORNIA.

to mean that he *was flown* to California as a passenger in an airplane. Had the sentence been about a bird, we might have taken the sentence to mean that the bird did the flying.

As an example of how knowledge about the current physical situation can be of aid in understanding sentences, consider again the sentence:

PUT THE HAMMER IN THE TOOLBOX ON THE TABLE.

discussed in the earlier paragraph on syntax. If we know that the hammer is currently in a toolbox on the floor, the only interpretation of the sentence is to lift the hammer out of the toolbox and place it onto the table. The other interpretations are ruled out because they are impossible in the current state of the world.

*Knowledge of mental states* relates to comprehending the knowledge and goals of other participants in a dialogue. The use of such knowledge is shown in the locked-toolbox example in listing 7.

### Cost as a Function of Capability

The preceding sections sketched a spectrum of natural-language processing capabilities—ranging from isolated

questions about the data in conventional data bases, through the literal interpretation of utterances in dynamic contexts, to an understanding of the underlying goals and mental states of participants in a dialogue. As would be expected, progression through this spectrum entails rapidly escalating costs in two areas: the research and programming effort required to reach a particular level of capability, and the computing resources (measured in the number of machine instructions that must be executed and the memory requirements) needed to function at a given level.

This situation is illustrated graphically in figure 11, which plots cost as a function of system capability. Although the diagram shows a sharp rise in cost with increased capability, the situation is probably even more dramatic than indicated, and the cost scale might best be interpreted as being logarithmic.

The capability dimension has been separated into three major regions by two dividing lines. It appears that capabilities beyond (to the right of) the leftmost line require systems with explicit models of concrete objects in the world, the relationships among them, and the types of processes that can alter those relationships. The more advanced capabilities beyond the rightmost line require further enhancements for modeling such things as the mental states of dialogue participants.

Figure 12 repeats the curve of figure 11, but also shows curves for developing three kinds of systems. Systems on curve A are built without the use of explicit models. They cover most of the principal linguistic phenomena needed for accessing conventional data bases and, up to the point at which curve A intersects curve B, can be constructed and operated more economically than other types of systems. As the need for world models increases, at-



# LOGO: A Powerful New Language For Micro-Computers

In the past few years, a "micro-revolution" has been taking place — personal computers are fast becoming an integral part of our daily lives. With this revolution comes a need for a powerful new programming language, one which is highly sophisticated yet easy to use.

LOGO brings to children, as well as adults, the ability to exercise full control over an extremely rich and challenging micro-world — they become active participants in their own learning experience. Powerful ideas can become a reality.

LOGO Computer Systems Inc. is a new company which has been formed to develop and disseminate the LOGO methodology. Our product line includes hardware, software, written materials and training services.

logo  
computer  
systems inc.

150 Montarville Blvd.  
Suite 200  
Boucherville, Quebec  
Canada J4B 6N1  
(514) 641-0966

368 Congress St.  
Boston, Mass.  
U.S.A. 02210

(617) 451-2646

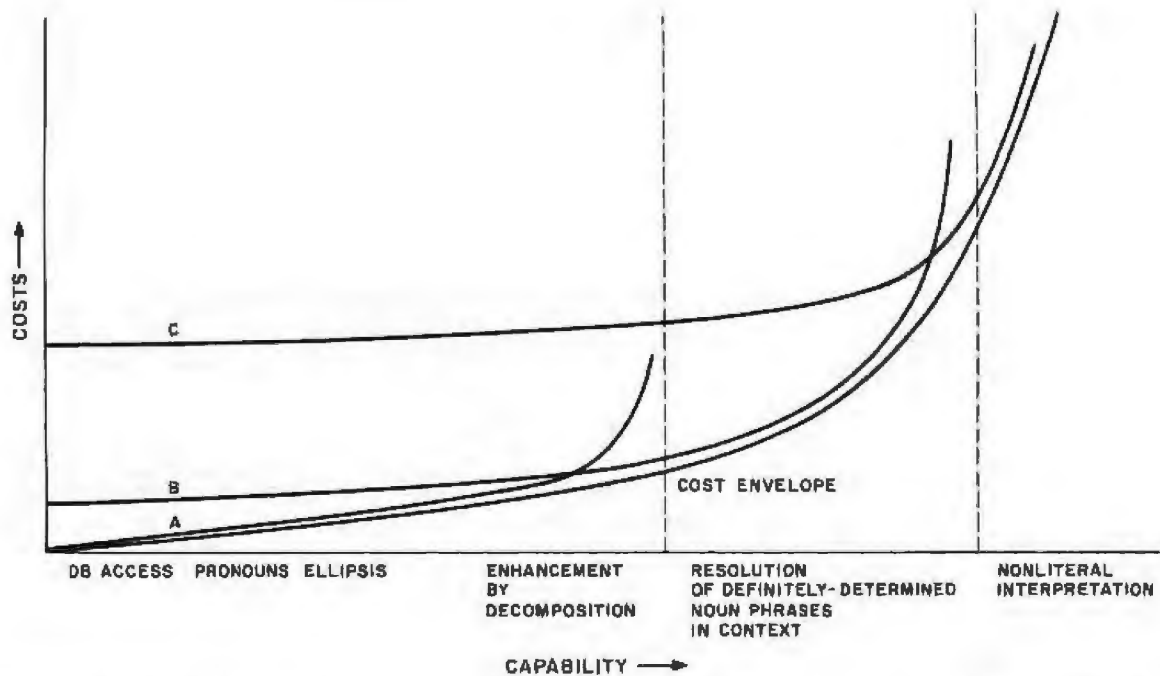

Figure 12: A graph of capability versus cost for different kinds of natural-language systems. Curve A refers to systems that do not use explicit world models. Curve B refers to systems that do use explicit world models. Curve C refers to systems that are built on a knowledge base including information about the goals and beliefs of other intelligent entities.

tempts to circumvent the problem by using various ad hoc methods become prohibitively expensive or downright impossible.

Systems on curve B are built with explicit world models that lack the ability to deal with intensional concepts, such as the goals and beliefs of others. Although these systems have greater capability potential than those on curve A, they entail considerable initial costs in the construction of machinery to support and exploit the models.

(Intensional concepts take into account the meaning, rather than just the truth values, of logical sentences. In standard logic, the truth value of a complex formula depends *only* on the truth of its subexpressions (eg: the truth of  $(P \text{ OR } Q)$  depends only on the truth of P and the truth of Q; no other properties of P and Q matter). The operator BELIEVE, however, is intensional because the truth of "A believes that P" depends on the meaning of P, not just its truth value. The problem is that many of the rules of standard logic, such as substitution of equals for equals, do not apply when intensional operators are involved. To use a classic example, since "the morning star" and "the evening star" refer to the same object, it must be the case that "the morning star is Venus" is true if, and only if, "the evening star is Venus" is true. However, it might be that "John believes the morning star is Venus" is true, but that "John believes the evening star is Venus" is false because, although the two embedded sentences possess the same truth value, they differ in meaning.)

Systems on curve C, if any existed, would be built upon a knowledge base supporting many intensional concepts. The initial costs of creating computational

machinery to support this level of sophistication appear to be quite high.

In today's computing environment, and in light of the current state of the art in natural-language processing, the only systems that perform robustly and efficiently are systems of type A. As mentioned in an earlier section on LADDER-like systems, there are a number of systems of this type, including one (INTELLECT, described in reference 10) available now as a commercial product.

A number of experimental systems of type B have been built, including SHRDLU, SAM, and TDUS. But these systems are currently of little practical value because they are relatively slow and use models that, while consuming considerable memory, cover pieces of the world too small to be of much more than academic interest.

Computational linguists and workers in related fields are devoting considerable attention to the problems of type-C systems. But currently, only bits and pieces of components for such systems are being constructed. For example, Moore (in reference 17) and Appelt (in reference 1) have devised formal methods for reasoning about the knowledge of others, and Perrault, Allen, and Cohen (in references 6 and 18) have devised systems that actually plan speech acts. But there is a huge gulf between the first experiments that demonstrate the feasibility of a principle and the creation of useful systems based on that principle. Our current state of understanding in natural-language processing is similar to that of the ancient makers of Chinese fireworks as compared with modern space research. In terms of achieving fluency in the field, our current experiments are merely fireworks poking a few holes in the darkness.

Nevertheless, even though the fluent use of natural

Circle 171 on inquiry card.

# Main/Frames from \$200

# Main/Frames from \$200

- 14 Basic Models Available
- Assembled & Tested
- Power Supply:
  - 8v@15A, ± 16v@3A
- 15 Slot Motherboard (connectors optional)
- Card cage & guides
- Fan, line cord, fuse, power & reset switches, EMI filter
- 8v@30A, ± 16v@10A option on some models



Rack mounted Main/Frame



8" Floppy Main/Frame (includes power for drives and main/frames)

Write or call for our brochure which includes our application note: 'Building Cheap Computers' **INTEGRAND**

8474 Ave. 296 • Visalia, CA 93277 • (209) 733-9288  
We accept BankAmericard/Visa and MasterCard

## TERMINALS FROM TRANSNET

PURCHASE PLAN • 12-24 MONTH FULL OWNERSHIP PLAN • 36 MONTH LEASE PLAN

DESCRIPTION	PURCHASE PRICE	PER MONTH		
		12 MOS	24 MOS	36 MOS
<b>DEC</b>				
LA36 DECwriter II	\$1,095	\$105	5	58
LA34 DECwriter IV	995	95	53	36
LA34 DECwriter IV Forms Ctr	1,095	105	58	40
LA120 DECwriter III KSR	2,295	220	122	83
LA120 DECwriter III RO	2,095	200	112	75
VT100 CRT DECscope	1,595	153	85	58
VT132 CRT DECscope	1,995	190	106	72
T1745 Portable Terminal	1,595	153	85	58
T1765 Bubble Memory Terminal	2,595	249	138	93
T1 insight 10 Terminal	945	90	53	34
T1785 Portable KSR 120 CPS	2,395	230	128	86
T1787 Portable KSR 120 CPS	2,845	273	152	102
T1810 RO Printer	1,895	182	102	69
T1820 KSR Printer	2,195	211	117	80
<b>TEXAS INSTRUMENTS</b>				
<b>DATAMEDIA</b>				
DT80 1 CRT Terminal	1,695	162	90	61
DT80 3 CRT Terminal	1,295	125	70	48
DT80 5L APL 15 CRT	2,295	220	122	83
<b>LEAR SIEGLER</b>				
ADM3A CRT Terminal	875	84	47	32
ADM31CRT Terminal	1,450	139	78	53
ADM42 CRT Terminal	2,195	211	117	79
<b>HAZELTINE</b>				
1420 CRT Terminal	945	91	51	34
1500 CRT Terminal	1,095	105	58	40
1552 CRT Terminal	1,295	125	70	48
<b>TELEVIDEO</b>				
920 CRT Terminal	895	86	48	32
950 CRT Terminal	1,075	103	57	39
<b>NEC SPINWRITER</b>				
Letter Quality, 55 15 RO	2,895	278	154	104
Letter Quality, 55 25 KSR	3,295	315	175	119
<b>QUME</b>				
Letter Quality KSR, 55 CPS	3,395	326	181	123
Letter Quality RO, 55 CPS	2,895	278	154	104
<b>CENTRONICS</b>				
730 Desk Top Printer	715	69	39	26
737 W P Desk Top Printer	895	86	48	32

FULL OWNERSHIP AFTER 12 OR 24 MONTHS • 10% PURCHASE OPTION AFTER 36 MONTHS

### MICROCOMPUTERS

APPLE • COMMODORE • HP85 • DEC LSI 11

### ACCESSORIES AND PERIPHERAL EQUIPMENT

ADJUSTABLE CHAIRS • MISCELLANEOUS • THERMAL PAPER • BINDING • NETWORK ADAPTERS • FLOPPY DISK DRIVES



**TRANSNET CORPORATION**

1945 ROUTE 22 • UNION, N. J. 07083 • (201) 688-7800  
TWX 710-985-5485

## Select a modem for your computer ... easy as ABC.

**CHOOSE A.** The Smart One™, Model AM232, with its own built in microcontroller. Auto Dials, Auto Answers, Auto Modes (originate/answer), "Direct Connect" for any computer with an RS232 interface ... \$299.00.

**CHOOSE B.** The Acoustic Modem, Model AM11/A, for the Apple\*. Comes complete with a powerful operating system. Supports 25 easy to use keyboard commands and operates interactively with your programs. No interface card required! ... \$179.00.

**CHOOSE C.** The "Direct Connect" Modem, Model AM11, for the Apple\*. Comes complete with a powerful operating system. Supports Auto Dial, Auto Answer, 27 easy to use keyboard commands and operates interactively with your programs. No interface card required! ... \$289.00.

Be a part of the information revolution. It's fun, exciting, informative, educational. Call or write your order today. COD's accepted.



**MICROMATE ELECTRONICS, INC.**

2094 Front Street • East Meadow, New York 11554 • Telephone 516.794.1072  
All "Direct Connect" modems are FCC certified. \*Registered trademark of Apple Computer, Inc.

language by machines may still be years away, it is important to realize that many practical applications of natural-language processing can be supported by systems of types A or B, both of which can be built now. Although the computational costs for natural-language processing will always be relatively high when compared with machine languages, the introduction of VLSI (very large-scale integration) technology promises to ease the attendant cost. Processes that were once performed only in the laboratory on research computers costing over one million dollars are becoming practical on personal computers. As a general trend, the expense of programming continues to rise while computer hardware continues to drop in price. For some applications, we may have already reached the point where it is cheaper to create systems that use subsets of English than it is to train people to use formal languages.

### Current Capabilities of Type-A Systems

To reach a better understanding of the types of natural-language processing possible on a cost-effective basis using technology available today, consider the dialogue of listing 8, which shows some of the more advanced types of processing available in the LADDER system.

Interaction 1 shows how LADDER deals with sentences it cannot understand. After trying to interpret the input as first a complete and then an elliptic sentence, LADDER

prints an error message indicating that the word "NY" is not known to it. The system also indicates that to complete the partial input, "How far is the Kennedy from the port of," it needs a construction matching its internal concept of a <PORT>. In interaction 2, the user seeks information about what LADDER would accept as a valid expression for a <PORT>. This is a very interesting question because it is not about the data in the data base, but rather a question about the language-processing system itself. LADDER can process questions about a variety of knowledge sources, including special routines that inspect its own internal information about the linguistic constructions it can accept. Using one of these special routines, LADDER produces a list of possible expressions for <PORT>, including the expression NEW YORK, which the user identifies as being what is meant by NY.

At this point, the user could rephrase the question by using NEW YORK in place of NY. But it is important for natural-language processing systems to accommodate the linguistic constructions their users are comfortable with—to accept inputs in the users' own terms, rather than force the users to master the system's terms. In particular, the learning of synonyms is relatively inexpensive computationally and quite helpful to users. In interaction 3, the user types a statement in English to tell LADDER that NY is a synonym for NEW YORK. Then, in interaction 4, the user asks that interaction 2 be tried again. This

**HOW TO GET THE SOFTWARE CATALOG WITH APPLE'S STAMP OF APPROVAL.**

We're picky at Apple. So you can imagine how picky we are about which programs we included in our catalog called Special Delivery Software. No, we don't develop these programs here at Apple. But they're so well done, so applicable and so easy to run that we give them our Special Delivery stamp of approval. They're useful and exciting programs - special programs you've never heard about before. But the only way you can get these programs is through our Special Delivery Software catalog. To get this catalog and all the catalog products, just visit your local authorized Apple dealer. Or grab your nearest telephone and dial. The phone call won't cost you a cent. And neither will the catalog: (800) 838-8400. In California (800) 678-1424.  apple computer inc.

**FIRST CLASS**

SAVE SALE SAVE SALE SAVE SALE SAVE

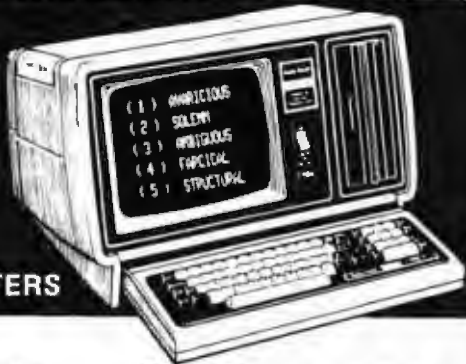

**TRS-80  
COMPUTERS**

Model II 64K 3360.00 freight included  
 Model III 32K 2150.00 freight included  
 Daisy Wheel Printer 1710.00 freight included

We can save you more on all the TRS-80 Computers, and we will! All items are brand new. We have the full line of TRS-80 computer products. Call collect (303) 945-2864 for price quotes.

**WE PAY ALL SHIPPING  
 NO TAXES ON OUT OF STATE SHIPMENTS**

**W-B SPORTING GOODS**

277 Grand Avenue  
 Glenwood Springs, Colorado 81601  
**CALL COLLECT (303) 945-2864**

SAVE SALE SAVE SALE SAVE SALE SAVE

**DISK DRIVE WOES?  
 PRINTER INTERACTION?  
 MEMORY LOSS?  
 ERRATIC OPERATION?**

**Don't  
 Blame The  
 Software!**



Power Line Spikes, Surges & Hash could be the culprit! Floppies, printers, memory & processor often interact! Our patented ISOLATORS eliminate equipment interaction AND curb damaging Power Line Spikes, Surges and Hash.

- ISOLATOR (ISO-1) 3 filter isolated 3-prong sockets; Integral Surge/Spike Suppression; 1875 W Maximum load, 1 KW load any socket ..... \$82.95
- ISOLATOR (ISO-2) 2 filter isolated 3-prong socket banks; (6 sockets total); Integral Spike/Surge Suppression; 1875 W Max load, 1 KW either bank ..... \$82.95
- SUPER ISOLATOR (ISO-3), similar to ISO-1 except double filtering & Suppression ..... \$94.95
- ISOLATOR (ISO-4), similar to ISO-1 except unit has 6 individually filtered sockets ..... \$108.95
- SUPER ISOLATOR (ISO-11) similar to ISO-2 except double filtering & Suppression ..... \$94.95
- CIRCUIT BREAKER, any model (add-CB) ..... Add \$ 8.00
- CKT BRKR/SWITCH/PILOT (-CBS) ..... Add \$16.00

AT YOUR DEALERS

Master-Card, Visa, American Express  
 Order Toll Free 1-800-225-4876  
 (except AK, HI, PR & Canada)

**Electronic Specialists, Inc.**

171 South Main Street, Natick, Mass. 01760  
 Technical & Non-800: 1-617-655-1532

**MODEL II**

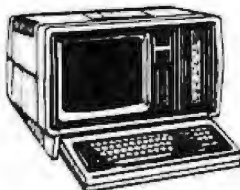

26-4002  
**64K 1 Drive  
 \$3440.00**

We carry the full line of TRS-80 Computers. All sold at Discount Prices.

**DISCOUNT**

**TRS-80®**

**BUY  
 DIRECT**

**COMPUTER SPECIALISTS**

**CALL US...**

WRITE US FOR A  
**FREE CATALOG**

**SAVE MONEY**

**1-800-841-0860 Toll Free Order Entry**

**MODEL III**



26-1061 4K I.....\$629.00  
 26-1062 16K III.....865.00  
 26-1063 32K III  
 W/2 Drives, R5232.....2225.00

**MICRO MANAGEMENT SYSTEMS, INC.**

No Taxes on Out Of  
 State Shipments

Immediate Shipment  
 From Stock on Most Items

**DOWNTOWN PLAZA SHOPPING CENTER**

DEPT. # 1  
 115 C. SECOND AVE. S.W.  
 CAIRO, GEORGIA 31728

**(912) 377-7120 Ga. Phone No. & Export**  
TRS-80 is a registered trademark of the Tandy Corp.

A Copy of the Radio Shack 90 day Limited Warranty can be obtained Free upon specific written request to the Electronics Dept. of our Cairo, Georgia Retail Store which is an Authorized Sales Center for Radio Shack Merchandise. Store #A301

# FOR ONLY \$129.95 Learn Computing From The Ground Up

Build a Computer kit that grows with you, and can expand to 64k RAM, Microsoft BASIC, Text Editor/Assembler, Word Processor, Floppy Disks and more.

## EXPLORER/85

Here's the low cost way to learn the fundamentals of computing. The all-important basics you'll need more and more as you advance in computer skills. For just \$129.95 you get the advanced design Explorer/85 motherboard with all the features you need to learn how to write and use programs. And it can grow into a system that is a match for any personal computer on the market. Look at these features: ROMS Control Processing Unit, the microprocessor "heart" of the Explorer/85 (from the millions who will buy and use the 8080/8085 chip you know); Four 8-bit plus one 6-bit input/output ports from which you can input and output programs, as well as control exterior switches, relays, lights, etc.; a cassette interface that lets you store and reload programs you've learned to write; deluxe 2,000 byte operating system/monitor makes it easy to learn computing in several important ways: it allows simpler, faster writing and entering of programs; it permits access by you to all parts of the system so you can check on the status of any point in the program; it allows tracing each program step by step, with provision for displaying all the contents of the CPU (registers, flags, etc.) and it does much more!

You get all this in the starting level (Level A) of the Explorer/85 for only \$129.95. Incredible! To use just plug in your 80VC power supply and terminal or keyboard/display — if you don't have them see our special offers below.

- Level A computer kit (Terminal Version) \$129.95 plus \$3 P&H
- Level A kit (Hex Keypad/Display Version) \$129.95 plus \$3 P&H

LEVEL B — This "building block" connects the motherboard into a two-slot 5100 bus (industry standard) computer. Now you can plug in any of the hundreds of 5100 cards available.

- Level B kit \$49.95 plus \$2 P&H
- 5100 bus connectors (two required) \$4.95 each, postpaid

LEVEL C — Add still more computing power, this "building block" mounts directly on the motherboard and expands the 5100 bus to two slots.

- Level C kit \$39.95 plus \$2 P&H
- 5100 bus connectors (five required) \$4.95 each, postpaid

LEVEL D — When you reach the point in learning that requires more memory, we offer two choices: either add 4k of a memory directly on the motherboard, or add 16k to 64k of memory by means of a single 5100 card, our famous "JAWS".

- Level D kit (CHECK ONE) \$10.00 on board, \$49.95 plus \$2 P&H; 16k 5100 "JAWS" \$149.95 plus \$2 P&H; 32k 5100 "JAWS" \$189.95 plus \$2 P&H; 48k 5100 "JAWS" \$249.95 plus \$3 P&H; 64k 5100 "JAWS" \$299.95 plus \$2 P&H

LEVEL E — An important "building block" it activates the ROM/EPROM space on the motherboard. Now just plug in one of our Microsoft BASIC or your own custom programs.

- Level E kit \$9.95 plus \$2 P&H

Microsoft BASIC — It's the language that allows you to talk English to your computer. It is available three ways:
 

- As cassette version of Microsoft BASIC (requires Level B and 12k of RAM minimum; we suggest a 16k 5100 "JAWS" — see above) \$69.95 postpaid
- As ROM version of Microsoft BASIC (requires Level B and a Level E and 4k RAM; you plug into your Level E socket. We suggest either the 4k Level D RAM expansion or a 16k 5100 "JAWS") \$99.95 plus \$2 P&H
- Disk version of Microsoft BASIC (requires Level B and 12k of RAM, floppy disk controller, 8" floppy disk drive) \$129.95 postpaid

TEXT EDITOR/ASSEMBLER — The editor/assembler is a software tool (a program) designed to simplify the task of writing programs. As your programs become longer and more complex, the assembler can save you many hours of programming time. This software includes an editor program to edit the programs you write, make changes, and save the programs on cassette. The system also performs the clerical task of translating symbolic code into the computer-readable object code. The editor/assembler program is available either in cassette or a ROM version.

- Editor/Assembler (Cassette version, requires Level B and 16k (min.) of RAM — we suggest 16k "JAWS" — see above) \$49.95 plus \$2 P&H
- Editor/Assembler (ROM version, supplied on a 5100 card, requires Level B and 4k RAM (min.) — we suggest either Level D or 16k "JAWS") \$99.95 plus \$2 P&H

FLOPPY DISK — A remarkable "building block" Add our 8" floppy disk when you need faster operation, more convenient program storage, perhaps a business application, and access to the literally thousands of programs and program languages available today. You simply plug them into your Explorer/85 disk system — it accepts all IBM-formatted CP/M programs.

- 8" Floppy Disk Drive \$199.95 plus \$12 P&H
- Floppy Controller Card \$199.95 plus \$2 P&H
- Disk Drive Cabinet & Power Supply \$99.95 plus \$3 P&H
- Drive Cables (set up for two drives) \$29.95 plus \$3 P&H
- CP/M 2.2 Disk Operating System, includes Text Editor/Assembler, dynamic debugger, and other features that give your Explorer/85 access to thousands of existing CP/M based programs \$19.95 postpaid

NEED A POWER SUPPLY? Consider our AP-1. It can supply all the power you need for a fully expanded Explorer/85 (note: disk drives have their own power supply) cabinet (see below).

- AP-1 Power Supply kit (80V @ 5 amps) in deluxe steel cabinet \$39.95 plus \$2 P&H

NEED A TERMINAL? We offer you choices the least expensive one is our Hex Keypad/Display kit that displays the information on a calculator-type screen. The other choice is our ASCII Keyboard/Computer Terminal kit that can be used with other

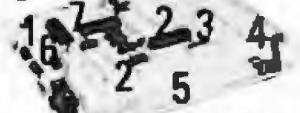

- 1 Plug in Motorola's (then Intel) 8080/8085 Microprocessor
- 2 Add Level B (to convert) to 8080/8085
- 3 Add 4k RAM
- 4 Plug in Level E (to activate ROM/EPROM)
- 5 Add your own custom or Microsoft BASIC

8" CRT monitor for a TV set (if you have an RF modulator)

- Hex Keypad/Display kit \$99.95 plus \$2 P&H
- ASCII Keyboard/Computer Terminal kit featuring a full 128 character set, 64k case, full cursor control, 75 ohm video output, convertible to manual output, selectable baud rate, RS-232-C, or 40 pin DTE, 32 or 64 character by 16 line format \$149.95 plus \$3 P&H

- Steel Cabinet for ASCII Keyboard/Terminal \$19.95 plus \$2 P&H
- RF Modulator kit (allows you to use your TV set as a monitor) \$9.95 postpaid
- 12" Video Monitor (1080 lines bandwidth) \$129.95 plus \$2 P&H
- Deluxe 80C Computer for the Explorer/85 \$49.95 plus \$2 P&H
- Fan for cabinet \$15.00 plus \$2 P&H

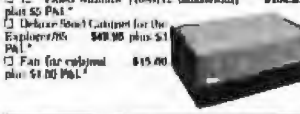

### ORDER A SPECIAL-PRICE EXPLORER/85 PAK — THERE'S ONE FOR EVERY NEED.

- Beginner Pak (Save \$24.00) — You get Level A (Terminal Version) with Mouse Source Listing (\$25 value, Reg. \$109.95) SPECIAL \$109.95 plus \$4 P&H
- Experiment Pak (Save \$53.40) — You get Level A Hex Keypad/Display Version with Hex Keypad/Display (deluxe 8080 Hex Manual, Level A Hex Monitor Source Listing and AP-1 5-amp power supply) (Reg. \$279.95) SPECIAL \$226.55 plus \$6 P&H
- Special Microsoft BASIC Pak (Save \$103.00) — You get Levels A, C (Terminal Version) & D (4k RAM), E, Hex Microsoft in ROM, Intel Hex ROM Manual, Level A Hex Monitor Source Listing and AP-1 5-amp power supply (Reg. \$439.95) SPECIAL \$336.95 plus \$7 P&H

ADD A ROM-VERSION TEXT EDITOR/ASSEMBLER (Requires Levels B and D or 5100 Memory) ... \$99.95 plus \$2 P&H

Startr 8" Disk System — Includes Level A, B Floppy disk controller, one 8" disk drive, two 5100 cables, two 5100 connectors, full and spare power supplies, cabinet and hardware. (Reg. \$495.00) SPECIAL \$399.95 plus \$13 P&H

32k Startr System, \$1099.95 plus \$13 P&H

48k Startr System, \$1299.95 plus \$13 P&H

64k Startr System, \$1499.95 plus \$13 P&H

Add to any of above Explorer/85 cabinets, AP-1 5-amp power supply, Level C with two 5100 connectors, disk drive cabinet and power supply, two 5100 connectors for connecting your printer and terminal (Reg. \$225.95) SPECIAL \$199.95 plus \$12 P&H

Complete 8k System, Wired & Traced \$1499.95 plus \$20 P&H

Special Complete Business Software Pak (Save \$625.00) — Includes CP/M 2.2 Microsoft BASIC, General Ledger, Accounts Receivable, Accounts Payable, Payroll Package (Reg. \$1223) SPECIAL \$600.95 postpaid

\*P&H includes for postage & insurance. For Canadian orders, double this amount.

Continental Credit Card Buyers Outside Continental:

**TO ORDER**  
Call Toll Free: 800-243-7428

To Order From Connecticut, or For Technical Assistance, call (203) 354-9379

★ (Clip and mail entire ad) ★

SEND ME THE ITEMS CHECKED ABOVE

Title (Lastname) (Cover, Residents and states only):

Full Name:

Address:

City:

State:

Zip:

Signature:

Print Name:

Address:

City:

State:

Zip:

Listing 8: Another actual conversation with the LADDER system.

1—How far is the Kennedy from the port of NY?  
Trying Ellipsis: ELLIPSIS HAS FAILED  
The parser does not expect the word "NY" to follow "HOW FAR IS THE KENNEDY FROM THE PORT OF"

Options for next word of symbol are: <PORT>  
2—What is a <PORT>?  
PARSED!

"<PORT>" may be any sequence of words following one of the patterns:

<PORT> => CAPE TOWN  
=> NEW YORK  
=> NEW ORLEANS  
[etc.]

3—Define NY like New York.  
PARSED!

4—redo 2  
[i.e., How far is the Kennedy from the port of NY?]

PARSED!  
(GCDIST 1974)

5—Q1 Kennedy  
[System gives syntax error.]

6—Let "Q1 Kennedy" be a paraphrase of "what is the position, fuel status and homeport of the Kennedy"

PARSED!  
<S> => Q1 <SHIP>

7—q1 Kennedy  
PARSED!  
(POSITION 4000N0600E PCFUEL 90 PORT MAYPORT)

8—American subs in the North Atlantic  
Trying Ellipsis: Q1 AMERICAN SUBS IN THE NORTH ATLANTIC

SHIP	POSITION	PCFUEL	PORT
STURGEON	3700N7600W	100	NORFOLK
WHALE	3750N7700W	100	NORFOLK
ASPRO	3300N3000W	100	NORFOLK

[etc.]

9—Let "show the forecastatus of the Kitty Hawk" be like "Display the employment and readiness condition of the Kitty Hawk. Print her destination. List ships in her organization."

PARSED!  
[New production added to system.]

10—show the forecastatus of Kennedy  
PARSED!  
[questions defined in 9 for Kitty Hawk are answered for the Kennedy.]

11—Define "Kennedy no nagasa wa ikura desuka" like "what is the length of the Kennedy."  
PARSED!

[Production added to system.]

12—Fox no nagasa wa ikura desuka?  
PARSED!  
LEN = 547

time, using the newly defined synonym, LADDER successfully interprets the question and produces the answer that the great-circle distance (labeled as GCDIST) from the Kennedy to New York is 1974 miles.

It is worth noting that LADDER must do more to answer queries 2 and 4 than merely retrieve information from a data base. Only the positions of ports and ships are stored in the data base—not the distances between them. Thus, LADDER interfaces not only with the data base, but also with programs that make calculations based on data-base information. Some of these are not trivial. For example, to find how long it would take a ship

NETRONICS Research & Development Ltd.  
333 Litchfield Road, New Milford, CT 06776

## Complete AIM 65 Expansion

For complete AIM 65 expansion, Forethought Products brings you the AIM-Mate Series, quality expansion products with price, performance and versatility that puts them in a class of their own.

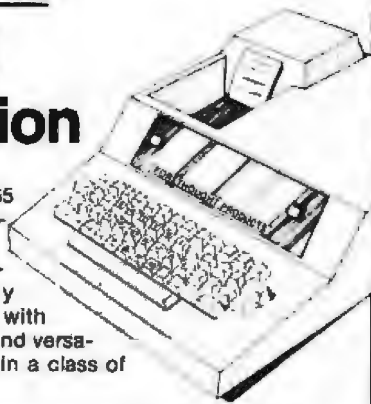

AIM-Mate Series expansion, including RAM (to 48K), PROM, I/O, video and floppy disk interface, STD BUS interface, parity protection and more, lets you configure the kind of system you need.

The compact AIM-Mate case puts it all together in a sturdy, portable, desk top unit.

Write today for complete details on the AIM-Mate System- AIM 65 expansion products for the professional.

**FORETHOUGHT  
PRODUCTS**

87070 Dukhobar Road, Eugene, Oregon 97402 (503) 485-8575

# NEVADA COBOL



**\$149<sup>95</sup>**

DISKETTE AND MANUAL

• Uses CP/M or MP/M operating system to work with TRS-80, Apple's with softcard, North Star, Superbrain, Micropolis, and many other microcomputers. Needs a minimum of 16K of RAM. Uses single density 8" or 5 1/4" diskette.



**ELLIS COMPUTING**  
SOFTWARE TECHNOLOGY

600 41st Avenue  
San Francisco, CA 94121

CP/M, MP/M and TRS-80 are registered TM's of Digital Research and Tandy Corporation.

Edition II of Nevada COBOL, a subset of ANSI-74, features:

- Copy statement for library handling
- CALL...USING...CANCEL.
- PERFORM...THRU...TIMES...UNTIL... Paragraph or section names
- IF...NEXT SENTENCE...ELSE...NEXT SENTENCE AND/OR <=> NOT.
- GO TO...DEPENDING ON.
- Unique easily understood diagnostic error messages.
- Interactive ACCEPT/DISPLAY ..
- RELATIVE (random) access files.
- Sequential files both fixed and variable length.
- DISPLAY, 16-bit binary or packed decimal (COMP-3) data types with up to 18-digit accuracy
- INSPECT...TALLYING... REPLACING.
- ADD, SUBTRACT, MULTIPLY, DIVIDE, GIVING, ROUNDED, ON SIZE ERROR.
- Generates optimized 8080 machine language at up to 500 statements per minute.

WE WELCOME C.O.D.'s



**(415) 751-1522.**

## MICROSTAT

Microstat is an advanced statistics package designed for use in research, education and industry. Microstat is a file-oriented statistics package with a Data Management Subsystem (DMS) that creates the data files plus the ability to: edit, list, destroy, delete cases, augment, sort, rank-order, lag, move, merge and transform the data. The data transforms include: add, subtract, multiply, divide, reciprocal, log, natural log and antilog, exponential, linear transformations plus adding any number of variables to create new variables.

Once the file is created, it can be used to produce: Descriptive statistics, Hypothesis tests (mean and proportion), ANOVA (one-way, two-way and random blocks), Scatterplots, Frequency distributions, Correlation analysis, Simple and Multiple regression, Time Series, Nonparametric tests (11 of them), Crosstabs and Chi-square, Factorials, Permutations, Combinations, and 8 Probability distributions.

The price of Microstat is \$250.00 and the user's manual is available for \$20.00 and includes sample printouts. Since the printouts reference standard statistics textbooks and journal articles, you can compare the accuracy of Microstat to results produced on much larger systems. No other statistics package seems to have the confidence to do that . . . at any price.

Microstat is available for the North Star DOS and Basic, Microsoft's Basic-80™ (5.03 or later) and Compiler Systems' CBasic2™. Please specify 8" SD (soft-sector) or North Star 5 1/4" disk when ordering.

**ECOSOFT**  
P.O. Box 68602  
Indianapolis, IN 46268  
(317) 283-8883



## INTERCHANGE

If you use the CP/M™ operating system, life just got a whole lot easier for you. Interchange is a Z-80™ assembly language program that gives you all of the features that PIP doesn't, plus several unique features. Some of the features of Interchange include:

DIR, in the usual fashion, plus listing all files *excluding* those with a specified character. Read/write status is also given.

ERA, as usual plus *exclusive* erases. In addition, a "Q" switch can be used to query on each erase, a "W" allows erases of R/O files without query (normally you are queried), and an "R" switch if system files are to be included.

LIST permits printer listings with formatting controlled by TAB, WIDTH, LINES and WRAP. If you are using the QT Systems Clock Board, listings include the date and time.

COPY including *exclusive* copies and the optional "Q", "W" and "R" switches plus an "E" switch that queries if the file already exists. It also allows for changing disks in the middle of a copy if either the disk or directory become full. It automatically verifies copies.

STAT, with ambiguous, unambiguous and *exclusive* listings. It produces an alphabetized listing and includes each file length, total directory entries and space used and unused.

Other commands include RENAME (including ambiguous), HELP, START, END, CLEAR, RESET, DATE, TIME, TAB, WIDTH, LINES, WRAP, QT, SETIT and TYPE. Once you've used Interchange, we doubt that you'll ever use PIP again. The price of Interchange is \$59.95 and the manual is available for \$10.00. Orders must be accompanied with your CP/M serial number. Interchange is recommended for a 32K or larger system and will not run with an 8080 CPU. At the present time, only User 0 is supported.

CBasic2 is a registered trademark of Compiler Systems.  
CP/M is a registered trademark of Digital Research.

to reach a given location, LADDER cannot simply divide the great-circle distance by the cruising speed of the ship, because the shortest path between two points on earth often crosses land masses. So LADDER computes routes that avoid land masses, which requires a knowledge of world geography.

Interactions 4 through 8 illustrate LADDER's ability to learn new syntactic constructions, as well as synonyms. Suppose a user has certain questions to ask repeatedly about different ships. Natural language is ideal for one-time questions, but a shorthand version would be useful for those used repeatedly. If, as in interaction 5, the user asks a shorthand question such as "Q1 Kennedy?", a syntax error will occur. However, the user can easily tell LADDER, by giving an example in English, how a new shorthand is to be interpreted. This is done in interaction 6. In response to this request, LADDER creates a new production rule that matches inputs that start with "Q1" and end with any expression designating a <SHIP>.

In interaction 7, this newly defined construction is used to ask for information about the *Kennedy*. In interaction 8, to obtain the same information for all the American subs in the North Atlantic, just "American subs in the North Atlantic" need be typed. LADDER's elliptical-processing routine, operating on the newly defined construction just as on the standard ones, fills in the rest. Because there are multiple answers to the question, a table is produced to display the data retrieved.

In interaction 9, the user tells LADDER to make a certain input sequence equivalent to not just one but a whole series of questions. It is as if the user were writing small programs in English, using English pronouns for formal parameters. In interaction 10, the new construction is used, but with a different ship than the one used to define the construction.

As an extreme example of this ability to accommodate the user-defined constructions, in interaction 11, the user tells LADDER a Japanese paraphrase of the English question, "What is the length of the *Kennedy*?" In interaction 12, the user poses this question about the *Fox*, rather than the *Kennedy*, entirely in Japanese.

The language-processing capabilities demonstrated in listings 3 and 8, while far from those possessed by a fluent

user of natural language, seem quite adequate for a wide range of practical applications. This technology, using the language INTERLISP, is available today in a large computing environment. It requires approximately 500 milliseconds to process a query—far less than the time needed to retrieve information from a large data base. With proven algorithms and data structures in hand, it is now essentially an engineering task to implement this technology on smaller machines in widely available programming languages. Such engineering will require a considerable effort, but the path of development appears to be clear of major theoretical obstacles.

One of the practical problems currently limiting the use of natural-language processing systems for accessing data bases is the lack of trained people and good support tools for creating the knowledge structures needed for each new data base. In laboratory systems, researchers have manually compiled bodies of knowledge such as information about the vocabulary employed in a particular application or about the logical structure of particular data bases. Work has already begun on new methodologies to automate this task or even make it entirely unnecessary (see references 9, 15, and 25).

## Conclusion

Considerably more research in computational linguistics will be required before mechanical devices can be created that are fluent in the use of natural language. However, current research efforts are shedding new light on the types of knowledge required for communication in human languages, as well as on prospective mechanisms for encoding and applying that knowledge in computers. These efforts are showing that language use is not an isolated intellectual activity; it also involves our basic facilities for commonsense reasoning and planning. A computer system fluent in a natural language will be a genuinely intelligent machine.

Although the fluent use of natural language by machines remains a long-term goal, a number of practical mechanisms have been developed to deal with significant fragments of language in specialized application areas. For many applications, an ability to communicate within such fragments is both sufficient for the task at hand and

# McGraw-Hill Bookstore

Please print clearly.

## An End-User's Guide to Data Base

*Written expressly for those with little or no knowledge of computers or software*

Success of data base operations is dependent on the end-user—and here are the principles that should be understood by all who will be affected! 144 pp. Prentice-Hall. \$21.95.

James Martin — The Most Referred-to Author of Computer Books

*Other James Martin Books on Data Base Systems:*  
Principles of Data-Base Management

Computer Data-Base Organization, 2nd Ed.

Security, Accuracy, and Privacy in Computer Systems

Design of Man-Computer Dialogues

Managing the Data-Base Environment

McGraw-Hill Bookstore BY9  
1221 Avenue of the Americas  
N.Y., N.Y. 10020

Please send me \_\_\_\_\_ copies of  
**An End-User's Guide to Data Base** by  
James Martin at \$21.95.

MasterCard \_\_\_\_\_ Visa \_\_\_\_\_ AmerExp \_\_\_\_\_

Account No. \_\_\_\_\_ Expires \_\_\_\_\_

Name \_\_\_\_\_

Address \_\_\_\_\_

City \_\_\_\_\_ State \_\_\_\_\_ Zip \_\_\_\_\_

Add sales tax plus \$2.50 postage, handling



# NEW TARBELL S-100 CPU/IO BOARD

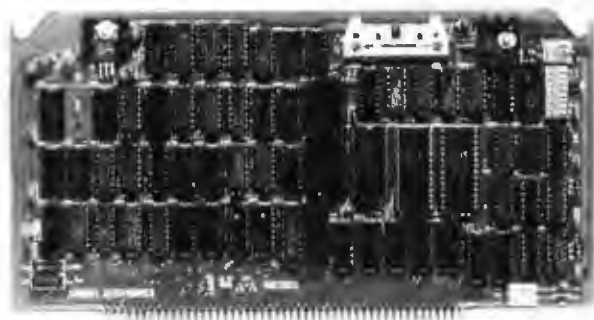

- Z-80™ will run at 2 or 4 Mhz
- 2 RS-232 Serial I/O ports
- Powerful Memory Management
- Programmable Timer
- Full masked priority interrupts
- Has everything needed for MP/M™
- 6 month full warranty

Z-80 is a trademark of Zilog Inc.  
MP/M is a trademark of Digital Research



950 Dovlen Place, Suite B  
Carson, CA 90746  
Phone (213) 538-4251



## Multi-Application Processing System

WORD PROCESSING



ORDER PROCESSING



ACCOUNTING & MORE!





MAPS  
**CT-80**  
CENTRAL PROCESSOR

### THREE COMPUTERS IN ONE!

THE DIGIAC MAPS® CT-80 SYSTEM

**Multi-User, Multi-Tasking, Cost Effective.**

● 3 business systems can run concurrently - that's 3 times the overall system productivity! ● Time share word processing, accounting, order processing, inventory, forms processing, billing & more! ● 3 workstations can share data base - preparations can be done by several operators concurrently! ● All workstations can share common peripherals. ● Uses DIGIAC MAPS-80 operating system. (Digital Research MP/M) ● High level language processors including Fortran - Basic - Pascal - Cobol. ● Complete Turn-key system for ease of operation & learning!



For Additional Information Contact:  
**MAPS**, Commercial Products Division of  
**DIGIAC CORPORATION**  
 175 Engineers Road, Smithtown, N.Y. 11787  
 Phone: (516) 873-8600  
 MP/M is a trademark of Digital Research Corp.

# GRAPHIC SOFTWARE FOR MICROCOMPUTERS

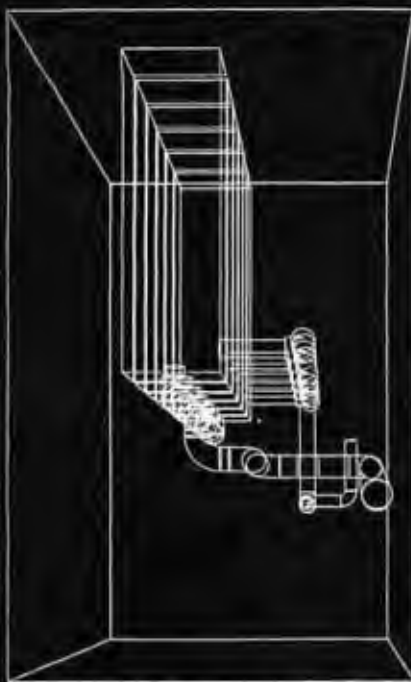

by B.J. Korites, PhD - a self-teaching guide that will show you how to write graphics software on your microcomputer. Theory and program listings presented side by side. Contains 61 programs for 2 and 3 dimensional graphics, isometric and perspective transformations, scaling, stretching, clipping, intersections, shading, tablet software, hidden line removal, dynamic simulation, applications to engineering, science and business. Practice problems for classroom use. Covers elementary to advanced concepts. Perfect for professionals, students and software developers. All programs in BASIC, written on the Apple II Plus 48K but convertible to other systems.

Book with program listings - \$19.95 Disk of programs - \$18.95 Add \$2 per item shipping in US and Canada. \$12 elsewhere Add \$5 for UPS, visa/mastercharge accepted. Call (517)934-0445 for faster delivery.

**KERN PUBLICATIONS • PO Box 1029A • Duxbury, MA 02332 (617)934-0445**

## How to Get More Information About Natural-Language Processing

The Association for Computational Linguistics is a professional society for people interested in this subject; it publishes the American Journal of Computational Linguistics. For information, contact Donald Walker, SRI International, Menlo Park CA 94025. Readers are also referred to the American Association for Artificial Intelligence (contact Bruce Buchanan, Computer Science Department, Stanford University, Stanford CA 94305), and the Cognitive Science Society, which publishes the journal Cognitive Science (contact Donald Norman, Center for Human Information Processing, C-009, University of California at San Diego, La Jolla CA 92093).

clearly preferable to forcing users to learn machine-oriented languages. In coming years, we expect to see natural-language processing employed in an increasing number of practical applications, enabling more and more people to interact directly and effectively with computer systems. ■

## Acknowledgments

We wish to express our thanks to SRI International and Machine Intelligence Corporation for supporting the preparation of this article, and acknowledge the helpful critiques of early drafts that were provided by Barbara Grosz, Norman Haas, Robert Moore, Jane Robinson, and Donald Walker. Listing 5 and figures 3 through 5 were adapted from Understanding Natural Language by Terry Winograd (Academic Press, 1972) with permission of the publisher and author

## References

1. Appelt, D E. "A Planner for Reasoning about Knowledge and Action." *Proceedings of the First Annual National Conference on Artificial Intelligence*, August 1980, pages 235 through 239.
2. Biermann, A B. "Approaches to Automatic Programming." *Advances in Computers*, volume 15, 1976, pages 1 through 63.
3. Bruce, B. "Pragmatics In Speech Understanding." *Advance Papers of the Fourth International Joint Conference on Artificial Intelligence*, 1975, pages 461 through 467.
4. Burton, R R. "Semantic Grammar: An Engineering Technique for Constructing Natural Language Understanding Systems." BBN Report 3453, Bolt, Beranek, and Newman Inc, Cambridge MA, December 1976.
5. Carbonell, J. "Politics." *Inside Computer Understanding* (reference 23), pages 259 through 317.
6. Cohen, P R and C R Perrault. "Elements of a Plan Based Theory of Speech Acts." *Cognitive Science*, volume 3, number 3, 1979, pages 177 through 212.
7. Grosz, B J. "Utterance and Objective: Issues in Natural Language Communication." *Sixth International Joint Conference on Artificial Intelligence*, 1979, pages 1067 through 1076; also in *AI Magazine*, volume 1, number 1, 1980, pages 11 through 20.
8. Grosz, B J. "Focusing and Description in Natural Language Dialogues." *Elements of Discourse Understanding: Proceedings of a Workshop on Computational Aspects of Linguistic Structure and Discourse Setting*, A K Joshi, I A Sag, and B L Webber (editors), Cambridge: Cambridge University Press, 1981.
9. Haas, N and G G Hendrix. "An Approach to Acquiring and Applying Knowledge." *Proceedings of the First Annual National Conference on Artificial Intelligence*, August 1980, pages 235 through 239.
10. Harris, L R. "User Oriented Data Base Query with the ROBOT Natural Language Query System." *Proceedings of the Third International Conference on Very Large Data Bases*, October 1977.
11. Hendrix, G G. "The LIFER Manual: A Guide to Building Practical Natural Language Interfaces." AI Center Technical Note 138, SRI International, Menlo Park CA, February 1977.
12. Hendrix, G G, E D Sacerdoli, D Sagalowicz, and J Slocum. "Developing a Natural Language Interface to Complex Data." *Association for Computing Machinery Transactions on Database Systems*, volume 3, number 2, June 1978.
13. Hobbs, J R and D A Evans. "Conversation as Planned Behavior." AI Center Technical Note 203, SRI International, Menlo Park CA, 1979.
14. Kaplan, S J. "Cooperative Responses from a Portable Natural Language Data Base Query System." PhD Dissertation, University of Pennsylvania, Philadelphia, 1979.
15. Lewis, W H. "TED: A Transportable English Datamanager." *Proceedings of the Principal Investigators' Meeting of the ACCAT Program*, October 1979.
16. Mann, W. "Toward a Speech Act Theory for Natural Language Processing." IS/RR-79-75, USC/Information Sciences Institute, Marina del Rey CA, 1980.
17. Moore, R C. "Reasoning About Knowledge and Action." AI Center Technical Note 191, SRI International, Menlo Park CA, October 1980.
18. Perrault, C R and J F Allen. "A Plan-Based Analysis of Indirect Speech Acts." *American Journal of Computational Linguistics*, volume 6, number 3-4, July-December 1980, pages 167 through 182.
19. Robinson, A E, et al. "Interpreting Natural-Language Utterances In Dialog About Tasks." AI Center Technical Note 210, SRI International, Menlo Park CA, 1980.
20. Robinson, J J. "DIAGRAM: A Grammar for Dialogues." AI Center Technical Note 205, SRI International, Menlo Park CA, February 1980.
21. Sacerdoli, E D. *A Structure for Plans and Behavior*. New York: Elsevier North-Holland, 1977.
22. Schank, R and R Abelson *Scripts, Plans, Goals, and Understanding*. Hillsdale NJ: Lawrence Erlbaum, 1977.
23. Schank, R and C Riesbeck. *Inside Computer Understanding*. Hillsdale NJ: Lawrence Erlbaum, 1981.
24. Templeton, M. "EUFID: A Friendly and Flexible Frontend for Data Management Systems." *Proceedings of the 1979 National Conference of the Association for Computational Linguistics*, August 1979.
25. Thompson, F B and B H Thompson. "Practical Natural Language Processing: The REL System as Prototype." *Advances in Computers* 13, M Rubinoff and M C Yovits (editors), New York: Academic Press, 1975.
26. Waltz, D. "Natural Language Access to a Large Data Base: An Engineering Approach." *Proceedings of the Fourth International Joint Conference on Artificial Intelligence*, September 1975, pages 868 through 872.
27. Wilensky, R. "Meta-Planning." *Proceedings of the First Annual National Conference on Artificial Intelligence*, 1980, pages 334 through 336.
28. Wilks, Y. "Natural Language Understanding Systems within the AI Paradigm: A Survey and Some Comparisons." *Linguistic Structures Processing*, A Zampolli (editor), Amsterdam: North-Holland, 1977, pages 341 through 398.
29. Winograd, T. *Understanding Natural Language*. New York: Academic Press, 1972.
30. Woods, W A. "Transition Network Grammars for Natural Language Analysis." *Communications of the Association for Computing Machinery*, volume 13, number 10, October 1970, pages 591 through 606.
31. Woods, W A, R M Kaplan, and B Nash-Webber. "The Lunar Sciences Natural Language Information System." BBN Report 2378, Bolt, Beranek, and Newman Inc, Cambridge MA, 1972.

DIP-84G

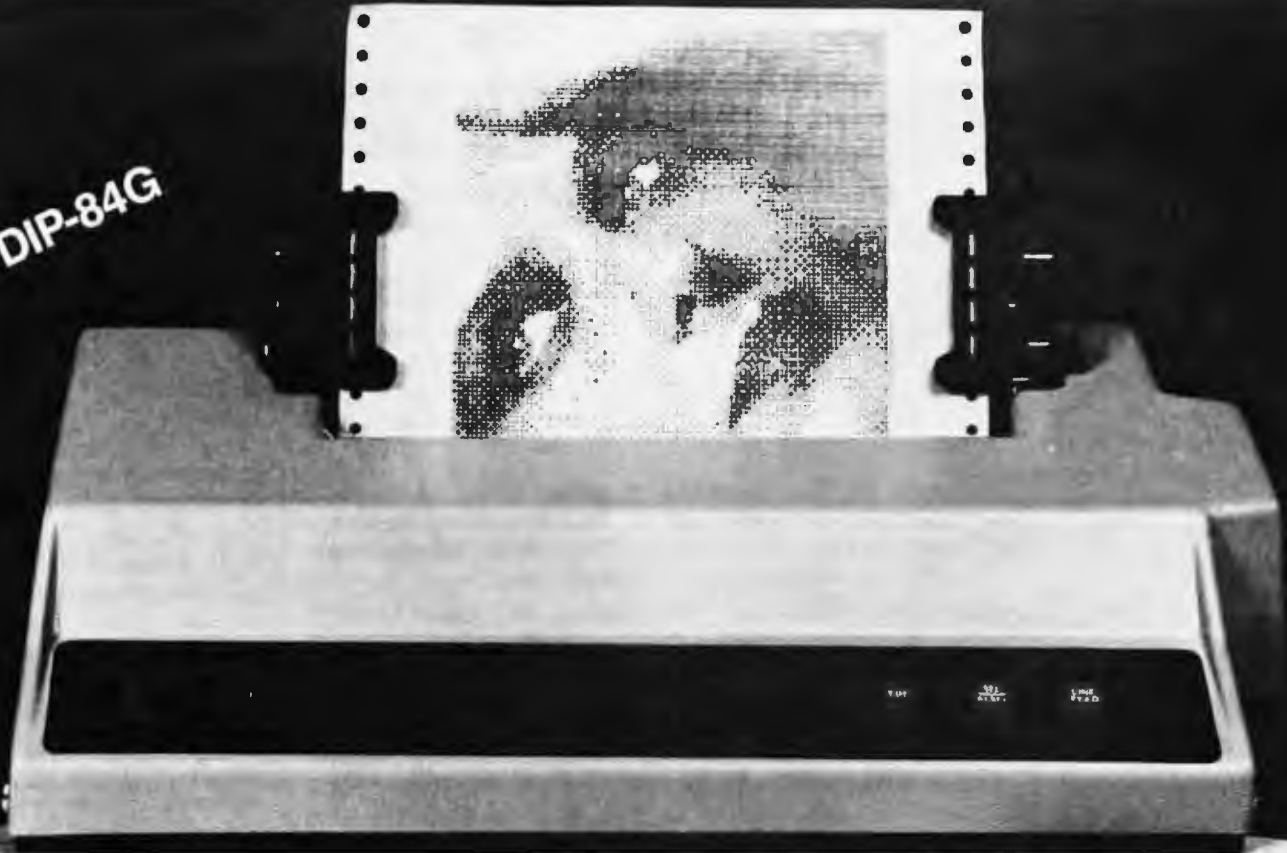

## Want a Better Printer @ Lower Cost? Compare DIP with the other best seller.

	<u>DIP-84G</u>	<u>XX-80 F/T</u>
Print Speed	100CPS	80CPS
Head Life	100x10 <sup>6</sup>	50x10 <sup>6</sup>
Character Sizes	40,48,66,80,96,132	40,66,80,132
RS232C	STD	\$ 89.00
Dot Graphic	STD	\$ 90.00
Friction Feed	STD	\$100.00
Matrix	7x7/11x7	9x9
Paper Handling	Rear&Bottom	Rear
Short Line Logic	STD	STD
Continuous Input	STD	None
Buffer Size	10 Lines	1 Line
2K Buffer	\$ 30.00	?
Ribbon Life	5 Million	3 Million
Price Basic	\$795.00	\$645.00
Friction	STD	\$100.00
RS232C	STD	\$ 89.00
Dot Graphic	STD	\$ 95.00
	<u>\$795.00</u>	<u>\$929.00</u>

In addition, we offer

DIP-81     \$499.00  
DIP-82     \$695.00  
DIP-85     \$895.00

Low Cost Friction Feed  
11x7, High Performance, Friction Feed  
X-on/X-off, 9600 Baud

YOU COMPARE  
THE DIFFERENCE

DISTRIBUTOR  
INQUIRIES INVITED



745 Atlantic Avenue • Boston, MA 02111 • (617) 482-4214  
Circle 119 on inquiry card.

## News and Speculation About Personal Computing

Conducted by Sol Libes

**P**eering Into Radio Shack's Crystal Ball: Tandy Corporation (Radio Shack's parent firm) once kept a very tight lid on upcoming products. But now it's leaking information on product plans, some of which extend well into 1982.

Here's what to expect: Among its most ambitious programs, Tandy plans to double its hardware and software products within the next six months—judging by past performance, it can do it. Several new peripheral hardware products will be added to all of its current machines, from the pocket computer to the Model II business-oriented system. The Model II will be offered with an optional 10-mega-byte hard-disk system that will include a 15 k bpi (bits per inch) tape backup. The complete hard-disk system will cost less than \$5000. Also in the works is a multi-processing and -programming system that will allow up to sixteen Model IIs to be chained together. A new system (Model IV?) with capabilities somewhere between the Models II and III, but closer to the Model II, will be unveiled. It will include 8-inch floppy-disk drives and a better disk-operating system, but it won't be CP/M compatible. Expect its base price to be in the \$1500 to \$1800 neighborhood.

As for software:

- Radio Shack will introduce packages geared toward specific "vertical" markets (eg: medical, legal, educational, etc).
- There will be a software package that allows the Model II to read and write

IBM-format disks and to serve as a terminal on an IBM system.

- There will be upgraded versions of TRSDOS for the Models I, III, and II.

Most of the upcoming Model III software will adhere to the company's policy of maintaining compatibility with the older Model I system. I must give Radio Shack credit for not making the mistake made by most other computer companies who virtually disown their older model computers when a new system is brought out, forcing customers to "junk" the older system and buy a new system merely to run new software.

Tandy also plans to change the name of its Radio Shack Computer Centers to Office Product Centers. These centers will sell copiers, facsimile machines, and other office products, as well as computer systems.

**Zilog's New Fall Fashion:** This fall Zilog will introduce an enhanced Z80 called the Z800. The designation doesn't mean that the Z800 is ten times better than the Z80 and only one-tenth as powerful as the Z8000, but Zilog claims it will have three times the performance of the Z80.

Zilog says that the Z800 will be fully compatible with the Z80 instruction set, which is a wise decision because the old software can still be used. It will contain circuits that facilitate multiplication, division, and memory mapping to access up to 4 megabytes of memory. It will be offered in a

nonmultiplexed version, like the Z80, and a Z-bus-compatible version that can be used as a Z8000 peripheral. Zilog hopes to start shipping samples soon.

**C**ommodore Releases The 6508 Microprocessor: After years of talk about an upgraded version of the 6502 microprocessor (used in the Apple II, Commodore PET, Atari 400 and 800, etc), Commodore Semiconductor, Norristown, Pennsylvania, has finally done it: the 6508. The 6508 has 256 bytes of programmable memory and an 8-bit parallel port. Its instruction set is compatible with the 6502's and its clock rate remains at 2 MHz. Commodore has let it be known that several other versions of the 6502 are forthcoming. They will include timer/counters, serial ports, and other functions. Its clock rate could go as high as 6 MHz.

**I**s There A Microfloppy Disk In Your Future? Sony is currently providing OEMs (original equipment manufacturers) with samples of its new 3½-inch "microfloppy"-disk drives. The drive represents a new technology that departs from the traditional 5- and 8-inch drives. Sony packs 437.5 K bytes per side into a drive that's 27% smaller than standard 5-inch models. Five-inch drives typically store about 250 K bytes (double-density) or 125 K bytes (single-density).

Even though the 3½-inch drive's compactness is very attractive for portable computers and word-processing

systems, Sony is meeting some resistance from OEMs who are leary of purchasing an unproven product from a single source.

The microfloppy has a stiffer media and a rigid envelope with a shutter over the head-access slot to protect the disk. The result is less contamination and better media stability, which, in turn, allows greater accuracy and higher data density. Sony has also borrowed from its video-head technology in developing the read/write head for this drive.

Sample drives range in price from \$400 to \$500, not including a controller interface, although many of the currently available controllers can be used with little or no modifications. The price should drop to \$200 to \$300, in 500-unit quantities.

Sony plans to use the drives in its new word-processing systems, which will be introduced later this year. A 1-megabyte version of the device is expected early next year, and Sony will probably use it in its Series 35 small-business systems. There are rumors that Sony is developing a 3½-inch hard-disk drive.

Shugart and several other floppy-disk suppliers are taking a hard look at "microflopies." There is no doubt that the trend is to smaller disk-storage units. The question really is whether or not manufacturers will adopt the Sony format or create a new standard... or will something different emerge?

**T**he IAPX432 Picture Becomes Less Fuzzy: Recently, *EDN* magazine commented on where the industry can be expected to go

# SOFTWARE SOFTWARE DIGITAL MARKETING™ DIGITAL MARKETING™

September 1981

DIGITAL MARKETING • 2670 CHERRY LANE • WALNUT CREEK • CALIFORNIA 94596 • (415) 938-2880

**MILESTONE™** - \$295. Manual alone - \$30.  
"Critical path" network analysis program for scheduling manpower, dollars and time to maximize productivity.

An interactive project management program that runs under CP/M and can relate together different skills, hourly pay rates and projects to maximize efficiency. MILESTONE could be used to track paper flow, build a computer, check a salesman's performance, or build a bridge. MILESTONE can be used by executives, engineers, managers, and small businessmen to:

- Find the critical tasks which can't be delayed
- Discover which tasks are not time critical.
- See how manpower and expenses vary versus time.
- Investigate tradeoffs between manpower, dollars and time.
- Give plans to others using a printed project schedule.
- Change details and immediately see the results on screen.

Requires 64K RAM and CP/M. Specify Z80, 8080 or CDOOS.  
Also available for Apple Pascal, UCSD Pascal or CP/M-86 operating systems.

Formats: B, NS, MP, CDOOS, SB, TRS2, APPL

**DATEBOOK II™** - \$295. Manual alone \$25.  
NOW SCHEDULES APPOINTMENTS FOR UP TO 27 DIFFERENT PEOPLE  
IMPROVED FILE STRUCTURE ALLOWS APPOINTMENTS UP TO ONE YEAR

- Replaces your office appointment calendar
- Searches for openings that fit time of day, day of week & day of year constraints
- Appointments made, modified or cancelled by a few key strokes
- Copies of day's appointments can be quickly printed

Requires 64K RAM and CP/M. Specify Z80, 8080 or CDOOS.  
Also available for Apple Pascal, UCSD Pascal or CP/M-86 operating systems.

Formats: B, NS, MP, CDOOS, SB, APPL, TRS2

**SUPERCALC™** - \$295. Manual alone - \$25.  
Allows a non-programmer to manipulate business data in a variety of forecasting and accounting applications. Combines the interactive nature of an electronic spreadsheet with the power and convenience of a simple simulation language. Video display can be scrolled over entire worksheet using cursor controls. Symbolic vector references eliminate repetitive low-level data manipulation commands. Menu driven "Help" command may be invoked at any time.

Requires CP/M. Formats: B, NS, MP, SB, APPL, TRS2

**ACCESS/80™**  
Level I - Report Generator - \$285.  
Read ASCII files and create sorted reports with subtotalling capability. Provides multi-dimensional cross tabulation and computation. Includes operating system commands.

Level II - Output & Logic Processor - \$495.  
Everything in Level I plus, write out new files in any sorted order (including subtotalling). Load arrays in memory. Includes forms binary search on sorted arrays in memory. Includes control language extensions for complex applications.

Level III - Information Management System - \$795.  
Available 1st/2nd  
Everything in Level I and II plus, create new files with data entry. Provides on-line updating and file indexing.

Requires CP/M & 64K RAM  
Formats: B, NS, MP, CDOOS, SB, TRS2, APPL

FORMAT CODES: B (8" single density IBM soft-sectored) NS (NorthStar DD) MP (Microplus Mod II/Vector MZ) SB (Superbrain 3.0) CDOOS (8" Cromemco CDOOS)

**PASCAL/M™** - \$225. Manual alone - \$20.  
CP/M™ compatible language for 8080/8085 CPUs, supports full Jensen & Wirth plus 45 extensions to Standard Pascal including Random access files, 40 segment procedures & 16 bit BCD real type. NOW INCLUDES symbolic debugger which features trapping on stores, examining and changing variables and tracing of program execution.

Requires CP/M 2.2 & 56K RAM. Formats: B, NS, APPL, TRS2

**PASCAL/M for 8086/88™** - \$270.  
Manual alone - \$20.  
All features of Pascal/M for the 8086 and 8088 processors running under the 8086/88 version of CP/M

Requires CP/M-86™ & 128K RAM. Format: B

**TRANS 86™** - \$125. Manual alone - \$20.  
8086/88 Translator for existing 8080/8085 programs. The new source code can be easily edited and assembled using ACT II to produce hex code which can be executed by 8086/88. Emphasizes the extensions and features available in the 8086/88.

Requires CP/M & 32K RAM. Formats: B, NS, APPL

**ACT™** - \$125. Manual alone - \$15.  
CP/M compatible macro assembler for Z80, 8080/85, 8080 & 8080.

One assembler that supports all major 8 bit micros. ACT features include full macro capabilities, comprehensive pseudo-opt, link file structures, cross reference map, and algebraic expression processor. Requires 24K RAM & CP/M.

**ACT II™** - \$125. Manual alone - \$20.  
CP/M 2.x compatible cross assembler for 8086/88

**ACT III™** - \$125. Manual alone - \$20.  
CP/M 2.x compatible cross assembler for 8080.

**ACT I and ACT II together™** - \$225.  
Formats: B, NS, CDOOS, MP/M, TRS2, APPL

**SUPERDOST™** - \$129.  
Upgrade of CP/M 2.2 for Superbrain includes ADM/31, Hazaline, or Superbrain Terminal emulation mode. Other new features include 132 character keyboard buffer, repeat on bit keys, key click, user programmable numeric keypad, 30% disk read/write improvement, real time clock, baud rates utilities, and 4 fixes.

Requires Superbrain 3.0. Format: SB

MORE SOFTWARE	PRODUCT/MANUAL ALONE
TEXTWRITER III	\$125./\$25.
PEARL LEVEL 1	\$130./\$35.
PEARL LEVEL 2	\$950./\$35.
PEARL LEVEL 3	\$450./\$50.
CBASIC2	\$120./\$25.
ULTRASORT-II	\$175./\$20.
FABS	\$325./\$30.
CBASIC/86	\$650./\$35.
SELECTOR/86	\$550./\$35.
SELECTOR IV	\$450./\$35.
SELECTOR for SELECTOR IV	\$295./\$35.
S-BASIC	\$150./\$25.
dbzic	\$695./\$50.
DBASE II	\$ 75./n/a
MAGIC MENU	\$ 95./n/a
w/Spellguard option	\$200./n/a
SPELL MENU	
MONEY MAESTRO	

DEALER INQUIRIES INVITED

**PLAN80™** - \$285. Manual alone - \$30.  
A financial modeling system that's easy to learn yet powerful enough to replace most timesharing applications.

Let's you tackle any numeric problem that can be defined in a worksheet format. It performs complex calculations quickly and precisely and lets you examine "What if?" questions so you can evaluate more planning alternatives in greater detail.

With PLAN80 you get more than your calculated results. You know how you get them, because you define rows and columns with familiar names such as UNITS, PRICE and JANUARY and express calculations in terms such as SALES-UNITS\*PRICE. It's easy to review your assumptions and methods with people who have never seen PLAN80.

At any point in the PLAN80 model you may display or print results on your screen, printer or disk, save all or part of the results for use by another model, or play "What if?" by inputting new values, recalculating and displaying or printing results.

Best of all, you can incorporate PLAN80 results into any report that requires a financial model - using your word processor - to create professional results.

Requires 64K RAM and CP/M. Also available for CP/M-86. Specify Z80, 8080 or CDOOS. Formats: B, CDOOS, NS, MP, SB

**SPELLGUARD™** - \$295. Manual alone - \$20.  
20,000+ word dictionary containing commonly used words that find spelling & typographical errors in text files. Allows review of mis-matched words & speedy search routine.

Requires CP/M, 48K RAM & Magic Wand. WordStar™ or Spellfinder™

Formats: B, NS, MP, SB, TRS2, CDOOS

**SPELLBINDER™** - \$395. Manual alone - \$30.  
Full feature word processing system with Office Management capabilities. Its special features include ease-of-use by office personnel, flexible print formatting & output, and a powerful macro capability which allows features to be added for the unique requirements of each user. Mail list macros is included for mail merge with form letters.

Requires CP/M & 32K RAM. Formats: B, NS, MP, CDOOS, SB, APPL

**MCALL™** - \$85.  
Communications program designed to drive an acoustic coupler. Features include:

- Time sharing Terminal emulation
- Disk file transfer between CP/M computer & Time Sharing Computer in either direction
- Disk file transfer between two CP/M computers with error detection and correction

**AMCALL™** - \$95.  
Auto-answer, auto dial version of MCALL currently supports IDS 88-modem & Potomac Micro-Magic MM-103 boards.

Requires CP/M. Formats: B, NS, MP, SB, CDOOS

**MICROSTAT™** VERS. 2.0 - \$295. Manual alone - \$25.  
Now includes stepwise and meta flexible file structure. Code size smaller (= more data area). Also a data management subsystem for editing, sorting, ranking, logging, data file transfers PLUS eleven data transformations (log, linear, reciprocal, exponential, etc.)

- Frequency distributions, & probability distributions
- Multiple regression, correlation analysis
- Time series
- Crosstabs/Chi-Square, non-parametrics
- Factorials, permutations, combinations
- Scatterplots
- ANOVA (one and two-way)

Requires 48K RAM, NorthStar Basic or CP/M & CBASIC2 or Microsoft Basic 8.0.

Formats: B, NS, MP, SB, TRS2, CDOOS, APPL (Apple II)

Access/80 trademark  
Friends Software Money Maestro  
Trademark Innosoft Pascal trademark CPU Int'l  
Pascal/M, ACT, Trans 86, SuperCalc trademarks Sorcim,  
CBASIC2, CBASIC/86 trademarks Compiler Systems Datebook II,  
Milestone, Textwriter III trademarks Organic Software Spellguard trademark  
ISA CP/M, CP/M-86 trademarks Digital Research Superbrain trademark Intertec Data  
Systems Microstat trademark Ecosoft S-Basic trademark Topaz Programming Spellbinder  
Trademark Leusoft MCALL, AMCALL trademarks Micro-Call Services Selector IV, Selector/86, Selector  
Trademark Micro-App Prices subject to change without notice for shipping add \$7 per item California residents  
add sales tax Terms: Prepaid check, M/C, VISA or in US CDD (UPS) Prices quoted do not include dealer installation & training  
Telex 17-1852 DIGMKTG WNCX DEALER INQUIRIES INVITED OUTSIDE CALIFORNIA CALL 501/442-0664 INSIDE CALIFORNIA CALL 415/938-2853

with the new Intel 32-bit microprocessor. I have taken the liberty of extracting some of the major comments here.

The iAPX432 was designed by and for computer scientists, rather than electrical engineers (as were Intel's 4-, 8-, and 16-bit microprocessors). The iAPX432's internal elements are less accessible than those in other microprocessors, so writing programs will be different.

"Instead of considering the machine in terms of bits and registers, you must focus on software objects ... the 432 has no assembly language, per se; you might consider its instruction set to be a high-level language ... a nearly optimum intermediate language specifically designed to simplify the task of writing efficient compilers. In turn, these compilers can effectively handle programs coded in high-level languages." The iAPX432's instruction set "does not constitute a complete operating system; rather, it contains the essential primitives from which you can construct such an operating system ... the machine can't be programmed directly in code written in, say, Ada or FORTRAN; you need the appropriate compiler. Because the 432 simplifies system programming, programmers need not be hardware experts; thus personnel with a lower level of expertise can program it. Further, programs written in high-level languages can generally be developed more rapidly than those coded in assembly language.

"The machine performs arithmetic operations quickly and with a high level of precision. It also automatically prevents many typical programming errors (you can't inadvertently execute data, for example). Further,

it provides functional redundancy checking, a feature that allows graceful system degradation when a CPU [processor] fails in a multiprocessing environment. And finally, the 432 ensures that all programs are naturally reentrant and recursive. The 432 chip set is complex and currently very expensive. It could incur speed penalties when performing certain operations."

The iAPX432 will not be the ultimate processor. "Although its instruction set is close to the ideal," says *EDN*, "it might be improved in other ways." It will not make 4-, 8-, and 16-bit microprocessors obsolete; and, in fact, it should increase the market for these as 'peripheral processors.'

"In summary, a good analogy is that the 432 is to standard microprocessors what the 7400 Series TTL was to discrete-device logic gates and flip-flops. It should free EEs [engineers] from many mundane system-design chores, allowing them to concentrate on more rewarding creative pursuits, while also reducing their projects' software costs. It's a minicomputer replacement, one that will open up scores of application opportunities."

Intel is already shipping a board-level iAPX432 evaluation system, called the Intellec 432/100. It consists of a board with a complete iAPX432 processor, RS-232C serial interface, evaluation software, and seven volumes of documentation. The user can plug the board into an Intel Intellec development system and create and execute iAPX432 programs using an object-oriented language. The 432/100 costs \$4250.

The Intellec uses the Intel Multibus (IEEE-796), which has a 16-bit-wide data bus.

The 32-bit-wide processor is interfaced to the bus via an interface-processor that handles data-bus transfers as two 16-bit words (the IBM 360, which was also a 32-bit processor, handled data transfers as 8-bit words, on its smaller machines).

Several S-100 (IEEE-696) bus-system manufacturers have iAPX432 development projects underway. I expect to see an S-100-based iAPX432 machine with disk operating system later this year.

**The Software Shop:**

When I was a kid, I would go to the record shop and buy a copy of one of the top-ten records on the hit-parade. Well, soon I may be going to the "software shop" to buy a copy of one of the top-ten programs. At least that is what Cut & Curl hopes. It plans to open a franchised chain of stores that sell only software—"software supermarkets." Cut & Curl already franchises 500 Edie Adams Cut & Curl and Great Expectations Precision Haircutting salons. The first Programs Unlimited store has been opened, and Cut & Curl is talking about 100 more stores.

**Random News Bits:**

Apple Computer Inc reported that sales for the first quarter of 1981 tripled over the same period a year ago. Sales were nearly \$79 million, with a net of \$9.2 million—a 16% increase over the previous quarter. Also, Apple claims to have produced over 200,000 Apple IIs and that the Apple III's "production problems" have been ironed out (most of the original design group has been fired). The Apple III is now in full production. ... Zilog reported an \$11 million loss on \$42 million

business for 1980. Zilog has yet to show a profit. ... Commodore expects to introduce its "Micromainframe," with 132 K bytes of memory and 6502 and 6809 processors. It is really a PET computer with a second processor (the 6809). You can elect to run either the 6502 or the 6809. Commodore claims to have BASIC, FORTRAN, APL, Pascal, and an Assembler ready for the machine. COBOL will come later. The software was developed at the University of Waterloo in Ontario, Canada. Commodore has not yet set the price. ... Interlude, Houston, Texas, claims to have sold 15,000 copies of its sex-oriented software package for the Apple II and TRS-80 computers. The program asks users questions about themselves and their partners, and then tells them how to enjoy their spare time. ... Florida Data Corporation, Melbourne, Florida, has introduced two serial dot-matrix printers that can rocket along at 600 cps (characters per second) for draft or data-processing output and at 150 cps for letter-quality output—that's three times faster than any daisy-wheel printer. The letter-quality output is produced by passing the head over each line four times, with the dots displaced slightly on each pass to fill in the character. ... Intel will introduce a set of two integrated circuits for the Ethernet controller and interface that will allow a user to implement the physical and data links. A little bit of extra circuitry, some special cables, and interfacing software, and you can connect any personal computer to an Ethernet system. ...

**Texas Instruments' Bubble Bursts:** In a surprise move, Texas Instru-

# DEC LSI-11 Components

Dependable service  
at discount prices

Domestic  
and Export

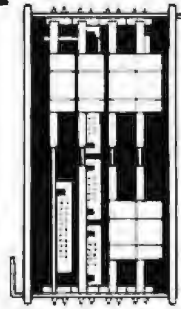

Mini  
Computer Suppliers, Inc.

25 Chatham Rd., Summit, N.J. 07901  
Since 1973

(201) 277-6150 Telex 13-6476

© Mini Computer Suppliers, Inc.  
1979

# WOW

## APPLE II PLUS 64K\* ONLY \$1249

16K RAM CARD INCLUDED WITH FACTORY 48K SYSTEM  
16K APPLE II PLUS..... \$1129

**DISK II DRIVE & CONTROLLER  
ONLY \$519**

DISK II DRIVE ADD-ON..... \$439  
SILENTYPE PRINTER & CARD..... \$349  
Z-80 SOFTCARD..... \$299  
HAYES MICROMODEM II..... \$299  
16K RAM CARD..... \$130  
VIDEX VIDEOTERM 80 COLUMN..... \$269

SEE PAGES 476 & 477 FOR MANY MORE  
PRODUCTS AT UNBEATABLE PRICES.

**ORDER TOLL FREE 800-854-6654**

CALIFORNIA & OUTSIDE CONTINENTAL U.S. (714) 698-8088

CONSUMER COMPUTERS MAIL ORDER  
8314 PARKWAY DRIVE LA MESA, CA 92041



## VIP's Call A.E.I.

VIP's customarily need top quality and service within stringent budgetary limits. Naturally, they call A.E.I.

...For software, firmware, or hardware; For custom systems assistance, connectors, interface boards and service; For peripherals, including printers, CRT's, disc drives, or modems; For as little as one part such as a cable or connector, or as much as an entire national computer complex for a multi-branch company.

**Item:** A.E.I. tests virtually every\* item sold, before shipping.

**Item:** A.E.I. initializes every piece of software, and makes a copy. If you have a problem, A.E.I. can check to locate the problem by using the in-house duplicate, saving you time.

**Item:** A.E.I. has in-house expertise on every item offered.

**Item:** A.E.I. prices are competitive with the lowest, no-service, no in-house expertise dealer.

**40% OF ALL A.E.I. SALES ARE TO PUBLIC AND SEMI-PUBLIC INSTITUTIONS.**

A partial list\*\* of A.E.I. customers who purchased during the last quarter of 1980 includes: University of Nebraska, University of Virginia, U.S. Dept. of Interior, University of Kentucky, University of California, Massachusetts Institute of Technology, U.S. Air Force, Naval Air Development Center, Brown University, University of Oregon, University of Utah, Ohio State University, University of Southern California, California State Dept. of Water Resources, University of Michigan, and Princeton University.

In the private sector, an equal number of major national organizations purchased during the same period.

**You can call A.E.I. too!**

\*With our normal fast shipping, we have time to test; expedited shipment may preclude testing.  
\*\*A.E.I. does not wish to imply that any of these fine organizations endorse A.E.I., merely that A.E.I. is proud to have them as customers.

Automated Equipment, Inc.

18430 Ward Street, Fountain Valley, California 92708 (714) 963-1414 (Outside of California (800) 854-7635)

# DISK DOCTOR

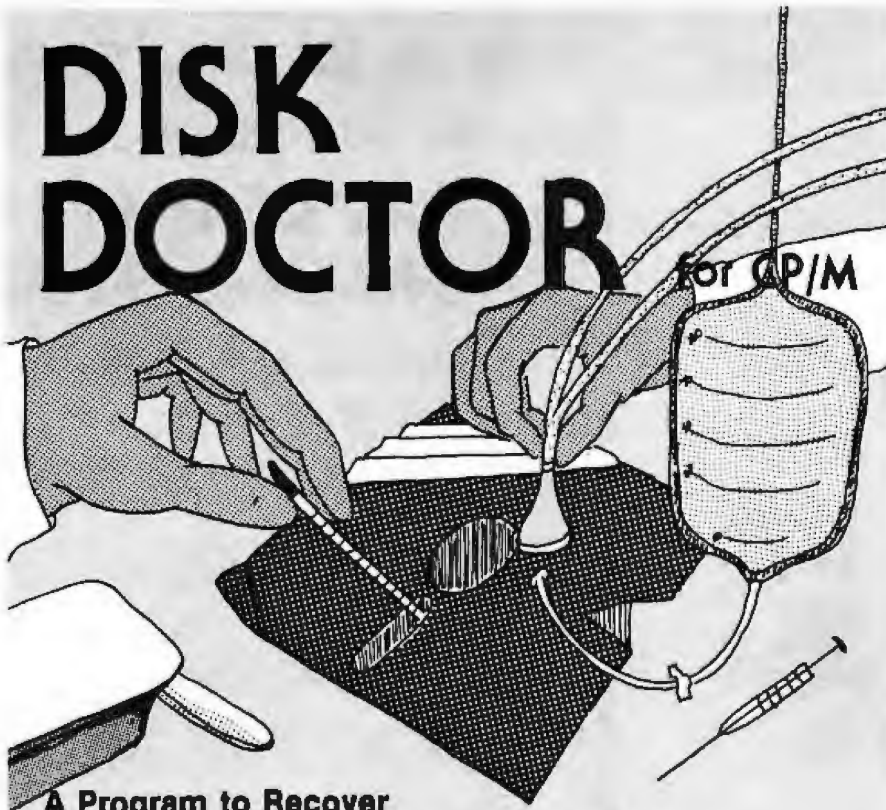

## A Program to Recover "Crashed" Discettes AUTOMATICALLY!

Maybe it was a lightning storm, static from the rug, or just too late at night to be working. Whatever the cause, when a discette "crashes" and valuable data or programs are destroyed, the loss is enormous, both in time and money.

DISK DOCTOR is a program which automatically recovers bad discettes. Best of all DISK DOCTOR does not require any knowledge of CP/M file structure! If you can operate CP/M, then you can use DISK DOCTOR. The entire system is menu driven with key information displayed.

DISK DOCTOR is comprised of five "wards", each capable of performing a specific discette recovery operation.

- **Ward A:** Verifies discettes and locks out bad sectors without touching the good files that remain.
- **Ward B:** Copies whatever can be read from a "crashed" file and places it into a good file under user control.
- **Ward C:** Copies discettes without stopping for bad sectors. Bad sectors are replaced by spaces.
- **Ward D:** "Un-erases" files. That is, Ward D will recover accidentally erased disk files.
- **Ward E:** Displays directory of recoverable erased files.

DISK DOCTOR will pay for itself the first time it is used.

Best of all, DISK DOCTOR operates almost complete automatically. The small amount of user interaction is explained in the manual as well as prompted by DISK DOCTOR.

Requires: 48K CP/M, two drives needed for complete operation.

DISK DOCTOR: \$100.00  
Manual Alone: \$ 10.00

CP/M Formats: 8" soft sectored, 5" Northstar, 5" Micropolis Mod II, Vector MZ, Superbrain DD/QD, Apple II +

**SuperSoft**  
First in Software Technology



All Orders and General Information:  
SUPERSOFT ASSOCIATES  
P.O. BOX 1628  
CHAMPAIGN, IL 61820  
(217) 359-2112

Technical Hot Line: (217) 359-2691  
(answered only when technician is available)

CP/M REGISTERED TRADEMARK DIGITAL RESEARCH

## BYTELINES

ments (TI) will phase out its magnetic bubble-memory products as part of a company-wide retrenchment program. The move, ironically, comes less than a month after TI announced it was expanding its line. Rockwell International announced a similar move earlier this year. Besides dropping its bubble-memory line, TI also announced plans to get out of the digital-watch business and lay off 3% of its work force.

## The 64 K-Bit Memory Devices Are On The Way:

Intel and a few other integrated-circuit makers are now shipping 64 K-bit memories. Prices are currently in the \$30 range but are expected to drop to around \$8 by year's end. Look for products using these circuits by early next year. It's rumored that Apple has placed an order for 60,000 of the devices, at \$12 a chip, for a new business computer.

Reportedly, Intel has 256 K-bit memory devices in the prototype stage. Using the 64 K-bit devices, you could build a 64 K-byte memory system using only eight memory circuits. When the 256 K-bit products become available, only two circuits will be required.

**MAIL:** I receive a large number of letters each month as a result of this column. If you write to me and wish a response, please include a self-addressed, stamped envelope.

**Sol Libes**  
POB 1192  
Mountainside NJ 07081



# RAM/COBOL MAKES IT ACROSS!



## .. FROM ONE OPERATING SYSTEM TO ANOTHER! A VITAL WAY TO PROTECT YOUR SOFTWARE INVESTMENT FOR THE FUTURE!!

The **RAM/COBOL** language runs on more different Operating Systems and more different-sized computers than any other similar language. For starters, it runs on NCR and TI minicomputers and, in the micro field, on the CP/M<sup>2</sup>, MP/M<sup>2</sup>, TRSDOS<sup>3</sup>, OASIS<sup>4</sup>, MOASIS<sup>4</sup>, and UNIX (ONYX version) Operating Systems...to mention only a few.

Until now, serious business software of the scope and flexibility seen in the minicomputer world has not been available on micros. **RAM/COBOL** now allows transfer of such software with a minimum of fuss.

We have participated in such a mini-to-micro transfer of a major set of general business software...using **RAM/COBOL** as the transfer mechanism, of course. Running on literally thousands of minicomputers, these refined, enhanced, and proven software packages cover A/R, A/P, G/L, P/R, Order Entry (with Invoicing and Inventory Control) as well as Sales Analysis. The packages define a new level of achievement for features and flexibility in micro applications software and offer top quality at a reasonable price.

For immediate information, call 714-848-1922 for your complete product descriptions. Be sure to circle no. indicated below.

.. **PLUS ALL THE OLD, FAMILIAR FAVORITES** that we continue to offer, such as:

**General Business**—Client Accounting (CPA Write-up)  
FMS<sup>6</sup> (Financial Modeling System)  
NAD<sup>7</sup> (Name and Address System)

**Real Estate**—REAP (Real Estate Acquisition Programs)  
FMS (Property Management System)  
MLS<sup>6</sup> (Multiple Listing System)

**Health Care**—APH<sup>5</sup> (Automated Patient History)

**Word Processing and System Software**—Magic Wand<sup>8</sup>  
QSORT<sup>9</sup>  
CRASIC<sup>10</sup>

and Cybernetics' unique TRS-80<sup>3</sup>, Model II CP/M offering high performance, hard disk support, and CP/M compatibility.

### Trademarks of:

1—Ryan McFarland Corp.; 2—Digital Research, Inc.; 3—Tandy Corp.; 4—Phase One Systems, Inc.; 5—Bell Telephone Laboratories, Inc.; 6—American Business Systems, Inc.; 7—Structured Systems Group, Inc.; 8—Cybernetics, Inc.; 9—Peachtree Software, Inc.; 10—Compiler Systems, Inc.

MR. SMITH, THIS SOFTWARE WILL DEFINITELY ENHANCE YOUR CURRENT DATA PROCESSING FINANCIAL INDEXING REtrievABILITY.

THOSE ARE NICE WORDS

**CYBERNETICS**  
N  
C

8041 NEWMAN AVE., SUITE 208  
HUNTINGTON BEACH, CA 92647

TEL. 714-848-1922

# Ask BYTE

Conducted by Steve Ciarcia

## Ciarcia's Circuit Court?

Dear Steve,

I am a member of the Evanston Township High School Computer Club, and I was wondering if you could settle a dispute for me. The supervisor of our computer room will not allow us to double-side our floppy disks because of the fact that they accelerate the accumulation of oxide and dust deposits on the read/write head of the disk drive. Is this true?

Scott Coleman  
Evanston IL

*I don't like to jump into the middle of disputes, but if you can live with my opinion, I will voice it. It should not make any difference whether you have a single-sided or double-sided disk. The disk-drive head does not come in contact with the oxide surface: it rides above it. So, theoretically, it should not cause any accumulation on the read/write head.*

*Now, that's in theory. In truth, there's always some oxide that comes off on the head, but if the computer room is doing regular maintenance, which is to clean the heads every once in a while, it should never be built up to a point at which it makes any difference anyway.*

*Perhaps the way to settle this is to have the computer club volunteer to clean the disk drives once in a while.*

. . . Steve

## Tools of the Course

Dear Steve,

I am beginning implementation of a hands-on micro-computer experimentation and interfacing course here at the University of Dubuque

Theological Seminary. I want to establish a digital-micro-processor laboratory. What would you consider to be the *minimum* test equipment necessary? Our financial resources are somewhat limited, so your advice would be most helpful.

Terry A Ward  
Dubuque IA

*At the very minimum, I would recommend that you get an oscilloscope. If you can afford it, it should be dual-trace and have at least a 15 MHz bandwidth. With it, you can troubleshoot many pieces of equipment and perform some logic-analyzer functions. If you can afford it, of course, a logic analyzer is always a good piece of equipment to have around. However, you can spend so much time teaching people how to use a logic analyzer that you don't have any time left in the course.*

*Other than an oscilloscope, the only other piece of equipment that you probably need would be a simple digital voltmeter (DVM) or digital multimeter.*

*Often the things that are needed when teaching students are not the things that you can buy off the shelf as test equipment. Frequently, simpler equipment, such as a buffered LED (light-emitting diode) that functions as a logic probe, is what's necessary.*

*A logic probe, 'scope, and a DVM should take care of practically anything that would arise. . . . Steve*

## Auto Warning

Dear Steve,

In a book on microcomputers that I read, the author predicted that an automotive

warning device that would tell drivers they were too close to another vehicle would be devised.

It occurred to me that such a gadget might be realized right now using the Polaroid development kit and a simple single-board computer. Software, it seems to me, might be the biggest hurdle. What do you think?

Bob Crafts  
Edgartown MA

*The Polaroid ranging sensor is definitely usable for a driver-warning device like the kind you mentioned. However, I don't see this sensor being used as a crash-avoidance device because its response time is a little slow. I have seen one company using the device on each side of a car's fenders, with a dash-mounted display for the driver. In my mind, while this may work, its feasibility and production is another matter. It would seem to be rather expensive unless produced in large quantities.*

*When using the Polaroid development kit in an automobile, you must try to isolate the ignition noise from any power being drawn from the car's electrical system. From my experience, the Polaroid ranging kit is also electromagnetic interference and static sensitive. If used in a car, it should be in a shielded enclosure. . . . Steve*

## Scheming Schematics

Dear Steve,

I would like to expand an Atari 400 or 800 with minimum programmable memory to a full 64 K memory by using 4116 chips. To this expansion board, I would also like to add RS-232C circuitry to handle a printer and

modem. Of course, it would need its own power supply.

I am a technician with a good background in digital electronics but not a circuit designer. Where can I find the necessary schematic and parts list?

Emanuel Soffer  
Rockaway NY

*Expanding the memory and adding RS-232C to the Atari are two completely different problems, each requiring diverse amounts of talent. The 6502 has no internal refresh logic, as does the Z80. External refresh logic must be added.*

*An RS-232C serial port can be added fairly easily to the expansion connector on the side of the Atari if the proper software is added to the unit. One company that has been working on this is the Code Works, POB 550, Goleta CA 93017. I suggest that you write the Code Works (attention Ron Jefferies) asking about its serial port for the Atari. It should be fairly inexpensive because it's practically all software.*

*Presently, it is cheaper to use static memory on the Atari. Whether this situation continues will be determined by the prices of dynamic versus static memory, the development of an inexpensive refresh method, or the evolution of new quasistatic programmable memories, such as the Zilog Z6132. If any readers have a good circuit for using dynamic memory with a 6502, I'd appreciate seeing it. . . . Steve*

## Little Problems Cause Big Ones

Dear Steve,

We have a problem with our 6800 microcomputer,

# HEATH H9 OWNERS

**UPGRADE your H9 for a fraction of the cost of a new terminal with these features.**

**FLICKER FREE**

**\$99.95 KIT \$79.95 ASSEMBLED**  
If Columbus would have had to wait for his H9 operating at 600 baud, he might not have discovered America. At last your computer can communicate with your H9 eight times faster (4800 baud) without that annoying refresh interrupt that causes the screen to flash at rates greater than 600 baud. Faster listings. Faster program execution. Eight times faster.

**CURSOR CONTROL**

**\$39.95 KIT \$49.95 ASSEMBLED**  
Why limit your output to consecutive lines of your terminal? CURSOR CONTROL allows your computer to move the cursor anywhere on the screen. Add that professional touch to your displays by utilizing marking techniques. Functions included are: left, right, up, down, left and right 2D spaces, home and erase page.

**GRAFIX**

**\$99.95 KIT \$69.95 ASSEMBLED**  
Open a whole new world to your output! The graphical display capabilities of GRAFIX allow you to create displays never before possible on the H9.

**LOWER CASE ENTRY**

**\$39.95 ASSEMBLED**  
Now you can enter lower case characters from the keyboard. A Shift Lock key allows the keyboard to operate as the standard H9 keyboard or to generate upper and lower case depending upon the Shift key as per a normal typewriter.

**LOWER CASE DISPLAY**

**\$34.77 ASSEMBLED**  
Lower case capabilities greatly improve readability on terminals modified for 24 lines.

**KEY CAPS**

**\$12.95 SET 4 ARROWS \$100**  
These quality contour key caps have molded-in alphanumeric. For that professional look.

**Full Six Month Warranty - 24 Line Compatible**

**NORTHWEST COMPUTER SERVICES, INC.**  
8503 N.E. 30th Ave.  
Vancouver, WA 98665  
(206) 573-8381

\*H9 is a registered trademark of Heath Co. MASTER CARD and VISA welcome

# ROBOTS The Future Arrives



Intelligent machines are rapidly appearing in homes, automobiles, offices and factories. Affordable cameras, speech synthesizers, and even robot arms are now on the market. Such advances are giving microcomputers the power to see, hear, grasp objects, and to move around the room. Where can you learn about this technology? In *Robotics Age Magazine*, the journal of intelligent machines.

*Robotics Age* reports the experience of hobbyists building their own robots, the latest products from industry, and the most powerful techniques from research labs. The face of the world is changing. Join us as we enter the Robotics Age.

**YES! I want to stay up-to-date on this fascinating new technology!**



Name \_\_\_\_\_ Title \_\_\_\_\_

Company \_\_\_\_\_ Address \_\_\_\_\_

City/State/Province/Country \_\_\_\_\_ Postal Code \_\_\_\_\_

	United States	Canada Mexico*	Foreign Rates*
<input type="checkbox"/> 1 year (6 issues)	\$15	\$17	\$19
<input type="checkbox"/> 2 years (12 issues)	\$28	\$32	\$36
<input type="checkbox"/> 3 years (18 issues)	\$39	\$45	\$51

Bill VISA  MasterCard  Bill me (in America only)

\*US Funds on US Bank

Card No. \_\_\_\_\_ Exp \_\_\_\_\_

Signature \_\_\_\_\_  
Send to: **ROBOTICS AGE** PO Box 512, Tujunga, CA 91042

RACET SORTS — RACET UTILITIES — RACET computes — RACET SORTS — RACET UTILITIES — RACET computes — RACET SORTS — RACET UTILITIES — RACET computes —

**FIELD PROVEN!!**

**10 MEGABYTES and MORE for the TRS-80\* Model II plus SHARED ACCESS to HARD DISK DRIVE**

**Hard/Soft Disk System (HSDS) Software** allows access as single drive. You can have that 10 Megabyte continuous file - that 50,000 name maillist or inventory! Or a directory with 1000 entries! All completely compatible with TRSDOS 2.0 BASIC. You can mix floppy and hard disk drives. Includes special utilities including HPURGE, DCS Directory Catalog System, HZAP Hard Disk Superzap, and many special formatting options. Three to eight times faster than floppy! RACET quality.

**HARD DISK DRIVE & CONTROLLER \$5995. Second User \$395. HSOS Software \$400.** (Note: HSOS now also available for CORVUS drives!!)

**INFINITE BASIC (Mod I & III Tape or Disk) Mod I \$50.00, Mod III \$60.00**  
Extends Level II BASIC with complete MATRIX functions and 50 more string functions. Includes RACET machine language sorts! Sort 1000 elements in 9 seconds!! Select only functions you want to optimize memory usage.

**INFINITE BUSINESS (Requires Infinite BASIC) Mod I & III \$30.00**  
Complete printer pagination controls — auto headers, footers, page numbers. Packed decimal arithmetic — 127 digit accuracy +, -, \*, /. Binary search of sorted and unsorted arrays, Hash codes.

**BASIC CROSS REFERENCE UTILITY (Mod I) 64K \$50.00**  
SEEK and FIND functions for Variables, Line Numbers, Strings, Keywords. 'All' options available for line numbers and variables. Load from BASIC — Call with 'CTRL'R. Output to screen or printer!

**DSM Mod I \$75.00, Mod II \$150.00, Mod III \$90.00**  
Disk Sort/Merge for RANDOM files. All machine language stand-alone package for sorting speed. Establish sort specification in simple BASIC command file. Execute from DOS. Only operator action to sort is to change diskettes when requested! Handles multiple diskette files! Super fast sort times — improved disk I/O times make this the fastest Disk Sort/Merge available on your TRS (Mod I Min 32K 2-drive system. Mod II 64K 1-drive. Mod III 32K 1-drive)

**GSF (Mod I & III Tape or Disk - Specify Memory Size) Mod I \$25; Mod II \$50; Mod III \$30**  
Generalized Subroutine Facilities. The STANDARD against which all other sorts are compared! And then compare prices! Machine language — fast and powerful! Multi-key multi-variable and multi-key character string. Zero and move arrays. Mod II includes USR PEEKS and POKES. Includes sample programs.

**DISCAT (32K 1-drive Min) Mod I, III \$50.00**  
This comprehensive Diskette Cataloging/Indexing utility allows the user to keep track of thousands of programs in a categorized library. Machine language program works with all TRSDOS and NEWDOS versions. Files include program names and extensions, program length, diskette numbers, front and back, and diskette free space.

**KFS-80 (1-drive 32K Min — Mod II 64K) Mod I, III \$180.00; Mod II \$175.00**  
The keyed file system provides keyed and sequential access to multiple files. Provides the programmer with a powerful disk handling facility for development of data base applications. Binary tree Index system provides rapid access to file records.

**MAILLIST (1-drive 32K Min - Mod II 64K) Mod I, III \$75.00; Mod II \$150.00**  
This ISAM-based maillist minimizes disk access times. Four keys, no separate sorting. Supports 9-digit zip code and 3-digit state code. Up to 80 attributes. Mask and query selection. Record access times under 4 seconds!

**COMPROC (Mod I & Mod III — Disk only) Mod I \$20; Mod III \$30**  
Command Processor. Auto your disk to perform any sequence of instructions that you can give from the keyboard. DIR, FREE, pause, wait for user input, BASIC, No. of FILES and MEM SIZE, RUN program, respond to input statements, BREAK, return to DOS, etc. Includes lowercase driver software, debounce and screenprint!

**UTILITY PACKAGE (Mod II 64K) \$150.00**  
Important enhancements to the Mod II. The file recovery capabilities alone will pay for the package in even one application! Fully documented in 124 page manual! XHIT, XGAT, XCOPY and SUPERZAP are used to reconstruct or recover data from bad diskettes! XCOPY provides multi-file copies, Wild Card, mask select, absolute sector mode and other features. SUPERZAP allows examine/change any sector on diskette include track-0, and absolute disk backup copy with 100% recovery. DCS builds consolidated directories from multiple diskettes into a single display or listing sorted by disk name or file name plus more. Change Disk ID with DISKID. XCREATE preallocates files and sets 'LOF' to end to speed disk accesses. DEBUGII adds single step, trace, subroutine calling, program looping, dynamic disassembly and more!!

**DEVELOPMENT PACKAGE (Mod II 64K) \$125.00**  
Includes RACET machine language SUPERZAP, Apparal Disassembler, and Model II interface to the Microsoft 'Editor Assembler Plus' software package including uploading services and patches for Disk I/O.

CHECK, VISA, M/C, C.O.D., PURCHASE ORDER  
TELEPHONE ORDERS ACCEPTED (714) 997-4950  
\*TRS-80 IS A REGISTERED TRADEMARK OF TANDY CORPORATION

**RACET COMPUTES**  
1330 N. GLASSSELL, SUITE M,  
ORANGE, CA 92667

RACET SORTS — RACET UTILITIES — RACET computes — RACET SORTS — RACET UTILITIES — RACET computes — RACET SORTS — RACET UTILITIES — RACET computes —

RACET SORTS — RACET UTILITIES — RACET computes — RACET SORTS — RACET UTILITIES — RACET computes — RACET SORTS — RACET UTILITIES — RACET computes —

## Ask BYTE

This problem appears to be entirely within the computer itself. Local experts and Technical System Consultants (it wrote the software) all seem to be baffled by the problem.

The computer is a SwTPC (Southwest Technical Products Corporation) 6800 microcomputer with 32 K bytes of programmable memory (two 4 K-byte boards at 0000 to 1FFF hexadecimal and three 8 K boards at 2000 to 7FFF), an A2 processor board with SwTBUG monitor, MP-C interface, and MF-68 dual disk drives. The system runs under Flex 1.0. The peripherals are: CT64 terminal, AC30 cassette interface, GE Terminal 300 hard-copy terminal, and a PR40 parallel printer.

Running MEMTEST1 indicates one small problem at address 3C2D hexadecimal, but, other than that, there appear to be no problems.

The problem appears when using the PRINT statement running under Disc BASIC 3.0 and all versions of 8 K BASIC. When running a program with any more than 25 characters in a PRINT statement *anywhere* in the program, one of the following happens:

- The CT64 terminal will go into numerous control character gyrations after printing the first 25 characters.
- Both printers print the same "garbage" after the 25 characters.

Each line printed will have the same "garbage" characters after the first 25 characters.

Strangely enough, this problem with the terminal and the printers does not occur with the LIST command on any of the aforementioned versions of BASIC. When I use the 4 K-byte version, I encounter no problems at all with the PRINT statement.  
Dave Coultish  
Ottawa, Ontario, Canada

I asked our local SwTPC guru, Leo Taylor, to provide an answer. . . . Steve

Unfortunately, I can't tell you anything solid, because I do not have the BASIC you are using. I can, however, offer a few suggestions.

I suspect you have confused a few people with your software description. To the best of my knowledge, I guess you have Miniflex and SwTPC BASIC 3.0. Many people are confused between versions of Flex. If you have 5-inch floppy-disk drives, you can't have Flex 1.0 because it requires 8-inch drives and memory at hexadecimal A000. TSC did not write BASIC 3.0; it was written by Rober Uterwick and adapted by SwTPC.

There is never a "small memory problem." BASIC has a way of finding memory

problems that defy any other means of detection. Since you mentioned the memory error, you probably haven't swapped boards to eliminate it as a suspect. You have enough memory to remove any one board and still have the required 12 K starting at address 0000 and 4 K at hexadecimal 7000. The BASIC you are using will scan for end-of-memory. If it finds a byte it considers bad, it stops scanning, backs up one address, and loads its stack. If the end-of-memory is near the start of a page (such as 3C2D), BASIC will fail to reserve enough stack space. This can cause all sorts of problems. Thus, a minor memory problem becomes a major malfunction. . . . Leo Taylor

hoping that you might know of an integrated circuit that can be used. We need three or more digitally proportional channels that can be easily controlled by a computer.

Michael Dubno  
Bronx NY

National Semiconductor has recently introduced a set of devices for the remote-controlled toy market that may be of interest to you. The LM1871 (transmitter) and LM1872 (receiver) have the following capabilities:

- two analog channels
- two digital channels
- operates on 27, 49, or 72 MHz band
- regulated pulse-width modulation radio-frequency output

It doesn't have three analog channels as you requested, but it has a lot of power for an 18-pin chip. I recommend that you contact your local National Semiconductor sales representative for pricing and availability. . . . Steve ■

### Control Search

Dear Steve,

My company has been looking for a way to communicate with a robot by using radio control. We were

In "Ask BYTE," Steve Clarcia answers questions on any area of microcomputing. The most representative questions received each month will be answered and published. Do you have a nagging problem? Send your inquiry to:

Ask BYTE  
c/o Steve Clarcia  
POB 582  
Glastonbury CT 06033

If you are a subscriber to The Source, send your questions by electronic mail or chat with Steve (TCE317) directly. Due to the high volume of inquiries, personal replies cannot be given. Be sure to include "Ask BYTE" in the address.

## 6809 SYSTEMS



## 6809 SYSTEMS



## 6809 SYSTEMS



## 6809 SYSTEMS

Featuring the GIMIX mainframe with 30 amp C.V. ferro-resonant power supply; fifteen 50 pin and eight 30 pin slot Mother Board; 2 Mhz CPU with time of day clock & battery back-up, 1K RAM, 6840 programmable timer, provisions for 9511A or 9512 Arithmetic processors, and 4 PROM/ROM/RAM sockets that can hold up to 32KB of monitor or user software.

**VARIETY:** you can have 32KB, 56KB, 128KB and up of static RAM. You can use 5" and/or 8" disk drives, single or double density, single or double sided, and single or double tracking with GIMIX disk controllers. You have a wide choice of serial or parallel I/O cards.

**EXPANDABILITY:** You can add memory, I/Os, Video or Graphics cards, Arithmetic processors, additional drive capacity, and other hardware now or in the future to this S550 bus structured system from GIMIX or other S550 bus compatible manufacturers.

**SOFTWARE VERSATILITY:** GIMIX systems can use TSC's FLEX or UNIFLEX and MICROWARE'S OS-9 operating systems. A wide variety of software and languages is available for these systems.

**QUALITY:** All boards are assembled, burned-in, and tested and feature GOLD PLATED BUS CONNECTORS. Only top quality components are used and all boards are fully buffered for maximum system expansion. All boards come complete with bus connectors and all necessary instruction and documentation.

GIMIX designs, manufactures and tests, in-house, their complete line of products. Complete systems are available to fill your needs. Please contact the factory if you have any special requirements.



**GIMIX** inc.

The Company that delivers  
Quality Electronic products since 1975.

1337 WEST 37th PLACE, CHICAGO, IL 60608  
(312) 927-5510 • TWX 010-221-4055

GIMIX\* and GHOST\* are registered trademarks  
of GIMIX inc.

Flex and Uniflex are trademarks of Technical Systems  
Consultants Inc. OS9 is a trademark of Microware Inc. See  
their ads for other GIMIX compatible software.

For GIMIX compatible software see Technical Systems Consultants ad page 199.

# small ad: Big Savings

## Sample Prices

DRIVES-LOBO/TANDON/MPI-From	\$270.00
64K SUPERBRAIN	\$2640.00 QD \$2990.00
ZENITH Z89/48K-1 DRIVE	\$2204.20
C. ITOH STARWRITER (25 cps)	
w/trac.	\$1499.00
DIABLO 630 w/trac.	\$2184.00
NEC 5510 /5530 w/trac.	\$2650.00
EPSON MX-80	\$475.00 MX-80 FT \$575.00
MX-100	\$695.00
FULL LINE OF CCS BOARDS	CALL

Call for prices on items not listed.  
Prices subject to change.  
\$100.00 min. order

SUITE 439 • 111 S. OLIVE STREET  
MEDIA, PA 19063 • (215) 461-5437

## DISK SUPPLY CO.

# DISK III 100% Compatible Model III Disks



Disk III Single  
Drive Assy.<sup>1</sup>  
\$599.00

Disk III Dual  
Drive Assy.  
\$864.00

### IMMEDIATE DELIVERY COMPARE & SAVE

#### VR DATA's Disk III features:

- Completely compatible w/TRSDOS™
- State-of-the-art circuitry.
- Fully tested, calibrated and burned in
- Warranty 120 days
- Installation with simple hand tools
- Optional dual side and/or 80tk.
- Conforms to FCC Class B Specs.

<sup>1</sup>DISK III single drive assembly includes: one 10 track 5 1/4" double density drive, power supply, controller, mounting hardware, and applicable cables.

Prices subject to change without notice.

## VR Data

777 Henderson Boulevard  
Folcroft, PA 19032

To order call toll free-800-245-8102 or (215) 461-5300 in PA.



# Olympic Sales Company

SERVING YOU SINCE 1947

Main Showroom & Offices:  
216 South Oxford Avenue  
Los Angeles, CA 90004

WE HONOR  
VISA and MASTERCHARGE



TELEX: 67 34 77

ORDER DESKS open 7 Days a Week!  
7:00 AM to 7:00 PM Mon thru Sat  
Sunday Noon to 5:00 PM

Order Desks: (213) 739-1130

TOLL-FREE TOLL-FREE  
(outside Calif.) (within Calif.)  
800-421-8045 800-252-2153

Write & request our FAMOUS Catalog!  
Hundreds & hundreds of products from many  
manufacturers such as SONY, CASIO, VICTOR,  
CODE-A-PHONE, MATTEL, SHARP, CANON,  
and on and on... too many to list here!

All goods subject to availability. This ad super-  
saves all previous ads. We are not responsible  
for typographical errors. We will meet or beat  
any advertised prices if the competition has  
the goods on hand.  
Minimum shipping and handling \$4.95.  
All orders subject to verification and acceptance.

## hp HEWLETT PACKARD

HP-85 Microcomputer	3250.00	2595.00
HP-83 Microcomputer	2750.00	1795.00
16K Exp-Memory Module	295.00	258.95
Graphics Plotter 7225	2450.00	2089.95
Personality Mod. for 7225	750.00	579.95
2631B Impact printer/hwy dty	3950.00	3295.00
Option 020 for 2631B	750.00	129.95
8 Disk Drives to choose from		
829025	1300.00	1149.95
8895A 8" Dual Drive	1850.00	5595.00
Graphics Tablet 9111A	2050.00	1699.95

HP-41CV New 2.2K bytes mem	325.00	259.95
HP-41C Calculator	250.00	188.95
Card Reader for 41CV/C	215.00	168.95
Printer for 41CV/C	385.00	284.95
Optical Wand for 41CV/C	125.00	97.95
Dual Ram equah 4 Mem. Mods	95.00	84.95
Memory Modulet for 41C		26.95

HP-97 Programmable Printer	750.00	579.95
HP-67 Programmable Calculator	375.00	297.95
HP-34C Programmable Scientific	150.00	117.95
HP-38C Programmable Bus R/E	150.00	119.95
HP-32E Adv Scientific	55.00	48.95
HP-37E Business Mgmt.	75.00	58.95

We carry a large inventory of Libraries,  
accessories and supplies

## apple computer

We are an AUTHORIZED SERVICING  
APPLE DEALER

the best price in America!

16K 32K-48K-96K-128K	
Drive with controller DOS 3.3 and others.	
80 column cards	
Dow Jones & Quate Reporter	
DC Hayes Micro Modem II	
and others.	
Graphics Tablet	
Pascal and Fortran	
Languages	
VisiCalc and more and more	
APPLE III 96K and 128K "CALL US"	
Ask for Package One to Three Special Price!	



## Texas Instruments

T1 99/4 Home Computer	950.00	\$379.95
10" Color Monitor for 99/4	650.00	319.95
32K Exp. Mem. Module	399.95	314.95
Extended Basic, a MUST for 100.00		75.00
32K Module		
Speech Synthesizer	150.00	129.95
Disk Memory Drive	500.00	397.95
RF Modulator	68.50	48.50
Telephone Coupler (Modems)	225.00	189.95
Printer (local state)	400.00	319.95

T1-58 Programmable Calculator	295.00	189.95
T1-58C Programmable Calculator	130.00	93.95
PC 100C Print/Plot for 59/58	225.00	149.95
T1-57 Scientific Calculator	59.95	39.95
MBA Finance & Business	70.00	51.95
T1 Investor Analyst	65.00	46.95
T1-55 Slide Rule	40.00	32.95
T1 Program Headset/Detail	65.00	48.50

We carry a large inventory of software,  
accessories and supplies

## OHIO SCIENTIFIC

Professional Computers	Retail	Your Cost
COPDF-48K	3495.00	3186.00

- Dual 8" Drives
  - 3 MBPS FAS II
  - 64 col x 32 line/color
  - Many more standard features
  - Fortran & Pascal available
- Many other OSJ products available  
at discounted prices, of course!

## ATARI PERSONAL COMPUTER

SPECIAL! ATARI 400 (16K) \*\*\*\*\*  
Retail: \$595.00 Your Cost: \$339.95  
Language cartridge not included,  
Optional basic language cartridge \$54.95

800 16K bytes of RAM	1080.00	759.95
410 Program Recorder	90.00	75.95
810 Disk Drive	600.00	469.95
825 Printer (88 col)	999.95	779.95
Centronic (33)		
820 Printer (40 col output)	450.00	369.95
830 Apogee Modem	200.00	159.95
850 Interface Module	220.00	179.95
Atari VisiCalc	700.00	169.95

Large inventory of software and accessories.

NEW! From TI-Series 10 Personal Information Terminal Retail 995.00 Your Cost 795.00

## PRINTERS

• DIABLO (Letter Quality)	Retail	Your Cost
830 R102 hi-res dot matrix tractor	2895.00	2699.00
1640K 108 keyboard, tractor	3072.00	2899.95
830 RD Receive only	2710.00	2499.95
1650K 136 keyboard/tractor	3220.00	2999.95

• CENTRONICS dot matrix		
700 S Parallel, heavy duty	1460.00	1199.95
704 S Serial, heavy duty	1795.00	1599.95
737 I Parallel	995.00	799.95
737 S Serial	1045.00	899.95
704 T1 Parallel	1870.00	1699.00
P-1 Electrostatic	495.00	389.95

• PAPER TIGER		
445G with graphics	795.00	685.00
460G with graphics	1394.00	1185.00
560G New full size	1835.00	1399.00

• EPSON		
M8 80 Impact printer	645.00	499.95
M8 16 Impact printer	500.00	399.95
M8 80 FT cut sheet tractor	745.00	639.95
M8 100 FT 15" paper	945.00	785.00

## WE ALSO HAVE

• NOVATION Modems	Retail	Your Cost
CAT	199.95	168.95
D CAT	199.95	158.95
APPLE CAT Direct connect	349.95	314.95

• SANYO Monitors		
High Resolution, Number 1 seller!		
13" Color (new) high quality	550.00	399.95
12" Green Phosphorus	360.00	239.95
12" Black and White	340.00	219.95
15" Black and White	370.00	239.95
9" B/W the best seller!	235.00	149.95

• AMDEK (Leadex) High Quality Monitors		
100 12" B/W, 12 MHz	179.00	129.95
100-80 12" B/W, metal cab., space for floppy	199.00	159.95
100-G 12" Green, 12 MHz	199.00	159.95
300-G 12" Green, 18 MHz	249.00	189.95
Color I 13" Color, NTSC comp. 449.00	329.95	
input, audio amp & speaker		
Color II 13" Color, RGB input, 999.00	899.95	
hi res graphics, speaker		

- MAZELTIME Video Display Terminals
  - SHUGART Disk Drives
  - DEC VT100 & VT103
- Call us for your DISCOUNTED price TODAY!

# INNOVATIVE PRODUCTS

**COMPLETE CATALOG OF COMPUTER EQUIPMENT AT DISCOUNT PRICES.**

**BEST PRICE EVER!**

# \$169

**RAM 65. 16K STATIC S-100 RAM**

BY COMPUTER SYSTEM RESOURCES

**FEATURES:** Switch selectable I/O port bank select 4K address steps. Uses 2114L-3 low power memory 1K de-select feature. Memory protect Phantom, fully socketed, assembled and tested Full one-year warranty.

**TELEVIDEO TERMINALS:**

Model 912C ..... 695 00  
 Model 920C ..... 720 00  
 New! Model 950 ..... 995 00

**EPSON PRINTERS:**

Model MX-70 ..... \$CALL  
 Model MX-80 ..... \$CALL

**Q.T. COMPUTER SYSTEMS:**

MODEL	DESCRIPTION (ALL ASSEMBLED & TESTED)	PRICE
MF-DD12A	25 A Mainframe: 12 Slot, S100, Dual 8" Drive	\$625 00
MF-18A	25 A Tabletop Mainframe 18 Slot S100	450 00
MF-12A	25 A Mainframe: 12 Slot, S100, Dual 5" Drive	450 00
Z-80A	Single Board Z-80 Computer 2/4 Mhz S-100	185 00
Z-80A/22	Monitor Program for Z-80A & Tarbell or VF-1	30 00
RAM 32	32K Static RAM Board, Low Power, S-100	499 00
OTCIOA	2 Serial & 4 Parallel Port I/O, S-100	339 00
OTCCSA	Clock Calendar Board, S-100	125 00
OTCCAA	Clock Calendar Board, for Apple	125 00
OTCCTR80	Clock Calendar Module for TRS-80	125 00

**VISTA COMPUTER COMPANY:**

MODEL	DESCRIPTION (ALL ASSEMBLED & TESTED)	PRICE
V300/25	Letter Quality Printer 25 CPS	\$1895 00
V300/45	Letter Quality Printer 45 CPS	2195 00
V-DRIVE	Dual 8" Disk Cabinet, Power Supply, Rack Mountable	375 00

**COMPUTER SYSTEM RESOURCES:**

MODEL	DESCRIPTION (ALL ASSEMBLED & TESTED)	PRICE
RAM 16	16K Static RAM S-100	\$189 00
RAM 16C	Low Power (CMOS) Version of RAM 16, 1.3 Watt	259 00
RAM 65	16K Static RAM, I/O Port Bank Select, S-100	169 00
RAM 65C	Low Power (CMOS) Version of RAM 65, 1.4 Watt	279 00
RAM 32	32K Low Power 8/16 Bit Static RAM, Fully IEEE 696	499 00
RAM 256	256K 8/16 Bit Dynamic RAM Fully IEEE 696	1295 00
I/O-B	8 Port Serial I/O, Fully IEEE, up to 200K BAUD	395 00

**ORDERING INFORMATION:**

Minimum Order is \$15 00. Prices quoted do not include shipping and handling. Foreign orders require prepayment by MICR or Money Order in U.S. funds. Purchase Orders accepted from U.S. Government & firms with published A1 Rating from Dunn & Bradstreet. All other orders require prepayment, charge card, or COD shipment.

**TOLL-FREE PHONE NUMBER:**

Call Toll-Free: 1 (800) 423-5141. In Alaska, and Hawaii, call us collect at (213) 883-3244.

**TO RECIEVE OUR FREE CATALOG:**

Call our Toll-Free (800) number, or circle Reader Service #

7131 OWENSMOUTH AVE. / #21D  
 CANOGA PARK, CALIFORNIA 91303  
 213 / 883-3244  
 800 / 423-5141



## Books Received

*Apple Crunch*, novel by Frederic Vincent Huber. New York: Seaview Books, 1981; 15 by 22 cm, 264 pages, hardcover, ISBN 0-87223-687-0, \$10.95.

*Calculator Clout: Programming Methods for Your Programmable*, Maurice D Weir. Englewood Cliffs NJ: Prentice-Hall, 1981; 18.5 by 24.5 cm, 235 pages, hardcover, ISBN 0-13-110411-X, \$17.95; softcover, ISBN 0-13-110403-9, \$8.95.

*Computers for Everybody*, Jerry Willis and Merl Miller. Beaverton OR: Dillithium Press, 1981; 14 by 22 cm, 173 pages, softcover, ISBN 0-918398-49-5, \$4.95.

*Computer Literacy: Problem-Solving with Computers*, C E Horn and J L Poirot. Austin TX: Sterling Swift Publications, 1981; 18.5 by 23.5 cm, 304 pages, softcover, ISBN 0-88408-133-8, \$13.95.

*Computer Solution of Large Sparse Positive Definite Systems*, Alan George and Joseph W Liu. Englewood Cliffs NJ: Prentice-Hall, 1981; 16 by 23.5 cm, 324 pages, hardcover, ISBN 0-13-165274-5, \$24.95.

*The Devil's DP Dictionary*, Stan Kelly-Bootle. New York: McGraw-Hill, 1981; 13.5 by 20.5 cm, 141 pages, softcover, ISBN 0-07-034022-6, \$7.50.

*Electronic Circuits Note Book. Proven Designs for Systems Applications*, edited by Samuel Weber. New York: McGraw-Hill, 1981; 22 by 28 cm, 344 pages, hardcover, ISBN 0-07-019244-8, \$32.50.

*Manual of Pharmacologic Calculations with Computer Programs*, Ronald J Tallarida and Rodney B Murray. New York: Springer-Verlag, 1981; 16 by 24.5 cm, 150 pages, hardcover, ISBN 0-387-90500-6, \$17.50.

*Microsoft FORTRAN*, Paul M Chirlian. Beaverton OR: Dillithium Press, 1981; 14 by 22 cm, 333 pages, softcover, ISBN 0-918398-46-0, \$14.95.

*Outland, The Movie Novel*, edited by Richard J Anobile, from the screenplay by Peter Hyams. New York: Warner Books, 1981; 22 by 27.5 cm, 160 pages, softcover, ISBN 0-446-97829-9, \$9.95.

*Program Flow Analysis: Theory and Applications*, S S Muchnick and N D Jones. Englewood Cliffs NJ: Prentice-Hall, 1981; 16 by 23.5 cm, 418 pages, hardcover, ISBN 0-13-729681-9, \$23.50.

*Scientific Analysis for Programmable Calculators with Algebraic Operating Systems*, H R Meck. Englewood Cliffs NJ: Prentice-Hall, 1981; 18.5 by 24.5 cm, 175 pages, hardcover, ISBN 0-13-796417-X, \$15.95; softcover, ISBN 0-13-796409-9, \$7.95.

*Software Metrics*, edited by A J Perlis, F G Sayward, and M Shaw. Cambridge MA: The MIT Press, 1981; 16 by 23.5 cm, 404 pages, hardcover, ISBN 0-262-16083-8, \$25.

*Thirty-Two BASIC Programs for the Exidy Sorcerer*, T Rugg, P Feldman, and K McCabe. Beaverton OR: Dillithium Press, 1981; 14 by 22 cm, 265 pages, softcover, ISBN 0-918398-35-5, \$16.95. ■

This is a list of books received at BYTE Publications during this past month. Although the list is not meant to be exhaustive, its purpose is to acquaint BYTE readers with recently published titles in computer science and related fields. We regret that we cannot review or comment on all the books we receive; instead, this list is meant to be a monthly acknowledgment of these books and the publishers who sent them.

# Clipper™

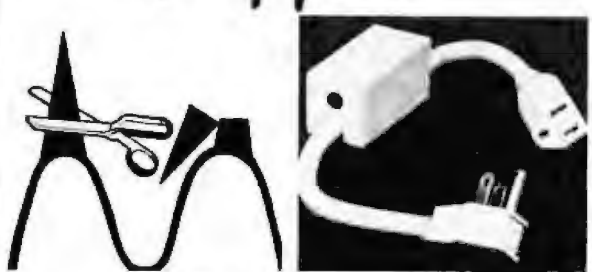

## LINE VOLTAGE TRANSIENT CLIPPING

Features Parallel Operation      5000 Hits/Second

**PROTECTS:**

- Computers
- Micro-Computer Systems
- Word Processors
- Cash Registers
- Power Supplies

**PROTECTS AGAINST:**

- High Energy Voltage Transients
- On-Off Switching
- Lightning Induced Transients
- Inrush of On/Off Power



TRANSIENT VOLTAGE SURGE SUPPRESSOR LISTED

### DYMARC INDUSTRIES, INC.

Dealer Inquiries Invited.

7133 Rutherford Rd. Baltimore, Md. 21207  
(301) 298-3130      800-638-9098

## CATCH THE S-100 INC. BUS!



	LIST PRICE	OUR SPECIAL CASH PRICE
S.D. Systems 80x24 Video Board A&T	556.00	420.00
S.D. Systems Versafloppy II Double Density Disk Controller w/SDOS, DDBIOS, VDIAG3, & Monitor; A&T	500.00	380.00
Shugart SA 800/801R Bare Drive	600.00	399.00
IMC Disk Box for 5¼" Drives	39.00	29.00
SSM I/O-4 Kit 2 Parallel + 2 Serial	210.00	168.00
Mullen TB-4 Extender Kit w/Probe	59.00	47.00

Subject to Available Quantities • Prices Quoted Include Cash Discounts Shipping & Insurance Extra

We carry all major lines such as  
S.D. Systems, Cromemco, Ithaca Intersystems, North Star, Sanyo, ECT, TEI, Godbout, Thinker Toys, SSM.  
For a special cash price, telephone us.

*Please note our new address.*

## S-100, inc.

14425 North 79th Street, Suite B  
Scottsdale, Arizona 85260  
800-582-3138 • 602-991-7870  
Hours: Mon. - Fri. — 9 a.m. to 6 p.m. MST

# 6809 COLOR COMPUTER

## EDITOR, ASSEMBLER AND MORE!

**NEW!**

### SOFTWARE DEVELOPMENT SYSTEM

The Micro Works Software Development System (SDS80C) is a complete 6809 editor, assembler and monitor package contained in one Color Computer program pack! Vastly superior to RAM-based assemblers/editors, the SDS80C is non-volatile, meaning that if your application program bombs, it can't destroy your editor/assembler. Plus it leaves almost all of 16K or 32K RAM free for your program. Since all three programs, editor, assembler and monitor are co-resident, we eliminate tedious program loading when going back and forth from editing to assembly and debugging!

The powerful screen-oriented Editor features finds, changes, moves, copies and much more. All keys have convenient auto repeat (typamatic), and since no line numbers are required, the full width of the screen may be used to generate well commented code.

The Assembler features all of the following: complete 6809 instruction set; complete 6800 set supported for cross-assembly; conditional assembly; local labels; assembly to cassette tape or to memory; listing to screen or printer; and mnemonic error codes instead of numbers.

The versatile ABUG monitor is a compact version of CBUG, tailored for debugging programs generated by the Assembler and Editor. It features examine/change of memory or registers, cassette load and save, breakpoints and more. SDS80C Price: \$89.95



### CRACK THOSE ROMS!

**SOURCE GENERATOR:** This package is a disassembler which runs on the color computer and generates your own source listing of the BASIC interpreter ROM. Also included is a documentation package which gives useful ROM entry points, complete memory map, I/O hardware details and more. A 16K system is required for the use of this cassette. 80C Disassembler Price: \$49.95

---

### CBUG IS HERE!

**MONITOR TAPE:** A cassette tape which allows you to directly access memory, I/O and registers with a formatted hex display. Great for machine language programming, debugging and learning. It can also send/receive RS232 at up to 9600 baud, including host system download/upload. 19 commands in all. Relocatable and reentrant. CBUG Tape Price: \$29.95

**MONITOR ROM:** The same program as above, supplied in 2716 EPROM. This allows you to use the entire RAM space. And you don't need to re-load the monitor each time you use it. The EPROM plugs into the Extended Basic ROM Socket or a modified ROMPACK. CBUG ROM Price: \$39.95

**LEARN 6809!**

6809 ASSEMBLY LANGUAGE PROGRAMMING, by Lance Leventhal, contains the most comprehensive reference material available for programming your Color Computer. Price: \$16.95

**PARALLEL O!**

USE A PARALLEL PRINTER with your Color Computer! Adaptor box plugs into the serial port and allows use of Centronics/Radio Shack compatible printers with parallel interface. Assembled and tested. P180C Price: \$69.95

**32K RAM!**

MEMORY UPGRADE KITS: Consisting of 4116 200ns integrated circuits, with instructions for installation. 4K-16K Kit Price: \$39.95. 16K-32K Kit (requires soldering experience) Price: \$39.95



## GOOD STUFF!

**WE SHIP FROM STOCK!**  
Master Charge/Visa and COD Accepted



P.O. BOX 1110 DEL MAR, CA 92014    714-942-2400

THE TSE-HARDSIDE 1982 MICRO-COMPUTER BUYER'S GUIDE



is now available! We've included such valuable information as print samples from each of the printers we carry, feature-by-feature comparisons of Micro-Computer systems in an easy-to-read table format, an informative article on Micros, and pages and pages of complete product descriptions.

We're making this valuable reference available for only \$2.95 (refundable on your next purchase from TSE-HARDSIDE.) Charge customers are welcome to call our toll-free number: 1-800-258-1790 (in NH call 673-5144) THE TSE-HARDSIDE 1982 MICRO-COMPUTER BUYER'S GUIDE will soon arrive at your address via first class mail.

Send to:

**TSE-HARDSIDE**  
Dept. C, 14 South Street  
Milford, NH 03055

Yes! Send me the **TSE-HARDSIDE 1982 Micro-Computer Buyer's Guide.**

89

I've enclosed \$2.95      Please send only your FREE Price List  
Charge to my credit card      MasterCard      Visa

Card No. \_\_\_\_\_  
Interbank No. \_\_\_\_\_ Exp. Date \_\_\_\_\_  
Signature \_\_\_\_\_  
Name \_\_\_\_\_  
Address \_\_\_\_\_  
City \_\_\_\_\_  
State \_\_\_\_\_ Zip Code \_\_\_\_\_

**BUS-TO-BUS COMMUNICATION**

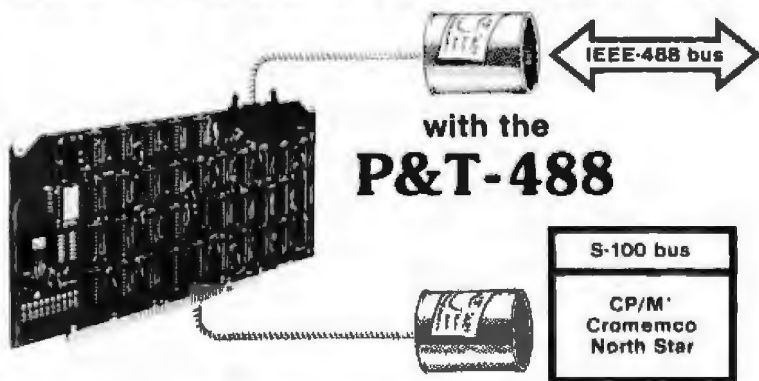

- Inexpensive S-100 computers can now communicate with the IEEE-488 instrumentation bus. The P&T-488 meets the IEEE-488 1980 standard for controller, listener, and talker.
- "Canned" software allows simple communication with the 488 bus from Basic, Pascal, and other high level languages.
- Special features include an interactive busmonitor program and a functional self-test program.



Price for (1) P&T-488 with software, assembled and tested: \$450 (domestic price) FOB Goleta, CA  
CP/M is a registered trademark of Digital Research

**PICKLES & TROUT**  
P O BOX 1206. GOLETA, CA 93116. (805) 685-4641

**Clubs and Newsletters**

**Join a Georgian Club**

The Statesboro TRS-80 Users Group is interested in all aspects of TRS-80 computers, especially word-processing and business applications. Contact the club c/o Dr Russell A Dewey, 223 N Edgewood Dr, Statesboro GA 30458, (912) 681-3631.

**Apple Guild**

The Apple Guild promotes the interchange of information and applications among Apple users. The Guild maintains a collection of hard-copy material and software at the Apple Resource Center. The Resource Center is located at Massasoit Community College, Brockton, Massachusetts. The Guild publishes a quarterly journal and supports a telecommunications system at (617) 767-1303. Contact the Apple Guild, POB 371, Weymouth MA 02188.

**Ohio Apples**

The NEO Apple Corps is devoted to Apple computers. The Corps publishes a newsletter called *Apple Bits*. Contact the group at 21750 Miller Ave, Euclid OH 44119, (216) 486-2317.

**Micropolis Users Group**

Members of the Micropolis Users Group use Micropolis disk drives in their computer systems. The group offers its members a monthly newsletter and discounts on software. Also available are library disks and directories of software vendors and group



# Apple Dealers....

We Need  
You



 **apple computer**

We've written TRAVO, a complete surveying package that is second to none. It has all the routines needed for surveying. It's menu driven and heavily prompted. The manual was written in straightforward every day surveying language by a third generation surveyor who has been working with computers since 1965.

Surveyors are generally accustomed to dedicated calculators or computers. Most of them are just doing their surveying and engineering computations and are not utilizing the capability of a general purpose computer like the Apple to do payroll, G/L, A/P, A/R, word processing or job costing.

That's where you come in. You sell 'em the hardware and the other software and we'll help you sell 'em our program. If you or your customer have questions, we'll be happy to answer them for you.

TRAVO is no stranger to surveyors. We're advertising in all national surveying publications. We have satisfied users all over the U.S.

Our discounts are great.  
Call or write for a user manual.

## Surveyors Supply Co.



P.O. Drawer 808 Hwy 64 at Old Hwy 1  
Apex, N.C. (919) 362-7000

## LDP88 8088 CPU BOARD

- 8088 CPU 5 MHz operation upgradeable to 8 MHz • 8 vectored interrupts • Fully complies with IEEE 696 electrical and timing specs • RS232 serial port with modem controls • 1K bytes of static RAM • 2 EPROM sockets (2716 or 2732) • 8087 upgrade kit available in Sept. • 8 bit bus sees interface to other S100 bus boards • 1MByte address space • 65K I/O ports

## 64/256K MEMORY

- 8 or 16 bit operation • Meets all IEEE 696 specs • Access time 350 ns from PSYNC low • Intel 8203 dynamic RAM controller • 24 or 18 bit address decoding • No wait states with 5 MHz 8088 or 8086 • Parity with Error Interrupt generation • No DMA RESTRICTIONS • 64K board is upgradeable to 256 Kbyte board

## HAZITALL

- 2 Serial RS232 ports • 2 parallel ports with handshake control • Math processor support (8231/9511 or 8232/9512) • WINCHESTER DISK support • Real time programmable interrupt • Clock/calendar with battery back up • Synchronous data communication supported

## LDP72 FLOPPY DISK CONTROLLER

- IBM compatible single and double density format • Single or double sided drives • Programmable data record length (128 to 8192 bytes/sector) • Multi sector and multi track transfer capability • Parallel seeks on up to 4 drives • On board digital data separator • Software selectable single or double density operation • Separate connectors for 5 1/4" and 8" drives • Software selection of standard or minidrives allowing mixing of both drives on a single controller

### Software support for 86-DOS and CP/M-86.

CP/M-86	\$250	86-DOS	\$195.00
LDP88	\$349.95	LDP72	\$274.95
HAZITALL	\$325.00	LDP84K RAM	\$695.00
LDP128K RAM	\$1295.00	LDP256K RAM	\$2095.00

Complete systems also available.

CP/M-86 is a trademark of Digital Research  
86-DOS is a trademark of Seattle Computer Products

## LOMAS DATA PRODUCTS

11 Cross Street  
Westborough, MA 01581  
Telephone: (617) 366-4335

SAVE \$\$

# DISCOUNT PRICES

SAVE \$\$



 **apple computer**

16K APPLE II	1089.00
32K APPLE II	1134.00
48K APPLE II	1179.00
DISK W/CONTROLLER	535.00
DISK ONLY	455.00
APPLESOFT CARD	159.00
INTEGER CARD	159.00
PASCAL SYSTEM	425.00
SILENTYPE PRINTER	525.00
HAYES MICROMODEM	295.00
Z-80 SOFTCARD	285.00
VIDEX 80 COL. BRD.	295.00
16K RAM BOARD	169.00

### RAM MEMORY

FOR TRS-80, APPLE II	
16K SET 4116's (200 NS)	34.95



 **ATARI**

400 16K	349.00
800 16K	759.00
410 Recorder	64.00
815 Disk	1199.00
810 Disk	489.00
822 Printer	359.00
825 Printer	779.00
830 Modem	159.00
850 Interface Module	179.00
CX853 RAM	85.00
CX70 Light Pen	64.00
CX30 Paddle	18.00
CX40 Joystick	18.00

### VERBATIM DISKETTES

Box of 10 5 1/4"	29.50
Box of 10 8"	39.50



**North Star Computers**

HR2-2D-32K	2795.00
HR2-2D-48K	2956.00
HR2-2D-64K	3145.00
HR2-2Q-32K	2975.00
HR2-2Q-48K	3185.00
HR2-2Q-64K	3360.00
HRAM 32K	469.00
HRAM 48K	662.00
HRAM 64K	849.00
HDS-18 HARD DISK	4025.00
MDS-DRV-D	495.00
MDS-DRV-Q	665.00
ADC-1-D	740.00
ADC-2-D	995.00
ADC-1-Q	795.00
ADC-2-Q	1265.00

### PRINTERS

EPSON MX-70	399.00
EPSON MX-80	499.00
EPSON MX-80 FT	599.00
GRAFTRAX	90.00
INTERFACE (APPLE)	75.00
CABLE	22.50
CENTRONICS 737-1	795.00
CENTRONICS 737-3	855.00
IDS 445G	815.00
IDS 480G	1195.00
IDS 560G	1450.00
NEC 5510 W/TRACTORS	2650.00
NEC 5520 KSR W/TRAC.	2995.00
QUME 5/45 SPRINT	2675.00
FORMS TRACTOR	185.00
STARWRITER W/TRAC.	1895.00
STARWRITER W/O TRACTOR	1500.00

### General Information:

We carry a large selection of hardware and software by other companies. Send for our catalog  
We are an authorized repair center for APPLE, ATARI, NORTH STAR, AND EPSON.

PRICES SUBJECT TO CHANGE WITHOUT NOTICE. MARYLAND RESIDENTS ADD 5% SALES TAX

## FREDERICK COMPUTER PRODUCTS, INC.

5726 INDUSTRY LANE  
FREDERICK, MD. 21701

### Store Hours:

MON. THRU THURS. 9:30 AM—9:00 PM  
FRI. AND SAT. 9:30 AM—5:00 PM

TO ORDER CALL: (301) 694-8884

## ATTENTION GOVERNMENT D P USERS AND PURCHASERS

We represent many fine micro products and manufacturers on the U.S. Government's GSA Schedule, including

***Apple, Cromemco, Micropolis  
and Seequa Computers***

Purchasing from the Schedule will save you the time consumed by the bid process. Products shipped throughout the United States and world-wide. Visit or write any of our stores for more information or to receive our catalogue of products represented.

**Computers,  
Etc.....  
the dependable store**

257 West Street, Annapolis, MD 21401 - (301) 268-6505  
13A Allegheny Avenue, Towson, MD 21204 - (301) 296-0520  
9330 Georgia Avenue, Silver Spring, MD 20910 - (301) 588-3748  
6671 Backlick Road, Springfield, VA 22150 - (703) 644-5500  
Plaza 38, 2442 Route 38, Cherry Hill, NJ 08002 - (609) 779-0023  
Callers outside metropolitan areas served by our stores  
Please call (301) 268-5801  
*Career Opportunities Available \* An Equal Opportunity Employer*

## LETTER QUALITY PRINTER

- DUAL USE. A PRINTER AND A TYPEWRITER
- SELF TEST PROGRAM BUILT IN

The BYTEWRITER is a printer consisting of a micro-processor controlled assembly internally connected to an SCM Coronamatic 8000 office typewriter.



**\$795**

### OTHER FEATURES

- Back space.
- Parallel input.
- Pin compatible with TRS-80 expansion interface.
- Typewriter operation with nothing to disconnect.

### TO ORDER

- Send certified check or money order. Personal checks take 2 weeks.
- We do not ship C.O.D.
- Add \$10 for shipping and handling in continental U.S.A.
- N.Y.S. residents add 7% sales tax.

## BYTEWRITER

125 NORTHVIEW RD., ITHACA, N.Y. 14850  
(607) 272-1132

SCM Coronamatic 8000 is a trademark of SCM Corp.  
TRS-80 is a trademark of Tandy Corp.  
BYTEWRITER is a trademark of Williams Laboratories

members. Contact the Micropolis Users Group at 604 Springwood Cr, Huntsville AL 35803, (205) 883-2621.

### MCMS

MCMS (Military/Civilian Microcomputer Society) is devoted to the exchange of ideas and information about all types of computers. No particular microcomputer is emphasized. Contact the Military/Civilian Microcomputer Society, Gunter AFS, AL 36114, or call Jim Wolfe at (205) 279-4816.

### Lists of Used Microcomputers

The Used Computer Exchange is a listing service that puts you in direct contact with sellers. Customers pay \$5 for quotes on completed transactions and for full current listings. Sellers pay a commission only if a transaction is completed with a buyer referred by the Exchange.

The Used Computer Exchange lists any microcomputer hardware that originally sold in the \$400 to \$25,000 price range. Contact the Used Computer Exchange at 2329 Hunters Woods Plz, Reston VA 22091, (800) 327-9191, ext 61; in Virginia, (703) 471-0044.

### 1802 Fans

The VIP Hobby Computer Association is made up of users of the RCA VIP and other 1802-based microcomputers. The group's newsletter, *Viper*, contains programs, advice, and helpful hints. Membership fees are \$12 per year, which includes the newsletter. Contact the VIP Hobby Computer Asso-

# Components Express, Inc.

"Have you kissed your computer lately?"

1380 E. Edinger, Unit CC Santa Ana, CA 92705 (714) 558-3972

## BROAD BAND MICROWAVE RECEIVER SYSTEM 1.8GHZ to 2.4 GHZ

only  
**\$295.00**



With built-in-converter to channel 2, 3, or 4 of any standard TV set.

**RANGE** Line of sight to 250 miles

**SCOPE** Will receive within the frequency band from satellites, primary microwave stations, and repeater microwave booster stations

**CONTENTS** Packaged in 19"x19"x4 1/2" corrugated carton complete with:

- 24" Dish
- 300 Ohm to 75 Ohm Adapter
- Feed-Horn Receiver
- 750 Ohm to 300 Ohm Adapter
- Mounting Bracket
- 60 Feet Coax Cable with Connectors
- Mounting Clamp
- 3 Feet Coax Cable with Connectors
- Instructions

**WARRANTY:**

180 days for all factory defects and electronic failures for normal usage and handling. Defective sub assemblies will be replaced with new or re-manufactured sub assembly on a 48 hour exchange guarantee.

This system is not a kit and requires no additional devices or equipment other than a TV set to place in operation. **DEALER INQUIRIES INVITED.**

# GET THE BUG OUT OF YOUR PROGRAM!



Locate the bug in your program quickly with the all-new BUG CATCHER. Reliable and easy to use, this timesaver fits easily in pocket or case. Functional for any computer where EPROMs



are used. Capable of halting the cpu at any specific address. Stop losing time and patience. BUG CATCHER is the efficient answer. \$195 complete (plus applicable sales tax)



## BUGCATCHER

MARTEC SYSTEMS, INC  
P.O. BOX 2069, NEWBURGH, NY 12550 (914) 265-4044

### PMC PERSONAL COMPUTER

Ideal for small businesses, schools, colleges, homes, etc. Suitable for the experienced, inexperienced, hobbyist, teacher, etc.

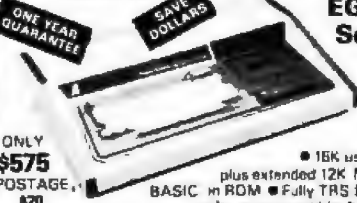

#### EG3000 Series

WITH NEW EXTRA KEYS!

ONLY \$575  
POSTAGE \$20

• 16K user RAM plus extended 12K Microsoft BASIC in ROM • Fully TRS 80 Level II software compatible • Huge range of software already available • Self contained PSU, UHF modulator, and cassette • Simply plugs into video monitor or UHF TV • Full expansion to disks and printer • Absolutely complete just fit into mains plug



#### SHARP PC1211 \$190

COMPUTER POWER THAT ONCE FILLED A ROOM CAN NOW BE CARRIED IN YOUR POCKET!

- Programs in BASIC • "QWERTY" Alphabetic Keyboard • 1.8K Random Access Memory • Long Battery Life.

### TV GAME BREAK OUT KIT

This isn't to be one of the world's greatest TV games. You really get hooked. Has also 4 other pinball games and lots of options. Good for the teenagers and amusement games.



**MINI KIT** PCB, source & video modulator, memory chip and de-coupler. Very simple to construct. \$30.00  
**OR** PCB \$6.00 MAIN LSI \$17.00

### TTL SALE

74LS00	\$0.15	74LS74	\$0.45	74LS365	\$0.75
75LS04	\$0.15	74LS86	\$0.55	74LS373	\$2.20
74LS05	\$0.20	74LS93	\$0.90	Z80A	\$5.50
74LS10	\$0.29	74LS157	\$1.20	Z80	\$4.20
74LS32	\$0.35	74LS165	\$1.75	REG 7805	\$0.90

#### SOCKETS LOW PROFILE

14 PIN	\$0.10	18 PIN	\$0.15	24 PIN	\$0.25
16 PIN	\$0.10	20 PIN	\$0.15	40 PIN	\$0.30

10V Power Adapter 600ml. \$6.90 UHF Modulators \$9.90

### GET YOURSELF A NEW EPSON MX80 & MX70 PRINTER AND SAVE A FORTUNE

Price on application

Interface Cards for Apple, Pet, TRS80 and PMC. RS232 Interface Cards not necessary for parallel. Full TRS80



### COMP PRO MIXER

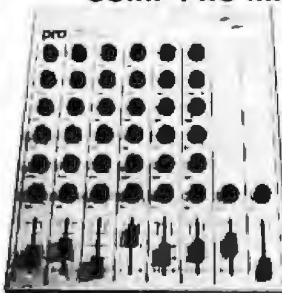

Professional audio mixer that you can build yourself and save over \$200.

Only \$199 for complete kit  
power supply \$50.00  
POSTAGE \$20

### ACCESSIT AUDIO ADD-ONS

## LOOK! MICROACE/SINCLAIR USERS

### 8K FLOATING POINT SUPER ROM PACK

WITH NEW MANUAL ONLY \$35

### MICROACE/SINCLAIR VIDEO UPGRADE KIT

Only runs with NEW ROM (Smooth screen display) ONLY \$29

### MICROACE/SINCLAIR 16K RAM PLUS EXPANSION BOARD

3 SLOTS WITH EXTRA POWER SUPPLY  
ONLY 16K \$149 ONLY 4K \$110

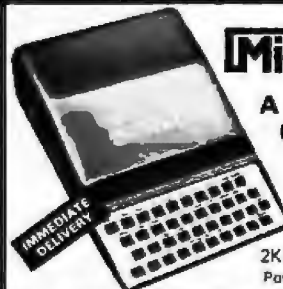

## MicroAce

### A COMPLETE COMPUTER

A new generation of miniature computers

2K Kit ONLY \$149 Post and Packing FREE

Sinclair is a Registered Trademark of Sinclair Research Ltd

## MicroAce



Please make checks and money orders payable to **MicroAce** or phone your order quoting **Master Charge, Visa, Diners Club or American Express** number for immediate despatch. Add 6% Tax for Shipments inside California. **MicroAce, 1348 East Edinger, Santa Ana, California, Zip Code 92705. Telephone: (714) 547 2526**

# UNBELIEVABLE!

**State-of-the-art Single-Board computer now available! Can be used in S-100 (Master, Slave, Multi or Single user) or Stand-Alone configurations.**

FINALLY, state-of-the-art performance is available at an affordable price.

**COMPARE THESE FEATURES:**

- Z80A or Z80B
- 4 TIMERS (ZTC)
- 64K RAM (640X1 CHIPS)
- 2 SERIAL PORTS (ZSIO)
- 4 PARALLEL PORTS (ZPIO)
- UP TO 16K EPROM (Z732)
- NEC FLOPPY DISK CONTROLLER (UP TO FOUR 8" DOUBLE SIDED/DOUBLE DENSITY DRIVES)
- INTELLIGENT WINCHESTER INTERFACE
- ON-BOARD EPROM BURNER (DOES NOT REQUIRE 24V)

**FOR THESE SINGLE QUANTITY PRICES:**

- 4M2 VERSION (Z80A) **\$895<sup>00</sup>**
- 6 M2 VERSION (Z80B) **\$1,195<sup>00</sup>**
- 4 M2 SLAVE PROCESSOR (NO DISK CONTROLLERS ON BOARD) **\$795<sup>00</sup>**
- 6 M2 SLAVE PROCESSOR (NO DISK CONTROLLERS ON BOARD) **\$1,095<sup>00</sup>**

The S-100 version of this product can act as a Master processor, Slave processor, or Intelligent peripheral controller. Intra-processor communication is achieved through the use of efficient, high speed bus transfers using special hardware/software techniques.

We also have what we think is one of the best implementations of a CP/M BIOS available off the shelf. The BIOS has the following features:

- All Devices INTERRUPT DRIVEN
- Type Ahead Input/Output Buffers
- Real-Time Clock
- Time Of Day Clock
- Multi-level User Password Support
- Menu Driven Utilities for Format, Disk Copy, etc.
- Unique Configuration Utility Program for Setting Baud Rates, Changing Step Time, Changing Passwords, etc.
- Cylinder Concept used for Double Sided /Double Density Configuration Resulting in Increased Performance

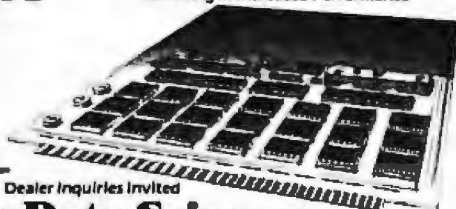

CP/M is a registered trademark of Digital Research Corporation

Dealer Inquiries Invited

## Sierra Data Sciences

1800 East Shaw Avenue • Suite 164 • Fresno, California 98710 • (800) 884-0880

## ATTENTION GOVERNMENT D P USERS AND PURCHASERS

We represent many fine micro products and manufacturers on the U.S. Government's GSA Schedule, including

*Apple, Cromemco, Micropolis and Seequa Computers*

Purchasing from the Schedule will save you the time consumed by the bid process. Products shipped throughout the United States and world-wide. Visit or write any of our stores for more information or to receive our catalogue of products represented.

**Computers,  
Etc.....  
the dependable store**

- 257 West Street, Annapolis, MD 21401 - (301) 268-6505
  - 13A Allegheny Avenue, Towson, MD 21204 - (301) 296-0520
  - 9330 Georgia Avenue, Silver Spring, MD 20910 - (301) 588-3748
  - 6671 Backlick Road, Springfield, VA 22150 - (703) 644-5500
  - Plaza 38, 2442 Route 38, Cherry Hill, NJ 08002 - (609) 779-0023
- Callers outside metropolitan areas served by our stores  
Please call (301) 268-5801

*Career Opportunities Available \* An Equal Opportunity Employer*

ciation, 32 Ainsworth Ave,  
East Brunswick NJ 08816.

### Amethyst Users Group In Texas

Amethyst is an expandable text editor and formatter distributed by Mark of the Unicorn. Amethyst's command set is written in BDS C. The Amethyst Users Group assists users in developing extensions to Amethyst. Annual membership is \$6, and floppy disks are \$6. Contact the group at 1633 Royal Crest, #1128, Austin TX 78741, (512) 441-9466.

### Sorcerer Users Newsletter

Port Fe is a newsletter for Evidy Sorcerer users. It includes articles, equipment reviews, and program listings. Subscriptions are \$15 in Canada and \$23 elsewhere. Contact the Sorcerer Users Group Toronto, POB 1173, Station B, Downsview, Ontario, M3H 5V6, Canada.

### Club In the Heart of Texas

The Midland Microcomputer Users Association meets at 7 PM on the first Wednesday of the month at the Sound Machine in Midland, Texas. The club's main interests are exchanging information and assisting new computer hobbyists. If you own a microcomputer, you are invited to join, even if you don't live in the area. The annual fee is \$15, and a newsletter is being worked on. Contact the Midland Microcomputer Users Association, 1024 Andrews Hwy, Midland TX 79701; or contact Mark T Cruse, 3609 Stanolind, Midland TX 79703. (915) 694-4868. ■

# CAT-100 FULL COLOR GRAPHICS

The original 256-color imaging system with high resolution video FRAME GRABBER for the S-100 bus.

Capture and digitize a video frame in 1/60 of a second. Select the best resolution for your application, from 256 to 1280 pixels per TV line. Display your digitized or computer processed image with 256 gray levels or 256 colors on standard B&W, NTSC or RGB color TV monitors.

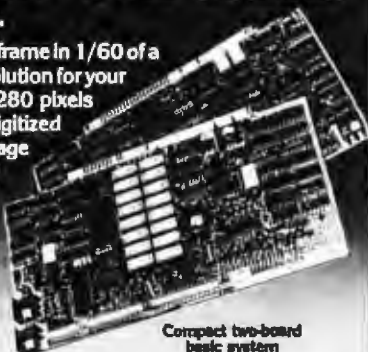

Compact two-board basic system



240x256 Digitized image, 16 levels

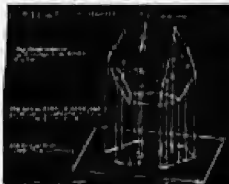

480x512 Computer-generated

**Features:**

- Highest possible quality 480x512x8 digital video image presently available on the market
- Input capability from TV camera or other sources
- Variety of synchronization choices
- 2 selectable video A/D conversion circuits
- Choice of 1, 2, 4, 8, 16 or 32 bits per pixel
- 32K-byte image memory on the basic system
- 32, 64, 128 & 256K byte system capacity
- Lightpen Input
- Photographic trigger control input
- Software selectable system parameters
- Interfaces for TRS-80 and other processors
- Comprehensive line of accessories, monitors and support software

SEND FOR FREE CATALOG



DIGITAL GRAPHIC SYSTEMS

935 Industrial Ave., Palo Alto, CA 94303 415/856-2600

ADA

JANUS



the language that is based on the past but looks to the uses of the future:

JANUS is a true compiler for a subset of ADA. ADA is the much awaited U.S. Department of Defense language. With JANUS, it is available now on your CP/M system.

**JANUS has such features as:**

- Separate Compilation
- Records with variants
- Subranges, Enumerations, and Arrays
- Initialized Variables
- Integers and Arbitrary Precision Reals
- Produces ROMable, Re-entrant BOBO machine code and much more . . .

JANUS is the face of the future. The structured language that you need for efficient programming. This is your chance to get to the head of the crowd and learn the language that will be the language of the 80's.

JANUS requires an 8080/8085 or Z80 CPU, 56K of memory, and at least one 8" floppy disk. JANUS is supplied on a single density 8" floppy. For \$250, you get the JANUS compiler, linker, assembler, and owners manual.

CP/M is a trademark of Digital Research, Inc. ADA is a trademark of the U.S. Department of Defense

RR SOFTWARE

specialists in state of the art programming

P.O. BOX 1512

MADISON, WISCONSIN 53701

THE UNBEATABLE COMBINATION :



AND TEAM ELECTRONICS

1 (800) 547-2492

APPLE 16k+ \$1039  
48k+ \$1089

ATARI 400 (16k)\* \$329  
800 (16k) \$749

\*w/o BASIC

TOLL FREE NUMBER FOR ORDER DESK ONLY. IN OREGON CALL 478-8723. REPAIRS, PARTS, AND WARRANTIES CALL (503) 479-4150. SORRY NO C.O.D.'S. MASTERCHARGE AND VISA ADD 3%. WE WILL SHIP U.P.S. FREIGHT COLLECT OR ADD 3% FOR FREIGHT AND INSURANCE TO AVOID C.O.D. CHARGES. ALLOW 10 DAYS FOR PERSONAL CHECKS TO CLEAR. PRICES SUBJECT TO CHANGE WITHOUT NOTICE. PRICES GOOD AT MAIL ORDER DEPARTMENT OF STORE #162 ONLY.

APPLE		HARDWARE	
DISK DRIVE W/3.5 CONTROLLER	499	9" B&W MONITOR (SANYO)	159
DISK DRIVE ONLY	429	8" B&W MONITOR (N.E.C.)	169
DOT MATRIX PRINTER W/INTERFACE	349	12" B&W MONITOR (SANYO)	199
GRAPHICS TABLET	829	12" GREEN MONITOR (SANYO)	259
APPLESOFT OR INTEGER FIRMWARE	129	13" COLOR MONITOR (T.I.)	349
LANGUAGE CARD (PASCAL)	209	I.D.S. 480G PRINTER	989
PARALLEL PRINTER CARD	129	I.D.S. 480G PRINTER	1099
SERIAL PRINTER CARD	199	I.D.S. 960G PRINTER	1329
CENTRONICS PRINTER INTERFACE CARD	149	EPSON MX-80 PRINTER	479
C.C.S. 7716A	139	EPSON CABLE AND INTERFACE	89
C.C.S. 7726A	109	CENTRONICS 727.1 PRINTER	749
DATA SHIFT ADAPTOR	99	CENTRONICS 729.2 PRINTER	899
16K RAM CARD (MICROSOFT)	169	N.E.C. SPINWRITER PRINTER	2699
Z 80 CARD (MICROSOFT)	289	QUME SPRINT PRINTER	2499
HAYES MICROMODEM	279	TEXAS INST. 98/4	499
4 B F 10 KEY PAD	99		
RAID SUP R TERM	299		
N&N SUP R MOD (MODULATOR)	22		
16K MEMORY EXPANSION	49		
PROGRAMMA JOYSTICK	49		
ATARI		APPLE SOFTWARE	
410 PROGRAM RECORDER	59	VISICALC	199
810 DISK DRIVE	429	VIDEON	139
820 PRINTER	499	VISIFLOT	129
822 THE DMAI PRINTER	369	VISITERM	109
825 80 COLUMN PRINTER	609	VISITREND	179
830 MODEM	169	D.D.S. TOOL KIT	59
850 INTERFACE MODULE	179	D.D.S. 3.5 UPDATE	52
857 8K MEMORY EXPANSION	75	APPLE WRITER	59
853 16K MEMORY EXPANSION	99	SHR TEXT II	199
BASIC LANGUAGE CARTRIDGE	49	GENERAL BUSINESS CONTROLLER	459
VISICALC (ATARI)	159	SUITE TECH PAYROLL	179
WE HAVE ATARI GAME CARTRIDGES		STOCKPILE INVENTORY PROGRAM	369
		APPLE ADVENTURE	29
		ACORN	29
		GARCON CHESS	29
		GALAXIAN	22
		HI RES FOOTBALL	25
		COMPUTER QUARTERBACK	29
		MANY OTHER BUSINESS PERSONAL AND GAME SOFTWARE AVAILABLE	



NO SALES TAX

530 N.E. "E" STREET  
GRANTS PASS, ORE  
97526



# Event Queue

## September 1981

### September-December

**Four Seminars from Management Information Corporation (MIC)**, various sites throughout the US. These seminars are designed for businesspeople who need an introduction to system selection and use. For a complete schedule of seminars, fees, and locations, contact Carol Bell, c/o MIC, 140 Barclay Ctr, Cherry Hill NJ 08034, (609) 428-1020.

### September 8-10

**An Introduction to Microcomputers for the Electronic Data-Processing Professional**, Las Vegas NV. This course is designed for electronic data-processing managers, systems analysts, and engineers. Some of the course topics are applications for microcomputers in a large company, programming in BASIC, and future developments of the microcomputer. A general knowledge of computers is recommended. For dates and other information, contact Byte Educational Services, 2412 Second Ave, Seattle WA 98121, (206) 625-1961.

### September 9-11

**Eurographics '81**, Technical University, Darmstadt, West Germany. Almost seventy exhibitors are expected to attend this computer-graphics show. Detailed information can be obtained from Diebold Deutschland GmbH, Attn: Dr H J Grobe, Feuerbachstrasse 8, D-6000 Frankfurt/Main, West Germany.

### September 9-12

**Workshops on Pascal and Programming Techniques**, University of California Ex-

tenston, Santa Clara CA. An introduction to Pascal and modern programming techniques and style will be provided in this sequence of four one-day workshops. The sequence is structured so that each workshop is independent but leads to the next. Fees are \$175 for individual courses and \$600 for the four-part sequence. Contact Continuing Education in Engineering, University of California Extension, 2223 Fulton St, Berkeley CA 94720, (415) 642-4151.

### September 10-11

**Office Automation Systems**, Holiday Inn, Chicago City Centre, Chicago IL. This seminar will feature discussions on office automation. Among the topics to be covered are Ethernet, Xerox strategies, and worker acceptance of office automation. For information, contact Architecture Technology Corporation, POB 24344, Minneapolis MN 55424, (612) 925-2930.

### September 10-13

**The Second Annual Midwest Computer Show**, McCormick Place, Chicago IL. This show features office systems, data- and word-processing equipment, telecommunications equipment, microcomputers, computer graphics, peripherals, and other related supplies. For information, contact the National Computer Shows, 824 Boylston St, Chestnut Hill MA 02167, (617) 739-2000.

### September 14-17

**Software Info '81**, Merchandise Mart Expocenter, Chicago IL. The conference theme is "Productivity Through Packaged Software." Fran Tarkenton is the keynote

speaker. The president of Input, Peter Cunningham, will deliver an address. For more information, contact Software Info, 1730 N Lynn St, Suite 400, Arlington VA 22209, (703) 521-6209.

### September 14-17

**COMPCON Fall '81**, Capital Hilton Hotel, Washington DC. The conference theme is "Productivity—An Urgent Priority." This conference is intended to provide a focus on productivity throughout the computer industry. General inquiries for program information should be addressed to COMPCON Fall '81, POB 639, Silver Spring MD 20901, (301) 589-3386.

### September 15-16

**Workstations, The Convergence of Information Processing and Telecommunications**, New York NY. The role of workstations for professional, managerial, and executive use is the focus of this two-day seminar. Speakers will discuss the Xerox Star workstation and other new designs. For more information, contact Probe Research Inc, POB 251, Millburn NJ 07041, (201) 376-7730 or (212) 732-5417.

### September 15-17

**Wescon/81**, Brooks Hall, Municipal Auditorium, and Hilton Hotel, San Francisco CA. Sessions on communications, components and devices, computer and microprocessor hardware and software, office automation, and memory systems will be presented. Exhibits of computer equipment and related products will be featured. Contact Electronic Conventions Inc, Suite 410, 999 N Sepulveda Blvd, El Segundo CA 90245, (213) 772-2965.

### September 16-18

**Diagnostic Software: Planning and Design**, Colonial Hilton Inn, Wakefield MA. The Polytechnic Institute of New York is cosponsoring this seminar for design, test, and diagnostic engineers and managers. Design examples, lectures, informal sessions, and individual and group diagnostic-programming sessions are part of the course. Tuition is \$495. Contact Professor Donald D French, Institute for Advanced Professional Studies, One Gateway Ctr, Newton MA 02158, (617) 964-1412.

### September 16-18

**The Engineer As a Communicator**, Crystal City Marriott, Arlington VA. This conference is sponsored by the IEEE (Institute of Electrical and Electronics Engineers) Professional Communication Society. Some of the topics to be covered are communications technology, computers in technical communications, and information gathering, storage, and retrieval. Contact Dr Daniel Rosich, School of Business Administration, University of Connecticut, Stamford CT 06903, (203) 322-1673.

### September 21-24

**Microtest '81**, University of Kent, Canterbury, England. This symposium will cover the testing, maintenance, and reliability of microelectronic systems from development to field use. Development systems, emulators, reliable software and hardware, and high-level languages are some of the issues to be discussed. Contact the Symposium Secretary, Microtest '81, SERT, 57-61 Newington Causeway, London, SE1 6BL, England.

## Ultimate STATIC RAM is here!

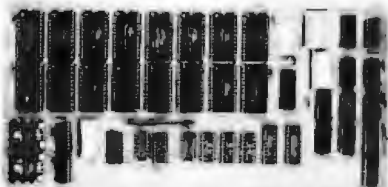

- Bank Select
- Extended Address
- 8/16 bit Data

\$ 295 16KB  
\$ 465 32KB

Assembled and Tested.

Features: Model 32KUS "Uniselect: 3"

- S-100 Bus - conforms with IEEE-696(S100) specifications.
- Data-8 or 16 bit wide, compatible with 8 bit or new 16 bit machines.
- Extended Address - 24 bit addressing.
- Bank Select - by ports and bits, compatible with Cromemco, Alph Micro, North Star, and many others.
- Fully Static and low power - current is 0.6A typical with 32K byte.
- Two separate 16K addressing, 32K bank select with window capability in any 2K increments, any place within the addressed.
- EPROM, 2716, can be mixed with RAM in any place.
- Has provision to take new CMOS mem chips with battery back-up.
- Will support Z80-Z8000 up to 4Mhz clock, 8088/8088 up to 8Mhz.

Other S-100 Boards Available: Z80 based CPU, I/O Memory Interface, 16K Static Ram.

Fully socketed, solder masks, gold contacts and guaranteed for one full year. Delivery: from stock to 72 hours. Ordering: you may call for MC, Visa or COD orders. (Add \$5.00 for C.O.D.) Personal checks OK but M.O. speeds shipping. Allow 7 to 15 days to clear personal checks before shipping. Undamaged boards can be returned within 10 days for full refunds.

Illinois residents add 5% sales tax.

OEM, Dealer pricing available

**S.C. Digital**

P.O. Box 906 Phone:  
Aurora, IL 60507 (312) 897-7749

# Convert Your IBM Selectric into a printer for only \$599

Driven by any Micro or Mini Computer



12919 Alcosta Boulevard  
San Ramon, CA 94583

Call Toll Free:  
**800-227-2148**



## MARYMAC INDUSTRIES, INC.

In Texas Orders  
Questions & Answers  
1-713-392-0747

21969 Katy Freeway  
Katy (Houston) Texas 77450

To Order  
1-800-231-3680  
800-231-3681

### SAVE BIG DOLLARS ON ALL TRS-80<sup>+</sup> HARDWARE & SOFTWARE

TRS-80<sup>+</sup> BY RADIO SHACK. Brand new in cartons delivered. Save state sales tax. Texas residents add only 5% sales tax. Open Mon.-Sat. 9-6. We pay freight and insurance. Come by and see us. Call us for a reference in or near your city. Ref: Farmers State Bank, Brookshire, Texas.

### WE OFFER ON REQUEST

- Federal Express (Overnight Delivery)
- Houston Intercontinental Airport Delivery (Same Day)
- U.P.S. BLUE (Every Day)
- References from people who have bought computers from us probably in your city
- Telex 77-4132 (Fleks Hou)

\* TRS 80 is a Registered Trademark of Tandy Corp

**ED McMANUS**

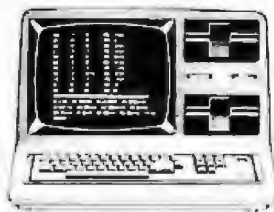

In stock TRS-80 Model II and III

No Tax on Out of Texas Shipments!

Save  
**10% 15%**  
OR MORE

We Specialize In Overseas Shipments

Telex 77-4132 (Fleks Hou)

### WE ALWAYS OFFER

- NO extra charge for Master Card or Visa
- We use Direct Freight Lines. No long waits.
- We always pay the freight and insurance
- Toll free order number
- Our capability to go to the giant TRS-80<sup>+</sup> Computer warehouse 5 hours away, in Ft. Worth, Texas, to keep you in stock.

**JOE McMANUS**



**FREE**  
with software purchase -  
One year subscription to **InfoWorld**

# DISCOUNT SOFTWARE

## Ad #17

### ULTIMATE SOFTWARE PLAN

We'll match any advertised price on any item that we carry. And if you find a lower price on what you bought within 30 days of buying it, just show us the ad and we'll refund the difference. It's that simple.

Combine our price protection with the availability of full professional support and our automatic update service and you have the Ultimate Software Plan. It's a convenient, uncomplicated, logical way to get your software.

✓ (New items or new prices)

CP/M users, specify disk systems and formats. Most formats available

CP/M	
<b>ARTIFICIAL INTELLIGENCE</b>	
Medical (PAS-3)	\$849/\$40
Dental (PAS-3)	\$849/\$40
<b>ASYST DESIGN</b>	
Prof Time Billing	\$549/\$40
General Subroutine	\$269/\$40
Application Utilities	\$439/\$40
<b>COMPLETE BUS. SYSTEMS</b>	
Creator	\$269/\$25
Reporter	\$169/\$20
Both	\$399/\$45
<b>COMPUTER CONTROL</b>	
Fabs (B-free)	\$159/\$20
UltraSort II	\$159/\$25
<b>COMPUTER PATHWAYS</b>	
Pearl (level 1)	\$ 99/\$25
Pearl (level 2)	\$299/\$40
Pearl (level 3)	\$549/\$60
<b>DIGITAL RESEARCH</b>	
CP/M 2.2	
NorthStar	\$149/\$25
TRS-80 Model II (P+T)	\$159/\$35
Micropolis	\$169/\$25
Cromenco	\$189/\$25
PL/I-80	\$459/\$35
BT-80	\$179/\$30
Mac	\$ 85/\$15
Sid	\$ 85/\$15
Z-Sid	\$ 90/\$15
Tex	\$ 90/\$15
DeSpool	\$ 50/\$10
<b>D.M.A.</b>	
Ascom	\$149/\$15
DMA-DOS	\$179/\$35
CBS	\$369/\$45
Formula	\$639/\$45
<b>GRAHAM-DORIAN</b>	
General Ledger	\$729/\$40
Acct Receivable	\$729/\$40
Acct Payable	\$729/\$40
Job Costing	\$729/\$40
Payroll II	\$729/\$40
Inventory II	\$729/\$40
Payroll	\$493/\$40
Inventory	\$493/\$40
Cash Register	\$493/\$40
Apartment Mgt	\$493/\$40
Surveying	\$729/\$40
Medical	\$729/\$40
Dental	\$729/\$40
<b>MICRO-AP</b>	
S-Basic	\$269/\$25
Selector IV	\$469/\$35
<b>MICRO DATA BASE SYSTEMS</b>	
HDBS	\$269/\$35
MOBS	\$795/\$40
DRS or ORS or RTL	\$269/\$10
MOBS PKG	\$1295/\$80
<b>MICROPRO</b>	
WordStar	\$319/\$80
Customization Notes	\$ 89/\$na
Mail-Merge	\$109/\$25
WordStar/Mail-Merge	\$418/\$85
DataStar	\$249/\$80
WordMaster	\$119/\$40
SuperSort I	\$199/\$40

DISK WITH  
MANUAL  
MANUAL  
ONLY

<b>MICROSOFT</b>	
Basic-80	\$289/\$30
Basic Compiler	\$329/\$30
Fortran-80	\$349/\$30
Cobol-80	\$574/\$30
M-Sort	\$124/\$30
Macro-80	\$144/\$20
Edit-80	\$ 84/\$20
MuSimp/MuMath	\$224/\$25
MuLisp-80	\$174/\$20
<b>ORGANIC SOFTWARE</b>	
TextWriter III	\$111/\$25
DataBook II	\$269/\$25
Milestone	\$269/\$30
<b>OSBORNE</b>	
General Ledger	\$ 59/\$20
Acct Rec/Acct Pay	\$ 59/\$20
Payroll w/Cost.	\$ 58/\$20
All 3	\$128/\$60
All 3 + CBASIC-2	\$199/\$75
<b>PEACHTREE*</b>	
General Ledger	\$399/\$40
Acct Receivable	\$399/\$40
Acct Payable	\$399/\$40
Payroll	\$399/\$40
Inventory	\$399/\$40
Surveyor	\$399/\$40
Property Mgt	\$799/\$40
CPA Client Write-up	\$799/\$40
Mailing Address	\$349/\$40
<b>SOFTWARE WORKS</b>	
Adapt (CDOS to CP/M)	\$ 69/\$na
Ratfor	\$ 86/\$na
<b>SOHO GROUP</b>	
MatchMaker	\$ 97/\$20
WorkSheet	\$177/\$20
<b>STRUCTURED SYSTEMS</b>	
GL or AR or AP or Pay	\$599/\$40
Inventory Control	\$599/\$40
Analyst	\$189/\$25
Letterright	\$179/\$25
QSort	\$ 89/\$20
<b>SUPERSOFT</b>	
Diagnostic I	\$ 49/\$20
Diagnostic II	\$ 84/\$20
Disk Doctor	\$ 84/\$20
Forth (8080 or Z80)	\$149/\$30
Fortran	\$219/\$30
Fortran w/Ratfor	\$289/\$35
Other	less 10%
<b>TCS</b>	
GL or AR or AP or Pay	\$ 79/\$25
All 4	\$269/\$99
<b>UNICORN</b>	
Minca	\$149/\$25
Scribble	\$149/\$25
Both	\$249/\$50
Amethyst	\$299/\$75
<b>WHITESMITHS</b>	
C Compiler	\$800/\$30
Pascal (incl "C")	\$850/\$45
<b>"DATA BASE"</b>	
FMS-80	\$849/\$45
dBASE II	\$829/\$50
Condor	\$599/\$30
Condor II	\$899/\$50
Access/80	\$749/\$50

<b>"PASCAL"</b>	
Pascal/MT+	\$429/\$30
Pascal/Z	\$349/\$30
Pascal/UCSD 4.0	\$429/\$50
Pascal/M	\$169/\$20
<b>"WORD PROCESSING"</b>	
WordSearch	\$179/\$50
SpellGuard	\$229/\$25
VTS/80	\$259/\$65
Magic Wand	\$289/\$45
Spell Binder	\$349/\$45
<b>"OTHER GOODIES"</b>	
The Last One	\$549/\$95
SuperCalc	\$269/\$50
Target	\$189/\$30
BSTAM	\$149/\$15
BSTMS	\$149/\$15
Tiny "C"	\$ 89/\$50
Tiny "C" Compiler	\$229/\$50
CBASIC-2	\$ 99/\$20
Nevada Cobol	\$129/\$25
MicroStat	\$224/\$25
Vedit	\$105/\$15
MiniModel	\$449/\$60
StatPak	\$449/\$40
Micro B+	\$229/\$20
Raid	\$224/\$35
String/80	\$ 84/\$20
String/80 (source)	\$279/\$na

**APPLE II -**

<b>INFO UNLIMITED</b>	
EasyWriter	\$224
Datadax	\$349
Other	less 15%
<b>MICROSOFT</b>	
SoftCard (Z-80 CP/M)	\$259
Fortran	\$179
Cobol	\$489
<b>MICROPRO</b>	
Wordstar	\$269
MailMerge	\$ 89
Wordstar/MailMerge	\$349
SuperSort I	\$159
<b>PERSONAL SOFTWARE</b>	
Visicalc 3.3	\$159
CCA Data Mgr	\$ 84
Desktop/Plan II	\$159
Visiterm	\$129
Visidex	\$159
Visiplot	\$149
Visitrend/Visiplot	\$229
Zork	\$ 34
<b>PEACHTREE*</b>	
General Ledger	\$224/\$40
Acct Receivable	\$224/\$40
Acct Payable	\$224/\$40
Payroll	\$224/\$40
Inventory	\$224/\$40
<b>"OTHER GOODIES"</b>	
dBASE II	\$329/\$60
VU #3 (use w/Visicalc)	\$ 79
Super-Text II	\$127
Data Factory	\$129
DB Master	\$164
OEM (complete accting)	\$399
Charles Mann	less 15%
STC	less 15%

ORDERS ONLY—CALL TOLL FREE VISA • MASTERCARD

1-800-854-2003 ext. 823 • Calif. 1-800-522-1500 ext. 823

Overseas—add \$10 plus additional postage • Add \$2.50 postage and handling per each item • California residents add 6% sales tax • Allow 2 weeks on checks, C.O.D. ok • Prices subject to change without notice • All items subject to availability • ®—Migs Trademark.

**THE DISCOUNT SOFTWARE GROUP**

6520 Selma Ave. Suite 309 • Los Angeles, Ca. 90028 • (213) 666-7677  
Int'l TELEX 499-0032 BVHL Attn: DiscSoft • USA TELEX 194-834 BVHL Attn: DiscSoft •  
TWX 910-321-3597 BVHL Attn: DiscSoft

September 24-25

**Microprocessors: Hardware, Software, and Applications,** Worcester Polytechnic Institute, Worcester MA. Among the courses to be offered are hardware and software basics, selection and evaluation of microprocessors, memory and input/output systems, multiprocessor systems, real-time-system design, and debugging and circuit testing. For more information, contact Ginny Bazarian, c/o Continuing Education, Worcester Polytechnic Institute, Worcester MA 01609, (617) 753-1411, ext 517.

September 24-27

**The Second Annual Mid-Atlantic Computer Show,** Washington Armory, Washington DC. For details, see September 10-13.

September 30-October 2

**Data and Telecommunications Expo '81,** Rhein-Main-Halle, Wiesbaden, West Germany. This exhibition and conference will cover data communications, distributed data processing, and telecommunications networks. Future telecommunications developments, international network management, and graphics will also be discussed. Contact Cahners Exposition Group, 222 W Adams St, Chicago IL 60606, (312) 263-4866. In Europe, contact Kiver Communications S A, UK Branch Office, Millbank House, 171/185 Ewell Rd, Surbiton, Surrey, KT6 6AX, England.

**October 1981**

October-November

**Workshops from Virginia Polytech,** Virginia Polytechnic Institute and State University, Blacksburg VA. Workshops on microcomputer-design interfacing and programming, digital electronics



THE BIGGEST NAME IN LITTLE COMPUTERS™

TRS-80™ Model II — Your Best Buy  
In a Business Microcomputer

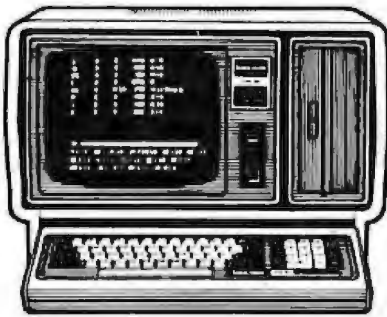

**UP  
TO  
15%  
OFF!**  
on

**TRS-80™ computers,  
software and peripherals**

Similar values on all merchandise

CALL COLLECT:

**915-283-2920**

**Van Horn Office Supply**  
701 W. Broadway -- P.O. Box 1060  
Van Horn, Texas 79855

DEALER G055  
Form F48 Provided



Standard Warranty on Merchandise  
**THE NATIONWIDE SUPERMARKET OF SOUND®**



# BUY COMPUTERS BY MAIL ORDER AND SAVE 16%

## APPLE HARDWARE

48K (SPECIAL) \$1,125.00  
Disk with Controller \$ 540.00  
Disk \$ 440.00  
Pascal \$ 445.00  
Graphics Tablet \$ 655.00  
Versawriter Digitizer System \$ 215.00

## TERMINALS

Zenith Z-19 \$ 789.00  
Soroc ID120 \$ 729.00  
Televideo 950 \$ 999.00  
Televideo 920C \$ 758.00  
Televideo 912C \$ 729.00  
AODS Viewpoint \$ 589.00

## SOFTWARE

Superbrain Double Density 64K \$2,850.00  
Quad Density 64K \$2,977.00

ATARI 800 16K \$ 775.00

## PRINTERS

TI Basic Serial \$1,495.00  
Epson MX-80 CALL  
Centronics 737 Parallel \$ 719.00  
IDS 560 \$1,395.00

## NORTHSTAR

Horizon-2-64 00 \$3,350.00

## VERBATIM & MEMOREX

5 1/4" \$ 27.50

CROMEMCO COMPUTERS CALL  
INTERSYSTEM COMPUTERS CALL

## MONITORS

Leadex 12" B&W \$ 138.00  
12" GP \$ 152.00

Send certified check (regular checks require 2 weeks to clear) or charge to VISA or Master Charge. Customer pays shipping.

## MIRO COMPUTERS, INC.

27 Long Meadow Place South Setauket, L.I., N.Y. 11720  
(516) 423-7955 CALL MON.-SAT., 10AM-6PM

# THE SYSTEM INTEGRATORS

- Are you tired of installing systems that cannot expand to meet your needs?
- Are you tired of the problems of interfacing multi-vendor systems?
- Are you tired of receiving new systems that don't work and waiting days or weeks for replacements?
- Are you tired of making a computer investment and not receiving the professional help and support you deserve?

If you have answered yes to any one of the above questions, you need a change!

We have combined the most flexible microcomputer on the market (Ithaca InterSystems™) with reliable, large capacity floppy and hard disk storage systems from Qume, Memorex, Shugart and Priam, along with the most dependable CRTs and printers available today. Using the industry standard CP/M\* Operating System, our turnkey systems are delivered to you fully assembled, tested and burned in.

**PROVEN RELIABILITY** — Our turnkey systems have been performing daily for over a year in high volume point-of-sale operations throughout the country.

**SOFTWARE AVAILABILITY** — A wide variety of application software packages are ready for CP/M systems. Our library contains many of these systems, and it is expanding daily.

**CUSTOM DESIGN** — P.O.S. Terminals, hardware and software interfaces between Ithaca InterSystems and other specialized I/O devices.

**COMPETITIVE PRICES** — Floppy-based systems start at \$7,950, 10MB hard-disk systems with floppy back-up start at \$10,650. These are true turnkey system prices that include CRT, printer, and double-sided/density floppies, tested and burned in.

TALK TO THE PEOPLE WHO SELL CUSTOMER SATISFACTION



## Specialized Business Systems

5306 S. Bannock, Littleton, CO 80120  
(303) 797-8709

\*Trademark of Ithaca InterSystems, Inc.

\*CP/M is a Registered Trademark of Digital Research

# IF YOU WANT LOWER PRICES AND QUICKER SERVICE ... YOU WANT MICROMAIL.



Model 912 C shown

**TELEVIDEO 910**

**\$599.00**

912.....\$699.00  
920.....\$749.00  
950.....\$995.00

**DIABLO 630**

**\$1959.00**

1640 RO.....\$2269.00  
1640 KSR.....\$2499.00  
1650 RO.....\$2599.00  
1650 KSR.....\$2599.00



Model 630 shown

**ANADEX DP 8000**

**\$775.00**



**DEC LA34 DA**

**\$969.00**



Shown with optional forms tractor and keypad.

**ANADEX**

DP 9500.....\$1299.00  
DP 9501.....\$1299.00  
DP 9000.....\$1199.00  
DP 9001.....\$1199.00

**TEXAS INSTRUMENTS**

810/2.....\$1549.00  
810/2 PKG (U/L VFC, CP).....\$1679.00  
**TELETYPE**  
43 PF(TTL).....\$975.00

**SOROC**

IQ 120.....\$689.00  
IQ 140.....\$1099.00  
IQ 135.....\$849.00

**DEC**

VT 100.....\$1650.00  
DEC LA 34AA.....\$1050.00

**C. ITOH**

CIT 101.....\$1625.00

**NEC**

5510.....\$2395.00  
5530.....\$2395.00

To Order: Send check to MICROMAIL, P.O. Box 3297, Santa Ana, CA 92703. Personal or company checks require two weeks to clear. Visa/MasterCard accepted. COD requires a 15% deposit. Handling: Add 3% to orders less than \$750, 2% to orders \$751 - \$2,000, 1% to orders over \$2,000. NOTE: Handling charges are waived on orders pre-paid in advance by check. Shipping: We ship FREIGHT COLLECT via UPS or Motor Freight. Air and Express delivery is available. Prices subject to change without notice.

for automation and instrumentation, and sessions using the TRS-80 are part of the curriculum. All workshops are hands-on with participants designing and testing concepts on the actual hardware. Contact Dr Lindy Leffel, Virginia Polytechnic Institute and State University, Blacksburg VA 24061, (703) 961-5241.

October 7-9

Institute on Microcomputers for Instruction and Research in Higher Education, Jane S McKimmon Center, North Carolina State University, Raleigh NC. The institute is designed to help high-level educators learn about the microcomputer and the role it can play in higher education. Contact Joyce Currie, c/o North Carolina Educational Computing Service, POB 12035, Research Triangle Park NC 27709, (919) 549-0671.

October 7-21

The 1981 Far East Computer Tour, Japan, South Korea, Taiwan, and Hong Kong. This tour group will visit various computer-related conferences and exhibitions throughout the Far East. Transportation for this three-week tour, plus shows, meals, and other items are included in trip packages, ranging in price from \$2290 to \$3095. For more information, contact Terry Butler, Commerce Tours International Inc, 870 Market St, Suite 742-744, San Francisco CA 94102, (415) 433-3072.

October 9-11

Rhode Island Computer and Video Electronics Show, Providence Civic Center, Providence RI. This is the first major computer exhibition and show to be held in Rhode Island. Exhibitors and sales teams will present the latest

**MICROMAIL**

P.O. Box 3297  
Santa Ana, CA 92703  
Phone: 714/731-4338  
TWX: 910 595 1146

# BYTE

## TOLL-FREE SUBSCRIPTION LINE

# 1-800-258-5485

New Hampshire Residents Dial 924-9281

The Quickest Way To

- Order a Subscription
- Renew a Subscription
- Change or Correct an Address
- Give a Friend a Gift Subscription
- Inquire about a Subscription

We are waiting to help you. Call us between:

**8:30-4:00 Mon.-Thurs.**

**8:30-12:30 Fridays**

(Eastern Time)

**BYTE** the small systems journal

## Z-80 and 8086 FORTH

**Z-80<sup>®</sup> FORTH**—a complete program development system. Uses standard CP/M<sup>®</sup> compatible random access disk files for screen storage. Package includes: interpreter/compiler with virtual memory management, line editor, screen editor, Z-80 Assembler, de-compiler, utilities, demonstration programs, and 80 page user manual. System requirements: Z-80 microcomputer, 48 kbytes RAM, CP/M 2.2 or MP/M<sup>®</sup> 1.1. **\$50.00**

**Z-80 FORTH WITH NAUTILUS SYSTEMS CROSS-COMPILER.** Extend/modify the FORTH runtime system, recompile on a host computer for a different target computer, generate headerless code, generate ROMable code with initialized variables. Supports forward referencing to any word or label. Produces load map and list of unresolved symbols. 107 page manual. System requirements as for Z-80 FORTH above. **\$200.00**

**8086 FORTH** with line editor, screen editor, assembler, and utilities. Uses standard CP/M compatible random access files for screen storage. Requires 8086 or 8088 microcomputer, 64 kbytes RAM, and CP/M-86 operating system. **\$100.00**

**MACHINE TEST PROGRAM PACKAGE** for Z-80 systems. Includes memory, floppy disk, printer, and terminal tests with all source code. Requires CP/M 2.2. **\$50.00**

All software distributed on eight-inch soft sectored single density diskettes. Prices include shipping by first class or UPS within USA or Canada. COD charges extra. Purchase orders accepted at our discretion. (CP/M and MP/M are registered trademarks of Digital Research, Inc. Z-80 is a registered trademark of Zilog, Inc.)

**Laboratory Microsystems**  
4147 Beethoven Street  
Los Angeles, CA 90066  
(213) 390-9292

A REFURBISHED DAISY WHEEL TERMINAL  
FOR PERSONAL COMPUTER USERS AND SMALL BUSINESSES.

## Now you can have letter-quality printing and professional features for just **\$1,495\***

AJ daisy wheel printer terminals are renowned for exceptional performance, high reliability, and applications versatility. Now you can have all this for only \$1,495\* in our special limited offer.

- 30 cps *letter-quality* printing
- Changeable type faces
- Full ASCII keyboard with numeric pad
- High resolution X-Y plotting
- Complete electronic forms control
- 128-character buffer
- Asynchronous RS-232 interface
- Printwheel, ribbon cartridge, and cable included
- 30-day parts/labor warranty



And you can choose from a list of options including forms tractor, pin-feed platen, paper trays, side shelves, extra printwheels, APL keyboard and 2K buffer.

Call your nearest AJ regional office for details: San Jose, CA (408) 946-2900; Rosemont, IL (312) 671-7155; Hackensack, NJ (201) 488-2525. Or check the phone book for the number of your local AJ sales/service office.

\*Price excludes options and is subject to change without notice. Model shown includes certain options. Offer available only in the contiguous U.S.

**ANDERSON  
JACOBSON**

## System Log

3:10 P.M. - System Down!

4:45 P.M. - Problem diagnosed using  
DIAGNOSTICS II.

Board replaced and  
system back on line.

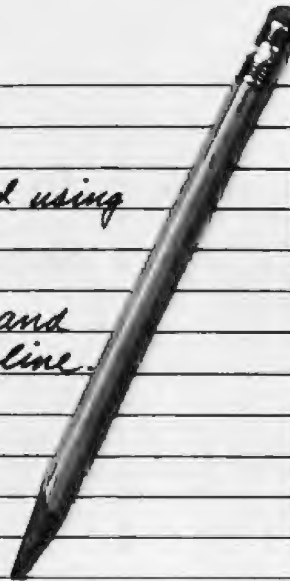

# DIAGNOSTICS II

Diagnosics II is SuperSoft's expanded Diagnostic package.

Diagnostic II builds upon the highly acclaimed Diagnostics I. It will test each of the five areas of your system:

Memory      Terminal      Printer      CPU      Disk

### Every test is expanded.

Every test is "submit"-able. A "submit" file is included in the package which "chains" together the programs in Diagnostics II, achieving an effective acceptance test. All output can be directed to a log file for unattended operation, for example over night testing. Terminal test is now generalized for most crt terminals. A quick-test has been added for quick verification of the working of the system.

The memory test is the best one we have encountered. It has new features, including:

- default to the size of the CP/M Transient Program Area (TPA)
- printout of a graphic memory map
- bank selection option
- burn in test
- memory speed test

Diagnosics-II still includes the only CPU test for 8080/8085/Z80.

A Spinwriter/Diablo/Qume test has been added, which tests for the positioning and control features of the Spinwriter/Diablo/Qume as well as its ASCII printing features. (Serial Interface only)

And, as with all SuperSoft products, a complete online HELP system and user manual is included.

Price: \$100.00 (manual only): \$15.00

Requires: 32K CP/M

CP/M Formats: 8" soft sectored, 5" Northstar, 5" Micropolls  
Mod II, Vector MZ, Superbrain DD/QD



All Orders and General Information:  
SUPERSOFT ASSOCIATES  
P.O. BOX 1628

CHAMPAIGN, IL 61820  
(217) 359-2112

Technical Hot Line: (217) 359-2691

(answered only when technician is available)

CP/M REGISTERED TRADEMARK DIGITAL RESEARCH

**SuperSoft**

First in Software Technology

in computers and video products for business, industry, government, education, and home use. Contact New Leaf Productions, Suite 335, 77 Ives St, Providence RI 02906, (617) 679-0089.

October 12-15

**Information Management Exposition and Conference: INFO 81, Coliseum, New York NY.** Discussions on pre-packaged, customized pre-packaged, and custom-designed software will complement hardware and software exhibits. For more information, contact Clapp & Poliak Inc, 245 Park Ave, New York NY 10167, (212) 661-8410.

October 13-15

**Understanding and Using Computer Graphics, New York NY.** Headed by Carl Machover, this two-day seminar examines the state of the art in graphic systems. The focus will be on hardware, software, and applications. Contact Bob Sanzo, c/o Frost & Sullivan Inc, 106 Fulton St, New York NY 10038, (212) 233-1080.

October 15-18

**The Third Annual Northeast Computer Show and Office Equipment Exposition, Hynes Auditorium, Boston MA.** This show will feature hardware, software, and supplies for business, education, government, home, and office use. Office systems and equipment will also be shown. Contact National Computer Shows, 824 Boylston St, Chestnut Hill MA 02167, (617) 739-2000.

October 16-23

**The Fourteenth Brazilian Computer Conference and Exhibit, Anhembi Convention and Exhibit Halls, São Paulo, Brazil.** This conference will feature technical talks, conference tutorials,

# BYTE Back Issues for sale



The following issues are available:

- 1976: July  
 1977: April thru December except October  
 1978: February thru December except November  
 1979: January thru December except March  
 1980: January, March thru August, and December  
 1981: February to current issue except March
- Cover price for each issue through August 1977 is \$1.75  
 Domestic; \$2.75 Canada and Mexico; \$3.75 Foreign.  
 September 1977 through October 1979 issues are \$2.50  
 Domestic; \$3.50 Canada and Mexico; \$4.50 Foreign.  
 November 1979 to current is \$3.00 Domestic; \$4.00 Canada  
 and Mexico; \$5.00 Foreign

Send requests with payment to:

**BYTE Magazine**  
 70 Main St, Peterborough NH 03458  
 Attn: Back Issues

Please allow 4 weeks for domestic delivery and 6 weeks for foreign delivery.

\* Payments from foreign should be made in US funds convertible at a US bank.

Circle 56 on Inquiry card.

## SURPLUS BUYS of the YEAR!!

*The Most Sought After Most Desirable*

### DIABLO 10 MEG DISK DRIVES

- 5 Mb Fixed, 5 Mb Removable
- 115 VAC 60 Hz
- Takes 5440 Disk
- Industry Std. Drive
- Daisy Chain up to 4
- I/O Data Included

MODEL 44B



- Built-in Power Supplies
- 200 Tracks / Inch
- 266 Bytes per Sector
- 24 Sectors / Track
- 19,583 Sectors / Platter

REFURBISHED & OPERATIONAL

Now Only

**\$1995.00** each

Includes 3 FREE DISK CARTRIDGES

**MODEL 44A DISK DRIVE** 10 Mb. Earlier design, same I/O. Used whole, untested. Includes schematics and data... **\$1200.00**  
**MODEL 43 5 MEG DISK DRIVE** 100 TPI, good cond., used whole, untested. With data and schematics... **\$798.00**  
**MODEL 429 POWER SUPPLY** ±24VDC @ 8 amps 5V @ 8 amps Required for both the 44A and 43 drives (above)... **\$75.00** ea.

### MORE BARGAINS

#### • SELECTRIC-II Typewriter/Printer

With stepper-driven platen & carrier. Existing possibilities removed from sophisticated word processors. Solenoids (standard selectric carriage code) self contained. Mostly whole, "as-is" with schematics and data.

REDUCED!!



Only \$349.00 ea.

#### RO"SELECTRIC-II PRINTER

"Receive-only" (no keyboard). Features X&Y steppers plus all solenoids & standard IBM Selectric-II printer mechanism. Takes Tech-III ribbon cartridges. Less case and platen, mostly whole, "as-is". Schematics included.

Only \$129.00 ea.

Disk Drives Add \$30 for Help & Pkg. Pay Shipping on Delivery. Selectric Printer Add \$20 Help & Pkg. Pay Shipping on Delivery. New. True-Start of IBM Corp.

**COMPUTERS, PERIPHERALS, UNLIMITED!**

NEW NUMBER — **617/372-8637**  
 18 GRANITE STREET  
 HAVERHILL, MASS 01830

# Does Your Printer Have a One Track Mind? Then You Need The Paper Tractor™

The Paper Tractor™ turns your tractor feed printer into a friction feed printing system. Inexpensively.

With The Paper Tractor you can abandon dull continuous form stock and move into new realms of high quality personalized writing paper. Without costly hardware modifications.

This revolutionary product acts as a carrier, protecting and guiding any standard letter or

legal size paper through the printing area. Any paper. Bond, parchment, onionskin, vellum, NCR, manuscript paper (sheet music). Even your company or personal letterhead.

The Paper Tractor is a unique solution to the restrictive nature of the tractor feed printer.

- ★ Compatible with Matrix, Impact, Daisywheel and Ink Ejection printheads.
- ★ Fits front, back and dual tractor paper feeds.
- ★ Designed with self-aligning feed system.
- ★ Positions letter or legal size paper automatically with an edge-protecting guide.
- ★ Designed for use with forward/reverse plotting printers.
- ★ Proven with all major manufacturer's printers, including Epson, Tiger, TI, GP-80M, DEC-Writer, Commodore, Centronics, Radio Shack V VI VII, Beehive, Vista, Grafix-Plus, Axiom, Comment, HI-Q, DIP, C-ITOH, Cromemco, Okidata and many more.

Retails for only \$19.50

Contact your local computer dealer. If he doesn't carry the Paper Tractor, call or write us.

Circle 284 on Inquiry card.

**Paper Tractor, Ltd.™**  
 P. O. Box 4218  
 Santa Barbara, CA 93103

Information line:  
 800-235-6967  
 In Calif (805) 966-5448

Model \_\_\_\_\_

Name \_\_\_\_\_

Street \_\_\_\_\_

City \_\_\_\_\_ State \_\_\_\_\_ Zip \_\_\_\_\_

★ DISTRIBUTORS WELCOME ★

## ATTENTION GOVERNMENT D P USERS AND PURCHASERS

We represent many fine micro products and manufacturers on the U.S. Government's GSA Schedule, including

**Apple, Cromemco, Micropolis  
and Seequa Computers**

Purchasing from the Schedule will save you the time consumed by the bid process. Products shipped throughout the United States and world-wide. Visit or write any of our stores for more information or to receive our catalogue of products represented.

**Computers,  
Etc.....  
the dependable store**

257 West Street, Annapolis, MD 21401 - (301) 268-6505  
13A Allegheny Avenue, Towson, MD 21204 - (301) 296-0520  
9330 Georgia Avenue, Silver Spring, MD 20910 - (301) 588-3748  
6671 Backlick Road, Springfield, VA 22150 - (703) 644-5500  
Plaza 38, 2442 Route 38, Cherry Hill, NJ 08002 - (609) 779-0023  
Callers outside metropolitan areas served by our stores  
Please call (301) 268-5801

*Career Opportunities Available \* An Equal Opportunity Employer*

roundtable discussions, and special events. Computer-aided design and manufacture in developing countries will also be discussed. Contact Suce-su São Paulo, Rua Tabapuã, 627-1.º andar, 04533, São Paulo, S P, Brazil.

October 18-20

The Annual Conference of the New York State Association for Educational Data Systems (NYS AEDS), Syracuse NY. NYAEDS is made up of people with an interest in computers and education. Workshops on the educational uses of microcomputer software will be held. Contact Don Ross, Ardsley High School, Ardsley NY 10502.

October 19-23

Systems '81, Munich, West Germany. Computer systems and their applications will be featured. Additional information is available from Kallman Associates, 30 Journal Sq, Jersey City NJ 07306, (201) 653-3304.

October 20-22

The Annual Government-Industry Data Exchange Program (GIDEP) Workshop, Rickey's Hyatt House, Palo Alto CA. The GIDEP annual workshop is open to anyone interested in the exchange of technical information relating to engineering, failure experience, reliability, and maintainability. Contact the Officer-in-Charge, GIDEP Operations Center, Corona CA 91720.

October 20-22

Computerized Office Equipment Expo, Southwest, Astorhall, Houston TX. Approximately 100 exhibitors will present office equipment and supplies, including word-processing systems, at this show. Contact Cahners Exposition Group, 222 W Adams St, Chicago IL 60606, (312) 263-4866.

## "Forget Memory Loss Problems"

### RAMLOK FEATURES:

- 100% LINE VOLTAGE LIMITS
- MAX. ONE CYCLE RESPONSE TIME
- BROWNOUT/SURGE PROTECTION
- BUILT IN BATTERY CHARGER
- NOISE INTERFERENCE PROTECTION

GET STANDBY POWER  
WITH  
**RAMLOK**

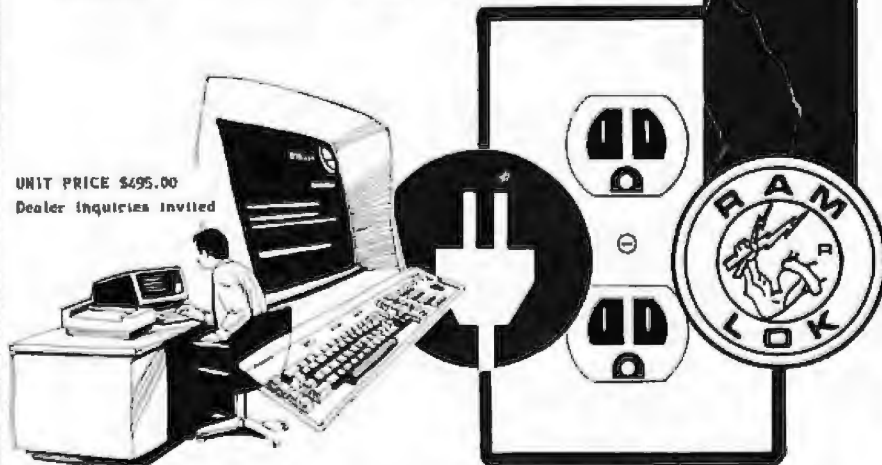

UNIT PRICE \$495.00  
Dealer Inquiries Invited



**LADCO**

LADCO DEVELOPMENT CO., INC.  
P. O. BOX 484, OLEAN, N. Y. 14760  
716-372-0168

## Event Queue

October 21-24

**COMPUTA 81**, World Trade Center, Singapore. This international show attracts professionals and buyers from Hong Kong, India, and Sri Lanka. Additional information can be obtained from Kallman Associates, 30 Journal Sq, Jersey City NJ 07306, (201) 653-3304.

October 24-25

**The Second Annual New Jersey Microcomputer Show and Fleamarket**, Holiday Inn (north) Convention Center, Newark International Airport, Newark NJ. This show will feature 75 commercial exhibitors and more than 100 vendors. User-group meetings will be held. Registration is \$5 for both days. Contact Kengore Corporation, 3001 Rt 27, Franklin Park NJ 08823, (201) 297-2526.

October 25-30

**The Forty-Fourth Annual Meeting of the American Association of Information Societies (ASIS)**, Washington Hilton Hotel, Washington DC. The theme for this meeting is "The Information Community: An Alliance for Progress." Among the topics to be addressed are information and creativity, information and society, and overcoming the barriers between information sciences. Contact ASIS, 1010 Sixteenth St, NW, Washington DC 20036, (202) 659-3644.

October 27-29

**Computer Graphics 81**, Regent Centre Hotel, London, England. Some of the topics to be covered are graphics systems: hardware and software; animation; image processing; simulation; and business and home graphics. An equipment exhibition will also be presented. For more information, contact Online Conferences Ltd, Argyle House, Northwood Hills,

Middlesex, HA6 1TS, England.

October 29-November 1

**Southeast Computer Show and Office Equipment Exposition**, Atlanta Civic Center, Atlanta GA. For details, see October 15-18.

October 31-November 1

**Computers in Ambulatory Medicine**, Washington Sheraton, Washington DC. The Society for Advanced Medical Systems and the Society for Computer Medicine are sponsoring this conference. Basic and advanced tutorials on the fundamentals of medical computing will be featured along with technical sessions and presentations of papers. Fees are \$115 for Society members and \$165 for nonmembers. Contact SCM, 9650 Rockville Pike, Bethesda MD 20014, (301) 530-7120.

October 31-November 2

**Annual Meeting of the American Society for Cybernetics**, Washington Hilton Hotel, Washington DC. The theme for this meeting is "The New Cybernetics." A goal of the meeting will be to redefine the field of cybernetics and to provide a focus for the research efforts of the Society. Among the topics to be discussed are robotics, problem solving, pattern recognition, remote sensing, and communication networks. Contact Dr Laurence D Richards, Department of Administrative Science, Colby College, Waterville ME 04901, (207) 873-1131, ext 587.

## November 1981

November 1-4

**DPMA San Francisco '81**, San Francisco Civic Center and Brooks Hall, San Francisco CA. This is DPMA's (Data Processing Management Association's) thirtieth

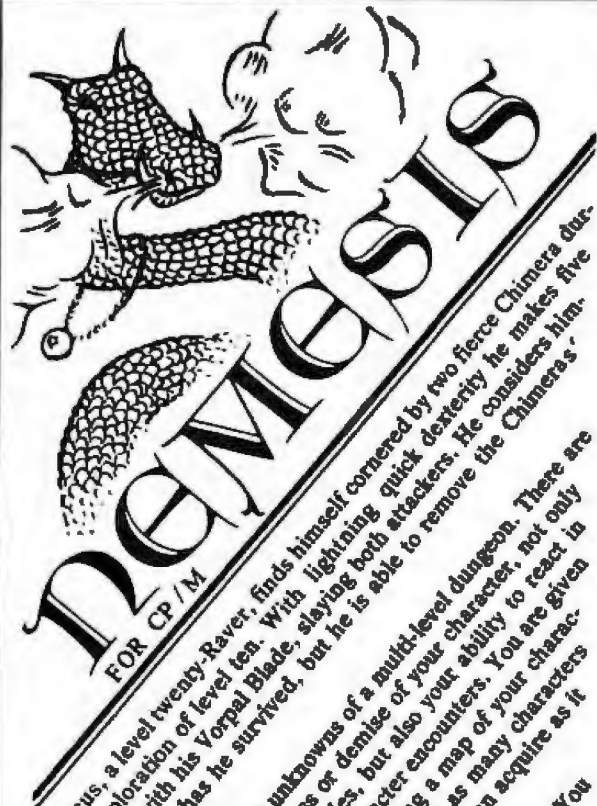

Theus, a level twenty-Raver, finds himself covered by two fierce Chimera during his exploration of level ten. With lightning quick dexterity he makes five mighty swings with his Vorpal Blade, slaying both attackers. He considers himself lucky - not only has he survived, but he is able to remove the Chimeras' Mithril Cloak.

NEMESIS... a journey into the unknowns of a multi-level dungeon. There are many factors contributing to the success or demise of your character, not only your character's innate and acquired abilities, but also your ability to react in REAL TIME to the changing situations your character encounters. You are given abundant information to aid you in your quest, including a map of your character's knowledge of the current level. The player may create as many characters as he desires, and there is no limit to the power your character can acquire as it delves into the mysteries of the dungeon.

DUNGEON MASTER allows you to create entire dungeons for NEMESIS. You have complete control over the monster population, the items which may be found, and the architectural layout of the dungeon. Up to one thousand levels are allowed in each of the dungeons created.

NEMESIS and DUNGEON MASTER are available on the following CP/M media: 8" soft sector, 5" Northstar, 5" Microplus, 5" Apple II Plus, Vector MZ, and Superbrain DD/QD.

NEMESIS: \$40 for discette and manual (requires NEMESIS).

DUNGEON MASTER: \$35 for discette and manual.

First In Software Technology  
**SUPERSOFT ASSOCIATES**  
P.O. BOX 1628  
CHAMPAIGN, IL 61820

Technical Hot Line: (217) 359-2691  
(answered only when technician is available)

All Orders:  
(217) 359-2112



CPM is a Registered Trademark of Digital Research

## Event Queue

annual conference and business exposition. Contact the conference coordinator, DPMA, 505 Busse Hwy, Park Ridge IL 60068, (312) 825-8124.

*November 5*

**Invitational Computer Conference, Amsterdam, Netherlands.** The Invitational Computer Conference is a one-day computer show designed for quantity buyers. Exhibits and seminars are featured. For details, contact B J Johnson & Associates Inc, 2503 Eastbluff Dr, Suite 203, Newport Beach CA 92660, (714) 644-6037.

*November 8-10*

**The Twelfth ACM North American Computer Chess Championship, Bonaventure Hotel, Los Angeles CA.** A four-round, Swiss-style tournament is planned for this year's championship competition. In addition, a round-robin blitz tournament will be held. Games in this event proceed at a rate of 5 seconds per move. Belle, the current world champion, Chaos, Duchess, Nuchess, and L'Excentrique are among the programs being entered. For more information, contact

Professor Monroe Newborn, School of Computer Science, McGill University, 805 Sherbrooke St West, Montreal, Quebec H3A 2K6, Canada.

*November 9-10*

**Software Fair, Stouffers' Riverfront Towers, St Louis MO.** This show is made up of software exhibitions from companies whose packages are in current use by members of the Southern and National Industrial Distributors Association. Distributors who are not members of these organizations can also exhibit their wares. Contact Don White or Tony Carroll, 1900 Arch St, Philadelphia PA 19103, (215) 564-3484.

*November 9-11*

**ACM '81, Bonaventure Hotel, Los Angeles CA.** This meeting will feature panel discussions on computers, software products in the 1980s, tutorials on computer-aided design, and a survey on the impact of robots on employment. Ray Bradbury and Dr Simon Ramo will speak. Computer exhibits and the North American Computer Chess Tournament will also be held. Contact ACM '81, POB 24059, Village Station,

Los Angeles CA 90024, (213) 536-9735.

*November 10-12*

**Midcon/81 Show and Convention, O'Hare Exposition Center and Hyatt Regency O'Hare, Chicago IL.** Talks on microcomputers, energy, memory, communications, and consumer electronics will highlight this show. Contact Electronic Conventions Inc, 999 N Sepulveda Blvd, El Segundo CA 90245, (800) 421-6816; in California (213) 772-2965.

*November 12*

**Invitational Computer Conference, Paris, France.** For details, see November 5.

*November 16-19*

**The Canadian Computer Show and Conference, International Centre of Commerce, Mississauga, Ontario Canada.** For details, contact Reg Leckie, Industrial Trade Shows of Canada, 36 Butterick Rd, Toronto, Ontario, M8W 3Z8, Canada, (416) 252-7791.

*November 17*

**Invitational Computer Conference, Milan, Italy.** For details, see November 5.

*November 17-19*

**Understanding and Using Computer Graphics, Atlanta GA.** For details, see October 13-15.

*November 19-20*

**Western Educational Computer Conference, San Francisco CA.** Many of the computer-related talks at this conference will cover areas of interest to college instructors and administrators. For details, contact Ron P Langley, Data Processing Services, California State University-Long Beach, 1250 Bellflower Blvd, Long Beach CA 90840.

*November 29-December 1*

**National Telecommunications Conference, New Orleans LA.** This event is sponsored by the IEEE (Institute of Electrical and Electronics Engineers) and the New Orleans chapter of the Communications Society Conference Board. Some of the papers to be presented will discuss communications electronics, including software, terminals, theory, and data and computer communications. Contact G Allan Ledbetter, South Central Bell, 365 Canal St, Rm 1360, New Orleans LA 70140, (504) 528-7350. ■

## WIREMASTER

### A COMPILER FOR HARDWARE

• WIREMASTER is a software tool to aid in the design layout and construction of electronic hardware. It is intended primarily for wire wrap, though it is also highly useful in the layout, error-checking, and trouble-shooting of PC boards.

• Inputs are easily derived directly from the schematic diagram and fed to WIREMASTER in a CP/M\* text file. Outputs include a network map that graphically shows all pins and wires, a wire list sorted by lengths and levels, a parts list, wrap count and continuity checklists, plus signal and pin cross-references.

• The resulting information is then used for PC board layouts, error-checking, wiring, component-stuffing and system-debugging. This forms a complete and easily updated documentation package. Although it runs on small computers, WIREMASTER can handle large projects.

• WIREMASTER runs on any Z801 CP/M system of 47K or larger including TRS-801 Model II and Apple vs SoftCard.

Complete Package — \$125; Manual only — \$10

### AFTERTHOUGHT ENGINEERING

7266 Courtney Drive  
San Diego, California 92111  
(714) 278-2968

IBM and CP/M are trademarks of International Business Machines Corporation.



## Dysan

CORPORATION

Solve your disc problems, buy 100% surface tested Dysan diskettes. All orders shipped from stock, within 24 hours. Call toll FREE (800) 235-6137 for prices and information. Visa and MasterCard accepted. All orders sent postage paid.

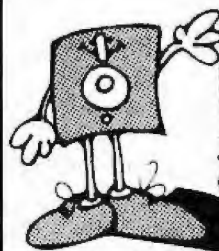

**PACIFIC EXCHANGES**  
100 Foothill Blvd.  
San Luis Obispo, CA  
93401 (In Cal call  
(805) 543-1037.)

Circle 277 on Inquiry card.



### POCKET COMPUTER NEWSLETTER

P.O. BOX 232, Seymour, CT 06483

#### FOR POCKET COMPUTER USERS!

News and Product Reviews  
Programming Tips  
Operating Timesavers  
Tutorials  
Customizing Your Unit  
Short Cuts  
Practical Programs  
Technical Details  
Inside Information  
Application Forums

— and more!

- YES! Sign me up as a charter subscriber. Enclosed is my \$20.00 for 10 issues. (\$24 to Canada, \$30 elsewhere.)
- Not sure. Enclosed is \$2 for a sample issue.

Name \_\_\_\_\_  
Addr \_\_\_\_\_  
City/St \_\_\_\_\_ Zip \_\_\_\_\_

Circle 288 on Inquiry card.



# Software Received

This is a list of software packages that have been received by BYTE Publications during the past month. The list is correct to the best of our knowledge, but it is not meant to be a full description of the product or the forms in which the product is available. In particular, some packages may be sold for several machines or in both cassette and floppy-disk format; the product listed here is the version received by BYTE Publications.

This is an all-inclusive list that makes no comment on the quality or usefulness of the software listed. We regret that we cannot review every software package we receive. Instead, this list is meant to be a monthly acknowledgment of these packages and the companies that sent them. All software received is considered to be on loan to BYTE and is returned to the manufacturer after a set period of time. Companies sending software packages should be sure to include the list price of the packages and (where appropriate) the alternate forms in which they are available.

## Apple

**Desktop Plan II**, for development and analysis of business plans for the Apple II. Floppy disk, \$199.95. Personal Software, 1330 Bordeaux Dr, Sunnyvale CA 94086.

**NORAD**, a graphics arcade game for the Apple II and III. Floppy disk, \$27.50. Western MicroData Enterprises Ltd, POB G 33, Postal Station G, Calgary, Alberta, T3A 2G1, Canada.

**Robotwar**, a graphics game using programmable robots for the Apple II. Floppy disk, \$39.95. Muse, 330 N Charles St, Baltimore MD 21201.

**Time Manager**, a personal-information and organization system for the Apple II. Floppy disk, \$149.95. Image Computer Products Inc, 615 Academy Dr, Northbrook IL 60062.

**VisiCalc**, the electronic spreadsheet for the Apple II. Floppy disk, \$199.95. Personal Software, (see above address).

**VisiDex**, a data-base management system for the Apple II. Floppy disk, \$199.95. Personal Software, (see above address).

**VisiPlot**, a graph-plotting system for the Apple II. Floppy disk, \$179.95. Personal Software, (see above address).

**VisiTrend and VisiPlot**, a utility program that analyzes trends of graphs from VisiPlot for the Apple II. Floppy

disk, \$259.95. Personal Software, (see above address).

## TRS-80

**Armadillo Bug**, utility program to manipulate machine-language routines for the TRS-80 Color Computer. Cassette, \$12.95. Armadillo Software, POB 7661, Austin TX 78712.

**Attack Force**, a graphics arcade game for the TRS-80. Floppy disk, \$19.95. Big Five Software, POB 9078, Van Nuys CA 91409.

**Cosmic Fighter**, a graphics arcade game for the TRS-80. Floppy disk, \$19.95. Big Five Software, (see above address).

**Faster**, a utility program for TRS-80 Model I and II that speeds up the execution time of BASIC programs. Cassette, \$29.95. ProSoft, POB 839, Hollywood CA 91603.

**Galaxy Invasion**, a graphics arcade game for the TRS-80. Floppy disk, \$19.95. Big Five Software, (see above address).

**Meteor Mission II**, a graphics arcade game for the TRS-80. Floppy disk, \$19.95. Big Five Software, (see above address).

**Super Nova**, a graphics arcade game for the TRS-80. Floppy disk, \$19.95. Big Five Software, (see above address).

**Tanjali**, mind game comparing shapes and colors for the TRS-80 16 K Color Computer. Cassette, \$29.95. Strawberry Software Inc,

POB 743, Vashon Island WA 98070.

## CP/M

**Analiza**, a computerized psychiatrist for the Commodore CP/M computer system. Eight-inch floppy disk, \$35. SuperSoft Associates, POB 1628, 40 Main St, Suite 401, Champaign IL 61820.

**SELECT**, a CP/M word-processing system. Eight-inch floppy disk, \$595. Select Information Systems, 919 Sir Francis Drake Blvd, Kentfield CA 94904.

## Other Computers

**Intruders and Airwar**, graphics games for the Interact computer. Cassette, \$10. Ernie Piette, 110 Hillcrest Rd, Pineville LA 71360.

**Schedule**, a utility program to help organize daily activities for the North Star

computer. Floppy disk, \$19.95. Azimuth Associates, POB 1636, Arlington VA 22210.

**Shuttle Ascent Simulation**, a graphics arcade game for the Atari 800. Cassette, \$9.95. Starbound Software, POB 214, Cocoa Beach FL 32931. ■

## BYTE's Bugs

### PR Problems

The letter entitled "Plot: North by Northwest," by William McWorter (May 1981 BYTE, page 14), was found to have a bug in line 10 of the program. The first "p" in line 10 should have been an "r." The line should read:

10 A\$="rqvwrsvupqpwtstu"

Many thanks to all who wrote in with the correction. ■

"THIS IS DIGITALKER"  
OUT 127,0

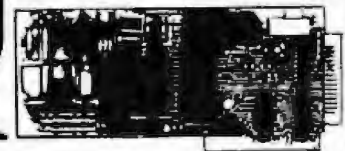

This is all it takes to say this or 143 other expressions with MICRO-MOUTH\*. No software drivers or subroutines to load. MICRO-MOUTH\* the latest Circuit Celler product can be used as an emergency annunciator, as an aid for the handicapped, for process control and to add dimensions to computer games.

Sample phrases that can be programmed are:

"THE TIME IS 4 HOURS 23 MINUTES... (BEEP)"

"THE SPEED IS 100 METERS A SECOND... SLOW DOWN"

Thousands of expressions can be added by changing the ROM chips. MICRO-MOUTH\* is plug compatible with APPLE II and TRS-80\*

Directions included for S100, H8 and parallel port operation.

As featured in BYTE, June, 1981

Complete Kit: APPLE II ..... \$120.00

TRS-80 Model I ..... \$150.00

Assembled and tested:

APPLE II ..... \$150.00

TRS-80 Model I w/power

supply and cable ..... \$170.00

TRS-80 Model III ..... \$200.00

\*MICROMOUTH is a trademark of Micromint Inc

\*DIGITALER is a trademark of

National Semiconductor Corp

MICROMINT INC.

917 Midway

Woodmere, N.Y. 11598

Dealer Inquiries Invited



Call 1-800-645-3479,  
in N.Y. 1-516-374-6793



Circle 348 on Inquiry card.

# BYTES ARCADE

## Big Five Software

Gregg Williams, Senior Editor

It may seem to many readers that BYTE's Arcade has concentrated on games for Apple and Atari computers. In a sense, this is natural; after all, both machines have excellent graphics, color, and sound capabilities—assets with which Radio Shack's TRS-80 Models I and III are less endowed. Given the coarse graphics, lack of color, and limited sound capabilities of the Radio Shack computers, what do they have in their favor?

The answer is: the ingenuity of Bill Hogue and Jeff Konyu.

Bill and Jeff comprise Big Five Software, a company that has developed an unequalled line of arcade-like software for the TRS-80. At the time of this writing, they had five games. Their first, Super Nova (an adaptation inspired by the Atari game, Asteroids), was reviewed in the May 1981 BYTE's Arcade (page 108). The three games I will describe here are Attack Force (similar to the arcade game Targ), Cosmic Fighter (similar to Cosmic Patrol), and Galaxy Invasion (similar to Galaxian). At present, they also have a game called Meteor Mission II, which resembles the arcade game Lunar Rescue.

### Attack Force

Attack Force is my favorite game. The player drives a single ship in one of four directions around a "city" seven blocks square. Eight Ramships roam the avenues of the city with the sole intent of ramming and destroying your ship. You can fire missiles at the attackers, and are allowed to lose three ships before the game ends.

Several features make this a fascinating game. The *Flagship* (on the right edge of the screen in photo 1) can zap a Ramship and change it into a Flagship; or it can simply step into the boundaries of the city and start hunting your ship. A Flagship is especially dangerous because it can fire even when you're not in its line of

sight. Once you clear the screen of all eight enemy ships, you get a stunning visual and aural display (that's right, this game has sound effects), bonus points, and a new set of enemy ships that are somewhat faster and net you more points when destroyed. Each score of 10,000 points gives you an extra ship (as in the other games described in this article), and, like all popular arcade games, the game gets harder and harder until you are inevitably overcome.

One feature that makes Attack Force particularly interesting is a practical joke that occurs at one point in

### At a Glance

#### Name

Attack Force, Cosmic Fighter, Galaxy Invasion

#### Type

Arcade-style games

#### Manufacturer

Big Five Software  
POB 9078-185  
Van Nuys CA 91409  
(213) 782-6861  
(phone orders only)

#### Price

Model I/Model III cassette version, \$15.95; Model I/Model III disk version, \$19.95

#### Author

Bill Hogue

#### Format

Cassette or 5-inch floppy disk

#### Language

Z80 machine code

#### Computer

Radio Shack TRS-80 Model I or III with either 16 K bytes (cassette version), or 32 K bytes and one disk drive (disk version)

#### Documentation

Color leaflet plus documentation in program

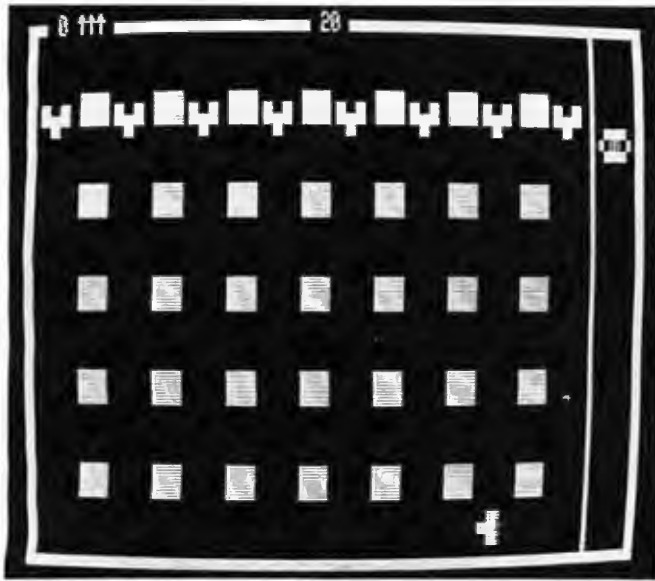

Photo 1: *Attack Force* in progress.

the game. I won't tell you what or when, so that you can be as surprised and delighted as I was.

### Cosmic Fighter

Your ship appears at the bottom of the screen and you try to destroy a wave of alien ships that slowly drift from the top to the bottom of the screen in *Cosmic Fighter*. The alien missiles can move either straight or diagonally down the screen (see photo 2), and once you destroy the first wave (or let them go off the bottom of the screen), a new, more intelligent wave of aliens appears. Occasionally, a deadly Flagship that can fire from any angle ap-

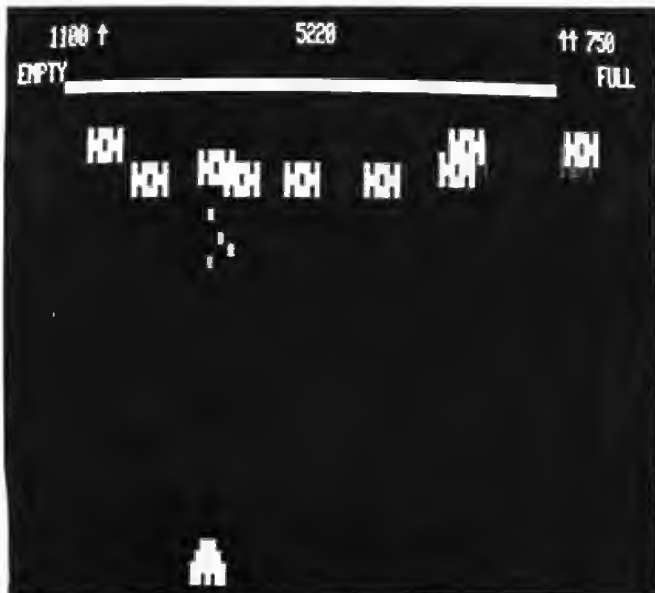

Photo 2: *Cosmic Fighter* in progress.

pears—you have to destroy this one quickly. If you survive four waves of aliens, you have the chance to fight off the Flagship near your space station and then dock to get extra fuel for the next round. This time, however, the wave of enemy ships requires two hits per ship to destroy. This continues until you either lose three ships or run out of fuel.

### Galaxy Invasion

*Galaxy Invasion* is a surprisingly faithful rendition of the popular Galaxian arcade game (which is itself a variation of the original *Space Invaders*). In *Galaxy Invasion*, you have a ship at the bottom of the screen that shoots up at a formation of enemy ships (see photo 3). The enemy ships don't move toward you, but instead send out attack groups that "peel off" the main formation, gliding diagonally down the screen and strafing the area they cover with missiles. The ever-present Flagship is just as dangerous in this game as it is in the others. A particularly nice feature is the different kinds of alien ships, all of which flap graphic "wings," both in the main formation and during strafing runs. In fact, it's difficult to imagine how Bill Hogue (who programs all the games) obtains such smooth movement of so many objects on the screen.

*Galaxy Invasion* lacks the color and the whining sound of attacking enemy ships, but is nonetheless amazingly close to the original arcade game that costs \$.25 to play.

### Common Features

All the games use the TRS-80's arrow keys for ship movement and the space bar for missile firing. Unlike



Photo 3: *Galaxy Invasion* in progress.

many microcomputer-based arcade games that exhibit a delay between a keypress and the reaction to it, these games always respond immediately to any keypress. All the games reviewed here also generate sound effects through the TRS-80 tape recorder and earphone (a standard method to get sound effects in a TRS-80). Although the sound is rough and scratchy, it adds immensely to the arcade quality of the games, the most frequent sound effects occurring every time you fire a missile or an explosion occurs.

Each of the games starts with a fancy billboard outlined in flashing lights, which also contains the names of the ten top scorers. (My only criticism is that for a home environment, ten names seem too many; five would give you more incentive to excel.) If you make one of the top scores, you put your initials into the billboard display.

From the beginning display you can either get a screen of instructions or start the game. All three games allow one or two people to play at the same time. A game may be aborted at any time.

Not only are these games fun to play—they are reasonably priced. At the time of this writing, two versions of each game were available (all supplied on cassette). One tape runs on both a TRS-80 Model I and a Model III with 16 K bytes of memory and costs \$15.95.

A disk version of each game is available for \$19.95 (one game per disk); the disk will run on any Model I or Model III TRS-80 with 32 K bytes of memory and one disk drive.

Big Five also sells a joystick adapter (\$39.95) that allows you to connect the rugged Atari joysticks to your TRS-80. All Big Five Software programs will respond to a joystick, and although I have not seen the adapter unit, I am confident it is of high quality.

### Conclusions

- To the best of my knowledge, Attack Force, Cosmic Fighter, and Galaxy Invasion are the best arcade-style games available for the TRS-80 Models I and III. In fact, they represent some of the best examples of microcomputer game animation that I have ever seen. They are as challenging as their arcade counterparts and, as much as possible, overcome the limitations of the TRS-80 graphics.

- Each game is based on an arcade-type game but adds its own distinctive touches. All games use both sound and extensive graphics.

- The games are reasonably priced (especially in comparison to graphics games that range from \$20 to \$40 each) and are, in my opinion, a "best buy." ■

# The Prisoner

Bob Liddil, POB 66, Peterborough NH 03458

You're on an island with your every need provided for—everything, that is, except your freedom. The island's caretaker is watching and experimenting, his ultimate goal is to take away the last scrap of individuality you possess. It's you against the island. You are The Prisoner.

The Prisoner, by Edu-Ware Services Inc of Canoga Park, California, offers a unique, sometimes bizarre, recreation of an early 1970s TV series that has attained cult status in recent years. To play the game, you assume the role of a disenchanting member of a covert intelligence agency. You're fed up with The Company—the whole system in general. After quitting the service, you're abducted and spirited off to The Island, an isolated, self-contained community where electronic surveillance, brainwashing, plots and counterplots, illusions, delusions, and confusions are the order of the day.

This program is not in the Adventure format that has become so popular over the last year. It is, in fact, a graphics-oriented, disk-accessing collection of fixed and randomized events that leaves you pounding your desk in endless frustration trying to make heads or tails of it. This is not necessarily bad because that is the program's intent.

The game is fundamentally a contest between two equally difficult goals. The computer wishes to obtain your resignation code (and, not incidentally, doesn't care how insane it drives you). You, on the other hand, wish to escape from The Island and must use every possible means to do so.

By studying the documentation carefully, you learn (well before booting the disk) that the program is going to lead you on an incredible journey. Before the game begins you are assigned a resignation code. The

documentation explains that this code is a condensation of your reasons for leaving The Company. When you awaken, the game begins in room #6, which contains a time-consuming invisible maze that is never the same twice. If you escape the maze, the machine greets you by asking you to identify yourself. Considering the twenty-minute invisible maze and the possible frustration of having to restart the game due to misinterpreting the screen—the tricks start coming right at the beginning—the inattentive player is in for rough sailing.

Once in the courtyard, the movement codes are different from those in the maze. A dead keyboard raises the frustration level before you realize that this is precisely what the author, in the guise of The Caretaker, or Master of the Island, is trying to do.

Subsequent scenarios are contained in twenty "buildings," each of which you may enter at any time. The trick is to survive and outwit the event once you're inside. For example, there is the Hospital, where an encounter with a "shrink" might be expected, and at the Town Hall you must play politics. There is a Bank, a Courthouse, a Church, and so on. All these locations are riddled with pitfalls and potential disasters. They are all designed to get you to throw in the towel and reveal your code.

The program uses an awesome mixture of graphics, sound, and text. There are high-resolution pictures with beeps and whistles and low-resolution pictures that confound you with simplicity. At times, portions of the program "jump loose" and seem to suffer a programming error. However, the program is not in error—it does this by design. It's a nightmare. The program doesn't do what you think it should.

The Prisoner is not for the easily frustrated, nor for those looking for a shoot-em-up arcade-type game. Instead, The Prisoner is complex beyond belief, nearly unbeatable, and at times irrational on purpose; careening through a calculated mind-warp, its sole function is to entertain.

If you follow the rules, trust your fellow man, or display anything less than a total commitment to anti-social, anti-island behavior, you will be hopelessly doomed to repeated failure.

Author David Mullich, a computer science student at California State University, Northridge, is a meticulous researcher with an artist's eye for depth and detail. In speaking about The Prisoner, he said: "I was sick and tired of all the arcade games and (conventional) Adventure games. They seemed to be imitations of each other."

As a youngster Mullich enjoyed *The Prisoner* on TV and found that, as a young man, the themes appealed to him. "I dreamed of doing a program on The Prisoner, and through Edu-Ware, I got the chance," he said.

## At a Glance

<b>Name</b> The Prisoner	<b>Language</b> Applesoft BASIC
<b>Type</b> Epic nonclassical adventure game	<b>Computer</b> Apple II or Apple II Plus Applesoft and 48 K bytes of memory
<b>Manufacturer</b> Edu-Ware Services Inc 22222 Sherman Way Canoga Park CA 91303 (213) 346-6783	<b>Documentation</b> 12-page booklet
<b>Price</b> \$29.95	<b>Audience</b> Puzzle solvers, adventure fans and students of the weird
<b>Author</b> David Mullich	

Mullich's version of The Prisoner, though not untrue to the series, is a product of his vivid imagination. It will appeal to puzzle solvers and seekers of the bizarre. ■



**GO!...**

**GET YOUR SHARE OF THE MICRO MARKET!  
IF A NUDGE IS ALL YOU NEED, READ ON....**

**HARDWARE** — Boards, systems and support at the right price, featuring CCS, Televideo and others.

**SOFTWARE** — Many industry-standard packages and some unique surprises, such as:

- AUTOGEN** — Interactively reconfigure your CP/M® BIOS. Bring new peripherals on-line quickly.
- READER** — Analyze your English prose. Measure how easy or hard it is to read.
- ...** — Do discrete-event simulation on a micro. Make parallel programs appear to use multiple resources, much more.

**WANTED! GET OUR CATALOG FOR THE FULL STORY!  
CALL OR WRITE NOW!**

**MICROCOMPUTER APPLICATIONS, INC.**  
1715 HOLLYVILLE ROAD, AUSTIN, TX 78768  
(512) 546-8208

## Three Microcomputer LISPs

Steven P Levitan and Jeffrey G Bonar  
Computer and Information Science Department  
Graduate Research Center  
University of Massachusetts  
Amherst MA 01003

"(TELL ME MORE ABOUT YOUR FAMILY)" With these immortal words, Joseph Weizenbaum's ELIZA program confronted the world with the power of artificial intelligence (AI) techniques. A good deal of that power comes from the expressiveness of the programming language LISP. Some sophisticated and powerful LISP software packages are now available for microcomputers. In this article, we review three LISPs, one of which is distributed with a modern version of ELIZA. The LISP packages are muLISP/muSTAR from The Soft Warehouse, Cromemco LISP from Cromemco Inc, and (T.(L.C)) from The LISP Company.

We have compared two basic issues: speed and functionality. In the LISPs reviewed, you will see that these two aspects are continually traded off: the slower LISP has more capabilities. The trade-off is more complex than in most languages, though. Due to the extreme flexibility of LISP, any feature of one LISP package can usually be emulated in another LISP package at the cost of increased run time.

LISP purchasers should realize that LISP is anything but a standardized language. Most LISPs are fairly idiosyncratic, representing many years of development, modification, and tailoring by their designers and users. The microcomputer-based LISPs are no exception. This can cause problems for new LISP users. A

LISP you purchase may look quite unlike some of the dialects discussed in textbooks. Furthermore, many features of LISP are rarely discussed in texts, but they are quite useful for LISP programming.

### Overview

muLISP successfully provides a useful artificial-intelligence development system to the microprocessor user community. It is billed as more than a LISP interpreter for the Z80, and it is a good bit more. It provides a reasonable set of LISP functions and special forms. It also supports the user with muSTAR, a development subsystem that makes entering and debugging code as painless as possible.

On the positive side, muLISP runs remarkably fast and allows for the creation and execution of fairly large LISP programs. On the negative side, some of the design decisions about error handling and type checking make debugging in muLISP harder than need be. In particular, muLISP provides almost no facilities to detect obvious nonsensical programs, and it does not allow a user to examine the data stack after an error or user interrupt. We like the ideas that motivated the muSTAR development subsystem, but are disappointed by some of the holes in the design. In particular, it is not easy to alternate between the high-efficiency environment and the development environ-

### At a Glance

**Name**

muLISP/muSTAR-80 version 10/06/80

**Type**

Version of LISP programming language

**Manufacturer**

The Soft Warehouse  
POB 11174  
Honolulu HI 96828

**Price**

\$200, from Lifeboat Associates  
1651 Third Ave  
New York NY 10028  
(212) 860-0300;  
\$200, from Microsoft  
10800 NE Eighth, Suite 819  
Bellevue WA 98004  
(206) 455-8080

**Format**

5-inch or 8-inch floppy disk

**Language used**

8080 or Z80 machine language

**Computer needed**

8080-, 8085-, or Z80-based computer with at least 20 K bytes of memory, running under a CP/M-compatible operating system

**Documentation**

100 pages, 8½ by 11 inches (22 by 28 cm), in a 3-ring binder

**Audience**

Students, educators, computer-language enthusiasts

ment. Also, the screen editor is not adaptable to all terminals. The example programs delivered with the system are interesting and give just a hint of the power of a micro-computer-based LISP system.

John Allen, who served as guest editor for the August 1979 BYTE LISP issue and wrote *Anatomy of LISP*, is the primary author of both the Cromemco and (T.(L.C.)) LISP systems. Therefore these two LISPs are similar in most respects and will usually be discussed together. We believe that they are, in fact, different revisions of the same program. These LISPs are also a successful attempt to bring LISP into the world of microprocessors.

In many respects, Cromemco LISP and (T.(L.C.)) LISP are more modern than muLISP. They lack an integrated development environment, but include many more intrinsic functions and data types, helpful type checking, and error detection. The extra functionality is provided at the expense of speed, but we feel that these LISPs still run acceptably fast. Our most important criticism is of the small, fixed-size stack. These LISPs do not allow one to write the powerful recursive functions that make LISP such a clean and elegant language. This is not necessarily a practical limitation since iteration is cleanly supported, but it is rather inelegant and unaesthetic.

### Data Types in LISP

Most modern programming languages support a variety of data types. So do modern LISPs. In addition to the basic atoms, integers, lists, and property-list data types, different LISPs support "infinite-precision" integers, floating-point numbers, character strings, arrays, and Pascal-like records. For now, we ignore the fact that functions and special forms are also data types in LISP. We discuss them separately below. (*Special forms* are things that look like LISP functions, but have special conventions for their evaluation. COND is an example of an intrinsic special form.)

The inherent flexibility of the basic

LISP data types allows almost any other data type to be emulated, but at a considerable price in execution speed and/or memory space. For example, we could emulate a character string as a list of single-letter atoms, but operations performed at the end of the "string" would be quite expen-

sive. Furthermore, assuming a two-byte address, more than  $4n$  bytes would be needed to store an  $n$ -character-length string. One would like a LISP implementation to directly support a variety of data types using machine-level data structures and operations.

## At a Glance

### Name

Cromemco LISP, version 1.06

### Type

Version of LISP programming language

### Manufacturer

Cromemco Inc  
280 Bernardo Ave  
Mountain View CA 94043  
(415) 964-7400

### Price

\$295

### Format

5-inch or 8-inch floppy disk

### Language used

Z80 machine language

### Computer needed

Z80-based computer with at least 48 K bytes of memory, running under Cromemco's CDOS or Cromix operating systems

### Documentation

135 pages, 8½ by 11 inches (22 by 28 cm), in 3-ring binder; includes various CDOS manuals and a copy of *Artificial Intelligence Programming*

### Audience

Students, educators, computer-language enthusiasts

## NEW! ada

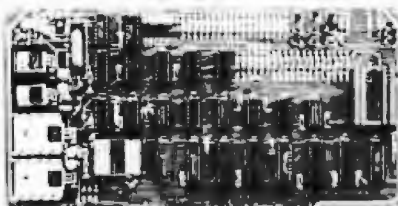

IEEE 896/S-100

All programming characteristics are software controlled; runs under CP/m\*

\*CP/m trademark Digital Research, Inc.

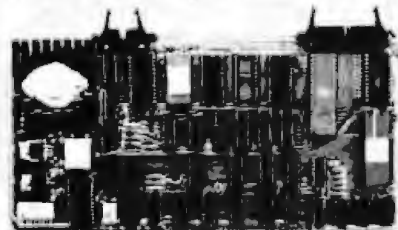

IEEE 896/S-100

- 20 parallel I/O lines
- Baud rates: 110 to 9600

**ACKERMAN DIGITAL SYSTEMS, INC. (312) 530-8992**  
110 N. York Rd., Suite 208, Elmhurst, IL 60126

## PROM BLASTER

- Programs 1K/2K/4K/8K eproms
- Programs EEproms
- Functions as an I/O device
- Programs single or three supply parts
- Phantom slave option
- Extended device option & much more

## 6809 S.B.C.

(Single-Board Computer)

- 2K ram
- RS 232 interface
- 4K/8K/16K Rom
- Simulated 8080 I/O ports: memory mapped & much more

# Buy by Mail and **SAVE!**

## COMPUTERS



### Intertec Superbrain SPECIALS

64K Ram, List \$3495                   \$2595  
64K Quad, List \$3995                 \$2995

#### NorthStar

Horizon I 32K DD List \$2695        CALL  
Horizon I QD List \$2995            CALL  
Horizon 2 32DD List \$3095         CALL  
Intersystem DPS-1 List \$1749      CALL



Cromemco Z-2H, List \$9995         \$7945  
System 2, 64K List \$4695          \$3749  
System 3, 64K, List \$7995         \$6395

#### Disk Systems

Thinker Toys Discus 2D             \$939  
Dual Discus 2D                     \$1559  
Discus 2 + 2, List \$1549           \$1259  
M26 Hard Disk, List \$4995         \$3949  
Discus M-10, List \$3695            \$2995

#### Printers & Terminals

Paper Tiger IDS-445                \$649  
with graphics option               \$719  
Centronics 730-1, List \$795        \$549  
739-1, List \$295                    \$769  
704-9 RS232                         \$1495  
704-11                                 \$1569  
TI 810, List \$1895                  \$1489  
NEC SPINWRITER 5530                \$2395  
NEC SPINWRITER 5515, 5510         \$2395  
Diablo 630 List \$2711               \$2399  
Intertube III List \$895              \$729  
Zenith Z-19                         \$719  
Televideo 912C                     \$679  
920C                                 \$799  
950                                  \$999  
Hazeltime 1420                     \$789  
1500                                 \$845  
Soroc 120 List \$995                 \$689  
IQ135                                \$719  
140                                  \$994

## Computers Wholesale

P.O. Box 144 Camillus, NY 13031



(315) 472-2582



Most items in stock for immediate delivery. Factory sealed cartons, w/ full factory warranty. NY residents add appropriate sales tax. Prices do not include shipping. VISA and Master Charge add 3% C.O.D. orders require 25% deposit. Prices subject to change without notice.

Support of many data types does not imply strict type checking, as in Pascal. LISP style dictates that "reasonable" data-type conversions will happen automatically. For example, if an operation performed on two integer values yields a value not representable as an integer, one would expect LISP to return a floating-point or infinite-precision integer as the value.

Cromemco and (T.(L.C)) LISP support a richer set of data types than does muLISP. They support atoms, 14-bit integers, floating-point numbers, single characters, strings up to 256 characters long, lists, and property lists. Atoms in these LISPs can take only one value. This contrasts with many LISPs, including muLISP, which allow an atom to have two values, one interpreted as a function. Each atom does have an associated property list.

Cromemco and (T.(L.C)) LISP

check data types fairly strictly. For example, single characters, denoted with a back slash ("`\`"), are not directly comparable to strings of length one, nor are they directly comparable to single-character atoms. Similarly, the string "123" is not directly comparable to the integer 123. Of course, functions are provided to convert between types. Cromemco and (T.(L.C)) LISP do provide facilities for building and supporting user-defined data types.

Cromemco and (T.(L.C)) LISP do have functions that behave differently depending on the type of argument passed in. For example, the ASCII function yields an integer when passed a character and a character when passed an integer:

(ASCII \ C) returns 67

(ASCII 67) returns \ C

The details of how these data structures are implemented are hidden from the users of (T.(L.C)) LISP. The "clever tricks" which this prevents are no loss to most programmers. The Cromemco LISP manual does discuss details of these data structures for use in writing external assembly-language functions.

muLISP supports atoms (called *names* in the manual), infinite-precision integers (actually, they must be in the range  $\pm 256^{32}$ ), lists, and property lists. Each name can take two values—a value that is returned when the name appears as a function call, and a value that is returned in all other situations. Each name also has an associated property list. Strings are partially supported by allowing manipulation of the print names of atoms.

muLISP does almost no type checking. The manual discusses the implementation of the different data types very early, and some knowledge of this implementation is important in using the system. Many operations are defined for all data types, irrespective of whether this makes any sense. CAR and CDR, for example, will work perfectly well on numbers. This may be useful in some situations, but it often causes confus-

### At a Glance

#### Name

(T.(L.C)) LISP version 1.07

#### Type

Version of LISP programming language

#### Manufacturer

The LISP Company  
18215 Bayview Dr  
Los Gatos CA 95030  
(408) 353-2227

#### Price

\$150

#### Format

5-inch or 8-inch floppy disk

#### Language used

Z80 machine language

#### Computer needed

Z80-based computer with at least 48 K bytes of memory, running under a CP/M-compatible operating system

#### Documentation

135 pages, 8 1/2 by 11 inches (22 by 28 cm)

#### Audience

Students, educators, computer-language enthusiasts



ing results and subtle bugs. We feel the marginal extra functionality and generality provided in this way are only an invitation to poor code, obscure hacking, and subtle bugs. If it is necessary to explicitly manipulate an internal representation, there should be an explicit function to do this. Of course, muLISP saves both time and space by not checking data types.

### User-Defined Special Forms

In a LISP system, one wishes to write things which look like functions, but behave differently. For example, we would like to write things

like the standard LISP AND:

```
(AND predicate-1 predicate-2 . . .
predicate-n)
```

AND evaluates each *predicate-i* in order, stopping if any predicate returns the value NIL (the standard LISP representation of the Boolean value *false*). There are two independent problems with writing AND as a standard LISP function. First, how do we pass an indefinite number of arguments, and second, how do we pass the parameters unevaluated? Special forms allow us to tell the system to treat the parameters in a

special way. Below, we follow LISP convention and use the word *form* as a general term for both functions and special forms.

muLISP solves the problem of an indefinite-length parameter list with *no-spread forms*, in which there is only one formal parameter. (A formal parameter is a dummy variable in the form definition.) When a no-spread form is called, a list of all arguments is bound to that single formal parameter. The form uses this list of arguments in any way desired.

In muLISP, call-by-name forms are specified with NLAMBDA (for *No* evaluation of LAMBDA) instead of

Listing 1: Definition of AND-1 in muLISP.

```
(LAMBDA (PRED-LIST)
  (COND
    ((NULL PRED-LIST) T)
    (% we have reached the end of the predicates
     % and all have evaluated non-NIL -
     % return T.
    ((EVAL (CAR PRED-LIST))
     (AND-1 (CDR PRED-LIST)))
    (% eval the next predicate, if non-NIL
     % recur on the rest
    (T NIL)
     % otherwise, the last predicate was false,
     % exit with NIL)
  ))
```

Listing 2: A LISP function to print out the integers from 1 to N. The version in listing 2a is the function written in muLISP. The version in listing 2b is the function written in either Cromemco LISP or (T.(L.C)) LISP.

(2a)

```
(LAMBDA (N)
  (SETQ COUNT 1)
  (LOOP
    (PRINT COUNT)
    ((EQ COUNT N) N) % exit test
    (SETQ COUNT (PLUS (COUNT) 1)))
```

(2b)

```
(LAMBDA (N)
  (DO
    ((COUNT 1 (PLUS COUNT 1)))
    ; Only one local variable, COUNT. It is
    ; initialized to 1, and incremented on
    ; each iteration
    ((EQ COUNT N) N)
    ; Only one exit test. It specifies an
    ; exit with value N when count equals 101
    (PRINT COUNT)
    ; The body contains only the PRINT
  ))
```

LAMBDA. Normal (LAMBDA) functions are call-by-value and evaluate each actual parameter, binding formal parameters to the values of the actual parameters. (Actual parameters are the expressions appearing as arguments to a function call.) In a call-by-name function, the formal parameters are bound directly to the actual parameters. If evaluation is desired for any of these parameters, it is explicitly specified with EVAL.

We can write a muLISP version of AND defined as:

```
(NLAMBDA PRED-LIST
 (AND-1 PRED-LIST))
```

Because AND is a call-by-name no-

spread form, all its actual parameters are gathered, unevaluated, into a list that is bound to PRED-LIST. AND-1 is called with PRED-LIST as its single parameter. AND-1 is a call-by-value spread function. AND-1 is then defined as shown in listing 1.

In summary, muLISP supports two types of forms—call-by-value and call-by-name—and two parameter-binding styles—spread and no-spread. All four combinations are permitted and useful. muLISP forms are compiled in a way that is largely transparent to the user.

Cromemco and (T.(L.C)) LISP also allow both call-by-value and call-by-name (referred to as "call-unevaluated" in the manual) forms.

Additionally, LISP macros are supported. A LISP macro has only one parameter, which is bound to the complete text of the expression that calls the macro. For example, consider a macro TEST, which is called with the following expression:

```
(TEST JOE (CAR A) 5)
```

The formal parameter of TEST would be bound to the expression:

```
(TEST JOE (CAR A) 5)
```

The macro body is then free to manipulate the original expression with the full power of LISP. The

Issue Discussed	Cromemco and (T.(L.C)) LISP	muLISP
Cost	\$295-Cromemco *\$150-(T.(L.C))	\$200
Data types supported	*Atoms, integers, floating-point, characters, strings, lists, property lists	Atoms, strings, infinite integers, lists, property lists
Type checking	*yes	no
Number of intrinsic functions	*145-Cromemco; 144-(T.(L.C))	71
Parameter options	*Optional, auxiliary, rest	Spread or no-spread
Special forms	*Macros, read-macros "call-by-unevaluated"	"Call-by-name"
Control flow	DO, PROG1, PROGN, COND, AND, OR, CATCH, THROW	LOOP, implicit sequencing, PROG1, COND, implicit conditional, AND, OR
Input and output at the terminal	Allows backspace	*Allows backspace, retype line, abort line
Program saving and restoring	Text files, absolute memory image, auto-load	Text files and compressed internal image files
Program-controlled input and output	*Well done, I/O functions work on strings	Well done
Space management	Dynamic space allocation for all data types, the stack is fixed in size and too small	*Dynamic space allocation for all data types and the stack
User environment	Simple environment for developing, debugging, and executing programs; ability to examine the data stack after errors, extensive error checking; tracing abilities	Separate development (muSTAR) and execution (muLISP) environments; no ability to examine the data stack after errors, too little error checking; muSTAR includes a screen editor; tracing abilities; source code for muSTAR included
Linking to assembly language	Cromemco-well documented and supported (T.(L.C))-not supported	Possible but poorly documented
Documentation/library software	Clear manual suitable for beginners; many examples	Clear user's manual; too terse and formal for beginners; includes several utilities and games
Speed	Adequate	*4 to 7 times faster than the others

**Table 1:** Comparison chart for the versions of LISP reviewed. This table summarizes the differences discussed in the text. For each issue discussed, an asterisk (\*) denotes the LISP the reviewers consider to be superior. The absence of an asterisk denotes a tie among the three versions.

Expression evaluated in TESTER loop	(T.(L.C)) counts	Cromemco counts	muLISP counts
NIL	8122	8061	31260
LC	265	258	1667
DC	408	409	2100
BIGCAR	556	549	4316
BIGCDR	555	552	4200
'(HAS-AS-MEMBER-I 'B LONG1)	119	118	704
'(HAS-AS-MEMBER-R 'B LONG1)	79	79	367
'(REMOVE-ELEMENT-I 'B LONG41)	84	85	24
'(REMOVE-ELEMENT-R 'B LONG41)	64	66	318
'(HOW-RELATED 'FRODO-B 'BILBO-B)	3	3	16

Notes:

- All of the above expressions were evaluated as many times as possible in 30 seconds (60 seconds for the call to HOW-RELATED). The counts represent how many complete evaluations occurred in that time.
- The counts given represent an average of three separate trials, except for the Cromemco counts, which represent one trial. The one Cromemco trial was run to verify the similarity between (T.(L.C)) and Cromemco LISP, as explained in the text.
- muLISP performs particularly slowly with REMOVE-ELEMENT-I because this function uses APPEND, which is not intrinsic to muLISP. To run REMOVE-ELEMENT-I we used the recursive version of APPEND supplied in the muLISP utility library. The use of an interactive APPEND would improve the performance shown.
- These tests were run on a Cromemco C3 Z80-based system with 64 K bytes of memory running at 4 MHz.
- The amount of available memory influences these results in two opposing ways. More memory means fewer garbage collections, but the garbage collections that do occur last longer.

Table 2: Timing results for the LISP benchmark programs. For details on how this table was compiled, see the text box "Notes on LISP Benchmarks."



EPSON - \$445



APPLE II - \$1175



M83 - \$749

APPLE GRAPHICS PARALLEL INTERFACE

Full Hi Res Graphics for Epson, OKI and others \$99

TRS80 BIDIRECTIONAL I/O PORT

Cascadable with Selectable Addressing \$39

**ALTOS**  
 ACS 8000-15 - \$4750  
**ANADEX**  
 9500 - \$1225 9501 - \$1275  
**CENTRONICS**  
 730 - \$600 737 - \$750  
**DATASOUTH**  
 DS120 - \$595 DS180 - \$1295  
**DIABLO**  
 630 - \$2150 1640 - \$2575  
**DISKETTES**  
 Scotch 5 1/4 - \$2.75 Dysan - \$3.40  
**EPSON**  
 MX70 - \$379 MX100 - \$849  
**HAZELTINE**  
 1500 - \$995 Esprit - \$650

**INTERFACES**  
 SSM-A10 - \$160 CPS-Card - \$199  
**LOBO**  
 APPLE Drive/Card - \$150/200  
 TRS 80 Drive/Interface - \$260/\$87  
 APPLE DD Drive - \$2740  
**MODEMS**  
 CAT - \$155 HAYS - \$325  
**MONITORS**  
 88G - \$595 99G - \$695  
**MONITORS**  
 APF - \$125 SANYO - \$159  
 AMDEK Green - \$150 Color - \$350  
 SANYO Green - \$249 Color - \$425  
**NEC**  
 5510 - \$2540 5520 - \$2900

**TELEVIDEO**  
 912 - \$720 950 - \$950  
**OKIDATE**  
 M80 - \$370 SL-125 - \$3150  
 M82 - \$510 SL-250 - \$4200  
 M83 - \$749 SLG - \$4750  
**TI**  
 810 - \$1475 820 - \$1795  
**SOFTWARE**  
 All Major Brands - \$ Cell  
**EXTRAS**  
 MEMORY 16K 200NS - \$19.95  
 Game Paddle Extension - \$19.95  
 Game Paddles - \$19.95  
**ZENITH**  
 Z19 - \$775 Z89 - \$2195

DISCOUNT LINE  
 1-800-528-8960

**EXPOTEK CORPORATION INTERNATIONAL**  
 2231R West Shangri La Road, Phoenix, AZ 85029

Arizona 1-602-861-3181  
 TWX 910-950-1194

value computed, however, is then itself evaluated, yielding the final value of the macro call. Often a problem is best solved by manipulating the text of a form's call. Macros allow this manipulation in a clean way. Macros are particularly suitable for hiding data-structure implementations.

Cromemco and (T.(L.C)) LISP allow a very general formal-parameter-list specification for call-by-value functions. In particular, one can specify *regular* parameters, *optional* parameters, *auxiliary* parameters, and a *rest* parameter. Optional parameters are bound to a specified default value if they are not specified as an actual parameter. Auxiliary parameters are local variables to the function, and they are specified with an initialization value. The rest parameter is bound to a list of all actual parameters not bound to a formal parameter of some other type. This is more flexible than the no-spread parameter of muLISP

because some actual parameters can be required even though the total number is indefinite. The call-by-name and macro forms of Cromemco and (T.(L.C)) LISP also allow the definition of auxiliary parameters. We found this sophisticated parameter list to be quite useful and concise once we were familiar with it.

### LISP Control Structures

Because LISP uses the same representation for data and programs, the difference between control structures and data structures becomes blurred. For example, one function may construct a list which is then evaluated as a function call. We have done this in the function BUILD-LONG-CONS in listing 3. For the purpose of this review, we consider any construct that affects the order of expression evaluation to be a control structure. LISP easily allows the definition and integration of new control structures that reflect the needs of a particular problem. In particular,

the LISPs reviewed here allow one to create new control structures using the special forms described above. This means that if you like a control structure in one LISP, you can usually emulate it in another.

### Sequencing Control Structures

The simplest control structure allows one to evaluate a sequence of expressions. In muLISP, sequential evaluation is implied by putting several expressions to be evaluated into a list. For example:

```
((PLUS 3 4) (CAR (QUOTE (A B)))
 (SETQ Z 6))
```

returns:

```
(7 A 6)
```

and binds 6 to the atom Z. Also provided is the PROG1 form which returns the value of the first expression it evaluates, but also evaluates

*Text continued on page 396*

**Listing 3: Benchmark functions for versions of the LISP programming language. These functions are used either to build expressions used in the timing benchmarks or as functions to be benchmarked. BUILD-LONG-CONS, BUILD-DEEP-CONS, and NESTED-APPLICATION are used to build expressions that test CONS, CAR, and CDR. Listing 5 shows how they are used. REMOVE-ELEMENT and HAS-AS-MEMBER represent archetypical LISP functions. They are tested in both a recursive and an iterative form. These functions are written in a neutral "standard" LISP, except for the iterative versions of REMOVE-ELEMENT and HAS-AS-MEMBER. Comments are delimited with braces ({}). See also table 2 and the text box labeled "Notes on LISP Benchmarks."**

---

#### build-long-cons

```
{ Builds a CONS expression which, when evaluated, will
  produce a list LENGTH long of ELEMENT. Example:
  (BUILD-LONG-CONS 5 'A) returns
  (CONS 'A (CONS 'A (CONS 'A (CONS 'A (CONS 'A NIL)))))
}

(lambda (length element)
  (cond ((zerop length) nil)
        (t (list 'cons
                  (list 'quote element)
                  (build-long-cons (difference length 1)
                                  element)))))
```

---

#### build-deep-cons

```
{ Builds a CONS expression which, when evaluated, will produce
  a list DEPTH deep with the innermost list containing
  ELEMENT. Example:
  (BUILD-DEEP-CONS 5 'A) returns
  (CONS (CONS (CONS (CONS (CONS 'A NIL) NIL) NIL) NIL) NIL)
}

(lambda (depth element)
  (cond ((zerop depth) (list 'quote element))
```

Listing 3 continued:

```
(t (list 'cons
        (build-deep-cons (difference depth 1)
                        element)
        nil))))
```

---

#### nested-application

{ Builds an expression which, when evaluated, will apply FUNCTION to ARG, then FUNCTION to the results, then to those results, etc. for a total of LENGTH times. Example:

```
(NESTED-APPLICATION 'CAR 5 '((((A)))) ) returns
(CAR (CAR (CAR (CAR (CAR (((A)))) ) ) ) ) )
```

}

```
(lambda (function length arg)
  (cond ((zerop length) arg)
        (t (list function
                  (nested-application
                   function
                   (difference length 1)
                   arg))))))
```

---

#### has-as-member-r

{ Returns T if ELEMENT appears in (S). This is the recursive version of the function. }

```
(lambda (element lst)
  (cond ((null lst) nil)
        ((eq element (car lst)) t)
        (t (has-as-member element (cdr lst)))))
```

---

#### remove-element-r

{ Returns a copy of LST with all occurrences of ELEMENT deleted. This is the recursive version. }

```
(lambda (element lst)
  (cond ((null lst) nil)
        ((eq element (car lst)) (remove-element-r
                                element
                                (cdr lst)))
        (t (cons (car lst)
                  (remove-element element (cdr lst))))))
```

---

#### has-as-member-i-muLISP

{ The muLISP iterative version of HAS-AS-MEMBER. }

```
(lambda (element lst)
  (setq cdr-lst lst)
  (loop ((null cdr-lst) nil)
        ((eq (car cdr-lst) element) t)
        (setq cdr-lst (cdr cdr-lst))))
```

---

#### remove-element-i-Cromemco-tlc

{ The Cromemco/(T.(L.C)) iterative version of REMOVE-ELEMENT. }

```
(lambda (element lst)
  (do ((front nil)
      (back lst (cdr back)))
      ((if (eq element (car back))
           (append front (list (car back))
                   front))
        ((null back) front))))
```

---

Text continued from page 394:

all other expressions in order. For example:

```
(PROG1 (PLUS 3 4) (CAR (QUOTE (A B))) (SETQ Z 6))
```

returns 7, but also executes the CAR, throwing away the result, and binds 6 to the atom Z.

The implicit sequence evaluation, while convenient, is often confusing and error-prone. Quite often, incorrect functions evaluate without an error because there is almost always a legal interpretation of any expression. We feel this disadvantage outweighs the convenience of the implicit form.

Cromemco and (T.(L.C)) LISP provide PROG1 as well as a PROGN special form. PROGN evaluates its expressions in sequence, like PROG1, but returns the value of the last expression evaluated.

### Conditional Control Structures

The standard LISP form for ex-

pressing conditionality is COND. In muLISP, COND is implied in any list of expressions. If any element of the list is of the form:

```
(predicate expression)
```

and *predicate* evaluates to non-NIL, then control exits from the outer list with the value of *expression*. Like the implicit sequence evaluation, this feature trades readability and ease of debugging for conciseness and speed. Of course, an explicit COND is also available in muLISP.

The COND form is augmented with an IF form in Cromemco and (T.(L.C)) LISP:

```
(IF predicate expression-1  
expression-2 . . . expression-n)
```

If *predicate* is true, *expression-1* is evaluated and its value is returned. Otherwise, *expression-2* through *expression-n* are evaluated, and the

results of evaluating *expression-n* are returned.

All three LISPs provide the conditional logical operators AND and OR:

```
(AND predicate-1 predicate-2 . . .  
predicate-n)  
(OR predicate-1 predicate-2 . . .  
predicate-n)
```

If any *predicate-i* evaluates to NIL for AND, or other than NIL for OR, the form immediately returns with that value, evaluating no other *predicate-i*.

### Recursion and Iteration

LISP is one of the cleanest languages in which to express a recursive solution to a problem. LISP programs that use only recursion are clean, elegant, and very simple to debug because there are no global variables or side effects. Unfortunately, purely recursive LISP programs are usually too slow. Typically, when an application program is found to be too slow, a few functions are taking most of the time. (In our genealogy program in listing 4, SONG-1 and SING-1 are the critically slow functions.) Once these functions are found, they can each be optimized, usually by making them iterative. Good LISPs must provide clean iterative structures which localize any use of side effects and easily replace recursive structures. All LISPs reviewed here have good iteration constructs.

The LOOP iteration construct of muLISP allows any sequence of expressions within the loop body. If any expressions are of the form:

```
(predicate expression)
```

then *predicate* is evaluated on each iteration of the loop. If it is non-NIL, the LOOP returns with the value of *expression*.

Consider the problem of writing a function to print out the integers from 1 to *n*, returning the value *n*. In muLISP this would be written as shown in listing 2a.

The DO iteration construct of

Text continued on page 404

### Notes on LISP Benchmarks

The timing benchmarks were designed to test the speed of CAR, CDR, and CONS, the workhorse functions of LISP; the speed of some simple but "archetypical" LISP functions, in both recursive and iterative form; and the speed of a reasonably large LISP program with several modules. Basically, the benchmarks were performed in an environment created by defining the functions shown in listing 3 and evaluating the expressions shown in listing 4.

To test CAR, CDR, and CONS, we built long nested expressions that invoke only these functions. This is done with the functions BUILD-LONG-CONS, BUILD-DEEP-CONS, and NESTED-APPLICATION in listing 3.

We chose REMOVE-ELEMENT and HAS-AS-MEMBER as the "archetypical" LISP functions. In listing 3, we show the recursive versions of each and a sample iterative version of each. Since iteration constructs differ widely among LISPs, we tailored an iterative version for each LISP to be benchmarked.

Finally, listing 4 shows the genealogy program we developed as our full-size LISP program. This program allows one to enter family-tree information through the functions BORN, MARRIED, and FIRST-BORN (FIRST-BORN is used when the parents of the new entry are unknown). The family tree is queried by calling the function HOW-RELATED with two names. This program has three principal components. The first group of functions know about kinship. These functions use another set of functions that perform a breadth-first search through a family tree. Finally, the family tree is implemented with a set of graph-manipulating functions based on the language GRASPER.

In listing 5, we entered parts of the BAGGINS and TOOK family trees. Our test then involved asking how Bilbo Baggins and Frodo Baggins are related. These family trees can be found in appendix C of J R R Tolkien's Return of the King.

Timing is actually done by counting the number of times a given expression will be evaluated in a fixed time period. The function TESTER in listing 5 performs the evaluation and counting repeatedly until it is interrupted after a fixed time period. The count is then examined. Note that before entering the main tester loop we always perform a garbage collection.

Listing 4: A genealogy program written in LISP. This program is intended to test the LISPs on a moderate-sized program with several modules. It allows one to enter family-tree information through the functions BORN, MARRIED, and FIRST-BORN (FIRST-BORN is used when the parents of the new entry are unknown). The system is initialized with the function CREATE-UNIVERSE. The program has three levels: a group of functions that know about kinship, another group of functions that perform a breadth-first search, and finally a set of graph-manipulation functions that implement the family-tree data structure.

---

how-related

```
{ Describes how P1 is related to P2. First we check the simple
cases that P1 is the same as P2 and that P1 is P2's spouse.
Otherwise, we call DESCRIBE-RELATION after computing the
path in the family tree between P1 P2. }
(lambda (p1 p2)
  (cond ((eq p1 p2) (list 'same))
        ((eq p1 (spouse-of p2)) (list
                                   (sex-of-spouse p1)))
        (t (describe-relation p1
                               p2
                               (find-path-between p1 p2)))))
```

---

describe-relation

```
{ Based on a legal connecting path through the family tree,
describes how P1 is related to P2. PATH-UP-AND-DOWN is a
list with the distance up from P1 to the lowest common
ancestor and the distance down to P2 from the lowest
common ancestor. We use a LAMBDA binding to cut this
list into components D1 and D2. If either D1 or D2 is
zero, the relationship is direct. Other cases are dealt with
by NOT-DIRECT-RELATIONS. }
```

```
(lambda (p1 p2 path-up-and-down)
  (cond ((null path-up-and-down) '(not
                                   related
                                   by
                                   blood))
        (t ((lambda (d1 d2)
              (cond ((= d1 0)
                    (direct-ancestor p1 d2))
                    ((= d2 0)
                    (direct-descendent p1 d1))
                    (t (not-direct-relations
                       p1
                       p2
                       d1
                       d2))))
            (car path-up-and-down)
            (cadr path-up-and-down)))))
```

---

direct-descendent

```
{ The relationship is known to be child, grandchild, great
grandchild, or etc. This function invokes choosing the
right relation name by sex - son or daughter, and the
right number of greats. }
```

```
(lambda (younger distance)
  (add-grand-greats (sex-of-child younger) distance))
```

---

direct-ancestor

```
{ The relationship is known to be parent, grandparent, great
grandparent, or etc. This function invokes choosing the
right relation name by sex - father or mother, and the
right number of greats. }
```

```
(lambda (older distance)
  (add-grand-greats (sex-of-parent older) distance))
```

Listing 4 continued on page 398

---

not-direct-relations

{ Based on the distances D1 and D2, determine the relation P1 and P2. If D1 and D2 are both one, then P1 and P2 are siblings. If D1 equals D2, and both are greater than one, then P1 is P2's nth cousin, where n is D1 (or D2) minus one. Finally, if D1 is not equal to D2, and both are greater than one, P1 is P2's Nth cousin, M removed. N is D1 minus 1, and M is the absolute value of the difference between D1 and D2.

```

}
(lambda (p1 p2 d1 d2)
  (cond ((and (eq d1 1) (eq d2 1)) (list
                                   (sex-of-sibling p1)))

        ((eq d1 d2) (list (difference d1 1)
                           'cousin))

        ((eq d1 1) (ancestors-sibling p1 d2))

        ((eq d2 1) (siblings-descendent p1 d1))

        (t (list (difference d1 1)
                  'cousin
                  (abs (difference d2 d1))
                  'removed))))

```

---

find-path-between

{ To find a path between P1 and P2 we use a breadth first search. Starting at P1 we look for P2 one step away, then two steps away, etc. The BREADTH-FIRST-SEARCH is passed a list of unexpanded nodes and a goal. The unexpanded nodes are lists with the following information:

- a person to be checked next
- the distance traveled up to get to this person
- the distance traveled down to get to this person
- the last person visited before this person

We start with a P1 node and initial values on the unexpanded list. }

```

(lambda (p1 p2)
  (breadth-first-search (list (list p1
                                   0
                                   0
                                   'the-great-unknown))
                        p2))

```

---

breadth-first-search

{ We take the first unexpanded node of the unexpanded list. if it represents the goal node, we return its accumulated distances. Otherwise, we check its relations to see who needs to be added as nodes to the unexpanded list. }

```

(lambda (unexpanded goal-node)
  (cond ((null unexpanded) nil)
        (t ((lambda (next)
                (cond ((eq (node-of next)
                           goal-node)
                       (list (dist-up-of next)
                             (dist-down-of next)))
                      (t (check-relatives
                          next
                          goal-node
                          (cdr unexpanded))))))
           (car unexpanded))))

```

---

check-relatives



Listing 4 continued:

```
{ Appends new nodes on the end of the unexpanded list. By
  putting them on the end we get a breadth first search.
  These new nodes are built by BUILD-NEW-UNEXPANDED which
  uses various information from the last node expanded.
}
(lambda (last-expanded person unexpanded)
  (breadth-first-search (append unexpanded
                               (build-new-unexpanded
                                (node-of
                                 last-expanded)
                                (dist-up-of
                                 last-expanded)
                                (dist-down-of
                                 last-expanded)
                                (where-of
                                 last-expanded)))
                        person)))
```

---

build-new-unexpanded

```
{ Finds all the neighbors of the node last expanded and
  builds unexpanded nodes for them. If we have not
  yet started down in the tree (D-DOWN equals 0),
  we can also build unexpanded nodes from parents of the
  node last expanded. In each case we will note
  the new distances and the node last expanded. }
(lambda (node d-up d-down from)
  (append (make-unexpanded (song node 'child)
                          node
                          d-up
                          (plus d-down 1)
                          from)
          (cond ((eq d-down 0) (make-unexpanded
                              (song
                               node
                               'parent)
                              node
                              (plus d-up 1)
                              d-down
                              from))
              (t nil))))
```

---

make-unexpanded

```
{ Given a list of nodes and information about how we got
  to those nodes, builds unexpanded nodes for the
  breadth first search. We do not make an unexpanded node
  for THE-GREAT-UNKNOWN or for the place we were at two steps
  ago. In this way we avoid infinitely looping through
  the family tree. }
(lambda (node-list from d-up d-down from-from)
  (cond ((null node-list) nil)
        ((or (eq (car node-list)
                  'the-great-unknown)
              (eq (car node-list) from-from))
         (make-unexpanded (car node-list)
                          from
                          d-up
                          d-down
                          from-from))
        (t (cons (list (car node-list)
                        d-up
                        d-down
```

Listing 4 continued on page 400

Listing 4 continued:

```
from)
(make-unexpanded (cdr node-list)
  from
  d-up
  d-down
  from-from))))))
```

---

node-of

```
{ This and the next three functions select sub fields of an
  unexpanded node. }
(lambda (unexpanded-entry) (car unexpanded-entry))
```

---

dist-up-of

```
(lambda (unexpanded-entry) (cadr unexpanded-entry))
```

---

dist-down-of

```
(lambda (unexpanded-entry) (caddr unexpanded-entry))
```

---

where-of

```
(lambda (unexpanded-entry) (caddr unexpanded-entry))
```

---

born

```
{ Allows a user to declare that PERSON of sex SEX was born
  to PARENT1 and PARENT2. Various graph primitives are
  used to link the new arrival into the family tree. These
  primitives are explained below. }
```

```
(lambda (person parent1 parent2 sex)
  (progn (cun person)
         (bun person sex)
         (cip person 'child parent1)
         (cip person 'child parent2)
         (cop person 'parent parent1)
         (cop person 'parent parent2)
         person))
```

---

married

```
{ Allows a user to declare that PERSON1 and PERSON2 were
  married. The graph processing primitives used to do
  this are explained below. }
```

```
(lambda (person1 person2)
  (progn (cap person1 'spouse person2)
         (list person1 person2)))
```

---

add-grand-greats

```
{ Adds the right NUMBER of "grand"s and "great"s to the
  basic relationship name ONE-CASE. }
```

```
(lambda (one-case number)
  (cond ((eq number 1) (list one-case))
        ((eq number 2) (list 'grand one-case))
        (t (cons 'great
                  (add-grand-greats one-case
                                     (difference
                                      number
                                      1))))))
```

---

add-greats

```
{ Add the right NUMBER of "great"s to the basic relationship
  name ONE-CASE. Note that "grand"s are not used. This
  is more common usage for great uncles and aunts. }
```

```
(lambda (one-case number)
  (cond ((eq number 1) (list one-case))
        (t (cons 'great
```

```
(add-greats one-case
  (difference number 1))))))
```

-----  
ancestors-sibling

```
{ Builds up the appropriate kind of uncle or aunt based
  on the sex of UNCLE-OR-AUNT and the DISTANCE. }
(lambda (uncle-or-aunt distance)
  (add-greats (sex-of-uncle-or-aunt uncle-or-aunt)
    (difference distance 1)))
```

-----  
siblings-descendent

```
{ Builds up the appropriate kind of niece or nephew based
  on the sex of NIECE-OR-NEPHEW and the DISTANCE. }
(lambda (niece-or-nephew distance)
  (add-greats (sex-of-niece-or-nephew niece-or-nephew)
    (difference distance 1)))
```

-----  
spouse-of

```
{ Follows NODEs spouse link using a graph processing primitive. }
(lambda (node)
  (car (song node 'spouse)))
```

-----  
sex-of-child

```
{ This and the next 6 functions chose the appropriate relation
  name based on the PERSONs name. They all pass a FEMALE-CHOICE
  and a MALE-CHOICE to CHOOSE-BY-SEX, which actually looks
  up the sex of PERSON and returns a choice. }
(lambda (person)
  (choose-by-sex person 'daughter 'son))
```

-----  
sex-of-parent

```
(lambda (person)
  (choose-by-sex person 'mother 'father))
```

-----  
sex-of-spouse

```
(lambda (person)
  (choose-by-sex person 'wife 'husband))
```

-----  
sex-of-uncle-or-aunt

```
(lambda (person)
  (choose-by-sex person 'aunt 'uncle))
```

-----  
sex-of-niece-or-nephew

```
(lambda (person)
  (choose-by-sex person 'niece 'nephew))
```

-----  
sex-of-sibling

```
(lambda (person)
  (choose-by-sex person 'sister 'brother))
```

-----  
choose-by-sex

```
(lambda (person female-choice male-choice)
  (cond ((eq (sex-of person) 'female)
    female-choice)
    (t male-choice)))
```

-----  
sex-of

```
{ Uses graph processing primitives to look up the sex of PERSON }
(lambda (person) (vun person))
```

-----  
first-born

Listing 4 continued:

```
{ Useful to enter a person whose parents are not known. }  
  (lambda (person sex)  
    (progn (cun person)  
           (bun person sex)))
```

---

create-universe

```
{ Sets up the two global lists used by the graph processing  
system. The UNIVERSE-NODE-LIST is a list of all the nodes  
in the system. Here, a node is a person in the family tree.  
The UNIVERSE-EDGE-LIST holds all the connections between  
nodes in the system. These are kept as triples of (node1  
edge node2) to represent an edge called EDGE pointing  
from NODE1 to NODE2. In this case the edges will be  
familial relations. This function also creates THE-  
GREAT-UNKNOWN who is related to no one. }
```

```
(lambda nil  
  (progn (setq universe-node-list nil)  
         (setq universe-edge-list nil)  
         (cun 'the-great-unknown)))
```

---

cun

```
{ Creates a node in the universe by updating the  
UNIVERSE-NODE-LIST. }
```

```
(lambda (node)  
  (progn (setq universe-node-list (cons  
                                         node  
                                         universe-node-list))  
         node))
```

---

bun

```
{ Binds a value to a node in the universe. Node values are  
kept on the node's property list, under the indicator VALUE.  
Here the value of a node is the person's sex. }
```

```
(lambda (node value) (putprop node value 'value))
```

---

vun

```
{ Get the value of a node in the universe. The converse of bun }
```

```
(lambda (node) (getprop node 'value))
```

---

sun

```
{ Set of all nodes in the universe. This is just the  
UNIVERSE-NODE-LIST itself. }
```

```
(lambda nil universe-node-list)
```

---

cip

```
{ Create an inpointing edge. This just reverses the arguments  
passed to it and calls add-triple which does the work. }
```

```
(lambda (node1 edge node2)  
  (progn (add-triple node2 'edge node1) node1))
```

---

cop

```
{ Creates an outpointing edge, from node1 to node2. As above  
but without the reversal of arguments. }
```

```
(lambda (node1 edge node2)
```

Listing 4 continued:

```
(progn (add-triple node1 edge node2) node1))
```

---

cap  
{ Creates a pair of edges one in each direction. }

```
(lambda (node1 edge node2)
  (progn (cip node1 edge node2) (cop node1 edge node2)))
```

---

sing  
{ Set of nodes who point to this node via edges of type EDGE.  
here we just set up the call for the recursive helper  
function. }

```
(lambda (node1 edge) (sing-1 node1 edge universe-edge-list))
```

---

sing-1  
{ This is the recursive version of the helper function for sing.  
Since this function and song-1 below are the two workhorses  
of the graph functions, we used iterative versions in the  
timing tests. The recursive versions are shown here for  
clarity. The function CDRs down U (initially the UNIVERSE-  
EDGE-LIST) looking for a triple of the form (node1  
edge node2) where node2 equals N1 and edge equals E.  
Whenever it finds such a triple it CONSES the node1 element  
to the set of nodes to be returned. This is just the set  
of nodes which have edges of type E which point to N1. }

```
(lambda (n1 e u)
  (cond ((null u) nil)
        ((and (eq (caddr u) e) (eq (caddr u) n1))
         (cons (caar u) (sing-1 n1 e (cdr u))))
        (t (sing-1 n1 e (cdr u)))))
```

---

song  
{ Set of nodes which NODE1 points to via an edge of type EDGE.  
This is just like sing above, except it calls song-1. }

```
(lambda (node1 edge) (song-1 node1 edge universe-edge-list))
```

---

song-1  
{ Identical to sing-1 above except here we are matching  
node1 and edge of the triple and returning node2. }

```
(lambda (n1 e u)
  (cond ((null u) nil)
        ((and (eq (caar u) n1) (eq (caddr u) e))
         (cons (caddr u) (song-1 n1 e (cdr u))))
        (t (song-1 n1 e (cdr u)))))
```

---

dun  
{ Destroys a node in the universe by removing it from  
the UNIVERSE-NODE-LIST and the UNIVERSE-EDGE-LIST.  
the real work is done by retriples and remember below. }

```
(lambda (node)
  (progn (setq universe-node-list (remember
                                         node
                                         universe-node-list))
```

Listing 4 continued on page 404

Listing 4 continued:

```
(setq universe-edge-list (retriples
                           node
                           universe-edge-list))
node))
```

---

remember

{ Remove all occurrences of NODE in LIST. This is just a simple recursive constructor function. It CDRs down the list and CONSES together all elements which are not NODE. }

```
(lambda (node list)
  (cond ((null list) nil)
        ((eq (car list) node) (remember
                               node
                               (cdr list)))
        (t (cons (car list) (remember node (cdr
list))))))
```

---

retriples

{ Remove all triples from U (the UNIVERSE-EDGE-LIST) where N is either node1 or node2. This eliminates any edges which point to or from node N. }

```
(lambda (n u)
  (cond ((null u) nil)
        ((or (eq n (caar u)) (eq n (caddr u)))
         (retriples n (cdr u)))
        (t (cons (car u) (retriples n (cdr u))))))
```

---

add-triple

{ Updates the global UNIVERSE-EDGE-LIST to reflect the new edge given by the triple (N1 E N2). E points from N1 to N2. }

```
(lambda (n1 e n2)
  (setq universe-edge-list (append universe-edge-list
                                   (list
                                   (list n1 e n2)))))
```

---

Text continued from page 396:

Cromemco and (T.(L.C)) LISP is more complex, more powerful, and more baroque. Particularly useful is the ability to specify an arbitrary number of local variables, how each is to be initialized, and how each is to be modified at each iteration. Also, one can specify an arbitrary number of exit tests and associated exit values. Finally, an arbitrary and possibly empty sequence of expressions make up the loop body. Our counting example above for Cromemco and (T.(L.C)) LISP is given in listing 2b.

### Nonstructured Function Exits

Sometimes we want a function to

exit from an arbitrary number of function call levels. For example, we might design a system that always allows users to type QUIT to return to the system's top command level. The CATCH and THROW forms of Cromemco and (T.(L.C)) LISP give this capability.

For example:

```
(CATCH label expression-list)
```

says to evaluate the *expression-list*, much like a PROGN. If, during that evaluation, the expression:

```
(THROW label exit-expression-list)
```

is evaluated, then the CATCH immediately returns with the value

returned by treating *exit-expression-list* as a PROGN. This exit ignores any intervening computation or pending functions specified within the CATCH *expression-list*. If a THROW with the corresponding label is not evaluated, the CATCH is treated just like a PROGN. Note that the label is just an atom to establish a correspondence between a given CATCH and THROW.

### Input and Output in LISP

Since LISP is a highly interactive language, an implementation must have high-quality I/O (input/output) capabilities. A user will be involved with three similar (and often interchangeable) aspects of I/O. First,

there is the common method of interaction with the interpreter: typing expressions and reading the results. Second, there are the techniques of saving and restoring disk files containing programs and data. Third, there are the input and output operations that happen during user-function execution.

The distinctions here are somewhat arbitrary. Since the difference between program and data is explicitly not enforced in LISP, it is easy to create functions that, for instance, write themselves onto disk. In fact, a common way to load programs is to redefine the source of expressions for the "driver" as a disk file rather than the keyboard. For the sake of clarity, though, we discuss the three aspects

of I/O mentioned above as separate topics.

Terminal I/O in all three LISPs leaves something to be desired. muLISP allows for CP/M-style within-the-line editing during input. It recognizes IX (control-X) as rubout; IR as *retype line*; IU as *abort line*. It has the usual backspace and delete characters. If the user, while typing an expression, goes beyond one line of text, the system does not reprompt the user. This is especially important if the user is not sure if the form he or she is typing is correct (in terms of matching parentheses). The user has no indication from the system that it is expecting more input rather than executing the desired expression.

Cromemco and (T.(L.C.)) LISP accept input in an immediate mode. When appropriate, they do not wait for a carriage return to accept a legal expression. Unfortunately, they allow no within-the-line editing except for backspacing. On a hard-copy terminal, this can be extremely frustrating. On a video terminal, this would not be a serious problem.

Cromemco and (T.(L.C.)) LISP have very flexible and easy-to-use read-macro capabilities. The input routines are table-driven in such a way that the user can easily redefine the meaning of *any* ASCII (American Standard Code for Information Interchange) character, even to the point of causing the system to invoke a

*Text continued on page 407*

**Listing 5:** A set of LISP expressions used to conduct the benchmarks of table 2.

```
% Expressions to set up the basic benchmarks %
```

```
(SETQ LC (BUILD-LONG-CONS 50 'A))
(SETQ DC (BUILD-DEEP-CONS 50 'A))
(SETQ LONG (EVAL LC))
(SETQ DEEP (EVAL DC))
(SETQ BIGCAR (NESTED-APPLICATION 'CAR 49 'DEEP))
(SETQ BIGCDR (NESTED-APPLICATION 'CDR 49 'LONG))
(SETQ LONG1 (APPEND LONG '(B)))
(DE MIX-4-1 (LENGTH E1 E2)
  (COND
    ((LT LENGTH 1) NIL)
    (T ( APPEND (LIST E1 E1 E1 E1 E2)
                (MIX-4-1 (SUB LENGTH 5) E1 E2)
              )
      )))
(SETQ LONG41 (MIX-4-1 50 'A 'B))
```

```
% The muLISP version of tester %
```

```
(DE TESTER (FORM)
  (SETQ COUNT 0) % initialize the count %
  (PRINT (RECLAIM)) % perform an initial garbage collect %
  (LOOP % loop infinitely (until an external "interrupt") %
    (EVAL FORM) % eval the expression to be tested %
    (SETQ COUNT (PLUS COUNT 1)) % increment the count %
  ))
```

*Listing 5 continued on page 406*

Listing 5 continued:

```
% The next four definitions are helpers to enter the data %  
% base. DF is the Cromemco and (T.(L.C)) LISP function %  
% to define call-by name, no-spread functions. DE defines %  
% a call-by-value spread function. %
```

```
(DF F (X) (FIRST-BORN (CAR X) (CADR X)))
```

```
(DF B (X) (BORN (CAR X) (CADR X) (CADDR X) (CADDR X)))
```

```
(DF M (X) (MARRIED (CAR X) (CADR X)))
```

```
(DF C (X) (C-1 (CAR X) (CADR X) (CDDR X)))
```

```
(DE C-1 (P1 P2 CS-LIST)
```

```
(COND ((NULL CS-LIST) NIL)
```

```
(T (CONS (BORN (CAR CS-LIST) P1 P2 (CADR CS-LIST))  
         (C-1 P1 P2 (CDDR CS-LIST))))))
```

```
% The following expressions enter the BAGGINS and %  
% TOOK family trees. %
```

```
(MARRIED (F BALBO-B MALE) (F BERYLLA-BOFFIN FEMALE) )
```

```
(C BALBO-B BERYLLA-BOFFIN MUNGO-B MALE PANSY-B FEMALE PONTO-B MALE  
  LARGO-B MALE LILY-B FEMALE)
```

```
(MARRIED (F LAURA-GRUBB FEMALE) (QUOTE MUNGO-B))
```

```
(C LAURA-GRUBB MUNGO-B BUNGO-B MALE)
```

```
(MARRIED (F BELLADONNA-TOOK FEMALE) (QUOTE BUNGO-B))
```

```
(C BELLADONNA-TOOK BUNGO-B BILBO-B MALE)
```

```
(MARRIED (F TANTA-HORNBLOWER FEMALE) (QUOTE LARGO-B))
```

```
(C TANTA-HORNBLOWER LARGO-B FOSCO-B MALE)
```

```
(MARRIED (F RUBY-BOLGER FEMALE) (QUOTE FOSCO-B))
```

```
(C RUBY-BOLGER FOSCO-B DROGO-B MALE)
```

```
(MARRIED (F PRIMULA-BRANDYBUCK FEMALE) (QUOTE DROGO-B))
```

```
(C PRIMULA-BRANDYBUCK DROGO-B FRODO-B MALE)
```

```
(MARRIED (F THE-OLD-TOOK MALE) (F ADAMANTA-CHUBB FEMALE))
```

```
(C THE-OLD-TOOK ADAMANTA-CHUBB BELLADONNA-TOOK FEMALE MIRABELLA-TOOK FEMALE)
```

```
(MARRIED (QUOTE MIRABELLA-TOOK) (F GORBADOC-BRANDYBUCK MALE))
```

```
(C MIRABELLA-TOOK GORBADOC-BRANDYBUCK PRIMULA-BRANDYBUCK FEMALE)
```

A.



Text continued from page 405:

MACRO form when it sees a given character.

Although it is possible to redefine the READ function in muLISP, it is not as convenient as the read-macro capability described above. An example of the usefulness of read-macros is:

*'expression*

which, in (T.(L.C)) and Cromemco LISP, will be transformed into:

(QUOTE *expression*)

Not only is this not done for you in muLISP, it is not easy to change the system to do it.

To overcome the lack of a read-macro capability, muLISP provides auto-quoting. This means that any atom not bound to a value is bound to itself as a value. This is normally done for numbers (the value of "3" is three), but most LISP systems raise an error when asked for the value of an undefined atom. The consequences of this are discussed further in the section on error handling.

### Disk I/O

Basically, programs are stored on disk as text files or "internal image" files. Text files here are simply ASCII files of function definitions, atom values, and function calls in the same "free-format" style used when typing at the console. Internal image files are "snapshots" of the memory taken at the time they were created, including all the bindings of values that were in effect. muLISP compresses all active data structures that define the environment and generates a coded file that can be loaded with the execution system. The other two LISPs take advantage of the SAVE utility of CP/M and CDOS. They exit to the operating system, and the user must explicitly SAVE a memory image of the entire user area.

In muLISP, the internal image files can also be brought in, using LISP functions. Restoring an environment in this way is fast, but it will explicitly destroy any environment (bindings) that were in effect at the time of the

load. In the other LISPs, one is actually reloading memory with the exact contents it had at the time of the exit. This, again, is done through CP/M or CDOS and cannot be done from LISP.

On the other hand, (T.(L.C)) LISP and Cromemco LISP both have an auto-load feature not available in muLISP. This feature, while complicated to use, allows the programmer to store functions on disk as part of a large virtual memory. Functions can be stored and loaded only if actually needed (called). After the execution of the function, the system can reclaim the space it occupied (NOKEEP or SMASH), or the function can remain resident (KEEP or NOSMASH) after its first access.

Program-controlled I/O in all three LISPs is surprisingly easy, partly because the LISP language allows the programmer to treat programs as data. Still, "CP/M-compatible" disk I/O is generally a messy subject at best, and all three of these LISPs do an exceptional job of hiding the gory details from the programmer.

### Space Management

Since data structures in LISP are dynamic (ie: their size changes during program execution), it is generally a good idea to have dynamic reallocation of memory space in a LISP system. This means that there is no a priori limit on the number of variables, functions, or strings. Rather, as more space is needed for one kind of object, it is found at the expense of space available for other kinds of objects.

Cromemco and (T.(L.C)) LISP accomplish dynamic allocation by a technique in which memory is broken into 256 pages of 256 bytes each. Any of these pages can, in theory, be used for storage of any data type. But the entire page is always used for the same type of object. This scheme has two major advantages. First, it simplifies type checking. The high byte of any object's address defines the type of that object as well as identifying its location. The page-byte-to-type correspondence is kept in a table in memory. This table allows for the second advantage. If more space for a

## ADA™ A NEW BEGINNING

```
pragma ___ type ___ is ___ subtype ___ is ___ raise ___ abort ___
case ___ is ___ when ___ = ___ end case, access ___ with ___ use ___
return ___ ; record ___ and record; exit ___ when ___ , when ___ = ___
if ___ then ___ elseif ___ else ___ end if; case ___ is when ___ delay ___
for ___ in reverse ___ loop ___ and loop, while ___ loop ___ entry ___
procedure ___ in out ___ is ___ begin ___ exception ___ and; return ___
function ___ in out ___ return, select ___ else ___ and select loop ___
accept ___ do ___ end; task body ___ is ___ begin ___ exception ___ end;
select accept ___ or delay ___ and select, task ___ is ___ end ___
package ___ is ___ private ___ end, for ___ use record ___ end record;
```

**ADA/M** - Compiles ADA program for Host system execution.

Excellent for learning ADA and converting existing programs Includes  
**ADA Compiler and Compiler ADA Programming Support Environment (CAPSE)** ..... \$495

**ADA/C** - Compiler and Kernal APSE (KAPSE) for CP/M® ..... \$995.

**ADA Programmers Manual** ..... \$25.

**ADA Syntax Reference Card** ..... \$6.

Specify exact configuration and operating system. Courses are available for compiler customers to learn the most powerful and complex software language, ADA.

Credit for purchase of ADA/M will be given toward purchase of larger ALS. Royalty will be paid to customers who convert existing programs into ADA for inclusion in the ALS, ADA Language System library

**DIGITAL ELECTRONIC SYSTEMS, INC.**

**Box 5252, Torrance, California 90510**

**213/539-6239**



ADA is a registered trademark of Dept. of Defense. CP/M is a registered trademark of Digital Research.



other two LISPs. One example of this is the idea of having a separate *development environment* as well as an *execution environment*. A development environment supports editing and debugging of functions (programs) in an interactive setting. While development and testing can be done in muLISP's execution system, there are no facilities to make this easy. Another example of the difference is the related stance on error handling, which is discussed below.

The development subsystem, muSTAR, is an internal image file which is delivered with the muLISP system. (It is an application program written in LISP.) muSTAR is a menu-based program that allows for the user to pick any of the following options:

- Edit Function
- Edit Variable
- Edit Property
- Eval LISP
- Eval-Quote LISP
- Trace Function
- Untrace Function
- Read File
- Write File
- Select Drive

Menu-based systems are generally designed to be used with video terminals. This one is no exception; it is a joy on the screen of a 9600 bps terminal and very frustrating on a 300 bps DECwriter.

The editor that comes with muSTAR is a flexible screen editor intended to be adaptable to any type of video terminal. Unfortunately, the "interrupt execution" character, Escape, is used by some terminals for cursor control. Since Escape is detected at a very low level in the system, there is no way to tailor the screen editor to use these terminals. Unlike some LISP "structure" editors that use atoms and expressions as the units to be modified, the muSTAR editor is a conventional character-oriented screen editor; however, it is convenient and easy to use. When functions are being edited, the text is pretty-printed to make it easier to read and edit.

The Trace and Untrace facilities

allow the user to specify to the muSTAR system that when a given function is called the system should print its arguments *before* the execution of the function and the result *afterward*. This is the single most important tool for the user in the process of debugging and developing programs.

Read and Write are for text files and assume a CP/M file extension of ".LIB". The files can be created either by muSTAR or by an external editor. Read works in the obvious way. Write, however, writes out only func-

tions and variables whose names appear on the property list of the atom that is the name of the file. While this can be done using the Edit Property function of muSTAR, it is easy to forget to add new function names during a session and thus lose your work when you exit the muSTAR system.

The error-handling facility in muLISP is virtually nonexistent. The three "advisory" messages: ZERO DIVIDE ERROR, END-OF-FILE READ, and NO DISK SPACE are printed at the console, and the

## Z80 C CROSS-COMPILER

- Upgrade for Whitesmiths 8080 cross-compiler users
- Allows full 8-bit operations without promotion
- Assembler/Code generator expanded to take full advantage of Z80 instruction set
- Post-pass peephole optimizer
- 15-35% code space reduction over Whitesmiths
- Many other features - write for full information

Currently available for RSTS/E with RSX support or VAX with UNIX.  
Binary license is \$3800, or \$2500 if you are a registered  
Whitesmiths 8080 cross-compiler user.

VANDATA, 17544 Midvale Ave. N., Suite 205  
Seattle, Wa. 98133 (206) 542-7611

RSTS E RSX-11 VAX are Trademarks of Digital Equipment Corporation  
Z80 is a registered Trademark of Zilog, Inc.  
UNIX is a Trademark of Bell Laboratories.

offending primitive function is forced to return NIL. Execution of the rest of the user function proceeds, according to the manual, "normally." The only error that causes termination of execution is INSUFFICIENT MEMORY SPACE. When execution stops, as when the Escape key is typed, the user has four options. He or she can continue execution, go back to the top-level driver, restart muLISP, or go back to the CP/M system. Unfortunately, the user cannot examine the functions or arguments that caused the problem.

Because of the auto-quoting and implicit-sequence-evaluation features of the system, there are no other errors that can occur during program execution. In fact, since evaluation of any syntactically legal expression is defined, and the input routines for the driver loop ensure that only legal expressions are read in, the user cannot cause any error other than the ones listed above.

Although this may be an elegant concept, it makes debugging awkward at best and virtually impossible at worst except for the Trace

option available in muSTAR. Since this is not available in the core muLISP system, you would always do development in muSTAR.

Cromemco LISP and (T.(L.C)) LISP take a more traditional attitude to the user environment and error handling. Errors are flagged in many situations. In particular, the errors UNDEFINED VARIABLE and WRONG NUMBER OF ARGUMENTS, as well as data-type violations, are checked for during program evaluation. The characters G, Control-G, and Bell act like the Escape key in muLISP to end execution of user functions. In addition, the function ERROR can be called by a function at any time.

Once an error occurs, evaluation stops, a message is printed, and the user has several options. He or she can examine the function or arguments that caused the error, trace the execution stack back through all the nested calls, or "pop" up the stack (to the top or any intermediate place) giving a return value for the function that was called at that level. Although these functions are a good idea, they are poorly explained in the manual.

#### Documentation, Library Software

We were very pleased with the quality of the documentation for all three LISPs. Because Cromemco and (T.(L.C)) LISP are just different versions of the same program, the two user's manuals are almost identical. These manuals begin with a long discussion of LISP style and philosophy and include a discussion of how to code a recursive descent parser in LISP. This background information is quite good and will be a great help to a beginner. Most of the function descriptions include an illustrative example. The Cromemco LISP manual adds a section on the internal representation of data structures and gives information needed to link to assembly-language subroutines. The (T.(L.C)) LISP manual includes some annotated LISP examples adapted from *Artificial Intelligence Programming* (see the "Where to Learn LISP" text box for a description of this book and

# SAVE BIG BUCKS

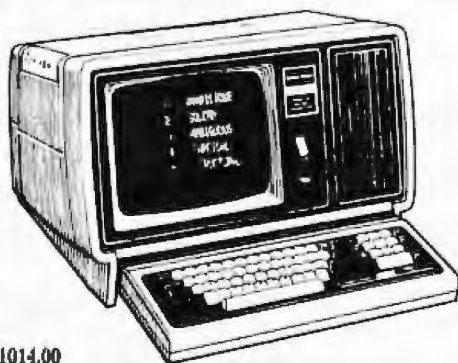

## Model II 64K \$3395

26-4160 1 Drive Exp .....	\$1014.00
26-4161 2 Drive Exp .....	1559.00
26-4162 3 Drive Exp .....	2099.00
26-4530 Scripsit II .....	259.00
26-4512 Profile II .....	159.00
26-4511 Visicalc II .....	259.00
26-4501 Gen Ledger .....	179.00
26-4506 Mail List .....	72.00

## MODEL III

26-1061 4K I .....	\$ 599.00
26-1062 16K III .....	859.00
26-1063 32K III .....	
W/2 Drives, RS 232 .....	2225.00
26-1162 1st Drive .....	765.00

## IDS PAPER TIGERS

Dot Resolution Graphics quality print

IDS 445G 7 wire printhead, graphics .....	(List \$ 985) .....	\$ 795.00
IDS 460G 9 wire printhead, graphics .....	(List 1094) .....	896.00
IDS 560G 9 wire, wide carriage, graphics .....	(List 1394) .....	1129.00

## Model I

26-1140 Expansion Interface .....	\$249.00
26-1141 16K Exp. Interface .....	359.00
26-1142 32K Exp. Interface .....	469.00
26-1145 RS 232C Board .....	84.00
26-1160/1 Mini Disk Drive .....	419.00
26-1563 Scripsit-Disk .....	79.00
26-1566 Visicalc .....	83.00

## PRINTERS

26-1167 9 1/2 Line Printer VII .....	\$ 360.00
26-1166 Line Printer VI .....	1080.00
26-1158 Daisy Wheel II .....	1798.00
26-1165 Line Printer V .....	1710.00
26-1401 Cable .....	36.00

## Color Computer 4K \$353

26-3001 4K .....	\$353.00
26-3002 16K Ext. Basic .....	533.00
26-3009 Joysticks .....	22.50
26-3010 Color Video .....	353.00
26-1206 Recorder .....	54.00

All prices are subject to change without notice. Freight, handling, and insurance charges are extra. Most items are shipped United Parcel Service. Model II and other hardware weighing over 50 lbs. is shipped freight collect by truck. Certified Check for immediate shipment from stock. Master Charge, Visa or Bank Card add 3% surcharge.

Vern Street Products 114 West Taft Sapulpa, Ok 74066  
 The Computer Store, Inc. 4949 South Peoria Tulsa, Ok 74105  
 918-747-9333

other useful LISP information). These examples are prefaced by a discussion of the differences between (T.(L.C)) LISP and the LISP used in *Artificial Intelligence Programming*. We found this discussion quite useful. Both manuals are about 135 pages long.

The muLISP manual, which is about 100 pages long, is shorter and terser, but of high quality. This manual gives a limited amount of background information. The function descriptions are in a formal metalanguage that is complete but often obscure. These descriptions would be much clearer if they included examples. The manual includes commented listings of many useful utilities and the muSTAR development environment, and they will be quite useful for users who wish to tailor their LISP environment. In particular, there are instructions for tailoring the muLISP screen editor to different kinds of terminals.

Cromemco LISP is distributed with a fairly complete set of Cromemco software, including the CDOS operating system, several CDOS utilities, and a screen editor. Unfortunately, the screen editor can only be used with a Cromemco terminal. This is downright unfriendly of Cromemco, particularly since it is trivial to provide the "hooks" to do screen editing with almost any modern terminal. Also provided are files with LISP utilities, a trace function, a pretty-printer program, examples from *Artificial Intelligence Programming*, and examples of the more esoteric features of Cromemco LISP.

(T.(L.C)) LISP is distributed with the same example and utility files as Cromemco LISP. Also included are several additional files of examples.

muLISP is distributed with the muSTAR utility and the other utilities described in the manual. Also included are several games and programs, including a version of Weizenbaum's ELIZA, called DOCTOR, and a guessing game which learns, called ANIMAL.

muLISP has the beginnings of an active user group and software library. Information about the user

group and the software is published in a small newsletter available to muLISP purchasers. (T.(L.C)) LISP purchasers also receive a newsletter, though it is less formal and less regular. As of now, there is no (T.(L.C)) LISP users' group.

#### Conclusions

- Cromemco and (T.(L.C)) LISP have many modern features, yet they still run acceptably fast. The auto-load feature potentially allows very large programs to run in a virtual-memory environment. The documentation is

quite good and would be useful for LISP beginners. Cromemco LISP also includes information that would be useful to someone adding his or her own machine-language subroutines. A major drawback of these LISPs is a small, fixed-sized stack that severely limits the use of recursive functions. (T.(L.C)) LISP is the cheapest of the LISPs reviewed here—\$150. Cromemco LISP, with only a small amount of additional functionality, is the most expensive—\$295.

- muLISP is an extremely fast LISP with a complete but basic set of

## ATTENTION S-100 USERS, OEMs & ISOs!

### MM-103 IS THE ONLY MODEM FOR YOUR NEEDS!

In previous issues, we listed more than 50 reasons why PMMI MM-103 modems are superior, along with a list of satisfied users that is now too long to print. Quality, integrity and low cost have made the MM-103 America's most popular modem. PMMI was the first to gain FCC approval and meet IEEE-696 S-100 standards. You won't find another modem for the S-100 bus with a wider range of Baud rates, more extensive and controllable software and such an unbeatable warranty. And since PMMI has eliminated the need for an acoustic coupler or an RS 232 adapter, your connection is more reliable and you buy no unnecessary hardware.

**SO DON'T DELAY!**  
GO WITH THE MODEM WITH EXPERIENCE!



**COMMUNICATIONS**  
(POTOMAC MICRO-MAGIC, INC.)

For further information, call or write:

Three Skyline Place  
5201 Leesburg Pike, Suite 604  
Falls Church, VA 22041  
(703) 379-9660

Or dial into our 24 hour-a-day Modem Test Center:  
(703) 379-0303 (300 Baud)

**AFTER ALL...  
ALL MODEMS ARE NOT  
CREATED EQUAL!**

features. It is distributed with muSTAR, a nice LISP development environment that includes a screen editor. The documentation is good, but it is too terse and formal for beginners. Much of the speed of muLISP comes from features that make programs hard to read and hard to debug. In particular, muLISP does almost no type checking or error detection.

• LISP is alive and well and living in a Z80 microprocessor. Although there are great differences between muLISP and the other two packages, we feel that all three are successful products. Each would allow a user to develop and use fairly large LISP programs. ■

#### Acknowledgments

The benchmark tests were performed on a system purchased and supported by Army Research Office grant DAAG29-79-G-0046. We would like to thank E Jeffrey Conklin and Caxton C Foster.

#### Where to learn LISP: Recommended Books and Articles

1. Allen, J. *Anatomy of LISP*, New York: McGraw-Hill Book Co, 1978. An examination of many issues in computer science through LISP-tinted spectacles. This is also the only published discussion of many modern LISP implementation techniques and styles.
2. Allen, J. "An Overview of LISP" in *BYTE*, August 1979, page 10. A compact overview to LISP style and usage. All the important LISP functions are discussed. The most difficult aspect of learning LISP is understanding exactly when and how values get bound to names. These issues are not discussed.
3. Charniak, Eugene, Christopher Riesback, and Drew McDermott. *Artificial Intelligence Programming*. Hillsdale NJ: Lawrence Erlbaum Associates, 1979. A very complete introduction to sophisticated uses of LISP for AI programming. The first few chapters do a good job of explaining the name-value-binding issues.

4. Friedman, Daniel. *The Little LISP*. London, England: Science Research Associates Inc, 1974. An entertaining introduction to the style of LISP programming. This book does not cover everything you need to know to use LISP on a real machine. It, again, avoids key issues of how and when LISP names get values.

5. McCarthy, John. "Recursive Functions of Symbolic Expressions and Their Computation by Machine," *Communications of the Association for Computing Machinery*, pages 184 through 195, April 1960. This is where it all started, the article that suggested that the mathematical lambda calculus could be embodied in a programming language.

6. Winston, Patrick Henry. *Artificial Intelligence*. Reading MA: Addison-Wesley, 1977. An easily understood introduction to AI and AI programming.

7. Winston, Patrick Henry and Berthold Klaus Horn. *LISP*. Reading MA: Addison-Wesley, 1981. A pleasant, chatty introduction to LISP.

SciTronics introduces . . .

## REAL TIME CLOCKS

with full Clock/Calendar Functions

The Worry-free Clocks for People  
Who Don't Have Time to Worry!!

#### What makes them worry-free?

- Crystal controlled for high (.002%) accuracy
- Lithium battery backup for continuous clock operation (6000 hrs!!!)
- Complete software in BASIC-including programs to Set and Read clock
- Clock generates interrupts (seconds, minutes, hour) for foreground/background operation

#### Applications:

- Logging Computer on time
- Timing of events
- Use it with the SciTronics Remote Controller for Real Time control of A.C. operated lights and appliances

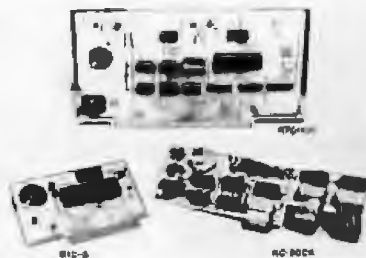

#### Versions available for:

- |                           |         |       |
|---------------------------|---------|-------|
| • S-100 bus computers     | RTC-100 | \$159 |
| • Apple II computer       | RTC-A   | \$129 |
| • SciTronics RC-80 owners | RC-80CK | \$109 |

Send  
Check or  
money  
order to: **SciTronics Inc.**  
523 S. Clewell St., P.O. Box 5344  
Bethlehem, PA 18015  
(215) 868-7220

Please list system with which you plan to use controller • Master Charge and Visa accepted. COD's accepted. PA residence add sales tax.

## BYTE's Bits

### Microsoft Drops APL Interpreter

Microsoft has dropped work on an APL interpreter. The demand of other projects has caused the company to stop work on the interpreter for 8-bit microcomputers. The company still plans to develop a 16-bit version.

## BYTE's Bugs

### Price Mis-Steak

In the April 1981 "Software Received," the price of the "Beef Cattle Least-Cost Ration Program" was incorrectly listed. The correct price is \$495. A demonstration tape of the program is available for \$5.

For information on the program, contact Agricultural Software Consultants, 1706 Santa Fe, Kingsville TX 78363 (512) 595-1937. ■

# Do more with your Commodore. Plug in the printer that business professionals prefer.

Discover the quality difference and move up to Mannesmann Tally printing. The high speed 8024 serial printer comes ready to plug into and work with your Commodore system. No fussing with converters or adapter boxes.

Here's what you get. Print speeds up to 200 lines per minute. Full 132 column printing. Conforms with Commodore specified program functions for full software compatibility. Whisper quiet operation. Clean, crisp and pleasing print quality that's always consistent copy to copy. Rugged, industrial strength construction. A print head that promises years of usage before replacement. A machine you can drive as hard as you want, yet it never requires preventive maintenance. Never needs periodic adjustments.

There's more. An easy to change, snap-in ribbon cartridge. Dual tractor paper engagement for positive alignment. A built-in self-test routine. Double wide printing on demand. A nine-needle print head model for true descenders on lower case characters. An optional Quick-Tear kit for forms removal immediately after printing. See this machine for yourself.

Ask for the Model 8024 at your nearest Commodore dealer or contact us.

Mannesmann Tally, 8301 S. 180th St. Kent, WA 98031. Phone: (206) 251-5524.

## MANNESMANN TALLY



# The Emperor's Old Clothes

Charles Antony Richard Hoare  
Oxford University, England

The 1980 ACM Turing Award was presented to Charles Antony Richard Hoare, Professor of Computation at Oxford University, England, by Walter Carlson, chairman of the awards committee. The presentation took place at the ACM Annual Conference in Nashville, Tennessee, October 27, 1980.

Professor Hoare was selected by the General Technical Achievement Award Committee for his fundamental contributions to the definition and design of programming languages. His work is characterized by an unusual combination of insight, originality, elegance, and impact. He is best known for his work on axiomatic definitions of programming languages through the use of techniques popularly referred to as axiomatic semantics. He developed ingenious algorithms such as Quicksort and was responsible for inventing and promulgating advanced data-structuring techniques in scientific programming languages. He has also made important contributions to operating systems through the study of monitors, and his most recent work is on communicating sequential processes.

Before his appointment to Oxford in 1977, Professor Hoare was Professor of Computer Science at The Queen's University in Belfast, Ireland, from 1968 to 1977, and was a Visiting Professor at Stanford University in 1973. From 1960 to 1968 he



Professor Charles Antony Richard Hoare

held a number of positions with Elliot Brothers Ltd, England.

Professor Hoare has published extensively and is on the editorial boards of a number of the world's foremost computer science journals. In 1973 he received the ACM Programming Systems and Languages Paper Award. Professor Hoare became a Distinguished Fellow of the British Computer Society in 1978 and was awarded the degree of Doctor of Science Honoris Causa by the University of Southern California in 1979.

The Turing Award is the Association for Computing Machinery's highest award for technical contributions to the computing community. It is presented each year in memory of Dr A M Turing, an English mathematician who made many important contributions to the computing sciences.

A transcript of Professor Hoare's 1980 Turing Award Lecture follows.

My first and most pleasant duty in this lecture is to express my profound gratitude to the Association for Computing Machinery for the great honor which they have bestowed on me and for this opportunity to address you on a topic of my choice. What a difficult choice it is! My scientific achievements, so amply recognized by this award, have already been amply described in the scientific literature. Instead of repeating the abstruse technicalities of my trade, I would like to talk informally about myself, my personal experiences, my hopes and fears, my modest successes, and my rather less modest failures. I have learned more from my failures than can ever be revealed in the cold print of a scientific article, and now I would like you to learn from them, too. Besides, failures are much more fun to hear about afterwards; they are not so funny at the time.

I start my story in August 1960, when I became a programmer with a small computer manufacturer, a division of Elliott Brothers (London) Ltd, where in the next eight years I was to receive my primary education in computer science. My first task was to implement for the new Elliot 803 computer a library subroutine for a new fast method of internal sorting just invented by Shell. I greatly enjoyed the challenge of maximizing efficiency in the simple decimal-ad-

## Acknowledgments

BYTE wishes to thank Professor CAR Hoare and the Association for Computing Machinery for granting us permission to reprint this article, which originally appeared in the February 1981 Communications of the ACM. Copyright 1981 by the Association for Computing Machinery, Inc. Reprinted by permission.



dressed machine code of those days. My boss and tutor, Pat Shackleton, was very pleased with my completed program. I then said timidly that I thought I had invented a sorting method that would usually run faster than SHELLSORT, without taking much extra store. He bet me sixpence that I had not. Although my method was very difficult to explain, he finally agreed that I had won my bet.

I wrote several other tightly coded library subroutines, but after six months I was given a much more important task—that of designing a new advanced high-level programming language for the company's next computer, the Elliott 503, which was to

have the same instruction code as the existing 803 but run sixty times faster. In spite of my education in classical languages, this was a task for which I was even less qualified than those who undertake it today. By great good fortune there came into my hands a copy of the Report on the International Algorithmic Language ALGOL 60. Of course, this language was obviously too complicated for our customers. How could they ever understand all those begins and ends when even our salesmen couldn't?

Around Easter 1961, a course on ALGOL 60 was offered in Brighton, England, with Peter Naur, Edsger W Dijkstra, and Peter Landin as tutors. I

attended this course with my colleague in the language project, Jill Pym, our divisional Technical Manager, Roger Cook, and our Sales Manager, Paul King. It was there that I first learned about recursive procedures and saw how to program the sorting method which I had earlier found such difficulty in explaining. It was there that I wrote the procedure, immodestly named Quicksort, on which my career as a computer scientist is founded. Due credit must be paid to the genius of the designers of ALGOL 60 who included recursion in their language and enabled me to describe my invention so elegantly to the world. I have regarded it as the

## KEEP YOUR EYE ON THE BALL

THE FORMULA™ allows the computer professional to focus on the most important part of business: the needs of the client. Customized systems for any business application can be created in a fraction of the time required by conventional methods.

- Interactive data entry, file updating, and maintenance routines are automatically generated from a definition of the fields.
- Reports can be created through a unique full screen editor simply by typing a sample format.
- Menus and job streams are defined through a preprogrammed parameter-driven procedure.
- Fast response time is insured because each routine can be interpreted directly by the computer and data management is controlled by an efficient ISAM algorithm.

THE FORMULA™ is a complete system language which brings the process of developing applications closer to the user's description of his needs. That's THE FORMULA™ for success.

Disk and manual, \$595. Manual only, \$60.

THE FORMULA™ will run on any 8080 or Z80 computer with CP/M,\* 48K RAM, 300K total disk storage, and a CRT.

**DMA • WE SPEAK YOUR LANGUAGE.**

DYNAMIC MICROPROCESSOR ASSOCIATES • 545 Fifth Avenue, New York, New York 10017 • (212) 687-7115

We ship prepaid and COD orders. Shipping & handling charges extra. \$5 UPS areas; \$7 non-UPS areas. Mexico, Canada: \$10 + elsewhere. MasterCard and VISA accepted. New York State residents add appropriate sales tax. \*CP/M is a trademark of Digital Research.

highest goal of programming language design to enable good ideas to be elegantly expressed.

After the ALGOL course in Brighton, Roger Cook was driving me and my colleagues back to London when he suddenly asked, "Instead of designing a new language, why don't we just implement ALGOL 60?" We all instantly agreed—in retrospect, a very lucky decision for me. But we knew we did not have the skill or experience at that time to implement the whole language, so I was commissioned to design a modest subset. In that design I adopted certain basic principles which I believe to

be as valid today as they were then.

### Principles of Design

The first principle was *security*, the principle that every syntactically incorrect program should be rejected by the compiler and that every syntactically correct program should give a result or an error message that was predictable and comprehensible in terms of the source language program itself. Thus no core dumps should ever be necessary. It was logically impossible for any source language program to cause the computer to run wild, either at compile time or at run time. A consequence of this principle

is that every occurrence of every subscript of every subscripted variable was on every occasion checked at run time against both the upper and the lower declared bounds of the array. Many years later we asked our customers whether they wished us to provide an option to switch off these checks in the interests of efficiency on production runs. Unanimously, they urged us not to—they already knew how frequently subscript errors occur on production runs where failure to detect them could be disastrous. I note with fear and horror that even in 1980, language designers and users have not learned this lesson. In any respectable branch of engineering, failure to observe such elementary precautions would have long been against the law.

The second principle in the design of the implementation was *brevity of the object code produced by the compiler and compactness of run time working data*. There was a clear reason for this: the size of main storage on any computer is limited, and its extension involves delay and expense. A program exceeding the limit, even by one word, is impossible to run, especially since many of our customers did not intend to purchase backing stores.

This principle of compactness of object code is even more valid today, when processors are trivially cheap in comparison with the amounts of main store they can address, and backing stores are comparatively even more expensive and slower by many orders of magnitude. If as a result of care taken in implementation the available hardware remains more powerful than may seem necessary for a particular application, the applications programmer can nearly always take advantage of the extra capacity to increase the quality of his program, its simplicity, its ruggedness, and its reliability.

The third principle of our design was that *the entry and exit conventions for procedures and functions should be as compact and efficient as for tightly coded machine-code sub-routines*. I reasoned that procedures are one of the most powerful features of a high-level language, in that they

# MEMOREX

WHEN YOU ADD IT UP,  
MEMOREX FLEXIBLE DISCS  
FROM PACIFIC EXCHANGES  
ARE YOUR BEST BUY.



For Data Reliability—  
Memorex  
Flexible  
Discs

CALL FREE FOR PRICES & INFORMATION

**(800)235-4137**

In California, (800)592-5935 or (805)543-1037

DEALER INQUIRIES INVITED



C.O.D. ACCEPTED

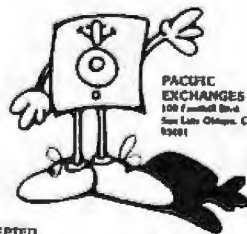

PACIFIC  
EXCHANGES  
100 Foothill Blvd.  
San Luis Obispo, CA  
93081

both simplify the programming task and shorten the object code. Thus there must be no impediment to their frequent use.

The fourth principle was that *the compiler should use only a single pass*. The compiler was structured as a collection of mutually recursive procedures, each capable of analyzing and translating a major syntactic unit of the language—a statement, an expression, a declaration, and so on. It was designed and documented in ALGOL 60, and then coded into decimal machine code using an explicit stack for recursion. Without the ALGOL 60 concept of recursion, at that time highly controversial, we could not have written this compiler at all.

I can still recommend single-pass, top-down recursive descent both as an implementation method and as a design principle for a programming language. First, we certainly want programs to be read by *people*, and people prefer to read things once in a single pass. Second, for the user of a time-sharing or personal computer system, the interval between typing in a program (or amendment) and starting to run that program is wholly unproductive. It can be minimized by the high speed of a single-pass compiler. Finally, to structure a compiler according to the syntax of its input language makes a great contribution to ensuring its correctness. Unless we have absolute confidence in this, we can never have confidence in the results of any of our programs.

### Principles at Work

To observe these four principles, I selected a rather small subset of ALGOL 60. As the design and implementation progressed, I gradually discovered methods of relaxing the restrictions without compromising any of the principles. So in the end we were able to implement nearly the full power of the whole language, including even recursion, although several features were removed and others were restricted.

In the middle of 1963, primarily as a result of the work of Jill Pym and Jeff Hillmore, the first version of our compiler was delivered. After a few

months we began to wonder whether anyone was using the language or taking any notice of our occasional reissue, incorporating improved operating methods. Only when a customer had a complaint did he contact us, and many of them had no complaints. Our customers have now moved on to more modern computers and more fashionable languages, but many have told me of their fond memories of the Elliott ALGOL System. The fondness is not due just to nostalgia, but to the efficiency, reliability, and convenience of that early simple ALGOL System.

As a result of this work on ALGOL, in August 1962 I was invited to serve on the new Working Group 2.1 of the International Federation of Information Processors (IFIP) charged with responsibility for maintenance and development of ALGOL. The group's first main task was to design a subset of the language which would remove some of its less successful features. Even in those days and even with such a simple language, we recognized that a subset could be an improvement on the original. I greatly welcomed the chance of meeting and hearing the wisdom of many of the original language designers. I was astonished and dismayed at the heat and even rancor of their discussions. Apparently the original design of ALGOL 60 had not proceeded in that spirit of dispassionate search for truth which the quality of the language had led me to suppose.

In order to provide relief from the tedious and argumentative task of designing a subset, the working group allocated one afternoon to discussing the features that should be incorporated in the next design of the language. Each member was invited to suggest the improvement he considered most important. On October 11, 1963, my suggestion was to pass on a request of our customers to relax the ALGOL 60 rule of compulsory declaration of variable names and adopt some reasonable default convention such as that of FORTRAN. I was astonished by the polite but firm rejection of this seemingly innocent suggestion. It was pointed out that the redundancy of ALGOL 60 was the

# WHAT'S BETTER THAN AN ISAM

And Will Turn

MICROSOFT'S  
BASIC  
COBOL  
FORTRAN

DIGITAL'S  
PL/I-80

CBASIC  
PASCAL/MT+  
S-BASIC

CROMEMCO 16K BASIC

Into first class application languages?

## MICRO B+™

The first and most complete implementation of B-TREE index structures for micro-computers. B-TREES eliminate index file reorganization.

### Search

An Index of over

**10,000 Key Values In Less Than One Second**

On A Floppy Disk System for only

**\$260.00!**

System Houses:  
MICRO B+™

Available in Language C

**FAIR COM** 2506 Johnson Drive  
Columbia, MO 65201  
(314) 445-3304

©1980 Fair Com

Shipping \$4 USA / \$8 Foreign  
We accept VISA and MASTERCARD

PL/I-80 is a trademark of Digital Research  
CBASIC is a trademark of Compiler Systems Inc  
S-BASIC is a trademark of Tapas Programming  
PASCAL/MT+ is a trademark of MT Micro Systems

best protection against programming and coding errors which could be extremely expensive to detect in a running program and even more expensive not to. The story of the Mariner space rocket to Venus, lost because of the lack of compulsory declarations in FORTRAN, was not to be published until later. I was eventually persuaded of the need to design programming notations so as to maximize the number of errors which cannot be made, or if made, can be reliably detected at compile time. Perhaps this would make the text of

programs longer. Never mind! Wouldn't you be delighted if your Fairy Godmother offered to wave her wand over your program to remove all its errors and only made the condition that you should write out and key in your whole program three times? The way to shorten programs is to use procedures, not to omit vital declarative information.

Among the other proposals for the development of a new ALGOL was that the Switch declaration of ALGOL 60 should be replaced by a more general feature, namely an ar-

ray of label-valued variables, and that a program should be able to change the values of these variables by assignment. I was very much opposed to this idea, similar to the assigned Go To of FORTRAN, because I had found a surprising number of tricky problems in the implementation of even the simple labels and switches of ALGOL 60. I could see even more problems in the new feature, including that of jumping back into a block after it had been exited. I was also beginning to suspect that programs that used a lot of labels were more difficult to understand and get correct, and that programs that assigned new values to label variables would be even more difficult still.

It occurred to me that the appropriate notation to replace the ALGOL 60 switch should be based on that of the conditional expression of ALGOL 60, which selects between two alternative actions according to the value of a Boolean expression. So I suggested the notation for a "case expression" which selects between any number of alternatives according to the value of an integer expression. That was my second language design proposal. I am still most proud of it, because it raises essentially no problems either for the implementer, the programmer, or the reader of a program. Now, after more than fifteen years, there is the prospect of international standardization of a language incorporating this notation—a remarkably *short* interval compared with other branches of engineering.

Back again to my work at Elliott. After the unexpected success of our ALGOL Compiler, our thoughts turned to a more ambitious project: to provide a range of operating system software for larger configurations of the 503 computer, with card readers, line printers, magnetic tapes, and even a core backing store which was twice as cheap and twice as large as the main store, but fifteen times slower. This was to be known as the Elliott 503 Mark II software system. It comprised:

1. An assembler for a symbolic assembly language in which all the rest of the software was to be written.
2. A scheme for automatic ad-

# BOOKKEEPING MADE SIMPLE

<b>GENERAL LEDGER FUNCTIONS</b>	<b>ACCOUNTS PAYABLE</b>
1 Set-Up & Renew Accounts	40 Payables Ledger
2 Post to General Ledger	41 Write Payable Checks
3 Close Month/Year	42 Accounts Payable Labels
4 Daily Journal	
5 Monthly Journal	<b>ACCOUNTS RECEIVABLE</b>
6 Monthly Detail Report	50 Receivable Ledger
7 Trial Balance	51 Customer Billing
8 Income Statement	52 Receivable Aging
9 Balance Sheet	53 Interest Add-On
10 Chart of Accounts	54 Receivable Labels
<b>PAYROLL FUNCTIONS</b>	<b>SPECIAL FUNCTIONS</b>
20 Adjust Tax Tables	60 Initialization
21 Payroll Ledger	61 Index Update
22 Write Payroll Checks	62 Update & Post to Files
23 Print W-2	63 Special Directories
24 Initialize New Pay Period	64 General Director
	65 Adjust Budget
	66 Comparative Budget Report
30 CALL OPTIONAL TASKS MENU	67 Call End of Session
	□

## The Menu

- ▶ A Combined General Ledger, Accounts Payable, Accounts Receivable, and Payroll
- ▶ Expandable to include Inventory, Order Entry, Certified Payroll, or Mail List
- ▶ Complete Easy-To-Follow Manual and Instructions
- ▶ For Microcomputers using CP/M, OASIS or TRSDOS Operating System
- ▶ 64 K Minimum, Hard Disk Compatible
- ▶ Demonstration Disk Available

CP/M, OASIS and TRSDOS are TM's of Digital Research, Phase One Systems and Tandy Corp respectively

## THE BOOKKEEPER SYSTEM™

Dealer Inquiries Welcome



(615) 452-1027

179 West Smith Street, Gallatin, TN 37066

**We're Writing Programs For People**

ministration of code and data overlays, either from magnetic tape or from core backing store. This was to be used by the rest of the software.

3. A scheme for automatic buffering of all input and output on any available peripheral device, again to be used by all the other software.

4. A filing system on magnetic tape with facilities for editing and job control.

5. A completely new implementation of ALGOL 60, which removed all the nonstandard restrictions which we had imposed on our first implementation.

6. A compiler for FORTRAN as it was then.

### Deadline Pressures

I wrote documents which described the relevant concepts and facilities, and we sent them to existing and prospective customers. Work started with a team of fifteen programmers, and the deadline for delivery was set some eighteen months ahead, in March 1965. After initiating the design of the Mark II software, I was suddenly promoted to the dizzying rank of Assistant Chief Engineer, responsible for advanced development and design of the company's products, both hardware and software.

Although I was still managerially responsible for the 503 Mark II software, I gave it less attention than the company's new products and almost failed to notice when the deadline for its delivery passed without event. The programmers revised their implementation schedules, and a new delivery date was set some three months ahead, in June 1965. Needless to say, that day also passed without event. By this time, our customers were getting angry and my managers instructed me to take personal charge of the project. I asked the senior programmers once again to draw up revised schedules, which again showed that the software could be delivered within another three months. I desperately wanted to believe it, but I just could not. I disregarded the schedules and began to dig more deeply into the project.

It turned out that we had failed to

make any overall plans for the allocation of our most limited resource—main storage. Each programmer expected this to be done automatically, either by the symbolic assembler or by the automatic overlay scheme. Even worse, we had failed to simply count the space used by our own software which was already filling the main store of the computer, leaving no space for our customers to run *their* programs. Hardware address length limitations prohibited adding more main storage.

Clearly, the original specifications of the software could not be met and had to be drastically curtailed. Experienced programmers and even managers were called back from other projects. We decided to concentrate first on delivery of the new compiler for ALGOL 60, which careful calculation showed would take another four months. I impressed upon all the programmers involved that this was no longer just a prediction; it was a promise. If they found they were not meeting their promise, it was their personal responsibility to find ways and means of making good.

The programmers responded magnificently to the challenge. They worked nights and days to ensure completion of all those items of software which were needed by the ALGOL compiler. To our delight, they met the scheduled delivery date; it was the first major item of working software produced by the company over a period of two years.

Our delight was short-lived; the compiler could not be delivered. Its speed of compilation was only two characters per second, which compared unfavorably with the existing version of the compiler operating at about a thousand characters per second. We soon identified the cause of the problem: it was thrashing between the main store and the extension core backing store which was fifteen times slower. It was easy to make some simple improvements, and within a week we had doubled the speed of compilation to four characters per second. In the next two weeks of investigation and reprogramming, the speed was doubled

again to eight characters per second. We could see ways in which within a month this could be still further improved, but the amount of reprogramming required was increasing and its effectiveness was decreasing; there was an awful long way to go. The alternative of increasing the size of the main store so frequently adopted in later failures of this kind was prohibited by hardware addressing limitations.

There was no escape: the entire Elliott 503 Mark II software project had to be abandoned, and with it, over thirty man-years of programming effort, equivalent to nearly one man's active working life. And I was responsible, both as designer and as manager, for wasting it.

A meeting of all our 503 customers was called and Roger Cook, who was then manager of the computing division, explained to them that not a single word of the long-promised software would ever be delivered to them. He adopted a very quiet tone of delivery, which ensured that none of the customers could interrupt, murmur in the background, or even shuffle in their seats. I admired but could not share his calm. Over lunch our customers were kind to try to comfort me. They had realized long ago that software to the original specifications could never have been delivered, and even if it had been, they would not have known how to use its sophisticated features, and anyway many such large projects get cancelled before delivery. In retrospect, I believe our customers were fortunate that hardware limitations had protected them from the arbitrary excesses of our software designs. In the present day, users of microprocessors benefit from a similar protection—but not for much longer.

At that time I was reading the early documents describing the concepts and features of the newly announced OS 360, and of a new time-sharing project called Multics. These were far more comprehensive, elaborate, and sophisticated than anything I had imagined, even in the first version of the 503 Mark II software. Clearly IBM and MIT must be possessed of some secret of successful software de-

sign and implementation whose nature I could not even begin to guess at. It was only later that they realized they could not either.

So I still could not see how I had brought such a great misfortune upon my company. At the time I was convinced that my managers were planning to dismiss me. But no, they were intending a far more severe punishment. "OK, Tony," they said. "You got us into this mess, and now you're going to get us out."

"I don't know how," I protested, but their reply was simple. "Well then, you'll have to find out." They even expressed confidence that I could do so. I did not share their confidence. I was tempted to resign. It was the luckiest of all my lucky escapes that I did not.

Of course, the company did everything they could to help me. They took away my responsibility for hardware design and reduced the size of my programming teams. Each of my managers explained carefully his own theory of what had gone wrong, and all the theories were different. At last, there breezed into my office the most senior manager of all, a general manager of our parent company, Andrew St. Johnston. I was surprised that he had even heard of me. "You know what went wrong?" he shouted (he always shouted). "You let your programmers do things which you yourself do not understand." I stared in astonishment. He was obviously out of touch with present-day realities. How could one person ever understand the whole of a modern software product like the Elliott 503 Mark II software system?

I realized later that he was absolutely right; he had diagnosed the true cause of the problem and he had planted the seed of its later solution.

### Defining the Problems

I still had a team of some forty programmers. We needed to retain the goodwill of customers of our new machine and even regain the confidence of the customers for our old one. But what should we actually plan to do when we knew only one thing—that all our previous plans

had failed? I therefore called an all-day meeting of our senior programmers on October 22, 1965, to thrash out the question among us. I still have the notes of that meeting. We first listed the recent major grievances of our customers: cancellation of products, failure to meet deadlines, excessive size of software "not justified by the usefulness of the facilities provided," excessively slow programs, failure to take account of customer feedback. "Earlier attention paid to quite minor requests of our customers might have paid as great dividends of goodwill as the success of our most ambitious plans," we concluded.

We then listed our own grievances: lack of machine time for program testing, unpredictability of machine time, lack of suitable peripheral equipment, unreliability of the hardware even when available, dispersion of programming staff, lack of equipment for keypunching of programs, lack of firm hardware delivery dates, lack of technical writing effort for documentation, lack of software knowledge outside the programming group, interference from higher managers who imposed decisions without a full realization of the more intricate implications of the matter, and overoptimism in the face of pressure from customers and the sales department.

But we did not seek to excuse our failure by these grievances. For example, we admitted that it was the duty of programmers to educate their managers and other departments of the company by presenting the necessary information in a simple palatable form. The hope "that deficiencies in original program specifications could be made up by the skill of a technical writing department...was misguided. The design of a program and the design of its specification must be undertaken in parallel by the same person, and they must interact with each other. A lack of clarity in specification is one of the surest signs of a deficiency in the program it describes, and the two faults must be removed simultaneously before the project is embarked upon." I wish I had followed this advice in 1963; I wish we all would follow it today.

My notes of the proceedings of that day in October 1965 include a complete section devoted to failings within the software group; this section rivals the most abject self-abasement of a revisionist official in the Chinese cultural revolution. Our main failure was overambition. "The goals which we have attempted have obviously proved to be far beyond our grasp." There was also failure in prediction, in estimation of program size and speed, of effort required, in planning the coordination and interaction of programs, in providing an early warning that things were going wrong. There were faults in our control of program changes, documentation, liaison with other departments, with our management, and with our customers. We failed in giving clear and stable definitions of the responsibilities of individual programmers and project leaders. Oh, need I go on? What was amazing was that a large team of highly intelligent programmers could labor so hard and so long on such an unpromising project. You know, you shouldn't trust us intelligent programmers. We can think up such good arguments for convincing ourselves and each other of the utterly absurd. Especially don't believe us when we promise to repeat an earlier success, only bigger and better next time.

The last section of our inquiry into the failure dealt with the criteria of quality of software. "In the recent struggle to deliver any software at all, the first casualty has been consideration of the quality of the software delivered. The quality of software is measured by a number of totally incompatible criteria, which must be carefully balanced in the design and implementation of every program." We then made a list of no less than seventeen criteria which has been published in a guest editorial in Volume 2 of the journal *Software Practice and Experience*.

### Recovery Period

How did we recover from the catastrophe? First, we classified our 503 customers into groups, according to the nature and the size of the hard-

ware configurations which they had bought. For example, those with magnetic tapes were all in one group. We assigned to each group of customers a small team of programmers and told the team leader to visit the customers to find out what they wanted, to select the easiest request to fulfill, and to make plans (but not promises) to implement it. In no case would we consider a request for a feature that would take more than three months to implement and deliver. The project leader would then have to convince me that the customer's request was reasonable, that the design of the new feature was appropriate, and that the plans and schedules for implementation were realistic. Above all, I did not allow anything to be done which I did not myself understand. It worked! The software requested began to be delivered on the promised dates. With an increase in our confidence and that of our customers, we were able to undertake fulfilling slightly more ambitious requests. Within a year, we had recovered from the disaster. Within two years, we even had some moderately satisfied customers.

Thus we muddled through by common sense and compromise to something approaching success. But I was not satisfied. I did not see why the design and implementation of an operating system should be so much more difficult than that of a compiler. This is the reason why I have devoted my later research to problems of parallel programming and language constructs which would assist in clear structuring of operating systems—constructs such as monitors and communicating processes.

While I was working at Elliott, I became very interested in techniques for formal definition of programming languages. At that time, Peter Landin and Christopher Strachey proposed to define a programming language in a simple functional notation that specified the effect of each command on a mathematically defined abstract machine. I was not happy with this proposal because I felt that such a definition must incorporate a number of fairly arbitrary representation

decisions and would not be much simpler in principle than an implementation of the language for a real machine. As an alternative, I proposed that a programming language definition should be formalized as a set of axioms, describing the desired properties of programs written in the language. I felt that carefully formulated axioms would leave an implementation the necessary freedom to implement the language efficiently on different machines and enable the programmer to prove the correctness of his programs.

But I did not see how to actually do it. I thought that it would need lengthy research to develop and apply the necessary techniques, and that a university would be a better place to conduct such research than industry. So I applied for a chair in Computer Science at the Queen's University of Belfast, where I was to spend nine happy and productive years. In October 1968, as I unpacked my papers in my new home in Belfast, I came across an obscure reprint

of an article by Bob Floyd entitled, "Assigning Meanings to Programs." What a stroke of luck! At last I could see a way to achieve my hopes for my research. Thus I wrote my first paper on the axiomatic approach to computer programming, published in the *Communications of the ACM* in October 1969.

Just recently, I have discovered that an early advocate of the assertional method of program proving was none other than Alan Turing himself. On June 24, 1950, at a conference in Cambridge, he gave a short talk entitled, "Checking a Large Routine," which explains the idea with great clarity. "How can one check a large routine in the sense of making sure that it's right?" Turing asked. "In order that the man who checks may not have too difficult a task, the programmer should make a number of definite assertions which can be checked individually, and from which the correctness of the whole program easily follows."

Consider the analogy of checking

## FINDING SOLUTIONS AND BEING COMPETITIVE IS OUR BUSINESS.

Having problems and looking for a computer to help solve them? Are you finding computer dealers come in one of two ways? Either Full system support with Full price or Take it or Leave it with Low price. At Omega we don't believe that you should have to make a choice. Yes, we're in business to sell products but also, to solve your problems. Our prices will be the lowest possible. Our support and product quality will be second to none. Check out our Mail Order prices in this ad (our retail prices will be higher). See if you don't agree with our first claim. For our second claim, call us with your data processing needs and problems. Better yet, come in and see us. Finding solutions and being competitive is our business. We never forget either of them.



APPLE III	\$CALL
APPLE II "PLUS" 48K	\$ 1129 00
HEWLETT PACKARD 85 or 83	\$CALL
<b>APPLE II ACCESSORIES:</b>	
Disk II with controller	\$ 515 00
Disk II 2nd drive	452 00
Graphics Tablet	665 00
Language System with PASCAL	385 00
Silentype Printer W/Ini	525 00
Integer Firmware Card	152 00
Microsoft Z-80 Software	259 00
Videx videoterm 80 col Card	256 00
Sanyo 12" Green Monitor	269 00

<b>Supplies:</b>	
Scotch Diskettes - Best of Quality!	
price per box of (10)	
744-0, 10, 32	\$ 27 00
740-0 SS/SD 0 Sector	31 00
741-0 SS/DD 0 Sector	37 00
743-0 DS/DD No Format	44 00
<b>New Products:</b>	
Videx L/C Adapter	110 00
Microsoft 16K RAM Card	169 00
D.C. Hayes Micromodem II	307 00
Novation DCAT Modem	195 00
EPSON MX-80	CALL

Mail Order Terms of Sales: Price based on prepaid orders. NO COD's. Allow 14 working days for personal and company checks to clear. Order under \$100.00 add \$3.00 for shipping and handling. All orders (unless specified in ad) within Continental U.S. shipped U.P.S. no charge. APO or out of Continental U.S. write or call for shipping charges. All prices subject to change and all offers subject to withdrawal without notice. CA residents add 6% sales tax.

## OMEGA MICRO COMPUTERS

The Problem Solving Company 3447 Torrance Boulevard • Torrance, California 90503 • (213) 328-1760

an addition. If the sum is given as a column of figures with the answer below, one must check the whole at one sitting. But if the totals for the various columns are given with the carries added in separately, the checker's work is much easier, being split up into the checking of the various assertions (that each column is correctly added) and the small addition (of the carries to the total). This principle can be applied to the checking of a large routine, but we will illustrate the method by means of a small routine: one to obtain  $n$  factorial without the use of a multiplier. Unfortunately, there is no coding system sufficiently generally known to justify giving this routine in full, but a flow diagram will be sufficient for illustration. That brings me back to the main theme of my talk, the design of programming languages.

During the period August 1962 to October 1966, I attended every meeting of the IFIP ALGOL working group. After completing our labors on the IFIP ALGOL subset, we started on the design of ALGOL X, the intended successor to ALGOL 60. More suggestions for new features were made and in May 1965, Niklaus Wirth was commissioned to collate them into a single language design. I was delighted by his draft design, which avoided all the known defects of ALGOL 60 and included several new features, all of which could be simply and efficiently implemented, and safely and conveniently used.

The description of the language was not yet complete. I worked hard

on making suggestions for its improvement, and so did many other members of our group. By the time of the next meeting in St. Pierre de Chartreuse, France, in October 1965, we had a draft of an excellent and realistic language design which was published in June 1966 as "A Contribution to the Development of ALGOL" in *Communications of the ACM*. It was implemented on the IBM 360 and given the title ALGOL W by its many happy users. It was not only a worthy successor of ALGOL 60, it was even a worthy predecessor of Pascal.

At the same meeting, the ALGOL committee had placed before it a short, incomplete and rather incomprehensible document describing a different, more ambitious and, to me, a far less attractive language. I was astonished when the working group, consisting of all the best known international experts of programming languages, resolved to lay aside the commissioned draft on which we had all been working and swallow a line with such an unattractive bait.

### Two Design Paths

This happened just one week after our inquest on the 503 Mark II software project. I gave desperate warnings against the obscurity, the complexity, and overambition of the new design, but my warnings went unheeded. I conclude that there are two ways of constructing a software design: One way is to make it so simple that there are *obviously* no deficiencies, and the other way is to make it

so complicated that there are no *obvious* deficiencies.

The first method is far more difficult. It demands the same skill, devotion, insight, and even inspiration as the discovery of the simple physical laws which underlie the complex phenomena of nature. It also requires a willingness to accept objectives which are limited by physical, logical, and technological constraints, and to accept a compromise when conflicting objectives cannot be met. No committee will ever do this until it is too late.

So it was with the ALGOL committee. Clearly the draft which it preferred was not yet perfect. So a new and final draft of the new ALGOL language design was promised in three months' time; it was to be submitted to the scrutiny of a subgroup of four members including myself. Three months came and went, without a word of the new draft. After six months, the subgroup met in the Netherlands. We had before us a longer and thicker document, full of errors corrected at the last minute, describing yet another but to me, equally unattractive language. Niklaus Wirth and I spent some time trying to get removed some of the deficiencies in the design and in the description, but in vain. The completed final draft of the language was promised for the next meeting of the full ALGOL committee in three months' time.

Three months came and went—no word of the new draft appeared. After six months, in October 1966,

<p><b>COMMUNICATIONS-</b></p> <ul style="list-style-type: none"> <li>• Synchronous to 800KB</li> <li>• Asynchronous to 24KB</li> <li>• Serial RS-232 or 20 Ma.</li> <li>• IEEE 488 - 78 GPIB</li> <li>• Distributed Systems</li> <li>• BiSync-DEC net -X.25</li> </ul> <p><b>ANALOG I/O -</b></p> <ul style="list-style-type: none"> <li>• Low/High Level A/D</li> <li>• X-Ducer Compensation</li> <li>• 16 to 64 Channel MUX</li> <li>• Differential/Single Ended</li> <li>• Programmable Gain</li> <li>• 12/14 Bit Resolution</li> <li>• Video Digitizers</li> <li>• Multiple DACs</li> </ul> <p><b>DIGITAL I/O -</b></p> <ul style="list-style-type: none"> <li>• Optically Isolated</li> <li>• High Level AC or DC</li> <li>• Pulse Count I/O</li> <li>• Programmable Timers</li> <li>• Digital Multiplexers</li> <li>• UNIBUS/IEEE Drivers</li> <li>• Voice Synthesizers</li> </ul>	<p><b>Z80/Z8000</b> <b>LSI-11/PDP-11</b> <b>SYSTEMS</b></p>	<p><b>ASC Computers</b></p> 	<p><b>8085/8086/88</b> <b>6800/09/68000</b> <b>PERIPHERALS</b></p>	<ul style="list-style-type: none"> <li><input type="checkbox"/> <b>PERIPHERALS -</b></li> <li>• Flexible Disks to 1Mb</li> <li>• Winchester Disks to 300Mb</li> <li>• Magnetic Tape Units</li> <li>• Printers/Terminals</li> <li>• Video Cameras</li> <li>• Color Graphics</li> <li>• CRT Displays/Plotters</li> <li><input type="checkbox"/> <b>SYSTEMS -</b></li> <li>• Modular Expandability</li> <li>• Industrial Enclosures</li> <li>• Rack-Mounting Cabinets</li> <li>• I/O Termination Panels</li> <li>• Portable DAS Option</li> <li>• Control Console/Displays</li> <li>• Development Systems</li> <li><input type="checkbox"/> <b>SOFTWARE -</b></li> <li>• CP/M Operating Systems</li> <li>• Multi-User Support</li> <li>• Fortran, Basic, Pascal</li> <li>• DAS - Process Languages</li> <li>• MACRO &amp; Assembler Language</li> <li>• Network Communications</li> <li>• Graphics and Applications</li> </ul>
<p>Featuring a full range of industry standard 8 and 16 Bit Micro-Processors, Memories, I/O Controllers, Analog/Digital Modules and Peripheral Equipment.</p> <p><b>-ASC CUSTOM MICRO-COMPUTER SYSTEM CONFIGURATIONS-</b></p> <p>Expedited delivery on the latest technology in Micro-Computers, Disk Memories and Peripheral options, including Software and System Integration.</p> <p>ASC Micro-Computer Systems are offered with optional IEEE/S-100 Bus, INTEL MULTI-Bus, MOTOROLA EXOR-Bus, or STD-Bus compatible Micro-Processors, Memories, I/O Controllers, and Enclosures to your specifications.</p> <p>Call ASC for prompt quotations on Micro-Computer configurations.</p>		<p><b>ASC Computer Systems</b></p>		<p>26401 Harper Ave. St. Clair Shores Michigan 48061</p> <p><b>313</b> <b>779-9700</b></p>



the ALGOL working group met in Warsaw. It had before it an even longer and thicker document, full of errors corrected at the last minute, describing equally obscurely yet another different, and to me, equally unattractive language. The experts in the group could not see the defects of the design and they firmly resolved to adopt the draft, believing it would be completed in three months. In vain, I told them it would not. In vain, I urged them to remove some of the technical mistakes of the language, the predominance of references, the default type conversions. Far from wishing to simplify the language, the working group actually asked the authors to include even more complex features like overloading of operators and concurrency.

When any new language design project is nearing completion, there is always a mad rush to get new features added before standardization. The rush is mad indeed, because it leads into a trap from which there is no escape. A feature which is omitted can always be added later, when its design and its implications are well understood. A feature which is included before it is fully understood can never be removed later.

At last, in December 1968, in a mood of black depression, I attended the meeting in Munich at which our long-gestated monster was to come to birth and receive the name ALGOL 68. By this time, a number of other members of the group had become disillusioned, but too late: the committee was now packed with supporters of the language, which was sent up for promulgation by the higher committees of IFIP. The best we could do was to send with it a minority report, stating our considered view that "...as a tool for the reliable creation of sophisticated programs, the language is a failure." This report was later suppressed by IFIP, an act which reminds me of the lines of Hilaire Belloc:

But scientists, who ought to know  
Assure us that it must be so.  
Oh, let us never, never doubt  
What nobody is sure about,

I did not attend any further meetings of that working group. I am pleased to report that the group soon came to realize that there was something wrong with their language and with its description; they labored hard for six more years to produce a revised description of the language. It is a great improvement but I'm afraid that, in my view, it does not remove the basic technical flaws in the design, nor does it begin to address the problem of its overwhelming complexity.

Programmers are always surrounded by complexity; we cannot avoid it. Our applications are complex because we are ambitious to use our computers in ever more sophisticated ways. Programming is complex because of the large number of conflicting objectives for each of our programming projects. If our basic tool, the language in which we design and code our programs, is also complicated, the language itself becomes part of the problem rather than part of its solution.

#### Another Project

Now let me tell you about yet another overambitious language project. Between 1965 and 1970 I was a member and even chairman of the Technical Committee No. 10 of the European Computer Manufacturers Association. We were charged first with a watching brief and then with the standardization of a language to end all languages, designed to meet the needs of all computer applications, both commercial and scientific, by the greatest computer manufacturer of all time. I had studied with interest and amazement, even a touch of amusement, the four initial documents describing a language called NPL, which appeared between March 1 and November 30, 1964. Each was more ambitious and absurd than the last in its wishful speculations. Then the language began to be implemented and a new series of documents began to appear at six-monthly intervals, each describing the final frozen version of the language, under its final frozen name PL/I.

But to me, each revision of the doc-

## Employment Opportunities

FOR INFORMATION  
REGARDING THIS  
SECTION  
Call 212-997-2556

### COLORADO!

#### PROGRAMMING COORDINATOR

Responsible for planning, organizing and monitoring programming projects. Also supervises program production and maintenance. Requires B.S. degree in Management Information Systems or related field and three years programming and/or systems design experience. Including one year as a project leader preferred. Solid Fortran programming skills a must.

#### ENGINEERING SYSTEMS ANALYST

Analyzes and evaluates user requirements and designs and implements systems and procedures for engineering applications. Requires a B.S. degree in Computer Science or related field and three years systems programming experience.

#### EE/COMPUTER SCIENCE

Will be involved in the development, testing, integration and maintenance of the software associated with the Energy Management System. Requires a B.S. degree in computer science, electrical engineering, mathematics or related field. Fortran programming and real-time systems experience desirable.

Submit resume to: Tri-State Generation & Transmission Assn., Inc. Personnel Department BT, P.O. Box 33695, Denver, CO 80233.

An Affirmative Action/  
Equal Opportunity Employer



**TRI-STATE**  
GENERATION & TRANSMISSION  
ASSOCIATION, INC. (MTWYVATL)

Let  
**McGraw-Hill's**  
**Classified**  
**Ads Work**  
**For You**

ument simply showed how far the initial F-level implementation had progressed. Those parts of the language that were not yet implemented were still described in free-flowing flowery prose giving promise of unalloyed delight. In the parts that *had* been implemented, the flowers had withered; they were choked by an undergrowth of explanatory footnotes, placing arbitrary and unpleasant restrictions on the use of each feature and loading upon a programmer the responsibility for controlling the complex and unexpected side-effects and interaction effects with all the other features of the language.

At last, March 11, 1968, the language description was nobly presented to the waiting world as a worthy candidate for standardization. But it was not. It had already undergone some seven thousand corrections and modifications at the hand of its original designers. Another twelve editions were needed before it was finally published as a standard in 1976. I fear that this was not because everybody concerned was satisfied with its design, but because they were thoroughly bored and disillusioned.

For as long as I was involved in this project, I urged that the language be simplified, if necessary by subsetting, so that the professional programmer would be able to understand it and be able to take responsibility for the correctness and cost-effectiveness of his programs. I urged that the dangerous features such as defaults and *on* conditions be removed. I knew that it would be impossible to write a wholly reliable compiler for a language of this complexity, and impossible to write a wholly reliable program when the correctness of each part of the program depends on checking that every other part of the program has avoided all the traps and pitfalls of the language.

At first I hoped that such a technically unsound project would collapse, but I soon realized it was doomed to success. Almost anything in software can be implemented, sold, and even used given enough determination. There is nothing a mere scientist can say that will stand against the

flood of a hundred million dollars. But there is one quality that cannot be purchased in this way—and that is reliability. The price of reliability is the pursuit of the utmost simplicity. It is a price which the very rich find most hard to pay.

All this happened a long time ago. Can it be regarded as relevant in a conference dedicated to a preview of the Computer Age that lies ahead? It is my gravest fear that it can. The

---

### **There is nothing a mere scientist can say that will stand against the flood of a hundred million dollars.**

---

mistakes which have made in the last twenty years are being repeated today on an even grander scale. I refer to a language design project which has generated documents entitled *strawman, woodenman, tinman, ironman, steelman, green* and finally now *Ada*. This project has been initiated and sponsored by one of the world's most powerful organizations, the United States Department of Defense. Thus it is ensured of an influence and attention quite independent of its technical merits, and its faults and deficiencies threaten us with far greater dangers. For none of the evidence we have so far can inspire confidence that this language has avoided any of the problems that have afflicted other complex language projects of the past.

I have been giving the best of my advice to this project since 1975. At first I was extremely hopeful. The original objectives of the language included reliability, readability of programs, formality of language definition, and even simplicity. Gradually these objectives have been sacrificed in favor of power, supposedly achieved by a plethora of features and notational conventions, many of them unnecessary and some of them, like exceptions handling, even dangerous. We relive the history of the design of the motor car. Gadgets and glitter prevail over fundamental concerns of safety and economy.

It is not too late! I believe that by careful pruning of the *Ada* language, it is still possible to select a very powerful subset that would be reliable and efficient in implementation and safe and economic in use. The sponsors of the language have declared unequivocally, however, that there shall be no subsets. This is the strangest paradox of the whole strange project. If you want a language with no subsets, you must make it *small*.

You include only those features which you know to be needed for every single application of the language and which you know to be appropriate for every single hardware configuration on which the language is implemented. Then extensions can be specially designed where necessary for particular hardware devices and for particular applications. That is the great strength of Pascal, that there are so few unnecessary features and almost no need for subsets. That is why the language is strong enough to support specialized extensions—concurrent Pascal for real-time work, Pascal Plus for discrete event simulation, UCSD Pascal for microprocessor work stations. If only we could learn the right lessons from the successes of the past, we would not need to learn from our failures.

And so, the best of my advice to the originators and designers of *Ada* has been ignored. In this last resort, I appeal to you, representatives of the programming profession in the United States, and citizens concerned with the welfare and safety of your own country and of mankind: do not allow this language in its present state to be used in applications where reliability is critical, ie, nuclear power stations, cruise missiles, early warning systems, anti-ballistic missile defense systems. The next rocket to go astray as a result of a programming language error may not be an exploratory space rocket on a harmless trip to Venus. It may be a nuclear warhead exploding over one of our own cities. An unreliable programming language generating unreliable programs constitutes a far greater risk to our environment and to our society than unsafe cars, toxic

pesticides, or accidents at nuclear power stations. Be vigilant to reduce that risk, not to increase it.

Let me not end on this somber note. To have our best advice ignored is the common fate of all who take on the role of consultant, ever since Cassandra pointed out the dangers of bringing a wooden horse within the walls of Troy. That reminds me of a story I used to hear in my childhood.

### The Emperor's Old Clothes

Many years ago, there was an Emperor who was so excessively fond of clothes that he spent all his money on dress. He did not trouble himself with soldiers, attend banquets, or give judgment in court. Of any other king or emperor one might say, "He is sitting in council," but it was always said of him, "The emperor is sitting in his wardrobe." And so he was. On one unfortunate occasion, he had been tricked into going forth naked to his chagrin and the glee of his subjects. He resolved never to leave his throne, and to avoid nakedness, he ordered that each of his many new suits of clothes should be simply draped on top of the old.

Time passed away merrily in the large town that was his capital. Ministers and courtiers, weavers and tailors, visitors and subjects, seamstresses and embroiderers, went in and out of the throne room about their various tasks, and they all exclaimed, "How magnificent is the attire of our Emperor."

One day the Emperor's oldest and most faithful minister heard tell of a most distinguished tailor who taught at an ancient institute of higher stitchcraft, and who had developed a new art of abstract embroidery using stitches so refined that no one could tell whether they were actually there at all. "These must indeed be splendid stitches," thought the minister. "If we can but engage this tailor to advise us, we will bring the adornment of our Emperor to such heights of ostentation that all the world will acknowledge him as the greatest Emperor there has ever been."

So the honest old minister engaged

the master tailor at vast expense. The tailor was brought to the throne room, where he made obeisance to the heap of fine clothes which now completely covered the throne. All the courtiers waited eagerly for his advice. Imagine their astonishment when his advice was not to add sophistication and more intricate embroidery to that which already existed, but rather to remove layers of the finery, and strive for simplicity and elegance in place of extravagant elaboration.

"This tailor is not the expert that he claims," they muttered. "His wits have been addled by long contemplation in his ivory tower, and he no longer understands the sartorial needs of a modern Emperor." The tailor argued loud and long for the good sense of his advice but could not make himself heard. Finally, he accepted his fee and returned to his ivory tower.

Never to this day has the full truth of this story been told: that one fine morning, when the Emperor felt hot and bored, he extricated himself carefully from under his mountain of clothes and is now living happily as a swineherd in another story. The tailor is canonized as the patron saint of all consultants, because in spite of the enormous fees that he extracted, he was never able to convince his clients of his dawning realization that their clothes have no Emperor. ■

## BYTE's Bits

### Transplanted Apple Shoppe

Joseph L Rollinson is the new publisher of *The Apple Shoppe Magazine*. *Apple Shoppe*, which describes itself as the "journal of Apple applications," is a periodical for users of Apple II and III computers. The magazine was previously published by David Smith of Placentia, California. Mr Rollinson is a native of San Diego, California.

*Apple Shoppe* is published eight times a year, for a subscriber's cost of \$12 in the United States. Contact *The Apple Shoppe Magazine*, POB 22026, San Diego CA 92122. ■

## THE MOST

# POWERFUL SMALL BUSINESS COMPUTER

## IN THE WORLD

The IBC ENSIGN business computer was designed from the ground up to run MP/M, multi-user OASIS, MVT-FAMOS, and other multi-user Z-80 operating systems faster than any other computer in the world.

Consider these features:

- Up to 16 users
- Up to 768K byte memory
- Up to 150M bytes/disk drive
- 17M byte tape cartridge
- 46M byte 9 track tape
- 6 MHz Z-80B CPU

But it takes more than a lot of I/O ports, memory, and disk storage to make a super multi-user computer. The ENSIGN has what it takes.

**MULTIPLE MICROPROCESSORS:** The ENSIGN has two separate Z-80's and 32K byte memory buffer to handle all I/O between CRT's and printers at baud rates up to 19,200 baud.

A third Z-80 handles all disk and tape I/O. Commands from the main CPU are totally supervised by the disk slave Z-80.

And the main CPU is the new 6 MHz Z-80B running at full speed with 120 nsec memory.

**PERIPHERALS:** The ENSIGN supports the tape and winchester disk family from Kennedy Co. These drives, tape cartridges, and 9 track tape drives are the premier of the industry. Yet prices are low on the ENSIGN.

**SOFTWARE:** If you are running MP/M, OASIS, or MVT-FAMOS you will run better on an ENSIGN. And if you're not already tied to one of these systems you may want to try IBC-SUPERDOS SUPERDOS is very powerful and very fast.



For dealership information contact:

**IBC** / Integrated  
Business  
Computers

22010 S. Wilmington Avenue, Suite 306  
Carson, CA 90745 • Call (213) 518-4245

The following have registered trademarks: Z-80 / OASIS / MP/M / DIGITAL / MVT-FAMOS / SUPERDOS / IBC-SUPERDOS / MVT-FAMOS / MVT-MICROCOMPUTER / SUPERDOS

## Microcomputers and the IRS

---

James C Kingman, Chief, Examination Section  
Helena International Revenue Service District  
Helena MT 59601

---

*Although the author is an employee of the Internal Revenue Service, the content of this article is his opinion and does not necessarily reflect the position of the United States Internal Revenue Service....SM*

The 1980s will see unprecedented growth in the use of microcomputers by small independent businesses and professional persons. With great potential for fast, accurate processing of accounting data and other types of business records at a minimal cost, microcomputers, like photocopying machines, will soon be standard equipment in most offices.

Microcomputers offer a means of simplifying record-keeping systems while producing more timely, accurate, and detailed reports than were ever possible using a manual accounting system. The greatest benefit to a small business or professional person, however, is the cost. For a cost comparable to the annual salary of a bookkeeper, the individual can purchase a hardware and software system capable of many times the work output of a single person. If the system is well planned and properly implemented, it can result in an overall cost savings and a significant increase in the usefulness and efficiency of the record-keeping system.

Traditionally, a person entering a new business works with his accountant to set up a record-keeping system that meets generally accepted accounting principles and practices. These systems provide a logical method of tracing detailed records such as invoices and vouchers through the accounting process to the final financial reports. The systems usually produce a general ledger which is supported by subsidiary ledgers or such journals as Accounts Receivable and Accounts Payable. These, in turn, provide a complete listing of the detailed records. Thus, with the traditional method it is possible to trace an individual detailed record through the entire system. This system of tracking records is known as the "Audit Trail."

As more and more business and professional people acquire and learn to program their microcomputer systems, there may be a temptation to simplify record-keeping systems to the point where the Audit Trail is lost. For example, an individual might be tempted to write a program that would simply require the input of detailed records

and would produce completed financial statements as output. While such a program would be very simple to write and even simpler to operate, it would completely eliminate any form of Audit Trail.

The lack of an Audit Trail creates two major problems:

First, any error or discrepancy on the original detailed record would be impossible to locate without a complete reconstruction of all detailed records. Suppose you had such a simplified program for your Accounts Receivable. Each day, week, or month you would key in new charges and payments on account. At the end of the period your simple system would produce a statement for each customer, without any reference to the original detailed records. Such a program might work well as long as no errors were made in entering the detailed records. What would happen, however, if one of your customers paid \$50 on his account and you recorded \$57? Without a reference to any records, you would need to manually reconstruct the customer's entire account to verify whether or not he had, in fact, paid \$50. Not only would the process be time-consuming—it would create a relation problem with the customer because of the original error.

The second problem with such a program is that it is unacceptable to the Internal Revenue Service. Section 6001 of the Internal Revenue Code of 1954 requires, in part, that "every person liable for any tax imposed by this title, or for the collection thereof, shall keep such records, render such statements, make such returns and comply with such rules and regulations as the Secretary may from time to time prescribe." Under the authority of this code section, the Internal Revenue Service has issued Revenue Procedure 64-12 (Cumulative Bulletin 1964-1, Part 1, page 672), which defines "guidelines for record requirements to be followed in cases where part or all of the account records are maintained within automatic data processing systems." The Internal Revenue Service has also issued Revenue Ruling 71-20 (Cumulative Bulletin 1971-1, page 392), which holds that "punched cards, magnetic tapes, disks, and other machine-sensible data media used in the automatic data processing of accounting transactions constitute records within the meaning of section 1.6001-1 of the regulations." Let us see how this Revenue Procedure and Revenue Ruling affect the busi-

ness or professional person using a microcomputer in his business.

Revenue Procedure 64-12 deals directly with the need for an Audit Trail in an accounting system. Section 1.01 of the Revenue Procedure states its purpose:

### Section 1. Purpose

.01 *The purpose of this Revenue Procedure is to set forth guidelines specifying the basic record requirements which the Internal Revenue Service considers to be essential in cases where a taxpayer's records are maintained within an automatic data processing (ADP) system. References here to ADP systems include all accounting systems which process all or part of a taxpayer's transactions, records, or data by other than manual methods.*

Section 3 states the objectives of the Revenue Procedures:

### Section 3. Objectives

*...The ability to provide in legible form the data necessary to determine at a later date whether or not the correct tax liability has been reported must be carefully considered in designing and programming a machine system. This factor may add to the complexity of the system and require additional cost, but this cost may be negligible in comparison to the expense that may be incurred at a later date if the system cannot practically and readily provide the information needed to support and substantiate the accuracy of the previously reported tax liability.*

(Emphasis supplied.)

Section 4 gives the specific record requirements that the Internal Revenue Service considers essential in any ADP accounting system:

### Section 4. ADP Record Guidelines

.01 *...A computer's accounting program must include a method of producing from the punched cards or tapes visible and legible records which will provide the necessary information for the verification of the taxpayer's tax liability.*

.02 *General and Subsidiary Books of Account.—A*

(1) *general ledger, with source references, should be written out to coincide with financial reports for tax reporting periods. In cases where subsidiary ledgers are used to support the general ledger accounts, the subsidiary ledgers should also be written out periodically.*

(2) *Supporting Documents and Audit Trail.—The audit trail should be designed so that the details underlying the summary accounting data, such as invoices and vouchers, may be identified and made available to the Internal Revenue Service upon request.*

(3) *Recorded or Reconstructible Data.—The records must provide the opportunity to trace any transaction back to the original source or forward to a final total. If printouts are not made of transactions at the time they are processed, then the system must have the ability to reconstruct these transactions.*

Revenue Ruling 71-20 clarifies the term "records" as used in Code Section 6001:

*...It is held that punched cards, magnetic tapes, disks, and other machine-sensible data media used for recording, consolidating, and summarizing accounting transactions and records within a taxpayer's automatic data processing system are records within the meaning of section 6001 of the Code and section 1.6001-1 of the regulations and are required to be retained so long as the contents may become material in the administration of any internal revenue law...*

Both the Revenue Procedure and the Revenue Ruling are well known to most large companies using computer systems in their accounting process, but they may not be as well known to the small business using mini- and microcomputer systems. These businesses should check the following items in order to be sure their systems meet the requirements of the Internal Revenue Service:

- Any system or program should preserve the integrity of the Audit Trail so that any summary total may be traced back to the original detailed records, and any detailed record may be traced forward to the summary total.

- If the system or program does not produce printouts of the detailed transactions as they are processed, then the system or program must have the ability to reconstruct these transactions at the request of the Internal Revenue Service.

- If the system or program maintains accounting records on machine-sensible data media, such media are considered records and must be maintained for the same period of time as a hard-copy printout.

- Finally, if the system or program does maintain such machine-sensible data media, the system or program must include a method of producing visible and legible printouts of the media.

This article may raise more questions than it has answered. What should you do if you have questions about your system? A final quote from Revenue Ruling 71-20:

*...taxpayers who are in doubt as to which records are to be retained or who desire further information should contact their District Director for assistance. ■*

## Add Dual Trace and Delayed Sweep to Your Oscilloscope

Robert J Stetson, BASF Systems  
Crosby Dr, Bedford MA 01730

Occasionally the need arises to make timing comparisons between two signals with an interval delay. However, with a conventional oscilloscope you cannot scan a looped serial-data exchange with the clock in registration and still look at the data that occurs 40 bytes later. In this situation, you may want to build an add-on unit that converts your present single-channel scope to a digital dual-trace scope with delayed sweep for about \$15.

### Theory of Operation—Data Multiplexer

Figures 1 and 2 show the complete logic diagram of the unit. Figure 2 is a simple, stable, clock circuit. A chopping frequency of 1 F CLK was selected, since it is common among dual-trace scopes. The 555 integrated circuit is used as a free-running timer that generates 2 F CLK. Since the output of the 555 is highly asymmetrical, it runs at twice the desired rate, and 2 F CLK is fed to the input of a 74LS74-type D edge flip-flop. The 74LS74 is wired as a divider and neatly converts the pulse train from the 555 timer into a perfectly symmetrical square wave of half the frequency of 2 F CLK. It is important that 1 F CLK be symmetrical to insure that the two traces have the same relative brightness. This brightness is a direct function of the sample time (controlled by 1 F CLK) for each channel.

In figure 1, 1 F CLK enables the channel 1 NAND gate (74LS00) when high, and enables the channel 2 NAND gate (74LS00) through a 74LS04 inverter when low. The two channels are multiplexed into a single signal on pin 11 of the 74LS00, an active low NOR gate.

Vertical separation of the traces can best be understood by walking through the circuit with 0V input to both channels. If both inputs stay at a low level, the output on pin 11 of the 74LS00 NOR gate stays low. Even though there is no signal, the output signal, SCOPE, will switch at 1 F CLK speed.

The diagrams in figure 4 show the relationship between the 100 k-ohm 1 F CLK leg of the summing network and the 150 k-ohm DATA leg. With 1 F CLK in a low logic state, the DATA input selects one of the two possible zones in the channel 2 area of the screen. With 1 F CLK high, the DATA input selects one of the two channel 1 areas of the screen:

Where DATA is low, DATA = 0 V  
Where 1 F CLK is low, 1 F CLK = 0 V

Where DATA is high, DATA = 2 V  
Where 1 F CLK is high, 1 F CLK = 3 V

The output from the summing network is one of the four possible combinations:

low + low = channel 2 low 0 + 0 = 0 V  
low + high = channel 2 high 0 + 1 = 2 V  
high + low = channel 1 low 1 + 0 = 3 V  
high + high = channel 1 high 1 + 1 = 5 V

Even though half of the oscilloscope display time is spent on the upper area of the screen and half on the lower, the traces appear as two solid lines, because the 1 F CLK is synchronized with the two channel inputs, but not with the scope. The chopping frequency free-runs with relationship to the horizontal-sweep frequency of the scope, which is synchronized only with the signal at the input to channel 1.

Any attempt to synchronize on the signal at the multiplexer's SCOPE output will fail. The multiplexing action only allows you to synchronize on 1 F CLK; otherwise, as the two channels of data race across the screen they will be out of synchronization with the horizontal oscillator in the scope. A sample of the signal on which you want to synchronize is taken from the channel 1 input *before* it gets chopped by the multiplexer. This signal is then coupled by the trigger-control circuit to the scope's SYNC or TRIGGER input.

### Trigger Control Circuit Theory

When INT (internal trigger) is used, the channel 1 probe should always be on the signal from which you want to synchronize. The 74LS04 inverter at the channel 1 input buffers the input signal so that the circuit being sampled does not see the added load of the extra circuitry. The second 74LS04 reinverts the signal to its true polarity.

Inverters are placed in the channel 2 signal path to balance the gate delays between the two channels. This ensures accurate results, regardless of the quality of the scope.

Another 74LS04 inverter gates the signal over to a switch where either NORMAL trigger mode or DELAYED SWEEP is selected.

With the MODE switch in the NORM position, the

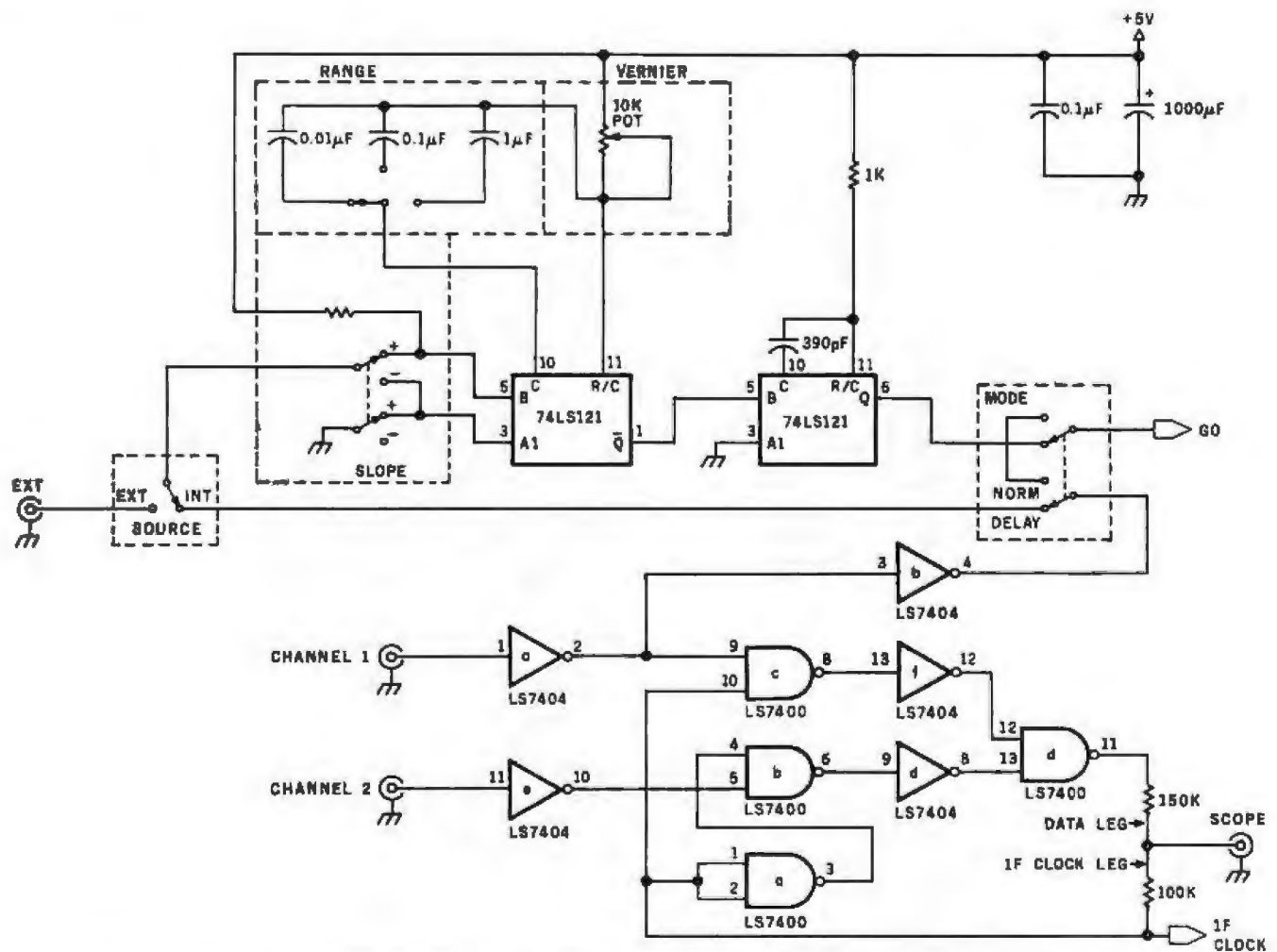

Figure 1: Multiplex interface schematic for adding dual trace and delayed sweep to an oscilloscope. See text for details on how the circuit works.

trigger signal is switched straight through to the 74LS04 inverter, which drives the 2N2222 transistor output-driver.

The TRIGG output is monitored by the coupling capacitor, which sets off the trigger timer and lights the trigger LED (light-emitting diode). The 74LS74 driving the trigger LED acts as an inverter; with its preset and clear inputs both low, the output on Q and  $\bar{Q}$  are high. But, when the clear input goes high, the output Q goes low. In this way, the  $\bar{Q}$  output will always be the inverse of the clear input, while the Q output remains high at all times. As long as the trigger LED remains lit, the scope is being triggered.

With the MODE in the DELAY position, the trigger pulses are routed through the SLOPE switch. The SLOPE switch directs the pulse to either the A or B input of a 74LS121 monostable multivibrator.

I chose a 74LS121 over other multivibrators because it is not retriggerable. While a 74LS123 would reduce the parts count, recurring triggers would extend the delay time indefinitely.

By using the RANGE and VERNIER controls, you can adjust the delay time. These controls increase or decrease the time from the selected edge of the triggering pulse to

the timeout of the first stage of the timer chain. The second 74LS121 fires when the first one times out. The second emits a short spike from which to trigger the scope.

An additional feature, the SOURCE switch, allows you to trigger from an independent source. This may be an index pulse, sector pulses or other reference signals from equipment you are working on.

Mastering the use of this unit requires patience. For instance, the channel 1 trigger source can be used only in certain applications. Other applications are best served by the external trigger option. Under certain conditions during the delayed-sweep mode, a vertical line appears on the left edge of the screen, caused by the deflection of the beam in the absence of a horizontal trace.

Since this add-on unit can only be used on logic-level signals, the unit under test can supply power. No internal power supply is shown, but you may prefer to add one.

The true amplitude of the signals on the SCOPE output will be less than the 2 V, 3 V, and 5 V levels in the description given here, because the output of the TTL devices during their source mode are less than the supply voltage. Also, the resulting voltage will be further reduced by the input impedance of the scope.

Caution: If you're tempted to cut up the front panel of





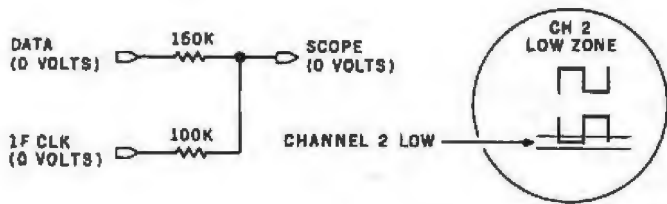

CHANNEL 2 IN LOW ZONE

(4a)

(4b)

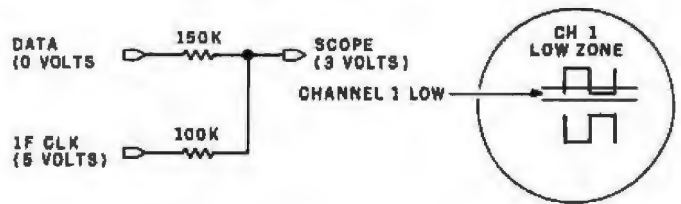

CHANNEL 1 IN LOW ZONE

(4c)

(4d)

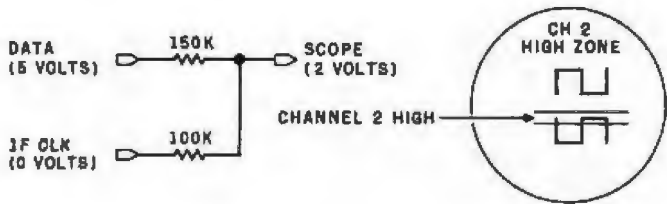

CHANNEL 2 IN HIGH ZONE

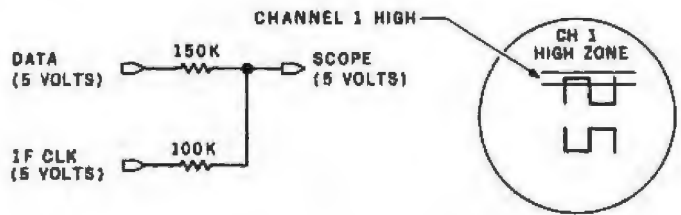

CHANNEL 1 IN HIGH ZONE

Figure 4: Operation of the circuit shown in figures 1 and 2. Each of the four input conditions decodes to four different zones on the oscilloscope screen.

## COMPSTAT

THE MOST COMPREHENSIVE STATISTICS PACKAGE AVAILABLE FOR MICROCOMPUTERS. NORTH STAR BASIC AND 8" BAZIC\* VERSIONS AVAILABLE.

OVER 420 PROGRAMS COVERING ANALYSIS OF VARIANCE, BASIC STATS, CONTINGENCY TABLE TECHNIQUES, ESTIMATION, EXPLORATORY DATA ANALYSIS, FOURIER ANALYSIS, NONPARAMETRIC STATISTICS, MULTIVARIATE STATISTICS, PROBABILITY PLOTTING, QUALITY CONTROL, RANDOM VARIATE GENERATION, REGRESSION, ROBUST TECHNIQUES, SAMPLING, STATISTICAL DISTRIBUTIONS, SURVIVAL TECHNIQUES AND TIME SERIES.

COMPLETE PACKAGE \$1500  
MANUAL ONLY \$100

TOPICS SOLD SEPARATELY AT \$200 A TOPIC.

**COMPSTAT**  
P.O. BOX 268  
GLOUCESTER POINT, VA. 23062

\*BAZIC IS A REGISTERED TRADEMARK OF MICRO MIKE'S

## Password Distributors

(408) 425-5411

### QUME DT 8

\$545

Includes 1 year factory warranty

### TELETEK FDC 1

- 4 MHZ CPU
- NEC 765 FDC

\$605

1 YEAR WARRANTY

### QUME DT 5

\$315

### QUME SPRINT 9/45

\$2295

### LIGHT PEN

WITH CORD & SOCKET

\$75

### INTERLINK MODEM

- 300-600 BAUD
- ASYN/SYN
- AUTO DIAL
- AUTO ANSWER
- SERIAL AND MODULAR JACK INTERFACE
- 2 YEAR WARRANTY

\$119

### FLOPPY DISK ADD-ONS

- DUAL-DOUBLE DENSITY DRIVES
  - ENCLOSURE
  - POWER SUPPLY
  - FAN
  - ALL CABLES
  - 1 YEAR WARRANTY
- 8" SYSTEM \$1375  
5 1/4" SYSTEM \$949

## An Almost Optimum Z80 Memory Test Program

Ira J Rampil, 60 Haven Ave Apt 15D, New York NY 10032

One of the great joys of building a computer is testing to see whether or not it works. The most interesting subsystem to check is the memory. Even average-sized memory systems contain several hundred thousand bits, each of which must be checked to insure that it can store and output the desired data. The memory must also be tested to confirm both the uniqueness of the address and the absence of bit-to-bit interference. Problems such as printed-circuit-board shorts and decoder-circuit bugs can cause data access at one address to disturb data at an entirely different address. Decoder-circuit bugs are usually encountered when a new memory is first brought up, but printed-circuit-short problems can and do occur at any time. Most memory component failures also occur early.

It is not feasible to detect and localize any but the most severe problems through the use of manual hardware debugging techniques. Memory bugs are best found by using software techniques, provided that plugging the questionable boards into the system bus doesn't cause the whole system to crash. As long as the processor, some peripherals, and at least some memory are up, programs can be loaded and run to test the remaining memory.

The most obvious test is to store all possible combinations of bits. Unfortunately there are  $2^{262144}$  possible combinations in a 32 K-by-8-bit memory. To test each possible combination separately would take a length of time significantly greater than the projected duration of the universe.

A great deal of research has been done in order to find tricks that will shorten the time required to test memory, but many manufacturers and suppliers of microcomputer kits seem unaware of the results. For example, I recently built a system kit that was supplied with a memory test program that counted from 0 to hexadecimal FF, checking each increment in every byte in memory. It took more than five minutes per pass in my 34 K memory, and the program failed to detect four address-line foil bridges, one solder splash, and the bad decoder chip that mapped two 8 K boards into the same memory location. It did locate a data-to-address foil short and a few bad memory chips, but the program crashed after every bug it caught. By contrast, the program I'm about to describe can detect all of these problems and most others, except certain bit-to-bit interference problems, within a single byte. It runs

on the same system in less than 3 seconds per pass.

Memory problems usually occur as input (address) or output (data) lines that are stuck at either a 0 or a 1, or a line having the value of a different line. Such problems are the result of open circuits or shorts to power lines. Blown memory devices usually have bits that are internally shorted or open. It should be understood that memory test programs will detect these problems and usually supply the offending addresses, but will almost never diagnose the problem. Diagnosis remains a human function that uses clues provided by memory test and dump routines. After localizing a bug, successive dumps of the offending area of memory while changing data at that address will reveal patterns characteristic of the particular bug.

The program described here is based on an algorithm described by John Knaizuk and C R P Hartmann (*IEEE Transactions on Computers*, April 1977). This algorithm is called optimal because it uses the minimal number of memory accesses to test the memory for all single-bit errors. It also catches many multiple-bit errors.

The memory under test is divided into three partitions based upon the byte addresses modulo 3. When a partition is accessed, all memory addresses within it are accessed. Each partition is then independently accessed. The address lines and the decoding circuits are exhaustively tested. Data lines and memory chips are also tested, to the extent that each bit must be able to write and read back both a 0 and a 1. The algorithm uses a total of four accesses per address. This corresponds to the number of accesses required to read and write a 0 and a 1 in each location.

The program shown in listing 1 was written for a Digital Group Z80 system, but it can be easily transported to other Z80 and 8080 systems. The major changes will be in the character output linkages and system utilities. I do not claim that this code is optimally short or fast. It was written to be legible, and it is fast enough and reasonably short. If an error is encountered, the offending address is printed, along with the erroneous data byte read and the correct byte. Errors do not terminate the test and an "A" is printed at the completion of the test sequence. ■

Listing 1: A memory test program for the Z80 microprocessor. Although written for a Digital Group Z80 system, it can easily be modified for 8080 and other Z80 systems. Note the use of octal notation.

```

ASSM 006000 100000

006000          0100  .....
006000          0110  * AN ALMOST PERFECT MEMORY
006000          0120  * TESTER BASED ON THE K-H
006000          0130  * ALGORITHM. WRITTEN BY
006000          0140  * IRA JAY RAMPIL FOR
006000          0150  * THE Z-80
006000          0160  .....
006000  315  346  0000  0170  BEGIN  CALL  ERASE          ;CLEAR SCREEN
006003          0175  *
006003          0180  * FIND TOP OF MEMORY
006003          0185  *
006003  315  251  006  0190  MAIN  CALL  TOP
006006          0200  *
006006          0210  * TEST SEQUENCE
006006          0220  *
006006  021  001  000  0230          LD  DE,000001
006011  315  117  006  0240          CALL WR
006014  021  002  000  0250          LD  DE,000002
006017  315  117  006  0260          CALL WR
006022  021  000  377  0270          LD  DE,377000
006025  315  117  006  0280          CALL WR
006030  021  001  000  0290          LD  DE,000001
006033  315  147  006  0300          CALL RD
006036  021  001  377  0310          LD  DE,377001
006041  315  117  006  0320          CALL WR
006044  021  002  000  0330          LD  DE,000002
006047  315  147  006  0340          CALL RD
006052  021  000  377  0350          LD  DE,377000
006055  315  147  006  0360          CALL RD
006060  021  001  377  0370          LD  DE,377001
006063  315  147  006  0380          CALL RD
006066  021  000  000  0390          LD  DE,000000
006071  315  117  006  0400          CALL WR
006074  315  147  006  0410          CALL RD
006077  021  002  377  0420          LD  DE,377002
006102  315  117  006  0430          CALL WR
006105  315  147  006  0440          CALL RD
006110  076  201  0450          LD  A,301          ;SIGNAL END OF
006112  315  372  000  0460          CALL TV          ;TEST TO SCREEN
006115  030  264  0470          JR   MAIN          ;START OVER
006117          0480  *
006117          0490  * SUBROUTINE TO WRITE TEST DATA
006117          0500  *
006117  052  255  006  0510  WR   LD   HL,(START)
006122  173          0520          LD   A,E          ;SET UP
006123  205          0530          ADD  L          ;STARTING
006124  157          0540          LD   L,A          ;ADDR OF
006125  174          0550          LD   A,H          ;PARTITION
006126  316  000  0560          ADC  0
006130  147          0570          LD   H,A
006131  162          0580  WLP  LD   (HL),D          ;WRITE LOOP
006132  043          0590          INC  HL          ;TO FILL
006133  043          0600          INC  HL          ;PARTITION
006134  043          0610          INC  HL
006135  170          0620          LD   A,B
006136  274          0630          CP   H
006137  330          0640          RET  C
006140  040  367  0650          JR   NZ,WLP
006142  171          0660          LD   A,C
006143  275          0670          CP   L
006144  330          0680          RET  C
006145  030  362  0690          JR   WLP
006147          0700  *
006147          0710  * SUBROUTINE TO READ AND CHECK DATA
006147          0720  *
006147  052  255  006  0730  RD   LD   HL,(START)
006152  173          0740          LD   A,E
006153  205          0750          ADD  L
006154  157          0760          LD   L,A
006155  174          0770          LD   A,H
006156  316  000  0780          ADC  0

```

Listing 1 continued on page 434

# System Notes

Listing 1 continued:

```

006160 147          0790          LD      H,A
006161 176          0800  RLP      LD      A,(HL)
006162 272          0810          CP      D
006163 304 203 006  0820          CALL   NZ,ERR          ;FOUND A BUG
006166 043          0830          INC     HL
006167 043          0840          INC     HL
006170 043          0850          INC     HL
006171 170          0860          LD      A,B
006172 274          0870          CP      H
006173 330          0880          RET     C
006174 040 363          0890          JR      NZ,RLP
006176 171          0900          LD      A,C
006177 275          0910          CP      L
006200 330          0920          RET     C
006201 030 356          0930          JR      RLP
006203          0940          *
006203          0950          * SUBROUTINE TO PRINT ERROR MESSAGE
006203          0960          *
006203 325          0970  ERR      PUSH   DE
006204 134          0980          LD      E,H          ;PUT OFFENDING ADDRESS ON TV
006205 315 267 001  0990          CALL   OCT
006210 139          1000          LD      E,L
006211 315 267 001  1010          CALL   OCT
006214 076 275          1020          LD      A,275          ;OUTPUT "="
006216 315 372 000  1030          CALL   TV
006221 136          1040          LD      E,(HL)          ;OUTPUT OFFENDING CONTENTS ON TV
006222 315 267 001  1050          CALL   OCT
006225 076 233          1060          LD      A,233
006227 315 372 000  1070          CALL   TV
006232 132          1080          LD      E,D          ;OUTPUT DESIRED CONTENTS
006233 315 267 001  1090          CALL   OCT
006236 305          1100          PUSH   BC
006237 006 022          1110          LD      B,22
006241 315 370 000  1120  SPACE  CALL   TV-2          ;OUTPUT SPACES TO GET NEXT
006244 020 373          1130          DINZ  SPACE          ;LINE OF TV SCREEN
006246 301          1140          POP    BC
006247 321          1150          POP    DE
006250 311          1160          RET
006251 001 377 207  1170  TOP      LD      BC,207377          ;MY SYSTEM'S TOP OF MEMORY
006254 311          1180          RET
006255          1190          *
006255          1200          * TV IS A ROUTINE THAT OUTPUTS
006255          1210          * THE CONTENTS(CHARACTER) OF A
006255          1220          *
006255          1230  TV      EQU   372
006255          1240          *
006255          1250          * OCT IS A ROUTINE THAT CONVERTS THE
006255          1260          * CONTENTS OF E FROM BINARY TO OCTAL
006255          1270          * AND THEN PRINTS IT ON TV
006255          1280          *
006255          1290  OCT      EQU   001267
006255          1300          *
006255          1310          * ERASE IS A ROUTINE THAT ERASES
006255          1320          * THE SCREEN
006255          1330          *
006255          1340  ERASE  EQU   346
006255 270 006          1350  START  DW    006270

```

## How to Build an Inexpensive Cassette Level Indicator

Dr Milan D Chepko  
119 Belleville Ct  
Thief River Falls MN 56701

Looking for an inexpensive way to adjust the level of your recorder when loading programs into your microcomputer? The circuit diagram in figure 1 shows two LEDs (light-emitting diodes) and a 270- to 330-ohm resistor wired across the line from the recorder's earphone jack. The earphone or speaker is optional, but it allows you to hear the data transfer in operation. A photograph of the completed circuit is shown in photo 1.

Most microcomputers require about two volts of audio signal for reliable operation. Since LEDs "turn on" at about 1.7 V, adjust the recorder's volume control until one of the LEDs begins to flicker steadily, and you should be in business. The LEDs also seem to absorb some of the extra signal if you turn the volume up too high. ■

**Technical Forum** is a feature intended as an interactive dialog on the technology of personal computing. The subject matter is open-ended, and the intent is to foster discussion and communication among readers of *BYTE*. We ask that all correspondents supply their full names and addresses to be printed with their commentaries. We also ask that correspondents supply their telephone numbers, which will not be printed.



Photo 1: The cassette level indicator built inside a small plastic box.

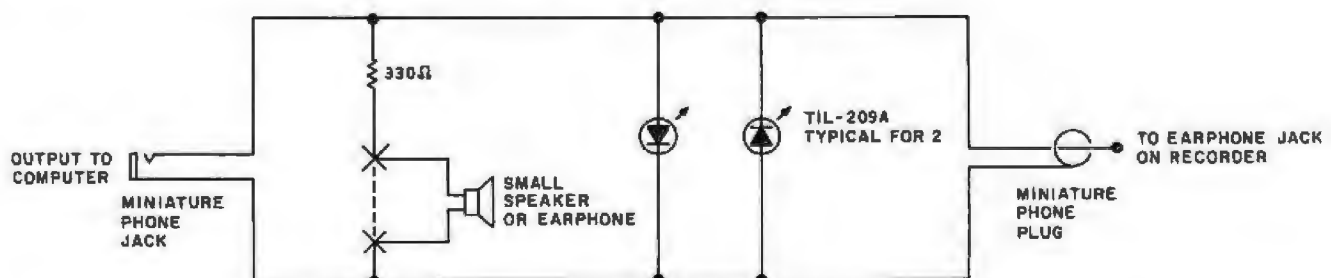

Figure 1: Schematic diagram of the cassette level indicator.

## Interactive Fiction: Six Micro Stories

Bob Liddil, The Programmer's Guild, POB 66, Peterborough NH 03458

Adventure International has a new concept in computer simulation called Interactive Fiction. The product I'm reviewing is a sampler of six Interactive Fiction stories. The sampler is, of course, designed to whet your curiosity about the full-length titles offered by the company.

Defined in its simplest terms, an Interactive Fiction episode is a story that needs your responses to achieve its outcome. It goes far beyond Adventure's two-word responses by encouraging you to input complete sentences. I must confess that, at first, I was uncomfortable with the new format. Gradually, though, I became accustomed to bantering with the computer.

The first story places you in wartime Nazi Germany. You're an Allied spy, and you must uncover as many secrets as possible. You have been invited to a banquet, where you find yourself chatting with a high-ranking Gestapo officer. The conversation between you and the computer determines whether you live or die.

In another scenario, you are a near-bankrupt shipping tycoon entertaining a Greek billionaire. He has just made a \$30 million offer for your company, but you know that in a day or so your company will be worth only \$10 million. I took great delight in fleecing that fellow for \$70 million.

Interactive Fiction seems to be a stylized Eliza or Dr Chips, both of which are programs that cause the computer to act as if it understands your input. While giving the illusion of intelligence, these scenarios actually have a smaller vocabulary than the most basic Adventures. For example, there's a story about a chance encounter in San Francisco. You're in a park and you stumble upon a pretty girl who has dropped her books. Her monosyllabic replies not only break the mood of the story, but sadly attest to the lack of intelligence in the program. Don't misunderstand me; these stories do have some redeeming qualities.

As in Eliza, the computer "psychiatrist," it is obvious that the program zeros in on individual words, ignoring

most of the input. The rest of the stories in the sampler are similarly disappointing in their lack of versatility; there are only a couple of ways each story can be played.

I suspect that Six Micro Stories is not an adequate showcase of the Interactive Fiction concept. The stories fall far short of what the computer community expects from Scott Adams. As a party mixer or novelty, this offering will fill the bill, but don't buy this package expecting the high-quality entertainment you've received from Adventure International in the past.

Six Micro Stories should be approached as a sampler. If you expect more, you are inviting disappointment. If you want to get into the heart of this new format, you had better get Local Call for Death or Two Heads of the Coin, two full-length titles in the Interactive Fiction product line. ■

### At a Glance

**Name**

Interactive Fiction: Six  
Micro Stories

**Type**

Adventure-type user-  
interactive game

**Manufacturer**

Adventure  
International  
POB 3435  
Longwood FL 32750  
(305) 862-6917

**Price**

\$15

**Format**

5-inch floppy disk

**Language**

Mixture of BASIC and  
machine code

**Computer**

Radio Shack TRS-80 Model  
I with one disk drive and  
32 K bytes of memory

**Documentation**

Several screens of informa-  
tion within the program

**Audience**

Adventure enthusiasts and  
people who like role-playing  
games

# THE ROBOT

BY TOM SLOAN

THERE! YOU ARE FINALLY FINISHED

NOW LETS SEE HOW YOU PERFORM UNDER THE ULTIMATE TEST.

WHAT'S THAT?

DO MY TAX RETURN.

SURE THING MASTER.

HMM... WHAT'S THIS!

YOU KNOW, IF YOU TAKE A DEDUCTION HERE AND PUT IT IN A TAX SHELTER OVER THERE AND DO THIS AND THAT... YOU CAN CUT YOUR TAX 29.26999%.

WOW! YOU'RE KIDDING!?

NO, ITS SIMPLE AS PI.

THAT GIVES ME AN IDEA.

TAXES BY METAL MAN

FAST, PROMPT, COURTEOUS!

STEP UP NOW, GET YOUR TAXES DONE!

OH BOY, IS BUSINESS GREAT!

..AND YOUR EARNED INCOME CREDIT IS EXACTLY \$54.9999...

NEAT-O

THANK YOU SIR, CALL AGAIN.

TOODLES

BOY MASTER, WE'RE REALLY CLEARING UP.

MAYBE NOW I CAN UPGRADE YOUR MEMORY TO 8K.

NOT SO FAST, I.R.S.

YOU'RE BROUGHT BEFORE THIS COURT ON CHARGES OF IMPROPER TAX RETURN PREPARATION.

YOUR HONOR, I CONTEND THAT THESE TWO KNOWINGLY AND DELIBERATELY MADE GROSS MATHEMATICAL ERRORS, LIKE  $1,200 - 50 = 1,149.999!$

999! WAIT A MINUTE! WHAT'S  $2+2$ ?

EASY, ITS 3.9999

YEE GADS YOUR HONOR! I MUST HAVE MIS-PROGRAMED HIS MATH FUNCTIONS.

I CAN UNDERSTAND THAT, BECAUSE I OFTEN HAVE THE SAME PROBLEM ON MY HOME BREW SYSTEM.

SO I FIND YOU NOT GUILTY UNDER THE CONDITION YOU DE-BUG THE ROBOT.

YOU GOT IT JUDGE WUDGEY!

READ ME THAT NEW LISTING. I'LL BURN IT INTO THE NEW EPROM.

```

0000 28      CLD
0001  A9 01  BIP  LDA $01
0003  80 02  76  STA $102
0006  20 81  FE  JMP $FE
0009  00 F6      BNE $1P
000B  21 ...
    
```

DONE. NOW ILL JUST PUT IT IN.

AND NOW THE TEST... WHAT'S  $2+2$ ?

MERE CHILDS PLAY. ITS 4.000001.

# DP/NET: Redefined

## INDIVIDUAL/NET

WORD PROCESSOR



S-100, 7 Slot, 360K Double Density

## DUAL/NET

SMALL BUSINESS  
APPLICATIONS



Up To 4 Terminals  
Can Be Slaved Off Master

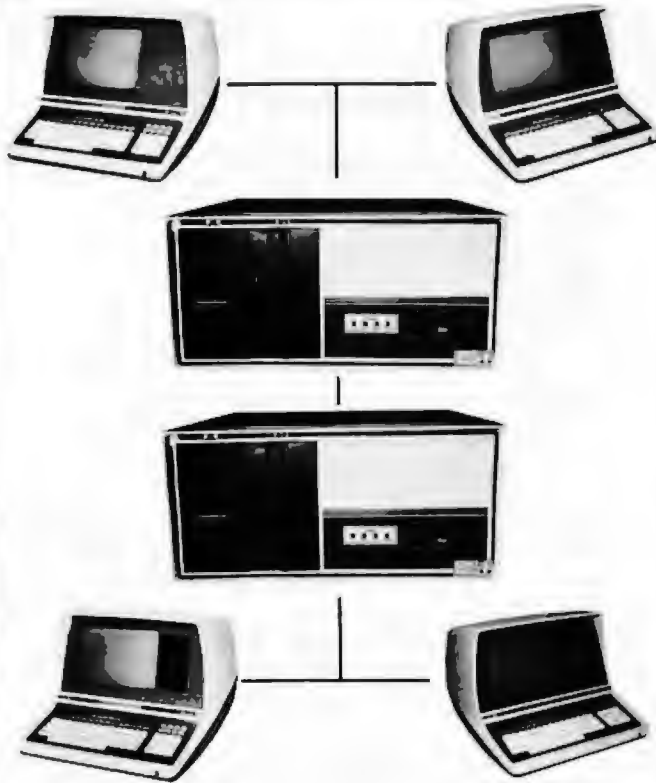

LOCAL/NET

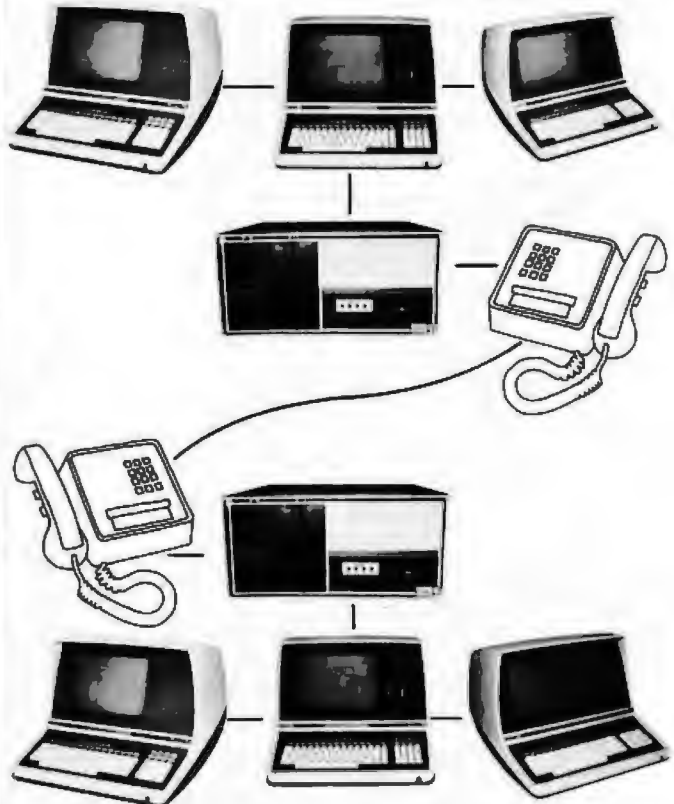

TELEPHONE/NET



# Configurability

## SYSTEM/NET

### LARGE SYSTEM NUCLEUS



Hard Disc and 8" Floppy  
Any Combination of Master or Slave

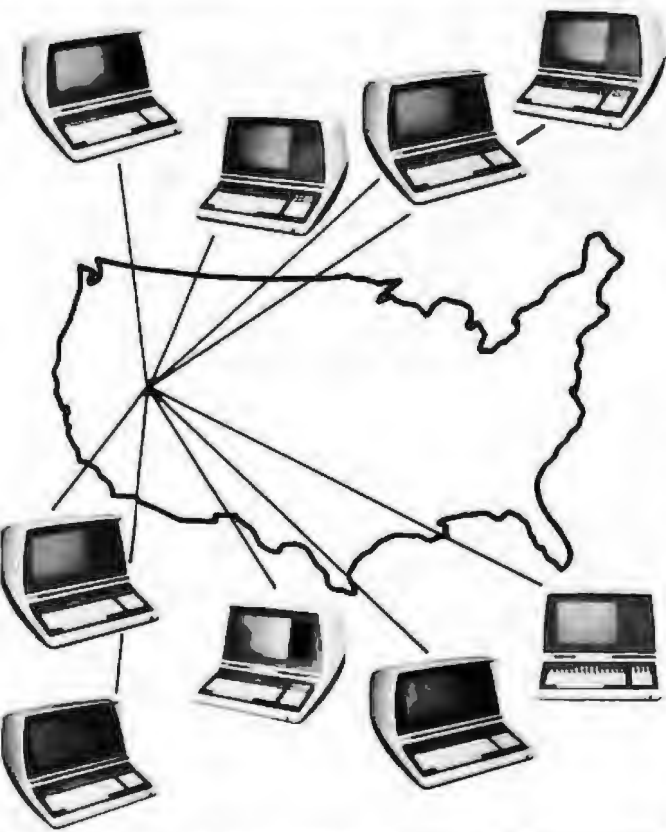

## MASTER/NET

## "BUY" WORD FOR THE 1980's

*NETWORKING* is the newest 'buzzword' in microprocessors. Delta Products has produced a superior hardware system that cannot be matched in either cost or performance.

Don't buy a system that has "designed-in" limitations; check the following:

### PERFORMANCE

This is where DP/NET® beats them all. Delta does multiuser and multitasking operations by using distributed processors. DIGITAL RESEARCH has provided a new operating system (CP/NET®) which combines MP/M® and CP/M 2.2® into the world's most powerful microcomputer system.

The system cannot be bogged down by adding more users. High-speed DMA transfers from Host to Slave, allow many processors to share workloads. (There can be 3 processors at EACH user terminal; a Z-80 for screen function, and a pair of 8085/8088 for main processing.)

### FLEXIBILITY

One of the most important advantages of DP/NET® is that you never have to purchase more system than you currently need. Your system can start with a 5" minifloppy 32K terminal for under \$3000.00. Adding a second terminal and additional mass storage is as simple as the original purchase. Networking up to 16 OR MORE intelligent and semi-intelligent work stations can follow in perfect step with the growth of your Company and requirements.

### COST

Since you never buy more computer power than you need, the system cost is matched to the demand to be placed upon it. DELTA PRODUCTS has a lot of experience in building micros, with over 2000 DELTA systems now in the field. DELTA component cost has always been extremely competitive. DELTA's new "networking system" is a natural and simple combination of the competitive "good deals" we have been offering for some time.

### SOFTWARE

A computer system to the end user IS THE SOFTWARE. All CP/M® compatible programs run perfectly on the DP/NET®. DELTA PRODUCTS is currently writing its' own high-performance custom data base, screen editor, order entry/inventory, and accounting packages in PL/1®. Target release date for the complete package is November, 1981.

**SOLD ONLY THROUGH DEALERSHIPS  
CALL FOR YOUR NEAREST REPRESENTATIVE**

**DELTA PRODUCTS**

15392 Assembly Lane  
Huntington Beach, CA 92649  
TELEPHONE: (714) 898-1492



TELEX: 681-367 DELTMAR HTBH

MP/M, CP/M 2, PL/1 & CP/NET ARE REG. TM OF DIGITAL RESEARCH INC.

# AMAZING VALUES...

<p><b>HEAD CLEANING KIT</b> <b>\$24<sup>95</sup></b> FOR 5 1/4" DRIVES</p>	<p>EPSON <b>MX-80 MX-80FT</b> —PRINTERS— CALL FOR PRICE</p>	<p>VERBATIM <b>DATALIFE DISKETTES</b> <b>\$26<sup>95</sup></b> BOX OF 10 SS, SS, 5 1/4"</p>
<p><b>"OTHER MYSTERIES" VOLUME I</b> <b>\$19<sup>95</sup></b></p>	<p>VERBATIM <b>FD34-8000 DISKETTES</b> <b>\$43<sup>95</sup></b> BOX OF 10 SS, SS, DD</p>	<p>PLAIN JANET™ <i>Gold</i> 5 1/4" <b>DISKETTES</b> <b>\$25<sup>95</sup></b> SS, SS, DD HUB RING</p>
<p><b>"OTHER MYSTERIES" VOL. II or VOL. III</b> <b>\$29<sup>95</sup></b></p>	<p><b>CABLE</b> <b>\$24<sup>95</sup></b> CONNECTS EPSON PRINTER &amp; TRS-80 MICRO</p>	<p>PLAIN JANET™ <b>DISKETTES</b> <b>\$21<sup>95</sup></b> BOX OF 10 SS, SS, 5 1/4"</p>
<p><b>DISKETTE FILE BOX</b> <b>\$29<sup>95</sup></b> HOLDS 50-60 8" DISKS</p>	<p><b>DISK DRIVE EXTENDER CABLE</b> <b>\$9<sup>95</sup></b> FOR VISTA, MTI, PERTEC, PERCOM &amp; OTHERS</p>	<p>DISKETTE <b>FILE BOX</b> <b>\$24<sup>95</sup></b> HOLDS 50-60 5 1/4" DISKS</p>
<p><b>TRI-STAR FLOPPY SAVER™ HUB RING KIT</b> <b>\$10<sup>95</sup></b> FOR 5 1/4" DISKS</p>		

FROM

**M** **ETATRONICS**  
CORPORATION

RETAIL STORE  
22297 EUCLID AVENUE  
EUCLID, OHIO 44117  
(EAST 222nd & EUCLID AVE.)

MOST ORDERS  
SHIPPED WITHIN  
ONE BUSINESS DAY



TO ORDER  
CALL TOLL FREE  
1-800-321-9390  
IN OHIO, call  
(216) 289-1210 (COLLECT)

OFFICES  
26111 BRUSH AVENUE  
EUCLID, OHIO 44132  
(SEND MAIL ORDERS HERE)

TRS-80 is a trademark of the  
Radio Shack Division of Tandy  
Corporation. PLAIN JANE is a  
Trademark of Meta Technologies  
Corporation.

PRICES IN EFFECT  
Sept. 1, 1981 THRU  
September 30, 1981.  
Prices, Specifications,  
and Offerings subject to change  
without notice.

\*Add \$3.00 for shipping & handling.  
\*\$3.00 EXTRA for C.O.D.  
\*Ohio residents add 5 1/2% sales  
tax.

© 1981 by Metatronics Corp.

# What's New?

## SYSTEMS

### The Stratos

The Stratos is a 4 MHz, Z80-based computer with 80 K bytes of programmable memory and 1.2 megabytes of floppy-disk storage (expandable to 5 megabytes). Stratos features a ROM (read-only memory) monitor, CP/M 2.2, the Spellbinder word-processing program, a CBASIC or a Pascal compiler, business and personal-reminder software, printer driver routines for most printers, and two RS-232C ports.

Additional features of the Stratos include a memory-mapped video controller, utilities that allow many combinations of disk drives and formats to be connected, a light pen, and an AC-controller port. The Stratos microcomputer is housed in a teakwood case. Contact Symbiotic Systems Inc, 118 Naglee Ave, Santa Cruz CA 95060, (408) 425-5533.

Circle 501 on Inquiry card.

### A Rair Thing Indeed

Inside Rair Microcomputer Corporation's Black Box 3/30 is a 5-megabyte Winchester hard disk and a dual-sided, double-density floppy-disk drive for backup. The Black Box 3/30 features either the CP/M or MP/M operating systems and an IEEE-488 bus with 64 K bytes of programmable memory and 16 programmable I/O (input/output) ports.

For applications and development, Rair offers BASIC, PL/I, FORTRAN, COBOL, and Pascal. The Black Box 3/30 costs \$7500. Contact Rair Microcomputer Corporation, 4101 Burton Dr, Santa Clara CA 95050, (408) 988-1790.

Circle 502 on Inquiry card.

### Tiny BASIC Computer Board

The K-8073 single-board computer features National's INS8073 Tiny BASIC Microinterpreter microprocessor. Features include serial communication data rates from 110 to 4800 bps (bits per second), a cassette-tape I/O (input/output), 8 K bytes of EPROM (erasable programmable read-only memory), 1 K of programmable memory with expansion to 8 K externally, STD bus structure, remote controller for single-wire data control from remote stations, and 24 bidirectional I/O lines. The board is supplied with a 2 K ROM (read-only memory) of development utilities and a real-time calendar/clock.

The K-8073 requires +5 V and costs \$388. Contact Transwave Corporation, RD 1 Box 489, Vanderbilt PA 15486, (412) 628-6303.

Circle 503 on Inquiry card.

### The LNW80 Microcomputer

The LNW80 microcomputer is software-compatible with the TRS-80. It includes a 4 MHz, Z80A microprocessor, high-resolution black-and-white and color graphics, 12 K bytes of ROM (read-only memory), 16 K bytes of programmable memory, upper- and lowercase display, reverse video, an RF (radio frequency) modulator, expansion bus, cassette interface, and power supply.

The LNW80 costs \$1664 with a black-and-white monitor and a single 5-inch floppy-disk drive, but it can be purchased without peripherals for \$1200. For details, contact LNW Research Corporation, 14661 C Myford Rd, Tustin CA 92680, (714) 544-5744.

Circle 504 on Inquiry card.

### Xerox 820 Microcomputer

The Xerox 820 microcomputer can be used as a word-processing system, a business computer, or both. The basic 820 system includes two RS-232C and two parallel ports, dual 5-inch floppy-disk drives each with a 92 K-byte unformatted capacity, a standard keyboard, and a 12-inch black-and-white video-display monitor with 24 lines by 80 characters.

The 820 features a Z80 microprocessor with 64 K bytes of programmable memory and 4 K bytes of ROM (read-only memory). The CP/M operating system and applications software, including CBASIC-2, COBOL 80, MBASIC, and word-processing programs, are available. A word-processing system utilizing WordStar and the SuperCalc electronic spreadsheet are available as options. It can be connected to the Ethernet communications network. The Xerox 820 costs \$2995 and is available from Xerox and authorized dealers. For further details, contact the Office Products Division, Xerox Corporation, 1341 W Mockingbird Ln, Dallas TX 75247.

Circle 505 on Inquiry card.

### Sierra 4000

The Sierra 4000 computer is an S-100, Z80-based computer that features dual floppy-disk drives and a hard disk. Together, these devices provide a total of up to 96 megabytes of storage. A two-drive hard-disk system is optional.

For more information, contact Sierra National Corporation, 5037 Ruffner St, San Diego CA 92111, (714) 277-4810.

Circle 506 on Inquiry card.

# What's New?

## SOFTWARE

### MP/M-86 Operating System

Digital Research's MP/M-86 is a multiuser operating system for 8086-based microcomputers. It is compatible with the CP/M-86 operating system and programs. MP/M-86 will support networking capabilities through CP/NET. It allows multiple users to execute programs with only one copy of the object code in main memory.

Other features of the MP/M-86 operating system are file and record lockout, standard input/output, and internal queue mechanisms that support mutual exclusion, pipes, synchronization and communication between

multiple tasks. Customized operating environments can be defined within the MP/M-86 structure. For more information, contact Digital Research Inc, POB 579, 801 Lighthouse Ave, Pacific Grove 93950, (405) 649-3896.

Circle 507 on inquiry card.

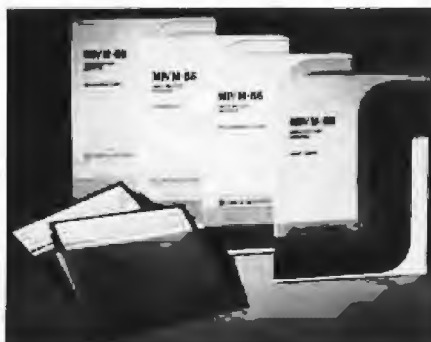

### New Personal Software Products

Personal Software has five new items in its product line: a new version of the VisiCalc business and planning program and four new VisiCalc-compatible programs. The new VisiCalc program includes a full implementation of a program-independent data-storage format called Data Interchange Format. It allows transfers of files between VisiCalc and other text and data programs regardless of format structure. An Edit command lets users edit formulas without retyping them. Also Boolean functions and the ability to choose specific elements in a list based on the results of another calculation are featured. The new VisiCalc costs \$199.95.

VisiPlot is a new VisiCalc-compatible program with high-resolution color plotting and graphics. It costs \$179.95. VisiDex is a personal-information system that can handle mailing lists and personal calendars. It costs \$199.95. VisiTrend/VisiPlot is a combination of VisiPlot graphics and a program for time-series manipulation, trend forecasting, and descriptive statistics. Its suggested price is \$259.95. Then, there is VisiTerm, which can send and receive files from the other Visi-programs over telephone lines to any other computer. VisiTerm is \$149.95.

For details, contact Personal Software Inc, 1330 Bordeaux Dr, Sunnyvale CA 94086, (408) 745-7841.

Circle 508 on inquiry card.

### Music Reader

Music Reader I shows you the notes while it plays the melody through the Apple II's speaker. You can learn to read treble and bass clefs, note values, time and key signatures, sharps and flats,

and complex rhythms because the program plays what you write. Music Reader I comes on a floppy disk and costs \$30. Contact Shafer Software, 749 W Fremont Ave, Sunnyvale CA 94087.

Circle 509 on inquiry card.

### Applesoft Compiler

The Hayden Book Company's Applesoft compiler can increase a BASIC program's speed as much as ten times and occupies only 3.2 K bytes of memory. The 17-pass compiler generates true machine code. High-resolution graphics and shape tables are supported, and multiple programs can reside in memory at the same time.

Hayden's Applesoft compiler requires a 48 K-byte Apple II Plus or Apple II with Applesoft in ROM (read-only memory), the Auto-start ROM, and at least one floppy-disk drive. The compiler can be used with multiple- and hard-disk drives, and it can work on systems using the Apple Language Card or Microsoft RAM-Card. The compiler costs \$200. Contact Hayden Book Company Inc, 50 Essex St, Rochelle Park NJ 07662, (201) 843-0550.

Circle 510 on inquiry card.

### Air Combat Game

The Computer Air Combat game recreates World War II aerial combat. The player(s) choose from thirty-six fighters or bombers. Each plane is rated in historical accuracy and detail for firepower, speed, maneuverability, damage-tolerance, and climbing and diving ability. Five scenarios are provided to refight actual combat engagements.

Computer Air Combat includes a rule book, two map-board charts, and three player-aid charts. The game is available for 48 K-byte Apple IIs with Applesoft in read-only memory and a floppy-disk drive. It costs \$59.95. Contact Strategic Simulations Inc, 465 Fairchild Dr, Suite 108, Mountain View CA 94043, (415) 964-1353.

Circle 511 on inquiry card.

# What's New?

## SOFTWARE

### Language for Education—TI Logo

TI Logo was designed for the TI-99/4 microcomputer. It is the end result of collaboration between Texas Instruments and the Massachusetts Institute of Technology. TI Logo has been tested in schools in New York City and Dallas, Texas, with students ranging from nursery school through the twelfth grade.

TI Logo is structured so that children can successfully use the computer with little formal instruction. Students can draw geometric figures and designs and program the movement of special graphics figures. To work with the language, students must teach the computer what to do, which makes learning with TI Logo an interactive process rather than a feedback situation. Using TI Logo, students make on-the-spot judgments as to whether their approach to a problem is effective.



A TI Logo set-up requires the software and a TI-99/4 computer with a video display, floppy-disk drive and controller, and a memory-expansion unit. TI Logo software costs \$299.95. For more in-

formation, contact the Customer Relations Department, Texas Instruments Inc., POB 53, Lubbock TX 79408.

Circle 512 on Inquiry card.

### The MDBS-QRS

The MDBS-QRS add-on lets nonprogrammers interrogate any Micro Data Base Systems data base using English-like commands. Utilities defining macroinstructions are included. Titles and synonyms for the various database entities can be defined. A report generated in response to a query can be displayed in a standard or customized format using the Report Writer feature. String comparisons are allowed, and an optional conditional clause can be included for highly selective data retrieval. Existing data values can be modified. It is available for \$300 from Micro Data Base Systems Inc., POB 248, Lafayette IN 47902, (317) 448-1616.

Circle 513 on Inquiry card.

### CP/M Cross-Assemblers

Avocet Systems's XASM family of cross-assemblers can now run on 8080 and Z80-based microcomputers under CP/M and similar operating systems. Pseudo-operation codes support nested conditional assembly, listing-format control, definition of mnemonic synonyms, and the inclusion of external source files. The assemblers generate object files in the Intel HEX format.

Other members of the XASM family of cross-assemblers are designed for 6805, 6801, 1802, 6502, 6800, COP400, and other microprocessors. Each XASM cross-assembler costs \$200; manuals cost \$25. Contact Avocet Systems Inc., 804 S State St, Dover DE 19901, (302) 734-0151.

Circle 514 on Inquiry card.

### Music and Animation Program

Rainbow Writer is a graphics, text, music, and animation program that runs on the Apple II and the Apple II Plus computers. It can create special effects that feature color, animation, letters, shapes, and sounds. The program lets users define character fonts and choose between nine sizes and nineteen different colors of upper- and lowercase English and Greek letters. Musically, the program offers six chromatic octaves and note sustain. Music data can be stored on disk.

The suggested retail price is \$39.95. For details, contact Personal Software Inc., 1330 Bordeaux Dr, Sunnyvale CA 94086, (408) 745-7841.

Circle 515 on Inquiry card.

# What's New?

## PUBLICATIONS

### Evaluation of Educational Programs

**School MicroWare Reviews** contains user evaluations of instructional programs and packages for the Apple, PET, and TRS-80 microcomputers. Each edition includes an index to evaluations in other publications. The reviews are organized by school department and within that by subject. Each review contains comments about the quality of the documentation, the instructions to users given by the programs, the student-computer dialogue, and other concerns. The evaluation includes the producer, price, hardware configuration, storage medium, program type, grade level, and functional description. **School MicroWare Reviews** costs \$30 per edition.

Also available is the **School MicroWare Directory**. A subscription to it costs \$20 per year. It contains descriptions of over 900 programs. If you are a directory subscriber and provide a courseware evaluation that follows a form provided by the publishers, you can receive **Reviews** free if your evaluation is published. Nondirectory subscribers whose material is published receive **Reviews** at half price. Contact Dresden Associates, POB 246, Department BY-1, Dresden ME 04342, (207) 737-4466.

Circle 516 on Inquiry card.

### Literature on Computer Science and Technology

The United States Government Printing Office has books and manuals on computer-related subjects for sale. For information on titles and ordering, contact the Superintendent of Documents, US Government Printing Office, Washington DC 20402.

Circle 517 on Inquiry card.

### Microsoft Catalog

Microsoft Consumer Products has a new catalog that describes all of the software products it produces and sells. The free catalog is available at Microsoft dealers or by contacting the company at 400 108th Ave, NE, Suite 200, Bellevue WA 98004, (206) 454-1315.

Circle 518 on Inquiry card.

### Structured Requirements Definition

**Structured Requirements Definition**, by Ken Orr, covers recent advances in systems theory, tools, and methodology. The book is written for analysts, programmers, managers, and users. It is available for \$25 from Ken Orr and Associates Inc, 715 E 8th, Topeka KS 66607, (800) 255-2459; in Kansas (913) 233-2349.

Circle 519 on Inquiry card.

### Courseware Evaluation Guidelines

**Guidelines for Evaluating Computerized Instructional Materials** is a guide for buying and selling instructional software. Previous programming experience is not assumed in this book for users and creators of educational computer software. Divisions within the guide explain ways to determine what sort of software is needed, how to look for it, and minor modifications that can be made.

**Guidelines for Evaluating Computerized Instructional Materials** costs \$3.75. Contact the National Council of Teachers of Mathematics, 1906 Association Dr, Reston VA 22091, (703) 620-9840.

Circle 520 on Inquiry card.

### FORTH Beginner's Book

**Starting FORTH** is for novice FORTH programmers. It embraces such topics as defining words, compiling words, vectored execution, virtual memory, and number-scaling techniques. Many programming examples and illustrations are featured. The book is published by Prentice-Hall Inc. For more information, contact FORTH Inc, 2309 Pacific Coast Hwy, Hermosa Beach CA 90254, (213) 372-8493.

Circle 521 on Inquiry card.

### DEC LSI/PDP-11 Systems Catalog

A catalog featuring DEC (Digital Equipment Corporation) LSI/PDP-11 computer systems, peripheral equipment, and software is available from Compumart Corporation. Compumart distributes equipment and systems from DEC and peripherals from other major manufacturers. For your copy, contact Compumart Corporation, 65 Bent St, POB 568, Cambridge MA 02139, (617) 491-2700.

Circle 522 on Inquiry card.

### Software Protection

The legal protection of computer software is examined in **Computers, Copyright and the Law**. This report was developed to help software authors make decisions about protecting their product's proprietary rights. The report encompasses the theories behind software protection, but it emphasizes protection methods and their relationship to software sales, leasing, and licensing. Contact Educational Programming Systems, 1328 Baur Blvd, St Louis MO 63132, (314) 991-0300.

Circle 523 on Inquiry card.

# What's New?

## PUBLICATIONS



### International Software Directory

The International Microcomputer Software Directory is a reference source of new and established software for all applications and systems. The directory is divided into sections listing programs for specific computers, describing categories of programs, and a section for users wishing to buy from a particular software house. Programs are cross-referenced throughout the sections. Details as to date of release, warranties, distributors, medium, source code, compatible systems, special configurations needed, limitations, and prices are all provided.

The directory is available for \$29; updates are available every six months. System-specific directories that are extracted and cross-referenced from the main data base are available for \$12. These directories list programs written for the Apple, TRS-80, and PET computers, and the CP/M operating system. The directory is available from Imprint Software, 420 S Howes, Fort Collins CO 80521, (303) 482-5574. In England, contact Imprint Software, 16 Milton Ave, Highgate, London, N6.

Circle 524 on inquiry card.

### 600 Microprocessors Cross-Referenced

The Microprocessor IC D.A.T.A. Book lists characteristics of over 5000 integrated circuits, including over 600 microprocessors and associated programmable and read-only memory devices, interface-support circuits, processor architecture, and manufacturer software support. Processors are cross-referenced by generic numbers, technical characteristics, logic, block drawings, instruction sets, outline drawings, and manufacturers. The book is published twice a year. The subscription rate is \$55 per year. Contact D.A.T.A. Inc, POB 26875-PR, San Diego CA 92126, (800) 854-7030; in California (714) 578-7600.

Circle 525 on inquiry card.

### Computer Music Journal

A special two-part issue of *Computer Music Journal*, a quarterly from MIT Press, surveys the applications of artificial intelligence to music. Articles deal with devices that will be capable of listening to, understanding and playing music, and reports on research underway that hopes to explain human musical cognition. Other topics include the use of the computer as an assistant for musical-score analysis and composition, automatic music transcription from sound to score, multilevel graphic representation of scores and sound in natural languages, intelligent music instruments, new theories of music, and an introduction to LISP.

A subscription to the *Computer Music Journal* costs \$25 per year. Contact the MIT Press, 28 Carleton St, Cambridge MA 02142, (617) 253-2889.

Circle 526 on inquiry card.

### Software Vendor Directory

The fourth edition of the *Software Vendor Directory* contains 1001 software vendors, 4195 products, and 80 hardware and 200 software categories. The directory costs \$57.95. Optionally, the directory can be purchased for \$100, which includes two updates at six-month intervals. A single update costs \$25. Also, a CP/M disk version is available for \$78. Contact Micro-Serve Inc, 250 Cedar Hill Ave, Nyack NY 10960, (914) 358-1340.

Circle 527 on inquiry card.

### Guide to Published Material on Computers

*Bookguide 1: Microprocessors and Microcomputers* covers publications that describe the concepts, applications, and potential of microprocessor devices. It lists authors, abstracts, publishers, and prices for nearly 500 titles from 39 publishers. Books on more than 50 topics ranging from histories to dictionaries, microcomputer architecture, programming techniques, personal computers, and artificial intelligence, are listed. *Bookguide 1* is available for \$11.50 from Leatherleaf Book Services Inc, POB 28, Pembina ND 58271.

Circle 528 on inquiry card.

### Books for the Apple

*MICRO/Apple 1* is the first volume of a series of books that will contain articles from *Micro, The 6502 Journal*. The articles contain Apple program listings, which are on a floppy disk that accompanies the book. *MICRO/Apple 1* costs \$24.95, including the disk. Contact Micro Ink Inc, POB 6502, Chelmsford MA 01824.

Circle 529 on inquiry card.

# What's New?

## PERIPHERALS

### Connect an Olympia ES100 to a Microcomputer

Using the Ren Tec RS-232C interface, the Olympia ES100 typewriter can provide letter-quality printing and still function as a standard typewriter. The Ren Tec RS-232C uses CMOS (complementary metal-oxide semiconductor) logic. It accepts an RS-232C serial or a parallel interface; accommodates odd, even, or no parity; features handshake logic; and also provides any character-translation format.

The Ren Tec ES costs \$295. For additional details, contact Renaissance Technology Corporation, 3347 Vincent Rd, Pleasant Hill CA 94532, (415) 930-7707.

Circle 530 on inquiry card.

### Color Printer for the Apple

The OmniColor II is a color-ink jet printer with a 16 K- or 32 K-byte buffer. Intended for the Apple II, software for 3.3 DOS is included. The OmniColor II uses eight colors, prints at 40 cps (characters per second), and can

print paper up to 13 inches wide, as well as print overlay pages and screens. It features normal or expanded print and the ability to dot-plot any section of memory. Contact Omnicolor Computer Corporation, 3300 Buckeye Rd, Atlanta GA 30341, (404) 455-8460.

Circle 532 on inquiry card.

### Double Your Graphics Capability

The Double Hi-Res card provides two levels of grey scale and can display 80 columns by 24 lines. It is designed for the Apple II or III and is compatible with the Apple III's super-high-resolution graphics. Character sets can be defined with the Define Font program supplied. The Double Hi-Res features italics, underline, multiple-character sets as well as

graphics on the same screen, proportional spacing, mathematics symbols, and APL- and Japanese-character sets. Multiple-character sets can reside in memory simultaneously.

The price for the Double Hi-Res card and support software on a floppy disk is \$295. Contact Spies Laboratories, POB 336, Lawndale CA 90260, (213) 644-0056.

Circle 533 on inquiry card.

### The Rhythm Box

The Rhythm Box synthesizes bass and snare drums, wood blocks, short and long cymbals, hand claps, and tom-toms. It is programmable in Level II BASIC or assembly language. The unit has a phono jack for connection to an audio system, a power supply, a manual including BASIC and assembly-language software examples, and a selection of rhythm charts. The Model RBX-T for the TRS-80 Model I Level II is available for \$149.

The Model RBX-S is for S-100, Apple II, PET, and other systems. It connects to 9600 bps (bit per second) serial interfaces using either RS232C or 20 mA current-loop levels. It costs \$179. For more information, contact Newtech Computer Systems Inc, 230 Clinton St, Brooklyn NY 11201, (212) 625-6220.

Circle 531 on inquiry card.

### Thin Floppy-Disk Drives

The Thinline 8-inch floppy-disk drives are 5.9 cm (2 3/16 inches) high and weigh 7 pounds. These double-sided head drives can be turned on and off by control signals from the interface. Head positioning is accomplished by a band-driven carriage. The door arrangement has been simplified by using a lever that closes and positions the disk in the drive. The Thinline drives record at 48 and 96 tracks per inch.

There are two models available. The TM 848-1 stores 600 K bytes on one side of a disk and TM 848-2 stores 1.2 megabytes on both sides. The drives can be used in single- and double-density applications. For more information, contact Tandon Corporation, 20320 Prairie St, Chatsworth CA 91311, (213) 993-6644.

Circle 543 on inquiry card.

### 11 by 11 Digitizer

The Demi-Pad is an 11- by 11-inch digitizer tablet featuring a 200-sample-per-second rate. It includes a Z80-based interface, which provides RS-232C ASCII (American Standard Code for Information Interchange) or binary-coded data, and 0.001-inch resolution. The Demi-Pad comes

with a pen or stylus cursor.

Options include a power supply, 16-button stylus or crosswire cursor, X Y display, and an ASCII keyboard. Priced at \$990, the Demi-Pad is available from GTCO Corporation, 1055 First St, Rockville MD 20850, (301) 279-9550.

Circle 534 on inquiry card.



# What's New?

## MISCELLANEOUS

### 5-Inch Drives for the TRS-80 Model III

Percom Data Company has 5-inch floppy-disk drives for the TRS-80 Model III. Systems can be ordered with either 40- or 80-track drives rated for double- and single-density operation. The first two drives mount inside the computer; the others mount externally. The first internal drive comes with a four-drive controller, a two-drive power supply, cables, a double-density disk operating system, and mounting hardware.

The four-drive controller features data-separation and write-precompensation circuitry. It is capable of handling two-headed drives and single-density 8-inch drives. The computer can use the Model III's disk operating system or Percom's OS-80/III. The first internal drive sells for \$749.95 in the 40-track version and \$914.95 in the 80-track version.

The second internal drive in-



cludes the drive mechanism, electronics, and installation hardware. It costs \$315 in the 40-track version and \$474.95 in the 80-track version.

Single external 40-track drives are \$439, and the dual 40-track drives are \$878. Cables for the ex-

ternal drives are \$29.95. For details, contact Percom Data Company Inc, 211 N Kirby, Garland TX 75042, (800) 527-1592; in Texas, (214) 272-3421.

Circle 535 on Inquiry card.



### Speech Processor

The Mimic speech processor converts speech to digital data and reconstructs the digital representation to analog form for reproduction through a speaker. The system can be used for digital speech-communications applications without a computer. The speech data rate is user-selectable, with speech reproduced at rates from 9600 to 20,000 bps [bits per second].

There are four versions of the

Mimic speech processor: a \$20 bare board, an assembled and tested module for \$79, a \$149 system configured for parallel-port interfacing, and a TRS-80-compatible plug-in version for \$169. Documentation, including program examples and schematics for an S-100 bus interface, is also available. Contact Mimic Electronics Company, POB 921, Acton MA 01720.

Circle 536 on Inquiry card.

### Small-Systems Software and Services Sourcebook

Small Systems Software and Services Sourcebook lists and cross-indexes software and services available to users of mini- and microcomputers in business,

professions, and government. Entries include software and service listings related to system software, application software, and consulting and services in medical, business, investment, modeling, and other applications. The

book has some marketplace listings and display advertising. For more information, contact Information Sources Inc, 1807 Glenview Rd, Glenview IL 60025, (312) 724-9285.

Circle 537 on Inquiry card.

# What's New?

## MISCELLANEOUS

### Buy and Sell

Horsetrader is a publication for buyers and sellers of computer equipment. It features used, new, and rebuilt computers, terminals, printers, and other items. For information on ad or subscription rates, contact Horsetrader, POB 11712, Santa Ana CA 92711, (714) 832-0628.

Circle 538 on inquiry card.

### Book Catalog

Telecom Library's 1981 catalog contains more than 300 titles of books, periodicals, training manuals, and audio cassettes for information professionals. The catalog features books on telecommunications management, data communications, data processing, computer programming, office automation, word processing, teleconferencing, satellites, and cable television. The catalog is free from Telecom Library Inc, 205 W 19th St, New York NY 10011, (212) 691-8215.

Circle 539 on inquiry card.

### CBASIC Program Directory

Compiler Systems Inc has published a directory listing 157 business-application programs as well as vertical-market packages written in CBASIC available from 30 software vendors. The CBASIC Software Directory provides a description of each program, its memory requirements, and the vendor's name, address, and telephone number. Unless noted, all products support CP/M and MP/M and require at least one floppy-disk drive. The directory is available for \$14.95 from Compiler Systems Inc, 37 N Auburn Ave, POB 145, Sierra Madre CA 91024, (213) 355-1063.

Circle 540 on inquiry card.

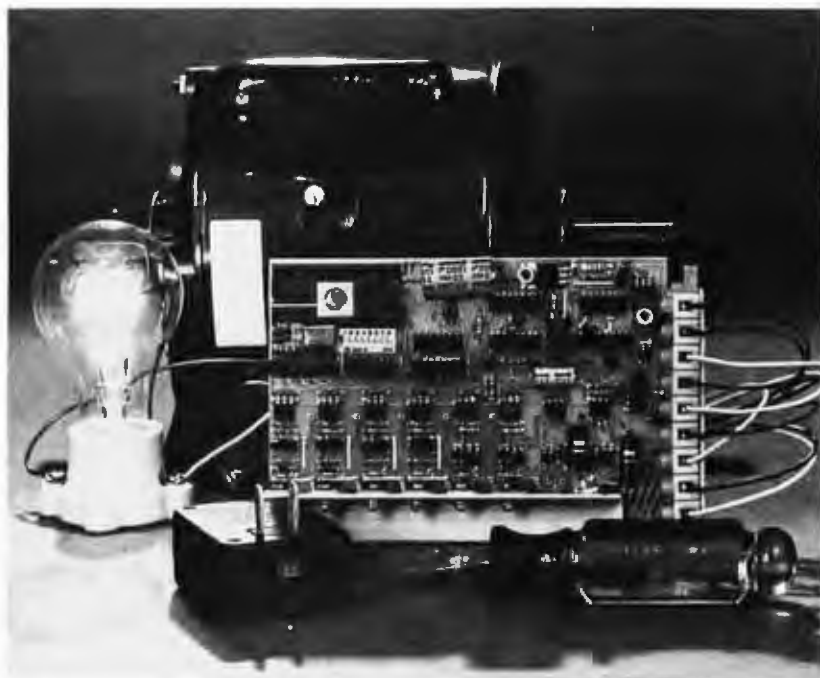

### Single-Board Computer

A single-board computer with analog, serial, and power-control I/O (input/output) has been announced by Wintek. The board features a 6801 or 68701 microprocessor with 2 K bytes of ROM (read-only memory), 128 bytes of programmable memory, and an internal and an external timer. The 12-bit A/D (analog-to-digital) converter can be configured for eight single-ended or four differential inputs. The eight digital I/O lines can be configured for

any mix of AC or DC inputs or outputs. The serial I/O allows half-duplex 20 mA current-loop communication to a host computer at software-selectable rates.

The prices range from \$88 to \$295, depending on options and quantity. Applications include remote data acquisition, machinery control, and energy management. Contact Wintek Corporation, 1801 South St, Lafayette IN 47904, (317) 742-8428.

Circle 541 on inquiry card.

### Software for the Atari

Personal Software has introduced MicroChess and Checker King for the Atari 400 and 800 microcomputers. Both games feature an on-screen, real-time clock for game timing. The games require 8 K bytes of memory and are priced at \$19.95 each, on cassette.

The MicroChess program turns a color-display screen into a chessboard. It has eight selectable

levels of play, plays by tournament rules, and allows no illegal moves.

Checker King allows single, double, and triple jumps, forces jumps, and performs according to the tournament rules of checkers. For details, contact Personal Software Inc, 1330 Bordeaux Dr, Sunnyvale CA 94086, (408) 745-7841.

Circle 542 on inquiry card.

### A-D & D-A CONVERTER

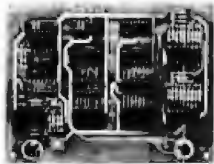

JBE one channel A-D & D-A Converter can be used with any system having parallel ports • Interfaces with JBE Parallel I/O Card • D-A conversion time — 5  $\mu$ s • A-D conversion time — 20  $\mu$ s • Uses JBE 5V power supply • Parallel inputs & outputs include 8 data bits, strobe lines & latches • Analog inputs & outputs are medium impedance 0 to 5 volt range.

79-287 ASSM. \$79.95  
Bare Board \$39.95 Kit \$59.95

### 6502 MICROCOMPUTER

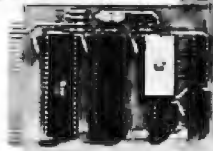

JBE's 4 1/2" x 3 1/4" dedicated controller features: • 1024 bytes RAM (two 2114s) • 2048 bytes EPROM (2716) • Uses one 6522 VIA (comp. doc. incl.) • Interfaces with JBE Solid State Switches & A-D & D-A Converter • Uses JBE 5V power supply • 2716 EPROM available separately (2716 can be programmed with an Apple II & JBE EPROM Programmer & Parallel Interface) • 50 pin connector included in kit & assm.

80-153 ASSM. \$110.95  
Bare Board \$49.95 Kit \$89.95

### SOLID STATE SWITCH



Your computer can control power to your printer, lights, stereo & any 120VAC appliances up to 720 watts (6 amps at 120VAC). Input 3 to 15VDC • 2-14MA TTL compatible • Isolation — 1500V • Non zero crossing • Comes in 1 or 4 channel version.

79-282-1 ASSM. \$13.95  
Bare Board \$6.95 Kit \$10.95  
79-282-4 ASSM. \$49.95  
Bare Board \$24.95 Kit \$39.95

### APPLE II DISPLAY BOARD



80-144 ASSM. \$49.95  
Bare Board \$25.95 Kit \$42.95

• Has run-stop, single step switch • Has 16 address LEDs, 8 data LEDs & 1 RDY LED • All lines are buffered.

### Z80 MICROCOMPUTER

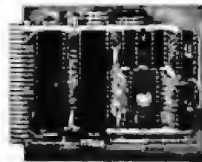

JBE's 4-1/8" x 3-1/4" single board dedicated computer is designed for control functions. It features: • A Z80 Microprocessor software compatible with the Z80, 8080 & 8085 Microprocessors • Uses a Z80 PIO chip for I/O which has 2 independent 8 bit bidirectional peripheral interface ports with handshake & data transfer control • Uses one 2716 EPROM (2K) & two 2114 RAM memories (1K) • Single 5V power supply at 300MA req. • Clock frequency is 2MHz, RC controlled • Board comes with complete doc. • 50 pin connector is included • 2716 EPROM available separately.

80-280 ASSM. \$129.95  
Bare Board \$49.95 Kit \$119.95

### PRINTER INTERFACE

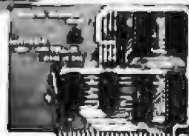

JBE Parallel Printer Interface interfaces your Apple II® to Centronics® compatible printers. This 3" x 4" board features: on board ROM compatible with Integer Basic, Applesoft® and Pascal® • Flat one 8 bit parallel latched output port with selectable positive or negative strobe and one bit input selectable for Ready or Ready • Cable and Connectors available separately.

80-297 ASSM. \$79.95  
Kit \$69.95  
4 ft. Std. Dip Jumpers 16 pin \$ 4.25  
Champ Connector \$ 8.95

### POWER SUPPLIES

• Use wall transformers for safety • Protected against short circuit and thermal breakdown.

#### 5 VOLT POWER SUPPLY

Rated at 5V 500MA • Operates JBE A-D & D-A Converter, Z80 & 6502 Microcomputers, 8085 & 8088 Microcomputers.

80-160 ASSM. \$20.95  
Bare Board \$16.85 Kit \$16.85

#### ± 12 VOLT POWER SUPPLY

Rated at ± 12V 120MA • Can be used as a single 24V power supply • Ideally suited to OP-AMP experiments.

80-161 ASSM. \$22.95  
Bare Board \$8.95 Kit \$18.95

### ICS

6502 \$9.95  
6522 \$9.95  
Z80 CPU \$9.95  
Z80 PIO \$9.95  
2716 \$14.95  
2716 Programmed \$19.95

### 6522 APPLE II INTERFACE

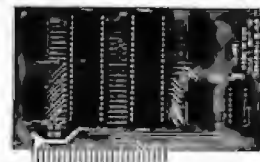

• Interfaces printers, synthesizers, keyboards, JBE A-D & D-A Converter & Solid State Switches • Has handshaking logic, two 6522 VIAs & a 74LS05 for timing • Inputs & outputs are TTL compatible.

79-295 ASSM. \$69.95  
Bare Board \$39.95 Kit \$59.95

### 2716 EPROM PROGRAMMER

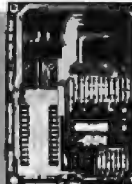

JBE 2716 EPROM Programmer was designed to program 5V 2716 EPROMS • It can also read 2716s. It interfaces to the Apple II using JBE Parallel I/O Card & four ribbon cable connectors • An LED indicates when power is being applied to the EPROM

• A textool zero insertion force socket is used for the EPROM • Comes with complete doc. for writing and reading in the Apple II or Apple II+ • Cables available separately.

80-244 ASSM. \$49.95  
Bare Board \$24.95 Kit \$39.95  
2 FL Ribbon Cable \$ 4.25

### BARE BOARDS

#### APPLE II EXTENDER BOARD

3 1/2" x 2 1/2". Price includes 50 pin Connector.

80-143 \$12.95

#### 8085 3 CHIP SYSTEM

State-of-the-art system using an 8085, 8156 & either an 8355 or 8755 • Instruction set 100% upward compatible with 8080A.

Bare Board \$24.95

#### 8088 5 CHIP SYSTEM

An 8086 family microcomputer system using an 8088 CPU, 8284, 8155, 8755A & an 8185.

Bare Board \$29.95

#### CRT CONTROLLER

This intelligent CRT Controller uses an 8085A CPU & an 8275 Integrated CRT Controller. It features: • 25 lines (80 Char./line) • 5x7 dot matrix • Upper & lower case • two 2716s (controller & char. generator) • serial interface RS232 & TTL • baud rates of 110, 150, 300, 600, 1200, 2400, 4800 & 9600 • keyboard scanning system • unencoded keyboard is req'd • uses +5V & ± 12V power supplies • Doc. includes program listing & composite video circuit.

Bare Board only (Doc. incl.) \$39.95  
Programmed 2716s each \$19.95



# JOHN BELL ENGINEERING, INC.

ALL PRODUCTS ARE AVAILABLE FROM JOHN BELL ENGINEERING • P.O. BOX 338  
REDWOOD CITY, CA 94064 • ADD SALES TAX IN CALIFORNIA • ADD 5% SHIPPING & HANDLING  
(415) 387-1137 10% OUTSIDE U.S.A.

MC

VISA

# What's New?

## MISCELLANEOUS



### Piggybacked Prototyping Boards

Circbords are perforated prototyping boards that can add 24 square inches of working area and 20 to 60 DIP (dual-inline package) positions when mounted on spacers, piggyback-style, on edge connector boards. Circbords can also be installed using card guides or in aluminum extrusions.

The Model 8001 is designed for solder connections. It holds up to twenty 16-pin integrated circuits. The Model 8002, for wrapped wire, can hold up to thirty-five 16-pin DIPs. On the 8003 model, up to sixty 16-pin DIPs, or any combination of devices, can be attached using solder or wire-wrap. Each Circbord costs \$9.95. Contact Vector Electronic Company, 12460 Gladstone Ave, Sylmar CA 91342, (213) 365-9661.

Circle 545 on Inquiry card.

### Compact Fluorescent Display Panel

The iron square-format DM128X128C 128 by 128 dot matrix display panel is slightly over 76.6 by 76.55 mm square (3 inches) and only 20 mm (0.8 inch) thick. It is capable of displaying special symbols, geometric patterns, graphics, block and curvilinear alphanumeric, continuously

scrolling images, and lighted areas. Each dot is individually addressable, and ascenders and descenders, script lettering, linear graphics, and charts can be produced. For more information, contact Nortake Electronics Inc, 22410 Hawthorne Blvd, Torrance CA 90505, (213) 373-6704.

Circle 544 on Inquiry card.

### 16 K-Byte ROM from OKI

OKI Semiconductor Inc has introduced an NMOS (n-type metal-oxide semiconductor), 128 K-bit ROM (read-only memory). The MSM-38128 is organized as 16 K bytes by 8 bits. It has a 450 ns maximum access time, operates off a single +5 V supply, and features a 120 mA supply current in the operating mode and 20 mA current in standby. Compatible with the 128 K-bit 2364 ROM from Intel, the MSM 38128 features power-down state and is nonclocked. All inputs and outputs are TTL (transistor-transistor logic) compatible.

For information, contact the company at 1333 Lawrence Expy, Suite 401, Santa Clara CA 95051, (408) 984-4842.

Circle 548 on Inquiry card.

#### Where Do New Products Items Come From?

The information printed in the new products pages of BYTE is obtained from "new product" or "press release" copy sent by the promoters of new products. If in our judgment the information might be of interest to the personal computing experimenters and homebrewers who read BYTE, we print it in some form. We openly solicit releases and photos from manufacturers and suppliers to this marketplace. The information is printed more or less as a first-in first-out queue, subject to occasional priority modifications. While we would not knowingly print untrue or inaccurate data, or data from unreliable companies, our capacity to evaluate the products and companies appearing in the "What's New?" feature is necessarily limited. We therefore cannot be responsible for product quality or company performance.

# THE STAR MODEM

From Livermore Data Systems



RS232 MODEM SALE \$128  
 IEEE 488 MODEM SALE \$199  
 RS232 CCITT \$170  
 IEEE 488 CCITT \$280

STAR Modem is the price performance leader with a full 2 YEAR FACTORY WARRANTY.

## We carry Apple II+ from Bell & Howell



REVERSAL (Spracklen) 32K Apple 28.00  
 Super FORTH 48K Apple 40.00  
 Energy Miser for PET, Apple, or Zenith 24.50  
 Data Manager (Lutus) 24K Apple 40.00  
 Histo-Graph (Boyd) 48K Apple 24.50  
 Data-Graph (Boyd) 48K Apple 40.00  
 Apple II User's Guide (Osborne) 12.00  
 Introduction to Pascal (Sybex) 10.30  
 Pascal Handbook (Sybex) 12.00  
 Graphics Cookbook for Apple 9.90  
 Musical Applications of Micros (Chambeylin) 20.00  
 Basic FORTRAN (Coan) 7.25

**PROGRAM YOUR OWN EPROMS**  
 Branding Iron for PET/CBM \$79  
 EPROM Programmer with software for all ROM versions. Includes all necessary hardware and software to program or copy 2716 and 2532 EPROMS.

**Paper-Mate Word Processor \$39.95**  
 PET/CBM full featured 60 command system by Michael Riley. Uses either tape or disk and any printer. Includes in-text commands, floating cursor, scrolling, etc.

**FLEX-FILE Data Base for CBM/PET \$60**  
 Random file handling system with Report Writer and Mail Label Handler. By Michael Riley.

6502	7.45	10/6.95	50/6.55	100/6.15
6502A	8.40	10/7.95	50/7.35	100/6.90
6520 PIA	5.15	10/4.90	50/4.45	100/4.15
6522 VIA	6.45	10/6.10	50/5.75	100/5.45
6532	7.80	10/7.40	50/7.00	100/6.60
2114-L200 ns RAM	3.75	25/3.50	100/3.25	
2114-L300 ns RAM	3.15	25/2.90	100/2.65	
2716 EPROM	7.75	5/7.45	10/6.90	
2532 EPROM			17.00	
4116 200ns			8 for \$20	
S-100 Wire Wrap			2.85	
Zero Insertion Force 24 pin Socket			\$2.00	

**CASSETTES - AGFA PE-611 PREMIUM**  
 High output, low noise, 5 screw housing, labels.  
 C-10 10/5.85 50/25.00 100/48.00  
 C-30 10/7.30 50/34.00 100/66.00  
 All other lengths available. Write for price list.

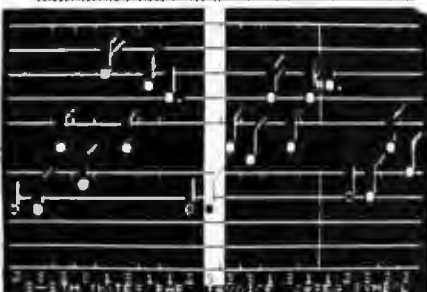

**4 PART HARMONY MUSIC SYSTEM for PET**  
 The Visible Music Monitor, by Frank Levinson, allows you to easily enter, display, edit, and play 4 part harmony music. Includes whole notes thru 64ths (with dotted and triplets), tempo change, key signature, transpose, etc. The KL-4M unit includes D to A converter and amplifier (add your own speaker).  
 KL-4M Music Board with VMM Program \$59.90

**KMMM Pascal for PET \$75**  
 Subset of standard Pascal with (true machine language translator for faster execution 16K with tape or disk.

**EARL for PET (disk file based) \$65**  
 Editor, Assembler, Relocator, Linker to generate relocatable object code.

**FORTH for PET/CBM or Apple \$65**  
 A full-featured FORTH with extensions conforming to Forth Interest Group standards. Includes assembler, string processing capabilities, disk virtual memory, multiple dimensioned arrays, floating point and integer processing.



**CBM-PET SPECIALS**  
 FREE Up to \$375 free merchandise with purchase of one of following CBM-PET items:

8032 32K - 80 Column CRT	\$1495	295	FREE
8050 Dual Disk Drive	1795	375	
4016 Full Size Graphics Keyboard	995	170	
4032 Full Size Graphics Keyboard	1295	260	
8096 96K - 80 Column CRT			
2040/4040 Dual Disk Drive - 340K	1295	260	
4022 Tractor Feed Printer	795	140	
CBM Voice Synthesizer	395	50	
C2N External Cassette Deck	95	12	
Used CBM/PET Computers			CALL
VIC Personal Computer	300	26	

WRITE FOR SYSTEM PRICES

\*\*\* EDUCATIONAL DISCOUNTS \*\*\*  
 Buy 2 PET/CBM Computers, receive 1 FREE

WordPro 3+ - 32K CBM, disk, printer	250
WordPro 4+ - 8032, disk, printer	335
OZZ Data Base System for CBM 8032	335
VISICALC for PET or ATARI	170
3M-KIT - Super PET ROM UTILITIES	40
Programmers Toolkit - PET ROM Utilities	34.90
PET Spacemaker II ROM Switch	36.00
2 Meter PET to IEEE or IEEE to IEEE Cable	40.00
Dust Cover for PET	6.90
IEEE-Parallel Printer Interface for PET	110.00
IEEE-RS232 Printer Interface for PET	120.00
The PET Revealed	17.00
Library of PET Subroutines	17.00

Source Hookup over 1000 programs/services 88

## MIPLIT Intelligent Plotter by Watanabe Instruments (Digiplot)

**SPECIAL \$1195**

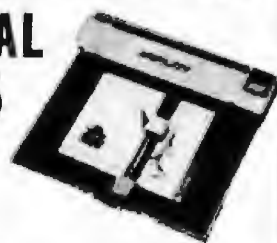

Has all intelligent functions for producing graphs and drawings including 3 vector and 4 character commands. Solid and broken lines can be specified. Character generator for alpha, numeric, and symbols. Characters can be rotated in 4 orientations, and can be 16 sizes. Coordinate axes drawn by specifying graduation interval and number of repetitions. Parallel ASCII interface, 11 x 17 paper.

## SPECIALS

EPSON MX-80 Printer	475
EPSON MX-80 F/T Printer	575
EPSON MX-70 Printer	380
EPSON MX-100 Printer	770
Centronics 739 Printer	750
STARWRITER Daisy Wheel Printer	1445
Leedex Video 100 12" Monitor	129
ZENITH DATA SYSTEMS	
Z19 Video Terminal	729
Z89 with 48K	2150
Extra 16K RAM	116
Z-47 Dual 8" Drive	2775

SYM-1	209
SYM BAS-1 BASIC or RAE-1/2 Assembler	85
KTM-2/80 Syntek Video Board	349

## DISK SPECIALS



SCOTCH (3M) 5 1/4"	10/2.85	50/2.75	100/2.65
SCOTCH (3M) 8"	10/2.90	50/2.80	100/2.70
Verbatim 5 1/4"	10/2.45	50/2.40	100/2.35
(add 1.00 for 5 1/4" Verbatim plastic storage box)			
Verbatim 8" Dbl. Dens.	10/3.45	50/3.35	100/3.25
BASF 5 1/4"	10/2.40	20/2.35	100/2.30

WRITE for prices on WABASH Disks  
**WE STOCK MAXELL DISKS**

Diskette Storage Pages	10 for 3.95
Disk Library Cases	8" - 2.85 5" - 2.15

**ATARI 800 \$745**  
 All Atari Modules 20% OFF

ATARI EDUCATIONAL PLAN Write for details.

**A P Products 15% OFF**  
**A P Hobby-Blox 15% OFF**



## ALL BOOK and SOFTWARE PRICES DISCOUNTED

The 8086 Book (Osborne)	14.00
Z8000 Assembly Language Programming	16.90
PET Personal Computer Guide (Osborne)	12.75
PET and the IEEE-488 Bus (Osborne)	13.60
6502 Assembly Language (Osborne)	14.45
Programming the 6502 (Zaks)	10.45
6502 Applications Book (Zaks)	10.45
6502 Software Cookbook (Scalbi)	9.45
CP/M Handbook (w/ MP/M) Zaks	11.85
Practical BASIC Programs (Osborne)	13.60
Some Common BASIC Programs (Osborne)	12.75

WRITE FOR CATALOG.

Add \$1.25 per order for shipping. We pay balance of UPS surface charges on all prepaid orders. Prices listed are on cash discount basis. Regular prices slightly higher.

252 Bethlehem Pike  
 Colmar, PA 18915

215-822-7727 **A B Computers**

## ZENITH/Heath Users



**Double Your 5 1/4" disk storage capacity without adding a drive.**

Get twice as much from your H88 or H89 microcomputer. Our FDC-880H floppy disk controller, in conjunction with your 5 1/4" drives, for example, expands memory capacity from 256 bytes to 512 bytes per sector.

And it handles single and double-sided, single and double-density, 8" and 5 1/4" drives — simultaneously.

Call 714/276-1272 today or write for details.



**C.D.R. Systems Inc.**  
Controlled Data Recording Systems, Inc.  
7687 Vickers St., San Diego, CA 92111

Circle 55 on inquiry card.

## ONE BOARD CP/M SYSTEM!



**only \$750  
Assem., Tested  
& Burned-In  
for one week**

**Features:**

- 8 1/2 by 12 inches
- 10 MHZ 8085 CPU
- 64K RAM
- 3 RS-232 channels
- 8272 Floppy Disk Controller
- Handles Single/Double Density
- One to Four Drives. 801 R or 850R.

Documentation \$15.  
CP/M Floppy Disk Operating System \$150  
Check or Money Order



**autocontrol**  
11744 Westline Industrial Drive  
St. Louis, MO 63141  
(314) 432-1313

Circle 32 on inquiry card.

## AC-85 CP/M® SYSTEM

**Assem., Tested  
& Burned In  
for one week** **\$2450**

**Features:**

- One board 8085 Computer
- 2 - SA800R\* (1.2 megabytes)
- CBIOS Diskette
- Installed and wired in a cabinet with P/S and Fan ready to plug-in
- Manual
- 17 1/2" W x 17" D x 10" H
- SYSTEM with 2 SA800R (2.4 mbytes)

**\$2750.00**  
CP/M Floppy Disk Operating System \$150  
Check or Money Order



**autocontrol**  
11744 Westline Industrial Drive  
St. Louis, MO 63141  
(314) 432-1313

\* CP/M is a registered trademark of Digital Research, Inc.

Circle 33 on inquiry card.



## Scotch

### DISKETTES

**SAVE 40%** Write for our complete list.

**5 1/4" Sgl. Dens. 26.70/10**  
Specify soft, 10 or 16 hard sectors

**8" Sgl. Dens. 27.30/10**  
**8" Dbl. Dens. 35.80/10**  
Specify soft or 32 hole hard

Add \$2.00 shipping - Michigan add 4% tax

**LYBEN COMPUTER SYSTEMS**  
27204 Harper Ave.  
St. Clair Shores, MI 48081

Authorized Distributor  
Information Processing Products 

Circle 186 on inquiry card.

## ATARI OWNERS

### Parallel Printer Interface for the ATARI 800

connects to controller jacks 3 and 4  
works with BASIC/DOS/ASSEMBLER

FOUR printer connectors available:

TRENDCOM 100/200	ABP 1
ATARI 825/CENTRONICS 730/737	ABP 2
EPSON MX-80/MX-70 & other 36 pin	ABP 3

\* Fits all other parallel Centronics plus Okidata, Anadex, Base 2 Microtek, etc.  
I D S PAPER TIGER 440/445 ABP 4

**\$69.95** 6% CA sales tax  
order by part number M.C. VISA accepted

GRAPHICS PRINTING SOFTWARE &  
ATARI 400 printer interfaces also available



To order toll free 1 800-344-7493  
In CA call (209) 667-2688

**MACROTRONICS, inc.**  
1024 N. Golden State Blvd.  
Brea, CA 92603

Circle 187 on inquiry card.

## WANTED:

### APPLE, PET, TRS-80, CP/M SOFTWARE

Westico is a publisher and distributor of professional software for microcomputers. If you have a new program ready for distribution or want your existing programs to reach a larger market, contact:

Phillip Woolfhol, V.P. Mktg  
Westico, Inc.  
25 Van Zant Street  
Norwalk, CT 06855  
(203) 853-6880

To increase your profits, take advantage of Westico's worldwide promotion and distribution

## WESTICO

The Software Express Service

## CONTROL-Z

### SINGLE BOARD Z-80\* COMPUTER FOR CONTROL USES



**USES:** Industrial Test Equipment, Inexpensive Programmable Controller, Automatic Drilling Equipment, Solar Heating & Power Systems, Machine Control, Battery Systems, Traffic Signal Control, Applications Control, Remote CPU Products, Etc.

**FEATURES:** 4 1/2" Z-80\* on board system, 16 RAM locations for 3 1/2" x 5 1/4" (4K PRG) ROM, 2 1/2" x 5 1/4" output ports, 2 1/2" x 5 1/4" TTL input ports, 4 channel serial ports, 1000 user programmable I/O, 5 high current output relays (relays), a non-volatile expansion, stand alone or TTL output for control, Z-80 control lines brought to edge connector, auto part detection through 16 single components, 1 input port available to host for serial communications, approved for response, 4 Year Warrantee, 24 hour emergency service, fully automated, reparable - \$ to US user \$90 net.

**PRICE:** \$275  
Attractive PRICED 32K Full function monitor program with download capability, software manual, drive & test tape history.

**TERMS:** CHECK, MC, VISA, or C.O.D. Call 1-800-875-5611  
Post Office Shipping Included Original Patent of 1976, etc.

**COMPUTER-AID**  
1192 DE LA VINA - SANTA BARBARA, CA 93101 (805) 966-3077

Circle 71 on inquiry card.

## CP/M COMMUNICATIONS

# LYNC™

### THE BEST AVAILABLE PROGRAM FOR CP/M COMMUNICATIONS

LYNC is extremely powerful and easy to use and a must for every computer user that wants to communicate with time-sharing systems or other CP/M computers.

**TERMINAL MODE**  
In this mode your system acts as a terminal. Can send to or receive from a time-sharing system. When receiving data from a remote system, received data is buffered in your maximum memory then can be saved as a disk file.

**LYNC MODE**  
Communicate on-line with another computer similarly equipped. Both ends can type messages that appear simultaneously on both screens.

**SEND: AUTOMATIC ERROR DETECTION & RETRY**  
LYNC sends block of information with 16 bit checksums. In case of error it will keep retrying until successful.

**FETCH**  
Check both systems are in LYNC mode, either operator can FETCH files from other system.

**REMOTE AND LOCAL DIRECTORY**  
Can display both local and remote directories.

**BAUD RATES: UP TO 9600 BAUD**

**SELF GENERATING I/O ROUTINES REQUIRE NO PATCHING**

**PRICE \$85 TERMS MONEY ORDER, CHECK, C.O.D. OR VISA.**  
PLEASE SPECIFY DESIRED FORMAT: S\* Single Density, S\* Microplots, TRS-80 Mod 8 with CP/M, North Star single or double density, Superstar 3.0 ODS or later, Cromemco S\* single density.

**COMPUTER-AID**  
1192 DE LA VINA - SANTA BARBARA, CA 93101  
(805) 966-3077

Circle 72 on inquiry card.



## Free

### Microprocessor Catalog

48 page catalog of 4800 single board computers, interface modules, 1980H 32 control computer/development system, WIZRD multitasking DOS, assemblers, compilers, BASIC, cross assemblers, cross compilers, custom engineering, OEM applications software.



**Wintek Corp.**  
1801 South Street  
Lafayette, IN 47904  
317-742-8428

Circle 386 on inquiry card.

# NOBODY KNOWS MORE ABOUT ADDING MEGABYTES TO YOUR TRS-80 MODEL II\* THAN AMERICAN SMALL BUSINESS COMPUTERS

## THE CAMEO CONNECTION

The Cameo 10 Million Character Disk Drive Subsystem (pictured in foreground) is a 5 Megabyte Fixed, 5 Megabyte Removable Cartridge-Type Disk Drive. Advantages to this unit are ease of backup for data and program files and low cost. By attaching a Multiplexor Unit several Model II's can be attached to the Cameo Disk Drive. For further pricing, availability, and operating systems options, call or write to American Small Business Computers and ask for the CAMEO CONNECTION.



## THE CORVUS CONNECTION

The Corvus Disk Drive Subsystem (center of picture) is available in 5, 10, and 20 Million Character Capacities. The Corvus System is the Ultimate in the Sealed "Winchester, All-Fixed" Type Drive. The Corvus is designed to operate in the harshest environments such as factories, oil rigs, etc. Backup of data is accomplished via optional MIRROR Backup Device whereby data is written onto a standard video tape recorder. A great number of Model II's may be attached to the Corvus via an optional CONSTELLATION Multiplexor. For further pricing, availability, and operating systems, call or write to American Small Business Computers and ask for the CORVUS CONNECTION.

## THE AMERICAN SMALL BUSINESS COMPUTERS MINI-WINCHESTER SPECIAL

The MINI-5 (being held by Corporate President Robert Webster) is American Small Business Computer's very own Disk Subsystem. The MINI-5 offers approximately 5 million characters of information storage and is based on the famous Seagate Technology ST-506 Micro Winchester Drive. Now you can own state-of-the-art technology at an affordable price — only \$3500 — which includes drive, controller electronics, power supply, cabinet, cables, documentation and operating system software.

### DEALER INQUIRIES INVITED

Circle 17 on inquiry card.

## AMERICAN SMALL BUSINESS COMPUTERS

\*TM TANDY CORPORATION

118 SOUTH MILL STREET

PRYOR, OK. 74361

918-825-4844



NEW! for  
the '89 from

**MAGNOLIA**  
MICROSYSTEMS

**DOUBLE DENSITY  
DISK CONTROLLER**

for both 5 1/4" & 8" drives  
only **\$595** complete  
including CP/M™2.2

MAGNOLIA MICROSYSTEMS, INC.  
2812 Thornadyke W., Seattle 98199  
(206) 285-7268 (800) 426-2841

CP/M is a trademark of Digital Research

Circle 199 on Inquiry card.

**FULLY  
AUTOMATED  
BARCHARTS**

Use the TBAR program with your CP/M system and Diablo printer to produce fully automated bar charts. Produce professional quality charts in two colors with many special symbols and features.

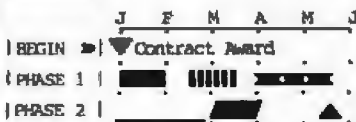

Price: \$175.00

**JMCA Software, Inc.**  
4717 University Dr., NW  
Suite 108  
Huntsville, AL 35805

Circle 182 on Inquiry card.

**CHIPS & DALE**

THE INFLATION FIGHTERS!  
— RAM —

4116 200ns 8/\$16.25

2114L 300ns 8/\$18.45

4164 200ns \$27.00

— EPROM —

2716 (5V)450ns 8/\$5.35 ea. \$5.75 ea.

2732 (5V)450ns 8/\$13.50 ea. \$14.50 ea.

We buy from Manufacturer's Authorized Distributors. All Chips are fully Guaranteed. Call for quantity pricing. Please allow up to 3 wks. for personal checks to clear.

Add \$2.50 Shipping & Handling  
C.O.D. \$3.00. Wash. residents add 5.4% Sales Tax

CHIPS & DALE  
P.O. Box 31607  
Seattle, Wash. Zip 98103 Master Charge  
1-206-524-9126 VISA accepted.

Circle 60 on Inquiry card.

**COMPUTER SHOWS**

SECOND ANNUAL  
NJ MICROCOMPUTER  
SHOW AND FLEAMARKET - 1981  
NEWARK, NEW JERSEY



Sat. Oct. 24 & Sun. Oct. 25  
10-5:30 PM & 10-3:00 PM  
HOLIDAY INN (NORTH)  
NJ Turnpike • Exit 14

(Take Route 1-9 Service Road - Follow Signs)

REGISTRATION \$5.00 -  
FLEAMARKET ONLY \$3.00  
Fleamarket Permits \$5/Spot  
(Includes Admission)

Commercial Exhibits • User Groups • Fleamarket

SECOND ANNUAL  
NATIONAL "80" MICROCOMPUTER  
SHOW (FOR TRS-80\* USERS)  
April 29, 30, May 1, 1982  
NEW YORK STATLER HOTEL  
NEW YORK CITY

100 Exhibit Booths • Speakers • User Groups  
\*TRS-80 is a Trademark of Tandy Corporation

For Registration, Exhibitor or Fleamarket  
Information Contact:  
**KENGORE CORPORATION**  
3001 Route 27 • Franklin Park, NJ 08823  
(201) 297-2526

Circle 288 on Inquiry card.

Heath owners . . .

**Percom's  
Double-Density  
Disk Controller  
Available Soon!**

Under  
**\$300**

See our full-page ad  
for Z drives in this issue.

**PERCOM:**  
Quality disk drive systems  
since 1977.

Circle 363 on Inquiry card.

**8% OVER COST**

HP-85's	\$2540.00
HP-83's	\$1760.00
HP-9885 Dual 8" Drives	\$5300.00
HP-8292 Dual 5" Drives	\$1960.00
HP-7225B Plotter	\$1720.00
Apple II + Computers	\$1090.00
LOBO Disc Drives	\$ 395.00
EPSON MX-70 Printers	
with Apple 10	\$ 450.00
IDS 445G Printers	\$ 699.00
NEC Spinwriters	
with Tractors	\$2580.00
IDS 480G Printers	\$1099.00
IDS 580G Printers	\$1330.00
C ITOH Starwriter 25's	\$1300.00
CCS 300 Dual 8" Drive computer with	
64K RAM, OASIS, CP/M 2.4MB Disc	
memory, 2 serial ports, 1 parallel	
port and a Teletideo	
910 CRT	Call for price
CDC Lark Subsystems	Call for price

210/838-5350

**Meade's  
DATA SYSTEMS**

"THE COMPLETE SYSTEMS AND SUPPORT TEAM"

Circle 209 on Inquiry card.

**HOBBY ROBOTICS'  
Shoppers Mart**

— For the SERIOUS Hobbyist —

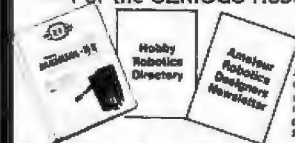

Complete R.U.S. Manual!  
Everything you need to  
build your own robot  
shown, detailed! Based  
from base up with Hobby  
Robotics' highly  
maneuverable 2 1/2 bar  
sec superposition base,  
adjustable arms (14"  
rated at 15 lbs. dip-the  
hands! Manual only  
\$25.00, refundable with  
first purchase

Hobby Robotics' Parts Supplier Directory  
Check full of names, addresses,  
phone numbers you want for hard-to-  
find parts systems. Build-your-own-  
robot into only \$3.50. Get yours now!

ARD Newsletter  
Quarterly keeps  
you abreast of  
latest news,  
prices up interest!  
\$6.00

**HOBBY ROBOTICS**  
5410 E. Buford Highway  
Norcross, Ga 30071 404/448-0190  
Please send name checked below  
DI Newsletter R.U.S. Manual  
Parts Directory Robot Base  
FREE to Hobby Robotics Catalog FREE  
Name Enclosed \$ \_\_\_\_\_  
Personal Check Cashiers Check/M.D.  
MasterCharge Bank American  
Airtel \$ \_\_\_\_\_  
Signature \_\_\_\_\_ \$60  
Name \_\_\_\_\_  
Address \_\_\_\_\_  
City \_\_\_\_\_



**HOBBY ROBOTICS' ROBOT BASE**  
Ready to roll!  
ONLY \$485 (includes shipping)

**HOBBY ROBOTICS**  
5070-E Buford Highway • Norcross, Ga 30071 • 404/448-0190

Circle 161 on Inquiry card.

**C. C. WRITER  
TRS-80\***  
Color Computer  
WORD PROCESSING

USER MODIFIABLE EX. BASIC W/PAGE  
FORMATTING, MOVE, TABS, DELETION  
INSERTION, GLOBAL SEARCH & EDIT  
CENTERING, INDENTING, PAGE PAUSE  
ASCII CODES, JUSTIFY, 32K OPTION  
THIS AD PREPARED WITH C.C. WRITER  
Dist: TRANSFORMATION TECHNOLOGIES  
\*TRS-80 is a TM of Tandy Corp.

**\$30 Check or M.O. to  
C. C. WRITER  
194 Lockwood Ln.  
Bloomington, IL 61018**

Circle 363 on Inquiry card.

**MEMOREX  
FLEXIBLE DISCS**

WE WILL NOT BE UNDER-  
SOLD!! Call Free (800)235-4137  
for prices and information. Dealer  
inquiries invited and C.O.D.'s  
accepted.

VISA

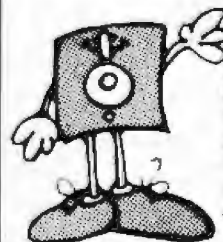

**PACIFIC  
EXCHANGES**  
100 Foothill Blvd.  
San Luis Obispo,  
CA 93401 In Cal.  
call (800) 592-5935  
or (805) 543-1037

Circle 278 on Inquiry card.





## NEW 16K-RAM PERSONAL COMPUTER

**\$229<sup>00</sup>** FACTORY SALE  
PRICE

For \$229<sup>00</sup> you get the new Interact Model "R" Computer, 16K-RAM, 2K-ROM, 8080A Microprocessor, color, sound, full 53 keyboard, high speed cassette, AC adapter, R.F. Modulator, Black Console Case, 90 days parts and labor warranty, owners' guide, FCC approved.  
**15 DAY FREE TRIAL** Return within 15 days complete and undamaged for refund of purchase price.

**PROTECTO ENTERPRIZES**  
BOX 550, BARRINGTON, IL 60010  
PHONE 312/382-5244  
TO ORDER

Circle 301 on inquiry card.

## MULTIBUS for SALE:

SBC 86/12A	.....	\$1200
SBC 80/30	.....	\$ 450
SBC 064	.....	\$ 900
SBC 604	.....	\$ 85
SBC 614	.....	\$ 85
BLC 556	.....	\$ 175

Much more in stock. We buy/swap/sell any/all computer systems. Add 2% for shipping/handling.

**Oracle Electronics  
& Trading Co., Inc.**  
467 Hamilton Ave., Suite 22  
Palo Alto, CA 94301  
(415) 321-7650

Circle 133 on inquiry card.

## RS-232 PROBLEMS?

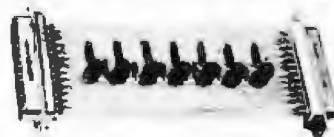

LET THE RS-232 TESTER HELP YOU SOLVE YOUR COMPUTER INTERFACE PROBLEMS. DESIGNED TO CONNECT IN SERIES WITH ANY RS-232 INTERFACE, IT DISPLAYS THE STATUS OF SEVEN OF THE MOST IMPORTANT LINES: TRANSMIT DATA, RECEIVE DATA, REQUEST TO SEND, CLEAR TO SEND, DATA SET READY, CARRIER DETECT, AND DATA TERMINAL READY. THE RS-232 TESTER REQUIRES NO POWER AND MAY BE LEFT IN THE LINE PERMANENTLY.

**\$39.95 POST PAID**  
**B & B ELECTRONICS**  
BOX 476/MENDOTA, IL 61342

Circle 35 on inquiry card.

## ALL FOR QUALITY COMPONENTS SLIDER

48 HOUR BOARD EXCHANGE WARRANTY ON GODOUT & SYSTEMS GROUP COMPUTERS. A tested duplicate board will be sent via UPS BLUE LABEL Service for one year.

GODOUT Systems include DMA CPU, 64K-10MBs Ram (expandable to 512K) DMA Disk 1 Controller. 2 serial ports, IEEE S-100 Single Unit 12 Slot Mainframe & Dual 8" Drive Cab with (2) Shugart 801A's (One Megabyte) CPU & 6MHz 280 System w/CP/M 2.2 3995.  
CPU 6MHz 8068/8085 System w/CP/M 2.2 4995.  
CASIOIC 86 275. PASCAL M 86 325.

SYSTEMS GROUP 2800 Series COMPUTERS with 4MHz 280, 64K Ram, 2 serial & 2 par. ports  
CP/M System (2) Shugart 801A's 1MB 3995.  
CP/M System (2) NEC 1160's 298 4695.  
CP/M System 1 NEC 1 Hard Disk 10MB 7995.  
MP/M System 2 NEC 1160's 128K 298 5584.  
CPC7811 4MHz 280 365. FDC2801 Disk 343.  
Word Star 300. DBASE III A.2. 585.  
GODOUT 6MHz 280 389. Disp: 1 DMA Ast 388.  
Reason MICRO par 473. Shipping Extra

WE BEAT ANY DEVIANT PRICE ON TELEVIEWED SYSTEM I, II, OR III. Call for price O.T. SYSTEM I 64K, (2) 801A's 280A 2995. TELEVIEWED 910, 912, 920, & 950 Best Prices ALL PRICES & SPECS. SUBJECT TO CHANGE. CP/M is Registered P.M. of Digital Research P.O. BOX 451 WESTMINSTER CA 92382 714 795 1746

Circle 329 on inquiry card.

## ISIS ↔ CP/M®

Full bi-directional file transfer capabilities are provided in the ISIS-CP/M utilities package. Written in machine language and running under CP/M, these utilities permit the CP/M user to read or write files direct to/from an ISIS Diskette. They will run under any version of CP/M without regard to diskette density. The complete package is \$250.00 including user's manual. Write for free brochure on other CP/M software.

CP/M is a registered trademark of Digital Research  
ISIS is a trademark of Ives Corporation



**SOUTHERN  
COMPUTER  
SYSTEMS, INC.**  
P O Box 3373A  
Birmingham, AL 35255  
(205) 933-1859

Circle 333 on inquiry card.

## Serial Printer Interface



(RS232C) for  
**APPLE II®**  
only \$179;  
assembled  
tested  
burned in-  
docum

- Powerful ON BOARD SOFTWARE provides  
-TOP OF FORM & AUTO PAGING  
-LIST format for program listings (inserts 1 or 2 blank lines after any user specified program line)  
-HARD COPY reproduces screen text on printer  
-INPUT from printers with keyboards
- 32 DIP SWITCH levers select ALL printer interface parameters (columns-line lines/page vertical margins and more)
- BAUD rates between 70 and 1500
- Output functions selected via ATTRACTIVE color coded CONTROL PANEL (fits under keyboard)
- Control panel and 7 ft printer cable included  
ORDER NOW or send for MORE INFORMATION

**RADIX, Inc.** 1 CO residents add 3% sales tax  
P O Box 3365 Foreign orders add 10%  
Littleton CO 80161 MC VISA CDD MO  
(303) 985-4152 Personal Check (add 3 wks)  
\* registered trademark of Apple Computer Inc.

Circle 315 on inquiry card.

## 68KFORTH

New SYSTEMS LANGUAGE for ERG 68-696 CPU and Motorola's KDM board. D/S, Compiler, Monitor, Assembler, Interpreter, Virtual Memory, Screen Editor, DBL Precision Arithmetic and more. FORTH-79 Standard Vocabulary.

**\$795**

**Empirical Research Group, Inc.**  
PO Box 1176  
Milton, WA 98354  
206-631-4855

Circle 138 on inquiry card.

## IC-IRS will Find It

IC-IRS \$37.50 1980 CMDB \$29.95  
IC-IRS by Island Cybernetics is THE Information Retrieval System for indexing and retrieving entries with large amounts of FREE FORM TEXT, such as ABSTRACTS; CORRESPONDENCE FILES (with complete letters); Attorney's CASE NOTES, CONTRACTS, WILLS; MD'S and Scientist's JOURNAL ARTICLES, or any other similar type of information. EASY TO USE.

COMPUTERIZE your CARD FILES or MAIL LISTS.

IC-IRS runs as a ".com" file on CP/M compatible systems with 2 disk drives and 32K memory. IC-IRS is written in CONVERS for fast execution. It searches the 884 entry 1980 COMPUTER MAGAZINE ARTICLE DATA BASE in 25 seconds using combinations of KEY WORDS with up to 65 "and"s and 32 "or"s.

Get IC-IRS and the 1980 COMPUTER MAGAZINE ARTICLE DATA BASE (1980 CMDB) on standard 8" 50 disks or 5 1/4" disks in several popular formats.

IC-IRS 2.07 with manual = \$37.50 + \$2.50 postage.  
1980 CMDB = \$29.95 (no postage with IC-IRS)

Call (512) 258-8310 and use your MASTERCARD or VISA, use the bingo card or write to:

**FYI, INC.**  
P. O. Box 10998 #615  
Austin, Texas 78766

CP/M is a registered trademark of Digital Research

Circle 146 on inquiry card.

## LOWEST POSSIBLE PRICES BEST POSSIBLE WARRANTY



model III 16K

**\$839**

color  
computer 4K  
**\$310**



call TOLL FREE 1-800-343-8124  
**computer plus** 2454 Great Road  
Littleton, MA 01460  
617-486-3193  
Write for your free catalog.  
IBM PC is a registered trademark of International Business Machines Corporation

Circle 77 on inquiry card.

# MICROPROCESSOR SUPPORT I.C.'S

**WE GUARANTEE FACTORY PRIME PARTS**

2716 EPROM			1-9	10 & UP	2708 EPROM			3 SUPPLY	2732 EPROM			1-9	10 & UP
HITACHI	+5	7.00	6.00	AMERICAN MICRO DEVICES			INTEL			17.00	16.00		
INTEL	+5	9.50	8.00	AM2708DC			MITSUBISHI			16.00	15.00		
MOTOROLA	+5	7.00	6.00	1-24	25-99	100 & UP	NEC			16.00	15.00		
NATIONAL	+5	7.00	6.00	3.50	3.20	2.90							
TI	3 Supply		7.50	6.00									
16K x 1 DYNAMIC RAM				2114L STATIC RAM				74LS SPECIAL					
NEC	UPD	416C-2	200NS	1Kx4		1-31	99 & UP	LS175 .75					
1-31	2.50	100-499	2.10	HITACHI	200NS	2.85	2.60	2.35	LS240 1.15				
32-99	2.30	500 & UP	1.90	INTEL	200NS	3.00	2.85	2.70	LS241 1.15				
				NEC	250NS	3.00	2.85	2.70	LS244 1.00				
								LS245 1.95					
								LS373 1.15					

Z80-P10	6.00	8755	49.95	4050	.69	4531	.99	74C925	8.95	74LS107	.46	74LS244	1.00
Z80A-P10	7.10	4000	.35	4051	1.10	4532	1.25	74LS00	.35	74LS109	.45	74LS245	1.85
Z80-CTC	6.00	4001	.35	4052	1.10	4539	.99	74LS01	.28	74LS112	.49	74LS247	1.10
Z80ACTC	7.10	4002	.35	4053	1.10	4543	1.99	74LS02	.28	74LS122	.65	74LS248	1.10
Z80-DMA	18.50	4006	1.39	4055	3.95	4553	3.50	74LS03	.28	74LS123	1.19	74LS249	1.69
Z80A-DMA	22.50	4007	.29	4066	2.95	4555	.75	74LS04	.39	74LS125	1.35	74LS251	1.79
Z80-S10/0	18.50	4008	1.39	4059	9.95	4556	.75	74LS05	.28	74LS126	.89	74LS253	.98
Z80A-S10/0	22.50	4009	.49	4060	1.39	4581	1.99	74LS08	.39	74LS132	.79	74LS257	.98
Z80-S10/1	18.50	4010	.49	4066	.75	4582	1.01	74LS09	.39	74LS136	.59	74LS258	.98
Z80A-S10/1	22.50	4011	.35	4068	.35	4584	.55	74LS10	.28	74LS138	.89	74LS259	2.95
Z80-S10/2	18.50	4012	.29	4069	.35	4585	.99	74LS11	.39	74LS139	.89	74LS260	.89
Z80A-S10/2	22.50	4013	.49	4070	.49	4702	9.85	74LS12	.39	74LS145	1.25	74LS261	2.49
3205	3.95	4014	1.39	4071	.35	74C00	.39	74LS13	.47	74LS148	1.49	74LS266	.59
3242	10.00	4015	1.15	4072	.35	74C02	.39	74LS14	1.25	74LS151	.79	74LS273	1.75
8155	11.25	4016	.69	4073	.35	74C04	.39	74LS15	.39	74LS153	.79	74LS275	4.40
8185	29.95	4017	1.19	4075	.35	74C08	.49	74LS20	.26	74LS155	1.19	74LS279	.59
8185-2	39.95	4018	.99	4076	1.29	74C10	.49	74LS21	.38	74LS156	.99	74LS283	1.10
8202	45.00	4019	.49	4078	.35	74C14	1.65	74LS22	.38	74LS157	.99	74LS290	1.29
8205	3.95	4020	1.19	4081	.35	74C20	.39	74LS26	.39	74LS158	.75	74LS293	1.95
8212	2.00	4021	1.19	4082	.35	74C30	.39	74LS27	.39	74LS160	.98	74LS295	1.10
8214	3.95	4022	1.15	4085	1.95	74C32	.99	74LS28	.39	74LS161	1.15	74LS298	1.29
8216	1.85	4023	.38	4086	.79	74C42	1.85	74LS30	.26	74LS162	.98	74LS324	1.75
8224	2.65	4024	.79	4093	.99	74C48	2.39	74LS32	.39	74LS163	.98	74LS347	1.95
8226	1.85	4025	.38	4099	2.25	74C73	.85	74LS37	.79	74LS164	1.19	74LS348	1.95
8228	5.00	4026	2.50	4104	1.99	74C74	.85	74LS38	.39	74LS165	.89	74LS352	1.65
8238	5.45	4027	.65	4501	.39	74C85	2.49	74LS42	.79	74LS166	2.49	74LS353	1.65
8243	4.65	4028	.85	4502	1.65	74C89	4.95	74LS47	.79	74LS170	1.99	74LS363	1.49
8251A	5.55	4029	1.29	4503	.69	74C90	1.85	74LS48	.79	74LS173	.89	74LS365	.99
8253	9.85	4030	.45	4505	8.95	74C93	1.85	74LS51	.26	74LS174	.99	74LS366	.99
8255A	5.40	4031	3.25	4506	.75	74C95	1.85	74LS54	.35	74LS175	.75	74LS367	.73
8255A-5	5.40	4032	2.15	4507	.95	74C107	1.19	74LS55	.35	74LS181	2.20	74LS368	.73
8257	9.25	4033	2.15	4508	3.95	74C151	2.49	74LS73	.45	74LS190	1.15	74LS373	1.15
8257-5	9.25	4034	3.25	4510	1.39	74C154	3.50	74LS74	.59	74LS191	1.15	74LS374	2.75
8259A	7.30	4035	.95	4511	1.39	74C157	2.10	74LS75	.68	74LS192	.98	74LS375	.69
8271	60.00	4037	1.95	4512	1.39	74C160	2.39	74LS76	.45	74LS193	.98	74LS377	1.95
8275	32.95	4040	1.29	4514	3.95	74C161	2.30	74LS78	.65	74LS194	1.15	74LS385	1.95
8279	10.80	4041	1.25	4515	3.95	74C163	2.39	74LS83	.99	74LS195	.95	74LS386	.65
8279-5	10.80	4042	.95	4516	1.69	74C164	2.39	74LS85	1.19	74LS196	.89	74LS390	1.95
8282	6.70	4043	.85	4519	.99	74C173	2.59	74LS86	.45	74LS197	.89	74LS393	1.95
8283	6.70	4044	.85	4520	1.39	74C174	2.75	74LS90	.75	74LS221	1.49	74LS395	1.70
8284	5.85	4046	1.75	4522	.99	74C175	2.75	74LS92	.75	74LS240	1.15	74LS399	2.95
8286	6.70	4047	1.25	4526	1.15	74C192	2.39	74LS93	.75	74LS241	1.15	74LS424	2.95
8287	6.70	4048	.99	4527	1.75	74C193	2.39	74LS95	.88	74LS242	1.95	74LS668	1.75
8288	25.40	4049	.69	4528	.99	74C195	2.39	74LS96	.98	74LS243	1.95	74LS670	2.29
8289	49.95												

**MINIMUM ORDER \$10.00**  
**INCLUDE \$3.00 FOR U.P.S. GROUND**  
**\$4.00 FOR UPS BLUE or 1st CLASS MAIL**  
 Washington State Add 5.4% Sales Tax

**HANLEY ENGINEERING**  
 (206) 643-0792  
 13400 NORTHUP WAY #22  
 BELLEVUE, WASHINGTON 98005

**FOR THE FINEST IN MICROPROCESSOR SUPPORT I.C.'S**

## 6809 Small C Compiler

- Generates assembly language source output
- Requires only 16K memory
- Library functions in source code
- Generates position independent code
- Supports most C functions
- Generates ROMmable code

INTRODUCTORY PRICE \$75  
specify 5 or 8 inch diskette SSB or FLEX

TERMS: Check or Money Order. California residents add 6%. C.O.D. orders add \$3.50 shipping & handling.

**BUGGERY GROWING SYSTEMS**  
POST OFFICE BOX 306 SOLANA BEACH, CA 92075  
714-755-4373

Available soon: Basic to C Converter

Circle 126 on Inquiry card.

# LABELS

# 295

perM

15/16" x 3 1/4" white pressure  
1 up - pin feed sensitive

**PRICE INCLUDES SHIPPING**  
Packed 5M per box - Min. order 1 box - \$14.75  
Check with order - Mass Residents add 5% Sales Tax



**CHECK-MATE**<sup>TM</sup>

P.O. Box 103, Randolph, MA 02368  
Telephone: 617-963-7694

Circle 58 on Inquiry card.

## A PROFESSIONAL MICROCOMPUTER



**THE BEST VALUE ON THE MARKET**

- 280 4MHZ
- 64K RAM
- DUAL 8" DRIVES
- 1.2 MB STORAGE
- 2 SERIAL I/O
- 2 PARALLEL I/O
- OPERATING SYSTEM AND UTILITIES

MICRO BUSINESS ASSOCIATES, INC  
500 SECOND STREET  
SAN FRANCISCO, CA 94107  
415-957-1343

Circle 217 on Inquiry card.



**DATAPoint**  
1134 Diskette Systems

16k Processor with Four Diskettes  
(1 Megabyte). 80 CPS Matrix  
Printer. Nationwide maintenance  
available.

## \$2,645

SOFTWARE AVAILABLE  
DISK OPERATING SYSTEM  
SORT UTILITY  
ISAM UTILITY  
ALSO AVAILABLE FOR \$250 EACH:  
A/P, A/R, GENERAL LEDGER, PAYROLL, TIME  
ACCOUNTING, AND INVENTORY

**AMERICAN COMPUTER EXCHANGE**  
100 N. MAIN ST. BOX 52  
CHAGRIN FALLS, OH 44022  
216-247-2100

Circle 19 on Inquiry card.



## DIGITAL PROPORTIONAL CONTROLLER

7 BIT TTL/CMOS INPUT

OPTICAL ISOLATION

INTERFACE COMPUTERS TO MOTORS,  
HEATERS, LAMPS

120 VAC 240 VAC 15 AMP

**CS** 3715 WHITSELL AVE.  
PALO ALTO, CA 94306  
(415) 493-0779

Circle 98 on Inquiry card.

## BIBLIOTEK

The Bibliographic  
Management System

- Includes journals, books and symposia (patents, technical reports, government documents available soon)
- A minimum of 500 references per bibliography
- Rapid citation entry through multi-page video forms
- Search by authors, titles, editors, dates and/or keywords
- User defined output formats
- Requires 48K Apple II, ROM Applesoft & two drives
- \$300.00

**Scientific Software Products**  
3171 Donald Avenue  
Indianapolis, IN 46224  
(317) 290-0467

In residents add 4% tax please. Dealer inquiries welcome. Apple II and Applesoft are trademarks of Apple Computer Co., Inc. IBM and Mainframe are registered trademarks.

Circle 320 on Inquiry card.



FULL PERFORMANCE CP/M\* computer  
\$1995 list

dealer-distributor discounts

**Alspa Computer, Inc.**  
5215 Scotts Valley Drive  
Scotts Valley, CA 95066  
(408) 436-3326

\*trademarks of Digital Research, Inc.

Circle 15 on Inquiry card.



## FREE!

1981  
DISCOUNT  
ELECTRONICS  
CATALOG

**JOIN THE PAK!**

Send for our Free catalog and become a member of our exclusive Pak. Our members receive Poly Paks' exciting catalog several times a year. We offer:

- Penny Sales, Free Premiums and Low.
- Low Prices on a wide variety of Electronic Products such as Computer Peripherals, Integrated Circuits, Speakers, Audio Equipment, Rechargeable Batteries, Solar Products, Semiconductors, and much, much more!

Take advantage of our 25 years as America's foremost Supplier of discount electronics.

Over  
4.5 Million  
Satisfied  
Customers

**POLY PAKS, INC.**  
P.O. BOX 942, RT9  
S. LYNNFIELD, MA 01940 (617) 265-3828

Circle 294 on inquiry card.

## IPEX **NEW!**

Interface Converts  
Your Typewriter  
into Printer

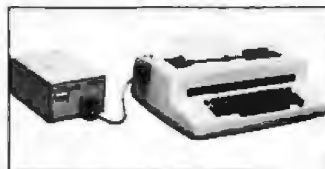

- Finest print quality
- Easy installation
- Fits IBM SELECTRIC<sup>®</sup> Typewriter with no modification.
- For TRS-80<sup>®</sup>, Apple<sup>®</sup>, or any parallel or RS232 port.
- Write or phone for more information, today!
- Low cost
- Quick delivery

— U.S. and worldwide sales —

**IPEX** INTERNATIONAL INC.  
16140 Valerio St.  
Van Nuys, CA 91406 USA  
TEL: 213/781-0020 TLX/TWX: 910-495-1767

Circle 178 on Inquiry card.

# WE WILL NOT BE UNDERSOLD

## DISK DRIVES

FOR TRS-80\* Model I  
CCI-100 5 1/4", 40 Track (102K) \$299

ADD-ON DRIVES FOR ZENITH Z-89  
CCI-189 5 1/4", 40 Track (102K) \$394  
Z-87 Dual 5 1/4" system \$995



External card edge and power supply included. 90 day warranty/one year on power supply.

## RAW DRIVES

5 1/4" TEAC or TANDON \$ CALL POWER SUPPLIES \$ CALL

## DISKETTES — Box of 10

5 1/4" Maxell \$40	BASF/Verbatim \$26.95
8" Maxell \$45	BASF/Verbatim \$36.00
PLASTIC FILE BOX—Holds 50 5 1/4" diskettes	\$19.00
PLASTIC LIBRARY CASE 5 1/4" \$3.00	8" \$ 4.00
HEAD CLEANING DISKETTE	\$25.00
FLOPPY SAVER \$11.95	RINGS \$ 6.95

## 16K RAM KITS

200ns for TRS-80; Apple II, (specify): 2 for \$37 \$19  
Jumpers \$2.50

## SYSTEM SPECIAL

Apple II Plus 48K w/driver and controller. Epson MX-80 printer and interface. SUP-R Mod RF Modulator: List \$2965 You Pay \$2299

## COMPUTERS/TERMINALS

ARCHIVES 64K, 2-Drives, 77 Track	\$ CALL
ALTOS ACS8000 Series	\$ CALL
ZENITH 48K, all-in-one computer	\$2200
ZENITH Z-19	\$ 725
TELEVIDEO 910 \$559 920C \$ 729	950 \$1039
IBM 3101 Display Terminal	\$1189
ATARI 400 \$ 429	800 \$ 795
MATTEL INTELLIVISION	\$ 259
APPLE PERIPHERALS	\$ CALL

## S-100 CALIFORNIA COMPUTER SYSTEMS

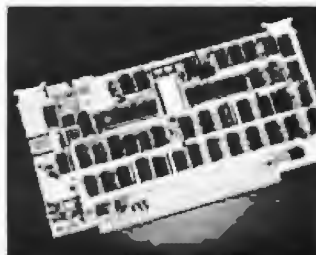

MAINFRAME Model 2200A	\$349
Z80 CPU Model 2810	\$259
MOTHER BOARD Model 2501	\$106
16K STATIC RAM, 200ns Model 2116C	\$309
32K STATIC RAM, 200ns Model 2032C	\$619
64K DYNAMIC RAM Model 2085C	\$580
FLOPPY DISC CONTROLLER Model 2422A	\$345
EXTENDER BOARD Model 2520K	\$ 52
2P + 2S I/O Model 2718A	\$309

For fast delivery, send certified checks, money orders or call to arrange direct bank wire transfers. Personal or company checks require two to three weeks to clear. All prices are mail order only and are subject to change without notice. Call for shipping charges.

## PRINTERS



NEC SPINWRITER  
Letter Quality High Speed Printer  
R.O. \$2395  
R.O. with tractor feed \$2555  
KSR with tractor feed \$2795

NEC SPINWRITER 3500 Series, 5 new models \$ CALL  
EPSON MX-70 MX-80 MX-80FT MX100 \$ CALL

## PAPER TIGER

IDS 445 Graphics & 2K buffer	\$ 695
IDS 460 Graphics & 2k buffer	\$ 799
IDS 560 Graphics	\$ 999
ANADEX DP-8000 \$849	DP-9500/01 \$1295

## OKIDATA

Microline 80 Friction & pin feed	\$ 415
Microline 80 Friction, and pin & tractor feed	\$ 500
Microline 82 Friction & pin feed feed	\$ 615
Microline 83 120 cps, uses up to 15" paper	\$ 849
CENTRONICS 739, new model with graphics	\$ 749

## C. ITOH

Starwriter I 25 cps, parallel interface	\$1449
Starwriter I 25 cps, serial interface	\$1529
Starwriter II 45 cps, parallel interface	\$1829
Starwriter II 45 cps, serial interface	\$1949

## PRINTER SPECIAL

SEIKOSHA GP-80M List \$399 You Pay \$319

## MONITORS

BELL & HOWELL 9" B & W BHD911	\$195
LEEDEX 12" B & W \$129	12" Green Screen \$159
13" Color \$329	
SANYO 9" B & W \$149	12" Green Screen \$238
12" B & W \$219	13" Color \$406
ZENITH 13" Color \$349	12" Green Screen \$129

## TELECOMMUNICATIONS

LIVERMORE STAR MODEM 2-year guarantee	\$125
UNIVERSAL DATA SYSTEMS UDS-103	\$179
D-CAT HARD WIRED DIRECT MODEM	\$189
AUTO-CAT Auto Answer, Direct Connect Modem	\$249
APPLE-CAT II	\$349
D.C. HAYES MICRO-MODEM	\$295
D.C. HAYES SMART-MODEM	\$235
CCI Telnet Communications Package	\$135

## APPLE ACCESSORIES AND SOFTWARE

VISICALC \$155.00	DB MASTER \$159.00
Z-80 SOFTCARD \$259.00	
VIDEX BOARD \$259.00	
KEYBOARD ENHANCER \$110.00	
16K CARD \$169.00	
APPLE JOYSTICK \$ 49.00	
SUP-R MOD \$ 25.00	
CCS CARDS \$ CALL	
GALAXIAN \$ 22.95	
SPACE ALBUM \$ 35.00	
ASTEROIDS \$ 17.95	
FLIGHT SIMULATOR \$ 29.00	
WIZARD & PRINCESS \$ 28.00	
SARGON 2 \$ 29.00	
MYSTERY HOUSE \$ 24.00	HI-RES FOOTBALL \$ 35.00



DEALER (NATIONAL/INTERNATIONAL) INQUIRIES INVITED

Send for FREE Catalogue

# The CPU SHOP

TO ORDER CALL TOLL FREE 1-800-343-6522

TWX: 710-348-1796 Massachusetts Residents call 617/242-3361

5 Dexter Row, Dept. B09M  
Charlestown, Massachusetts 02129  
Hours 10AM-8PM (EST) Mon.-Fri. (Sat. 11l 5)

Technical Information call 617/242-3361  
Massachusetts Residents add 5% Sales Tax  
Tandy Corporation Trademark™ Digital Research  
Circle 96 on inquiry card.

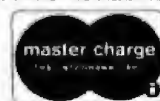

## database manager for TRS-80 Model I

- CREATE random access disk files 15 fields or 255 bytes/record
- Files can span 4 disk drives
- Password protected file access
- Database DIRECTORY displays all user files and their attributes
- Powerful TRANSACTIONS—add, edit, read, delete & list records
- Efficient binary tree sorts
- Sophisticated QUERY with multi-key relational & logical operations
- REPORT formatter requires only for user to select desired fields
- Automatic sub & grand totals
- May be used with lower case
- Entirely MENU DRIVEN operation
- Extensive error trapping routines
- User oriented instruction manual
- Requires 32k—2 disk drives

**Introductory price \$59.95**  
 Visa and MasterCard accepted

**mentor software**

816 McLane Ave—Morgantown, WV 26505  
 Tandy Corp. Trademark

Circle 212 on Inquiry card.

## PRIAM

Disk Subsystems  
 and  
 Accessories,  
 (SMD interface available)

lowest cost and greatest established reliability for H.P., DEC, Apple, 2-80, 8085... and so on.

We can show you how to overcome "foreign disk" warranty worries.

Special Opportunity:

### 14A. S-100 Power Supply Kit

Input: 95-220VAC, 50/60 Hz  
 Outputs: 14A @ ±8VDC **\$29.95**  
 2A @ ±18VDC

Includes: UL Spec. Transformer, Rectifiers, Computer Grade Capacitors. RFI line filter, and Schematics.

**ADVANCED TECHNOLOGY**  
 735 Loma Verde, Palo Alto, CA 94303  
 415-483-5930

Send 36 ct SASE for our 16 page flyer.

Circle 10 on Inquiry card.

\*\*\*\*\*  
**COMPUTER SURPLUS**  
 \*\*\*\*\*

**Brand new Perkin-Elmer  
 No. 550 terminals**  
 —priced ridiculously low.  
 Call us for a quote.

**CALL VICTOR CLOUGH**  
**(216) 473-0866**

Also buy scrap computer systems, printed circuit boards, connectors etc. ...  
**LARGE VOLUME ACCEPTABLE**

**DATA HARDWARE**  
 701 Beta Dr. #4  
 Cleveland Ohio 44143

\*\*\*\*\*  
**DEALERS WELCOME**

Circle 101 on Inquiry card.

## PROCAP

EAGLES ?  
 COWBOYS ?

RAIDERS ?  
 RAMS ?

If you'd like to know NOW before the big game

With PROCAP and your TRS-80™ you can use statistics and probability theory to predict the results of this week's big games. And more PROCAP

- Gives offensive and defensive ratings for every National Football League team
- Predicts range of results and probabilities for each game
- Allows computer matchups of any two teams (Great for playoffs)
- Gives up-to-the-minute standings statistics and ratings for each NFL Division

PROCAP is easy to use and comes with extensive documentation. Disk or cassette version is only \$49.95

To order call our toll free number NOW. Money back guarantee so you can't lose.

Dist (800) 543-3000 operator #00  
 411 Ohio St (800) 543-3004 operator #00

Please specify TRS-80 Model I (800) or 32K cassette version only.  
 • TRS-80 Model II: 16K cassette or 32K Model II-4

VISA



The Trinity Computer Group • Software Agent/Publisher

Circle 366 on Inquiry card.

## CP/M® Compatible \$GOLD DISKS Z-80 Software

Z-80 Disassembler **\$175.**  
 ppd  
 creates assembly language source files

E-Z Text **\$75.**  
 ppd

unique text file word processor

## Bower-Stewart & Associates

POST OFFICE BOX 1389  
 HAWTHORNE, CALIFORNIA 90250  
 213 / 676-5055  
 Trademark  
 Digital Research

VISA

MasterCard

Circle 43 on Inquiry card.

## ARE WE CRAZY?

NO! WE ARE KLOFOK, the people that bring to you a system with so many features, it could sell for twice as much (like some of our competitors do). We believe high quality need not have a high price, and our systems prove it!

For just 1695.00, you'll get a Z-80 system with 64K of RAM, and up to 5K of bank-selected PROM. The two bidirectional parallel ports let you interface to almost anything. The basic system is equipped with one 5D 8" disk drive, but can easily be expanded to four giving you megabytes of on-line storage. You will have a console between an 80x24 terminal simulating video interface, or two serial ports, or even both (at an extra charge).

Our systems will run CP/M and MP/M, and we include our custom BIOS and KIDS, plus many other useful system utilities.

**KLOFOK**

PO BOX 93

SAN LUIS OBISPO, CA 93406 USA

(805) 528-7440

Note: CP/M and MP/M are both trademarks of Digital Research of Pacific Grove, CA

Circle 185 on Inquiry card.

## FACTORY PRIME STATIC RAM CHIPS

2114 Super Low Power  
 200ns. 1Kx4 ..... \$ 2.90  
 6514 CMOS 300ns. 1Kx4 ..... \$ 6.90  
 6116 CMOS 200ns. 2Kx8 ..... \$22.50  
 Add \$5.00 Handling on Orders Under \$200.00

**FACTORY PRIME** From the same shipments used in GIMIX Professional quality boards.

### 32KB STATIC RAM CARDS

for the S850 and S850C BUS  
 (16KB — \$298.12), (24KB — 348.14)  
 (32KB — \$398.15)

### NEW! 64KB BATTERY BACK UP

#### CMOS RAM CARDS

Two independently addressable 32KB blocks, each with extended addressing.

(56KB - \$394.56), (64KB - \$1088.64)

2MHZ 6809 56KB S850 SYSTEMS \$2498.29

**DISK SYSTEMS AVAILABLE**

**GIMIX inc.**



1337 W. 37th Place • Chicago, IL 60609  
 (312) 927-5510 • TWX 910-221-4055  
**The Company that delivers.**  
 Quality Electronic products since 1975.

GIMIX® and GIMIX™ are Registered Trademarks of GIMIX INC.

Circle 148 on Inquiry card.

## 1802 fig-FORTH

high-level compiler language

10-20X faster than BASIC

ELF II / SuperELF / Other

w/assembler-editor **\$60**

w/macro-assembl.  
 screen-editor **\$80**  
 extras

on cassette/requires 12K+RAM

SOFTWARE FOR SMALL COMPUTERS

P.O. Box 8443  
 Austin, Texas  
 78712

1382 Rio Grande  
 Austin, Texas  
 78705

VISA

1-512-477-2267

master charge

Circle 145 on Inquiry card.

## COMPUTER EQUIPMENT & SOFTWARE BARGAINS

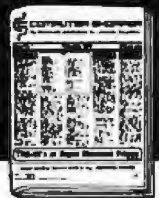

### EVERY MONTH

BUY, SELL OR TRADE ALL TYPES OF COMPUTER EQUIPMENT AND SOFTWARE (pre-owned and new) among 20,000 readers nationwide in BIG (11x14") pages. Classified ads are only 10¢ per word and are indexed for easy and fast location. Subscription: \$10 a year / 12 issues. Money back guarantee. Sample copy, \$1.50.

### COMPUTER SHOPPER

P.O. Box F-14

Titusville, FL 32780

(305) 269-3211

MasterCard or VISA subscription orders only.  
 call TOLL FREE 1-800-327-9920

Circle 78 on Inquiry card.

### SONAL COMPUTER 1000 Family

4" display, hi-res color or low res case popular in Japan. Prices compare with Apple II.

01A CPU  
A, 32K RAM  
Soft Basic  
Keyboard: Numeric pad, programmable keys parallel, one serial port

12A I/O  
RAM, expandable to 128K  
16 bus expansion

31A Mini-Diskette  
yes, 143K per drive  
V  
C-8001A \$1295 PC-8012A \$795  
9031A \$1295

Discount \$3200



Authorized Dealer

### QT SYSTEM H+

Byte hard disk  
2-Z-80A, 4 serial, 2 parallel  
RAM usable per user  
A multi-user DOS  
up to 1 MByte floppy  
Optional tape cartridge

SYSTEM H+ and SYSTEM+



### QT SYSTEM+

2-Z-80A, 2 serial, 2 parallel  
floppies, double density  
RAM, EPROM monitor for RS-232  
A 2.2  
onal 8, 8, or 12 slot motherboard  
onal single or double-sided floppies  
ad in—just add video terminal

EXP + 15 \$270 EXP + 48 \$310  
EXP + 32 290 EXP + 64 330  
(Less \$40—kit)

### QT MINI-SYSTEM+

ve with 5 1/4" floppies  
MINI-SYSTEM+ (5 1/4")

MS(6) \$2495 MSYS+DS(6) \$4495  
MS(8) 2595 MSYS+DS(8) 4595  
MS(12) 3795 MSYS+DS(12) 4895



### QT RAM+16

16K Static, S-100

switchable RAM  
ousands of happy customers

\$35 4MHz Kit \$180 4MHz A&T \$165

### QT DISK CAGES

2-801R, cab., ps, fan \$1250  
2-200S DT-8, cab., ps, fan 1875  
2-3 Cabmat, ps, fan, cables 325  
2-4 Cabinet only 58

2-801R \$390  
DT-8 585  
-61 250  
-52 350

### QT SBC+2/4

00 Single Board Computer

A, 2 or 4 MHz, switch  
ram, 1 parallel, 1 serial  
OM monitor (specify)  
A, programmable timers

\$185 A&T \$300

### STARWRITER

- Daisywheel printer
- Diablo compatible
- Nationwide service
- Centronics parallel or RS-232 serial
- 25 cps or 45 cps, specify

25-P \$1400 25-S \$1500  
45-P 1750 45-S 1850  
Tractor \$200



### EPSON MX-100

- Wide carriage
- Friction, tractor, graphics
- "Correspondence" quality print

Unbeatable price \$795

### SEALS IS BACK

Seals 64K Static S-100

- Uses Fujitsu MB8167, 16K x 1 static in 20 pin
- 70ns DMA to 14MHz
- Complete 16 bit or 8 bit flexibility
- IEEE S-100 and Cromem compatible

List \$1195 Now \$1050

### STATIC MEMORY SYSTEMS

64K Static S-100

- See ad, this issue
- Interim RAM and EPROM
- 200ns, very low power

SMS-64K A&T \$550

### QT Z+80 CPU

- 2 or 4 MHz, switch
- Monitor with jump
- Serial port to 9600 baud

Kit \$165 A&T \$225

### QT EXPANDABLE + REV II

S-100 64K Dynamic RAM

- 2 or 4 MHz, switch
- Bank switch, IEEE Standard
- On board refresh, 4 layer PCB
- Burned in, tested.

### QT I/O+

S-100 4 Parallel, 2 Serial

- On board crystal
- Prog baud
- 16 prog timers
- 8 level prog. interrupt

Brd \$70 Kit \$235 A&T \$375

### QT SILENCE+

S-100 Motherboards

- Full ground shield network
- Specify board, kit, or assembled

5-B \$25 8-B \$27 12-B \$30  
6-K .40 8-K .55 12-K .70  
8-A .60 8-A .70 12-A .80

18-B \$50 22-B \$75  
18-K 100 22-K 140  
18-A 140 22-A 180

### QT MAINFRAMES

- 18A power supply, 5-100
- Drive power supply
- Specify motherboard slots
- Specify 8", 5 1/4" or no floppy

2-8" Floppy w/motherboard  
MFB-6 \$625  
MFB-8 850  
MFB-12 875

2-5 1/4" Floppy—w/Motherboard  
MFS-6 \$450  
MFS-12 500

No Floppy—w/Motherboard  
MP-12 \$450  
MP-18 500  
MP-22 600

### QT SINGLE 8" CABINET

- Accepts one 8" floppy
- Power supply, fan, AC filter
- 117v AC/220v IAC
- Data cable, power cables

DDC-8 \$175



### SD SYSTEMS

20%+ Discount on A&T

All SD items available

38007	Z-80 Starter Board	\$424
38013	VDB-8024 (60 Hz)	444
38020	Expanderom II-16K	310
38023	Expanderom II-64K	370
38025	PROM 100	248
38059	Versafloppy II (RS-232)	400
38080	Versafloppy II (VDB-8024)	400
38061	SBC-200 (VDB-8024)	378
38062	SBC-200 (RS-232)	378

Call for kit, software, and cable prices.



### CALIFORNIA COMPUTER SYSTEMS

15% Discount

All CCS items available

S-100		
2032A	32K Static - 2 MHz	\$581
2032B	32K Static - 4 MHz	641
2116A	16K Static - 2 MHz	297
E116B	16K Static - 4 MHz	331
2200A	Mainframe	368
2210A	System	1800
2422A	Floppy Controller	380
2710A	4-Port Serial	289

APPLE

7114A	12K ROM/PROM Board	\$68
7440A	Programmable Timer	97
7470A	A/D Converter	182
7490A	GPB IEEE-488	255
7500A	Wire Wrap Board	20
7510A	Solder Tail Board	21
7520A	Extender Board	25
7710A	Serial Async Board	136
7728A	Centronics Parallel Bd	105
7811B	Arith Processor - disk	355
7811C	Arith Processor - ROM	355



### NEC SPINWRITER 55CPS

- Receives only, serial interface

Only \$2900

### IDS PAPER TIGERS

#445		\$710
#460G		1050
#560G		1300

### TELETEK

FDC-1	Single Board Computer	\$685
FDC-2	Double Density Controller	325

### QT S-100 EXTENDER

- With connector

Kit \$30 A&T \$35

### CABLES

RS-232	male/male - 9 ft.	\$24.00
RS-232	male/male - 18 ft.	29.00
RS-232	male/female - 9 ft.	29.00

### NEW ADDS VIEWPOINT

Smart CRT Terminal

- 80 x 24
- Detachable keyboard

The Best for Less \$625

### QT S-100 CARD CAGES

- 8, 6, or 12 slot
- Accepts Silance 1 mother
- With card guides
- Accepts 4" fan
- Specify with mother, with fan

8 Slot (5 1/2" w x 10 1/2" d x 8" h)  
CC-8 \$24  
CC-8M 80  
CC-8M/F 115

6 Slot (7 1/4" w x 10 1/2" d x 8" h)  
CC-6 \$39  
CC-6M 99  
CC-6M/F 134

12 Slot (11 1/4" w x 10 1/2" d x 8" h)  
CC-12 \$61  
CC-12M 114  
CC-12M/F 149

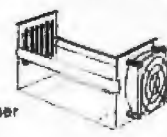

### ADES S-100 HARD DISK

- PRIM 3350 8" Winchester
- 31 MByte with CP/M 2.2
- With S-100 controller
- Cables, cabinet, power supply
- Full line available

#S33 List \$5195 Now \$3850



### 2 MBYTE FLOPPY FOR APPLE

- 2 double density, double sided 8" drives
- Cabinet, power supply, cable, controller
- DOS 3.3 compatible (Pascal and CP/M optional)
- This package is best spec for spec price for price
- Suggested List \$2550 Now Only \$2050
- SAVE \$500 CP/M Patch \$75 Pascal Patch \$75

### ADD-ON DRIVE FOR APPLE

- Works with Apple disk controller
- Functionally identical to Apple
- Expandable to 40 track

Pratte Fire Price \$375

### BULK DISKETTES

- Single side, double density
- Specify hard, soft, # of sectors
- Sold in hundreds

5 1/4" \$215/100 8" \$275/100  
Library cases  
5 1/4" \$25/10 8" \$32/10



### ANTI-STATIC CHAIR MAT

- 4'x5' black, hard
- With ground strap
- New religion—thousands of believers

List \$185 Special \$160

### QT CLOCK/CALENDAR+

Apple, S-100, TRS-80 (Specify)

- Date, month, year
- Day of week, leap year
- 24 hour or AM-PM
- 4 interrupt intervals
- With software
- Now with on-board battery

S-100/Apple/TRS \$150

### Floppy-Data: Card Edge

Type SD • Jade

DSC-34-1	Single, mini	\$24.00
DSC-34-2	Dual, Mini	29.00
DSC-34-4	Quad, Mini	34.00
DSC-50-1	Single, 8"	24.00
DSC-50-2	Dual, 8"	32.00
DSC-60-4	Quad, 8"	40.00

### Floppy-Data: Pin Type

CCS • Tarbell • Teletek

DSP-34-1	Single, Mini	\$24.00
DSP-34-2	Quad, Mini	29.00
DSP-34-4	Quad, Mini	34.00
DSP-50-1	Single, 8"	24.00
DSP-50-2	Quad, 8"	29.00
DSP-50-4	Quad, 8"	34.00

8" Floppy-DC Power  
POC-8 24" long \$7.00

### INTEGRATED CIRCUITS

4116 (200ns)	\$2.00	8257	17.95
2114 (450ns)	2.00	8295	16.50
2708	3.50	MC14411	11.00
2716 (5V)	6.50	14411(Xtal)	4.95
2716 (5-12V)	8.00	1771B01	24.85
2732	13.00	1791A01	37.95
4184 (200ns)	25.00	82350	7.95
Z-80A	12.95	N8T28	2.50
8080A	3.50	1488	1.25
8085A	20.00	1489	1.25
8086-4	80.00	D3242	10.15
TMS9900	29.95	TMS5001	19.00
8212	3.50	TR1802B	4.50
8214	4.50	6845P	22.00
8228	5.00	4118	16.95
8238	6.00	DP8304BN	4.00
8251	7.00		

Apple is a trademark of Apple Computer, Inc. CP/M and MP/M are trademarks of Digital Research. TRS-80 is a trademark of Radio Shack.

# BISON PRODUCTS

MAIL ORDER: PO Box Q, Sherman Oaks, CA 91423 Circle 39 on inquiry card.  
 RETAIL: 15620 S. Inglewood Ave., Lawndale, California 90260  
 (213) 970-1476 (800) 421-5150 1/2 Block South of San Diego Fwy.  
 TERMS OF SALE: Cash, checks, credit cards, C.O.D. Calif. residents add 6% sales tax.

## FULL ELIZA FOR YOUR MICRO!

AT LAST! A FULL IMPLEMENTATION of the original ELIZA program is now available for use on your microcomputer! Created at MIT in 1966, ELIZA has become the world's most celebrated artificial intelligence demonstration program. ELIZA is a non-interactive psychotherapist who analyzes each statement as you type it and then responds with her own comment or question. Responses here is usually meaningful and her remarks are often extremely appropriate. Designed for use on a single mainframe, ELIZA has recently been redesigned to operate on any computer - a concept of greatly simplified design using the sophistication which made the original program so fascinating. Now a new version possessing the full power and range of expression of the original is available to run on any CP/M compatible microcomputer system with at least 60K of RAM. Supplied as a 3.5" CD-ROM machine language file on a standard 5 1/4" diskette, the program is being offered for a limited time at the introductory price of only \$25. And if you want to find out if the software is for you, we will include the complete Source Program, written in Microsoft BASIC-80, Version 3.03, for only \$20 additional. Circle 28 today if ELIZA 2000 and you'll receive a free video file to register when the CD-ROM arrives. Only lets you what the computer of yours can actually do!

HERE IS AN ACTUAL SAMPLE OF ELIZA'S CONVERSATIONAL ABILITY. ELIZA'S comments are printed in capital letters.

AI: How are you?  
 IN WHAT WAY?  
 They're always bugging me about something or other.  
 CAN YOU TALK OF A SPECIFIC EXAMPLE?  
 Well... my boyfriend made me come here.  
 YOUR BOYFRIEND MADE YOU COME HERE. THAT'S INTERESTING.  
 I need some help, but I can't seem to think of what to do.  
 WHAT WOULD IT MEAN TO YOU IF YOU GOT SOME HELP?  
 Perhaps I could learn to get along with my mother.  
 TELL ME MORE ABOUT YOUR FAMILY.  
 You are her only child, is that correct?  
 WHAT RESEMBLANCE DO YOU SEE?  
 You are almost her.  
 DOES THAT HAVE ANYTHING TO DO WITH THE FACT THAT YOUR BOYFRIEND MADE YOU COME HERE?  
 I'm sure he is ahead of everything.  
 WHAT ELSE COMES TO MIND WHEN YOU THINK OF YOUR FATHER?  
 (Silence)  
 DOES THAT HAVE ANYTHING TO DO WITH THE FACT THAT YOUR BOYFRIEND MADE YOU COME HERE?

### ARTIFICIAL INTELLIGENCE RESEARCH GROUP

921 NORTH LA JOLLA AVENUE  
 LOS ANGELES, CALIFORNIA 90048  
 (213) 856-7368 (213) 854-2214  
 MC VISA, and CHECKS ACCEPTED



Circle 28 on inquiry card.

# floppy disks.

100% CERTIFIED AND TESTED  
 PREMIUM QUALITY



Immediate off the shelf delivery... one box or quantity orders welcome.

## SAVE UP TO 40%

WE PAY SHIPPING!

CALL OUR ORDER DESK NOW!

Western States: Los Angeles... (213) 469-9861  
 Phoenix... (802) 277-5766

Central States: Dallas... (214) 988-1885

All Others: ..... (805) 985-9824

MASTERCARD - VISA - C.O.D.

### NATIONAL DATA SUPPLIES, INC.

Circle 252 on inquiry card.

## — Discounts Discounted —

We Feature

CP/M — Osborne — Rejas — Forth  
 Micro-soft — Micro-Pro —  
 Micro-AP — Fortran — S-Basic

Special Feature Packages

CP/M — Peachtree Programs

General Ledger

Acci. Rec.

Acci. Payable

Pay Roll

Inventory

Mailing Address

\$1250.00  
 Plus — Sales Tax  
 Plus — Shipping

This sale terminates when this ad closes.  
 Act Now.



Write for our free catalog

## PACIFIC DISCOUNT SOFTWARE

3204-A Production Avenue  
 Oceanside, California 92054  
 Telephone (714) 439-6201

Circle 276 on inquiry card.

## CROMEMCO USERS

### PMSI INTRODUCES

A UNIQUE PERSONAL REPORTING SYSTEM FOR SMALL BUSINESSES AND INDIVIDUALS

#### BANKKEEPING \* REPORTER

FOR Offers Current Cash Flow Analysis and Complete Professional Picture for Each Month and Business Year To Date. Available in All Types of Businesses, Farms, Property Management and Investments.

FOR Provides a Unique Budget for Family and Individual Expenditures for Current Month and Year To Date. Shows a Monthly Record of Tax Deductible Items as Well as a Complete Listing of All Tax Deductible Items for the Entire Year.

AVAILABLE FOR CDS - or EPROM - FOR FLOPPY OR HARD DRIVE SYSTEMS

Perfect Package for CPA's, Bookkeeping Services, Service Business, Banks and Savings/Loans.

\* ALL INDIVIDUAL BUSINESS PACKAGES FOR CROMEMCO USERS

PRACTICAL MANAGEMENT SYSTEMS, INC.  
 P.O. BOX 1301 2900 KING STREET  
 JONESBORO AR 72401  
 501 932 8208

— DEALER DISCOUNTS AVAILABLE —

\* Registered trademark of Cromemco, Inc.  
 \* Registered trademark of Practical Management Systems, Inc.

Circle 288 on inquiry card.

## ATARI<sup>®</sup>

Atari 800 16K .....	\$10.00	16K RAM .....	\$5.00
Atari 800 48K .....	\$50.00	Atari 850 Interface .....	\$175.00
Atari 810 Disk .....	\$480.00	Atari 830 Modem .....	\$156.00
Atari 400 16K .....	\$79.00	Microsoft Basic .....	\$72.00

#### TELECOMMUNICATIONS PACKAGES

Base Unit, AB50, AB30, TeleLink I  
 with 800: \$1150.00 with 400: \$710.00  
 PLUS FREE NOVATION SUPERMIKE!

The Bit Bucket is a company made up of computer professionals. We are able to provide low prices as well as technical support. Give us a call and find out why we consider the Atari the best home computer on the market today. You won't be disappointed.

### The Bit Bucket

Specializing in Atari Home Computers  
 P.O. Box 365  
 Newton Highlands, MA 02161  
 (617) 783-3144

Circle 40 on inquiry card.

## FORTH FOR/MAT™

SCREEN EDITOR

### A MUST FOR THE SERIOUS FORTH PROGRAMMER

- All code is Forth-79 standard. Each line of code is fully explained and flow-charted (Forth style) for easy modification.
- This editor works just like the popular word processors on the market except it is written in high level forth and is confined to the 1024 byte boundary of a forth screen.
- There are over 20 different commands for cursor positioning, text modification, tabs, relocating lines, spreading lines, and moving lines to other screens.
- Insert mode is toggled on and off for midstream insertions and deletions. Text ahead of CP is moved right during insertion and left during deletion if insert mode is on.
- Column position is displayed at all times.
- Bomb proof — all unused control codes are trapped.
- Must be used with a CRT that has cursor addressing or with a memory mapped video.
- Send check or money order in the amount of \$50.00 and receive complete source code, flowcharts, documentation, and instructions for bringing up on your system.

KV33 CORPORATION  
 P.O. BOX 27246  
 TUCSON, AZ 85726  
 (802) 889-5722

Circle 186 on inquiry card.

# EPSON

## DOT MATRIX PRINTERS

### SUPER DISCOUNTS ON

MX-80F/T	3600* LOWER!	NOW
MX-80	\$495 LOWER!	IN
MX-100	\$890 LOWER!	STOCK

We also stock direct connect cables for TRS-80, Apple, Atari, Pet or RS 232

CALL TOLL FREE

## 1-800-344-7493

In CA and for service (209) 667-2888

MICROTRONICS, inc..

475 N. Colton Street Blvd  
 Los Angeles, California 90008

Circle 198 on inquiry card.

## Heath/Zenith 89 Users

### 16K MEMORY EXPANSION CARD

to make a  
 H/Z89 a 64K  
 machine.  
 Assembled  
 and Tested  
**\$100.00**

#### COMPUTER TABLES

60 x 28 x 28	<b>\$186.40</b>
48 x 28 x 28	<b>\$162.40</b>

Shelves Available

**PRINTER STAND \$75.00**

data systems

AUTHORIZED SERVICE CENTER

#### SECURED COMPUTER SYSTEMS

12011 Acilare St. • Cerritos, CA 90701  
 (213) 924-6741 *Shipping not included*

Circle 328 on inquiry card.

## ANALOG ↔ DIGITAL

## DIGITAL ↔ ANALOG

### CONVERSION MODULES

#### SOFTWARE GAIN CONTROL

high accuracy conversion time from 1 to 1024 channels differential high frequency amplifier	programmable gain instrumentation amplifier
custom board test \$100	gain control and hold complete \$100
mixable high and low inputs	16-channel
2 to 15 the conversion time	programmable gain instrumentation amplifier
from 1 to 1024 channels differential	16-bit sample and hold amplifier
high accuracy	programmable gain instrumentation amplifier

For additional details about the AD-100-4 and other fine California Data Corporation 100% individually tested, high reliability products, circle the reader service card number below or for faster response write or call us.

### CALIFORNIA DATA CORPORATION

3475 Old Conajo Road, Suite C-10  
 Newbury Park, CA 91320  
 (805) 498-3651

Circle 50 on inquiry card.



**DEALS □ DEALS □ DEALS**

OUR BUYERS ARE IN CONTACT WITH EVERY MAJOR SUPPLIER AND O.E.M. BUY HERE AT 1000 PIECE

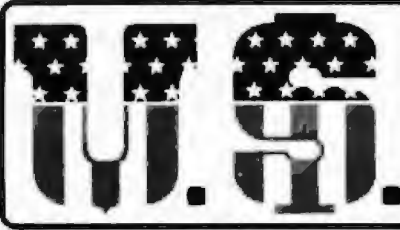

**MICRO SALES**

**QUANTITY PRICES**

ALL MERCHANDISE 100% GUARANTEED! 15 DAY FULL CASH REFUND!

11 EDISON DRIVE ★ NEW LENOX ★ ILLINOIS 60451  
CALL TOLL FREE: 1-800-435-9357 ★ MONDAY thru SATURDAY  
(ILLINOIS RESIDENTS CALL: 815-485-4002) ★ 8:00 a.m. to 6:30 p.m.

TERMS: Prepayment — C.O.D. up to \$100.00 — M/C Visa \$5.00 Processing and Handling added to each order PLUS Shipping Charges. Please allow personal check to clear before shipment.

**JUST HOT STUFF**

**SPECIAL OF THE QUARTER**

**SPECIALS OF THE MONTH**

**POWER SUPPLIES**

If you can beat these prices we will be truly amazed. OEM's at 500 lot pay more than this. Call or write for full spec. sheets.



DISK POWER SUPPLIES				
PRIAM - SHUGART - CENTURY - MICROPOLIS				
+5V @ 9A	-5V @ 3A	+24V @ 7A	US-384	89.00
SHUGART - SIEMANS - MPI 5 1/2"				
+5V @ 5A	+12V @ 9A		US-340	33.50
+5V @ 2A	+12V @ 4A		US-323	56.25
SHUGART - SIEMANS - CDC 8"				
+5V @ 1A	-5V @ 5A	+24V @ 1.5A	US-205	52.50
+5V @ 2A	-5V @ 5A	+24V @ 3A	US-206	69.00
+5V @ 3A	-5V @ 6A	+24V @ 5A	US-162	89.00
+5V @ 1.7A	-5V @ 1.5A	+24V @ 2A	US-272	69.00
+5V @ 2A	+12V @ 4A	-12V @ 4A	US-HTAA	37.50

**TELEVIDEO 950**

Televideo 950 — \$950.00  
Televideo 912C — 665.00  
Televideo 920C — 720.00  
ADDS R-25 — 710.00

Also have 920C, SOROC, HAZELTINE, etc. What we don't have is room on this page. Call Toll Free 800 number for prices.



**C-ITOH PRINTER**

**\$499.00**

Look closely at the photo and see other adds in this rag at \$995.00. Perfect units, warranted. Only 500 pcs. Same story, manufacturer had too many.



**S-100 CARD EXTENDER**

**\$12.50**

(Gold Contacts)

As long as there is a price war, we will fight your battle. Compare at your local Dept. store and buy U.S. MICRO.



**MEMOREX — VERBATUM — WABASH BASF FLOPPIES**

BOX OF 10 ONLY:

5 1/4"	SOFT	\$2.65 ea.
5 1/4"	HARD 10	2.55 ea.
5 1/4"	HARD 16	2.65 ea.
8"	SOFT 1D	3.25 ea.
8"	SOFT 2D	3.85 ea.
8"	SOFT 2DDS	5.00 ea.



**S1-MOD (KIT)**

**\$189.00**



Complete S-100 12 Slot Computer. Ample system power with regulated power for drives. Excellent for Subsystem or Hobby use. 4 hours to build. (6 conn. incl., less fans)

**DUAL DRIVE SUBSYSTEM**

**\$995.00**

\$195.00 w/no Drives  
If this looks like a Lobo Drive System, don't be fooled. Just because it looks like one, works like one, smells like one, and tastes like one (?) doesn't mean it has to cost like one!



**TWIN VERTICAL DRIVES**

5" \$550.00 — 8" \$980.00

Attractive, convenient and compact Two Drive Mass Storage includes Power Supply, Drives, Cabinets and Cables. Double Sided, Double Track available too!



**Z-80 CPU (KIT)**

The first time this world popular CPU offered in Kit. 2 serial, 3 parallel, CTC, EProm Z-80 at 4 mhz. Software busd rate, etc. (less Prom & cable) \$212.00



**EXPANDABLE RAM**

★SPECIAL★SPECIAL★SPECIAL★

This is the best all around 64K board you can buy. If after you see it, you don't agree return for full refund. Bank Select by extended address lines or I.O. 40H.



★\$389.00 A & T★

US — DSK \$255.00

Double Density 8" and 5" Disk Controller designed for S-100 IEEE standards. Uses Western Digital 1795, 1691 2143 Chip Set.

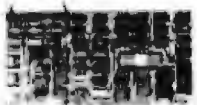

**FANS \$14.95**

These are brand new, in the box fans. Not noisy bearing pullouts. Never again at these low prices!

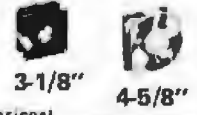

**4116s**

**\$2.95**

Expansion 16K Dynamic RAMs for Apple, TRS-80 S-100 systems. T.I., Mostek Intel, Call for manufacturer.

200 NS

**INTEL**

**8251 \$4.95**

**8255 \$6.50**

VERY POPULAR I.O. CHIPS BY LEADING MANUFACTURER

**2114s**

**\$3.25**

One of the world's two most popular STATIC RAMs. Factory prime tested units. Sold in lots of 8 only. FUJITSU, HITACHI, etc.



200 NS

**TMS-4044**

**\$4.25**

**MM-5257**

**INTEL 2147**

250 NS

CMOS Version \$4.50!

The other of the world's most popular STATIC RAMs. This one is 4K by 1 organization. Don't buy Gold, buy these, the price won't last!

**2716s**

**\$7.50 (450 NS)**

**2708s**

**\$6.95 (450 NS)**

Remember when 2716s were \$50.00 and hard to get? These units are so beautiful it's hard to part with them. But we will, for a small price. Guaranteed!

**SHUGART DRIVE**



**8" 801R**

**\$395.00**

Manufacturer had too many, buys at 1000 piece rate, sales dropped, so we got'em. Fantastic buy, get them while they last! Full warranty.

**8" 851R \$585.00**

**SIEMANS DRIVE**

**8" 100-8**

**\$375.00**

Very Special Price on these BRAND NEW current production units Add \$10.00 for Extended 1 Year Warranty!



# COMPUTER STOP

2545 W. 237 St. Torrance, CA. 90505

ORDER BY PHONE  
MON.—SAT.  
10-6

(213) 539-7670 PST  
TELEX: 678401 TAB IRIN

**LOWEST PRICES IN THE WEST, NORTH, SOUTH & EAST**



**apple computer 1-800-421-1947**  
Sales and Service

APPLE /// OPTION A: .....	3850
APPLE /// 96K Information Analyst Package 12" B/W Monitor	
APPLE /// OPTION B: .....	4350
SAME AS OPTION A PLUS: DISK II for APPLE ///	
APPLE /// OPTION C: .....	4800
SAME AS OPTION A PLUS: DISK II FOR APPLE ///	
SILENTYPE Thermal Printer	



## APPLE HARDWARE

Parallel Printer Interface Card .....	160
Communications Card .....	195
High Speed Serial Interface .....	160
Pascal Language System .....	425
Centronics Printer Interface .....	185
Applesoft Firmware Card .....	160
Integer Firmware Card .....	160
Disk ][ with Controller DOS 3.3 .....	529
Disk ][ only .....	475
Graphics Tablet .....	625

## OTHER HARDWARE

All Music Synthesizer (3 Voice) .....	245
9 voice .....	175
ABT Numeric Keypad .....	119
Micromodem ][ .....	295
Apple Clock .....	245
Rom Plus with Keyboard Filter .....	175
Introl/X-10 System .....	250
Romwriter .....	150
DoubleVision 80 x 24 Video Interface .....	245
CCS Arithmetic Processor .....	399
CCS Parallel Interface .....	119
16K Ram Card .....	145
Microworks DS-65 Digisector .....	339
SVA 8 inch Disk Controller .....	335
Sup-R-Mod .....	30
CCS Synchronous Serial Interface .....	119
CCS Asynchronous Serial Interface .....	99
Corvus 10 Meg. Hard Disk .....	4395
Corvus Constellation .....	595

## MISCELLANEOUS/SUPPLIES

16K RAM (200-250 NS) .....	29
Verbatim Datalife Diskette (Box of 10) .....	30
Dysan Diskettes (Box of 5) .....	22
Apple Diskettes (Box of 10) .....	45
Verbatim Diskette Boxes (Holds 50 Disks) .....	18
Silentye Paper (Box of 10 rolls) .....	40

## MONITORS/DISPLAYS

Leadex Video 100 12" .....	140
Sanyo 9" Monitor .....	195
KG-12C Green Phos. Monitor .....	275
Sanyo 12" Green Phosphor. Monitor .....	275
NEC 12" Green Phosphor. Monitor .....	275
Sanyo 12" B/W Monitor .....	250

## PRINTERS

Apple Silentye with Interface .....	525
IDS 445 (Paper Tiger) with Graphics .....	650
IDS 460 with Graphics .....	1049
IDS 560 with Graphics 10) .....	1199
Centronics 737 .....	795
NEC Spinwriter (RO, Serial) .....	2650

## SOFTWARE

The Controller .....	525
Apple Post (Mailing List Program) .....	40
Easywriter Professional System .....	195
Apple Pie 2.0 .....	95
DB Master Data Management .....	175
The Cashier .....	210
Apple Writer .....	65
Visicalc .....	170
CCA Data Management System .....	90
Full Screen Mapping for CCA DMS .....	59
Pascal Interactive Terminal Software (PITS) .....	29
Basic Interactive Terminal Software (BITS) .....	29
Data Capture .....	29
Data Factory DMS .....	110
Apple Plot .....	55
Apple Pilot .....	120
Magic Wand Word Processor (Needs Z-80 Softcard) .....	345
Dow Jones Portfolio Evaluator .....	45
Fortran .....	140

**ORDERING INFORMATION:** Phone orders invited using VISA, MASTERCARD or bank wire transfers. VISA & MC credit card service charge of 2%.

Mail order may send charge card number (include expiration date), cashier's check, money order or personal check (allow 10 business days to clear.) Please include a telephone number with all orders. Foreign orders (excluding Military PO's) add 10% for shipping. All funds must be in U.S. dollars (letters of credit permitted). Shipping, Handling and Insurance in U.S. add 3% (minimum \$4.00). California residents add 6% sales tax. Our low margins prohibit us to send COD or on purchase orders or open account (please send for written quotation). All equipment is subject to price change and availability. Equipment is new and complete with the manufacturer warranty. We do not guarantee merchantability of products sold. All returned equipment is subject to a 15% restocking fee. We ship most orders within 2 days.

WE ARE A MEMBER OF THE CHAMBER OF COMMERCE.

RETAIL STORE PRICES MAY DIFFER FROM MAIL ORDER PRICES.

PLEASE SEND ORDERS TO:  
**COMPUTER STOP, 2545 W. 237 St., TORRANCE, CA 90505**



CALIFORNIA COMPUTER SYSTEMS

## S100

2032 32K STATIC RAM A & T	
450NSEC \$579.00 300NSEC \$585.00 200NSEC \$629.00	
2116 16K STATIC RAM A & T	
450NSEC \$285.00 300NSEC \$289.00 200NSEC \$329.00	
2055 64K DYNAMIC RAM A & T	\$548.95
2200 S-100 MAIN FRAM A & T	\$379.95
2422 FLOPPY DISC WITH CP/M 2.2™	\$329.95
2802 6502 PROCESSOR A & T	\$282.95
2810A Z80 CPU A & T	\$249.95
2710A 4 SERIAL I/O A & T	\$281.95
2718A 2 SERIAL, 2 PARALLEL A & T	\$305.95
2720A 4 PARALLEL A & T	\$214.95
PROTO BOARDS WW \$39.95. SOLDERTAIL \$29.95	

## APPLE PRODUCTS

7114A 12K ROM/PROM	\$68.50
7424A CALENDAR/CLOCK	\$106.95
7440A PROGRAMMABLE TIMER	\$88.50
7470A A TO O CONVERTER	\$105.95
7480A GPIB (IE 488) INTERFACE	\$265.95
7710A ASYNC SERIAL	\$125.95
7712A SYNC SERIAL	\$153.95
7720A PARALLEL STANDARD	\$98.95
7720B PARALLEL CENTRONICS	\$98.95
7811B ARITHMETIC PROCESSOR W/DISC	\$342.95
7811C ARITHMETIC PROCESSOR W/ROM	\$342.95
7500A WW BOARD	\$22.95
7510A SOLDERTAIL BOARD	\$23.95

## SOFTWARE

2810 CP/M™ MACRO ASSEMBLER ON DISK	\$76.95
2820 CP/M™ SYMBOLIC INSTRUCTION DEBUGGER	\$64.25
2830 CP/M™ TEXT FORMATER	\$64.25
2840 CP/M™ BACKGROUND PRINT UTILITY	\$42.95

OTHER CCS PRODUCTS ARE AVAILABLE  
CALL FOR PRICE.



MICROCOMPUTER PRODUCTS

## S100 PRODUCTS

CB1A 8080 PROCESSOR PCBD	\$32.95
KIT \$155.95, A & T	\$215.95
CB-2 280 PROCESSOR BOARD	
KIT \$198.95, A & T	\$269.95
VB1C 64 x 16 VIDEO, PCBD	\$32.95
KIT \$153.95, A & T	\$199.95
VB2 64 x 16 VIDEO, PCBD	\$32.95
KIT \$175.95, A & T	\$234.95
VB3 80 CHARACTER VIDEO 4MHZ	
KIT \$345.95, A & T	\$425.95
UPGRADE RAMS FOR VB-3	\$42.00
104 2 PARALLEL, 2 SERIAL PCBD	\$32.95
KIT \$155.95, A & T	\$194.95
PR-1 270B, 2716 PROGRAMMER BOARD	
KIT \$135.95, A & T	\$185.95
MB-10 16K STATIC RAM	
KIT \$299.95, A & T	\$339.95

## APPLE PRODUCTS

A488 IEEE 488 INTERFACE	\$399.95
A10 SERIAL/PARALLEL INTERFACE	
KIT \$125.95, A & T	\$155.95
AS10 SERIAL I/O	
KIT \$87.95, A & T	\$97.95
AP10 PARALLEL I/O	
KIT (W/O CABLES) \$67.95, A & T (W/O CABLES) \$87.95	

OTHER SSM PRODUCTS ARE AVAILABLE  
CALL FOR PRICES.

# MIKOS

MONDAY-FRIDAY, 9:00 TO 12:00 1:00 TO 5:30  
THURSDAYS 9:00 TO 3:00 P.M.

(415) 728-9121

P.O. BOX 955 • EL GRANADA, CA 94018  
PLEASE SEND FOR IC, XISTOR AND COMPUTER PARTS LIST

SEPT. SPECIAL SALE  
ON PREPAID ORDERS

(CHARGE CARDS AND C.O.D. OR P.O. NOT AVAILABLE ON THESE OFFERS)

WAMECO BOARDS WITH MIKOS PARTS 10% OFF  
ADVERTISED PRICE

**WMC inc.** WAMECO INC.  
BOARDS WITH MIKOS PARTS

MEM-3 32K STATIC RAM, PCBD	\$36.95
KIT LESS RAM \$95.95, A & T	\$135.95
CPU-2 Z80 PROCESSOR, PCBD	\$32.95
KIT LESS ROM \$109.95, A & T	\$149.95
EPM-2 16K/32K EPROM, PCBD	\$32.95
KIT LESS ROM \$65.95, A & T	\$99.95
FPB-1 FRONT PANEL, PCBD	\$48.50
KIT \$144.95, A & T	\$184.95
CPU-1 8080 PROCESSOR PCBD	\$29.95
KIT \$89.95, A & T	\$129.95
OMB-12 13 SLOT MOTHER BOARD, PCBD	\$39.95
KIT \$95.95, A & T	\$135.95

OTHER WAMECO PRODUCTS ARE AVAILABLE  
CALL FOR PRICES

MIKOS PARTS ASSORTMENTS ARE ALL FACTORY MARKED PARTS. KITS INCLUDE  
ALL PARTS LISTED AS REQUIRED FOR THE COMPLETE KIT. LESS PARTS LISTED  
ALL SOCKETS INCLUDED.

LARGE SELECTION OF LS TTL AVAILABLE.  
PURCHASE \$50.00 WORTH OF LS TTL AND GET 10% CREDIT  
TOWARD ADDITIONAL PURCHASES. PREPAID ORDERS ONLY.

VISA or MASTERCARD: Send account number, expiration number, expiration date  
and right your order. Approx. postage will be added. Check or money order will be sent  
paid in U.S. If you are not a regular customer, please use charge, cash, or check or  
partial money order. Otherwise there will be a two-week delay for checks to clear. Cash  
requirements add 6% tax. Money back 30-day guarantee. We cannot accept returned IC's  
that have been suspended to. Prices subject to change without notice. \$10 minimum order.  
\$1.00 service charge on orders less than \$10.00.

# STOP

## DON'T TURN THIS PAGE...

...if you are tired of dealing with mail order houses that never have in stock what you need, when you need it. We are not a mail order house. Micro Source of Texas is a stocking wholesale distributor of microcomputer printers, video display terminals, and supplies. What makes us different? We don't just take orders!

Whether you're a dealer, systems integrator or first-time micro user, you expect help from your supplier in determining the best product to fit a particular application. We give that help, and more. Since complete documentation is essential, we provide it with every order we ship. And if you're located in Texas, stop by and we'll demonstrate our products without obligation. Try to do that mail order!

Don't waste valuable time. Talk to Micro Source. We can help.

*Micro*  
**SOURCE**

# LOOK

## AT THESE POPULAR...

...low cost, high quality products:

- EPSON MX-80 matrix printer
- C.I.TOH "Starwriter" WP printer
- TELEVIDEO Model 910 CRT terminal and many more!

What about supplies? No hassle. We stock ribbons and accessories for EPSON, C.I.TOH, DIABLO, QUME, NEC, DEC, and CENTRONICS printers. All products and supplies are in stock, available for immediate delivery.

Micro Source of Texas is a specialty distributor handling only peripheral hardware. We don't sell microcomputers or software. So if you're a systems dealer, consider us a dependable supplier, not a competitor.

Micro Source wants to be your source.

Micro Source of Texas, Inc.  
834 N. Glenville Drive  
Richardson, Texas 75081

# 214-690-5111

# LISTEN

## TO WHAT WE OFFER...

### LOW PRICES

The best in the industry! Because of our volume purchases, we offer attractive discounts to independent dealers and micro systems builders. Call or circle our reader inquiry number and receive a current dealer price list and catalog.

### IMMEDIATE DELIVERY

We stock a variety of popular micro printers and display terminals including EPSON, C.I.TOH, and TELEVIDEO. If your needs are immediate, we'll ship within 24 hours of receiving your order. And if you're nearby, just drop in and pick up your order the same day.

### TECHNICAL ASSISTANCE

Micro Source offers in-depth application assistance to Apple, Commodore, and TRS-80 dealers, among others. We want you to buy the right product with the right interface at the right price. Product support and courteous service are "standard features" with Micro Source. Call today and make us prove it!

## WE'RE IN TEXAS

Ask about our **NO FREIGHT CHARGE** special offer to Texas customers

# DOWN-TO-EARTH PRICES ON OUT-OF-THIS-WORLD PERSONAL COMPUTERS AND COMPONENTS.

Look at this!



## Ohio Scientific Superboard II \$329

- It's the first complete computer system on a board.
- Superboard II uses the ultra powerful 6502 Microprocessor
- 8K Microsoft BASIC-in-RDM
- 4K static RAM on board, expandable to 8K
- Full 53-key keyboard, with upper and lower case. Plus user expandability.
- Video interface and audio cassette interface.

The Ohio Scientific Superboard II at \$329 — in today's economy — has got to be the best buy by far. It will entertain you with spectacular graphics made possible by its ultra high resolution graphics and super fast BASIC. It will help you in school or industry, as an ultra powerful scientific calculator. Advanced scientific functions and a built-in "immediate" mode allow you to solve complex problems without programming.

The Superboard II can be expanded economically, for business uses, or to remotely control your home appliances and security. Even communicate with other computers.

### Read what's been written about Superboard II:

"We heartily recommend Superboard II for the beginner who wants to get into microcomputers with a minimum cost. A real computer with full expandability."

—POPULAR ELECTRONICS, MARCH 1979

"The Superboard II is an excellent choice for the personal computer enthusiast on a budget."

—BYTE, MAY 1979

Look at these easy hardware prices:

<b>610 Board</b> For use with Superboard II and Challenger 1P. 8K static RAM. Expandable to 24K or 32K system total. Accepts up to two mini-floppy disk drives. Requires +5V @ 4.5 amps.	<b>\$ 298</b>
<b>Mini-Floppy Disk Drive</b> Includes Ohio Scientific's PICO DOS software and connector cable. Compatible with 610 expander board. Requires +12V @ 1.5 amps and +5V @ 0.7 amps. [Power supply & cabinet not included.]	<b>299</b>
<b>630 Board</b> Contact us for important details.	<b>229</b>
<b>AC-3P</b> 12" combination black and white TV/video monitor.	<b>159</b>
<b>4KP</b> 4K RAM chip set.	<b>79</b>
<b>PS-005</b> 5V 4.5 amp power supply for Superboard II.	<b>45</b>
<b>PS-003</b> 12V power supply for mini-floppies.	<b>45</b>
<b>RF Modulator</b> Battery powered UHF Unit.	<b>35</b>
<b>AC-12P</b> Wireless remote control system. Includes control console, two lamp modules and two appliance modules, for use with 630 board.	<b>175</b>
<b>AC-17P</b> Home security system. Includes console, fire detector, window protection devices and door unit for use with 630 board.	<b>249</b>
<b>C1P Sams</b> C1P Service manual	<b>8</b>
<b>C4P Sams</b> C4P Service manual	<b>16</b>
<b>C3 Sams</b> Challenger III manual	<b>40</b>

Ohio Scientific and independent suppliers offer hundreds of programs for the Superboard II, in cassette and mini-floppy form.

**Freight Policies** All orders of \$100 or more are shipped freight prepaid. Orders of less than \$100 please add \$4.00 to cover shipping costs. Ohio residents add 5.5% Sales Tax.



Hours: Call Monday thru Friday  
8:00 AM to 5:00 PM E.D.T.  
TOLL FREE: 1-800-321-5805

**Guaranteed Shipment**  
Cleveland Consumer Computers & Components guarantees shipment of computer systems within 48 hours upon receipt of your order. Our failure to ship within 48 hours entitles you to \$39 of software, FREE.

**To Order:** Or to get our free catalog CALL 1-800-321-5805 TOLL FREE. Charge your order to your VISA or MASTER CHARGE account. Ohio residents call: (216) 464-8047. Or write, including your check or money order, to the address listed below.



## CLEVELAND CONSUMER COMPUTERS & COMPONENTS

P.O. Box 46627  
Cleveland, Ohio 44146

**Order Form:** CLEVELAND CONSUMER COMPUTERS & COMPONENTS P.O. Box 46627 Cleveland, Ohio 44146

- |  |   |
|--|---|
| <input type="checkbox"/> Superboard II \$329.          | <input type="checkbox"/> RF Modulator \$35.           |
| <input type="checkbox"/> 610 Board \$298.              | <input type="checkbox"/> AC-3P 12" B/W Monitor \$159. |
| <input type="checkbox"/> Mini-Floppy Disk Drive \$299. | <input type="checkbox"/> C1P Sams Manual \$8.         |

[Attach separate sheet for other items.]

NAME \_\_\_\_\_

ADDRESS: \_\_\_\_\_

CITY: \_\_\_\_\_ STATE: \_\_\_\_\_ ZIP: \_\_\_\_\_

PHONE: \_\_\_\_\_

Payment by: VISA \_\_\_\_\_ MASTER CHARGE \_\_\_\_\_ MONEY ORDER \_\_\_\_\_

Credit Card Account # \_\_\_\_\_

Expires \_\_\_\_\_ Interbank # [Master Charge] \_\_\_\_\_

TOTAL CHARGED OR ENCLOSED \$ \_\_\_\_\_ [Ohio Residents add 6.5% Sales Tax]

Orders of less than \$100, please add \$4.00 to cover shipping costs. Orders will be accepted from U.S. and Canada only. All prices quoted are U.S., date of publication, standard UPS shipping FOB the factory.

PRICES SUBJECT TO CHANGE WITHOUT NOTICE



# INCREDIBLE? BELIEVE IT!

## PRINTERS



150 cps bidirectional-9x9 dot matrix, quietized case, 136 col, vertical form control and many other functions

**\$1195**

We feel this printer offers the best price/performance ratio available. RS-232 serial to 19,200 baud x-on, x-off add \$40

**Teletype 40**, 300 LPM-typewriter quality, RS-232 interface This quality printer is available in many configurations including forms access, quietized case, etc. **from Only \$2928**

**Teletype 43** **from \$995**

**Teletype AP-200**, 340 cps dot matrix (similar to Data Prod. M-200) **\$2799**

**NEC Spinwriter-55** cps, bidirectional, letter quality **\$2660**

**DIABLO 630-40** cps, bidirectional, daisy wheel, plot/graph **\$2449**

**C. ITOH Starwriter**, 25 cps, daisy wheel **\$1575**

**C. ITOH Starwriter**, 45 cps, daisy wheel **\$1849**

**EPSON MX-80**, 80 cps, 9x9 dot matrix **SCALL**

**ANADEX 9500/9501**, up to 200 cps, high resolution dot **\$1349**

**OKIDATA Microline 80**, 80 cps, 9x7 dot matrix **\$490**

**Microline 82**, bidirectional, friction/pin feed **\$599**

**Microline 83**, bidirectional, 120 cps, uses 15" paper **\$875**

**TI-810**, 150 cps, Basic **\$1695**

**Package-Compressed** print, vertical form control **\$1830**

**CENTRONICS 704-9**, 180 cps, 9x9 dot matrix, 132 col, RS-232 **\$1595**

**704-11**, 180 cps, 9x9 dot matrix, 132 col, parallel **\$1695**

**730**, 100 cps, 7x7 dot matrix, same as R.S. LPIII **\$660**

**737**, 80 cps, 9x9 dot matrix, same as R.S. LPIV **\$849**

**739 Graphics** **SCALL**

**DEC LA-34** **\$1085**

**IDS 460G** **\$1199**

## S-100 SPECIALTIES



**DP12-80A**, CPU, 64K ram, floppy cont., RS-232 port, SIOO IEEE, 8 slot in adds terminal, inc. CP1M 2.2 **SCALL**

Delta has Winchester based networks of up to 16 users available.

**Systems Group** Call us for best prices on these high quality 2nd generation boards and systems.

**California Computer Systems** These high quality, reliable products have made CCS defacto industry standard for S-100 products Assembled and tested

**2200** H.D. Mainframe, 20 a P.S., 12 slot MB **\$434 \$359**

**2065C** 64K dynamic RAM/Bank Select **\$720 \$580**

**2810A** Z-80 CPU, serial port, ROM monitor **\$310 \$259**

**2422A** Floppy Cont, CP/M 2.2, ROM monitor **\$425 \$345**

**IMS 8000 DT** — w/164k, 1.2 MB 8" floppies, 2 serial, 3 par. CPM 2.2 **SCALL**

**FULL 2 YEAR WARRANTY!**

**Z-80 CPU** **\$310**

**Dz Disk controller** **\$354**

**64K Dynamic Ram** **\$648**

**MICROBYTE FULL SYSTEMS AVAILABLE** **SCALL**

**SUPERBRAIN** Similar savings on the full lines of CCS, SSM, NNC, MORROW, DELTA,

**NORTHSTAR, ITHACA INTERSYSTEMS, GODBOUT, NEC, TELEVIDEO, IMS**

**ZENITH, ADDS, DEC, DATA GEN., ATARI, DYNABYTE.**



## 8" DISK DRIVE SALE

**8" SHUGART SA801R** **\$450**

**QUME DATATRACK B** **\$625 2 for \$1199**

Enclosure, power supply for 2 8" drives A&T **\$299**

**NNC industrial grade enclosure** for 2 drives with P.S. **\$445**

**MORROW Discus 2D + CP/M** **\$863**

Discus 2+2 + CP/M **\$1259**

## HARD DISK SPECIALS

**CORVUS 10MB** and controller **List \$3550 Only \$3500**

**20MB** and controller **\$6450 SCALL**

**Constellation Network Multiplexer** **\$750 SCALL**

**Mirror Video Tape Disk Backup** **\$790 SCALL**

**MORROW 26MB + controller + CP/M 2.2** **\$4995 \$3995**

**CAMEO cartridge drive controller** **\$1500 \$1275**

**controller, CDC Hawk Drive (5 fix, 5 rem)** **\$6995 \$5995**

**controller, Western Dynex (5 fix, 5 rem)** **\$5995 \$5099**

**Winchester 5 1/4 drives** complete with case, cable, software, S-100 controller Adapter avail. for use with

any Z-80 system. Cartridge drive controllers avail. **List**

**5MB** **\$2898**

**10MB** **\$3398**

Quantity discounts available!

**S-100 CONTROLLER FOR PRIAM** **\$693**

**PRIAM 8" and 14" Winchester/tape** subsystems avail

We carry the full line of **ADES** disk and tape controllers and subsystems.

## FULLY CONFIGURED BUSINESS SYSTEMS

The following are some examples of the fully assembled and tested business

and scientific computer systems which we offer. All include CP/M 2.2,

64K bytes dynamic RAM, Z-80A 4mh CPU We offer a full line of quality,

tested software.

**Delta TVD w/ 1.2 Mb floppy drives, 2 serial, 3 parallel ports** **SCALL**

**Delta 1004 w/10 MB hard disk, 1MB floppy, 6 serial, 3 parallel ports** **SCALL**

**CCS 2210A w/floppy controller, 1 serial port** **\$1849**

**CCS 300-1A w/1.2MB floppy drives, 2 serial, 2 parallel ports** **\$4849**

**CCS 400-1A w/10MB hard disc, 2 serial, 2 parallel ports** **\$6999**

**Optional CP/M for CCS 300, 400 (OASIS available)** **\$150**

**NNC 80 w/1MB floppy drives, 2 serial, 3 parallel ports** **\$3799**

**NNC 80W w/ 5MB floppy, 8.4MB hard disc, (OASIS optional)** **\$6693**

**ALDOS single and multi-user systems** **SCALL**

**MORROW Decision 1, MICROSOFT basic, UNIX** **SCALL**

## TERMINALS

**AMPEX DIALOGUE 30, 80** **SCALL**

**TELEVIDEO 912 C** **\$950 \$725**

**920 C** **\$1030 \$789**

**950C** **\$1195 \$989**

**SOROC IQ 120** **\$995 \$729**

**IQ 140** **\$1395 \$1149**

**INTERTUBE III or EMULATOR (multi-terminal)** **\$895 \$799**

**DEC VT-100** **\$2050 \$1575**

Similar savings for our **HAZELTINE** and **LEAR SIEGLER** lines

## LOOK HERE!

Call us for ALL your software needs

**AMPEX Dialogue 80**

**SYSTEMS HOUSES & EDUCATIONAL INSTITUTIONS**

**GIVEN SPECIAL CONSIDERATION.**



ALL OF OUR PERIPHERALS CAN BE CONFIGURED FOR RADIO SHACK® MODEL II

## DEALER and INTERNATIONAL INQUIRIES WELCOME

### WASHINGTON COMPUTER SERVICES

an affiliate of **WASHINGTON ELECTRIC COMPANY** est. 1912

CUSTOM COMPUTER ROOM WIRING SINCE 1960

97 Spring Street

New York, N.Y. 10012

Hours: 8AM-5:30PM (EST) Mon.-Fri.

TO ORDER: CALL OUR TOLL-FREE NUMBER:

★ (800) 221-5416 ★ in N.Y. State and for technical information call 1-(212) 226-2121

For fast delivery, send certified checks, money order or call to arrange direct bank wire transfers Personal or company checks require two to three weeks to clear All prices are mail order only Prices subject to change without notice; call for latest prices. Prices include 2% cash discount. N.Y. residents add sales tax.

Quantex is a trademark of North Atlantic Industries, Inc.

Radio Shack® is a trademark of the Tandy Corp

CP/M® is a trademark of Digital Research



# SAVE UP TO \$600.00 NOW on TRS-80<sup>™</sup> Computers & Accessories

## With This Coupon

Now you can own a great little computer at a great big discount off the manufacturer's list price. For home or office use the Radio Shack line of computers is first in quality, performance and price.

- **FREE SHIPPING** in the 48 continental contiguous states.
- **NO SALES TAX** collected on out-of-state orders.
- **CONVENIENT ORDERING** Call us **TOLL FREE**.
- **FREE COMPLETE PRICE LIST** available upon request.

Model II

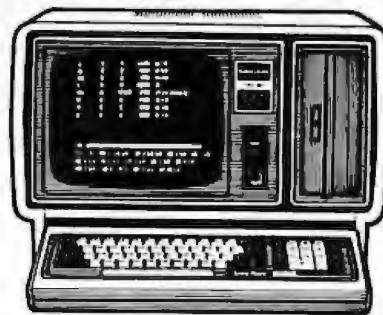

Catalog Number	Description	List Price	Charge By Phone	Cashier's Check Or Money Order	Cash Price You Save
Radio Shack <sup>®</sup> TRS-80 Model II					
26-4002	64K 1-Disk Model II.....	3,899.00	3,579.30	*3,299.00	600.00
Radio Shack <sup>®</sup> TRS-80 Model III					
26-1062	Model III 16K.....	999.00	865.00	865.00	134.00
26-1066	Model III 48K.....	2,495.00	2,243.50	*2,149.00	346.00
Radio Shack <sup>®</sup> TRS-80 Color Computer					
26-3001	4K Color Computer.....	399.00	359.10	359.10	39.90
26-3002	16K Color Computer.....	599.00	539.10	539.10	59.00
Atari <sup>®</sup> CX-2600 Video Computer System		180.00	164.95	164.95	15.05
Pioneer <sup>®</sup> VP-1000 LaserDisc Player		CALL FOR PRICES			
Mattel Electronics <sup>®</sup> Intellivision <sup>™</sup> Home Video System		CALL FOR PRICES			
Magnavox <sup>®</sup> Odyssey <sup>2</sup> Home Video System		CALL FOR PRICES			
Magnavox <sup>®</sup> Magnavision <sup>™</sup> Videodisc Player		CALL FOR PRICES			

## Pan American Electronics

CALL TOLL FREE 800-531-7466 • (Operator 19) • Texas & Principal Number 512/581-2766 • Telex 767339  
Dept. 19 • 1117 Conway Avenue • Mission, Texas 78572

### NEW BRANCH

2912 N. Main, Fort Worth, Texas 76106 • Phone Number 817-625-6333 • Telex 794836

TRS-80 is a Trademark of Tandy Corp. \*With this coupon only! Prices subject to change without notice.

## SUNNY LOW LOW COST POWER SUPPLIES

FOR S-100, FLOPPY DISKS.



KIT 1, 2 & 3 For S-100



R3 For Three 8" or 5 1/4" Disk Drives



S3 2 in 1 Unit for S-100 and two 8" or 5 1/4" Disk Drives. It fits most Disk System Mainframes

### S-100 POWER SUPPLY KITS (OPEN FRAME WITH BASE PLATE, 3 HRS. ASSY. TIME)

ITEM	USED FOR	@ + 8 Vdc	@ - 9 Vdc	@ + 16 Vdc	@ 18 Vdc	@ + 28 Vdc	SIZE W x D x H	PRICE
KIT 1	15 CARDS SOURCE	15A		25A	25A		12" x 5" x 4 1/2"	52.95
KIT 2	SYSTEM SOURCE	25A		3A	3A		12" x 5" x 4 1/2"	59.95
KIT 3	DISK SYSTEM	15A	1A	2A	2A	4A	14" x 8" x 4 1/2"	67.95

### DISK DRIVE POWER SUPPLY "R3" REGULATED, OPEN FRAME, ASSY. & TESTED ..... 67.95

SPECS • 5V @ 5A OVP • 5V @ 1A • 24V @ 5A SHORTS PROTECT 2 SIZES AVAIL 1) 9" (W) x 6 1/4" (D) x 4 1/2" (H) 2) 9" (W) x 4 1/2" (D) x 5 1/4" (H)  
OPTION 1) REPLACE + 24V BY + 12V, 2) FOR SIZE 1 ONLY, ADD + 12V @ 1A AT AN ADDITIONAL \$12.00  
IDEAL FOR THREE 8" or 5 1/4" FLOPPY DISK DRIVES SUCH AS SHUGART 801/851 SIEMANS FDD 100-B/200 8 OR 100 5 ETC

### DISK SYSTEM PWR SUPPLY "S3" OPEN FRAME, ASSY. & TESTED COMPACT SIZE, 10 (W) x 6" (D) x 5 (H) 92.95

REGULATED OUTPUTS FOR DISK DRIVES + 5V @ 4A, 5V @ 1A, + 24V @ 4A (OR + 12V @ 4A) SHORTS PROTECT  
UNREGULATED OUTPUTS FOR S-100 + 8V @ 14A + 16V @ 3A (OPTION ADD OVP FOR + 5V, ADD \$5.00)  
A COMPLETE UNIT FOR DISK SYSTEM WITH THE MAINFRAME CONTAINING 12 SLOTS & TWO 8" or 5 1/4" DISK DRIVES

### POWER TRANSFORMERS (WITH MOUNTING BRACKETS)

ITEM	PRIMARY	SECONDARY #1	SECONDARY #2	SECONDARY #3	SIZE W x D x H	PRICE
T1	110/120	2 x 8 Vac, 15A	28 Vac, CT, 2.5A		3 1/2" x 3 1/2" x 3 1/2"	21.95
T2	110/120	2 x 8 Vac, 25A	28 Vac, CT, 3.5A		3 1/2" x 4 1/2" x 3 1/2"	27.95
T3	110/120	2 x 8 Vac, 15A	28 Vac, CT, 2.5A	48 Vac, CT, 2A	3 1/2" x 4 1/2" x 3 1/2"	29.95
T4	110/120	2 x 8 Vac, 6A	28 Vac, CT, 1.5A	48 Vac, CT, 3A	3 1/2" x 3 1/2" x 3 1/2"	22.95
T5	110/120	2 x 8 Vac, 6A	28 Vac, CT 2A		3" x 3" x 2 1/2"	14.95

SHIPPING For each power supply \$5.50 in Calif., \$7.50 in other states, \$14.00 in Canada  
For each Transformer \$5.00 in all States, \$10.00 in Canada. Calif Residents add 6% Sales Tax

MAILING ADDRESS:  
P.O. BOX 4296  
TORRANCE, CA 90510  
TELEX: 830-5010  
ANSWER BACK FOR TELEX SUNYOO TRUC

SUNNY INTERNATIONAL  
(TRANSFORMERS MANUFACTURER)  
(213) 328-2425 MON-SAT 9-6

SHIPPING ADDRESS:  
22129 1/2 S. VERMONT AVE  
TORRANCE, CA 90502





# Better Products,

## JADE Double-D™ Get the Inside Track

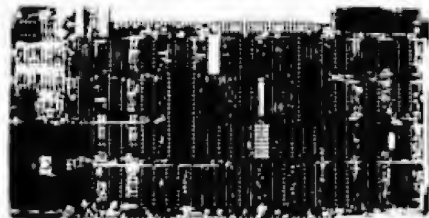

S-100 bus compatible • Reads and writes single or double density • Density is software selectable • Controls up to four 5-1/4" or 8", single or double-sided drives • Single or double-sided drives may be mixed in the same system • On-board Z-80A to assure reliable operation • EIA level serial printer interface on board, baud rates to 9600 (perfect for despooling operations) • Uses IBM standard formats • Designed to meet IEEE signal disciplines • Works with 8080, 8085, and Z-80 CPUs.

IOD-1200B Bare Board .....	\$59.95
IOD-1200K Kit .....	\$299.95
IOD-1200A A & T .....	\$375.00
SFC-58001200E DD boot PROM ..	\$20.00
SFC-58002001F CP/M 2.2 for DD ..	\$149.95

## JADE Memory Bank™ 8 or 16 Bit Dynamic Memory

A 64K S-100 dynamic memory that looks toward the future. • S-100 standard pinout and signal discipline • 8 or 16 bit words, automatically, depending on the type of CPU on the bus • 4-layer PC board designed for extremely low-noise operation.

With its on-board refresh controller, this board allows DMA operations without regard to time factors. It will run reliably at any system clock rate up to 4 MHz—because it is clocked with the system clock itself (no one-shots are used for timing operations). Its unique design enables it to switch from a 64K by 8-bit board to a 32K by 16-bit board automatically (responds to IEEE's 16 Rqst line and, if enabled, replies with 16 Grant).

MEM-99730B Bare Board .....	\$49.95
MEM-99730K Kit, no RAM .....	\$199.95
MEM-16730K 16K kit .....	\$219.95
MEM-32731K 32K kit .....	\$239.95
MEM-48732K 48K kit .....	\$259.95
MEM-64733K 64K kit .....	\$279.95
Assembled & Tested .....	add \$50.00



4 MHz Z-80 CPU, 80 x 25 display with graphics and 8 colors, 32K RAM, 24K ROM, parallel/serial/cassette interfaces, upper/lower case, numeric keypad, 10 special function keys, uses CP/M 3.2

NEC-8001A 32K CPU/keyboard ..	\$1095.00
NEC-8012A I/O with 32K RAM ..	\$695.00
NEC-8031A Dual disk unit .....	\$1095.00
VDM-651300 12" green CRT .....	\$269.95
NEC-1202D Hi-res RGB color CRT	\$1045.00
NEC-90005 Gen. acctg softwar ..	\$375.00

## JADE The Big Z™ Z-80A Based CPU

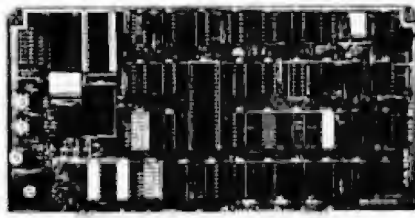

S-100 bus compatible • Switch selectable 2 or 4 MHz operation • Serial I/O port • Accommodates a 2708, 2716, or 2732 EPROM in shadow mode allowing full use of 64K RAM • MWRITE signal is generated automatically if used without front panel • On-board 8251 USART controls serial port at baud rates from 75 to 9600 baud • Switch selectable 1K, 2K, or 4K boundary fully buffered • Power-on jump to EPROM

CPU-30201K Kit .....	\$139.95
CPU-30201A A & T .....	\$189.95
CPU-30200B Bare board .....	\$35.00

### Memory Chips on Sale

	1-8	10-24	25-10	50+
2114L 4 MHz	3.35	2.99	2.75	2.49
2708 2 MHz	4.90	3.90	3.45	2.90
2532 2 MHz	24.90	19.90	15.90	12.90
2716 2 MHz	8.90	7.45	6.45	5.75
2716 4 MHz	19.90	15.45	13.45	11.75
2732 2 MHz	24.90	19.90	15.90	12.90
2732 4 MHz	39.90	29.90	24.90	19.90
2758 2 MHz	6.90	6.25	5.50	4.50
4116 200 ns	3.25	2.99	2.49	1.99
4164 200 ns	28.90	24.90	22.90	19.90

## JADE Disk Sub-Systems Shugart, Siemens, Qume



Handsome metal cabinet with proportionally balanced air flow system • Rugged dual drive power supply • Power cable kit • Power switch, line cord, fuse holder, cooling fan • Never-Mar rubber feet • All necessary hardware to mount Z-8" disk drives, power supply, and fan • Does not include signal cable

### Dual 8" Subassembly Cabinet

END-000420 Bare cabinet .....	\$59.95
END-000421 Cabinet kit .....	\$225.00
END-000431 A & T .....	\$359.95

### 8" Disk Drive Subsystems

#### Single Sided, Double Density

END-000423 Kit w 2 FD100-8Ds ..	\$975.00
END-000424 A & T w 2 FD100-8Ds	\$1175.00
END-000433 Kit w 2 SA-801Rs ..	\$999.95
END-000434 A & T w 2 SA-801Rs	\$1195.00

### 8" Disk Drive Subsystems

#### Double Sided, Double Density

END-000428 Kit w 2 DT-8s .....	\$1475.00
END-000427 A & T w 2 DT-8s ..	\$1675.00
END-000436 Kit w 2 SA-851Rs ..	\$1495.00
END-000437 A & T w 2 SA-851Rs	\$1695.00

Circle 178 on Inquiry card.

## JADE S.P.I.C.

Our "SPICy" New I/O Board

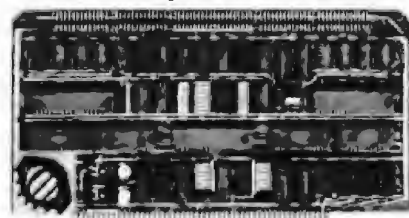

New, from JADE, one of the most advanced, technologically sophisticated Serial/Parallel Interrupt Controller systems in the world. On a single IEEE S-100 standard board, JADE has packed two bi-directional parallel ports with full handshaking, four serial channels (asynchronous, IBM-compatible bi-synch, synchronous, HDLC/SDLC) with full and complete modem control lines, and 16 counter-timer channels.

Utilizing the highly advanced Zilog peripheral chips, (Z-80 SIO, PIO & CTCs), the SPIC board is fully programmable to serve as the foundation for a multi-user multi-tasking system. Each of the seven Z-80 peripheral chips can generate its own interrupt vector, with daisy-chain priority levels. Each counter-timer channel can be programmed to monitor an interrupt vector line on the S-100 bus. Each SIO channel can be driven independently with separate Tx/Rx clocks so your peripherals can have varied baud rates from 110 to 76,800 baud.

IOI-1045B Bare Board .....	\$49.95
IOI-1045K 2 CTCs, 1 SIO, 1 PIO ..	\$179.95
IOI-1045A A & T .....	\$239.95
IOI-1046K 4 CTCs, 2 SIOs, 1 PIO ..	\$219.95
IOI-1046A A & T .....	\$299.95

## Build It Yourself and Save \$1850

### Complete S-100 Micro-Computer Kit

4 Mhz Big Z CPU, 64K Memory Bank, Double-D disk controller, 12 slot mainframe, dual disk sub-assembly with 2 double density 8" disk drives & power supply, ADDS Viewpoint terminal, CP/M 2.2, boot PROM, system monitor, & all necessary cables and manuals - PLUS FREE Business Software Package. Save over \$1850.00 \$2795.00

## Jade Business Software

Now, for the first time, at an amazingly low price, CP/M and SDOS users can get an affordable business software package. Just look at these programs! All come complete with basic code (written to run under CBASIC 5), for easy customizing and modification. All software is self-documenting. The package price includes a word-processing system. When printed on the system's printer, all files with the extension xxxTOT. constitute a complete manual. No manuals are supplied with the package other than as they appear on the disks. All software is supplied on 8" premium quality JADE Diskettes. Software sold as is. (Sorry, but at these low prices we can not offer our usual friendly support and handholding.)

Includes: General Ledger, Payroll, Invoicing, Inventory Control, Accounts Receivable, Cash Disbursements, Fixed Assets, Cash Receipts, & Mailing List Management.

Special Package Price .....

\$249.95

# Lower Prices,

## Printers



### BEST BUY in PRINTERS - Epson

- MX-70** 132 column, 80 CPS, 5 x 7 dot matrix, adjustable tractor feed, & graphics  
**PRM-27070** List \$459 ..... \$389.95
- MX-80** 132 column, 80 CPS, bi-directional/logic seeking printing, 9 x 9 dot matrix, adjustable tractor feed, & 64 graphics characters  
**PRM-27080** List \$645 ..... \$474.95
- MX-80FT** same as MX-80 with friction feed and full graphics added  
**PRM-27082** List \$745 ..... \$574.95
- MX-100** 233 column, correspondence quality, ultra-high resolution graphics, up to 15" paper, friction feed & removable/adjustable tractor feed, 18 x 18 dot matrix, 80 CPS, programmable forms handling  
**PRM-27100** List \$945 ..... \$795.00
- PRA-27084** Serial interface ..... \$69.95  
**PRA-27088** Serial intf & 3K buffer .. \$144.95  
**PRA-27091** Apple card ..... \$74.95  
**PRA-27082** Apple cable ..... \$22.95  
**PRA-27086** IEEE 488 card ..... \$52.95  
**PRA-27087** TRS-80 cable ..... \$32.95  
**PRA-27085** Grafrax II ..... \$95.00  
**PRA-27083** Extra ribbon ..... \$14.95

### SPINWRITER - NEC

- 65 cps, bi-directional, letter quality printer with deluxe tractor mechanism, both parallel and serial interfaces on-board, 16K buffer, ribbon, print thimble, graphics, micro-space justification, data cable, and self test/diagnostic ROM.  
**PRD-55511** without 16K buffer ... \$2795.00  
**PRD-55512** with 16K buffer ..... \$2895.00

## Accessories for TRS-80

### DISK DRIVES for TRS-80

- 25% more storage, 8 times faster, 40 track with free patch, 120 day warranty.  
**MSM-12410C** Save \$125.00 !!! ..... \$325.00

### 8" DISK DRIVES for MODEL II

- 2 double density drives with cabinet, power supply, & cables  
**END-000433** Kit ..... \$1050.00  
**END-000434** Assembled ..... \$1250.00  
**WCA-5036A** Cable (required) ..... \$29.95

## 16K Atari ... \$359.95

### ATARI 800 - Atari

- Complete personal computer with high resolution color graphics, built-in RF modulator, 4 controller ports, internal speaker, 16K RAM & 8K ROM  
**SYO-2080A** 16K Atari 800 ..... \$759.95  
**Atari 800 with 32K of RAM** ..... \$799.95  
**Atari 800 with 48K of RAM** ..... \$849.95  
**SYO-2040A** 16K Atari 400 ..... \$359.95  
**MSM-330810** Disk drive ..... \$595.00  
**MSM-330815** Dual drive ..... \$1395.00  
**IOX-5050A** 850 interface ..... \$189.95  
**MEX-16853K** 16K RAM module ..... \$69.95  
**SFI-241011005** VisiCalc ..... \$184.95

## Accessories for Apple



### 16K MEMORY UPGRADE

- Add 16K of RAM to your TRS-80, Apple, or Exidy in just minutes. We've sold thousands of these 16K RAM upgrades which include the appropriate memory chips (as specified by the manufacturer), all necessary jumper blocks, fool-proof instructions, and our 1 year guarantee.  
**MEX-16100K** TRS-80 kit ..... \$25.00  
**MEX-16101K** Apple kit ..... \$25.00  
**MEX-16102K** Exidy kit ..... \$25.00

### 16K RAM Card - Microsoft

(There is life after 48K)

- MEX-16300A** A & T ..... \$174.95

### Z-80\* CARD for APPLE

Two computers in one, Z-80 & 6502, more than doubles the power & potential of your Apple, includes Z-80\* CPU card, CP/M 2.2, & BASIC-80

- CPX-30800A** A & T ..... \$299.95

### APPLE CLOCK - Cal Comp Sys

Real time clock w/battery back-up

- IOK-2030A** A & T ..... \$109.95

### DISK DRIVE for APPLE

5 1/4" disk drive with controller for your Apple

- MSM-12310C** with controller ..... \$475.00  
**MSM-123101** w/out controller ..... \$375.00

### 8" DRIVES for APPLE

- Controller, DOS, two 8" double density drives, cabinet, power supply, & cables  
**Special Package Price** Kit ..... \$1399.95

### PRINTER INTERFACE - C.C.S.

Centronics type I/O card w/ firmware

- IOI-2041A** A & T ..... \$99.95

### AIO, ASIO, APIO - S.S.M.

- Parallel & serial interface for your Apple (see Byte pg 11)  
**IOI-2050K** Par & Ser kit ..... \$139.95  
**IOI-2050A** Par & Ser A & T ..... \$169.95  
**IOI-2052K** Serial kit ..... \$89.95  
**IOI-2052A** Serial A & T ..... \$99.95  
**IOI-2054K** Parallel kit ..... \$69.95  
**IOI-2054A** Parallel A & T ..... \$89.95

### A488 - S.S.M.

- IEEE 488 controller, uses simple basic commands, includes firmware and cable, 1 year guarantee, (see April Byte pg 11)  
**IOX-7488A** A & T .. \$399.95

### CPS MULTICARD - Mtn. Computer

- Three cards in one! Real time clock calendar, serial interface, & parallel interface - all on one card.  
**IOX-2300A** A & T ..... \$199.95

### Apple-CAT - Novation

- Software selectable 1200 or 300 baud, direct connect, auto-answer/auto-dial, auxiliary 3-wire RS232C serial port for printer.  
**IOX-5232A** Save \$50.00!!! ..... \$339.95

## Single Board Computers



### AIM-65 - Rockwell

6502 computer with alphanumeric display, printer & keyboard, and complete instructional manuals

- CPK-50185** 1K AIM ..... \$424.95  
**CPK-50485** 4K AIM ..... \$499.95  
**SFK-74600008E** 8K BASIC ROM ... \$99.95  
**SFK-64600004E** 4K assembler ROM \$84.95  
**PSX-030A** Power supply ..... \$64.95  
**ENX-000002** Enclosure ..... \$54.95  
 4K AIM, 8K BASIC, power supply, & enclosure  
**Special package price** ..... \$675.00

### Z-80\* STARTER KIT - SD Systems

Complete Z-80\* computer with RAM, ROM, I/O display, keyboard, manual, and kluge area.

- CPS-30010K** Kit ..... \$369.95  
**CPS-30010A** A & T ..... \$459.95

### SYM-1 - Synertek Systems

Single board computer with 1K of RAM, 4K of ROM, keypad, LED display, 30ma & cassette interface on board.

- CPK-50020A** A & T .. \$249.95

## Video Terminals

### VIEWPIONT - ADDS

Detachable keyboard, serial RS232C interface, baud rates from 110 to 19,200, auxiliary serial output port, 34 x 80 display, tiltable screen, international character set

- VDT-501210** Sale Priced ..... \$639.95

### TELEVIDEO 950

Detachable keyboard, split screen with line lock, etched CRT, programmable function keys, on-screen status line, buffered auxiliary port, 14 x 10 dot matrix, self test, serviced nationwide by General Electric

- VDT-901250** List \$1195.00 ..... \$995.00

## Video Monitors

### Leedex / Amdek

Reasonably priced video monitors

- VDM-801210** Video 100 12" B&W .. \$139.95  
**VDM-801230** Video 100-80 12" B&W \$179.95  
**VDM-801250** 12" Green Phosphor .. \$169.95  
**VDC-801310** 13" Color I ..... \$379.95

### 13" COLOR MONITOR - Zenith

The hi rez color you've been promising yourself

- VDC-201301** ..... \$449.00

### 12" GREEN SCREEN - NEC

20 MHz, P31 phosphor video monitor with audio, exceptionally high resolution - A fantastic monitor at a very reasonable price

- VDM-651200** 12" monitor ..... \$269.95

## EPROM Erasers

### EPROM ERASERS

L.S. Engineering UV eraser for up to 48 EPROMs

- XME-3200** A & T ..... \$39.99

Spretronics hi intensity industrial eraser

- XME-3100** Without timer ..... \$69.50  
**XME-3101** With timer ..... \$94.50

# Faster Service.

## S-100 PROM Boards

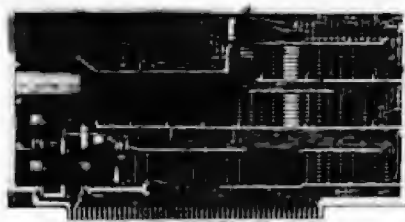

**PB-1 - S.S.M.**

2708, 2716 EPROM board with built-in programmer  
**MEM-99510K Kit** ..... \$154.95  
**MEM-99510A A & T** ..... \$219.95

### PROM-100 - SD Systems

2708, 2716, 2732, 2758, & 2516 EPROM programmer  
**MEM-99520K Kit** ..... \$219.95  
**MEM-99520A Jade A & T** ..... \$269.95

### EPROM BOARD - Jade

16K or 32K uses 2708's or 2716's, 1K boundary  
**MEM-16230K Kit** ..... \$79.95  
**MEM-16230A A & T** ..... \$119.95

## S-100 Video

**VB-3 - S.S.M.**

81 characters x 24 lines expandable to 80 x 48 for a full page of text, upper & lower case. 256 user defined symbols, 160 x 192 graphics matrix, memory mapped, has key board input.

**IOV-1095K 4 MHz kit** ..... \$349.95  
**IOV-1095A 4 MHz A & T** ..... \$439.95  
**IOV-1096K 80 x 48 upgrade** ..... \$39.95

### VDB-8024 - SD Systems

80 x 24 I/O mapped video board with keyboard I/O, and on-board Z-80A\*  
**IOV-1020K Kit** ..... \$399.95  
**IOV-1020A Jade A & T** ..... \$459.95

### VIDEO BOARD - S.S.M.

64 characters x 16 lines, 128 x 48 matrix for graphics, full upper/lower case ASCII character set, numbers, symbols, and greek letters, normal/reverse/blinking video, S-100.  
**IOV-1051K Kit** ..... \$149.95  
**IOV-1051A A & T** ..... \$219.95  
**IOV-1051B Bare board** ..... \$34.95

## Motherboards

### ISO-BUS - Jade

Silent, simple, and on sale - a better motherboard

8 Slot (5 1/4" x 8 1/2")  
**MBS-061B Bare board** ..... \$19.95  
**MBS-061K Kit** ..... \$39.95  
**MBS-061A A & T** ..... \$49.95

12 Slot (8 1/4" x 8 1/2")  
**MBS-121B Bare board** ..... \$29.95  
**MBS-121K Kit** ..... \$69.95  
**MBS-121A A & T** ..... \$89.95

18 Slot (14 1/4" x 8 1/2")  
**MBS-181B Bare board** ..... \$49.95  
**MBS-181K Kit** ..... \$89.95  
**MBS-181A A & T** ..... \$139.95

## Mainframes

### MAINFRAME - Cal Comp Sys

12 slot S-100 mainframe with 20 amp power supply

**ENC-112105 Kit** ..... \$379.95  
**ENC-112106 A & T** ..... \$409.95

### DISK MAINFRAME - N.P.C.

Holds 2 8" drives and a 12 slot S-100 system. Attractive metal cabinet with 12 slot motherboard & card cage, power supply, dual fans, lighted switch, and other professional features

**ENS-112325 with 25 amp p.s.** ..... \$699.95  
 plus \$79 on inquiry card.

## S-100 Memory

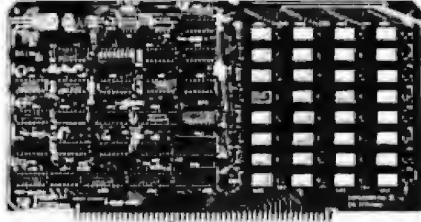

### EXPANDORAM II - S-D Systems

4 MHz RAM board expandable from 16K to 64K

**MEM-16630K 16K kit** ..... \$275.95  
**MEM-32631K 32K kit** ..... \$295.95  
**MEM-48632K 48K kit** ..... \$315.95  
**MEM-64633K 64K kit** ..... \$335.95  
 Assembled & tested ..... add \$50.00

### 64K RAM - Calif Computer Sys

4 MHz bank part bank byte selectable, extended addressing, 16K bank selectable, PHANTOM line allows memory overlay, 8080 / Z-80 front panel compatible.  
**MEM-64585A A & T** ..... \$575.00

### 32K STATIC RAM - Jade

2 or 4 MHz expandable static RAM board uses 21141's  
**MEM-16151K 16K 4 MHz kit** ..... \$169.95  
**MEM-32151K 32K 4 MHz kit** ..... \$299.95  
 Assembled & tested ..... add \$50.00

### 16K STATIC RAM - Mem Merchant

4 MHz 16K static RAM board, IEEE S-100, bank selectable, Phantom capability, addressable in 4K blocks, "disable-able" in 1K segments, extended addressing, low power  
**MEM-16171A A & T** ..... \$174.95

## S-100 Disk Controller

### DOUBLE DENSITY - Cal Comp Sys

5 1/4" and 8" disk controller, single or double density, with on-board boot loader ROM, and five CP/M 2.2\* and manual swt.

**IOD-1300A A & T** ..... \$369.95

### VERSAFLOPPY II - SD Systems

New double density controller for both 8" & 5 1/4"

**IOD-1160K Kit** ..... \$339.95  
**IOD-1160A A & T** ..... \$379.95

## Disk Drives

### 8" DISK DRIVES

Highly reliable double density floppy disk drives  
 Shugart 801R single sided, double density  
**MSF-10801R SA-801R** ..... \$425.00  
**Special Sale Price** ..... 2 for \$790.00

Shugart 851R double sided, double density  
**MSF-10851R SA-851R** ..... \$595.00  
**Special Sale Price** ..... 2 for \$1150.00

Siemens FDD100-8D2 single sided, double density  
**MSF-201120** ..... \$385.00  
**Special sale price** ..... 2 for \$750.00

Qume Datatrak 8 double sided, double density  
**MSF-750080 SA-851R compatible** ..... \$599.95  
**Special sale price** ..... 2 for \$1160.00

### JADE DISK PACKAGE

Double density controller, two 8" double density floppy disk drives, CP/M 2.2 (configured for controller), hardware and software manuals, boot PROM, cabinet, power supply, fan, & cables

**Special Package Price Kit** ..... \$1395.00

5 1/4" Diskettes **Box of 10** .. \$22.00

8" Diskettes **Box of 10** .... \$24.00

## S-100 CPU

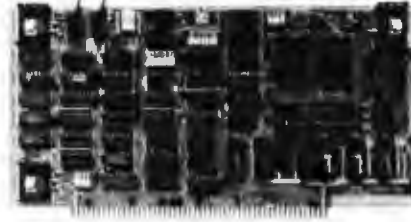

### CB-2 Z-80 CPU - S.S.M.

2 or 4 MHz Z-80 CPU board with provision for up to 8K of ROM or 4K of RAM on board, extended addressing, IEEE S-100, front panel compatible.

**CPU-30300K Kit** ..... \$239.95  
**CPU-30300A A & T** ..... \$299.95

### 2810 Z-80\* CPU - Cal Comp Sys

2, 4 MHz Z-80A\* CPU with RS-232C serial I/O port and on-board MOSS 2.2 monitor PROM, front panel compatible.  
**CPU-30400A A & T** ..... \$269.95

### SBC-200 - SD Systems

4 MHz Z-80\* CPU with serial & parallel I/O ports, up to 8K of on-board PROM, software programmable baud rate generator, 1K of on-board RAM, Z-80 CTC.

**CPC-30200K Kit** ..... \$339.95  
**CPC-30200A Jade A & T** ..... \$399.95

## S-100 I/O

### I/O-4 - S.S.M.

2 serial I/O ports plus 2 parallel I/O ports

**IOI-1010K Kit** ..... \$179.95  
**IOI-1010A A & T** ..... \$249.95  
**IOI-1010B Bare board** ..... \$35.00

## Novation Cat Modem



-Limited Quantity-

**IOM-5200A List price \$189.95** ..... \$125.00

D-CAT 300 baud, direct connect modem  
**IOM-5201A Special sale price** ..... \$169.95

AUTO-CAT Auto answer/originate, direct connect  
**IOM-5230A Special sale price** ..... \$239.95

## Place Orders Toll Free

Continental U.S. Inside California  
**800-421-5500 800-262-1710**

For Technical Inquiries or Customer Service call:

213-973-7707

## JADE Computer Products

4901 W. Rosecrans, Hawthorne, Ca 90250

TERMS of SALE: Cash, checks, credit cards, or Purchase Orders from qualified firms and institutions. Minimum Order \$15.00. California residents add 6% tax. Minimum shipping & handling charge \$3.00. Pricing & availability subject to change

# 16K Memory 8/\$16.95

4116 300ns

ALL MERCHANDISE 100% GUARANTEED

CALL US FOR VOLUME QUOTES

## LS SERIES

74LS00	.25	74LS163	.95
74LS01	.25	74LS164	.95
74LS02	.25	74LS165	.95
74LS03	.25	74LS168	2.40
74LS04	.25	74LS168	.75
74LS05	.25	74LS169	1.75
74LS06	.35	74LS170	1.75
74LS09	.25	74LS173	.80
74LS10	.25	74LS174	.95
74LS11	.35	74LS175	.95
74LS12	.35	74LS181	2.15
74LS13	.45	74LS189	9.95
74LS14	1.00	74LS190	1.00
74LS15	.35	74LS191	1.00
74LS20	.25	74LS182	.85
74LS21	.35	74LS193	.95
74LS22	.35	74LS194	1.00
74LS26	.35	74LS195	.95
74LS27	.35	74LS196	.85
74LS28	.35	74LS197	.85
74LS30	.25	74LS221	1.20
74LS32	.35	74LS240	1.85
74LS33	.55	74LS241	1.85
74LS37	.55	74LS242	1.85
74LS38	.35	74LS243	1.85
74LS40	.25	74LS244	1.75
74LS42	.55	74LS245	2.85
74LS47	.75	74LS247	.75
74LS48	.75	74LS248	1.25
74LS49	.75	74LS249	.99
74LS51	.25	74LS251	1.30
74LS54	.35	74LS253	.85
74LS55	.35	74LS257	.85
74LS63	1.25	74LS258	.85
74LS73	.40	74LS269	2.85
74LS74	.45	74LS260	.65
74LS75	.50	74LS266	.65
74LS76	.40	74LS273	1.65
74LS78	.50	74LS275	3.35
74LS83	.75	74LS279	.55
74LS86	.40	74LS287	1.95
74LS90	.65	74LS290	1.25
74LS91	.89	74LS293	1.85
74LS92	.70	74LS295	1.05
74LS93	.65	74LS298	1.20
74LS95	.85	74LS352	1.55
74LS96	.95	74LS353	1.55
74LS107	.40	74LS363	1.35
74LS109	.40	74LS365	.95
74LS112	.45	74LS368	.95
74LS113	.45	74LS367	.70
74LS114	.50	74LS368	.70
74LS122	.45	74LS373	1.85
74LS123	.95	74LS374	1.80
74LS124	2.89	74LS377	1.45
74LS125	.85	74LS378	1.18
74LS126	.85	74LS379	1.35
74LS132	.75	74LS385	1.90
74LS136	.55	74LS386	.85
74LS137	.99	74LS390	1.90
74LS138	.75	74LS393	1.90
74LS139	.75	74LS395	1.85
74LS145	1.20	74LS399	1.70
74LS147	2.49	74LS447	.37
74LS148	1.35	74LS460	1.95
74LS151	.75	74LS668	1.89
74LS153	.75	74LS669	1.89
74LS154	2.35	74LS670	2.20
74LS155	1.15	74LS674	9.65
74LS158	.95	74LS682	3.20
74LS157	.75	74LS683	2.30
74LS158	.75	74LS684	2.40
74LS160	.90	74LS685	2.40
74LS161	.95	74LS688	2.40
74LS162	.95	74LS689	2.40

## 7400 SERIES

7400	.19	74128	.55
7401	.18	74132	.45
7402	.19	74136	.50
7403	.19	74141	.65
7404	.19	74142	2.95
7405	.22	74143	2.95
7406	.22	74144	2.95
7407	.22	74145	.60
7408	.24	74147	1.75
7409	.19	74148	1.20
7410	.19	74150	1.35
7411	.26	74151	.85
7412	.30	74152	.65
7413	.35	74153	.55
7414	.35	74154	1.40
7418	.25	74155	.75
7417	.25	74158	.85
7420	.19	74159	.85
7421	.35	74165	1.85
7422	.29	74160	.85
7423	.29	74181	.70
7425	.29	74162	.85
7426	.29	74183	.85
7427	.29	74164	.85
7428	.45	74165	.85
7430	.19	74166	1.00
7432	.29	74167	1.95
7433	.45	74170	1.65
7437	.29	74172	5.95
7438	.29	74173	.75
7440	.19	74174	.89
7442	.49	74175	.89
7443	.65	74176	.89
7444	.69	74177	.75
7445	.69	74178	1.15
7446	.59	74179	1.75
7447	.69	74180	.75
7448	.69	74181	2.25
7450	.19	74182	.75
7451	.23	74184	2.00
7453	.23	74185	2.00
7454	.23	74186	18.80
7460	.33	74190	1.15
7464	.39	74191	1.15
7465	.39	74192	.79
7470	.35	74193	.79
7472	.29	74194	.85
7473	.34	74195	.85
7474	.35	74196	.79
7475	.49	74197	.75
7476	.35	74198	1.35
7480	.59	74199	1.35
7481	1.10	74221	1.35
7482	.95	74246	1.35
7483	.50	74247	1.25
7484	.50	74248	1.85
7485	.65	74249	1.85
7486	.35	74251	.75
7489	4.99	74259	2.25
7490	.35	74265	1.35
7491	.40	74273	1.95
7492	.50	74276	1.25
7493	.49	74279	.75
7494	.65	74283	2.00
7495	.55	74284	3.75
7496	.70	74285	3.75
7497	2.75	74290	.95
74100	1.00	74293	.75
74107	.30	74298	.65
74109	.45	74351	2.25
74110	.45	74365	.65
74111	.55	74366	.85
74116	1.55	74367	.85
74120	1.20	74368	.85
74121	.29	74376	2.20
74122	.45	74390	1.75
74123	.55	74393	1.35
74125	.45	74425	3.15
74126	.45	74426	.85
		74490	2.55

## T.V. CIRCUITS

MC1330	1.89
MC1350	1.29
MC1358	1.79
LM380	1.29
LM386	1.50
LM665	.99
LM741	.29
LM1310	2.90
LM1800	2.99
LM1889	2.49

## MISC.

8T26	1.89	3242	9.95
8T28	2.49	AY5-1013	3.95
8T95	.99	TR1602	4.85
8T96	.99	IM6402	7.95
8T97	.99	1771	24.95
8T98	.99	1781	36.95
1488	.99	UPD765	39.95
1489	.99	8272	39.95
DM8131	2.95	1793	49.95

## CMOS

74C00	.35	74C373	2.75	4018	.85	4093	.95
74C02	.35	74C374	2.75	4019	.45	4099	1.95
74C04	.35	74C801	.80	4020	.85	14409	8.95
74C08	.35	74C802	.85	4021	.85	14410	8.95
74C10	.35	74C803	.85	4022	1.15	14411	9.95
74C14	1.50	74C805	10.95	4023	.35	14412	12.95
74C20	.35	74C808	.85	4024	.75	14419	2.95
74C30	.35	74C807	1.00	4025	.35	4502	.95
74C32	.50	74C808	2.00	4026	1.65	4503	.65
74C42	1.75	74C809	2.75	4027	.65	4508	1.95
74C48	2.10	74C810	9.95	4028	.80	4510	.95
74C73	.85	74C811	10.00	4029	.65	4511	.95
74C74	.85	74C812	10.00	4030	.45	4512	.85
74C76	.80	74C814	1.85	4034	2.85	4514	1.25
74C83	1.95	74C815	2.00	4035	.85	4515	2.25
74C85	1.95	74C818	2.75	4040	.95	4516	1.55
74C86	.85	74C820	17.95	4041	1.25	4518	1.25
74C89	4.50	74C821	15.95	4042	.75	4519	1.25
74C90	1.75	74C822	5.95	4043	.85	4520	1.25
74C93	1.75	74C823	5.95	4044	.85	4522	1.25
74C95	1.75	74C825	5.75	4046	.95	4526	1.25
74C107	1.00	74C826	7.95	4047	.95	4527	1.95
74C150	5.75	74C827	7.95	4049	.55	4528	1.25
74C151	2.25	74C828	7.95	4050	.55	4531	.95
74C154	3.25	74C829	19.95	4051	.85	4532	1.95
74C157	1.75	74C830	19.95	4053	.95	4536	1.95
74C160	2.00	4000	.35	4060	1.45	4539	1.95
74C161	2.00	4001	.35	4068	.75	4543	2.70
74C162	2.00	4002	.25	4069	.40	4555	.95
74C163	2.00	4006	.95	4069	.35	4556	.95
74C164	2.00	4007	.29	4070	.35	4581	1.95
74C165	2.00	4008	.95	4071	.30	4582	1.95
74C173	2.00	4009	.45	4072	.30	4584	.95
74C174	2.25	4010	.45	4073	.30	4585	.95
74C175	2.25	4011	.35	4075	.30	4702	12.95
74C192	2.25	4012	.25	4076	.95	4724	1.50
74C193	2.25	4013	.45	4078	.30	80C07	.95
74C195	2.25	4014	.95	4081	.30	80C85	.85
74C200	5.75	4015	.85	4082	.30	80C88	.95
74C221	2.25	4016	.45	4085	.85	80C97	.95
		4017	1.15	4086	.95	80C98	1.20

## DIP SWITCHES

4 position	.85
5 position	.90
6 position	.80
7 position	.95
8 position	.95

## CONNECTORS

RS232 MALE	3.25
RS232 FEMALE	3.75
RS232 HOOD	1.25
S-100 ST	3.95
S-100 WW	4.95

## TRANSISTORS

PN2222	10/1.00	100/8	.99
2N3904	10/1.00	100/8	.99
2N3906	10/1.00	100/8	.99
2N3055	.79	10/8	.99
IN4148		25/1.00	
IN4004		18/1.00	

## LINEAR

LM301V	.34	LM741V	.29
LM308V	.98	LM747	.79
LM309K	1.49	LM748V	.59
LM311	.64	LM1310	2.90
LM317T	1.95	MC1330	1.89
LM317K	3.95	MC1350	1.29
LM318	1.49	MC1368	1.79
LM323K	4.95	LM1414	1.59
LM324	.59	LM1456V	1.69
LM337K	3.95	LM1488	1.39
LM339	.99	LM1489	1.39
LM377	2.26	LM1800	2.99
LM380	1.29	LM1809	2.49
LM386V	1.50	LM3900	.59
LM555V	.39	LM3909V	.99
LM556	.89	LM3914	3.95
LM565	.99	LM3915	3.95
LM566V	1.49	LM3916	3.95
LM567V	1.29	75451V	.39
LM723	.49	75452V	.39
LM733	.98	75453V	.39

## 74S00 SERIES

74S00	.44	74S74
-------	-----	-------

# 4K STATIC RAMS 8/18.95

2114 LOW POWER 450ns

ALL MERCHANDISE 100% GUARANTEED

CALL US FOR VOLUME QUOTES

## 8200

8202	45.00
8205	3.50
8212	1.95
8214	3.90
8216	1.95
8224	2.50
8226	1.85
8228	4.95
8237	19.95
8238	4.95
8243	4.50
8250	14.95
8251	5.50
8253	9.85
8253-5	9.85
8255	5.25
8255-5	9.00
8257	9.00
8259	7.00
8272	39.95
8275	29.95
8279	10.50
8279-5	10.50
8282	6.65
8283	6.65
8284	5.80
8286	6.65
8287	6.65
8288	25.00
8289	49.95

## 6800

6800	6.95
6802	11.95
6809	37.95
6810	4.60
6820	4.95
6821	4.95
6825	9.95
6834	16.95
6840	14.95
6843	42.95
6844	44.95
6845	29.95
6847	15.95
6850	4.75
6852	5.75
6860	10.95
6862	11.95
6871	25.95
6875	6.95
6880	2.95

## Z80

Z80	8.95
Z80A	9.95
Z80B	19.95
Z80-PIO	6.50
Z80-CTC	6.50
Z80-CTC	8.65
Z80-DART	15.25
Z80-DART	18.75
Z80-DMA	17.50
Z80A-DMA	27.50
Z80-SIO/0	23.95
Z80A-SIO/0	26.95
Z80-SIO/1	23.95
Z80A-SIO/1	28.95
Z80-SIO/2	23.95
Z80A-SIO/2	28.95
Z80-SIO/9	17.95
Z80A-SIO/9	22.95

## SEPTEMBER SPECIALS

4116	150ns	NEC	8 for 19.95
4116	200ns		8 for 17.50
2708		2.99	8 for 2.75ea
2716	Intel and NEC	5.95	8 for 5.50ea
2732	Intel	16.50	8 for 15.95ea
2532	Ti and Hitachi		19.95ea

## MPU'S

8035	18.95
8039	18.95
8080A	3.95
8085	12.95
8086	99.95
8088	39.95
8155	11.95
8158	11.95
8185	29.95
8185-2	39.95
8741	39.95
8748	69.95
8755	49.95

## 6502

6502	6.95
6502A	12.95
6504	6.95
6505	8.95
6520	4.95
6522	9.95
6532	14.95
6551	14.95

## IC SOCKETS

1-100 100pcs	
8 pin ST	.13 .11
14 pin ST	.15 .12
16 pin ST	.17 .13
18 pin ST	.20 .18
20 pin ST	.29 .27
22 pin ST	.30 .27
24 pin ST	.30 .27
28 pin ST	.40 .32
40 pin ST	.49 .38

ST = SOLDERTAIL

8 pin WW	.59 .49
14 pin WW	.69 .52
16 pin WW	.69 .56
18 pin WW	.99 .90
20 pin WW	1.08 .98
22 pin WW	1.39 1.28
24 pin WW	1.49 1.35
26 pin WW	1.69 1.49
40 pin WW	1.99 1.80

WW = WIREWRAP

BEFORE YOU BUY CALL  
JDR FOR THE BEST PRICE.

800-538-5000

800-662-6233

(CALIFORNIA RESIDENTS)

Z80A		6.00ea
Z80A	PIO	6.00ea
Z80A	SIO/1	15.00ea

8251A	Intel	4.75ea
UPD 765	(8272)	35.00ea
LM323K		3.50ea 10 for 3.00ea

## LS SPECIALS

LS240	.99	LS245	1.90
LS241	.99	LS373	.99
LS244	.99	SL374	1.75

(Sale Ends September 30, 1981)

## LEDS

Jumbo Red	10/1.00
Jumbo Green	6/1.00
Jumbo Yellow	6/1.00
5082-7760 43°C	79
MAN74 .3°C	99
MAN72 .3°C	99

## DYNAMIC RAMS

100pcs			
4027	(250ns)	2.50	2.00
4116-150	(150ns)	8/21.95	2.65
4116-200	(200ns)	8/19.95	2.35
4116-300	(300ns)	8/16.95	2.00
4164	(200ns)	CALL	CALL

## STATIC RAMS

100pcs			
2101	(450ns)	1.95	1.85
2102-1	(450ns)	.89	.85
21L02-1	(LP) (450ns)	1.29	1.15
2111	(450ns)	2.99	2.49
2112	(450ns)	2.99	2.79
2114	(450ns)	8/18.95	2.25
2114L-2	(LP) (200ns)	8/22.95	2.45
2114L-3	(300ns)	8/21.95	2.45
2114L-4	(LP) (450ns)	8/18.95	2.25
4044-4	(450ns)	3.49	3.25
4044-3	(300ns)	3.99	3.75
TMM2016	(200ns)	CALL	CALL
MB6116	(200ns)	CALL	CALL

LP = LOW POWER

## EPROMS

8pcs			
1702	256 x 8	(1us)	4.95 4.50
2708	1024 x 8	(450ns)	3.95 3.50
2716	(5v) 2048 x 8	(450ns)	6.95 5.95
2758	(5v) 1024 x 8	(450ns)	9.95 8.95
2716-1	(5v) 2048 x 8	(350ns)	12.95 11.95
TMS2716	2048 x 8	(450ns)	9.95 8.95
TMS2532	(5v) 4096 x 8	(450ns)	21.95 19.95
2732	(5v) 4096 x 8	(450ns)	17.95 16.95

## PROMS

74S188	(82S23)	OC	32 x 8	3.95
74S287	(82S129)	TS	256 x 4	4.75
74S288	(82S123)	TS	32 x 8	4.45
74S387	(82S126)	OC	256 x 4	5.75
74S471		TS	256 x 8	9.95
74S472	(82S147)	TS	512 x 8	16.85
74S474	(82S141)	TS	512 x 8	17.85
74S570	(82S130)	OC	512 x 4	7.80
74S571	(82S131)	TS	512 x 4	7.80

## JDR MICRODEVICES, INC.

1101 South Winchester Blvd.  
San Jose, California 95128  
800-538-5000 800-882-6263 (Callf.)  
408-247-4852

TERMS: For shipping include \$2.00 for UPS Ground; \$3.00 for UPS Blue Label Air; \$10.00 minimum order. Bay Area Residents add 6 1/2% sales tax Call. Residents add 6% sales tax. We reserve the right to limit quantities and substitute manufacturer. Prices subject to change without notice.



# WHAT'S NEW FROM CONSUMER COMPUTERS

Consumer Computers announces it's lowest prices ever.

## Apple Cards and Hardware

16K Ram Card by CCI .....	130
Language System w/Pascal .....	379
Silentype Printer w/interface card .....	349
Hayes Micromodem II .....	299
Novation Apple-Cat II .....	339
Videx videoterm 80 column w/graphics .....	259
Z-80 Softcard by Microsoft .....	299
16K RamCard by Microsoft .....	159
ABT Numeric Keypad (old or new kybord) .....	110
ALF 3 voice Music Card .....	239
ALF 9 voice Music Card .....	169
Heuristics Speechlink 2000 .....	259
Alpha Synlaur Keyboard System .....	1399
Corvus 10MB Winchester Disk system .....	CALL
Lazer Lower Case Plus* .....	55
Micro-Sci Disk Drives (A-40 & A-70) .....	CALL
SSM AIO Serial/Parallel card A&T .....	189
Sup-R-Terminal 80 Column Card .....	329
SVA 2VX4 Megabyte 8" disk controller .....	589
SVA 2+2 Single Den. 8" disk controller .....	345
Versawriter Dighizer Pad .....	229
Digisector Camera interface .....	299
ThunderClock Plus .....	119
Symtec Hi-Res Light Pen .....	210
Integer or Applesoft Firmware card .....	145
Graphics Tablet .....	619
Parallel Printer interface card .....	135
Hi-Speed Serial interface card .....	135
Smarterm 80 column card .....	299
Joystick by Keyboard Co. .....	46
Music System (16 Voices) .....	479
A/D + D/A interface .....	289
Expansion Chassis .....	599
Intro/X-10 controller card .....	169
Clock/Calendar card .....	225
CPS Multi-function card .....	189
Supertalker SD-200 .....	239
Romplus* Card .....	135
Romwriter Card .....	149
Clock/Calendar Module .....	99
GPIB IEEE 488 Card .....	249
Asynchronous Serial Interface Card .....	129
Centronics Parallel Interface Card .....	99
Arithmetic Processor Card .....	299
We carry all CCS cards, please call for best prices.	

## The versatile Apple Computer



**16K** NOW ONLY  
**\$1025**

**48K** NOW ONLY  
**\$1129**

**64K\*** NOW ONLY  
**\$1249**

\*16K Ram Card installed on 64K

## AVAILABLE NOW!

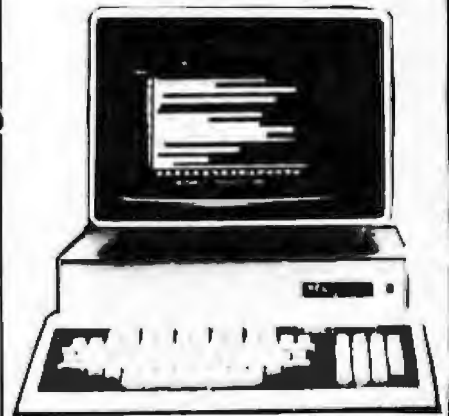

### NEC MICROCOMPUTER

PC-8001A 32K RAM COMPUTER ..... CALL  
 PC-8012A I/O UNIT W/32K RAM ..... CALL  
 PC-8031A DUAL MINI-DISK DRIVE UNIT ..... CALL  
 Please write for more information about the NEC computer.

## Apple II Entertainment Software (Top Ten)

Raster Blaster .....	29
Alien Rain .....	23
Hungry Boy .....	24
Adventure by Microsoft .....	27
Sargon II Chess .....	32
Pulsar II .....	29
Space Eggs .....	29
Fight Simulator .....	34
Cosmos Mission (Space Invaders) .....	24
Worlds Greatest Black Jack game .....	40

WE OFFER HUNDREDS OF SOFTWARE GAMES. PLEASE CALL OR WRITE FOR A LIST.

## VIDEO TAPES

WE SELL HUNDREDS OF FEATURE FILMS ON VHS AND BETA VIDEO TAPE. CALL OR WRITE FOR A PRICE LIST.

**TOLL FREE ORDER LINE**  
**800-854-6654**  
 California & outside continental U.S.  
**(714) 698-8088**

International Telex 695-000 Beta CCMO

## APPLE ///

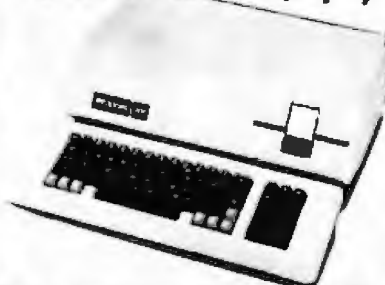

These systems come complete with the information analyst software package and a video monitor of your choice.  
**96K FOR ONLY \$3495**  
**128K FOR ONLY \$3995**

DISK /// .....	450
SILENTYPE /// .....	329

With Controller

**\$519**

Without Controller

**\$439**



Apple Disk Drives

## Solution Software the Apple II

Visicalc 3.3 .....	169
CCA Data Management .....	85
DB Master .....	169
WordStar (Apple 80 co. version) .....	299
Super Text II .....	139
Desktop Plan II .....	169
Appletwiter .....	65
Infolory .....	225
Landlord Apt. Mngmt .....	649
Stock Tracker by H&H .....	175
Easywriter .....	225
ASCII Express .....	59
Peachtree Business Software .....	CALL
Applesoft Compiler .....	185
Visiterm .....	129
Visitrend/Visiprot .....	219
Real Estate Analyzer .....	89
Tax Preparer .....	99
DOS Toolkit .....	65
Tax Planner .....	99
Dow Jones Portfolio Evaluator .....	45
Dow Jones News & Quotes Reporter .....	85
Apple Fortran .....	165
Apple Pilot .....	129
Controller Gen. Bus. System .....	499
The Analyzer Dakin 5 .....	519
Music Theory .....	45

# WHAT'S NEW FROM CONSUMER COMPUTERS

Buying Mail Order saves time, money and energy!

## Atari Personal Computer

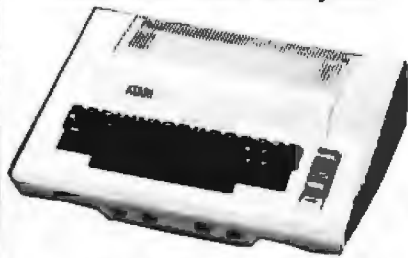

ATARI 800 16K

**\$749**

ATARI 400 16K **\$349**

410 Program Recorder	65
810 Disk Drive	449
815 Dual Disk Drive (Dbl. Den.)	1295
820 40 Col. Impact Printer	349
822 Thermal Printer	349
825 80 Col. Impact Printer (Cent. 737)	699
830 Acoustic Modem	159
850 Interface Module	159
Atari Light Pen	65
16K Ram Memory Module	149
16K RAM Memory Module (by ConComp)	89

## Ohio Scientific Challenger Computer

4P



**\$549**

IP MOD II

**\$399**

## Exidy Sorcerer II



We have the Sorcerer II in stock at unbeatable prices. Available in 16K, 32K & 48K models. Please Call for Price.

S-100 Expansion Unit	429
Word Processing Pac.	179
Development Pac.	89

## PMC-80 Micro Computer



**\$599 16K**

Compatible with TRS-80 Model I hardware and software!

# S-100

Quality S-100 cards available now at incredibly low prices.

Asm & Tested  
KH

## CALIFORNIA COMPUTER SYSTEMS

Z-80 CPU 2810	n/a	229
64K Dynamic Ram board	n/a	499
16K Static Ram 2 MHz	n/a	249
16K Static Ram 4 MHz	n/a	299
Dbl. Density Floppy Disk Controller	n/a	299
12 Slot S-100 Mainframe	n/a	349

## SSM

Z-80 CPU CB-2	219	279
I/O 2 par. & 2 ser. I/O board	189	249
VB 3 80 + 24 Video board	329	379
VB-3 80 + 48 Video board	369	429
VB-2 I/O Mapped video board 64 + 16	159	219
PBI PROM Prgrmr & EPROM board	139	199

## SD SYSTEMS

EXPANDORAM I (2MHz Uses 4116	16K	240	310
dynamic RAM and is expandable to 64K	32K	256	325
	48K	275	345
	64K	295	365
EXPANDORAM II (4MHz Uses	16K	250	319
4116 or 4164 dynamic RAM, is expandable to 64K or 256K respectively.	32K	269	339
	48K	289	359
	64K	305	375
VERSAFLOPPY I Disk controller	250	319	
VERSAFLOPPY II Disk controller	299	369	
SBC-100 2.5 MHz Z-80 w/I/O	299	369	
SBC-200 4 MHz Z-80 w/I/O	299	369	
PROM 100 EPROM programmer	210	279	

We will beat any currently advertised price on S-100 boards

**TOLL FREE ORDER LINE**  
**800-854-6654**

California & outside continental U.S.  
**(714) 698-8088**  
International Telex 695-000  
**Beta CCMO**

Use your Mastercard, Visa, American Express, Carte Blanche, Diners Club to charge your order phone. Open 7 days.

## Video Monitors



Amdel/Leedex Video 100 12" B&W	139
Amdel (Hitachi) 13" Color	359
NEC 12" Green Phosphor Screen	CALL
NEC 12" RGB Hi-Res Color	CALL
Panasonic 13" Color	449
Sanyo 9" B&W	185
Sanyo 9" Green Phosphor Screen	CALL
Sanyo 12" B&W	269
Sanyo 12" Green Phosphor Screen	285
Sanyo 13" Color w/excellent resolution	449

## PRINTERS

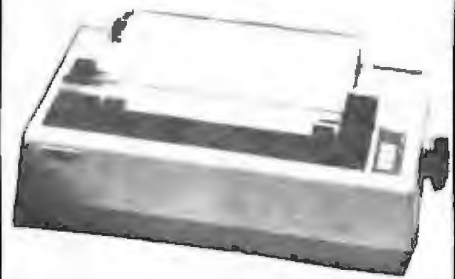

Epson MX-80

**CALL**



Paper Tiger IDS-460

**\$949**

Anadex 9500/9501 w/ 2K Buffer	1299
C. Itoh Starwriter 25 CPS	1499
C. Itoh Starwriter 45 CPS	1899
Epson MX-70	CALL
Epson MX-80 F/T	CALL
Paper Tiger IDS-445	699
Paper Tiger IDS-460	949
Paper Tiger IDS-560	1249
Silentype w/Apple II interface card	349
Quine Sprint 5/45	2495

Silentype w/apple II Interface

**\$349**



## How to Order:

Ordering Information: Phone orders using VISA, MASTERCARD, AMERICAN EXPRESS, DINERS CLUB, CARTE BLANCHE, bank wire transfer, cashiers or certified check, money order, or personal check (allow ten days to clear.) Unless prepaid with cash, please add 5% for shipping, handling and insurance minimum \$5.00). California residents add 6% sales tax. We accept COD's. PO's accepted from Educational Institutions. All equipment is subject to price change and availability without notice. All equipment is new and complete with manufacturer's warranty. Showroom prices may differ from mail order advertisement.

Send Orders to:

**consumer computers**  
Mail Order

8314 Parkway Drive  
La Mesa, California 92041

# CALL US TODAY FOR SPECIAL SYSTEM PACKAGE PRICES . . .

Now is the time to buy a complete system of your choice...

- CROMEMCO SYSTEM 2
- DYNABYTE
- NORTHSTAR
- SUPERBRAIN

*Complete with printer and software.  
READY TO USE!!!*

## Participate in our expansion sale.

*MiniMicroMart is moving to larger quarters to serve you with a larger staff and with the largest inventory of systems and peripherals.*



### MiniMicroMart, Inc.

943 W. Genesee St.  
Syracuse, New York 13204  
(315) 422-4467



# WE ARE MOVING TO LARGER QUARTERS!

Thank you . . .

. . . for making our expansion possible and for helping make us the leading distributor of microprocessor systems, terminals and printers.

We are showing our appreciation by producing a special catalog with thousands of items at greatly reduced prices. Call or write today.

Help us move our inventory before we have to move it.



**MiniMicroMart, Inc.**  
943 W. Genesee St.  
Syracuse, New York 13204  
(315) 422-4467

**ok PRODUCTS**



**JUST WRAP KIT**

Just Wrap tool for daisy chain wiring. Tool strips as it wraps and cuts. Includes one 50 foot spool of wire.

Part No.	Description	Price
JW-1*	Just Wrap Tool	\$14.95
JWK-6	Tool w/4 Spools and JUW1	24.95
R-JW*	50 Ft. Replacement Wire	3.49
JUW-1	Unwrapping Tool	3.49

\*Specify Color: Red, Blue, White or Yellow.



Regular Wrap



Modified Wrap

**HAND WRAP TOOL**

Part No.	Description	Price
WSU30	Regular	\$6.95
WSU30M	Modified	7.95

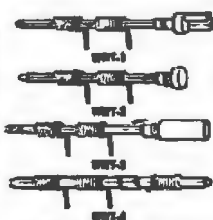

**TERMINALS**

- .025 (0.63mm) Square Post
- 3 Level Wire-Wrapping
- Gold Plated
- 25 PER PKG.

Part No.	Description	Price
WWT-1	Slotted Terminal	\$4.98
WWT-2	Single Sided Terminal	2.98
WWT-3	IC Socket Term.	4.98
WWT-4	Double Sided Terminal	1.98
INS 1	Insertion Tool for above	2.49

**SOCKET WRAP - ID**



Slipped onto socket before wrapping to identify pins.

Wrap-ID  
Pol. Pond

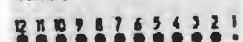

Part #	Price	Bulk Price	Part #	Price	Bulk Price
14ID	1.49/10	5.50/100	22ID	1.49/5	5.95/50
16ID	1.49/10	5.95/100	24ID	1.49/5	5.95/50
18ID	1.49/10	5.00/50	28ID	1.49/5	6.50/50
20ID	1.49/5	5.00/50	40ID	1.49/5	5.00/25



**P.C.B. TERMINAL STRIPS**

The TS strips provide positive screw activated clamping action, accommodate wire sizes 14-30 AWG (1.8-0, 25mm). Pins are solder plated copper, .042 inch (1mm) diameter, on .200 inch (5mm) centers.

Part No.	Description	Price
TS- 4	4-Pole	\$1.69
TS- 8	8-Pole	2.59
TS-12	12-Pole	3.49
TS6MD	2-Pole Interlocking	3/1.79



**DESOLDERING PUMP**

Easy one hand operation. Rugged all metal construction. Replaceable TEFLON™ Tip. Self cleaning on each stroke. Suction precisely regulated for reliable desoldering without damage to delicate circuitry.

DSP1	Desoldering Pump	\$9.95
------	------------------	--------

**LOGIC PROBE**



Compatible with all logic families using a 4 to 15V power supply. Thresholds automatically programmed. Visual indication of logic levels to show high, low, bad level or open circuit logic pulses.

- 10 N sec. pulse responses
- 120 K input impedance.
- Automatic resetting memory.
- Includes tip with protective cap & coiled cord.

PRB-1	\$36.95
-------	---------

**LOGIC PULSER**

Superimposes a pulse train (20 pps) or a single pulse onto the circuit node under test without un-soldering IC's.

- Automatic polarity sensing
- 2 us pulse width
- Finger tip push button actuated
- Includes tip with protective cap & coiled cord.

PSL-1	\$48.95
-------	---------

**VACUUM VISE**

Unique vacuum-based light duty vise for precision handling of small components and assemblies. Rugged ABS construction. 1 1/2" (32mm) travel for maximum versatility. Also features screw lugs for permanent installation.



VV1	Vacuum Vice	\$3.49
-----	-------------	--------



**HOBBY-WRAP TOOL BW263**

- Auto-indexing
- Anti-Overwrap
- Modified Wrap

Part No.	Description	Price
BW2630	Tool	\$19.85
BT30	#30 Bit (not incl.)	3.95
BT2628	#28 Bit (not incl.)	7.95
BC1	Batteries & Charger	14.95

**INSERTION/EXTRACTION TOOLS**

Part No.	Description	Price
INS1416	14-16 pin Insertor	\$3.49
MOS1416	14-16 pin MOS Safe Insertor	7.95
MOS2428	24-28 pin MOS Safe Insertor	7.95
MOS40	40 pin MOS Safe Insertor	7.95
EX1	14-16 pin IC Extractor	1.49
EX2	24-40 pin IC Extractor	7.95



**WK-7 IC INSERTION KIT**

Complete IC Insertor/Extractor Kit. Individual Components (listed above) \$22.95

**IC DISPENSER**

Allows IC's to be dispensed from their tube 1 at a time and picked up by insertion tools above.

- Dispenses 8-42 pin IC's
- Compatible with all IC carrying tubes
- Use with WK7 for MOS safe insertion.

Part No.	Description	Price
MDD1	1 Chan. Dispenser	\$21.85
MDD5	5 Chan. Dispenser	83.43
MDD10	10 Chan. Dispenser	160.45

\*No Discount.

ALL FREE ORDERING NUMBER 1-(800) 423-7144

### IDC CONNECTORS



#### RIGHT ANGLE HEADERS

Size	SOLDER TAIL		WIRE WRAP	
	Part No.	Price	Part No.	Price
10	IDH10SRB	\$1.20	IDH10WRB	\$2.60
20	IDH20SRB	1.90	IDH20WRB	4.15
26	IDH26SRB	2.75	IDH26WRB	5.35
34	IDH34SRB	3.75	IDH34WRB	6.25
40	IDH40SRB	3.75	IDH40WRB	7.35
50	IDH50SRB	4.75	IDH50WRB	9.20

1" Spacing. Mounts on PC Board & Mates with IDS Socket below. Ejector Bars 4/1.00.



#### EDGE CARD CONNECTORS

Size	Part No.	Price
10	IDE10B	\$3.95
20	IDE20B	4.35
26	IDE26B	5.00
34	IDE34B	6.05
40	IDE40B	6.90
50	IDE50B	7.50

.1" Spacing. Crimps onto cable with ordinary vise & mates with standard .062" Card Edge.

#### RIBBON CABLE

Size	Solid Color		Color Coded	
	10 ft.	100 ft.	10 ft.	100 ft.
10	2.90	17.00	4.00	30.00
14	3.40	23.80	5.00	42.00
16	3.70	27.20	5.60	48.00
20	4.40	34.00	7.00	60.00
24	5.00	40.80	8.00	72.00
26	5.40	44.20	8.60	78.00
34	6.80	57.80	11.00	102.00
40	7.80	68.00	13.00	120.00
50	9.50	85.00	16.00	150.00



#### 25 PIN "D" CONNECTORS

Solder Style	Part No.	Price
Male	DB25P	\$2.95
Female	DB25S	3.95
Cover	DB25C	1.50

IDC Style	Part No.	Price
Male	IDB25P	6.25
Female	IDB25S	6.60
Cover	IDB25C	1.60

Solder Style solders onto cable, IDC Style crimps onto cable with vise. 9, 15, 37 and 50 pin available also.



#### CABLE PLUGS

Size	Part No.	Price
14	IDP14B	\$1.45
16	IDP16B	1.65
24	IDP24B	2.50
40	IDP40B	4.15

.1" Spacing. Crimps onto cable with ordinary vise & plugs into standard IC Socket.



#### SOCKETS

Size	Part No.	Price
10	IDS10B	\$1.88
20	IDS20B	2.75
26	IDS26B	3.50
34	IDS34B	4.50
40	IDS40B	5.40
50	IDS50B	6.50

.1" Spacing. Crimps onto cable with ordinary vise & mounts to header sold above.

### WIRE WRAP SUPPLIES

#### WIRE WRAP WIRE

Length	#30 Wire Wrap Wire		
	100/Bag	500/Bag	1K/Bag
2.5"	\$1.38	\$3.94	\$6.81
3.0"	1.43	4.25	7.46
3.5"	1.51	4.57	8.11
4.0"	1.56	4.88	8.73
4.5"	1.63	5.21	9.39
5.0"	1.69	5.54	10.04
5.5"	1.74	5.92	10.69
6.0"	1.82	6.23	11.34
6.5"	2.11	7.08	12.99
7.0"	2.19	7.44	13.68
7.5"	2.29	7.78	14.40
8.0"	2.35	8.12	15.10
8.5"	2.40	8.46	15.80
9.0"	2.46	8.92	16.51
9.5"	2.53	9.15	17.22
10.0"	2.63	9.58	17.91

All lengths are overall, including 1" strip on each end. Choose from colors; Red, Blue, Black, Yellow, White, Green, Orange, and Violet.

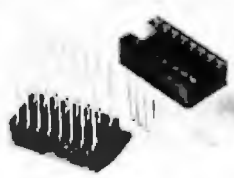

Size	Part No.	Each	Tube
08	ICN083WBSG	.44	52x .39 = \$20.28
14	ICN143WBSG	.53	30x .46 = \$13.80
16	ICN163WBSG	.58	26x .50 = \$13.00
18	ICN183WBSG	.78	23x .68 = \$15.64
20	ICN203WBSG	1.00	21x .85 = \$17.85
22	ICN224WBSG	1.07	19x .92 = \$17.48
24	ICN246WBSG	1.09	17x 1.09 = \$18.98
28	ICN286WBSG	1.43	15x 1.23 = \$18.45
40	ICN406WBSG	1.85	10x 1.60 = \$16.00

Selective Plating provides gold in contact where it counts. 3-level wrap. Save by buying sockets by the tube. All gold available at 1/2¢/pin extra charge.

\* \* \* No Discount

#### WIRE KITS

Kit No. 1 - \$9.95			
250	3"	100	4 1/2"
200	3 1/2"	100	5"
100	4"	100	6"
Kit No. 2 - \$24.95			
250	2 1/2"	250	5"
500	3"	100	5 1/2"
500	3 1/2"	100	6"
500	4"	100	6 1/2"
250	4 1/2"	100	7"
Kit No. 3 - \$34.95			
250	2 1/2"	500	4 1/2"
500	3"	500	5"
500	3 1/2"	500	5 1/2"
500	4"	500	6"
Kit No. 4 - \$59.95			
500	2 1/2"	1000	4 1/2"
1000	3"	1000	5"
1000	3 1/2"	1000	5 1/2"
1000	4"	1000	6"

### ORDERING INFORMATION

Prepaid orders over \$50 shipped prepaid via UPS. All others add \$3.00 for handling. VISA, MC, COD's and open account orders will be charged freight. \$15 minimum order, \$100 minimum open account order.

### DISCOUNT SCHEDULE

Order Amount	Discount	Requirement
\$15 - 99	None	None
100 - 199	less 10%	Discount and the name of this magazine must be mentioned at time of order to get discount. Discount applies on all items except as noted, "No Discount."
200 - 499	less 15%	
500 - 999	less 20%	
1000 up	less 25%	





# California Digital

Post Office Box 3097 B • Torrance, California 90503



## DISKETTES

FREE PLASTIC LIBRARY CASE INCLUDED WITH THE PURCHASE OF EVERY BOX OF DISKETTES

Specialty diskettes for California Digital are made of the finest quality magnetic grade vinyl of magnetic grade. Each diskette is certified double density at 60 cps. The longer extended media life each diskette is manufactured with a resin-coated hub-hole. And all diskettes, plastic library case is included with every box of diskettes. 15311-CDS01X100  
Minimum amount computer or required system.

**\$24.95**  
BOX

Ten boxes \$22.75 One hundred boxes \$21.50

MINIDISKETTES	Box 10 boxes	Box 100 boxes
5 1/4" 5 1/4" 100	\$22.75	\$21.50
5 1/4" 5 1/4" 250	\$22.75	\$21.50
5 1/4" 5 1/4" 500	\$22.75	\$21.50
5 1/4" 5 1/4" 1000	\$22.75	\$21.50
5 1/4" 5 1/4" 2000	\$22.75	\$21.50
5 1/4" 5 1/4" 4000	\$22.75	\$21.50
5 1/4" 5 1/4" 8000	\$22.75	\$21.50
5 1/4" 5 1/4" 16000	\$22.75	\$21.50
5 1/4" 5 1/4" 32000	\$22.75	\$21.50
5 1/4" 5 1/4" 64000	\$22.75	\$21.50
5 1/4" 5 1/4" 128000	\$22.75	\$21.50
5 1/4" 5 1/4" 256000	\$22.75	\$21.50
5 1/4" 5 1/4" 512000	\$22.75	\$21.50
5 1/4" 5 1/4" 1024000	\$22.75	\$21.50
5 1/4" 5 1/4" 2048000	\$22.75	\$21.50
5 1/4" 5 1/4" 4096000	\$22.75	\$21.50
5 1/4" 5 1/4" 8192000	\$22.75	\$21.50
5 1/4" 5 1/4" 16384000	\$22.75	\$21.50
5 1/4" 5 1/4" 32768000	\$22.75	\$21.50
5 1/4" 5 1/4" 65536000	\$22.75	\$21.50
5 1/4" 5 1/4" 131072000	\$22.75	\$21.50
5 1/4" 5 1/4" 262144000	\$22.75	\$21.50
5 1/4" 5 1/4" 524288000	\$22.75	\$21.50
5 1/4" 5 1/4" 1048576000	\$22.75	\$21.50
5 1/4" 5 1/4" 2097152000	\$22.75	\$21.50
5 1/4" 5 1/4" 4194304000	\$22.75	\$21.50
5 1/4" 5 1/4" 8388608000	\$22.75	\$21.50
5 1/4" 5 1/4" 16777216000	\$22.75	\$21.50
5 1/4" 5 1/4" 33554432000	\$22.75	\$21.50
5 1/4" 5 1/4" 67108864000	\$22.75	\$21.50
5 1/4" 5 1/4" 134217728000	\$22.75	\$21.50
5 1/4" 5 1/4" 268435456000	\$22.75	\$21.50
5 1/4" 5 1/4" 536870912000	\$22.75	\$21.50
5 1/4" 5 1/4" 1073741824000	\$22.75	\$21.50
5 1/4" 5 1/4" 2147483648000	\$22.75	\$21.50
5 1/4" 5 1/4" 4294967296000	\$22.75	\$21.50
5 1/4" 5 1/4" 8589934592000	\$22.75	\$21.50
5 1/4" 5 1/4" 17179869184000	\$22.75	\$21.50
5 1/4" 5 1/4" 34359738368000	\$22.75	\$21.50
5 1/4" 5 1/4" 68719476736000	\$22.75	\$21.50
5 1/4" 5 1/4" 137438953472000	\$22.75	\$21.50
5 1/4" 5 1/4" 274877906944000	\$22.75	\$21.50
5 1/4" 5 1/4" 549755813888000	\$22.75	\$21.50
5 1/4" 5 1/4" 1099511627776000	\$22.75	\$21.50
5 1/4" 5 1/4" 2199023255552000	\$22.75	\$21.50
5 1/4" 5 1/4" 4398046511104000	\$22.75	\$21.50
5 1/4" 5 1/4" 8796093022208000	\$22.75	\$21.50
5 1/4" 5 1/4" 17592186444416000	\$22.75	\$21.50
5 1/4" 5 1/4" 35184372888832000	\$22.75	\$21.50
5 1/4" 5 1/4" 70368745777664000	\$22.75	\$21.50
5 1/4" 5 1/4" 140737491553328000	\$22.75	\$21.50
5 1/4" 5 1/4" 281474983106656000	\$22.75	\$21.50
5 1/4" 5 1/4" 562949966213312000	\$22.75	\$21.50
5 1/4" 5 1/4" 1125899932426624000	\$22.75	\$21.50
5 1/4" 5 1/4" 2251799864853248000	\$22.75	\$21.50
5 1/4" 5 1/4" 4503599729706496000	\$22.75	\$21.50
5 1/4" 5 1/4" 9007199459412992000	\$22.75	\$21.50
5 1/4" 5 1/4" 18014398918825984000	\$22.75	\$21.50
5 1/4" 5 1/4" 36028797837651968000	\$22.75	\$21.50
5 1/4" 5 1/4" 72057595675303936000	\$22.75	\$21.50
5 1/4" 5 1/4" 144115191350607872000	\$22.75	\$21.50
5 1/4" 5 1/4" 288230382701215744000	\$22.75	\$21.50
5 1/4" 5 1/4" 576460765402431488000	\$22.75	\$21.50
5 1/4" 5 1/4" 115292153080482976000	\$22.75	\$21.50
5 1/4" 5 1/4" 230584306160965952000	\$22.75	\$21.50
5 1/4" 5 1/4" 461168612321931904000	\$22.75	\$21.50
5 1/4" 5 1/4" 922337224643863808000	\$22.75	\$21.50
5 1/4" 5 1/4" 1844674449287727616000	\$22.75	\$21.50
5 1/4" 5 1/4" 3689348898575455232000	\$22.75	\$21.50
5 1/4" 5 1/4" 7378697797150910464000	\$22.75	\$21.50
5 1/4" 5 1/4" 14757395584301820928000	\$22.75	\$21.50
5 1/4" 5 1/4" 29514791168603641856000	\$22.75	\$21.50
5 1/4" 5 1/4" 59029582337207283712000	\$22.75	\$21.50
5 1/4" 5 1/4" 118059164674414567424000	\$22.75	\$21.50
5 1/4" 5 1/4" 236118329348829134848000	\$22.75	\$21.50
5 1/4" 5 1/4" 472236658697658269696000	\$22.75	\$21.50
5 1/4" 5 1/4" 944473317395316539392000	\$22.75	\$21.50
5 1/4" 5 1/4" 1888946634910633078784000	\$22.75	\$21.50
5 1/4" 5 1/4" 37778932698212661577568000	\$22.75	\$21.50
5 1/4" 5 1/4" 755578653964253231555328000	\$22.75	\$21.50
5 1/4" 5 1/4" 1511157307928506463111056000	\$22.75	\$21.50
5 1/4" 5 1/4" 3022314615857012926222112000	\$22.75	\$21.50
5 1/4" 5 1/4" 6044629231714025852444224000	\$22.75	\$21.50
5 1/4" 5 1/4" 12089258464228051704888848000	\$22.75	\$21.50
5 1/4" 5 1/4" 24178516928456103397777776000	\$22.75	\$21.50
5 1/4" 5 1/4" 48357033856912206785555552000	\$22.75	\$21.50
5 1/4" 5 1/4" 967140677138244135711111104000	\$22.75	\$21.50
5 1/4" 5 1/4" 1934281354276888271422222208000	\$22.75	\$21.50
5 1/4" 5 1/4" 3868562708553776542844444416000	\$22.75	\$21.50
5 1/4" 5 1/4" 7737125417107553085688888832000	\$22.75	\$21.50
5 1/4" 5 1/4" 1547425083421510617377777764000	\$22.75	\$21.50
5 1/4" 5 1/4" 3094850166843021235475555528000	\$22.75	\$21.50
5 1/4" 5 1/4" 618970033368604247095111111104000	\$22.75	\$21.50
5 1/4" 5 1/4" 123794006737720849419011111104000	\$22.75	\$21.50
5 1/4" 5 1/4" 24758801347541709838011111104000	\$22.75	\$21.50
5 1/4" 5 1/4" 49517602695083419676011111104000	\$22.75	\$21.50
5 1/4" 5 1/4" 99035205390166839352011111104000	\$22.75	\$21.50
5 1/4" 5 1/4" 19807041078033367874011111104000	\$22.75	\$21.50
5 1/4" 5 1/4" 39614082156066735748011111104000	\$22.75	\$21.50
5 1/4" 5 1/4" 79228164312133471496011111104000	\$22.75	\$21.50
5 1/4" 5 1/4" 15845632864426694299201111104000	\$22.75	\$21.50
5 1/4" 5 1/4" 31691265728853388598401111104000	\$22.75	\$21.50
5 1/4" 5 1/4" 633825314577067771996801111104000	\$22.75	\$21.50
5 1/4" 5 1/4" 126765062915441343993601111104000	\$22.75	\$21.50
5 1/4" 5 1/4" 2535301258308826879971201111104000	\$22.75	\$21.50
5 1/4" 5 1/4" 5070602516617653759942401111104000	\$22.75	\$21.50
5 1/4" 5 1/4" 10141205033235307119884801111104000	\$22.75	\$21.50
5 1/4" 5 1/4" 2028241006647061439977601111104000	\$22.75	\$21.50
5 1/4" 5 1/4" 4056482013294122879955201111104000	\$22.75	\$21.50
5 1/4" 5 1/4" 8112964026588245759910401111104000	\$22.75	\$21.50
5 1/4" 5 1/4" 16225928111776491519920801111104000	\$22.75	\$21.50
5 1/4" 5 1/4" 32451856223552983039841601111104000	\$22.75	\$21.50
5 1/4" 5 1/4" 64903712447105966079683201111104000	\$22.75	\$21.50
5 1/4" 5 1/4" 129807424934211913159366401111104000	\$22.75	\$21.50
5 1/4" 5 1/4" 2596148498684238223187212801111104000	\$22.75	\$21.50
5 1/4" 5 1/4" 5192296997368447644374425601111104000	\$22.75	\$21.50
5 1/4" 5 1/4" 103845939547689312888748851201111104000	\$22.75	\$21.50
5 1/4" 5 1/4" 20769187909537865777577762401111104000	\$22.75	\$21.50
5 1/4" 5 1/4" 4153837581907573155555544801111104000	\$22.75	\$21.50
5 1/4" 5 1/4" 830767516381514631111110801111104000	\$22.75	\$21.50
5 1/4" 5 1/4" 166153503276302926222221601111104000	\$22.75	\$21.50
5 1/4" 5 1/4" 332307006552605852444443201111104000	\$22.75	\$21.50
5 1/4" 5 1/4" 66461401310521170488886401111104000	\$22.75	\$21.50
5 1/4" 5 1/4" 13292280262104234097772801111104000	\$22.75	\$21.50
5 1/4" 5 1/4" 2658456052420846819555556401111104000	\$22.75	\$21.50
5 1/4" 5 1/4" 5316912104841693639111110801111104000	\$22.75	\$21.50
5 1/4" 5 1/4" 1063382420968338727822221601111104000	\$22.75	\$21.50
5 1/4" 5 1/4" 2126764841936677455644443201111104000	\$22.75	\$21.50
5 1/4" 5 1/4" 4253529683873354911288886401111104000	\$22.75	\$21.50
5 1/4" 5 1/4" 850705936774670982257772801111104000	\$22.75	\$21.50
5 1/4" 5 1/4" 17014118735493419645155556401111104000	\$22.75	\$21.50
5 1/4" 5 1/4" 340282374709868392903111110801111104000	\$22.75	\$21.50
5 1/4" 5 1/4" 68056474941973678580622221601111104000	\$22.75	\$21.50
5 1/4" 5 1/4" 136112949883955357161244443201111104000	\$22.75	\$21.50
5 1/4" 5 1/4" 2722258977679107143248886401111104000	\$22.75	\$21.50
5 1/4" 5 1/4" 5444517955358214284977772801111104000	\$22.75	\$21.50
5 1/4" 5 1/4" 1088903511071642856955556401111104000	\$22.75	\$21.50
5 1/4" 5 1/4" 21778070221432857139111110801111104000	\$22.75	\$21.50
5 1/4" 5 1/4" 43556140442865727822221601111104000	\$22.75	\$21.50
5 1/4" 5 1/4" 8711228088573145544443201111104000	\$22.75	\$21.50
5 1/4" 5 1/4" 17422451771462829088886401111104000	\$22.75	\$21.50
5 1/4" 5 1/4" 34844903543225658177772801111104000	\$22.75	\$21.50
5 1/4" 5 1/4" 69689807086451316355556401111104000	\$22.75	\$21.50
5 1/4" 5 1/4" 13937961417290262711244443201111104000	\$22.75	\$21.50
5 1/4" 5 1/4" 2787592283458052542248886401111104000	\$22.75	\$21.50
5 1/4" 5 1/4" 5575184566916105084497772801111104000	\$22.75	\$21.50
5 1/4" 5 1/4" 1115036913823221016895556401111104000	\$22.75	\$21.50
5 1/4" 5 1/4" 22300738276464420337911110801111104000	\$22.75	\$21.50
5 1/4" 5 1/4" 4460147655292884067582221601111104000	\$22.75	\$21.50
5 1/4" 5 1/4" 89202953105857681351644443201111104000	\$22.75	\$21.50
5 1/4" 5 1/4" 1784059062117115363248886401111104000	\$22.75	\$21.50
5 1/4" 5 1/4" 356811812423423066497772801111104000	\$22.75	\$21.50
5 1/4" 5 1/4" 713623624846846132995556401111104000	\$22.75	\$21.50
5 1/4" 5 1/4" 1427247297693692659911110801111104000	\$22.75	\$21.50
5 1/4" 5 1/4" 285449459538738531992221601111104000	\$22.75	\$21.50
5 1/4" 5 1/4" 5708989190774770639844443201111104000	\$22.75	\$21.50
5 1/4" 5 1/4" 11417978381549541397772801111104000	\$22.75	\$21.50
5 1/4" 5 1/4" 22835956762899082795556401111104000	\$22.75	\$21.50
5 1/4" 5 1/4" 456719135257981655911110801111104000	\$22.75	\$21.50
5 1/4" 5 1/4" 91343827051596331182221601111104000	\$22.75	\$21.50
5 1/4" 5 1/4" 1826876441031926623644443201111104000	\$22.7	



### 7400

SN7400N	.25	SN7402N	.25	SN7406N	.75
SN7401N	.20	SN7403N	.35	SN7407N	.65
SN7402N	.25	SN7404N	.35	SN7408N	.65
SN7403N	.25	SN7405N	.35	SN7409N	.65
SN7404N	.25	SN7406N	5.00	SN7410N	.65
SN7405N	.25	SN7407N	.50	SN7411N	.65
SN7406N	.25	SN7408N	.65	SN7412N	.65
SN7407N	.25	SN7409N	.65	SN7413N	.65
SN7408N	.25	SN7410N	1.75	SN7414N	.65
SN7409N	.25	SN7411N	.65	SN7415N	.65
SN7410N	.25	SN7412N	.65	SN7416N	.65
SN7411N	.25	SN7413N	.65	SN7417N	.65
SN7412N	.25	SN7414N	.65	SN7418N	.65
SN7413N	.25	SN7415N	.65	SN7419N	.65
SN7414N	.25	SN7416N	.65	SN7420N	.65
SN7415N	.25	SN7417N	.65	SN7421N	.65
SN7416N	.25	SN7418N	.65	SN7422N	.65
SN7417N	.25	SN7419N	.65	SN7423N	.65
SN7418N	.25	SN7420N	.65	SN7424N	.65
SN7419N	.25	SN7421N	.65	SN7425N	.65
SN7420N	.25	SN7422N	.65	SN7426N	.65
SN7421N	.25	SN7423N	.65	SN7427N	.65
SN7422N	.25	SN7424N	.65	SN7428N	.65
SN7423N	.25	SN7425N	.65	SN7429N	.65
SN7424N	.25	SN7426N	.65	SN7430N	.65
SN7425N	.25	SN7427N	.65	SN7431N	.65
SN7426N	.25	SN7428N	.65	SN7432N	.65
SN7427N	.25	SN7429N	.65	SN7433N	.65
SN7428N	.25	SN7430N	.65	SN7434N	.65
SN7429N	.25	SN7431N	.65	SN7435N	.65
SN7430N	.25	SN7432N	.65	SN7436N	.65
SN7431N	.25	SN7433N	.65	SN7437N	.65
SN7432N	.25	SN7434N	.65	SN7438N	.65
SN7433N	.25	SN7435N	.65	SN7439N	.65
SN7434N	.25	SN7436N	.65	SN7440N	.65
SN7435N	.25	SN7437N	.65	SN7441N	.65
SN7436N	.25	SN7438N	.65	SN7442N	.65
SN7437N	.25	SN7439N	.65	SN7443N	.65
SN7438N	.25	SN7440N	.65	SN7444N	.65
SN7439N	.25	SN7441N	.65	SN7445N	.65
SN7440N	.25	SN7442N	.65	SN7446N	.65
SN7441N	.25	SN7443N	.65	SN7447N	.65
SN7442N	.25	SN7444N	.65	SN7448N	.65
SN7443N	.25	SN7445N	.65	SN7449N	.65
SN7444N	.25	SN7446N	.65	SN7450N	.65
SN7445N	.25	SN7447N	.65	SN7451N	.65
SN7446N	.25	SN7448N	.65	SN7452N	.65
SN7447N	.25	SN7449N	.65	SN7453N	.65
SN7448N	.25	SN7450N	.65	SN7454N	.65
SN7449N	.25	SN7451N	.65	SN7455N	.65
SN7450N	.25	SN7452N	.65	SN7456N	.65
SN7451N	.25	SN7453N	.65	SN7457N	.65
SN7452N	.25	SN7454N	.65	SN7458N	.65
SN7453N	.25	SN7455N	.65	SN7459N	.65
SN7454N	.25	SN7456N	.65	SN7460N	.65
SN7455N	.25	SN7457N	.65	SN7461N	.65
SN7456N	.25	SN7458N	.65	SN7462N	.65
SN7457N	.25	SN7459N	.65	SN7463N	.65
SN7458N	.25	SN7460N	.65	SN7464N	.65
SN7459N	.25	SN7461N	.65	SN7465N	.65
SN7460N	.25	SN7462N	.65	SN7466N	.65
SN7461N	.25	SN7463N	.65	SN7467N	.65
SN7462N	.25	SN7464N	.65	SN7468N	.65
SN7463N	.25	SN7465N	.65	SN7469N	.65
SN7464N	.25	SN7466N	.65	SN7470N	.65
SN7465N	.25	SN7467N	.65		
SN7466N	.25	SN7468N	.65		
SN7467N	.25	SN7469N	.65		
SN7468N	.25	SN7470N	.65		

### 4-Digit 16 Segment Alphanumeric Intelligent Display with Memory, Recorder, Driver

End-strokeable, 4-character package, high contrast, 100000 hrs. ruggedized monolithic character set. Character ASCII format built in memory, decoder, multiplexer and driver. Greatly exceeds all other independently sold systems. Character set: 16 x 16 x 16 x 16 x 22.2".

DL-146 Alphanumeric Display \$19.95 ea.

### 10-Segment Bi-Color Displays (with On-Board Driver IC-Chip)

Size: 1/2" x 1/2" x 1/8" (10 pins)

Use in any display mode externally operated by user. Package is end-strokeable for automated display. Can be cascaded to 10 digits (100 through elements). LED current programmable from 2mA to 20mA. Stable constant voltage reference for full scale analog inputs from 1.0 to 1.2V. Each LED current of 10mA. IC has external address. Size: 1/2" x 1/2" x 1/8".

NS4205	Linear Function (10 bars red)	0.90
NS4206	Linear Function (10 bars green)	0.90
NS4207	Linear Function (10 bars red/green)	0.90
NS4208	Linear Function (10 bars red/green)	0.90
NS4209	Linear Function (10 bars red/green)	0.90
NS4210	Linear Function (10 bars red/green)	0.90
NS4211	Linear Function (10 bars red/green)	0.90
NS4212	Linear Function (10 bars red/green)	0.90
NS4213	Linear Function (10 bars red/green)	0.90
NS4214	Linear Function (10 bars red/green)	0.90
NS4215	Linear Function (10 bars red/green)	0.90
NS4216	Linear Function (10 bars red/green)	0.90
NS4217	Linear Function (10 bars red/green)	0.90
NS4218	Linear Function (10 bars red/green)	0.90
NS4219	Linear Function (10 bars red/green)	0.90
NS4220	Linear Function (10 bars red/green)	0.90

### INTERFIL

Part No.	Function	Price
7065PI	CMOS Precision Timer	14.95
7065V/K1*	Stowwatch Chip, XTL	24.95
7108CPL	IC, Circuit A/D LCD Driver	24.95
7108V/K1*	IC, Circuit B/B, Display	24.95
7109CPL	3 1/2 Digit A/D LCD Driver	19.95
7109V/K1*	IC, Circuit B/B, Display	24.95
7110CPL	3 1/2 Digit A/D LCD D. H.L.D.	24.95
7111CPL	3 1/2 Digit A/D LCD D. H.L.D.	17.95
7112CPL	Low Battery Volt Indicator	2.25
7205IPD	CMOS LED Stowwatch/Timer	12.95
7205V/K1*	Stowwatch Chip, XTL	14.95
7205C/P	Tone Generator	1.95
7205V/K1*	Tone Generator Chip, XTL	12.95
7205IPD	Quadrator Counter	15.50
7205V/K1*	Freq. Counter Chip, XTL	17.95
7205IPD	Seven Decade Counter	17.95
7205C/P	Clock Generator	3.95
7211IPD	4 Func. CMOS Stowwatch GMT	11.95
7211V/K1*	4 Func. Stowwatch Chip, XTL	19.95
7212IPD	8-Digit Univ. Counter C.A.	25.95
7212V/K1*	8-Digit Freq. Counter C.C.	25.95
7213IPD	4-Digit LED Up/Down Counter	12.95
7213V/K1*	4-Digit LED Up/Down Counter	12.95
7214IPD	LCD 4 1/2 Digit Up Counter DRI	17.95
7214V/K1*	8-Digit Univ. Counter	31.95
7215V/K1*	5 Function Counter Chip, XTL	24.95
7216IPD	Quadrator Counter	4.95
7216V/K1*	CMOS Div-by-256 RC Timer	5.00
7217IPD	CMOS BCD Pres. Timer/Counter	2.00
7217V/K1*	CMOS BCD Pres. Timer/Counter	2.00
7218IPD	CMOS 555 Timer	1.45
7218V/K1*	CMOS Timer (4 pin)	1.45
7219IPD	CMOS Op Amp Comparator	5M 2.25
7219V/K1*	CMOS Op Amp Est. Cmv.	5M 2.25
7220IPD	CMOS Dual Op Amp Comp.	5M 3.50
7220V/K1*	CMOS Dual Op Amp Comp.	5M 3.50
7221IPD	CMOS Quad Op Amp Comp.	5M 4.50
7221V/K1*	CMOS Quad Op Amp Comp.	5M 4.50
7222IPD	CMOS Quad Op Amp Comp.	5M 4.50
7222V/K1*	CMOS Quad Op Amp Comp.	5M 4.50
7223IPD	Voltage Converter	7.25
7223V/K1*	Waveform Generator	14.95
7224IPD	Monolithic Logic Arithmetic AM	23.00
7224V/K1*	560pp Base-CAP Volt Ref. Diode	2.00
7225IPD	Volt Ref. Indicator	1.95
7225V/K1*	Volt Ref/Indicator	2.00

### 74LS

74LS00	.75	74LS128	1.15
74LS01	.75	74LS129	1.15
74LS02	.75	74LS130	1.15
74LS03	.75	74LS131	1.15
74LS04	.75	74LS132	1.15
74LS05	.75	74LS133	1.15
74LS06	.75	74LS134	1.15
74LS07	.75	74LS135	1.15
74LS08	.75	74LS136	1.15
74LS09	.75	74LS137	1.15
74LS10	.75	74LS138	1.15
74LS11	.75	74LS139	1.15
74LS12	.75	74LS14	1.15
74LS13	.75	74LS15	1.15
74LS14	.75	74LS16	1.15
74LS15	.75	74LS17	1.15
74LS16	.75	74LS18	1.15
74LS17	.75	74LS19	1.15
74LS18	.75	74LS20	1.15
74LS19	.75	74LS21	1.15
74LS20	.75	74LS22	1.15
74LS21	.75	74LS23	1.15
74LS22	.75	74LS24	1.15
74LS23	.75	74LS25	1.15
74LS24	.75	74LS26	1.15
74LS25	.75	74LS27	1.15
74LS26	.75	74LS28	1.15
74LS27	.75	74LS29	1.15
74LS28	.75	74LS30	1.15
74LS29	.75	74LS31	1.15
74LS30	.75	74LS32	1.15
74LS31	.75	74LS33	1.15
74LS32	.75	74LS34	1.15
74LS33	.75	74LS35	1.15
74LS34	.75	74LS36	1.15
74LS35	.75	74LS37	1.15
74LS36	.75	74LS38	1.15
74LS37	.75	74LS39	1.15
74LS38	.75	74LS40	1.15
74LS39	.75	74LS41	1.15
74LS40	.75	74LS42	1.15
74LS41	.75	74LS43	1.15
74LS42	.75	74LS44	1.15
74LS43	.75	74LS45	1.15
74LS44	.75	74LS46	1.15
74LS45	.75	74LS47	1.15
74LS46	.75	74LS48	1.15
74LS47	.75	74LS49	1.15
74LS48	.75	74LS50	1.15
74LS49	.75	74LS51	1.15
74LS50	.75	74LS52	1.15
74LS51	.75	74LS53	1.15
74LS52	.75	74LS54	1.15
74LS53	.75	74LS55	1.15
74LS54	.75	74LS56	1.15
74LS55	.75	74LS57	1.15
74LS56	.75	74LS58	1.15
74LS57	.75	74LS59	1.15
74LS58	.75	74LS60	1.15
74LS59	.75	74LS61	1.15
74LS60	.75	74LS62	1.15
74LS61	.75	74LS63	1.15
74LS62	.75	74LS64	1.15
74LS63	.75	74LS65	1.15
74LS64	.75	74LS66	1.15
74LS65	.75	74LS67	1.15
74LS66	.75	74LS68	1.15
74LS67	.75	74LS69	1.15
74LS68	.75	74LS70	1.15
74LS69	.75	74LS71	1.15
74LS70	.75	74LS72	1.15
74LS71	.75	74LS73	1.15
74LS72	.75	74LS74	1.15
74LS73	.75	74LS75	1.15
74LS74	.75	74LS76	1.15
74LS75	.75	74LS77	1.15
74LS76	.75	74LS78	1.15
74LS77	.75	74LS79	1.15
74LS78	.75	74LS80	1.15
74LS79	.75	74LS81	1.15
74LS80	.75	74LS82	1.15
74LS81	.75	74LS83	1.15
74LS82	.75	74LS84	1.15
74LS83	.75	74LS85	1.15
74LS84	.75	74LS86	1.15
74LS85	.75	74LS87	1.15
74LS86	.75	74LS88	1.15
74LS87	.75	74LS89	1.15
74LS88	.75	74LS90	1.15
74LS89	.75	74LS91	1.15
74LS90	.75	74LS92	1.15
74LS91	.75	74LS93	1.15
74LS92	.75	74LS94	1.15
74LS93	.75	74LS95	1.15
74LS94	.75	74LS96	1.15
74LS95	.75	74LS97	1.15
74LS96	.75	74LS98	1.15
74LS97	.75	74LS99	1.15
74LS98	.75	74LS00	1.15
74LS99	.75	74LS01	1.15

### DISCRETE LEDs

Part No.	Color	Size	Price
KC300	200' red	1/4"	1.25
KC301	200' green	1/4"	1.25
KC302	200' yellow	1/4"	1.25
KC303	200' clear	1/4"	1.25
KC304	200' red	1/4"	1.25
KC305	200' green	1/4"	1.25
KC306	200' yellow	1/4"	1.25
KC307	200' clear	1/4"	1.25
KC308	200' red	1/4"	1.25
KC309	200' green	1/4"	1.25
KC310	200' yellow	1/4"	1.25
KC311	200' clear	1/4"	1.25
KC312	200' red	1/4"	1.25
KC313	200' green	1/4"	1.25
KC314	200' yellow	1/4"	1.25
KC315	200' clear	1/4"	1.25
KC316	200' red	1/4"	1.25
KC317	200' green	1/4"	1.25
KC318	200' yellow	1/4"	1.25
KC319	200' clear	1/4"	1.25
KC320	200' red	1/4"	1.25
KC321	200' green	1/4"	1.25
KC322	200' yellow	1/4"	1.25
KC323	200' clear	1/4"	1.25
KC324	200' red	1/4"	1.25
KC325	200' green	1/4"	1.25
KC326	200' yellow	1/4"	1.25
KC327	200' clear	1/4"	1.25
KC328	200' red	1/4"	1.25





# NEW!

## "THE BIG BOARD" OEM - INDUSTRIAL - BUSINESS - SCIENTIFIC SINGLE BOARD COMPUTER KIT! Z-80 CPU! 64K RAM!

# NEW!

PARTIALLY ASSEMBLED KITS  
For All Sockets Installed  
And Soldered Add \$50.

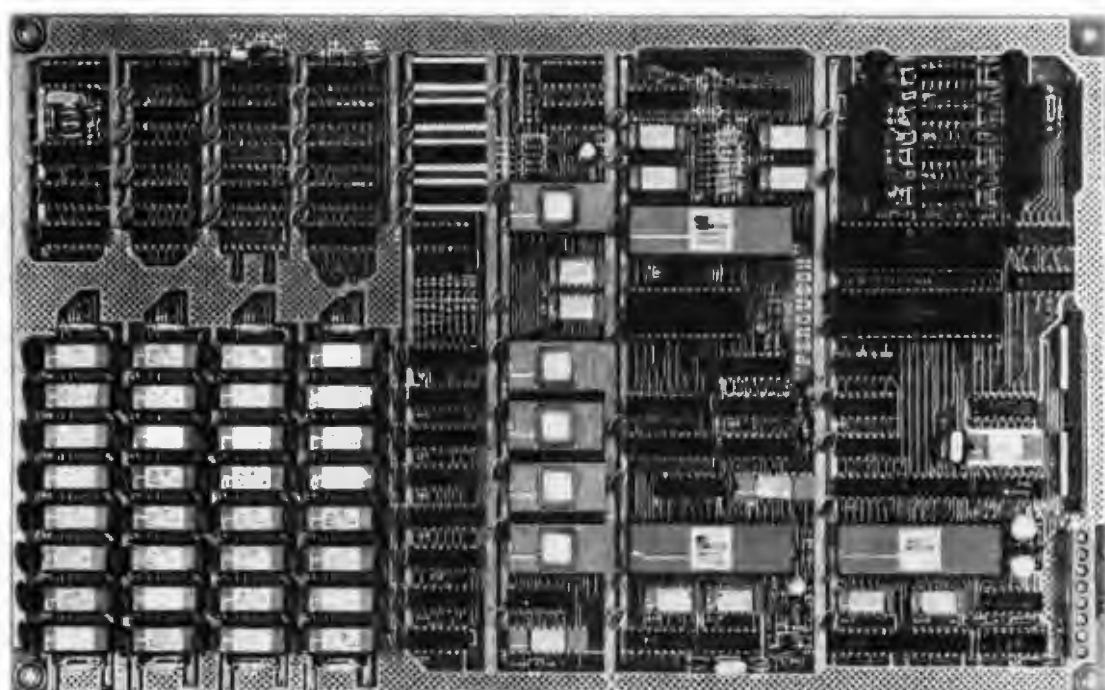

U.K. AND EUROPE: CONTACT VINCELORD LTD. 47 GOLDHURST TERRACE LONDON NW6

**THE FERGUSON PROJECT:** Three years in the works, and maybe too good to be true. A tribute to hard headed, no compromise, high performance, American engineering! The Big Board gives you all the most needed computing features on one board at a very reasonable cost. The Big Board was designed from scratch to run the latest version of CP/M\*. Just imagine all the off-the-shelf software that can be run on the Big Board without any modifications needed! Take a Big Board, add a couple of 8 inch disc drives, power supply, an enclosure, C.R.T., and you have a total Business System for about 1/3 the cost you might expect to pay.

**\$649<sup>00</sup>\*\*** (64K KIT BASIC I/O)

SIZE: 8 1/2 x 13 1/2 IN.  
SAME AS AN 8 IN. DRIVE.  
REQUIRES: -5V @ 3 AMPS  
+12V @ .5 AMPS.

**FULLY SOCKETED!** **FEATURES: (Remember, all this on one board!)**

### 64K RAM

Uses Industry standard 4116 RAM'S. All 64K is available to the user, our VIDEO and EPROM sections do not make holes in system RAM. Also, very special care was taken in the RAM array PC layout to eliminate potential noise and glitches.

### Z-80 CPU

Running at 2.5 MHZ. Handles all 4116 RAM refresh and supports Mode 2 INTERRUPTS. Fully buffered and runs 8080 software.

### SERIAL I/O (OPTIONAL)

Full 2 channels using the Z80 SIO and the SMC 8116 Baud Rate Generator. FULL RS232! For synchronous or asynchronous communication. In synchronous mode, the clocks can be transmitted or received by a modem. Both channels can be set up for either data-communication or data-terminals. Supports mode 2 Int. Price for all parts and connectors: \$85.

### BASIC I/O

Consists of a separate parallel port (Z80 PIO) for use with an ASCII encoded keyboard for input. Output would be on the 80 x 24 Video Display.

### 24 x 80 CHARACTER VIDEO

With a crisp, flicker-free display that looks extremely sharp even on small monitors. Hardware scroll and full cursor control. Composite video or split video and sync. Character set is supplied on a 2716 style ROM, making customized fonts easy. Sync pulses can be any desired length or polarity. Video may be inverted or true. 5 x 7 Matrix - Upper & Lower Case

### FLOPPY DISC CONTROLLER

Uses WD1771 controller chip with a TTL Data Separator for enhanced reliability. IBM 3740 compatible. Supports up to four 8 inch disc drives Directly compatible with standard Shugart drives such as the SA800 or BA801. Drives can be configured for remote AC off-on. Runs CP/M\* 2.2.

### TWO PORT PARALLEL I/O (OPTIONAL)

Uses Z-80 PIO. Full 16 bits, fully buffered, bi-directional. User selectable hand shake polarity. Set of all parts and connectors for parallel I/O: \$29.95

### REAL TIME CLOCK (OPTIONAL)

Uses Z-80 CTC. Can be configured as a Counter on Real Time Clock. Set of all parts: \$14.95

### CP/M\* 2.2 FOR BIG BOARD

The popular CP/M\* D.O.S. modified by MICRONIX SYSTEMS to run on Big Board is available for \$150.00.

### PC BOARD

Blank PC Board with Rom Set and Full Documentation. \$199.00

SYSTEM COMPARISON	
64K RAM KIT .....	\$370.00
80 x 24 Video Kit .....	365.00
Floppy Disk Controller Kit .....	235.00
Z-80 CPU Kit .....	185.95
SER & PAR. I/O .....	129.95
S-100 Mother Board .....	45.00
<b>SUB TOTAL</b> .....	<b>\$1330.90</b>

Talk about bangs per buck! The prices shown for \$100 kits were taken from the July 1980 BYTE. This will give some basis for comparison between the Big Board and a similar system implementation on the S100 Bus.

### PFM 3.0 2K SYSTEM MONITOR

The real power of the Big Board lies in its PFM 3.0 on board monitor. PFM commands include: Dump Memory, Boot CP/M\*, Copy, Examine, Fill Memory, Test Memory, Go To, Read and Write I/O Ports, Disc Read (Drive, Track, Sector), and Search. PFM occupies one of the four 2716 EPROM locations provided. Z-80 is a Trademark of Zilog.

**Digital Research Computers**  
(OF TEXAS)  
P.O. BOX 401565 • GARLAND, TEXAS 75040 • (214) 271-3538

**TERMS:** Shipments will be made approximately 3 to 6 weeks after we receive your order. VISA, MC, cash accepted. We will accept COD's (for the Big Board only) with a \$75 deposit. Balance UPS COD. Add \$3.00 shipping  
USA AND CANADA ONLY

\*TRADEMARK OF DIGITAL RESEARCH. NOT ASSOCIATED WITH DIGITAL RESEARCH OF CALIFORNIA, THE ORIGINATORS OF CPM SOFTWARE  
\*\*1 TO 4 PIECE DOMESTIC USA PRICE. Circle 118 on inquiry card.

# DIGITAL RESEARCH COMPUTERS

(214) 271-3538

## 32K S-100 EPROM CARD

**NEW!**

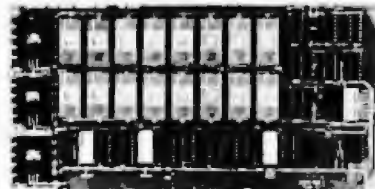

**\$79.95**  
KIT

USES 2716's  
Blank PC Board - \$34  
ASSEMBLED & TESTED  
ADD \$30

SPECIAL: 2716 EPROM's (450 NS) Are \$9.95 Ea. With Above Kit.

### KIT FEATURES

- |  |   |
|--|---|
| 1 Uses +5V only 2716 (2Kx8) EPROM's          | 7 Any or all EPROM locations can be disabled                          |
| 2 Allows up to 32K of software on line!      | 8 Double sided PC board, solder-masked, silk-screened                 |
| 3 IEEE S-100 Compatible                      | 9 Gold plated contact fingers   |
| 4 Addressable as two independent 16K blocks  | 10 Unselected EPROM's automatically powered down for low power select |
| 5 Cromemco extended or Northstar bank select | 11 Fully buffered and bypassed  |
| 6 On board wait state circuitry if needed    | 12 Easy and quick to assemble   |

## 32K SS-50 RAM

**\$299<sup>00</sup>** KIT

For 2MHZ  
Add \$10

Blank PC Board  
\$50

For SWTPC  
6800 - 6809 Bus

Support IC's  
and Caps  
\$19.95

Complete Socket Set  
\$21.00

Fully Assembled,  
Tested, Burned In  
Add \$30

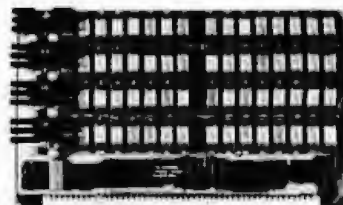

At Least An affordable 32K Static RAM with full 6809 Capability.

### FEATURES:

1. Uses proven low power 2114 Static RAMS.
2. Supports SS50C - EXTENDED ADDRESSING
3. All parts and sockets included.
4. Dip Switch address select as a 32K block.
5. Extended addressing can be disabled.
6. Works with all existing 6800 S550 systems.
7. Fully bypassed. PC Board is double sided, plated thru, with silk screen.

## 16K STATIC RAM KIT-S 100 BUSS

PRICE CUT!

**\$169<sup>95</sup>**  
KIT

FOR 4MHZ  
ADD \$10

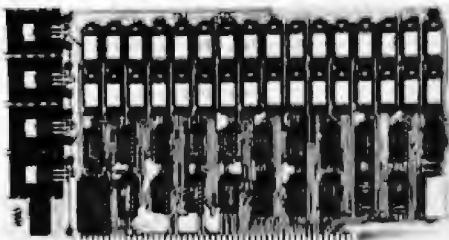

### KIT FEATURES

- 1 Addressable as four separate 4K Blocks
- 2 ON BOARD BANK SELECT circuitry (Cromemco Standard) Allows up to 512K on line!
- 3 Uses 2114 (450NS) 4K Static Rams
- 4 ON BOARD SELECTABLE WAIT STATES.
- 5 Double sided PC Board, with solder mask and silk screened layout. Gold plated contact fingers
- 6 All address and data lines fully buffered
- 7 Kit includes ALL parts and sockets
- 8 PHANTOM is jumpered to PIN 87
- 9 LOW POWER under 1.5 amps TYPICAL from the +5 Volt Bus
- 10 Blank PC Board can be populated as any multiple of 4K

BLANK PC BOARD W/DATA-\$33  
LOW PROFILE SOCKET SET-\$12  
SUPPORT IC'S & CAPS-\$19.95  
ASSEMBLED & TESTED-ADD \$35

**OUR #1 SELLING  
RAM BOARD!**

## 16K STATIC RAM SS-50 BUSS

PRICE CUT!

**\$159** KIT

FULLY STATIC!

FOR 2MHZ  
ADD \$10

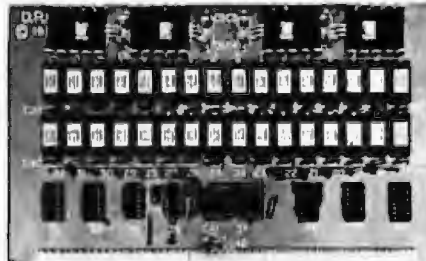

FOR SWTPC  
6800 BUSS!

ASSEMBLED AND  
TESTED - \$35

### KIT FEATURES

- 1 Addressable on 16K Boundaries
- 2 Uses 2114 Static Ram
- 3 Fully Bypassed
- 4 Double sided PC Board Solder mask and silk screened layout
- 5 All Parts and Sockets included
- 6 Low Power Under 1.5 Amps Typical

BLANK PC BOARD-\$35 COMPLETE SOCKET SET-\$12  
SUPPORT IC'S AND CAPS-\$19.95

## NEW! STEREO! S-100 SOUND COMPUTER BOARD NEW!

At last, an S-100 Board that unleashes the full power of two unbelievable General Instruments AY3-8910 NMCOS computer sound IC's. Allows you under total computer control to generate an infinite number of special sound effects for games or any other program. Sounds can be called in BASIC, ASSEMBLY LANGUAGE, etc.

### KIT FEATURES:

- TWO GI SOUND COMPUTER IC'S
- FOUR PARALLEL I/O PORTS ON BOARD
- USES ON BOARD AUDIO AMPS OR YOUR STEREO.
- ON BOARD PHOTO TYPING AREA
- ALL SOCKETS, PARTS AND HARDWARE ARE INCLUDED
- PC BOARD IS SOLDERMASKED, SILK SCREENED, WITH GOLD CONTACTS
- EASY, QUICK AND FUN TO BUILD WITH FULL INSTRUCTIONS
- USES PROGRAMMED I/O FOR MAXIMUM SYSTEM FLEXIBILITY

Both Basic and Assembly Language Programming examples are included

### SOFTWARE:

SCL™ is now available! Our Sound Command Language makes writing Sound Effects programs a SNAP! SCL™ also includes routines for Register-Examine-Modify, Memory-Examine-Modify, and Play-Memory. SCL™ is available on CP/M™ compatible diskette or 2708 or 2716 Diskette - \$24.95 2708 - \$19.95 2716 - \$29.95. Diskette includes the source. EPROM'S are ORD at \$2000+ (Diskette is 8 Inch Soft Sealed)

COMPLETE KIT!  
**\$84<sup>95</sup>**  
(WITH DATA MANUAL)

BLANK PC  
BOARD W/DATA  
\$31

## SPECIAL PURCHASE!

### UART SALE!

TR1602B - SAME AS TMS6011,  
AY5-1013, ETC. 40 PIN DIP

**TR1602B**

**\$2<sup>95</sup>**  
EACH

**4 For \$10<sup>00</sup>**

### CRT CONTROLLER CHIP

SMC #CRT 5037. PROGRAMMABLE FOR 80 x 24, ETC. VERY RARE SURPLUS FIND. WITH PIN OUT. \$12.95 EACH.

### NEW! G.I. COMPUTER SOUND CHIP

AY3-8910 As featured in July, 1979 BYTE! A tonastically powerful Sound & Music Generator. Perfect for use with any 8 Bit Microprocessor. Contains 3 Tone Channels. Noise Generator. 3 Channels of Amplitude Control. 16 bit Envelope/Period Control. 2-Bit Parallel I/O. 3 D to A Converters, plus much more! All in one 40 Pin DIP. Super easy interface to the S-100 or other buses. **\$11.95** PRICE CUT!

SPECIAL OFFER: **\$44.95** each Add \$3 for 80 page Data Manual

### 4K STATIC RAM

National Semi. MM5257. Arranged 4K x 1. +5V, 18 PIN DIP. A Lower Power, Plug in Replacement for TMS 4044. 450 NS. Several Boards on the Market Will Accept These Rams. SUPER SURPLUS PURCHASE! PRIME NEW UNITS!

8 FOR \$16 32 FOR \$59.95

## Digital Research Computers

(OF TEXAS)

P.O. BOX 401565 • GARLAND, TEXAS 75040 • (214) 271-3538

TERMS: Add \$2.00 postage. We pay balance. Orders under \$15 add 75¢ handling. No C.O.D. We accept Visa and MasterCard. Tex. Res. add 5% Tax. Foreign orders (except Canada) add 20% P & H. Orders over \$50, add 85¢ for insurance.

ALL SALES ARE MADE SUBJECT TO THE TERMS OF OUR 90 DAY LIMITED WARRANTY. A COPY OF THIS WARRANTY IS AVAILABLE FREE, ON REQUEST.



Verbatim

Verbatim

ORDER TOLL FREE (800) 423-5922

**MICROPOLIS**

MCPI053M4	Dual 77 1k D/Sided	LIST PRICE \$1888.00
	12MB S-100 Subys	OUR PRICE \$1399.99
MCPI053M2	Dual 77 1k s/sided	LIST PRICE \$1534.00
	630Kb S-100 Subys	OUR PRICE \$ 998.00
MCPI043M2	SNGL 77 1k S/sided	LIST PRICE \$ 939.00
	315Kb S-100 Subys	OUR PRICE \$ 499.00
MCPI037M4	Dual TRS-80	LIST PRICE \$1301.00
	77 1k Add-on	OUR PRICE \$ 880.00
MCPI027M2	SNGL TRS-80	LIST PRICE \$ 689.00
	77 1k Add-on	OUR PRICE \$439.00

**NEW DOS 80  
Extended TRS-80 DOS**

APP 395	Supplied on 35 track	PRICE \$149.00
APP 39577	Supplied on 77 track	\$89.00
IF SIMULTANEOUSLY PURCHASED WITH A MICROPOLIS DISK DRIVE ...		
APP 395M	Supplied on 35 track	\$100.00
APP 395M77	Supplied on 77 track	\$100.00

**3M SCOTCH DISKETTES**

Part No.	Size/Disk	Sectoring	Price Box/10
MM24740-0	1/2gi	Soft-IBM	\$39.95
MM24740/3-0	2/2gi	Soft-IBM	\$79.00
MM24740/32	1/2gi	32-Subgran 801	\$39.95
MM24740/322	2/2gi	32-Subgran 801	\$79.00
MM24741-0	1/dbl	Soft-Shugart Edb	\$89.00
MM24743-0	2/dbl	Chd) Soft-IBM	\$89.00
MM24768-0	1/2gi	Soft-Shugart SA400 (TRS-80)	\$39.95
MM24744-10	1/2gi	Soft/10 SA400	\$39.95
MM24744-16	1/2gi	Soft/16 Micropolis	\$39.95

**VISTA PRINTER**

VIVF30025	25 CPS Daisy Wheel	LIST PRICE \$1895.00
		OUR PRICE \$1495.00
VIVF30046	45 CPS Daisy Wheel	LIST PRICE \$2195.00
		OUR PRICE \$1995.00

**MODEMS**

LIVITAR	0-300 Baud Acoustic	LIST PRICE \$199.00
		SALE PRICE \$129.00
NOVCAT	0-300 Baud Acoustic	LIST PRICE \$198.00
		OUR PRICE \$175.00
NOVDCAT	0-300 Baud Direct	LIST PRICE \$199.00
		OUR PRICE \$195.00
NOVAUTOCAT	0-300 Baud Direct & Auto Answer	LIST PRICE \$295.00
		OUR PRICE \$250.00
NOVAPELCAV	0-300 Baud	LIST PRICE \$389.00
	APPLE MODEM AUTO ANS	OUR PRICE \$359.00
NOVMEDE	SUPERMILE	PRICE \$15.95

**GIARCIA'S CIRCUIT CELLAR**

Microcass for use on Apple II or other parallel ports A&T Featured in June BYTE

MM2494VOCAPL		\$149.00
MM2494VOTTSY		\$149.00

Microcass for use on TRS-80 Model I complete with cable AC Adapter, test enclosure A&T.

MM2494VOTTSY		\$149.00
--------------	--	----------

Expansion Interface for TRS-80 Model I with DATA SEPARATOR, SET of RAM and Centronics Printer port A&T Featured in MARCH BYTE

MM2494VOTTSY		\$499.00
--------------	--	----------

I/O Interface for TRS-80. Features 50-19200 Baud PC, PC Serial port and Centronics printer port. Connect up to 16 COMMS to single keyboard or Expansion Interface Featured in June 80 BYTE

MM2494VOTTSY		\$199.00
--------------	--	----------

**FLUKE DMM'S**

FLUDB00X	3.5 Dig 6 Funct	PRICE \$129.00
FLUDA02A	3.5 Dig 7 Funct	PRICE \$129.00
FLUDB04A	3.5 Dig 9 Funct	PRICE \$129.00

**BENCH OR FIELD**

FLUD810	3.5 Dig AC Oper	PRICE \$129.00
FLUD811	3.5 Dig AC/DC Oper	PRICE \$129.00

GET A CARRYING CASE FOR 10 WITH ANY FLUKE DMM

**HICKOK DMM'S**

HICK1303	3.5 Dig 10 DC	PRICE \$129.00
HICK1304	3.5 Dig Low Power Ohms	PRICE \$129.00

**BENCH OR FIELD**

HICK1333	3.5 Dig with Varipitch and Logarith	PRICE \$129.00
----------	-------------------------------------	----------------

**NLS MINISCOPES**

NLSM116	3/2 Trace 15 MBZ	LIST PRICE \$39.00
		OUR PRICE \$29.00
NLSM215	D/Trace 15 MBZ	LIST PRICE \$49.00
		OUR PRICE \$39.00
NLSM330	D/Trace 30 MBZ	LIST PRICE \$69.00
		OUR PRICE \$49.00
NLS170	LCD Touch Test	LIST PRICE \$49.00
		SALE PRICE \$29.00
NLS171	LCD Touch Test 20	LIST PRICE \$49.00
		SALE PRICE \$29.00
NLS172	Touch Test 20	LIST PRICE \$49.00
		OUR PRICE \$29.00
NLS173	Touch Test 20	LIST PRICE \$49.00
		SALE PRICE \$29.00
NLS174	Touch Test 20	LIST PRICE \$49.00
		OUR PRICE \$29.00
NLS175	Touch Test 20	LIST PRICE \$49.00
		OUR PRICE \$29.00
NLS176	Touch Test 20	LIST PRICE \$49.00
		OUR PRICE \$29.00
NLS177	Touch Test 20	LIST PRICE \$49.00
		OUR PRICE \$29.00
NLS178	Touch Test 20	LIST PRICE \$49.00
		OUR PRICE \$29.00
NLS179	Touch Test 20	LIST PRICE \$49.00
		OUR PRICE \$29.00
NLS180	Touch Test 20	LIST PRICE \$49.00
		OUR PRICE \$29.00

**SANYO VIDEO MONITORS**

909	9 inch B&W	LIST PRICE \$235.00
		OUR PRICE \$198.00
9013	12 inch B&W	LIST PRICE \$340.00
		OUR PRICE \$310.00
9013	12 inch GREEN	LIST PRICE \$360.00
		OUR PRICE \$325.00
9013	13 inch COLOR	LIST PRICE \$550.00
		OUR PRICE \$495.00

**HITACHI OSCILLOSCOPES**

15	15 MHZ D.T.	LIST PRICE \$735.00
		OUR PRICE \$629.00
30	30MHZ D.T. w/Delay	LIST PRICE \$995.00
		OUR PRICE \$819.00
20	20 MHZ D.T.	LIST PRICE \$860.00
		SALE PRICE \$775.00
35	35 MHZ D.T.w/Delay	LIST PRICE \$1150.00
		SALE PRICE \$950.00
60	60MHZ D.T.w/VariDelay	LIST PRICE \$1745.00
		OUR PRICE CALL
100	100MHZ D.T.w/VariDelay	LIST PRICE \$2390.00
		OUR PRICE CALL

**CCS PRODUCTS APPLE**

Calendar/Clock	\$109.95
Programmable Timer	\$101.00
Analog to Digital Converter	\$99.95
Asynchronous Serial Interface	\$139.00
Parallel Interface	\$107.95
Centronics Parallel Interface	\$107.95
Extender Board	\$30.00

**SSM APPLE PRODUCTS**

IEEE-488 Interface	LIST PRICE \$475.00
	SALE PRICE \$415.00
15. 2P Interface Kit	LIST PRICE \$165.00
	SALE PRICE \$145.00
Assembled & Tested	LIST PRICE \$325.00
	SALE PRICE \$285.00

**MORROW HARD DISK**

MDSM265 26 MB 5-100 Subsystem	LIST PRICE \$4495.00
	SALE PRICE \$3495.00

**B & K OSCILLOSCOPE**

BKP1405	5 MHZ S.T.	LIST PRICE \$315.00
		SALE PRICE \$280.00
BKP1420	15 MHZ D.T. Portable	LIST PRICE \$825.00
		SALE PRICE \$750.00
BKP1530	30 MHZ D.T. Vari. Delayed	LIST PRICE \$1365.00
		SALE PRICE CALL
BKP1500	100 MHZ Q.T. Vari. Delay	LIST PRICE \$2575.00
		SALE PRICE CALL

**B & K TEST EQUIPMENT**

BKP3010	Function Generator	LIST PRICE \$220.00
		OUR PRICE \$198.00
BKP3020	Sweep/Funct. Generator	LIST PRICE \$379.00
		OUR PRICE \$349.00
BKP3300	5 MHZ Pulse Generator	LIST PRICE \$350.00
		SALE PRICE \$320.00

**VISTA APPLE PRODUCTS**

VIR50	Type Ahead Buffer	LIST PRICE \$49.95
		SALE PRICE \$44.95
VIR800	8" Floppy Controller	LIST PRICE \$395.00
		SALE PRICE \$350.00

**PRIORITY ONE ELECTRONICS**  
 9161-B DEERING AVE. • CHATSWORTH, CA 91311  
**ORDER TOLL FREE (800) 423-5922 CA, AK, HI CALL (213) 709-5464**

Terms U.S. VISA, MC, BAC, Check, Money Order, U.S. Funds Only. CA residents add 6% Sales Tax. MINIMUM PREPAID ORDER \$15.00. Include MINIMUM SHIPPING & HANDLING of \$2.50 for the first 3 lbs. plus 25¢ for each additional pound. Orders over 50 lbs. sent freight collect. Just in case, please include your phone no. Prices subject to change without notice. We will do our best to maintain prices thru September 1981. SOCKET and CONNECTOR prices based on GOLD, not exceeding \$700.00 per ct. Sales Prices Valid only if YOU mention publication and month. Credit Card orders will be charged appropriate freight.

**CA, AK, HI ORDER (213) 709-5464**

**CCS MAINFRAMES**

CCS 2200A	5-100 12 slot	LIST PRICE \$434.00
		OUR PRICE \$410.00

**TEI MAINFRAMES**

TEIMCS12	12 slot desk	LIST PRICE \$685.00
		OUR PRICE \$615.00
TEIMCS22	22 slot desk	LIST PRICE \$845.00
		OUR PRICE \$760.00
TEIRM12	12 slot rack mount	LIST PRICE \$800.00
		OUR PRICE \$720.00
TEIRM22	22 slot rack mount	LIST PRICE \$945.00
		OUR PRICE \$860.00
TEIDFDO	60IR desk	LIST PRICE \$535.00
		OUR PRICE \$485.00
TEIRFDO	60IR desk	LIST PRICE \$725.00
		OUR PRICE \$670.00

**8" DISK DRIVES**

STR801R	D/Dens 1/Sided	REG. PRICE \$495.00
		SALE PRICE \$425.00 2/\$395.00 ea.
GM8DTS	D/Dens D/Sided	Each \$625.00
		2 or more \$500.00 ea.

**MORROW DESIGNS**  
**Qume**  
**ESM**  
**Vista**  
**CompuPro**  
**PRIORITY ONE ELECTRONICS**  
**TOLL FREE**  
**1-800-423-5922**

**S-100 ROM**

**PIB FROM PROGRAMMER - SSM**  
 programs 2708 or 2716's, operates as a 4KIBK EPROM board as well

SSM-PB1K	Kit	\$154.95
SSM-PB1A	A&T	\$219.00

**ECONOM 2708 - GODBOUT**

18K x 8 EPROM Board using 2708, Power on jump to any 256 byte

GBT 125U	UnKit	\$85.00
GBT 125A	A&T	\$120.00
GBT 125C	CSC	\$175.00

**S-100 DISK CONTROLLERS**

**DISK 1 - GODBOUT**  
 DMA, Soft Sector, Controls 8" or 8 1/4", single or double density

GBT 171A	A&T	\$450.00
GBT 171C	CSC	\$556.00
GBT CPM80	CP/M 2.2 for 28018085 with Manuals & BIOS 8" S.D. disk	\$175.00
GBT CPM88	CP/M for 8086 with manuals & BIOS 8" S/D disk	\$300.00

**M22A - CA. COMP. STYT.**

I/O Mapped, controls 8" or 5 1/4", single or double density

CCS-2422	A&T with CPM 2.2 8" S.D.	\$365.00
----------	--------------------------	----------

**DISK JOCKEY 1 - MORROW**

Single density disk controller with serial I/O, controls 8"

I.DSDJ1108	A&T	\$219.00
------------	-----	----------

**DISK JOCKEY 20 - MORROW**

I/O Mapped, controls 8", single or double density, serial I/O

MDSDJ2208	A&T	\$375.00
-----------	-----	----------

**DISK DRIVES**

**SOB - SHUGART**

Single sided double density most popular 8" drive

SHUB01R	\$425.00 ea. or 2 or more	\$395.00
SHUB01RM	Manual for 801R drives	\$10.00

**DT-8 - QUME**

Data track 8 double sided, double density

QME-DT8	\$625.00 ea. or 2 or more	\$600.00 ea.
---------	---------------------------	--------------

**DISK CABINETS**

**V-100 - VISTA**

Dual 8" drive cabinet with power supply. Rack or Desk Mount

VIS-V100		\$395.00
----------	--	----------

**SINGLE 8" - Q.T.**  
 Single 8" cabinet with power supply

OTC-DDC8		\$195.00
----------	--	----------

**5" CABINETS - VISTA**  
 Single 5" with P.S.

VIS-9801		\$75.00
VIS-9802	Dual 5" with P.S.	\$95.00

**S-100 DISK SUBSYSTEMS**

**DISC SINGLE SIDES MORROW**

8" DBL Density drives with cabinet, power supply controller, with CP/M 2.2 and Microsoft Basic

MDSF1218	Single Drive System	\$950.00
MDSF1228	Dual Drive System	\$1598.00

**DISCUS DOUBLE SIDED - MORROW**

8" DBL Density/sided drives with cabinet Power supply controller, with CP/M 2.2 and Microsoft Basic

MDSF2218	Single Drive System	\$1250.00
MDSF2228	Dual Drive System	\$2195.00

**26MB HARD DISK - MORROW**

Special purchase, limited stock - 26MB formatted hard disk complete with cabinet, P.S., Controller, CPM 2.2 and Microsoft Basic

MDS-M26S	26 MB Subsystem List	\$4495.00
----------	----------------------	-----------

**SALE**

**\* \$3495.00 \***  
**SAVE \$1,000.00**  
**MICROPOLIS**

**Priority 1 Electronics is the worlds largest distributors of MICROPOLIS disk sub Systems**  
**CALL FOR PRICES**



**PRIORITY ONE ELECTRONICS**

9161-B DEERING AVE. • CHATSWORTH, CA 91311

**S-100 I/O BOARDS**

**SYSTEM SUPPORT I - GODBOUT**

Serial port (software prog baud), 4K EPROM or RAM provision, 15 levels of interrupt, real time clock, optional math processor

GBT-162U	UnKit	\$295.00
GBT-162A	A&T	\$360.00
GBT-162C	CSC	\$460.00
GBT-8512	Math Chip	\$195.00

**MPX CHANNEL BOARD - GODBOUT**

I/O Multiplexer, using 8085A-2 cpu on board

GBT-166A	A&T	\$450.00
GBT-166C	CSC	\$550.00

**INTERFACER I - GODBOUT**

Two Serial I/O

GBT-133A	A&T	\$219.00
GBT-133C	CSC	\$298.00

**INTERFACER II - GODBOUT**

Three parallel, one serial I/O board

GBT-150A	A&T	\$219.00
GBT-150C	CSC	\$298.00

**MULTI I/O - MORROW DESIGNS**

Three Serial, Two parallel

MDSMB3200	A&T	\$309.00
-----------	-----	----------

**SWITCHBOARD-MORROW DESIGNS**

Two serial I/O, four parallel I/O, one status port, one strobe port

MDS5B2411	A&T	\$239.00
-----------	-----	----------

**I/O2 - SSM**

One parallel input, one parallel output, proto work area

SSMI02K	Kit	\$69.00
SSMI02A	A&T	\$89.00

**I/O4 - SSM**

Two serial I/O, two parallel I/O

SSMI04K	Kit	\$210.00
SSMI04A	A&T	\$260.00

**SS-SSM**

Music synthesizer board

SSMSB1K	Kit	\$249.00
SSMSB1A	A&T	\$310.00
SSMSB1S	Software	\$ 25.00

**S-100 VIDEO BOARDS**

**SPECTRUM - GODBOUT**

Color Graphics board with Parallel I/O

GBT-144U	UnKit	\$299.00
GBT-144A	A&T	\$349.00
GBT-20	Sublogic Software	\$ 35.00

**VE - J SSM**

80 x 24 or 48 character video display Memory Mapped, Parallel Keyboard port

SSM-VB3K24	Kit 80x24	\$349.00
SSM-VB3A24	A&T 80x24	\$429.00
SSM-VB3UP	Upgrade Kit	\$ 30.00

**V12 - SSM**

I/O Mapped Video Board, with Parallel Keyboard port. 64x16

SSM-VB2K	Kit	\$169.00
SSM-VB2A	A&T	\$229.00

**V16C - SSM**

Memory Mapped Video Board 64x16 character display or 64x18 graphics display

SSM-VB1CK	Kit	\$189.00
SSM-VB1CA	A&T	\$220.00

**S-100 MOTHERBOARDS**

**MOTHERBOARD - GODBOUT**

Active termination, 6-12-20 slot

GBT-153U	Unkit 6 slot	\$ 89.00
GBT-153A	A&T 6 slot	\$119.00
GBT-154U	Unkit 12 slot	\$129.00
GBT-154A	A&T 12 slot	\$149.00
GBT-155U	Unkit 20 slot	\$174.00
GBT-155A	A&T 20 slot	\$189.00

**WUNDERBUS - MORROW DESIGNS**

Active termination, 8-12-20 slot, peripheral power outputs (5V @ 1A, 12V @ 500ma, -12V @ 500ma)

MDS0800A	A&T 8 slot	\$129.00
MDS1200A	A&T 12 slot	\$149.00
MDS2000A	A&T 20 slot	\$199.00

**S-100 MISC.**

**CRO17 ACTIVE TERMINATOR-GODBOUT**

Extender/terminator, Active and/or passive

GBT-108U	Kit	\$ 34.95
----------	-----	----------

**2830 - CCS**

Kit

CCS2830AK	Kit	\$ 58.00
-----------	-----	----------

**EXTENDER/LOGIC PROBE-MULLEN**

Kit

MUL-CK004	Kit	\$ 59.00
-----------	-----	----------

**GM VECTOR JUMP - SSM**

with prototyping area

SSM-OB1K	Kit	\$ 65.00
SSM-OB1A	A&T	\$ 90.00

**ORDER TOLL FREE**  
**(800) 423-5922**

Terms U.S. VISA, MC, BAC, Check Money Order, U.S. Funds Only. CA residents add 6% Sales Tax. MINIMUM PREPAID ORDER \$15.00 include MINIMUM SHIPPING & HANDLING of \$25.00 for the first 3 lbs, plus 25¢ for each additional pound. Orders over 50 lbs sent freight collect. Just in case, please include your phone no. Prices subject to change without notice. We will do our best to maintain prices thru September 1981. SOCKET and CONNECTOR prices based on GOLD, not exceeding \$700.00 per oz. Sales Prices Valid only if YOU mention publication and month. Credit Card orders will be charged appropriate freight.

Circle 300 on Inquiry card.

**CA, AK, HI CALL**  
**(213) 709-5464**

**STAR MODEM FROM LIVERMORE LIST PRICE \$199.00 SALE PRICE \$129.00**

0 to 300 baud data rate. Compatible with Bell 103 and 113. Answer/Originate. Full/Half Duplex. Special self test features.

**RS232 and "D" SUB-MINIATURE CONNECTORS**



P- Plug, Male Type - S - Socket, Female Type - C - Cover, Hood

PART NO.	DESCRIPTION	PRICE
CND-DE3P	9 pin male	1-9 \$ 2.10 10-24 \$ 1.90 25-99 \$ 1.70
CND-DE3S	9 pin female	\$ 2.70 \$ 2.40 \$ 2.10
CND-DE3C	9 pin cover	\$ 1.50 \$ 1.25 \$ 1.10
CND-DA15P	15 pin male	\$ 1.75 \$ 1.45 \$ 1.15
CND-DA15S	15 pin female	\$ 3.95 \$ 3.60 \$ 3.20
CND-DA15C	15 pin cover	\$ 1.50 \$ 1.30 \$ 1.10
CND-DB25P	25 pin male	\$ 3.50 \$ 3.25 \$ 3.00
CND-DB25S	25 pin female	\$ 4.60 \$ 4.35 \$ 4.20
CND-DB51212	1 pc. gray hand	\$ 1.60 \$ 1.45 \$ 1.30
CND-P25R	2 pc. gray hand	\$ 1.50 \$ 1.25 \$ 1.10
CND-DB51226	2 pc. black hand	\$ 1.90 \$ 1.65 \$ 1.45
CND-DC37P	37 pin male	\$ 5.30 \$ 5.10 \$ 4.45
CND-DC37S	37 pin female	\$ 8.70 \$ 7.70 \$ 6.70
CND-DC37C	37 pin cover	\$ 1.60 \$ 1.55 \$ 1.30
CND-DD50P	50 pin male	\$ 8.75 \$ 7.75 \$ 6.70
CND-DD60S	50 pin female	\$11.65 \$10.25 \$ 9.90
CND-DD50C	50 pin cover	\$ 2.90 \$ 1.80 \$ 1.60
CND-D2041B	Hardware set 2 pc RS232, DB25P, ETA	\$ 2.00 \$ .80 \$ .70
CND-RS23216F	Class 1 cable 8 con 8 ft Cent 700 Series Printer connector	\$19.95 \$17.95 \$15.95
CND-5730360		\$ 9.00 \$ 7.50 \$ 6.80

**MICROCOMPUTER PRODUCTS 6502 SERIES**

PART NO.	PRICE	PART NO.	PRICE
2016P3	8/\$100.00	6502	\$12.95
2114N3L	0/\$28.00	6502A	\$18.95
5257N3L	0/\$50.00	6520	\$8.95
2732	8/\$120.00	6522	\$10.95
2718	8/\$50.00	6530-002	\$21.95
2708	8/\$32.00	6530-003	\$21.95
		6530-004	\$21.95
		6530-005	\$21.95
		6532M	\$21.95
		6551M	\$21.95

**8080 SERIES**

PART NO.	PRICE
INS 8080A	\$5.50
INS 8085A	\$18.95
DP8212N	\$2.95
DP8214N	\$5.25
DP8216N	\$2.95
DP8224N	\$3.25
DP8224-4N	\$9.95
DP8226N	\$3.50
DP8228N	\$5.55
DP8238N	\$5.55
INS8250N	\$15.00
INS8251N	\$7.50
INS8253N	\$17.95
INS8255N	\$6.80
INS8257N	\$16.45
INS8259N	\$18.00
INS8275N	\$59.95
INS8279N	\$49.95

**8800 SERIES**

PART NO.	PRICE
MC6800P	\$11.95
MC6802P	\$17.95
MC6808P	\$9.95
MC6809P	\$34.95
MC6821P	\$5.95
MC6822P	\$14.95
MC6840P	\$14.95
MC6845P	\$31.00
MC6847P	\$14.95
MC6850P	\$5.41
MC6852P	\$5.79
MC6854P	\$24.95
MC6860P	\$10.89
MC6862P	\$12.00
MC6875L	\$7.40
MC68710P	\$12.50
MC68750P	\$12.50

**UARTS**

PART NO	PRICE
AYS1013A	\$5.95
TR1802B	\$5.95
TR1803	\$6.95
IM5402	\$7.95

**Z80 SERIES**

PART NO.	PRICE
Z80A	\$14.95
Z80AP10	\$14.95
Z80ACTC	\$13.95
Z80ADMA	\$45.00
Z80AS700	\$59.95
Z80AS701	\$59.95
Z80AS102	\$59.95

**FLOPPY DISC CONTROLLER**

PART NO.	PRICE
FD1771B-01	\$24.95
FD1791B-01	\$44.95

**CompuPro™ from GODBOUN ELECTRONICS**

**10 MHZ 16K A&T STATIC S-100 RAM GBT-143A**

List \$349.00 **\$169.00 Ea** 3/\$450.00



**SAVE \$180.00**

- Operates up to 10 MHZ (90 ns RAM Chips)
- Assembled & Tested • Meets or exceeds all IEEE 696/S-100 specifications (including timing).
- Fully static design eliminates the timing problems associated with dynamic memories.
- Switch selectable choice of 24 address lines conforming to the IEEE 696/S-100 extended addressing specifications, or 16 address lines as used in older S-100 systems.
- Ideal for multi-user installations.
- Board is addressable as one 16K x 8 block on any 4K boundary.
- Switch selectable PHANTOM disable and write protect.
- + 5 Volt operation (requires no other supply voltages).
- Low power operation (900 mA typical, 1200 mA maximum).
- 1 year Factory Warranty.

**VCT-8804**

S-100 "ANY DIP" has full power and ground planes back to back. Boards accommodates .3, 4, 5, .9" Dips

1-4	5-9	10-24
\$24.67	\$22.34	\$20.02

**APPLE FLUGBOARD**

Vector 4809 Peripheral Interface Plugboard for construction of custom circuits. Plug compatible with Apple II. Commodore PET and Super Kim microcomputers.

1-4	5-9	10-24
\$20.74	\$18.79	\$16.84

**Vector Plugboards**



**VCT-3677 9.6" x 4.5"**  
\$12.33

**VCT-3667 9.6" x 4.5"**  
\$10.88

**VCT-3662 6.5" x 4.5"**  
\$9.69

**VCT-3677-2 6.5" x 4.5"**  
\$10.88

**VCT-3662-2 9.6" x 4.5"**  
\$10.85

**VCT-3690-12 \$26.64**

Card Extender has 100 contacts 50 per side on 125 contacts. Attached connector is compatible with S-100 Bus Systems. VCT-3690 6.5" 22/44 pin 158 ctrs. Extenders \$15.95

**POWERLINE INSULATOR**

GOF-IBARW3 SH. WT. 3 lbs.

List Price \$59.95  
Sale Price **\$29.00**

A MUST FOR EVERY OFFICE WITH DATA PROCESSING EQUIPMENT

**Vector BOARD**

1/16" .042 diaholes on 0.1 spacing for IC's

Phenolic	PART NO	SIZE	1-9	10-19
	VCT-84P44-X	4.5" x 8.5"	\$1.56	\$1.40
	VCT-169P44-X	4.7" x 17"	\$3.69	\$3.32

Epoxy Glass	PART NO	SIZE	1-9	10-19
	VCT-84P44	4.5" x 8.5"	\$1.83	\$1.65
	VCT-169P44	4.5" x 8.5"	\$2.25	\$2.03
	VCT-169P44	4.5" x 17"	\$4.61	\$4.15
	VCT-169P48	8.5" x 17"	\$9.00	\$8.10

**TRS-80/APPLE MEMORY EXPANSION KITS**

**4116's RAMS**

from Leading Manufacturers (16Kx1 200)

**8 for \$20.00**

Add \$3.00 for programming jumpers for TRS-80 Keyboard

**POWERLINE INSULATOR**



GOF-IBARW3 SH. WT. 3 lbs.

List Price \$59.95  
Sale Price **\$29.00**

A MUST FOR EVERY OFFICE WITH DATA PROCESSING EQUIPMENT

**SPECIAL PURCHASE GOLD**

16 FIN LOW PROFILE LC. C-35 BOOKETS

**TIG-16LP pkg. of 100 \$16.00**

**TIG-16LP pkg. of 1000 \$120.00**

OEMS Stock up at this LOW PRICE.

**ZERO INSERTION FORCE TEST SOCKETS**



ZIP-18DIP	1-9	10-24	25-99
	\$ 5.50	\$3.35	\$4.95
ZIP-24DIP	\$ 7.50	\$7.25	\$8.95
ZIP-40DIP	\$10.25	\$9.85	\$9.90

**6 OUTLET MULTI USE CORD REEL**



SH WT 5 LBS  
GOF-ER1 22 ft Cord \$24.95  
GOF-CR50 50 ft Cord \$29.95

**1M-10A List \$104.95 SPECIAL \$69.95 with tube**

Perfectly balanced fluorescent lighting with precision magnifier lens. Tough thermoplastic shade. Easy lens removal. New wire clip design permits easy installation and removal of fluorescent tube. Comes

**LEDU**



with plastic shield to protect tube from soiling and damage.

Colors: Gray, Black and Chocolate Brown. Comes with one 22 watt T-9 Circline fluorescent tube, 3 diopter lens, 10 lbs.

**\$69.95**

**SEND \$1<sup>00</sup> for 60 Page CATALOG**

**PRIORITY ONE ELECTRONICS**

9161-B DEERING AVE. • CHATSWORTH, CA 91311

**ORDER TOLL FREE (800) 423-5922 CA, AK, HI CALL (213) 709-5464**

Terms: U.S. VISA, MC, BAC, Check, Money Order, US Funds Only. CA residents add 6% Sales Tax. MINIMUM PREPAID ORDER \$15.00 include MINIMUM SHIPPING & HANDLING of \$2.50 for the first 3 lbs. plus 25¢ for each additional pound. Orders over 50 lbs. send freight collect. Just in case please include your phone no. Prices subject to change without notice. We will do our best to maintain prices thru September 1981. SOCKET and CONNECTOR prices based on GOLD, not exceeding \$700.00 per oz. Sales Prices Valid only if YOU mention publication and month. Credit Card orders will be charged appropriate freight.

# Unclassified Ads

**FOR SALE:** TRS-80 Model I Level II with 16 K memory, lowercase installed, in mint condition including 5200 system disk, manual and computer books, and complete library of games and software (including Script package) worth \$300. Complete system worth over \$1400 for only \$1000. Mike Clay 3008 E Meadow Grove Rd. Orange CA 92667 (714) 998-0155

**FOR SALE:** Netronics ELF II microcomputer with 8 K programmable memory, RS-232 interface, cassette-tape interface, Netronics video terminal, Motorola video monitor, Tiny BASIC on cassette, and full documentation. \$400 (price negotiable) Mike Heitmann, 114 S Overbrook, St Charles MO 63301. (314) 723-3950 weekends or after 4:30 weekdays.

**FOR SALE:** DECAHeath H-11 16-bit computer DEC LSI-11 16-bit processor with floating-point processor option, 56 K (28 KW, 16-bit) MOS memory, serial port (20 mA or RS-232), dual 8-inch disk drive, disk operating system, FORTRAN compiler, and BASIC. Spare parts include LSI-11 processor card, Memorex 8-inch disk drive, disk controller, memory, and disk controller parts. Cables, service manuals, and operation manuals. New cost over \$10,500. Sell for \$6000. Mike. (612) 920-2440

**FOR SALE:** IBM/Esccon Selectric typewriter (correcting, with legal keyboard). Eight months old. Factory-installed RS-232C interface with backspace and tab, in new condition, too slow for my purpose. \$1600. Also, four Axiom printers, Model EXB01P (parallel). Trouble-free printers in original boxes. My project canceled. \$425 each of all four for \$1600. J Turner, 309 Mac-Corkle Ave. St Albans WV 25177. (304) 776-3675

**FOR SALE:** Decreek paper-tape reader. Easily runs at 600 cps. 7 inch rack mount. Complete power supply, parallel interface, and documentation. \$200 or best offer. Tom Lux 375 Frank St. Box B-12 Berea OH 44017. (216) 234-2798

**FOR SALE:** Set of 8 K Microsoft BASIC ROMs for Netronics Explorer-85 computer. All documentation included. \$60. Warnaco MEM-1A B-K 5-100 bus static memory with 300 ns low-power programmable memories. \$75. Pat Taylor, 1200 S Market St. Bloomsburg PA 17815. (717) 784-6173

**FOR SALE:** PET/CBM 2001 with 16 K programmable memory plus Skyles Toolkit read-only memory to debug BASIC programs. About one year old \$650 FOB. Many PET programs included. Also, Divers-A-Matic phone-call diverter. SASE for description \$150. Consider exchange for tape answerer. P Young, 1496 Cherywood Dr. San Mateo CA 94403. (415) 574-4212 or 349-4325.

**FOR SALE:** SIM I microcomputer with 1 K programmable memory, expandable to 4 K and 51 I/O lines. \$135. Mike Underwood, Rte 3 Box A-594, Troutville VA 24175. (703) 977-4337

**FOR SALE:** Ltron 1241-1251 with Multiplexer General Ledger, Payroll, Amortization, Depreciation Software, supplies, etc. Best offer. Alan Phelps, 1664 McDade Est. Conroe TX 77304. (713) 756-8889

**WANTED:** The United States Yacht Racing Union is developing a Race Management Manual for use by race committees. A section will be devoted to computer and calculator programs. We are seeking programs related to sailing, race scoring, handicapping, measurement rules, etc. A library of these programs is being maintained. A listing of the programs available will be included in the manual. United States Yacht Racing Union, POB 209, Newport RI 02840.

**FOR SALE:** Goodoul Interfacer I 25: \$200. CSI Clunie Sprint 3 interfacer with 16 K buffer. \$450. Jade Big Z Z80 processor card. \$150. Prinit Clunie Sprint 3 interface card. \$75. Spell-binder word-processing program. \$300. All items in excellent condition with manuals. Kirby Nickell 2849 Angeliq. St. Joseph MO 64501

**FOR SALE:** BYTE from January 1977 thru August 1977 and March 1981. \$21 best offer or trade for the following BYTES: September 1975 thru October 1976. February 1980. September 1980, October 1980 or January 1981. Mark D Ybarrá, 2604 Bobolink Dr. San Jose CA 95125. (408) 264-7789

**WANTED:** Cartridges for Video Brain computer. Also need instructions for Finance cartridge. Particularly interested in Wordwise 2 cartridge and any schematic information. James Kasperki, 23-01 30 Dr. Long Island City NY 11107

**FOR SALE:** Zenith/Heath H-11 system, 64 K programmable memory, two 8-inch floppy-disk drives, HT-11, and Pascal software. Fully DEC PDP 11/03 compatible. \$4200. K W Scholz, 8716 Pethering St. Philadelphia PA 19150. (215) 248-0439 evenings

**FOR SALE:** Heath H-8 computer. Assembled and tested, with manual. Will sell for best offer. David Wong, 1916 Grand Conc. New York NY 10452. (212) 294-8087

**FOR SALE:** T1810 printer with full ASCII uppercase and lowercase, floor stand, paper catch and ribbon. \$1100. HP 2321P interactive video terminal with built-in printer. \$2100. Both items purchased for a remote station, but never used and are in brand-new condition. James Leonard, 58 Beverly Dr. Columbia OH 44408. (716) 482-2291

**FOR SALE:** 32 K Ekydy Sorcerer BASIC and Assembler ROMPACs plus Extended Cassette BASIC, RS-232 parallel dual-cassette control. All documentation plus internal hardware and software manuals. Over \$450 worth of software (graphics, games, word processing, data base, utilities, etc.). All in excellent condition for \$1250 or best offer. With Compint printer, add \$500. With 12-inch monitor, add \$75. R L Henrie, 5870 Wood Flower, Burke VA 22015. (703) 250-5323

**FOR SALE:** IMSAI 8080 microcomputer with 48 K memory. Processor Technology boards included are 3P+5 I/O, CUTS cassette, GPM, VDM-1 and ALS-B chip set (9 chips). Cromemco boards included are TV Dazzler, ZPU processor, and 8 K Bytesaver. Miscellaneous boards are TB-1 Extender, IMSAI MIO interface, and others. Comes with Infoton Vista GTX video display. Software includes: 15 K Extended BASIC, Music System, games, etc. All manuals included. Over \$5200 invested. First offer over \$3300 takes everything. Steve Dover, 821 Laraine, Wilmette IL 60091. (312) 251-4683 evenings

**FOR SALE:** Heath/Zenith disk software for H-17 disk system. I changed to CP/M, and have the latest HDOS 2.0 with Extended BASIC, editor, assembler, debugger, etc. With all manuals and binder, never used. Also, Microsoft BASIC for Heath H-8 or H-89 under HDOS. Latest version supports assembly-language subroutines. Never used. Either or both for half current catalog price. G Hammond (603) 366-4012 evenings

**FOR SALE:** Tamo Outpost II 6800 computer. 48 K. Two RS-232 I/O ports, two 5-inch Shugart disk drives, Tamo BASIC, COPS II (utility program), Hemingway editor, compiler and link editor. Also, Flex II ROM, Flex II, editor, compiler and debugger. Several disks and all manuals. \$2000 or best offer. Arthur Shore. (415) 364-5006

**FOR SALE:** (MSA) PCS 8030 with 48 K, dual single/double-density diskette drives (1 megabyte total), intelligent keyboard (IKB-II), Leedex VT-100 monitor, and MMDOS \$4000 or best offer. Bill Levening, 76 Maple Rd. Westford MA 01886. (617) 692-3847

**FOR SALE:** Apple II plus 64 K Pascal language system. Zenith 13-inch color monitor, IDS-440 printer with graphics option, Hayes modem, dual disk drives, Mountain Clock, Controller, Cashier, Apple Writer, Apple Post, VisiCalc 1.37, Dow Jones Stock Evaluator, personal programs, and other accessories. \$5900 complete. Fritz E Hockman, 48 Grampian Blvd, Williamsport PA 17701. (717) 326-4954 or 368-8631

**FOR SALE:** Rockwell AIM-65 with 4 K programmable memory, ROM-based text editor/assembler, 8 K BASIC in ROM power supply, and manuals. \$475. Greg Van, 7170 S Lewis Way, Littleton CO 80127. (303) 979-1998

**FOR SALE:** Terak B510/a graphics computer system in perfect working condition. Includes DEC LSI-11 processor, 56 K programmable memory, 8-inch floppy drive, 240 by 320 black and-white graphics on 12-inch video display, full ASCII keyboard, and UCSD Pascal software, including volumes 3 thru 5 of the USUS library. Excellent for schools, industry, or fanatic hobbyists. (Similar systems originally spawned UCSD Pascal.) Cost \$8285. New make offer. Jerome Wood, 6105 Harris, Raytown MO 64133. (816) 356-8290 after 5 PM weekdays

**WANTED:** 16 K or 32 K Ekydy Sorcerer/Sorcerer II computer. I am primarily interested in the computer itself, but will consider systems with peripherals (cassette or disk, printer, video monitor, etc.). Please state asking price in first letter—will pay any reasonable price, depending on condition and age. Christopher Lett, 145 Meadow Ln, New Rochelle NY 10805

**FOR SALE:** Pro-Log Z80 single-board computer, Model 7803, for the standard bus. This board is brand new—never been out of its protective package. \$150 or trade for sailboat. Wayne Miller, 83 Brookwood Ct, Elgin IL 60120

**FOR SALE:** Pascal Microengine computer manufactured by Western Digital Corp. The system is fully boxed and factory tested. This is not just a board; it is virtually unused. You get 64 K programmable memory and a processor that is optimized for the use of Pascal. Asking \$3000, but will take the best offer. Robert Powers, 75 W Green St. Pasadena CA 91105. (213) 792-0893

**FOR SALE:** Two complete SwTPC computers. Each has 24 K, MPS, MPC, MPL, JPC (ast cassette, two tape decks, CT-64, 9-inch Sanyo, Fast BASIC with files, multi software, and all cables. Ready to use. \$800 each or \$1500 for both, including PR-40 printer. Will trade for two CT-82 terminals. Howard Johnson, (207) 244-7444

**FOR SALE:** 16 K Commodore PET computer, including external cassette drive, Programmer's Toolkit ROM, Soundware's Soundbox, and assorted programs. Game programs include Microchess 2.0, Super Star Trek, Tanks, Othello, Backgammon, Breakout, and Bowling. Basic programs include Infinite Long Division, Synthetic Division of Polynomials, and a polar-graph plotting routine. \$900. Mike Sarna, 118 Georgetown Pt McKeesport PA 15135. (412) 751-8075

**FOR SALE:** SD Systems boards. SBC-200 Z80 processor, 3280, VDB-8024 video controller, \$300. Expansorium II 64 K \$250. All assembled and tested at factory, never used, 6 months old. Also, California Computer Systems maintenance, 12-slot motherboard, and power supply, \$290. Xerox word-processing keyboard, \$30. 10% off purchase of entire group. John A Maurer, (313) 884-0471

**FOR SALE:** Recently purchased HP-41C system, including HP-41C calculator, two memory modules, printer with six rolls of paper, card reader with two packs of cards, rechargeable battery pack, and all manuals. \$600. Paul Dimes, POB 279, Marshalltown IA 50158. (515) 754-7177 work. 753-3661 home.

**FOR SALE:** Anderson Jacobson 242A acoustic coupler. Used, but in good condition. Best offer. Greg McDonald, 1434 Fenwick Ln, Silver Spring MD 20910. (301) 587-8536

**UNCLASSIFIED POLICY:** Readers who are soliciting or giving advice, or who have equipment to buy, sell or swap should send in a clearly typed notice to that effect. To be considered for publication, an advertisement must be clearly noncommercial, typed double spaced on plain white paper, contain 75 words or less, and include complete name and address information.

These notices are free of charge and will be printed one time only on a space available basis. Notices can be accepted from individuals or bona fide computer users clubs only. We can engage in no correspondence on these and your confirmation of placement is appearance in an issue of BYTE.

Please note that it may take three or four months for an ad to appear in the magazine.



# Reader Service

Inquiry No.	Page No.	Inquiry No.	Page No.	Inquiry No.	Page No.	Inquiry No.	Page No.
1	47th STREET PHOTO 123	85	COMPUTERS ETC. 380	171	INTEGRAND 345	255	NETRONICS 104, 108, 348
2	A B DIGITAL DESIGN 103	56	COMP.PERIPH.UNLTD 379	172	INTEGRATED BUSN.COMP. 426	255	NORSEA DATA CORP 165
4	AB COMPUTERS 451	86	COMPUTERS WHOLESAL 390	173	INTERACTIVE MICROWRE 210	256	NORTH AMER TECH 178
5	ABM PRODUCTS 190	87	COMPUTEX CORP 294	173	INTERACTIVE STRUCT. 326	257	NORTH AMER TECH 82
6	ACKERMAN DIGITAL SYS 389	88	COMPUTIQUE 285	174	INTERACTIVE STRUCT. 338	258	NORTHWEST COMPUTER 381
7	ACTION COMPUTER 85	89	COMPUIVIEW PROD.INC. 69	193	INTERTEC DATA 25	259	NOVATION 290
7	ADAPTIVE DATA & ENERGY 183	90	CONCOMP IND. 308	178	INTERTEC DATA SYS. 177	*	NRI SCHOOLS ELECTR DIV 289
8	ADV.COMP.PROD. 482, 483	91	CONCOMP IND. 357	178	IPEX INT'L 458	*	OASIS SYSTEMS 258
9	ADV.MICRO SYS. 126	92	CONCORD COMP.PROD. 468	177	ITHACA INTERSYSTEMS 8, 9	260	OHIO SCIENTIFIC INSTR C IV
10	ADVANCED TECH 480	93	CONSUMER COMP. 139	178	JADE COMP.PROD. 471	261	OKIDATA CORP 219
388	ADVENTURE INT'L 125	94	CONSUMER COMP. 476, 477	179	JAMECO ELECTR. 486, 487	389	OKIDATA CORP 221
11	AFTERTHOUGHT ENG 382	95	CPI 298	180	JDR MICRODEVICES 474, 475	282	OLIVER ADVANCED ENGIN 464
12	ALLENBACH IND. 158	96	CPU SHOP, THE 459	182	JMCA SOFTWARE 454	283	OLYMPIC SALES 389
13	ALPHA BYTE STORAGE 31	97	CROMEMGO 1, 2	183	KADAK PRODUCTS 300	284	OMEGA MICRO COMPUTER 421
14	ALPHA BYTE STORAGE 120, 121	98	CS 458	*	KENGORE CORP. 454	285	OMEGA SALES 302, 303
15	ALSPA COMP SYS. 456	*	CYBERNETICS INC 359	184	KERN PUBLISHING 351	286	OMIKRON 49
16	ALTOS COMP SYS. 152, 153	99	D & W DIGITAL 26	185	KLO-FOX 460	287	OMNI RESOURCES 115
18	AMER.COMP. & TELECOMM. 265	*	DATA DISCOUNT CTR 130	186	KV 33 462	133	ORACLE ELECTR 456
19	AMER.COMP.EXCH. 458	*	DATA GENERAL 70, 71	187	LABORATORY MICROSYS. 377	288	ORANGE MICRO 148, 149
17	AMER.SMALL BUSN.COMP 453	101	DATA HARDWARE 460	188	LADCO DEVELMNT CO INC 380	289	ORANGE MICRO 141
20	AMER.SQUARE COMP. 261	102	DATA-ED 161	189	LIFEBOAT ASSOC 283	271	ORION INSTRUMENTS 464
21	ANADIX 145	103	DATALEX COMPANY, THE 318	191	LIFEBOAT ASSOC 309	272	OSBORNE COMPUTERS 33
22	ANACRON 228	104	DATASOUTH COMP CORP 87	191	LIFEBOAT ASSOC 213	273	OSBORNE WILSON LABS 332
23	ANDERSON JACOBSON 377	105	DATASOUTH COMP.CORP. 279	192	LNGW RESEARCH 331	274	OSBORNE/MCGRAW-HILL 107
24	APPARAT INC 77	106	DATATRONIC 287	194	LOGO COMP.SYS. 343	275	OWENS ASSOC 254, 255
25	APPLE COMPUTER INC 12, 13	385	DELTA PRODUCTS 438, 439	195	LQMAS DATA PRODUCTS 367	276	PACIFIC COMP BRK 226
3	APPLE COMPUTER INC 12, 13	107	DENVER SFTW.CO. THE 151	198	LYBEN COMP.SYS. 452	277	PACIFIC DISC SFTW 462
26	APPLIED SYSTEMS 422	108	DESIGNER SOFTWARE 81	197	MACROTRONICS 452	278	PACIFIC EXCHANGES 382
27	ARTEC ELECTRONICS 88	109	DIGIAC CORP 351	198	MACROTRONICS 462	278	PACIFIC EXCHANGES 454
28	ARTIFICIAL INT'L. RESRCH 482	110	DIGIBYTE SYS CORP 205	199	MAGNOLIA MICROSYS 454	279	PACIFIC EXCHANGES 464
29	ASAP COMP.PROD.INC. 335	111	DIGICOMP RESRCH CORP 150	200	MALIBU ELECTR CORP 143	280	PACIFIC EXCHANGES 416
30	ASAP COMP.PROD.INC. 236, 237	112	DIGITAL ELECT.SYS 407	201	MANNESMANN TALLY 413	386	PACIFIC MEDIA PRODUCTS 194
31	ASHTON-TATE 282, 283	113	DIGITAL GRAPHIC SYS 371	202	MAROT SFTW.SYS.INC 203	281	PAGE DIGITAL 480, 481
32	AUTOCONTROL INC 452	114	DIGITAL MARKETING 355	203	MARTEC 369	282	PALOMAR COMP EQUIP 333
33	AUTOCONTROL INC 452	115	DIGITAL MARKETING 6	204	MARYMAC INDUSTRIES 373	283	PAN AMERICAN ELEC INC 470
34	AUTOMATED EQPTMNT. 357	116	DIGITAL PRESS 157	205	MASTER ELECTR.INC 96	284	PAPER TRACTOR 379
AVOCET 14		117	DIGITAL RESEARCH 127	206	MAURO ENGINEERING 268	285	PASSWORD DISTR 431
35	B & B ELECTR. 456	118	DIGITAL RESEARCH COMP 488, 489	207	MAXEK 32	286	PC NEWSLETTER 382
36	BASF SYSTEMS 278	119	DIP INC. 353	400	MCLINTOCK CORP 156	287	PEACHTREE SOFTWARE 73
37	BEAMAN PORTER 269	120	DISCOUNT SFTW GRP, THE 374	*	MCGRAW-HILL BOOK CO 256, 257	PERCOM DATA 7, 15	PERCOM DATA 454
38	BELL JOHN ENGR. 449	121	DISK SUPPLY 363	208	MCGRAW-HILL BOOK CO 360	288	PERSONAL COMPUTERS 272
39	BETA COMP.DEVICES 275	122	DMA 166	209	MCGILLAN BOOK CLUBS 305	289	PETRO-LEWIS CORP 234
40	BIZBUCKET, THE 482	123	DMA 415	210	MEADE'S DATA SYS 454	290	PHASE ONE SYS INC 267
41	BIZCOMP 253	124	DUAL SYS.CONTROL CORP 76	211	MEAS.SYS. & CONTROLS 28, 29	291	PICKLES & TROUT 368
43	BOWER-STEWART 480	125	DUAL SYS.CONTROL CORP 78	212	MEMORY MERCHANT 53	294	POLY PAKS 456
44	BUSINESS OPERATING SYS 187	126	DUAL SYS.CONTROL CORP 80	212	MENTOR SOFTWARE 460	295	POLYLINE CORP 464
45	BUSINESS WEEK 341	127	DUGGER'S GROWING SYS 458	213	META TECHNOLOGIES 440	296	POPULAR COMPUTING 225
*	BYTE BOOKS 249	127	DYMARC IND. 365	214	MICRO AGE COMP.STORE 174, 175	297	POTOMAC MICRO-MAGIC 411
46	BYTE BOOKS 250	128	DYNABYTE BUSN.COMP. CIII	216	MICRO BUSINESS WORLD 179	297	POWER ONE INC 163
47	BYTE BOOKS 251	129	DYNACOMP 324, 325	217	MICRO BUSN. ASSOC 458	298	PRACTICAL MGMTN SYS 462
48	BYTE BOOKS 252	130	DYSAN CORP 136, 137	218	MICRO BUSN. SYS 125	299	PRIORITY ONE 482, 493
*	BYTE BACK ISSUES 379	131	ECSOFT 349	218	MICRO COM 147	300	PROTECTO ENTERPR 456
50	CALIF DATA CORP 462	132	ELECTROLABS 468	220	MICRO DECISIONWARE 140	302	PURCHASING AGENT, THE 186
51	CALIF DIGITAL 484, 486	134	ELECTRONIC CONTROL 316	221	MICRO FOCUS 79	303	GANTEX DIV 327
52	CALIF.COMP.SYS 21	135	ELECTRONIC SPLISTS 347	222	MICRO HOUSE 280, 281	304	QUALITY COMP PARTS 464
53	CALIF.COMP.SYS. 20	136	ELECTRONIC SYS.FURN 102	222	MICRO 310	305	QUALITY COMP PARTS 84
54	CAMEO ELECTR.INC 233	57	ELECTRONICS CENTER 126	223	MICRO MANAGEMENT SYS 347	306	QUALITY SOFTWARE 81
55	CDR SYS.INC 452	138	ELLIS COMPUTING 349	345	MICRO MINT 383	307	QUASAR DATA PROD INC 313
137	CHATSWORTH DATA CORP 125	139	EMPIRICAL RESRCH GRP 455	224	MICRO PRO INT'L 231	308	QUEST ELECTR 455
56	CHECK-MATE 458	140	EMPIRICAL RESRCH GRP. 464	225	MICRO SCI 93	309	R K S ENTERPRISES INC 312
58	CHECKS-TO-GO 10	141	EPSON AMERICA 299	226	MICRO SOURCE OF TX 466	310	R.R.SOFTWARE 371
60	CHIPS & DALE 454	142	ESCON 373	227	MICRO WORKS, THE 365	311	RACET COMPUTES 361
61	CHRISLIN INDUSTRIES 323	* F.E.C.LTD. 464	EXPOTEK 393	228	MICROACE 369	312	RADIO SHACK 35
401	CINEMATRONICS 496	FAIRCOP 417	F.E.C.LTD. 464	229	MICROCOMP.TECH.INC 173	313	RADIO SHACK ASSOC STR 124
62	CLEV.CON.S.COMP. & COMP. NTS. 467	143	FORETHOUGHT PRODUCTS 349	230	MICROCOMPUTER APP. 387	314	RADIO SHACK-GLNW SPR 347
63	CMC.INT'L 220	144	FREDERICK COMP.PROD. 367	231	MICROCRAFT SYS 214	315	RADIX INC 456
65	COMPONENTS EXPRESS 369	145	FSS 460	232	MICRODASYS 201	316	ROBOTICS AGE 381
66	COMPSTAT CO. 431	146	FYI INC. 456	234	MICROMAIL 376	317	S C DIGITAL 373
67	COMPUMART 184, 185	147	GIDDINGS & LEWIS 181	235	MICROMATE ELECTR.INC 345	318	S-100 INC 385
181	COMPUPRO/GODBOU 243	148	GIMIX INC 362	236	MICROSOFT (CPD) 111	319	SCIENTIFIC ENGRG LABS 206
152	COMPUPRO/GODBOU 244, 245	149	GIMIX INC 480	237	MICROTECH EXPORTS 212	320	SCIENTIFIC SFTW PROD 458
68	COMPUSERVE 291	150	GNT AUTOMATIC INC 242	238	MIKOS 486	321	SCION CORP 5
70	COMPUTER AGE 322	154	H & E COMPUTRONICS 227	239	MILLER MICROCOMP.SERV 288	322	SCITRONICS 412
71	COMPUTER AID 452	155	H & E COMPUTRONICS 229	240	MINI COMP.SUPPLIERS 357	324	SCOTSDALE SYSTEMS 154
72	COMPUTER AID 452	156	HANLEY ENGRNG 457	241	MINI MICRO MART 478	325	SCR ELECTR 484
73	COMPUTER DISC.OF AM. 270	157	HAYES MICROCOMP.PROD. 63	242	MINI MICRO MART 479	326	SEATTLE COMP PRODS 113
74	COMPUTER EXCHANGE 321	158	HAYES MICROCOMP.PROD. 215	243	MINI MICRO MART 18	327	SECURED COMP SYS 462
75	COMPUTER FURN. & ACCESS. 30	*	HEATH COMPANY 16, 17, 207	244	MIRO COMPUTERS INC 375	327	SELECT INFO SYS 293
76	COMPUTER MAIL ORDER 247	159	HEATH POSTCARD 400 A&B	245	MORROW DESIGNS 57	328	SIERRA DATA SCIENCES 370
77	COMPUTER PLUS 456	160	HEMENWAY ASSOC. 319	246	MOUNTAIN COMPUTER 19	329	SLUDER 456
78	COMPUTER SHOPPER 480	161	HEWLETT-PACKARD 51	248	MPI 181	330	SOFTTECH MICROSYS 317
79	COMP. SPLISTS. 100, 101	182	HOUSTON INSTRUMENTS 224	*	MRD SYS INC 484	330	SOFTWARE ARTS 273
80	COMPUTER STOP, THE 485	183	HOUSTON INSTRUMENTS 224	249	MSD 156	233	SOFTWAREHOWS 65
81	COMPUTER STORE, THE 410	184	IMS INTERNATIONAL 159	250	MTI 188	*	SOLID STATE SALES 172
83	COMPUTER WARE 117	186	INDEPENDENT BUS.SYS. 118	251	NASHUA CORP 162	332	SORRENTO VALLEY ASSOC 340
84	COMPUTERS ETC. 368	187	INFOSOFT SYSTEMS INC 286	252	NAT'L DATA SUPPLIES 462	333	SOUTHERN COMP SYS 456
84	COMPUTERS ETC. 370	188	INNOVATIVE PROD. 384	253	NATIONAL COMP. SHOW 339	334	SOUTHWEST TECH PROD C II
		189	INNOVATIVE SFTW APPL 178	254	NEBS 208	335	SPECIALIZED BUSN SYS 375
		189	INT'L MICRO SYS 311		NEECO 285	336	SPECTRUM SOFTWARE 187
						337	SSM MICRO COMP PROD 11
						338	STATCOM CORP 89
						338	STATIC MEMORY SYS 235
						339	SUNNY INT'L 470
						340	SUNNY INT'L 470
						341	SUPER STAR INT'L 222
						341	SUPERSOFT 54, 99, 155, 358, 378, 381
						342	SURVEYOR SUPPLY CO 387
						343	SYBEX 93
						*	SYNCHRO SOUND 334
						344	SYNCHRONICS 170
						397	SYNEMED INC 109
						345	SYS INTERFACE CONSUL 82

To get further information on the products advertising in BYTE, fill out the reader service card with your name and address. Then circle the appropriate numbers for the advertisers you select from the list. Add an 18-cent stamp to the card, then drop it in the mail. Not only do you gain information, but our advertisers are encouraged to use the marketplace provided by BYTE. This helps us bring you a bigger BYTE. The index is provided as an additional service by the publisher, who assumes no liability for errors or omissions. \*Correspond directly with company.

## Reader Service

Inquiry No.	Page No.	Inquiry No.	Page No.	Inquiry No.	Page No.	Inquiry No.	Page No.
346	SYSTEMS PLUS 189	357	THREE M COMPANY 223	368	U.S. MICRO SALES 307	*	VR DATA 363
347	TAB BOOKS 337	358	THREE M COMPANY 94	369	U.S. MICRO SALES 463	381	WASHINGTON COMP SERV 489
	TARBELL ELECTR 351	359	THREE M COMPANY 95	370	U.S. ROBOTICS 271	382	WEIGH SYSTEMS TECH 292
349	TEAM ELECTR 371	*	THUNDERWARE 187	371	UNIVERSAL SFTW.STUDIOS 418	*	WESTICO INC 171, 452
*	TECHNICAL SYS CONS 199	360	TINNEY,RBT.GRAPHICS 408	372	UVEON COMP SYS 27	383	WESTWARE 125
350	TECMAR INC 301	381	TKS CORP 329	373	VAN HORN OFFICE SUPP 375	*	WHITESMITHS LTD 191
351	TEI, INC 81	381	TNW CORP 367	374	VANDATA 409	384	WICAT SYSTEMS 55
352	TEI, INC 238	382	TOSHIBA AMERICA INC 23	375	VECTOR ELECTR 88	385	WICAT SYSTEMS 217
353	TELERAM COMMUNC 306	383	TRANSFORMATION TECH 454	376	VECTOR GRAPHICS 75	49	WILLIAMS LABS 368
354	TELEVIDEO INC 209	364	TRANSNET CORP 345	377	VERBATIM CORP 87	386	WINTER CORP 452
355	TERCER MEDIO 211	365	TRANSWAVE CORP 193	378	VERTICAL DATA SYS INC 150	387	WINTERHALTER & ASSOC 328
356	TEXAS COMP SYS 204	366	TRINITY GRP, THE 480	380	VIDEX 277	388	X COMP 297
*	TEXAS INSTRUMENTS 136	367	TSE/HARDSIDE 366	379	VISTA COMPUTER CO 105	*	ZOBEX 83
				380	VOTRAX 166, 169		

## BOMB

### BYTE's Ongoing Monitor Box

Article #	Page	Article	Author(s)
1	38	Build an Unlimited-Vocabulary Speech Synthesizer	Ciarcia
2	52	The Big Board: A Z80 System in Kit Form	Thompson
3	58	The Xerox Alto Computer	Wadlow
4	72	Tree Searching, Part 1: Basic Techniques	Williams
5	112	One Step Forward—Three Steps Backup	Stakem
6	146	Misosys Software's DISKMOD: Put Radio Shack's Editor/Assembler on Disk	Hughes
7	150	MINCE, A Text Editor	Kern
8	164	Artificial Intelligence	Roberts
9	180	A High-Level Language Benchmark	Gilbreath
10	200	Science Fiction's Intelligent Computers	Byrd
11	216	Symbolic Differentiation à la LISP	Nicol
12	238	Knowledge-Based Expert Systems Come of Age	Duda, Gaschnig
13	284	The Atari Tutorial, Part 1: The Display List	Crawford
14	304	Natural-Language Processing, The Field in Perspective	Hendrix, Sacerdoti
15	384	BYTE's Arcade: Big Five Software: The Prisoner	Williams, Liddil
16	388	Three Microcomputer LISPs	Leviton, Bonar
17	414	The Emperor's Old Clothes	Hoare
18	436	Interactive Fiction: Six Micro Stories	Liddil

### June BOMB Speaks Out

Steve Ciarcia's "Build a Low-Cost Speech-Synthesizer Interface" has talked its way into first place this month. Steve gets the \$100 purse for his description of National Semiconductor's Digitalker speech-synthesis system. The article, obviously, left our readers speechless. The \$50 second-place award goes to Gary Kildall for his article, "CP/M: A Family of 8- and 16-Bit Operating Systems," which describes the de facto standard "software bus." Robert Greenberg and James Larson tied for third place. Greenberg's "The UNIX Operating System and the XENIX Standard Operating Environment" provided an inside look at a large-computer operating system for microprocessors. Larson's article, "The Ins and Outs of CP/M," clarified and expanded on input/output and disk interfacing within the CP/M environment.

## GAME DESIGNERS

**CINEMATRONICS**, a leader in the coin-operated video game industry, is expanding its game design staff. We are seeking individuals with the special talent for game design, exceptional creativity, and superior Assembly language programming skills.

**CINEMATRONICS** offers competitive salaries, paid sick and vacation time, medical coverage, pension and profit sharing.

If you're looking for an excellent opportunity with a rapidly growing, employee conscious company, please forward your resume to Sandra Baca, Director of Personnel:

**CINEMATRONICS, INC.**  
1841 Friendship Drive, El Cajon, CA 92020

An Equal Opportunity Employer

The Dynabyte Difference: Unequalled price/performance with total expandability.

---

# Buying the powerful Dynabyte 5615 isn't only smart, it's cost efficient.



The 5615 is the sure way to get the system you need. With more power for the price. You can select memory to 400 KB on our S-100 bus architecture. Choose from 3 sizes of Winchesters to 45 MB and have diskette back-up to your system also. If it's tape back-up you need, then choose our 5700. If you need less storage, our 5¼" floppy 5200, our 8" floppy 5300 or our 5400 system using both floppies, with up to 3.6 MB capacity, can be yours.

The 5615 system is available with either single user CP/M or our enhanced MP/M for multi-user applications. Our MP/M operating system supports up to eight terminals, with a separate or shared spooler, and up to sixteen printers with no required partition space. Add to this multi-tasking, bank switching, record lockout, type-ahead and DMA and you have an MP/M operating system that supports a

host of existing languages and meets minicomputer standards.

No multi-user applications library is so responsive to your needs. The 5615 features Business Manager,™ the fully integrated, menu-driven, well documented, easy to install accounting system that gives you file/record protection, HELP commands, multi-level security, keyed data access, internal disk management, available source code and more.

System expandability, power and price/performance are further enhanced by on-hand availability, quantity discounts, 180-day warranty and a national WATS line for support.

Whether you use or sell computer systems, you should ask about the microcomputer that puts minicomputer capability in your hands. That's the 5615. That's the Dynabyte Difference. Call Mike Seashols, V. P. Marketing (800) 227-8300. In California (415) 329-8021. Dynabyte, 115 Independence Drive, Menlo Park, California 94025.

**DYNABYTE**  
Business Computers

# "Over 15,000 items in inventory could be a nightmare. But it's not 'cause my Challenger computer works like a dream."

"My fastener business is growing rapidly. I have over 800 customers utilizing my 15,000 inventory items daily. Keeping track of inventory, orders, and receivables at this volume level could be a nightmare. But it's not 'cause my Challenger computer works like a dream. Terrific, Ohio Scientific!"

*Richard Nolan, President,  
Aerospace Nylok Corp.,  
Hawthorne, New Jersey*



Ohio Scientific was first to add Winchester hard disk drives to microcomputers. This advanced technology allows low cost microcomputers to store over 100 times as much information on line as they could before.



"With our Challenger computer we've developed sophisticated real estate programs and information files that give our customers and our sales associates that extra edge in fast, accurate real estate market information analysis and forecasting. We now have a strong managerial accounting and market information system as well as word processing at an affordable cost. Terrific, Ohio Scientific!"

*Charles Smith, Jr., President, Montague, Miller & Co., Realtor  
Charlottesville, Virginia*

**OHIO SCIENTIFIC HARD DISK BASED MICROCOMPUTERS START AT LESS THAN \$10,000 AND ARE SOLD BY MORE THAN 400 DEALERS NATIONWIDE. FOR THE ONE NEAREST YOU, CALL 1-800-321-6850 TOLL FREE.**



"I'm a fuel oil jobber, and I can't believe how reliable my Challenger has been, with all it has to keep track of. But, it's been doing it for two years now, and that's terrific, Ohio Scientific!"

*Wade Carlson,  
Vice President,  
Wally Carlson & Sons,  
Lindstrom, Minnesota*



*terrific!* **OHIO SCIENTIFIC**  
a *M/A/COM* Company  
1333 SOUTH CHILLICOTHE ROAD  
AURORA, OH 44202 • [216] 831-5600

Circle 260 on inquiry card.