

# BYTE<sup>®</sup>

the small systems journal

JUNE 1982 Vol. 7, No. 6  
\$2.95 in USA  
\$3.50 in Canada/£1.85 in U.K.  
A McGraw-Hill Publication



ROBERT  
SZTINNEY

**Interactive Videodiscs**

# A new small computer that won't limit you tomorrow



New Cromemco System One shown with our  
high-capability terminal and printer.

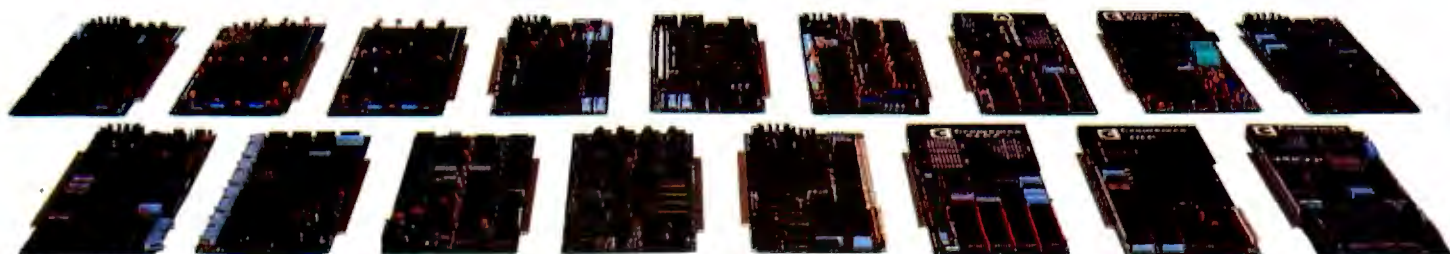

Expandability



Here's a low-priced computer that won't run out of memory capacity or expandability halfway through your project.

Typically, computer usage tends to grow, requiring more capability, more memory, more storage. Without a lot of capability and expandability, your computer can be obsolete from the start.

The new System One is a real building-block machine. It has capability and expandability by the carload.

Look at these features:

- **Z80-A processor**
- **64K of RAM**
- **780K of disk storage**
- **CRT and printer interfaces**
- **Eight S-100 card slots, allowing expansion with**
  - **color graphics**
  - **additional memory**
  - **additional interfaces for telecommunications, data acquisition, etc.**
- **Small size**

### **GENEROUS DISK STORAGE**

The 780K of disk storage in the System One Model CS-1 is much greater than what is typically available in small computers. But here, too, you have a choice since a second version, Model CS-1H, has a 5" Winchester drive that gives you **5 megabytes** of disk storage.

### **MULTI-USER, MULTI-TASKING CAPABILITY**

Believe it or not, this new computer even offers multi-user capability when used with our advanced CROMIX\* operating system option. Not only does this outstanding O/S support multiple users on this computer but does so with powerful features like multi-

ple directories, file protection and record level lock. CROMIX lets you run multiple jobs as well.

In addition to our highly-acclaimed CROMIX, there is our CDOS\*. This is an enhanced CP/M† type system designed for single-user applications. CP/M and a wealth of CP/M-compatible software are also available for the new System One through third-party vendors.

### **COLOR GRAPHICS/WORD PROCESSING**

This small computer even gives you the option of outstanding high-resolution color graphics with our Model SDI interface and two-port RAM cards.

Then there's our tremendously wide range of Cromemco software including packages for word processing, business, and much more, all usable with the new System One.

### **ANTI-OBSOLESCENCE/LOW-PRICED**

As you can see, the new One offers you a lot of performance. It's obviously designed with anti-obsolence in mind.

What's more, it's priced at only \$3,995. That's considerably less than many machines with much less capability. And it's not that much more than many machines that have little or nothing in the way of expandability.

Physically, the One is small — 7" high. And it's all-metal in construction. It's only 14 1/8" wide, ideal for desk top use. A rack mount-option is also available.

### **CONTACT YOUR REP NOW**

Get all the details on this important building-block computer. Get in touch with your Cromemco rep now. He'll show you how the new System One can grow with your task.

\*CROMIX and CDOS are trademarks of Cromemco Inc.

†CP/M is a trademark of Digital Research

 **Cromemco**™  
i n c o r p o r a t e d  
280 BERNARDO AVE., MOUNTAIN VIEW, CA 94040 • (415) 964-7400  
Tomorrow's computers today

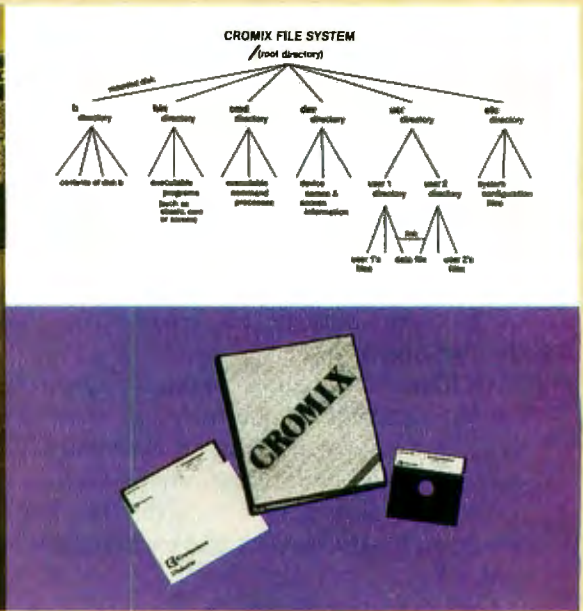

# CROMIX\* — Cromemco's outstanding UNIX† — like operating system

CROMIX is just the kind of major development you've come to expect from Cromemco. After all, we're already well-known for the most respected software in the microcomputer field.

And now we've come up with the industry's first UNIX-lookalike for microcomputers. It's a tried and proven operating system. It's available on both 5" and 8" diskettes for Cromemco systems with 128K or more of memory.

Here are just some of the features you get in this powerful Cromemco system:

- Multi-user and multi-tasking capability
- Hierarchical directories
- Completely compatible file, device, and interprocess I/O
- Extensive subsystem support

## FILE SYSTEM

One of the important features of our CROMIX is its file system comprised of hierarchical directories. It's a tree structure of three types of files: data files,

\*CROMIX is a trademark of Cromemco, Inc.  
†UNIX is a trademark of Bell Telephone Laboratories

directories, and device files. File, device, and interprocess I/O are compatible among these file types (input and output may be redirected interchangeably from and to any source or destination).

The tree structure allows different directories to be maintained for different users or functions with no chance of conflict.

## PROTECTED FILES

Because of the hierarchical structure of the file system, CROMIX maintains separate ownership of every file and directory. All files can thus be protected from access by other users of the system. In fact, each file is protected by **four separate access privileges** in each of the three user categories.

## TREMENDOUS ADDRESS SPACE, FAST ACCESS

The flexible file system and generalized disk structure of CROMIX give a disk address space in excess of one gigabyte per volume — file size is limited only by available disk capacity.

Speed of access to disk files has also been optimized. Average access speeds far surpass any yet implemented on microcomputers.

## 'C' COMPILER AVAILABLE, TOO

Cromemco offers a wide range of languages that operate under CROMIX. These include a high-level command process language and extensive subsystem support such as COBOL, FORTRAN IV, RATFOR, LISP, and 32K and 16K BASICs.

There is even our highly-acclaimed 'C' compiler which allows a programmer fingertip access to CROMIX system calls.

## THE STANDARD O-S FOR THE FUTURE

The power and breadth of its features make CROMIX the standard for the next generation of microcomputer operating systems.

And yet it is available for a surprisingly low \$595.

The thing to do is to get all this capability working for you now. Get in touch with your Cromemco rep today.



**Cromemco**™  
i n c o r p o r a t e d

280 BERNARDO AVE., MOUNTAIN VIEW, CA 94040 • (415) 964-7400  
Tomorrow's computers today

Circle 138 on Inquiry card.



## Features

- 48 The Videodisc Interfacing Primer** by Rod Daynes / Learn how to develop interactive videodisc programs.
- 56 Interactive Videodisc Design and Production** / Wicat Systems presents a systematic approach to the design, development, and production of an interactive videodisc system.
- 60 Build an Interactive-Videodisc Controller** by Steve Ciarcia / You can use your personal computer to control a Pioneer VP-1000 laser-optical videodisc player through its remote-control circuitry.
- 78 Videodiscs In Education, Integrating the Computer and Communication Technologies** by Isaac I. Bejar / Educators are discovering ways to use videodiscs as an aid to learning.
- 108 Interactive Training in Cardopulmonary Resuscitation** by David Hon / Computer and videodisc technologies are combined to provide instruction in lifesaving techniques.
- 142 Videodiscs and Optical Data Storage** by Dick Moberg and Ira M. Laefsky / We may soon be measuring mass storage in gigabytes.
- 182 On the Way to Standard BASIC** by Thomas E. Kurtz / A survey of what's in the proposed ANSI standard and why it's there.
- 242 The Input/Output Primer, Part 5: Character Codes** by Steve Leibson / Character codes turn computer data into messages that people can understand.
- 260 A General-Purpose I/O Board for the Color Computer** by William Barden Jr. / You can build this interface for less than \$25 and plug it into the ROM cartridge slot.
- 286 User's Column: Terminal Madness, The Word, Grammatk, and Then Some** by Jerry Pournelle / The critic reviews some new computer terminals, word-processing software, compilers, and M-drive.
- 302 The Atari Tutorial, Part 10: Human Engineering** by Chris Crawford / The interaction between the computer and the person using it is the most important and the most often neglected aspect of commercial software.
- 321 Upward Migration, Part 1: Translators** by Roger Taylor and Phil Lemmons / Using translation programs to move CP/M-80 programs to CP/M and MS-DOS.

- 410 TAFT: Terminal Apple with File Transfer** by Tom Gabriele / Low-cost telecommunication capability for the Apple II.
- 452 Maintenance Alternatives for Personal Computers** by Lewis A. Whitaker / Repair service options to consider before you buy a computer and preventive maintenance steps to perform once you've made the purchase.
- 468 Omni Aviation Navigation System** by Richard Campbell / Simulate aircraft instrument navigation using simple trigonometry.

## Reviews

- 162** BYTE's Arcade: Armored Patrol by Pete Callamaras; The Eliminator: Mayhem in Space, TRS-80 Style by Silas Pike; Galactic Chase by Stan Wszola
- 220** App-L-ISP by Jeff Bonar and Steve Levitan
- 235** Tawala's Last Redoubt by Hartley G. Lesser
- 348** The Osborne 1 by Mark Dahmke
- 364** Applescope Stores Dual Traces by Gregory MacNicol
- 376** NEWDOS/80 Version 2.0 by Mahlon G. Kelly
- 488** Micro-Decision Support System/Finance (DSS/F) by Robert Moskowitz

## Nucleus

- 6** Editorial: West Coast Computer Faire Report
- 26** Letters
- 232, 493** Technical Forum: Find That Disk; Conditionals in LISP
- 237, 497** Programming Quickies: A Word-Counting Utility for Writers; Listing the Disk Directory in CP/M-based Pascal
- 402** Book Review: Beneath the Apple DOS
- 404, 460** System Notes: Adapting "Harvesting the Sun's Energy" for the Commodore PET; Text-Handling Routines in Extended BASIC
- 434** Ask BYTE
- 440** BYTELINES
- 479** Clubs and Newsletters
- 480, 510** Books Received
- 480** BYTE's Bugs
- 482** Event Queue
- 487** Software Received
- 502** What's New?
- 558** Unclassified Ads
- 558** BOMB, BOMB Results
- 559** Reader Service



Page 48



Page 60



Page 78



Page 108



Editor in Chief

**Christopher Morgan**

**Managing Editor**

Mark Haas

**Technical Editors**

Gregg Williams, Senior Editor;  
Richard S. Shuford; Curtis P. Feigel;  
George Stewart; Arthur Little;  
Stanley Wszola; Steve Ciarcia; Mark Dahmke  
Philip Lemmons; Allan Lundell, Consulting  
Editors; Jon Swanson, Drafting Editor

**Copy Editors**

Beverly Cronin, Chief; Faith Hanson;  
Warren Williamson; Anthony J. Lockwood;  
Ann Graves; Hilary Selby Polk;  
Elizabeth Kepner; Margaret Cook,  
Junior Copy Editor

**Assistants**

Faith Ferry; Debe Wheeler;  
Beverly Jackson

**Production**

David R. Anderson, Assoc. Director;  
Patrice Scribner; Damian Henriques;  
Jan Muller; Virginia Reardon;  
Sherry McCarthy, Chief Typographer;  
Debi Fredericks; Donna Sweeney;  
Valerie Horn; Jonathan M. Graves,  
Creative Consultant

**Advertising**

Thomas Harvey, Director; Marion Carlson;  
Rob Hannings; Deborah Porter;  
Vicki Reynolds; Cathy A. R. Drew;  
Jacqueline Eamshaw, Reader Service  
Coordinator; Wai Chiu Li, Advertising/  
Production Coordinator; Linda J. Sweeney

**Circulation**

Gregory Spitzfaden, Manager;  
Andrew Jackson, Asst. Manager;  
Agnes E. Perry; Barbara Varnum;  
Louise Menegus; Pinky Krulis;  
Sheila A. Bamford  
James Bingham, Dealer Sales;  
Deborah J. Cadwell, Asst.  
Linda Ryan

**Marketing**

Wilbur S. Watson, Marketing Coordinator;  
Timothy W. Taussig, Marketing Production  
Coordinator

**Controller's Office**

Daniel Rodrigues, Controller;  
Mary E. Fluhr, Acct. & D/P Mgr.; Karen  
Burgess; Jeanne Cilley; Linda Fluhr;  
Vicki Bennett

**Traffic**

N. Scott Gagnon; Scott Jackson,  
Kathleen Reckhart

**Receptionist**

Jeanann Waters

**Publishers**

Virginia Londoner; Gordon R. Williamson;  
John E. Hayes, Associate Publisher;  
Cheryl A. Hurd; Michele P. Verville, Publisher's  
Assistants;

Officers of McGraw-Hill Publications Company: Paul F. McPherson, President; Executive Vice Presidents: Daniel A. McMillan, III, Gene W. Simpson; Senior Vice President-Editorial: Ralph R. Schulz; Vice Presidents: Kemp Anderson, Business Systems Development; Harry L. Brown, Special Markets; Robert B. Doll, Circulation; James E. Hackett, Controller; Eric B. Herr, Planning and Development; H. John Sweger, Jr., Marketing.

Officers of the Corporation: Harold W. McGraw Jr., Chairman and Chief Executive Officer; Joseph L. Dionne, President and Chief Operating Officer; Robert N. Landes, Senior Vice President and Secretary; Ralph J. Webb, Treasurer.



## In This Issue

Imagine carrying around the entire Encyclopaedia Britannica in your shirt pocket with room left over for every issue ever published of The New York Times and then some. Videodiscs and optical data storage technology have the potential to make this a reality. They also promise to provide a medium for an effective delivery of information hitherto impossible. Several articles this month illustrate the possibilities. Dick Moberg and Ira M. Laefsky describe one use for videodiscs in "Videodiscs and Optical Data Storage." Rod Daynes presents a primer on the video aspects of videodisc production in "The Videodisc Interfacing Primer." In "Videodiscs in Education" Isaac I. Bejar discusses ways in which videodisc technology might affect teaching methods. David Hon describes teaching lifesaving techniques with the aid of videodiscs and computers in "Interactive Training in Cardiopulmonary Resuscitation." And Steve Ciarcia's project is how to "Build an Interactive-Videodisc Controller." Thomas E. Kurtz, co-author of the original Dartmouth BASIC, surveys what's in the proposed ANSI standard and why it's there. Roger Taylor and Phil Lemmons explain what's really involved in adapting 8-bit software to a 16-bit environment in "Upward Migration, Part 1: Translators." Steve Leibson's "The Input/Output Primer" continues with "Part 5: Character Codes." Of course, we have Jerry Pournelle, William Barden Jr., and all our other regular features.

BYTE is published monthly by BYTE Publications Inc. 70 Main St, Peterborough NH 0345B, phone (603) 924-9281, a wholly-owned subsidiary of McGraw-Hill, Inc. Address subscriptions, change of address, USPS Form 3579, and fulfillment questions to BYTE Subscriptions, POB 590, Martinsville NJ 08836. Second class postage paid at Peterborough, N.H. 0345B and additional mailing offices. USPS Publication No. 528890 (ISSN 0360-5280). Canadian second class registration number 9321. Subscriptions are \$19 for one year, \$34 for two years, and \$49 for three years in the USA and its possessions. In Canada and Mexico, \$21 for one year, \$38 for two years, \$55 for three years. \$43 for one year air delivery to Europe. \$35 surface delivery elsewhere. Air delivery to selected areas at additional rates upon request. Single copy price is \$2.95 in the USA and its possessions, \$3.50 in Canada and Mexico, \$4.50 in Europe, and \$5.00 elsewhere. Foreign subscriptions and sales should be remitted in United States funds drawn on a US bank. Printed in United States of America.

Address all editorial correspondence to the editor at BYTE, POB 372, Hancock NH 03449. Unacceptable manuscripts will be returned if accompanied by sufficient first class postage. Not responsible for lost manuscripts or photos. Opinions expressed by the authors are not necessarily those of BYTE. Entire contents copyright © 1982 by BYTE Publications Inc. All rights reserved. Where necessary, permission is granted by the copyright owner for libraries and others registered with the Copyright Clearance Center (CCC) to photocopy any article herein for the base fee of \$1.00 per copy of the article or item plus 25 cents per page. Payment should be sent directly to the CCC, 21 Congress St, Salem MA 01970. Copying done for other than personal or internal reference use without the permission of McGraw-Hill is prohibited. Requests for special permission or bulk orders should be addressed to the publisher.

BYTE® is available in microform from University Microfilms International, 300 N Zeeb Rd, Dept PR, Ann Arbor MI 48106 USA or 18 Bedford Row, Dept PR, London WC1R 4EJ England.



Office hours: Mon-Thur 8:30 AM - 4:30 PM, Friday 8:30 AM - Noon, Eastern Time





# ADD QUALITY GRAPHICS For Just \$711.\*

The OEM's best choice for graphics is MicroAngelo™, the single board graphics display computer from SCION. Install MicroAngelo in your Multibus or S-100 host and let this intelligent display processor bring your screen to life with full graphics and text. MicroAngelo features 512 by 480 pixel graphics and 40 line by 85 character text displays.

Save development time and overhead with SCREENWARE™, SCION's high level display firmware language. SCREENWARE provides point, vector, region, circle, flood, crosshair, light pen interface, tracking cross, screen load and dump, split screen, macro, and full terminal emulation commands. Use MicroAngelo both as your main console and as your application software's display screen.

MicroAngelo's on-board processor frees your host processor and bus to perform other tasks, while on-board memory and firmware reduce the size of your application programs. With our direct, easy interface to any high level language, you are no more than a simple sub-

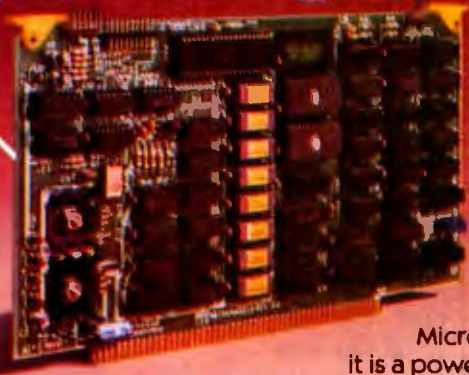

routine call away from MicroAngelo's powerful capabilities. Use one MicroAngelo for monochrome graphics displays. And combine two or more MicroAngelos to create high resolution color graphics.

MicroAngelo is the OEM's choice because it is a powerful self-contained graphics display computer that is easy to add to your host. A graphics display computer that is proven reliable in over 1000 field installations. A graphics display computer that is so affordable you don't have to design your own.

**Think SCION for your graphics display needs. Think MicroAngelo. Call us at (703) 476-6100.**

\*OEM quantity 25 price for Multibus or S-100 board.

## SCION

**if the image is important.**

12310 Pinecrest Rd./Reston, VA 22091  
(703) 476-6100 TWX: 710-833-0684

Circle 402 on inquiry card.



## THINK AHEAD



## THINK CP/M-86

**MILESTONE-86™**—\$395. Manual alone — \$30.  
 "Critical path" network analysis program for scheduling manpower, dollars and time to maximize productivity. Interactive project management program that runs under CP/M-86. MILESTONE can be used to track paper flow, build a computer, check a department's performance, or build a bridge. MILESTONE can be used by executives, engineers, managers, and small businessmen.

- Produce PERT chart in minutes.
  - Find critical tasks that can't be delayed.
  - Investigate tradeoffs between manpower, dollars and time.
  - Give plans to others using a printed project schedule.
  - Change details and immediately see results on the screen.
  - Balance time, manpower and costs.
- Formats: 8, IDW, IPC.

**SUPERCALC-86™** — \$295.

Allows a layman to manipulate data in a variety of forecasting and accounting applications. Combines the interactive nature of an electronic spreadsheet with the power and convenience of a simple simulation language. Video display can be scrolled over the entire worksheet using cursor controls. Symbolic vector references eliminate repetitive low-level data manipulation commands. Easy to use menu driven "help" command.

Also available for IBM-DOS.  
 Formats: 8, IDW, IPC.

**DATEBOOK-86™**—\$295. Manual alone—\$30.

Schedule appointments for up to 27 different doctors, lawyers, rooms etc. Three appointment schedules are displayed on the screen at a time. File structure allows for appointments for up to one year in advance. Searches for openings that fit time of day, day of week and/or day of year constraints. Appointments made, modified or cancelled easily. Copies of day's appointments can be printed easily.

Formats: 8, IDW, IPC

MORE SOFTWARE	PRODUCT/MANUAL ALONE	
CBASIC/86	\$325.	\$25.
PASCAL/M-86	\$495.	\$25.
Pascal: SORT-86	\$195.	\$20.
FIELD COMPANION-86	\$295.	\$30.
PERSONAL DATEBOOK	\$150.	\$30.
TEXTWRITER-86*	\$125.	\$30.

\* Also available for IBM-DOS

FORMAT CODES: 8 (8" single density IBM soft-sectored) IDW (IBM Display Writer with CP/M 86) IPC (IBM Personal Computer with CP/M-86)

SOFTWARE  
 SOFTWARE  
**DIGITAL MARKETING**  
 DIGITAL MARKETING™



**DIGITAL MARKETING CORPORATION**

2670 CHERRY LANE • WALNUT CREEK • CALIFORNIA • 94596  
 (415) 938-2860 • Telex: 17-1852 (DIGMKTG WNKX)

Dealer Inquiries Invited

TRADEMARKS: CP/M-86, CBASIC/86 - Digital Research; Milestone, Datebook, Personal Datebook, Textwriter - Organic Software; Pascal/M - Sorcim; Pascal: SORT, Field Companion - Technical Software.

# Editorial

## West Coast Computer Faire Report

by Chris Morgan, Editor in Chief

You are in a large, cavernous building. To the north, south, east, and west are booths—all filled with microcomputer hardware and software. You are equipped with (1) a BYTE plastic bag, (2) a press badge, (3) a camera, and (4) sensible shoes. Your goal: see everything in the building in three days.

A stream flows into the building from the north—a stream of 40,000 people that is, who poured into the Seventh West Coast Computer Faire held in San Francisco this past March. It was the ultimate adventure game for personal computer lovers.

By some accounts it was a relatively tame show. Indeed, many of the expected blockbuster announcements were held in reserve for the National Computer Conference (underway in Houston as this issue appears). Nonetheless, for patient show-goers there were enough rewards to make the show a real success. I'll touch on a few highlights here.

### A Beautiful Concept

Ironically, the most interesting product I saw during my trip to the West Coast was not on public display. It's the Corvus Concept computer, manufactured by Corvus Systems (2029 OToole Ave., San Jose, CA 95131). I made a special trip to San Jose immediately after the Faire to see this new state-of-the-art personal computer.

In looks alone, the Concept is a hands-down winner. But more important, it offers an amazing number of features for its \$4995 suggested retail price tag. It has a 68000 16-bit processor; 256K bytes of RAM standard (512K bytes optional); a 120-column by 66-line (!) bit-mapped black-and-white display



**Photo 1:** The Corvus Concept computer, which features a 68000 processor and a 120-column by 66-line display. Suggested retail price is \$4995.



# PERCOM

## YOU GET MORE OUT OF PERCOM DISK SYSTEMS.

# EXPECT IT!

At Percom, our business is making disk storage systems for microcomputers — something we've been doing right, since 1977.

From the design of rock-solid drive controller circuitry to quality controls that include 100% life testing of every drive shipped, you can expect to get more out of Percom Disk Systems.

And Percom provides you with comprehensive after-sales service from our wholly owned, fully independent customer service center.

### WINCHESTER 10-MEGABYTE DISK STORAGE SYSTEMS

Enormous storage capacity plus high speed. Percom 5¼ inch hard disk systems are 40 times faster than single-density floppy mini-disks, 20 times faster than double-density units.

Systems include a smart, four-drive controller featuring state-of-the-art data encoding and separation, adaptable industry-standard disk interfacing. Versions for the Apple II, Atari,



### FLOPPY MINI-DISK STORAGE SYSTEMS

40 or 80-track drives, single or dual-head, floppy or non-floppy — all double-density rated. Available in 1, 2 and 3-drive add-on units, 1 and 2-drive internal units, with full documentation and software support. Add-on drives from \$399, complete systems from \$459.95.

To learn more about quality Percom disk storage systems, mail the coupon today. Or, call toll-free 1-800-527-1222.

# PERCOM

## THE DRIVE PEOPLE

11220 Pagemill Road • Dallas TX • 75243 • (214) 340-7081

**YES... I'd like to know more about Percom disk systems. Please rush me information.**

Send to: PERCOM DATA COMPANY, INC. Dept BD1  
11220 Pagemill Road, Dallas TX 75243

name \_\_\_\_\_

street \_\_\_\_\_

city \_\_\_\_\_ state \_\_\_\_\_ zip \_\_\_\_\_

phone number \_\_\_\_\_

I'm interested in floppy disk storage for my...  
TRS-80  Mdi I  Mdi II  CC  IBM PC  
 H/Z-89  H-8  AIM/KIM/SYM  System-50

I'm interested in hard disk storage for my...  
 IBM PC  TRS-80 Mdi III  Apple II  Atari  H/Z-89

Other computer? \_\_\_\_\_  
( floppy disk or  hard disk?)

PRICES AND SPECIFICATIONS SUBJECT TO CHANGE WITHOUT NOTICE.

\*TRS-80 is a trademark of Tandy Radio Shack Corporation which has no relationship to Percom Data Company, Inc.  
© 1981 Percom Data Company, Inc.

JOHN STARKWEATHER'S

**NEW**

NEVADA

# PILOT

**\$149.95**

DISKETTE AND MANUAL

For all CP/M systems. Works with Apple (SoftCard™ system needed), TRS-80, North Star, Superbrain, Micropolis, Vector and many other microcomputers. Needs 32K RAM, one disk drive and CRT or video display and keyboard.

- PILOT for Programmed, Inquiry, Learning Dr Teaching.
- An excellent interactive language for education and office automation.
- Perfect companion for BASIC, COBOL and PASCAL to solve training and documentation problems.
- John Starkweather, Ph.D., creator of PILOT, wrote this version to meet all PILOT-73 standards and added many new features.
- New features include full screen text editor, commands to drive optional equipment such as VTR's & voice response units.
- Currently used in many college and progressive high schools.
- Use for interactive applications—data entry, programmed instruction and testing.

**NEW**

NEVADA

# EDIT

**\$119.95**

DISKETTE AND MANUAL

For all CP/M-based systems. Requires 32K RAM, one disk drive and CRT or video display and keyboard.

- A character oriented full screen video display text editor designed specifically for program preparation.
- Write program in COBOL, FORTRAN, BASIC or similar languages.
- Features include single key commands for cursor control, scrolling, block moves, search and replace, tab setting and multiple file insertions.

NEVADA

# COBOL



**\$199.95**

DISKETTE AND MANUAL

For all CP/M or MP/M operating systems. Requires 32K RAM and one disk drive.

- Edition II of Nevada COBOL is based on ANSI-74 Standards.
- With 48K RAM, you can compile and execute up to 4000 statements.
- COPY statement for library handling.
- CALL...USING...CANCEL
- PERFORM...THRU...TIMES...UNTIL...paragraph or section names.
- IF...NEXT SENTENCE...ELSE...NEXT SENTENCE AND/OR <=> NOT.
- GO TO...DEPENDING ON...
- Interactive ACCEPT/DISPLAY...
- RELATIVE (random) access files
- Sequential files both fixed and variable length.
- INSPECT...TALLYING...REPLACING.



**ELLIS COMPUTING**  
SOFTWARE TECHNOLOGY

600 41st Avenue, Dept. B  
San Francisco, CA 94121  
U.S.A.

COD's WELCOME



**(415) 751-1522**

CP/M, MP/M, TRS-80 and SoftCard system are registered TM's of Digital Research, Tandy Corporation and Microsoft respectively.

## Editorial

(560 by 720 pixels, versus 808 by 1024 for the Xerox Star—you can get the equivalent of eight Apple II images on the Corvus screen, albeit without color); mixed text and graphics on the same page; on-screen window management; ISO Pascal as the main language; Selectric-style keyboard with 10 programmable-function keys (key labels appear along the bottom of the display, à la Hewlett-Packard); built-in Omninet local network hardware; and various software packages, including a CP/M emulator in software that runs regular CP/M programs (although somewhat more slowly than most standard CP/M machines); Logicalc (a Visicalc look-alike spreadsheet program), and Edword, a sophisticated word processor. The Concept's operating system (designed by Corvus) is menu-based, which makes the machine a natural for Unix. In fact, it would be an excellent candidate for a Smalltalk system. Its designers say they are working on an experimental "mouse" (a small, mechanical interface that lets the user position the cursor on the screen by rolling the interface box on a flat surface and select screen menu options by pressing buttons). Such a unit is currently available on the Xerox Star system.

### Good Design

The Concept is one of the best-designed computers I've seen in the microcomputer field, and it will set the price/performance standard in its price class for some time to come. The only machine that may give it real competition is the still-under-wraps Apple Lisa machine. Details about Lisa and its date of introduction are still sketchy. It's rumored to have graphics comparable to the Concept, but it may end up costing more.

The Concept resembles the Xerox Star in many ways. The user-definable screen windows bear an uncanny, though perhaps not entirely accidental, resemblance to those on the Star. And while it lacks some of the flexibility and sophistication of the Star's estimable software package, it comes surprisingly close in its hardware features—screen resolution, for instance. It's a pleasure finally to be able to see an 8½ by 11 page of text displayed on a personal computer screen as it will appear on paper when printed. And all this for about one-third the price of the Star!

### Flipping Your Display

Another novel feature of the Concept is the switchable display screen (made by Ball Brothers). It's but the work of a few seconds to remove the screen from its quick-release flange mount (the screen can be tilted and swiveled by the operator for optimum viewing angle) and flipped 90 degrees to get a horizontal aspect ratio. A quick press of a key converts the characters on the video screen to either horizontal or vertical display. Having the two options is a real convenience: the horizontal mode is perfect for spread-sheet programs and the vertical mode lends itself well to word processing.



# Ithaca 525/800™

A computer system so advanced, the technology you'll need later  
is already here. And waiting.

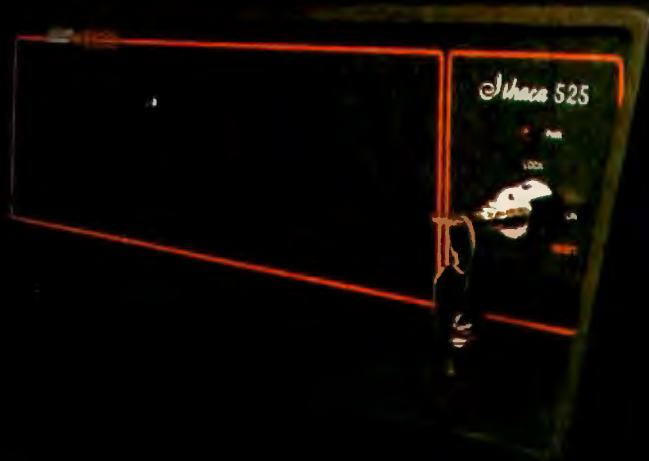

The Ithaca 525/800 gives you the ability to address an almost unlimited number of applications in business, scientific, and educational environments.

Its state-of-the-art hardware gives you a single or multi-user 8-bit system in one machine that handles 5 1/4" or 8" floppy and hard disks.

It has a processor that's 50% faster than conventional systems. A unique Cache CP/M\* - MP/M\* system that's typically 500% faster. That's right, 500%. And up to 1 Mbyte of memory.

It has add-on capacity built-in now, ready to expand when you're ready. There are no hidden costs to pay for later. Everything you need comes with the

Ithaca 525/800. In fact, it could be the only system you'll ever need.

It's simply the finest price/performance Z-80<sup>†</sup> based system available. And it's here now, waiting for your call.

**800-847-2088**

In New York State  
(607) 257-0190

**Ithaca**  
InterSystems™

*We think as fast as you do.*

1650 Hanshaw Road, P.O. Box 91  
Ithaca, NY 14850  
TWX: 510-255-4346

\* CP/M and MP/M Digital Research, Inc.    † Z-80 Zilog, Inc.    ™ Ithaca 525/800 Ithaca InterSystems, Inc.

See us at Comdex Booth #2019

# The A113 Interface puts your Apple® Computer to work in the Laboratory

For Only  
**\$550\***



You can plug this powerful interface easily into your Apple Computer and create a fast, flexible analog data acquisition system with all these features:

- 16 independent input channels
- Ranges from 100mV to  $\pm 5V$ , selectable by software
- 12-bit precision, 0.024% accuracy
- Fast 20-microsecond conversion time
- Sample-and-hold circuitry captures changing signals
- External trigger mode responds to commands from remote equipment
- Software diskette included, to get you started right away

A113 comes with a 1-year warranty and is backed by full technical support. It is part of a full line of **IS** analog and digital systems, all inexpensive and modularly designed so that you can select and pay for only the interfaces and functions you need.

Interactive Structures has been designing and producing interfaces for Apple Computers since 1977. Thousands of **IS** units are in use internationally. One is being used in the instrumentation for making analog readings aboard the NASA Space Shuttle.

Write or call now for more information on the A113—the best investment you'll make in a research assistant.

\*Recommended U.S. list price each

Apple is a registered trade name of Apple® Computer Inc. Circle 233 on inquiry card.



Interactive Structures, Inc.  
112 Bala Avenue  
P.O. Box 404  
Bala Cynwyd, PA 19004  
(215) 667-1713

## Editorial

The Edword word processor (designed by Corvus) has one feature that's worth the price of admission: an Undo key that lets you "undo" what you've done to your text file *all the way back to the beginning of the editing session*. Some other word processors have limited "undo" capability, but this is the first I've seen in which the program gives you so much power. An optional Corvus hard disk attached to the Concept contains the Mirror backup system that works in conjunction with any standard VHS video-tape recorder with remote control. The system can be programmed to come on at any time (nighttime is probably most convenient) and back up and verify the contents of the hard disk. The procedure takes about 15 minutes. And you can program the computer to automatically save the contents of your current working file to disk as often as every 10 seconds.

A drawer in the back of the Concept opens to reveal a motherboard that, the company says, will accept some (not all) of the available Apple peripheral boards on the market. That's another unexpected feature that makes this computer so intriguing.

The Corvus designers have paid a lot of attention to minor and major details that other companies have passed over. The result is a major advance in the current state of the art in personal computer design.

In today's age of giant computer makers, it's ironic—and reassuring—that some of the best designs can still come from the most unexpected sources.

## New Products at the Faire

I saw several plug-in boards designed to let you run software written for one computer on another computer. One such board is the Baby Blue from Xedex Corporation (645 Madison Ave., New York, NY 10022). This \$600 board lets IBM Personal Computer users run standard CP/M programs. With the board in place, a program with a Baby Blue header loads under PC DOS into native memory and is executed. The header instructs the IBM's

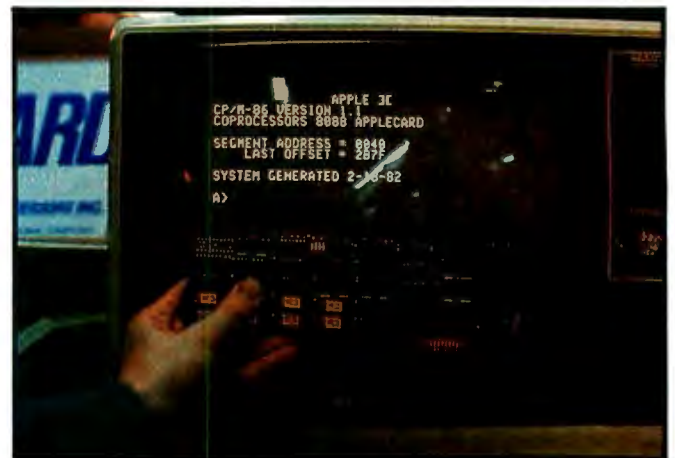

Photo 2: Coprocessors' 8088 conversion card for the Apple II.

Circle 421 on inquiry card. →





## Every Apple Is Created Equal. But It Doesn't Have To Stay That Way.

An Apple™ is really something. But from now on, it's going to be something much more. How come? Simple. We're introducing three revolutionary new data communication packages, called Transend™, designed especially to make your Apple II™ rise above all others.

Our Transend data communications software provides access to information utilities; complete file transmission of charts, VisiCalc™ reports, and entire programs; as well as all electronic mail functions.

Transend comes in three different versions. You can begin economically with the simplest form, Transend 1, an intelligent terminal/file transfer system. As your needs increase, you can move up to two other Transend packages, without worrying about retraining or repurchasing. Transend 2 gives any Apple II intelligent terminal capabilities, plus file transfer with complete error detection and

automatic retransmission for demanding business applications. Transend 3 incorporates electronic mail—with password security, text editing, mailbox with mailstop, unattended scheduling and receiving, automatic redialing, and much more.



Transend's support of most popular Apple II "add-in" cards and modems lets you upgrade your Apple without hassle or unnecessary expense. And you'll immediately cut operating costs by as much as 30% with simple, easy-to-use menus, data compression and 1200-baud modem support.

Nobody on the personal computer scene today is offering the speed, flexibility, and reliability of Transend in a single upgradable software system.

Don't miss this chance to uplift your Apple II. Contact us or your dealer for all the delicious details.

SSM Microcomputer Products, Inc.,  
2190 Paragon Drive, San Jose, CA  
95131, (408) 946-7400, Telex: 171171,  
TWX: 910-338-2077.



The Transformation People

Apple and Apple II are trademarks of Apple Computer, Inc. VisiCalc is a trademark of Personal Software, Inc. And Transend is a trademark of SSM Microcomputer Products, Inc.

**SOFTWARE**  
**CP/M®**  
**SORCIM**

SUPERCALC..... 209.00  
List: 295.00

**SOFTWARE**  
**CP/M®**  
**ASHTON-TATE**

dBASE II VERSION 2.3A . 529.00  
DATA BASE MANAGEMENT  
SYSTEM AVAILABLE  
IN MANY FORMATS.  
List: 700.00

**SOFTWARE**  
**APPLE®**  
**VISICORP**

VISCALC® APPLE  
DOS 3.3 ..... 190.00  
List: 250.00

**HARDWARE**  
**PRINTERS**  
**EPSON**

MX-100 ..... 729.00  
List: 995.00  
MX-80 FT with  
GRAFTRAX ..... 619.00  
List: 795.00  
MX-80 FT ..... 549.00  
List: 745.00  
MX-80 with GRAFTRAX.. 479.00  
List: 645.00  
8141 SERIAL INTERFACE. 64.00  
8150 SERIAL  
INTERFACE ..... 140.00  
WITH 2K BUFFER  
8151 SERIAL  
INTERFACE ..... 155.00  
WITH 2K BUFFER AND  
Xon/Xoff PROTOCOL  
8230 APPLE® CABLE.... 24.00  
PARALLEL  
8131 APPLE®  
INTERFACE ..... 63.00  
PARALLEL  
GRAPPLER INTERFACE  
AND CABLE: ..... 125.00  
FOR APPLE™, MX-80  
(MUST have Graftrax), MX-80 FT,  
MX-100, IDS PAPER TIGERS  
AND C. ITOH PROWRITER

**THE MICROHOUSE**  
**"ddQ" PACKAGE:..... 699.00**  
ASHTON-TATE's dBASE II  
FOX & GELLER's  
dUTIL and QUICKSCREEN  
List: 924.00

**FOX & GELLER**  
QUICKSCREEN..... 129.00  
List: 149.00  
dUTIL..... 75.00  
List: 99.00

**MICROSOFT**

BASIC 80 ..... 285.00  
BASIC COMPILER ..... 315.00  
COBOL 80 ..... 568.00  
FORTRAN 80 ..... 345.00  
muSIMP/muMATH..... 215.00  
MACRO 80 ..... 140.00

VISCALC® IBM 64K .... 158.00  
List: 200.00  
VISCALC® IBM 256K ... 190.00  
List: 250.00  
VISIDEX ..... 190.00  
List: 250.00  
VISIPILOT ..... 158.00  
List: 200.00  
VISITERM ..... 79.00  
List: 100.00  
VISITREND..... 249.00  
List: 300.00  
VISIFILE ..... 190.00  
List: 250.00  
DESKTOP PLAN II..... 190.00  
List: 300.00  
DESKTOP PLAN III ..... 149.00  
List: 250.00

**LEXISOFT**

SPELLBINDER..... 299.00  
List: 295.00  
SPELLCHECK ..... 225.00  
List: 295.00

VISIPACK: ..... 599.00  
List: 250.00  
INCLUDES VISICALC,  
VISIFILE, & VISITREND/  
VISIPILOT.  
List: 700.00

**Microhouse™ continues to feature  
the best savings on the best software.**

**MICROPRO**

WORDSTAR..... 293.00  
List: 495.00  
WORDSTAR FOR IBM ... 289.00  
List: 495.00  
SUPERSORT ..... 168.00  
MAILMERGE ..... 103.00  
DATASTAR..... 235.00  
List: 495.00  
SPELLSTAR..... 155.00  
CALCSTAR ..... 199.00

**HAYDEN**

PIE Writer ..... 124.00  
APPLE™ WORDPROCESSOR  
List: 149.95  
APPLESOFT COMPILER. 145.00  
**MICROSOFT**  
TIME MANAGER ..... 125.00  
List: 150.00  
TASC  
APPLESOFT COMPILER. 150.00  
FORTRAN 80 ..... 165.00  
COBOL 80 ..... 550.00  
A.L.D.S. .... 105.00

**IDS**

PRISM PRINTER 132... 1699.00  
List: 1995.00  
PRISM PRINTER 80 ..... 799.00  
List: 895.00  
PAPER TIGER 560G ... 1149.00

**OKIDATA**

MICROLINE 84 ..... 1199.00  
MICROLINE 83A ..... 749.00  
MICROLINE 82A ..... 499.00  
MICROLINE 80 ..... 365.00

**ACCESSORIES**  
**APPLE®**

**VIDEX**  
VIDEOTERM ..... 290.00  
KEYBOARD ENHANCER. 105.00

**MOUNTAIN**

MULTI I/O..... 178.00

**MICROSOFT**

PREMIUM SYSTEM:..... 619.00  
INCLUDES: Z-80 SOFTCARD,  
16K RAMCARD, VIDEX  
VIDEOTERM, and CP/M USER  
GUIDE.  
List: 775.00  
Z-80 SOFTCARD ..... 299.00  
16K RAMCARD..... 150.00

**MICROPRO**

WORDSTAR..... 234.00  
List: 375.00  
CALCSTAR ..... 149.00

**MODEMS**  
**NOVATION**

APPLE® -CAT..... 325.00  
List: 389.00  
AUTO-CAT..... 213.00  
D-CAT..... 156.00

**HAYES**

CHRONOGRAPH ..... 199.00  
List: 249.00  
SMARTMODEM ..... 227.00  
MICROMODEM II ..... 299.00  
APPLE®

**C. ITOH**

PROWRITER PARALLEL . 499.00  
List: 845.00  
PROWRITER SERIAL .... 650.00  
List: 885.00  
F-10 PARALLEL ..... 1560.00  
F-10 SERIAL ..... CALL  
COMET I. .... 295.00  
List: 495.00  
STARWRITER I  
PARALLEL ..... 1450.00  
List: 1895.00  
STARWRITER I SERIAL . 1500.00  
List: 1960.00  
STARWRITER II  
PARALLEL..... 1700.00  
List: 2325.00  
STARWRITER II  
SERIAL ..... 1800.00  
List: 2025.00



## TO ORDER:

THE MICROHOUSE ORDER CENTER IS OPEN  
9:00 AM - 8:00 PM EASTERN TIME MONDAY  
THROUGH FRIDAY.

CALL TOLL-FREE FOR ORDERS, PRICE  
QUOTES, AND AVAILABILITY:

**1-800-523-9511**

IN PENNSYLVANIA, AND FOR TECHNICAL  
SUPPORT:

**1-215-868-8219**

## MICROLINE™

MICROHOUSE OFFERS 24 HOUR COMPUTER  
SHOPPING WITH MICROLINE. MICROLINE IS  
A COMPUTERIZED ORDER-ENTRY SYSTEM,  
SIMILAR TO ACCESSING TIME-SHARING  
SYSTEMS. MICROLINE ENABLES YOU TO  
ACCESS SPECIFIC INFORMATION ON OVER  
1000 MICROCOMPUTER HARDWARE AND  
SOFTWARE PRODUCTS, IN ADDITION TO  
NUMEROUS SUPPLIES AND ACCESSORIES.

MICROLINE GIVES YOU THE OPTION OF  
ORDERING AS MUCH AS YOU WANT, AS  
OFTEN AS YOU WANT. MICROHOUSE WILL  
PROCESS YOUR ORDER WITHIN 24 HOURS.

**1-215-868-1230**

MICROLINE OPERATES AT 300 BAUD, 8 BITS,  
NO PARITY, 1 STOP BIT.

## SHIPPING:

ADD 2% TO ALL ORDERS. DIFFERENCE WILL  
BE CREDITED. OUTSIDE CONTINENTAL UNITED  
STATES ADD AN ADDITIONAL \$5.00.

ALL ITEMS SHIPPED UPS GROUND. OTHER  
SHIPPING METHODS AVAILABLE UPON  
REQUEST.

## PAYMENT:

ACCEPTED PAYMENT BY PERSONAL CHECK,  
MONEY ORDER, C.O.D., MASTERCARD, OR  
VISA. PURCHASE ORDERS NEED PRIOR  
APPROVAL.

MICROLINE PAYMENTS BY PERSONAL CHECK,  
MONEY ORDER, C.O.D., MASTERCARD, OR  
VISA ONLY.

PENNSYLVANIA RESIDENTS ADD 6% SALES  
TAX.

MICROHOUSE  
1444 LINDEN STREET  
P.O. BOX 498  
BETHLEHEM, PA 18016

PRICES AND SPECIFICATION SUBJECT TO  
CHANGE WITHOUT NOTICE.

ALL ITEMS SUBJECT TO AVAILABILITY.

SUPERCALC is a trademark of SORCIM.  
VISICALC, VISIDEX, VISIPLLOT, VISITERM,  
VISITREND, DESKTOP PLAN, and VISIFILE  
are trademarks of VISICORP.

QUICKSCREEN and dUTIL are trademarks of  
FOX & GELLER ASSOC.

SOFTCARD, RAMCARD, TIME MANAGER,  
and PREMIUM SYSTEM are trademarks of  
MICROSOFT.

WORDSTAR, SUPERSORT, MAILMERGE,  
DATASTAR, SPELLSTAR, and CALCSTAR  
are trademarks of MICROPRO INTERNATIONAL.

dBASE II is a trademark of ASHTON-TATE.

SPELLBINDER and SPELLCHECK are trademarks  
of LEXISOFT.

MICROMODEM II is a trademark of HAYES  
MICROCOMPUTER PRODUCTS, INC.

PRISM is a trademark of INTEGRAL DATA  
SYSTEMS, INC.

APPLE is a registered trademark of APPLE  
COMPUTERS.

CP/M is a registered trademark of DIGITAL  
RESEARCH.

## NEW FROM IDS PRISM PRINTER™

The Prism Printer is the first truly modular, field-upgradable dot matrix printer. Now your printer can be as flexible as the rest of your system.

No other printer offers you as much - or as little - as you need. Start with the basic printer which features text quality printing; then add the performance modules you need when you need them. Getting into word processing? Add the automatic cut sheet feeder. Handling lots of data? Install the high speed Sprint Mode. Want to get the big picture? Add the Dot Plot graphic option. And for communicating information and ideas faster, nothing is more effective than Prism Color for high quality, multi-color output.

And that's just the beginning. Additional Prism option modules will soon be available to help your evolving system meet its true potential.

If you are an Apple, IBM, or other professional microcomputer user, Prism Printer is the key to your total system solution. At last, the chemistry is right between you and your printer.

Microhouse offers both the Prism 80 and Prism 132 Printers at great savings. Please call for availability.

**Microhouse™**  
**has it. MicroPro's™**  
**WordStar for**  
**IBM: \$289**

**Microhouse™**

## NEW FOR APPLE® HAYDEN PIE WRITER

Yes, that's right. Another word processing system for the Apple II. So, what makes the Hayden PIEWriter so different? Well, for one - the price. Secondly - you need not purchase any additional hardware for your computer to make it operational.

PIEWriter has the ability to do incremental spacing so that fractions of a space can be added between words when justifying text. This makes the distribution of the space required to fill out a justified line more uniform and less noticeable. In addition, with its optional proportional spacing formatter program, PIEWriter becomes the ONLY word processor that can print true proportionally spaced documents.

Versatility and compatibility are two important features of PIEWriter. While some word processors for the Apple II computer will only work with specific accessories, such as 80-column display boards, lowercase adaptors and printers, PIEWriter is versatile enough to work with almost any combination of these. If you have any one of these hardware accessories in your system, Hayden has a PIEWriter for your particular configuration.





Photo 3: Full-View 80, an 80-column conversion board for the Atari 800, from Bit 3 Computer Corporation.



Photo 4: The Xebec 5-megabyte hard disk and controller kit for \$1295.

8088 processor to run the program on the Baby Blue's built-in Z80B processor.

From Coprocessors Inc. (50 West Brokaw Rd., Suite 64, San Jose, CA 95110) comes the 88-Card, a plug-in card that effectively converts the Apple II to 16-bit operation, complete with PC DOS (see photo 2). The board also adds 64K bytes of memory to the Apple, all for \$899. Another such board is the Apple '88 Up-Grade Board from Systems Research (4355 West Tropicana, Las Vegas, NV 89103). It has CP/M-86 and an 8088 processor

but no memory; it retails for \$550. The Apple probably now holds the all-time championship for being able to emulate the highest number of different computer systems via plug-in boards.

At last someone has come up with a badly needed board: a plug-in card that converts the Atari 800 to 80-column operation (see photo 3). It's called Full-View 80, and it's available for \$379 from Bit 3 Computer Corporation (8120 Penn Ave. S, Suite 548, Minneapolis, MN 55431).

## "THE BETTER BOARD"

### SB-80 Single Board Computer

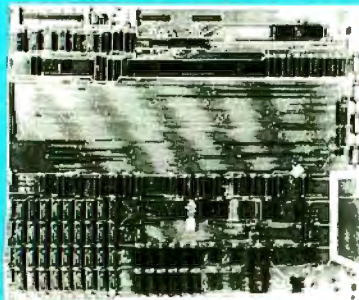

**Z-80-A  
64K RAM**

Fully Assembled and Tested

Size: 16" x 13"  
Same as 2 8" floppy drives. Requires  
+5V 1.5 Amp  
-5V 1.0 Amp  
+12V 1.5 Amp

**\$695.00\*\***

#### CONSTRUCTION

- Sockets for all integrated circuits.
- 50 pin connector allows access to system for future expansion.

#### PROCESSOR

- Z80A with 4 MHz system clock with no wait states.

#### MEMORY

- 64K of 200ns dynamic RAM is standard. 4116 IC's
- Parity protection is standard.

#### ROM

- 256 bytes bootstrap ROM

2 PARALLEL I/O's 2 SERIAL I/O's  
COUNTER TIMERS  
FLOPPY DISK CONTROLLER

#### OPTIONS:

- Character video board 80 x 24 for use with black and white monitor using a stand alone keyboard ..... \$215.00
- Winchester Host Adapter board for Shugart SA-1000 or Corvus Hard Disk. Includes cables ..... \$315.00
- Stand alone keyboard and cable plugs into computer board for 80x24 video option ..... \$190.00

#### CPU — DISK DRIVE CABINET ACCOMMODATES

- SB-80
- BRI 2000
- DIGITAL RESEARCH "The Big Board"
- OTHER SINGLE BOARDS

Metal cabinet with proportionately balanced air flow-convective cooling AC power cord connector, lighted power switch; Fuse assembly; 0L65 Dual drive power supply (Will also power single board CPU). All hardware included to mount 2, 8" disk drives. Includes space area to mount any single board computer. Fully assembled and tested



18" W x 19" L x 8" H



SB — ..... Cabinet Kit \$645.00  
SB — ..... Bare Cabinet \$145.00

#### SS/DD DISK DRIVE SYSTEM

SB Assembled tested with 2, 8" drives ..... \$1425.00

#### DD/DD DISK DRIVE SYSTEM

SB Assembled tested with 2, 8" drives ..... \$1850.00

#### 8" FLOPPY DISK DRIVES

Single Sided / Double Density Double Sided / Double Density  
Shugart 800/801R ..... \$395.00, 2/\$780.00  
Shugart 850/851R ..... \$590.00, 2/\$1170.00

CP/M\* 2.2 & BIOS  
CP/M\* 2.2 & BIOS modified by S & M systems to run on single board is available for ..... \$200.00

**HOW TO ORDER** Phone orders using American Express, Visa, MasterCard, Bank wire transfer, Cashier's or Certified check, Money Order, or Personal check (allow 10 days to clear). Please add 5% for shipping, handling and insurance minimum \$500.00. Conn. residents add 7.5% sales tax. All equipment is subject to price changes and availability without notice. All equipment is new and comes complete with manufacturers warranty. Showroom prices may differ from mail-order advertisement.

\* CP/M is a trademark of Digital Research Corp.

\*\* 1 to 4 piece domestic U.S. price



**Colonial Data Services Corp.**

105 Sanford Street Hamden, Conn. 06514

(203) 288-2524 • Telex: 956014





**In an age when new standards are constantly emerging,  
one disk consistently meets or exceeds them all.**

## **Maxell. The Gold Standard.**

Not all disks are created equal. Some are better than others. To find out what's best for you, look for Maxell disks. They now carry the Gold Standard symbol of quality. It's your assurance Maxell disks meet or exceed every definition of quality. No matter who establishes it. We've earned this universal superiority by never relaxing our uniquely demanding quality control. Every aspect of manufacturing is checked, then checked again.

Your benefits are many. Take the perpetual problem of drop-outs. A drop-out is a tiny defect that wastes time and degrades computer accuracy and performance. Now that you understand what a drop-out is, forget it. Maxell disks don't have any. Each disk comes to you certified

drop-out free at the time of manufacture. You can depend on this quality protecting your valuable programs and programming time, indefinitely. We've run disks over ten million passes under conditions designed to find weak points and wear. We couldn't. And you won't.

There is a Maxell disk for the floppy system you use, or plan to use. Check your computer's instructions. Or write for our complete, highly informative brochure.

When you set the Gold Standard as your level of quality, you'll benefit from improved disk performance. Immediately. Bank on it.



# **maxell®**



# S-100 MEMORIES

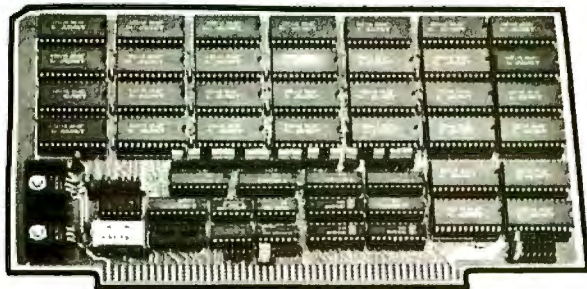

## 64K STATIC RAM

150 ns 2Kx8 Rams  
Extended Addressing  
Bank Select  
Low Power Consumption  
Cromix, MPM Compatible

M12

\$625.00

## 256 DYNAMIC RAM

150 ns Access—270 ns Cycle  
8—or 16—Bit Data  
Parity Error Detection  
Extended Addressing  
ROM Driven Bank Select

M23

\$945.00

Industrial Quality  
FULL 12 Month Warranty

indigo tech

(408) 727-4710 Master Charge and Visa  
670 Nuttman Ave. No. 110 Santa Clara, CA 95050

## 1982 VERSION IFR SIMULATOR Apple II Plus DOS 3.3

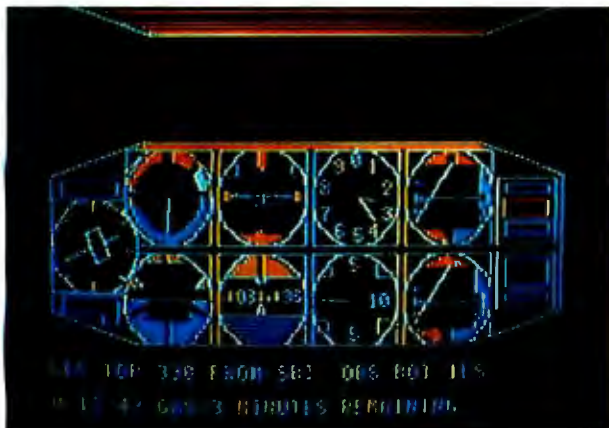

Features a lifelike panel that simulates the airplane instruments that are used for flying and navigating in clouds. FLY IFR LANDINGS, PATTERNS, and CROSS COUNTRY in several areas of The United States. \$50.00 at your computer store or direct from:

**PROGRAMMERS SOFTWARE**  
2110 N.2nd St.  
Cabot Arkansas 72023  
(501) 843-2988

## Editorial



Photo 5: Non-Linear Systems' Kaycomp II computer.

### A Best Buy

Looking for a great buy? The Xebec 5-megabyte hard disk and controller is hard to beat at \$1295 (see photo 4). But there's a catch: it's a kit. The manufacturer (Xebec, 432 Lakeside Dr., Sunnyvale, CA 94086) claims that assembly takes only 10 minutes or so because the various sub-assemblies, including the controller board, come pre-assembled. If the kit, which comes with either Apple DOS or CP/M software, is as easy to assemble as Xebec says (we haven't had time to evaluate it yet), it could be the bargain of the year.

### Osborne Look-Alike

Non-Linear Systems Inc. (533 Steven Ave., Solana Beach, CA 92075) introduced the Kaycomp II (see photo 5), a portable Osborne 1 look-alike that sells for the same price as the Osborne (\$1795) and sports features such as a Z80 processor, two built-in 5¼-inch floppy-disk drives, CP/M, MBASIC, Multiplan (similar to Visicalc), and a word processor (the negotiations for which were still underway at the time of this writing). The Kaycomp II's screen is bigger than the Osborne's, measuring 9 inches diagonally, and it displays a full 80 columns per line. In addition, some people feel the Kaycomp II's keyboard has a better layout and key response. It's an interesting entry from a company that has been in the electronics field since the early fifties. NLS was the originator of the digital voltmeter back in the days of Nixie tubes. Whether NLS can beat Osborne's significant headstart in marketing remains to be seen.

### The 68000 Pulls Ahead

The 68000 seems to be the leading 16-bit processor at the moment in terms of the number of new computers that use it. New 68000-based machines were on display from Sage and Fortune, as well as the previously mentioned Corvus Concept Computer. Add the TRS-80 Model 16 to that list and you can see that the 68000 has made fast inroads into the market. Look for more 68000-based machines in the near future, including en-



# CompuStar™



## The Best Made Better

When we unveiled our CompuStar™ multi-user terminal system just over a year ago, we thought we had created the most powerful, lowest-priced multi-user computer we would ever manufacture. We were wrong. Today, we've made our best even better!

Our newly redesigned CompuStar™ boasts the same performance statistics that made its predecessor such an overnight success, plus a host of exciting *new* features. CompuStar users now get the added benefits of dual character set capability, an expanded library of visual attributes including reverse video, underlining and below-the-line descenders, an enhanced disk operating system and Microsoft® BASIC — all at no extra cost! And single-user systems now start at as little as \$2995.

There are four types of CompuStar™ workstations (called Video Processing Units or VPU's) that can be connected into a variety of central disk systems with 10 to 96 megabytes of multi-user storage.

Up to 255 VPU's can be tied together to form a massive multi-user network. Or, you can start with only a single VPU and easily expand your system as your processing needs become more sophisticated. But whether you start with one or one-hundred VPU's, you'll probably never outgrow your CompuStar. Unlike other systems, you configure the CompuStar the way *you* want it . . . connecting any combination of VPU's in a "daisy chain" fashion into the central disk system. And since each VPU has its own twin Z80 processors, its own CP/M\* operating system and a full 64K of internal memory, (not to mention disk capacities of up to 1½ million bytes), overall system response time remains unbelievably fast! And that's a claim most of the other multi-user vendors just can't make.

Inside our new CompuStar you'll find a level of design sophistication that's destined to establish a new standard for the industry. A series of easy-to-service modular components has been

engineered to yield the most impressive reliability figures we've ever seen. But CompuStar users are not only thrilled with our system's performance (and the miserly few dollars they spent to get it), they also have the peace of mind of knowing that Intertec's comprehensive customer protection and field service programs will insure their total after-the-sale satisfaction.

For more information on what just may be the last multi-user microcomputer you'll ever (have to) buy, ask your dealer today about our all new CompuStar™ system. Or, contact us at the number and address below. We'll gladly explain how we've made our best . . . even better!



2300 Broad River Rd. Columbia, SC 29210  
(803) 798-9100 TWX: 810-666-2115

# WE HAVE THE UNBELIEVABLE!!

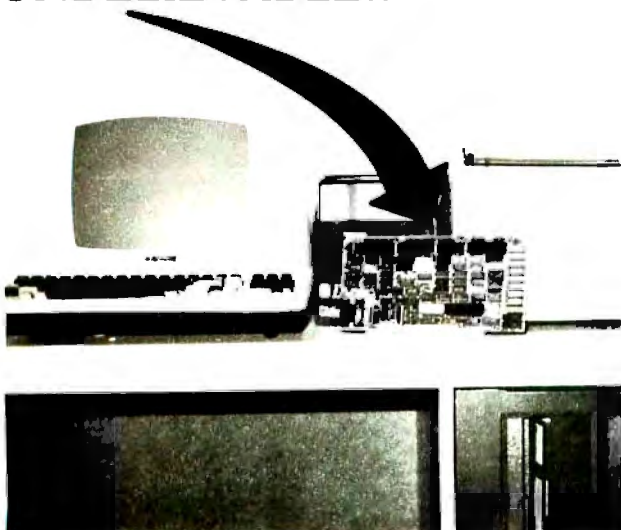

"This board is all it takes to build an S-100 Computer" for only \$875.00. It's called Super Quad™ It contains 64K of memory, Z-80A-CPU, Floppy Disk Controller, 2 Serial and Parallel I/O Ports.

**UNBELIEVABLE AS IT MAY SEEM,**

IT'S ALL ON A 5" x 10" S-100 BOARD AND MEETS IEEE 696.

Super Quad™ for 5 1/4" Disk .....	\$875.00
Super Quad™ for 8" Disk .....	875.00
Shugart Floppy Disk SA801R .....	450.00
Qume DataTrack-8 .....	550.00
10 Slot Enclosure with Power Supply .....	700.00
TV 912C Terminal .....	750.00
CPM 2.2 .....	150.00

™ - Trademark of Advanced Micro Digital Corporation

For more information contact:

- **MICRO SPOT ELECTRONICS**
- P.O. Box 772
- Westminster, CA 92683
- (714) 891-0382

\* ALL ORDERS ARE PRE-PAID. ADD \$5.00 FOR SHIPPING

## Editorial

tries from Epson and Apple (in the case of the latter, probably later this year).

### More Developments

The FORTH Interest Group and the Japan Microcomputer Club were two of the more interesting nonprofit groups displaying wares at the show. FORTH in particular seems to be thriving among computer devotees looking for an original (to say the least!) approach to language design.

Scott Kim entranced visitors at his booth by creating "inversions" of their names. Inversions are words that read the same right-side-up and upside-down or that exhibit other interesting symmetry features. (I highly recommend Scott's book, *Inversions*, published by BYTE Books. It is an example of brilliant visual pyrotechnics.)

Volkswriter promises to be one of the best IBM-based word processors yet, and the \$195 price is right too (see photo 6). It is a stand-alone program written in Microsoft Pascal (which compiles to 8088 machine language), so it is fast. Volkswriter is also highly integrated into the IBM Personal Computer; for example, it makes use of more than 64K bytes of memory and uses the IBM function keys. Volkswriter is available from Lifetree Software Inc. (177 Webster St., Suite 342, Monterey, CA 93940).

### Seven West Coast Faires Already?

It's hard to believe this was the seventh WCCF. It seems like only yesterday I attended the first one. Over the years the show has gone from a gathering of aficionados and slightly eccentric computer hackers to a major show attracting a wide range of people. I saw a lot more three-piece suits this year than in years past, but I still saw a comforting number of (now slightly aging) left-wing computer activists haunting the show. The microcomputer field manages to remain both egalitarian and vital at the same time. Quite a trick.

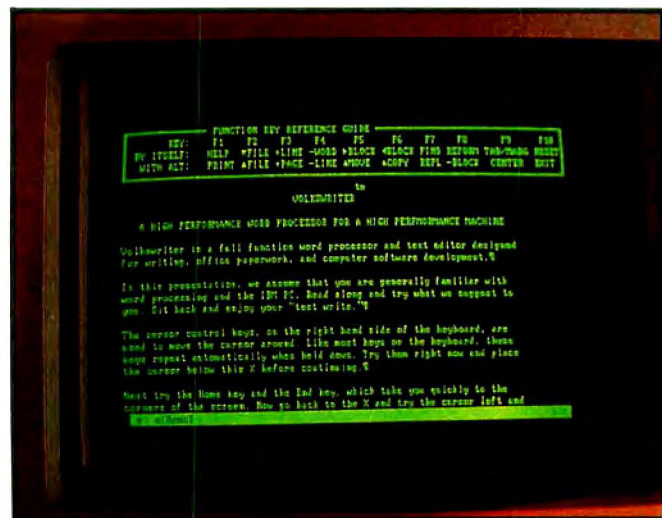

Photo 6: Volkswriter, an inexpensive word processor for the IBM Personal Computer.



# ENHANCE YOUR APPLE II® WITH MOUNTAIN COMPUTER PERIPHERALS



**Expansion Chassis \$750**

- Adds eight peripheral I/O slots.
- Independent power supply.
- Bank selectable.

**Model 1100A Intelligent Card Reader \$1,495**

- Automatic feeding, optical card reader
- Reads pencil marked or punched cards.
- Compatible with any RS232C computer.

**Mountain Computer,  
the Leader in Quality Apple Peripherals.**

**Available at your local  
computer store.**

All prices are suggested retail prices.

Apple and Apple II are trademarks of Apple Computer, Inc.  
Model 1100A, Expansion Chassis, CPS MultiFunction, Rampius+, The Clock,  
MusicSystem, A/D → D/A, Romplus+, RomWriter, and Supertalker SD20  
are trademarks of Mountain Computer, Inc.



**Mountain Computer**  
INCORPORATED

300 El Pueblo, Scotts Valley, CA 95066  
TWX: 910 598-4504 (408) 438-6550

Circle 326 on inquiry card.





Photo 7: DEC's new Professional 350 personal computer.

### New Computers from DEC

Digital Equipment Corporation (DEC) has introduced three new personal computers. They are being displayed at this month's National Computer Conference. The low-end model, called the Rainbow 100, is designed to compete with the IBM Personal Computer. Similar to the IBM in many ways, it features a dual processor board with Z80 and 8088 processors; CP/M8086 (part of the

new Softsense package that automatically picks the right processor to run either CP/M or CP/M-86 programs); MS-DOS operating system compatibility; two dual 5¼-inch floppy-disk drives with a total of 1.6 megabytes; a 12-inch display with 80 columns by 24 lines or 132 columns by 24 lines of characters; up to 256K bytes of RAM; a graphics/color option; and an optional color monitor. Prices for the Rainbow 100 start at approximately \$3000.

The second model, the DECmate II, is word-processing and business oriented. It features a 6120 processor (which uses the PDP-8 instruction set). Prices start at \$4000. The third model comes in two configurations: the Professional 325 and the Professional 350. Both feature DEC's F-11 processor and VAX-compatible files. The 350 also allows the user to add an optional 5-inch hard-disk drive. The Professional series starts at \$5000. A sophisticated combination telephone-management/voice-actuation system will be announced later this year. At a recent preview showing, we were impressed by the modular construction of the computers (modules snap out for easy replacement by users), the excellent color graphics, and the well-designed keyboards.

### News from Cromemco

Cromemco is introducing a new personal computer at the NCC. We've learned that it is a 64K-byte, Z80-based

# Systems II Ex™



**Westware**

**Software Inc.**

2455 S.W. 4th Ave.  
Ontario, OR 97914 • (503) 881-1477

## One Step Above The Competition

- General Ledger
- Payroll
- Inventory
- Accounts Receivable
- Accounts Payable
- Data Base

The **Systems II Ex** helps you gain complete financial control over your business by providing reports such as:

- Balance Sheets
- Aged Receivables
- Payroll
- Ledger Reports
- Inventory List
- Database Reports

It makes office operations more efficient by printing: **payroll checks, invoices, vendor file and statements.** The KSAM card provides fast online sorting capability, making the EX one of the fastest accounting systems available on the APPLE II.

available on CORVUS hard disk.

Optional Modules - Job Costing - Cycle Billing

Take a step above YOUR competition with the **Systems II Ex**

Source # TCK 757



APPLE II is a trademark of Apple Computer; CORVUS is a trademark of Corvus Systems; SYSTEMS II EX is a trademark of Westware, Inc.











**wabash** express

<p><b>5 1/4" \$199*</b></p> <p>SINGLE SIDE SINGLE DENSITY W/HUB RING</p> <p>SOFT, 10 OR 16 SECTORS</p> <p>100% CERTIFIED 2 YEAR WARRANTY</p>	<p><b>8" \$199*</b></p> <p>SINGLE SIDE SINGLE DENSITY</p> <p>SOFT OR 32 SECTORS</p> <p>100% CERTIFIED 2 YEAR WARRANTY</p>
<p><b>5 1/4" \$219*</b></p> <p>SINGLE SIDE DOUBLE DENSITY W/HUB RING</p> <p>SOFT, 10 OR 16 SECTORS</p> <p>100% CERTIFIED 2 YEAR WARRANTY</p>	<p><b>8" \$249*</b></p> <p>SINGLE SIDE DOUBLE DENSITY</p> <p>SOFT OR 32 SECTORS</p> <p>100% CERTIFIED 2 YEAR WARRANTY</p>
<p><b>5 1/4" \$299*</b></p> <p>DOUBLE SIDE DOUBLE DENSITY W/HUB RING</p> <p>SOFT, 10 OR 16 SECTORS</p> <p>100% CERTIFIED 2 YEAR WARRANTY</p>	<p><b>8" \$309*</b></p> <p>DOUBLE SIDE DOUBLE DENSITY</p> <p>SOFT OR 32 SECTORS</p> <p>100% CERTIFIED 2 YEAR WARRANTY</p>

\* Minimum order 100 • For smaller quantities: add 10%  
 • Packed 10 boxes of 10 diskettes with sleeves and labels  
 • Quantity discounts - 1,000 deduct 3%, 5,000 deduct 5%, 10,000 deduct 7%  
 • Add \$5.00 per case 5 1/4", \$7.00 per case 8"  
 For shipping and handling Continental U.S.A., U.P.S. ground.

<p><b>Free 10 Diskette - \$5*</b></p> <p>OPUS . . . . . ss/sd \$20 ss/sd \$21          BASF . . . . . ss/dd \$23 ss/sd \$24          MAXWELL } TOO LOW TO QUOTE CALL          OYSAN }</p> <p><small>SPECIFY SECTORING WHEN ORDERING 5 1/4" QUAD DENSITY IN STOCK</small></p>	<p><b>DISK DRIVE HEAD CLEANING KITS</b></p> <p>Prevent head scratches and ensure error-free operation</p> <p>5 1/4" or 8" . . . . . \$19.50</p> 
<p><b>HARDHOLE DISK PROTECTORS</b></p> <p>Reinforcing rings of tough mylar protect disk hole edge from damage.</p> <p>Applicators . . . . . \$3 \$4          Hardhole Rings (50) . . . . . \$6 \$8</p> 	<p><b>SFD C-10 CASSETTES . . . 10/87</b></p> <p>100 cassette (includes box and labels)</p> <p>Get 6 cassettes, C-10          Sonic, and Casette/8          Library-Album,          as illustrated,          for only -- \$8</p> 
<p><b>LIBRARY CASES</b></p> <p>8" Kas-sette/10 . . . . . \$2.99          5 1/4" Mini Kas-sette/10 . . . . . \$2.49</p> 	<p>5 1/4" or 8"</p> <p>Vinyl          Storage          Pages . . . . . 10/55</p>

• Written purchase orders accepted from government agencies and well rated firms at a 10% surcharge (wabash media only) for net 30 billing. • International orders accepted with a 15.00 surcharge for handling, plus shipping charges. • C.O.D. requires a 10% deposit. • We accept Visa, Mastercharge, Money Orders, and Certificate checks. • Checks require bank clearances. • All shipments F.D.B. San Diego. • Minimum shipping and handling 2.00, minimum order 10.00. • California residents all 6% sales tax. • Prices and terms subject to change without notice. • All sales subject to availability, acceptance, and verification. • All sales are final. • Satisfaction guaranteed or full refund.

We also offer printer ribbons, printwheels, type elements, equipment covers, power consoles, paper supplies, storage and filing equipment, furniture and many other accessories for word and data processing systems. Write for our free catalog.

Toll Free Order Only

**800-854-1555**

For Information  
or California Orders

**(714) 268-3537**

**ABM  
PRODUCTS**

8868 CLAIREMONT MESA BLVD.  
SAN DIEGO, CALIFORNIA 92123

**Editorial**

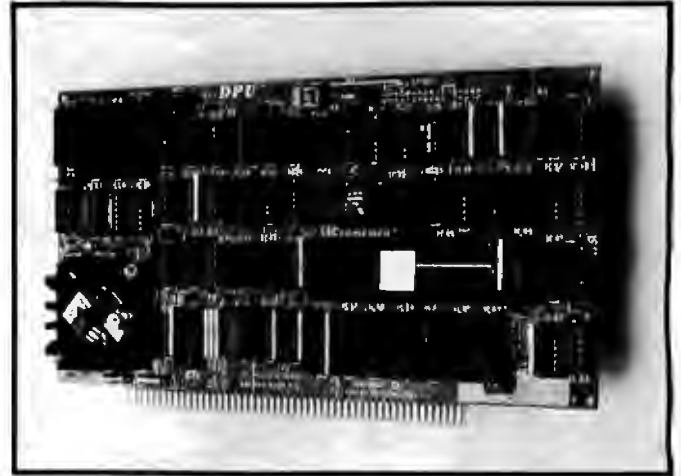

Photo 8: Cromemco's dual-processor unit combines a 68000 processor with a Z80A for easy expandability of existing microcomputer systems.

machine with a number of custom LSI (large-scale integration) chips. The custom circuits implement the built-in network interface and display. The computer has a detachable keyboard (individual keys may be redefinable) and a 25-line by 80-column green-phosphor display. It's priced under \$2000.

The network interface allows the computer to be used as a work station on Cromemco's recently announced C-NET, an Ethernet-like system employing an industrial-quality, shielded, twisted wire pair. It is broadband in nature, capable of carrying voice and video too. Cables are driven through isolation transformers by a differential transmitter/receiver, thus providing excellent noise immunity and immunity to single station failures. The C-NET protocol has full collision detection and CRC error detection, and data is transmitted at 880K bits per second. Stations may be as far apart as 2000 meters.

Cromemco is also showing its new 68000/Z80 DPU (dual-processor unit) at the NCC (see photo 8). The 68000 was chosen primarily because of its 32-bit architecture and its large (16-megabyte) addressing range. The two processors may be used in tandem, and the Z80 provides compatibility with existing software.

\* \* \*

**"Dum Volvo, Video Disco"**

Our theme this month is videodiscs. And few words sum up better the benefits of a videodisc coupled with a microcomputer than the Latin phrase *dum volvo, video disco*. It means "while I turn I see and learn." You'll see what I mean when you read our special theme-oriented articles this month. (I'm indebted to Bernie Greenberg, a polymath friend who lives in Cambridge, Massachusetts, for introducing me to that phrase.) Thanks go to Mark Dahmke, Dick Moberg, and Rod Daynes for their help in preparing this issue. ■



# Personal computers are full of promises. MBA makes them deliver.

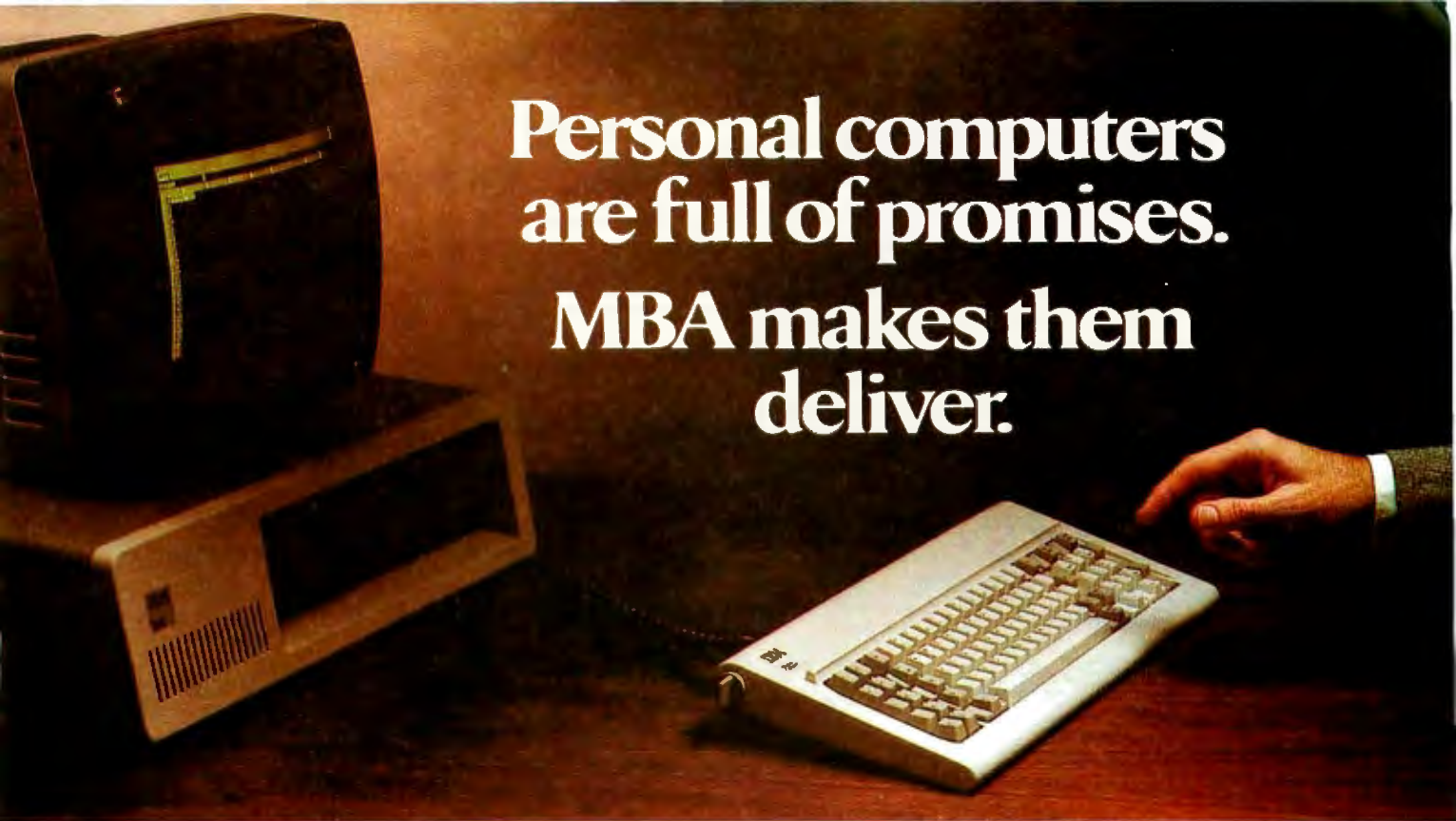

You've heard how the personal computer is going to revolutionize the way you work.

Sofar, the reality hasn't measured up to the promises.

But now there's a remarkable new software package that transforms the IBM Personal Computer into an incredibly powerful management tool (Apple and Xerox owners: read on).

## The first totally integrated management software.

There are a lot of useful programs available for personal computers.

Unfortunately, they all seem to use different commands and different ways of storing data. This creates two major problems:

1. Every time you want to add a new function, you have to learn a whole new command language.
2. You may not be able to exchange data between different programs.

But now there's a better way. It's called the MBA, and it was created by a blue-chip management consultant, an MIT-trained systems designer, and some of the country's most experienced business programmers.

For the first time, MBA combines all the essential management functions in one easy-to-use package:

**Electronic Spreadsheet.** The ultimate financial modeling tool that lets you create a giant spreadsheet of figures and text. Change one number, and every affected item is instantly re-calculated.

**Word Processing.** Compose, edit, and print any kind of document. Make revisions yourself—faster than you can explain them to your secretary. Because MBA is an *integrated* system, it's easy to incorporate data from its other modules into a report you're writing.

**Data Management.** A sophisticated electronic filing system that lets you store information—ANY information—then retrieve it, analyze it, and generate reports to your specifications.

**Graphic Output.** For those occasions when a picture tells your story better than words, you can easily generate clear, readable graphs.

**Communications.** Tie into your company data center, a financial information service, or virtually any other computer system. MBA automatically retrieves the information you want, and lets you edit or rearrange it with a few keystrokes.

## Easy to learn. Easy to use.

MBA's designers devoted great care to giving it a simple, consistent set of commands. So when you've learned one module, you'll immediately be comfortable with the others.

## What, where, and how.

MBA is offered through selected computer retailers who have qualified people to demonstrate and answer questions.

It runs on the IBM Personal Computer, with Xerox and Apple versions available soon. But whichever machine you use, MBA will make a dramatic improvement in your personal productivity.

And that's a promise.



## Context Management Systems, Inc.

Management software for personal computers.

23864 Hawthorne Blvd., Suite 101  
Torrance, California 90505  
(213) 378-8277

© Copyright 1982 Context Management Systems, Inc.



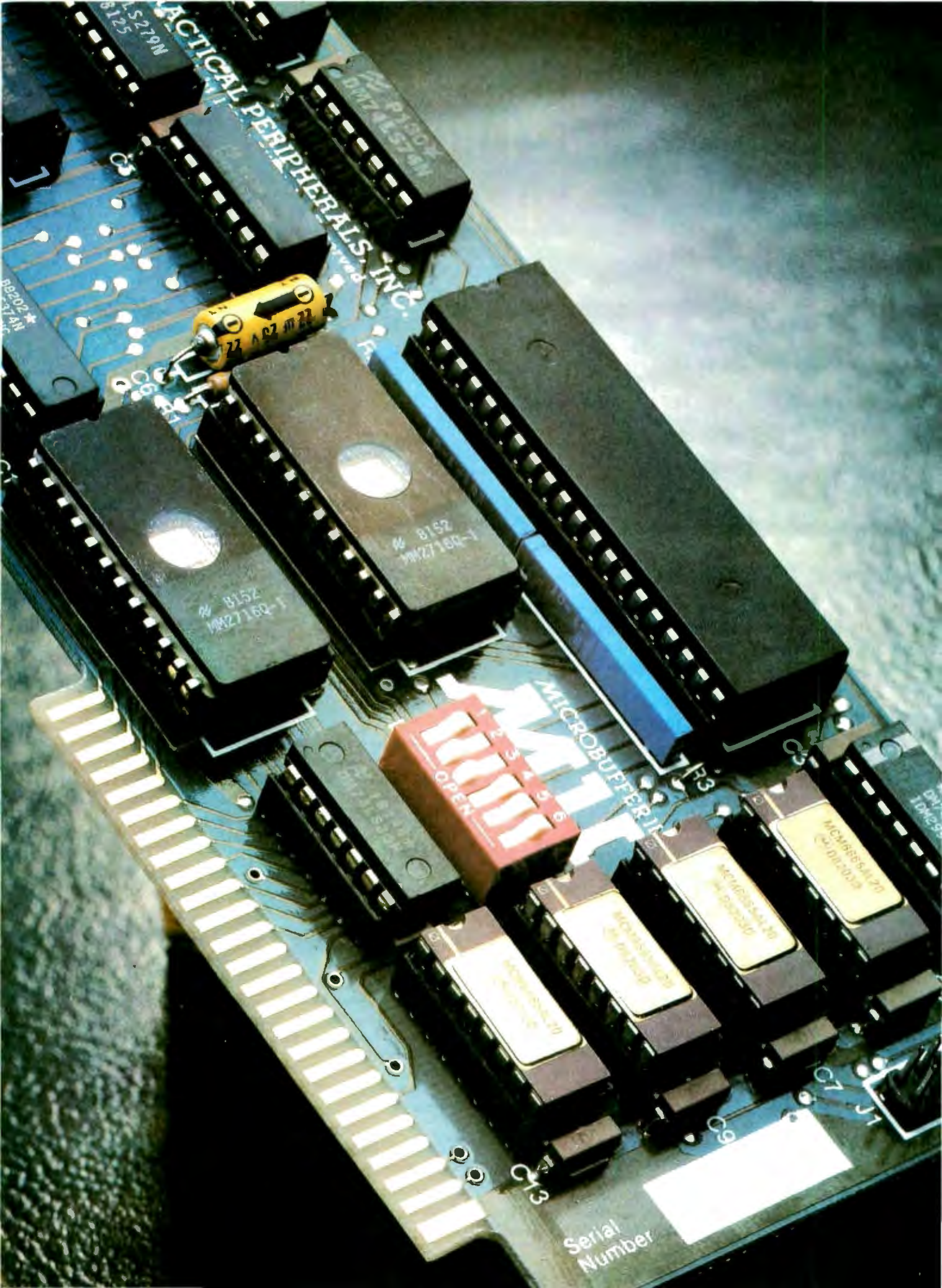

FACTICAL PERIPHERALS, INC.

8125  
S-279N

8120X  
MR27157AN

# 8152  
MR2718Q-1

# 8152  
MR2718Q-1

MICROBUFFER II

1 2 3 4 5 6  
OPEN

MCM8654A20  
C-0102012

MCM8654A20  
C-0102012

MCM8654A20  
C-0102012

MCM8654A20  
C-0102012

Serial Number

8202\*  
37AN

C6  
47

C3

F3

C7

J1

C13

C6



# INTRODUCING MICROBUFFER.

## NOW YOU CAN USE YOUR PRINTER WITHOUT WASTING COMPUTER TIME.

Your computer is capable of sending data at thousands of characters per second. But the average printer goes no faster than 80 characters per second.

This means your computer is forced to wait for the printer to finish one line before it can send the next.

A waste of valuable time.

### **THE NEW MICROBUFFER™ INCREASES YOUR EFFICIENCY.**

Microbuffer allows you to print and process simultaneously. No waiting!

### **MICROBUFFER ACCEPTS PRINTING DATA AS FAST AS YOUR COMPUTER CAN SEND IT.**

Microbuffer first stores the data in its own memory buffer and then takes control of your printer. This frees the computer for more productive functions.

Additional output may be dumped to the buffer at any time and it will be printed in turn.

Microbuffer — a must for any program that requires printed output.

### **PARALLEL, SERIAL OR APPLE II.**

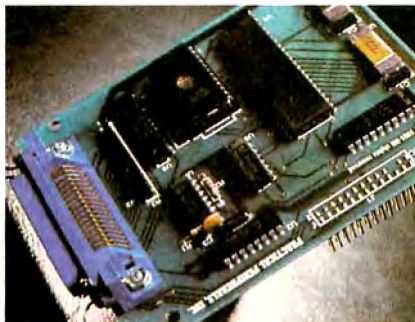

MICROBUFFER MODEL MBP-16K™ is a Centronics-compatible parallel interface for your Epson printer with 16,384 bytes of on-board RAM for data buffering.

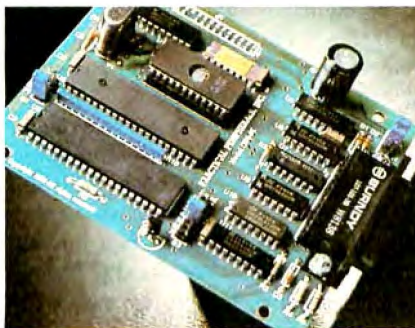

MODEL MBS-8K™ is a full-featured RS-232C serial interface for your Epson printer with both hardware and software (x-on/x-off) handshaking, baud rates from 300 to 19,200 and a 8,192-byte RAM buffer.

MICROBUFFER II™ (pictured on the left-hand page) is a Centronics-compatible parallel interface for the Apple II computer with up to 32K of on-board RAM for data buffering as well as on-board firmware for text formatting and advanced graphics dump routines.

### **SIMPLE TO INSTALL.**

Microbuffer MBP-16K and MBS-8K mount easily in the existing auxiliary slot directly inside the Epson printer.

Microbuffer II, being slot-independent, will fit into any slot directly inside the Apple except zero.

### **MICROBUFFER FROM PRACTICAL PERIPHERALS.**

When you think of how much time Microbuffer will save, can you afford *not* to have one?

PRACTICAL PERIPHERALS, INC.  
31245 LA BAYA DRIVE  
WESTLAKE VILLAGE, CA 91362  
(213) 991-8200

Circle 368 on Inquiry card.

## Outsailing the Software Pirates

In the old days, sailing ships had problems with pirates. Two great nations used opposite solutions to reduce the piracy. Spain increased the cannon and armor on its ships. This increased the cost and the weight of the vessels, which slowed them down and made them less desirable as shipping vehicles. England did the opposite. It lightly armed its small, inexpensive ships, thus making them lighter and faster than the Spanish ships. They were better at their intended purpose—to trade and deliver cargo quickly. History has shown us that England won, not because it avoided pirates better than Spain, but because it did not let pirates get in the way of good business—in this case efficient shipping.

This bit of historical fact has great import in the software piracy problem of today. Many software companies are spending too much time and money trying to defend themselves against pirates. They reduce, if not ruin, the usefulness of their products with locked disks, unlistable programs, secret source code, hidden locks, codes in ROM chips, full-page advertisements devoted to discouraging pirates (e.g., Atari), and so forth. These devices have made many programs inefficient and costly to produce and support. Buyers are greatly taxed because they cannot make modifications or backup copies of the programs they have purchased. Often they are inconvenienced by added expenses for backups or future modifications. This hurts sales and angers good customers.

There is a better way, as exemplified by our company, Andent Inc. We produce Apple II software for health professionals (medical and dental systems, appointments, hypnosis, and so on). We have been in business since 1978, which makes us one of the oldest software houses for microcomputers. We are making a profit and always have. We pay our bills and our programmers on time. All our software is unlocked and can be copied for backup purposes. We support all sales by offering free replacement of damaged disks. All our software is listable and can be modified by the user.

We do business in this way because it pays. It pays us, and it pays our

customers for buying our software. Because our software is unlocked, customers have little or no trouble with backups (you make your own); updates (we mail out a letter with changes); expensive phone calls (documentation and listings tell you how to make program modifications); disk recalls; changes in DOS; printer-slot and special-character problems; or equipment incompatibility due to unusual interfaces, old computer models, and so forth.

Our customers like this. They are buying a program, not a software lease. They have immediate support because changes and problems can be handled over the phone or by letter. Customers can backup programs immediately and as many times as needed. They like our low prices. Unlocked software is good for business—our business, your business, and the customer's business.

But what about pirates? Large-scale pirates, those enterprising souls who copy our programs and sell them worldwide, are discovered and given an option to become our dealers and pay us a royalty on distributed software or meet us in court. As in the old sailing days, reformed pirates (privateers) make the best dealers and we don't mind sharing the wealth. For those who don't want to cooperate, we look to history for the remedy. The English and Spanish both learned that a few executions were good for the morale of the troops. Small-time pirates, the sort who give program copies to their friends, can be controlled by low program cost, registration, and continuing updates and documentation. It just doesn't pay to get our programs secondhand.

Andent Inc. believes that a sale of software is just that—the sale of programs, listings, source code, and backup capability—a complete sale. Our customers do not buy a disguised lease—they buy and own our products. We do this because locking programs is very expensive and time consuming and hurts sales.

It is time for the industry to realize that, as with the sailing ships of old, our prime business is producing and distributing a product, not fighting pirates.

**E. J. Neiburger, President**  
**Andent Inc.**  
1000 North Ave.  
Waukegan, IL 60085

In conjunction with the release of The Graphics Magician and the updated Complete Graphics System II, Penguin Software is announcing a new policy with our applications software for the Apple. The Complete Graphics System II, Special Effects, and The Graphics Magician will all be available now on nonprotected disks.

We've been torn between two points of view. As computer users, we appreciate the ability to have several working copies of our applications software and the ability to go in and modify the code, if desired. We'd use programs such as Visicalc or DB Master for dozens of other applications if we could have them running off several separate disks and didn't have to guard our master copies with such extreme care. Being programmers also, occasionally we'd like to adapt a program slightly to fit our systems' needs or our personal needs. On locked disks, much of a software product's potential goes untapped.

On the other hand, as publishers we've been drawn into the prevailing point of view that lack of copy protection means greatly decreased sales due to casual piracy. This is not just a crazed overreaction; we've all been to user-group meetings, homes of acquaintances, and even some computer stores where we've been aghast at the almost encouraging attitude toward reproducing copyrighted software, most of which took authors months, maybe years, to perfect. The real scare here is that many of us have decided to take a risk on a very new industry and trust our livelihoods to it. Suddenly, individuals out there become statistics, some of which say that for every nonprotected program sold, there are least a dozen pirated copies. Those numbers indicate a cut in sales that could really play havoc with the software producer's ability to pay the bills. Scary? Yes.

From these conflicting points of view, our desire to make a good product better won (but not by much) over our fear of tampering with something that is already going well. Our policies, from pricing to support, have always been very consumer-oriented. Ultimately, it is from that viewpoint that we decided to go ahead with removing the program protection. We feel that you, the consumer, are entitled to software as useful as possible for the money you spend. Our hope is that the added convenience will result in more



# It's the best part of any Apple.



**Your Apple computer can grow from ordinary to awesome in a matter of minutes.**

The Elite disk drive Series by Rana Systems gives you that kind of magic. Quickly, easily and cost-effectively.

This superb family of sophisticated floppy drives was designed and perfected by a team of industry-respected engineers expressly for Apple® computer owners who have long been demanding more disk drive for their money.

Now they have a drive that makes an Apple perform the way it should. For example;

Elite One, the most economical Rana drive, delivers 15% more storage capacity than Apple's drive. The top-of-the-line Elite Three will provide an astonishing *four-times* more storage,

approaching hard disk performance. It's done through exclusive high-density single and double-sided disks and heads.

**Here's a tantalizing taste of just how formidable your Apple can become.**

Next to enormously increased disk space, Apple buyers are most excited about Rana's fingertip Write/Protect feature. A pushbutton on the LED-lit panel gives you a new measure of failsafe control.

While Elite drives are all plug-compatible with Apple's controller, Rana's vastly superior controller card is a *must* for those with growing data processing demands. With it, you control up to *four* floppy drives using only one slot. . . while still utilizing your

Apple computer to achieve dramatic new heights of system flexibility and processing power.

A specially programmed Rana utility disk assures you of far-reaching compatibility, and extra dimensions of business, leisure and learning applications with your Rana-enhanced Apple computer.

There are many, many more operating refinements: Uncanny head-positioning accuracy, 300% faster track-to-track speed, better operating economy, and gentler clamping action through an all-new diskette centering cone, to name just a few.

A disk drive package like this doesn't grow on trees, so write or call today for more information about the Elite Series.

## RanaSystems



20620 South Leapwood Avenue, Carson, CA 90746 213-538-2353. For dealer information call toll free: 1-800-421-2207. In California only call: 1-800-262-1221. Source Number TCT-654.  
Apple is a registered trademark of Apple Computer Inc.

Circle 387 on inquiry card.



The Only Complete Document Proofreading System  
From Aspen Software  
For CP/M, TRS-80 and IBM-PC Word Processors

## PROOFREADER™

Featuring Official Version of Random House Dictionary

- Complete Accuracy—looks up every word; does not use less accurate root word analysis
- + • Full interactive Correction—standard (optional of TRS-80 Model I/III)
- Instant Access to Dictionary
- Compact—Random House Dictionary supplied in sizes to fit your system (50,000 words standard)

## GRAMMATIK™

Beyond Spelling Checking

- Detects typos, punctuation and capitalization errors, misused words and phrases
- Analyzes Poor Writing Styles
- Suggest Alternative Usages

## = NO ERRORS

*"The programs together (Proofreader and Grammatik) offer a dynamic tool for comprehensive editing beyond spelling corrections."*

--Dona Z. Meilach in Interface Age, 5/82

*"Grammatik is the perfect complement to a spelling check program."*

--Dr. Alan R. Miller in Interface Age, 5/82

*"If you use a word processor and a spelling checker, then you should investigate the unique capabilities of this program. Grammatik is a surprisingly fast and easy tool for analyzing writing style and punctuation."*

--Bob Louden in InforWord, 12/81

*"For the user who is a tight with his dollar as I, Proofreader is the program of choice."*

--Stephen Kimmel in Creative Computing, 3/82

Aspen Software also has its own full featured word processor called Writer's Companion for all these systems. One of the best implementations of Ratfor (Rational Fortran) is available, too, along with an automatic Ratfor pretty printer. Please call or write for more details about these products.

Grammatik and Proofreader are compatible with all CP/M, MS-DOS (incl. IBM MPC), and TRS-80 word processors. Current CP/M formats: standard 8", Northstar, Omikron, Osborne, Apple. Please call or write for details of minimum system sizes and availability of additional disk and operating system formats. Shipping costs included. Please specify your system configuration when ordering. Dealer inquiries invited.

	Proofreader	Grammatik
CP/M, MS-DOS	\$129.00	\$150.00
TRS-80 Model II	\$99.00	\$99.00
TRS-80 Mod. I/III	\$59.00	\$59.00
Model I/III interactive correction option - \$30.00		

Random House is a registered trademark of Random House, Inc. Other registered trademarks: CP/M: Digital Research; TRS-80: Tandy Corp., MS-DOS: Microsoft; IBM: IBM; Proofreader, Grammatik: Aspen Software Co.

**Aspen Software Co.**

P.O. Box 339-B Tijeras, NM 87059  
(505) 281-1634



## Letters

sales, not less, and that the software market has matured to the point where people realize that the result of illegal copying is less convenience for everyone. We hope that people will think twice before accepting copies from friends, and we hope to be able to continue this policy and start a new trend toward improved usability of all applications software. Please don't abuse our trust in you.

**Mark Pelczarski, President**  
**Penguin Software**  
**830 4th Ave.**  
**Geneva, IL 60134**

*Someone once made the point that many of the positive connotations of "software piracy" disappear when you call it, simply, "stealing." Copying software that you have not paid for is stealing, not adventurous pirating (yo-ho-ho), and I think that few of us will actually make that illegal copy if this thought is in our minds. (Please note that I am saying nothing against making backup copies of disks that we have paid for.) The decision made by Mr. Neiburger's and Mr. Pelczarski's companies is indeed a brave one, one that has been called for by no less a person than Mike Markkula, president of Apple Computer Inc. We at BYTE applaud this decision, encourage more vendors to do the same, and stress the necessity of all consumers to refuse to copy or accept software they have not paid for. . . . G. W.*

## Of Paperbacks and Program Protection

I continue to read with interest the controversy over program protection. I haven't seen much awareness that this is not a new problem nor a problem unique to the computer industry. Like the similar problems that occurred in the book industry with the advent of the copier and in the record industry with the advent of relatively low-cost, high-quality home music taping, I am sure this one will work its way to resolution.

Certainly I believe that the cost of most computer programs is too high for the personal computer user. I am one, and my case is typical: I had my computer for almost a year before I could justify purchasing a commercial program. While I'm very pleased with the product, I'm simply not about to pay over \$100 apiece for many programs.

The problem right now is volume. I can

appreciate how much work goes into a really high-quality program, and I believe the author should be fairly compensated. But software producers should consider that 10,000 copies sold at \$20 per copy will return him almost the same amount as 1000 copies at \$200 per copy. A high volume of sales explains why the book industry now loves rather than hates low-cost paperback books. With the growing number of computers out there, the demand for programs will grow. The competition will also grow as all those computer owners take a fling at writing a commercial program so they can write off their computers at tax time.

With a little patience on the part of software vendors, the problem will resolve itself. In a few years, programs will be as available as paperback books and priced as reasonably. People will buy them rather than copy them because copying won't be worth the trouble.

**L. P. Leach**  
**2250 Woodruff**  
**Idaho Falls, ID 83401**

## Let the Buyer Beware

Congratulations on Gregg Williams' very informative article, "A Closer Look at the IBM Personal Computer" (January 1982 BYTE, page 36). It certainly makes this machine appear very attractive, despite the minor product-availability problems mentioned in the article (many of which have since been answered by advertisements in BYTE).

I would like to make a few comments about IBM's product-identification and pricing policies—questions I feel Mr. Williams could have addressed more completely in his article. The first concerns the IBM matrix printer. In photo 1 this item appears very similar to the Epson MX-80, a suspicion which has since been confirmed by a local IBM Personal Computer dealer. The article might have mentioned that the Epson printer is available from various retail and mail-order dealers for savings of \$100 to almost \$300, and that the only difference between the Epson and IBM variations is the case color. IBM tacitly admits to the interchangeability of the units by marketing its printer cable separately.

I have a similar, though presently unconfirmed, suspicion concerning the IBM floppy-disk drive. Inspection of this



# PICK A WINNER

**Be Picky. Get Economy, Quality, Flexibility and Compatibility from Board Level Products to Complete Multi-User Computer Systems.**



**1 Bank Selectable S-100 128K Memory.** Systems Group's new 128K dynamic memory board has eight independent 16K software selectable memory banks, each addressable on any 16K boundary. It's jumper selectable so you're not PROM locked in to any one configuration. And with more advanced features, it's the most flexible in the industry.



**2 Fully Compatible — S-100 Boards.** Use any of Systems Group's bank select memory boards for Alpha Micro, Cromemco/CROMIX, Dynabyte, North Star, MP/M, OASIS and most other S-100 systems. Other high quality S-100 microcomputer boards include the newest high performance single and multi-user Z80 CPU board with up to 4 serial I/O's, floppy and hard disk controllers with Super CP/M and much more. All fully burned in and tested.



**3 Eight-Inch Add-On Floppy Disk, Hard Disk, and Tape Drive Subsystems.** This series was created to provide a full range of mass storage products to complement the System 2800 computers. The subsystems also offer universal systems expansion to the users of other S-100 systems.



**4 Series 2800 Business Computers.** Systems Group offers a choice of expandable systems with dual floppies (up to 2.4M Bytes) or hard disk (up to 40M Bytes) w/ floppy (1.2M Bytes) or tape (20M Bytes) for back-up.



**5 Expandability.** Add-on memory, I/O and drive subsystems means never being trapped into systems without flexibility. With Systems Group's reliable designs you can add more floppy and hard disk drives or tape back-up for increasing mass storage requirements. Add more memory and I/O for up to 12 independent users per system. Choose from Super CP/M, MP/M II, or OASIS operating systems.

Come to Systems Group for any of your microcomputer needs. Everything from our new 128K Memory Board to complete systems. We're helping make computers what they should have been in the first place.

All Systems Group's products are warranted for one year. Ask about our 30 day dealer/OEM evaluation policy.

CP/M and MP/M are Registered Trademarks of Digital Research. OASIS is a Trademark of Phase One Systems, Inc.

## Systems Group

A Division of MEASUREMENT systems & controls incorporated  
1601 Orangewood Avenue  
Orange, California 92668. (714) 633-4460  
TWX/TELEX 910 593 1350 SYSTEMGRP ORGE



# Turn your TV into a time-sharing videotex display for \$399.\*

Now you can connect your family to the informative and entertaining world of CompuServe, The Source, Dow Jones News/Retrieval and other time-sharing and data-base networks.

All you need is the RCA VP-3501 Videotex Data Terminal (with built-in modem and RF modulator), your telephone and your TV set. You can get instant access to regional newspapers and newsletters...weather reports and sports results...computer games and more. You can use the VP-3501 to make airline reservations...find restaurant recommendations in cities around the world. Plus stock market and corporate data. Or access your school or business computer. You can even send electronic mail and buy products.

In addition to information retrieval, the VP-3501 provides full interactive communications with a host computer. What you have working for you is a versatile, feature-packed interactive data terminal which can be worth far more to you than its low price. Its unique color-locking circuitry gives you sharp color graphics and rainbow-free characters. You get 20- and 40- character formats in one of eight foreground colors and separate color backgrounds.

With reverse video, you can emphasize certain letters, words, or sentences. A built-in tone generator...plus a white noise generator...let you create everything from the sound of explosions to the sound of music. The spill-proof, easy-to-clean keyboard is highly suitable for hostile environments. And its membrane key switches give you a natural feel.

The VP-3501 is truly a fine Videotex Data Terminal. And don't forget, it's made by RCA...the first name in television...now the foremost name in videotex terminals.

See a demonstration at your computer or electronics dealer, or contact RCA. Order now and you'll get a free password and a free hour's time-sharing on both CompuServe and Dow Jones News/Retrieval! (Limited time offer.)

For more information or to order, call toll-free, 800-233-0094. (In Pennsylvania, call 717-393-0446.) Visa or MasterCard orders accepted by phone. Or send a check including \$3.00 delivery charge plus your local sales tax to RCA MicroComputer Products, New Holland Avenue, Lancaster, PA 17604.

*\*Suggested User Price*

# PRIME TIME-SHARING



## Letters

item (see, for example, the IBM advertisement in the February 1982 BYTE, pages 24 and 25) suggests that this drive is component-for-component identical to the Tandon 100-1 5¼-inch drive currently available from various suppliers for approximately half the IBM drive's price. The IBM Personal Computer *Technical Reference* manual should clear up this question (I'm presently awaiting the arrival of my copy), but a recent advertisement from VR Data Corporation (February 1982 BYTE, page 181) suggests that these drives are indeed equivalent. Of course, one is still left wondering whether installing such drives would void the warranty.

In both these examples the IBM "unbundling" practice referred to in Mr. Williams's article may serve the knowledgeable buyer almost as well as it does IBM—buyers aren't restricted to purchasing the peripherals from IBM because the interface cards (and the printer cable) are available separately. Though I suppose it's a case of *caveat emptor*, I think readers of the article would have been better served if at least the printer question had been addressed.

As Mr. Williams said in the article, the IBM pricing strategy may easily become a source of hard feelings among users down the road. The present IBM policy of offering 40 percent discounts to its employees (see "BYTELINES," February 1982 BYTE, page 328) makes the company's high prices particularly questionable because one doubts if IBM is so altruistic that it will take a loss on these sales.

I've been an avid reader of your magazine since 1978, and I don't feel that these complaints imply a lower quality or objectivity in Mr. Williams's article as compared to that of any of the similar, excellent product reviews BYTE has previously published. I am disappointed, however, in IBM's apparent attempt to gouge its customers, because the typical buyer often approaches buying a system in terms of "how much can I get for \$3000?" and will spend any money left over on more hardware or software from the same source. At least that's the case with me, and I'm still interested in the IBM Personal Computer (especially if I can buy and install Tandon drives in my system and still get service from IBM).

Louis C. Kovacs  
RR 2, Box 30  
White Plains, MD 20695

Circle 388 on inquiry card.





# A simple fact:

The considerable benefits of a personal computer like the Osborne 1® are often intangible, often exciting, and always expanding.

The value of the Osborne 1 is clear and simple:

**\$1795. Complete.**

## **\$1795 includes this hardware:**

- Z80A™ CPU with 64K RAM
- Dual floppy disk drives with 100K bytes storage each
- 5" CRT
- Business keyboard with numeric keypad and cursor keys
- RS-232C Interface
- IEEE 488 Interface
- Weather-resistant, portable housing
- Operates on European and American voltages

Trademarks: Z80: Zilog Corporation SUPERCALC: Sorcim Corporation WORDSTAR: MicroPro International Corporation of San Rafael, California, U.S.A.

Registered Trademarks: OSBORNE I: Osborne Computer Corporation CP/M: Digital Research MBASIC: Microsoft CBASIC: Complier Systems, Inc. MAILMERGE: MicroPro International Corporation of San Rafael, California, U.S.A.

## **\$1795 includes this software:**

- CP/M® Operating System
- WORDSTAR™ word processing with MAILMERGE®
- SUPERCALC™ electronic spreadsheet
- CBASIC®
- MBASIC®



# OSBORNE

SEE US AT NCC BOOTH #5710 AND COMDEX BOOTH #1860.

**The Price Is Right**

Was I the only new CP/M user with a Z80 processor who was surprised (not to say annoyed) to learn that I could not assemble Z80 code with the CP/M assembler? I immediately searched for a Z80 assembler, but I was astonished at the prices for such a basic utility (e.g., \$162 for Macro 80 from Microsoft).

I have now discovered a small company with just the Z80 assembler I wanted at the price I wanted to pay, and I think other BYTE readers might like to know about it. The company is Software Toolworks (14478 Glorietta Drive, Sherman Oaks, CA 91423), and someone there patiently answered my questions on the phone and then shipped my order very promptly. The product is the utility UV-MAC, a macro assembler for the Z80, and it costs \$29.95. It's fast and has macro definitions and all the options most of us will ever need. Also included is an even faster stripped-down assembler (AS) with no macros. Altogether, it's a really fine package.

The Software Toolworks offers other software (languages, utilities, games, and editors) all in the \$24 to \$39 range. This could be the beginning of the end of outlandish software prices! I recommend the company highly.

**Dr. David L. DuPuy, Associate Professor**  
**Department of Astronomy**  
**Saint Mary's University**  
**Halifax, Nova Scotia**  
**B3H 3C3 Canada**

**In Praise of Elegance**

After debugging my typing, I feel Edward Heyman's FIT program ("FIT—A Federal Income Tax Program in UCSD Pascal," February 1982 BYTE, page 148) is one of the best ever to appear in a magazine and is a masterpiece tutorial on the elegance of Pascal. Christopher Morgan, the editor of BYTE, deserves commendation for recognizing the merit of the program and for devoting pages in

his very popular magazine to the publication of the source code.

The program as published for calendar-year 1980 really works. In only a few minutes, I entered all the figures from my 1980 tax return and got a result which agreed with my hand calculations to the penny (no mean feat). That in itself justified the two rainy days I spent typing in the 1328 lines of source code for the main program. The auxiliary programs involved a fair amount of typing, but they were much easier than the main program.

Even more important than its being a working program is its excellence in illustrating the versatility and beauty of Pascal. It covers formatting, linked lists, extended precision using strings, files, data types, elegant algorithms, etc. I shall be studying it for months as a sophisticated use of the language and as a tutorial. It will, of course, have to be modified for 1981, but the beauty of the program and its lucidity is such that anyone with even a conversant knowledge of the language will be able to modify it.

I recently purchased a text which purported to be a guide to Pascal for engineers. It totally ignored the subtleties of the language and made no bones about it. All it aimed to do was translate old BASIC or FORTRAN programs to Pascal, totally ignoring the major intent and purpose of Pascal. Instead of "think Pascal," the attitude was "think FORTRAN and translate to Pascal."

Anyway, Mr. Heyman's kindness in contributing an article with professional merit if not, perhaps, marketability, is much appreciated by those whose main interest is computer languages.

**Albert Weinschelbaum, M. D.**  
**9 Merrimac Court**  
**Danville, CA 94526**

**Go To  
The Head Of  
Your Class**



**Polish off your Apple™ with a disk drive from A.M. Electronics!**

Now there is an affordable, high performance, 5¼-inch disk drive that is fully compatible with your Apple — and compatible with your pocketbook.

The A.M. Electronics drive comes complete with an Apple-beige case and connecting cables. It's fully tested with Apple's disk operating system and software.

Just plug it in — it's ready to run.

You also receive a 90-day limited warranty and a 10-day money back guarantee.

**Order Today.** The Apple-compatible disk drive is now available direct from A.M. Electronics for only \$395 (40 track) or \$495 (80 track). Upgrade your Apple with our disk drive today and increase the fruit of your labor.

**AM**  
**A.M. ELECTRONICS, INC.**  
3446 Washtenaw Avenue • Ann Arbor, MI 48104  
 313/973-2312

©Apple Computer, Inc.

**Attention Dealers & Distributors:** For information on attractive pricing and sales opportunities, call us today. Key territories are still available.

**Simplifying Apple PIAs**

I have been homebrewing with 6800-series devices for several years now, and I have some comments on Kenneth J. Ciszewski's fine hardware article "Add a Peripheral Interface Adapter to Your Apple II" (January 1982 BYTE, page 324). While the circuits in figures 1 and 3 of the article will work for interfacing a 6520 PIA (peripheral interface adapter) to the Apple, the 74LS04 chip could be eliminated from both circuits. In both figures,



# And The Winner Is... IBC By Four Users!



When you are racing toward that finish line, beating the competition is everything. IBC is the choice of OEM's, system integrators and dealers throughout the world, because in benchmark after benchmark our small business computer systems finish first.

We finish first because we are faster, offer higher quality peripherals and can expand our system significantly beyond our nearest competitors. In fact, looking at the chart below, you can quickly see why knowledgeable resellers are choosing IBC.



Circle 220 on Inquiry card.

Join us in the winners circle with high performance equipment and the best dealer plan in the industry. Call or write:

	<b>IBC</b>	<b>ONYX</b>	<b>ALTOX</b>
Oasis Operating System (Max. Users)	9	5	4
CPU Speed (MHz)	6	4	3
Disk Speed I/O (MB/Sec.)	.81	.65	.54
Seek (Milli Sec.)	35	50	65
Cache Disk Memory	Yes	No	No

OUTSIDE THE USA  
**IBC** / Integrated Business Computers  
 21592 Marilla Street  
 Chatsworth, CA 91311  
 (213) 882-9007 TELEX NO. 215349

WITHIN THE USA  
**IBC** / DISTRIBUTION  
 4185 Harrison Blvd., Suite 301  
 Ogden, UTAH 84403  
 (801) 621-2294



the CS0 and CS1 inputs of the PIA can be tied directly to +5 volts. In figure 1, the active-low CS2 input can be ungrounded and connected directly to the active-low Device Select line. In figure 3, the CS2s will stay connected to the 74LS42 decoder as indicated. Pin 12 (D) of the 74LS42 can be ungrounded and connected to the Device Select line, eliminating the 74LS04 again.

The only other thing I note is that the CA1, CA2, CB1, and CB2 lines from the PIA are shown tied to +5 volts through 1000-ohm resistors. These lines can be very handy to use as handshaking signals, especially with a Centronics-compatible printer interface. The CA2 (or CB2) is used to send a Data Ready signal to the printer, while the CA1 (or CB1) is used to receive a Data Accepted signal from the printer. The states of these lines are set and read through the control registers in the PIA under software control.

Randy L. Kron  
Route 2  
Kalona, IA 52247

**Cruel but Fair**

In Robert Moskowitz's review, "Missile Defense vs. ABM" (December 1981 BYTE, page 80), the author regrets that Muse Software's ABM did not restore cities and that in On-Line Systems' Missile Defense the enemy continued to destroy cities after the defender ran out of ammunition.

I agree that these features are unsportsmanlike and may make the game less fun, but they are, if nothing else, very realistic.

R. S. Peterson, Commander, USN  
1116 Davidson Rd., Apt. 133  
Nashville, TN 37205

**Algorithmic Roots**

I enjoyed David R. Borger's letter (see "Faster Algorithms," February 1982 BYTE, page 18) describing a fast method for shuffling cards, and I can provide a source for this algorithm. It can be found

in *Combinatorial Algorithms*, Second Edition, Albert Nijenhuis and Herbert S. Wilf (Academic Press, 1978). This book contains program listings and extended discussions of many related algorithms of potential interest to BYTE readers.

Dave Bayer  
33 Cherry St.  
Somerville, MA 02144

**Seeking Fellow Explorers**

I am interested in joining a users group catering to Netronics Explorer 85 owners. Can you or any of your readers put me in touch with one? If there is none, I would like to hear from anyone out there interested in forming one.

Clarence Heier  
3430 93rd St.  
Sturtevant, WI 53177

**Now available from your computer store—  
the whole line of AJ couplers and modems.**

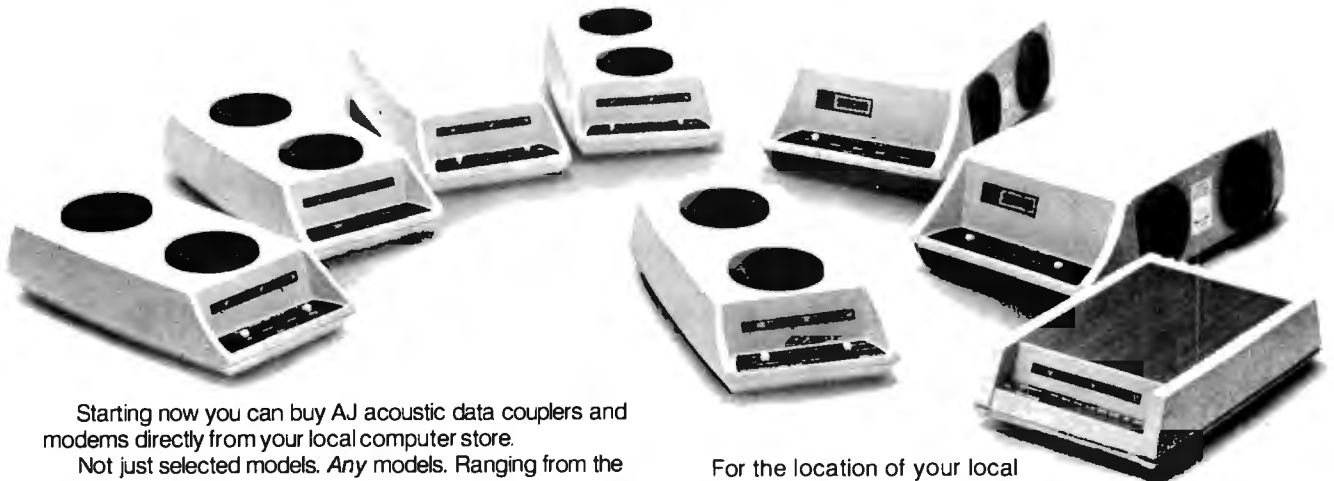

Starting now you can buy AJ acoustic data couplers and modems directly from your local computer store.

Not just selected models. Any models. Ranging from the 0-450 bps A 242A, the world's most widely used acoustic data coupler, to the revolutionary AJ 1259 triple modem that handles 300 bps Bell 103, 1200 bps Bell 212A, and 1200 bps VA 3400 protocols.

Whether you need full or half duplex or both in one; originate or answer, auto answer; acoustic coupling, or direct-connect—there's a model for you in the AJ line.

Starting now you don't have to settle for second best.

For the location of your local computer store handling the AJ line, call toll-free:

**800/538-9721**

California residents call 408/263-8520, Ext. 307.

See us at COMDEX/Spring in Atlantic City.





See us at NCC  
Booth # M150-M152 and  
NCGA Booth # 1012

# GRAPHICS FOR CP/M<sup>®</sup> COMPUTERS

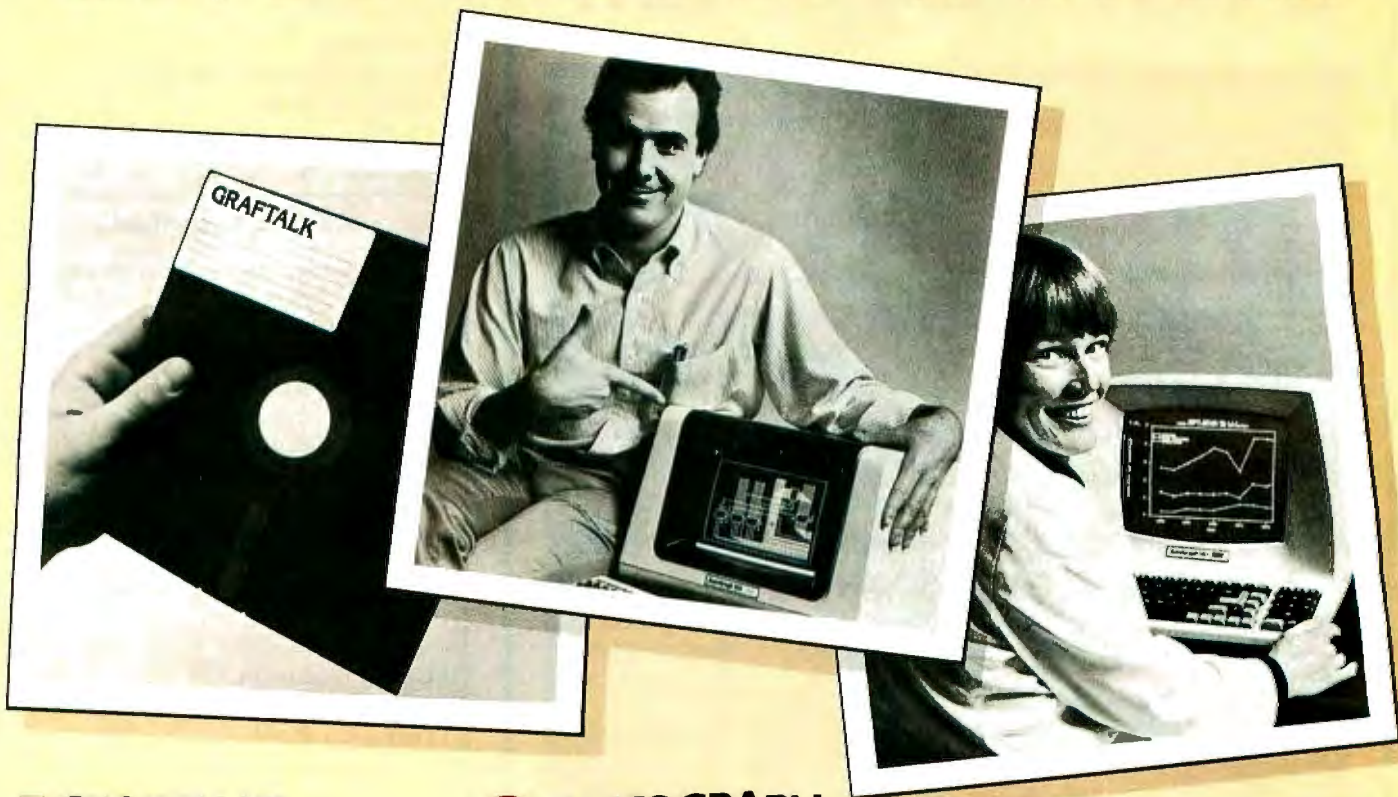

## 1 GRAFTALK<sup>®</sup>

The first graphics software for CP/M systems, GRAFTALK reduces data to pictures, giving you the ability to look at information that would otherwise be a boring text file.

GRAFTALK is friendly and easy to use. Great for first-time users. But that doesn't mean GRAFTALK lacks capability.

Bar charts. Pie charts. Line plots. Symbol plots. Composite plots. Text. Color. Advanced graphics, over 100 powerful commands, and sophisticated "tuning" features.

You name it, you can picture it.

Available from:

## Lifeboat Associates

(212) 860 0300

Trademarks: CP/M: Digital Research  
GRAFTALK: Redding Group, Inc.

## 2 AUTOGRAPH

Terminals and printers for graphics and alphanumerics, from DATATYPE.

The AUTOGRAPH terminal is based on the popular TeleVideo series. So you get all the terminal you need for your CP/M system's alphanumeric requirements.

We've added the logic necessary to make the terminal fully compatible with GRAFTALK. (With ISSCO's Tell-A-Graf and Tektronix graphics software, too.) And you can combine a graphic display with alphanumeric information. (We can even supply retrofits for your TeleVideo terminals.)

The AUTOGRAPH dot matrix printer is quiet, reliable, and fast. (You get up to 200 characters per second at only 54dba.)

The 7 x 9 dot print head will also produce draft-quality and correspon-

dence-quality letter characters. In the graphics mode you get a true hard copy of the graphics you create on your AUTOGRAPH terminal using GRAFTALK.

## 3 RESULTS

You can now put graphics to work to communicate your business information. Quickly, easily, and affordably. Your local AUTOGRAPH distributor can provide a demonstration of GRAFTALK and the AUTOGRAPH series.

Call or write DATA TYPE for more information and the name of your local AUTOGRAPH distributor.



**DATA TYPE**  
2615 Miller Avenue  
Mountain View, CA 94040  
(415) 949-1053  
Telex 172042



# WATCH US

## EVOLVE HERE!!

In an era when the integration process has brought the mainframe computer down to the size of the microcomputer of years past, a new dedicated level of processing technique is in high demand. And with this demand a new evolution in computer technology has begun. This evolution will yield highly dedicated levels of processing and the blending of several generations of computer technology.

Within the software industry the development of tree structured programming has given way to a new tree structured processing architecture in which three generations of computers can share the workload that will be demanded of the future generations of computers.

This development is one of many new releases of **REMOTE EVOLUTIONARY COMPUTERS, INCORPORATED**. Its purpose is to coordinate all our new products into processing architectures that can meet and in many instances exceed the processing demand of the new computing society.

The new architecture is **BRANCHARC** and its new software support is called **SEE**. These new concepts in data processing may prove to be new standards in the Microcomputer Industry. For more detailed info and reports on these new products contact:

**REMOTE EVOLUTIONARY  
COMPUTERS, INC.  
ADVANCED ORDER OFFICE**

**RT.#6; P.O. BOX 105, Lebanon, TN 37087  
or phone (615) 449-6663**

### Letters

#### Brewing Up an Interface

I was fascinated to read "A Homebrew Graphics Digitizer" by Neal Atkins and Enrique Castro-Cid (February 1982 BYTE, page 72). I would like to construct such a device, but my technical skills being what they are, I am not able to design the proper way to interface it with my Atari. If any of your readers could be of assistance I would greatly appreciate the help.

Scott Berfield  
5816 North Sheridan Rd., 2F  
Chicago, IL 60660

#### Keep It Technical

I object strenuously to your decision to include in your Letters column of the February 1982 BYTE a letter on page 30 from Steven Pacenka.

I buy technical journals for technical information. I believe that an antinuclear faction's ideas no more belong in the pages of BYTE than do any other views on moral or social issues.

Perhaps you feel that this type of rhetoric has a place in your journal. If your answer is yes, than I can certainly exist without BYTE.

Martin J. Weitzman  
POB 1153  
Loomis, CA 95650

#### Powerful ELF

In his review "The Flexibility of VisiPlot" (February 1982 BYTE, page 32) Robert E. Ramsdell claims that its companion program, VisiTrend, "is the most powerful forecasting and analysis software presently available." This is not true.

Our statistical package ELF (Econometrics and Linear Forecasting) does everything VisiTrend can do and much more. For example, ELF does regressions with 25 independent variables, while VisiTrend can handle only 5. ELF also does factor analysis, discriminant analysis, and ANOVA (analysis of variance), which VisiTrend does not. ELF has been available for over a year (and advertised in BYTE).

Recently we released TWG/ARIMA, the first time-series-analysis package for a



Microcomputer Business Industries Corporation  
presents  
**Two Practical Peripherals For  
Your Apple™ II**

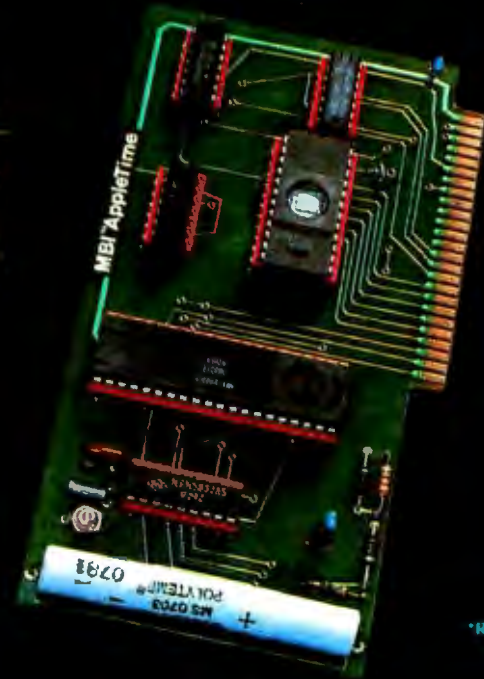

\*Recommended  
Retail Price

**AppleTime™ Clock Card**

**\$9900\***

- Fully Mountain Computer Software compatible
- Disk included with all software
- Includes Datebook™ - a complete desk calendar
- Time of day • International time-keeping ability
- Calendar date • Recharging battery backup
- Day of week • Complete software formatting
- Program timer • Offset time/date/day readout

**VIP™ Card - "Versatile Interface Peripheral"**

(Available for EPSON, NEC, C-ITOH, IDS PRISM, OKIDATA and other graphic printers soon.)

**VIP™ G- The Ultimate Graphics Card**

**\$11900\***

- A Centronics Parallel Interface and Cable featuring:
- Text and graphics screen dump routine
- Graphics with inverse & emphasized modes

- Enlarged picture mode
- Variable line length with left & right margins
- Block graphics
- 90° picture rotation
- Chart Recorder Mode
- Upgradable to VIP™ G+

**VIP™ G+**

**\$14900\***

- has all the features of the VIP™ G plus:
- A serial port with full RS232 capability
- Software baud rate control from 140 to 9600 baud

**VIP™ P**

**\$11900\***

- an interface card featuring:
- Two parallel ports
- Upgradable to VIP™ SP

**VIP™ SP**

**\$14900\***

- an interface card featuring:
- Two parallel ports
- One serial port

**VIP™ Graphics Diskette**

**\$1995\***

- for the person who already owns a parallel interface and cable. Features:

- Full VIP™ I software capabilities
- Plus side-by-side twin picture capability
- Self-documentation



**Microcomputer Business Industries Corporation**

Suite 200 • 1019 8th Street  
Golden, Colorado 80401  
(303) 279-8438 TWX: 910-934-0191

National and international  
dealer inquiries welcome.

Apple is a trademark of Apple Computer Inc. MBI, AppleTime, VIP, and Datebook are trademarks of Microcomputer Business Industries Corporation.

Circle 309 on inquiry card.



Here's proof that you don't have to sacrifice on service to save money:

# Our customers gave us an **A-**

We're proud of our service but continually search for ways to improve it.

That's why we include this Report Card in every order we ship. (We even offer a \$5.00 discount to customers who fill out the card and return it.)

We want to know what you think: what you like, what you don't. How can we serve you better?

So far, we have received over 5,000 Report Cards. You've told us you think our salespeople are knowledgeable and friendly. You appreciate that we carry a full line of products at the lowest possible prices. And, you enjoy the economy and convenience of mail-ordering.

Overall, we got an A-minus. Thank you.

We'll continue to ask for your opinion — our goal is an A-plus.

## 16K RAM KITS . . . 13.95

Set of 8 NEC 4116 200 ns. Guaranteed one full year.

## DISKETTES

ALPHA DISKS . . . 21.95

Single sided, certified Double Density 40 Tracks, with Hub-ring. Box of 10. Guaranteed one full year.

## VERBATIM DATALIFE

MD 525-01, 10, 16 . . . 26.50

MD 550-01  
MD 557-01  
MD 577-01  
FD 32 or  
FD 32 or  
FD 34-

DISK

5 1/4"

8"

PL

PH

PH

PH

PH

PH

PH

PH

PH

PH

PH

PH

PH

PH

PH

PH

PH

PH

PH

PH

PH

PH

PH

PH

PH

PH

PH

PH

PH

PH

PH

PH

PH

PH

PH

PH

PH

PH

PH

PH

PH

PH

PH

PH

PH

SYSTEMS  
Call Alpha Byte for our low Altos

## ATARI COMPUTERS

ATARI 800	699.00
ATARI 400 (16K)	339.00
ATARI 810 DISK DRIVE	449.00
ATARI 850 INTERFACE	449.00
ATARI 410 PROGRAM RECORDER	79.00
EPSON CABLE	35.00
MEMORY MODULE (16K)	89.95
JOYSTICK CONTROLLERS	10.00
PADDLE CONTROLLERS	19.95
STAR RAIDERS	35.00
MISSILE COMMAND	35.00
ASTEROIDS	35.00

## INTEC PERIPHERALS RAM MODULES

48K FOR ATARI 400	279.00
32K FOR ATARI 800	135.00

## ACTIVISION ATARI CARTRIDGES

LAZAR BLAST	21.95
SKIING	21.95
DRAGSTER	21.95
BOXING	21.95
CHECKERS	21.95
BRIDGE	21.95
KABOOM	21.95

## HEWLETT PACKARD

HP COMPUTERS	
HP-85A PERSONAL COMPUTER	2195.00

## PRINTERS

ANADEX DP 9500	1295.00
ANADEX OP 9501	1295.00
C-ITOH F-10 40 CPS PARALLEL	1595.00
C-ITOH 45 CPS PARALLEL	1770.00
C-ITOH 40 CPS SERIAL	1870.00
C-ITOH PROWRITER PARALLEL	549.00
C-ITOH PROWRITER SERIAL	695.00
C-ITOH COMET I	289.00
EPSON MX-80	SCALL
EPSON MX-80 F/T	SCALL
EPSON MX-100 GRAPHIC	SCALL
EPSON GRAFTRAX	90.00
IDS-445G PAPER TIGER	779.00
IDS-460G PAPER TIGER	945.00
IDS-560G PAPER TIGER	1195.00
IDS PRISM 80 W/O COLOR	1099.00
IDS PRISM 132 W/COLOR	1799.00
NEC SPINWRITER 3510 S. RO	1995.00
NEC SPINWRITER 3530 P. RO	1995.00
NEC SPINWRITER 7710 S. RO	2545.00
NEC SPINWRITER 7730 P. RO	2545.00
NEC SPINWRITER 7700 D SELL UM	2795.00
NEC SPINWRITER 3500 SELLUM	2295.00
OKIDATA MICROLINE 80	389.00
OKIDATA MICROLINE 82A	549.00
OKIDATA MICROLINE 83A	799.00
OKIDATA MICROLINE 84	1199.00
QUME 9/45	2149.00

## MONITORS

NEC 12" GREEN MONITOR	179.00
NEC 13" COLDR MONITOR	399.00
SANYO 12" MONITOR (B & W)	249.00
SANYO 12" MONITOR (GREEN)	269.00
SANYO 13" COLOR MONITOR	469.00
ZENITH 13" HI RES GREEN MON	139.00
AMDEK COLOR I	389.00
AMDEK RGB COLOR	859.00
AMDEK RGB INTERFACE	169.00

## MOUNTAIN HARDWARE

CPS MULTIFUNCTION BOARD	199.00
SUPERTALKER SD200	259.00
ROMPLUS W/ KEYBOARD FILTER	179.00
ROMPLUS W/O KEYBOARD FILTER	130.00
KEYBOARD FILTER ROM	49.00
COPYROM	49.00
MUSIC SYSTEM	369.00
ROMWRITER	149.00
APPLE CLOCK	252.00
A/D + D/A	299.00
EXPANSION CHASSIS	625.00

**VISTA COMPUTER CO.**

80-80 COL CARD .329.00  
CONTROLLER .549.00

### REPORT CARD

Grade us on our service with an A, B, C, D, or F (A being best and F being worst). Feel free to make additional comments that you feel will help us provide better service to you.

Category	Grade	Additional Comments
Knowledge	B	I saw the prices & thought I would take a chance. I am glad I did. I'll be back
Telephone Courtesy	A	
Friendliness	A	
Helpfulness	A	
Quality of Products	A	
Available Selection of Products	A	
Speed of Service	B+	
Hours of Operation	A	
Prices	B	
Warranty Policy	A	
Overall Impression	A+	
	A	

Do you like to receive computer sales information in the mail? Yes

Are you a repeat customer of Alpha Byte Computer Products? No

If you are a repeat customer, Explain why.

Do you order from other Mail-Order Computer suppliers? No (3rd time)

If YES, from which and why.



## NEC PERSONAL COMPUTERS

PC-8001A CPU	899.00
PC-8012A I/O	559.00
PC-8033A DISK I/O	125.00
PC-8031A DUAL DISK	899.00

## APPLE HARDWARE

VERSA WRITER DIGITIZER	259.00
ABT APPLE KEYPAD	119.00
MICROSDFT Z-80 SOFTCARD	299.00
MICROSDFT RAMCARD	159.00
VIDEX 80 x 24 VIDEO CARD	299.00
VIDEX KEYBOARD ENHANCER II	129.00
VIDEX ENHANCER REV D-6	99.00
VIDEX SOFT SWITCH	29.00
M & R SUPERTERM 80 x 24 VIDEO BD	315.00
SSM AIO BDARD (INTERFACE) A & T	165.00
SSM AIO BOARD (INTERFACE) KIT	135.00
APPLE FAN	44.95
T/G JOYSTICK	54.95
T/G PADOLE	34.95
VERSA E-Z PORT	21.95
MICRO SCI A2 W/O CONTROLLER	419.00
MICRO SCI A40 W/CONTROLLER	479.00
MICRO SCI A40 W/O CONTROLLER	409.00
MICRO SCI A70 W/CONTROLLER	629.00
MICRO SCI A70 W/O CONTROLLER	549.00
THE MILL-PASCAL SPEED UP	329.00
PROMETHEUS VERSACARD	229.00
SUPERCLOCK II	129.00
LAZAR LOWER CASE +	59.00
MICROBUFFER II 16K W/GRAPHICS	259.00
MICROBUFFER II 32K W/GRAPHICS	299.00
WIZARD 80 COL VIDEO	279.00

## MODEMS

NOVATION CAT ACUSTIC MODEM	145.00
NOVATION D-CAT DIRECT CONNECT	165.00
NOVATION AUTO-CAT AUTO ANS	219.00
NOVATION APPLE-CAT	349.00
UDS 103 LP DIRECT CONNECT	175.00
UDS 103 JLP AUTO ANS	209.00
HAYES MICROMODEM II (APPLE)	299.00
HAYES 100 MODEM (S-100)	325.00
HAYES SMART MODEM (RS-232)	249.00
HAYES CHRONOGRAPH	225.00
LEXICON LX-11 MODEM	109.00
RACAL VA01C 1200 BAUD/212A	795.00

## TERMINALS

TELEVIDEO 910	639.00
TELEVIDEO 912C	745.00
TELEVIDEO 920C	830.00
TELEVIDEO 950C	995.00
ZENITH Z-19	799.00

## TRS-80 MOD I HARDWARE

PERCOM DATA SEPARATOR	27.00
PERCOM DOUBLER II	159.00
TANDON 80 TRACK DISK DRIVE	429.00
TANDON 40 TRACK DISK DRIVE	289.00
LNW DOUBLER W/ DOSPLUS 3.40	159.00
MOO III DRIVE KIT	649.00

## MORROW DESIGNS

### FLOPPY DISK SYSTEMS

Controller, P.S., Microsoft Basic, CP/M® A & T	
DISCUS 2D (Single Drive — 500K)	869.00
DISCUS 2D (Dual Drive — 1 MEG)	1499.00
DISCUS 2 + 2 (Single Drive — 1 MEG)	1099.00
DISCUS 2 + 2 (Dual Drive — 2 MEG)	1999.00

### HARD DISK SYSTEMS

Controller, P.S., Microsoft Basic, CP/M® A & T	
DISCUS M10 (10 Megabytes)	3099.00
DISCUS M26 (26 Megabytes)	3749.00

## ISOLATORS

ISO-1 3-SOCKET	53.95
ISO-2 6-SOCKET	53.95

## BARE DRIVES

### TANDON 5 1/4 INCH

100-1 SINGLE HEAD 40 TRK	219.00
100-2 DUAL HEAD 40 TRK	299.00
100-3 SINGLE HEAD 80 TRK	299.00
100-4 DUAL HEAD 80 TRK	429.00

## TANDON THINLINE 8 INCH

848-1 SINGLE SIDE	459.00
848-2 DUAL SIDE	549.00

## MICRO PRO

### APPLE CP/M®

WORDSTAR*†	249.00
SUPERSORT*†	145.00
MAILMERGE*†	90.00
DATASTAR*†	215.00
SPELLSTAR*†	169.00
CALCSTAR*†	169.00

### CP/M®

WORDSTAR	310.00
SUPERSORT	195.00
MAILMERGE	110.00
DATASTAR	245.00
SPELLSTAR	195.00
CALCSTAR	239.00

## MICROSOFT

### APPLE

FORTRAN*	165.00
BASIC COMPILER*	315.00
COBOL*	595.00
Z-80 SOFTCARD	299.00
RAMCARD	159.00
TYPING TUTOR	17.95
OLYMPIC DECATHLON	24.95
TASC APPLESOFT COMPILER	159.00

### CP/M®

BASIC 80	299.00
BASIC COMPILER	319.00
FORTRAN 80	369.00
COBOL 80	595.00
MACRO 80	189.00
mu MATH/mu SIMP	219.00
mu LISP/mu STAR	175.00

## APPLE SOFTWARE

MAGIC WINDOW	79.00
MAGIC SPELL	59.00
BASIC MAILER	59.00
APPLE PIE	99.00
DB MASTER	179.00
PFS: (NEW) PERSONAL FILING SYSTEM	85.00
PFS: REPORT	79.00
Z-TERM*	89.95
Z-TERM PRO*	129.95
ASCII EXPRESS	63.95
HAYDEN APPLESOFT COMPILER	149.00
EASY WRITER-PRO	199.00
EASY MAILER-PRO	79.00
EXPEDITER II APPLESOFT COMPILER	73.95
A-STAT COMP STATISTICS PKG	129.00
SUPER TEXT II	129.00
FINANCIAL PARTNER	199.00
LISA 2.5	59.95
SUPERSCRIBE II	99.95

## CONTINENTAL SOFTWARE

G/L	199.00
A/R	199.00
A/P	199.00
PAYROLL	199.00
PROPERTY MGMT	399.00
THE HOME ACCOUNTANT	59.95

## PERSONAL SOFTWARE

DESKTOP PLAN II	199.00
VISIPILOT	179.00
VISITREND/VISIPILOT	239.00
VISIDEX	199.00
VISITERM	79.00
VISICALC	199.00
VISIFILES	209.00

## CP/M® SOFTWARE

THE WORD-SPELL CHECK	75.00
d BASE II	599.00
SUPER CALC	229.00
SPELLGUARD	239.00
P & T CP/M® MOD II TRS-80	175.00
COMM X TERMINAL PROG	82.50
C BASIC 2	115.00
PASCAL Z	349.00
PASCAL MT+	439.00
PASCAL/M	205.00
SYSTEMS PLUS —	
G/L, A/R, A/P, P/R	1799.00
CONDOR I	579.00
CONDOR II	849.00

## DIGITAL RESEARCH

MAC	89.00
SID	69.00
ZSID	97.00
PL/1-80	439.00

## SUPERSOFT

DIAGNOSTIC I	69.00
DIAGNOSTIC II	89.00
'C' COMPILER	179.00
UTILITIES I	59.00
UTILITIES II	59.00
RATFOR	89.00
FORTRAN	239.00

## TRS-80 GAMES

TEMPLE OF APASHAI	34.95
HELLFIRE WARRIOR	34.95
STAR WARRIOR	34.95
RESCUE AT RIGEL	24.95
CRUSH, CRUMBLE AND CHOMP	24.95
INVASERS FROM SPACE	17.95
PINBALL	17.95
STAR TREK 3.5	17.95
MISSILE ATTACK	18.95
STAR FIGHTER	24.95

## TRS-80 SOFTWARE

NEWDDS/80 2.0 MOD I, II	139.00
LAZY WRITER MOD I, II	165.00
PROSOFT NEWSOFT MOD I, III	99.00
SPECIAL DELIVERY MOD I, III	119.00
X-TRA SPECIAL DELIVERY MOD I, III	199.00
TRACKCESS MOD I	24.95
OMNITERM SMART TERM. MOD I, III	89.95
MICROSOFT BASIC COMP. FOR MOD I	165.00
LDOS 5.1 MOD I, II	159.00

## APPLE GAMES

### PERSONAL SOFTWARE

CHECKER KING	21.95
GAMMON GAMBLER	21.95
MONTY PLAYS MONOPOLY	29.95
ZORK I	32.95
ZORK II	32.95
MONTY PLAYS SCRABBLE	34.95

### BRODERBUND

GALAXY WARS	20.95
ALIEN RAIN (AKA GALAXIAN)	20.95
ALIEN TYPHOON	20.95
APPLE PANIC	24.95
MIDNIGHT MAGIC	29.95
SPACE QUARKS	24.95

### AUTOMATED SIMULATIONS

INVASION ORION	20.95
STAR WARRIOR	32.95
TUES MORNING QUARTERBACK	25.95
CRUSH, CRUMBLE AND CHOMP	24.95
THE DRAGON'S EYE	20.95

### MUSE SOFTWARE

ROBOT WARS	32.95
THREE MILE ISLAND	32.95
A B.M.	20.95
GLOBAL WAR	20.95
CASTLE WOLFENSTEIN	24.95

### ON-LINE SYSTEMS

WIZARD AND PRINCES	29.95
MISSILE DEFENSE	25.95
SABOTAGE	20.95
SOFT PORN ADVENTURE	24.95

THRESHOLD	31.95
JAW BREAKER	24.95
CROSSFIRE	16.45
TIME ZONE	72.95
H/R FOOTBALL	32.95
H/R CRIBBAGE	20.95
PEGASUS II	25.95

## SIRIUS SOFTWARE

SPACE EGGS	24.95
VERGON	32.95
SNEAKERS	24.95
EPOCH	29.95
BEER RUN	24.95
HADRON	29.95
PULSAR II	24.95
EPOCH	29.95

## EDU-WARE

PERCEPTION PKG.	19.95
COMPU-READ	24.95
COMPU-MATH: ARITHMETIC	39.95
COMPU-MATH: FRACTIONS	34.95
COMPU-MATH: DECIMALS	34.95
COMPU-SPELL (REQ. DATA DISK)	24.95
COMPU SPELL DATA DISKS 1-4, ea.	17.95

## MORE GREAT APPLE GAMES

COMPUTER QUARTERBACK	32.95
TORPEDO FIRE	49.95
THE SHATTERED ALLIANCE	49.95
POOL 1.5	29.95
ULTIMA	33.95
RASTER BLASTER	24.95
FLIGHT SIMULATOR	27.95
INTERNATIONAL GRAND PRIX	25.95
SARGON II	28.95
SHUFFLE BOARD	29.95
FIREBIRD	24.95
SNACK ATTACK	24.95
THIEF	24.95
ROACH HOTEL	29.95
JABBERTALKY	24.95
THE WARP FACTOR	32.95
COSMO MISSION	24.95

## SUPPLIES

### AVERY TABULABLES

1,000 3 1/2 x 15/16	8.49
3,000 3 1/2 x 15/16	14.95
5,000 3 1/2 x 15/16	19.95

## FAN FOLD PAPER

(Prices F.O.B. S.P.)

9 1/2 x 11 18lb WHITE 3,000 ct	29.00
14 7/8 x 11 18lb WHITE 3,000 ct	39.00

# Alpha Byte

## COMPUTER PRODUCTS

To order or for information call  
**(213) 706-0333**  
 Modem order line: (213) 883-8976

We guarantee everything for 30 days. If anything is wrong, return the item and we'll make it right. And, of course, we'll pay the shipping charges.

We accept Visa and Master Card on all orders; COD up to \$300.00.

Add \$2.00 for standard UPS shipping and handling on orders under 50 lbs, delivered in continental U.S. Call for shipping charges over 50 lbs. Foreign, FPO and APO orders, add 15% for shipping. Californians add 6% sales tax.

Prices quoted are for stock on hand and subject to change without notice.

**31245 LA BAYA DRIVE, WESTLAKE VILLAGE, CALIFORNIA 91362**

Circle 16 on inquiry card.



# What if you're having to clean floppy drive heads too often?



Ask for SYNCOM diskettes,  
with burnished Ectype® coating and  
dust-absorbing jacket liners.

As your floppy drive writes or reads, a Syncom diskette is working four ways to keep loose particles and dust from causing soft errors, dropouts.

Cleaning agents on the burnished surface of the Ectype® coating actually remove build-up from the head, while lubricating it at the same time.

A carbon additive drains away static electricity before it can attract dust or lint.

Strong binders hold the signal-carrying oxides tightly within the coating.

And the non-woven jacket liner,

more than just wiping the surface, provides thousands of tiny pockets to keep what it collects.



- Liner collects and "pockets" loose particles
- Tightly bonded milled ferrous oxides
- Head-cleaning and anti-static agents

To see which Syncom diskette will replace the ones you're using now, send for our free "Flexi-Finder" selection guide and the name of the supplier nearest you.

Syncom, Box 130,  
Mitchell, SD 57301.  
**800-843-9862**; 605-996-8200.

## SYNCOM

Manufacturer of a full line of flexible media

See us at the NCC, Booth #5510.

A Division of Schwann's Sales Enterprises, Inc.

Circle 432 on Inquiry card.

## Letters

microcomputer (also advertised in BYTE), which implements the Box-Jenkins technique. This method is usually able to forecast commodity prices within 1.5 percent of the actual price.

Perhaps the only thing more powerful about VisiTrend is the company that sells it.

Eric Weiss, PhD  
The Winchendon Group  
3907 Lakota Rd.  
POB 10114  
Alexandria, VA 22310

## ARCNET Speed Correction

The January 1982 BYTE (see "BYTE-LINES," page 296) carried a short piece about Tandy Corporation's ARCNET local-network system and its basis in Datapoint Corporation's Attached Resource Computer (ARC).

I enjoyed the article and appreciate the coverage. However, an error was made in reference to ARCNET's speed. The article stated that ARCNET operates at 21.5 megabytes per second. This is incorrect; ARCNET operates at 2.5 megabits per second.

Gerard L. Cullen, Vice President  
Corporate Communications  
Datapoint Corporation  
9725 Datapoint Dr.  
San Antonio, TX 78284

## More Memory for the ZX80

I would like to correct one detail in Hilton K. Ernde's article "Memory Expansion for the ZX80" (January 1982 BYTE, page 216). Mr. Ernde notes that the ZX80, when powering up, will not recognize more than 16K bytes of RAM (random-access read/write memory). This is true but not as restrictive as one might think.

The ZX80 (and ZX81) can be forced to recognize up to 48K bytes of RAM. On the 8K-byte ROM (available as an option for the ZX80; standard on the ZX81), this is simply accomplished by using POKE statements to place the address of the last byte of memory plus 1 (i.e., the address of the first nonexistent memory byte) into the system variable RAMTOP (addresses 16388 and 16389). The system-initialization code can then be called directly from BASIC with the statement RAND USR



# What Are You Paying . . . For Room And Board?

## TRULY ONE OF A KIND!

THE FIRST AND STILL THE BEST SINGLE-BOARD Z80 COMPUTER. ONLY \$895.00 BUYS YOU THE FOLLOWING FEATURES:

- Z80A CPU
- 4 TIMERS (ZCTC)
- 64K RAM
- 2 SERIAL PORTS (ZSIO)
- 2 PARALLEL PORTS (ZPIO)
- NEC FLOPPY DISK CONTROLLER

PLUS MORE . . .

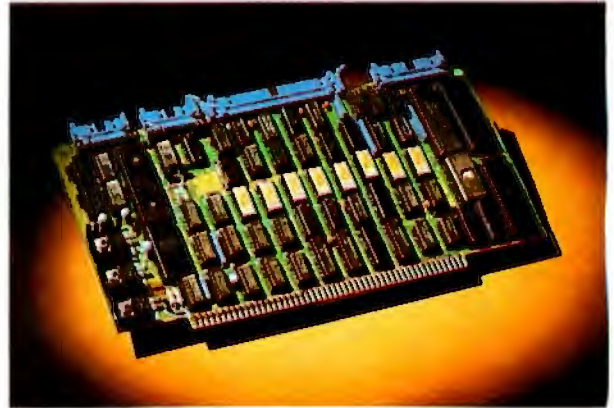

Fresno, California

Marketing Division

21162 Lorain Avenue  
Fairview Park, Ohio 44126  
(216) 331-8500  
TELEX 980131 WDMR



Watch for our new RS-232 Multiplexer card (Software Controlled Switching). See us at Comdex Booth #1664.

## NETWORKING NECESSITY!

LIGHTNING BUSS TRANSFERS ARE THE HEART OF THIS S-100 SLAVE COMPUTER. COMBINED WITH THESE OTHER GREAT FEATURES YOU HAVE MAINFRAME POWER IN YOUR GRASP.

- Z80A CPU
- 4 TIMERS
- 64K RAM
- 2 SERIAL PORTS (ZSIO)
- 4 PARALLEL PORTS (ZPIO)
- ON-BOARD EPROM BURNER

PLUS MORE . . .



## NEED HIGH SPEED SERIAL I/O PORTS? MPM?

THIS 4 PORT SERIAL I/O CARD PROVIDES EXPANSION FOR YOUR SYSTEM NEEDS. ALSO AVAILABLE WITH SYNCHRONOUS COMMUNICATIONS CAPABILITIES.

- 4 SERIAL PORTS (ZSIO)
- 4 TIMERS (ZCTC)
- 0-880K BITS/SECOND
- BAUD RATES PROGRAMMABLE 75 TO 19.2K



OUR BOARDS CAN BE CONFIGURED TO OPERATE WITH THE FOLLOWING SOFTWARE PRODUCTS:

\*CP/M    \*MP/M    \*CP/NET  
\*\*TURBODOS SINGLE USER OR NETWORKING  
SPECIAL NETWORKING SOFTWARE  
KONAN HARD DISK SUB SYSTEMS

\*REGISTERED TRADE MARK OF DIGITAL RESEARCH CORPORATION.  
\*\*REGISTERED TRADE MARK OF SOFTWARE 2000.



# Vive la Difference.

Micros may all seem alike with their Z-80 logic, S-100 bus, and CP/M<sup>®</sup> operating system.

Until you take a hard look.

**Only Delta is the "Private Computer."** You won't find it in some department store. We market exclusively through systems integrators who add value to our product.

Delta fields a complete product line, from single-user systems to 64-user distributed processing networks.

Delta offers an expanding software library; engineering and software development assistance; extensive factory service and support.

Delta's flexible financial program keeps you in business, keeps your profits up.

Some of our competitors may claim there's not much difference between us and them.

**But Vive La Difference.\***



DELTA  
PRODUCTS  
INC.  
15392 Assembly Lane  
Huntington Beach, California 92649  
(714) 898-1492  
Telex: 681-367 DELTMAR HTB

\*See it, believe it. Send for Delta's half-inch video tape promo today (specify Beta or VHS).

\*Registered trademark of Digital Research  
Circle 154 on inquiry card.

## Letters

997. The machine will then reinitialize, placing the stack at the end of memory.

On a ZX80 with the 4K-byte ROM, the same result can be achieved with slightly less ease. The 4K-byte ROM has no RAM-TOP system variable. It is thus necessary to write a short machine-code routine to perform the parallel function. The following code will initialize the ZX80 (4K-byte ROM) with up to 48K bytes of RAM:

```
LD A,$3F
LD HL,$BFFF; For 32K
JP INIT ; @$26B
```

Heuristics of Massachusetts is a company devoted to supporting the Sinclair line of computers. We are attempting to fill what we see as the one hole in the Sinclair domain—information and documentation. It is nice to know that we aren't the only people who feel that this hole exists.

David B. Ornstein, President  
Heuristics  
25 Shute Path  
Newton, MA 02159

### A Fix for GEOSAT

I would like to take this opportunity to thank the many people who have written or called me with comments and questions on my article "The GEOSAT Program" (January 1982 BYTE, page 420). In particular, I would like to thank Mike Flaherty of Miami, Florida. While running the program, he created a condition for which I had failed to check. That condition occurs when a zero latitude is entered by the receiver position (i.e., the receiver is on the equator). In that case a division-by-zero error occurs.

To fix that one case, the following code should be entered at line 299:

```
299 If L1 = 0 then L1 = 1.0E-4
```

I would also like to thank Cedrig Onsruth of Merrimack, New Hampshire. Because of discussions with Cedrig, I will be adding some enhancements to the computational section of this program.

If anyone is interested in obtaining the derivations of the formulas used in this

program, I will be glad to send them a copy if they would supply me with a self-addressed, stamped envelope.

Steve Emmett  
12816 Tewksbury Drive  
Herndon, VA 22071

### In Search of Faster Modems

This letter concerns itself with the questions of modem transfer speed, cost of high-speed modems, and transmission protocols. It is quite clear that the standard 300 bits per second (bps) Bell-103-compatible modem has become extremely popular in the microcomputer community. However, as is probably very obvious to those who use these modems frequently, 300 bps is quite slow. Although 1200-bps modems do exist, they can cost as much as eight to ten times that of a 300-bps modem. Furthermore, there are two different protocols for 1200-bps communication: Bell 212A and Racal-Vadic protocols. Thus what we really need are





# We don't make a Winchester for just anybody.

We're Corona Data Systems and we've made Starfire, a Winchester disk just for Apple II\*.

### What's in it for you?

5 million characters of storage. And that's not all. You'll get Corona's Disk Partitioning which allows for up to 16 separate operating systems such as Apple DOS, CP/M\* and Pascal, all sharing the same disk. Of course, you'll still be able to use DB Master\* and protected software like VisiCalc\*.

### Double Size Volumes.

And with our Double Size Volumes, your Apple DOS is transformed into something special that offers larger data files. And you'll never have to type commands like "catalog"

and "run" or type program names again. You can even forget what volumes the programs are in.

### Reliability.

But you'll never forget Starfire's reliability. That's because we built DataGuard\*, the feature that will correct errors, not just report them. And we also provide a one-year warranty that you can count on. That's reliability.

So why take chances? With Starfire, you're not just adding a hard disk to an Apple II, but transforming an Apple II into a full hard disk business computer.



21541 Nordhoff Street, Unit B Chatsworth, California, 91311 (213) 998-0505

Circle 133 on Inquiry card.

## Starfire – the Winchester disk made just for Apple II.

\*Starfire and DataGuard are trademarks of Corona Data Systems

\* Apple II is a registered trademark of Apple Computers, Inc.

\*VisiCalc is a trademark of Personal Software Inc.

\* CP/M is a registered trademark of Digital Research, Inc.

\* DB Master is a trademark of Stantware

Compliment  
your  
Apple III®  
or IBM...



simply  
**\$599<sup>00</sup>**

- ✱ 13" RGB Color.
- ✱ 16 Colors on your Apple III® or IBM.
- ✱ Up to 80 Characters per line.
- ✱ 360 Dots per color. (horizontal resolution)
- ✱ Available for immediate shipment.

Other models available:

12" Green Phosphor  
(1200 lines resolution) \$179.00

12" Black & White  
(15 Mhz) \$139.00

Contact your local dealer  
or call us direct.

Toll Free 1-800-258-6370



® Apple III is a registered  
trademark of Apple Computer.



18 Bridge Street, Salem, NH 03079  
Tel. (603) 893-2047  
TWX: 710-366-0502

## Letters

the so-called "triple" modems which support data rates of 300 bps and 1200 bps under both of the above protocols. With 1200-bps communication, phone costs are reduced accordingly and interactive programming is much more feasible. (With appropriate data compression, e.g., Huffman coding, an additional transmission-speed factor of 2 can be obtained on many types of redundant data such as English text and ASCII files.) My point is that some innovative company should break the \$800 price barrier and provide us with higher-speed modems. I believe that the demand would justify the undertaking.

Anthony Skjellum  
1695 Shenandoah Rd.  
San Marino, CA 91108

*Because they work in both the digital and analog domains, modems must deal with subtle problems that occur only at the intersection of these domains. The binary phase-coherent FSK (frequency-shift keyed) transmission method of the low-speed Bell 103 modem is limited in its transmission speed by the bandwidth of the two-wire telephone line. To pack more bits into the same bandwidth, a faster modem must modulate its data in some other way.*

*The Bell-212A and the Racal-Vadic protocols are the two most commonly employed for full-duplex medium-speed 1200 bps transmissions; both are variants of a technique called quadrature amplitude modulation, or QAM, which is a four-level PSK (phase-shift keyed) protocol. (A somewhat older protocol, used by Bell-202-type modems, works only for half-duplex transmissions, where "half-duplex" means that transmission of data occurs alternately in two directions over the same two-wire link. Bell 202 modems have often been used over four-wire links, so that transmission in both directions can proceed simultaneously.)*

*In 1973, before the Bell 212A had been introduced, Racal-Vadic developed a protocol for its VA3400-series medium-speed modems that allowed full-duplex 1200-bps transmission over two-wire connections. Three years later, the Bell System brought out the 212A modem, which incorporated a different design methodology and was not compatible with the VA3400 protocol.*

*An originate-mode 212A transmits on a carrier frequency of 1200 Hz, on which the data bits are phase-shift modulated, and the answer-mode 212A transmits on a*

*carrier at 2400 Hz. Many telecommunication engineers have objected to Bell's choice of frequencies, because the answer-mode transmission frequency is exactly the second harmonic of the originate transmission frequency. Second-harmonic distortion is quite common in analog circuitry in general and is pandemic in telephone handsets. Therefore, making an acoustic-coupled version of the Bell 212A is extremely difficult, because the telephone handset may fool the modem into thinking that the answer carrier is present when it is not.*

*In contrast, Racal-Vadic set up its originate-mode dataset to transmit its carrier tone at a frequency of 2250 Hz, while its answer-mode counterpart transmits on a carrier at 1150 Hz. The originate modem is never in danger of being fooled by the second harmonic of its own carrier, because the harmonic falls at 4500 Hz, well outside the communication pass-band. Racal-Vadic claims other advantages of its equipment, but the frequency difference is the most fundamental.*

*Racal-Vadic thinks its own protocol is better, but not wishing to neglect the Bell-compatible segment of the telecommunication market, it developed the VA3451 triple modem, which sells for \$900. This device can operate using the low-speed Bell-103 protocol and both the medium-speed Bell-212A and VA3400 protocols. Another firm that makes triple modems is Anderson-Jacobson, which recently announced the Model AJ1233 acoustic-coupled triple modem (\$995 for one unit). Perhaps more companies will enter the field and increase the level of competition, but medium-speed modems are necessarily more complex than the low-speed ones.*

*For further information, contact Racal-Vadic Inc., 222 Caspian Dr., Sunnyvale, CA 94086, (408) 744-0810, and Anderson-Jacobson Inc., 521 Charcot Ave., San Jose, CA 95131, (408) 263-8520.*

*For information on Huffman codes and other means of compression, see "Text Compression" by James L. Peterson (December 1979 BYTE, page 106), "An Introduction to Data Compression" by Harold Corbin (April 1981 BYTE, page 218) and "An Effective Text-Compression Algorithm" by David Cortesi (January 1982 BYTE, page 397). The problem with text-compression codes is that as yet no particular code has become used widely enough for many people to bother setting up their equipment to transmit and receive compressed data . . . R. S. S.*



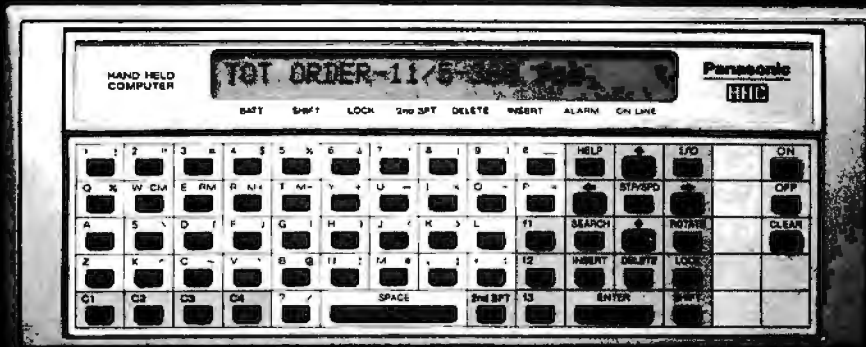

## The Link™ from Panasonic.

### The portable computer that lets you take the advantages of an office computer anywhere you go.

The Link. It's the next major business tool because it's a full-logic computer that's fully portable.

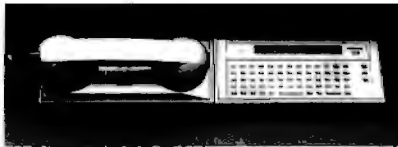

Exchange information with other computers with the telephone modem.

By itself, it can perform a wide variety of sophisticated computer functions because it can store 4K bytes of information. Equally important, it can link you to the information and brainpower of your main office computer — wherever you go. You can program in Microsoft Basic.® Yet it's easy to operate, even if you've never worked with a computer before.

Imagine. Using just The Link, anyone in the field, the plant or on the sales floor — like salesmen, managers, engineers or retailers — can now answer questions that used to mean a trip back to the office. A sales engineer, for example, types data into The Link and gets detailed product information and specs on the spot.

And The Link is part of an entire computer system: By adding different optional components, you can create whatever kind of computer you need. Wherever you need it.

By adding the telephone modem, for example, a salesman can put his company's main office computer or a data bank

to work for him from any telephone booth. He can check credit ratings and inventory, trace

shipments, enter orders, make bids and estimates, and much more. So The Link can make him and his office computer much more productive.

By adding the microprinter, the salesman gets hard copies of information right on the spot — an instant record of his transactions.

By adding the TV adapter, he can display information and 8-color charts on any color TV



Display information and charts with the TV adapter.

screen. So he can use data from his office computer to develop a sales presentation in a motel room. And show it on a client's video monitor the next day.

If the salesman needs to work with a bigger program and

more memory, other optional components increase The Link's capacity to 52K RAM plus 64K ROM. That's more than many desktop computers.

The Link measures only 9" x 4", weighs only 21 ounces,

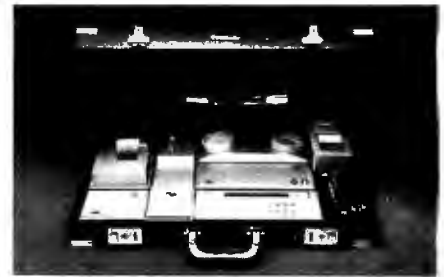

Take The Link and all its components anywhere in its slim attaché case.

and runs on AC or rechargeable batteries.

And it costs only \$600.00.\* That's amazingly small when you realize the big change it could make in the way you do business.

\*Manufacturer's suggested price.

Panasonic Company, Portable Computers  
One Panasonic Way, Secaucus, N.J. 07094

- Please send me information on The Link.  
 Please have a salesman call me.

NAME \_\_\_\_\_

TITLE \_\_\_\_\_ PLEASE PRINT

COMPANY \_\_\_\_\_

TYPE OF BUSINESS \_\_\_\_\_

ADDRESS \_\_\_\_\_

CITY \_\_\_\_\_ STATE \_\_\_\_\_ ZIP \_\_\_\_\_

PHONE NUMBER \_\_\_\_\_

**Panasonic**®  
just slightly ahead of our time. B

**The Link. It will change the way the world uses computers.**





# Now you don't have to decide between a personal computer and a VT100 terminal.



Digital's introduced a personal computing option which can turn a VT100 terminal into a personal computer that uses the CP/M® operating system.

It's called Digital's Personal Computing Option. You can purchase just the option, or you can buy the complete terminal/computing package called the VT180.

Either represents significant advantages over the choices available to you now. For now, you can provide access to a large computer and personal computing at the same terminal.

More than that, you save the additional cost of putting personal computers and terminals side by side on the top of a desk.

With the CP/M operating system Digital's personal computing terminal will run the literally hundreds of programs available for it. Including word processing, mailing lists, financial modeling, statistics, even data base communications—in addition to the many more being specially edited for this terminal.



And by virtue of the fact that Digital's personal computing terminal is VT100-based, you get all the features that people buy VT100s for in the first place. Features like smooth scrolling with up to 132 columns display, split-screen viewing, double-height and width characters, and reverse video.

Plus a reputation that's second to none in the industry. Plus Digital's service, on-site, anywhere in the world.

All of this should make great sense when you're confronted with the choice of terminals or personal computers.

Because now you can pick one and get both.

See your Digital dealer for more information or write: Digital Equipment Corporation, Terminals Product Group, 2 Mt. Royal Avenue, UPI-5, Marlboro, MA 01752. Telephone toll-free 800-225-9378 (outside the continental U.S. or in Massachusetts call 617-480-4077) between 8:30am and 5:00pm Eastern time. In Europe: 12 Av. des Morgines, CH-1213 Petit-Lancy/Geneva. In Canada: Digital Equipment of Canada, Ltd.

**digital**

Circle 156 on Inquiry card.

CP/M® is a registered trademark of Digital Research, Inc.

# The Videodisc Interfacing Primer

*Learn what it takes to develop interactive videodisc programs.*

---

Rod Daynes  
Videodisc Design/Production Group  
POB 83111  
Lincoln, NE 68501

---

Imagine yourself as a student pilot in a light plane coming in for a landing. As you make your approach, you see the landing strip through the propeller's arc. The computer informs you of the distance to the field. You glance at the instruments, and then back at the field. The sound of the engine changes as you glide in for the touchdown. You then request a view of the landing as seen from the field. The computer responds to your request, and asks if you want to repeat the landing. Are you flying a super complicated flight simulator? No, you're interacting with a videodisc player interfaced to a personal computer.

This experimental flight-training program developed by the Nebraska Videodisc Design/Production Group uses a realistic visual database from the videodisc player controlled by a TRS-80 Model III, which also provides the text "overlay." The overlay is used to plot running distances between the airstrip and the aircraft; provide additional instrumentation data; and point out tutorial

information for the pilot trainee, all "keyed" over the videodisc-player picture (see photo 1).

[Editor's Note: Like all new developments in microcomputers, videodisc interfacing comes complete with its own set of technical terms and jargon. The author has thoughtfully provided a glossary, located at the end of this article, to help decipher these terms. . . S. J. W.]

Another example of computer-controlled interactive videodiscs is Think It Through, a problem-solving

---

## About the Author

Rod Daynes is the director of the Videodisc Design/Production Group. Starting in 1978, the Office of Science and Technology at the Corporation for Public Broadcasting funded station KUON-TV at the University of Nebraska to investigate the potential of videodisc technology, with special emphasis on interactive and educational applications. Initial funding was used to investigate interactive videodisc applications for the hearing impaired. This resulted in the first two videodiscs ever made with closed captions, providing teletext-like applications for hearing-impaired children. The Nebraska Videodisc Design/Production Group has since developed more than 30 interactive videodiscs covering a variety of subjects.

---



Photo 1: An "instrument tutorial" section of a low-cost flight-training system using the "overlay" interface, a TRS-80 Model III, and an optical videodisc player. The text, generated by the computer, is keyed directly over NTSC video (the flight instruments).



exercise/sleuth-game series developed for hearing-impaired children in conjunction with the University of Nebraska's Barkley Memorial Center (see photos 2, 3, and 4). Designed to incorporate elements of a mystery story and an adventure game, Think It Through uses visuals from the disc and prompts generated by the computer to pose problems for the children to solve. Two discs are in the series, each with a different subject matter. But both use the same basic problem-solving approach: defining the problem, selecting a possible solution, and then testing the solution to see if it works. The game *Something's Missing* contains 76 different motion sequences. The terrific idea about these games is that when the computer is added, these sequences can be redesigned, frozen, accelerated, slowed down, and treated in an almost infinite variety of ways, which is the heart of the idea behind interactive video.

### System Classification

Our general approach to all of this has been from a potential user's point of view. Our main interest is in what it takes to put together a usable system with emphasis on producing the discs themselves. (We have focused almost exclusively on optical reflective discs, otherwise called "constant angular velocity (CAV)," since optical transmissive discs are seldom used and most capacitance discs are not frame addressable.)

Because so many different types of videodisc players are on the market, we developed classifications based on the functional capabilities of the players in relation to their intended uses:

*Level One:* This includes "consumer" videodisc players, such as the Pioneer VP-1000 and Magnavox 8000. They are characterized as having individual frame addressability, worst-case frame access (1-54,000) less than 20 seconds, limited memory, and no processing power.

*Level Two:* These "industrial" videodisc players, such as the Sony LDP-1000 and the Discovision Associates (DVA) PR-7820, have the capabilities of level one, improved worst-case access times (the DVA PR-7820-3 is fastest at less than 4 seconds), two-way player/computer communication capabilities, and a built-in microprocessor.

*Level Three:* This level includes either a level-one or level-two videodisc player interfaced to a personal computer.

Actually, this classification also has a level zero, which includes players having no inherent capability for still/freeze framing and addressability, such as the CED (capacitance electronic disc) systems and optical discs designated as "extended play," or CLV (constant linear velocity). Also, a level-four group includes even more advanced systems.

### Level One

The principal videodisc player in this category is the Pioneer VP-1000 (see photos 5 and 6). The VP-1000 is

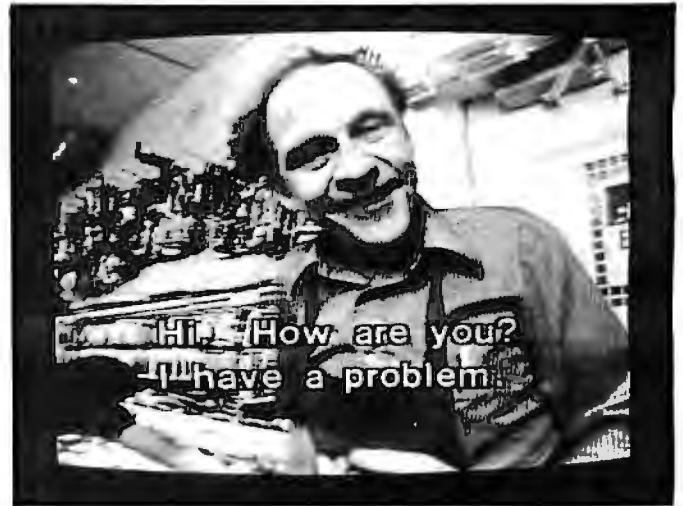

2



3

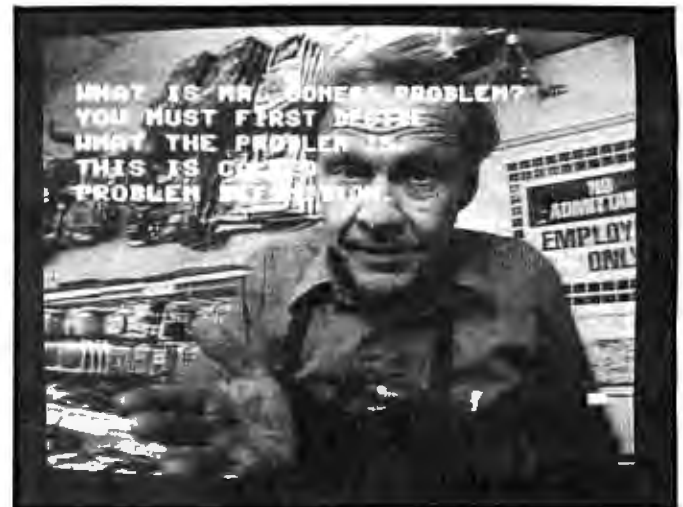

4

Photos 2, 3, and 4: These photos are taken from an experimental videodisc/computer sleuth-game series for hearing-impaired children. In this game, called *Something's Missing*, Mr. Jones, the grocer, sets up the problem (some items are missing from his shelves). Open captions are video generated (photos 2 and 3), and the computer prompts the student via the "overlay" (photo 4).

	Magnavox Model 8000	Pioneer VP-1000	Sony LDP-1000	DVA PR-7820 1, 2, 3
Still frame	X	X	X	X
Step frame	X	X	X	X
Slow motion	variable	variable	1/5	variable
Fast play	forward x3	x3	x3	
Direct frame access		X	X	X
Scan/search	X	X	X	X
Remote control		option	X	X
Dual audio	X	X	X	X
Pause (CLV)	X	X		
Auto repeat	X	X		
Chapter stop	X	X		
Picture stop	*	X		
Programmable			X	X
Digital disc dumps			X	X
Worst-case access (secs)	20 +	18-20	5	2-5
Power	65 W	95 W	95 W	130 W
Weight	28 lb	39 lb	44 lb	54 lb

\* With additional circuit board

**Table 1:** Comparison of videodisc-system capabilities. The table covers level one and two systems that are not interfaced to a microcomputer.



**Photo 5:** The Pioneer VP-1000 consumer (level-one) optical reflective videodisc player.



**Photo 6:** The Pioneer VP-1000's control panel. The VP-1000 is distinguished from other level-one players by its ability to directly access a videodisc frame and its remote-control unit.

capable of "searching" directly to any addressable frame on the disc, which is essential for interactivity and external control. Also, it has a remote-control unit, which means that all typical functions of an optical videodisc player (see table 1) come together in one place, the remote-control jack. The Magnavox 8000 is capable of displaying individual frames, but can only grossly access individual frames, much in the same manner as you thumb through a book to find a single page.

The Pioneer VP-1000 can read "picture stop" and "chapter" codes if they are encoded on the disc. A picture stop halts forward play of the disc on the frame where it has been encoded. Currently, with the VP-1000, the frame number has to be displayed. If this is not done, the player will ignore it (this may change in future versions). The Magnavox player requires a special circuit card to read picture stop codes.

The chapter code enables the VP-1000 to directly search to the first frame of a chapter. This is handy if you want to find a particular set of still frames or a motion sequence. The Magnavox player, since it cannot directly access single frames, finds chapters during a "scan" by sampling every 400 frames (also called the "landing pad").

Keep these features in mind. When you finally decide to connect your level-one system to your computer, picture stops and chapter codes can make your programming more economical.

### Level Two

Only two level-two videodisc-player systems are currently on the market. The first is the DVA PR-7820 series Models 1, 2, and 3 (see photo 7). Models 2 and 3 differ because of two updates of the 7820's EPROMs (erasable programmable read-only memories). The second system is the Sony LDP-1000 (see photo 8). Sony also has a Model



2 with updated EPROMs. (A third videodisc player, the Thompson-CSF, has yet to get off the ground.) Before the release of the LDP-1000 in 1981, we had been using the reliable DVA players with no real complaints. We are now using both and are quite enthusiastic about the LDP-1000 because it offers some different features.

Level-two videodisc players are distinguished from level-one systems mainly by their programmability. You can program these players, on a limited basis, to execute a set of frame searches and autostops, to wait for input from the user, and to branch back into the programmed instructions accordingly. Programs can be recorded onto the second audio track of the videodisc and loaded into the videodisc player's RAM (random-access read/write memory). Multiple loads are possible, allowing maximum use of available memory.

The DVA PR-7820 Models 1, 2, and 3 contain F-8 microprocessors with 1023 bytes of RAM (initial memory locations per load). Commands and registers are stored in these locations. Each command takes up one byte. For example, if you want the player to find frame 1000, then play to frame 3000, the DVA commands would be:

Bytes	Command	Comment
1	1	
2	0	
3	0	
4	0	
5	Search	Find frame 1000
6	3	
7	0	
8	0	
9	0	
10	Autostop	Play to frame 3000

A more sophisticated program would use registers to accomplish the same task:

Program		
Bytes	Step	Command Comment
1	1	Recall 1000 Store 1000
2	2	Store 3000 Store 3000
3	1	1
4	2	Recall 1000
5	3	Search 1000
6	4	Autostop 3000
7	5	Halt

This is useful if you want to save RAM, especially if your program searches and autostops frequently.

The Sony player also provides approximately 1023 bytes of initial memory, but there are a couple of differences. First, the idea of searching and autostopping is implied. The programming structure permits the user to



Photo 7: The Discovision Associates (DVA) PR-7820 "industrial" (level-two) optical reflective videodisc player. The DVA PR-7820's EPROMs have been updated twice (Models 2 and 3), resulting in faster search times and increased user-definable functions. Two-way communication between computer and disc is possible.



Photo 8: The Sony LDP-1000 (level-two) optical reflective videodisc player, which has a built-in RS-232C interface.

program up to 63 "segments" on two pages, totaling 512 lines (0-255 and 256-511). The other difference is that each command does not consume one memory location. Following the previous example, this is how the LDP-1000 would store a simple program:

Bytes (Lines)	Command	Comment
1	Stop	Stop on . . .
2	S001	Segment 1
3	Play	Play to the end of . . .
4	S002	Segment 2

You would then define the length of each segment like this:

Bytes	Command
1	Segment 1 = 1-1000
2	Segment 2 = 1000-3000

**Listings 1a and 1b:** Comparison between programs for the DVA PR-7820 and the Sony LDP-1000. Both programs perform the same function, but the Sony program is shorter because of its more efficient management of memory.

1a

A DVA PROGRAM:

```

00 0
01 1
02 RECALL
03 2
04 STORE      SET 2 IN REG 1
05 1
06 2
07 8
08 5
09 6
10 SEARCH     QUESTION 1
11 5
12 INPUT
13 0
14 1
15 1
16 BRANCH     0. DEFAULTS 0
17 2
18 9
19 BRANCH     1. TO CORRECT ANSWER
20 3
21 6
22 BRANCH     2. TO REMEDIATION
23 3
24 6
25 BRANCH     3. TO REMEDIATION
26 3
27 6
28 BRANCH     4. TO REMEDIATION
29 STP FWD    CORRECT ANSWER
30 1
31 0
32 WAIT       WAIT 1 SECOND
33 5
34 0
35 BRANCH     TO MUSIC
36 6
37 8
38 0
39 1
40 SEARCH     REMEDIATION START
41 7
42 3
43 1
44 0
45 AUTOSTOP   REMEDIATION END
46 1
47 DEC REG    SUBTRACTS 1 FROM REG 1
48 5
49 BRANCH     TO QUESTION 1
50 1
51 2
52 8
53 7
54 0
55 SEARCH     MUSIC START
56 1
57 3
58 2
59 7
60 0
61 AUTOSTOP   MUSIC END (NEXT QUES)
62 HALT

```

1b

A SONY PROGRAM DESIGNED TO DO THE SAME THING:

```

SEGMENTS:
01 13016-13016
02 13017-13017
03 06931-07740
04 13032-13431

PROGRAM:
00 REG 0=     SET REGISTER
01 002
02 STOP
03 S001       QUESTION 1
04 000        WAIT INDEFINITELY
05 INPUT
06 1-016     1. (A) TO CORRECT ANSWER
07 2-010     2. (B) TO REMEDIATION
08 3-010     3. (C) TO REMEDIATION
09 4-010     4. (D) TO REMEDIATION
10 J=0        JUMP IN REGISTER 0
11 021        JUMP TO REMEDIATION
12 PLAY
13 S003       (PLAY WHEN REG 0=0)
14 GOTO
15 025        TO MUSIC
16 STOP
17 S002       CORRECT ANSWER
18 001        WAIT 1 SECOND
19 GOTO
20 025        TO MUSIC
21 PLAY
22 S003       REMEDIATION
23 GOTO
24 002        TO QUESTION 1
25 PLAY
26 S004       MUSIC SEGMENT (NEXT QUESTION)
27 END

```

Entering actual segment locations into memory does not affect the number of lines available for entering commands.

Listings 1a and 1b are more complex programs that exercise most of the programming capabilities of the DVA and Sony players. Assume that you have just seen a video sequence on the screen. The videodisc player is now waiting for you to input an answer to a multiple-choice question (four choices). You have two chances to make the correct choice. If you get the right answer, the program will step the disc player forward to a feedback frame, wait one second, play some music, and stop at the next question. If you get it wrong, the program will "search" and return you to the previous video sequence (remediation) to jog your memory, and then branch back to the same question. If you are wrong again, the disc will branch directly to the music and stop on the next question. From the listing, you can see that the Sony player is more economical with memory space than the DVA player.

Some problems exist, however, with using a bare-bones level-two system. First, you cannot just enter these





Photo 9: The Discmaster 5000 by New Media Graphics, a complete level-three system using the Pioneer VP-1000 and an Atari 400 computer.

programs into the players' memories and run them with any old videodisc. Significant frame locations, such as menus, questions, feedback frames, etc., must first be written and recorded onto video tape in an entirely separate environment (called postproduction or premastering). Once the significant frame locations, the program, and the video have been mastered onto a disc, it becomes a "video ROM (read-only memory)," which can cause another, more frustrating problem. If there is a bug in the program (e.g., the video player looks for the wrong frame number), the mistakes must be corrected by remastering the entire disc. DVA will provide a "proof" disc upon request so that programming can be verified prior to replication. You can also have your program simulated with a computer-controlled video-cassette or video-tape recorder (VTR) prior to mastering and replication, which seems to be a better solution (more on this later). Either way, producing an interactive videodisc is a "top-down" situation that can end up costing a lot of time and money if you are not careful.

The level-two videodisc players are faster than level-one systems, they are more rugged, and they provide better control capabilities for the user (because of the microprocessors). As stand-alone systems, however, they have some limitations.

### Level Three

Level-three systems consist of either level-one or level-two videodisc players interfaced to a personal computer. Because there aren't any standards for videodisc players and due to the conflicting needs of videodisc producers and users, the interface can take many forms: those made exclusively for the Pioneer VP-1000; those designed to accommodate several disc players; interfaces made exclusively for Apple II, TRS-80, Atari, and custom-built computer systems; and generic interfaces made for any computer. Some interfaces are also designed to either switch (or "flip") back and forth from the computer's video output to the videodisc image or "key" the text/graphics from the computer directly onto NTSC video. Here are just a few examples of what's available.

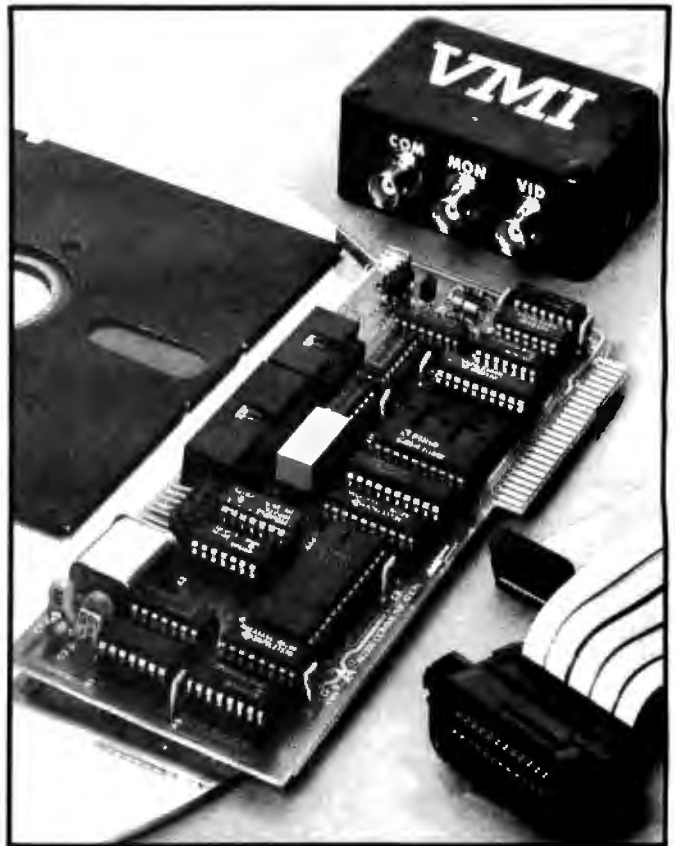
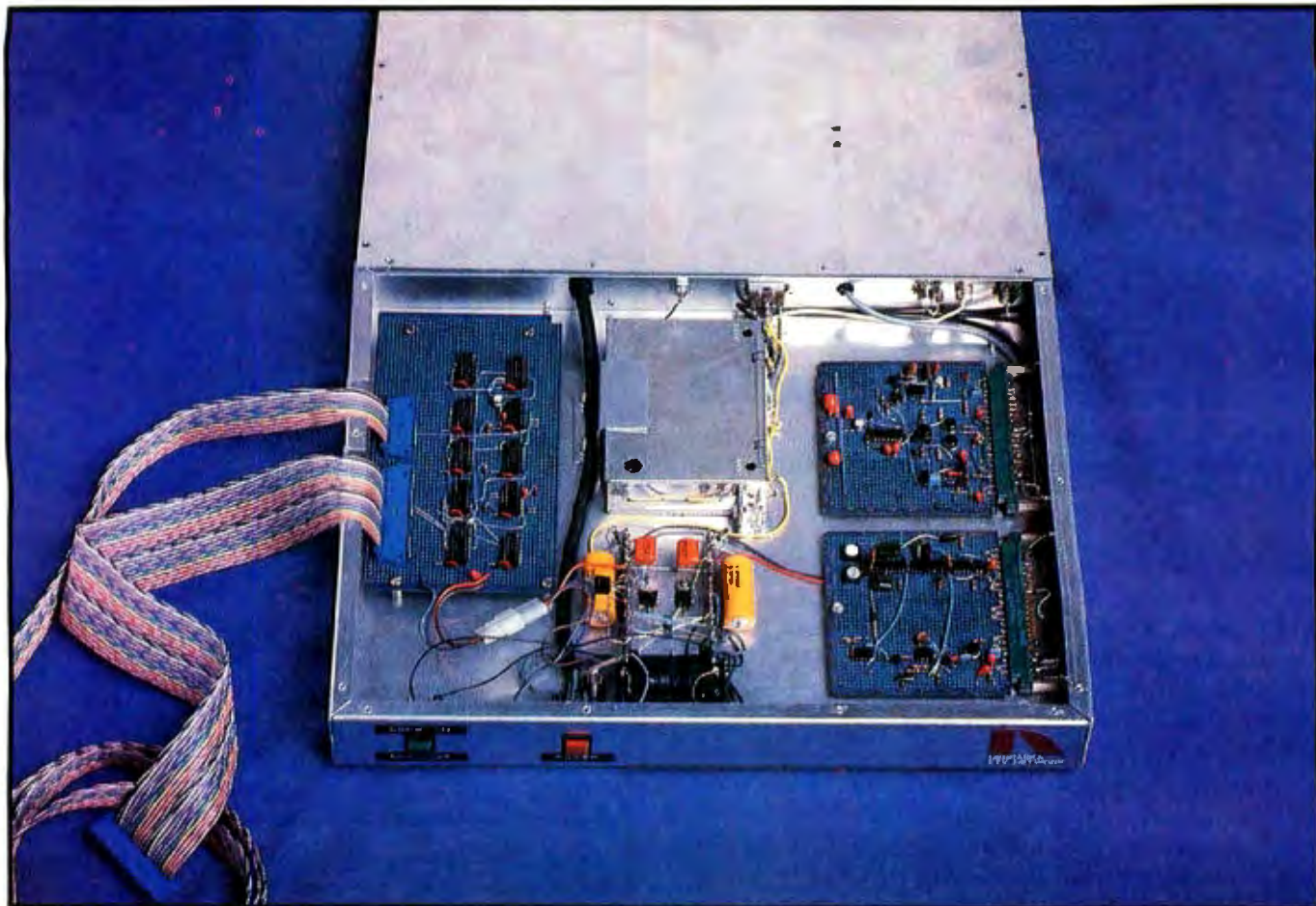

Photo 10: The VMI by Allen Communication, an interface designed for the Apple II and almost every optical reflective videodisc player.

Discmaster 5000 by New Media Graphics (see photo 9) is designed for the Pioneer VP-1000. This complete system includes an Atari 400 with 16K bytes of memory, Atari BASIC, floppy-disk drive, the New Media Graphics interface with a built-in Z80 processor (RS-232C serial), all necessary cables, connectors, user documentation, and the Pioneer VP-1000. Martin Duhms, its president, says, "New Media Graphics has now done the necessary system integration to deliver a ready-to-use system at a price comparable to what industrial videodisc players sell for by themselves. Also, the Discmaster 5000 allows complete reprogramming in BASIC of the videodisc playback, which the other players don't." New Media Graphics also offers the Discmaster 1000, which is similar to the Discmaster 5000 minus the Atari 400 and the Pioneer VP-1000. New Media Graphics, 139 Main St., Cambridge, MA 02142, (617) 547-4344.

Another system for the Pioneer VP-1000 is the Omniscan by Aurora Systems Inc., which uses an Apple II as the exclusive controller. The Apple duplicates the operation of the Pioneer VP-1000's keypad and automatically "flips" the video between the computer's output and standard video. The Omniscan includes the interface, documentation, and a tutorial on the software (the Apple II and Pioneer VP-1000 are extra). Aurora Systems Inc., 2040 East Washington Ave., Madison, WI 53704, (608) 249-5879.

The VMI by Allen Communication (see photo 10) is



**Photo 11:** The first-generation "wire-wrapped" model of the "overlay" interface for the TRS-80 Model I, by the Videodisc Design/Production Group. The second-generation unit (not shown) is designed as a "plug-in" inside the TRS-80 Model III and uses the Model III's RS-232C port.

also designed exclusively for an Apple II, but it can drive every existing optical videodisc player with the exception of the Magnavox 8000. The VMI includes an extremely well-documented user's manual, the interface, switching box, cables, software, information packet, and a sample videodisc. Allen Communication, 3004 Arapahoe Ave., Boulder, CO 80303, (303) 449-2971.

Some systems are based on a company's own personal computer, such as the Positron system by Ron Lane. This is a hardware and software system that arranges interactive strategies hierarchically. Still frames, motion, and text can be selected from five types of displays: (1) outline, in any level of detail; (2) dictionary; (3) questions; (4) titles that relate to a particular frame; and (5) titles previously selected. The nice thing about the Positron system is that its application to program development requires no computer programming or storyboarding of the video, which are two of the main bottlenecks in interactive videodisc production. Information need only be listed; Positron controls everything else, including the interaction. The Positron system comes with its own specially built microcomputer (64K bytes of memory), disk drive, special keyboard, interface, software, and operating system (the Pioneer VP-1000 is extra). Ron

Lane, Positron, 30 Lincoln Plaza, Suite 3S, New York, NY 10023, (212) 586-1666.

Another such system is the Random Access Video Controller (RAVC), supported by a 68000-based microcomputer, developed by Wicat Systems. The RAVC uses the TI 9900 microprocessor for on-board intelligence with 16K bytes of video RAM. It works with any available commercial optical videodisc player, including the Magnavox 8000 if some modifications are made to the player. The controller has both serial and parallel ports for interfacing to the videodisc player. In addition to player control, the RAVC also has a TI 9981 video-processor chip (the same chip as in the TI 99/4 home computer) that provides it with its own video-display capabilities. It can generate screens with 16 different background colors and 16 character colors. Like the 99/4, the controller board can create different video planes for animation. Wicat Systems, 1875 South State St., POB 539, Orem, UT 84057, (801) 224-6400.

Another type of interface falls into the category of "video reprocessing." This, very simply, is the process of converting the video from the computer to mix with the 525-line NTSC standard television.

Sanders Associates has developed a video-reprocessing



system made for an Apple II, called the Interactive Video Training System (ITVS). Besides being able to mix Apple-generated text and graphics with NTSC video, the ITVS can also carry digital data "nested" unseen in the NTSC video signal. This data can be used to define the location of an object, download instructions to the computer on the rules and procedures needed for a given sequence, overlay Apple/NTSC text and graphics symbols on the video picture, and control the functions of the VTR or videodisc player. Sanders Associates Inc., 95 Canal St., Nashua, NH 03060, (603) 885-3731.

Another video-reprocessing system designed for the Apple II is available from Video Associates Labs Inc. The VB-3 Micro-Keyer allows the Apple II to be used for both video production and training. It comes with software that allows a person with no technical knowledge of video or computers to take full advantage of the broadcast features built into the VB-3 Micro-Keyer system. Video Associates Labs Inc., 2304 Hancock Dr., Suite 1-F, Austin, TX 78756, (512) 459-5684.

This type of system is marketed primarily to television stations. For example, they use it to key weather maps, forecasts, etc., directly onto the screen during news programs. While they are considered real bargains compared to the cost of the other broadcast equipment, unfortunately, most video-reprocessing systems cost more than the personal computer that controls them.

### The Videodisc Design/Production Group

In April 1980, the Nebraska Videodisc Design/Production Group demonstrated the first version of the overlay interface (see photo 11). Like other video-reprocessing systems, this configuration is also a true keyer. But being able to key is merely the end result. "Interlace" is accomplished prior to keying. The overlay interface is designed exclusively for the TRS-80 Models I and III. Focusing on the TRS-80 enabled us to build the keyer minus expensive signal processing, making the system affordable to the personal computer user at home, at school, or on the job. While the overlay contains a decoder for turning the video on and off, it also permits interaction between text/graphics generated by the computer and television images, which is preferable in our book to merely switching back and forth from computer to videodisc.

The utility software package designed to control our level-three discs is called the VDC-1 (videodisc controller). The package, written in Z80 assembly language, is designed to be called from disk BASIC, although it is possible to call it directly from assembly language, or even from FORTRAN or some other high-level language. A common subset of disc player functions is provided, and it is possible to extend the capabilities of the package by adding custom functions. It is also possible to download or perform data dumps to players that have internal intelligence (e.g., DVA PR-7820 and the Sony LDP-1000). Macros are also allowed, making it possible for the programmer to send a string of commands that are frequently used or requested, thus saving time and memory.

Some of the internal (housekeeping) functions include initialization, a manual mode, player-definition mode, and frame lock-out. Initialization consists of telling the VDC-1 which player is connected to the TRS-80. The VDC-1 asks the user which videodisc player is being used and then performs all functions transparently. For example, if your BASIC program was written using the DVA PR-7820 as a development system, the program could run in the field with a Pioneer VP-1000. The VDC-1 is designed for that kind of compatibility.

In addition to the standard keyboard functions that can be accessed manually, the VDC-1 supports the decoding functions of the overlay with video on/video off commands so that the computer can continue to display information while the player searches to a location. This is particularly applicable for the Pioneer player (worst-case access: 18-20 seconds). Other commands include lock-out functions for both frame locations and the player panel, timing and pause commands for CLV discs, and "bookmark" commands that switch from computer control to manual control and resume again where the user had previously left off.

### Videodisc Production

Designing and producing an interactive videodisc is similar to writing, producing, and directing a film. Hidden in both the film and disc development are layers of various media (including computer software) and hours of evaluation in many forms. What really sets interactive videodisc development apart from the development of motion pictures or television productions, however, is interactivity, the dynamic interplay between the user and the medium—which neither film nor television can provide. Yet, as we have learned something about developing interactive discs, as producers, we have also learned that we are using yesterday's tools to develop tomorrow's media. [Editor's Note: *To give you a better understanding of the various steps involved in the production of an interactive videodisc, we have included a design and production chart on pages 56 and 57. . . .S. J. W.*]

Our pet project (and pipe dream) for the last two years has been the development of an interactive editing system (IES), which could individualize the postproduction process in the same way that filmmaking is individualized during the editing process. The requirements for an IES as we see them include read-write capability, rapid-frame access, broadcast quality, the ability to reedit, simulation capabilities, and portability. The IES would be a computer-controlled offline system. Under ideal circumstances, the computer would be involved from the design process, flowcharting, creating visuals, etc., right up to the final coding of the finished product.

The first signs of an IES are beginning to appear. We are blessed with a first-rate teleproduction facility, and as we move further into the digital world, we are able to piece things together.

The current IES configuration is based on a Bosch BCN-50, a 1-inch helical VTR, controlled by an 8080 microprocessor with an RS-232C serial interface, de-

*Text continued on page 58*

# Interactive Videodisc

The design and production chart shows the steps required to design, develop, and produce an interactive videodisc. The individual steps vary in length and complexity. Although some activities may overlap in practice, each step in the sequence depends on the successful completion of the steps leading up to it. A critical stage occurs at the beginning, when the client and subject-matter experts define the goals and objectives for the videodisc program. The participation of the client is also essential at every "review/approve" step (marked by a "revision" path back to the previous step).

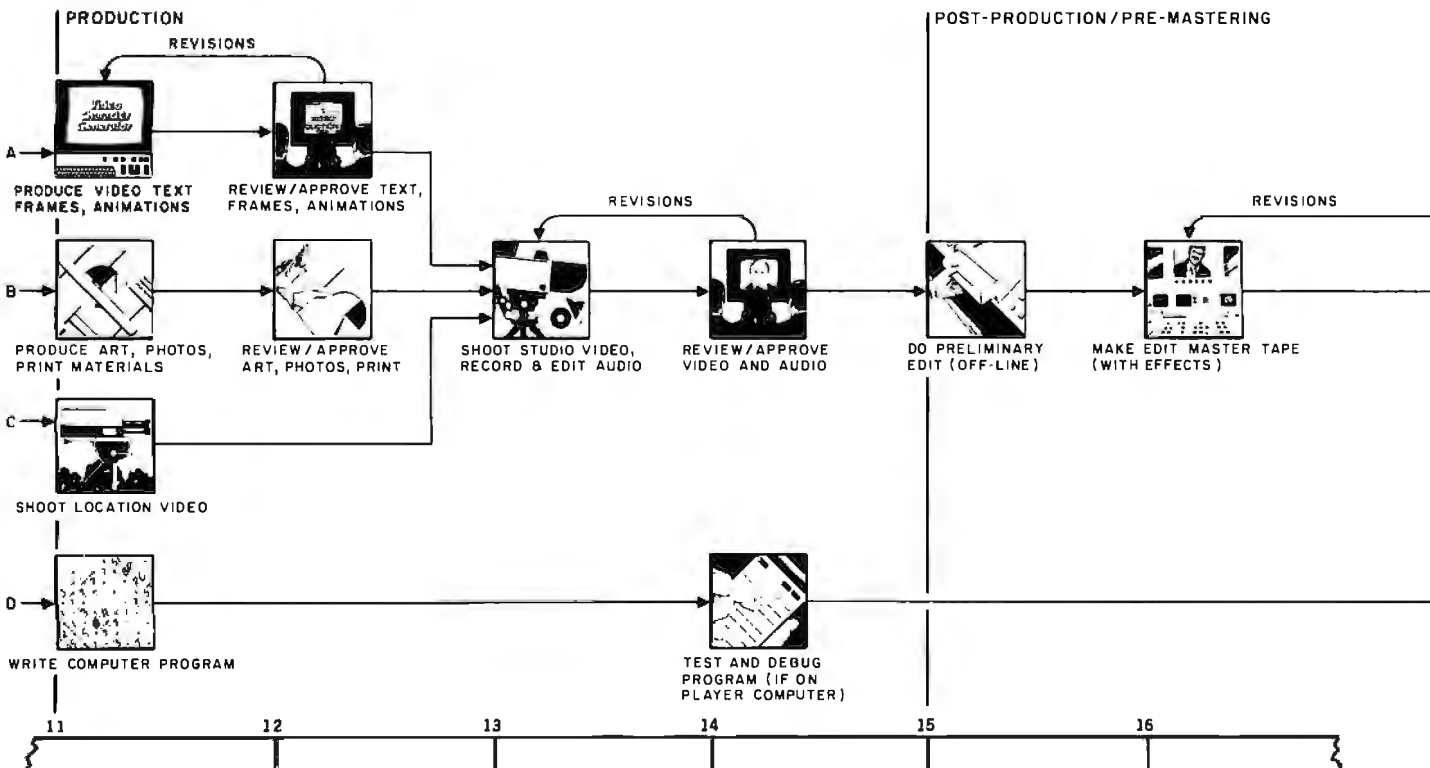
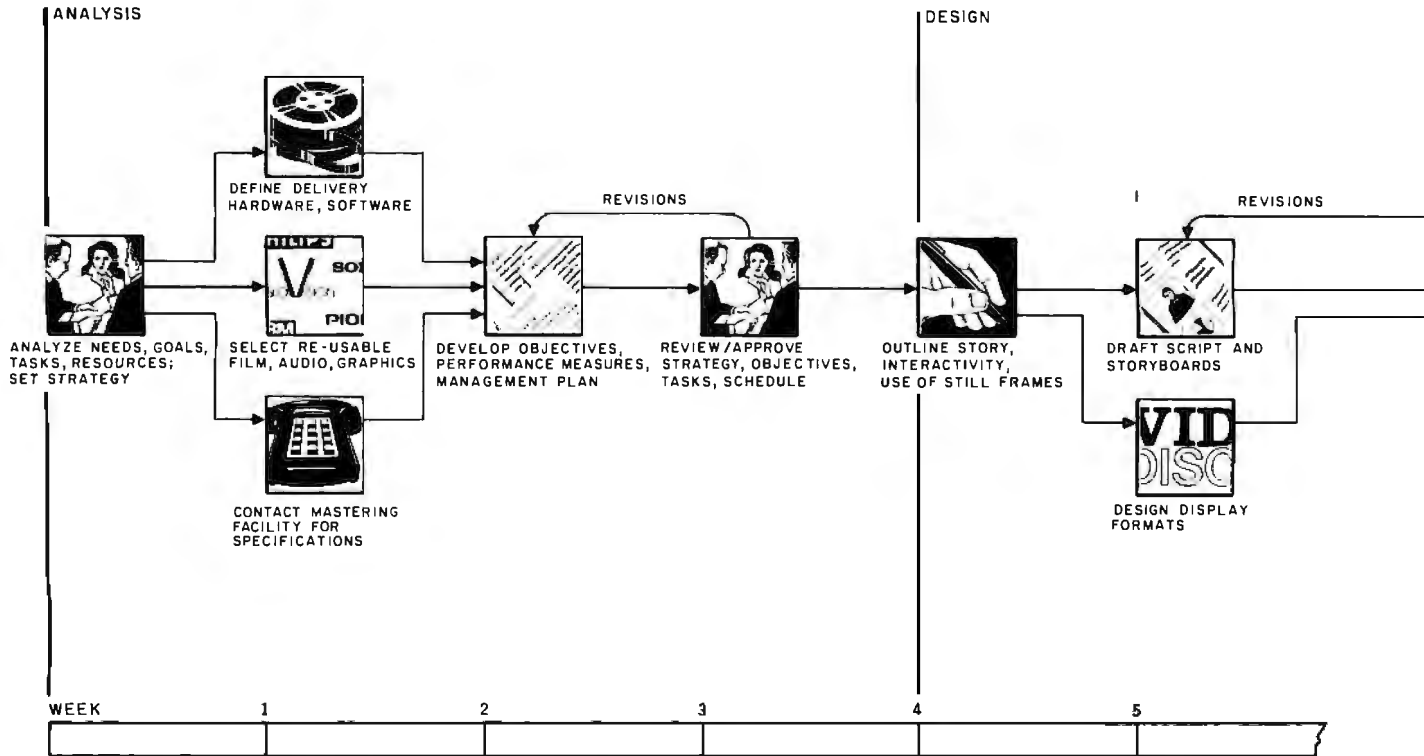



# Design and Production

The schedule shown here—20 weeks from concept to master tape—suggests the time typically recommended for a well-managed project of medium complexity, using primarily studio production (with one or two scenes shot on location), about 400 still frames, and a modest computer program. Simpler projects require less time, while those employing sophisticated computer-simulation techniques take longer, both to produce and to plan. For videodiscs controlled by an external computer system, program coding and testing can continue during the mastering of the videodiscs.

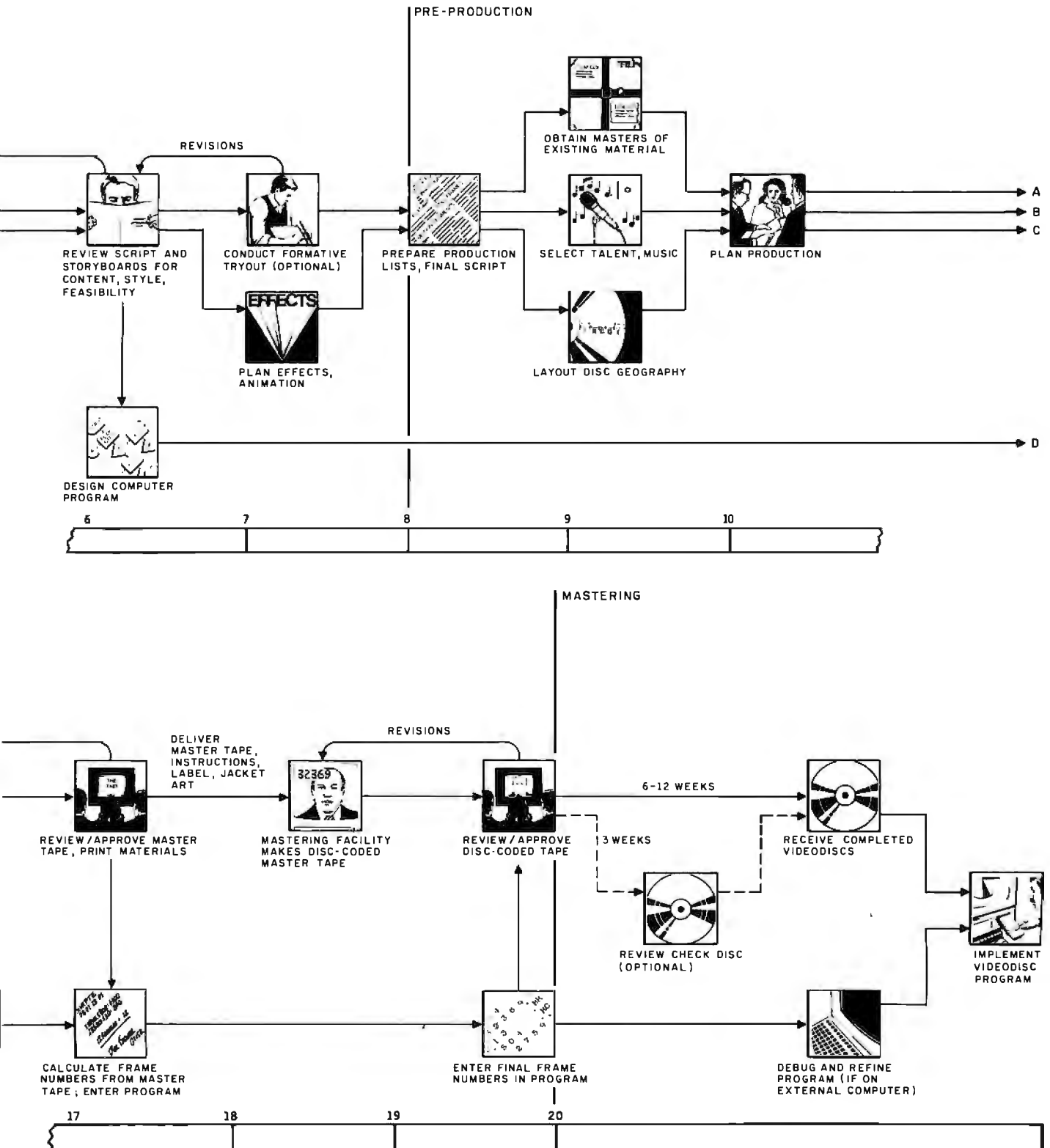



**Photo 12:** A videodisc simulator/editor developed by the Videodisc Design/Production Group. The Bosch BCN-50 1-inch helical VTR (left) serves as a surrogate disc player but with the added capability of offline insert edit capability with "broadcast quality."

*Text continued from page 55*

signed and built by our group (see photo 12). Using this standard interface, the BCN-50 can be driven by almost any external source. The 8080 system already had programming in EPROMs to control the tape transport and still store functions. The main task was to locate and con-

trol the subroutines stored in the EPROMs and write a "driver" program to access and execute them in a manner that would duplicate the capabilities of a videodisc player. Once the driver was completed, software was developed that recognized inputs from any given disc player. From there, the user-oriented software could be written.

Since the Bosch machine is a broadcast-quality recorder with full editing capabilities, it operates by the same SMPTE time code used to assemble materials online. Also, since it is a recorder with frame-accurate editing capability, part of the tape can be edited offline to revise a text frame or menu, for example.

Once the premastering stage has been completed and a finished tape is available, the master can be made. The coded tape is sent to a mastering facility, where a master is made on a glass disc. This master is then used to produce the finished videodisc.

### Into the Future

The videodisc has almost unlimited potential. Programs will appear that are made for interactive use, including games, educational programs, simulations, and more. The future of interactive videodisc technology could be as bright as the microcomputer industry itself, and the videodisc may become the medium of the eighties. ■

## Glossary

*(This information can also be found in 3M's Producing Interactive Videodiscs manual.)*

**authoring:** a structured approach to developing all elements of an interactive videodisc program with emphasis on preproduction.

**branch:** an instruction to diverge from one sequence in a program to another.

**capacitance disc:** a videodisc system that uses capacitance signals embedded on the disc and a stylus that touches the surface of the disc to read encoded information.

**CED:** capacitance electronic disc developed by RCA.

**chapter:** a consecutive sequence of frames.

**chapter stop:** a code embedded in the vertical interval of the videodisc that enables certain videodisc players (mostly level one) to locate the beginning of chapters.

**compressed audio:** sometimes called still frame audio, compressed audio describes a method

of digitally encoding and decoding several seconds of voice-quality audio per individual disc frame, resulting in a potential for several hours of audio per disc.

**constant angular velocity (CAV):** a CAV disc revolves continuously at 1800 rpm, one revolution per frame, making each frame of a CAV disc addressable, a basic requirement for interactive videodiscs.

**constant linear velocity (CLV):** a CLV or extended-play disc maintains a consistent length for each frame, thus enabling longer playing time per side, but sacrificing individual frame addressability. Reference to locations on CLV discs is limited to time in minutes and seconds. CLV discs are basically useless for interactive videodisc applications.

**cue:** a pulse entered onto one of the

lines in the vertical-blanking interval (VBI) that results in frame numbers, picture codes, chapter codes, closed captions, white flags, etc., on the disc.

**direct-read-after-write (DRAW):** a record-once optical-disc technology primarily used for mass storage of digital data.

**field:** a scan of 262 lines on the screen at 1/60 second constituting one-half of a complete video frame. See **frame**.

**flicker:** sometimes known as "interfield jitter" or "jitter," flicker is a phenomenon that occurs in a videodisc freeze frame or still frame when both fields are not identically matched, thus creating two different pictures alternating every 1/60 second.

**frame:** two complete scans of the video screen at 1/30 second. A frame is composed of two fields (at



262 lines) and a retrace; a single frame is a standard CAV videodisc reference point. There can be as many as 54,000 addressable frames on one side of a CAV videodisc.

**freeze frame:** a single frame from a motion sequence that is stopped.

**full frame time code:** otherwise known as nondrop frame time code, full frame time code is a standardized SMPTE (Society of Motion Picture and Television Engineers) method of addressing a video tape. It gives an accurate frame count rather than an accurate clock time.

**interaction:** a reciprocal dialogue between the user and the system, interactivity.

**interchangeability:** a videodisc design strategy that includes information readable on consumer, industrial, and computer-controlled videodisc systems.

**interlace:** in NTSC video, half the horizontal scanning lines are laid down. After retrace, the other half are laid down so that they fall in between the previous lines.

**intermediate materials:** all media selected for assembly onto the videodisc premaster (i.e., 16mm film, video tape, 35mm slides, etc.).

**jaggies:** a tearing phenomenon around the edges of NTSC images. Research at MIT has effectively solved this problem. By so doing, it has created a new way of thinking about displays, computer graphics, and NTSC video. See **soft fonts**.

**keyer:** it cuts a hole in the background video and fills in the hole from a different video source, i.e., computer-generated text and graphics keyed over NTSC video. See **video reprocessing**; **overlay**.

**landing pad:** a range of frames within which a player can locate a frame or frame sequence. Landing pad (LPD) is also a command that modifies the number of times a player attempts to locate a frame following an unsuccessful search.

**level of interactivity:** the potential for interaction prescribed by the

capabilities of videodisc hardware.

**level one:** usually a consumer-model videodisc player with still/freeze frame, picture stop, chapter stop, frame addressability, and dual-channel audio, but with limited memory and less processing power.

**level two:** an industrial-model videodisc player with the capabilities of level one, plus on-board programmable memory and improved access times.

**level three:** level-one or level-two players interfaced to an external computer.

**level four:** a theoretical configuration with more advanced equipment wherein all things are possible.

**mastering:** a real-time process in which the premaster video tape is used to modulate a laser beam onto a photosensitive glass master disc.

**NTSC:** the American television standard set at 525 lines by the National Television Standards Committee.

**optical disc:** a videodisc that uses a light beam to read information from the surface of the disc.

**optical memory:** digital data encoded on an optical disc used for mass data storage. It is estimated that one side of an optical disc could store up to 10 billion bits.

**overlay:** a term used to describe the keying of computer-generated text/graphics onto NTSC video.

**picture stop:** an instruction encoded in the vertical interval on the videodisc to stop the videodisc player on a predetermined frame.

**postproduction mastering:** sometimes called video processing, this is the process of editing, assembly, evaluation, revision, and coding of intermediate materials. A premaster is a fully coded video tape.

**preproduction:** all design tasks, e.g., flowcharting, storyboarding, scriptwriting, software design, etc., prior to videodisc production.

**reflective (optical) disc:** method by which the laser beam reads data

encoded on an optical videodisc. In the case of a reflective disc, the laser beam is reflected off the shiny surface on the disc.

**scan:** to traverse the surface of the disc with the video displayed.

**search:** to rapidly access a single frame or a sequence of frames on a disc with video off.

**sequence:** two or more frames forming one unit, e.g., motion sequence, still-frame sequence.

**slow motion:** in videodisc technology, the controlled movement of the laser from frame to frame at a variable rate of less than 30 frames per second.

**soft fonts:** a gray-level scheme developed by MIT for high-quality fonts in NTSC video. This adds legibility, removes scintillation, and enhances encodability, which results in a display with more than 80 characters per line on a color-television receiver.

**step:** to advance one frame forward or reverse.

**still frame:** still material, including photographs, line drawings, pages, etc., designed and presented as a single videodisc frame.

**three-two (3-2) pulldown:** a means of transferring film shot at 24 frames per second (fps) into video (30 fps). The first film frame is actually exposed on three video fields, and the next film frame is exposed on two fields.

**transmissive disc:** method by which the laser beam reads data encoded on an optical videodisc. In the case of the transmissive disc, the laser beam passes through the transparent surface of the disc.

**vertical-blanking interval (VBI):** 21 blanked lines during field 1 and 21 blanked lines during field 2, wherein frame numbers, picture stops, chapter stops, white flags, closed captions, etc., are encoded.

**VHD:** video high density (see **capacitance disc**).

**video reprocessing:** the process of keying video from the computer over NTSC video.

**white flag:** a code that identifies a new film frame.

## Build an Interactive-Videodisc Controller

*You can use your personal computer to control a Pioneer VP-1000 laser-optical videodisc player through its remote-control circuitry.*

---

Steve Ciarcia  
POB 582  
Glastonbury, CT 06033

---

The theme of this issue is computers and videodiscs, so I don't need to explain why I chose this month's Circuit Cellar project. Several articles this month make specific reference to the capabilities of a video presentation directly controlled by a computer.

With that in mind, my objective is to discuss the more familiar consumer videodisc players and outline how you can build an interface for your computer that allows it to control a Pioneer VP-1000 Laserdisc player. The required hardware is as involved as you care to make it. The software experts among you might in fact be able to do the trick without any special hardware.

Perhaps by experimenting with a videodisc you will more easily recog-

nize the potential benefits of this revolutionary data-storage medium. First, we'll look at the way information is stored on the disc, and then we'll examine how to build an interface to a personal computer.

---

**It's really rather simple to design and use a full-function computer/videodisc-player interface.**

---

### Videodisc Information Storage

About the size of a 33 $\frac{1}{3}$ -rpm long-playing phonograph record, a videodisc contains not only audio (sound) information but video (picture) information as well. Because the basic function of videodisc equipment has

been to play back programming such as motion pictures and special-purpose television shows (although, as I alluded, the videodisc can serve other purposes), the disc was designed to store this kind of normal, TV-type programming.

For such programming, the amount of data needed to store the video portion is vastly greater than that needed for the audio portion: the video bandwidth is much greater, so it is impossible to use the recording method used for conventional audio discs, a continuous surface groove cut so that the amplitude of the transverse linear excursions of a stylus tracing the groove corresponds to the amplitude of the signal.

Diligent engineers have thus far developed two widely used, competing methods of storing video data on a disc: the capacitive method and the optical method. Several manufacturers have developed variations of each



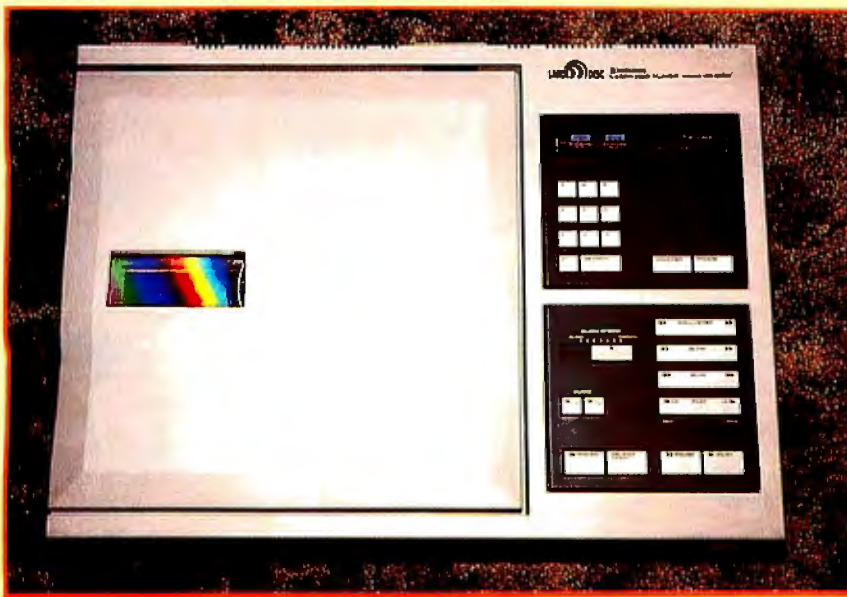

**Photo 1:** The Pioneer VP-1000 Laserdisc optical videodisc player. The unit in this project has both wire and wireless remote-control inputs; some other players may not have both of these. The principles in the project can be adapted to other videodisc players with similar characteristics.

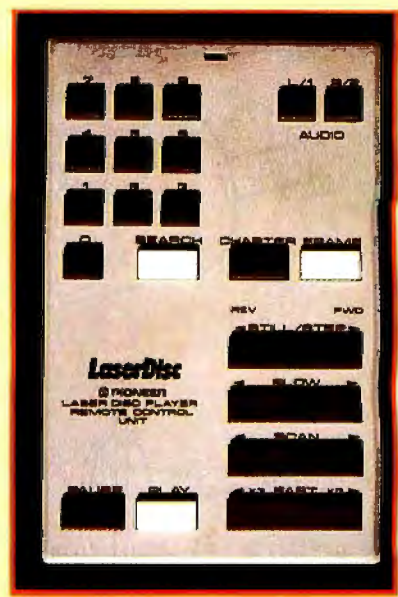

**Photo 2:** The hand-held remote-control unit for the VP-1000. All of the functions work only in the standard-play mode, but not in the extended-play mode.

technique, but a discussion of the systems as used in only two products will suffice for illustration.

### Capacitance-Encoded Discs

Videodisc players from RCA use a

capacitance encoding system named Capacitance Electronic Disc (CED). A CED disc contains a spiral surface groove, as does an audio disc, in which a metal-coated diamond stylus rides in physical contact with the

rotating disc. There are approximately 10,000 groove layers per radial inch, producing a 1-hour playing time per side. The groove is about 1/38 the width of the groove in an audio disc.

The video and audio signals are en-

### JPL Puts the Planets on a Disc

The Jet Propulsion Laboratory (JPL) of the National Aeronautics and Space Administration (NASA) is preparing a videodisc for distribution to various geology schools, planetary-geology laboratories, and some libraries. The disc contains some 100,000 planetary images collected by space probes, including the Mariner, Viking, and Voyager missions.

Viewing this disc, you can see what the space probes saw as they crashed into Mars, plunged past Venus and Mercury, and swooped past Jupiter and its moons.

Each frame on the videodisc contains one black-and-white still image, with the images stored, for the most part, in the order they were taken. A test videodisc prepared earlier contained some full-color images, but the

final research version is all monochrome. (A very clever video technician could reconstruct a few full-color images by electronically combining some of the three-frame sets of the same field of view shot through three subtractive-primary color filters.)

Working under contract to JPL, the Sony Corporation developed for this project a special method for encoding the laser-optical videodisc so that the same disc can be played with full still-frame capability by Pioneer, Sony, MCA, Philips, and DVA (Discovision Associates) videodisc players. (Ironically, it now seems that several of these companies will discontinue production of videodisc players.)

Last February at the San Francisco Video Expo trade show, Mike Martin, Planetary Data Management Team Leader for JPL's Planetary Image Facili-

ty, demonstrated a planet-image search-and-retrieval system. He used a Sony videodisc player, controlled by an Apple II equipped with a joystick and a control program written in BASIC, to show attendees how to take an imaginary tour of a planet's surface, using the joystick as a "throttle" to speed up or slow down the displaying of images from the videodisc. He reports that the people who used the system quickly became enthusiastic about the capabilities of the system and the technology that makes it so easy to widely distribute pictures of the planets.

But at present NASA has no plans to make discs available to the public, though there are plans to produce a second research disc containing the remainder of NASA's space-picture archive, including Voyager's pictures of Saturn....R.S.S.

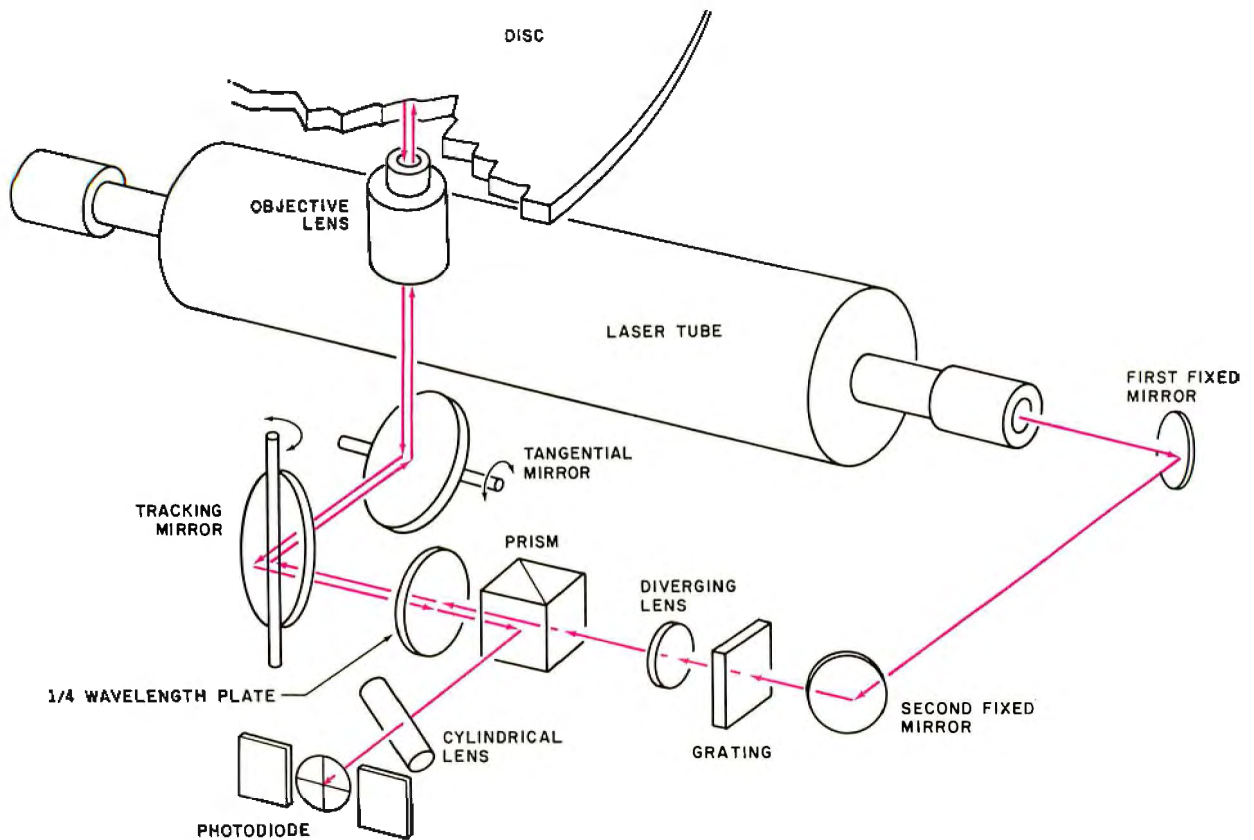

**Figure 1:** Diagram of the path of the laser light beam inside the Pioneer VP-1000 Laserdisc videodisc player. The red helium-neon laser projects its light through a complex optical path to the information-bearing layer of the videodisc. The light is reflected into the photodiode in a pattern that reproduces the carrier signal for the program material.

coded by frequency modulation on a carrier signal that is represented on the disc by the presence or absence of pits in the groove. The metal coating on the stylus functions as one plate of a variable capacitor. The disc itself, which is made of conductive vinyl, forms the other plate. As the stylus moves along the groove, the presence and absence of pits generates a variable capacitance which is converted to a voltage that reproduces the carrier signal.

Each "track" (a single rotation of the disc) in the CED system contains four video frames. Such high density allows lengthy recordings of one hour per side but prohibits slow motion and still-frame viewing. Therefore, RCA and other CED-system players are not well suited to certain computer-controlled applications. Also, because CED-system videodiscs use a contact interaction with the playback mechanism, they are sensitive to scratches and debris that can collect

on the disc surface; you have to take care to keep them unmarred and clean.

### Optical-Encoded Discs

The Pioneer VP-1000 Laserdisc system uses the optical-reflective videodisc encoding method jointly developed by MCA and Philips. The VP-1000 uses a disc in which the carrier signal is stored as an alternating spiral series of reflective areas and opaque pits in a layer lying underneath a surface that is smooth, grooveless, and transparent.

Figure 1 is a diagram of the optical scanning system inside the Pioneer Laserdisc player. The visible-red light beam from a low-power helium-neon laser is directed through a series of lenses and mirrors to the disc. The light shines through the surface layer and is reflected off the information-bearing layer back through the surface and optical path onto a photodiode. When the incident light hits an

opaque pit, it is not reflected back. The photodiode detects the presence or absence of reflected light and converts it into a current that reproduces the recorded carrier signal, on which the video and audio signals are modulated.

The Pioneer player can play back a videodisc at two different rates: standard play and extended play. The two modes are distinguished by differences in the density of the recorded data and the speed of the drive mechanism. In the standard-play mode, the information is stored on the disc so that the system reads data at a constant angular velocity (CAV), whereas in the extended-play mode, the data is read at a constant linear velocity (CLV—constant along the path traversed by the laser beam).

In addition to these differences from the CED system, the optical videodiscs used by the Pioneer machine have the advantage of near immunity to wear and tear. Because the



video information is sandwiched between protective transparent plastic layers, the disc is undamaged by dust and scratches. The laser just looks through the surface junk to the information-bearing layer beneath. Also, because the disc player has no stylus and uses a noncontact readout method, there is absolutely no wear on either the disc or the photodiode when in use, even in the still-frame mode, although some motion occurs in the optical-tracking mechanism.

### Two Operating Modes

In the VP-1000's CAV mode, the disc always rotates at 1800 rpm (revolutions per minute), so that one rotation takes 1/30 of a second. A single video frame (one still picture) is recorded on each rotation (track) of the disc; each side of the disc contains 54,000 tracks and therefore 54,000 frames. At the center of the disc, the packing density (amount of data squeezed into a given segment of a track) is four times greater than on the outside edge.

Because each rotation plays only one frame, it is possible to view a single frame as a still picture by causing the laser beam to repeatedly scan the same track. Because of the single-frame-per-track arrangement of data and the constant disc speed, the scanning repetition occurs 30 times per second, which is the standard television frame-refresh rate (in North America), and there is no flicker or distortion of the picture. This still-frame capability is unique to the optical videodisc players; it facilitates fixed- and variable-speed slow motion, fast motion, and rapid scan in both forward and reverse. Features such as these are very important in educational and industrial applications where viewers might want to stop and discuss pertinent details of various still pictures.

While the CAV mode is particularly suited for video interaction and computer-related activities, the extended-play CLV mode was designed simply to store more video frames, to be competitive with CED-format video players in the length of the program that the disc can hold. It would be impractical and cost-

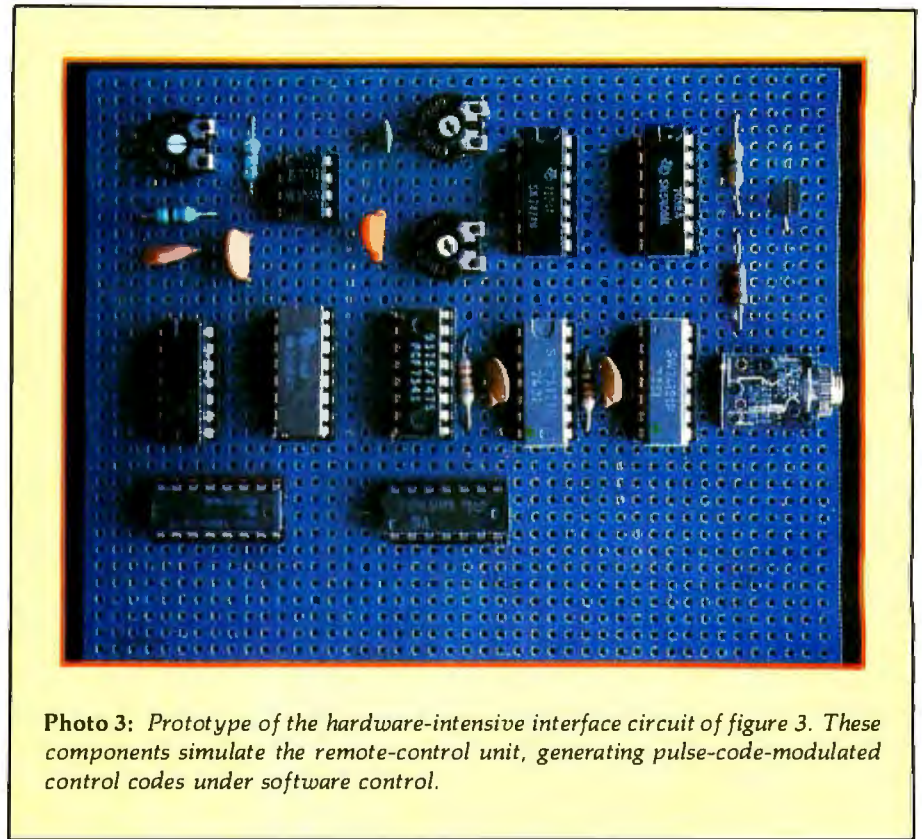

**Photo 3:** Prototype of the hardware-intensive interface circuit of figure 3. These components simulate the remote-control unit, generating pulse-code-modulated control codes under software control.

prohibitive to require three discs for an average-length movie.

In the CLV mode, the track closest to the center of the disc contains one frame, while a track on the outside edge contains four frames. The packing density of the information is the same for all frames. By varying the speed of rotation from 1800 rpm (when the light beam is reading from the center of the disc) to 600 rpm (when reading at the edge), up to one hour of program material can be recorded on each side. Unfortunately, because more than one frame is stored per track, various special functions such as still-frame, slow motion, and fast motion are inhibited. Since the projected applications of my videodisc interface need these features, I shall discuss the use of only the standard-play discs and the CAV mode.

### Embedded Signals

So far we have seen that the VP-1000 is indeed an advanced videodisc player for use in entertainment. More significant to us, however, is that the VP-1000 is directly suited for remote control through a computer.

Various control codes and data are placed in the video signal, in the vertical-blanking interval that occurs between the fields of picture information. (The vertical-blanking interval can be seen as the black horizontal bar across the screen when you cause the picture on your TV screen to roll vertically.) The VP-1000 stores 24-bit biphas-coded signals that define picture numbers, picture stops, "chapter" numbers, and various control codes (CAV-mode, CLV-mode, lead-in, and lead-out).

Every still picture on a CAV videodisc has a unique frame number (from 1 to 54,000). Using this number, the player-control system can identify and search for any one of the 54,000 frames and display it. This ability to so easily recall 54,000 separate still pictures may revolutionize certain types of visual research, when coupled with a computer-control system. (See the text box "JPL Puts the Planets on a Disc" on page 61.)

To search for and view one of these 54,000 frames, you merely enter the frame number on the VP-1000's control keyboard. The microprocessor control system in the player then

Function	Signal Transmission Code Value									
	K0	K1	K2	D0	D1	D2	D3	D4	D5	D6
0	0	0	1	0	0	0	0	1	0	0
1	0	0	1	1	0	0	0	1	0	0
2	0	0	1	0	1	0	0	1	0	0
3	0	0	1	1	1	0	0	1	0	0
4	0	0	1	0	0	1	0	1	0	0
5	0	0	1	1	0	1	0	1	0	0
6	0	0	1	0	1	1	0	1	0	0
7	0	0	1	1	1	1	0	1	0	0
8	0	0	1	0	0	0	1	1	0	0
9	0	0	1	1	0	0	1	1	0	0
Search	0	0	1	1	1	0	1	0	0	0
Chapter	0	0	1	0	0	1	1	0	0	0
Frame	0	0	1	0	1	0	1	1	0	0
Audio L/1	0	0	1	0	1	1	1	0	0	0
Audio R/2	0	0	1	1	0	1	1	0	0	0
Still/Step										
Forward	0	0	1	0	0	1	0	0	0	0
Reverse	0	0	1	1	0	0	1	0	0	0
Scan										
Forward	0	0	1	0	1	0	0	0	0	0
Reverse	0	0	1	1	1	1	0	0	0	0
Fast										
Forward	0	0	1	1	0	0	0	0	0	0
Reverse	0	0	1	0	1	1	0	0	0	0
Slow										
Forward	0	0	1	1	1	0	0	0	0	0
Reverse	0	0	1	0	0	0	1	0	0	0
Mode										
Pause	0	0	1	0	1	0	1	0	0	0
Play	0	0	1	1	0	1	0	0	0	0

Table 1: The 25 control codes accepted by the Pioneer VP-1000 Laserdisc player.

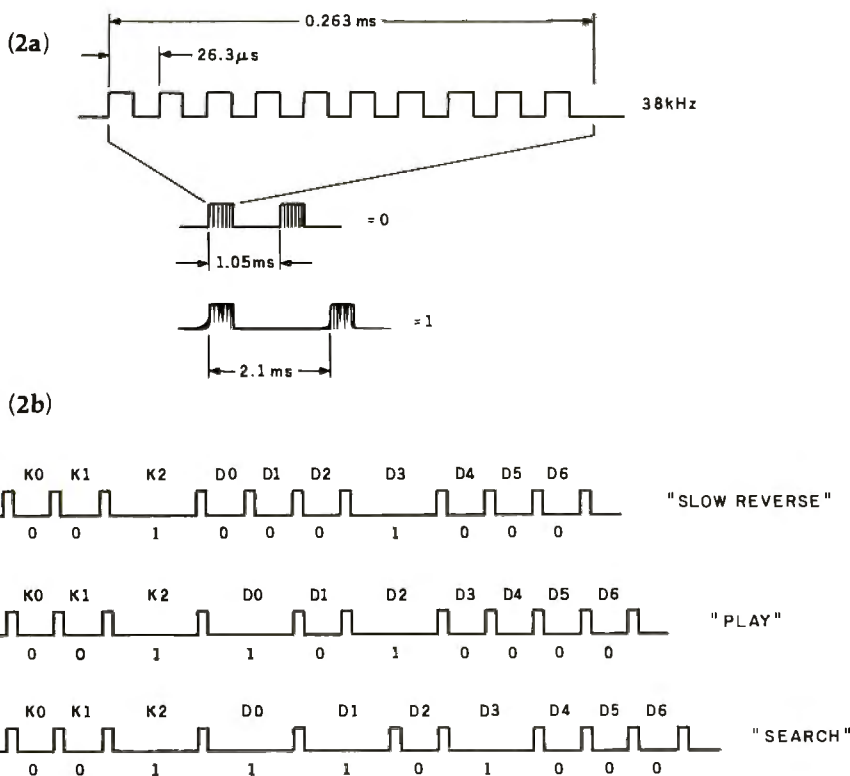

Figure 2: Encoding of the VP-1000's control signals. Bursts of a 38-kHz carrier signal are sent in a pulse-code-modulation pattern to convey 25 different commands. The pulse bursts are shown in figure 2a; examples of real control codes are shown in figure 2b.

searches for that particular frame and displays it on the video screen. The slowest access time is about 20 seconds; for 2 frames within 1000 counts of each other, it takes about 5 seconds.

### VP-1000 Remote Control

In reading magazine articles about videodiscs, I've seen many descriptions of videodisc formats and reviews of various commercial interfaces to the VP-1000, but I've seen very few articles that actually discuss the construction of an interface to the VP-1000 and disclose the control codes needed. (I did read one in which the author cut the Gordian knot: he unsoldered the encoder chip from the Pioneer hand-held remote-control keyboard and reattached the chip to a parallel port on a Commodore PET computer.)

It's really rather simple to design and use a full-function computer/videodisc-player interface without resorting to destructive measures. In the version of the Pioneer VP-1000 Laserdisc machine that I have, the optional remote-control keyboard communicates with the main unit by coded signals sent through a cable or via a wireless infrared-light link. These coded signals can easily be created by an external computer connected through the VP-1000's remote-control input jack. (Or use an infrared link similar to the one I described in "Use Infrared Communication for Remote Control," April 1982 BYTE, page 40.)

### Control Encoding

The VP-1000 can recognize and act on 25 different commands (listed in table 1) that are transmitted via a 10-bit PCM (pulse-code modulation) scheme. In the code combinations, five of the bit values are fixed, and five vary to specify the command. The first three bits (K0, K1, and K2) always have the values 0, 0, and 1, respectively. Similarly, the last two bits (D5 and D6) are always 0. Bits D0 through D4 form the command-selection segment of the transmission. For example, to command the player to pause, the remote-control unit sends the 10-bit code 0010101000, in



which bits D0 through D5 are 01010. The format of the transmission is detailed in figure 2.

The 10-bit commands are transmitted as a series of bursts of a carrier frequency, with the bursts separated by a specified duration of time that determines whether a 1 or a 0 is being transmitted. Each pulse burst consists of 10 cycles at 38 kHz (kilohertz) and is exactly 0.263 ms (milliseconds) long, as indicated in figure 2a.

A 10-bit transmission starts with a burst and ends with a burst; it contains 11 bursts. The elapsed time between the beginning of one burst and the beginning of the next, defined as the *bit period*, can be either of two durations: 1.05 ms to indicate a logic 0 or 2.10 ms to indicate a logic 1. The actual length of a 10-bit transmission will vary depending upon the quantities of 1s and 0s. Three examples are shown in figure 2b.

You can synthesize these codes in many ways. Depending upon your abilities, you may choose either a hardware- or software-intensive design. Generally speaking, if I have a choice, I always choose hardware. This time, however, synthesizing the control codes entirely in hardware would have unduly complicated the interface and only proven that I can make a mountain out of a molehill. Given the PCM coding used by the VP-1000, it's best to do much of the timing in software.

But old habits die hard, so I had to find someplace to wire a few chips. I have included two relatively simple hardware designs that are manipulated by software to varying degrees. Depending upon your programming talents, you might choose to reduce the hardware further.

#### Videodisc Controller: More Hardware

Figure 3 on page 68 is the schematic diagram of a relatively hardware-intensive controller design. Bit timing and pulse-burst generation are done with counters and one-shot multivibrators. The advantage of such a circuit is that it takes relatively little computer power and relies upon software only to provide the next code bit for transmission. I call this my full-



(4a)

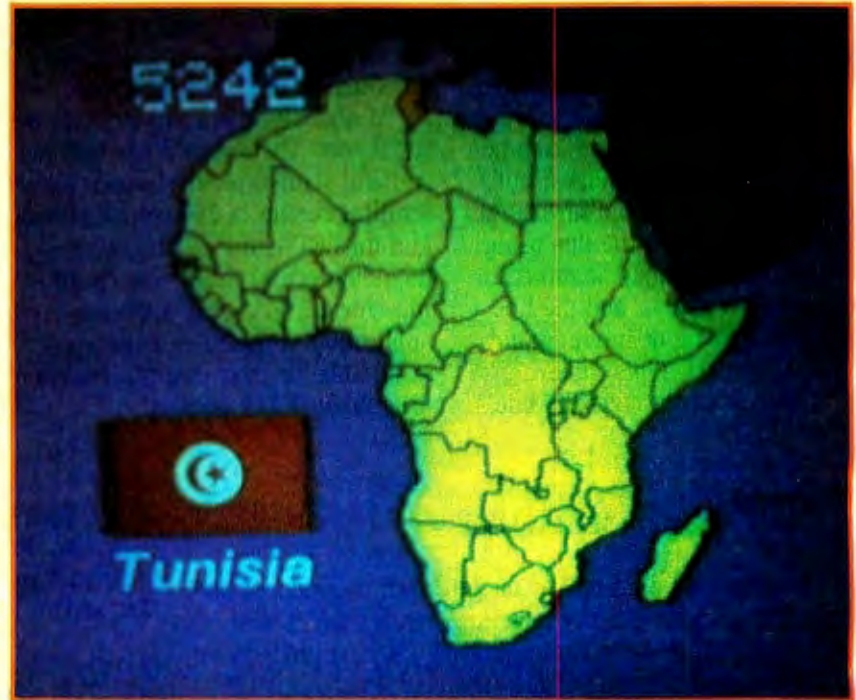

(4b)

**Photo 4:** In educational use, a computer program could ask a student to name the country associated with the flag shown in a still-framed video image, identified as frame 5241 in photo 4a. Then, to reinforce the answer, the program can call up frame 5242 (photo 4b) to show the country and its location on a map. Display of frame numbers is optional.



## CP/M-86 Now Mainframe Features For Your IBM Personal Computer

The CompuView implementation of CP/M-86 for the IBM Personal Computer has the features needed to run the full range of CP/M-86 application programs. Included are serial and parallel printer support, a 'smart' screen driver which can emulate many popular CRT terminals, and 193K/drive disk capacity. Innovative features include built-in horizontal scrolling for up to 254 columns and screen line editing, which lets the user extensively edit or re-enter any command line on the screen for CP/M-86 and application programs. In addition to IBM hardware, the TECMAR, Inc. Winchester hard disk, other hard disks and 80 tpi double sided drives are also supported.

Screen line editing is a desirable, time saving feature common on large mainframe computers, but not previously available on any CP/M system. Besides editing the line being typed in, the cursor may be moved to any line on the screen, and the line edited by overtyping or inserting and deleting characters. Typing the 'Return' key will then enter the line,

as it appears on the screen, to CP/M-86. Also, a string of 10 long commands can be repeated by moving the cursor to the first command and just typing the 'Return' key 10 times. This greatly reduces the amount of re-typing necessary due to mis-typed or repeated commands. Another common mainframe feature implemented is page control, which allows the screen to automatically stop after each new screen full of text.

The CompuView CP/M-86 is licensed from Digital Research and comes complete with all CP/M-86 utility programs. Software interchange is simplified by the ability to read and write IBM-MSDOS disks, IBM CP/M-86 disks and transfer files with other CP/M and CP/M-86 computers via the serial port. The screen driver includes a useful status line, horizontal scrolling for up to 254 columns, and faithful CRT terminal emulation, including editing functions, cursor movement and display attributes. Application programs can use the status line for their own purposes or to emulate a Z19 terminal.

We encourage you to compare our CP/M-86 with the version available from IBM. We have been careful to insure software compatibility and can read/write their disks. The table lists the major points of comparison between the two versions.

### Compare CompuView With IBM

	IBM	CompuView
Horizontal Scrolling	No	Yes
Screen Line Editing	No	Yes
Page Control	No	Yes
Emulate popular terminals	No	Yes
'Smart' CRT functions	No	Yes
Read/Write IBM MSDOS disks	No	Yes
Serial file transfer	No	Yes
Support non-IBM hardware	No	Yes
Programmable Function Keys	Yes	Yes
Status Line	Yes	Yes
Support Light Pen	Yes	Soon
File Capacity	154K	193K
CP/M-86 for IBM P.C. . . . . .		\$325
VEDIT-86 with above purchase (This version of VEDIT has horizontal scrolling for up to 254 columns) . . . . .		\$100

### V-COM Disassembler

Finally a Z-80 disassembler for CP/M which produces easy to read code, a cross reference table and handles INTEL and ZILOG mnemonics. V-COM is exceptionally fast and produces an .ASM file directly from a .COM file. The disassembly of a 12K program producing a 76K .ASM file containing 7500 lines of source code and a 33K cross reference file will typically take less than two minutes.

V-COM can accept two user created information files to *make the resulting code more readable*. One contains assignments of labels to 8 and 16 bit values; the second specifies the location of tables and ASCII strings. The resulting .ASM file will then contain labels and proper storage allocation for tables and

strings. Each information file may contain nested 'INCLUDE' to other files. Each package includes a 30 page manual, sample program files and variations of V-COM compatible with TDL, MAC and two types of ZILOG assemblers . . . . . \$80

### 8086 Software

VEDIT full screen editor for CP/M-86, MSDOS, IBM Personal Computer and IBM Displaywriter . . . . . \$195

CP/M-86 BIOS for popular S-100 disk controllers and SCP 8086 computer. Source Code . . . . . \$96

Bootable CP/M-86 disks for popular S-100 computers . . . . Call



# Software

## An Industry Standard for CP/M & 8086



### Uniquely User Oriented

VEDIT is user oriented to make your editing for program development and word processing as fast and easy as possible. The customization (installation) process makes VEDIT the only editing package that allows you to determine your own keyboard layout and use any available cursor and function keys. Just think of the difference it makes in your ease of learning and usage to type cursor and function keys instead of memorizing obscure control characters. This customization is menu driven, extends to much more and takes only a few minutes.

### Unequaled Hardware Support

The CRT version directly supports over 35 terminals (including ANSI standard) in its installation menu and utilizes 'smart' terminal features such as line insert/delete, reverse scroll, status line and reverse video. Function keys on terminals like the Televideo 920/950, Heath H19, and IBM 3101 are all supported. The memory mapped version is extremely flexible, supports bank select such as on the SSM VB3 and screen sizes up to 70 X 200.

### Sophisticated Full Screen Editing

VEDIT gives you true 'what you see is what you get' full screen editing with an extensive set of features for creating and editing standard text files of up to one diskette in length. Very large files are effortlessly handled by VEDIT's ability to edit up to 47K of a file entirely in memory without performing any slow and annoying disk accessing. And you can handle multiple files, insert a specified line range of another file anywhere in the text and even change diskettes.

### User Oriented Features

You get the features you expect, like searching, a scratchpad buffer for moving and rearranging sections of text, complete file handling on multiple drives and flexible macros. For ease of use VEDIT has features you won't find elsewhere, like automatic indenting for use with structured languages such as Pascal and PL/I. You are less likely to make a mistake with VEDIT, but if you do, one key will 'Undo' the changes you just made to a screen line. And if you run out of disk space with VEDIT, you can easily recover by deleting old files or even inserting another diskette. It is therefore no surprise that VEDIT is the industry standard for program development editing.

### Word Processing

VEDIT is suitable for simple stand-alone word processing, or it may be used in conjunction with a text processor. Its features include word wrap, adjustable left margin, reformatting of paragraphs, word oriented cursor movement and deleting, and imbedding of printer control characters. VEDIT can print any portion of your file and display the cursor's line and column positions.

Now for  
IBM  
Personal Computer  
XEROX 820

### Ordering

Please specify your micro-computer, video board or the CRT terminal version, the 8080, Z80 or 8086 code version and disk format.

VEDIT - Disk and manual  
For 8080 or Z80 . . . . . \$145  
For CP/M-86 or IBM MDOS . \$195  
Manual only . . . . . \$15

VISA and MASTER CARD Welcome.

Apple II Softcard • TRS-80 II and I  
SuperBrain • Heath H8/H89 • Altos  
NorthStar • Vector • MP/M • IBM

1955 Pauline Blvd., Suite 200  
Ann Arbor, Michigan 48103  
(313) 996-1299

# CompuView

PRODUCTS, INC.

CP/M and MP/M are registered trademarks of Digital Research, Inc. Apple II is a registered trademark of Apple Computer, Inc. Softcard is a trademark of Microsoft. TRS-80 is a trademark of Tandy Corporation. IBM Personal Computer is a trademark of International Business Machines, Inc.

Number	Type	+5V	GND
IC1	7400	14	7
IC2	7404	14	7
IC3	7475	5	12
IC4	74LS367	16	8
IC5	74121	14	7
IC6	74121	14	7
IC7	7474	14	7
IC8	74160	16	8
IC9	7404	14	7
IC10	NE555	8	1

Figure 3: Schematic diagram of a moderately hardware-intensive circuit to control the VP-1000 Laserdisc player from an external computer. Some software control steps are needed, notably the monitoring of I/O port hexadecimal 80 to determine when the interface can accept the next bit of the control code.

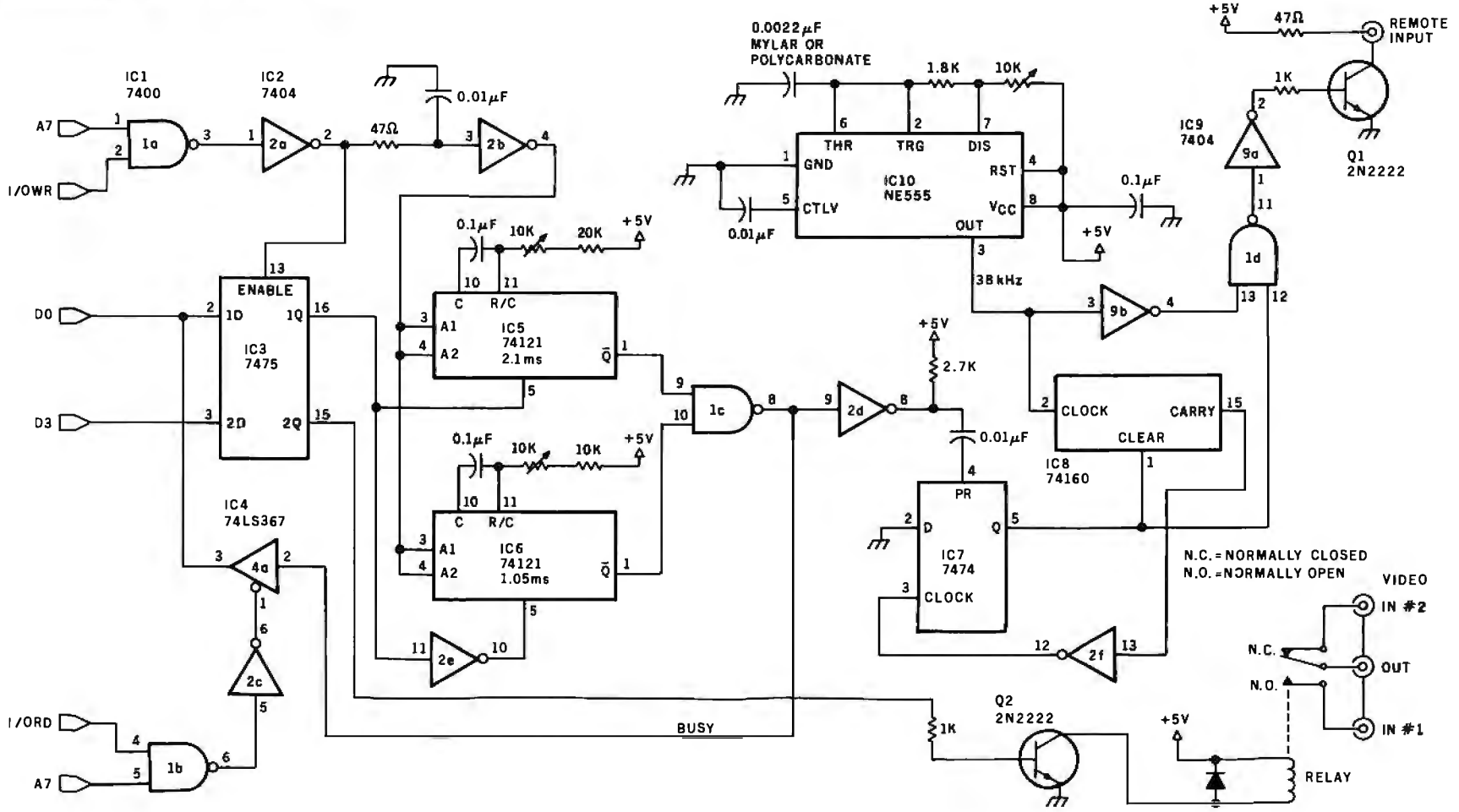



**Right for the time.** Finally someone invented an RS-232C compatible calendar/clock system, complete with 6-digit display... and selling for only \$249. Hayes did it!

Introducing the Hayes Stack Chronograph, the newest addition to the Hayes Stack microcomputer component series. It allows your computer to accurately record all of your system activities by date and time... down to the second. Thanks to a battery back-up system, you never have to reset the time when your computer is off, and it will keep on ticking even when there's a power failure. A write-protect switch prevents accidental

# Hayes Stack™

Microcomputer Component Systems

changing of day, date or time.

**Right for the job.** The Hayes Stack Chronograph is ideal for any home or business application requiring accurate timekeeping. Use it for timing everything from lights, burglar alarms, or sprinkler systems... to sending mail electronically (with the Hayes Stack auto-dial Smartmodem and your computer)... logging and recording reports or time-sharing access time...

and batching all your messages to send at night, when rates are lowest. Chronograph helps do it all.

**And Chronograph stacks up.** Keep your computer system up-to-date with the Hayes stackables, including the RS-232C compatible Smartmodem, the most sophisticated 300-baud originate/answer modem you can buy. And yet, it's probably the easiest to use too.

The Hayes Stack Chronograph and Smartmodem are available wherever fine computer products are sold. It's time. And it's now.

 Hayes

The Hayes Stack™ Chronograph.  
There's no better time.



Hayes Microcomputer Products, Inc. 5835 Peachtree Corners East, Norcross, Georgia 30092 404/449-8791

Hayes Stack is a trademark of Hayes Microcomputer Products, Inc. © Hayes Microcomputer Products, Inc.

Circle 208 on inquiry card.

hardware approach, which is used according to the flowchart and typical program sequence shown in figure 4 on page 70.

The interface is designed to communicate with a microcomputer via an I/O (input/output) port at hexadecimal address 80. To transmit the

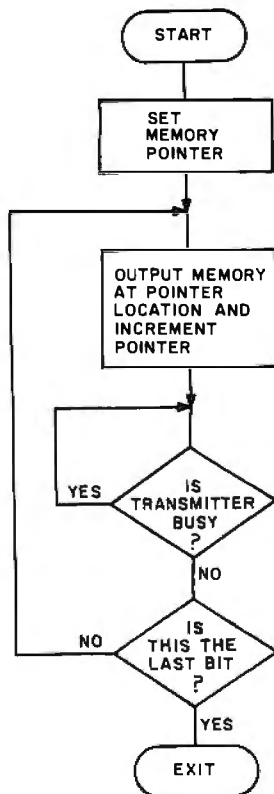

Figure 4: Flowchart of the algorithm to control the Laserdisc player using the hardware of figure 3. Typical microprocessor code (Z80) is shown in listing 1.

Listing 1: Assembler code for the Z80 microprocessor to perform the algorithm of figure 4, controlling the interface of figure 3.

```

LD HL, POINTER
AGAIN LD C, PORT
      OUTI
      CALL TEST
      LD A,L
      CP END
      JNZ AGAIN
TEST  IN A, PORT
      BIT 7,A
      JP 0, TEST
      RETURN
POINTER EQU 8000
PORT EQU 80
END EQU 8008
  
```

10-bit control code (which has been selected and formatted by some other high-level program), the computer first outputs the first control-code bit (K0) to port 80 as a logic 0 in the LSB (least significant bit) of the data bus (K0=0) or as a 1 in the LSB (K0=1). This value is loaded into the bistable latch IC3.

Depending upon this logic level, one of the two one-shots IC5 or IC6 will fire when IC3 is loaded. If the control-code bit is 0, then IC6 fires; if the control-code bit is 1, then IC5 fires.

The computer monitors the outputs of the two one-shots by testing the LSB of input port 80. If bit 0 is high when examined, then the interface is still busy transmitting the control-code bit. When the port's LSB indicates a logic 0 again, the interface has finished transmitting, and the computer program should output the next control-code bit to port 80.

The variable timing that sends a 1 or 0 is handled in hardware, with the computer cued to send the next bit by a Busy/Not-Busy signal from port 80. All the program has to do is simply monitor the Busy line and output the 10-bit VP-1000 control code one bit at a time. As shown in listing 1 accompanying figure 4, the program is barely 20 bytes long (written for a Z80 microprocessor).

The rest of the hardware in figure 3 produces the pulse burst. The flip-flop IC7 and the decade counter IC8 form a 10-cycle counter clocked by a 38-kHz oscillator (the timer IC10). When one of the one-shots fires, timing a bit period, the leading edge of this signal presets flip-flop IC7 and raises the Clear line on IC8 (allowing it to count). IC8 counts until it reaches 9 and then generates a carry pulse when it rolls over. This carry pulse clears the flip-flop and stops the counting process until a one-shot is triggered again. During the counting period, the 10 clock cycles (the 38-kHz pulse burst) are transmitted to the VP-1000. The timing between pulse bursts is controlled by the computer monitoring the busy line.

One extra item in figure 3 is a relay. The relay is enabled by bit 3 of the input port 80 and can be used to switch

a single video monitor between two video sources. One source could be the output of the computer's regular display, while the other could be the videodisc player's output. Using the relay, the computer could display some appropriate material from the videodisc and then switch the screen back to the computer's own output to pose a question about the contents of the videodisc program.

### Videodisc Controller: Less Hardware

Figure 5 on page 72 shows a more software-intensive approach, which uses just the pulse-burst generator from figure 3. A flowchart of the algorithm to use this circuit is shown in figure 6 on page 74. As all timing except for the carrier is done in software and this circuit is triggered by a pulse rather than a discrete logic level, a data latch is unnecessary. Bit timing is still important, but a few microseconds here or there won't make much difference.

As configured, the control program should allow either 1.05 or 2.10 ms to elapse (depending upon the control-code bit value) and then activate the pulse-burst generator. In my opinion, this method is preferable to the hardware-intensive design of figure 3.

As I have described, handling the entire communication between the computer and the videodisc player is simply a matter of timing and logic switching. If you have just a parallel output port on your computer and excellent skill with software, you could conceivably synthesize the entire command sequence, including the 10-cycle 38-kHz pulse burst, entirely in software. At only 26.3 microseconds per cycle, however, you will have to code a tight program without many branches and subroutines. Because such a program has to be machine-specific and coded with the clock speed of the processor in mind, I decided to forego the exercise for this article.

### Future of Computer Videodiscs

Every computer manufacturer is striving to maximize the processing



MDBS: Superior Data Base Management for Application Developers

# Mainframe solutions at micro prices.

MDBS solves the problem of expensive, time-consuming application development and maintenance.

Here's what makes the MDBS Data Base Management System so unique:

**ECONOMY**—Our state-of-the-art system cuts application development costs by up to 80%.

**EFFICIENCY**—Data compression allows optimum use of space.

**HARDWARE COMPATIBILITY**—From 8080, Z80™...to the PDP-11™, MDBS delivers uniformly excellent results.

**PORTABILITY**—MDBS operates under most popular operating systems and languages, including CP/M™, UNIX™, IBM PC DOS™, COBOL, BASIC, PASCAL, C, PL/I, FORTRAN, and many more.

**INTEGRITY**—RECOVERY, RESTART, and the ability to roll the data base back are available. Data base integrity is supported through advanced data structuring techniques.

**AUTHENTICITY**—MDBS is the first and only true and complete DBMS currently available on microcomputers.

**CAPABILITY**—Our system includes features you won't find anywhere else, at any price.

- Fully-integrated, dictionary-driven.
- Unparalleled data structuring ability—far superior to hierarchical, CODASYL, and relational approaches.
- Powerful, English-like query system entirely non-navigational. Fully supports spur-of-the-moment "what if" inquiries.
- Query nesting allowed. Automatic sorting of output tables.
- Built-in data security down to the field level. Data encryption capability.
- Performance tuning, including the ability to influence physical storage structures.
- Extremely fast retrieval even for large volume data bases.
- Multi-users capabilities including active and passive lockout.

MDBS is not restricted to the limitations of data base "pretenders" like file management systems.

To help make application development more effective and efficient, MDBS also offers extensive consulting services and professional training seminars.

Z80 is a registered trademark of Zilog; PDP-11 of Digital Equipment Corp; CP/M of Digital Research; UNIX of Western Electric; PC DOS of IBM.

**MDBS and other fine products are distributed in most countries through ISE.**

For further information contact:

In U.S.:  
ISE-USA  
350 West Sagamore Parkway  
West Lafayette, IN 47906  
Tel: (317) 463-2581  
TWX: 810-342-1881

In France:  
ISE-CEGOS  
Tour Chenonceaux  
204, Rond-Point du Pont de Sevres  
92516 Boulogne Billancourt Cedex  
Tel: 620-61-04

In Germany:  
ISE-ADV/ORGA GERMANY  
Lothstr. 19  
D-8000 Munich 40  
Tel: 089-192 071/4

In Sweden:  
ISE-DATEMA SWEDEN  
Box 1056  
Huvudstagan 1  
171 21 Solna

In Switzerland and Austria:  
ISE-ADV/ORGA SWITZERLAND  
Morgartenstrasse 6  
CH-6003 Luzern  
Tel: 041-23 23 60/61

In the UK and Ireland:  
ISE-PACTEL  
Rochester House  
33 Greycoat Street  
London SW1P2QF  
Tel: 01-828 7744

Elsewhere:  
ISE-INTERNATIONAL  
350 West Sagamore Parkway  
West Lafayette, IN 47906  
Tel: (317) 463-4561  
TWX: 810-342-1881



**Professionals know the difference.**

Note: For more about ISE see page 223

Please call me immediately at ( ) \_\_\_\_\_  
(phone no.)

Please tell me about your half-day seminar

Please tell me about your three-day workshop

I'm enclosing \$105 in payment for the MDBS manual (\$135 overseas; Indiana residents please add \$3.80 sales tax)

Please charge to my VISA \_\_\_\_\_ or MasterCard \_\_\_\_\_

Card Number \_\_\_\_\_ Phone No. \_\_\_\_\_

Signature \_\_\_\_\_ Expiration Date \_\_\_\_\_

Name \_\_\_\_\_ Title \_\_\_\_\_

Company \_\_\_\_\_

Address \_\_\_\_\_

City \_\_\_\_\_ State \_\_\_\_\_ Zip \_\_\_\_\_

Phone \_\_\_\_\_ (area code) \_\_\_\_\_ (ext.) \_\_\_\_\_

MAIL TO: Your local ISE affiliate.

1B 222

Please look for us at the NCC, Booth No. 3745.  
and Booth No. 226, Computerama, Toronto.

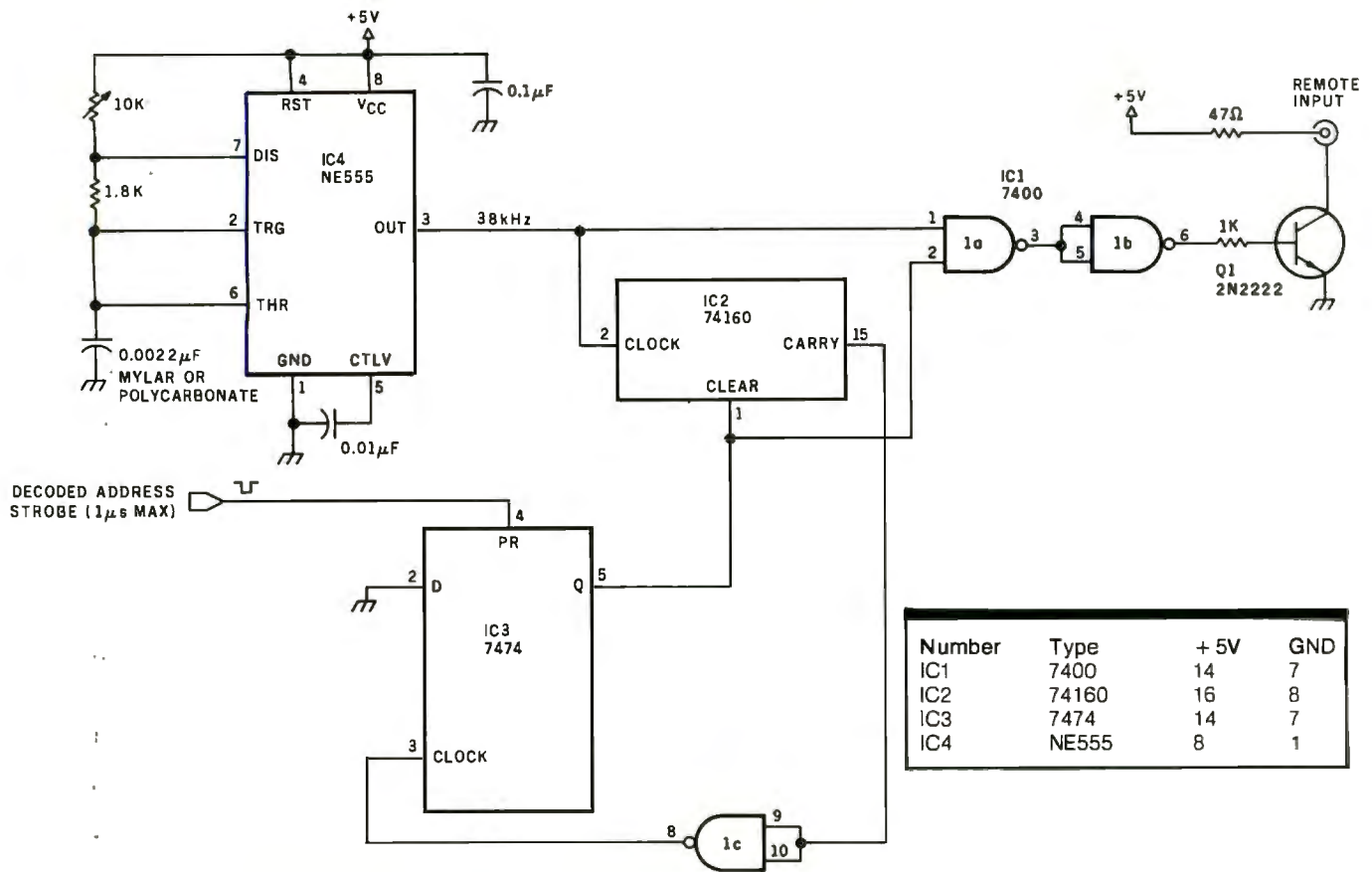

Figure 5: A simpler circuit for controlling the VP-1000 Laserdisc player that relies somewhat more on software to perform timing of the pulse bursts.

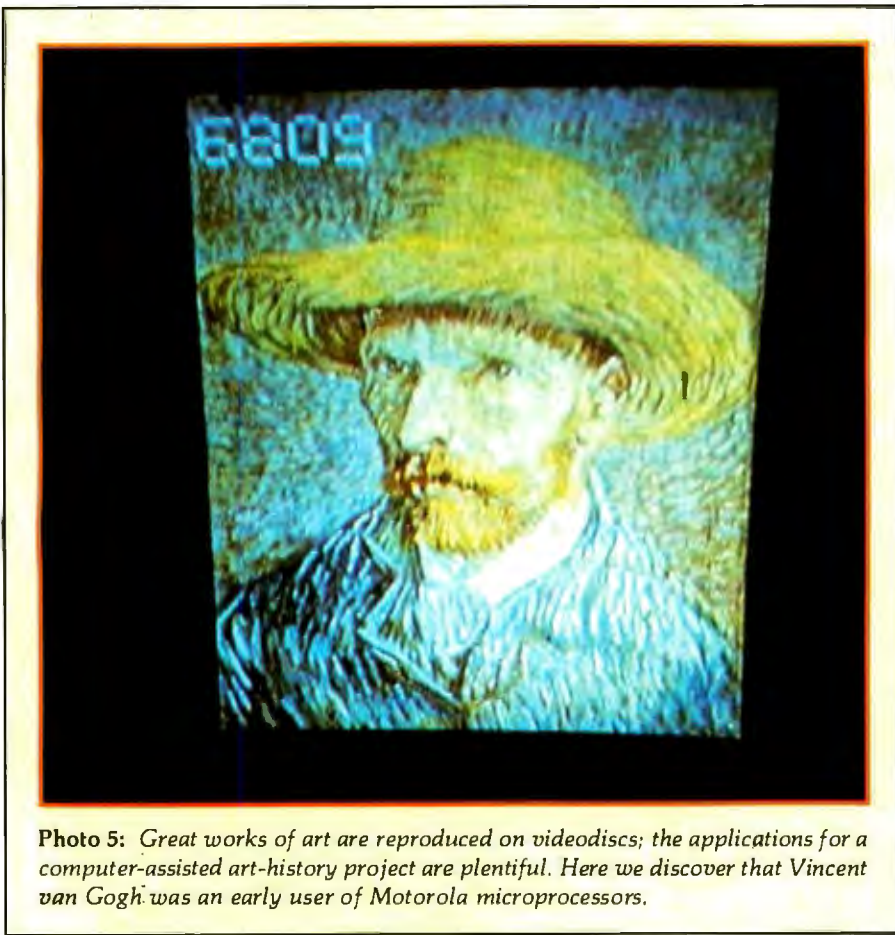

Photo 5: Great works of art are reproduced on videodiscs; the applications for a computer-assisted art-history project are plentiful. Here we discover that Vincent van Gogh was an early user of Motorola microprocessors.

power of its machines while minimizing the cost per bit of online storage. Increasingly, 10-megabyte or larger Winchester-technology hard-disk drives are spoken of as required peripheral devices as more and more computer applications are developed that require storage and use of large amounts of data.

We should take care not to overlook the technical possibilities of the Pioneer Laserdisc and its kin while viewing *Star Trek* and *The Jerk*. The laser-optical videodisc player is a mind-boggling 20-gigabit random-access read-only memory that costs only \$600. Try pricing that storage on any kind of magnetic disk!

Eventually, optical storage discs will be produced which contain vast databases, not simply as video still frames, but as computer-readable program code and data files. Instead of pictures of 10,000 pages of text, the disc will simply contain the text stored as ASCII (American Standard Code for Information Interchange) files. Then several billion characters could be stored.



# ALL MATTER IS MODULAR. YOUR PRINTER SHOULD BE, TOO.



Introducing the Prism Printer™ from Integral Data Systems, the first truly modular, field-upgradeable dot matrix printer. Now your printer can be as flexible as the rest of your system.

Start with the basic printer which features text-quality printing; then add the performance options you need — when you need them. Add the automatic cut sheet feeder for word processing. Install the Sprint Mode™ for high-speed data output. For communicating information and ideas faster, nothing is more effective than the Dot Plot™ graphic option and Prism Color™ option — this gives you high-quality, multi-color output in text, graphs and charts. And that's just the beginning. More Prism option modules will be available soon.

If you're an APPLE™, IBM™ or other professional microcomputer user, Prism Printer is the key to your system solution. At last, the chemistry is right between you and your printer. You'll never pay too much or get too little again. The Prism Printer from Integral Data Systems.

For the name of your nearest Integral Data Systems Dealer, call toll free (800) 258-1386. In New Hampshire, Alaska and Hawaii, call (603) 673-9100.



**Integral Data Systems, Inc.**

Millford, NH 03055

Telex: 95 3032

*APPLE is a registered trademark of Apple Corporation.*

*IBM is a registered trademark of International Business Machines Corporation.*

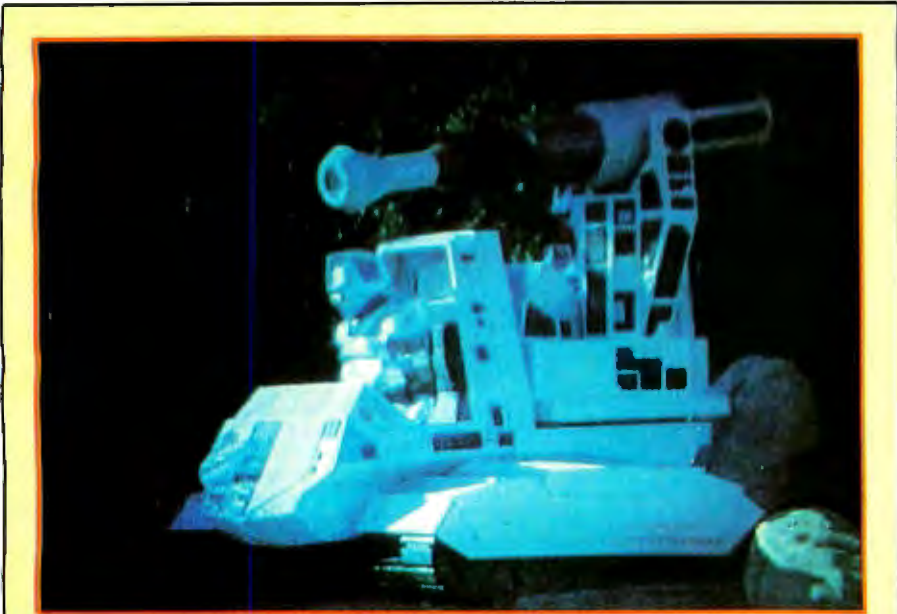

Photo 6: Computer game fans will use their computer-interfaced videodisc players for fun, perhaps playing a space-war game spiced up with images from Battlestar Galactica. The video images reproduced in this article were photographed from a Pioneer LS-501 large-screen projection television receiver.

The real breakthrough in videodisc technology will come with the ability to record as well as play a disc. While some descendant of today's videodiscs might become a fully flexible read/write medium, it appears that the first such machine to appear might be a gigantic write-once read-only memory, or WOROM.

**In Conclusion**

The technology is still in its infancy today, but I expect that eventually optical videodisc players will become not only practical but necessary computer peripherals. For the present, however, our computer interfaces will have to wait for material suitable for video/computer interaction.

Considerable effort is being expended in the production of educational and scientific discs, but I am sure you can expect one of the major software suppliers to have a videodisc specially produced for adventure games. For my own use of the Laserdisc player, my controller will be there when computer-applicable material arrives at my door. But right now, I think I'll sit down and watch a cooking-class disc. I heartily recommend the *clams cassino*.

**Next Month:**

When we've finished working with video, we can turn our attention to audio. In July we'll see how to create sound effects using a new integrated circuit from Texas Instruments. ■

**Editor's Note:** Steve often refers to previous Circuit Cellar articles as reference material for each month's current article. Most of these past articles are available in reprint books from BYTE Books, 70 Main St., Peterborough, NH 03458. Ciarcia's Circuit Cellar, Volume I covers articles that appeared in BYTE from September 1977 through November 1978. Ciarcia's Circuit Cellar, Volume II contains articles from December 1978 through June 1980. Ciarcia's Circuit Cellar, Volume III contains the articles that were published from July 1980 through December 1981.

To receive a complete list of Ciarcia's Circuit Cellar project kits available from the Micromint, circle 100 on the reader service inquiry card at the back of the magazine.

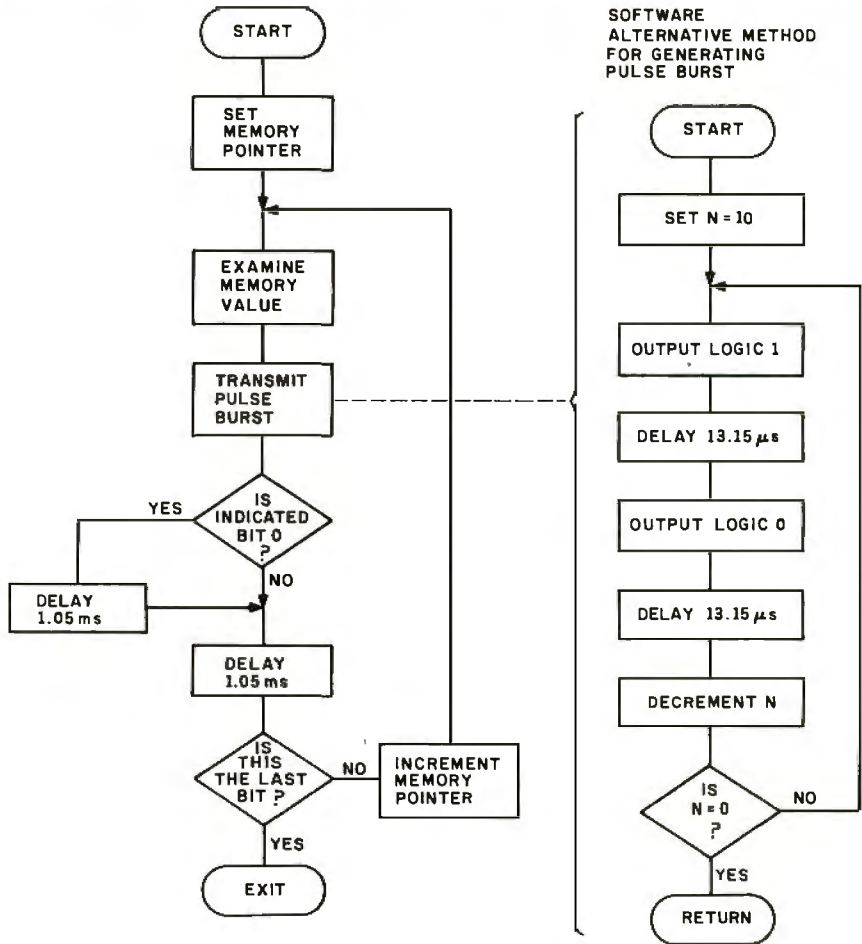

Figure 6: The algorithm to control the Laserdisc player using the circuit of figure 5. Clever, tight coding could produce a program that can handle all of the timing and make the needed hardware even more simple.



# GALAXY OF FEATURES

A **GALAXY** of features makes the **LNW80** a remarkable computer. As you explore the **LNW80**, you will find the most complete, powerful, ready to run, feature-packed personal and business computer ever made into one compact solid unit.



**MODEL I COMPATIBILITY** – The **LNW80** is fully hardware and software compatible with the Model I. Select from a universe of hardware accessories and software – from VisiCalc™ to space games, your **LNW80** will launch you into a new world of computing.

**FULLY LOADED** – A full payload includes an on-board single and double density disk controller for 5 1/4" and 8" single or double sided disk drives. RS232C communications port, cassette and parallel printer interfaces are standard features and ready to go. All memory is fully installed – 48K RAM, 16K graphics RAM and 12K ROM complete with Microsoft **BASIC**.

**QUALITY CONSTRUCTION** – Instrumentation quality construction sets **LNW80** computers apart from all the rest. Integrated into the sleek solid steel case of the **LNW80** is a professional 74-key expanded keyboard that includes a twelve key numeric keypad.

**HIGH RESOLUTION GRAPHICS & COLOR** – The stunning 480 X 192 resolution gives you total display control – in color or black and white. The choice of display formats is yours; 80, 64, 40 and 32 columns by 24 or 16 lines in any combination of eight colors.

**PERFORMANCE** – Lift-off with a 4MHz Z80A CPU for twice the performance. The **LNW80** outperforms all computers in its class.



Our down to earth price won't send you into orbit

## LNW Research Corp.

2620 WALNUT Tustin, CA. 92680  
(714) 641-8850 (714) 544-5744

Monitor and Disk drives not included  
IBM Personal Software, Inc.



# Peachpak



∞ PeachPay<sup>™</sup>  
payroll system

User's Manual



∞ sales invoicing

User's Manual



∞ inventory

User's Manual



∞ accounts receivable

User's Manual



∞ accounts payable

User's Manual



General ledger

User's Manual





# Pick a Pak of Peachware™

Peachtree Software™ has long been a leader in the microcomputer software field. Its quality and reliability have made it the standard in business software, and its documentation and ease of operation have made it the choice of users everywhere.

Now there's a new look to Peachtree Software. The look is Peachware,™ and it's destined to change the way you think about software.

The Peachware concept is simple: give the user a complete solution to his business software needs. How? The Peachpak.™

In our Peachpaks, we've put together integrated systems of related packages—in accounting or word processing, for example—to give the user the most benefit from his micro in his business functions.

The Peachpak 8 Accounting Series—which includes General Ledger, Accounts Payable, Accounts Receivable, Sales Invoicing, Inventory Control and PeachPay™ payroll—gives you the quick response, accurate results and timely reports you need to maintain complete control of your finances, the lifeblood of your business.

The Peachpak 9 Office Productivity Series is centered on the PeachText™ word processor (formerly Magic Wand®; we've improved it and like the results so much we decided to put our name on it) and includes the PeachCalc™ Electronic Spreadsheet, Spelling Proofreader, Mailing List Manager and Telecommunications. Peachpak 9 extends the Peachware solution to all areas of the electronic office.

That's not all. We've got Peachpaks for different levels of accounting

needs, for vertical applications, even one designed specifically for the Apple II™ computer.

And we have Peachcare,™ our own approach to the critical problem of after-sale support and service. It runs the gamut from PeachTax,™ a subscription service to keep your PeachPay package updated on changes in tax requirements, to the Peachtree Software Product Center, which offers direct sales and software support to the user.

We're bringing these services to more people every day, both in the United States and abroad, through our network of almost 1,000 dealers and Peachtree Software International, headquartered just outside London. We have more than 40,000 packages installed worldwide, and the number is growing rapidly.

Peachtree Software is picking up its pace to meet the burgeoning needs of micro users. It's part of our effort to make sure that, when it comes time for you to pick your software, you pick the leader. Pick a peach.

**Peachpak™ 4 Accounting Series**  
General Ledger      Inventory  
Accounts Payable      Payroll  
Accounts Receivable

**Peachpak™ 40 Accounting Series, Apple II Edition**  
General Ledger      Inventory  
Accounts Payable      Payroll  
Accounts Receivable

**Peachpak™ 6 Client Accounting Series**  
Client Posting and Accounting System  
Passive Payroll



**Peachpak™ 61 Property Management Series**  
Property Management System  
General Ledger

**Peachpak™ 71 Sales Tracker (COBOL)**  
Accounts Receivable and Sales Analysis  
Inventory  
Order Entry

**Peachpak™ 8 Accounting Series**  
General Ledger  
Accounts Payable  
Accounts Receivable  
Sales Invoicing  
Inventory Control  
PeachPay™ Payroll System

**Peachpak™ 9 Office Productivity Series**  
PeachText™ Word Processor  
Spelling Proofreader  
PeachCalc™ Electronic Spreadsheet  
Mailing List Manager  
Telecommunications

Circle 360 on inquiry card.

Apple II is a trademark of Apple Computer Inc. Peachtree Software, Peachware, Peachpak, PeachPay, PeachText, Magic Wand, PeachCalc, Peachcare and PeachTax are trademarks of Peachtree Software Incorporated, an MSA Company.

Copyright © 1982 Peachtree Software Incorporated, an MSA Company.

Please send me information on Peachware™ by Peachtree Software.

Name: \_\_\_\_\_

Company: \_\_\_\_\_

Address: \_\_\_\_\_

City: \_\_\_\_\_ State: \_\_\_\_\_ Zip: \_\_\_\_\_

I am a:  prospective dealer     user of software

BY 682

**Peachtree Software Incorporated** an MSA company

3445 Peachtree Road, N.E. / 8th Floor / Atlanta, Georgia 30326 / (404) 266-0673



# Videodiscs in Education

## Integrating the Computer and Communication Technologies

*Interactive videodiscs are entering the classroom.*

---

Dr. Isaac I. Bejar  
Educational Testing Service  
Princeton, NJ 08541

---

Both the communications and computer industries have achieved tremendous growth but, for the most part, have developed unmindful of each other. Their disagreement over legislation to deregulate the communications industry suggests both are beginning to step on each other's turf. Now that the antitrust cases against AT&T and IBM have been dropped, some predict the two industries will eventually coalesce into a new information industry. The recent coming of age of the videodisc, a product that integrates both technologies, suggests that the prediction may be valid.

Both the communications and computer technologies have a long, and perhaps sad, tradition in education. Critics often refer to educational television as a "failure." That charac-

terization is probably not fair to much of today's educational television, but the early attempts were certainly affected by a lack of understanding of the medium. Some of the early experiments on the effectiveness of television as an instructional medium were little more than comparisons of a live lecturer and a "talking head." No wonder many of these experiments showed "televised" instruction to be no better than live instruction.

Today, while less than inspiring educational programs continue to be produced, a fair amount of good educational television does exist. Moreover, the medium's potential effectiveness for educational purposes is gradually being established as suggested by the evaluation of Sesame Street (see reference 1) and other programs.

The computer has also had a mixed history in education. While the technology's potential was realized by some of the early innovators, the realities of the marketplace prevented the predicted boom of computers in education (see reference 2). Because software developers were not sure of the market, they did not strive to produce the best possible product. This led, in turn, to poor acceptance of the software, which fulfilled the developers' own prophecy.

However, the effectiveness of CAI (computer-assisted instruction) now seems established judging by the results of several projects including a large-scale field test being conducted in Los Angeles public schools by the Educational Testing Service for the National Institute of Education. On the market side, the cottage industry that has provided educational programs is now beginning to be supplemented by established publishers.

Together, these trends suggest that at last technology is gaining a foothold in education, and because of this, the videodisc may be more readily accepted into the classroom than television or computers.

Nevertheless, caution is necessary. From a historical perspective, the current educational application of videodisc technology stands at a point equivalent to the early years of educational television and CAI. The collective results of current projects are bound to have a significant impact on the future of videodisc technology in education. Therefore, the technology must be given a fair chance to demonstrate its effectiveness, which will be a function of tangible factors, such as the quality of the hardware and software, as well as intangible factors, such as the attitudes of teachers toward technology. This article concentrates on the tangible factors by

---

### About the Author

Isaac I. Bejar is a Research Scientist at the Educational Testing Service.

---

*This article is based upon work supported by the National Science Foundation and the National Institute of Education under Grant No. SED-8024465. (Isaac I. Bejar and Spencer Swinton, principal investigators.) Any opinions, findings, conclusions, or recommendations expressed in this publication are those of the author and do not necessarily reflect the views of the National Science Foundation or the National Institute of Education.*

---





# COMMODORE VIC-20<sup>®</sup>

## “THE WONDER COMPUTER OF THE 1980s. UNDER \$300.”

—WILLIAM SHATNER



“The best computer value in the world today. The only computer you’ll need for years to come.”



JOYSTICK PADDLE LIGHTPEN  
ON/OFF SWITCH  
POWER PACK



PLUG-IN PROGRAMS  
2K/8K/16K MEMORY EXPANSION  
PLUG-IN PROGRAM  
EXPANSION MODULE  
RF MODULATOR  
TELEVISION OR MONITOR  
VIDEO CABLE  
SINGLE DISK DRIVE  
PRINTER  
COMMODORE DATACASSETTE  
MODEM FOR TELEPHONE AND TELECOMPUTING

### VIC-20<sup>®</sup> VS. OTHER HOME COMPUTERS

Product Features	Commodore VIC-20	Atari <sup>™</sup> 400 <sup>™</sup>	TI <sup>®</sup> 99/4A	TRS-80 <sup>®</sup> Color Computer
Price*	\$299.95	\$399.00	\$454.00	\$399.00
Maximum RAM Memory	32K	16K	48K	32K
Keyboard Style	Full-Size Typewriter Style	Flat Plastic Membrane	Full-Size Typewriter Style	Calculator Style
Number of Keys	66	57	48	53
Programmable Function Keys	4	0	0	0
Graphic Symbols On Keyboard	62	0	0	0
Displayable Characters	512	256	192	256
Microprocessor	6502	6502	TMS 9900	6809
Accessible Machine Language	YES	YES	YES	YES
Upper/Lower Case Characters	YES	YES	YES	NO
Operates with all Peripherals (Disk, Printer and Modem)	YES	NO	YES	YES
Full Screen Editor	YES	YES	YES	NO
Microsoft <sup>®</sup> Basic	Standard	N/A	N/A	\$ 99.00
Telephone Modem	\$109.95	\$399.95	\$450.00	\$154.95



Read the chart and see why COMPUTE! Magazine<sup>1</sup> calls the VIC-20 computer “an astounding machine for the price.” Why BYTE<sup>2</sup> raves: “...the VIC-20 computer unit is unexcelled as a low-cost consumer computer.” Why Popular Mechanics<sup>3</sup> says “...for the price of around \$300, it’s the only game in town that is more than just a game.” And why ON COMPUTING INC.<sup>4</sup> exclaims: “What is inside is an electronic marvel... if it sounds as if I’m in love with my new possession, I am.”

The wonder computer of the 1980s. The VIC-20 from Commodore, world’s leading manufacturer of a full range of desktop computers. See the VIC-20 at your local Commodore dealer and selected stores.

1 April '81 issue 2 May '81 issue 3 November '81 issue 4 Fall '81 issue

\*Manufacturer’s suggested retail price Mar. 1, 1982



Commodore Computer Systems  
681 Moore Rd., King of Prussia, PA 19406  
Canadian Residents: Commodore Computer Systems  
3370 Pharmacy Ave., Agincourt, Ont., Canada, M1W 2K4

BY-6

Please send me more information on the VIC-20.

Name \_\_\_\_\_  
Address \_\_\_\_\_  
City \_\_\_\_\_ State \_\_\_\_\_ Zip \_\_\_\_\_  
Phone \_\_\_\_\_

Circle 98 on inquiry card



exploring hardware-software considerations and courseware (instructional or educational software) issues and leaves the intangible factors for another occasion and forum. An ongoing project concerned with applying videodisc technology to the teaching of elementary mathematics has provided a framework for the discussion that follows.

### Hardware-Software Considerations

Our research is oriented toward the development of individualized learning stations. That is, we envision an environment where individual students will have access to a computer which, in turn, will control several peripherals, including a videodisc player. The video output from the computer, both text and graphics, and the video from the videodisc will appear on a single screen. Input to the computer will be through a keyboard, light pen, and eventually natural speech.

**Choice of computers:** An important principle in choosing a computer system for an educational environment is to distinguish between development and delivery systems. You need a development system to facilitate authoring, i.e., the creation of both textual and graphic materials and the selection of audiovisual materials. A delivery system need only be capable of delivering and managing the instructional materials. In principle, you need a substantially less expensive machine for delivery purposes. Choose the development system with an eye toward transporting the results to a delivery system. Because research takes time, often by the time the project ends a new generation of hardware has emerged. With luck, the emergence of the new generation will bring down the price of what was the development system to such an extent that you can justify it as a delivery system, thus obviating the need to transport everything to the new machines.

This reasoning suggests that it would be inappropriate to base research and development effort entirely on the current crop of computers because they are now near the end of their life cycle. For example, the TRS-80 has definite limitations, such as the difficulty of going beyond 48K bytes of memory and implementing standard operating systems, such as CP/M. The Apple also has a serious limitation in the use of a nonstandard video signal, which makes it difficult to integrate the video output from the computer and videodisc. (As it turns out there is a board from Video Associates Lab that makes this possible, but the board itself costs more than the Apple. Also Adwar sells a black box, the ARS-170, that brings the Apple video signal up to National Television Standard Code [NTSC] standards.)

A second determining factor in the choice of a computer is the availability of software to facilitate the authoring process as well as the delivery of instruction. Currently the most powerful authoring system that supports both video tape and videodisc is the University of Utah's Video Courseware Implementation System (VCIS). The system runs under UCSD Pascal on a Terak 8510/a computer. We chose the Terak-VCIS combination as our development system because, theoretically, with it you can use any machine running under UCSD Pascal as a delivery system.

The Terak is a 16-bit, medium-resolution (256 by 320), black-and-white graphics computer based on the LSI-11 processor. Our system has 56K bytes of memory, two double-density disk drives, one serial port, a keyboard, and a display. The educational price was close to \$8000. The documentation is not extensive, but over-the-phone technical support has been excellent. Two operating systems are available for the Terak, UCSD Pascal and RT-11. You can upgrade the Terak 8510/a for high-resolution color, but this costs several thousands of dollars.

**Choosing a videodisc player:** Three competing videodisc systems are on the market today. These include the RCA Selectavision, which is based on

## ARBAGATOR

### *Puts it on the line*

**ARBA Register**

**"on line with virtually any computer."**



**ARBA**

FINE BUSINESS COMPUTING  
890 E. ROOSEVELT  
LOMBARD, IL 60148  
312-620-8566

- Do real time point of sale inventory control
- RS232C interface at 300 baud
- Standard asynchronous ASCII code.
- Time tested LSI circuitry.
- \$1295 suggested retail—dealer pricing available.

**Coming soon! Point of sale software.**



# New from HIPLØT™

## multi-pen plotting for as little as \$1480\*.



FCC class B tested.  
UL listed.

### *the Houston way*

The new HIPLØT DMP Series 6-pen option makes high performance multi-pen plotting affordable. It's available on the DMP 2, 3, and 4 models in the HIPLØT family so you can enjoy the advantages of multi-colored plots on 8½" × 11" (DIN A4) surfaces. Of course, you also get the standard HIPLØT range of capabilities such as intelligence, controls, interfaces and resolutions. There's a model for virtually every plotting application.



**Big Performance in a Small Plotter**  
Since its introduction, the HIPLØT DMP Series has been recognized as the innovative plotter

line which made low-cost, high performance digital plotting a reality.

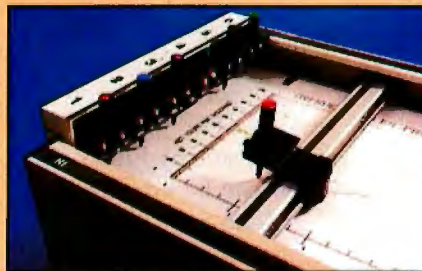

Now, with our new 6-pen option, there's an exciting new dimension in the DMP Series' versatility. Imagine two standard models with RS-232-C and parallel interfaces, four intelligent models with RS-232-C or Centronics® compatible interfaces, a choice of controls, resolutions, and pen speeds. Add to this the ability to plot with 6-pens on paper, vellum or mylar (ideal for overhead projectors) and you have the ultimate plotter price/performance combination — the perfect choice for the user or OEM.

#### 8-Pen Models Also Available

If you need a little more capability, take a look at our new 8-pen option. It's available on the DMP 5, 6, and 7 so you can have 8-pen multi-colored plots on 11" × 17" (DIN-A3) surfaces.

*Why wait? Let us send you complete information on this breakthrough in affordable, multi-pen plotting. Contact Houston Instrument, P.O. Box 15720, Austin, Texas 78761. (512) 835-0900. For rush literature requests, outside Texas, call toll free 1-800-531-5205. For technical information ask for operator #5. In Europe contact Houston Instrument, Rochesterlaan 6, 8240 Gistel, Belgium. Phone 059/27-74-45.*

**INSTRUMENTS & SYSTEMS DIVISION**  
Together...we'll create tomorrow.

**BAUSCH & LOMB**

Circle 55 for literature.  
Circle 56 to have representative call.

™ Trademark of Houston Instrument.  
\* U.S. Suggested retail prices.  
Centronics® registered trademark of Centronics Data Computer Corp.

# IBM

## personal computer

# UCSD

## p-System™ IV-1

A superior implementation of the UCSD p-SYSTEM is available NOW for your IBM Personal Computer.

Network Consulting has added many features which the professional programmer will find useful. These features are not available from any other sources.

- Hard disk support for Corvus, Tall Grass Technology and others
- 25% more floppy storage, without adding or modifying hardware, retaining compatibility with standard IBM diskettes
- Double sided/double tracking/fast stepping floppy disk drive support
- RAM disk support (uses up to 512k RAM)
- Adaptable system support for adding custom I/O drivers
- Remote Terminal support
- XON/XOFF flow control for serial printers
- Disk write verification
- and more!

**Standard p-System features include:**

- Program chaining
- Standard I/O redirection (including command files)
- Dynamic program overlays
- Support for asynchronous processes and concurrency primitives in Pascal
- Fast Pascal, Fortran and Basic compilers, all producing universal p-code programs
- A powerful screen oriented editor that runs in both programming and text editing modes
- A Native machine Code Generator that processes your Pascal, Fortran and Basic programs to convert parts of them to Native machine code
- Dynamic runtime binding of separately compile programs and units.
- Turtlegraphics for easy graphics displays
- Print spooler for background printing
- Symbolic debugger
- Extended memory support
- A library of program modules and other utilities

48 HOUR DELIVERY — CALL NOW!

**UCSD p—SYSTEM from  
Network Consulting**

**The only serious choice for business  
Dealer Inquiries Welcome**

TM The Regents of the University of California



**Network Consulting Inc.**

A106 - 1093 W. Broadway  
Vancouver, B.C.  
Canada V6H 1E2  
(604) 738-3500

the capacitance electronic disc (CED) system. In this system, the audio-visual information is engraved on a plastic disc and is picked up by a stylus making physical contact with the grooves of the disc. A second system, produced by Matsushita-JVC, is the video high-density (VHD) system, which is also based on capacitive pickup but, unlike the RCA system, uses a grooveless disc that does not have to make physical contact with the pickup. Finally, there is the optical-laser system which uses a laser beam to pick up the audiovisual information without making physical contact with the disc. Actually, two types of laser systems are available: one, manufactured by Thompson-CSF, is called transmissive, and the other, manufactured by Sony, Pioneer, Magnavox, and Discovision Associates (DVA), is reflective. (Most of DVA, formerly a joint venture between IBM and MCA, has been sold to Pioneer. For convenience, however, I will refer to DVA products in this article even though they may now be marketed by Pioneer.) The transmissive disc is soft, while the reflective disc is rigid and requires no special handling at all, thus making the optical-laser-reflective-disc technology the most congenial for educational applications. I will focus on the laser-reflective-disc technology.

The laser-reflective videodisc players come in "consumer" and "industrial" models. The primary consumer models are sold by Pioneer and Magnavox and can be bought at discount for less than \$600. Both Sony and Discovision Associates manufacture and retail industrial players for close to \$3000 depending on what options you choose. Naturally, the industrial models are sturdier and have more features. For one thing, they have their own onboard microprocessor, a Z80 in the case of the Sony, and an F8 Fairchild in the case of the DVA unit. They also have 1K bytes of RAM (random-access read/write memory) for storing programs. Although the players are not programmable in BASIC, the instructional language is fairly straightforward. The consumer videodisc players, however, are not directly program-

mable, but the Pioneer can be interfaced to a host computer.

We chose the industrial DVA model. While it is currently outrageously expensive, chances are that many of its features will find their way to the consumer model. Thus, by choosing a state-of-the-art machine, we protect ourselves against some of the problems mentioned earlier.

An important characteristic of the industrial videodisc player is its ability to support two-way communication with the host computer. For the Pioneer player, communication is strictly one-directional. That is, the computer can instruct the videodisc player to perform a task, but no information regarding the status of the player can be transmitted to the external computer.

The Sony and DVA videodisc players make information on their status available. With the DVA player three kinds of information can be transmitted to the host computer:

- current frame number
- the contents of RAM
- the player status (for example, whether it's playing forward, searching for a frame, etc.)

Of these, the capability of transmitting the current frame number is most important for instructional purposes (more on this later). For the Sony player, the standard port for communicating this information is a built-in RS-232C, whereas for the DVA player, it is a nonstandard parallel port. However, DVA sells an RS-232C interface that allows any computer with a serial port to communicate with the player.

**Integrating the computer and videodisc output:** While you can use any computer with an RS-232C port to communicate with either the DVA or Sony player, unless additional interfacing is provided, you will need two displays, one for the video output from the videodisc player and one for the computer display. Two displays are more expensive and, in an instructional setting, may have a distracting effect. Fortunately, a number of firms have developed interfaces that allow the computer and the



# Look What Apparat has for your IBM Personal Computer



The following add-ons are available immediately:

- 2 Dual Headed 40 Track Drives — (appears as four) 640K of storage, software patch, easy internal mount. \$630.00
- Combo Card — Parallel printer, ASYNC communication (RS-232), and clock/calendar functions, uses only one slot. \$279.00
- 2 Single Headed 40 Track Drives — 320K of disk storage, easy internal mount. \$450.00
- 48K additional RAM — 27 chips plug into master PC board \$75.00
- Add-on Memory Card — (uses 64K dynamic RAM chips), 64K — \$425.00, 128K — \$525.00, 192K — \$625.00, 256K — \$725.00
- Prom Blaster — Programs most 1K to 4K EPROMS of 25XX and 27XX single or multivoltage, personality modules, read/write

software. \$149.00

- Apparat Game Diskette — \$24.95
- Clock Calendar — Features seconds, minutes, hours, day of week, date, month and year, backup battery, leap year and crystal time base. \$129.00
- Prototype Card — 3.5 by 8 inch wirewrap holds 150-14 pin dips. \$29.95
- RGB Color Monitors — Includes cable, 16 color modifications, NEC — \$1,095.00, AMDEK — \$899.00, TECO — \$699.00.
- 3rd and 4th Add-on Drives — Expansion cabinet and IBM compatible drives, cabinet and 1 drive — \$499.00, two drives — \$749.00
- 64K Hardware Print-Spooler — Parallel printer adapter, buffers 15 minutes of output at 80 characters/second. \$399.00.
- EPSON MX Printers — MX-80 (with dot



addressable

- graphics) — \$499.00, MX-80 P/T — \$575.00, MX-100 — \$775.00
- Verbatim Datalife Diskettes — (5-1/4" 40 track, box of 10) \$24.95
- 16K Memory Kits (9 chips) — \$25.00

- 5-1/4" Flip-Sort — \$21.95
- 5-1/4" Plastic Library Case — \$1.95

Apparat will continue to develop add-on products for your IBM Personal Computer. Call today for more information. Dealer inquiries welcome.

**(303) 741-1778**

IBM Personal Computer is a trademark of IBM.



**Apparat, Inc.**

4401 So. Tamarac Parkway, Denver, CO 80237 (303) 741-1778

**"ON GOING SUPPORT FOR MICROCOMPUTERS"**

Circle 28 on Inquiry card.





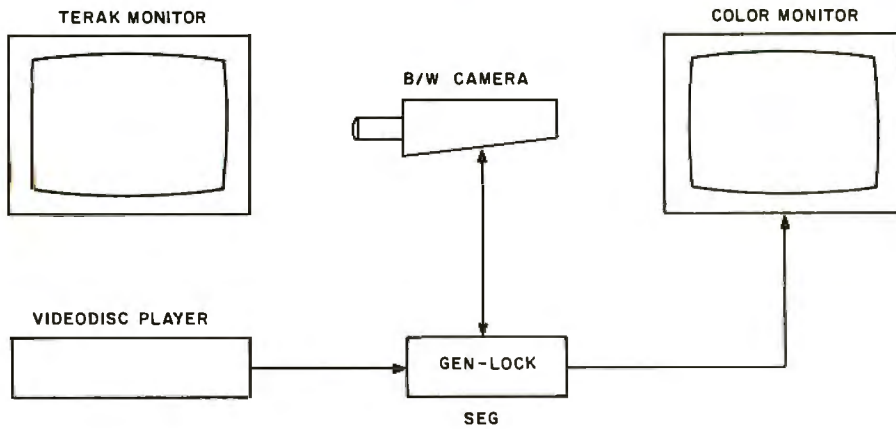

**Figure 1:** System used to produce photo 1. This arrangement can be used to overlay text and graphics that appear on the Terak monitor over the video output from the videodisc player. The black-and-white camera and the videodisc are synchronized through the special-effects generator (SEG). The composite video from the videodisc is sent to the gen-lock input of the SEG, which in turn locks the sync of the black-and-white camera.

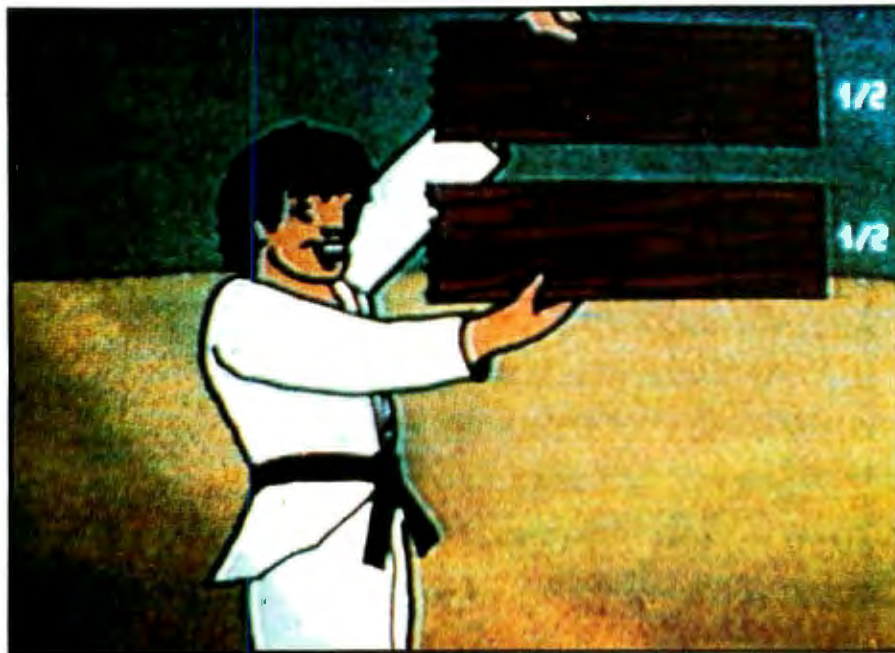

**Photo 1:** An example of text keyed over another video source. A black-and-white Sony video camera (AVC-3250) was pointed at the Terak screen. The camera was synchronized to the videodisc with the Sony special-effects generator (SEG 1-A). The output was displayed on a Sony monitor (VM-2150).

screen, much as one would dump the computer screen to a plotter, into an interface that regenerates the screen and superimposes it on the videodisc output.

The crudest implementation (see figure 1) requires a black-and-white camera capable of accepting external sync and a special-effects "keyer." The special-effects keyer locks itself to the sync pulses from the player. The black-and-white camera, in turn, accepts sync from the special-effects keyer. As a result the black-and-white camera video output (which is a replica of what is being displayed by the computer, be it character or graphics) and the videodisc video output are in perfect sync. The internal circuitry of the special-effects keyer takes care of integrating the two video signals. Because the keyer is constantly integrating the two signals, to display one or the other, it is necessary to blank the corresponding screen.

The results of the approach are illustrated in photo 1, a picture of the color-monitor screen. The still is from *Infinity Factory*, an educational series very popular in schools and recently put on disc by the U.S. Office of Education. (I'm grateful to Dr. Frank Withrow for providing the set of discs.) The fractional numbers were overlaid with the setup illustrated in figure 1. The readability of the numbers is not great because the regular character set was used. You can use a "wide" character set yielding 40 instead of 80 characters per line to improve readability.

You would need a monitor, the black-and-white camera, and the special-effects keyer to implement this approach—a cumbersome arrangement. On the other hand, this setup can be used with any computer and is fairly inexpensive.

An improvement upon the configuration shown in figure 1 is to bypass the black-and-white camera by feeding the computer video directly into the special-effects keyer. Because computers are not designed to accept external sync, this is far easier said than done. As you might suspect, the key to the problem is synchronizing the computer and videodisc video output.

videodisc player to share the same display. Some of these firms are listed at the end of this article. These interfaces not only control the videodisc but also switch, under computer control, between the two video sources.

A still higher level of integration requires not only that the computer and videodisc share the same display but that both video signals be shown

simultaneously. In an instructional setting, this opens up a new dimension for courseware development. For example, the same video segment could be used for different purposes by "overlaying" different text and graphics. One approach to accomplishing this integration combines the two video signals, while the other approach dumps the computer





# **“THAT WORKS GREAT!”**

Planning an on-time, on-budget project has always been hard work. But our new VisiSchedule™ program can help you and your personal computer make short work of it.

The VisiSchedule program is a fast and easy way to control projects, level resources, meet deadlines, and beat cost targets.

The VisiSchedule program instantly shows you the critical path among your project's tasks. It allocates all costs and personnel, and specifies earliest/latest start dates, slack times, holidays, prerequisites and deadlines for each task. And it produces summaries, time charts, and milestone reports for management.

You can actually develop your project as you enter data, investigate tradeoffs between manpower, costs and time. Ask “what if?” ... add, move, slip or change any task, skill level or cost, and the VisiSchedule

program automatically displays the impact of your changes. This makes it a snap to keep schedules and costs current, too.

While the VisiSchedule program does a lot by itself, it can do even more for you when used with other Visi™ programs. That's because they're all inter-related, just like your needs and tasks, to give you a fully integrated solution. For example, automatically transfer the cost data to our VisiTrend/Plot™ program and analyze cause-and-effect relationships. Then instantly plot the results in charts and graphs for better communication.

In addition, our series includes the VisiCalc®, VisiFile™, VisiDex™, VisiPlot™, VisiTerm™

and Desktop/PLAN™ programs.

Ask your retail computer store salesperson for a demonstration of the VisiSchedule program. Discover how easy it is to make short work of planning and budgeting all your work.

VISISCHEDULE™ FROM

VISICORP™  
PERSONAL SOFTWARE™





# CONCURRENT CP/M-86™ LETS YOUR COMPUTER DO MORE THAN ONE THING AT A TIME.

Another productivity breakthrough  
from the creators of CP/M.™

If you have to wait impatiently for your microcomputer to finish a job before moving on to another task, you need Concurrent CP/M-86. Digital Research introduces new software technology to increase the productivity of 16-bit microcomputers, including IBM's Personal Computer.

Using Concurrent CP/M-86, you can run several programs simultaneously, switching instantly from one program to another. For the first time you can write text while printing other documents. For the first time you can see directories without leaving your application program. For the first time you can edit programs while your computer compiles. Concurrent CP/M-86 is the best investment you can make in microcomputing, because it multiplies the value of your hardware, it lets you use all the CP/M-86 compatible programs, and if you're developing software, it insures that you're on the crest of the hottest new wave in the business.

As the chart shows, there's nothing else like Concurrent CP/M-86 in the microcomputing world, and only Digital Research offers it. For information, call or write Digital Research Inc., P.O. Box 579, 160 Central Ave. Pacific Grove, California 93950 (408) 649-3896.

#### Europe

Vector International  
Research Park  
B-3030 Leuven  
Belgium  
32 (16) 20-24-96  
Telex 26202 VECTOR

#### Far East

Microsoft Associates  
6 Floor A. Y. Building  
3-2-2 Kitaaoyama,  
Minato-ku  
Tokyo 107, Japan  
03-403-2120  
Telex 2426875 MSA



**DIGITAL  
RESEARCH™**  
The creators of CP/M.™



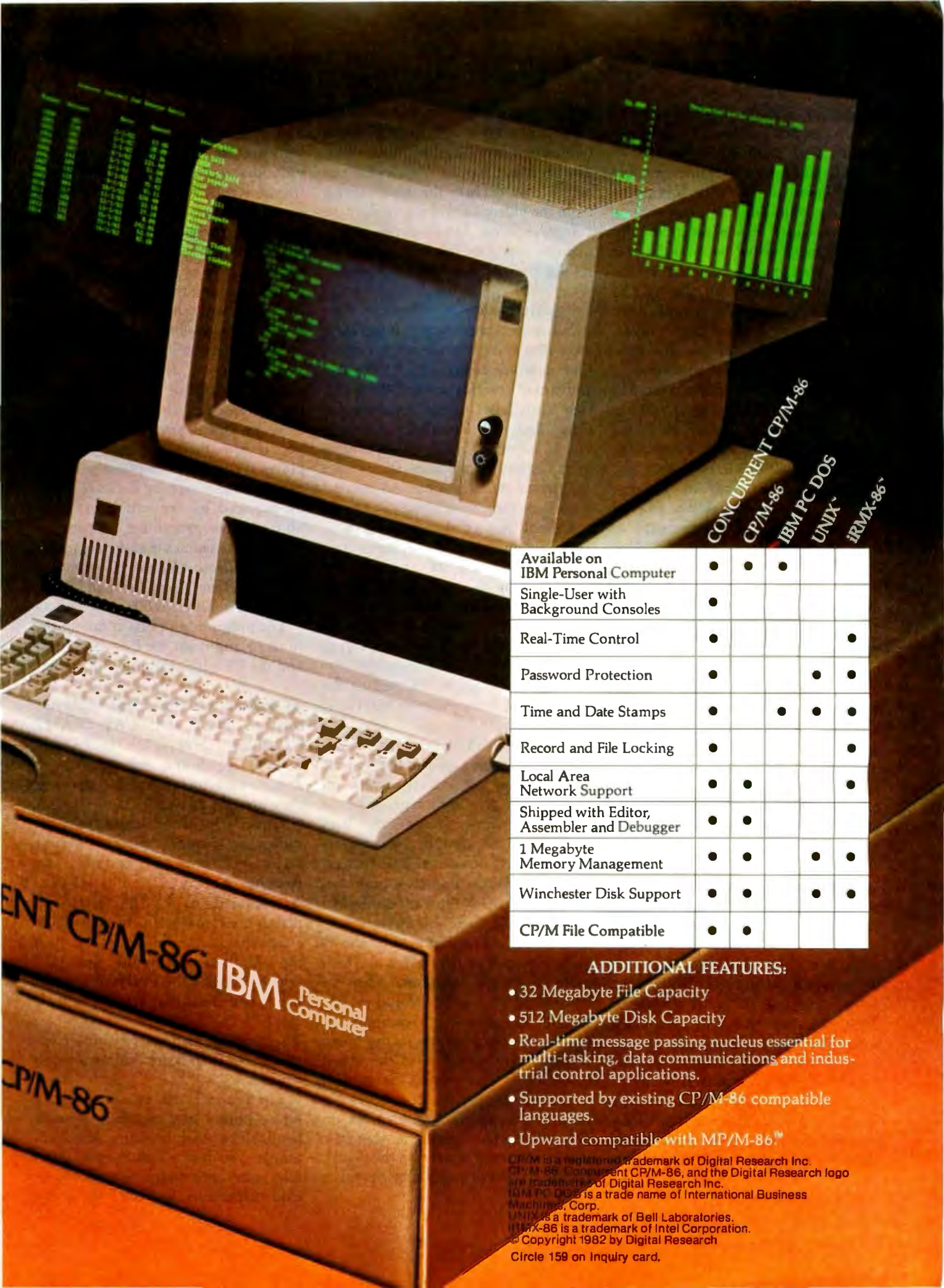

CONCURRENT CP/M-86  
 CP/M-86  
 IBM PC DOS  
 UNIX<sup>®</sup>  
 iRMX-86<sup>™</sup>

Available on IBM Personal Computer	•	•	•		
Single-User with Background Consoles	•				
Real-Time Control	•				•
Password Protection	•			•	•
Time and Date Stamps	•		•	•	•
Record and File Locking	•				•
Local Area Network Support	•	•			•
Shipped with Editor, Assembler and Debugger	•	•			
1 Megabyte Memory Management	•	•		•	•
Winchester Disk Support	•	•		•	•
CP/M File Compatible	•	•			

#### ADDITIONAL FEATURES:

- 32 Megabyte File Capacity
- 512 Megabyte Disk Capacity
- Real-time message passing nucleus essential for multi-tasking, data communications and industrial control applications.
- Supported by existing CP/M-86 compatible languages.
- Upward compatible with MP/M-86<sup>™</sup>

CP/M is a registered trademark of Digital Research Inc.  
 CP/M-86, Concurrent CP/M-86, and the Digital Research logo are trademarks of Digital Research Inc.  
 IBM PC DOS is a trade name of International Business Machines, Corp.  
 UNIX is a trademark of Bell Laboratories.  
 iRMX-86 is a trademark of Intel Corporation.  
 © Copyright 1982 by Digital Research  
 Circle 159 on Inquiry card.

To appreciate the problem, remember that television images, like movie images, are created by rapidly displaying frames. For movies, 24 frames per second is the standard; for television the standard rate is 30 frames per second. Whereas for film the frame is a piece of celluloid, for television a frame consists of an electronically created image displayed for 1/30 of a second. That image is "painted" on the screen by an electron gun, the input to which is a video signal that could have originated at a video-tape player, videodisc player, or camera. This electron gun paints one line at a time on the screen. A frame consists of 525 lines; however, for technical reasons (see "A Simplified Theory of Video Graphics, Part 1" by Allen Watson III, November 1980 BYTE, page 180), the painting is done in two fields. The first field consists of the odd-numbered lines, while the second consists of even-numbered lines. This is called interlacing.

By now you are wondering how the electron gun knows to jump to the next line as well as to the beginning of the screen when a field is completed. Horizontal and vertical sync pulses provide this information. The horizontal sync pulse tells the gun to jump to the left uppermost corner of the screen. Because there are two fields per frame, two such pulses occur in the video signal comprising a frame. Similarly, the vertical sync pulse tells the gun to go to the beginning of the next line. Two video signals are synchronized when their vertical and horizontal sync pulses occur at the same instant.

To my knowledge, no available computers or video boards accept external sync. Moreover, manufacturers of personal computers have done away with interlacing to cut costs. Thus, the sync pattern of a standard (i.e., interlaced) video signal is inherently incompatible with the sync pattern of most computers. Much to our chagrin, we found this to be true of the Terak also. However, we are experimenting with a modification to the Terak video circuit to get around this difficulty, as well as to have the Terak accept external sync.

The second approach to integrating computer and videodisc output is to digitize the contents of the computer video and send it over to an interface (which in reality is another computer). The interface has its own video circuitry that accepts the sync signals from the videodisc and regenerates the computer video. Syntec is one manufacturer that uses this approach. The results are very good but expensive.

### Software Issues

Software is important in integrating videodisc and computer technologies. One issue, discussed by Dr. Thomas DeFanti in the November 1980 BYTE (see "Language Control Structures for Easy Electronic Visualization," page 90), is the need for control structures in a computer language to support "electronic visualization." A second issue is software portability.

DeFanti argued that existing computer languages do not contain control structures capable of creating and manipulating electronic images in real time. Likewise, the software support for videodiscs in education often lacks this capability used for overlaying video (as I just discussed) and for permitting responses on the part of the student other than choosing from a set of alternatives.

For example, in the teaching of fractions students are expected to learn the symbolic and pictorial representation for fractions. A common procedure is simply to show circles and bars colored to different degrees corresponding to various fractions. Using a videodisc player, a possible improvement would be to allow the student to construct an appropriate circle or bar. This could be accomplished by showing a sequence of 100 frames in which each frame has an additional 1 percent colored. The student would be instructed to single-step back and forth within these 100 frames to the frame that has, say, one half of the object colored. At that point, the student could indicate his choice by pressing Return. The program, in turn, would determine what frame the videodisc player was on. If it were on the fiftieth frame, the answer would be scored as correct.

This same procedure could be implemented using computer graphics, but the program would tend to be hardware specific. By contrast, the software to communicate with the videodisc player can be more transportable. Moreover, video stills can be made more realistic. For example, the above sequence could be done with a child pouring a liquid into a container. The student's task then becomes to locate the frame that corresponds to, say, a half-filled container.

To use a videodisc in this fashion, as opposed to using it as a repository of visual segments, requires underlying software to exploit the capabilities of the videodisc. I have developed a series of Pascal procedures that support most of the commands the DVA player is capable of responding to, including single-stepping back and forth as required by the examples given above. The procedures appear in listing 1. It assumes that the computer and the videodisc player (DVA model PR-7820-2) are linked through DVA's universal interface (UEI).

The program supports communications to and from the host computer and the UEI, including the following:

- Commands to the videodisc player, such as STOP, DISPLAY FRAME NUMBER, TURN AUDIO on TRACK 2 OFF, etc. Some commands have arguments associated with them, and they are sent as well.
- Requests for information from the videodisc player: current player status, current frame number, and contents of memory.
- Commands to the UEI. The commands used most often are 'D1', which establishes communication between the UEI and the computer, and 'D2', which requests the interface to echo back commands that are sent to it.

The program also employs an exception status to indicate communication problems.

The program can be easily turned into a library unit and thus be made available to other programs. If, for example, you had a Pascal-based Pilot interpreter, you could then add videodisc commands to Pilot. (It is my



# FDC SBC SYSTEMMASTER®

## The Next Logical Step

### Teletek FDC-I, The First Step

A CPU, floppy disc controller and I/O all on one board. Until SYSTEMASTER® the most powerful IEEE-S-100 board on the market.

### Teletek SBC-I, The Second Step

A board designed for use in high performance, multiprocessing systems. SBC-I combines its own CPU, serial and parallel ports, 128K of segmented memory and FIFO.

### SYSTEMASTER®, The Next Logical Step

Teletek's newest product — a breakthrough in S-100 board design. SYSTEMASTER® is a complete system. No other boards are required. It doesn't even require a bus!

But, when used with an S-100 bus, SYSTEMASTER® has even more capabilities. You can readily expand to multi-user or multi-processor systems using SYSTEMASTER® as the master board.

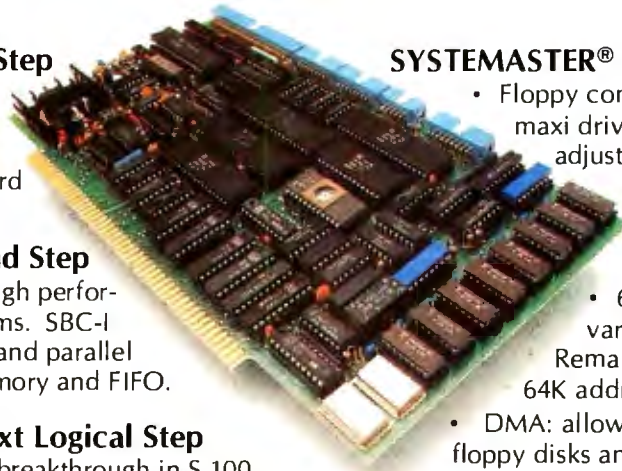

### SYSTEMASTER® Features:

- Floppy controller: controls mini and/or maxi drives; variable independently-adjustable pre-write compensation.
- CPU: 4MHz Z80A
- Two RS-232C ports.
- Two full parallel ports.
- 64K bank-selectable memory variable from 32K to 60K.
- Remaining memory is fixed at top of 64K address space.
- DMA: allows transparent data transfer to floppy disks and other devices without CPU wait states.
- Relocatable EPROM/ROM/PROM: 2K, 4K or 8K with deselect capability.
- Real-time clock.
- Operating systems available: Digital Research or Turbodos.
- Parallel ports may be connected to Teletek's PSC board for RS-422 capability.

# TELETEK

9767F Business Park Drive Sacramento, CA 95827 (916) 361-1777

Circle 445 on Inquiry card.

# ERG/68000 MINI-SYSTEMS

- Full IEEE 696/S100 compatibility

## HARDWARE OPTIONS

- 8MHz or 10 MHz 68000 CPU
- 4-8 RS232 Serial Ports
- 64K STATIC RAM (70 nsec)
- 256K Dynamic RAM, with full parity
- 8" D/D, D/S floppy disk drives
- 5MB-32MB hard disk drives
- Full DMA host adaptor
- 20MB tape streamer
- 10 to 20 slot backplane
- 30 amp power supply

## SOFTWARE OPTIONS

- 68KFORTH<sup>1</sup> systems language with MACRO assembler
- Fast Floating Point package
- Motorola's MACSBUG
- IDRIS<sup>2</sup> operating system with C, PASCAL, FORTRAN 77, 68K-BASIC<sup>1</sup> compilers

Trademark <sup>1</sup>ERG, Inc.  
<sup>2</sup>Whitesmiths

30 day delivery  
with valid Purchase Order

OEM prices available  
For CPU, Integrated Card Sets  
or Systems.

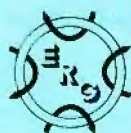

**Empirical Research Group, Inc.**  
P.O. Box 1176  
Milton, WA 98354  
206-631-4855

understanding that the next release of Apple Pilot will support communication with a videodisc. Also, the International Institute of Applied Technology has announced a CP/M-based Pilot that supports videodisc commands.)

Because, inevitably, different schools will have different computers and because software development costs are constantly growing, you should develop software that can be run on a number of different computers. The UCSD operating system

*Text continued on page 96*

**Listing 1:** Pascal procedures for controlling the DVA PR-7820-2 videodisc player through DVA's universal interface. The program is written in UCSD Pascal for the Terak computer and allows the computer to communicate in both directions with a DVA player. Specifications for writing the program were derived from two manuals from DVA (see vendor list).

```
{*****}
CONST
  CR=13;{ CARRIAGE RETURN}
  LF=10;{ LINE FEED }
  CS=12;{ CLEAR SCREEN }
  LFR=4;

TYPE
STR4= PACKED ARRAY[0..LFR] OF CHAR;
STR1= PACKED ARRAY[0..1] OF CHAR;
VAR
  ERROR: STR1;{ERROR CONTAINS THE ERROR ISSUED BY UEI.}
  FRAME: STR4;{CONTAINS THE ARGUMENT NEEDED BY SOME COMMANDS.}
  COM: CHAR;{ HOLDS THE VIDEODISK COMMAND}
  FRAMENO: INTEGER;{FRAMENO IS THE VALUE RETURNED IN RESPONSE TO}
                {THE DUMP FRAME COMMAND.}

  FRLEN: INTEGER;{FRLEN IS THE NUMBER OF DIGITS IN FRAME.}
  RWS: STR4;{WORK STRING TO RECEIVE BYTES FROM UEI.}
  TWS: STR1;{WORK STRING TO TRANSMIT TWO BYTES TO UEI.}

{*****}
FUNCTION READCHR:CHAR;
{ Reads one character from the keyboard.}
VAR
  X: CHAR;
BEGIN
  READ(X);
  READCHR:=X;
END;
{*****}
PROCEDURE READFR(VAR FR:STR4;VAR LEN:INTEGER);
{Reads a frame number from the keyboard.}
VAR
  I: INTEGER;
  X: CHAR;
BEGIN
  FOR I:= 0 TO LFR DO
    BEGIN FR[I]:= ' ';END;

  I:=0;
  REPEAT
    X:=READCHR;
    IF (ORD(X)>=48) AND (ORD(X)<=57) THEN
      BEGIN FR[I]:=X;I:=I+1; END;
    UNTIL (EOLN) OR (I=LFR+1);
  LEN:=I;
END;
{*****}
FUNCTION HEXDEC(X:CHAR):INTEGER;
{ Converts hexadecimal character to hexadecimal digit.}
BEGIN
  CASE X OF
    '0','1','2','3','4','5','6','7','8','9':HEXDEC:=ORD(X)-48;
    'A','B','C','D','E','F':HEXDEC:=ORD(X)-55;
  END;
END;
{*****}
PROCEDURE FRAMECON (VAR NUMBER:INTEGER);
{ Converts frame number from hexadecimal to decimal.}
VAR
  I,C: INTEGER;
  TEMP: PACKED ARRAY[0..3] OF CHAR;
```

*Listing 1 continued on page 92*



# The MultiMode Printer with The Magnificent Fonts



## MultiMode Printer Offers Flexibility

. . . At a Sensible Price—\$1,995 (Qty. 1)

“Flexibility” means instantaneous call up of any of this trend-setting machine’s many features whether for *word processing*, *data processing*, *graphics* or *forms generation*. Using either of the two built in interfaces, an external keyboard or downloading from your computer, you can program the Qantex Model 7030 to do more.

Compare the “Beauty” of our printed letters for the word processing fonts which include Cubic, Trend, Spokesman, Courier, Italics, Script, OCR-A, APL, Scientific plus *downloaded* fonts from your computer. Draft copy modes include 8 resident fonts — U.S., U.K., German, French, Spanish, Swedish, Finnish, Norwegian and Danish.

Other features include high resolution graphics — 144 x 144, single pass and double pass word processing, and 180 cps data processing modes and user defined formats.

Operator initiated, the MultiMode printer provides a complete printed status report of operating parameters and diagnostics.

For more information, or a demo, call us about the new Qantex Model 7030 MultiMode Printer.

**Qantex**<sup>\*</sup> Division of North Atlantic  
60 Plant Avenue, Hauppauge, NY 11788  
(516) 582-6060 (800) 645-5292

\*Registered Trademark of North Atlantic Industries

## The “Beautiful” Font

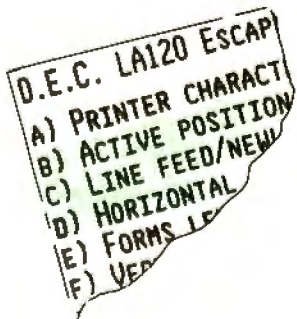

See us at NCC Booth #4516.

Circle 378 on Inquiry card.

# Announcing 'MULTI-USER' UCSD p-System™

## Features

- Full p-System compatibility.
- No changes required to current application programs.
- Up to 4 users and 3 printers simultaneously.
- Full upward support of future UCSD p-System.
- Field proven with over 100 installations.
- Auto-start of application programs for each user.
- Remote Diagnostic capability.
- High speed re-entrant interpreter.
- High speed buffered disk and terminal I/O.
- Full memory available per user.
- RAM disk makes use of any extra memory.
- Hard disk mapping with privacy protection for users.
- Inter-user communication and resource sharing.
- Xon/Xoff printer protocols.

## Future Enhancements

- Networking.
- Data communication intrinsics.
- Extended memory support for large Code pools.
- Extended File System.

## Present Implementation

- ALTOS 5", B" and 14" Winchester systems.
- For future implementations, consult Dynamic Control Systems.

## Pricing

TURNKEY — \$495.00  
FULL SYSTEM — \$925.00

DEALER ENQUIRIES INVITED

For information contact:



**dynamic  
control  
systems**

Ste. 204, 13662-104A Ave.  
Surrey, B.C. Canada, V3T 1Y8

**(604) 585-0655**



## LATE BREAKING NEWS!

Market proven PDP-11™ Application Development System soon will be available for the UCSD p-System.

UCSD p-System is a trademark of the Regents of the University of California.

PDP-11 is a trademark of Digital Equipment Corporation.

Listing 1 continued:

```

BEGIN
  TEMP[3]:=RWS[2];
  TEMP[2]:=RWS[3];
  TEMP[1]:=RWS[0];
  TEMP[0]:=RWS[1];
  NUMBER :=0;

FOR I:= 0 TO 3 DO
  BEGIN
    C:=0;
    CASE I OF
      0: C:=1;
      1: C:=16;
      2: C:=256;
      3: C:=4096;
    END;
    NUMBER:=NUMBER + C*HEXDEC(TEMP[I]);
  END;
END;
{*****}
PROCEDURE COMMAND(X:CHAR);FORWARD;
PROCEDURE ERRORCHK;
{ This procedure may be useful for debugging communication problems with UEI.}
BEGIN
  UNITCLEAR(8);
  UNITCLEAR(7);
  RWS:=' ';
  TWS:='EA';
  UNITWRITE(8,TWS,2);
  UNITWAIT(8);
  WRITELN('FINICED WRITING');
  UNITREAD(7,RWS,2);
  UNITWAIT(7);
  WRITELN('FINISHED READING',RWS);

  IF RWS[0]='!' THEN
    BEGIN
      ERROR[1]:=RWS[1];
      ERROR[2]:=RWS[2];
      WRITELN(' UEI HAS DETECTED ERROR ',ERROR,'SEE PAGE 2-16. ');
    END;
END;
{*****}

PROCEDURE SENDFRAM(FR:STR4;LEN:INTEGER);
{ Converts frame number to code expected by UEI.}
VAR L : INTEGER;
BEGIN
  FOR L:=0 TO LEN-1 DO
    BEGIN
      CASE FR[L] OF
        '0':TWS:='3F';
        '1':TWS:='0F';
        '2':TWS:='8F';
        '3':TWS:='4F';
        '4':TWS:='2F';
        '5':TWS:='AF';
        '6':TWS:='6F';
        '7':TWS:='1F';
        '8':TWS:='9F';
        '9':TWS:='5F';
      END;
      UNITWRITE(8,TWS,2);
      UNITWAIT(8);
    END;
    {ERRORCHK;}
  END;
  {*****}

PROCEDURE LINK;
{ Initializes communication with UEI.}
BEGIN
  WRITELN('ENTERINBG LINK');
  UNITCLEAR(8);
  TWS:='DO';
  UNITWRITE(8,TWS,2);
  UNITWAIT(8);
  TWS:='FD';
  UNITWRITE(8,TWS,2);
  UNITWAIT(8);

```

Listing 1 continued on page 94



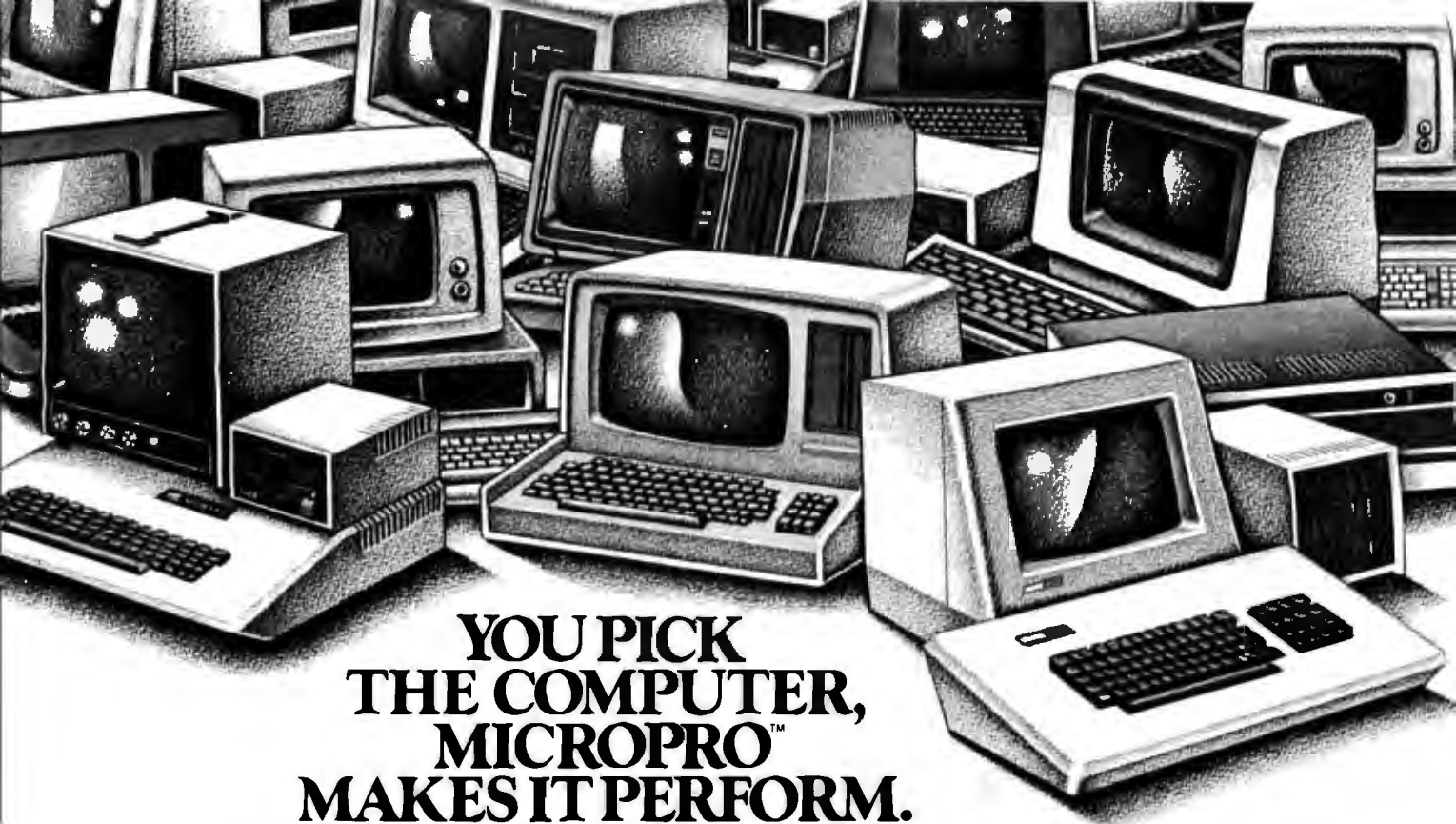

# YOU PICK THE COMPUTER, MICROPRO™ MAKES IT PERFORM.

There are a lot of fine names in microcomputers. But there's only one name in software to remember. MicroPro. Because MicroPro has taken the best ideas in business software and put them together to make the MicroPro Software System™ — a family of software products that work together on your computer, whether it's an Apple™ II, TRS-80™ Model II, Heath/Zenith H/Z-89, Xerox™ 820, or more than 100 other brands — and soon the IBM® Personal Computer.

## Software makes the difference.

The key to getting the most out of your computer is the software you use. And the Software System is designed to get the most out, faster. The Software System is our new name for the MicroPro family of software products, each remarkably powerful and versatile — and even more so when you combine them.

The products: WordStar™ (word processing), MailMerge™ (WordStar option — personalized form letters and other file-merging uses); SpellStar™ (WordStar option — spelling checker); DataStar™ (data entry and retrieval); CalcStar™ (electronic spread sheet and financial modeling); SuperSort™ (sorting, selecting, and merging); and WordMaster® (video text editing).

## More solutions, less work.

The Software System enables you to use your micro-computer to its fullest with less time and effort. That's because, for one thing, most MicroPro products have similar methods of operation, so it's easier to move from one product to another. And they readily adapt to your way of doing business, instead of forcing you to make changes to fit a rigid software package, like you have to do with many other software products. Most important, you can combine MicroPro products' information and abilities. The result: a lot more ways to make your

business more productive than you'd get from just using each product by itself.

## The System doesn't stop.

Count on MicroPro to keep expanding the Software System with new products that make it even more useful and powerful in your business. Coming this year: a series of in-depth accounting packages; InfoStar,™ a powerful report generator and partner to DataStar; and StarBurst,™ a new kind of software that will link our products together into an even friendlier and easier to use package.

If you're shopping for a computer, we recommend you shop for software even more carefully. After all, there are a lot of good hardware systems to choose from. But there's only one Software System. From MicroPro.

To get our brochure on the MicroPro Software System, visit any of our 1200 dealers around the world.

**Or phone toll-free 800-227-2400, ext. 933.**  
**(In California 800-772-2666, ext. 933.)**



SOFTWARE  
THAT MEANS BUSINESS.™



MicroPro Apple software requires a CP/M-Z-80 adaptation device. Apple is a trademark of Apple Computer Inc. TRS-80 is a trademark of Tandy Corp. Xerox is a trademark of Xerox Corp. Heath/Zenith is a trademark of Zenith Data Systems. IBM is a trademark of International Business Machines Corp. © 1982 MicroPro International Corp. All rights reserved.

# INTELLIGENT PRINTER INTERFACE

Free Your Computer from the  
Mundane Task of Printing



Imagine being able to use your computer seconds after beginning an extensive printout.

Visualize your printout with page breaks, page numbering and titles, margins of your choice, indented carryover lines, on any size paper!

Appreciate the time and money you will save by not waiting for your printer.

SooperSpooler, a buffered printer interface, maintains control over your printer while you go on using your computer for more productive activities. Eliminate waiting while your printer pecks through a long document. SooperSpooler accepts information from your computer at up to 3000 characters per second and feeds it to your printer as fast as it can handle it—without using any of your computer's memory or time!

### SooperSpooler features include:

- 16K Memory (62K optional)
- Buffer Status Readout
- Space Compression
- Pagination
- Single Sheets
- Headers and Page Numbering
- Indentation on Carryover Lines
- Self Test Routine
- Features also Software Controllable
- Plugs into Most Computer Systems
- ★ 16K Parallel I/O Unit—\$349.00!
- ★ Serial I/O Option—\$95.00
- ★ 46K Memory Option—\$159.00

**SooperSpooler™ by Compulink—**  
The missing link that gives your microcomputer mainframe printing.

## COMPULINK CORPORATION

1840 Industrial Circle  
Longmont, CO 80501 (303) 651-2014

Send for brochure  
Dealer inquiries welcome  
Call for information: 800-525-6705

Listing 1 continued:

```

WRITELN("LEAVING LINK");
{ERRORCHK;}
END;
{*****}

PROCEDURE PRINTMEN;
{ Prints a menu of commands.}

BEGIN
  {WRITELN(CHR(CS)); CLEAR SCREEN}
  WRITELN(" a RECALL          k DUMP RAM          u STEP FWD          ");
  WRITELN(" b CLEAR            1 DUMP FRM #        w SEARCH          ");
  WRITELN(" c RUN/BRANCH        m DUMP PLYR STATUS x INPUT          ");
  WRITELN(" d WRITE PROG        n END PROG           y REJECT          ");
  WRITELN(" e FRM DSPLY OFF    o DEC REG             z SLOW REV        ");
  WRITELN(" f FRM DSPLY ON     p FRM DSPLY TOG.      1 STOP            ");
  WRITELN(" g AUDIO 2 OFF      q SLOW FWD           2 AUDIO 2 TOG     ");
  WRITELN(" h AUDIO 2 ON       r AUTO STOP          3 PLAY            ");
  WRITELN(" i AUDIO 1 OFF      s AUDIO 1 TOG         4 STEP REV        ");
  WRITELN(" j AUDIO 1 ON       t STORE              5 LOAD            ");
  WRITELN("                               9 TO END SESSION          ");

END;
{*****}

PROCEDURE SENDCOMM(X:CHAR);
{ Preprocesses commands to player.}
BEGIN
  CASE X OF
    'a','b','c','d','t','x','l': WRITELN(" COMMAND NOT IMPLEMENTED.");
    'e','f','g','h','i','j','k','l','m','n','o','p','s','u','y','2','3','4','5',
    '9':COMMAND(X);
    'q','r','w','z':BEGIN
      WRITELN("ENTER FRAME NUMBER FOLLOWED BY RETURN.");
      READFR(FRAME,FRLEN);
      WRITELN("FRAME AND FRLEN ARE",FRAME,FRLEN);
      SENDFRAM(FRAME,FRLEN);
      COMMAND(X);
      END;
  END;

END;

END;
{*****}
PROCEDURE COMMAND;
{ Translates commad to expected code and tranmits it to .}
BEGIN
  WRITELN(" ENTERING COMMAND PROC.");
  UNITCLEAR(7);UNITCLEAR(8);
  TWS:= " ";
  RWS:= " ";
  CASE X OF
    'e':TWS:="E3";
    'f':TWS:="E4";
    'g':TWS:="E5";
    'h':TWS:="E6";
    'i':TWS:="E7";
    'j':TWS:="E8";
    'l':BEGIN
      TWS:="EA";
      UNITWRITE(8,TWS,2);
      UNITWAIT(8);
      UNITREAD(7,RWS,4);
      UNITWAIT(7);
      WRITELN("THE FRAMENO IS",RWS);
      FRAMECON(FRAMENO);
      WRITELN(" THE DECIMAL FRAME NO IS ",FRAMENO);
      END;
    'm':BEGIN
      TWS:="EB";
      UNITWRITE(8,TWS,2);
      UNITWAIT(8);
      UNITREAD(7,RWS,4);
      UNITWAIT(7);
      WRITELN("THE PLAYER STSTUS IS", RWS);
      END;
  END;

```

Listing 1 continued on page 96



# QUME

SPRINT 9



STANDARD OPERATOR  
CONTROL PANEL.

Switch selection of interface parameters and forms handling allows simple OEM system integration.

Automatic proportional spacing, without decreasing system throughput, sets the new standard for print quality.

To cut service costs and reduce adjustments, the exclusive Kevlar® belt is stronger and lighter than steel, with virtually no stretch.

For the highest accuracy in the history of daisywheel printing, our Microdrive™ carriage drive mechanism has no cables or pulleys.



LIMITED OEM  
CONTROL PANEL.

## Test drive our hot new daisywheelers.

If you've always wanted letter-quality printing from your DP system but the cost has put you off, then a SPRINT 9 is for you. Now you can have the same high quality print—usually only available on word processing systems—at prices that will let you forget all about dot-matrix terminals. With speeds of 45 and 55 cps (average English text, not burst rate), the reliable high performance of SPRINT 9 terminals leaves the crowd behind. Prove it to yourself with a test drive. Call or write Qume at (408) 942-4000. 2350 Qume Drive, San Jose, California 95131.

Circle 383 on Inquiry card.

**Qume.**  
A Subsidiary of ITT

See us at NCC Booth #7119

# DISCOUNT LINE

1-800-528-8960

## GUARANTEED LOW PRICES

### APPLE CARDS

16K RAM — \$99      Z80 CARD — \$210  
Videx Card — \$249      Smart Term — \$269  
Graphic Card — \$89      Clock CARD — \$120

### ALTOS

8000-2 — \$2675      8000-15 — \$3850

### ANADEX

9500 — \$1200      9501 — \$1200

### ATARI

400-16K — \$399      800-16K — \$659  
410 — \$79      810 — \$429  
825 — \$569      850 — \$167

### C-10TH

F-10P — \$1380      F-10S — \$1525

### DATASOUTH

DS120 — \$595      DS180 — \$1259

### DIABLO

630RO — \$1945      630KSR — \$2475

### DISKETTES/BOXES

Elephant — \$20      Scotch — \$25      Dysan — \$35

### EPSON WITH GRAPHICS

MX70 — \$289      MX80 — \$429  
MX80FT — \$519      MX100 — \$689  
GRAPHIC ROM — \$69      RS232 — \$69

### HAZELTINE

1500 — \$995      ESPRIT — \$595

### LOBO

Apple Drive/Card — \$350/\$50

### MODEMS

HAYS — MICROMODEM — \$290  
HAYS — SMARTMODEM — \$229  
Penril — 300/1200 (212A) — \$795

### MONITORS

Teco-BW — \$99      Tecq-Green — \$115  
Sanyo-Green — \$249      Color — \$425  
Amdek-Green — \$159      Color — \$349

### NORTHSTAR

Advantage — \$2995      HR64QD — \$3025

### NEC

8023 — \$489      7710 — \$2350

### MPI

88G — \$550      99G — \$650

### SOROC

120 — \$659      135 — \$689

### TELEVIDEO

912 — \$669      950 — \$915

### TI

810 — \$1240      820 — \$1795

### SOFTWARE

All Major Brands — \$CALL

### MOUNTAIN HARDWARE

CPS Card — \$169      Music System — \$429

### OKIDATA

M80 — \$320      SL125 — \$3150  
M82A — \$450      SL250 — \$4200  
M83A — \$699      M84 — \$1059

### XEROX

820 — \$2399

### ZENITH

Z19 — \$669      Z89 — \$2129

All Prices Subject To Change

# EXPOTEK

2723 W. Windrose • Suite 3  
Phoenix, Arizona 85029

Listing 1 continued:

```

p: TWS:=F1;
q: BEGIN
  TWS:=D3;
  UNITWRITE(8,TWS,2);
  UNITWAIT(8);
  TWS:=F2;
  UNITWRITE(8,TWS,2);
  UNITWAIT(8);
  TWS:=D4;
  UNITWRITE(8,TWS,2);
  UNITWAIT(8);
  END;
r: BEGIN
  TWS:=F3;
  UNITWRITE(8,TWS,2);
  UNITWAIT(8);
  END;
s: TWS:=F4;
u: TWS:=F6;
w:
  BEGIN
  TWS:=F7;
  UNITWRITE(8,TWS,2);
  REPEAT
    COMMAND(m);
    WRITELN(RWS);
  UNTIL(RWS[1]=7);
  END;
x: TWS:=F8;
y: TWS:=F9;
z: BEGIN
  TWS:=FA;
  UNITWRITE(8,TWS,2);
  UNITWAIT(8);
  COMMAND(m);
  END;
2: TWS:=FC;
3: TWS:=FD;
4: TWS:=FE;
5: TWS:=CC;
9: TWS:=F9;
END;
IF NOT(X IN(1,m,w,q,r,z)) THEN UNITWRITE(8,TWS,2);
IF X=9 THEN
  TWS:=D1;
  UNITWRITE(8,TWS,2);
  UNITWAIT(8);
  {ERRORCHK;}
END;
{*****}
BEGIN
LINK;
PRINTMEN;
REPEAT
  WRITELN(ENTER COMMAND FROM MENU.);
  COM:=READCHR;
  SENDCOMM(COM);
  UNTIL COM=9;
  WRITELN( END OF SESSION.);
END.

```

Text continued from page 90:

makes this goal reachable. To demonstrate this, we transferred the program in listing 1 to an Apple II computer with Apple Pascal (which in reality is UCSD Pascal) and a serial communication card. To do this, I had the program "printed" from the Terak. The Apple on the other end received the file, placed it in a buffer, and upon completion of the transfer, saved it on disk. (I am grateful to Barbara Benton for writing this program.) It almost worked! While I was able to compile

the program on the Apple, it did not execute correctly. The problem was with the "unitwait" procedure, which makes the program wait until the port has completed sending the information. The unitwait procedure is not available in the Apple. Therefore, to make the program work, we had to insert an empty loop in lieu of the unitwaits.

What makes this little experiment interesting is that the program uses inputs and outputs rather than just inter-



# Ain't that a peach!



## \$649

### Single Board Computer Only

The Data-Neve Model 8064 is a complete general purpose single board Z80A based computer running under the CP/M 2.2 Operating System. Features include 64K 200nS RAM with parity check, 2 serial and 2 parallel ports, bootstrap ROM, high speed floppy disk controller, and expansion bus for attaching our hard disk interface option. Nearly one thousand 8064's have been delivered over the past year. This one works and is generally available from stock!

See it, try it and buy it at our sales and service locations below.

## \$2,395

### Full Computer with Dual 8" Drives

The Model 8864 is the system packaged version of the 8064 single board computer including full size dual 8" drives with total capacity of 1.2 MB, and powered by a very efficient switching power supply. The total power dissipation is so low, no fan is required. Double-sided drives providing total storage capacity of 2.4 MB are available in Model 8964 at \$2,995. CP/M 2.2 on 8" diskette, \$150.

Data-Neve is part of a 500 people, \$30 million world-wide group.

CP/M-Trademark of Digital Research

Prices are subject to change.

Sales taxes are added in Connecticut, California, Tennessee and Ontario (Canada).

# Data-Neve

A Division of Rupert Neve Incorporated



For Mail Delivery  
Call (203) 744-6230

**Headquarters:** Berkshire Industrial Park, Bethel, Connecticut 06801 Tel: (203) 744-6230 Telex: 969638

**West Coast:** 7533 Sunset Blvd., Hollywood, California 90046 Tel: (213) 874-8124 Telex: 194942

**Nashville:** P.O. Box 120907, Nashville, Tennessee 37212 Tel: (615) 385-2090

**Canada:** Rupert Neve of Canada, Ltd. 2721 Rena Road, Malton, Ontario L4T 3K1, Canada Tel: (416) 677-6611 Telex: 983502

**Europe:** Neve Electronics International, Ltd. Cambridge House, Melbourn, Royston, Hertfordshire, SGB 6AU England Tel: (0763) 60776

~~THE FUTURE OF  
BETTER THAN~~



# E<sup>2</sup>PROMS LOOKS WE THOUGHT.

For one reason.

Now you can put your hands on the future of memory technology — 16K E<sup>2</sup>PROMs — for a whole lot less than you thought.

Less than \$20 today. And less than \$10 by 1983.

Actually, that's because E<sup>2</sup>PROMs are already being designed in — faster than we predicted. Putting the Flotox technology of the 2815 (50-msec program time) and 2816 (10-msec program time) on a super fast learning curve.

But maybe we should have expected that.

After all, Intel's E<sup>2</sup>PROM has all the non-volatility of ROM, the flexibility of RAM. And a promise that CMOS with battery backup can't provide:

Lower system life cycle costs.

Starting with design. Since you don't have to contend with the kluge of battery support circuitry. The E<sup>2</sup>PROM's 250-nanosecond access time and JEDEC-approved, byte-wide pinout fit VLSI microprocessors like the 8086 and 8088 hand in glove.

And lower maintenance costs. Since there are no tapes to tangle with. And no batteries to replace or maintain.

No wonder Intel's electrically erasable E<sup>2</sup>PROMs are already taking over a lot of applications that need in-circuit system changes. Storing set up parameters for numerical controls. Adding self-correcting feedback to process control and robotics. Even storing access codes for PABX equipment.

And, at the same time, spawning some never-before-possible approaches to system maintenance. Like field changes by telephone instead of by engineer.

Which is just one more reason why you might want to take the future of memory technology into your own hands.

Before someone else gets the best of it.

For more information, call your local distributor.

Or contact Intel Corp., 3065 Bowers Ave., Santa Clara, California 95051 (408) 987-8080.

**intel**® delivers solutions

Circle 231 on Inquiry card.

# North Star's Advantage over IBM and Apple is easy to see.

The North Star ADVANTAGE desktop computer has higher precision graphics, better software, and greater disk capacity than the IBM Personal Computer or the Apple III. Plus, nationwide on-site service and free business graphics software. See it for yourself. Then check the price. You'll see how easy it is to own the North Star ADVANTAGE. For the name of the North Star dealer nearest you, call today.

CALL TOLL FREE  
**1-800-447-4700**  
(ILLINOIS 1-800-322-4400)



FOLLOW THE STAR  
**NorthStar**™

14440 Catalina Street, San Leandro, California 94577

nal computations. I/O (input/output) has traditionally been an area of incompatibility among computers. The fact that a program written on an entirely different computer is capable of running practically unmodified on another computer suggests that the software industry is moving in the right direction toward portable software. Unfortunately, full software transportability requires that not only I/O operation be transportable but graphics as well. Graphics transportability is likely to continue to be a problem for the foreseeable future, but progress is being made (see reference 3).

### Courseware Considerations

While hardware is at the heart of integrating the communication and information technologies, the quality of courseware will be the determining factor in whether videodisc technology has a lasting impact on education.

Just as you need to integrate the two technologies at the hardware and software level, there must also be a similar integration at the courseware level if you are to avoid the mistakes of early educational television and computer-based education. You must determine what the unique educational capabilities of the videodisc are and how you can develop materials to exploit those capabilities. In particular, what can you do better with interactive videodiscs than with computers alone?

Perhaps the most elementary application of the videodisc would consist of a series of discrete audiovisual segments. The word *audiovisual* gives you a hint that the videodisc is serving two modalities, vision and hearing, simultaneously. Furthermore, through branching you can choose the most relevant audiovisual segments for a given student and thus tailor instruction to the student. Because the videodisc has two audio tracks, sound can be stored in the second track to be used separately from the visuals. To use this sound without distracting the student with irrelevant visuals, you can overlay a white computer frame on the video. Clearly, this is possible only with systems that have overlay capabilities.



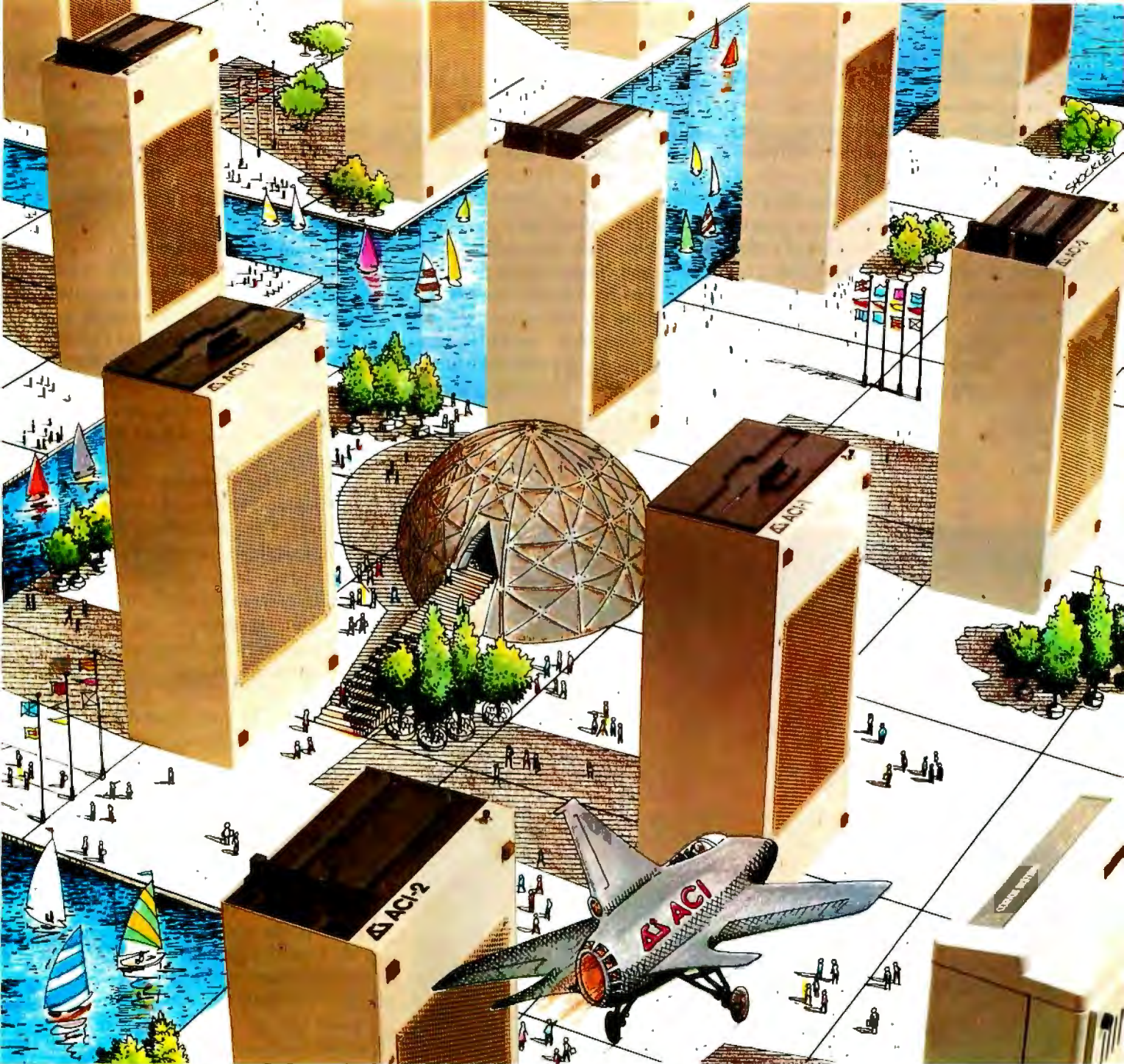

# Alspa Computers PLUS Multi-User Hard Disk



#### **SMALL SIZE AND LOW COST**

ALSPA full performance, CP/M computers are the smallest 8" drive micro's around. An ALSPA computer with a 4 MHz Z80A CPU, 64K of RAM, one or two 8" floppy drives, three RS-232 serial ports, one parallel port, and one hard disk port is no larger than most single add-on drives, and weighs only about 18 lbs. An ACI-1 can be yours for as little as \$1995.00 plus CP/M.

#### **CORVUS\*\* INTERFACE**

Standard on all ALSPA computers is a hardware interface which connects directly to either a Corvus hard disk drive or a Corvus Constellation\*\*, multi-user hard disk system. Our Corvus operation system is easy to install and use.

\*\*Corvus and Corvus Constellation are trademarks of CORVUS SYSTEMS, INC.

#### **SUPERIOR PERFORMANCE**

One demonstration will prove that our compact and durable ALSPA computers are designed to provide dependable, powerful computing service. Look at capability and speed and you'll agree we're the best value for the dollar.

DEALER INQUIRIES INVITED



**Alspa Computer, Inc.**

**MORE THAN OUR NAME IS UNIQUE**

300 Harvey West Blvd., Santa Cruz, CA 95060 (408) 429-6000

\*CP/M is a trademark of DIGITAL RESEARCH, INC.

Circle 19 on inquiry card.



While this use of a videodisc qualifies as interactive, more intense interaction with students is also possible. The example I gave earlier, in which the student steps through a set of frames, is prototypic of these more intense interactions. This same procedure can be used to enact word problems. Who doesn't remember the mileage problems of grade school? Problems like that can be made more realistic and fun by enacting them with video. For example, a problem could call for getting from city A to city B by

plane. The student might be given a certain amount of money and a plane with certain flying characteristics. The student's task would be to get from city A to city B. While en route, of course, the wind could change, and the student would have to make adjustments. With imagination the idea can be embellished to the point where solving word problems becomes more like playing an Adventure-type game.

Fully exploiting the wide range of possibilities made possible by linking a computer and a videodisc will require

the creativity of many individuals. To implement that creativity efficiently a mechanism, an authoring system, is needed. An authoring system facilitates the development of courseware. Pilot is an example of an authoring language. But there is only so much that you can do with Pilot. An authoring system gives you more capabilities. In fact, a growing number of such systems are on the market. We have chosen to work with the University of Utah's VCIS as indicated earlier.

The basic distinction between an authoring language and an authoring system is that in an authoring language, the logic and data are part of the program. In an authoring system, however, the instructional logic and the instructional content are kept separate. From a design point of view, this is most desirable because it parallels the dictum: program = algorithm + data structures. In the present context that equation becomes:

$$\text{Lesson} = \text{instructional logic} + \text{instructional content}$$

An increasing number of authoring systems are being offered, but little guidance as to how to choose one exists. A framework for comparing and evaluating authoring systems is beyond the scope of this article. However, I refer you to Ralph E. Grubb's "A Design Language for Computer Assisted Instruction" (see reference 4). Although the pamphlet was written 10 years ago, its content is very relevant today because it deals with general issues of design rather than specific implementations.

One important variable of any authoring system is the nature of interactions it supports. The University of Utah VCIS supports the interactions we contemplated using and, in principle, allows limited simulations with video tape, which is important because videodiscs are expensive to master and changes cannot be made except by remastering.

The University of Utah's authoring system consists of a series of Pascal programs and some utilities as well. It is, to say the least, a bit overwhelming at first. The authoring process en-

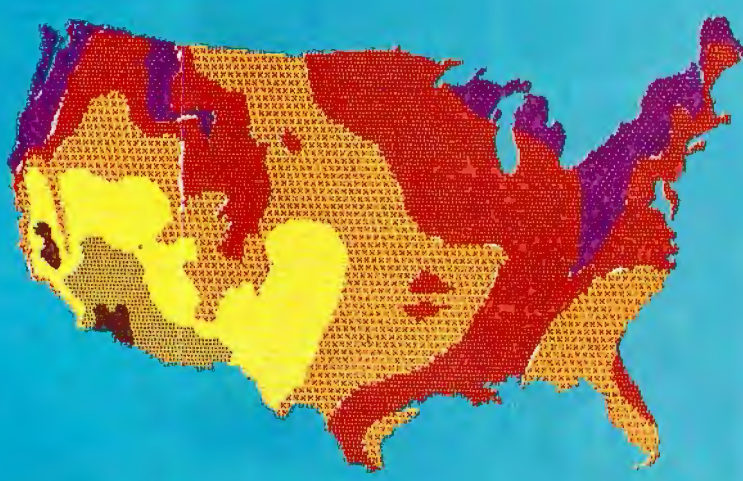

**Critical picture definition.** Does your application require high resolution color graphics? PrintaColor's GP1024 ink jet printer lets you be critical - with dot addressable color control of each pixel in a 1024x1024 display.

**Critical of high printer prices? Try \$5,495!**  
This printout (unretouched photograph) is vivid proof from PrintaColor that excellence does not have to be expensive. Virtually noiseless, the GP1024 produces a full page in just over two minutes. At only 10¢ per copy average! It's so simple to use, anyone who can operate your terminal can print informative color graphics with just a few key strokes. Call today for your nearest representative. Ask about our full line of dot-addressable and character graphics printers. There is a PrintaColor just right, and priced right, for your application.

**PrintaColor**

PrintaColor Corporation, P.O. Box 52, Norcross, GA 30091 (404) 448-2675



# Report Manager™ and the PC-8000 Personal Computer:

## An unprecedented three dimensions of management information.

All those legendary electronic spread sheets that have been making other kinds of personal computers so useful for managers are now literally flat by comparison to the remarkable combination of Report Manager™ and the NEC PC-8000 Personal Computer.

Here you get the power and versatility of an electronic book, not a mere electronic page. An axis of depth joins the horizontal and vertical—so you can, for instance, track a number of *different* profit centers over the same period of time... or follow actual performance against projections by both department and time frame.

The fact is that any sort of planning work you find useful in two dimensions, you will find that much more useful in three. The program allows you to see four separate "slices" of your 3-D "Data Cube™" on one screen, for fast, real time comparisons. There are, besides dozens of math and editing functions, built-in clock and calendar functions, too—an immensely useful convenience for scheduling, flow-charting, project management, and the like.

Watch Report Manager run—easy as A, B, C and powerful as X, Y, Z—on the PC-8000 at any NEC Home Electronics (USA) dealer.

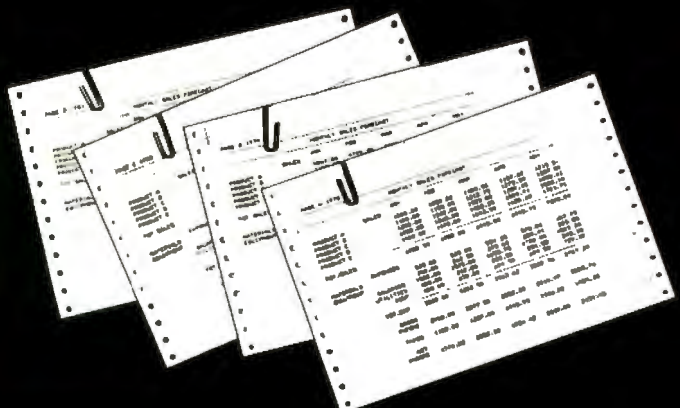
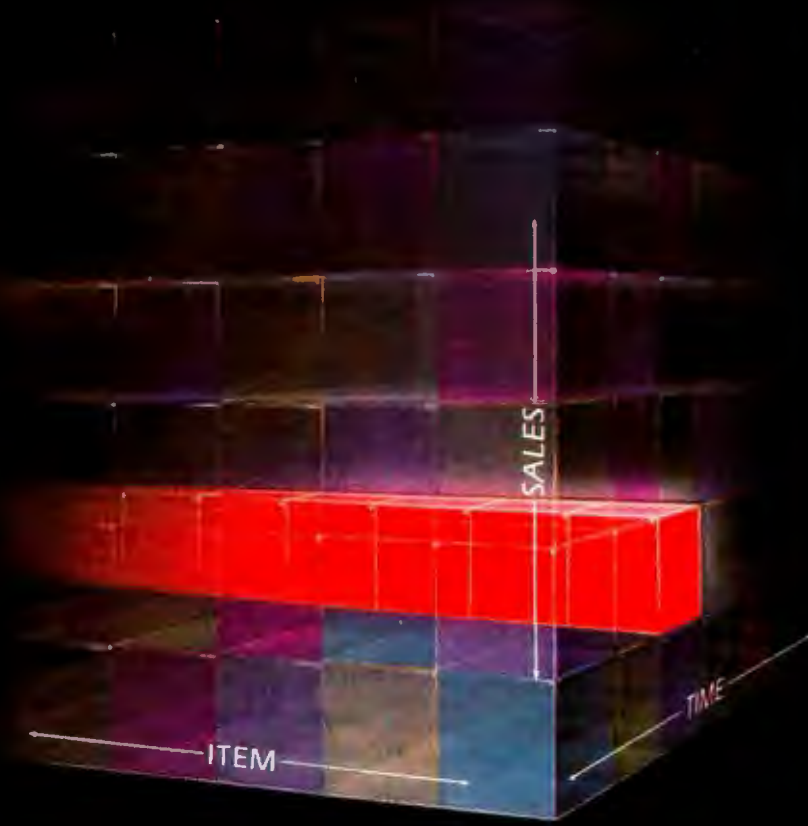

Sample printout showing use of X, Y, and Z axes.  
Report Manager and Data Cube are trademarks of The Image Producers, Inc.



**Productivity at your fingertips**

**NEC**

**NEC Home Electronics (USA) Personal Computer Division**  
1401 Estes Avenue  
Elk Grove Village, IL 60007



## Vendors Supplying Interactive Videodisc Equipment

Adwar Video Corporation  
100 Fifth Ave.  
New York, NY 10011  
(212) 691-0976

Manufactures video-related hardware for the Apple II Computer.

Allen Communication  
3004 Arapahoe Ave.  
Boulder, CO 80303  
(303) 449-2971

Manufactures an interface for the Apple II and various videodisc units.

Bell & Howell  
Audiovisual Products Division  
1 World-Trade Center, Suite 9869  
New York, NY 10048  
(212) 524-9113

Cavri Systems  
26 Trumbull St.  
New Haven, CT 06511  
(203) 562-4979

Specializes in interfaces between computer and video equipment.

Coloney Productions  
1248 Blountstown Highway  
Tallahassee, FL 32304  
(904) 575-0691

Specializes in Apple II-videodisc interfacing.

Discovision Associates  
3300 Hyland Ave.  
POB 6600  
Costa Mesa, CA 92626  
(714) 957-3000

DVA system manual for optical videodisc players (TP-101) and DVA installation/maintenance manual for the UEI (TP-102)

Independent Video Consultants  
125 West Durham St.  
Philadelphia, PA 19119  
(215) 248-0700

Specializes in authoring languages.

The International Institute of Applied Technology Inc.  
20010 Century Boulevard, Suite 100  
Germantown, MD 20874  
(301) 428-9010

Sells a CP/M-based Pilot which supports videodiscs.

Sony Video Communications  
9 West 57th St.  
New York, NY 10019  
(212) 371-5800

Sells the LDP-1000 laser-reflective videodisc player.

Syntec  
15933 West Eight Mile  
Detroit, MI 48235  
(313) 272-2950

Video hardware including overlay capabilities.

Texas Instruments  
Customer Product Service  
POB 10508  
Lubbock, TX 79408  
(214) 995-2011

In addition to the TI-99/4A, Texas Instruments now has a videodisc controller for the Pioneer disc player as well as authoring software.

Video Associates Labs  
2304 Hancock Dr., Suite 1-F  
Austin, TX 78756  
(512) 459-5684

Specializes in video hardware for the Apple II, including a board which allows the Apple video output to be overlaid on an NTSC video signal.

Wicat Systems  
POB 539  
1875 South State St.  
Orem, UT 84057  
(801) 224-6400

Wicat is a pioneer in the application of videodiscs to education.

couraged by the system is to create the content material with the help of the text, graphics, and animation editors. You then use the program Builder to establish the ordering presentation of these materials as well as parameters related to student responses.

While the standard features of the system allow the design of a large variety of instructional designs, the VCIS developers were not so pretentious as to think they had included all the possibilities in the system. You can incorporate features into the system through what they call "specials," a Pascal segment written by users to add a feature peculiar to their applications. The most common application of specials is to design dynamic graphics. For example, if the lesson calls for plotting the graph of an equation to be provided by the student, you need a special to parse the student's equation and then plot the results.

### Conclusions

The emphasis on technical issues in this article should not be taken to mean that nontechnical issues are unimportant. Education will continue to be for the foreseeable future an activity in which machines can have only a very limited role, and nontechnical issues are the order of the day. Nevertheless, I would like to think that technology, if intelligently used, can make the ideal of equal educational opportunity a little bit more reachable by making richer educational experiences accessible to a larger number of students. Videodisc technology has the potential of contributing to that goal. ■

### References

1. Ball, S. and Bogatz, G. *The First Year of Sesame Street: An Evaluation*. Princeton, NJ: Educational Testing Service, 1971.
2. Anastasio, E. J. "The Study of Factors Inhibiting the Use of Computers in Instruction." *EDUCOM—Bulletin of the Inter-university Communications Council*, Spring 1972, 1(1).
3. Foley, J. D. and Van Dam, A. *Fundamentals of Interactive Computer Graphics*. Reading, MA: Addison-Wesley, 1982.
4. Grubb, R. E. *A Design Language for Computer-Assisted Instruction*. Published by Albert E. Hickey Associates, 42 Pleasant St., Newburyport, MA 01950.



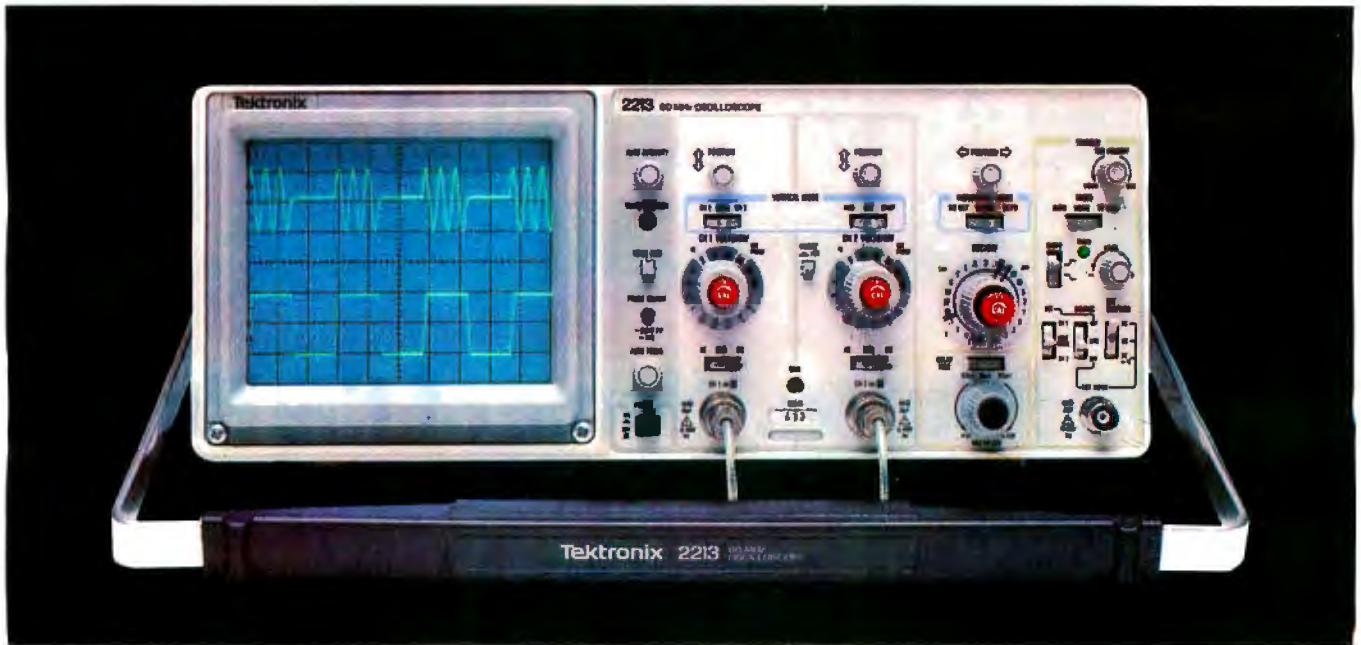

## Introducing a direct line to a 60 MHz Tektronix scope built for your bench!

**From the world's most respected name in oscilloscopes: a new scope, plus a new direct order number, that finally makes it practical to put Tektronix quality on your bench... at work or home.**

Among professional engineers and technicians there is no substitute for the performance and reliability of Tektronix oscilloscopes.

Now, for the first time, Tektronix is offering an advanced scope at an unprecedented low price—and has a direct order line that lets you get your order processed today!

**The scope: the 2213. Its radical new design brings you Tektronix quality for well below what you would pay for**

**lesser-name scopes.**

The 2213's practical design includes 65% fewer mechanical parts, fewer circuit boards, electrical connectors and cabling. Result: a lower price for you plus far greater reliability.

Yet performance is pure Tektronix: there's 60 MHz bandwidth for digital and high-speed analog circuits. The sensitivity for low signal measurements. The sweep speeds for fast logic families. A complete trigger system for digital, analog or video waveforms. And new high-performance Tektronix probes are included!

### 2213 PERFORMANCE DATA

**Bandwidth:** Two channels, dc—60 MHz from 10 V/div to 20 mV/div. (50 MHz from

2 mV/div to 10 mV/div).

**Sweep speeds:** Sweeps from 0.5 s to 50 ns (to 5 ns/div with X10 mag).

**Sensitivity:** Scale factors from 100 V/div (10X probe) to 2 mV/div (1X probe). Accurate to  $\pm 3\%$ . Ac or dc coupling.

**Delayed sweep measurements:** Standard sweep, intensified after delay, and delayed.

**(Need dual time-base performance and timing accuracy to  $\pm 1.5\%$ ?** Ask about our 2215 priced at \$1400.)

**Complete trigger system:** Modes include TV field, normal, vertical mode, and automatic; internal, external, and line sources; variable holdoff.

**Probes:** High perform-

ance, positive attachment, 10-14 pF and 60 MHz at the probe tip.

**The price: Just \$1100 complete\*. Order direct from Tektronix National Marketing Center.** Phones are staffed by technical people to answer your questions about the 2213. Your direct order includes a 15-day return policy and full Tektronix warranty.

**Now it's easier than ever to get your hands on a Tek scope!**

**ORDER TOLL-FREE**

**800-547-1845**

**Ask for Dept. A0320**

(In Oregon, Alaska and Hawaii: 1-503-627-5402 collect.) Lines are open from 8 am EST to 5 pm PST.

\*Price F.O.B. Beaverton, OR

# OUR PRICES, SELECTION AND SAME-DAY SHIPPING MAKE US COMPETITIVE.

## Red Baron. Home of the Nation's

### NEC 8023 Outstanding Graphics, Print Quality & Performance

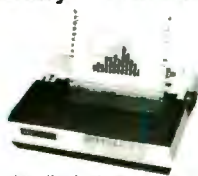

144 x 160 dots/inch • Proportional Spacing  
• Lower case descenders • N x 9 dot matrix  
• 8 character sizes • 5 unique alphabets  
• Greek character set • Graphic symbols  
• 100 CPS print speed • Bi-directional logic-seeking  
• Adjustable tractors • Single-sheet friction feed • Vertical & horizontal tabbing

NEC 8023  
Dot Matrix ..... List \$795 **\$Call**

### IDS Paper Tiger Prism 80/132 Affordable Color, Speed



Dot Resolution Graphics • 9-wire staggered printhead • Lowercase descenders • Over 150 CPS • Bi-directional, logic-seeking  
• 8 character sizes • 80-132 columns  
• Hi-res dot graphics • Proportional spacing  
• Text justifications • Optional Color

Prices Begin At  
Prism 80 ..... List \$999 **\$700**  
Prism 132 (Color) ..... List \$2095 **\$1895**

### NEC Spinwriter 7700 & 3500 Daisy Wheel Quality Leader



High speed, letter quality • 55/35 CPS  
• Typewriter quality • Bi-directional printing & proportional spacing • Quiet • OCR quality print • Hi-res plotting/graphing • Quick change ribbon • Optional cut-sheet feeder, horizontal or bidirectional tractors • Prints up to 8 copies.

NEC Spinwriter RO  
Serial Parallel 77xx .... List \$3055 **\$2575**  
35xx ..... List \$2290 **\$1975**

### The Epson Series. High-Quality Printers at a Low Price.



### Epson MX80FT

9 x 9 dot matrix • Lower case descenders  
• 80 CPS • Bi-directional • Logic seeking  
• 40, 66, 132 columns per line • 64 Special graphic characters: TRS 80 Compatible  
• Forms handling • Multipage printing  
• Adjustable Tractors/Friction Feed

Epson MX80FT ..... List \$745 **\$Call**



### Epson MX80

9 x 9 dot matrix • Lower case descenders  
• 80 CPS • Bi-directional • Logic seeking  
• 40, 66, 132 columns per line • 64 special graphic characters: TRS 80 Compatible  
• Forms handling • Multipage printing  
• Adjustable tractors

Epson MX80 ..... List \$645 **\$Call**  
with Free Graftrax



### Epson MX100

Same basic features as the MX80 • Plus friction feed for single sheets • Plus 15" wide carriage • Dot Resolution Graphics

MX100 ..... List \$995 **\$Call**

Full Line of Epson Accessories

### Anadex 9501 High Speed, Commerical Duty Plus Graphics

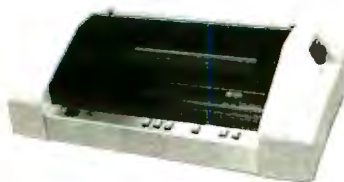

Dot graphics • Wide carriage • 11 x 9 dot matrix • Lower case descender • Dot resolution graphics • Bi-directional, logic seeking • Up to 200 CPS • RS 232 Serial & Parallel • Forms control • X-On/X-Off • Up to 6 part copy

Anadex 9501 ..... List \$1650 **\$1300**

### Televideo CRT's Price, Performance & Reliability



910 ..... List \$699 **\$600**  
925 ..... List \$995 **\$750**  
950 ..... List \$1195 **\$970**

### Interface Equipment

Complete Stock of Options,  
Cables and Accessories.

GRAPPLER APPLE INTERFACE ..... \$175  
CCS APPLE SERIAL Interface & Cable . \$150  
ORANGE INTERFACE for Apple II  
Parallel Interface Board and Cable .. \$110  
NOVATION D-CAT  
direct connect modem ..... \$180  
COMPLETE STOCK OF EPSON  
ACCESSORIES ..... \$Call  
CUSTOM PRINTER CABLES FOR Apple,  
Atari, IBM, TRS-80 (all models) ..... \$Call  
HAYES MICROMODEM ..... \$300  
PRINTER STANDS: Large ..... \$99  
Small ..... \$25  
PRINTER RIBBONS—Most Types ..... \$Call



# OUR PEOPLE MAKE US EXPERTS.

## Largest Computer Printer Inventory.

### The Grappler Apple Graphics Interface

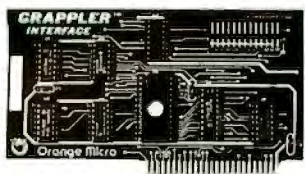

The most intelligent Apple Interface available. EPROM chip makes high-resolution graphics easy. Versions to accommodate the Anadex, Epson Series\*, IDS Paper Tigers, Centronics 739, NEC 8023, C. Itoh Prowriter, Okidata Series\* and more.

\*Requires Graphics Upgrade.

**\$175**

### The Okidata Series Hi-Res & TRS 80 Block Graphics



120 CPS • 9 x 9 Matrix • Bidirectional logic seeking printing • Lower case descenders • four print styles • Optional Hi-Res Graphics

Okidata 82A . . . . . List \$649 **\$480**  
Okidata 83A . . . . . List \$995 **\$745**  
Tractor Option . . . . . **\$65**

### C. Itoh F-10 Low Priced Letter Quality



40 cps • Uses Diablo Standard Printwheels • Built-in word processing functions • Universal power supply • Optional bidirectional tractors • Prints original plus 2 copies • Quick-change cartridge Ribbon

C. Itoh F-10 . . . . . List \$1995 **\$Call**

### Our People, Our Product: Both Are Specialized.

Because our salespeople are printer specialists, they know the capabilities of each printer—and how to match one to your exact need. Red Baron's volume stocking assures a low, low price on a wide array of major brands. We're sure you'll like the product and services you get from Red Baron, and we know you'll love our Customer Benefit Package; an exclusive at Red Baron.



### Customer Benefit Package

**1. Free Expert Consultation.** Before you buy, after you buy. **2. Toll-Free Ordering.** There's never a toll charge when you place your order at Red Baron. **3. Free Catalog.** Get your informative catalog with printer comparison chart and print samples today! **4. Warranty.** The manufacturer's warranty applies where applicable. **5. Same-Day Shipping.** Your order is sent the same day when you call before 11:00 a.m. **6. Free/MasterCard & Visa.** Call us toll-free and charge your printer to your credit card. **7. We Stock What We Sell.** No bait and switch, no hassle. We make every effort to keep a large stock of our advertised products.

### Other Quality Printers at Red Baron

	List	Discount
Centronics 739-1 . . . . .	\$695	<b>\$Call</b>
C. Itoh 8510 Prowriter . . . . .	\$795	<b>\$Call</b>
C. Itoh Starwriter . . . . .	\$1895	<b>\$Call</b>
Diablo 630/6 . . . . .	\$2995	\$2570
QUME Sprint 9/45 . . . . .	\$2475	\$2150

### Here's How To Order:

Phone orders are welcome; same-day shipment on orders placed before 11:00 a.m. Free use of MasterCard and Visa. COD's accepted. Personal checks require 2 weeks clearance. Manufacturer's warranty included on all equipment. Prices subject to revision.

### Call Toll Free For Catalog:

**1-800-854-8275**  
CA, AK, HI (714) 630-3322



Circle 390 on inquiry card.  
Member Better Business Bureau

# Interactive Training in Cardiopulmonary Resuscitation

*Computer and videodisc technologies combine to provide instruction in lifesaving techniques.*

---

David Hon, Director  
Advanced Technology Development  
American Heart Association  
National Center  
7320 Greenville Ave.  
Dallas, TX 75231

---

Cardiopulmonary resuscitation (CPR), when properly performed, is a technique that can save thousands of lives. Existing programs have successfully trained many individuals in the practice, but such programs have been limited by the number of qualified instructors available. If an effective, low-cost alternative to live instruction could be found to expand the programs, many more lives could be saved. The advanced state of videodisc technology suggested that a training system might be developed by interfacing a videodisc machine with a personal computer.

Despite recent progress in making computer systems and software easier to use, many people remain computer-shy. Any computer that is less than "ultrafriendly"—totally accommodating and transparent (in the sense of allowing someone to benefit from the system without having to learn how to operate it)—will frighten such people away. A systems designer can't expect them to voluntarily approach a computer's keyboard to find out how easy the computer is to use. Even an occasional pressing of the Return key is too much to ask.

The design of a transparent com-

puter system is difficult, however, and the more complex the functions that the system must perform, the harder it is to keep the interface with the user simple and accommodating. Before attempting to create an ultrafriendly system it is wise to ask whether the project is really important enough to merit the effort involved.

In the case of the American Heart Association's program to teach CPR techniques, many thousands of lives are at stake. Some 500,000 victims each year die before emergency care arrives: children jolted nearly to death by contact with high-voltage wires, businessmen collapsed on the street, football players whose hearts have stopped after vicious tackles, fathers stricken while shoveling snow, and many other ordinary people felled in ordinary surroundings.

The mechanism of death from a heart attack is well known. Heart failure cuts off the flow of oxygenated blood to the brain. Brain cells begin to die from lack of oxygen. The medical world agrees that a high proportion of heart-attack victims might be saved if life could somehow be sustained for even a few minutes until emergency care arrives.

## **A Plateau in Lifesaving**

But it seemed as if we had reached a plateau in the number of people to whom we could teach the lifesaving techniques of CPR. It seemed as if the number of instructors at any one time remained almost constant. Each year the number of newly trained instructors would continually be offset by the number of previous instructors who let their skills slip away. The plateau was at the level of about 12 million trained rescuers. That made the odds facing a stricken American about 18 to 1 *against* having a competent CPR rescuer present to sustain life during those grim minutes before the arrival of emergency care. Improving the survival odds even one or two percentage points could save tens of thousands of lives.

Human and organizational limits established the plateau in the number of trained rescuers. Expanding the training program through volunteers or paid instructors would always multiply logistics and personnel problems, strain finances, and increase the difficulty of standardizing live instruction.

On the other hand, conventional training media had failed to do much more than present information.



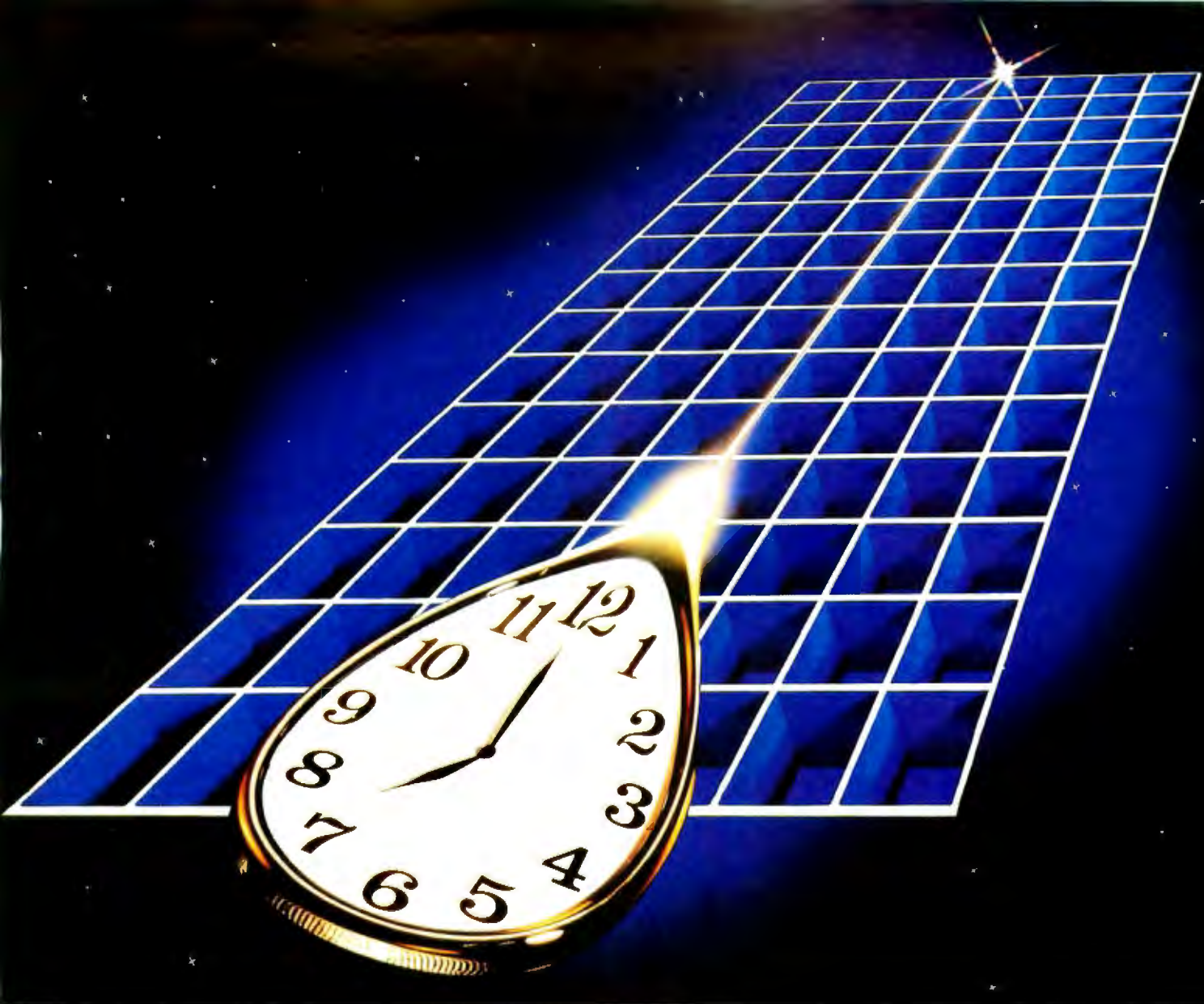

For PDP-11 RSX, RSTS/E, RT-11, and TSX-Plus users

# Pascal-2<sup>®</sup>

We can save you time because our Pascal-2 compiler matches or beats the run-time performance of any high-level language on the PDP-11. The same is true for the size of code generated.

We can save you time because Pascal-2 has excellent error reporting and recovery, because our interactive, source-level debugger helps detect deep-rooted logical errors, and because our package includes a number of other programmer-oriented utilities.

We can save you time because the structured methods of Pascal encourage problem solving the first time round. Team members can understand one another's code, thus improving communication and protecting you against the disruptive effects of staff changes.

We can save you time, and money, because you can take your standard Pascal programs with you to a new computer. You may even find our Pascal-2 compiler running on that new machine. We're working on a VERSAdos compiler and a stand-alone system for the MC68000. We're field-testing a cross-compiler from RSX to VERSAdos and a Pascal-2 for UNIX on the PDP-11. We're also developing a Pascal-2 for VAX/VMS (where our RSX product already runs in compatibility mode).

Call or write. We'll send benchmark details, a product description, and a distributor list. Pascal-2 manuals are also available.

Pascal-2. It's about time.

Digital Equipment Corporation trademarks: PDP, VAX, RSX, RSTS/E, RT-11; Motorola Inc. trademarks: MC68000, VERSAdos; Bell Labs. trademark: UNIX; S&H Computer Systems, Inc. trademark: TSX-Plus.

**Oregon  
Software**

2340 S.W. Canyon Road  
Portland, Oregon 97201  
(503) 226-7760  
TWX- 910-464-4779

Circle 345 on inquiry card.

AMERICAN HEART ASSOCIATION  
CARDIOPULMONARY RESUSCITATION AND EMERGENCY CARDIAC CARE  
PERFORMANCE TEST FOR ONE AND TWO RESCUER CPR

NAME: \_\_\_\_\_

DATE: \_\_\_\_\_

ELAPSED TIME (seconds)		ACTIVITY AND TIME (seconds)	CRITICAL PERFORMANCE	PASS	FAIL
Min.	Max.				
4	10	Establish unresponsiveness and call out for help. Allow 4-10 sec. if face down and turning is required.	Tap, gently shake shoulder and shout—"Are you OK?" Call out "Help!" Turn if necessary.		
			Adequate time.		
7	15	Open Airway. Establish breathlessness. (Look, Listen, and Feel) (3-5 sec.)	Kneels properly. Head tilt with one hand on forehead and neck lift or chin lift with other hand.		
			Ear over mouth, observe chest.		
10	20	Four ventilations. (3-5 sec.)	Ventilate properly 4 times and observe chest rise.		
15	30	Establish pulselessness and simulate activation of the EMS System. (5-10 seconds)	Fingers palpate for carotid pulse on near side (other hand on forehead maintains head tilt) Know local EMS number.		
			Adequate time.		
69	96	Four cycles of 15 compressions and 2 ventilations (54-66 sec.)	Proper body position.		
			Landmark check each time.		
			Position of hands.		
			Vertical compression/no bouncing.		
			Says mnemonic.		
			Proper rate and ratio.		
72	101	Check for return of pulse and spontaneous breathing (3-5 sec.)	Ventilates properly.		
			Check pulse and breathing.		

**Figure 1:** A reproduction of part of the American Heart Association's performance test for cardiopulmonary resuscitation by a single rescuer. The CPR training system had to meet the performance standards shown.

When the subject being taught is a hands-on skill requiring the exercise of judgment, merely presenting information isn't good enough. As a result, slides, tapes, films, and printed matter could do no more than assist a live instructor.

### Finding a Technological Solution

Could a computer-based, instructorless system succeed where human teachers and conventional aids had failed? The human instructor begins by giving basic instructions to the student, who then experiments with a training manikin. The process is one-on-one coaching through repeated drills. The live instructor gives the student constant attention, commentary, and evaluation as the student

works on the manikin. Often the student needs to receive instructions while keeping his or her eyes fixed on the manikin.

To replace the human instructor, then, a computer-based system had to meet a long list of general requirements. First, it should provide total, stand-alone interactivity with students. It should train people to meet the certification standards in the American Heart Association's Cardiopulmonary Resuscitation and Emergency Cardiac Care Performance Test (see figure 1). It must meet or exceed the results of live instruction at every comparison and should provide high standardization and limited need for personnel and logistics. The system should teach basic concepts as well as hands-on

skills and be able to instruct the student at times without requiring the student to take his or her eyes off the manikin (in other words, coach the student aloud). The entire setup should cost the agencies that would be the end users something under \$15,000. And finally, it should be accommodating, responsive, and as easy for the average person to operate as an arcade game.

These last two requirements were essential to achieving the kind of broad outreach in CPR training that the American Heart Association wanted to encourage. The rough figure of under \$15,000 as the retail price of all hardware and software would make the system affordable for those institutions that wanted to expand CPR programs but could not



# DAWN OF A NEW ERA

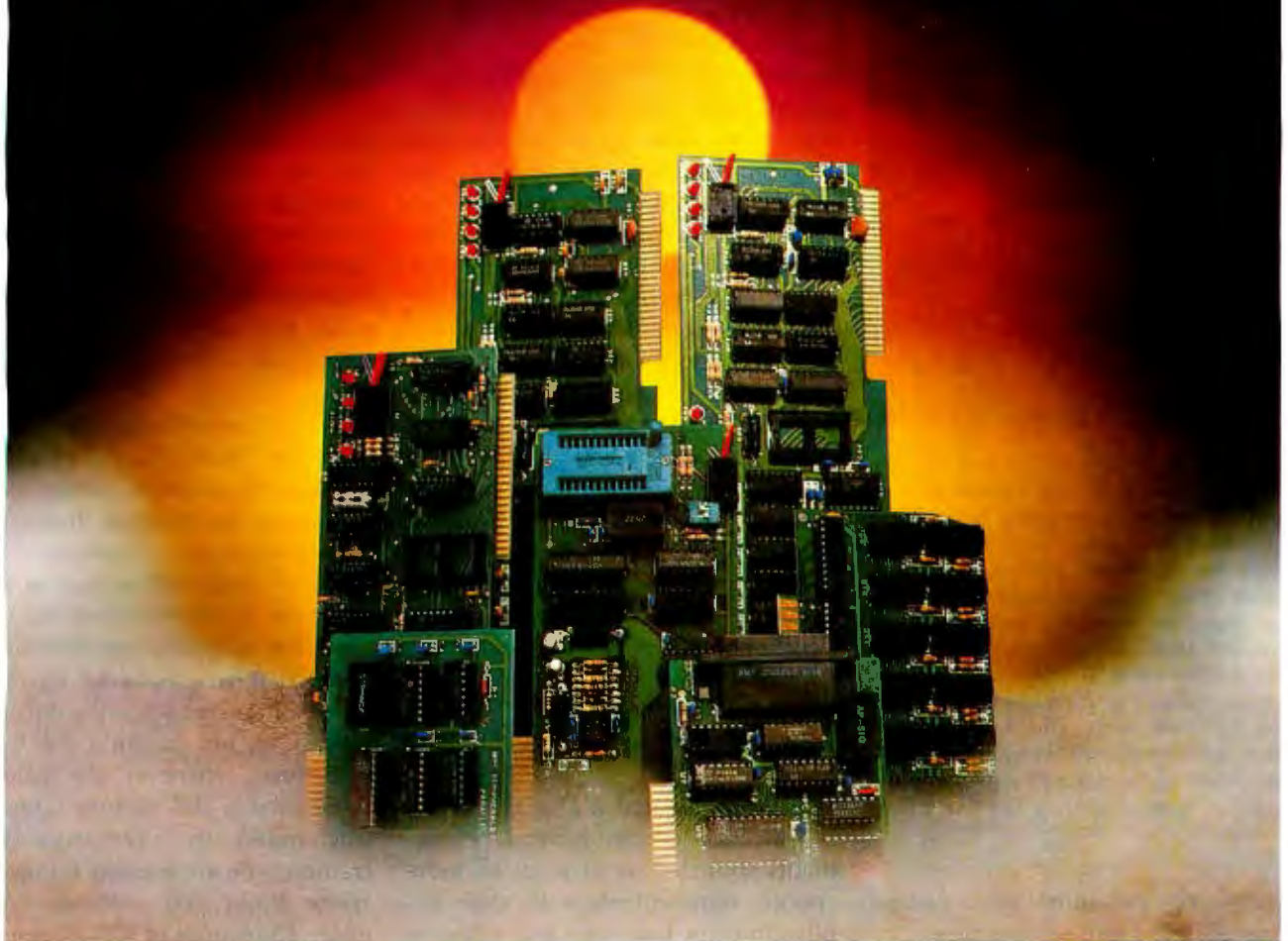

## Low-cost, high performance products from MPC

Powerful, well-built, precision machines . . . they came in numbers, like invaders from another dimension. Positioning themselves on the leading edge of a technological revolution. Initiating an era that heralds the unique combination of high quality and low price. Thousands of Apple and Atari users are amazed.

What magic formula propelled our successful entry into the national peripheral market? Intense research. Thorough product development. Established dedication to exacting standards of quality. Uncompromising quality.

We fine-tune all our products to a level that enables us to offer every buyer a **TWO YEAR WARRANTY** — an expression of product confidence unprecedented in the industry.

APPLE II		ATARI 400/800	
AP-16	16K Memory Board	AT-16	16K Memory Board
AP-32	32K Memory Board	AT-32	32K Memory Board
AP-80	Parallel Printer Card	AT-BSR	Home Controller
AP-SIO	Serial I/O Interface	AT-DISK	Single/Double Density Disk
AP-96	Upper/lower Case ROM	PROM-IT	EPROM Burner
PROM-IT	EPROM Burner	ATC-1, 2, 3	Cables
AP-VID	80 Column Card		

As for the challenge of the future, we are alert to changing market conditions. Our research will continue to venture across the boundaries of traditional disciplines. Our total commitment to Apple and Atari users has prepared us for uncharted horizons.

For a young company like MPC Peripherals, it is indeed the dawn of an exciting era of growth and satisfaction. We thank you for your faith in our products. Join us in meeting the challenge of tomorrow.

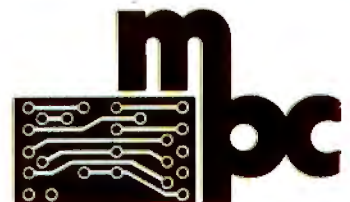

MPC PERIPHERALS CORP.  
9424 Chesapeake Drive  
San Diego, CA 92123  
714-278-0630

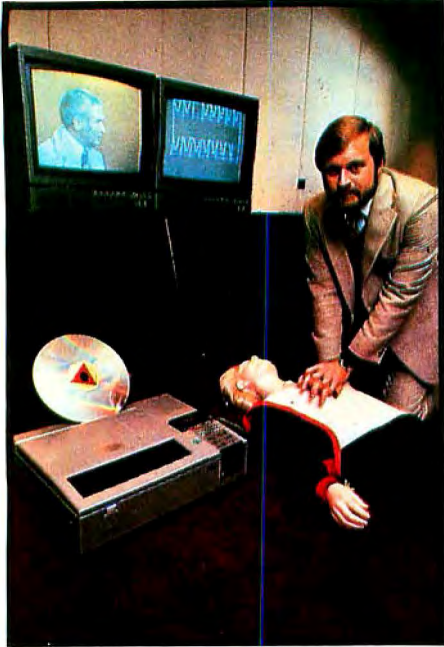

**Photo 1:** The complete CPR training system. The Sony LDP-1000 videodisc, normally out of sight, appears in the foreground. Author David Hon is trying to revive the electronic manikin. The video screen at left shows the doctor, who is coaching Hon from the videodisc. The computer video screen at right, which the doctor refers to as "Compy," is showing a graphic analysis of chest compressions as Hon performs them. The Apple II computer, which manages the system, is concealed behind the drapes below the video screen at right. (Photo by Jim Sheldon.)

justify the personnel or logistical costs of hiring more instructors.

We felt that the requirements of transparency and simplicity were as important as any of the others. We didn't believe that an instructional system that required students to develop skill in using a computer could succeed. We had learned something from games like *Space Invaders*: if you design a computer-based system in such a way that people know the difference between winning and losing, virtually anyone will jump in and try to win. Saving a life is a big victory and a big incentive. We were sure that if we could build a system that was easy to use and engaging, trainees would use it and learn from it willingly.

We also knew that the project wouldn't be easy. But the prospect of training thousands of people and saving thousands of lives justified the

effort required. In that context, we didn't have the luxury of that technical snobbery that says, "There's no sense wasting time on people who can't learn to use our computers."

In short, we needed a combination of hardware, software, and online data that would answer questions on request, instantaneously gather information about each student's hands-on performance, respond to each action with appropriate spoken instructions or video demonstrations, gather data on the student's next attempt, respond with appropriate instructions or demonstrations, and so on, until the student performed up to standards—without needing to know anything about how to use a computer. We needed a more-than-friendly "total coaching loop" for under \$15,000.

We seem to have achieved our goals. Photo 1 shows the finished system in use. But there's much more to the story than any photograph can show. I hope that the following description of the development of the CPR training system will encourage others to undertake similar projects with videodisc technology.

### Working Toward a Design

Reflection on our general requirements soon led us to a list of more specific requirements with clear implications for hardware and software design.

Meeting the performance standards for certification of millions of ordinary people who learn in different ways would take a large, comprehensive set of visual segments, both still and moving. We rejected the use of video tape because of its slow response time and its lack of first-rate freeze-frame capabilities. Videodisc technology seemed the only possibility for storage and rapid retrieval of the number of segments required.

We had to be able to retrieve instantly from storage the *right* video segments for each action of each student during training. This required, besides storage on videodisc, evaluation and management by computer. The computer would have to assess students' efforts, draw appropriate coaching from storage, reassess ef-

forts and supply appropriate coaching again and again, and provide a final evaluation of each student's performance. To achieve the necessary speed, we would have to do extensive machine-language programming.

We also had to face the fact that making software for a video display automatically makes you a television producer, with all the associated privileges and responsibilities. As a former television script writer, I saw that one of the greatest challenges of this project was creating a script that embodied a system design and had a format that three unrelated groups could work with: medical experts, video producers, and computer programmers. (I'll say more on this later.)

We also needed a large set of audio segments. Some of these would talk along with videodisc freeze frames, explaining the material shown in the still illustrations. Consequently, the speed of audio access had to match the speed of retrieval from the videodisc. The videodisc can record sound and play it back, but you can only get voice off the disc when the disc is running (i. e., not during a still frame). Therefore, whenever the voice accompanies a still picture (appearing unchanged in successive video frames), you are wasting frames. You waste about 400 video frames for every 15 seconds of still picture.

Since we didn't want the user or anyone else to have to change videodiscs, we had to squeeze a great deal onto a single disc. Rather than waste videodisc space on sound to accompany freeze frames, we decided to use another audio device of some kind for that purpose. Investigation of voice synthesizers showed that they would prove too expensive for the end user and too artificial in tone to achieve the kind of friendliness that we wanted. The remaining choice was an audio recorder. But ordinary sequential-access audio recorders were out of the question. We needed a random-access audio recorder to match the speed of the random-access videodisc. Unfortunately, there was no such thing as a random-access audio recorder. We would have to create one.



# S-100 STATIC MEMORY BREAKTHROUGH

## MEMORY MERCHANT



**16K STATIC RAM \$169**

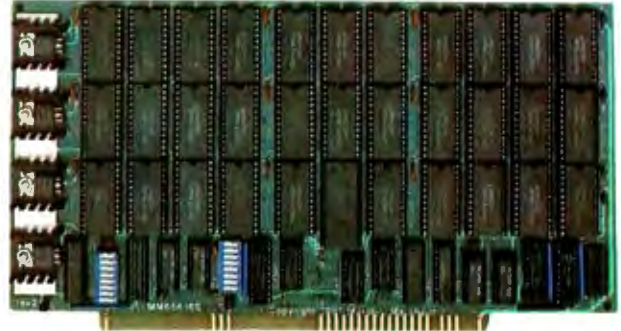

**64K STATIC RAM \$795**

**32K PARTIALLY POPULATED \$479 48K PARTIALLY POPULATED \$659**

Finally, you can buy state-of-the-art S-100 static memory for your computer at unprecedented savings.

Memory Merchant's memory boards provide the advanced features, quality and reliability you need for the kind of operational performance demanded by new high-speed processors.

### COMPLETELY ASSEMBLED

These memory boards are not kits, nor skeletons—but top quality, high performance memories that are shipped to you completely assembled, burned-in, socketed, tested and insured with one of the industry's best warranties.

### SUPERIOR DESIGN & QUALITY

Memory Merchant's boards are created by a designer, well-known for his proven ability in advanced, cost-efficient memory design. Innovative circuitry provides you with highly desired features and incredible versatility.

Only first quality components are used throughout, and each board is rigorously tested to assure perfect and dependable performance.

### SHIPPED DIRECT FROM STOCK

All Memory Merchant's boards are shipped direct from stock, normally within 48 hours of receipt of your order.

### NO RISK TRIAL

We are so convinced that you will be absolutely delighted with our boards that we extend a no risk trial offer. After purchasing one of our boards, you may return it (intact) for any reason within 15 days after shipment and we will refund the purchase price.

### NEW 18 MONTH LIMITED WARRANTY!

The reliability of our boards, through quality controlled production and proven performance, has enabled us to extend our warranty to a full 18 months. This includes a 6 month exchange program for defective units.

### HOW TO ORDER

Please send check, money order, VISA or MASTERCARD (add ICA#) with your order. Sorry, no C.O.D.'s. Specify model number, and quantity desired. Shipping and handling charge is \$5.00 per board. California residents add 6% Sales Tax. Credit card purchases may be telephoned to (415) 483-1008.

**OEM and DEALER inquiries invited.**



**14666 Doolittle Drive  
San Leandro, CA 94577  
(415) 483-1008**

### 64K RAM, Model MM65K16S

Cool running operation to 10 MHz  
Ultra low-power consumption  
Fully loaded 64K board draws:  
Typ. 350 Ma. (Max. current 550 Ma.)

Bank Select Capability

Extended Addressing Capability

One 16K submodule equipped with a 2K window which may be located in any of the 2K segments

2716 (5V) EPROM Compatibility:  
Programmed 2716 EPROM's may replace any or all of the RAM

Four independently addressable 16K submodules on one board organized as two pair of independent 32K banks or as one 64K Extended Address Page. Each 32K bank responds independently to phantom. Bank Select logic is compatible with either Cromemco Cromix\* or standard Bank Select software.

\*Cromix is a trademark of Cromemco.

New 16K (2K X 8) 150ns Static RAM  
Runs on any S-100, 8-bit system  
MPM Conversion Option: Write for details.

### 16K RAM, Model MM16K14

Bank Select Capability

Extended Addressing Capability

One 4K segment equipped with 1K windows

Four independent 4K X 8 byte segments

Uses field proven 2114 (1K X 4)

Low-power consumption (Typ. 1.3 Amps)

Runs on any S-100 8080, 4 MHz Z-80 or 5 MHz 8085 system.

Prices, terms, specifications subject to change without notice.

Circle 289 on inquiry card.

# CP/M<sup>®</sup> SOFTWARE

OUR  
MONTHLY  
SPECIAL

## dBASE II

60 DAY  
MONEY BACK  
GUARANTEE

**\$125<sup>00</sup>**

MERCHANDISE CREDIT  
TOWARDS ANY FUTURE PURCHASE

**PLUS - FREE DIGITAL WATCH (\*\$69<sup>00</sup> value)  
YOURS TO KEEP EVEN IF YOU RETURN YOUR dBASE II**

If your application calls for managing data, dBASE II may be the answer.

You can create a database and start entering data into it in less than a minute. Type CREATE, then respond to the dBASE II prompts to name the file and define the fields in your records.

Once the record is defined, you can start entering data immediately, or add information later by typing APPEND. In both cases, dBASE presents you with an entire record structure for which you simply fill in some or all of the blanks.

Now for a limited time only, you can purchase the most powerful DBMS system for your micro for the incredibly low price of \$595 delivered. We'll send you a copy of dBASE II that you can run on your system for 60 days. If you're not completely satisfied, then just send everything back and we'll return your money no questions asked! Even if you go for another system, you'll be an informed buyer!! dBASE II is a fine product by Ashton-Tate.

HEWLETT PACKARD FORMAT AVAILABLE

### ACCOUNTING PLUS<sup>®</sup>

General Ledger  
Accounts Payable  
Accounts Receivable  
Payroll  
Inventory  
Sales Order Entry  
Purchase Order Entry  
Point of Sale

1 MODULE	\$ 495
2 MODULES	940
3 MODULES	1385
4 MODULES	1830
5 MODULES	2275
6 MODULES	2675
7 MODULES	3050
8 MODULES	3400

### DIGITAL RESEARCH<sup>®</sup>

MAC	85
SID	65
ZSID	90
TEX	90
DESPOOL	45
PL/1-80	449
BT-80	175
PASCAL MT+	425
CB-80	419
CBASIC 2	110

### FOX & GELLER<sup>®</sup>

Quickscreen	139
Quickcode	call

### LEXISOFT<sup>®</sup>

Spellbinder	299
-------------	-----

### LIFEBOAT<sup>®</sup>

T/Maker II	229
------------	-----

### MICRO - AP<sup>®</sup>

S-Basic	269
Selector IV	259
Selector V	399

### MICRORAFT<sup>®</sup>

Legal Billing	\$ 495
Time Billing	495

### MICROPRO<sup>®</sup>

Wordstar	299
Mailmerge	95
Spellstar	169
Datastar	249
Calcstar	219
Supersort	199
Customization Notes	349
Wordmaster	119

### MICROSOFT<sup>®</sup>

Basic 80	284
Basic Compiler	325
Fortran 80	345
Cobol 80	569
Macro 80	144
Edit 80	84
MU Math /MU Simp	219
MU Lisp/MU Star	165
M-Sort	129

### PICKLES & TROUT<sup>®</sup>

CP/M	179
CP/M (Hard Disk)	259

### SORCIM<sup>®</sup>

Supercalc	239
-----------	-----

### DATA BASE<sup>®</sup>

FMS-80	649
CONDOR 20-I	249
CONDOR 20-II	529
CONDOR 20-III	839
CONDOR 20-R	249
CONDOR 20-Q	149

### XEROX 820 ACCESSORIES<sup>®</sup>

DUAL DENSITY BOARD	395
SERIAL PRINTER DRIVER	99
SMARTERM	129
PARALLEL PRINTER SOFTWARE	99

AND MUCH MORE!

## standard software

CORPORATION OF AMERICA

10 MAZZEO DRIVE, RANDOLPH, MA. 02368

**617-963-7220**

ORDER LINE **800-343-8420**

MasterCharge, VISA, C.O.D.

3% Discount on prepayment made by check (software only)  
All items subject to availability and price change

CP/M Is A Trademark Of Digital Research



To measure students' performance in the hands-on skills of CPR, we would have to install a number of different sensors in the training manikin. The sensors would be peripheral input devices to the microcomputer. The manikin would "feel" certain combinations of actions and feed resultant data into the microcomputer for instant evaluation, and the microcomputer would then call up one of the hundreds of branches available to coach the learner. Because no sensory peripherals existed that were appropriate for measuring student actions and sending data to the computer, the hardware would have to be designed in parallel with and after the software. Since the peripherals were yet to be designed, we needed a computer that permitted the flexibility of adding cards later to interface with the peripherals. We chose the Apple II because of its open structure.

The data supplied by the sensors would enable the system to talk along while the student was working on the manikin. With chest compression, for example, the system would say things like, "Find the notch on the sternum, or, "Do one compression. . . I'll give a low tone when you're close and a high tone for exactly right." To coach the student to apply the right pressure, the on-screen instructor would say "a little more gently this time," or "too deep," or "keep trying till you get a high tone."

As for transparency and simplicity, although we didn't want trainees to see the computer or its keyboard, we felt that interaction with a video screen would be all right. The television has become such a fixture of contemporary life that the screen seems anything but menacing to most people. People are accustomed to having control over television, and as the name "boob tube" makes plain, the television seldom displays anything resembling enough intelligence to pose a threat.

We decided to let trainees interact with the computer by using a light pen on the computer video screen. The light pen alone would enable trainees to learn the basic vocabulary



# IS THIS LEVEL OF RELIABILITY REALLY NECESSARY?

## ACCUTRACK



If you've ever lost data due to a faulty disk, you know how important reliability can be.

That's why Accutrack disks are critically certified at 2-3 times the error threshold of your system. Why they're precision fabricated for higher signal quality, longer life and less head wear. And why we take such extra steps as testing single-density mini disks at double-density levels. So you don't have to worry about the reliability of your media.

Accutrack disks. OEMs have specified them for years. You can trust them for your data. Call toll-free (800) 225-8715 for your nearest dealer.



**ACCUTRACK**  
Dennison KYBE Corporation

82 Calvary Street, Waltham, Mass. 02254  
Tel. (617) 899-0012; Telex 94-0179  
Outside Mass. call toll free (800) 225-8715  
Offices & representatives worldwide

Circle 155 on inquiry card.

**Dealers:** Give your customers a choice—Accutrack's OEM performance as well as your heavily advertised brand. We have the industry's only complete line of disks, cassettes and mag cards, including virtually all special formats. If you want a quality line, small minimums, the ability to mix and match, private labeling, fast delivery and great price, call today. Find out how responsive a media supplier can be.

and concepts of CPR. We would have to provide a way for the video screen to perform some of the functions normally handled by a keyboard.

### The Prototype

Now all we had to do was find the right videodisc, produce thousands of video images, develop a random-access audio recorder, record numerous audio segments, write software to permit hundreds of different instructional branches of both sound and images in such a way as to reflect

medical expertise in each simple response to every move by the student, and then arrange for the microcomputer to read the sensors in the manikin and the light pen on the video screen, control the audio recorder and the videodisc player, and integrate all this in a single high-speed system. As we sat down to design the prototype, we knew that it wouldn't be easy.

To make the building of the initial prototype more manageable, we decided to limit its instructional range

to a single hands-on skill. CPR involves opening the victim's airway, ventilating the victim (giving mouth-to-mouth resuscitation), and performing external chest compression. Because the prototype had to convince people of the system's value, we wanted to teach the most difficult of these skills. This is external chest compression, which requires controlling three different parameters: placement of the hands, depth of action, and rhythm. We felt that if we could demonstrate that the system could successfully coach external chest compression, we could do everything else. We would consider the prototype a success if it coached 95 percent of its students to a high level of performance.

Rather than give separate and sometimes overlapping accounts of the development of the prototype and the later development of a full, multifunctional system, I will just say here that the prototype was successful enough to make people see the real possibilities of the videodisc-based system. The first demonstration of the prototype was in November 1980 to 65 physicians in a back room of the Miami Convention Hall where the American Heart Association was holding its Annual Assembly. Those in attendance showed enthusiasm for the project, provided we could manage to teach *all* the CPR skills.

The American Heart Association's Emergency Cardiac Care Subcommittee saw the potential in the system; however, it said that to be really effective as a training tool, the manikin would have to respond not only to compressions and ventilations but also to a whole range of techniques that are simple for a teacher to evaluate but had never before been simulated or evaluated by a computer.

Meeting this challenge would demand real sophistication. The flow of CPR requires first shaking the victim to see if he or she can be awakened, calling out for help, rolling the victim on his or her back if necessary, then getting the victim's airway open, and then looking, listening, and feeling for spontaneous breathing. The manikin would have to be able to tell



## THE COMPLETE TOOL

The WORD PLUS has many features that SpellStar™ and other competitors leave out. The WORD PLUS finds errors, shows them to you *in context*, and with your consent, automatically corrects them throughout the text. SpellStar does not correct errors.

**Versatile** The WORD PLUS works with almost any CP/M® based word processor. SpellStar only works with WordStar™.

**Accurate** The WORD PLUS offers a 45,000 word vocabulary without the compromise of suffix stripping. SpellStar has only 20,000 words.

**Convenient** The WORD PLUS helps you find the correct spelling by consulting its dictionary. SpellStar gives no such help.

**Fast** The WORD PLUS proof reads 10,000 words of text in less than two minutes.

**Many Extra Features** The WORD PLUS offers automatic hyphenation, text analysis, and fast word counting. Also solves crossword puzzles, locates anagrams and finds rhyming words.

**Inexpensive** \$150... a low cost for freedom from the anxiety of misspelling.

The WORD PLUS - Clearly the Best Choice. For more information call Wayne Holder at

**OASIS SYSTEMS**

714-291-9489  
2765 Reynard Way  
San Diego, CA 92103

SpellStar and WordStar are trademarks of MicroPro Intl

CP/M is a registered trademark of Digital Research, Inc



# DAYSTAR

## BRIGHTENS YOUR DATA.

You have two problems . . . We have both solutions . . . How much Winchester to buy and how much can I afford? The Daystar Subsystem offers you reliability and versatility at a price you can afford. • 5¼ drives available in 6.4 and 12.8 unformatted megabytes • Subsystems are also available with 1 megabyte floppy back-up • It interfaces to the S-100, TRS-80\* Model II & III, Apple II\*, IBM\*, NEC\*, HEATH/ZENITH 89\*, and many others.

- Intelligent controller using 280B C.P.U. • The 5¼ Winchester has an on board addressable buffer • It features a D.M.A. (Direct Memory Access) when available • It gives you power fail data protect • The Winchester works with 115 or 230 VAC 50/60 C.P.S. • You can go from Winchester to floppy communications without C.P.U. assistance • This small, compact package unit gives you 625,000 (625K bytes) bytes per second data transfer.

\* Registered Trademarks

COST: Less than \$175.00 per megabyte  
6.4 megs (DS6400)....\$1,900.00  
12.8 megs (DS12,000)....\$2,200.00  
WARRANTY: 180 Days



Sold only through:

**asap**  
computer  
products, inc.

1198 E. Willow Street Signal Hill, CA 90806  
(800) 421-7701 (213) 595-8571 Telex: (814) 656-491

Circle 151 on inquiry card.



## SENSORS IN THE MANIKINS

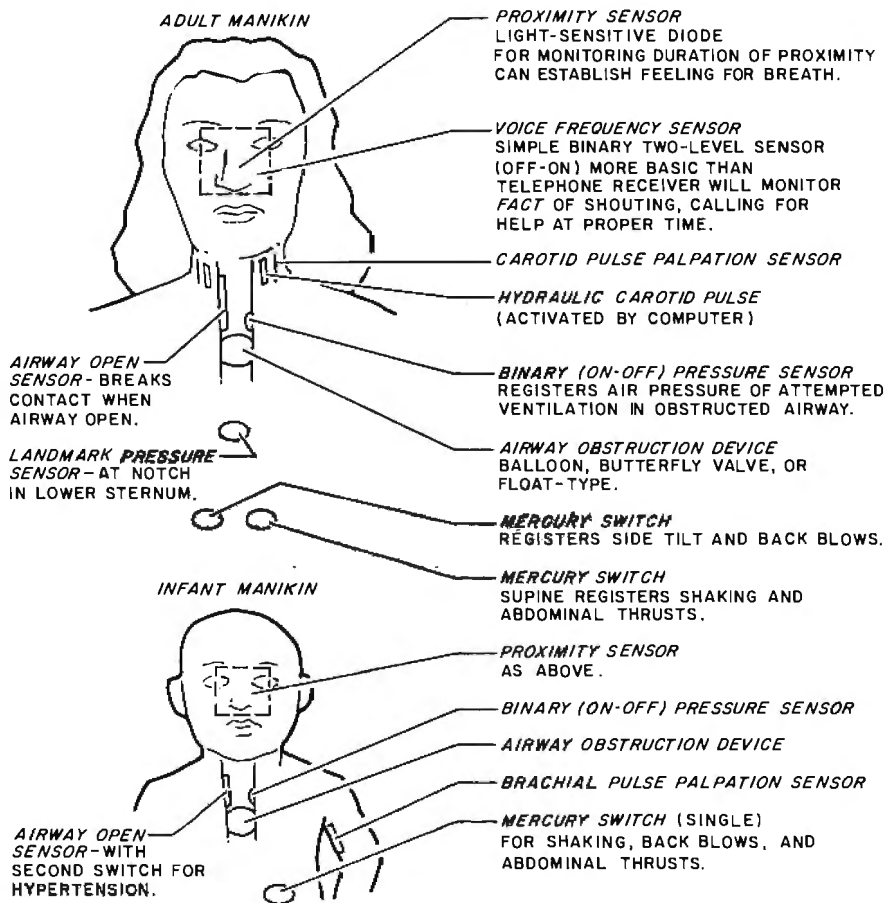

Figure 2: The placement and types of sensors in the adult and infant training manikins.

whether the student was doing all these things. This offered more challenges in the use of sensors and in writing complex software than I had planned. But the members of the Emergency Cardiac Care Committee, especially Drs. William Montgomery and William F. Kaye, set the goals. As a result of their demands and their efforts in reviewing my drafts of scripts for the videodisc, the full system is much better and more comprehensive than it would otherwise have been.

Now let's take a look at what was required to develop the full system.

### Help with Equipment

Finding the right video equipment for the project was difficult. No video-tape recorder could achieve the nearly instantaneous response to a student's actions, as measured by sensors in the manikin, that was essential to the success of the coaching loop. Video-tape recorders also lack the

ability to provide freeze frames of high quality. Even a home optical videodisc player would have required several seconds to react to the student's actions.

We approached a number of companies about videodiscs with greater capabilities. Few would talk to us. Only Sony was willing to cooperate in the project. Sony offered both technical and financial support. Ted Sato, Sony's chief videodisc engineer in the United States, and Dan Harris, manager of new-product development for Sony Video Products, were invaluable in supplying videodisc players, videodisc pressing, video monitors, and assistance in putting the first two sensors in the manikin. Even more important, Sato and Harris provided the kind of psychological support that difficult, innovative projects need even more than money and equipment.

The Sony videodisc player, an industrial model LDP-1000, has its

own built-in microprocessor for very fast access to video frames. The LDP-1000 and a videodisc are visible in photo 1. The LDP-1000 is a laser optical videodisc whose advanced features can give the student almost instant feedback. The machine also has a connector and a switch on the back to shift control to an external processor.

Laerdal Medical Corporation also generously helped the project by supplying some of its Resusci-Annie teaching manikins.

Because work on the entire system had to proceed in parallel, the people responsible for giving computer life to the manikins—Jerry Poplin and Bob Soltysik—developed a box to simulate the manikin to the computer and a box to simulate the computer to the manikin.

Figure 2 shows how complex the manikins, both adult and infant, became after the Emergency Cardiac Care Committee broadened our goals. Photo 2 provides a peek inside the infant manikin. Poplin and Soltysik spent late nights performing difficult surgery to equip the manikins as needed. Some of the sensors came from burglar-alarm catalogs, and others, like the airway that blocks on computer command, were sheer invention.

### The Script

As noted earlier, I thought that the single greatest challenge in this project was creating a script that could serve the needs of medical experts, video producers, and computer programmers. This unusual script wasn't really a flow chart, although we did sometimes have to make flow charts and then convert them to scripting. The script wasn't a storyboard, but it did have to do the work of one. The script wasn't a simple rendering of content either.

It took five drafts, each in excess of 100 pages, to achieve a workable script. Drs. Montgomery and Kaye contributed greatly by reviewing each of these drafts.

Part of the challenge of writing the script was in developing a sense of what various interactions would look and feel like while the videodisc was



# MULTIPLE CHOICE FOR MULTIPLE USERS.

**CompuPro**, the company that pioneered 8/16 bit dual processing for micro-computers, has now created the 8/16 bit multi-user operating system for the 80s.



**MP/M® 8-16**, CompuPro's proprietary edition of Digital Research's MP/M 86 V2.0, unleashes the power of dual processing for unprecedented multi-user performance. Let different users run different software packages at different stations—even mix 8 bit (CP/M 2.2) and 16 bit (MP/M 86) software in the same system, with 62K of available RAM per station. As a bonus, all 8 bit programs run under a true 16 bit operating system for maximum speed and efficiency.

Suddenly, other operating systems seem outdated: **MP/M 8-16** offers the best of the 8 and 16 bit worlds in high performance multi-user environments.

**MP/M 8-16** lists for \$1000. System requirements include CompuPro dual processor (CPU 8085/88) based system with appropriate interfacing, memory, and disk capabilities, as well as the System Support 1 and MPX 1 boards.

## Interfacer 4

Now it only takes one board to handle three of the most needed interface functions: **Interfacer 4** includes three RS-232C serial ports (two of which may be run in either synchronous or asynchronous mode), one full duplex parallel port with attention and strobe, and one pin compatible Centronics/Epson parallel printer port. **\$350, \$450 CSC.**

## CPU 86/87

8-16

**CPU 86/87** delivers ultra-efficient, high speed 16 bit computing. Based on Intel's 8086 16 bit processor, **CPU 86/87** also includes the 80130 interval timer/interrupt controller and a socket for the 8087 math co-processor (provides number-crunching capabilities rivalling many minicomputers). Compatible with both 8 and 16 bit peripherals. **\$695** (8 MHz operation), **\$850 CSC** (10 MHz operation). Optional 8087 available for **\$600, \$700 CSC.** Note: Clock speeds limited to 5 MHz with 8087.

## Disk 2

CSC boards are qualified under the Certified System Component high-reliability program (200 hour burn-in, direct exchange program). CP/M and MP/M are trademarks of Digital Research; OASIS is a trademark of Phase 1. MP/M 8-16 is used under license from Digital Research.

High performance, high speed DMA hard disk controller board set handles up to four disk drives, up to sixteen heads per drive. Includes configured version of CP/M® 2.2; also compatible with MP/M, OASIS, CP/M-80, and CP/M-86. **\$795, \$895 CSC.**

## 10 MHz STATIC MEMORY

**RAM 17** delivers ultra low power operation (1.6 Watts typical) in a 64K X 8 board. **\$599, \$699 CSC.**

**RAM 16** works automatically with 8 or 16 bit systems (64K X 8 or 32K X 16) **\$650, \$750 CSC.** **RAM 21** combines low power and high density while working automatically with 8 or 16 bit systems (128K X 8 or 64K X 16) **\$1695, \$1895 CSC.**

8-16



For business, industrial, and scientific computing, contact your authorized **CompuPro Systems Center.**

**Performance, quality reliability.**

CompuPro division, Godbout Electronics, Oakland Airport, CA 94614-0355

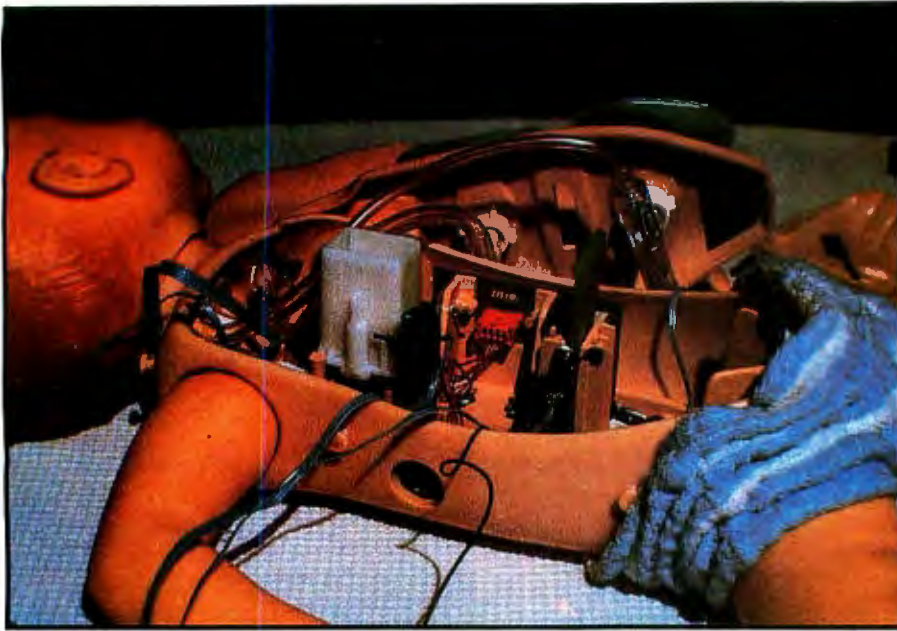

Photo 2: A peek inside the infant training manikin. Trainees never see the complex of sensors exposed here. (Photo by Jerry Poplin.)

being produced, three to six months before much of the programming would begin. It is much to the credit of Jane Sallis and Associates in Dallas, the producer of the videodisc, and Gay Hampton, the production

assistant, that the final shooting script resulted in a full and effective use of the random-access videodisc and audio-tape systems. The text box below shows a small excerpt from the script.

## Software

We were fortunate to have two excellent programmers working on the CPR project: Bob Sander-Cederlof and Mike Laumer. Bob is the president of S/C Software and author of S/C Assembler II and S/C Macro, bestselling assemblers for the Apple. Mike has written Flash!, what I understand is one of the best compilers for the Apple. Together they produced some 900 pages of assembly-language programming and a couple of Applesoft BASIC routines.

It was the software that brought the 700 video branches to life. (On this, Mike had some assistance from Bobby Deen, an Apple club member who was still a high school student.) To say the least, the programming task was demanding. The easy part was the 150 pages of text for quizzes and answers. The programmers had to make the videodisc operate in response to light-pen choices with "any time" interrupts. There were also interrupts for the 20 analog and digital systems in the manikin.

*Text continued on page 130*

## The Script for the Interactive Training System

TV Monitor

Computer Monitor

Script

ILLUSTRATION



COMPY(SO) V/O: All right. . . . In the position your friend is lying in, the muscles of the jaw relax and the base of the tongue falls back blocking the airway, which makes it difficult, if not impossible, for air to get through to his lungs . . . Let me show you what I mean. . . .

*(Video screen goes to next illustration, computer screen is blank)*

ILLUSTRATION

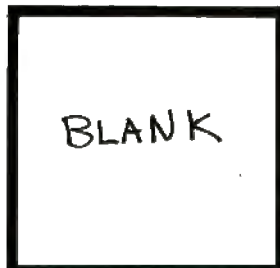
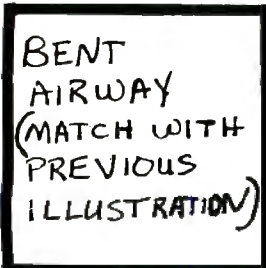

COMPY(SO) V/O: See how the flow of the air to the lungs is being blocked?

*(Video screen goes to next illustration, computer screen is blank)*



# .001 Second From Wallstreet

Now, a terminal in western Kansas is no more than a micro-second from the data of Wall Street or the Commodities Exchange.

Now, an advanced data communications system allows your CP/M® based computer system to access almost any dial-up computer, capture and store the received data, and transfer files between any two CP/M® systems — even when disk formats are incompatible.

What would you call a system like this?

## CROSSTALK™

What Crosstalk can do for you depends mostly on what you need done. It acts as a "smart terminal," automatically dialing any dial-up system. It allows you total modem control, changing modem speed, data word format and duplex instantly. It captures on-line data for analysis off-line, saving time and money. It transfers any type of file with complete error checking.

When you equip more than one office with Crosstalk, you can exchange information instantly by phone, even if you don't subscribe to an information utilities service.

So no matter where your office is located, Crosstalk can give you access to the world, instantly. Call or write for details.

 **Microstuf, Inc.**  
1900 Leland Dr., Suite 12  
Marietta, GA 30067  
(404)952-0267

DEALER INQUIRES WELCOME

CROSSTALK is a trademark of Microstuf, Inc.  
CP/M is a registered trademark of Digital Research Inc.

Circle 314 on inquiry card.



TV Monitor

Computer Monitor

Script

ILLUSTRATION

BENT  
AIRWAY  
and  
STRAIGHT  
AIRWAY

BLANK

COMPY (SO) V/O: So what you'll need to do is open that airway by tilting his head back. . . . This pulls the base of the tongue away from the back of the throat and opens the airway . . . We'll show you two ways to do that, and then we'll want you to try them on the manikin. . . .

(Video screen goes to next illustration, computer screen goes to "Touch this spot. . . ." display)

ILLUSTRATION

STUDENT  
AND  
MANIKIN IN  
FRONT OF  
SCREEN'S

TOUCH THIS  
SPOT WHEN  
YOU ARE  
READY TO  
BEGIN 

COMPY (SO) V/O: You can perform CPR on either side of a victim, but for teaching purposes, we'll always have the rescuer on the left side of the manikin. Now kneel down like this beside the manikin and make sure you can see the screen. We'll wait, and when you're ready to begin, touch the computer screen with the light pen. . . .

(When the computer screen is touched, video screen goes to illustration and computer screen is blank. If no response is monitored within 20 seconds, program reroutes to HAVE YOU TRIED THAT YET? BRANCH — Generic/Compy with video screen holding image of student in front of screens)

ILLUSTRATION

HEAD-TILT/  
CHIN-LIFT  
(MATCH WITH  
NEXT SLIDE)

BLANK

COMPY (SO) V/O: Good. . . . Okay, now, the first method for opening the airway is the head-tilt/chin-lift. Notice that one hand is tilting the head back by pressing on the victim's forehead, while the other hand, using three fingers, lifts up on the nearest side of the chin. The lower lip may also need to be held open with the thumb.

(Video screen goes to matched slide, computer screen is blank)

SLIDE

HEAD-TILT/  
CHIN-LIFT  
OF SAME  
RESCUER  
VICTIM  
(MATCH ILLUSTRATION)

BLANK

COMPY (SO) V/O: Here's how that would look in real life. . . . Now we'd like you to try opening the airway on the manikin using this head-tilt/chin-lift method. When you perform on the manikin, you won't need to touch the computer screen to let us know when you've begun, because we'll be able to sense this from the manikin. So go ahead and try it now. . . .

(Computer program monitors airway sensor in manikin. If airway is not open within 20 seconds, program routes to HAVE YOU TRIED THAT YET? BRANCH — Customized/Compy. If the airway is open within 20 seconds, the program proceeds to the SUCCESSFUL BRANCH)

HAVE YOU TRIED THAT YET? BRANCH — Customized/Compy

(Video screen holds image and computer screen goes to yes/no display)



# Fit Right in



Of course Percom diskette drives for the IBM Personal Computer fit right in. They fit right outside your Personal Computer, too. And they're fully compatible, providing the same full double-density storage capacity.

But just as important, Percom diskette drives also fit the same high standards set by IBM.

At Percom we've been making disk storage systems since 1977. We build quality, high-performance disk drive systems. From proven design through quality inspections that include 100% two-day operational tests. And Percom dealer support ensures competent after-sale service.

So expect more from Percom. You won't be disappointed.

**Percom disk drives for the IBM Personal Computer are available in 40-track single- and dual-head models, and 80-track single-head models. Call or visit your independent IBM Personal Computer dealer — and fit right in with Percom. For the names of dealers carrying Percom products for your Personal Computer call toll-free 1-800-527-1222.**

PRICES AND SPECIFICATIONS SUBJECT TO CHANGE WITHOUT NOTICE.



**PERCOM DATA COMPANY, INC.**

11220 PAGEMILL RD. • DALLAS, TX 75243 • (214) 340-7081

IBM and IBM PERSONAL COMPUTER are trademarks of International Business Machines, Inc.

PERCOM is a trademark of Percom Data Company, Inc.



Minimum system requirements are an IBM System Unit with 16 Kbytes of RAM and 5<sup>1</sup>/<sub>4</sub>" Diskette Drive Adapter. Drive models supported depend on DOS used. An optional cable available from Percom is required for external (add-on) drives.

Yes ... I'd like to know more about Percom diskette drives for my IBM Personal Computer. Rush me free literature.  
Send to **PERCOM DATA COMPANY, Inc.**, Dept. 2-B01  
11220 Pagemill Road, Dallas, Texas 75243

name \_\_\_\_\_

street \_\_\_\_\_

city \_\_\_\_\_

state \_\_\_\_\_

zip \_\_\_\_\_

phone number \_\_\_\_\_

I intend to add a hard-disk system to my computer | yes | no.

**MAIL TODAY!**

TV Monitor

Computer Monitor

Script

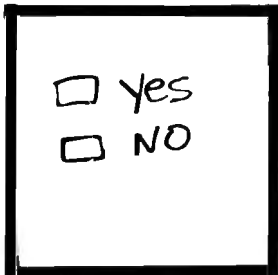

COMPY (SO) V/O: Did you try it? If you did, answer yes on my screen. If you didn't, answer no.

(Depending upon response, program advances to NO BRANCH or YES BRANCH)

(NO BRANCH)

(Video screen holds image of head-tilt/chin-lift, computer screen goes blank)

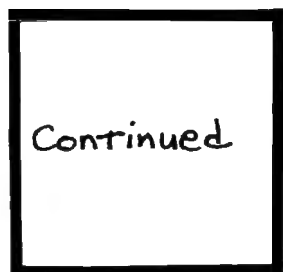

COMPY (SO) V/O: Well, don't be bashful. Please go ahead and try opening the airway. This unconscious victim needs air to breathe.

(Program continues to return to this response if no action is indicated)

(YES BRANCH)

(Video screen holds image of head-tilt/chin-lift, computer screen goes blank)

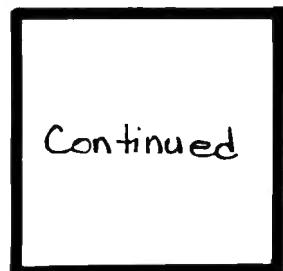

COMPY (SO) V/O: Well maybe you need to tilt the head back more, and lift up on the chin a little more forcefully. Please don't be hesitant—we want the airway wide open so that this person can breathe. . . . Once you've got it right, we'll proceed—Now, go ahead and try it again.

Program monitors performance and proceeds to appropriate branch. If two "Yes" answers entered in a row, program re-routes to LACK OF SUCCESS BRANCH—Generic/Compy. When airway opens, program proceeds to SUCCESSFUL BRANCH)

(SUCCESSFUL BRANCH)

(Video screen holds image, but adds TV key, computer screen goes blank)

ILLUSTRATION

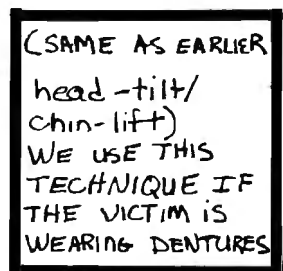
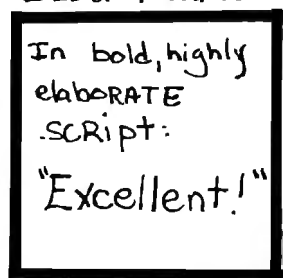

COMPY (SO) V/O: Excellent . . . And if the victim has dentures, this is the method to use to hold them into place. If rescue breathing is needed, the airtight seal is easier to perform when dentures are in place. But, if dentures cannot be managed in place, remove them.

(Video screen goes to illustration, computer screen is blank)

Listing 1 shows the programming that brought much of this excerpt to the video screens.



# HEATH/ZENITH & YOU, INC. ONE STRONG PARTNERSHIP

A computer purchase is the beginning of a long-term partnership between you and the people you buy from. Your ongoing need for software, peripherals and accessories requires a partner who will stand by you with a growing line of products to meet your needs. Heath/Zenith will be that strong partner for you. Look what we have to offer.

**THE ALL-IN-ONE COMPUTER** – The heart of the Heath/Zenith line is the stand-alone *89 Computer*. It's a complete system with built-in 5.25-inch floppy disk drive, professional keyboard and keypad, smart video terminal, two Z-80 microprocessors and three RS-232C Serial I/O Ports. It comes with 48K bytes of RAM, expandable to 64K.

**PERIPHERALS AND ACCESSORIES** – These include the popular *Heath/Zenith 19 Smart Video Terminal*, loaded with professional features. We also offer color and black and white monitors, modems, computer language courses, and high-speed typewriter-quality printers.

**SOFTWARE** – *New software*, includes the SuperCalc Spreadsheet and Condor Data Base Management System. *Word processing*, including three different programs. *Small Business Programs*, feature Peachtree's Series 5, Softstuff's General Ledger and Inventory Control. *HUG*, *Heath Users' Group*, offers members a library of over 500 low-cost programs for home, work or play.

**PROGRAMMING LANGUAGES** – For your own custom programs, Microsoft languages are available in BASIC (compiler and interpreter), FORTRAN and COBOL.



**APPLICATIONS SOFTWARE** – Expand the performance range of your computer with a broad selection of software, including the best of *Digital Research* and *Micropro* – as well as the complete line of *Softstuff™* products.

**OPERATING SYSTEMS** – Three versatile systems give you the capability to perform your specific tasks. *CP/M* by *Digital Research* makes your system compatible with thousands of popular CP/M programs. *UCSD P-System with Pascal* is a complete program development and execution environment. *HDOS*, *Heath Disk Operating System* gives you a sophisticated flexible environment for program construction, storage, and editing.

**DISK SYSTEMS** – *The new Heath/Zenith 67 Winchester Disk System*, for commercial use, adds nearly 11 megabytes of storage to your 89



computer. It includes an 8-inch floppy disk drive for data portability. *The new 5.25-inch 37 disk system*, available with 1 or 2 drives, adds up to 1.28 megabytes of storage. Both plug-in systems have write protection.



**SERVICE AND SUPPORT** – Prompt and professional service and assistance is available nationally through Heathkit Electronic Centers, Zenith Data Systems for commercial users or through Heath factory servicing and phone-in technical assistance.

Complete, integrated computer hardware and software, designed to serve and grow with you – that's what to look for in a strong partner. And with Heath/Zenith you get it all.

Heath/Zenith computer products are sold nationwide through Heathkit Electronic Centers\* (check your white pages for locations). For a **FREE catalog and mail order service**, write: Heath Co., Dept. 334-904, Benton Harbor, MI 49022.



## HEATH/ZENITH

Your strong partner



Product specifications are subject to change without notice.  
\*Heathkit Electronic Centers are operated by Veritechnology Electronics Corporation, a wholly-owned subsidiary of Zenith Radio Corporation.

Circle 210 on Inquiry card.



# Save \$2500<sup>00</sup>

Are you faced with having to spend \$3000 and up for a letter-quality printer?

**Mediamix** offers an alternative.



For only \$500 the **Mediamix ETI<sup>2</sup>** lets you connect the IBM Electronic Typewriter Models 50,60, or 75 to **any** computer. Why invest in two separate machines? Your office typewriter can do both jobs, yielding better type quality, a consistent corporate image and renowned IBM service.

The **ETI<sup>2</sup>** is no simple black box, either. It is a sophisticated micro-computer with 2000 characters of memory, over 39 special commands and the option of doing typesetting on the IBM Model 50.



Write or Call

## MEDIAMIX

P.O. Box 67B57  
Los Angeles, California 90067  
(213)475-9949

## The Interpretive Language Used to Program the CPR System

Mike Laumer  
Laumer Research  
1832 School Rd.  
Carrollton, TX 75006

The interpretive language developed for the CPR course contains over 80 different operations that make possible the programming of the various hardware elements of the system (light pen, Apple video display, videodisc, audio tape, and manikins). The language is similar to assembly language, with the familiar op-code-argument structure known to assembly-language programmers. About half of the instructions provide the computational and logic abilities of a 16-bit processor, while the other half is dedicated to the special hardware elements of the system.

A powerful sublanguage exists for displaying text and low- and high-resolution graphics on the Apple video screen and for building tables for the light pen commands to work from. The tables for the pen command contain the number of entries in the table and each entry contains the x, y, start and stop coordinates for an active region and an invert region. When the pen command executes any detection of the light pen in an active region of a menu, selection will cause the text in the invert region to be highlighted (black text on a white background) to indicate the current selection, and when the pen moves on to another field the previous field is changed back to normal and the new field is highlighted. Touching the ring on the pen to make a menu selection will return a number indicating the table index that was highlighted last, and a tone sounds on the Apple speaker as audio feedback.

Listing 1 shows a sample course segment coded in the interpretive language, with comments on the operation to the side. The related segment of the script is included in the text box on page 120.

**Listing 1:** A program segment written in the interpreter especially developed for the CPR project. The interpreter resembles assembly language in its use of op-codes and arguments.

	SHOW	23157	;show a still frame on the video disk.
	CHAN	#3	;select channel number 3 on audio tape unit.
	PLAYA	5740,5930	;play a segment of audio from cassette player but do not wait for completion in case student catches on to the instructions and tries the airway opening before the voice on the tape interrupts from the tape. Will shut it off at the proper tape address position.
*			
*			
*			
*			
*			
*			
*			
*			
	MENU	A	;show a menu to student on the Apple video screen.
CHK	TIMEOUT	30,ERR	;JUMP to ERR if 30 second limit expires and airway still not opened.
*			
*			
	WAITAIRWAY		;wait for student to open the manikin airway.
	JUMP	GOOD	;branch to good performance if airway opened.
ERR	LIST	B,PENTABLE	;show a menu for student.
	PLAYA	5940,6090	;"have you tried that yet?"



# Move Up to Tarbell



## *The Serious Business Machine*

Do you have a small computer system that operates with mini-floppies and has limited storage capacity? Then it's time to move up to the Tarbell Empire Series System. Tarbell starts where small systems leave off, providing storage from 1 to 20 megabytes. This means Tarbell is capable of growing right along with your business. (It also makes sense to start with Tarbell if you're a first-time computer buyer.)

Tarbell is the serious general purpose business machine, backed by years of experience with disk systems. It gives you word processing, inventory control with bill of materials, mailing lists — all in addition to accounting applications: general ledger, payables, receivables, payroll with cost accounting and order entry. Whatever your need may be, Tarbell can provide the working software that gets the job done.

With the Tarbell System you get a Z80 4 Mhz CPU with memory management, timer and full interrupt capability, 2 RS-232 serial ports with handshaking, 64 K bytes of random-access memory, double density floppy disk interface, 2 double density floppy disk drives, cabinet, power supply, and cables.

The software includes: CP/M™ 2.2 disk operating system, Tarbell Disk BASIC, Tarbell Database System, and all manuals and documentation.

Tarbell also offers the MP/M™ Multi-User Operating System and 4 additional RS-232 serial ports.

The Tarbell Empire Series is delivered assembled, tested, and with a FULL six-month warranty on parts and labor.

And when you need even more mass storage, Tarbell also has a hard disk that's system-compatible and provides easy back-up.

If your business is growing or you need more than a few hundred K bytes — it's time to move up to Tarbell. Call your local Tarbell dealer for competitive prices.

*Tarbell*  
Electronics

*The One-Stop Shopping Service*

950 Dovlen Place, Suite B  
Carson, CA 90746  
(213) 538-4251

CP/M and MP/M are trademarks of Digital Research

Circle 439 on Inquiry card.

# ScratchPad...

## THE ULTIMATE SPREADSHEET





# NEVER SEE "OUT OF MEMORY" AGAIN.

## ScratchPad

The problem with other spreadsheets is that you are only allowed relatively few entries. ScratchPad with virtual memory (an advanced memory management technique) allows essentially unlimited number of entries by letting your disk drive act as secondary memory when you run out of RAM.

Item	Quantity	Cost/Unit	Total Cost
Nails	1000	\$0.05	\$50.00
Hammers	25	\$10.50	\$262.50
Wrenches	100	\$8.75	\$875.00
Glue	2876	\$1.12	\$3221.12
Total:			\$4408.62

ScratchPad includes all the most useful features found in other popularly available spreadsheets, but has added these state-of-the-art innovations:

- Virtually unlimited number of entries.
- Unlimited screen splitting.
- Unlimited title locking.
- The "IF/THEN" function.

ScratchPad does more than all the others, better than all the others.

ScratchPad 2.0: \$295.00  
Manual Only: \$ 15.00

**ScratchPad and Stats-graph available for virtually all CP/M, compatible systems.**

Circle 430 on Inquiry card.

## Stats-graph

Now... Interactive Graphing and Statistics



Designed for data interchange... Data entered under ScratchPad can be used to create graphs under Stats-graph. Stats-graph also stands alone.

### No graphics hardware is required.

Stats-graph creates graphs using the ASCII character set (or graphics characters if available). It creates bar graphs, pie graphs, and scatter graphs. Stats-graph also performs various statistical analyses, including regression analysis, standard deviation, etc.

### Example pie graph:

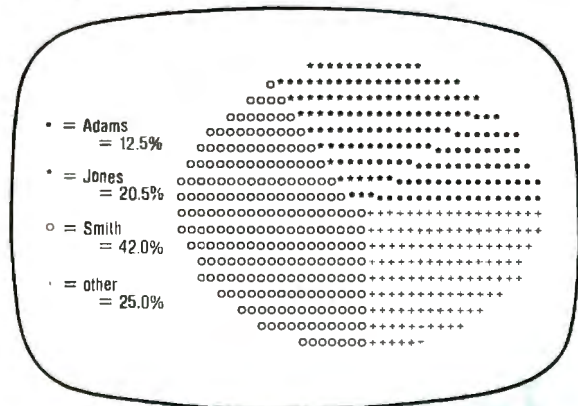

Data for Stats-graph may be entered interactively or converted from a spreadsheet (such as ScratchPad). The output from Stats-graph can be integrated into any document. This makes Stats-graph great for preparing reports.

Stats-graph: \$200.00  
Manual Only: \$ 15.00

Available from fine dealers everywhere, or directly from SuperSoft.

Japanese Distribution: ASR Corporation International, 3-23-8, Nishi-Shimbashi, Minato-Ku, Tokyo 105, Japan, Tel. (03)-437-5371, Telex. 0242-2723.

CP/M is a registered trademark of Digital Research.

# SuperSoft®

FIRST IN SOFTWARE TECHNOLOGY P.O. Box 1628 Champaign, IL 61820 (217) 359-2112 Telex 270365



# SWORD™

a Screen Oriented Relational Database, designed to put You in control of a powerful information management system: quickly, easily, and at a price you can live with.

### Powerful

- User defined CRT entry screens speed data input and editing.
- Makes full use of \*CP/M 2.0+ facilities for rapid access and retrieval.
- User controlled security access codes.
- Up to 32k records per relation with up to .8k per record.

### User Oriented

- A consistent system of help messages, menus, and prompts assists the user in all phases of operation.
- An English-like query format that is easy to use yet comprehensive.

### Clear Documentation

- Our manual is concise, easy to understand, and indexed.

**\$295** / \$25 manual

VISA, MC and COD welcome



INNOVATIVE SOFTWARE TECHNOLOGIES, INC.  
3990 VARSITY DRIVE  
ANN ARBOR, MICHIGAN 48104

(313) 996-1890

REQUIRES: CP/M 2.0+ SYSTEM WITH AT LEAST 42K, 64-80 COLUMN SCREEN, ADDRESSABLE CURSOR AND 8" DISK DRIVES.

\*CP/M is a trademark of Digital Research, Inc.

Listing continued from page 126

```

PEN          PENTABLE,SELECTCODE ;wait for student selection.
GOTO        SELECTCODE,YES,NO
YES PLAYA    5940,6090          ;"well, will you please try
                                it . . ."
                                JUMP      CHK          ;go monitor performance
                                ;again.
NO  PLAYA    6100,6180          ;"Well, don't be
                                bashful . . ."
                                JUMP      CHK          ;monitor performance again.
GOOD . . . . .                ;continue with course.
                                . . .
                                . . .
SELECTCODE   .BS 1             ;reserve 1 byte for pen
                                code.
* -----
* MENU DATA SELECTION
* -----
* MENU FOR STUDENT INSTRUCTION
*
A  BEGINMENU ;start menu A.
HOME         ;clear the screen.
VTAB 10      ;goto line 10.
HTAB 1       ;goto column 1.
TEXT "PLEASE OPEN THE AIRWAY ON THE MANIKIN"
VTAB 12      ;goto line 12.
HTAB 1       ;goto column 1.
TEXT "WE'LL CONTINUE WHEN YOU OPEN IT."
ENDMENU      ;end of menu A.
*
* MENU FOR HAVE YOU TRIED THAT YET?
*
B  BEGINMENU ;start menu B.
HOME         ;clear the screen.
VTAB 10      ;goto line 10.
HTAB 5       ;goto column 5.
TEXT "HAVE YOU TRIED THAT YET?"
VTAB 12      ;goto line 12.
HTAB 15      ;goto line 15.
BEGINFIELD   ;start a light pen selection
              field.
TEXT "YES"    ;text for pen selection.
ENDFIELD     ;end a light pen field.
VTAB 14      ;goto line 14.
HTAB 15      ;goto column 15.
BEGINFIELD   ;start second light pen field.
TEXT "NO"    ;text for pen selection.
ENDFIELD     ;end of second light pen
              selection.
ENDMENU      ;end of menu.
    
```

Text continued from page 120:

By far the most difficult parts of the software were the algorithms that governed the evaluation of hands-on performance by the student. The problem was to read the input array reflecting the student's performance and (1) judge whether the performance took too little or too much time and (2) determine whether each part of the performance occurred in the proper sequence. One or the other of these two parameters alone would have been easier to manage. Together

they posed difficulties. Based on performance, the software has to display high-resolution graphics and complement these with video demonstrations and explanations of how to improve performance. Figure 3 is a flow chart of the part of the program that teaches external chest compression.

In the text box on page 126, Mike Laumer gives some insights into how the programming was done. Listing 1 is a sample of some code that Mike wrote in the interpretive language developed for the CPR project.



High Technology

Transit



High Technology

Job Control System



High Technology

Information Master



High Technology

Doctor's Office Companion



High Technology

The Store Manager



# Software In Depth

The first time you use our software you'll find it does wonderful things. The more you use it, the more you'll find how useful it is. We have programs for doctors, CPA's, attorneys, retail store managers, contractors, estimators, print shops, schools, and manufacturers. We even have a program for programmers. And the list is growing. We have programs for the Apple™, NEC™, and Atari 800™ computers, and this list is growing, too. To see our software, please visit *The Xerox Store* or another fine computer dealership in your area. Call or write us for a free catalog. High Technology Software Products, Inc., 2201 N.E. 63rd Street, P.O. Box B-14665, Oklahoma City, Oklahoma 73113, 405/478-2105

Apple is a trademark of Apple Computer, Inc.  
Atari is a trademark of Atari, Inc.  
NEC is a trademark of Nippon Electric Company, Ltd.

# High Technology Software

High Technology

High Technology

High Technology

High Technology

High Technology

High Technology

Post Master

High Technology

The Order Scheduler

High Technology

Chem Lab Simulations

High Technology

Disk Check

High Technology

Client Billing System

High Technology

Post Master

High Technology

The Order Scheduler

High Technology

Chem Lab Simulations

High Technology

Disk Check

High Technology

Client Billing System



Circle 219 on Inquiry card.

A0C4C9D3CBA0D5D4C9CCC9D4D9A0A4B5B0A0

# Disk Utility for Apple DOS 3.3 LOST PROGRAM RECOVERY

If you haven't written over that program accidentally deleted, this software can recover it for you.

Also, it can reorganize your disk and inform you of the remaining space available.

And, it allows you to patch any sector: display in Hex and ASCII on standard Apple screen.

Menu driven and easy for the novice while still efficient for the professional. Compatible with M & R Superterm.

For more information or to place your order call:  
**(208) 263-1213**

**Cost: \$50**

We pay first class postage and insurance. You may use VISA or Master Card.

**TO ORDER:** Send us your check, money order or credit card number and expiration date. Certified checks avoid clearance delay.

**ANSWER Corporation**  
502A North Second Ave.  
Sandpoint, Idaho 83864

A0A0C2D9A0CAC5D2D2D9A0D4C9C6C6D4A0A0

A0  
C4  
C9  
D3  
CB  
A0  
C4  
C9  
D3  
D0  
CC  
C1  
D9  
A0  
A6  
A0  
D0  
C1  
D4  
C3  
C8  
A0  
D5  
D4  
C9  
CC  
C9  
D4  
D9  
A0  
CD  
C9  
CE  
C5  
A0  
CE  
C6  
C1  
D4  
D5  
D2  
C5  
C4  
A0  
C2  
D9  
A0  
C1  
CE  
D3  
D7  
C5  
D2  
A0  
A0  
A0  
A0  
A0  
C1  
A0  
D3  
CF  
C6  
D4  
D7  
C1  
D2  
C5  
A0  
D4  
CF  
CF  
CC  
A0

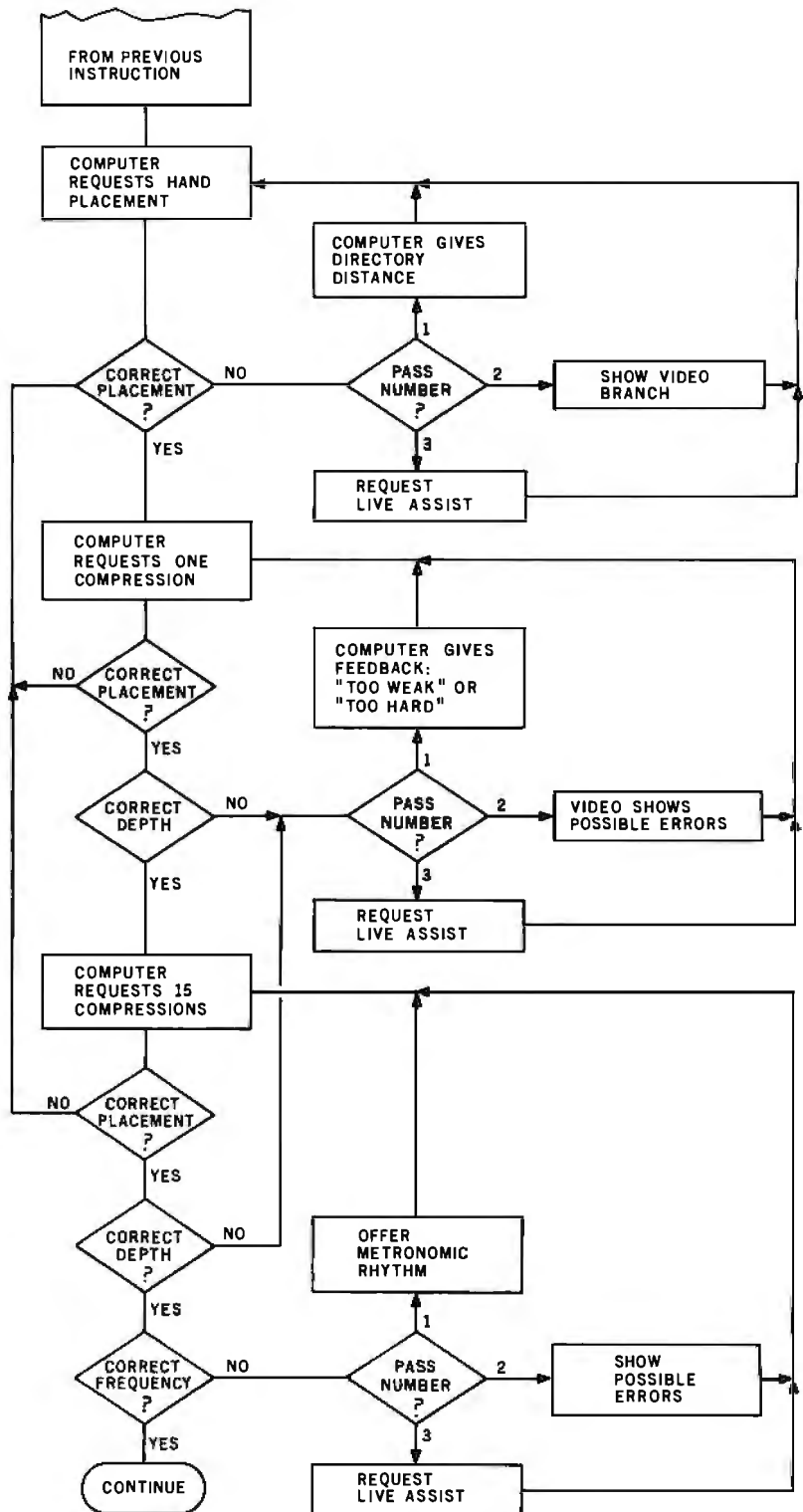

Figure 3: An early flow chart of the part of the CPR program that teaches external chest compression.

### The Light Pen

There is a big difference between using a light pen to simplify a few types of input and using a light pen as the only input under user control. In our system, the light pen had to do

almost everything that a keyboard can but without the keyboard's complexity.

We organized the use of the light pen around a menu of nine choices. The student would choose one of the



# THE STRANGE CASE OF THE DISAPPEARING DATA



"Mr. Holmes, Dr. Watson, I'm really glad you made it," said the office manager who had enlisted the services of my friend. "Last night, a big chunk of data disappeared from our computer system. My boss wants to know who was responsible...and fast!"

Holmes began to investigate.

"You would be wise to exonerate all of those in your employ," he concluded just moments later. "No one here is a fiendish database killer. Last night's lightning storm was the villain. It caused a momentary loss of power that destroyed immense portions of your database."

"How can we prevent this in the future?" asked the company president.

"By investing in a Zeus2™ multi-processor system from OSM," said Holmes. "Zeus2 has an integral power supply that will protect your data from momentary power glitches."

"Will it also protect our data from total power failures?" asked the office manager.

"Quite so," answered Holmes. "The uninterruptible power supply allows you to continue operating for up to twenty minutes when power dies, so your workers have ample time to save their critical documents."

"But how do we know Zeus2 will meet our special needs now and in the future?" asked the president.

"Zeus2 is well suited to virtually all multi-user, multi-processing applications," declared Holmes. "It easily accommodates 32 users\*—locally or remotely. In addition, its proprietary CP/M™ compatible MUSE™ operating system simplifies programming and allows you to utilize thousands of existing programs."

"With all those features, Zeus2 probably costs too much," snapped the vice president of finance.

"Quite untrue," replied Holmes. "In fact, Zeus2 offers the best price-performance ratios in the industry—with a price-tag so low some deem it criminal."

"But how, dear man," I interjected, "did you deduce that a power glitch was to blame for last night's loss of data?"

"Elementary, my dear Watson," he said, puffing contentedly on his pipe. "Elementary."

**The solution: The Zeus2 multi-processor system.**

Visit us at NCC booth #4722.



For more information on the Zeus2 solution, call or write us today.

## OSM

OSM COMPUTER CORPORATION  
2364 Walsh Ave., Santa Clara, CA 95051  
(408)496-6910 (800)538-5120 TWX: 910-338-2099

©OSM 1982 Zeus2 and MUSE are trademarks of OSM Corp.  
CP/M is a trademark of Digital Research Inc.  
\*16 users standard; 32 user special order.

Circle 351 on Inquiry card.



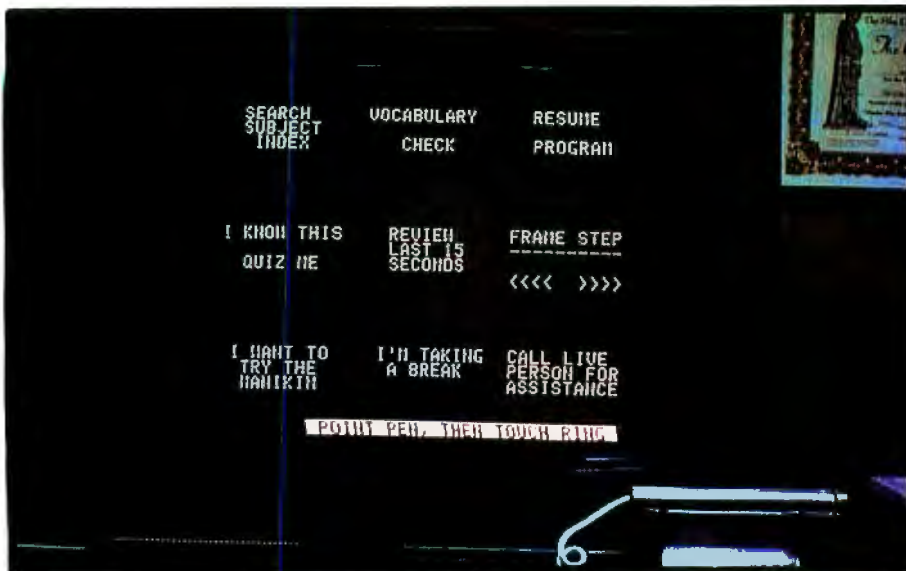

Photo 3: The main menu of the CPR system. Students select an item by using a light pen. (Photo by Bob Lukeman.)

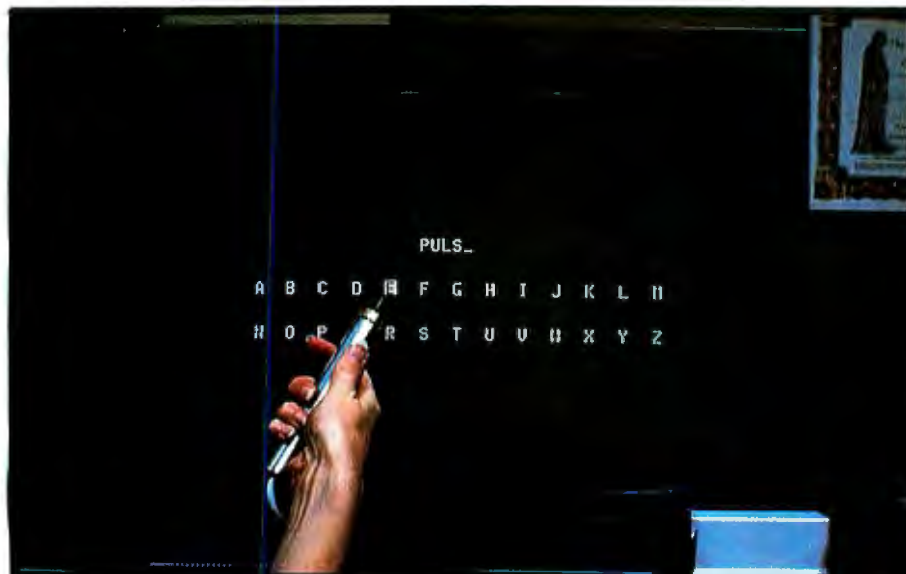

Photo 4: The CPR system's word template in use. The student is using a light pen to choose a letter. The letter will now appear on the line above the listing of the alphabet. (Photo by Bob Lukeman.)

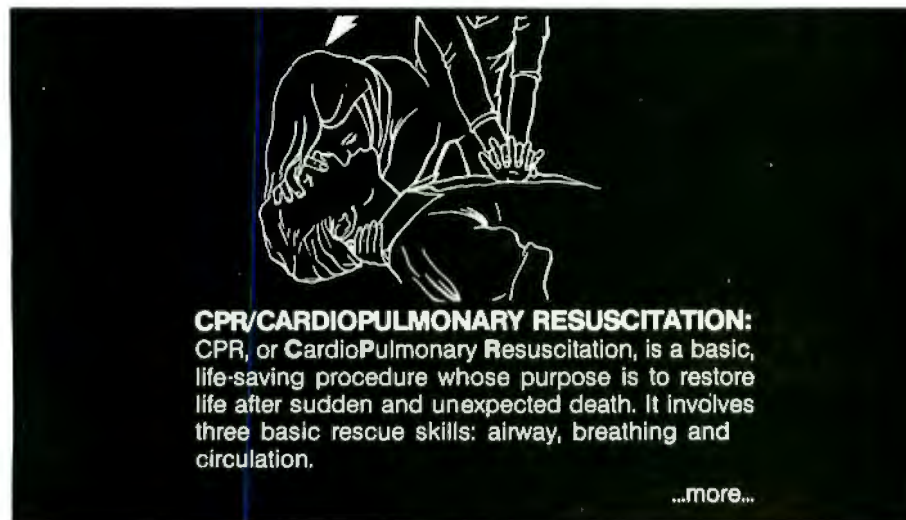

Photo 5: A video frame explaining CPR (cardiopulmonary resuscitation). The student can get a more thorough explanation on request.

nine items by pointing the light pen at it and, when the block around the item lights up, touching the place between the light pen's two metal rings. The nine choices, as shown in photo 3, include searching a subject index, a vocabulary check, reviewing the last 15 seconds of instruction, stepping through frame by frame, practicing on the manikin, taking a break, resuming the program after a break, requesting a quiz on material that the student thinks he or she knows, and calling a live person for assistance.

Since it was vital to give students the sense of being in control, we wanted the menu to be available always. We decided that two monitors were necessary and would add to the system's capability. One would always be available to take input from the student and to display output from the computer. The other would constantly display information from the videodisc. At times, we discovered, the two monitors could work together as a highly sophisticated instructional tool. Furthermore, the cost of the second monitor was a small part of the cost of the whole CPR system.

If at any point in the instruction the student gets bored rehashing, say, the anatomy of the heart, the student can switch to "I know this—Quiz me," or to "I want to try the manikin." Such freedom keeps students interested.

To provide for alphabetic input from the students, we provided a "word template" system that provides a listing of the alphabet and allows the student to spell out a word by touching characters in the list. Photo 4 shows the template in use. The software here can handle most misspellings of the words intended. Rather than insisting on exact spellings, the software checks to see if key letters are present in the correct order. If the student is trying to spell "pulse," the software will understand so long as the student enters the letters "PLS" in that order, regardless of the letters that come before, after, or in between.

The light pen provides access to several different levels of explanation of the key vocabulary words. Each level may involve printed and spoken



# Plot your next meeting yourself.

## Read how 2 pens can become your best presentation tools.

### Introducing the New Personal Computer Plotter from Hewlett-Packard.

Now you can use your personal computer to generate your own presentation charts, graphs, and pie charts. How? Simply add on the new high quality, low cost HP 7470A Personal Computer Plotter.

The 7470A helps you save time and save money, and lets you communicate quickly, accurately and *effectively*.

### Quicker understanding.

Data, when visualized graphically, becomes information fast. Charts and bar graphs can make any presentation clearer and more readily understood. But asking your staff to produce the graphics manually for your next presentation doesn't ensure accuracy or artistic talent. And going to outside graphics suppliers can be costly. Combined with your personal computer, the new HP 7470A plotter does the communicating for you. Quickly. Logically. And with off-the-shelf software available from most HP dealers.



### Fast and pretty.

The 7470A gives you high plotting speed with excellent line quality...faster than any competitive small plotter. On top of all that, it comes in an attractive design package that looks nice on your desk. And it does it for only \$1,550. (U.S.A. domestic suggested retail price.)



### Count on it.

The 7470A is built the Hewlett-Packard way. To last. Designed and engineered with only a few parts, none of which require adjustment. And with customized integrated circuits that ensure reliability.

### Pen pals.

The HP 7470A has two single-pen stables. Simple pen changes give you multi-color plots in your choice of ten coordinated colors. Pens are automatically capped and stored.

### An option you'll want, too.

For only \$95, you can also get a 17057 Overhead Transparency Kit that turns your plots into transparencies for overhead projectors. For "I need it tomorrow at 9:00 A.M.!" meetings, it's a necessity.

### Start plotting your next presentation today. Clip and mail the coupon below. Now.

Mail the coupon below and we'll send you—absolutely free—a sample plot, a more detailed brochure, and a sample overhead transparency.

Then...stop in at your nearest Hewlett-Packard Dealer. See the HP 7470A in action. Once you see it demonstrated you'll find a hundred ways to make your own applause-winning presentations.

*When performance must be measured by results*



Circle 212 on Inquiry card.

Seeing is believing. Send me a sample plot, a n overhead transparency, and more detailed information.

Name \_\_\_\_\_ Title \_\_\_\_\_

Company \_\_\_\_\_

Address \_\_\_\_\_

City, State & Zip \_\_\_\_\_

Phone Number (    ) \_\_\_\_\_

Send to: Hewlett-Packard, 16399 W. Bernardo Drive, San Diego, CA 92127—Attn: Nancy Carter

11203 BT-6



6a

Photo 6: A student using a light pen to show judgment. In photos 6a and 6b the computer screen displays a list of techniques out of order and the student indicates the next one in the order, which, if correct, will appear above the dotted line. The computer then accesses the videodisc to present the appropriate next segment on the video screen while the list of techniques remains visible on the computer screen (6c). In photo 6d the student makes another selection.



6b



6c

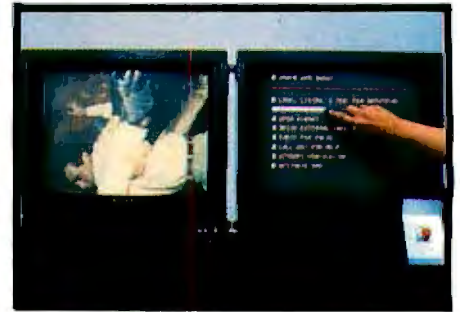

6d

explanations and labeled illustrations. The first definition provided is short and simple, letting the student quickly check the correctness of his or her understanding of the term. The student can always use the light pen to enter "M" for "More" to get a deeper level of explanation. Photo 5 shows a frame with a basic explanation of CPR.

Students also use the light pen during quizzes, as shown in photo 6. Providing different levels of explanation on demand helps to implement the "mosaic" concept of learning, as opposed to the traditional step-by-step, same-for-everyone, linear concept. The system meets the needs of each student. People who want more

thorough definitions can always get them. People who just want to learn enough to perform CPR need not go to such lengths.

One benefit of the mosaic approach is that a single nucleus program can satisfy several different levels of learning needs. This helps a great deal in amortizing development costs.

### Random-Access Audio

In order to keep up with the videodisc, a random-access audio system would have to be fast indeed. I reasoned that 1/30 of a second would be fast enough on stereo audio tape, and that three usable channels could give us three times the speed of access. To build the random-access

sound machine, I commissioned Bob Howard and Dave Weiszbrod of BCD Electronics in Oklahoma City, Oklahoma. They were the logical choices because they had already developed a successful frame-accurate video-tape interface card for the Apple II.

There was a certain irony in developing random-access audio at all. Audio technology had preceded video, but it was video technology that first achieved random access. Now we were going back to give the older audio technology one of the fruits of the newer video technology.

### How It Worked Out

Pending final validation results, the system will be used to train from one

### The Availability of the CPR Training System

People interested in obtaining the CPR videodisc training system described by David Hon should contact Interact Inc., 603 NE 17 St., Oklahoma City, OK 73105, telephone (405) 521-9073. Interact's chairman is Dr. Daniel Cassidy, an emergency care physician with a strong interest in interactive video. Jack Roseman, former head of Online Systems, is Interact's president.

Interact has other videodisc-based

medical training systems under development. Another American Heart Association course, the Advanced Cardiac Life Support (ACLS) program will train physicians, paramedics, and nurses in what to do after CPR, including medical management of cardiac arrest cases in all eventualities.

In addition, Interact will release at the same time as the CPR system another videodisc that creates simulations of cardiac arrest cases. The disc will randomly generate particular

types of cardiac arrest, based on the real probabilities for the exact nature of the case and the condition of the patient. The system will then ask the trainee to decide on the correct therapy. The system provides feedback at every step, telling the student how to correct any mistakes, and continues the simulation until the case is managed successfully.

Interact will soon be opening new headquarters in Pittsburgh, Pennsylvania.





## Boldly Go Where No Drive Has Taken You Before...

Give your APPLE II® a Fourth Dimension — the totally compatible 5¼" drive that takes your system farther, faster. With read/write electronics so advanced that reading errors are virtually eliminated. With a track zero microswitch that keeps boot and track access smooth and quiet. With the ability to read half-track software and up to 143,360 bytes on DOS 3.3®. With similar performance on DOS 3.2.1®, Pascal® or CP/M® operating systems. And, the disk enclosure mates perfectly with APPLE cabinetry.

**EXTENDED WARRANTY** — We offer a 12 month parts and labor warranty extension at no cost to you.

**IMMEDIATE DELIVERY** — Immediately available in quantity. We offer same-day shipment if your order is received by noon (PST).

**\$30 FACTORY REBATE** — Receive a \$30 factory rebate if the warranty card is received by us on or before August 31, 1982. See participating dealer, or call direct. Suggested Retail Price: \$419.00.

**TAKE YOUR APPLE TO THE LIMIT WITH A FOURTH DIMENSION DRIVE.** Ask for additional information. Dealer inquiries invited. Contact:  
Fourth Dimension Systems  
3100 W. Warner Avenue, #7/Dept. B  
Santa Ana, CA 92704  
(714) 850-1228

**FOURTH DIMENSION SYSTEMS**

Mastercard and Visa accepted.





7a



7c



7b

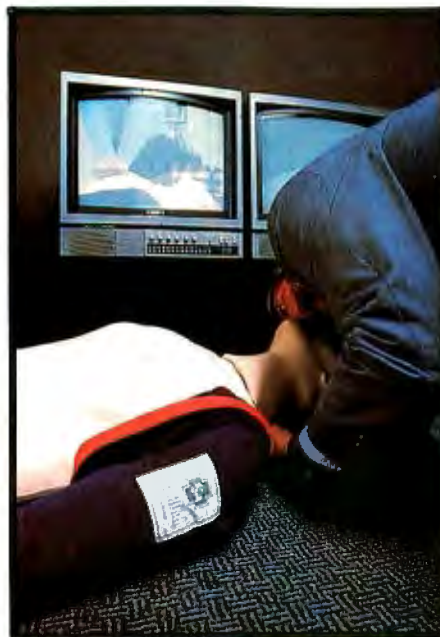

7d

**Photo 7:** The system in use. Photo 7a shows the author, in the role of a student, performing chest compressions on the manikin. In 7b the doctor, seen on the video screen, comments on the student's performance and explains the graphed evaluation shown on the computer screen. The student then goes on to perform a ventilation (7c) and "interacts" with an on-screen rescuer in simulated two-person CPR (7d).

to four people at a time in the techniques of CPR, with no assistance from a human instructor. If more than one person takes part at a time, the system evaluates each individually. The system also serves as an effective and rapid recertification tool for persons who have previously completed a course in CPR. If the system is used two hours a day, as many as 1700 persons who completed their previous courses six months ago may be recertified in one year.

The flexibility of mosaic courses makes it difficult to say how long the

course should take to train any one novice, but the range seems to be from one to five hours, depending on prior medical knowledge, with three hours about average for completing the entire course. When the system is training four people at a time, the expected duration is about four hours; for a recertification after six months, about half an hour; for a recertification after one year, about an hour.

Our early tests show that we accomplished what we set out to do. The CPR student never sees an instructor or a keyboard but is taught

CPR skills and is certified more quickly *and* with higher standards than a live instructor can achieve. By the time this article appears, our final validation of these results should be complete.

One of the reasons for the system's success becomes apparent only to someone who watches the system in use. Reacting to data supplied by the sensors in the manikin, the system gives far more precise and immediate coaching about the student's position and the depth and rhythm of compression than any human instructor could provide (see photo 7). An individual human instructor can't get inside the manikin the way technology has. An individual human instructor can't always be ready with exactly the right word of guidance or the most apt graphic illustration. But the system is always ready.

The videodisc's large storage capacity and high-speed random-access capability made the system possible, but the technology only presented an opportunity. Human ingenuity had to seize that opportunity. Our success was in bringing together the talents of cooperating physicians, programmers, engineers, and video experts to exploit videodisc technology. It is as if videodisc technology and the computer distilled the expertise of all these people into one small, self-sufficient, and convenient package for optimal presentation to a wide range of individuals. From our results it should be apparent that videodisc technology presents a real opportunity for concentrating expertise and imparting skills in many other fields as well. ■

#### Bibliography

1. Hessinger, Lynn. "Interactive Videodisc Teaching of CPR," *Bio-Medical Communications*, September 1981.
2. Hon, David. "The Videodisc, the Microcomputer and the Satellite," *ASTD Journal*, December 1980.
3. Hon, David. Series of seven articles for *Videodisc News*, February-August 1981.
4. Hon, David. "Interactive Video Column," *Video User*, July 1981-June 1982.
5. Hon, David. "Space Invaders, Videodiscs, and the 'Bench Connection,'" *ASTD Journal*, December 1981.
6. *Apple Magazine*, Vol. 2, No. 2, 1980.



# SX Is a Two Letter Word...



**...describing the price performance leaders in table top computers.**

Owning an SX from IMS International is a joy no matter which model you choose.

Both give you Winchester performance and a lot more.

Our 5000 SX table top computer features either a 5.5 or 11 MByte Winchester subsystem, plus one or two 5 1/4" floppy drives.

And our 8000 SX offers a 10, 20 or 40 megabyte Winchester, plus one or two 8" floppies, and a 17 megabyte

incremental cartridge tape drive subsystem.

Both high performance Winchester subsystems deliver awesome speed — ten times faster than floppies, on the average. You can load a 20 KByte system program in less than a second.

More importantly, IMS systems are engineered for reliability, so downtime won't take away the gains Winchester technology brings. They're strictly business, from their metal-not-plastic cabinets to their test-don't-guess circuitry.

And with our full 2-year warranty, you have it in writing.

Software for the SXs includes either single user, or our new high performance multiuser/multi-processor operating systems, plus BASIC, FORTRAN and COBOL languages, and a host of compatibility-tested application programs.

For complete information and specifications on the 5000 SX and 8000 SX, along with the location of your nearby IMS International dealer, just contact us.

We'll tell you everything you ever wanted to know about SX.

Call (714) 978-6966 or (702) 888-7611 today, or write:

**IMS**  
INTERNATIONAL

**WE BUILD COMPUTERS AS IF YOUR BUSINESS DEPENDED ON THEM.**

2800 Lockheed Way, Carson City, NV 89701 • Telex: 910-395-6051

Circle 223 on Inquiry card.

Introducing the premier award of the software industry.

# THE ATARI® STAR

Win \$25,000 in cash,  
plus prizes and an ATARI STAR  
by entering your software in  
the ATARI® ASAP competition.



ATARI is looking for some of the greatest software from the brightest stars in the software field. And naturally, we're willing to reward you for it.

Every three months, ATARI will be presenting ATARI STARS to the writers of software programs judged first, second and third place in the following categories: consumer (including entertainment, personal interest and development); education; home business (personal finance and record keeping); and system software. The decision of the ATARI judges is final.

Quarterly prizes will be from \$750 to \$3,000 worth\* of selected



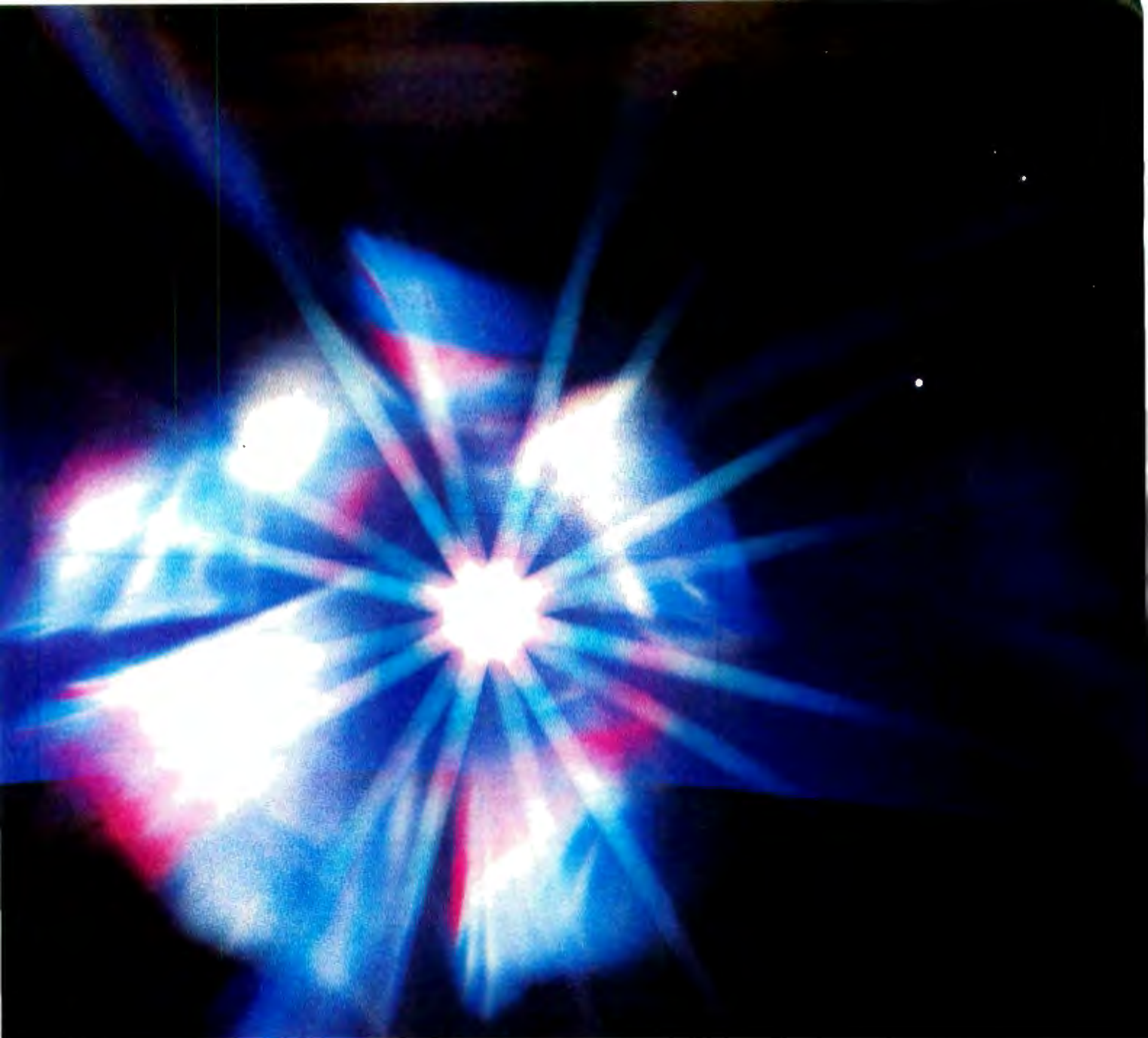

ATARI products and an ATARI STAR. The annual Grand Prize will be the coveted Super Star trophy and \$25,000 in cash.\*\*

To be eligible, your software idea must be submitted to and published in the ATARI Program Exchange catalog. Submit your program on the official entry form which we'll rush to you if you send in the attached coupon.

The ATARI STAR Awards are in addition to the percentage of revenues you will automatically be entitled to as

a result of sales of your software programs in the ATARI Program Exchange.

If you're a star, ATARI wants to reward you. Send in the coupon today, or call toll-free 800-538-1862, in California 800-672-1850, and you could be the proud winner of an ATARI ASAP STAR Trophy, and some great ATARI prizes.



\*Based on manufacturer's suggested retail price.

\*\*Taxes are the sole responsibility of the winner. Void where prohibited by law. Winners will be notified by mail. ATARI employees and their families are not eligible. For more contest details, call the toll-free numbers. © 1981 ATARI, INC.

Circle 43 on inquiry card.

For more contest details, call 800-538-1862, in California 800-672-1850.

Send to: ATARI Software Acquisition Program, Dept. C1E, P.O. Box 427, Sunnyvale, CA 94086

Yes, I want to enter the ATARI ASAP competition. Please rush me my entry form.

Name \_\_\_\_\_

Address \_\_\_\_\_

City \_\_\_\_\_

State/Zip \_\_\_\_\_



**ATARI**

A Warner Communications Company

*We've Brought  
The Computer Age Home.™*

# Videodiscs and Optical Data Storage

*We may soon be measuring mass storage in gigabytes.*

---

Dick Moberg  
404 South Quince St.  
Philadelphia, PA 19147

Ira M. Laefsky  
8808 Patton Rd.  
Philadelphia, PA 19118

---

Optical videodisc technology may be the next generation in mass storage of digital data. Though much of the effort to date involves large, expensive recording machines, some of the research is geared to the mass production of large databases that will be accessible by small-computer systems. In just a few years, your personal computer may be able to randomly access an entire encyclopedia, including text and photographs.

This article will review some methods of storing digital data optically on videodiscs. We will then look at some commercial products for office automation and mass data storage that are being developed using optical-storage techniques. Finally, we will assess the benefits this technology promises the small-computer user in terms of large databases of text and pictures.

## Trends in Data Storage

Let's look at the trends in data storage over the last two decades. In the 1960s, computers, for the most part, were still being used for storing numbers; businesses, banks, and the government relied on high-capacity magnetic hard-disk packs for data storage. The 1970s saw an increased need for storage of text: letters, manuscripts, and memos became increasingly important as our world became more knowledge-dependent. Word processors and office-automation systems popped up everywhere during

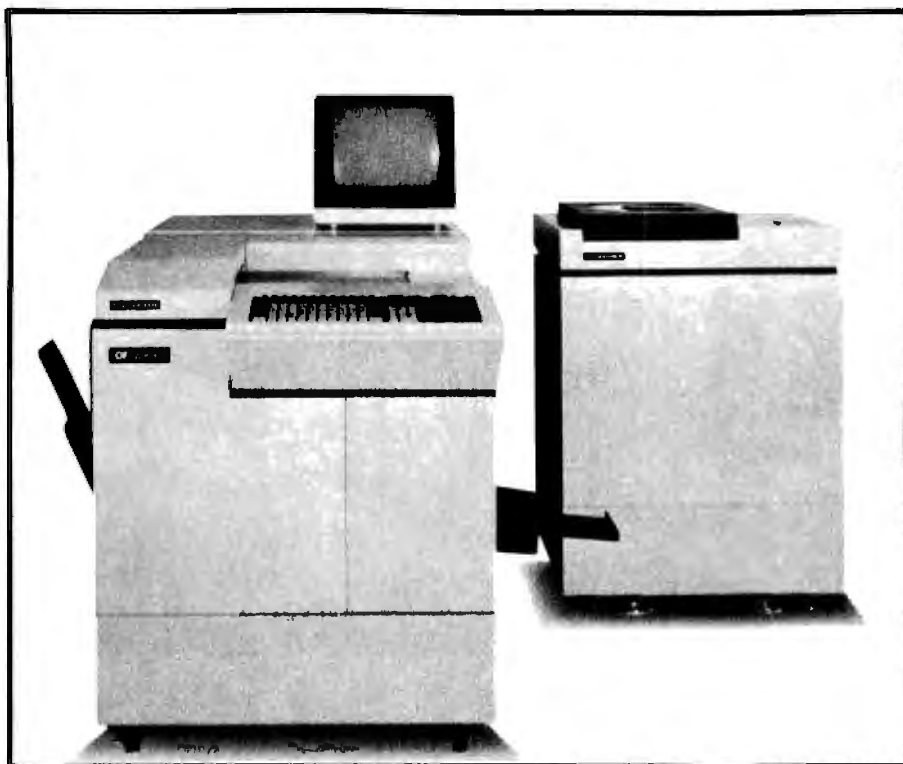

Photo 1: *The Toshiba DF-2000 Document Filing System.*

the 1970s, and the floppy disk, with its limited capacity but low cost, came into vogue.

Magnetic-storage technology has, until recently, kept pace with user requirements. Magnetic-tape density has increased from 800 bpi (bits per inch) to 1600 bpi and now to 6250 bpi. Low-cost hard disks presently offer many megabytes of storage for small-computer systems; but data-storage requirements are again chang-

ing. Entire documents must be stored, including graphics and pictures, increasing the memory required by two orders of magnitude. This challenge to the magnetic-media industry may give optical-storage technology the chance it needs to become a commercial reality.

The need for document storage is everywhere. In large institutions, file cabinets are grabbing more and more floor space. At the Jet Propulsion



# MICRO-SCI IS IN THE GAME FOR ALL THE APPLES...

**μ-SCI**

**μ-SCI**



## ...WITH A FULL HOUSE OF 5 1/4" DRIVES

Micro-Sci has three disk drives and two controllers so you can configure your Apple II™ or Apple II Plus™ system to fit your individual budget and performance requirements.

### THE FIRST ACE — A2

The new A2 is the price/compatibility substitute for the Disk II,™ intended as the second drive on an existing controller, or as a full A2 subsystem. The A2 drive or A2 subsystem is an ideal choice when the drives will be primarily used for entertainment or prepackaged software programs.

### THE SECOND ACE — A40

The A40 is a price/performance alternative to the Disk II. With 40 tracks, you get an additional 20K bytes, and faster track-to-track access. The A40 is intended for use in dedicated DOS, CP/M and Pascal applications, and as a companion drive for the A70. The A40 is Micro-Sci's most cost-effective

disk subsystem for the Apple IIs.

### THE THIRD ACE — A70

The A70 is the price/capacity alternative. At over a quarter million bytes per drive, the A70 has the capacity of two Disk IIs or an eight-inch floppy, but costs only slightly more than a single Disk II. One A70 supports a DOS file as large as 270K, a CP/M file up to 254K, and 560 blocks in Pascal.

### THE PAIR — MICRO-SCI'S CONTROLLERS

The A2 comes with a unique new controller. This controller supports any combination of A2s or Disk IIs, you have complete flexibility.

The A40 and A70 share a common controller. Mix A40s and A70s in any fashion, one A40 with one A70, two A40s or two A70s — all on the same controller.

You can have a Disk II or A2 controller with

Disk II or A2 drives and still add an A40 or A70 subsystem. That's full system-level compatibility.

### THE PAT HAND

Versatility, reliability, capability are assured when choosing Micro-Sci. Pick the drive, pick the controller, pick the capacity and function. Whatever your need, DOS 3.2, 3.3, Pascal, CP/M, games or pre-packaged software, Micro-Sci has the drive. Start wherever you choose with the knowledge that you can expand without concern. All Micro-Sci products are backed by a full 120-day warranty (parts and labor).

Our complete line of Apple compatible products makes us the dealer's choice. We're always looking for good dealers.

International dealer inquiries:  
International Markets Co., Telex: 69-6191.  
TELEX CO LSA

**μ-SCI**

**MICRO-SCI**

See Us At  
**COMDEX**  
JUNE 28-30, 1982

17742 IRVINE BOULEVARD • SUITE 205 • TUSTIN, CALIFORNIA 92680 • 714/731-9461 • TELEX: 910-346-6739

MICRO-SCI IS A DIVISION OF STANDUN CONTROLS, INC.

\* APPLE II, APPLE II PLUS \*\* DISK II © APPLE, APPLE II AND DISK II ARE REGISTERED TRADEMARKS OF APPLE COMPUTERS, CUPERTINO, CALIFORNIA

# BUYING?

You can save on computers and software using our commercial buying service. We buy wholesale for you. Our fee is one fourth of what we save you off list. We offer you:

- Access to over 500 Manufacturers
- 1500 Satisfied Clients
- Leasing
- Exporting Services

Examples of prices paid by our clients (including fee) are:

## Computers

Adds Multivision	\$ 3,075.00
Adds Multivision I	3,074.00
Alpha Micro 1030	12,047.00
Alpha Micro 1051	17,634.00
Alspa AC1-2/SS	2,320.00
Altos 8000-02	2,629.00
<b>Altos 8000-10</b>	<b>6,295.00</b>
Altos 8000-15	3,585.00
Altos 8600-10	7,586.00
Altos Seris 15D	2,182.00
Altos Seris 5-5D	4,372.00
Apple 2 + 48K	1,208.00
Apple III 128K	2,874.00
Amperex GP 300	3,695.00
BMC 20B	5,422.00
CCS Series 300-1 A	4,414.00
Columbia Data	CALL
Cromenco System 0	3,200.00
Cromemco System 1	2,946.00
Cromemco System 2	3,400.00
<b>DECVT-180xx</b>	<b>3,344.00</b>
Dual	12,636.00
Dynabyte	26% OFF
Eagle II	3,796.00
IBC Cadet	4,211.00
Micromation	CALL
NEC 8001A	750.00
NEC 8012A	490.00
NEC 8031A	750.00
<b>North Star Advantage</b>	<b>2950.00</b>
North Star Advantage HD 55	1,500.00
North Star Hoz II 64KDD	2,995.00
North Star Hoz II 64KQD	3,040.00
Onyx 5001 MU-6	7,350.00
Osborne	CALL

Sanyo 2000	2,708.00
Seattle System 2	3,251.00
Televideo TS-802	2,600.00
Televideo TS-802H	4,550.00
Televideo TS806	5,100.00
Toshiba T-200 w/Printer	4,099.00
Toshiba T-250 w/Printer	5,099.00
Toshiba EW-1000/4	6,799.00
Toshiba EW-1000/2 w/PTr	5,999.00
Vector 2600	4,221.00
Vector 3005	6,458.00
Vector 5005	7,308.00

## Printers

C. Itoh F-10	1,400.00
C. Itoh 40CPS Serial	1,500.00
C. Itoh Comet II	800.00
Diablo 630	2,098.00
IDS 560/G	995.00
IDS Prism 132 Column	1,495.00
NEC 3510	1,830.00
NEC 7710R/O	2,325.00
NEC 7720KSR	2,700.00
Olivetti 231	2,104.00
Qume 9/45	2,045.00
Sellem 1	2,725.00
Tally	CALL

## Others

Anderson Jacobsen	641.25
Corvus 10MEG	3,825.00
DEC VT-100	1,430.00
Houston Instrument DMP-21	1,470.00
Houston Instrument DMP-4	1,460.00
Houston Instrument DMP-7	2,077.00
Morrow 20MEG	3,650.00

For latest wholesale prices and to order Call Toll Free 800-227-2288. In California call 415-376-9020. Assembly, integration and testing also available from our service department.

**Ask about our Leasing Program.** We are buying agents for overseas computer dealers.  
**EXPORT SERVICES available.** International Telex 470851.

Mastercard, VISA at 3% handling fee. Prices subject to change without notice. Minimum fee \$100. 15% cancellation fee.

## THE PURCHASING AGENT

1635 School St., Suite 101, Moraga, CA 94556

Laboratory, photographs sent from space fill reel after reel of magnetic tape. Most hospitals have X-rays stacked to the ceiling for the duration of their legal storage term. The U.S. Government alone used 2 million reels of magnetic tape in 1975. Microfilm has had some impact here, but the time needed to access the stored information limits microfilm's usefulness.

Progress in the fields essential to the success of optical storage has been excellent. The development of the single-mode laser diode to replace the large, expensive gas laser has made the consumer videodisc a reality. Recent advances in microprocessor technology, error-detecting and error-correcting codes, and database techniques are also key elements to the success of this effort. The stage is now set for the creation of an optical data-storage industry.

## How Is Information Stored?

Storing digital data on optical videodiscs can be accomplished in two ways. In one method, the digital data is encoded in the video signal, then standard videodisc replication and reading techniques are used. The other method writes the digital information directly onto special discs. This method has applications in archival storage, whereas the first method is good for databases that must be easily replicated.

We will first review how video information can be stored on conventional optical videodiscs and show how this technique can be used to produce databases for small-computer systems.

For the purposes of this discussion, the scanning pattern of the electron beam inside the television's picture tube can be thought of as comprising 525 horizontal lines from top to bottom (the process is called raster scan). This scan produces one image (frame) on the face of the tube. The scan is repeated every 1/30 second, producing a new picture each time. (Actually, two *interlaced* frames of 262.5 scan lines are produced, 1/60 second each.) The picture data of each horizontal scan line consists of a varying



# top shelf

**Software for the IBM PC  
and the Apple II**



**With spoken instructions,  
our tested software doesn't try your patience.**

**EASY** Every Alpha software package contains spoken instructions on cassette to guide you through the program on the disk. You get professional software that a novice can use.

**PROVEN** Our business software for the IBM PC has been used since 1979 on the Apple. Thousands of people agree that our versatile **Data Base Manager** and **Mailing List** programs are effective time- and money-saving devices.

**INNOVATIVE** **Question** is a fun game based on artificial intelligence. It tries to guess what city, person or animal you're thinking of, and gets smarter as you play. You can even teach it new topics.

**Type Faces** lets your dot matrix printer generate 15 different kinds of large lettering.

With **The Apple-IBM Connection**, you'll be able to transfer files from the Apple II to the IBM and vice versa. Your VisiCalc work can be transferred without retyping or errors. Requires no technical knowledge. The software does all the work for you.

Alpha software products available at participating **ComputerLands**.  
Or call us for your nearest dealer: 617 229-2924



6 New England Executive Park • Burlington, Massachusetts 01803

Data Base Manager: \$185 Mailing List: \$95 Question: \$45 Type Faces: \$95 The Apple-IBM Connection: \$120

# UNIX, Ada™, FORTRAN 68000

## XAVAX One/32KB \$1,500

- 68000 8MHz single board computer
- Multibus™/IEEE 796 compatible
- 2 RS232C, 2 parallel ports
- Sockets for 64KB ROM
- Motorola KDM module compatible
- 128KB RAM on board, add . . . (\$500)
- Manual of boards, chips . . . (\$15)

## XAVAX Two \$8,500

- 68000 8MHz Multibus™ computer
- 256KB RAM expandible to 1MB
- 10MB Winchester, 960KB floppy
- One parallel, 2 RS232C ports
- Graphics display monitor
- Multitasking operating system
- Editor, filer, linker, utilities
- Language: (Pascal, C, COBOL, FORTRAN, BASIC, or Assembler)
- UNIX/7 and APL are options.
- Manual with OS summary . . . (\$15)
- Operating system manual . . . (\$25)
- System manuals set [7] . . . (\$85)

## XAVAX Two/3 \$10,850

- Multibus™/IEEE 796 bus, 3 users
  - /6 includes 512KB RAM, 6 users
  - /6 adds 3 RS232C ports [5 total]
- XAVAX Two/6 \$12,850

## XAVAX Three \$12,850

- XAVAX Two features, plus:
- Second 68000 processor
- Memory management on board
- Ada™ and Pascal with OS . . . (\$5000)
- Initial XAVAX Two/3, add . . . (\$2350)
- Initial XAVAX Two/6, add . . . (\$4350)

## XAVAX 10 Cartridge Backup \$5,000

- 10MB high speed mini-Winchester
- 7MB integrated backup [3 min.]
- Multibus™ controller [32KB RAM]
- 960KB floppy [in main cabinet]
- Interface to XAVAX Two, Three.

### HARDWARE [Multibus™]

- 880 Kilobaud I/O controller \$1,500
- 8 channel RS232C
- Bisync and ASCII asynchronous
- CRC generate, detect, check
- ports individually programmable
- 8 channel RS232C I/O board \$300
- 8 channel intelligent RS232C \$580
- 4 channel parallel board \$400
- ANSI Winchester controller \$500
- 512KB RAM [parity, 270ns] \$1,700
- 256KB RAM [half populated] \$1,500

### SOFTWARE

- BizBooks™ [80 modules] \$4,500
- Accounting, inventory control
- BizGraf™ [8 colors] \$2,500
- Business color graphs, plots.

MasterCard and VISA accepted.

Ask your distributor for XAVAX.

™ UNIX trademark of Bell Laboratories.  
™ Multibus trademark of Intel Corporation.  
™ Ada trademark Department of Defense.

(319) 344-0550

**XAVAX CORPORATION**  
300 Northwest Tower  
Bettendorf, IA 52722

TWX: Cable: 910 - 525-1177 XAVAXCORP

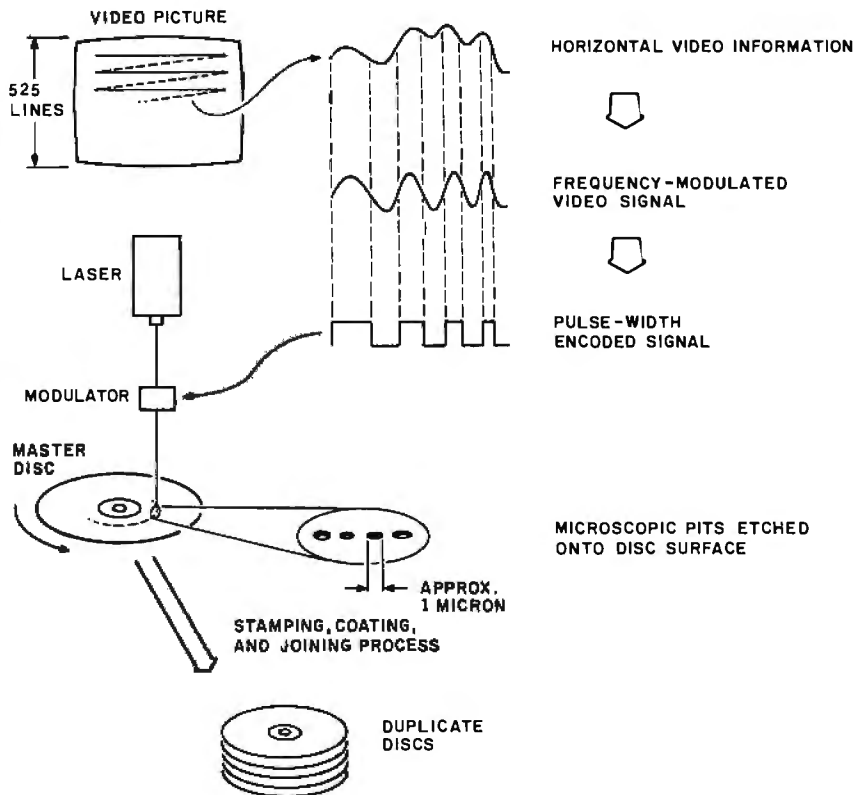

**Figure 1:** Information storage on a videodisc. The first step in storing video information on a videodisc is the production of an FM (frequency-modulated) signal from the horizontal scan information of the TV signal. Next, a pulse-width encoded signal is made by "clipping" the top and bottom of the FM signal. This signal is used to modulate a high-powered laser that etches pits onto the surface of a rotating, photosensitized glass disc. The pit length is proportional to the pulse width of the original signal. A nickel-plated copy is made to stamp one-sided plastic discs. After a reflective coating is added to the plastic disc, two are joined together to form both sides of the finished disc.

amplitude signal. The signal controls the intensity of each pixel (picture element) on the line (see figure 1). Sync pulses, both horizontal and vertical, make sure that the scan dot is at the same spot on the screen every 1/30 second. This is a standard video signal.

A videodisc master is made by first converting the AM (amplitude-modulated) video signal into an FM (frequency-modulated) signal. The tops and bottoms of this FM signal are "clipped" to make a pulse-width encoded signal, which is then used to modulate a laser focused on the photosensitized surface of a rotating glass disc. The laser etches tiny pits into the surface of the disc whose lengths correspond to the widths (time) of the pulses. One circular track on the disc holds all 525 horizontal lines needed to produce one TV frame.

From the glass master, a nickel stamping disc is made by a plating process. Plastic discs are then stamped and a reflective coating is added. Two of these discs are joined together to form a two-sided disc.

When reading the picture information back from the disc, a laser is aimed at the track and the reflection of the laser beam is detected. The reflected beam is broken by the pits in the disc, thus modulating the beam to give the pulse-width encoded signal from which the original video signal is reconstructed (see figure 2).

What about digital-information storage? From the above discussion, it can be seen that the pulse-width encoded signal is essentially an on-off digital-like signal. As you might expect, with the proper encoding scheme, digital information can be stored on a videodisc with little modification to the recording and



# new faces

## 15 type styles for the IBM PC and Apple II

With this program your dot matrix printer  
can output 15 large typefaces.

Type Faces generates distinctive presentations, fancy lettering,  
invitations, easy to read output, and over 100 symbols.  
Reduced printout on a copier gives you letter quality text...  
an inexpensive typesetter.

Type Faces comes with its own simple text editor and is  
compatible with most word processors.

Actual dot matrix printout

ABC abc  
ABC abc  
ABC abc  
ABC abc  
ABC abc

Reduced dot matrix printout  
gives you letter quality text

ABC abc  
ABC abc  
ABC abc  
ABC abc  
ABC abc

Alpha software products available at participating ComputerLands  
Or call us for your nearest dealer: 617 229-2924



6 New England Executive Park • Burlington, Massachusetts 01803

Type Faces supports Epson and IBM dot matrix printers. Type Faces: 695

Circle 18 on Inquiry card.



Type Faces



alpha

SOFTWARE FOR  
IBM and APPLE

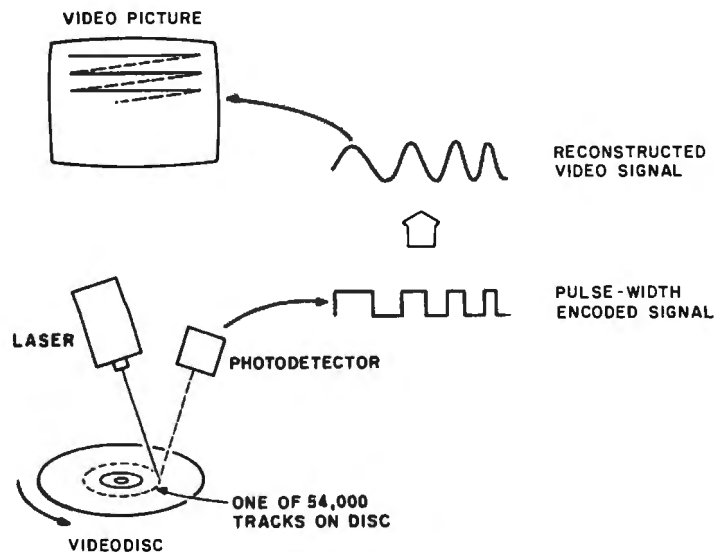

Figure 2: To read video information from a videodisc, a laser is focused on a track of the disc and the reflected light is picked up by a photodetector. Pits in the tracks break the reflected beam of light and produce the pulse signal that is decoded into the original video signal.

on only *one* side of a randomly accessible videodisc.

A significant problem with recording digital data on videodiscs in the same manner as a video picture is in the tolerance to errors. In a television frame, one pixel or a hundred pixels of the wrong intensity can hardly be detected. In fact, the videodisc-mastering process sometimes causes the signal of an entire line to be very weak, a condition called "dropout." To correct this error, players are equipped with detectors that sense the signal strength; when dropout is detected, the previous line is substituted for the incorrect line. To the viewer, this substitution is not noticeable.

The story is different with digital data because the intensity level of just one pixel may be responsible for up to three bits of data. Herein lies one of the major problems with optical storage of digital data directly as a video signal. Error-detection and error-correction codes are being used to attempt to reduce the rates. Fortunately, the disc has ample room for redundant information.

### Databases for Small Computers

The production of videodisc databases using the recording format just described is being researched at the Lister Hill Center in Bethesda, Maryland, which is the medical-communications arm of the National Library of Medicine. It is responsible for indexing the tremendous amount of medically related literature published each year. The index is sent to subscribers as a multivolume set some three to four feet thick.

Naturally, the Center is interested in publishing its indexes and other medically relevant information in machine-readable form. It has started a digital-videodisc program that, unlike most of the corporate ventures, is aimed at the mass publication of data using mastering and replication processes currently used for videodiscs in the entertainment industry. In this manner, it will be able to mix digital and video information—an added plus when dealing with medical information.

The Center's calculations indicate a

playback equipment. (In practice, it is not quite that simple. A few of the problems will be discussed later.)

For now, let's calculate how much digital data can be stored on a disc. We will start with the fact that, at 4 megahertz (the bandwidth of a television signal), each horizontal line contains 416 pixels. Although only 483 of the horizontal lines carry a picture signal in a TV signal, approximately 500 can be used for digital data storage. If we assume each pixel can represent either a 1 or a 0, the number of bits per TV frame becomes:

$$416 \frac{\text{bits}}{\text{line}} \times 500 \frac{\text{lines}}{\text{frame}} = 208,000 \frac{\text{bits}}{\text{frame}}$$

But the intensity of each pixel of the TV frame can be varied more than just on and off (1 or 0), representing only one bit of information. If we assume at least four intensity levels per pixel, two bits of information can be encoded per pixel, which gives us 416,000 bits/frame.

As was mentioned earlier, one TV frame fits on one circular track of a videodisc. Thus, the standard half-hour videodisc has:

$$30 \frac{\text{frames}}{\text{second}} \times 1800 \frac{\text{seconds}}{\text{half hour}} = 54,000 \frac{\text{frames}}{\text{disc}}$$

Thus, the total disc capacity for this example is:

$$54,000 \text{ frames} \times 416,000 \frac{\text{bits}}{\text{frame}} = 22 \times 10^9 \frac{\text{bits}}{\text{disc}}$$

This is approximately 2 billion characters (2 *gigabytes*) per side of a videodisc. If we can detect reliably more than four intensity levels per pixel, the number is even higher. The number of intensity levels is a function of the bandwidth of the TV signal. The best estimates indicate that eight levels would be feasible in data storage of this type, resulting in approximately 3 billion characters per side of the disc.

Three billion characters translates into approximately 750,000 pages of text (assuming a fairly dense page) or, for example, four years of 78 technical journals (assuming 200 pages per journal per month). And that is



# People can be trained to know how computers work. But we've trained QDP to know how people work.

Wed, Jun 30, 1982

11:56 AM

## QDP COMPUTER SYSTEMS

### SYSTEM UTILITIES

CP - COPY PROGRAM  
 CD - RECONFIGURE SYSTEM  
 ST - SYSTEM STATUS REPORT  
 MM - MAP OF MEMORY USE  
 ID - INITIALIZE DISKETTE

### BUSINESS APPLICATIONS

AR - ACCOUNTS RECEIVABLE  
 AP - ACCOUNTS PAYABLE  
 PR - PAYROLL  
 IN - INVENTORY  
 GL - GENERAL LEDGER

### WORD PROCESSING

WP - WORD PROCESSOR  
 SP - SPELLING DICTIONARY  
 MP - MAILING PROGRAM

### UTILITIES & MENUES

HE - HELP PROGRAM  
 TT - SET DATE & TIME  
 BH - BACKUP HARD DISK  
 RH - RESTORE HARD DISK  
 CM - COMMUNICATIONS  
 M2 - MENU # 2

### FINANCIAL MENU

FM - FINANCIAL MODELING

Enter Selection :



QDP 100H  
 10 MB (Formatted)  
 HARD DISK

QDP 100  
 2.4 MB (Formatted)  
 FLOPPY

## Introducing QDP's "user-friendly" computer system.

And other new QDP simplicitles that make QDP easiest to sell, install, and use.

Simply pressing one key will start the user off right with QDP. Up comes a user-friendly menu (now standard on all QDP computers) and even untrained operators have access to the full power of QDP to do whatever job they select. Users never have to see QDP's operating system.

If help is needed to understand a QDP program or system function, QDP has an on-line "HELP" system. Ask for help, and QDP delivers definitions, examples, documentation and explanations. New items? Add them to QDP's user-library function.

Our software warns users of many impending problems before they happen. A built-in SYSTEM STATUS program monitors performance of the electronics and drive systems. This way QDP helps

assure a profit-generating reliable system that has all these features as standard equipment:

- One-year, on-site warranty service performed by the Installation & Service Engineering Division of General Electric Company—with more than 50 service locations nationwide.
- Proprietary "cachè memory" system which makes QDP one of the fastest microcomputers available today.
- Unique system configuration program that allows users to easily modify operating system parameters via a menu-driven program.
- Best user-friendly implementation of a CP/M compatible operating system on the market — competitors, after two years, are finally trying to catch up.

- Z80 (4-6 MHZ), IEEE 696 (S-100) — CP/M, MP/M compatible operating system.
- CBASIC language.
- Excellent user documentation and reference manuals.

### And these options:

- Multi-user timesharing systems.
  - Hard Disk sub systems.
  - Memory disk to allow from 64K to 2MB of silicon memory to be accessed as a disk drive for extremely fast disk operations.
  - Software Languages: COBOL, FORTRAN, C, PASCAL, and Microsoft BASIC.
  - 16 bit version available this fall.
- Write or call for complete information.

CBASIC, CP/M and MP/M are registered trademarks of Digital Research Corp.  
 Z80 is a registered trademark of Zilog Corp.



## Quasar Data Products

10330 Brecksville Road, Cleveland, Ohio 44141  
 216/526-0838 Telex 241596

potential for storing approximately 1 billion characters per disc, the equivalent of more than 1000 novels per disc. This would allow storage of its online indexing information base on one to three discs. The Center has developed a VIU (videodisc interface unit) that has been used experimentally in the following research objectives:

- to determine the maximum density of data storage achievable, assuming no errors
- to identify the errors produced as a result of the commercial videodisc production processes

• to identify and test error-correction algorithms for purposes of maximizing usable stored data

The successful completion of this study could be the beginning of large, mass-producible databases usable by small-computer systems. The databases could contain a mixture of character and picture data, making such things as an electronic encyclopedia feasible.

#### Direct Storage

The other method for storing digital information on optical discs allows reading and writing with the

same machine. A relatively high-powered laser beam focused on the surface of a specially made disc burns a small pit into the disc (as in the other method). A second laser/detector combination immediately reads the pits just etched onto the disc and verifies the data. This technique is called the DRAW process for direct read after write (see figure 3). If errors are found in the read that occurs after the write, the computer rewrites the data into a new sector of the disc. This has been a very effective method for reducing error rates to within acceptable limits.

The DRAW discs contain 40,000

# ANNOUNCING...

## 80 Columns for the ATARI® 800

The FULL-VIEW 80 Display Card combines the best of two worlds — 80-column capability with normal ATARI 40-column/graphics mode. 80-column mode provides upper and lower case characters with full descenders.

Add the 32K MEMORY PLUS with the FULL-VIEW 80 to achieve a 48K, 80-column system. The 32K MEMORY PLUS card operates with both the ATARI 400 and ATARI 800 to increase the ATARI memory capacity to 48K.

The ATARI FULL-VIEW 80 and 32K MEMORY PLUS join the family of APPLE products currently available from BIT 3

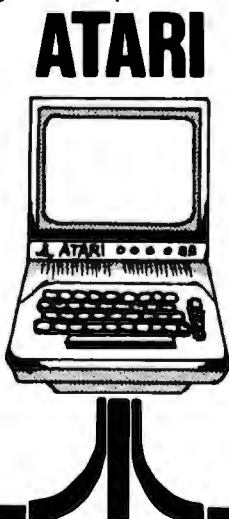

**FULL-VIEW 80—**  
80 x 24 display for the APPLE II and APPLE II PLUS supplies upper and lower case with full descenders, line drawing graphics, and shift key detector for typewriter-like operation.

**DUAL-COMM PLUS**  
Two independent serial I/O ports for the APPLE II combines features of APPLE High Speed Serial Card and APPLE Communications Card in one card. Baud rates range from 50 to 19,200. Great with the FULL-VIEW 80 and a modem.

**MEMORY PLUS—**  
16K addition to increase your 48K APPLE to 64K.



Contact your ATARI or APPLE dealer or BIT 3 for more information.

#### ATARI PRODUCTS:

Full-View 80	\$349.00
32K Memory Plus	\$179.00

#### APPLE PRODUCTS:

Full-View 80	\$295.00
Dual-Comm Plus	\$239.00
Memory Plus	\$149.00

ATARI is a registered trademark of ATARI, Inc.; FULL-VIEW80 and MEMORY PLUS are registered trademarks of BIT 3; APPLE II is a registered trademark of Apple Computer, Inc.



8120 Penn Avenue South, Suite 548  
Minneapolis, Minnesota 55431  
(612) 881-6955





Altos  
'Apple'  
Heath™  
IBM  
North Star™  
\*TRS-80 (I, II, III)  
S-50 S-100  
TI  
Zenith

# DISK DRIVES

Contact your nearest authorized  
Traxx\* dealer:

**Central Kansas Computers**  
Herrington, KS ..... (913) 258-2575

**CMD Performance**  
Windsor, CT ..... (203) 688-3862

**Connection 80**  
Vancouver, WA ..... (206) 573-0319

**Cottage Software**  
Wichita, KA ..... (316) 683-4811

**Dataflow Systems**  
Indianapolis, IN ..... (317) 888-3640

**Everett Computer Center**  
Everett, WA ..... (206) 259-0024

**H & S Microsystems**  
Burnaby, BC Canada (604) 430-4145

**Insync Systems Corp.**  
Arlin, TX ..... (713) 331-2024

**Meta Technologies**  
Euclid, Ohio ..... 1-800-321-3552

**Mitronix Computer Corp.**  
Richmond, ME ..... (207) 737-4447

**Web Products, Inc. Software Div.**  
Carol Stream, IL ..... (312) 653-5229

**TRAXX**  
COMPUTER CORPORATION

Dealer Inquiries

1-800-621-3102  
(312) 987-1024  
Telex-724389  
Telespan SKO  
Attention: Traxx

Circle 452 on Inquiry card.



**TRAXX**



**FREE**  
with software purchase  
One CPM/Handbook

# DISCOUNT SOFTWARE

## Ad#26 ULTIMATE SOFTWARE PLAN

We'll match any advertised price on any item that we carry. And if you find a lower price on what you bought within 30 days of buying it, just show us the ad and we'll refund the difference. It's that simple.

Combine our price protection with the availability of full professional support and our automatic update service and you have the Ultimate Software Plan.

It's a convenient, uncomplicated, logical way to get your software.

✓ (New items or new prices)

\* Special price of the month.

CP/M users:  
specify disk systems and formats. Most formats available.

CP/M     DISK WITH / MANUAL ONLY

<b>ARTIFICIAL INTELLIGENCE*</b>	
Medical (PAS-3).....	\$849/\$40
Dental (PAS-3).....	\$849/\$40
<b>ASYST DESIGN*</b>	
Prof Time Accounting.....	\$549/\$40
General Subroutine.....	\$269/\$40
Application Utilities.....	\$439/\$40
<b>COMPLETE BUS. SYSTEMS*</b>	
*Creator.....	\$199/\$25
*Reporter.....	\$129/\$20
*Both.....	\$299/\$45
<b>COMPUTER CONTROL*</b>	
*Fabs (B-tree).....	\$119/\$20
*UltraSort II.....	\$119/\$25
<b>COMPUTER PATHWAYS*</b>	
Pearl (level 1).....	\$99/\$25
Pearl (level 2).....	\$299/\$40
Pearl (level 3).....	\$549/\$50
<b>DIGITAL RESEARCH*</b>	
CP/M 2.2	
NorthStar.....	\$149/\$25
TRS-80 Model II (P+T)	\$159/\$35
Mopolis.....	\$169/\$25
PL/I-80.....	\$459/\$35
BT-80.....	\$179/\$30
Mac.....	\$85/\$15
Sid.....	\$65/\$15
Z-Sid.....	\$90/\$15
Tex.....	\$90/\$15
DeSpool.....	\$50/\$10
CB-80.....	\$459/\$35
CBasic-2.....	\$98/\$20
<b>D.M.A.</b>	
Ascom.....	\$149/\$15
Formula.....	\$599/\$45
<b>GRAHAM-DORIAN*</b>	
General Ledger.....	\$729/\$40
Acct Receivable.....	\$729/\$40
Acct Payable.....	\$729/\$40
Job Costing.....	\$729/\$40
Payroll II.....	\$729/\$40
Inventory II.....	\$729/\$40
Payroll.....	\$493/\$40
Inventory.....	\$493/\$40
Cash Register.....	\$493/\$40
Apartment Mgt.....	\$493/\$40
<b>MICRO-AP*</b>	
S-Basic.....	\$269/\$25
Selector IV.....	\$235/\$35
Selector V.....	\$495/\$50
<b>MICRO DATA BASE SYSTEMS*</b>	
HDBS.....	\$269/\$35
MDBS.....	\$795/\$40
DRS or QRS or RTL.....	\$269/\$10
MDBS PKG.....	\$1295/\$60
<b>MICROPRO*</b>	
WordStar.....	\$319/\$60
Customization Notes.....	\$429/\$90
Mail-Merge.....	\$109/\$25
WordStar/Mail-Merge.....	\$419/\$85
DataStar.....	\$249/\$60
WordMaster.....	\$119/\$40
SuperSort I.....	\$199/\$40
Spell Star.....	\$175/\$40
CalcStar.....	\$259/\$90
<b>MICROSOFT*</b>	
Basic-80.....	\$298
Basic Compiler.....	\$329
Fortran-80.....	\$349
Cobol-80.....	\$629
M-Sort.....	\$175
Macro-80.....	\$144
Edit-80.....	\$84
MuSimp/MuMath.....	\$224
MultiSp-80.....	\$174
Multi Plan.....	Call
Manager Series.....	Call

<b>ORGANIC SOFTWARE*</b>	
TextWriter III.....	\$111/\$25
DateBook II.....	\$269/\$25
Milestone.....	\$269/\$30
<b>OSBORNE*</b>	
General Ledger.....	\$59/\$20
Acct Rec/Acct Pay.....	\$59/\$20
Payroll w/Cost.....	\$59/\$20
All 3.....	\$129/\$60
All 3 + CBASIC-2.....	\$199/\$75
Enhanced Osborne.....	\$269/\$60
<b>PEACHTREE*</b>	
General Ledger.....	\$399/\$40
Acct Receivable.....	\$399/\$40
Acct Payable.....	\$399/\$40
Payroll.....	\$399/\$40
Inventory.....	\$399/\$40
Surveyor.....	\$399/\$40
Property Mgt.....	\$799/\$40
CPA Client Write-up.....	\$799/\$40
P5 Version.....	Add \$129
MagiCalc.....	\$269/\$25
Other.....	less 10%

<b>SOFTWARE WORKS*</b>	
*Adapt (CDOS to CP/M).....	\$49/\$90
*Ratfor.....	\$68/\$90
<b>SOHO GROUP*</b>	
*MatchMaker.....	\$89/\$20
*WorkSheet.....	\$159/\$20

<b>STAR COMPUTER SYSTEMS</b>	
✓ G/L, A/R, A/P, Pay.....	\$359
✓ All 4.....	\$1129
✓ Legal Time & Billing.....	\$849
✓ Property Mngmt.....	\$849

<b>STRUCTURED SYSTEMS*</b>	
Business Packages, Call for Price	
<b>SORCIM*</b>	
SuperCalc.....	\$269/\$90
Trans 86.....	\$115
Act.....	\$157
<b>SUPERSOFT*</b>	
Diagnostic I.....	\$49/\$20
Diagnostic II.....	\$84/\$20
Disk Doctor.....	\$84/\$20
Forth (8080 or Z80).....	\$149/\$30
Fortran.....	\$219/\$30
Fortran w/Ratfor.....	\$289/\$35
C Compiler.....	\$174/\$20
Star Edit.....	\$189/\$30
Other.....	less 10%

<b>TCS*</b>	
GL or AR or AP or Pay.....	\$79/\$25
All 4.....	\$269/\$99
Compiled each.....	\$99/\$25
Inventory.....	\$99/\$25

<b>UNICORN*</b>	
Mince.....	\$149/\$25
Scribble.....	\$149/\$25
Both.....	\$249/\$50
<b>WHITESMITHS*</b>	
"C" Compiler.....	\$600/\$30
Pascal (incl "C").....	\$850/\$45

<b>"PASCAL"</b>	
Pascal/MT+ Pkg.....	\$429/\$30
Compiler.....	\$315
Sp Prog.....	\$175
Pascal/Z.....	\$349/\$30
Pascal/UCSD 4.0.....	\$670/\$50
Pascal/M.....	\$355/\$20
<b>"DATA BASE"</b>	
FMS-80.....	\$649/\$45
dBASE II.....	\$595/\$50
Condor II.....	\$899/\$50

<b>"WORD PROCESSING"</b>	
WordSearch.....	\$179/\$50
SpellGuard.....	\$229/\$25
VTS/80.....	\$259/\$65
Magic Wand.....	\$289/\$45
Magic Spell.....	\$269/\$25
Spell Binder.....	\$349/\$45
Select.....	\$495/\$90
The Word.....	\$65/\$30
<b>"OTHER GOODIES"</b>	
Micro Plan.....	\$419/\$90
Plan 80.....	\$269/\$30
Target.....	\$189/\$30
BSTAM.....	\$149/\$90
BSTMS.....	\$149/\$90
Tiny "C".....	\$89/\$50
Tiny "C" Compiler.....	\$229/\$50
Nevada Cobol.....	\$179/\$25
MicroStat.....	\$224/\$25
Vedit.....	\$130/\$15
MiniModel.....	\$449/\$50
StatPak.....	\$449/\$40
Micro B+.....	\$199/\$20
Raid.....	\$224/\$35
String/80.....	\$84/\$20
String/80 (source).....	\$279/\$90
ISIS CP/M Utility.....	\$199/\$50
Lynx.....	\$199/\$20
Supervyz.....	\$95/\$90
CP/M Power.....	\$75/\$90
Mathe Magic.....	\$95/\$90

### APPLE II (80)

<b>INFO UNLIMITED*</b>	
✓ EasyWriter (Prof).....	\$159
✓ Datedex.....	\$129
✓ EasyMailer (Prof).....	\$129
Other.....	less 15%

<b>MICROSOFT*</b>	
Softcard (Z-80 CP/M).....	\$298
Fortran.....	\$179
Cobol.....	\$499
Tasc.....	\$139

<b>MICROPRO*</b>	
Wordstar.....	\$269
MailMerge.....	\$99
Wordstar/MailMerge.....	\$349
SuperSort I.....	\$159
Spellstar.....	\$129

<b>PERSONAL SOFTWARE/VISICORP*</b>	
✓ Visicalc 3.3.....	\$199
✓ Desktop/Plan II.....	\$199
Visiterm.....	\$90
✓ Visidex.....	\$199
Visiplot.....	\$180
✓ Visitrend/Visiplot.....	\$259
✓ Visifile.....	\$169

<b>PEACHTREE*</b>	
G/L, A/R, A/P, Pay or Inventory (each).....	\$224/\$40

<b>"OTHER GOODIES"</b>	
VU #3R (usew/Visicalc).....	\$49
Context Connector (usew/Visicalc).....	\$99
Micro Courier.....	\$219
Super-Text II.....	\$127
Data Factory.....	\$134
DB Master.....	\$184

### 16-BIT SOFTWARE

<b>8088 SOFTWARE</b>	
Supercalc.....	\$269
Call for others.....	

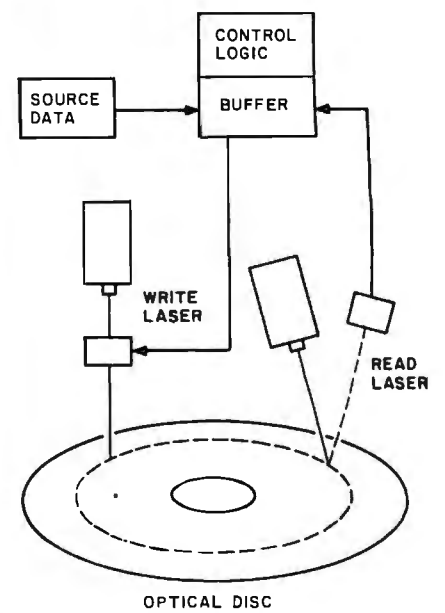

Figure 3: The direct read after write (DRAW) disc process. Data is written onto a disc by modulating a laser beam much the same as with standard video-discs. The data, digital to begin with, is stored in a buffer while it is written. Immediately afterward, the same data is read from the disc and compared to that in the buffer. If it is identical, the next track of data is read in; if not, the prior track is rewritten until correct.

tracks per side, 32 addressable sectors per track, and 15,200 bits per sector. They are preformatted, allowing random access of any of the sectors. Although old data cannot be overwritten or erased on these discs, their 10-billion-bit capacity means that the amount of redundant information is insignificant.

The DRAW process led to industry excitement in developing commercial products. Though no products are currently available, many companies are working toward that goal and a few product announcements are expected this year. We will now look briefly at some of these developments.

For quite some time, it has been known that a TV signal stored on video tape contained lots of information in a very small space. Storage of video data began to interest the government. In 1978, it asked Magnavox to build a video-based product for digital data storage. Magnavox, at that time, was beginning to produce

ORDERS ONLY—CALL TOLL FREE VISA • MASTERCHARGE  
1-800-854-2003 ext. 823 • Calif. 1-800-522-1500 ext. 823

Outside Continental U.S.—add \$10 plus Air Parcel Post • Add \$3.50 postage and handling per each item • California residents add 6% sales tax • Allow 2 weeks on checks, C.O.D. \$3.00 extra • Prices subject to change without notice. All items subject to availability • ®—Mfgs. Trademark. Blue Label \$3.00 additional per item.

THE DISCOUNT SOFTWARE GROUP  
6520 Selma Ave. Suite 309 • Los Angeles, Ca. 90028 • (213) 837-5141  
Int'l TELEX 499-0446 DISCSOFT LSA • USA TELEX 194-634 (Attn: 499-0446)  
TWX 910-321-3597 (Attn: 499-0446)



Ask your dealer for a demonstration



# Chart your financial future with MicroFinesse™

In this fast-paced business world, the best way to stay competitive is to be able to see your financial alternatives clearly and make decisions fast.

That's why P-E Consulting Group Ltd. developed MicroFinesse, a complete package providing professional financial forecasting PLUS full high-resolution color graphics support, including pie charts, histograms and graphs, for the financial projections you create.

Now this evolutionary financial resource planning tool eliminates the time-consuming reprogramming required for financial model

consolidation or expansion. MicroFinesse's menu-driven command format can also generate up to 15 user-defined reports per model, with visuals, without reprogramming.

Previously available only for main-frame applications, the MicroFinesse program can now be purchased at leading Dealers nation-wide. MicroFinesse is specifically designed for the 48K Apple II® with the Apple Language Card.

So when your variables are many and your time is limited, take a good look at the financial artistry of MicroFinesse.



## MicroFinesse

Distributed by: **A OSBORNE/McGraw-Hill**  
630 Bancroft Way, Berkeley, CA 94710, (415) 548-2805



Apple II is a registered trademark of Apple Computer, Inc.

Circle 349 on Inquiry card.

videodiscs and was familiar with the technology.

Magnavox developed a prototype system using a gas-argon laser to record on tellurium-coated plastic discs. The disc had a capacity of about  $2 \times 10^{10}$  bits. Although announcements of an industrial product appeared in the trade media about September 1979, Magnavox abandoned the project in 1980 to devote time to the development of a laser diode-based optical-disc system that would replace the large gas-argon laser. From this prototype system, however, parallel efforts began at a number of companies, including RCA, Exxon, Phillips, Thompson-CSF, Xerox, Zenith, and some smaller companies.

Both Xerox and France's Thompson-CSF have ongoing research efforts in optical-disc data-storage technologies. Thompson placed an industrial videodisc player using a transmissive technology on the market in early 1980 and has been developing optical-disc record-

ings in its French research labs. Xerox performed optical-disc research in its Palo Alto Research Center that was concerned with digital data storage.

About mid-1980, Xerox and Thompson formed a joint licensing agreement to exchange know-how in optical-disc storage, presumably with Xerox to market in the U.S. and Thompson in Europe. Xerox is currently pursuing product development at its Optimum Division. By late 1983 or early 1984, Xerox plans to produce an optical digital-disc cartridge with  $10^{10}$  bits of storage and 160-millisecond access time that will probably sell for about \$10,000.

In mid-1979, a group of entrepreneurs who formerly worked on optical discs at Zenith received a large sum of venture capital from Exxon Enterprises to establish a development facility for optical-disc-based computer memories. By mid-1980, a prototype using a gas-laser optical-disc system was developed that interfaced with upper-end IBM mainframes. It used a disc in a cartridge

having a capacity of 7.5 gigabytes, and was to have been available at the end of 1982 for a cost of \$20,000 to \$30,000. Discs were expected to be priced at \$150, or \$350 for a double-sided disc in a cartridge.

The company, Star Systems, apparently encountered a number of administrative problems and Exxon sold it to STC about mid-1981. Recent technical efforts are moving toward a laser diode-based system at a cheaper cost, and Exxon is aiming its product at the office-automation market as a work-station system for document display.

SRI International recently developed a document-storage system consisting of a laser scanner/printer for input and output and a videodisc for storage. This unit, the Laserfile, looks and operates like a standard office copier and even produces copies on plain paper (see figure 4).

The requirements for the development of this system were:

- Document resolution must be comparable to that of an office copier

---

## Allenbach is putting tomorrow on disks.

The future of the world is written in computer software. And Allenbach disk duplication is making sure that the future is faithfully reproduced. We use our own Allenbach diskettes and state-of-the-art equipment, with electronic surface evaluation of each diskette before use. Copies are 100% verified, track by track, and carry the Allenbach lifetime warranty against defects in workmanship or materials. For information and prices on disks, duplication, and dealer information, please call (800) 854-1515. In California, call (714) 438-2258 collect.



**Allenbach  
Industries Inc.**





For top quality performance from your computer, use the flexible discs known for memory excellence. Now, buy a specially marked box of 10 Memorex® 5¼" mini flexible discs and we'll send you an additional mini disc FREE.

Features like our uniquely sealed jacket and protective hub ring make our discs last longer. And a soft inner liner cleans the ultra-smooth disc surface while in use. It all adds up to better performance and reliability.

Our proprietary high density media formulation and 100% error-free certification guarantee reliable performance in all single or double density applica-

tions. So for business, word processing, or personal computer applications, Memorex mini discs are sure to do the job. And we back them with a full year warranty to prove it.

So see your local Memorex distributor or dealer or call (800) 538-8200 (In California (408) 987-1893) today. Buy a box of 10 flexible 5¼" mini discs. Then send the coupon in the box to Memorex for your free mini disc. It's that simple.

It's a great way to improve your memory and get a big bonus in computer performance.

**MEMOREX**  
A Burroughs Company

# Improve your memory by 10%.

Dealer inquiries invited.



**FREE  
DISC  
OFFER  
INSIDE!**

**MEMOREX**  
Mini Flexible Discs

See us at CES Booth #731  
McCormick Place, June 8-9.  
Circle 288 on inquiry card.

© 1982 Memorex Corporation  
Memorex is a registered trademark of Memorex Corporation.  
Offer ends December 31, 1982. Offer good only in U.S.A.





**\$4/DAY**  
**PER USER**

*Built For Dependability*  
**ALTOS**  
**COMPUTER SYSTEMS**  
**BRAND**  
**PROVEN VALUE**  
**QUALITY DELIVERY**  
**RELIABILITY**  
**PRODUCED IN THE HEART OF SILICON VALLEY, CALIFORNIA U.S.A.**



# OPEN FOR BUSINESS... THE NEW ALTOS ACCOUNTANT.

## Introducing the complete multi-purpose, multi-terminal desktop business accounting system with a built-in tutor.

Get everything you need to computerize your business. An ALTOS® Series 5 computer (including 5 MByte Winchester hard disk and 1 MByte floppy), three of our new smart terminals and a printer.

You also get the new ALTOS ACCOUNTANT, a completely integrated business accounting system that includes applications for general ledger, accounts payable, accounts receivable, inventory control, payroll, job costing and order processing.

There's more. You get the unique ALTOS COMPUTER TUTOR, the self-teaching tutorial that provides simple, self-paced, step-by-step training that makes using the computer easy.

Best of all, you get everything for less than \$4 per day per user.\*

Complete hard disk systems start at \$9,980.

An Altos system is like having three computers in one. For example, while your bookkeeper prepares payroll, other users can check inventory, compute cost estimates or produce reports. All at the same time.

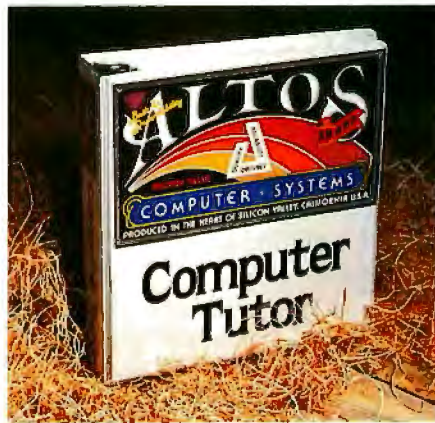

Need more? You can choose from hundreds of popular CP/M® and MP/M II™ applications like word processing, business planning, and communicating with other computers or networks. There's also nationwide on-site service available from your dealer.

Join the thousands of businesses that already rely on Altos. For more information, call our toll free number or write: Altos Computer Systems, 2360 Bering Drive, San Jose, CA 95131. We'll put you in touch with your local Altos sales and service dealer who'll introduce you to your very own ALTOS ACCOUNTANT.

### Packed with fresh ideas for business



**800-538-7872**  
**(In Calif. 800-662-6265)**

\*Complete 3 user system for \$4 per day per user. Price approximate and may vary in your area. Daily lease based on \$12,800 principal, 20% annual interest, five-year term. Packaged system includes Altos Series 5-SD computer with 5 MByte Winchester hard disk and 1 MByte floppy, a draft quality printer, three Altos smart terminals, and the ALTOS COMPUTER TUTOR software package. Price does not include tax, installation, additional training and maintenance.

ALTOS is a registered trademark of Altos Computer Systems.  
CP/M is a registered trademark and MP/M II is a trademark of Digital Research, Inc.

© 1982 Altos Computer Systems

Circle 20 on inquiry card.

# Fancy Shmancy

Elaborate microprocessor development systems cost a lot of money, and they can close off your engineering options by locking you into just one or two kinds of chips. Sound familiar? Well, read on—we've got a better idea.

Use your desktop computer; anything that will run CP/M\* is fine. With our microprocessor cross-assemblers you can produce software for eleven of the most popular chip families, and more are on the way.

In two years on the market, our cross-assemblers have gained a reputation for quality, performance, and reliability. Hundreds of industrial R&D labs and several major semiconductor houses have found these products a fast, cost-effective way to develop their microprocessor software. We invite you to join them.

## CP/M CROSS-ASSEMBLERS

Extremely fast absolute assemblers, running under CP/M. Generate object file (Intel hex or Motorola S-record format) and listing from standard assembly language for the target processors listed. Features include comprehensive syntax checking, listing control, nested conditional assembly, and insertion of external source files. All versions listed have been thoroughly field-tested and are available now.

	XASM05	.....	6805
	XASM09	.....	6809
	XASM18	.....	1802
	XASM48	.....	8048/41
	XASM51	.....	8051
	XASM65	.....	6502
	XASM68	.....	6800/01
NEW!	XASM75	.....	NEC 7500
	XASMF8	.....	F8/3870
NEW!	XASMZ8	.....	Z8
	XASM400	.....	COP400

Assemblers ..... \$200.00 each  
except XASM75 ..... \$500.00

Visa and Mastercard accepted. We ship on B" single-density and Softcard + 5.25" diskettes. Ask us about other formats. OEM INQUIRIES INVITED.

\*Trademark of Digital Research  
+Trademark of Microsoft



804 S. STATE ST., DEPT. BY62  
DOVER, DEL. 19901  
302-734-0151

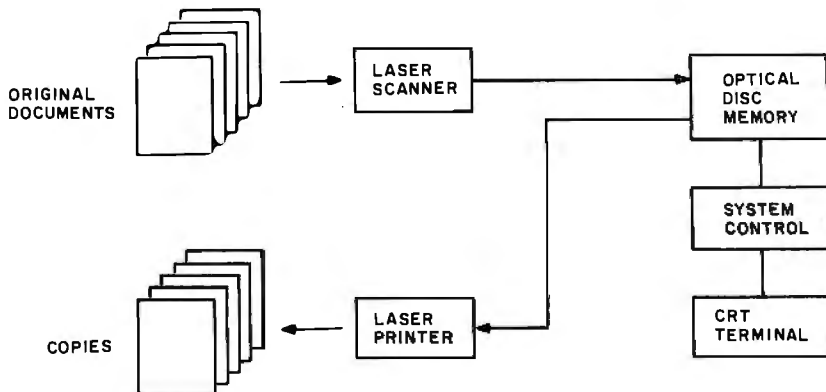

Figure 4: Block diagram of information flow in the Laserfile, now produced by Toshiba. It acts similar to an office copier except that each document is stored on an optical disc and can be retrieved by the console and printed.

(fewer than eight lines per millimeter) and must have continuous tone capability.

- Document copies must be retrieved in about three seconds and printed on plain paper.
- The data should be directly readable after writing on the disc (a so-called DRAW disc) to check the quality of the stored document.
- A disc must be postable; that is, new documents can be added at any time until the disc is full.
- The system should store about 4000 documents (2000 per side).

The Laserfile development proved successful and is being produced by Toshiba. It has nearly the same information-packing density as high-resolution microfilm (a 50-times reduction) since both operate near the optical-diffraction limit. But the advantage of the optical technology is in its ease of retrieving and printing copies at the machine or remotely. In terms of storage capacity, a standard 2-foot-deep file drawer can hold about 4500 tightly packed sheets of paper. Therefore, the Laserfile holds approximately one file drawer per disc. An added advantage is that a document cannot be misfiled, lost, or damaged.

Toshiba renamed the Laserfile the DF-2000 Document Filing System, and a model was shown at the 1981 National Computer Conference. It looks like a standard office copier with a computer terminal built in (see

photo 1). This version has a capacity of 10,000 document pages per disc. To retrieve a document, you enter an address code on a keyboard and the image is shown on a video display within three seconds. The document can also be printed by the laser printer. Toshiba is directing its marketing to commercial and government organizations with large paper files. The production model should be available in 1983 at a cost of about \$120,000. Since images are digitally encoded prior to their recording on the disc, such a system might easily be integrated with facsimile or computer networks.

RCA's efforts in optical-disc data storage are among the most technically advanced in terms of storage capacity and data rates. RCA uses a stronger gallium-arsenide laser and an ablative recording technique. Data rates have been more than 50 megabits per second, with a maximum of more than 12 gigabytes of storage.

It appears that RCA's commercial objectives with DRAW disc systems are limited to high-end government applications. The company plans to market a high-performance, specialized system for \$500,000.

Hitachi, a major Japanese computer manufacturer, and a close competitor of Toshiba, began work on optical-disc computer storage at its Central Research Laboratories in 1978. Hitachi's work in the development of a miniature semiconductor laser diode gave the company an



# MONITOR CHOICE WE MAKE IT VERY CLEAR

The Electrohome family of personal computer monitors features the extra degree of engineering excellence you've come to expect from Electrohome.

Our ECM 1302 Series 13" RGB analog color data monitors offer the latest in advanced electronic technology and design innovation.

There's a 1302 Series monitor that is fully compatible

with the IBM Personal Computer, the Apple II, and Apple III Micro Computers.

Electrohome monochrome data display monitors are available in 9" and 12" models, green or white phosphors to suit your needs.

Whatever your system, Electrohome monitors make your choice very clear. Call or write today for more information.

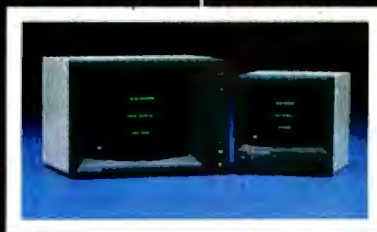

Data appearing on screens are actual images.

Apple II and Apple III are trademarks of Apple Computer Inc.

IBM is a registered trademark of International Business Machines Corporation. In Canada, IBM Canada is a registered user.

# ELECTROHOME ELECTRONICS

ELECTROHOME LIMITED, 809 WELLINGTON STREET NORTH, KITCHENER, ONTARIO N2G 4J6

## Electrohome Distributors

The Computer Store, Sudbury Mass. (800) 343-4900  
 Components Unlimited Inc., Lynchburg, VA (804) 237-6286  
 EMES Systems Ltd., New York, NY (212) 685-9100  
 Software Distribution Services Inc., Buffalo, N.Y. (716) 462-8488  
 Anthem Systems Company, Burlingame, CA (415) 342-9182

Mycrosystems Distributors Inc., Dallas, Texas (800) 527-3643  
 Computerland, San Leandro, CA (800) 772-3545 (Ext. 118)  
 Outside California (800) 227-1017 (Ext. 118)  
 Anderson Associates, Bountiful, Utah (801) 292-8991  
 Listec (West) Inc., Glendale, California (213) 247-9247

Come see us at booth #6623 at the NCC Show and booth #622 at the Comdex Spring '82 Show.

# MICROMAIL OFFERS THE LOWEST PRICES AND PERSONAL SERVICE.

## DEC LA 100

DUAL MODE  
MATRIX PRINTER  
CALL FOR PRICE!

★ NEW ★

## 3M WHISPER WRITER

• TWX • TIME SHARE  
• COMPUTER TERMINAL

★ NEW ★

## DEC

LA 34 DA ..... \$899.00  
DEC LA 120KSR..... \$2049.00  
VT 100 ..... \$1449.00  
VT101 ..... CALL  
VT131 ..... \$1499.00

## TELEVIDEO

910 ..... \$569.00  
912 ..... \$689.00  
920 ..... \$725.00  
950 ..... \$939.00  
925 ..... **NEW!** ..... CALL

## ANADIX

DP 9500 ..... \$1149.00  
DP 9501 ..... \$1149.00  
DP 8000 AP ..... \$749.00

**SPECIAL**

## TEXAS INSTRUMENTS

810/2 ..... \$1299.00  
(Includes upper/lower case option)  
810/2 VTC/CP ..... \$1499.00  
(Includes u/l case, forms control & compressed print)

## LETTER QUALITY PRINTERS

### DIABLO

• 630 RO  
**\$1949.00**  
• 630 KSR... CALL  
• 620 ..... CALL  
• 1640 ..... CALL

### QUME

• SPRINT 9/45  
**\$1949.00**  
• SPRINT 9/35  
CALL FOR PRICE

### NEC

• 7700 SERIES  
• 3500 SERIES  
**CALL FOR OUR  
LOW PRICES**

### "PORTABLES SPECIAL"

T.I. 745 ..... \$1399.00  
T.I. 743KSR ..... \$849.00  
TELETYPE 43 (TTL) ..... \$999.00

### LABOR SAVER!

• CUT SHEET FEEDERS  
**CALL FOR OUR  
SPECIAL PRICES**

**CALL TOLL FREE (800) 854-6028**

SAVE ON  
PREPAID  
ORDERS

MASTERCARD  
VISA  
ACCEPTED

C.O.D.  
REQUIRES  
15% DEPOSIT

SHIPPING IS  
FREIGHT  
COLLECT

**WE SELL INTERNATIONALLY**

**MICROMAIL**

P.O. Box 3297  
Santa Ana, CA 92703  
Phone: 714/731-4338  
TWX: 910 595 1146

early advantage in the development of small DRAW systems. Hitachi is known to have in development a system for document storage much like Toshiba's. At its 70th anniversary stockholders meeting in early 1982, Hitachi showed a prototype of its DRAW system, but it has been among the most secretive of the major companies involved in optical-disc development.

### Uses of Large Databases

Videodiscs probably offer the best medium for electronic printing and publishing due to their low reproduction costs and their text and graphics capabilities. Though some estimates place full electronic publishing as far as 15 years from now, there will surely be deep inroads made in this field within the next few years.

Many indexing and cataloging services could easily use optical discs as a distribution medium, as the information is usually in a computer to begin with. Literature and patent searches, for example, could be done with small computers. Businesses could have large demographic databases to aid in product marketing. Computer programs connected to large text and picture databases will give computer-aided education an added dimension. Special-purpose databases will be available at work or at home on a large variety of subjects.

It is difficult to predict future uses of any new technology, or even whether it will be used at all. We have heard, however, that the most valuable commodity in the near future will be information—and videodisc technology offers perhaps the least expensive method to produce, replicate, and distribute large collections of data. ■

### References

1. Edelhart, M. "Optical Discs; The Omnibus Medium." *Technology*, November-December 1981, p. 42.
2. "Optical Discs Excite Industry." *Electronics*, May 5, 1981, p. 97.
3. *Videodisc News*. Videodisc Services Inc., Washington, DC (general reference).
4. "Videodiscs: A Three-Way Race for a Billion-Dollar Jackpot." *Business Week*, July 7, 1980, p. 72.



# MPI Announces:

# Extended Capability.

Extended capability at a compacted price! The new MP150G wide carriage dot matrix printer at \$1,095.00\* sets a new standard for performance/price comparisons. A nine wire head prints six character densities and gives you a choice between a data processing or a correspondence font. Under microprocessor control, the bi-directional

logic-seeking head zips along at 150 CPS, with thruputs of up to 200 LPM for average text and as many as 226 columns on 15 inch wide paper. Dot graphics, a full 1,000 character buffer (with options up to 8,000 characters), an optional non-volatile soft switch keypad for configuration selection and retention. All in a handsome, heavy duty case. Another trendsetting printer from MPI.

For more information, write or call today.



**The Printer People**

**Micro Peripherals, Inc.**

4426 South Century Drive, Salt Lake City, Utah 84107  
Telephone (801) 263-3081

See us at the NCC.

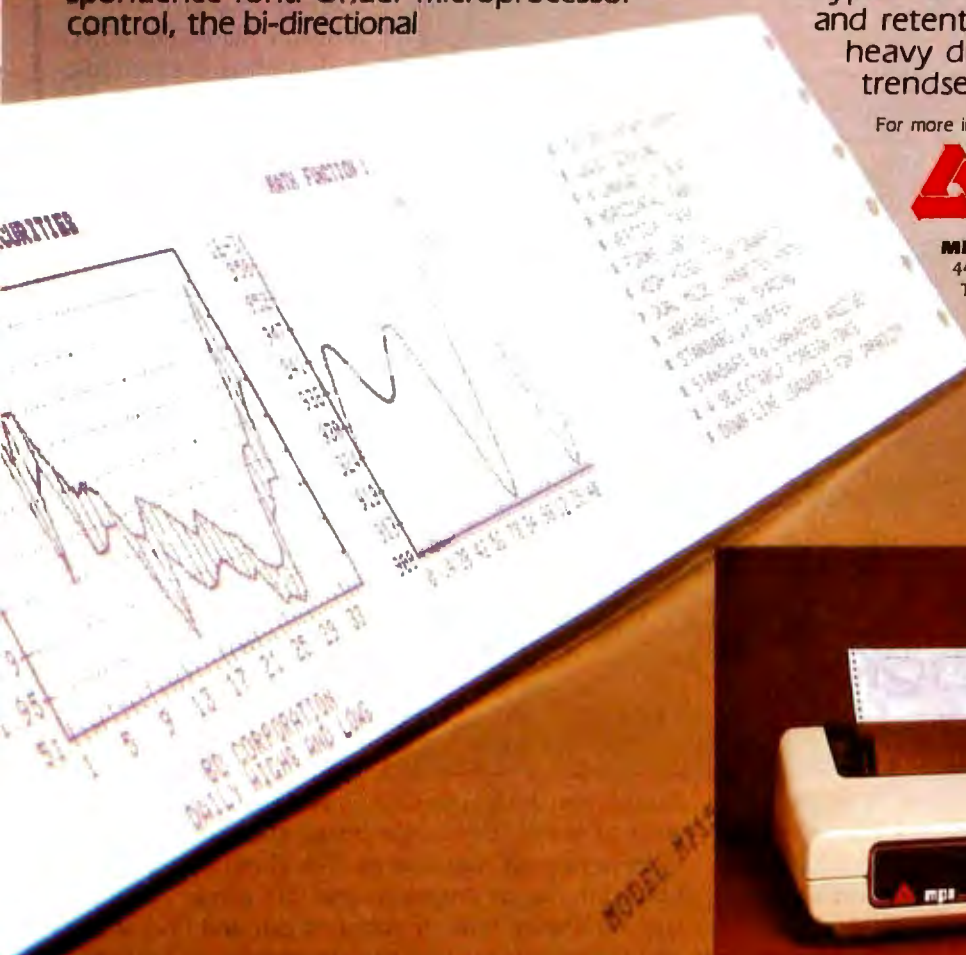

\*Suggested list price. Substantial OEM discounts available.

**Arizona** PLS Associates (602) 246-6477 • **California** VITEK (714) 744-8305 • Computer Potentials (408) 738-1740 • **Colorado** PLS Associates (303) 773-1218 • **Florida** Computer Village (305) 266-5965 • **Georgia** Micro Graphics (404) 790-5771 • **Illinois** CW Electronic Enterprises (312) 298-4830 • **Massachusetts** Butler Associates (617) 965-1080 • **Consumer Computer Marketing** (617) 443-5128 • **Minnesota** Bohlig & Associates (612) 922-7011 • **New Jersey** Hansen & Hughes (201) 652-7055 • **Ohio** EQS (216) 729-2222 • **Oregon** Microware (503) 620-8150 • **Pennsylvania** QED Electronics (215) 674-9600 • **Texas** Computer Wares (214) 373-4443 • **Thorson Distributors** (214) 233-5744 • **Utah** PLS Associates (801) 466-8729 • **Washington** Microware (206) 451-8586 • **International: Europe** Russet Instruments, Ltd (0234) 868147 Telex: 849721 • **Australia** Datatel Pty. Ltd. 690-4000 Telex: AA30996 • **Canada** Norango (416) 498-5332 Telex: 06966710 • **Mexico, Central and South America** Siscom-trol (905) 689-02-09



# BYTE'S ARCADE

## Armored Patrol

Pete Callamaras  
25C Scott Circle  
Bedford, MA 01730

When the assault cruisers first landed on this strange planet, you had no idea you would eventually find yourself commanding the last-surviving T-36 heavy-assault tank company in the entire sector. You have only a few tanks left, and transferring to a surviving tank is your only hope to keep fighting if your current tank is destroyed.

Suddenly, the targeting radar shows an enemy tank to the left, and the robot detector lights up. You fire but miss the tank. Oh no! The energy levels are dropping in your tank! The enemy robot has tapped your energy supply and is draining it. Wait, you have the other tank in your sights. You fire the T-36's high-energy plasma cannon. You got the tank. Now quick, spin and blast the robot before your energy is gone. Got 'em! And so the battle continues; you monitor the targeting radar and fight on against the alien foe.

Armored Patrol is one of the latest releases from Adventure International for the TRS-80, and it is a real winner. The game puts you in the commander's seat of

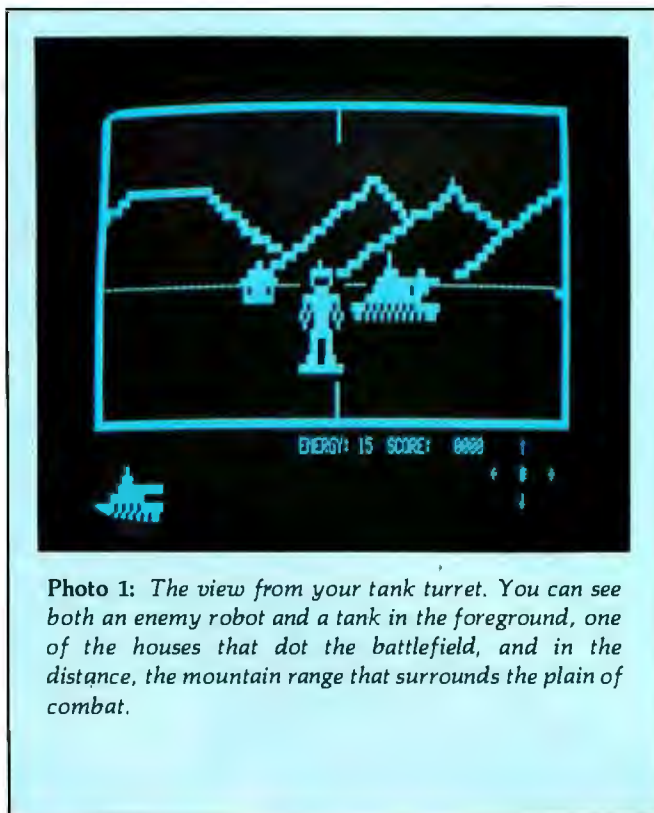

Photo 1: The view from your tank turret. You can see both an enemy robot and a tank in the foreground, one of the houses that dot the battlefield, and in the distance, the mountain range that surrounds the plain of combat.

an armored assault tank fighting an alien enemy on a hostile plain. The object is to destroy enemy tanks and robots with your tank's high-energy plasma cannon before they zap you. The enemy tanks can return fire with a similar plasma weapon. The robots drain your energy supply if they get close to you. You view the enemy and the surrounding planet surface through the T-36's viewport and locate the enemy via a direction finder at the lower-right side of the TRS-80 screen display.

### The Game

The really outstanding feature of this game is its three-dimensional graphics (you will notice similarities to the popular arcade game Battle Zone). As you move, the screen image changes perspective relative to your movements. The closer you get to an object, the larger it appears and vice versa. When you spot an enemy tank or robot, it can and does move, and the movement also has perspective. For instance, if a tank moves across your view from left to right, it starts small, gets larger when it's directly in front of





## At a Glance

<p><b>Name</b> Armored Patrol</p> <p><b>Type</b> Arcade-type game</p> <p><b>Manufacturer</b> Adventure International POB 3435 Longwood, FL 32750 (305) 862-6917</p> <p><b>Price</b> \$19.95, cassette; \$24.95, disk</p> <p><b>Authors</b> Wayne Westmoreland and Terry Gilman</p> <p><b>Format</b> Cassette tape or 5¼-inch floppy disk</p>	<p><b>Language</b> Z80 machine language</p> <p><b>Computer Needed</b> TRS-80 Model I or III with either 16K bytes (cassette version) or 32K bytes of memory and one disk drive (disk version)</p> <p><b>Documentation</b> Self-documented program</p> <p><b>Special features</b> Multiple-player option; sound-effects capability (re- quires an amplifier)</p> <p><b>Audience</b> TRS-80 owners who enjoy arcade games</p>
--	---

you, and then shrinks in size as it pulls away. The buildings also increase and decrease in size as you move in relation to them. It is all quite lifelike.

You control the movement of your tank via the keyboard. The "A" and "Z" keys control your tank's left tread; the ";" and "." keys control the right tread. Using them in combination, you can advance, retreat, and turn (slowly or rapidly) in either direction. The space bar fires your plasma cannon. The plasma "missile" will destroy the enemy if it hits but does not do any damage to the assorted buildings located on the planet's surface.

### How to Score

Scoring is straightforward. Enemy tanks are worth 1000 points, and robots are 5000 points. For every 20,000 points you score, you get another T-36 tank as a reserve. If the enemy tanks hit you with their fire or the robots suck all your tank's energy out, you lose that tank. Hiding behind buildings and darting out to fire can be a good tactic. Remember that the robots materialize at random locations and don't appear on your scope, so you

# General Software

**Mailing Address:**  
P.O. Box 2333  
Terre Haute, IN 47802  
WE HONOR  
VISA and MASTERCARD

**TOLL FREE - Outside Indiana**  
1-800-457-0517  
**ORDER DESKS**  
(812) 299-2484

Best Selection      Best Service

**Write for our famous CATALOG.**  
Contains many items not in ad.

Outside US add \$10 plus Air  
Parcel Postage. Add \$3.50  
postage and handling per each  
item. Indiana residents add 4%  
sales tax. Allow 2 weeks on  
checks. COD add \$3.00 per item.  
Prices subject to change without  
notice. All items subject to  
availability.

	Disk with Manual	Manual Only
<b>ARTIFICIAL INTELLIGENCE</b>		
Dental (PAS-3)		\$849/40
Medical (PAS-3)		\$849/40
<b>ASHTON-TATE</b>		
*dBASE II		\$575/50
<b>BUSINESS PLANNING SYSTEMS</b>		
Plan-80		\$269/30
<b>BYROM SOFTWARE</b>		
*BSTAM		\$149/15
*BSTMS		\$149/15

<b>COMPUTER CONTROL</b>	
*Fabs (B-Tree)	\$159/25
Ultrasort	\$159/25
<b>CONDOR COMPUTER</b>	
Condor II	\$549/50
Condor III	\$899/50
<b>DIGITAL RESEARCH</b>	
CP/M	
2.2 Intel MDS-800	\$149/25
Northstar (Horizon)	\$149/25
Micropolis	\$169/25
TRS Model II	\$159/35
CB-80	\$459/35
CBasic2	\$ 98/20
<b>EPIC COMPUTER</b>	
*Super vyc	\$ 89/15
<b>FAIRCROM</b>	
*Micro B+	
(Specify language)	\$229/20
<b>FINANCIAL PLANNING</b>	
*Mini Model	\$449/50
<b>FRIENDS</b>	
ACCESS 80 I	\$249
ACCESS 80 II	\$429
<b>FRONTIER SOFTWARE</b>	
Professional	
Time Accounting	\$549/40
General Subroutine	\$269/40
Application Utilities	\$439/40
<b>ISA</b>	
Spellguard	\$229/25
SP/Law	\$109
<b>PASCAL LANGUAGE</b>	
Pascal Z	\$349/30
Pascal MT+ V5.5	\$429/30
Compiler	\$316/20
SPP Only	\$140/15
<b>KEY BITS</b>	
Wordsearch	\$179/50
String 80	\$ 84/20
String 80 (Source)	\$279
String Bit	\$ 65
<b>LEXISOFT</b>	
*Spellbinder	\$349/45
<b>MICRO AP</b>	
Selector IV	\$269/35
Selector V	\$469/50
SBasic	\$269/25

<b>MICRO TAX</b>	
*Level I	\$249
*Level II	\$995
*Level III	\$749
*Combo II+ III	\$1495
Microsoft 5.3	49
Run time module	
<b>MICRO PRO®</b>	
Wordstar	\$309/60
WS Training Guide	20
WS Custom Notes	\$429/na
MailMerge	\$109/25
WS-Mailmerge	\$419/85
Datastar	\$249/60
DS Custom Notes	\$429/na
Calcstar	\$259/na
Supersort I	\$199/40
Spellstar	\$175/40
<b>MICROSOFT</b>	
Basic-80	\$298
Basic Compiler	\$329
Fortran-80	\$349
Cobol-80	\$629
M-Sort	\$124
Macro-80	\$144
Edit-80	\$ 84
MuSimp/muMath	\$224
MuLisp-80	\$174
<b>NORTHWEST ANALYTICAL</b>	
*Statpak	\$439/40
<b>OASIS</b>	
*"The Word"	\$ 75
<b>ORGANIC SOFTWARE</b>	
*Textwriter III	\$111/25
*Datebook	\$269/25
*Milestone	\$269/30
<b>PEACHTREE® SOFTWARE</b>	
General Ledger	\$399/40
Accounts Receivable	\$399/40
Accounts Payable	\$399/40
Payroll	\$399/40
Inventory	\$399/40
Mailing Address	\$399/40
for P5 Version	add \$119
Series 6-Peachtree	
CPA	\$799/40
Property Mgt	\$799/40
Passive Payroll	\$449/40
Series 7-Peachtree	
Sales Tracker	\$3049/55
AR-Sales Analysis	\$1299/50

Inventory	\$799/40
Order Entry	\$699/40
<b>REDDING GROUP</b>	
*Lynx	\$199/20
<b>SOHO GROUP</b>	
Matchmaker	\$ 97/20
Worksheet	\$177/20
<b>SORCIM</b>	
*Pascal/M Z80	\$349/40
Pascal/M 86/88	\$449/40
*Act65	\$149/20
*Act 68	
*Act 69	
*Act 86/88	\$149/25
*Trans 86	\$119/25
*Supercalc	\$269
<b>SOUTHERN COMPUTERS</b>	
*Raid	\$224/35
*Raid FP	\$349/35
*FFP	\$224/15
*Recover	\$ 75
*RADAR	\$449/25
ISIS	\$224/20
<b>STRUCTURED SYSTEMS GROUP</b>	
GL, AR, AP, PR, OE	\$849/40
Call for others	
<b>SUPERSOFT</b>	
*Diagnostic II	\$ 84/20
*Forth	\$149/30
*SSS Fortran	\$219/30
*Fortran w/RATFOR	\$289/35
*C Compiler	\$175/20
*Disk Doctor	\$ 84/20
*Term I	\$129/25
Term II	\$169/25
Z8000 Kassemler	\$449/35
Others less 10%	
<b>WHITESMITHS</b>	
C Compiler	\$600/30
Pascal (incl C)	\$850/45
<b>IBM PERSONAL COMPUTER</b>	
Wordstar 3.0 (DOS)	\$309/60
Mailmerge (DOS)	\$109/25
Supercalc (DOS)	\$269/NA
Visicalc (256K) DOS	\$229/NA
Optimizer CP/M86	\$200/NA
Supersoft C - CP/M86	\$500/NA
Call for catalog and other listings	

\* Available for Apple with Softcard



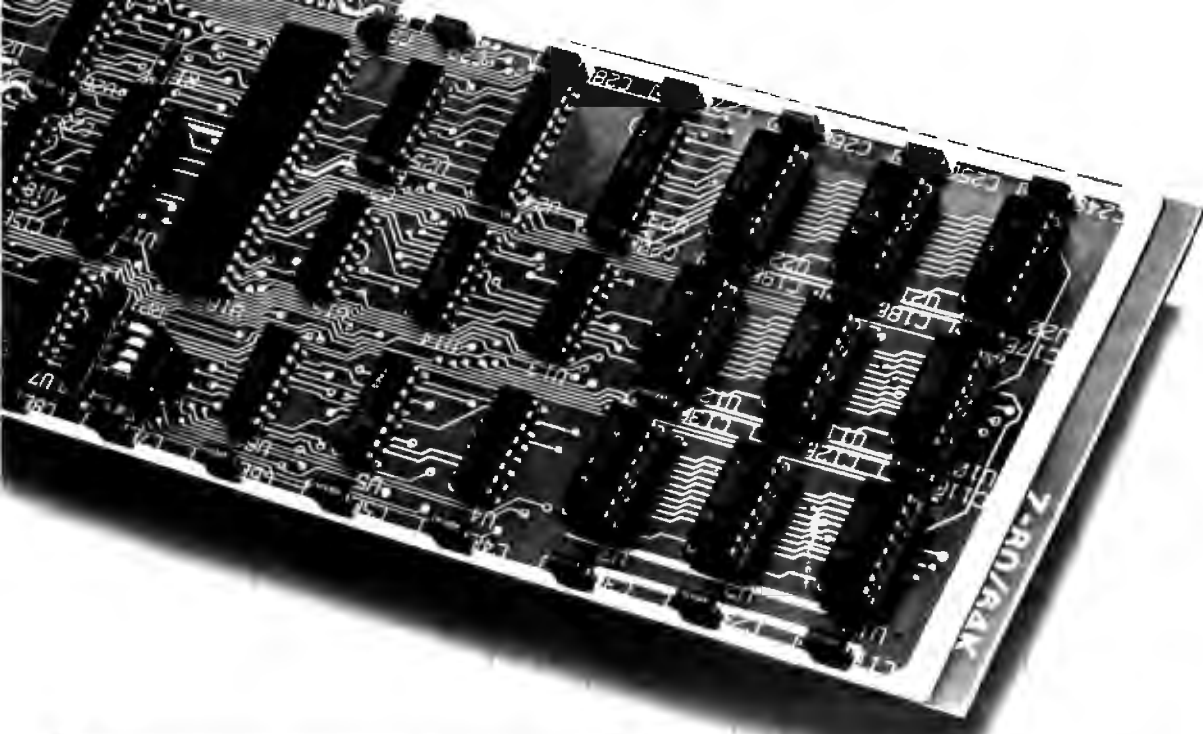

# TRUE CP/M<sup>®</sup> FOR YOUR IBM<sup>®</sup> INTRODUCING BYAD DS1

## More programs and faster access available now!

Today with the BYAD DS1 plug-in expansion circuit board, you can increase the speed and productivity of your IBM-PC.

## More programs

The BYAD DS1 allows you to transform your system into a CP/M computer giving access to the largest existing software library (CP/M version 2.2). Data base Management, word processing, business programs, and literally thousands of CP/M programs can be used.



## Faster

The DS1 board contains 64K bytes of parity RAM and a Z80B microprocessor. The Dual Systems, Z80 and IBM 8088, achieve improved performance CP/M with up to 30 times faster access through interrupt driven full I/O buffering. DS1 uses the 8088 as an intelligent concurrent I/O processor which performs keyboard type-ahead buffering, printer buffering, disk track and directory buffering.

## Easy Operation

No learning curve or new commands when using DS1. Utility programs are provided for reading various 5 1/4" diskettes directly, moving files, and to link your IBM with a serial port to any existing CP/M system. An expanded version, BYAD DS2, contains a built-in serial port and includes all features of DS1.

## Cost Competitive

Both BYAD DS1 and DS2 operate with a minimum 48K single drive system. The DS1 costs only \$660 and the DS2 with serial port, \$760. A comprehensive operating manual is available at \$40 and the cost will be applied to the purchase of either a DS1 or DS2.

Send check, money order or call 312 539-4922 and give your VISA or Master Card number for quick delivery.

## BYAD Inc.

5345 North Kedzie Avenue  
Chicago, Illinois 60625  
312 539-4922



# BYAD

Integrated Hardware and  
Software Systems

CP/M is a registered trademark of Digital Research.  
IBM is a registered trademark of International Business Machine Corporation

# TRS-80™ DISCOUNT

## BUY DIRECT

WE SELL THE FULL LINE OF TRS-80'S  
AT WHOLESALE PRICES

\*COMPUTERS - PRINTERS - SOFTWARE\*

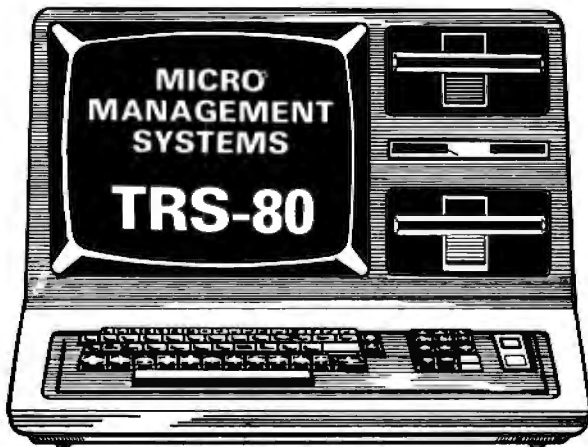

PURE RADIO SHACK EQUIPMENT

### MODEL II

26-4002 64K I Drive..... **\$3098**

Ask About Hard Drives

### MODEL III

26-1062 16K..... **\$819**

26-1066 48K with

2 Drives, RS232..... **\$2049**

### COLOR COMPUTER

26-3001 4K..... **\$309**

26-3002 16K Ext. Basic..... **\$455**

26-3003 32K Ext. Basic..... **\$569**

Model 16 TRS-80..... **CALL**

Printers..... **CALL**

### COLOR COMPUTER DISK DRIVES

26-3022 Color Disk Drive #1..... **\$498**

26-3023 Color Disk Drive #2, 3, 4..... **\$338**

- LARGE INVENTORY      WRITE FOR YOUR
- FAST DELIVERY      FREE CATALOG

**THOUSANDS OF SATISFIED  
CUSTOMERS**

**ORDER TOLL FREE**

**1-800-841-0860**

**MICRO MANAGEMENT  
SYSTEMS, INC.**

PARCEL DIVISION

DEPT. NO. 1

115 C. SECOND AVE. S.W. CAIRO, GA. 31728

GA. 912-377-7120

TM - TANDY CORPORATION

FREE COPY OF WARRANTY UPON REQUEST



must watch your energy levels. A significant drop means that a robot is in range. When you blast a robot and it shimmers out of existence, your energy reserves stabilize. The biggest problem is remembering to be aware of the robots as they sneak behind you and drain your tank's energy before you can turn around to blast them. You fight until you have exhausted all your reserve tanks. The game will display the top ten scores and save them to the game disk. After the final tank is destroyed, you begin again with your initial complement of tanks.

### Action Graphics

Wayne Westmoreland and Terry Gilman, authors of *Armored Patrol*, did a really super job with the graphics. The action is smooth as you move across the planet's surface. For block-type graphics, the view is quite realistic. You could even imagine you're watching a computer-generated target display.

Other notable features are the use of real time, the tracking of the highest ten scores, and the option of one or two players. In the two-player mode, you alternate at the controls of the tank, and whoever gets the highest score wins.

Even though your score climbs after the first couple rounds, this is not an easy game. You have to keep moving, and if an enemy tank or robots get behind you or you take too long turning to attack, you lose tanks. You have to be a pretty good shot to hit the enemy, especially when you and the enemy are moving toward each other or in opposite directions. Who knows—it may even sharpen your eye if you do any bird watching or picture taking.

### Conclusions

- *Armored Patrol* is a fast-paced, arcade-style action game that features three-dimensional graphics. It can be played on a TRS-80 Model I or Model III. The game is available on both tape and disk. Two players can compete during each round of play (players alternate turns).

- Scoring is straightforward. Novices and experienced game players should enjoy this one. The keyboard-controlled movement is simple to master, and the entire screen display is nicely done. Player instructions are actually a module in the game, so you don't have to worry about losing any instruction sheets.

- You won't find yourself getting bored with this game. The block-type TRS-80 graphics are quite adequate to convey the movement of your tank around the battlefield. The action is spirited and can become quite addictive.

- The price is a pleasant change when compared to the cost of many games.

- Overall, *Armored Patrol* is a well designed, nicely executed program, and I think you will enjoy it as much as I did.



# CASH FLOW PROBLEMS?



## IT'S NICE TO KNOW SOMEONE WHO HAS THE SOLUTION.

MicroAge is your Solution Store . . . that means at MicroAge Computer Stores we have a wide selection of time-saving computerized business systems designed specifically to solve the daily cash flow problems every businessman faces.

MicroAge has computerized business systems that

quickly and affordably allow you to regain control of your critical accounts receivable . . . at last making it possible for you to carry out effective collection procedures on a consistent basis. MicroAge has accounts receivable program packages to automatically display and update account information; prepare trial balance including a balance-due and delinquency aging

report, and take care of dozens of other tasks that eat into your time and profit!

Computerized business systems from the MicroAge Computer Store are available in the \$5,000 to \$15,000 range, to suit the individual budget of your small business or professional practice. MicroAge backs up every system with personalized service, warranty service and repair, installation, systems consulting, even customer training. Visit the MicroAge Computer Store in your area soon with your business problems, and let us help you with the solution.

**MicroAge**  
**COMPUTER STORE**

*"The Solution Store" SM*

#### VISIT THE STORE IN YOUR AREA:

El Paso, Texas  
(915) 591-3349  
Tucson, Arizona  
(602) 790-8959  
Albuquerque, New Mexico  
(505) 883-0955  
Pleasant Hill, California  
(415) 680-1489

Aurora, Colorado  
(303) 896-6950  
Rochester, New York  
(716) 244-9000  
Hurst, Texas  
(817) 284-3413  
Salina, Kansas  
(913) 823-7596  
Orland Park, Illinois  
(312) 349-8080

Milwaukee, Wisconsin  
(414) 257-1100  
Mountain View, California  
(415) 964-7063  
Scottsdale, Arizona  
(602) 941-8794  
Anchorage, Alaska  
(907) 279-6688  
San Diego, California  
(714) 278-0623

Richardson, Texas  
(214) 234-5955  
Minneapolis, Minnesota  
(612) 338-1777  
Omaha, Nebraska  
(402) 339-7441  
Phoenix, Arizona  
(602) 265-0065  
Columbus, Ohio  
(614) 858-1550

Indianapolis, Indiana  
(317) 849-5164  
Portland, Oregon  
(503) 256-4713  
Norwalk, Connecticut  
(203) 846-0851  
St. Louis, Missouri  
(314) 567-7644  
Oklahoma City, Oklahoma  
(405) 728-1837

Houston, Texas  
(713) 440-7547  
W. Palm Beach, Florida  
(305) 683-5779  
Toronto, Canada  
(416) 487-5551  
Houston, Texas  
(713) 270-9647  
Wilmington, Delaware  
(302) 658-3684  
Allentown, Pennsylvania  
(215) 434-4301

FOR FRANCHISE OPPORTUNITY INFORMATION CALL (602) 968-3168



THIS IS A TELEVIDEO TERMINAL;  
 THE SIMILARLY-PRICED  
 TERMINAL ON THE RIGHT IS NOT.  
 WHICH WOULD YOU RATHER READ ALL DAY?



Unretouched photos—identical conditions

## Which would you

Our competitor on the right claims high resolution. But what about that glare? The washed-out background? And the black and white screen? It's enough to give you a headache.

The TeleVideo terminal on the other hand, with its finer character dot matrix, sharper background contrast, and a black-on-green non-glare Panasonic screen is much easier on the eyes.

Obviously.

**Every TeleVideo terminal has just four basic modules. Each module is the best that can be made.**

Every screen, keyboard switch, power supply and video module on every TeleVideo terminal is identical. For the same high reliability. And same ease of service.

None of our competitors can say that.

**If you order 200 terminals today, we can ship them tomorrow. If you order 500, we can still ship them tomorrow.**

And if you order a 1,000, well, maybe you'll have to wait a day or two.



The 920C



The 910 PLUS

**We put our terminals through five bad days so you'll never have even one bad day.**

Our terminals are designed to withstand heat up to



THIS IS NOT A TELEVIDEO TERMINAL,  
 THE SIMILARLY-PRICED  
 TERMINAL ON THE LEFT IS  
 WHICH WOULD YOU RATHER READ ALL DAY?

## rather read all day?

155°F and shocks that simulate being tossed in the back of a truck. And before any terminal reaches you, every major component goes through a five day series of thermal and power-on cycling tests.

The result?

The highest reliability rate in our industry.

**TeleVideo sells 50% more terminals a month than our nearest competitor.**

Three years ago, TeleVideo shipped its first terminal. Today, we're the number one

The 925



The 950



The 910



independent terminal supplier. One reason is because our advantages are clearly visible. 8 hours a day.

For more information call, toll-free, 800-538-8725. (In California, call 408-745-7760.) Or call your nearest TeleVideo sales office.

 **TeleVideo**<sup>®</sup>

All TeleVideo terminals can be serviced by your nearest GE Instrumentation and Communication Equipment Service Center.

# The Eliminator

## Mayhem in Space, TRS-80 Style

Silas Pike  
POB 75  
Geneva, FL 32732

The Eliminator, a high-speed graphics game for the TRS-80, has that rare combination of fascination and frustration that will make you want to play just one more game. You must play several times to become familiar with its many aspects.

### The Game

As the game begins, you see a side view of your Eliminator ship moving horizontally over an ever-changing planetscape (see photo 1). You can control your craft's speed, altitude, and direction. Below the ship are gantry towers of varying heights. Upon these towers rest small cylinders called energizers. Around your ship, a veritable smorgasbord of alien craft exit hyperspace and appear on your screen. Of the four alien manifestations, one type, the *disruptoid*, is after your energizers. You must prevent the disruptoids from latching onto your energizers. If they reach the top of the screen with one of your energizers, they transmute into pulsating forms from which escape can be nigh impossible.

From an offensive standpoint, your Eliminator craft is equipped with an unlimited supply of plasma bursts. But once the airspace becomes very congested, you may have to rely upon your ultimate weapon—the *disruptor charge function*, which eliminates *all* enemy craft from the immediate area. Disruptor charges should be labeled "For Emergency Use Only" because you have just three per game. Once all ten of your energizers are captured or destroyed, the planetscape and gantry towers disintegrate in a blinding flash, thrusting your ship into the alien equivalent of 5 o'clock rush hour. Disruptoids swoop in for the kill, frequently in numbers so great as to completely overwhelm you.

### Playing The Eliminator

You can take many different approaches in playing a good game of The Eliminator because this game poses the

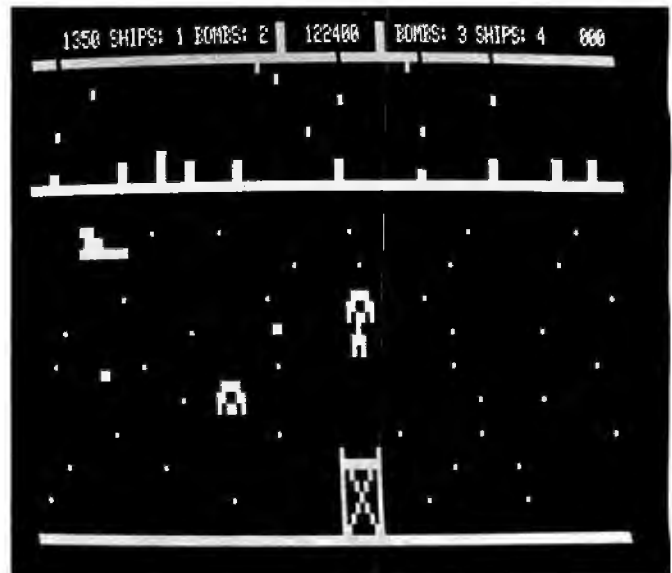

Photo 1: A disruptoid ascends, energizer in tow, while a second disruptoid hovers below and to the left. Your Eliminator ship is to the left of both alien craft and above them. Note the wide-screen monitor at the top of the screen.

triple challenge of (1) accumulating points (by destroying alien craft), (2) staying alive, and (3) preventing the capture or destruction of your energizers. You may focus on any one of these three tactics and play a moderately successful game. But the big points don't come until you are able to synthesize all three.

For example, one maneuver that separates the novices from the pros is the recovery of an energizer from an alien ship that has latched onto it and is in the process of ascending. This maneuver requires a deft hand and a steady eye and is done in several stages. First, the disruptoid must be destroyed. At this point you have an option:



# SUPERFILE™

**SOLVES YOUR FILING PROBLEMS**

**SUPERFILE makes your information files an ASSET!**

Menu driven

Customize  
program  
included

**CLIENT RECORDS  
SALES LEADS  
CORRESPONDENCE  
JOURNAL ABSTRACTS  
PERSONNEL RECORDS  
MAILING LISTS  
CARD FILES  
LEGAL CONTRACTS  
ALMOST ANYTHING!**

Learn in minutes

Ready to run  
Demo data base  
included

The **USERS MANUAL** tells you how to use **SUPERFILE**  
to index and retrieve information for these and other practical uses.

**IF YOU CAN TYPE, YOU CAN TEACH YOURSELF TO USE SUPERFILE IN MINUTES.**

## You Need

Computer with Z-80® cpu  
and at least 48K memory

CP/M® operating system

2 or more floppy disk  
drives or hard disk

## Disk Formats

8" single density

5" including:

Osborne, Xerox,

North Star, Intertec,

Apple (cp/m), Vector.

## Technical Specifications

SEARCH SPEED: **100 records per second\***  
RECORD ENTRY: **your own text processor or  
easily convert your present files**

# RECORDS PER DATA BASE: **max. 8,000**  
on 8" SD (depends on disk capacity)

RECORD LENGTH: **variable to 512,000 char.**  
(free format - no fixed length fields)

# KEY WORDS PER SEARCH: **max. 64 using  
"and", "or" & "not"**

# KEY WORDS PER DATA BASE: **max. 3,000  
alpha-numeric plus 32,000 integers**

# KEY WORDS PER RECORD: **max. 250**  
KEY WORD LENGTH: **max. 64 char. each**

# FILES PER DATA BASE: **no limit**

FILE SIZE: **max. 512,000 bytes**

SORT: **alpha-numeric by record**

MERGE and/or SPLIT: **records and files**

## Where

Your Dealer

Call FYI, INC.

Write FYI, INC.

Reader Service #

SUPERFILE costs only \$195  
(including DEMO data base and manual)  
(30 day money back guarantee)

MANUAL only: \$50 (applies to purchase)

Special Dealer DEMO free,  
on request from qualified  
Dealers and OEM's.

SUPERFILE (TM) trademark of FYI, INC.  
Z-80® registered trademark of Zilog  
CP/M® registered trademark of Digital Research  
\* Using Z-80, 4mhz, 8" DD, av. 10 keywords/record.

Please add \$10 outside the US, Canada, Mexico

## FYI, INC.

P.O. BOX 10998 #615

AUSTIN, TX. 78766

MC/VISA (800) 531-5033

Inside Texas (512) 346-0133

**IT'S WHAT YOU CAN FIND THAT COUNTS!**

# 20,000 Programs For The IBM



# Baby CPU PLUS Blue

TM

FOR THE IBM PERSONAL COMPUTER

SEE YOU AT THE NCC SHOW.  
BOOTH NUMBER A-732





# Are Now Available Personal Computer!

## INTRODUCING BABY BLUE CPU PLUS

Baby Blue CPU Plus is an accessory printed-circuit board for your IBM Personal Computer and special software on disk.

As far as normal PC DOS operations are concerned, Baby Blue acts just like any other normal, mild-mannered 64K byte random-access memory board.

But when you invoke a CP/M-80\* program, Baby Blue becomes a second computer within your computer, letting you run thousands (literally thousands) of programs written for the CP/M microcomputer operating system.

CP/M, the first microcomputer operating system to gain wide acceptance, has been around since 1975. Not only has it played host to a lot of programs, but those programs are among the most useful, most sophisticated, most thoroughly tested and debugged, most proven programs ever written. More than 200,000 computers were field-testing those programs for you before the IBM Personal Computer even existed.

The total CP/M library is immense. It includes the best efforts of thousands of professional and advanced-amateur programmers. There are time managers, spreadsheet manipulators and professional-office packages. Languages — BASIC, of course, ALGOL, FORTRAN, C, Pascal, LISP, COBOL, PILOT, and FORTH, to name a few. Text editors, text formatters, full-blown word processors, spelling checkers and indexers. Utilities that will massage problem files so that they lie back and purr. Games, including chess, Reversi, Adventure and tournament-level Star Trek. Database managers. Accounting packages that can run a million-dollar business . . . Just about anything you can imagine.

The net result is an integration of CP/M programs into the PC environment that's so smooth, so transparent that you won't need to know or care which operating system a program was originally written for.

### Special Baby Blue Features:

- Z80B\* microprocessor running at 4.77 megahertz.
- Additional 64K memory, fully available to PC DOS — looks just like the IBM 64K board to the system.
- Will accept CP/M programs on any of several popular 5¼" soft-sectored diskette formats.
- 63K of user memory is available for CP/M programs — 7K more than on any other popular machine.
- Files can be shared — CP/M and PC DOS programs can be mixed in a menu-driven system with common data files.
- IBM Personal Computer peripherals are supported — including keyboard, video boards, printer, Asynchronous Communications Adapter.

ONLY **\$600**

Special option —  
Baby Blue bundled  
with WordStar\*  
and Mail-Merge . . . \$980

For only \$60 more than the cost of the IBM 64K Memory Board (\$540) you get 64K of Memory **PLUS** an interface to over 20,000 programs!

**Call (212) 489-0444**

or write XEDEx Corporation  
1345 Ave. of Americas, New York, N.Y. 10105

WordStar\*  
and Mail-Merge  
are trademarks of  
MicroPro International  
Corporation.



WordStar\*, the popular CP/M word processor is among thousands of programs that can now be run on the IBM PC with Baby Blue.

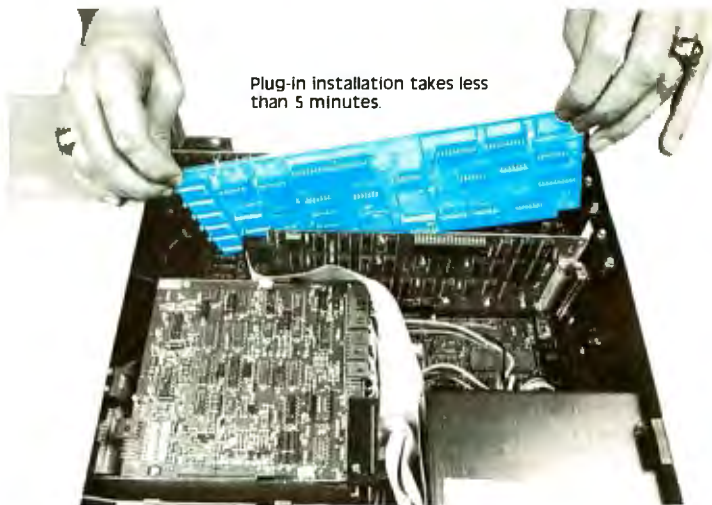

Plug-in installation takes less than 5 minutes.

CP/M is a registered trademark of Digital Research.  
Baby Blue is a trademark of XEDEx Corporation.  
Z80 is a trademark of Zilog, Inc.

Item	Point Value
Disruptoids	150
Drones	250
TDUs	1000
Tracers	150
Energizer save	250
Energizer replacement	500
Energizer interception	500

**Table 1:** *The point values for destroying enemy ships and for saving your energizers.*

either let the energizer fall slowly back into place upon its gantry pad (250 points) or maneuver your ship into contact with the free-falling energizer and replace it upon a gantry pad (500 points). Usually, this process requires several quick forward/reverse and up/down movements of your Eliminator craft. Once all ten of the disruptoid crafts have been dealt with, you will have a few seconds to relax while the screen displays the number of energizers remaining and designates the upcoming attack wave.

The second and subsequent waves consist of two types of alien craft: *drones*, which zigzag diagonally across the screen, and *TDUs* (Tracer Dispersal Units), which ascend and descend benignly until attacked, whereupon they discharge five small *tracer* craft which dip and dive with semi-intelligent abandon and change direction upon pursuit.

### Points

Points are accrued for the destruction of enemy craft and for ensuring the safety of your energizers (see table 1). When you use a disruptor charge, all the other spacecraft in the immediate area will disintegrate, garnering the point values of each destroyed ship. A tactical maneuver such as blasting two TDUs, which in turn will release a total of ten tracers, and then triggering a disruptor charge will rack up a minimum of 3500 points. Anything in excess of 30,000 points can be considered a good game. Co-author Wayne Westmoreland reports a high score of 122,400 (see photo 1), most humbling compared to my modest 62,000 high.

### Graphically Speaking

The Eliminator uses block graphics for most of the action. Interesting additions are the scrolling gantry towers and planetscape and a starfield backdrop, all of which serve to promote the illusion of true motion. Equally effective is the *wide-screen monitor* at the screen's top, which expands your forward/reverse view by the equivalent of about 2½ full-screen areas in each direction. This

### At a Glance

#### Name

The Eliminator

#### Type

Arcade-type game

#### Manufacturer

Adventure International  
POB 3435  
Longwood, FL 32750  
(305) 862-6917

#### Price

\$19.95, cassette tape;  
\$24.95, disk version

#### Authors

Wayne Westmoreland and  
Terry Gilman

#### Format

Cassette tape or 5¼-inch floppy disk

#### Language

Z80 machine language

#### Computer Needed

TRS-80 Model I or III with either 16K bytes (cassette version) or 32K bytes of memory and one disk drive (disk version)

#### Documentation

Pamphlet outlining key functions

#### Audience

TRS-80 owners who enjoy arcade games

enables you to monitor what's ahead or behind, before it arrives.

The sound routines in The Eliminator are definitely a cut above those of most TRS-80 programs. However, I prefer to be a member of the "soundless minority"; blips and bloops make me nervous, so I usually play with the sound patch disconnected.

### Possible Improvements

To be as fair as possible, The Eliminator does have two features that could stand improvement. First, the hyperspace control (Clear key) should be farther from the disruptor-charge control (Enter key). On occasion, I have detonated the disruptor charge by accident when attempting to use the hyperspace function. Second, it would be nice to be awarded an extra ship and/or disruptor charge after passing, say, 50,000 points, as a merit award.

### Conclusions

- The Eliminator is a fast-paced arcade game that makes excellent use of the TRS-80's low-resolution graphics.
- The on-screen presentation is well done and the wide-screen monitor is a marvelous feature.
- The game requires both fast reflexes and strategic thinking to be played effectively.
- The Eliminator is the best thing to happen to the TRS-80 in a long time.

**Editor's Note:** *The Eliminator is also available as a full-color, high-resolution game for the Apple II. This version requires an Apple II or Apple II Plus, 48K bytes of memory, and one disk drive. The price is \$29.95. . . . A.A.L.*



# “This year, I’m taking 2,000 people sailing. I wouldn’t trust the travel arrangements to anything less than Scotch® Brand Diskettes.”

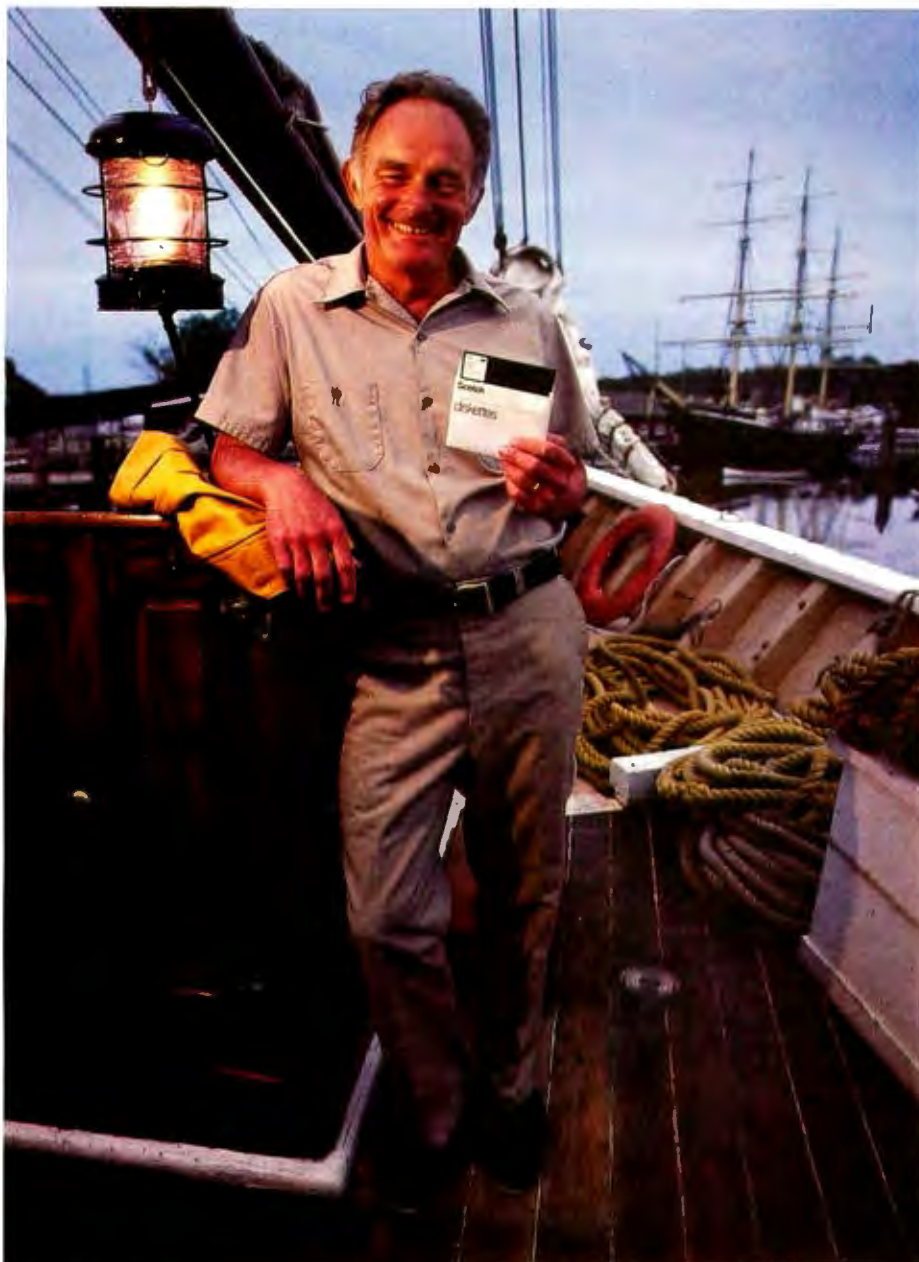

**Eben Whitcomb, Owner-Operator, Dirigo Cruise Company, Clinton, CT**

Eben Whitcomb runs the largest windjammer cruise business using American flag ships. He uses Scotch diskettes to keep track of thousands of names, bookings, sailing times, manifests and general ledger. While his computer saves time and repetition, Scotch diskettes assure him that vital information will be there when he needs it.

Dependable Scotch media can work just as hard for you. Each Scotch diskette is tested before it leaves our factory, and guaranteed error-free. So you can expect it to perform exactly right.

Scotch 8" and 5¼" diskettes are compatible with computer/diskette systems like TRS-80, Apple, PET, Wang and many others. Get them from your local 3M distributor. For the one nearest you, call toll-free: 800/328-1300. (In Minnesota, call collect: 612/736-9625.) Ask for the Data Recording Products Division. In Canada, contact 3M Canada, Inc., Ontario.

**If it's worth remembering, it's worth Scotch Data Recording Products.**



**3M Hears You...**

# Galactic Chase

Stan Wszola  
Technical Editor

I have this recurring nightmare in which I'm trapped in a video arcade and forced to play the games endlessly. Unfortunately, all the games are identical. I suppose these dreams are the result of seeing too many arcade-game clones. It seems as if everybody and his brother is producing arcade look-alike games for the personal computer market.

Fortunately, Galactic Chase is no nightmare; it's an implementation of the successful Galaxians arcade game with some interesting variations.

## The Game

Following the Galaxian theme, the object of the game is to shoot the alien ships. At the start of the game, a fleet of 36 alien ships appears, arrayed in ranks (see photo 1). The value of an alien ship depends on whether it is still in formation or moving in for an attack (see table 1). Not only is it more sporting to



Photo 1: Screen display for Galactic Chase. Two of the alien ships are shown peeling off from the formation and moving in for an attack.

shoot them while they're moving, but they're worth more points then.

When the game begins, the aliens peel off from the formation and attack individually. Rather than make a straight descent toward the bottom of the screen, the aliens swoop and curve, raining their missiles upon you all the time. In flight, the aliens appear to be little gloves trying to grab your ship. The movement of the alien ships is very smooth and looks quite good on the screen.

## Your Role

As the *Final Defender of Space*, you command three

ships per game. Your ship is controlled by the Atari joystick, and you fire missiles by pressing the button. You can destroy the alien ships either by firing missiles at them or by having the aliens collide directly with the *magnetic repellers* at the front of your ship.



See us at: NCC  
Booth 4355 June 7-10, 1982  
Also see us at: COMDEX  
Booth 1118 June 28-30, 1982

# WICAT 68000 MULTI-USER SYSTEM 150

## STANDARD EQUIPMENT

68000 Processor  
256KB RAM  
10MB Winchester  
5 1/4" Floppy Disk Backup  
5 RS-232 C Serial Interfaces  
Parallel Port  
Multibus™  
WICAT Operating System  
Choice of One Language

## HARDWARE OPTIONS

Graphics CRT  
Up to 1.5MB RAM  
Communications: Auto Answer  
and Auto Dial (1200 Baud)  
Local Networking  
Videodisc Interface

## SOFTWARE OPTIONS

UNIX™ V/7  
CP/M™ Emulator

## LANGUAGE SUPPORT

PASCAL  
C  
FORTRAN  
BASIC  
APL\*  
COBOL  
ADA™  
LISP  
Assembler



WICAT systems

P.O. Box 539 1875 South State Street Orem, Utah 84057 (801) 224-6400

Call or write WICAT Systems for additional information.

\*UNIX is a trademark of Bell Labs. Multibus is a trademark of INTEL.  
ADA is a trademark of the United States Dept. of Defense  
CP/M is a trademark of Digital Research  
APL 68000 is a product of the Computer Company

# FREE NEBS COMPUTER FORMS CATALOG

Send today for our NEW full-color 56-page catalog with continuous checks, statements, invoices, stationery, envelopes, supplies and accessories. We will also send our FORMS SELECTOR GUIDE, to help you find the right forms for your software.

- **Quality products at low prices**
- **Available in small quantities**
- **Fast Service**
- **Money-Back Guarantee**
- **Convenient TOLL-FREE ordering**

**Fast Service by mail or . . . PHONE TOLL FREE**

**1 + 800-225-9550**

Mass. residents 1 + 800-922-8560

8:30 a.m. to 5:00 p.m. Eastern Time Monday — Friday

Please rush a new computer forms catalog to:

NAME \_\_\_\_\_

COMPANY \_\_\_\_\_

STREET \_\_\_\_\_

CITY, STATE and ZIP \_\_\_\_\_

PHONE \_\_\_\_\_

Hardware and Software being used. \_\_\_\_\_



**Neb's  
Computer Forms**

CODE 22460

78 Hollis Street, Groton, Massachusetts 01471  
A division of New England Business Service, Inc.



Ships	Number	Point Value	Attack Value
Ensigns	20	20	40
Captains	7	30	60
Flankers	6	40	80
Command Ships	2	50	100 to 400

**Table 1:** The variety, number, and point values of the ships in the alien fleets.

In this game, there is nowhere to hide. You can't duck behind a convenient barricade. Your ship is out in the open, so the game requires a lot of movement to dodge the alien missiles and ships. The game is a true test of eye-hand coordination.

When you destroy one fleet of alien ships, another will take its place. You receive a bonus ship at the start of your encounter with the 16th, 32nd, and 48th fleets. You also get a bonus ship for each 7000 points scored.

The game is set up for one or two players, with the players taking turns. The current scores are displayed at the bottom of the screen, as are the highest score achieved and the number of fleets encountered from the previous game.

One nice feature is that you can stop and restart the action by pressing the Control-1 keys. This is especially convenient if the action becomes hot and heavy and suddenly the phone rings.

### Options

The game has three levels of skill. After you have destroyed 10 fleets in level one, you are moved up to level two, where the speed of the aliens increases. At your en-

### At a Glance

#### Name

Galactic Chase

#### Format

Cassette tape or 5¼-inch floppy disk

#### Type

Arcade-type game

#### Language

6502 machine language

#### Manufacturer

Spectrum Computers  
26618 Southfield Rd.  
Lathrup Village, MI 48076  
(313) 559-5252

#### Computer Needed

Atari 400 or 800 with 16K bytes of memory, one disk drive, and two joysticks

#### Price

\$24.95, cassette;  
\$29.95, disk

#### Documentation

One-page pamphlet

#### Audience

Game players

#### Author

Tony Weber



# 8086-SUPER MICRO.



## Superfast in its class and ready to run.

Computer Benchmarks—All systems running the same BASIC program.

Manufacture-Model	Class	Operating System	Language (Type*)	Run Time (Seconds)
IBM 3033	Mainframe	VS2-10RVYL	Stanford BASIC	10
Seattle Computer System 2	Micro	MS-DOS	Microsoft BASIC (C)	33
Digital Equipment PDP 11/70	Mini	n/a	BASIC (I)	45
Prime 550	Mainframe	PRIMOS	BASIC V1 6.4 (I)	63
Digital Equipment PDP-10	Mainframe	TOPS-10	BASIC (I)	65
IBM System 34	Mainframe	Release 05	BASIC (I)	129
TEI System 48	Micro	MAGIC 1.0	Microsoft BASIC (C)	178
Hewlett-Packard HP3000	Mini	Time Share	BASIC (I)	250
Seattle Computer System 2	Micro	MS-DOS	Microsoft BASIC (I)	310
Alpha Micro AM-100/T	Micro	AMOS 4.3a	Alpha BASIC (SC)	317
Digital Equipment PDP 11/45	Mini	n/a	BASIC (I)	330
Data General NOVA 3	Mini	Time Share	BASIC 5.32	517
Ohio Scientific C4-P	Micro	OS65D 3.2	Level 1 BASIC (I)	680
North Star Floating Point	Micro	NSDOS	NorthStar BASIC (I)	685
Radio Shack TRS-80 II	Micro	TRSDOS 1.2	BASIC (I)	792
Apple II+	Micro	DOS 3.2	Applesoft II (I)	960
Cromemco System 3	Micro	CDOS	32K BASIC (I)	1074
Commodore Pet 2001	Micro	n/a	Microsoft BASIC (I)	1374
IBM 5100	Micro	n/a	BASIC (I)	1951
Vector MZ	Micro	n/a	Micropolis BASIC (I)	2251

\*C = Compiler; I = Interpreter. Times (except for Seattle Computer) taken from August 1981 issue of Interface Age.

The Seattle Computer System 2 is the fastest micro on the block. In fact, System 2 outperforms many minis and mainframes.

Even the big boys such as: IBM System 34, Prime 550, and Hewlett-Packard HP 3000 are left in the dust when System 2 starts running.

The speedy System 2 consists of 8 Mhz. 8086 CPU set, 128K of 85 nsec. static RAM, double-density disk controller, 22-slot constant voltage mainframe, a cable for two 8" drives, and MS-DOS operating system (also called 86-DOS, IBM PC-DOS, Lifeboat SB-86).

High-level languages like Microsoft's Basic, Pascal, Fortran, Cobol are available now for your application programs.

System 2 comes fully assembled, tested and ready to run with the addition of disk drives (that we can supply) and terminal.

Call (206) 575-1830 for the location of your nearest System 2 dealer.

Dealer inquiries welcome.



1114 Industry Drive, Seattle, Washington 98188

Circle 405 on inquiry card.

counter with the 31st fleet, an *invisible ray* disables your missile launcher and slows the speed of your missiles. This is level three. You also have the option of starting at level two if you find level one too tame.

### Strategy

Conventional wisdom suggests that the safest approach is to shoot the alien ships one column at a time. However, another strategy is to destroy the alien ships only while they're in motion. You'll acquire more points if successful, but your ships will face the greatest danger. You might reserve this strategy for the command ships; one command ship can be worth up to 400 points. (The value is determined randomly and is displayed when you hit the ship.)

My usual *modus operandi* is to keep my ship in constant motion. I've found that if you concentrate on one specific target or column, it's easy to pick off ships. Also, the alien ships tend to follow the motion of your ship, so radical changes in direction will throw them off your track.

As I mentioned above, alien ships can be destroyed by

ramming them with the front of your ship. The latter tactic is *not* for the fainthearted. Because the alien ships are firing directly ahead, you must wait till the last moment before placing your ship in the path of the alien. If the alien should touch the side of your ship, both ships will be destroyed. This tactic, therefore, is only for macho game players or for use as a last-ditch effort.

### Conclusions

●I have only two complaints. I dislike the bursts of light in the background. Obviously meant to represent flickering stars, the effect looks more like cosmic dandruff. Also there is no software switch to turn off the sound effects. (My fellow editors did not appreciate hearing all of the galactic mayhem while they were trying to work.) These minor points become irritating if you play the game for any length of time.

●Galactic Chase is faithful to the original version. It offers an exciting game with a maximum of action and a minimum of complications. The graphics are smooth and colorful, and all information is nicely displayed. Galactic Chase is a natural for any Atari owner's game library. ■

# DATAFACE GRQ SERIES INTERFACE

## TURNS YOUR ELECTRONIC TYPEWRITER INTO A PRINTER/TYPEWRITER

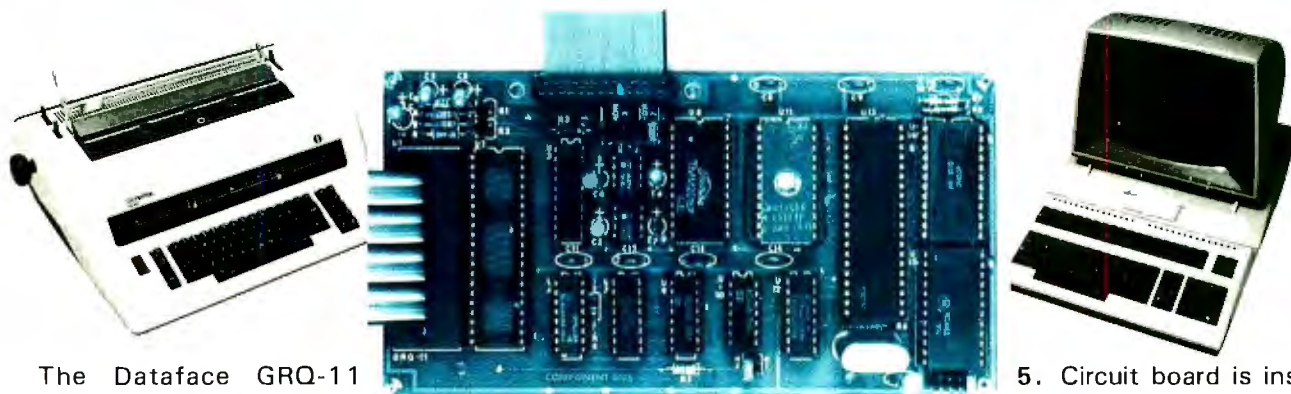

The Dataface GRQ-11 Interface expands your Olympia ES Series or Remington 200 Series electronic typewriters into a letter press quality printer for your personal or business computer. And, you still have a fully featured electronic typewriter—two machines in one.

The GRQ Series Interface features:

1. Standard EIA RS-232-C Serial Interface and Parallel (Centronics compatible).
2. Standard asynchronous ASCII code, 7 bit data; 1 start bit; accommodates 1 or 2 stop bits automatically; accommodates odd, even or absence of parity bit.
3. Fifty thru 9600 Baud data rate options.
4. Two K buffer; supports X-on, X-off protocol as well as RTS signals.

5. Circuit board is installed inside typewriter back panel along side logic board. The

connection between boards accomplished by 40 pin jumper cable using existing socket. No soldering required. Power is provided to the GRQ thru two pins of the 40 lead cable. Installation in 10 minutes.

**GRQ-10 — CALL FOR SPECIAL WHOLESALE PRICE. SUGGESTED RETAIL \$349.50.**

# DATAFACE INC.

2372 A WALSH AVE., SANTA CLARA, CA 95050  
(408) 727-6704



# MAXI MUSCLE MICRO MULTI

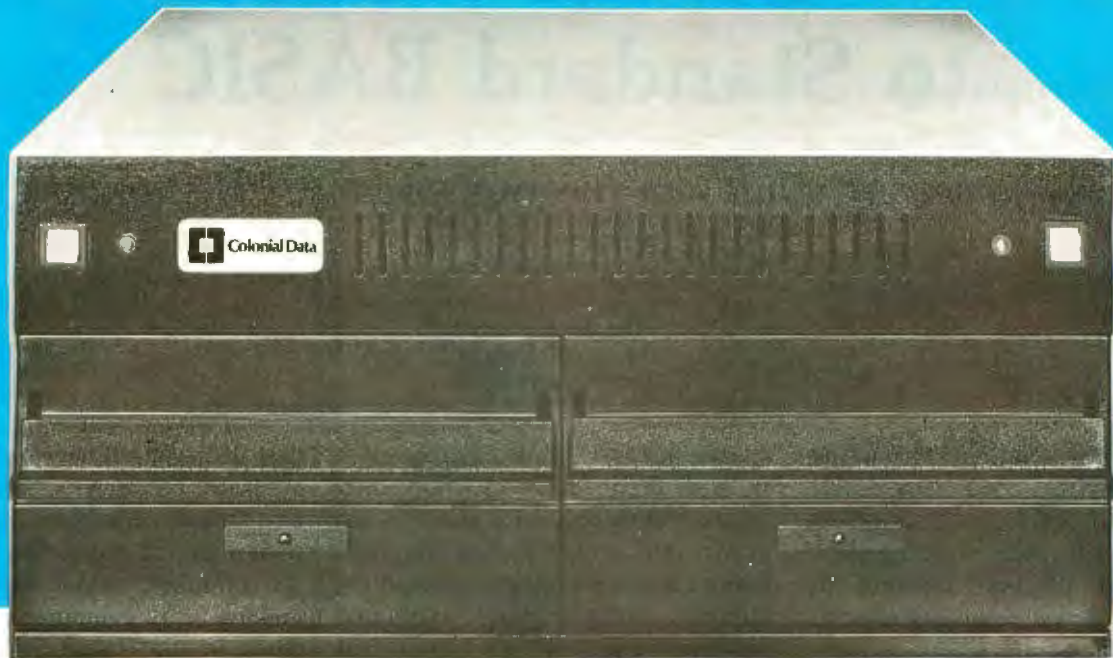

## SB-80/4. The affordable singleboard microcomputer with multi-user, multi-tasking muscle and brains.

**SB-80/4** A complete microcomputer system for the user who demands speed and storage capacity in single or multi-user applications. The CP/M® compatible operating system combined with our AMX I/O supervisor provides features and performance levels associated with more costly minicomputers.

**Single Board Technology** By utilizing the latest in large scale integration, engineers have packaged, into a singleboard, power and reliability usually found only in costly multi-board systems. This multi-processor board allows each user (up to four) a dedicated Z80A microcomputer and 64K of RAM. The master-slave architecture, residing in the same enclosure, supervises all user requests for storage and peripherals through four channel DMA.

**Memory and Disk Storage** Up to 320K of 200ns dynamic RAM provides the hardware to multi-task the operation. A 4K byte of EPROM for bootstrap, monitor and diagnostic test is standard. On board interface for Winchester type disk controller allows from 10 to 104

megabytes of storage for applications that require large database files and records. The four parallel ports and six serial ports provide the muscle to support additional peripherals.

**Software** The true CP/M compatible, in conjunction with the multi-user AMX I/O supervisory system provides DMA, real time clock and full vectored interrupt on all I/Os. BASIC, Fortran, Pascal, Cobol, APL and PL/1 languages are available.

**Affordability** The result is a high-speed, full featured microcomputer system at a price that beats the competition. The SB-80/4 gives you minicomputer performance and capacity at microcomputer size and price.

*Dealer and OEM inquiries are welcome.  
Nationwide field service through INDESERV.*



**Colonial Data**

Colonial Data Services Corp., 105 Sanford Street, Hamden, Conn. 06514 • (203) 288-2524 • Telex: 956014

\*CP/M is a registered trademark of Digital Research, Inc.

Circle 96 on inquiry card.

# On the Way to Standard BASIC

*A survey of what's in the proposed ANSI standard  
and why it's there.*

---

Thomas E. Kurtz  
Dartmouth College  
Hanover, NH 03755

---

The American National Standards Institute (ANSI) committee X3J2, charged with developing a standard for the BASIC programming language, held its first meeting in January 1974. We're now well into the eighties and still we have no published standard. Why so long? The standardization process is at best slow and cumbersome, but need it be this slow? After all, standards for FORTRAN, COBOL, and PL/I have been around for a while. Half of the short answer is that the X3J2 committee has produced in eight years two standards: the "draft," which is the subject of this article, and Minimal BASIC, which appeared in 1978 (see reference 1). (Minimal BASIC has not caught on because the rapid development of chip technology has made its modest capabilities obsolete.) The other half of the short answer is that BASIC was changing drastically while the committee was trying to standardize it. In other words, BASIC has been a moving target.

BASIC got its start as a simple language designed to make life easier for the nonexpert programmer. But what

started out as a simple language with no more than a dozen different statements dealing only with numbers has grown into a diverse language with many statements capable of handling numbers, strings, arrays, files, and plotting. Single-letter and letter-digit variable names have grown to multi-character variable names. Simple GOTOs and IF...THENs have evolved into the famous constructs of structured programming. Each vendor has developed its own formats and rules for these extensions so that present versions of BASIC differ widely as to form and content.

At long last, the diverging paths are being brought together in the new proposed standard for BASIC. The standard includes structured constructs, a "MAT" (matrix) package, formatted output, subprograms that can be made independent, files, exception handling, and optional sections on graphics, sophisticated file structures, real time, fixed decimal arithmetic, and editing. (Details appear later in this article.) The example in listing 1 illustrates a few of the highlights of standard BASIC: multi-character identifiers, subprograms, and several of the structured constructs.

The standard is currently (early 1982) under technical committee mail ballot, which will assert (if it passes)

that the technical development of the standard has been completed. The next major milestone is a public-review period conducted by ANSI's X3 committee, which supervises the making of all computer-related standards in the United States. Further steps, which usually take several years to complete, will follow before the standard becomes ANSI official, but these are formalities that have little likelihood of changing the content of the standard.

The standard will mainly benefit the educational world. Programs published in magazines such as BYTE may eventually be in standard BASIC rather than in some variation. Textbooks containing programs won't have to be written specifically for a particular brand or model of computer. Finally, programs written in standard BASIC will be easier to transport and distribute.

## **Difficulties with Standardization**

Developing a standard for BASIC has been difficult because the language serves such a diverse clientele.

Educational users tend to work on mini- and microcomputers. They desire a language that is easy to learn and is not cluttered with declarations or excessive structure. They would be satisfied with fairly simple file systems.

---

### **About the Author**

*Thomas E. Kurtz is co-author of the original, "Dartmouth" BASIC and is chairman of the ANSI committee that has developed the proposed draft standard for BASIC.*

---



**The revolutionary Discovery multiprocessor** is the only system that allows the total integration of powerful 16 bit 8086 processors with the more standard Z-80 user processors. The DISCOVERY system may be configured in any 8 bit/16 bit combination, or as a totally exclusive 16 bit system only to provide the ultimate in performance and flexibility in advanced micro systems.

**Ultimate performance.** The dpc-186 is the most sophisticated single board microcomputer available today offering more power and faster processing time through the 8086 CPU for bigger, more complex programs. Memory starts at 128 K (compared to the Z-80's 64 K), and is expandable to 1 megabyte. And the dpc-186 is fully compatible with the standard DISCOVERY multiprocessor system permitting efficient upgrading as future needs develop, without sacrificing any of your extensive hardware and software investment.

**World's best multiprocessor system.** The DISCOVERY system provides separate processors and memory for each of its 16 users. It offers full CP/M™ and CP/M-86™ compatibility, interprocessor communication, and shared and private files. Each user can take advantage of shared peripherals and cross submitting of tasks between processors. The system is controlled by a unique, two board dpc-280 service processor and dpc/os distributed processing operating system.

**By the board or by the system.** The DISCOVERY multiprocessor is ready for immediate delivery as a complete system, as processor boards, and everything in between. It offers exclusive technology in multiprocessing, yet is fully compatible with existing standards including CP/M and S-100. It is quite simply unmatched in performance, capabilities and offers a far greater degree of flexibility. DISCOVERY—offering a whole new world of possibilities.

## For the first time, 8 and 16 bit processor intermixing.



Action Computer Enterprises, Inc.



The Multiprocessing Company  
55 West Del Mar Boulevard, Pasadena, CA 91105 USA  
(213) 793-2440, TWX 910-588-1201

Circle 9 on inquiry card.

Dealer and OEM inquiries invited.

See us at N.C.C. Booth #8720.

\*CP/M is a registered TM of Digital Research, Inc.

# ZX81



## Introducing the Sinclair ZX81.

If you're ever going to buy a personal computer, now is the time to do it.

The Sinclair ZX81 is the most powerful, yet easy-to-use computer ever offered for anywhere near the price: only \$149.95\* completely assembled.

Don't let the price fool you. The ZX81 has just about everything you could ask for in a personal computer.

### A breakthrough in personal computers.

The ZX81 is a major advance over the original Sinclair ZX80—the first personal computer to break the price barrier at \$200.

In fact, the ZX81's 8K extended BASIC offers features found only on computers costing two or three times as much.

Just look at what you get:

- Continuous display, including moving graphics

# THE \$149.95 PERSONAL COMPUTER.

- Multi-dimensional string and numerical arrays
- Mathematical and scientific functions accurate to 8 decimal places
- Unique one-touch entry of key words like PRINT, RUN and LIST
- Automatic syntax error detection and easy editing
- Randomize function

useful for both games and serious applications

- Built-in interface for ZX printer
- 1K of memory expandable to 16K
- 164-page programming guide and operating manual

The ZX81 is also very convenient to use. It hooks up to any television set to produce a clear 32-column by 24-line display. It comes with a comprehensive 164-page programming guide and operating manual designed for both beginners and experienced computer users. And you can use a regular cassette recorder to store and recall programs by name.



### Order at no risk.\*\*

We'll give you 10 days to try out the ZX81. If you're not completely satisfied, just return it to Sinclair Research and we'll give you a full refund.

And if you have a problem with your ZX81, send it to Sinclair Research within 90 days and we'll repair or replace it at no charge.

### Introducing the ZX81 kit.

If you really want to save money, and you enjoy building electronic kits, you can order the ZX81 in kit form for the incredible price of just \$99.95.\* It's the same, full-featured computer, only you put it together yourself. We'll send complete, easy-to-follow instructions on how you can assemble your ZX81 in just a few hours. All you have to supply is the soldering iron.

### A leader in microelectronics.

The ZX81 represents the latest technology in microelectronics. More than 10,000 are sold every week. In fact, the ZX81 is the fastest selling personal computer in the world.

We urge you to place your order for the ZX81 today.

### To order.

To order, simply call toll free. Or use the coupon below. Remember, you can try it for 10 days at no risk.\*\* The sooner you order, the sooner you can start enjoying your own computer.

### Call toll free 800-543-3000.

Ask for operator #509. In Ohio call: 800-582-1364; in Canada call: 513-729-4300. Ask for operator #509. Phones open

24 hours a day, 7 days a week. Have your MasterCard or VISA ready.

These numbers are for orders only. If you just want information, please write: Sinclair Research Ltd., 2 Sinclair Plaza, Nashua, NH 03061.

\*Plus shipping and handling. Price includes connectors for TV and cassette, A/C adaptor, and FREE manual.

\*\*Does not apply to ZX81 kits.



**NEW SOFTWARE:** Sinclair has published pre-recorded programs on cassettes for your ZX81. We're constantly coming out with new programs, so we'll send you our latest software catalog with your computer.



**ZX PRINTER:** The Sinclair ZX Printer will work with your ZX81. It will be available in the near future and will cost less than \$100.



**16K MEMORY MODULE:** Like any powerful, full fledged computer, the ZX81 is expandable. Sinclair's 16K memory module plugs right onto the back of your ZX81. Cost is \$99.95, plus shipping and handling.

# sinclair

## To order call toll free: 800-543-3000

Ad Code	06BY	Price*	Qty.	Amount
ZX81		\$149.95		
ZX81 Kit		99.95		
16K Memory Module		99.95		
Shipping and Handling		4.95		\$4.95
			TOTAL	

**MAIL TO:** Sinclair Research Ltd.,  
One Sinclair Plaza, Nashua, NH 03061.

Name \_\_\_\_\_

Address \_\_\_\_\_

City \_\_\_\_\_ State \_\_\_\_\_ Zip \_\_\_\_\_

\*U.S. dollars



# Sinclair Owners...

## Expand Yourself! I/O Capability for Your ZX-80, ZX-81.

■ **8 Port I/O Board**  
Special adapter cable mates to Sinclair edge connector.  
Feed-thru accepts Sinclair 16K memory module.  
Buffered address lines.  
Separate power supply.  
I/O command with one line of BASIC.  
8-Port bus. **I/O \$109**

■ **A/D and D/A**  
16-pin cable connects to micro developments I/O bus.  
2 channels; A/D, 0-5V Input—  
D/A, 0-5V output. **AD \$97**

■ **Clock**  
16-pin ribbon cable connects to micro developments I/O bus.  
Switchable 0.1 or 1 sec resolution.  
Manual or computer control.  
Beeper. **SC \$75**

Complete operating instructions and technical documentation included. \$5.00 handling charge on all orders.

■ **CALL TOLL FREE**  
**800-227-1617** operator 641  
(CA, 800-772-3545 operator 641).  
These numbers for credit card orders only. For information, write us at:

Box 1140  
2000 Center St.,  
Berkeley,  
CA 94704.

**micro developments**

**Listing 1:** This program incorporates many of the new features of the proposed draft standard for BASIC.

```

100 Program CRAPS
110 !
120 ! A simple program in standard BASIC
130 !
140 ! Plays N games of craps
150 !
160 ! Read n
170     Data 10
180 !
190 For i = 1 to n
200     Call DICE (Total)
210     Print "You rolled a "; Total
220     Select Total
230     Case 7, 11
240         Print "You win."
250     Case 2, 3, 12
260         Print "You lose."
270     Case else
280         Print "which is your point."
290     Do
300         Call DICE (Newtotal)
310         Print Newtotal,
320         Loop until Newtotal = 7 or Newtotal = Total
330     If Newtotal = 7
340     Then
350         Print "You lose."
360     Else
370         Print "You win."
380     End if
390 End select
400 Next i
410 !
420 End
430 !
440 !
450 Sub DICE(Sum)
460 !
470 ! Roll two dice and add them up
480 !
490 Let d1 = Int(6*Rnd + 1)
500 Let d2 = Int(6*Rnd + 1)
510 Let Sum = d1 + d2
520 !
530 Sub end
    
```

Another group of users includes those with large machines or with access to large machines. These users want a rich, compiler-based language. They want to construct subroutine libraries of independently compiled subprograms. This group also wishes to write interactive programs that process strings of characters, something that FORTRAN and COBOL don't do easily. (PL/I allows string processing, but it's not accessible in many interactive environments.) Pascal does not offer what these users want either; it is too pristine.

A third group of users wishes to do business and financial calculations using BASIC. Such use is extensive

partly because many of the early financial applications were written in BASIC. In Europe, BASIC is the primary business data-processing language for small computers. This group wants formatted output, accurate dollars-and-cents calculations, and access to record-structured files. Few suitable alternatives exist for these users on small machines.

### What Most BASICs Are Like

Present-day BASICs, including the current version of the draft standard, reflect most of the goals of the original version of BASIC. For example, most BASICs avoid declaration of variables, with the notable exception that many, including the draft



Quality Computer Services presents..

# Hard Disk Systems



For TRS®, Apple®, Heath®, S-100, IBM.....  
6,12,20,40 and 80 Megabyte systems

Completely assembled and tested subsystem including:

- Switching power supply
- Winchester drive
- Host adapter card
- Sealed case
- Expansion

The enclosure, controller and power supply have been designed to allow for future backup hardware or increased storage

- Software
- Auto attach CP/M\*
- Hard disk utilities
- Real time clock

- Formatting program  
Assigns alternate sectors for any weak sectors detected during formatting assuring the lowest possible error rate

- Warranty: The system has a full one year warranty on all parts and workmanship
- Also available: attach for TRSDOS, OASIS\*, Apple DOS
- Optional 5 1/4" floppy (shown)



See local dealer  
or call:  
Quality Computer  
Services  
178 Main Street  
Metuchen, New Jersey  
201-548-2135

• Quantity discounts available. Distributor, Dealer and OEM inquiries invited.

\*OASIS is a trademark of Phase One Systems, CP/M is trademark of Digital Research

**QCS** inc  
Quality Computer Services

Toll free number: 800 631 5944



**SOMEDAY . . . in the comfort of your own home or office, you'll be able to shop and bank electronically, read instantly updated major newswires, analyze the performance of a stock that interests you, send electronic mail to business associates across the country, then play Bridge with your best friend in San Francisco and two strangers in Chicago and Dallas.**

## WELCOME TO SOMEDAY

Someday is today with the CompuServe Information Service. All this and more can be accessed with a local phone call in most major U.S. cities. For hardware you need a terminal or personal computer and a modem. The CompuServe Information Service costs only \$5.00 per hour, billed in minute increments to your charge card.

Ask for a demonstration at a Radio Shack® Computer Center. Videotex software is available for various brands of personal computers. CompuServe Information Service, 5000 Arlington Centre Blvd., Columbus, Ohio 43220. (614) 457-8650.

# CompuServe

# PHONE 1 FILLS THE VOID IN DATA COMMUNICATION

Powerful Z-80® communications software tools are now available. Fill the void between your microcomputer and mainframe.

Z-80 is a registered trademark of Zilog.



## PHONE 1

1011 River Lane • Loves Park, Illinois 61111 • 815/877-9008

### Timetable for Approval

*This article is the first public presentation of the main features of the standard now in preparation. The X3J2 committee will shortly send its proposed standard to the parent committee X3. X3 will then establish a public-comment period during which copies of the proposed standard will be available. The public is then invited to examine the standard, point out flaws, or propose modifications. Individual computer users and user groups should be on the lookout for the public-comment period and respond with suggestions or comments.*

*We also hope that the trade and academic press will examine the standard when it becomes available and draw comparisons between it and other popular versions of BASIC. The X3J2 committee doesn't really expect all vendors to implement all that is in the standard. But we hope that what vendors do implement will be compatible with the standard.*

*The schedule of events in the near future for the standard is:*

**Late July 1982:** Confirm the technical review, possibly make last-minute changes.

**Fall 1982:** Transmit the standard to X3 for further processing. At this point, the standard will be virtually stable, and vendors and users can begin to count on its features. Subsequent processing of the standard is largely formal, although it is possible to change the standard when there is a significant public aversion to some feature in the standard.

**Late 1982 or early 1983:** Public comment period and letter ballot within X3.

**1983:** Transmittal to ANSI for still further processing.

**1983:** Final approval by ANSI.

*As with any best-laid plans, unforeseen problems can only cause delays. The above schedule is therefore optimistic. On the other hand, the technical content of the standard is not likely to change after the fall of 1982. Implementers should be able to plan new compilers and interpreters with confidence at that time.*



# IBM

COMPATIBLE  
BOARDS

BY

# ZOBEX

## 256 K

Limited time only!

MEMORY WITH PARITY

**\$598**

~~\$998~~

## HARD DISC

## IBM

AND

## S-100

SUBSYSTEM FOR

## \$2495

HA62 IBM BUS HARD DISK INTERFACE FOR WD-1000

4SP 4 SERIAL PORTS FOR IBM

PB PROTOTYPING BOARD FOR IBM

EB EXTENDER BOARD FOR IBM

## S-100 BOARDS

ZOBEX CPU

Z-80A CPU WITH 4 SERIAL AND 3 PARALLEL PORTS

ZOBEX DDFDC

DOUBLE DENSITY DISK CONTROLLER

ZMS-100

64K RAM

HDCI

S-100 HARD DISK INTERFACE FOR WD-1000

## ZOBEX

7343 J. RONSON RD.  
SAN DIEGO, CA. 92111

(714) 571-6971

ZOBEX is trademark of ZOBEX CORPORATION  
IBM is trademark of International Business Machines Corporation

standard, require declaration of arrays (lists and tables). In most BASICs, variables are typed implicitly, according to some special symbol. Thus, string variables have the dollar sign (\$) in their name. This convention limits the number of different types of variables, because there aren't many special characters left. Some argue that this is good, not bad.

It is still true that a small job requires only a small program. Some BASICs even allow omitting the END statement. A language that lacks declarations and excessive structure lends itself more readily to interpreters. For these, a simple computation requires but a single statement. If you want to add 2 and 2, the single direct statement:

```
PRINT 2 + 2
```

will work. Try this in Pascal or FORTRAN!

Because a user can get by with a minimum of syntax rules and structure, BASIC is easy for novices to

learn. Perhaps even more important, it is easy for occasional users to remember. I know teachers who use the computer only twice a year but who can remember what to do without having to check the manual.

### The Proposed Standard

The standard will of course embrace most of simple BASIC or Minimal BASIC. (ANSI Minimal BASIC is similar to the earliest versions of BASIC. It includes the REM, LET, INPUT, PRINT, READ, RESTORE, DATA, DIM, FOR, NEXT, IF... THEN, line number, GOSUB, GOTO, RETURN, ON...GOTO, RANDOMIZE, single-line DEF, STOP, and END statements. It lacks string lists, files, plotting, etc. ANSI Minimal BASIC is quite minimal!) BASIC extends Minimal BASIC in a number of ways, for example, by allowing multicharacter variable names. It also includes features completely missing from Minimal BASIC, such as graphical output and real time. Incidentally, the com-

mittee elected to use the name BASIC for this standard. It had used the terms "Extended BASIC" and "Enhanced BASIC," but it dropped the modifiers, thus allowing their use by vendors later.

The standard is written so as to define *standard-conforming programs*. Any program that is written according to the rules of the standard is standard-conforming. A standard-conforming *implementation* (interpreter or compiler) is one that will correctly process a standard-conforming program. A standard-conforming implementation may offer extensions, provided that all standard-conforming programs will continue to be correctly processed. This point is important in order to understand some of the choices made by the committee.

Actually, the standard will consist of a core module plus five optional modules: enhanced files (direct access and keyed); graphics; real time; fixed decimal (for business users); and editing.

I'll now give a section-by-section summary of the features of the proposed standard.

### Data Types

BASIC includes variables and constants of type numeric and string. Numeric is, of course, single precision. The standard will not specify other types, such as integer or double precision, both of which have been requested by part of the user community. It will provide fixed decimal but only as an option. The reason for not including other types is that BASIC serves many masters—large machines, small machines, microcomputers, interpreters, compilers, education, business—making the choice of data types difficult. As it is, vendors can enhance their own versions of the standard BASIC with whatever additional data types are needed by their users. Of course, programs written to take advantage of such data types will not be standard-conforming and might not be transportable.

### Program Comments

In addition to the REM statement

## ATTENTION APPLICATION PROGRAMMERS DISPLAYMASTER IS HERE

**MASTERCOMPUTING** has the answer to your biggest headache: user data entry. Now devote your valuable time as a professional to the actual application rather than complex input prompt control and data entry checking.

**DISPLAYMASTER** is a two part screen oriented data entry system

- |  |  |
|--|--|
| <ol style="list-style-type: none"> <li><b>1. DISPLAYDEF - Development Utility</b> <ul style="list-style-type: none"> <li>• Define screen formats</li> <li>• Define entries, prompts, messages, text</li> <li>• Document screen format</li> <li>• Build screen files</li> </ul> </li> </ol> | <ol style="list-style-type: none"> <li><b>2. DISPLAYASM - Powerful assembly calls</b> <ul style="list-style-type: none"> <li>• Build screens, process entries</li> <li>• Handle messages and prompts</li> <li>• User callable directives and primitives</li> <li>• Screen fields transparent to program</li> </ul> </li> </ol> |
|--|--|

### DESIGN CONCEPTS

- |  |  |
|--|--|
| <ul style="list-style-type: none"> <li>• Large system approach</li> <li>• User friendly</li> <li>• Language and system independent</li> <li>• Complete entry checking, conversion &amp; protection</li> <li>• Low RAM and Disk overhead</li> </ul> | <ul style="list-style-type: none"> <li>• High speed operation</li> <li>• Screens easily changed &amp; tested</li> <li>• Professional documentation</li> <li>• Maintenance free</li> <li>• Low cost - \$175.00 with Manual</li> </ul> |
|--|--|

### SYSTEM REQUIREMENTS

- CP/M™ 1, 4 or 2.2 with cursor addressable terminal or CRT
- Languages - Microsoft Basic-80 and BASCOM. Other popular languages to follow

### FUTURE ATTRACTIONS

- FILEMASTER** - a data base definition system with user directives
- PRINTMASTER** - a page oriented print system with user directives

BASIC 80 and BASCOM  
are products of Microsoft  
CP/M is a trademark  
of DIGITAL RESEARCH



MasterComputing Inc.  
P.O. Box 16778  
Greenville, SC 29606  
(803) 244-8174



# Apple Logo has arrived

*The sophisticated yet simple to use language  
you have been reading about  
is now available for your Apple II.<sup>®</sup>  
Contact your Apple dealer today.*

logo  
computer  
systems inc.

222 Brunswick Blvd.  
Pointe Claire, Que.  
Canada  
(514) 694-2885

989 Avenue of the Americas  
New York, N.Y.  
U.S.A.  
(212) 564-6020

# Murry Foley thought "lowercase descenders" were people who avoided paying taxes.

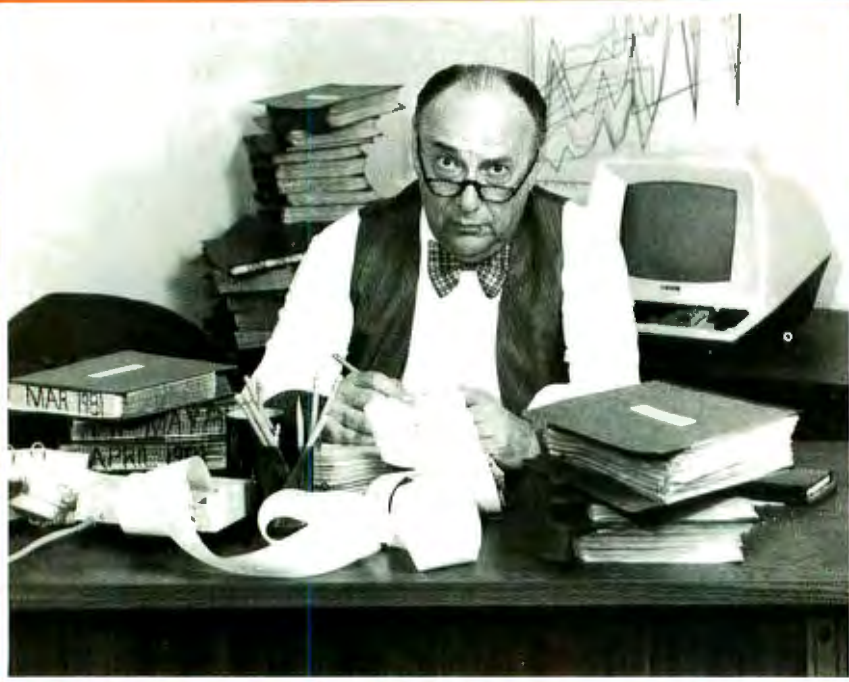

## Until he became an Orange Micro Printer Expert.

**Printers Can Be Confusing.** Sometimes, even the informed personal computer owner is caught short by the mound of technical differences in printers. Dot matrix for correspondence, or daisy wheel? What does bidirectional printing have to do with the price of tomatoes?

### We Educate First.

With so many different printers out there with as many different features, we feel a printer education is in order. We take what you already know

about computers and explain printers in the same terms. Our current customers seem to like that because of the friends they refer. (Nearly 50% of our business is referral.)

**It's Easy To Be An Expert.** Orange Micro printer specialists are there to make you feel comfortable with your newfound printer knowledge. And when you decide on the printer right for you, you'll know exactly why you picked it from all the rest. With over 35 popular models to choose from, and a complete selection of cables, options and interface accessories, we



have everything you need to get your new printer up and operating in minutes.

**We Have The Right Printer For You.** Bring along your toughest printer questions. Our salespeople will answer them honestly and practically. In less time than you'd imagine possible, you'll be a printer expert too!

After all, printers are our only business, so we always do a better job at finding the right one for you.

### Orange Micro Printer Stores

3150 E. La Palma, Suite I  
Anaheim, CA 92806 (714) 630-3622

13604 Ventura Boulevard  
Sherman Oaks, CA 91423 (213) 501-3486

3216 Scott Boulevard  
Santa Clara, CA 95051 (408) 980-1213



**Orange Micro**  
PRINTER STORE

© Orange Micro 1982

for comments, BASIC will allow on-line comments using the exclamation point (!).

### Identifiers

It did not take the committee long to vote for multicharacter variable names. Up to 31 characters (letters, digits, and underlines, starting with a letter) are permitted for variable and function names, with the trailing dollar sign for string-variables counting. Despite the obvious advantages over old-fashioned BASIC variable names, multicharacter names exact their price. For instance, spaces are required around keywords (such as FOR N = 1 to M instead of FORN = 1TOM), and certain words cannot be used as variable names (mainly, the names of the functions with no arguments, such as RND). The first restriction is probably a good idea anyhow. The second poses a challenge to implementers to come up with reasonable error messages when unsuspecting novice users try to assign one of these words as a variable name.

Incidentally, uppercase and lowercase may be used interchangeably for keywords, identifiers, function names, etc. Of course, the cases remain distinguishable in quoted strings, input replies, etc.

### Numeric Operations

The big news is that arithmetic will be floating decimal. Thus,  $2.29 + 4.71 = 7.00$ , not 6.999999. Also:

$$\begin{aligned} &.1 + .1 + .1 + .1 \\ &+ .1 + .1 + .1 + .1 \\ &+ .1 + .1 = 1 \text{ exactly} \end{aligned}$$

Vendors may offer native arithmetic (presumably floating binary or floating hexadecimal) as an option if efficiency is an issue. But users will finally be able to carry out dollars-and-cents calculations with confidence.

Minimal BASIC provides these numeric functions: ABS, ATN, COS,

Circle 343 on inquiry card.



# MORROW DESIGNS

## Cost effective answers to floppy disk problems.

**DMA answers.** Standard, accumulator transfer floppy disk controllers can stall your microcomputer system's CPU for as long as 160 milliseconds. Just to access and transfer a sector of data to main memory. If CPU processing speed and system performance are critical, you need something better. That's where Morrow Designs' new intelligent Disk Jockey DMA™ controller comes in. This new breed of peripheral handles both 5¼" and 8" drives and can read almost any format in existence. Speed? Your CPU runs at full tilt while the DMA controller seeks and gathers a sector of data. How? Information transfers to and from main memory occur as "cycle steals" from the system bus. And the missing memory cycles are transparent to the CPU totaling only two milliseconds instead of the usual 80.

**Build a buffer.** Give the Disk Jockey DMA a little extra memory and your system's performance gets even better. The extra storage is used as a track buffer. So, whenever a sector on a new track is read, the track buffer is automatically filled with the other sec-

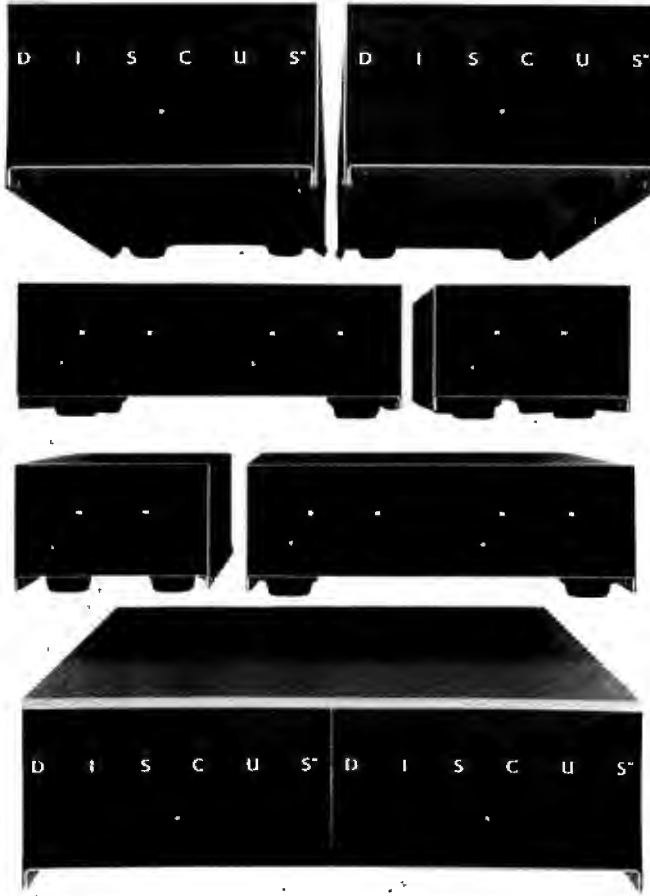

tors on the track. The result? Additional data on the track is immediately available. Without the 80 millisecond rotational latency normally encountered. And similar efficiencies occur with disk writes. Sectors in the track buffer are conditionally written on the disk only if a new track is accessed. And only one revolution of the disk is required.

**Now, prices.\*** All systems listed are supplied with a floppy disk drive, Disk Jockey Direct Memory Access Controller, CP/M\*\* 2.2 operating system, power supply, fan, cables, cabinet and Microsoft 5.2 BASIC.

**Even lower prices.** Morrow Designs' floppy disk systems with Disk Jockey™ 2D controllers offer the same high quality at even lower prices. Now without memory mapping!

**Fast answers.** See Morrow Designs' family of cost effective floppy disk systems at

your computer dealer. For a somewhat more leisurely answer, circle the reader service number below. For immediate answers, phone us at (415) 524-2101.

**LOOK TO MORROW FOR ANSWERS.**

### 5¼ Inch Systems (formatted data)

400,000 Bytes (1) Dual Sided 48 TPI Drive	\$ 995
800,000 Bytes (2) Dual Sided 48 TPI Drive	\$1695
800,000 Bytes (1) Dual Sided 96 TPI Drive	\$1495
1,600,000 Bytes (2) Dual Sided 96 TPI Drive	\$2495

OEM pricing available

### 8 Inch Systems (formatted data)

500,000 Bytes (1) Single Sided Drive	\$1195
1,000,000 Bytes (2) Single Sided Drive	\$1975
1,000,000 Bytes (1) Dual Sided Drive	\$1495
2,200,000 Bytes (2) Dual Sided Drive	\$2575

OEM pricing available

\*Prices subject to change without notice.  
Disk Jockey DMA and Disk Jockey 2D  
are trademarks of Morrow Designs  
\*\*CP/M is a trademark of Digital Research.

## MORROW DESIGNS

5221 Central Avenue, Richmond, CA 94804  
(415) 524-2101

EXP, INT (the floor), LOG (natural), RND, SGN, SIN, SQR, and TAN. New numeric functions include ACOS, ANGLE (easier to use than ATAN for determining the angle given the base and height), ASIN, CEIL (ceiling, the opposite of INT), COSH, COT, CSC (cosecant), DATE, DEG (radians to degrees), EPS (the smallest representable positive number), FP (fractional part—the same as X-INT(X) for positive X), INF (the largest positive number), IP (integer part—the same as INT for positive values), LOG10, LOG2, MAX, MIN, MOD, PI, RAD (degrees to radians), REM (remainder—the same as MOD for positive numbers), ROUND, SEC, SINH, TANH, TIME, TRUNCATE (reduce the number of significant digits, but don't round).

Taking a cue from the hand-held calculators, the user at his option can express angles in degrees instead of radians. Secondary school trigonometry and general math students

should benefit because normally students don't learn radian measure until they take calculus.

### String Operations

The two important operations on strings are concatenation (joining two strings) and substring extraction. The former is accomplished by using the ampersand (&); the latter is achieved by following the string variable with a range enclosed in parentheses. Thus, LINE\$(4:7) gives the fourth through seventh characters of the string LINE\$. This substring notation can appear on the left side of a LET statement, in which case the fourth through seventh characters are replaced by whatever appears on the right side of the LET statement. The old substring functions (SEG\$, MID\$, LEFT\$, etc.) that we have come to know and love are gone. Good riddance!

Functions whose arguments or values are strings include CHR\$, DATE\$, LEN, LCASE\$, ORD, POS,

STR\$, TIMES\$, UCASE\$, and VAL. CHR\$ and ORD are opposite, and associate a character to its numerical value. LCASE\$ and UCASE\$ are lowercase- and uppercase-conversion functions. DATE\$ and TIME\$ give the date and time as strings. STR\$ and VAL are the number-string conversion functions that have been around for a while in BASIC. LEN gives the length of a string. POS searches a string for another string.

### LET Statement

This brings us to a point that may disturb many. The LET in the LET statement is mandatory! One might ask why, as the option to omit it is such a common convention and a convenience to many users. The principal reason was to reduce the number of reserved words while retaining simple parsing. As it is, only the no-argument function names like RND and the words NOT, PRINT, REM, and ELSE are reserved (not allowed to be used as identifiers). This means that a user cannot write LET RND = 3. One should realize, however, that the standard actually prescribes only that *standard-conforming programs* may not omit the LET. Compilers and interpreters may, however, allow users to omit the LET, but they must accept the LET when it is present. Such implementations will have to be smart enough to recognize that:

INPUT = 3

is a LET statement and not an input statement.

### Arrays

Arrays must be dimensioned in the program before use. This rule conflicts with Minimal BASIC, which allows default dimensions for lists and tables (vectors and matrices) that do not appear in DIM statements. You might wonder why we are doing away with the convenience of not having to dimension small arrays. The reason is that general identifiers are now allowed for both arrays and functions. For example, in "LET X = A(3)" the meaning of A(3) is

THE MULTI-USER FRIENDLY MEMORY BOARD WITH

# NO COMPROMISE



- 256 kilobytes 150 NS dynamic ram
- Designed to operate in any S-100 System IEEE or Non-IEEE
- 16-bit addressing option: Powerful Macrotech Memory Mapping (M<sup>3</sup>) bank select architecture allows each 4K block of the 16 bit (64K) logical addresses to be dynamically translated to any 4K block of the 256K on board physical memory.
- 24-bit direct addressing option

- "Educated" cycle control module generates all timing on board *asynchronously* for maximum access speed and uniform operation
- Comprehensive technical manual, with complete installation guide and source listings for MP/M II™ \* and "Virtual Disk" solid state disk applications.
- DMA operation fully supported in strict accordance with IEEE 696 standard.
- 8/16 data transfer protocol
- Parity error detection

- Multilayer board and bus signal filtering for noise-free operation.
- Full one year warranty

If you wish, send a check or money order for \$1,379 (in California add 6% sales tax where applicable). Manual available at \$25.00 each refundable with order.

\*Registered Trademark of Digital Research Corp.  
OEM & Dealer Inquiries invited



MACROTECH International Corp.,  
22133 Cohasset St., Canoga Park,  
California 91303  
(213) 887-5737



INTRODUCING THE:



**SPECIAL INTRODUCTORY OFFER!**

**WITH CP/M™ OPERATING SYSTEM \$2,695**

**A Briefcase Size Computer with Full Size Abilities!**

**Standard Features**

- 4 MHZ Z80 PROCESSOR
- 64K LOW POWER RAM
- 1.2 MBYTE ON DUAL 8" FLOPPIES
- COMPACT SIZE: 5½" X 19" X 19"
- LIGHT WEIGHT - ONLY 30 LBS
- 4 RS-232 SERIAL PORTS
- ENVIRONMENTAL PACKAGING
- SWITCHING POWER SUPPLY

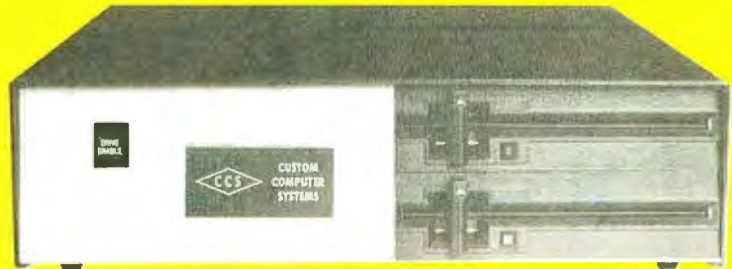

***This Is Not a Personal Computer!***  
THE EXEC-JR IS A TRUE BUSINESS COMPUTER WITH CAPABILITIES TO HANDLE THE TOUGH JOBS.

SERIAL PORTS CAN BE USED FOR TERMINALS, PRINTERS OR MODEMS

**Expansion Options**

- 192K BYTE RAM MEMORY
- MULTI-USER
- DUAL SIDED DRIVES (2.4 MBYTE)
- FIXED DISK INTERFACE WITH 11, 35, OR 70 MBYTE FIXED DISK

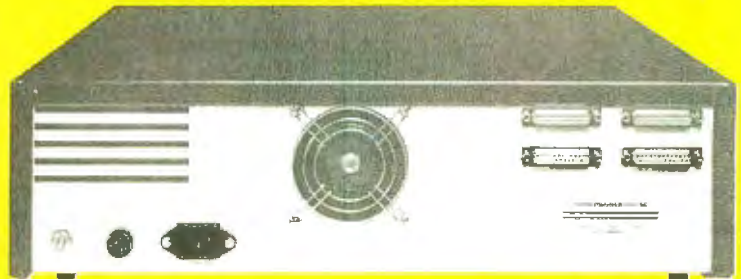

**Affordable Expansion**

**2.4 MBYTE**  
ON DUAL SIDED DRIVES  
ONLY \$375

**64K RAM Expansion**  
FOR A TOTAL OF 128K BYTE  
ONLY \$149

**128K RAM Expansion**  
FOR A TOTAL OF 192K BYTE  
ONLY \$298

*As a closing thought consider this . . .*

*Who else offers a small computer with:*

*192K BYTE RAM, 2.4 MBYTE on Floppies; 4 Serial Terminal Interfaces, Multi-User Capability and CP/M™ Operating System for \$3,368.*

**CUSTOM COMPUTER SYSTEMS INC.**  
AN INNOVATIVE LEADER IN PROCESSING SYSTEMS

Presented By

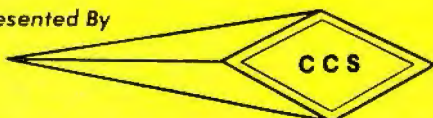

PRICE AND AVAILABILITY SUBJECT TO CHANGE WITHOUT NOTICE.  
REPRESENTATIVE INQUIRIES WELCOME.  
CP/M IS A TRADEMARK OF DIGITAL RESEARCH, INC.

7250 COMMERCE CIRCLE EAST • FRIDLEY, MINNESOTA 55432 • PHONE (612) 574-9493



# We Have It! 'till July 5, take an EXTRA 5% OFF the Prices in this ad!

## SUPER COMPUTER VALUE FROM CALIFORNIA COMPUTER SYSTEMS

4MHz, Z-80, 64K RAM, Disk Controller, C/PM 2.2	
w/dual 5 1/4" SS DD	\$2349
w/dual 5 1/4" DS DD	2599
w/dual 8" SS DD	2995
w/dual 8" DS DD	3595

## INTERTEC SUPERBRAIN

Self-contained computer with dual disks and two RS232C ports. Complete with CP/M 2.2. 64K Double Density, **NEW LOW!** \$2099  
64K Quad Density, **NEW LOW!** 2495

## VIDEO TERMINALS

INTERTEC EMULATOR	\$749
INTERTEC INTERTUBE III	749
ZENITH Z-19	729
SOROC IQ 120	649
SOROC IQ 130	595
SOROC IQ 135	749
SOROC IQ 135G	799
SOROC IQ 140	1149
HAZELTINE ESPRIT	CALL
1420	CALL
1500	CALL
1510	CALL
1520	CALL
TELEVIDEO 910C	CALL
912C	CALL
920C	CALL
925C	CALL
950C	CALL
TEXAS INST. 940 BASIC	1599
940 Package	2079
745 Portable Terminal	1399
745 Portable Terminal w/U/L/Case	1495

## PRINTERS

ANADEX DP-9500	\$1349
DP-9501	1349
PAPER TIGER IDS-560G	1139
PRISM PRINTER IDS-80, w/o color	998
IDS-80, w/color	1349
IDS-132, w/color	1695
NEC 3510, RO RS232C35 CPS	1945
NEC 3530, RO, Centr. Inter. 35CPS	1945
NEC 7710, RO RS232C 85 CPS	2395
NEC 7720, KSR, RS232C 55CPS	2999
NEC 7730, RO, Centr. Inter. 55 CPS	2395
QUME	
Sprint 9/45, LTD, 45 CPS, RS232C	2119
C.I.TOH Pro Writer, Parallel	549
Serial and Parallel	629
DIABLO 630, RS232C, 55CPS	2299
CENTRONICS 730-1, Parallel	399
730-3, RS232C	489
739-1 w/Graphics, Parallel	525
739-3B w/Graphics, RS232C	639
704-11, Parallel	1695
704-9, RS232C	1595
122G, Parallel, 120 CPS	949
EPSON	
MX80	489
MX80FT	589
MX100FT	789
RS232 Serial Interface	65
RS232/2K BufferInterface	125
Graffrax II	90
Apple Printer Interface	75
T110 Basic, RS232C	1349
810 Basic, RS232C & Parallel	1395
810 w/full ASCII, vertical forms control compressed print	1599
820 RO, Basic	1645
820 KSR, Basic	1839

OKIDATA	
Microline 80	\$465
Tractor-feed option	59
Microline 82A	519
Microline 83A	849
Microline 84	1199

## MONITORS

ZENITH-ZYM-121, 12" Green Phos.	\$125
AMDEK 100, 12"	139
100G, 12" Green Phosphor	149
300, 12" Green Phos., Hi. Res.	199
Color, 13"	359
Color II, 13", R.G.B. Hi Res.	799
Apple adapt. for R.G.B.	159
BMC, 12", Green Phosphor	169

## NORTH STAR Call For Prices

## FLOPPY DISK SYSTEMS

MORROW DESIGNS	
Discus 2D, single drive DD	\$898*
Dual Discus 2D, dual drive DD	1549*
Discus 2+2, double sided DD	1239*
Dual Discus 2+2	2139
*Includes CP/M 2+2 and Microsoft Basic	

## HARD DISK SUBSYSTEMS

MORROW DESIGNS	
Discus M-5 5 Meg.	\$2095*
Discus M-10 10 Meg.	3095*
Discus M-20 20 Meg.	4069*
Discus M-26, 26 Meg.	3795*
CORVUS 5 Meg.	3185
10 Meg.	4545
20 Meg.	5499
KONAN David 5 Meg.	2499
10 Meg.	3049
15 Meg.	3295
INTERTEC 10 Meg.	SPECIAL \$3195
*S-100 only w/CP/M 2+2 & Microsoft Basic	

## FLOPPY DISK CONTROLLER BOARDS

CROMEMCO 16FDC DD	\$499
NORTH STAR DD	479
MORROW Disk Jockey 2D, A&T	329
SD SYS. Versafloppy I, A&T	319
SD SYS. Versafloppy II, A&T	429
DELTA DD Disk Cont., A&T	345
CONDUCTOR DD, A&T	269
INTERSYSTEMS, FDC-2, A&T	439
TARBELL DD, A&T	445
SYSTEMS GROUP DD DMA	439

## ESCON CONVERSION FOR IBM SELECTRIC

Complete with microprocessor controller and power supply. Factory built. User installs solenoid assembly or it can be done at ESCON Factory.  
RS232 Serial & Parallel \$534  
Cable for above 25

## PROM PROGRAMMERS

SSM PB1 Kit	\$152
SSM PB1, A&T	225

## MODEMS

NOVATION CAT Acoustic Modem	\$149
D-CAT Direct Connect	155
AUTO-CAT Auto Ans.	219
APPLE CAT	329
USD 103 LP Direct Connect	175
103 JLP Auto Answer	209
DC HAYES MICROMODEM II (Apple)	299
MODEM 100 (S 100)	339
Smart Modem (RS 232)	239
Potomac Micro Magic (S 100)	339

## CALIFORNIA COMPUTER SYSTEMS

Z80 CPU Board	\$269
Disk Controller 2422, w/CP/M	359
16K Static, A&T	259
32K Static, A&T	599
64K Dynamic RAM	449
System 2210 w/64K, CP/M 2.2.	1795

## CPU BOARDS

(assembled unless noted)

NORTHSTAR Z-80A (ZPB-A/A)	\$269
INTERSYSTEMS (MPU-80)	349
SSM CB1 8080, A&T	214
CB2, Z-80, A&T	289
CB2, Z-80, Kit	219
DELTA Z-80 with I/O	289
SD SYSTEMS, SBC-100, A&T	349
SBC-200, A&T	399
SYSTEMS GROUP Z-80 with I/O	419

## MEMORY BOARDS

NORTHSTAR 16K RAM	\$299
HRAM 64K	589
HRAM 32K	419
CROMEMCO 16KZ	419
CROMEMCO 64KZ	595
MEMORY MERCHANT	
16K Static, 4MHz	159
64K Static, 4MHz	549
SYSTEMS GROUP	
(Measurement Systems & Controls)	
DM4800 48K Board	499
DM6400 64K Board	529
DM86400 64K Board	595
INTERSYSTEMS 64K Dynamic	845

## GODBOUN (A&T)

CPU Z	\$249
CPU 8085 88	359
RAM 20 30	359
RAM 17 64	675
RAM 21	1439
Interface 1	210
Interface 2	210
Disk 1	419
System Support 1	335
Enclosure 2 (Desk)	699
Enclosure 2 (Rack)	760

## VIDEO BOARDS I/O Mapped

SD SYSTEMS	
VDB-8024, A&T	\$469
SSM VB2 I/O, Kit	169
VB2 I/O, A&T	229
MEMORY MAPPED	
VB1C, 16x64, Kit	152
VB1C, 16x64, A&T	206
VB3, 80 Char. 4MHz, Kit	359
VB3, 80 Char. 4MHz, A&T	419

## APPLE BOARDS

### CALIFORNIA COMPUTER

7710A Asynchronous Ser Interface	\$129
7712A Synchronous Der Interface	149
7424A Calendar Clock	99
7728A Centronics Printer Interface	99

CPS Multifunction Board	\$199
Supertalker SD200	259
Romplus w/ keyboard filter	179
Romplus w/o keyboard filter	130
Keyboard filter ROM	49
COPYROM	49
Music System	459
ROMWRITER	149
Apple Clock	239
A/D-D/A	295
Expansion Chassis	625

## VISTA

8" Disk Controller (Apple II)	\$495
-------------------------------	-------

All prices, F.O.B. shipping point, subject to change. All offers subject to withdrawal without notice. Advertised prices reflect a 2% cash discount (order prepaid prior to shipment). C.O.D.'s and credits cards are 2% higher.

# MiniMicroMart, Inc.

943 W. Genesee St. P.O. Box 2991B Syracuse, N.Y. 13220 (315) 422-4467 TWX 710-542-0431



# We Have It!



**Integrated Desk Top Computer with 12 inch Bit-Mapped Graphics or Character Display, 64Kb RAM, 4 MHz Z80A,<sup>®</sup> Two Quad Capacity Floppy Disk Drives, Selectric<sup>®</sup> Style 87 Key Keyboard, Business Graphics Software**

FOLLOW THE STAR  
**NorthStar<sup>™</sup>**

## The New ADVANTAGE

w/ graphics running in sepearte 20K of RAM;  
also includes 2K Boot Strap ROM.

**Optional operating systems.**

G/DOS runs existing NorthStar programs: Graphics C/PM<sup>®</sup> also runs conventional NorthStar C/PM<sup>®</sup> programs. Serial ports and parallel ports are available as options.

**Call for prices.**

Typical Systems Graphics

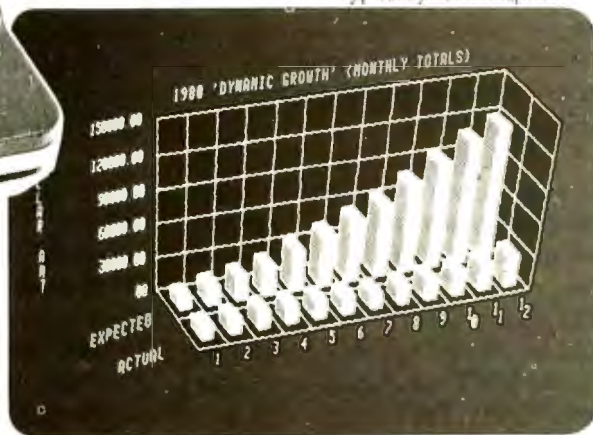

3-DIMENSIONAL CHART

### MULTI-USER HORIZON SYSTEMS

**Low Cost, Packaged, High Performance, Multi-user HORIZON<sup>®</sup> systems with 5Mb or 18Mb Integrated Winchester Hard Disks, Up to Five Users.**

**HRZ-IQ-64K-HD5**  
w/5 Megabyte Winchester . . . . . **\$4749\***

**Four-User HORIZON IQ-64K-18H**  
w/ 18Mg Hard Disk. only **\$8260\***

\* Through June 30, 1982

**Optional Operating Systems.**

Multi-user operating systems now available to run both NorthStar DOS/BASIC and standard C/PM programs (offers more available RAM than an MP/M system)



**HORIZON 2Q-64K, \$2896\***

(with metal case)

**H RAM 64K Memory Board, \$595\***

\* Through June 30, 1982

All prices, F.O.B. shipping point, subject to change. All offers subject to withdraw without notice. Advertised prices reflect a 2% cash discount (order prepaid prior to shipment). C.O.D.'s and credit card orders are 2% higher.



# MiniMicroMart, Inc.

943 W. Genesee St. P.O. Box 2991B Syracuse, N.Y. 13220 (315) 422-4467 TWX 710-542-0431

Circle 320 on Inquiry card.

ambiguous because it could be either element 3 of the array A, or the function A evaluated at 3.

There are three ways out of the dilemma. First, a two-pass compiler (or interpreter that does a pre-scan) could assume that A(3) was an array if it didn't find a function definition for A later in the program. Second, one could require that all functions be declared early in the program. Third, one could require that all arrays be declared early in the program. The committee adopted the third option because most arrays have to be dimensioned anyway and it's customary to place the dimension statements early in the program.

A MAT package includes matrix (or vector) input and output, scalar multiplication, matrix add, subtract, and multiply, and the matrix functions of linear algebra INV, TRN, DOT, and DET. Even those who have no interest in linear algebra will find the MAT input and output statements handy. For instance, suppose a small firm has several departments,

and that the sales results for all of them are kept in several lists (one-dimensional arrays). Then:

```
MAT net__sales =
      gross__ sales - expenses
```

will calculate the net sales for all departments at once. (The above statement, and others like it later in the article, is intended to occupy a single line.)

Only one- and two-dimensional arrays are included in the standard, though designers of interpreters and compilers may choose to allow more.

### Logical Expressions

Minimal BASIC allows only simple relational expressions (such as  $X \leq Y$ ) in IF statements. BASIC allows these to be combined using AND, OR, and NOT to form logical expressions. Parentheses are allowed, in case you forget whether AND takes precedence over OR or vice versa. Whereas Minimal BASIC allows only = and <> with strings (as

with  $IF A\$ = "YES"$ ), BASIC allows the full range of relational operators with strings. What actually happens when "IF  $A\$ < B\$$ " is used depends on the collating sequence. For instance, the ASCII collating sequence specifies that "B" comes before "a".

### Branching and Decision Making

The programmer can continue to use GOTO and IF. . . THEN from Minimal BASIC. Or instead he can choose to use structured constructs now typical of almost all programming languages. Take, for instance, the IF. . . THEN. . . ELSE construct. In BASIC, this takes the form:

```
IF <logical expression> THEN
. . .
ELSE
. . .
END IF
```

Two important features of this construct are, first, the keywords that define the construct must appear at the beginning of separate lines. Thus, the ELSE and END IF cannot be obscurely buried near the end of a line. Second, the construct ends with a keyword sequence that is unique to that construct.

You can use the simple one-line IF. . . THEN. . . ELSE, which might look like this:

```
IF x < y THEN LET a = 3
      ELSE LET a = 4
```

With both forms of IF. . . THEN. . . ELSE, the programmer may omit the ELSE part.

### Looping Structures

The FOR NEXT loop of Minimal BASIC is retained, and a new structure, the DO LOOP, is added. The loop-ending condition (or conditions) may be attached to the DO statement, the LOOP statement, or both. The loop-ending condition may be expressed either as a WHILE or as an UNTIL. The following is typical:

```
DO UNTIL i > n OR a$ = list$(i)
. . .
LOOP
```

## BYTEWRITER

### DAISY WHEEL PRINTER

LETTER QUALITY PRINTER AND TYPEWRITER  
IN ONE PACKAGE

The BYTEWRITER is a new Olivetti Praxis 30 electronic typewriter with a micro-processor controlled driver added internally.



\$795

plus shipping

Dealer  
Inquiries  
Invited

**FEATURES**

- Underlining • 10, 12, or 15 characters per inch switch selectable • 2nd keyboard with foreign grammar symbols switch selectable • Changeable type daisy wheel
- Centronics-compatible parallel input operates with TRS-80, Apple, Osborne, IBM and others • Cartridge ribbon • Typewriter operation with nothing to disconnect
- Service from any Olivetti dealer • Self test program built in.

## BYTEWRITER

125 NORTHVIEW RD., ITHACA, N.Y. 14850  
(607) 272-1132

Praxis 30 is a trademark of Olivetti Corp.  
TRS-80 is a trademark of Tandy Corp.  
BYTEWRITER is a trademark of Williams Laboratories.



# Start talking business



## with your Apple

COBOL is the most effective business language.  
Apple II is the most friendly business computer.

CIS COBOL with FORMS-2 brings together the best features of COBOL and Apple to enable you to deliver the most effective, user-friendly applications.

**Business Programmers:** Take the COBOL expertise you have acquired on big business mainframes, and use it on Apple II to create friendly applications that will talk directly to your users—where it suits them best, on their own desks.

CIS COBOL's dynamic module loading gives you big application capability and the FORMS-2 source generator lets you build and modify conversational programs from visual screen formats, creating much of the code automatically.

**Application vendors:** CIS COBOL with FORMS-2 steps up the pace for your development of the high quality professional application packages needed today. And creating them in COBOL makes them more maintainable.

Over half the Apple II's now being sold are going to business or professional users so demand for quality applications is growing fast, creating big business opportunities for you.

### **Stability proven by the US Government.**

CIS COBOL has been tested and approved for two consecutive years by the US General Services Administration as conforming to the ANSI '74 COBOL Standard. Apple II under CP/M is included in CIS COBOL's 1981 GSA Certificate of Validation (at Low-Intermediate Federal Standard plus Indexed I-O and Level 2 Inter-Program Communication).

**Get your hands on CIS COBOL at your Apple dealer.**

**Talk business with him now!**

Micro Focus Inc., 1601 Civic Center Drive  
Santa Clara, CA 95050. Phone: (408) 248-3982.

 **MICRO FOCUS**

CIS COBOL with FORMS-2 for use on the Apple II with CP/M is an Apple Distributed Product. CIS COBOL and FORMS-2 are trademarks of Micro Focus. CP/M is a trademark of Digital Research. Apple II is a trademark of Apple Computer.

Circle 300 on Inquiry card.

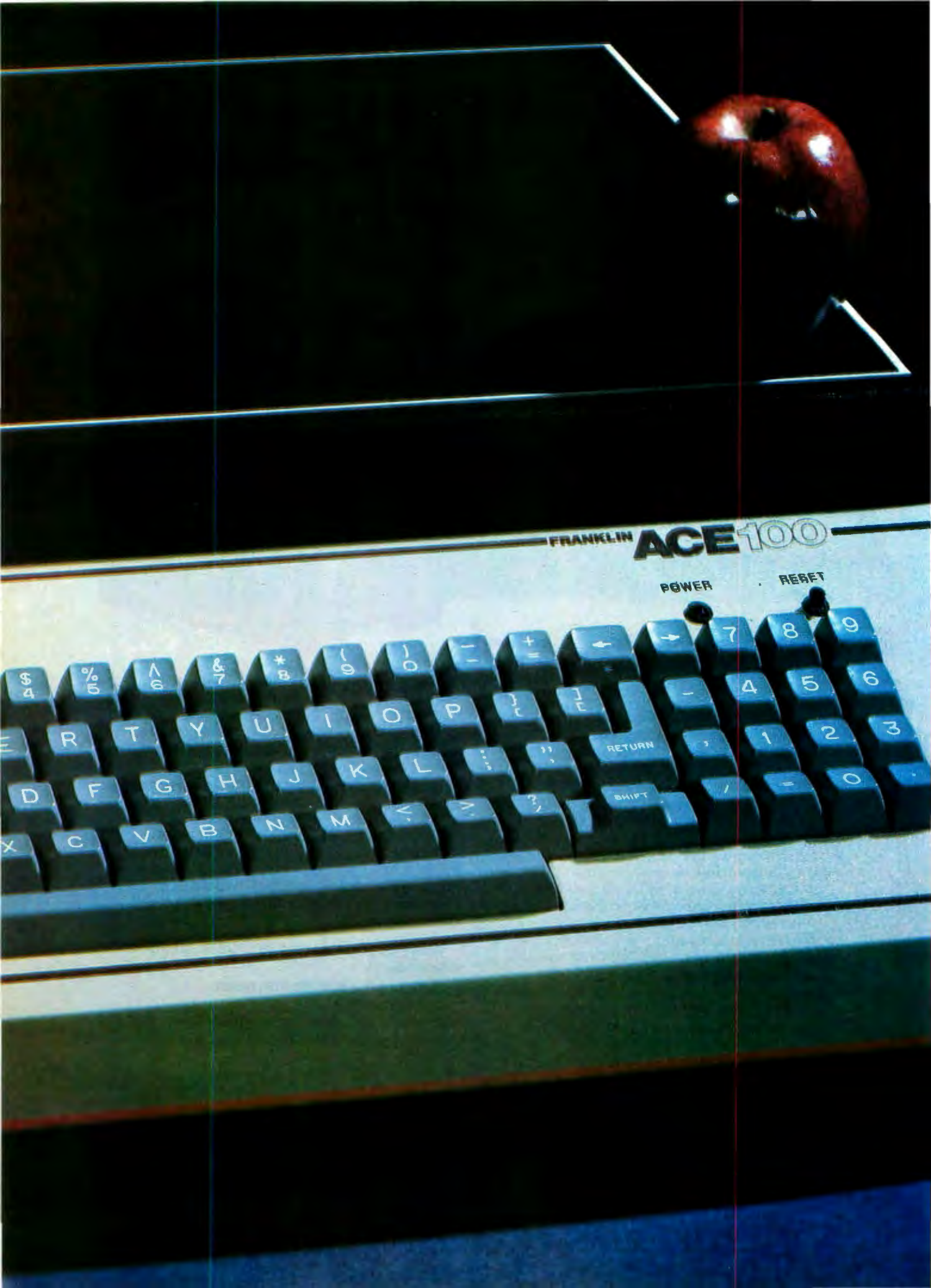

FRANKLIN **ACE100**

POWER . RESET



# WHAT IS SWEETER THAN AN APPLE?

## THE FRANKLIN **ACE**100

The Franklin ACE 100 is hardware and software compatible with the Apple® II. It is sweeter because it is more versatile, it includes 64K of RAM memory and—it costs less.

Any program that runs on the Apple II will run on the Franklin ACE 100. Any peripheral that works with Apple will work with ACE. The Franklin ACE 100 generates upper and lower case characters and includes a numeric pad, an alpha lock key and VisiCalc® keys.

The Franklin ACE 100—a professional personal computer with the quality and reliability for the most demanding business applications. It is sweeter than an Apple. Call or write today for the name of your local authorized Franklin dealer.



**FRANKLIN**  
COMPUTER CORPORATION

7030 Colonial Highway  
Pennsauken, NJ 08109  
609-488-1700

Circle 192 on inquiry card.

Franklin ACE is a trademark of Franklin Computer Corporation.  
Apple is a registered trademark of Apple Computer Inc.  
VisiCalc is a registered trademark of Visi Corp.

# THIS MONTH'S TOP TEN

TITLE	MANUFACTURER	LIST	NOW
dBase II	Ashton-Tate	700.00	499.00
WordStar	MicroPro	495.00	299.00
WordStar w/MailMerge	MicroPro	645.00	385.00
Supercalc	Sorcim	295.00	210.00
Pascal MT+	D. Research	475.00	425.00
CalcStar	MicroPro	295.00	185.00
CB80	D. Research	500.00	420.00
FMS 80 I	Systems+	495.00	359.00
PL 1/80	D. Research	500.00	420.00
Select w/Superspell	Select Info Systems	595.00	395.00

## MOVING UP THE CHARTS.....

Spellguard	ISA	295.00	225.00
Supervyz	Epic	100.00	90.00
Spellbinder	Lexisoft	495.00	295.00
Condor II	Condor	595.00	450.00
Mathemagic	ISM	100.00	90.00
Condor III	Condor	995.00	750.00

OSBORNE OWNERS: dBase II, Supervyz, Quickscreen, Spellguard, Crosstalk, Mathemagic, and many others available for the Osborne I at our advertised prices!

## GREAT HARDWARE BUYS!

**NEW!** C. ITOH 8500 PROWRITER Amazing 120 CPS printer w/Graphics, logic seeking, friction/tractor & more.  
Parallel/8500 List \$795.00 ..... \$515.00  
Serial/Parallel/8500 List \$845.00 ..... \$650.00

**NEW!** C. ITOH F10 STARWRITER Daisy-wheel Printer-incredible 40 CPS printer with all the features of Diablo, NEC, and Oume, at half the price!  
Parallel (Centronics interface) unit: List \$1995.00 ..... \$1475.00  
Serial (RS-232) interface unit: List \$1995.00 ..... \$1475.00  
F10 Tractor Feed Option: List \$325 ..... \$250.00  
2K Buffer Option ..... CALL  
Features Upgrade Option ..... CALL



**NEW!** SMITH-CORONA TPI Daisy-wheel printer-Letter quality printing at an unbelievable price! 120 WPM, parallel or serial interface (specify).  
List \$895.00 ..... \$750.00

### PRINTER ACCESSORY PACKAGES:

Apple II package: Complete package to interface with any of the above printers—includes cable and interface card: ..... \$120.00

Osborne Package: Osborne cable to interface to any of the above printers: ..... \$40.00

Other interface packages available for TRS-80, IBM, Xerox, Apple III, etc. .... CALL

HAYES SMARTMODEM-List 279.00 ..... \$230.00

**NEW!** SIGNALMAN MARK I direct-connect modem  
Auto Answer, W/RS-232 cable!! ..... \$99.95

Call for similar savings on ZENITH, ALTOS, OKIQUATA, HAYES, NORTHSTAR, TELEVIDEO, NEC, XEROX, ANAOEX, OUME, XCOMP, IDS, CENTRONICS, AMDEK, NOVATION, SANYO, EPSON.

## MORE SOFTWARE HITS.....

ART. INTELLIGENCE Dental 750.00 Medical 750.00	FRIENDS SFTW. Access 80 I 240.00 Access 80 II 405.00	MICRO-AP Selector III 165.00 Selector IV 235.00 Selector V 395.00 Glector III 170.00 Glector IV 250.00 SBasic 255.00	MICROSOFT COBOL 80 575.00 Macro 80 175.00 Edit 80 110.00 MuMath 220.00 MuLisp 170.00 MSort 165.00	STD. MICROSYS. Quic-n-Easi 299.00 Mailman 105.00
BUS. PLAN. SYS. Plan 80 240.00	GRAHAM OORIAN Apt. Mgmt. 240.00 C. Reg., Inv. I, Pay I, each 485.00 GLedg, Inv. II, OE/Inv., Pay II, 125.00 CP/M 2.2 135.00 MAC 85.00	MICROPRO Cust. Notes 350.00 DataStar 225.00 SuperSort I 170.00 SpellStar 165.00	SYSTEMS PLUS Acct. Plus 425.00 1 Module 785.00 2 & Up CALL	STRUCT. SYSTEMS G.L., A. Rec. Analyst 225.00 Ltright 175.00
DIGITAL RESEARCH PL/1-80 420.00 CBasic 125.00 CP/M 2.2 135.00 MAC 85.00	KEY BITS Wordsearch 175.00	MICROSOFT Basic 80 275.00 Compiler 310.00 Fortran 80 395.00	MIDW. MICRO TEK Cross Assem. 250.00 68XX CALL	SUPERSOFT Disk Doctor 95.00 Forth 175.00 SSS Fortran 210.00 Tiny Pascal 80.00 C Compiler 174.00 StarEdit 189.00
ECOSOFT Microstat 250.00	MARK OF UNICORN Mince 148.00 Scribble 148.00 Both 245.00			
FIN. PLAN. ASSOC. Mini-Model 375.00				
FOX & GELLER Quickscreen 140.00				

This is just a sample of the CP/M software available from DATASOURCE. Call us for great savings on the package you're looking for. APPLE TOO! We carry many of these items in Apple CP/M format..call!

**ORDER/TECHNICAL HOTLINE:**  
**1-612-944-7907**



**ORDERING INFORMATION** MAIL ORDERS: Cashier's check or money order. Charge cards add 3%. Shipping: \$3.00 per software item, 2% per hardware item. Min. res. add 5% sales tax. Pricing and avail. subj. to change. Prices are mail order only. DataSource is a Division of DataSource Systems Corporation. CP/M is a registered Trademark of Digital Research Corp.

**DataSource Systems**

P.O. BOX 35007 MINNEAPOLIS, MN 55435 612-944-7907

In addition, a DO LOOP may be exited with an EXIT LOOP statement. Whenever such a statement appears in the body of a loop, the next statement executed will be the one following the first LOOP statement encountered. The following example is typical:

```
DO
PRINT "Input an integer ";
PRINT "between 1 and 7";
INPUT x
IF 0 < x AND x <= 7 AND
x = INT(x) THEN EXIT DO
PRINT "Bad number; reenter"
LOOP
```

The EXIT DO gets you out of a DO LOOP. Similarly, an EXIT FOR gets one out of a FOR NEXT loop. The previous example of the DO LOOP for searching a string list could also be written:

```
FOR i = 1 TO n
IF a$ = list$(i) THEN EXIT FOR
NEXT i
```

Exit statements are also provided for multiline defined functions and subprograms.

## Multiway Selection

A SELECT construct allows choosing one of many alternatives. The following example illustrates some of its features:

```
SELECT DICE
CASE 7, 11
PRINT "Win"
CASE 2, 3, 12
PRINT "Lose"
CASE ELSE
PRINT "Roll again"
END SELECT
```

## Functions, Subprograms, and Chaining

Minimal BASIC gives us two simple methods for program modularization—single-line defined functions and subroutines (of the GOSUB RETURN type). BASIC adds three methods: multiple-line defined func-



# CALL "THE COMPUTER-LINE"™

When you call us, you talk to fully qualified computer specialists trained to answer all your questions pertaining to our line of microcomputers. We are reknown for our excellent after sales support and our promptness for delivery. Peace of mind and excellence in service is our pledge to all our customers.

## NEC PERSONAL COMPUTER

PC-8001A Keyboard and processor unit, including 32K Ram, 24KB N-Basic Rom, cassette tape recorder interface, parallel printer interface, display interface.  
\$749

PC-8012A Modular expansion unit, including I/O bus extension, diskette adaptor, 32KB Ram, real-time clock, 8 priority interrupt levels, 6 slots for additional boards.  
\$479

PC-8023A Dot matrix printer - 100 cps, bidirectional printing, proportional printer.  
\$499

PC-8031A Dual diskette unit, including two 163K byte diskette drives, interface cable, enclosure and operating system.  
\$749

We carry the entire line of NEC/BPI software for the personal computer. Please call or write for information.

## HEWLETT-PACKARD PRODUCTS • PLEASE CALL OR WRITE FOR CATALOG.

## APPLE SOFTWARE PLEASE CALL OR WRITE FOR OUR COMPREHENSIVE CATALOG.

Absolutely no one has lower Apple software prices!

### MICROCOMPUTER BUSINESS INDUSTRIES

Appletime™ Clock Card	\$ 89
VIP™ I Card. (The Ultimate graphics interface + cable)	\$99
All other VIP™ Cards	\$CALL

(See advertisement this Byte)

### CALIFORNIA COMPUTER SYSTEMS

7710 Async. Serial Int.	\$135	CPS Multi-Function Card	\$169
7490 GPIB (IEEE-488) Int.	\$239	The Clock	\$229
7470 Ana. to Dig. Converter	\$ 99	Supertalker	\$159
7711 Async. Serial (Term)	\$135	Music System	\$319
7712 Sync. Serial Int.	\$149	Expansion Chassis	\$599
7721 Apple Parallel Int.	\$109	Romwriter	\$139
Calendar/Clock Module	\$ 99	Ram Plus (32K Board)	\$149
Programable Timer	\$ 99		

### MOUNTAIN HARDWARE

7710 Async. Serial Int.	\$135	CPS Multi-Function Card	\$169
7490 GPIB (IEEE-488) Int.	\$239	The Clock	\$229
7470 Ana. to Dig. Converter	\$ 99	Supertalker	\$159
7711 Async. Serial (Term)	\$135	Music System	\$319
7712 Sync. Serial Int.	\$149	Expansion Chassis	\$599
7721 Apple Parallel Int.	\$109	Romwriter	\$139
Calendar/Clock Module	\$ 99	Ram Plus (32K Board)	\$149
Programable Timer	\$ 99		

## COMPARE!

DRIVES FOR APPLE / WITH CONTROLLER \$459

ADD-ON \$389

Hard Disks + 8" Disks for Apple, TRS-80 \$CALL  
Apple Computer Products \$CALL

### PRINTERS

NEC Spinwriter 7710	\$2339	INTEGRAL DATA SYSTEMS PRISM 132 Color printer with all options	
8023A	\$ 499		

EPSON MX-80	\$ 429	• 200 cps Sprint Mode	
MX-80FT	\$ 529	• 4-color printing	
MX-100	\$ 699	• Friction/Tractor feed	\$1595

All Epson and NEC dot matrix printer prices quoted are for **immediate** delivery inclusive of shipping, insurance and handling charges.



### C-ITOH

F10 word quality printer	\$CALL
Prowriter	\$CALL

OKIDATA PRINTERS	\$CALL
CORONA-SMITH	\$CALL

### BUSINESS SOFTWARE

VISICORP, INC. Desktop Plan III	\$229	STONWARE DB Master	\$169
Desktop Plan II	\$189	DB Utility Pack	\$ 69
Visifiles	\$189	MICRO PRO Apple CP/M	
Visiplot	\$159	Word Star	\$219
Visitrend/Visiplot	\$229	Super Sort	\$119
Visidex	\$189	Mail Merger	\$ 79
Visiterm	\$ 79	Data Star	\$179
Visicalc 3-3	\$189	Spell Star	\$119
Visipak	\$539	Call Star	\$119

### INFORMATION UNLIMITED

Pro Easy Writer \$169

Call For Continental, Dakin 5, Broderbund, Automated Simulations, Avant-Garde, Edu-Ware, Denver, Howard, Sirius, Sensible, Synergistic Software, Etc.

## IBM PRODUCTS • PLEASE CALL OR WRITE FOR CATALOG.

### MODEMS

Hayes Micromodem II	\$289	Verbatim Datalife	\$ 24-95
Hayes Smartmodem	\$229	Verbatim 8"	
Hayes Chronograph	\$199	Double-Side/DD	\$ 39-95
Novation Cat	\$145	RAM CARDS	
Novation D-Cat Modem	\$165	Davong 16K Card	\$ 89
Novation Apple Cat II	\$339	Microsoft 16K Card	\$129
Novation Auto Cat	\$209	T and G PRODUCTS	

### DISKETTES (Boxes of 10)

Game paddles	\$ 29
Joy Stick	\$ 44
Selecta-port Expander	\$ 49

### MONITORS

Zenith ZVM-121 Phosphor		80 COLUMN CARDS FOR APPLE	
15 MHZ	\$119	Wesper 80 Card	\$259
NEC 1201 Phosphor		Vision 80 Card (Vista)	\$299
20 MHZ	\$179	Videx 80 Card	\$259
NEC 0112 Composite Color	\$335	MISCELLANEOUS APPLE PRODUCTS	
NEC 2112 RGB Color	\$899	Enhancer II	\$ 119
Amdek 300 Phosphor	\$199	Dana Apple Fan	\$ 39
Amdek Composite Color	\$355	Sup R Mnd	\$27-95
Amdek IBM Compatible Color	\$899		

IN COLORADO (303) 279-2727

# CALL "THE COMPUTER-LINE"™ 1-(800)-525-7877

COMPUTERWORLD INTERNATIONAL, INC.

SUITE 133, P.O. BOX 81, WHEAT RIDGE, COLORADO, U.S.A. 80034-0081



TERMS: RETAIL/MAIL ORDER: ADD 1% SHIPPING (MINIMUM \$2.50) - UPS GROUND.

WE HONOR ALL MANUFACTURERS WARRANTIES AND EXCHANGE FAULTY GOODS IMMEDIATELY. SPECIALISTS IN APO AND INTERNATIONAL DELIVERIES.

RETAIL: 1019 8TH STREET  
GOLDEN, CO 80401

tions, subprograms, and the ability to chain. Multiple-line defined functions begin with a DEF statement and end with an END DEF statement. In between, there can be any code, but there should be at least one LET statement having the name of the function on the left side.

Subprograms are external to the main program and to each other. Their internal variables are thus local to them, in contrast with defined functions, which can access all variables in the program unit in which they are defined. Parameters of subprograms can be numeric, string, ar-

ray (of either type), or a channel-setter (which refers to a file, which I'll discuss later). Because input to and output from subprograms is through the calling sequence only, subprograms can be separately compiled (on those systems that provide compiling) and collected into libraries.

Multiple-line defined functions may also be made external to the program, so they can be collected into libraries. In this use, they start with the keyword FUNCTION instead of DEF and end with END FUNCTION.

A CHAIN statement allows a program to stop and start running some

other program, which could be in a different language. Information may be passed to the chained-to program through an argument list that works the same as with defined functions. That is, arguments may be numeric or string expressions or arrays, and they are called "by value." The corresponding parameters in the chained-to program follow the keyword PROGRAM.

### Input and Output

The READ and DATA statements work as they do in Minimal BASIC. String data can be quoted, in which

# microShell™ conducts your CP/M™ computer with more power than ever before!

#### WHAT IS MICROSHHELL?

MicroShell is a normal CP/M program which adds a powerful set of commands to all programs running under CP/M. MicroShell remains in your computer, out of the way to continue to process your commands.

#### WHAT WILL MICROSHHELL DO?

All the normal CP/M commands, plus:

- Automatic Disk and User Management - No more copying all your programs to each disk you use and having directories filled with programs. With MicroShell you can work on a nice clean disk or in a separate user area and MicroShell will find your programs from another drive or user number -automatically! You'll save time and precious disk space.
- Powerful Redirection Capability - You can send screen output to a file or to the printer. Or send printer output to a file. Or take program input from a file instead of the keyboard.
- Much More: Multiple commands on a line, more powerful and faster "submit" capability, and user-definable prompt.

#### DEALERS - MICROSHHELL GIVES YOU:

- An interface to the computer that can be tailored to the user's level of experience.
- Automatic execution of an application program at startup.
- MicroShell can manage self-running demos to free up your salesman from demonstrating software packages; have the software package sell itself!

#### WILL MICROSHHELL RUN ON MY COMPUTER?

If your computer runs CP/M 2.2, that's all you need to run MicroShell. Most popular 8 and 5 inch disk formats available. And MicroShell runs on Apple-CP/M, and IBM PC with "Baby Blue".™

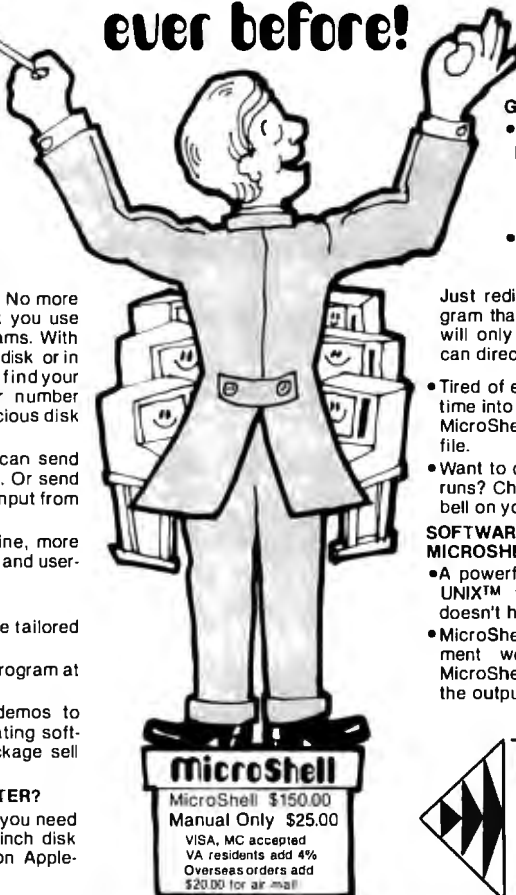

#### GIVE ME SOME EXAMPLES!

- Run Wordstar™ (or your favorite word processor) from any disk drive or user area: MicroShell will automatically find the programs and overlays as they are needed.
- Wish you could save the screen from some program for later use or to edit into a report? With MicroShell, you can! Just redirect the output into a file. Have a program that prints a report you want to save but it will only go to the printer? With MicroShell you can direct the printer output into a file.

- Tired of entering the same commands time after time into a program? Put them into a file and have MicroShell supply them to the program from the file.
- Want to do something else while a long program runs? Change MicroShell's prompt to sound the bell on your terminal.

#### SOFTWARE DEVELOPERS - MICROSHHELL GIVES YOU:

- A powerful development environment with many UNIX™ features, and some that even UNIX doesn't have.
- MicroShell eases the part of software development we all dislike: documentation. With MicroShell, you can run your program and collect the output in a file.

CALL OR WRITE TODAY!

**NEW  
GENERATION  
SYSTEMS, inc.**

2153 Golf Course Drive, Reston Va. 22091  
Phone: (703) 476-9143

CP/M - TM Digital Research, UNIX - TM Bell Labs, Wordstar - TM MicroPro, Baby Blue - TM XEDEX



# COMPUTER WAREHOUSE

CALL TOLL FREE **1-800-528-1054**

## ATARI

Special 32K 800 System  
800 w/32K. recorder, star  
raiders, joysticks ..... **Call**  
Above w/48K ..... **Call**

800 (16K) ..... **\$670**  
400 ..... **\$340**  
810 Disk Drive ..... **\$440**  
825 Printer ..... **\$590**  
850 Interface ..... **\$170**  
410 Recorder ..... **\$ 75**  
830 Modem ..... **\$155**  
16K Memory ..... **\$70**  
32K Memory ..... **\$125**

## MOUNTAIN HARDWARE

All products ..... **Call**

## DISK DRIVES

Lobo  
Apple 1st Drive ..... **\$400**  
Apple 2nd Drive ..... **\$350**

Percom  
Atari D/D Drives ..... **Call**

## PRINTERS

C. Itoh  
F-10 - Parallel ..... **Call**  
F-10 - Serial ..... **Call**  
55CPS - Series ..... **Call**  
Prowriter ..... **Call**  
1550 ..... **Call**

Datasouth  
DS 180 ..... **\$1260**

Diablo  
630 RO w/Tractors ..... **\$2260**  
630 RO wo/Tractors ..... **\$2050**  
630KSR wo/Tractors ..... **\$2435**

Epson  
MX-80 ..... **Call**  
MX-80 F/T ..... **Call**  
MX-100 ..... **Call**

Integral Data Systems  
Prism 80 ..... **Call**  
Prism 132 ..... **Call**

NEC  
PC-8023A ..... **Call**  
3510 ..... **\$1690**  
7710 ..... **Call**  
7720 ..... **Call**

Okidata  
Microline 80 ..... **\$330**  
Microline 82-A ..... **\$455**  
Microline 83-A ..... **\$740**  
Microline 84 ..... **Call**

Tally  
1805/1802 ..... **\$1555**  
1605/1602 ..... **\$1325**

Texas Instruments  
810 Basic ..... **Call**

## MONITORS

Zenith  
12" Green Screen ..... **\$115**

Amdek  
Video 100 ..... **Call**  
Video 300 ..... **Call**  
Color I. .... **Call**  
Color II. .... **Call**

## INTERNATIONAL DEALER INQUIRIES INVITED

To celebrate  
the beginning of our  
**3rd YEAR** we are offering  
**FREE SHIPPING** on  
all U.P.S. shipments

## SPECIAL WORD PROCESSING SYSTEM

Altos 8000-2, Televideo 950, Diablo 630RO, Word Star, Cables ..... **\$5830**  
above w/TELEVIDEO 910 ..... **\$5500**

## VIDEO TERMINALS

Adds  
Viewpoint ..... **\$530**

Altos  
Altos I ..... **Call**

Soroc  
IQ 120 ..... **Call**  
IQ 130 ..... **Call**  
IQ 135 ..... **Call**  
IQ 140 ..... **Call**

Televideo  
910 C ..... **\$570**  
912 C ..... **\$675**  
920 C ..... **\$735**  
925 C ..... **\$730**  
950 C ..... **\$915**

Zenith  
Z-19 ..... **\$680**

## DISKETTS

Elephant  
5 1/4" 0. Sector (100) ..... **\$215**

Maxell  
5 1/4" 0. or 10. Sector  
(100) ..... **\$300**  
8" 0. Sector (100) ..... **\$370**

## SOFTWARE

WordStar ..... **\$295**  
Mailmerge ..... **\$100**  
SpellStar ..... **\$160**  
DataStar ..... **\$240**  
CalcStar ..... **\$220**

## COMPUTERS

Altos  
ACS 8000-15 ..... **\$3850**  
ACS 8000-2  
w/CPM\* ..... **\$2650**  
Series 15D ..... **Call**  
Series 5-5D ..... **Call**

Alspa  
ACI-1 ..... **Call**  
ACI-2 ..... **Call**

California Computer  
Systems ..... **Call**

IBM  
Personal Computer ..... **Call**

NEC ..... **Call**

Northstar  
Advantage ..... **Call**  
Horizon II 64K QD ..... **\$2625**

Televideo Systems  
TS-802 ..... **Call**  
TS-802H ..... **Call**

Zenith  
Z-90 64K w/CPM\* ..... **\$2385**

## MODEMS

Novation  
CAT ..... **\$140**  
D-CAT ..... **\$155**  
Apple Cat II ..... **\$349**  
Auto Cat ..... **\$235**



2222 E. Indian School Rd. • Phoenix, Arizona 85016

Order Line: 1-800-528-1054

Other Information: 602-954-6109



Store Hours: Tues.-Fri. 10-5 MST Saturday 10-2 MST

# INVESTMENT ANALYSIS FROM CENTENNIAL

CENTENNIAL SOFTWARE / 410 17TH ST. SUITE 1375 / DENVER, CO 80202 / (303) 595-9193

## STOCK-FOCUS

Find out how low is low and how high is high. Using capital structure and performance data, Stock-focus objectively calculates the underlying value of a stock. The system was first developed by the management science department of a major money center bank, and is now in use by investment advisors, trust companies and brokerage houses. On your screen, Stock-focus will plot an estimate of lowest value, highest value and the current price. You then decide what to buy, sell or hold.

## REAL-FOCUS

Exhaustively analyze potential real estate investments using the Wharton School's approach to real estate analysis. In minutes you can project profit, costs, and IRR for any project over a 10 year period. Real-focus accounts for amortization, debt, income, operating expenses, taxes, depreciation, and cash flows for both after-tax holding and the results of sale. With Real-focus you can analyze any potential investment from a single building project to a complex time-phased planned unit development.

## THE FOCUS TECHNIQUE

FOCUS is CENTENNIAL SOFTWARE's new approach to Program Architecture, providing a natural interaction between microcomputers and users. It provides worksheet style input screens, free access to all program segments, and the ability to com-



bine individual results files for portfolio analysis. You also receive a usable reference manual, menu helps, a program glossary, multiple report formats and spooling. With our FOCUS technique even the most complex programs are versatile and easy to use.

COMPUTER	MEMORY-K	REAL-FOCUS	STOCK-FOCUS
IBM PC	64	\$179.00	\$189.00
Apple (plus) II	32/48	149.00	159.00
TRS-80 I	32/48	149.00	159.00
TRS-80 II	64	179.00	189.00
TRS-80 III	32/48	149.00	159.00

### ALL PROGRAMS IN DISK BASIC

IBM is a trademark of IBM. Apple is a trademark of Apple Computer Corp. TRS-80 is a trademark of Tandy Corporation.

**ORDER NOW! FILL IN OR CALL 800-525-2003 (Toll Free)**

PROGRAM NAME \_\_\_\_\_ COMPUTER \_\_\_\_\_ MEMORY \_\_\_\_\_  
 NAME \_\_\_\_\_ PHONE # \_\_\_\_\_  
 ADDRESS \_\_\_\_\_      
 ACCOUNT # \_\_\_\_\_ EXP. DATE \_\_\_\_\_

case the string includes all characters between the quote marks including possible leading and trailing spaces. If the string data contain no leading or trailing spaces, commas, or quote marks, they may be unquoted.

The INPUT statement works as in Minimal BASIC. Inputting an entire line without regard to commas and leading and trailing spaces is done with the LINE INPUT statement.

Input-prompt strings other than the "?:" can be provided. In addition, timeout control can be added. The following example is typical:

```
INPUT PROMPT "Answer = ",
TIMEOUT 5, ELAPSED t:
answer
```

As in Minimal BASIC, PRINT statements may use the comma to move to the next print zone, the semi-colon to stay where you are, and the TAB function to move to a specified columnar position. BASIC provides, in addition, a PRINT USING statement for more elaborate output formatting. The image, which is like a picture of the eventual printed line, can be contained in a string or in an IMAGE statement referred to by its line number. The alternate forms of the PRINT USING statement are:

```
PRINT USING format$: . . .
or
PRINT USING 100: . . .
```

Array input and output are also included. Variable amounts of input can be received by the statement:

```
MAT INPUT A(?)
```

## Files

BASIC provides for four types of file organization: sequential, stream, relative, and keyed. Sequential files consist of records that must be accessed sequentially. Stream files consist simply of a stream of values and must also be accessed sequentially. Relative files are sometimes called random-access files; they probably will exist on disks. Keyed files are accessed not by record number but by some key.

# A Smaller Alternative.

Need a quick, easy way to talk to a computer? Here's a hand-held, fully portable computer terminal that gives instant access to any ASCII transmitting data system with an RS232 interface. It's the revolutionary G.R. Electronics Pocket Terminal.



The silent, solid-state terminal has a 40-key, positive click-response keyboard. From its 32-character internal memory it displays eight bright 16-segment LED characters through a one-line window.

You may select from two alternate display modes. Entries may be in any format required, and all memory data can be edited as desired. Miniature switches allow selection of these options • Single or dual stop bits • Parity bit SET/RESET/EVEN/ODD • 300/110 baud transmission rates • Control code response ENABLE/DISABLE.

- Compact, Lightweight, Fully Portable
- 40 Multi-Function Keys
- 32-Character Memory
- Format-Controllable Input & Output
- Memory/Display Editing
- Large Eight-Char. LED Display Readable from 6 ft. Distance
- Full 128-Char. ASCII Transmit/Receive
- Two Selectable Transmission Rates

## GR Electronics

1640 Fifth Street, Santa Monica, CA 90401  
 Phone: (213) 395-4774 • Telex: 652337 (BT Smedley SNM)



## THE Prompt-Doc<sup>®</sup> MANUAL MAKER

You know better user manuals sell more software, but how do you make better user manuals? How do you identify just the right details to motivate prospective

users to buy? How do you organize these details into a sequence that makes sense to first-time users while it provides ongoing reference to veterans? How do you format and package a manual so it's attractive enough to get attention yet clear enough to be readily understood?

And, how do you do all this at a pace that keeps up with your product release schedule? The Prompt-Doc<sup>®</sup> Manual Maker is the answer.

### Introducing Computer-assisted Writing

Imagine a software product that prompts you through the process of planning, outlining and writing a user manual and even supplies boilerplate introductory and transitional text. Envision reducing your user manual preparation process to this:

1. Identify manual, select boilerplate chapter files from menu, review visual table of contents (VTOC) for chapters
2. Edit chapter VTOCs to tailor sequence and terminology to your product needs
3. Pause while computer modifies boilerplate chapters to match edited VTOCs and builds a skeletal manual in preformatted Wordstar<sup>®</sup> files
4. Use Wordstar<sup>®</sup> to edit the skeletal manual into a working draft, supplying product details as prompted
5. Tell computer to purge prompts and instructions from working draft, and build new Table of Contents; publish review draft
6. Review the draft for accuracy and usability; revise, polish and publish as instructed by documentation

Compared to your current process that may sound more like a software maker's dream than a real product. It's a dream all right. A dream come true called the Prompt-Doc<sup>®</sup> Manual Maker--the only product of its kind.

### Consider These Benefits

Improved productivity--with Prompt-Doc<sup>®</sup> you can gain as much as 40% on typical manual writing jobs

Project control--with prestructured modular chapters, writing tasks can be segmented without losing continuity

Manual uniformity--by product, by product line, by company

Quality assurance--the boilerplate files help assure completeness and usability; the Prompt-Doc<sup>®</sup> User Manual guides publishing

Proven performance--based on the Prompt-Doc<sup>®</sup> methodology, the structures and outlines have been proven in myriad applications for the past four years; now we've tailored it specifically for the commercial software vendor

### Reasonable Price

\$245 for software and manual, \$45 for manual only. This product will begin paying for itself the minute you start using it and continue making you money each time you publish a manual. What could be more reasonable?

### CP/M Compatible; Uses Wordstar<sup>®</sup>

Now available for use with Wordstar<sup>®</sup> on the Apple<sup>®</sup> II and III with the Softcard<sup>®</sup> and on the Xerox 820.

### Use The Coupon Now

You know a better way to make better manuals can enhance your competitive position. Why wait another minute? Complete the coupon now and mail it to Context, Inc., Attention Prompt-Doc<sup>®</sup>, 833 West Colorado Avenue, Colorado Springs, CO 80905. Or, if you'd rather not wait for the mail, call (303) 471-9875.



# Context

The Prompt-Doc<sup>®</sup> Company

Prompt-Doc is a registered trademark of Context, Inc. Apple, Apple II and Apple III are registered trademarks of Apple Computer Inc. Softcard is a registered trademark of Microsoft Corporation. CP/M is a registered trademark of Digital Research, Inc. Wordstar is a registered trademark of Micro-Pro International Corporation.

I need the Prompt-Doc Manual Maker now! Send a copy to:

Name \_\_\_\_\_ Telephone (\_\_\_\_) \_\_\_\_\_

Address \_\_\_\_\_

Send manual only.

My check is enclosed for \$\_\_\_\_.  UPS C.O.D.

You may charge my \_\_\_\_\_ VISA \_\_\_\_\_ Master Card

Account # \_\_\_\_\_

Amount \$ \_\_\_\_\_ Expiration Date \_\_\_\_\_

Signature \_\_\_\_\_

I need more information. Send it to the address above.

Three types of records are described: display, internal, and native. Display records are produced by PRINT statements—strings of characters ending in a carriage return-line-feed. Internal records contain values of numbers or strings, but in some internal format. The key point is that what gets read back in is exactly identical to what was written out. (This is not necessarily true with display-format files, as numbers must be converted to strings of characters on output and from strings of characters back to numbers on subsequent input.)

Of the 12 combinations of file organization and record type, only 3 are required in the core standard: sequential-display, sequential-internal, and stream-internal. Five other combinations are defined as possible enhancements. The remaining 4 are not defined by the standard, which leaves open the possibility that some implementations may use them.

The OPEN statement associates a channel-setter of the form "#13" to a

file whose name is given. Ways are provided to find out if a file exists, and if it does, what its attributes are. The CLOSE statement closes a file. The ERASE statement erases the contents of a file and leaves it of zero length. Two examples:

```
OPEN #infile: NAME "Myfile",
    ACCESS INPUT,
    ORGANIZATION
    SEQUENTIAL
```

```
OPEN #3: NAME "filename"
```

In the second example, it is assumed that the organization is sequential; the record-type, display; and the access, "outin" (both input and output).

PRINT and INPUT are used to pass information to and from sequential-display files, just about the way they work for the terminal. READ and WRITE are used to communicate with all three file types. Display files can thus be accessed by both PRINT and INPUT, and READ and WRITE.

Native-format files are accessed through "templates" and are provided for possible access to COBOL files.

### Exception Handling

The construct for intercepting exceptions (situations during execution that usually cause the program to terminate) is:

```
WHEN EXCEPTION IN
    . . .
USE
    . . .
END WHEN
```

The following simple example can be used to protect against an invalid VAL argument:

```
LET flag = 0
WHEN EXCEPTION IN
    LET x = VAL(a$)
USE
    PRINT "Bad number; reenter"
    LET flag = 1
END WHEN
```

# JANUS

*the language that is based on the past but looks to the uses of the future.*

# DA\*

## Now You Can Have JANUS On Your System.

**JANUS** is a subset of the famous ADA language developed by the U. S. Department of Defense. **JANUS** includes all of the most useful features of PASCAL, plus many useful enhancements. Enhancements found in no other microprocessor programming language. For example, **JANUS** includes true Modular programming, where the computer, rather than the user, remembers what modules are being used.

**JANUS** doesn't forget error handling, either. **JANUS** helps you with full error messages—no more looking up error numbers in a manual. At run time, **JANUS** gives you the line number of the error, and a full walkback including subprogram names.

### JANUS is available on the following systems:

- IBM Personal Computer
- TRS-80 Model II (CP/M)
- North Star (CP/M)
- All CP/M 8" Disk Systems
- Seattle Computer 8086
- Apple Softcard



The **JANUS** package produces ROMable, re-entrant 8080, Optimized Z80, or 8086 machine code. **JANUS** runs under CP/M, CP/M-86, and MS-DOS (also known as 86-DOS, IBM PC-DOS, and SB-86).

#### You too can take a step forward into the future.

8080 or Z80, CP/M (requires 56K memory) — \$300.00  
8086/8088, CP/M-86 or MS-DOS (requires 64K memory) — \$400.00

**JANUS** is supplied on IBM formatted, single density 8" floppy disks. North Star DD, Apple Softcard, IBM Personal Computer and other formats are available.

**RR SOFTWARE**

CP/M and CP/M-86 are trademarks of Digital Research, Inc.  
86-DOS is a trademark of Seattle Computer, Inc.  
ADA is a trademark of the U. S. Department of Defense  
MS-DOS is a trademark of Microsoft, Inc.

*specialists in state of the art programming*

P.O. BOX 1512 MADISON, WISCONSIN 53701

(608) 244-6436



# IT'S CRISP. IT'S CLEAR. IT'S COMPATIBLE.



## **Amdek's Video-300 green phosphor monitor is the easy-reading choice for almost any system — including IBM and Apple.**

Everything about our 12" Video-300 monitor was designed to be easy. Easy to read. Easy to use. And easy to match up with practically any computer or word processing system, including the popular Apple and IBM personal computers. So it's easy to see why you should choose Video-300 for your text display needs.

### **Amdek's Video-300 monitor features:**

- Non-glare screen to eliminate distracting reflections
- P-31 green phosphor display for no-strain viewing
- 80 x 24 character display

- 18MHz band width 900 lines (center) resolution
- Built-in carrying handle for portability
- Light-weight, industrial-grade cabinetry (only 17 lbs.)
- UL, FCC approved
- Full one-year warranty covering parts and labor

So ask your dealer about Video-300 — part of Amdek's complete line of color, green phosphor and black and white monitors. Then match Video-300's performance and price against any other display monitor. For quality and value, you'll choose Amdek.

# **AMDEK**

Amdek Corporation, 2420 E. Oakton St., Suite E, Arlington Heights, IL 60005. (312) 364-1180 • TLX: 25-4786

See our complete product line at the NCC Show, Booth #A-245, in Houston June 7-10.

# The MIND'S I

Fantasies and Reflections  
on Self & Soul

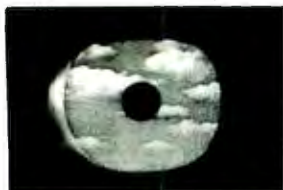

MORGES & SALLERHAN & MORROWITZ & BUCKER & MEDANER &  
WHEELS & CHAVENS & SUROFF & SANFORD & SEIB & TURNING &  
CHERNIAK & HARDING & SEARLE & NAGEL & PROCTOR & LEAF

Composed and Arranged by  
**DOUGLAS R. HOFSTADTER**  
**DANIEL C. DENNETT**

## “Utterly fascinating.”

— *ComputerWorld*

Douglas Hofstadter, author of the Pulitzer Prize-winning *Gödel, Escher, Bach*, and Daniel Dennett, author of *Brainstorms*, take you on a mind-jolting journey to confront “questions about consciousness, the self as software, and the paradoxes of free will... Inexplicably exhilarating.”

— *Washington Post*. “Superb.”

— *Martin Gardner*. “Charming and thought-provoking.” — *Popular*

*Computing*

\$16.95

# THE MIND'S I

Fantasies & Reflections on Self & Soul  
Composed and Arranged by Douglas R. Hofstadter  
and Daniel C. Dennett

**BASIC BOOKS, INC.**

10 E. 53rd St., New York, NY 10022 (212) 593-7083  
Visa and MasterCard welcome



- CC-86 Compiler available for both CP/M-86\* and MP/M-86\* (incl. IBM PC)
- Full Unix\*\* V7 language compatibility
- Standard I/O library supports both buffered and non-buffered I/O and OS calls
- Stand-alone assembler supports relocatable code, local symbols and linkage to external modules
- Introductory prices: \$500 for CC-86 and assembler/linker; \$200 for assembler/linker; \$50 for manual (incl. K & R)

\* CP/M and MP/M are trademarks of Digital Research

\*\* Unix is a trademark of Bell Laboratories



(503) 297-7153

**Control-C Software, Inc.**

6441 SW Canyon Court  
Portland, OR 97221

The USE part is invoked when any exception whatsoever occurs during the WHEN part. In the previous example, it is almost true that only one kind of exception is possible. The printed error message will thus be correct most of the time. The programmer may double-check by using the EXTYPE function, which returns the coded number of the exception. For the example above, the EXTYPE value is 4001. Some 144 exceptions are defined and coded in the standard.

---

**A CAUSE statement  
can force any  
particular exception.**

---

More elaborate exception handlers may be constructed. For such purposes there are the RETRY, CONTINUE, and EXIT HANDLER statements and the EXLINE function. RETRY sends control to the start of the line in which the exception occurred, CONTINUE sends control to the line following that in which the exception occurred, while EXLINE has as its value the line number of the line in which the exception occurred. There is also a CAUSE statement that can force any particular exception to occur; a programmer can use the cause statement to check his exception-handling code.

### Graphics

The language includes statements to carry out simple plotting. The basic plotting statement is PLOT. It can be used to plot dots or straight lines. As examples:

```
PLOT X,Y  
PLOT X1,Y1; X2,Y2  
PLOT
```

If the beam is off, the first plots a dot at (X,Y), and the second draws a line from (X1,Y1) to (X2,Y2). If the beam is on, the first and second also draw a line from the previous point to (X,Y) or (X1,Y1), respectively. The third turns the beam off (lifts the pen) if it's on and does nothing if the beam is off.



# POWER & RELIABILITY

## Toughest Boards in Town... IEEE696/S-100. Systems too!

### 256 Kb Dynamic Memory

Available now from Dual Systems: DMEM/256 memory boards. Put the most density of memory ever available on your IEEE/S-100 bus. Get industrial-grade quality with this ruggedly built board: it's been burned-in for 168 hours.

- FULL 256 Kb on a single board.
- Two independently addressable 128 Kb blocks.
- Runs in 8 MHz system.
- Runs at 4 MHz bus speed (no wait states).
- Runs in 8 or 16-bit systems with 8 or 16-bit wide data paths.
- Extended 24-bit addressing.
- Parity error or detection-generates either interrupt or bus error signals on error.
- DMEM/256KP (Parity)... S1495

### Static Non-Volatile Memory

The Dual Systems CMEM memory boards combine high speed CMOS memories with new 3-10 year lithium batteries to give you the non-volatility of an EPROM board while retaining the instant writability of a high-speed read/write RAM.

- Runs at 6 MHz (no wait states).
- 8 or 16-bit with 8 or 16-bit wide data paths.
- Extended 24-bit addressing and bank select.
- CMEM/32K \$995
- CMEM/16K \$795
- CMEM/8K \$695

### Non-Stop Clock

Keeps time with power off. Our industrial clock utilizes a new lithium battery for 3-8 years use. Easiest clock to program you'll ever see. Runs in all S-100 systems.

- Year, date, hrs., mins., and secs.
- Uses new LSI CMOS chip.

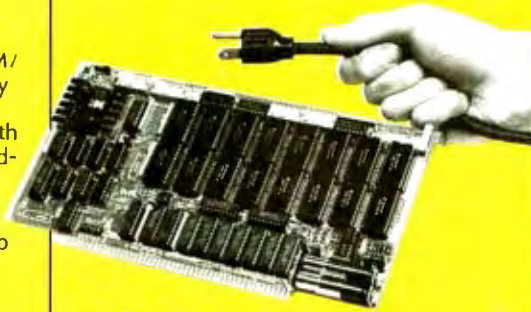

### A/D Converter

IEEE696/S-100 AIM-12 industrial standard module designed for industrial analog-to-digital use.

- Runs in all S-100 systems.
- 32-channel, 16-differential.
- 12-bit resolution/accuracy.
- 25-microsecond conversions.
- Instrumentation amplifier.
- BASIC program provided.
- AIM-12 w/1-1000 gain transducer amplifier... S785.
- AIM-12B... S695.

### D/A Converter

AOM-12 IEEE696/S-100 industrial level digital-to-analog (D/A) converter.

- 12-bit  $\pm 1/2$  L.S.B. accuracy over full 0-70°C temperature range.
- Outputs 0-10,  $\pm 5$ , or  $\pm 10$  volts.
- Short circuit protection, all outputs.
- Switch-programmable for multiple boards.
- AOM-12: S675.

### VIC 4-20

Standard output for industrial control 4-20 mA D/A converter. Used in conjunction with the D/A board.

- VIC4-20, S675.

### DMA Serial I/O

The SIO-4/DMA is an intelligent, DMA, high performance S100 four port serial input/output board. It conforms to the IEEE-696 specification and is designed to work with older S100 machines. The board is intended to be used with asynchronous terminals or printers in a multi-user system.

- Program selectable Baud rate.
- DMA transfers for output.
- 24-bits of address supported with no restrictions on boundaries.
- Can be connected to RS-232 terminals or modems.
- 256-bytes of FIFO buffer for input characters.
- RS-232 drivers and receivers conform fully to specification.
- Control-S/Control-Q protocol supported.
- Printers with 'Buffer full' signal lines supported.
- Limited synchronous mode capability.
- Occupies only 16 I/O addresses.

# DUAL/68000

... Hard Power from the Soft Support of **UNIX®**

A new and powerful computer has been born... the System 83. The versatile UNIX® operating system pilots the System 83's raw power through a myriad of software such as "C", FORTRAN, PASCAL, BASIC, COBOL, and even Networking. Step into a bold new frontier with more power than you ever dreamed possible.

- UNIX V7 configured by UNISOFT\*\*
- Full IEEE 696/S-100 Compatibility
- MC68000 8MHz Processor
- 32-Bit Data Operations with 32-Bit Internal Registers
- 16-Bit Data Transfer Operations
- Memory Management Allows Concurrent Use of Mapped and Non-mapped Address space
- 16 Mb of Main Memory Directly Addressable
- 7 Vectored Interrupt Levels
- 256 Kb of RAM with Parity Per Board Slot

\* UNIX is a trademark of Bell Laboratories and is supported on the DUAL System 83 by UNISOFT  
\*\*UNISOFT is a trademark of UNISOFT Corporation of Berkeley, CA.



OEM and Dealer pricing is available.

Sales representatives in most metropolitan areas.

DUAL SYSTEMS CORPORATION

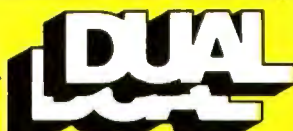

system reliability/system integrity

720 Channing Way • Berkeley • CA 94710 • (415) 5-49-3854/3890 • Telex: 172029 SPX

Circle 166 on inquiry card.

# CP/M® Users: Access IBM with ReformatTer™

ReformatTer conversion software lets you read and write IBM 3740 diskettes\* on your CP/M or MP/M system.

ReformatTer is ideal for CP/M users who want

- Access to large system data bases
- Distributed data processing
- Offline program development
- Database conversion

With ReformatTer, you have the ability to

- Bidirectionally transfer complete files between CP/M and IBM
- Automatically handle ASCII/EBCDIC code conversion
- Display and alter IBM 3740 directory and data

Enjoy the same advantages of mainframe access that other ReformatTer users have. Customers like Upjohn, M&M/Mars, The United Nations, Arthur Young & Co., Sandia Labs, FMC Corp., and Stanford University all use ReformatTer. So can you.

Other versions of ReformatTer conversion software include

CP/M ↔ DEC (RT 11)

TRSDOS Mod. II ↔ CP/M

TRSDOS Mod. II ↔ DEC (RT 11)

Order ReformatTer today for only \$249.

\*IBM 3740 basic data exchange format. ReformatTer requires one 8" floppy drive.

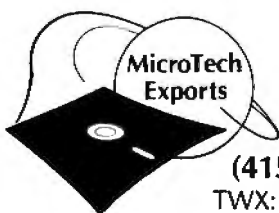

(415) 324-9114

TWX: 910-370-7457

467 Hamilton Av., Suite 2, Palo Alto, CA 94301

CP/M is a reg. trademark of Digital Research

Please send complete information on the following versions of ReformatTer \_\_\_\_\_

- Please send ReformatTer CP/M ↔ IBM. My check for \$249 (plus 6 1/2% tax for Cal. res.)  
 Charge to my  Visa  Mastercard

# \_\_\_\_\_

Signature \_\_\_\_\_

Name \_\_\_\_\_

Company \_\_\_\_\_

Street \_\_\_\_\_

City \_\_\_\_\_

State \_\_\_\_\_ Zip \_\_\_\_\_

Mail to MicroTech Exports, Inc.  
 467 Hamilton Av., Suite 2, Palo Alto, CA 94301

Listing 2: A graphics program written in the proposed draft form of standard BASIC.

```

100 ! Town
110 !
120 ! Draws a picture of a town
130 !
140 ! Naming the type of plotter is implementation-defined
150 !
160 Window 0, 4, 0, 3
170 !
180 Plot Town
190 !
200 End
210 !
220 Picture Town
230 !
240     For i = 1 to 2
250         For j = 1 to 3
260             Plot House with scale(.5) * shift(i,j)
270         Next j
280     Next i
290 !
300 End picture
310 !
320 Picture House
330 !
340     Plot 0,0; 0,1; 1,1; .5,1.5; 0,1; 0,0
350 !
360 End picture
    
```

The points to be plotted are given in user coordinates, which are specified with a WINDOW statement. The programmer may specify the physical size of the screen to be used, arrange to CLIP the picture, SET the color and line style, and use the ASK statement to find out about the current status of these quantities. The GRAPHIC INPUT and GRAPHIC PRINT statements provide text input and output. Polygon fill can be accomplished by:

### MAT FILL POLYGON

Complicated pictures may be built from simple ones with PICs, which are like subprograms. They are invoked with the PLOT statement (rather than with the CALL statement). As they are plotted, transformations of various types may be made. These include SHIFT, SCALE, ROTATE, and SHEAR, and combinations thereof.

Listing 2 is a complete program for drawing a picture of a town.

### Real Time

Most BASIC users would be surprised to learn that BASIC is one of the important languages for real-time applications, such as industrial-process control. The reason is that it is simple and can be provided easily on the small machines used in such applications. Standard BASIC will include optional features, such as parallel sections and definitions of device interfaces, to permit this use. This work grew out of earlier work sponsored by the IEEE in developing a standard for CAMAC (Computer Automated Measurement and Control) BASIC.

A real-time program consists of parallel sections, each of which is an independent program unit with respect to line numbers and identifiers. Each parallel section can receive input from and send output to any device specified and can exchange messages with other parallel sections. A section can become dor-



# INCREASE SALES OF CP/M®

**ANYONE CAN USE CP/M  
WITH SUPERVYZ**

SUPERVYZ is a revolutionary software concept that serves as a mediator between the user and CP/M, requesting information in plain English and translating the response into the form CP/M recognizes. Users are led from one application to another in a courteous and step-by-step sequence of menus. Aided by descriptive error messages and computer-assisted tutoring, the operator avoids mistakes and is advised of the next step in a polite and friendly manner.

**EXPAND YOUR MARKET  
AND LOWER COSTS**

As a Dealer, SUPERVYZ allows you to sell CP/M computers and application software to non-technical markets, without the added expense of teaching the operating system. EPIC supplies the menus or you create your own to meet the exact needs of your customers. Because SUPERVYZ is compatible with over 2,000 programs and 300 computers, you can bundle software from different suppliers and SUPERVYZ does the teaching. This eliminates costly after-the-sale handholding.

For further information about EPIC SUPERVYZ, call or write us today.

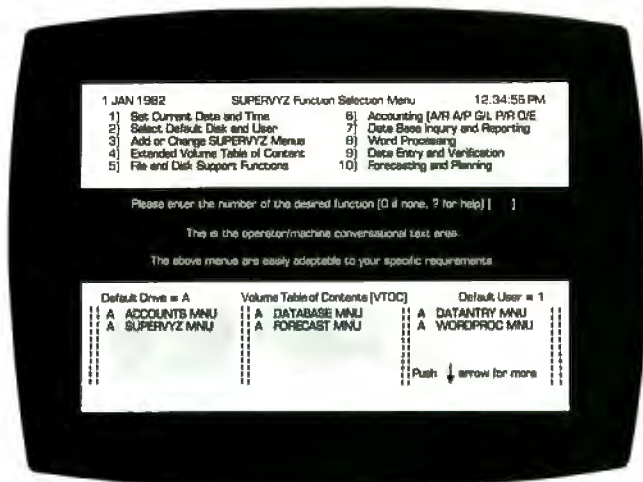

Supervyz is a trademark of  
Epic Computer Corporation.  
CP/M is a Trademark of  
Digital Research.

**EPIC**  
EPIC SOFTWARE

Epic Computer Corporation  
7542 Trade Street  
San Diego, CA 92121  
Tel. 714-695-3560

NOW SOLO THROUGH DISTRIBUTORS  
IN POPULAR FORMATS  
**800-421-0814**  
DEALERS ONLY PLEASE

Circle 185 on Inquiry card.



TM

## How Standards Are Written

One characteristic of standards work is that major points are usually settled easily, while seemingly minor points may take years to resolve. A classic example is the "option base controversy" in the X3J2 committee.

Most early versions of BASIC allowed default dimensioning of arrays. That is, in the absence of a DIM statement, the subscripts of an array (list or table) could range up to a value of 10. But BASICs differed in what they allowed for the lower bound. Some specified the lower bound to be 0, while others specified it to be 1. The argument for 0 is that many elementary applications need the subscript 0, and it should be available for those cases. The argument for 1 is that most arrays naturally begin with 1, and it would be a waste of storage to allow 0 when it isn't needed. The committee argued long and hard over this one. Each time we voted, we tied. The OPTION BASE compromise eventually emerged. The rule is this: if OPTION BASE 0 appears in the program, the lower bound for all subscripts is 0; if OPTION BASE 1 appears, the lower bound is 1; if neither appears, then by default the lower bound is 0.

Few members of X3J2 really liked this compromise, but the committee supported it in the interests of getting out the standard for Minimal BASIC. Subsequent efforts to remove this feature failed, for the same reason.

In a radical shift, the committee decided, five years later, to allow users to specify lower bounds for individual arrays in dimension statements. Thus, "DIM YEAR(1970:1980)" would create a list named "YEAR" having 11 elements identified with the numbers 1970, 1971, . . . 1980. If no lower bound is specified, it is assumed to be 1. Both sides now have their wish, but it took more than five years to achieve it.

## Logistics

Meetings of standards committees are held near where the members work, and members take turns hosting meetings. Since 1974, X3J2 has met 30 times. Ten of these meetings have been in the East, nine in the Midwest and South, and eight in the Far West. Because we are developing the standard jointly with ECMA (European Computer Manufacturers Association) TC21, we hold joint meetings yearly, alternating between the United States and Europe. Three of these meetings have been held in Europe.

Rotating meeting sites is required. Often we have to choose between alternate sites based on, for example, availability and cost of accommodations. But one factor we always consider very carefully is food. Whatever site we choose must have good restaurants. Thus we're fortunate that 20 per-

cent of the X3J2 membership works in the San Francisco area. In Europe, the ECMA TC21 members work in or near London, Paris, and Venice. I don't know what we would have done had computer companies located themselves in remote areas that offered no culinary delights.

By and large, the membership of X3J2 has been stable. Representatives from large companies sometimes change, and some members change employers. But, for the most part, the members have known each other and worked together for years. This leads to occasional amusing incidents.

In the early days of the committee, before individualized T-shirts became the fad, one member stood up to speak but instead doffed his shirt to reveal his custom T-shirt that had the words "BASIC Standard" on the front and "Strings Subco" on the back. We now take our special T-shirts for granted, but that one brought down the house.

Another member was amused to discover a brand of toilet paper called "Basic"; he presented this as an exhibit to illustrate the then-current status of the standard.

More recently, a member of long standing appeared at a meeting carrying a large plastic goose. When the discussion deteriorated (who can be brilliant for six hours a day all week long?), the goose would appear on the table.

# DISASTER INSURANCE

## PROTECT YOUR HARDWARE FROM THE UNEXPECTED.

Not to mention the unavoidable pollutants in the air. Performance robbing dust, grime, spills and static electricity.

Cover Craft Dust Covers help extend the useful life of your computer equipment at a fraction of the cost. Perhaps that's why more people throughout the world rely on Cover Craft Dust Covers than any other brand.

Visit your local dealer or contact us.

Dust Covers for most terminals, disks, printers, modems, etc.

**\$8.95-\$15.95**  
Shipping extra.



**COVER CRAFT** CORP

PO Box 555, Amherst, NH 03031 • (603) 889-6811





# Columbia Data's New Multi-Personal Computer Is Now Ready For Business

With IBM Personal Computer Software And Hardware Compatibility . . . For Starters.



Columbia Data Products Multi-Personal Computer can use software and hardware originally intended for the IBM® Personal Computer . . . while enjoying the flexibility and expandability of all of Columbia Data's computer systems.

Available operating system software includes either single-user MS-DOS® (also called IBM-PC-DOS or 86-DOS) or CP/M 86® or multi-user, multi-tasking MPM 86® providing users with a host of compatible software packages for both personal and business applications. DASE 16® and XENIX® operating systems are also available soon.

Our standard 16-bit 8088 hardware configuration provides 128K RAM with two RS-232 serial ports, Centronics parallel printer port, DATA communications mode of Interrupt, dual disk drive system with 1 Megabyte Winchester disk interface and eight IBM-PC compatible expansion slots and less for only \$2,995.

Columbia Data's expandability provides 256K RAM boards, 8087 Arithmetic co-processor for high speed math functions, dual RS-232/RS-422 boards, networking capability, and Winchester disk based system . . . our expansion capability can easily accommodate just about any imaginable hardware configuration, including a 1 Megabyte RAM 8-user system. Call us for more information.



**COLUMBIA**

DATA PRODUCTS, INC.

Home Office  
8880 Route 108  
Columbia, MD 21045  
Telephone 301-992-5400  
TWX 710-682-7881

West Coast  
3401 MacArthur Blvd  
Suite 211  
Newport Beach, CA 92660  
Telephone 714-762-6245  
Telex 692-210

Europe  
P.O. Box 1116  
4000 Moenchengladbach 1  
West Germany  
Telephone 02161-33159  
Telex 652482

IBM is the trademark of International Business Machines. CP/M and MPM are trademarks of Digital Research. DASE is the trademark of Phase One. MS-DOS and XENIX are trademarks of MICROSOFT.

Circle 77 on inquiry card.



# Hewlett-Packard on the professional use of personal

## There's a considerable difference between a computer and one that really fits.

There are a lot of places where the basic one-size-fits-all type of personal computer fits in really well. But if you're like most of the technical professionals we know, you'd rather use a tool that was clearly designed for the job you're doing.

That's why we've developed these five very different personal computers just for people like you. And configured each one specifically

to operate in technical environments. To interface with instruments and other computers. To give you all the computing power and all the high-level graphics capability you need.

Now we'd like to show you, in some detail, just what we mean.

### The HP-41.

You might remember the series 9100 engineering computer we introduced in 1968 for \$5000. Now,

just like a real craftsman's tool fits your hand. Add a printer for hard-copy output. Or our 128k byte cassette for mass storage. Or add both; they'll only take up as much space in your briefcase as three paperbacks.

You can even use your HP-41 as a remote data collector, then link it up with any HP Series 80 personal computer via HP-IL.



ically to operate in technical environments. To interface with instruments and other computers. To give you all the computing power and all the high-level graphics capability you need.

We also offer you a full range of printers, graphic plotters, additional memory systems, input devices, and communications links. Plus over 5000 software programs at last count.

As a result, you can practically design your own system. And have a personal computer that fits your professional environment

for a base price of \$250, you can hold all the power of that system in the palm of your hand.

All by itself, this hand-held computer can help a petroleum engineer evaluate gas or oil reservoirs. Or help civil engineers do critical computations in the field.

Add the new Hewlett-Packard Interface Loop (HP-IL), and you can turn your HP-41 into a powerful, port-

### The HP-85.

Complete with an integrated tape drive, printer and CRT, this typewriter-size system fits easily in a crowded work area. Where you can use its impressive number-crunching power any number of ways. For waveform analysis. Regression analysis. Linear programming.

Add the HP-IB interface, and you can control up to 14 instruments simultaneously. Add our Data Communications Pac and you can tie into another



All the power of our 9100 Series Desk-top Engineering Computer. Now you can hold it in the palm of your hand.



# computers.

## ence between the one-size-fits-all

on-site computer, a major data network, or a national timesharing service.

You can even use this portable machine to do all these same jobs out in the field. And more.

### The HP-87.

The HP-87 sets a new level of performance for personal computers in its price range. You get built-in screen graphics, up to 544k bytes of RAM, and an 80-column integrated CRT. Plus the same flexible I/O structure for control applications as the HP-85. Because of its extended memory, you can take advantage of a VisiCalc® PLUS worksheet with up to 16,000 cells. And since the HP-87 has a built-in HP-IB, it's easy to add instruments, disc drives, printers, plotters, and even a graphics tablet. To give you even more to work with, there's an optional CP/M® module. And all applications developed for the HP-85 in BASIC are upward-compatible to the HP-87.

### The HP 9826.

Designed to handle high-speed data acquisition and tests, the 9826 has a powerful MC 68000 CPU, a built-in flexible disc, up to 2 megabytes of read/write memory, and power-fail protection. Plus a built-in HP-IB in-



terface and a variety of other interface cards, so you're free to concentrate on testing. Instead of system configuration.

To give you even more flexibility, you can run applications in HP-enhanced BASIC, HPL, or Pascal. We've also built a CRT display with advanced graphics into the system, so you can see and interpret your data the instant you get it. And since everything about this system is built for speed, we've developed a special rotary control knob that lets you edit programs, calibrate instruments, and control motor speed, all with fast analog inputs.

### The HP 9836.

This full-function workstation does it all: design, computation, and high-speed testing. Because it gives you all the high-performance features of the 9826. And then some. With the 9836, you get a big, easy-to-read CRT. Sophisticated graphics capability. Two flexible disc drives. Room for up to two megabytes of memory. And an even longer list of engineering software and peripherals to choose from.

Our 7470 Plotter. One of many peripherals that help make our personal computers really personal.

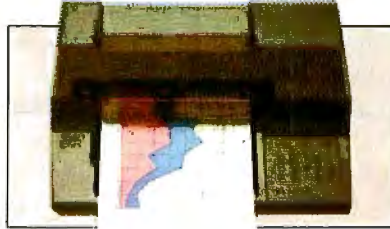

are just the five personal computers we've developed for technical professionals; we also make a full range of person-

al computers for business professionals.

So. Before you decide to adapt your routines to fit the needs of a one-size-fits-all computer, we think you should get in touch with us first. And see what it's like to have a personal computer that really is personal.

Come and try them out at our Productivity '82 seminar in your area. Just watch your local newspaper for details on Productivity '82, or return this coupon.

Hewlett-Packard  
1820 Embarcadero Road, Palo Alto, CA 94303  
I'd like to see which of your personal computers fits the way I work best. Please send more information on these models:  
 HP-41  HP-85  HP-87  HP9826  
 HP9836

Name \_\_\_\_\_

Title \_\_\_\_\_

Company \_\_\_\_\_

Address \_\_\_\_\_

City/State/Zip \_\_\_\_\_

77136



**HEWLETT  
PACKARD**

VisiCalc® is a registered trademark of VisiCorp.  
CP/M® is a registered trademark of Digital Research, Inc.

A wide variety of interfaces for technical environments, including HP-IB, HP-IL, RS 232, GPIO, and BCD.

TCG-203

Please Circle The Product/Products for Which You Would be Interested in Receiving Information:  
HP-41—CIRCLE 213 HP-85—CIRCLE 214 HP-87—CIRCLE 215  
HP-9826—CIRCLE 216 HP-9836—CIRCLE 217

mant upon reaching a WAIT statement and be awakened when some specified event or condition has occurred. Within a parallel section, all the usual BASIC statements may be used, including subprograms. Of course, there must be a supervisor program behind the scenes that attends to all message passing and scheduling.

As with BASIC in general, an example program that illustrates all of the features of real-time BASIC would be prohibitively long. Just a

hint can be gotten from this simple example:

```
320 PARACT RIG1
330 WAIT TIME 17*60*60
340 PRINT "Time to go home."
350 END PARACT
```

This parallel section will "hang" until 61,200 seconds have passed since midnight; it will then "wake up," print the message, and then loop back to the WAIT statement until 5 p.m. the next day.

## Fixed Decimal

An optional fixed-decimal module allows programmers to specify that all numeric variables and expressions be fixed decimal. Of use to data-processing programs, it can be invoked by an option statement. For instance:

```
OPTION ARITHMETIC FIXED*8.2
```

specifies that fixed-decimal arithmetic is to be used and that all variables (except those declared otherwise) must permit eight digits before the decimal point and two digits after.

Individual variables may be declared to have precisions other than those prescribed in the OPTION ARITHMETIC statement by using the DECLARE statement. For instance:

```
DECLARE NUMERIC
national_debt*15.2
```

would allow values up to a penny less than 1 quadrillion dollars.

## Editing

Although legally not part of the standard, an optional module will suggest forms to be used for the editing operations often associated with BASIC programs. These include LIST, EXTRACT, DELETE, and RENUMBER.

## Summary

For several years now, BASIC has been the de facto standard-programming language for small computers (and in Europe, for business computers as well). Finally, the de facto standard is about to become *standardized*. Far from holding back innovation, the proposed draft standard will be a major force in keeping software up to pace with hardware advances in the eighties. ■

## References

1. American National Standard for the Programming Language Minimal BASIC, X3.60-1978. ANSI, New York, 1978.
2. Kurtz, Thomas E., "Basic," from *History of Programming Languages*. Academic Press, 1981, pp. 515-549.

## COMPUTER FORMS AND SUPPLIES

### WE SUPPORT MORE SYSTEMS WITH FORMS THAN ANYONE!

Accounting Plus • Alpha Micro • Apple Computer • BPI Systems • Broderbund • CAD0 • Centurion/Warex/EDS • Cimarron • Compumax Associates • Continental Software • D.B. Software • Dakin-5 • Data Train • Denver Software Company • Designer Software • Digilog • Durango • Datamost • Dynabyte • IBM 5120 • IBM Sys 32/34 • IMS • Insoft • LIBRA • MCBA • NEC • Northstar • Open Systems • Osborne • Peachtree • R & B Systems • Radio Shack • Rocky Mountain Software • Serendipity • Shasta • (SSG) • Systems Plus • Taranto • TCS • The Bottom Shelf • Van Data • Vector Graphic • Wang

PLUS 86 MORE!

### NEW! DISKETTE'S SPECIAL THIS MONTH ONLY!

BUY TWO BOXES OF  
DISKETTES AND RECEIVE  
A \$10.00 COUPON GOOD ON  
ANY PURCHASE OVER \$50.

CHECKS • STATEMENTS  
CUSTOM FORMS • W-2'S  
INVOICES • STOCK TAB

30% OFF 1982 W-2  
ORDERS PLACED THIS MONTH

CALL FOR FREE 1982 TAX FORMS CATALOG!

## Checks To-Go

IN CALIFORNIA  
800-552-8817

8384 Hercules Street  
La Mesa, CA. 92041

NATIONWIDE  
800-854-2750



## COMPUTERS

### NORTHSTAR



New low price on the incredible Advantage™. Your choice GDOs and Basic, or GCP/M \$229. Let us burn and rest your Horizon or Advantage and we'll back it with our own fast warranty service.

Advantage	Call
Horizon II 64K Quad	\$2789
5 mg. Add-on Drive	\$2295

### XEROX



The under \$3000 system with the billion dollar name. Systems include CPU, dual drives, keyboard, monitor, and two serial ports for a printer and modem. CP/M® compatible.

820 w/5" drives	\$2375
820 w/8" drives	\$2949

### TELEVIDEO

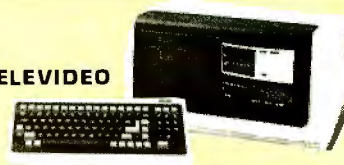

The new all-in-one that's backed by G.E. Built in CAT, detachable keyboard, 750K formatted, dual floppys, 64K, CP/M® and more. Five software business modules \$695.

Televideo 802	\$2795
Tele 806, w/10 Meg., Most.	\$5395
Televideo 802H (10 Meg.)	\$5095

### ALTOS

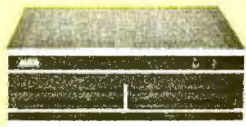

New 3-user system with 196K Ram, and 2Mg. on floppy. Call for prices on Altos new 16-bit systems.

Altos Series 5-15D	\$2295
Altos 8000-10	\$6375
Other Models	Call

### NEC



The low priced system that's big on features. 4 Mhz Z-80A, real time clock, color output, CP/M® compatible, 5 function keys and more.

PC8001A Computer	\$739
PC8012A I/O w/32K	\$479
PC8013A Dual 5 1/4" drives	\$739

### ZENITH



The all-in-one that's backed by your local Zenith-Heath Service center. Green Screen, CP/M®, Supercalc, and Basic incl.

Z-89 w/48K	\$2135
Z-90-82 w/64K	\$2395

## IMPORTS



NEC PC 8023A	\$489
Epson MX-80	\$444
Okidara 82A	\$455
Epson MX-100	\$719
Okidara 83A w/trac.	\$719
Okidara 84 (200 c.p.s.)	\$1059

## SOFTWARE

Software sold only with systems and not warranted for suitability to particular applications. All require CP/M® - All software sales final.

**WordStar** - Easy and powerful - the most popular word processing system for micros.

**MailMerge** - Works with or without Wordstar to keep up-to-date mailing lists and create individually produced letters.

**CalcStar** - Spread sheet analysis which is interactive with the other Micropro packages.

**DataStar** - Micropro's database system works with Wordstar to combine text and numbers.

**Benchmark** - CP/M based word processing that's both powerful and easy to learn. Does not use control characters on most systems.

**dBASE II** - The most popular CP/M based relational database.

**Accounting Plus** - General ledger, Accounts payable, accounts receivable, etc., plus Condor data base management.

**Crosstalk** - Plug into the personal computer networks and link-up with other systems via modem communications.

**S.A.I.L. CP/M** - Faruse with Northstar Horizons increases drive capacity 25K on doubles, 50K on Quads.

**S.A.I.L.B.O.A.T.** - Allows programs written under Northstar DOS and Basic to run on CP/M based systems.

## LOW COST



Viewpoint 3A	\$499
Televideo 910 plus	\$579
ADM 3A	\$569
Soroc IQ 130	\$589

## HIGH SPEED

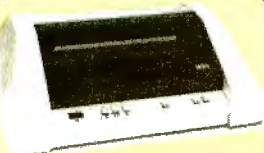

DataSouth DS-180	\$1269
Anadex 9501	\$1244
Ti810 Basic	\$1359
IDS Prism 80	\$889
IDS Prism 132	\$1469

## SERVICE/ORDERING

**INTEGRATION:** Prices listed are for new equipment in factory sealed boxes with manufacturer's warranty. We will pretest your equipment, integrate your system, configure your software, provide special cables, etc., for an additional charge. Call for prices.

**ORDERING: MAIL ORDER ONLY.** Prices listed are for cash. No C.O.D.'s. We sell on a net 20 basis to Fortune 500 companies and Universities (at cash prices). Charge cards add 2%. Prices subject to change, product subject to availability. AZ. residents add 5%. Personal checks take 3 weeks to clear. 0-20% restocking fee for returned merchandise. Shipping extra - products are F.O.B. point of shipment. CP/M and MP/M are registered trademarks of Digital Research.

## TELEVIDEO



Televideo 912	\$699
Televideo 920	\$728
Televideo 925	\$735
Televideo 950	\$927

## LETTER QUALITY



F10 Starwriter 40 c.p.s.	\$1449
F10 Starwriter 55 c.p.s.	\$1649
NEC 3510	\$1895
NEC 7710/7730	\$2340
NEC 7720	\$2695



# Scottsdale Systems Ltd.

6730 E. McDowell Road, Suite 110, Scottsdale, Arizona 85257

(602) 941-5856

Call 8-5 Mon.-Fri.  
(We Export) TWX 910-950-0082 (IMEC SCOT)

## TERMINALS



Folco TS-1 (VT52)	\$1069
Folco (VT-100)	\$1199
Zenith Z-19 (VT52)	\$689
Dialogue 80 Amber	\$895
Volker Craig 404	\$599

## MORE PRINTERS

Zenith Z-25	\$1225	DEC LA34AA	\$1049
Prowriter ACD	\$639	Tally MT 1805	\$1645
MPI 99G	\$719	Xerox D80	\$2149

## I/O DEVICES

Houston Instrument:		Hoyes Smartmodem	\$219
Hi-Plor DMP-2	\$849	NEC 12"-G Monitor	\$169
Hi-Plor DMP-7/8	\$2057		
Hi Pad DT-11	\$669		

## App-L-ISP

Jeff Bonar and Steve Levitan  
Computer and Information Sciences Department  
University of Massachusetts  
Amherst, MA 01003

In a previous article (see "Three Microcomputer LISPs," BYTE, September 1981, page 388), we discussed three implementations of LISP developed for Z80 microcomputers running under the CP/M operating system. Here, we discuss App-L-ISP, a version of LISP developed for the Apple II. The Apple is based on MOS Technology's 6502 microprocessor, which has a smaller instruction set than the Z80. The Apple is far more popular in educational settings than CP/M-based Z80 machines. We believe that LISP can be used successfully in many of these educational settings.

Within this article, we wish to address these questions: What compromises, if any, were made to fit App-L-ISP "onto" the 6502 microprocessor? How well is App-L-ISP integrated into the Apple environment? Is App-L-ISP suitable for the novice?

This article follows the format of our earlier article.

### Data Types in App-L-ISP

App-L-ISP supports a very limited set of data types. It provides atoms, lists, and 16-bit integers. Strings may be simulated using the PACK and UNPACK functions. These functions allow a string to be represented as a list of single-character atoms. For example:

```
(PACK '(A B C D)) ==> ABCD  
(UNPACK 'WXYZ) ==> (W X Y Z)
```

The double quote (") is used to delimit atom names that contain characters that might otherwise be misinterpreted. For example:

```
(UNPACK '(WXYZ)) ==> an error,  
UNPACK expects an atom  
(UNPACK ""(WXYZ)"") ==> (" ( W X Y Z ")
```

The last example yields a list of seven single-character atoms, the second of which is the open-parenthesis character.

App-L-ISP has an ASSOC function for manipulating association-lists (often called a-lists). An association-list has the following structure:

### At a Glance

<b>Name</b> App-L-ISP, version 1.7	<b>Language</b> 6502 machine language
<b>Type</b> LISP programming language	<b>Computer</b> Apple II with at least 48K bytes of memory; at least one disk drive
<b>Manufacturer</b> Datasoft Inc. 19519 Business Center Dr. Northridge, CA 91324	<b>Documentation</b> 68 pages in 3-ring binder, includes a copy of LISP by Winston and Horn
<b>Price</b> \$124.95	<b>Audience</b> Educators, college students, language enthusiasts
<b>Format</b> 5 1/4-inch floppy disk	

```
( (key-1 value-1)  
  (key-2 value-2)  
  •  
  •  
  •  
  (key-n value-n) )
```

The call (ASSOC key-i a-list) will return the value-i associated with key-i. For example, given the following:

```
(SETQ FRUIT '((APPLE RED)  
              (BANANA YELLOW)  
              (MANGO ORANGE)  
              (PLUM PURPLE) ))
```

we have:

```
(ASSOC 'MANGO FRUIT) ==> (MANGO  
ORANGE)
```

Traditionally, LISP property lists use association-lists. App-L-ISP does not have a property list associated with each atom. Instead, to use a property list, you must bind an association-list as the atom's value.



# FMS-80. THE TWO DOOR DATA BASE PLUS



Door # 1: Reports you'll use *today*.  
Door # 2: The sky is the limit.

We've split the proven, best-selling FMS-80 micro data base manager into two parts. And we've split the price.

Part one (FMS-81) gives you the essential file and reporting features. You can quickly create programs with input questions a clerk can understand, and with reports a manager can use.

And FMS-81 with its new manual, is so easy to use, you'll be generating reports the first day. FMS-81 sells for \$495.

Part two (FMS-82) has all the fancy stuff. Including an Extended File Maintenance language that lets you perform virtually unlimited manipulation on up to 19 different data files simultaneously.

Using FMS-82, you or your computer dealer can make FMS-80 do *just about anything*. FMS-82 sells for \$495.

Naturally, FMS-82 is fully compatible with all the files and functions you generate with FMS-81.

FMS-81 is so useful, it might seem like you'll never need FMS-82.

But as you expand your use of computers, isn't it nice to know it's there?

The FMS family runs under CP/M, MP/M, CDOS, and Turbodos. Call or write today for a brochure detailing the extensive capabilities of the Two Door Data Base Manager, and the name of your nearest dealer.

You'll be impressed.

**Systems Plus, Inc.**



1120 San Antonio Road  
Palo Alto, CA 94303  
(415) 969-7047

o *djr* product  
DJR Associates, Inc.  
2 Highland Lane  
North Tarrytown,  
NY 10591

FMS-80, FMS-81, FMS-82  
TM DJR Associates  
CP/M, MP/M TM Digital Research  
CDOS TM Cromemco  
Turbodos TM Software 2000, Inc.

Circle 437 on inquiry card.

# how the Data Princess became a Queen

a tale about ACCESS/80 from Friends Software



Princess DataStar<sup>1</sup> had a lot of magic powers. She could manipulate huge amounts of data fast and accurately. She could create forms and help produce personalized mailings. ¶ But Princess DataStar could not write reports. And this made her sad. What good was all that data if she had no easy way to answer questions about that data? Princess DataStar cried and cried. ¶ One day, a handsome young man suddenly appeared. "Don't cry, princess," he said with a bow. "My name is ACCESS/80 Report Writer. I can generate reports directly from your existing files—and, I might add, from any other files in industry standard ASCII character format." ¶ "You can?" she asked. "How?" ¶ "It's simple. Even a non-programmer can use me to quickly generate virtually any report using just one easy-to-write statement that resembles ordinary English. I can be used for a myriad of applications. I'm field-proven and I'm easy to upgrade." ¶ "You're so powerful!" she cried. "You must be expensive."



¶ "Not at all—I'm only \$295," he smiled. "Princess, add my powers to yours and you'll be a data queen." ¶ "I will," said Data Star lovingly. "ACCESS/80 Report Writer, you're the answer to my prayers." ¶ Moral:

**If you have data, you need ACCESS/80.**

ACCESS/80 works with Z80, 8080, and 8085 microprocessors with the CP/M<sup>2</sup> operating system.

**ACCESS/80 Report Writer** produces multiple reports, including subtotals and cross-tabulations, from a single pass over your data files—all without programming.

**ACCESS/80 Applications Development Tool** lets you develop programs up to 50 times faster than with BASIC.

**ACCESS/80 Information Management System** offers full-screen data entry and update.

*Excellent documentation:* easy-to-read Primer, Manual, and Reference Card.

ACCESS/86 too: for 8086-8088 micros with CP/M86<sup>2</sup>

*Dealer opportunities:* minimum investment, maximum return. Dealer package includes self-running demo.

1. Registered trademark of MicroPro International Inc.
2. Registered trademark of Digital Research, Inc.

**\$75 Trial Offer**  
Try ACCESS/80 for 45 days for only \$75. You can apply this fee to your purchase.



**FRIENDS SOFTWARE**  
P.O. BOX 527 • BERKELEY, CA 94701-0527 • (415) 540-7282  
TLX: 172 029 • ANS: SPX-SRFL

## Functions and Arguments

In App-L-ISP, atoms have two values: one used to hold a function or special form, and the other used to hold a normal value. The SET and SETQ functions bind an atom's normal value while DEFINE and DEFINEQ bind the functional or special form value. (The . . . Q form automatically quotes its atomic argument.) The function GETD retrieves a functional value, which is itself an S-expression representing a function or special form.

**Anything printed immediately after a Control-D will be treated as an operating-system command.**

App-L-ISP allows users to create LAMBDA (call-by-value), NLAMBDA (call-by-name), and MACRO forms. LAMBDA forms evaluate each actual argument and bind the results to corresponding formal arguments. LAMBDA forms cannot have no-spread parameters; each actual argument is bound to a single formal argument. NLAMBDA forms, on the other hand, do not evaluate their arguments. Instead, they bind the actual argument list to a single formal argument. Consider the form FIRST-REST, for example:

```
(DEFINEQ FIRST-REST
(NLAMBDA (ARGS)
(LIST (LIST 'ONE
(CAR ARGS))
(LIST 'TWO
(CDR ARGS)) )))
```

Running this form, we have:

```
(FIRST-REST HELP I AM STUCK IN THIS
MACHINE) == >
((ONE HELP) (TWO (I AM STUCK IN THIS
MACHINE)))
```

Notice that nothing after the form name is evaluated. Also, all the actual arguments of the form are passed into the formal argument ARGS. MACRO special forms are also available in App-L-ISP. As explained in the earlier article, MACROs allow manipulation of the complete list expression that invokes the MACRO.

## Control Structures

Sequential evaluation in App-L-ISP is specified with the PROGN or PROG forms. PROGN sequentially evaluates its subexpressions, returning the results of the last subexpression evaluation. For example:

```
(PROGN (SETQ Z (+ 3 4)) (PRINT (CAR '(A B)))
(* Z 5))
```

binds 7 to Z, prints A, and returns 35.



Check out a real data base management system.

# CHECKLIST

## Does Your DBMS Provide These 10 Essential Features?

1. **Data Integrity:** Does it protect against data corruption, erroneous data entry, and unauthorized relationships?
2. **Physical Data Protection:** Can you roll back your data base to a prior point? Recover or restart in case of damage?
3. **Data Security:** Does it provide optional data encryption and separate definitions for read/write access to the item level?
4. **Data Independence:** Can the data base structure be modified without changing previous programs?
5. **Integration:** Does the DBMS eliminate data redundancy?
6. **Performance:** Does it allow concurrent multi-user access with active and passive locking? Are response times acceptable even for very large data bases?
7. **Ease of Use:** Can many-to-many and recursive relationships be directly defined? Can programs be written in any major programming language? Are instructions short and simple?
8. **Query Report System:** Can ad hoc queries be easily made with non-procedural, English-like statements? Are sophisticated reports available from pre-defined queries? Nested queries?
9. **Portability:** Does the DBMS run under CP/M™, MP/M, CP/M-86, MP/M-86, PC DOS™, UNIX™? On Z80™, 8086, 8088, 68000, and PDP-11™? Does it run with COBOL, Pascal, FORTRAN, PL-7, Compiled BASIC and C?
10. **Support:** Are professional training, regular product updates, enhancements, and professional consulting all available?

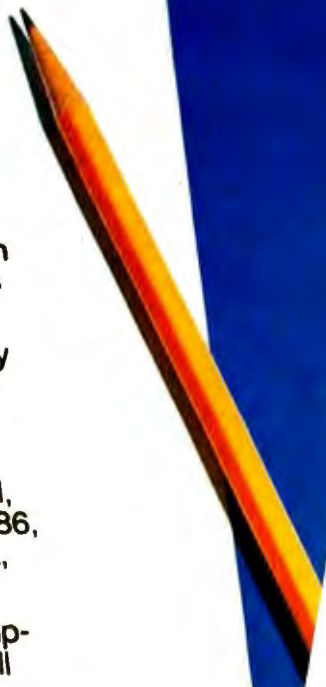

For further information contact:  
 U.S.:  
 E-USA  
 350 West Sagamore Parkway  
 West Lafayette, IN 47906  
 (317) 463-2581  
 TWX: 810-342-1881

France:  
 ISE-EGOS  
 Chenonceaux  
 Rond-Point du Pont de Sèvres  
 Boulogne Billancourt Cedex  
 9-61-04

Germany:  
 ISE-ORG GERMANY  
 9  
 Munich 40  
 92 071/4

Sweden:  
 ISE-SWEDEN

In Switzerland and Austria:  
 ISE-ADV/ORG SWITZERLAND  
 Morgartenstrasse  
 CH-6003 Luzern  
 Tel: 041-23 23 60/61

Ireland:  
 ISE-PACTEL  
 Rostmaster House  
 33 Greycoat Street  
 London SW1P2QF  
 Tel: 01-810 7744

Elsewhere:  
 ISE-INTERNATIONAL  
 350 West Sagamore Parkway  
 West Lafayette, IN 47906  
 Tel: (317) 463-4561  
 TWX: 810-342-1881

Professionals know the difference.

ISE is an international consortium of the world's leading consulting and software firms, representing over 5,000 professionals around the world.

If you can't answer "YES" to these questions, send for our comprehensive booklet, "How to Evaluate and Select a Data Base Management System."  
 MAIL TO: Your local ISE affiliate.

Name \_\_\_\_\_ 4B 222  
 Company \_\_\_\_\_ Title \_\_\_\_\_  
 Address \_\_\_\_\_  
 City \_\_\_\_\_  
 Phone \_\_\_\_\_ State \_\_\_\_\_ Zip \_\_\_\_\_  
 (area code) (ext.)

Z80 is a registered trademark of Zilog; PDP-11 of Digital Equipment Corp; CP/M of Digital Research; UNIX of Western Electric; PC DOS of IBM.  
 Please look for us at the NCC Booth No. 226, Computerama

**Listing 1:** *COUNT-DOWN* illustrates the use of the *GO* and *RETURN* forms to decrement the local variable *COUNT* and then end the evaluation of the *PROG*.

```
(DEFINEQ COUNT-DOWN
  (LAMBDA ()
    (PROG (COUNT)      COUNT is a local variable
      (SETQ COUNT 10) initialize COUNT
      LOOP           the top of the loop
      (PRINT COUNT)
      (SETQ COUNT (SUB COUNT 1))
      decrement COUNT
      (COND ((> 0 COUNT) (RETURN 'BLAST-OFF))
        (T (GO LOOP)))
      test and either exit or
      branch back
      )))
```

*PROG* also evaluates its subexpressions sequentially, but has a number of other features used to construct loops. The subexpressions of a *PROG* can be either regular expressions to evaluate, an atom that is used as a label, a *GO* form, or a *RETURN* form. Regular expressions are evaluated sequentially, as in the *PROGN*. A *GO* form takes a single atom as an argument and causes a branch to the corresponding label. A *RETURN* form takes a single expression as an argument and causes the *PROG* to return with the results of evaluating the argument. *PROG*s also allow you to declare variables local to the *PROG* body. These local variables are initialized to *NIL* upon entry to the *PROG* and restored to their previous values when the *PROG* returns. To see how this works, refer to the function *COUNT-DOWN* in listing 1. (Although *App-L-ISP* does not have a comment convention, we have added annotations in italics.)

*App-L-ISP* also has the *COND*, *AND*, and *OR* forms. *COND* is nonstandard in an inconvenient way. It will return *NIL* if no tests are successful. This makes debugging more difficult than if the *COND* complained when no test was satisfied. The only predicates in *App-L-ISP* are *>* (greater than), *EQ* (equal to), and *#* (is the argument a number?). Although this is all you really need to determine the expressions to evaluate, such a limited set is an inconvenience.

## User Environment

One of the advantages that the writers of *App-L-ISP* have, as opposed to the writers of *Z80 LISP*, is the standard Apple hardware. Unlike *Z80* systems, where "CP/M compatibility" is only an ideal at best, an Apple is an Apple. Unfortunately, the editor provided with *App-L-ISP* does not take advantage of any special features of the Apple.

The editor provided, however, is the best we have seen for a microcomputer *LISP*. It is a "structure" editor, which means it provides commands that deal explicitly with the list structure of programs and data. Instead of

```
A Advance to next element of the list you are editing.
D Down to the first subelement of the current element. The
  current element must be a list.
B Back up to previous element.
R <S-expression> Replace current element with
  <S-expression>.
X <S-exp1> <S-exp2> Exchange all occurrences of
  <S-exp1> with <S-exp2>.
DEL Delete current element.
I <S-expr> Insert <S-expr> after current element.
LI Add a set of parentheses around the current element.
RE Remove a set of parentheses from around the current
  element.
< Group items into a list. After typing "<", type "A" until the
  last element to be grouped is the current element. Then
  type ">" to close the list.
PRE <S-expr> Insert before the current element.
PP Pretty print entire list being edited.
T Go to top of list, the first element.
EX Exit the editor.
C Display the disk catalog.
E <S-expr> Edit list specified by <S-expr>.
S <S-exp1> <S-exp2> Save the expressions in list
  <S-exp1> on file <S-exp2>.
L <S-expr> Load expressions from the file <S-expr>.
H Help. Display the list of edit commands.
```

**Table 1:** *The Editor commands available in App-L-ISP.*

dealing with characters, the commands operate directly on *S*-expressions. For a list of the editor commands, see table 1.

The beauty of a structure editor is that you can "cut and paste" pieces of lists (or functions) without destroying the rest of the list. This kind of editor is tricky to use at first, but after a short while becomes well worth the effort.

We had several problems using the editor. The *Help* function only returns a list of the command names, with no explanation. The *pretty print* function does not generate end-of-line sequences at the right edge of the screen; instead, it counts on the Apple hardware to "wrap" to the next line. This is annoying to read on the screen and impossible to use with a printer.

The most serious problem we had was that the editor redefines global variables. For example, our atom "LC" in the timing tests was clobbered by the editor. This problem took several frustrating hours to locate. Normally, this problem is avoided by using lambda-bound variables or *PROG* local variables. Even when global variables are necessary, they should be given distinguishable names. For example, many *LISP* systems put an asterisk (\*) as the first character of any global variables that the system will modify.

## Error Handling

Two types of errors occur in *App-L-ISP*: "fatal errors" and "error traps." Fatal errors are *SYS ERR*, *MEM FULL*, and *FORMAL ARG ERROR*. These all cause a graceful return to the supervisor. You should then save any unsaved functions and restart *App-L-ISP*. The fatal errors are caught in such a way that system functions—in particular, *SAVE*—are still executable.



# The Butcher, Baker, Candlestick Maker



● They have one thing in common – computer business management.

Small businessmen, from all walks of life, have invested in sophisticated microcomputers, but, until now, have had to be satisfied with modified accounting software.

● Great Plains Software – a company with an eye on the future – created an easy to understand accounting/management software system *which expands as the business grows*. Flexible, quick response software developed on a hard disk providing in-depth program opportunities.

● Great Plains Software features immediate response at your fingertips. You'll get a complete data base of every journal entry posted during fiscal year, a CRT display of accounts payable, accounts receivable with customer and vendor records. And along with budgeting, payroll and inventory, there's a

built-in password security system that keeps all data confidential.

● Easy to follow documentation includes step-by-step instructions with cross reference screen displays.

● Your computer store has the details on Great Plains Advanced Software Systems. For personal service, call (701) 293-8483.



**Great Plains Software**  
123 15th Street N.  
Fargo, N.D. 58102  
(701) 293-8483

#### OVERALL

- Password privacy system standard
- Written in UCSD Pascal\*
- Hard disk oriented

\*TM UC Regents

#### G/L

- All entries on line entire fiscal year
- Flexible format financial statements
- Comparative income statements

#### A/R

- Up to 9999 customers
- Profit by customer, customer type, salesman and state
- Open item or balance forward
- Instant screen inquiry
- Automatically posts to G/L

#### A/P

- Up to 9999 vendors
- Instant screen inquiry
- Automatically posts to G/L

#### PAYROLL

- Up to 9999 employees
- Up to 25 deductions per employee
- Withholding computed
- Prints W2, 941 & checks

#### INVENTORY

- FIFO, LIFO, standard cost, weighted moving average or serial number valuation
- 5 price levels per part
- Concise report including profit by part and line
- Point of sale "cash register" program included



# Wizard-BPO™

## BUFFERED PRINTER OUTPUT

Allows new-task input while old-task prints out.

### STOP WAITING FOR SLOW PRINTER OPERATION

WIZARD-BPO is a parallel printer interface that lets you use your Apple while data from a previous operation is being printed. No more wasting of your precious time while your printer prints. The WIZARD-BPO contains a 16K byte "character buffer" that may be expanded to 32K bytes of character buffering. It accepts data at the Apple's rapid transfer rate, stores the data and feeds it to your printer at the rate the printer can accept it.

- Fully compatible with all Apple II and Apple II Plus\* computers

- Fully compatible with most Apple II expansion boards
- Fully compatible with most Apple software including Applesoft BASIC\*, Integer BASIC\*, CP/M, Pascal, etc
- Low power consumption for cool reliable operation
- Leads soldered directly into board for reliable operation
- Many formatting features
- Two-year factory replacement Warranty

Backed by the world's #1 independent manufacturer of peripheral controllers

Available at all fine Computer Stores \$179.00  
Telephone (800) 854-8737

 **WESPER MICRO Systems™**  
SUBSIDIARY OF WESPERCORP

\*Registered Trademarks of Apple Computer, Inc.

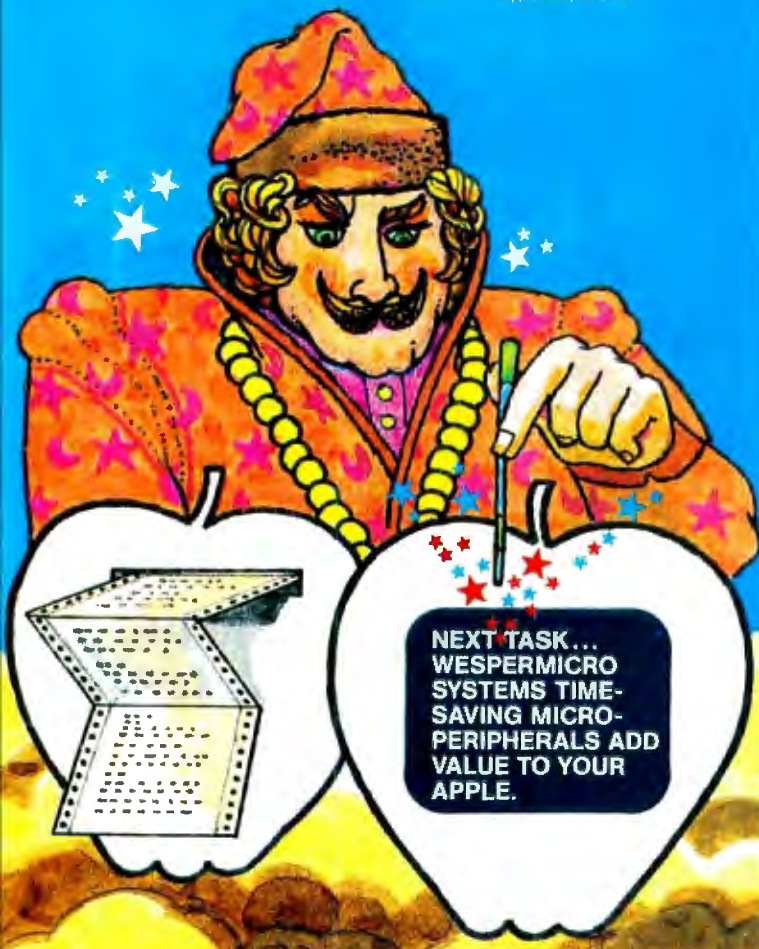

The error traps are EVAL ERR, LIST ERR, ATOMIC ERR, SUBR ERR, and NO LABEL ERR. These all invoke the error handler. The handler prints the error name, the current value in the evaluator, and the offending expression. It then allows you to take one of three actions. You can simply restart the supervisor, using the LISP function RESET (*not* the Reset button). Also, you can tell the evaluator what value to return from the error expression, using the RETURN function. The system then continues execution from that point, using the new value. You can also ask for a history of execution with the function BAKTRACE, which prints the stack of functions that have been invoked on the way to the error. This is the cleanest error-handling system for the microcomputer LISPs we have seen.

In addition to calling the error handler on an error trap, user functions can invoke the error handler by calling the function BREAK. You can also stop execution of a function and invoke the error handler from the keyboard by typing Control-B.

The editor and error handler in App-L-ISP together provide a reasonable environment for developing and debugging programs. This is one of the main advantages to using a LISP system in the first place.

### User Interaction

User interaction in "immediate mode" suffers from the same problems we observed in the other microcomputer LISPs. The same prompt character, "\$", is used to prompt for the first line of an expression and all subsequent lines. This makes it easier to mismatch parentheses.

Another problem is that the normal print function makes no attempt to format its output. Atom names can get split between two lines, making the results difficult to read.

### Saving and Restoring Programs

The form (SAVE <S-exp1> <S-exp2>) saves functions to the disk. The value of <S-exp1> is taken as a list of names of functions to be saved on the disk. The value of <S-exp2> is taken as the name of the file to use. Only the functions named in the list of <S-exp1> are saved. If the file already exists, it is then overwritten.

Functions are loaded from the disk with the form (LOAD <S-exper>), where the value of <S-exper> is taken as the <file-name>. Whenever this function is run, an atom named %<file-name> is generated. The system then binds a list of all the function names loaded to this atom. This list is then available to be used in subsequent SAVES.

No provision is made for internal image or binary disk files. The Apple disk operating system (DOS) treats the LISP files as text files.

### Program Input/Output

The function (IN = <S-exper>) is available to redirect the data source for the input functions to be the file whose name is the value of <S-exper>. READ will read



# The UniFLEX™ Operating System extracts



# every last drop

**from the 8 bit 6809 microprocessor allowing it to  
outperform many 16 bit systems**

With the UniFLEX™ Operating System, the 8 bit 6809 microprocessor can perform as well as larger CPUs in a multi-user, multi-tasking environment.

Independently developed from the ground up, UniFLEX™ closely models the features found in the UNIX™ Operating System. And in two years of use, UniFLEX™ has proven the abilities of the 6809 to perform large system functions when incorporated into a properly designed mainframe.

Some of the features supported include:

- full multi-user, multi-tasking capabilities
- hierarchical file systems
- device independent I/O
- four Gigabyte disk capacities
- full file protection
- inter-task communication via pipes
- I/O redirection
- task swapping for efficient memory usage
- full random-access files
- comprehensive shell command language
- foreground-background jobs
- electronic mail and printer spooling
- system accounting facilities

The support software currently available for use under UniFLEX™ is extensive.

A sampling of the programs available includes:

- native C compiler (full implementation)
- native Pascal compiler
- FORTRAN 77 ANSI Subset compiler
- COBOL compiler with ISAM files, Report Writer & Sort/Merge
- Extended BASIC interpreter
- Extended BASIC precompiler
- text editing and processing software
- enhanced printer spooler
- variety of absolute and relocatable assemblers
- debug and diagnostic packages

Technical Systems Consultants, Inc. also offers a line of single user FLEX™ software products for 6800 and 6809 processors. For those having an absolute need for a 16 bit processor, UniFLEX™ will be available through OEM licensing arrangements for the 68000 microprocessor. Please call or write for additional information on individual products or OEM licensing arrangements.

UNIX™ is a trademark of Bell Laboratories.  
FLEX™ and UniFLEX™ are trademarks of Technical Systems Consultants, Inc.

 technical systems  
consultants, inc.

111 Providence Road  
Chapel Hill, North Carolina 27514  
(919) 493-1451

any single valid S-expression and return it as the value of the READ. READA will read a single atom or the single characters open-parenthesis and close-parenthesis. READC will read a single character; it does not wait for a carriage return.

Similarly, the function (OUT = <S-exper>) controls the destination of the functions PRINT, PRIN1, and PRIN2. PRINT outputs one S-expression followed by a carriage return. PRIN1 outputs an S-expression, removing double quotes from atom names. It does not print a carriage return. PRIN2 is like PRINT, but does not print a carriage return.

The forms (OPEN <file-name>) and (CLOSE <file-name>) create input/output (I/O) buffers in memory for disk transfers and clear those buffers, respectively. These are necessary to allow for file I/O. Although we tried several different schemes, we could not get file I/O to work.

The forms (IN# <N>) and (OUT# <N>) also redirect I/O. These specify a slot number, <N>, on the Apple interface bus. OUT# <N> causes data to be sent both to the screen and to the device in slot N. IN# 0 and OUT# 0 reset input and output to normal operation, respectively. If no device is present in the slot specified (except for 0), the system will hang.

### Space Management

The NEW and MEM functions allow an App-L-ISP user to control space management. NEW clears all but the predefined forms from memory. MEM explicitly invokes garbage collection and returns the number of free bytes in memory.

It is not clear how App-L-ISP actually manages space. Normally, we would not have complained about this lack of information, as the typical LISP programmer need not be concerned how space is managed. The App-L-ISP

manual devotes three appendixes to this subject, however, and none of them is very clear.

### Interaction with the Apple

App-L-ISP provides a number of features for interacting with the Apple and Apple DOS. Unfortunately, many of these features are not well explained. For example, App-L-ISP provides PEEK and POKE functions, but it is not at all clear which memory locations are useful or available to the user. Similarly, it has a CALL function that will execute machine code at an arbitrary address, but there are no instructions about where you could put your own code or what system code might be worth calling.

As in Apple BASICs, anything printed immediately after a Control-D will be treated as an operating-system command. This capability seems quite useful to us. Some of the more common operating-system commands are also duplicated as functions. For example, (CATALOG) and (PROGN (PRIN1 "" <Control-D>)) (PRINT 'CATALOG)) have the same effect.

App-L-ISP also includes functions to use the Apple tone generator and graphics.

### Documentation and Library Software

As we have alluded to in several places, the documentation for App-L-ISP is far too sketchy. The software is distributed with a small manual and a textbook (LISP by P. H. Winston and B. Horn, Addison-Wesley, 1981). The manual claims only to contain "synoptic descriptions of the commands available in App-L-ISP." Users are expected to use the manual as a supplement to the textbook. To support this, App-L-ISP is distributed with a set of App-L-ISP functions that, it is claimed, emulate a number of the MACLISP functions used by Winston and Horn.



**Saturn Navigator  
now A2-3D1 licensed!**

Yes, SubLOGIC's A2-3DA Saturn Navigator is now available as a complete package, incorporating all of the graphic routines necessary for a successful flight from earth to Saturn. If you've been looking for a realistic 3D space flight simulation, this is the one for you. / For the Apple II plus or Apple II with Applesoft ROM. 48K. \$34.95.

**See your dealer!**

**subLOGIC**  
Communications Corp.  
713 Edgebrook Drive  
Champaign, IL 61820  
(217) 359-8482

"Apple" is the registered trademark of Apple Computer Inc.



# BUSINESS FORM PROCESSING

## Application Memo #1: **INVOICES**

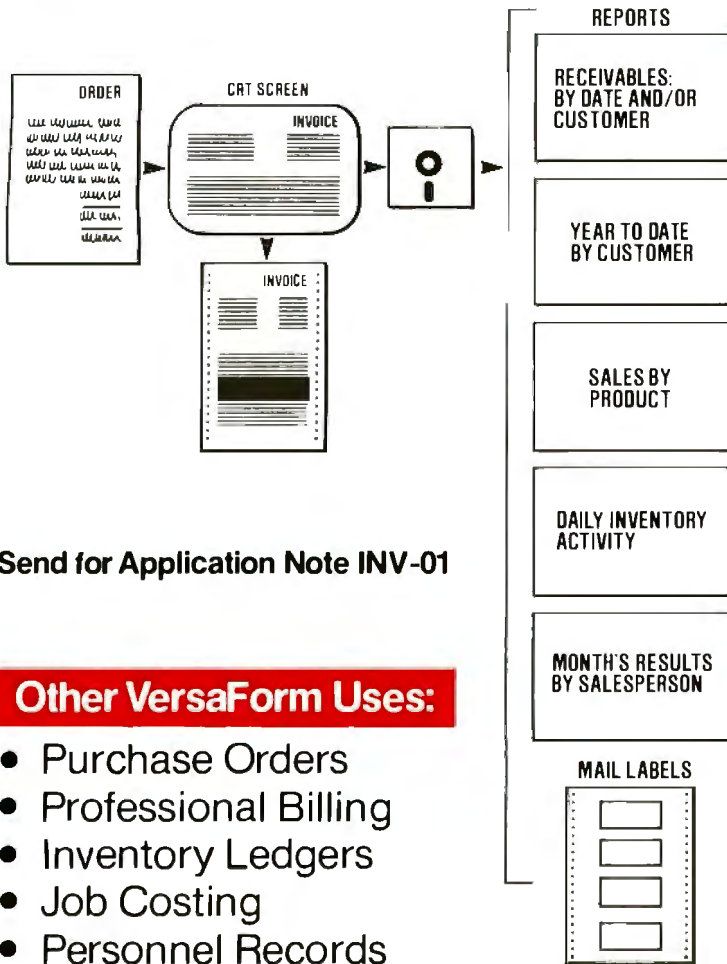

Send for Application Note INV-01

### Other VersaForm Uses:

- Purchase Orders
- Professional Billing
- Inventory Ledgers
- Job Costing
- Personnel Records

**Now there's a way** to quickly automate specific areas of your business . . . using existing forms. In a single session you can emulate a standard invoice on a personal computer (as shown on side). Automatic filling, calculating and data checking features to speed error-free processing. It's called Business Form Processing, a brand new concept in desktop computing.

**Producing management reports** that used to take days now takes minutes. Just specify which items contained within your form are to be sorted, sub and summary totalled. Each report as shown took only minutes to specify, and minutes to produce. It's the combination of the easy-to-use reporting facility with its powerful forms emulator that makes VersaForm more than just a data base.

**You can use existing forms.** With a simple output formatting module, VersaForm lets you overprint processed information to a pre-printed form, or to blank paper that becomes its own custom form. It even customizes your output to your printer's line spacing and number of characters per line, and can omit confidential data from final customer drafts.

**If you have a form,** we've got the system and solution to higher productivity. Visit your local computer store where Apples are sold.



Hard Disk versions available

**VersaForm**<sup>TM</sup>  
Business  
Form  
Processor

Applied Software Technology  
14125 Capri Drive  
Los Gatos, California 95030  
(408) 370-2662

# Stackworks Forth Means . . . Fast Development

**Stackworks Forth is more than a language—** it is a complete approach to Z80 software development. A full, extendable interpreter-compiler producing compact code, optionally ROMable to under 2K, Stackworks Forth is as fast as compiled Fortran, as easy to use as interactive Basic.

**Completely I/O compatible with CP/M,** Stackworks Forth is a simple, self-contained, stack oriented system allowing high level development and instantaneous debugging and modification of complete end user oriented programs. Stackworks Forth is fast and its threaded list structure offers production code approaching and in many cases exceeding the compactness of equivalent assembly code.

**Stackworks Forth is ideally suited** for rapid software design with immediate testing capability, for applications in robotics, hardware development, process control, any field with a need for Stackworks power.

## Stackworks Forth Means Power

**Stackworks Forth means** compact production code, high speed, high level coding, fast on-the-spot debugging, in-line assembly code capability, simplicity of structure, and more . . .

**Forty-Five Dollars** provides the user with a complete, fully documented system for Z80 CP/M software development (includes 16 bit, 32 bit, and 13 digit BCD math routines).

Option B adds the Stackworks Forth assembler and debugger to the base package and includes tutorial for a total of \$80.

Option C includes the above with ROM option and source code for creating modules in as little as 2K bytes and allows unlimited in-house use of Stackworks Forth for \$400. Commercial users are invited to inquire about additional Stackworks Forth licenses.

Option D provides Option B software and the **Xedex Baby Blue** add-in board for the IBM Personal Computer for a total of \$600.

MasterCard, Visa, or American Express call 800/457-4544 or write The Stackworks, 1414 E University, Box 1596, Bloomington, IN 47402.

The logo for Stackworks, featuring the word "stack" in a bold, lowercase, sans-serif font above the word "works" in a similar font, both slanted to the right.

Stackworks Forth for both CP/M-86 and DOS on the IBM Personal Computer . . . in development.

Expression evaluated by TESTER	Counts
LC	119
DC	162
BIGCAR	258
BIGCDR	256
'(HAS-AS-MEMBER-I 'B LONG1)	40
'(HAS-AS-MEMBER-R 'B LONG1)	34
'(REMOVE-ELEMENT-I 'B LONG41)	3
'(REMOVE-ELEMENT-R 'B LONG41)	34

**Table 2:** The results of the timing tests applied to App-L-ISP. For the benchmark programs used, see "Three Microcomputer LISPs," *BYTE*, September 1981, p. 388. This series of tests was conducted as in the previous article (except that the Apple had only 48K bytes of RAM). REMOVE-ELEMENT-I was particularly slow because of a very slow recursive version of APPEND. Trying (TESTER NIL) for more than 10 seconds caused the system to crash.

LISP is not standard and you need more than a "synoptic definition," particularly since App-L-ISP differs in many ways from the MACLISP dialect of Winston and Horn. In fact, the MACLISP emulation functions are relatively crude and do not always work as described.

Besides being sketchy, the manual is also inaccurate and confusingly organized. For example, the ADD1 (increment 1) predefined function is documented, but not provided. The table of contents is formatted in a confusing way and there is no index.

In addition to the MACLISP emulation functions and the editor functions (discussed in another section), several other files of functions are distributed with App-L-ISP. Included is a simple version of Weizenbaum's ELIZA (called DOCTOR here), a tower of Hanoi demonstration of App-L-ISP's graphics capabilities, functions to use the Apple screen for graphics, and functions to pretty print into a text file. None of these packages are adequately documented. An annotated listing of these files would have been quite helpful. Such a listing would help in both documenting the package and giving badly needed examples of App-L-ISP code.

## Conclusions

App-L-ISP provides a minimal, but complete, LISP system that runs at an adequate speed. (The timing tests are shown in table 2. These tests are the same as performed in our article on the Z80 LISPs.) App-L-ISP is slower and has fewer features than the Z80 LISPs.

The documentation, and much of the library software, is inadequate. The manual could easily be doubled in size and should be better organized. The library software should be rewritten so that the global variables used will not interfere with user code.

The editor, while not making full use of the Apple, is quite nice. The pretty printer is not satisfactory, working poorly with the Apple screen and not at all with a printer.

App-L-ISP is suitable as an educational tool for teaching recursion, applicative programming, and basic LISP. ■



# One of the great masters?

Although the Datasouth DS180 matrix printer may not exactly rate as a work of art, our customers have a *very* high opinion of its value. Over the past year, we have shipped thousands of DS180 printers to customers throughout the world. Many of our sales now come in the form of repeat business—a strong testimonial to the acceptance of a product.

The success of the DS180 in a very competitive market did not happen by accident; rather through our sensitivity to the needs of the industry. This sensitivity we carry through research and development, production and quality control and finally, to after sales support and service.

Recently we introduced new enhancements to make the DS180 printer even more versatile. Dot addressable raster scan graphics produces output of computer generated charts, maps and graphs at a resolution of 75 x 72 dots per inch. Variable horizontal pitch selection allows printing at 10, 12 or 16.5 characters per inch plus double wide printing at 5, 6 or 8.25 characters per inch. The expanded 2K FIFO print buffer handles a full CRT screen dump at up to 9600 baud without delaying the host system. We also offer transparent mode for isolating communications problems, and for APL users, the dual ASCII/APL character set option.

Check our list of features and we think you will agree that the DS180 offers the most complete performance package in matrix printers.

#### DS180 PRINTER STANDARD FEATURES

- Microprocessor Control
- 180 CPS Print Speed
- Bidirectional Logic Seeking
- 1000 Character Buffer (Expandable)
- 9x7 Dot Matrix
- Expanded Characters
- Adjustable Printwidth (1 to 6 Copies)
- 96 ASCII Character Set
- Cartridge Ribbon
- 132 Column Print Width
- Tractor Feed (Front or Bottom)
- Non-Volatile Format Retention
- Top of Form
- Horizontal Tabs
- Vertical Tabs
- Repetition Skip Over
- Auto Line Feed
- 60 LPI
- Auto End of Line Carriage Return
- 5 BPS Paper Slow
- Parallel and Serial Interfaces
- 110/9600 Baud Communications
- Terminal Status Indicators
- Audio Alarm
- Self Test
- 8 cm, 8 1/2"
- Paper Out Detection

#### OPTIONAL FEATURES

- Compressed Print—10, 12, 16.5 cpi
- High Resolution Dot Addressable Graphics
- 2k Expanded Print Buffer
- APL/ASCII Character Set



The DS180 is available nationwide through our network of sales/service distributors.

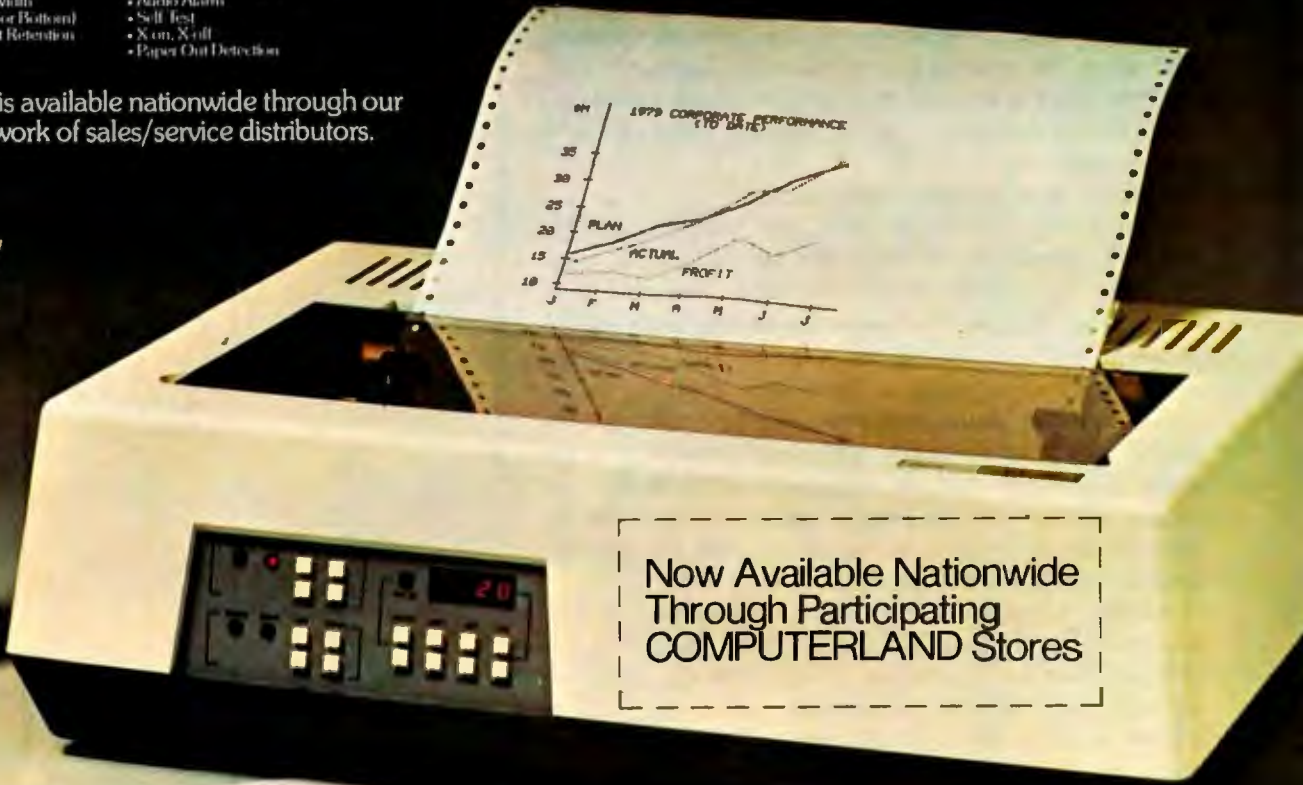

Now Available Nationwide Through Participating COMPUTERLAND Stores

Circle 149 on inquiry card.

**datasouth**  
**computer corporation**

P.O. Box 240947 • Charlotte, NC 28224 • 704/523-8500

## Find That Disk

R. E. Bruninga, LCDR, USN  
USS Blue Ridge LCC-19  
FPO San Francisco, CA 96628

I might never have organized, except that I moved aboard a ship with all my microcomputing junk, and limited quarters dictated more efficient use of space. One of the more annoying problems was what to do with my pile of 5¼-inch disks—the constant shuffling in search of a specific disk was a little like playing with a deck of awkward cards. Separating and boxing them according to broad categories was no help because each disk still had to be partially withdrawn to determine its contents. This generally resulted in a small wrestling match with the box and the assorted unused write-protect tabs and labels that always seem to get in the way. There had to be a better solution.

There is. And it doesn't cost a cent.

Having no use for those labels, and being the reckless sort who doesn't use write-protect tabs, I came up with the following solution: throw the labels away but save one to label the box. Then place the write-protect tabs in different positions on the top edge of each of the ten disks, as shown in figure 1. Don't write anything on the tabs—they are simply markers that correlate to the legend printed on the inside of the box cover. In fact, the order of the disks as you replace them in the box no longer matters: you can always find the correct disk by reaching for the one with the tab located opposite the desired title on the box lid.

Another advantage is not having to keep track of disk jackets: since you only use one or two disks at a time, you can leave them in the box. Using a disk then becomes a simple task of reaching for the right subject box, removing the selected disk, and inserting it in the right drive. After use, just place the disk in the box in any available jacket. It will always be retrievable by sight!

This system has worked successfully for more than six months and frustration is now a thing of the past. I may have lost my dexterity at card shuffling, but as long as I can continue to ignore write-protect tabs, I look forward to years of happy disk finding. ■

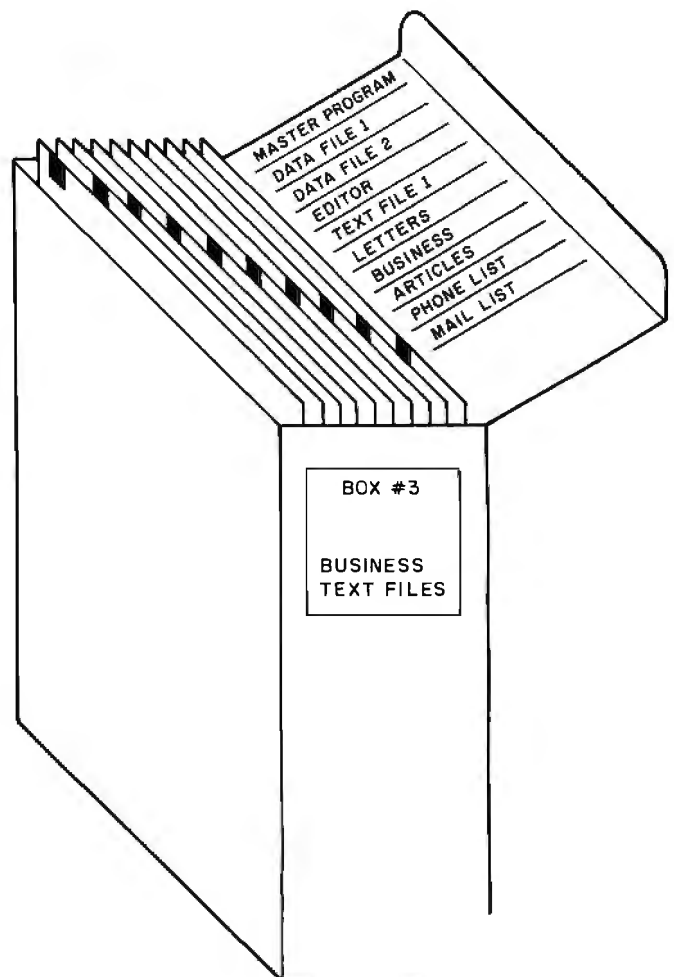

Figure 1: The write-protect tab on the top of each disk is directly opposite a short description written on the inside of the top cover.





## Two billion characters and still going strong.

We build Dataroyal computer printers to perform day after day in the harshest environments. As an example, we randomly chose five of our original production printers and ran them continuously in a life test that lasted 24 hours a day, 7 days a week, for 2 years. In that time they each printed more than two billion characters. They operated at a 100 percent duty cycle and 100 percent print density, and achieved an MTBF of 2,281 hours. This means from eight to ten years of maintenance-free operation in normal applications.

We achieve that kind of product reliability with modern LSI circuitry and fewer moving mechanical parts.

Computer systems manufacturers choose Dataroyal with confidence as do Fortune 500 companies who use Dataroyal with the finest business computers.

If you want a trouble-free computer printer, you want one from the company that's going strong. Call or write Dataroyal Incorporated, 235 Main Dunstable Road, Nashua, New Hampshire 03061, (603) 883-4157. Or contact your local dealer for Dataroyal information.



**DATAROYAL  
INCORPORATED**



# "IBM Personal Computer" USERS YOU DESERVE THE BEST!

choose what the professionals\* use

**NEW!**

Available Now  
**DISK++**

Up to 12 MB Winchester Disk,  
256KB parity memory  
**AND**  
1 Async Port



#### Combo Card (User Upgradeable)

- MC-064 64K From \$435
- MC-128 128K From \$635
- MC-192 192K From \$835
- MC-256 256K From \$1035
- Suffix S = ASYNC comm. option \$60
- Suffix P = parallel printer option \$60
- Suffix SP = both options \$120
- User upgrade document available for sale, order model MC-001SP
- Program compatible with IBM's

#### 64KB-256KB Parity Memory

- MP-064: \$395 • MP-128: \$595
- MP-192: \$975 • MP-256: \$995
- User upgradeable
- Fully assembled, tested & burned-in
- 1-year warranty

#### Advanced Communication

- CC-232: \$295
- 2 RS232 ports
- Capable of ASYNC, BISYNC, SDLC, HDLC

#### ASYNC Communication

- CC-032: \$145 • CC-132: \$275
- CC-032 offers 1 serial port
- CC-132 offers 2 ports
- Program compatible with IBM's Serial Com. Card

#### Hardware Prototype

- WW-068: \$75 • WW-069: \$55
- WW-068 wire wrap card (13" x 4.2")
- WW-069 extender
- Get both for \$95

\*Our customers include: IBM, TRW, Bell Labs, Visicorp, Softech Microsystems Inc., Information Unlimited Software, Context Management, Network Consulting Inc., etc.

**AST**  
**RESEARCH INC.**

17925 Sky Park Circle, Suite B  
Irvine, CA 92714 (714) 540-1333  
Dealer Inquiries Welcome





## Tawala's Last Redoubt

Hartley G. Lesser  
3243 Oakes Drive  
Hayward, CA 94542

Broderbund Software has finally released Tawala's Last Redoubt, the fourth and most challenging adventure so far in the Galactic Saga series.

Prior action followed the life of the mighty Emperor Tawala Mundo, whose origin was the small planet of Galactica. As his influence spread with the aid of Julian du Buque, Tawala crowned himself ruler of the 20 planets in the Central Galactic System.

Many years of restlessness followed. The Emperor cashiered du Buque, the one-time commander of Tawala's armed forces, for unstated reasons. Tawala lacked du Buque's skill in planning and logistics and feared du Buque would use his talents against his rule. Thus, Julian du Buque became a hunted man.

Elsewhere dissatisfaction among the merchant class ignited a revolution which du Buque ultimately joined. He led the successful overthrow of Tawala Mundo, and the once-proud and haughty ruler was forced to flee when the rebellion toppled his throne and swept aside his remaining puppets.

A newly opened planet, Farside, became Tawala's refuge. Amid a core of powerful supporters, Tawala constructed a redoubt, a fortification to protect him from those who wanted to destroy him.

### The Mission

The fourth adventure begins on Farside. You take the role of a rebel leader named Benth. The insurgents' camp is veiled by the southern mountains of the inhabited areas of Farside. Benth—earth-woman, fighter, and strategist—initially leads a small and ill-equipped band of rebels. Your goal is to elicit support from the eight village chieftains, avoid the forays sent by Tawala, and ultimately defeat the Emperor within his redoubt.

No easy task here. The pitfalls are many. Yet with cunning and forethought you can succeed.

Those who have played any of the preceding three Galactic Saga adventures may look forward to the same

### At a Glance

**Type**

Adventure-style game

**Manufacturer**

Broderbund Software  
1938 Fourth St.  
San Rafael, CA 94901  
415-456-6424

**Price**

\$29.95 (disk)

**Author**

Douglas Carlston

**Format**

5¼-inch floppy disk  
(13- and 16-sector)

**Language**

Applesoft BASIC; machine-code subroutines for animation

**Computer**

Apple II and II Plus; 48K bytes of memory and one disk drive (also available for TRS-80s, cassette and disk)

**Documentation**

27-page instruction booklet

**Audience**

Adventure and simulation game players

type of challenge. For those who have no prior experience Tawala's Last Redoubt is the best of the entire series.

### The Software

I reviewed the package for the Apple II, although versions for both disk- and cassette-based TRS-80s exist. The single disk boots on either 13- or 16-sector systems. The package includes a well-written and interesting rule book that introduces you to the control functions and gives you a history of the revolution on Farside.

### Game Features

The first outstanding game feature is its speed. Upon loading, you can indicate how fast you want to play. You can thus accelerate play during the waiting periods or slow the pace when several activities are taking place at once.

The second worthwhile feature is the ability to save up to nine games on the same disk. You can halt and save the

game at any point of play and have nine such partially played games awaiting recall. You are able, for example, to examine different strategies for specific results during any stage of the game.

The instruction booklet contains the 14 input and output routines used in the adventure.

### Master Menu

Play is governed by the entry of single-letter or number commands. After you have determined the game's speed, the screen clears to show Benth's headquarters, designated by a pitched tent and campfire. The action begins here.

A message in the upper left-hand corner of the screen tells you your current location, while the upper right-hand corner displays the passage of time. The master menu is shown in the lower right-hand corner. You have three main options: M)essenger, I)ntelligence, and O)rders.

### Military Intelligence

Because you will have very little information when you begin play, the I)ntelligence option perhaps should be examined first. After pressing the letter "I," a submenu that contains the four additional selections M)ap, D)ossier, G)eographical, and S)end Agent appears.

The first selection produces on the screen a map of the area on Farside where the adventure takes place. This consists of Benth's camp, Tawala's redoubt, and eight villages and their connecting roads. Also shown is your current strength in arms, money, troops, and your current geographic location.

The second selection contains all necessary information on the eight village chiefs. This is important because negotiations with these leaders are the only way you can increase your supply of arms, money, and troops. If this cannot be accomplished, your defeat by Tawala is certain.

The geographical selection deals with the stability of the different inhabited areas, and the fourth selection deals with your two spies. It also opens up communica-

tion with your Chief of Intelligence, Paoli. You tell Chief Paoli where you want the spies sent so that the information they gather can be relayed back to you. Paoli is a valuable ally and is best kept close at hand.

The M)essenger function of the master menu brings one of four animated messengers onto the screen. Whoever you call forth runs to the center of the screen, salutes, and asks for orders. At this point you'll tell the messenger to see either one of the village chieftains or one of your own rebels at a certain location. If the former, the messenger may be instructed to ask the chieftain for arms, money, or troops and to determine whether threats should be used to ensure compliance. The messenger then departs; he will tell you when the task is done.

The final master-menu option breaks up the camp to move elsewhere or O)rders your armed personnel either to attack and hold a village or to loot and pillage it. Such actions depend on the movement of Tawala's agents and forces. The latter option would be used primarily against a chieftain who failed to give you the requested aid.

### Tactical Considerations

Handling the village chieftains is an exercise in skilled negotiation because they all possess different characteristics. Carefully read their D)ossiers, which Paoli will give you on request, to learn as much as possible about them before you try to bargain for needed equipment or personnel.

Your defeat at the hands of Tawala can come quickly and without warning if you're careless. Suddenly shots will echo about in your location, and bursts of flame will scatter the graphics. This scene will fade, and an evening sky will appear. A man will walk to the center of the screen and salute the heavens, and a touching speech that eulogizes Benth will scroll before your eyes.

### Conclusion

I highly recommend this game for those with a daring and resourceful will; for those who are able to see the forest because of the trees; and for those who can remain undaunted by an occasional defeat. ■

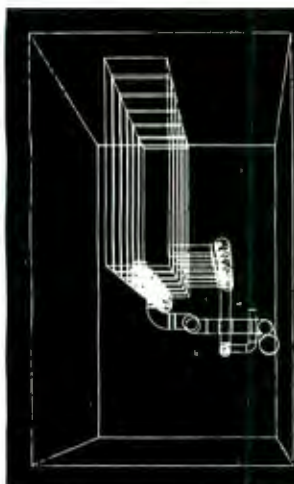

## GRAPHIC SOFTWARE

**GRAPHIC SOFTWARE FOR MICROCOMPUTERS** — This self-teaching guide will show you how to write your own graphics software. 61 programs for 2D and 3D graphics: interactive input, translations, rotation, isometric views, perspective, scaling, stretching, clipping, surface intersections, shading, hidden line removal, tablet software, animation and more. Applications to science, engineering and business. "One of the most outstanding books on computer software" — A. Grund, U. Illinois; "The best book available on microcomputer graphics" — Creative Computing Feb, 1982. Book — \$21.95; Disk — \$18.95.

Books contain fully documented program listings in BASIC with theory and equations. Disks contain the same programs as the books but without documentation. When ordering disks, please specify APPLE II Plus 48K DOS 3.3 or CP/M.

## ENGINEERING SOFTWARE

**ENGINEERING SOFTWARE FOR MICROS** — A self-teaching guide to developing software for engineering applications of microcomputers. Emphasis is on combining graphics with engineering problem solving. Programs included to interactively create engineering drawings, store on disk file, recall, modify and merge. Other programs for simulation, mechanisms design, heat transfer, circuit analysis, optimizations and including Monte Carlo techniques. Programs for Fourier analysis display frequency spectra graphically. This is a valuable collection of modern engineering analysis software for students and professionals. Book — \$28.50; Disk — \$19.95.



# Programming Quickies

## A Word-Counting Utility for Writers

Steven K. Roberts  
5885 Dublin Rd.  
Dublin, OH 43017

A microcomputer fully configured for use as a word processor is a valuable and addicting asset to a writer, as anyone who has spent more than a few minutes grappling with a typewriter can well imagine. I doubt that I would be trying to make a living in this volatile word business if my trusty word-processing computer system, BEHEMOTH, weren't here to deal with the brutal realities of somehow getting text from my head to paper.

But writing, it turns out, also involves a variety of data-shuffling tasks that are not directly involved with text editing and formatting. And then there's that fairly trivial but age-old problem of counting the number of words in a manuscript. Yes, you can multiply some average word count per page by the number of pages in the manuscript, but that's inelegant and fails to accommodate stylistic variations that can have significant effects on the length of the average word.

The word count of a manuscript, by the way, is more than an idle bit of trivia born of a love affair with information. Primarily, it is a key specification in article assignments, since the amount of space available to an

editor of a publication is predetermined. (Opening the reference book *Writer's Market 1981* at random, I note that *Bird Watcher's Digest* accepts nonfiction articles in the 600 to 3000 word range and fillers of 50 to 225 words.) Second, word count is a part of most book contracts, a fact that is giving me little rest these days (180,000 words, it turns out, is a lot). And finally, observing the amount written each day in some sort of dispassionate and objective fashion can provide useful feedback concerning a writer's output.

If all that text is in the form of disk files, it becomes quite easy to let the computer do the counting, and the Z80 assembly-language program COUNT (see listing 1) accompanying this 781-word [*Before editing...Ed.*] article does just that. Designed to be run under the Cromemco CDOS operating system, it can easily be adapted to CP/M-based systems, while the concept behind it can be applied to other personal computers.

Use of this utility program is straightforward. To count the words in this article, the program is invoked with the command line: COUNT C:WORDCNT.M62.

The text file is called WORDCNT.M62 (the manuscript serial number is 62) and happens to be on floppy disk drive C at the moment. The COUNT program just reads the entire article and accumulates the total number of words, using the space, hyphen, and carriage-return

### About the Author

Steven K. Roberts has written numerous microprocessor-related articles and two books. He lives and works in Dublin, Ohio, and offloads as much trivia as possible onto BEHEMOTH, his computer system.

### STRUCTURAL ANALYSIS SOFTWARE

**STRUCTURAL ANALYSIS ON MICROS** — This self-teaching guide contains a series of programs which calculate stresses and deflections in beams, plates, trusses and frames using conventional and matrix techniques. Theory, equations and program listings fully documented. Written for the non-specialist who wants to use his micro for structural analysis with minimum investment in time. Use the programs as is or modify for your own applications. **Book - \$39.95; Disk - \$19.95.**

### DATA PLOTTING SOFTWARE

**DATA PLOTTING ON MICROS** — A collection of programs to process and display all types of data: bar charts, stock market charts, engineering and scientific data, 3D views of surfaces, pie charts, sorting, filtering, running averages, curve fitting, and more. Application to business, engineering and science. All programs fully documented and keyed to theory. Use as is or modify for your own applications. **Book - \$24.95; Disk - \$19.95.**



**KERN PUBLICATIONS**

190 Duck Hill Rd  
Duxbury, MA 02332

To order, send check drawn on U.S. bank, money order in US funds, Visa or Mastercard number with expiration date to KERN PUBLICATIONS 190 Duck Hill Road, P. O. 1029A, Duxbury, MA 02332. Add \$2 per book 4th cl postage in US and Canada; \$3 1st cl or UPS in US; \$4.50 1st cl Canada; \$12 air Europe and Central America; \$18 elsewhere. Call (617) 934-0445 for faster delivery.

## Programming Quickies

**Listing 1:** This Z80 assembly-language program, COUNT, will return the word count of any text file. A word is defined as any group of characters delimited by a space, a hyphen, or a carriage return. When the end-of-file marker is encountered, the total word count is displayed. The subroutine names listed in the comments (FNAME, ZOPN, etc) are Cromemco CDOS system entry points. Their addresses (or the addresses of the equivalent routines on your system) must be set at assembly time.

```

0002          NAME    COUNT
0003 ;
0004 ;This program wanders through a text file and accumulates the total number
0005 ;of words (up to 65,535). A "word" is any group of one or more characters
0006 ;delimited by a space, a hyphen, or a carriage return.
0007 ;Execution is invoked with the standard CDOS command format:
0008 ;          COUNT file-ref
0009 ;The assembled file COUNT.REL must be linked with ASMLIB to provide the
0010 ;disk access and binary-decimal routines. These are characterized as follows:
0011 ;
0012 ;          FNAME - Sets up extended FCB from an FCB.
0013 ;          ZOPN  - Opens an existing file.
0014 ;          ZIOER - Prints file error message from ZOPN.
0015 ;          ABORT - Prints a message and exits to CDOS.
0016 ;          GCHAR - Inhales one character from the file.
0017 ;          BINDB - Converts binary number to decimal string.
0018 ;
0019 ;HISTORY:      Created 10/3/80 (SKR)
0020 ;             Edited for MS62 1/1/81 (SKR)
0021 ;             Edited for MS55 1/7/81 (SKR)
0022 ;
0023          EXTRN   FNAME,ZOPN,ZIOER,ABORT,GCHAR,BINDB
0024 ;
0000' 3A5D00      0025 START: LD    A,(5DH)          ;If the first byte of the filename
0003' FE20         0026 CP      ' '          ; is blank, print error message
0005' CA6500'     0027 JP      Z,ERROUT
0008' 97          0028 SUB     A          ;Set up file control block.
0009' 215C00      0029 LD      HL,5CH
000C' 119600'     0030 LD      DE,IXFCB
000F' CD0000#     0031 CALL   FNAME
0012' CD0000#     0032 CALL   ZOPN
0015' CC0000#     0033 CALL   Z,ZIOER
0034 ;
0018' 210000      0035 LD      HL,0          ;Initialize word count
001B' 229400'     0036 LD      (COUNT),HL
001E' AF          0037 XOR     A
001F' 329300'     0038 LD      (LAST),A      ; (and the LAST status bit)
0039 ;
0022' 119600'     0040 LOOP:  LD      DE,IXFCB      ;Get a character from the file
0025' CD0000#     0041 CALL   GCHAR
0028' FE1A        0042 CP      1AH          ;If it is EOF, quit
002A' 2829        0043 JR      Z,EOF
002C' FE20        0044 CP      SPACE        ;If space, hyphen, or CR, we are between words
002E' 280C        0045 JR      Z,YUP
0030' FE2D        0046 CP      DASH
0032' 2808        0047 JR      Z,YUP
0034' FE0D        0048 CP      CR
0036' 2804        0049 JR      Z,YUP
0038' 0600        0050 LD      B,WORD        ;Otherwise, we're in a word
003A' 1802        0051 JR      TRST        ;Set B=1 and go test
003C' 0601        0052 YUP:   LD      B,INTRVL      ;Set B=0 and test
003E' 3A9300'     0053 TEST:  LD      A,(LAST)      ;Get the last status
0041' B8          0054 CP      A,B          ;Same?
0042' 28DE        0055 JR      Z,LOOP        ;If so, go get another character
0044' FE01        0056 CP      A,INTRVL      ;(Only count word -> interval transitions,
0046' 2007        0057 JR      NZ,SAVE        ; not the opposite.)
0048' 2A9400'     0058 LD      HL,(COUNT)   ;Else, increment the word count
004B' 23          0059 INC     HL
004C' 229400'     0060 LD      (COUNT),HL
004F' 78          0061 SAVE:  LD      A,B          ; then save the new status
0050' 329300'     0062 LD      (LAST),A
0053' 18CD        0063 JR      LOOP        ; and loop.
0064 ;
0055' 218C00'     0065 EOF:   LD      HL,STRING      ;Translate binary count into decimal string
0058' ED4B9400'   0066 LD      BC,(COUNT)
005C' CD0000#     0067 CALL   BINDB
005F' 217F00'     0068 LD      HL,EOFMSG      ;Print it
0062' CD0000#     0069 CALL   ABORT
0070 ;
0065' 216B00'     0071 ERROUT: LD    HL,ERRMSG      ;Print an error message
0068' CD6300#     0072 CALL   ABORT
0073 ;
006B' 53706563   0074 ERRMSG: DEFB   'Specification Error',13
69666963

```

Listing 1 continued on page 240



# 8086/8087/8088 CROSS SOFTWARE TOOLS

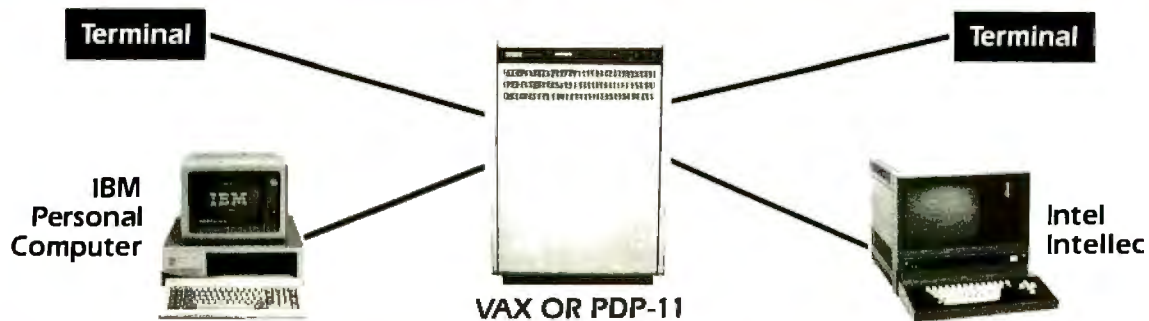

## OPTIMAL DEVELOPMENT ENVIRONMENT

### 1 OS COUPLER

Couples the user workstation to the host system such that

- all host commands are available.
- files can be moved to/from a mounted file system located at the workstation, and
- 8086/8087/8088 files can be executed at the workstation.

For example, assume that your editor is written in portable C, is running on the host system, and is giving poor response due to host system loading. To gain real-time response, simply cross-compile it on the host, move it to your workstation, and execute it there. You can move programs, including the C compiler itself, to your workstation as desired. Note that the workstation does not require massive amounts of file storage to provide a host system environment.

The workstation can be decoupled from the host for stand-alone operation.

Workstations supported: IBM Personal Computer and Intel Intellec system. Coming soon: DEC Personal Computer.

Intel and Intellec are trademarks of Intel Corporation. UNIX and UNIX/32V are trademarks of Bell Laboratories. DEC, RT-11, RSX-11M, PDP-11, VMS, and VAX-11 are trademarks of Digital Equipment Corporation. IBM, VM, CMS, and IBM Personal Computer are trademarks of International Business Machines Corporation.

### 2 PASCAL AND/OR C CROSS-COMPILERS

For Pascal, all facilities of the ISO definition are supported. For C, all facilities of the complete language, including floating point for the 8087 and 32-bit pointers, are supported. Optionally, memory can be allocated for optimal use of the 8088. Output is symbolic assembly language. Optionally, the output contains symbolic debug information.

### 3 CROSS ASSEMBLER/LINKER LIBRARIAN/LOADER

Assembler syntax is a notable improvement to that used by Intel. Features include optimized branches, symbol table listings, and full 8087 support. Loader output is an Intel OMF file, an Intel hex file, or an IBM PC-DOS file.

#### Host System for 1:

VAX/PDP-11 running UNIX. Coming soon: VAX running VMS, IBM running VM/CMS.

#### Host System for 2 and 3:

PDP-11 running RT-11, RSX-11M, UNIX/V6, UNIX/V7; or VAX running VMS, UNIX/32V.

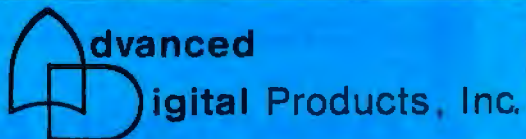

1701 21st Avenue S., Suite 222  
Nashville, Tennessee 37212  
Phone (615) 383-7520

## Programming Quickies

Listing 1 continued:

```

6174696F
6E204572
726F720D
007F' 576F7264      0075 EOFMSG: DEFB   'word count = '
20636F75
6E74203D
20
008C' 30303030      0076 STRING: DEFB   '000000',13
30300D
0077 ;
0093' 00            0078 LAST:  DEFB   0           ;Word/interval flag
0094' 0000          0079 COUNT: DEFW   0           ;Binary word count
0080 ;
0096' 00            0081 IXFCB: DEFB   0
0097' (0022)        0082         DEFS   34
00B9' BE00'        0083         DEFW   IBUFF,0
0000
00BD' 04            0084         DEFB   4
00BE' (0200)        0085 IBUFF:  DEFS   80H*4       ;Disk buffer
0086 ;
(0020)             0087 SPACE: EQU    20H
(002D)             0088 DASH:   EQU    2DH
(000D)             0089 CR:    EQU    0DH
(0000)             0090 WORD:  EQU    0
(0001)             0091 INTRVL: EQU    1
0092 ;
02BE' (0000')      0093         END     START
Errors              0
Program Length     02BE (702)

```

characters as delimiters. When it encounters the end-of-file mark (hexadecimal character 1A), it stops and displays the word count on the console.

This final value, it should be noted, includes any output-formatting directives associated with the word-processor that are embedded in the text, introducing a slight error in excess of the actual number of words. The word count of this article includes twenty-three nonprinting "words" (formatter commands). If you are paid by the word, it might be worthwhile to add a test for whatever command prefix character your formatter requires and suppress the normal toggling of the LAST flag (see listing 1) when one is found—but that may be more trouble than it's worth.

For convenience, I have built COUNT into a batch file that takes care of formatting the text on my Diablo printer. Thus, each time an article or chapter is printed,

its word count is displayed and can be noted on the title page, used for gambling purposes, or ignored entirely. In a current textbook project (*Industrial Design with Microcomputers*, to be published by Prentice-Hall), I am adding weekly segments to a graph fondly dubbed the "PFD curve": cumulative word count is plotted against time with a straight reference line drawn from the start of the project to the deadline. Naturally, the actual curve is roughly exponential, with a nice lazy slope at the beginning, a knee at the onset of stress, and a nearly asymptotic rise in the last few weeks as the approaching deadline triggers panic. Oh yes, "PFD" stands for "Procrastination Followed by Despair."

The word-count program allows informed, rather than naive, dismay at the amount of work left to be done in an ever-dwindling amount of time. Ain't technology wonderful? ■

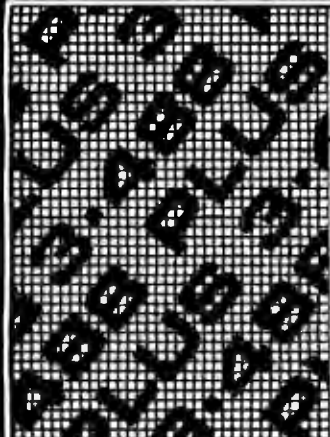

# THE 488+3

IEEE 488 TO S-100 INTERFACE

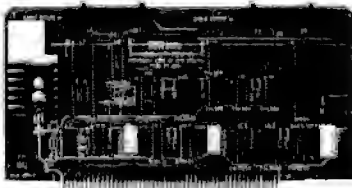

IEEE-488

S-100

- Handles all IEEE-488 1975/78 functions
- IEEE 696 (S-100) compatible
- MBASIC subroutines supplied; no BIOS mods required
- 3 parallel ports (8255A-5)
- Industrial quality; burned in and tested
- \$375

(Dealer inquiries invited)

## D&W DIGITAL

1524 REDWOOD DRIVE  
LOS ALTOS, CA 94022 (415) 966-1460



# The Alternative

## BASIS 108



Hardware and Software compatible with Apple II™

### Standard Features

- 6502 and Z80 Microprocessors
- 64K RAM, expandable to 128K
- 2K Monitor ROM, plus sockets for 10K additional ROM
- RGB and Composite Video Output
- Selectable 80 or 40 column text display
- High Resolution Graphics: 6 colors, 280x192 or 280x160 with four lines of text
- Color Graphic Mode: 15 colors, 40x48 or 80x48: 40x40 or 80x40 with four lines of text
- 8 bit Parallel I/O
- RS-232c Serial I/O
- Detached Keyboard: All standard keyboard functions, Upper/Lower case characters, Numeric keypad, Cursor block, and 15 Programmable special function keys
- Built-in mounting for two 5-1/4 inch floppy disk drives
- Six Apple compatible slots for plug-in peripherals
- Game paddle I/O
- Built-in loudspeaker
- Two switched accessory power outlets
- Mounting for up to six DP-25 plugs

SEE THE ALTERNATIVE  
AT BOOTH 1936



**COMDEX**  
**JUNE 28-30, 1982**  
Atlantic City Convention Hall  
Atlantic City, NJ

**BASIS**  
INCORPORATED 

23116 Summit Road  
Los Gatos, CA 95030  
(408) 353-1102  
TWX: 910-590-8000

# The Input/Output Primer

## Part 5: Character Codes

*Character codes turn computer data into messages that people can understand.*

---

Steve Leibson  
Cadnetics Corporation  
5797 Central Ave.  
Boulder, CO 80301

---

Last month, we looked at two interfaces: the BCD (binary-coded decimal) and the RS-232C serial. Our examination of these interfaces and our earlier look at the parallel and IEEE-488 interfaces showed some of the strides made in achieving hardware compatibility in data communications.

But hardware is only half the battle. All the people of the world share the same hardware for spoken communications: the lips, teeth, tongue, larynx, and the rest of the complex vocal tract for transmitting, and the ears for receiving. Spoken communication, however, is possible

only when two people know the same language—the same way of encoding information.

Just as speech would be impossible without common languages, communication between computers would be impossible without agreement on character codes. For this month, we will put aside considerations of equipment compatibility and concentrate on the codes that enable machines to communicate with one another.

As described earlier in this series, digital computers use a binary language to represent information internally. Since some of the devices to which computers must talk are designed for human use—notably printers and video-display terminals—it is important that a computer communications code be compatible with human communications. Several methods to achieve such compatibility are available. Each method involves a different way of encoding the letters and numerals that form the basis of person-to-person communication.

The advantages of having all computers use the same computer communications code are clear. While the quality of codes varies enormously, almost any universal standard would be better than none. The road to a single standard communications code

has not run straight, however, and has yet to reach its destination. A look back down this road will make the status of contemporary communications codes easier to understand.

### The Greek Standard Code

Long before the invention of the computer, people encoded information so they could communicate beyond the range of the human voice. Smoke signals, drumbeats, and flags all served to extend the range of communication.

Perhaps the first character code was that devised for the Greek alphabet in about 300 BC. The 24 letters were placed in a 5 by 5 arrangement, starting with alpha in row 1, column 1, and ending with omega in row 5, column 4. To signal each of the 24 characters, the Greek signalmen set vases atop two walls. The number of vases on one wall indicated the number of the row occupied by a character in the 5 by 5 table; the number of vases on the other wall indicated the number of the column occupied by the character. By setting five vases on the row wall and four vases on the column wall, a signalman could send the character omega.

Although understandable in a vase-intensive culture with an abundance of slave labor, this means of commu-

*This article is the fifth in Steve Leibson's six-part series, The Input/Output Primer. The series describes the problems involved in communications between computers and the outside world, and explains how some of these problems have been solved. The last article will discuss interrupts, buffers, grounds, and signal degradation. "An I/O Glossary," which defines many terms used in these articles, appeared with the series' first installment (February 1982 BYTE, page 122). Table numbers are continued from Part 3.*



nication had obvious drawbacks. For one thing, it suffered from the age-old problem of working only as far as the eye could see. Greater range required bigger vases. When vases became so big that men could hardly lift them, however, the rate of transmission must have slowed from say, 1 character every 2 minutes to 1 every 15 or 20 minutes. (This is a hardware problem, it's true; forgive the digression.)

Other problems with the Greek system were definitely in the software. The 5 by 5 table left no room for numerals and punctuation. The code derived from the 5 by 5 table also allowed no provision for error checking. Evidently, no one saw the need for anything like a parity vase. Attempts at handshaking were also doomed. You could have used the twenty-fifth character (five vases on each wall) to mean "start sending," for example, but what could you do to say "stop sending"? Smash a vase?

Euclid, who was then living in Alexandria, could probably have straightened out the system in the

beginning if someone had turned the matter over to him. The history of telecommunications might have avoided two millennia of needless confusion and grief. Unfortunately, no one bothered asking Euclid, or his consulting fee was too high.

As a result, the 5 by 5 table has plagued communications codes down the centuries. More than a thousand years later, prisoners in medieval dungeons communicated by using a similar 5 by 5 table to encode the 26 letters of the Roman alphabet. To squeeze 26 characters into 25 places, the prisoners used the same coordinates for both I and J. The prisoners sent messages by tapping out pairs of numbers; one tap followed by one tap meant A.

The torments of the 5 by 5 table afflicted everyone from the bottom of society to the top, from prisoner to intellectual. In 1551, the Italian mathematician Gerolamo Cardano proposed using five torches on five towers in much the same way the prisoners had used sounds. By 1803,

inventors in both France and Germany had devised optical telegraphs using codes much like Cardano's.

### Electrifying Changes

The discovery and harnessing of electricity introduced many new possibilities, but no one seemed to know quite what to do with them. One of the early proposals for a telecommunications code, submitted to a Scottish magazine in 1753 and signed "C. M.," was simple but had profound implications for hardware. C. M. wanted to run 26 parallel wires from town to town, one wire for each letter of the alphabet. A Swiss inventor built a prototype system based on this 26-wire principle. Too bad there was a shortage of wire.

In 1833, Carl Friedrich Gauss used a code like Cardano's to send messages by deflecting a needle five times, right or left.

Samuel Morse and others soon put electromagnets to use in communications. Morse devised his code of dots and dashes by 1835, and demon-

# S-100 INNOVATORS:

SCI-TRONICS INC.



### REMOTE CONTROLLER—Innovative Features:

- \* Complete 256 address control—not just 16
- \* No ultrasonic link—prevents erratic operation
- \* 120, 208, 240 and 277VAC control—for single & 3 phase operation
- \* Hardware driven—requires minimal software
- \* Complete line of industrial switches available—to 5.5KW

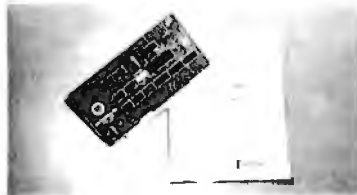

### REAL TIME CLOCK—Innovative Features:

- \* First to use LSI OKI clock chip
- \* Crystal controlled for .002% accuracy
- \* 4 software selectable clock generated interrupts
- \* Full clock and calendar data
- \* Lithium battery backup good for 6000 hours!



### ENERGY WATTCHER™—Innovative Features:

- \* First microcomputer based energy monitor
- \* Clip on probes for easy installation
- \* Monitors **Real Power**, not volt-amps
- \* Peak Power and continuous power readings
- \* Single and 3 phase operation

See your local computer dealer or contact SciTronics directly for more information. Watch for future innovative products from SciTronics Inc., 523 So. Clewett St., P.O. Box 5344, Bethlehem, PA 18015 (215) 868-7220

# BRAINS-MAINFRAMES

## SUPERBRAINS



**SUPERBRAIN QD 64K**

List \$2995. . . . . only \$2449



Z-89 48K  
List \$2895 . . . . . only \$2099  
Z-90 64K DD 3195  
ONLY \$2489

## COMPUSTARS

Available to Dealers

## NORTH STAR

Minicomputer  
Performance

Green Phosphor  
Options:  
Graphics + CP/M

List . . . . . \$3,999  
Only . . . . . \$2,989



Monitor Green Phosphor \$114

**TERMINALS Z-19** . . . . . \$638  
**INTERTUBE III Super Smart** . . . . . \$710

## EPSON

MX-80 FT. . . . . \$598  
MX-80 . . . . . \$474  
MX-100 . . . . . \$749



ANADEX 9501 . . . . . \$1290  
NEC Letter Qual Friction & Tractor . . . . . call  
ZENITH printer Z-25 list 1595 only . . . . . \$1256  
C. Itoh F10 Letter quality . . . . . \$1449



ATARI 400 . . . . . List \$399 . . . . . only \$340  
800 . . . . . List \$899 . . . . . only \$675

Wonderful Games—Education for your family

Main Frames-S-100 . . . . . \$200 up  
Advanced Micro Digital Superquad Single Board Computer  
with Z80 64K and FDC . . . . . \$749  
Dual 68000 CPU S100-Super Fast—Save . . . . . CALL

AMERICAN SQUARE COMPUTERS is organizing a World Wide Association of Computer Dealers. Open a Store or Start Work Out of Your Home! We Charge NO FRANCHISE FEE! (Our Competitors charge a FRANCHISE FEE of from \$15,000.00 to \$45,000.00.) Be a Winner! Let US help YOU get started MAKING MONEY by HELPING PEOPLE to put COMPUTERS to WORK. Write or Phone today.

**TELEVIDEO TERMINALS . . . 910 \$518, . . . 925 \$718**

## GODBOUT COMPUPRO

Super Sixteen 8085/8088 is the fastest combo 8/16  
CPU. LIST . . . . . \$3904 . . . . . Special \$2873

## SEATTLE'S

16 bit COMPUTER is here! 8 MHz 8086 CPU the fastest S-100 computer! 128K Static RAM, DD Disk Controller, 22-slot Main Frame, 86-DOS, #2 128K  
LIST . . . . . \$4185 . . . . . ONLY \$3349  
#1 As above but 64K LIST . . . \$3190 . . . ONLY 2649

## CALIFORNIA COMPUTER 2210A

LIST \$1995 . . . . . ONLY \$1722  
Z80, 64K, I/O, Disk controller + CP/M.  
Model 302 is the larger system: 2.4 Mb 8" Z80, 64K,  
and optional OASIS, CP/M, or MP/M operating system.  
LIST . . . . . \$5295 . . . . . ONLY \$4674

## SYSTEMS GROUP SYSTEM 2800

Runs CP/M or OASIS. Supports single user & multi-user & multi task. Up to 5 megabytes with 8" drives. Optional 10-megabyte hard disk. Optional tape back up #2812 \$5035 . . . . . ONLY \$3775

## TARBELL'S

Empire I&II have two 8" disk drives. The I is single sided, the II is double sided.

FREE Business Software

Empire I LIST \$4888 . . . . . Only . . . . . \$3666

We sell The Finest Hardware

# AMERICAN



We sell The Finest Software

# COMPUTERS

919-889-4577

4167 Kivett Dr.

Jamestown, NC 27282

919-883-1105

CP/M is a registered trademark of Digital Research, Inc.



# LOWEST PRICE - BEST QUALITY

## NORTH STAR Horizon 2

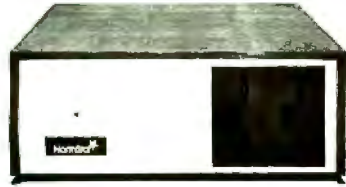

2-5 1/4" Disk Drives  
64K Double Density  
Factory assem. & tested  
Factory guaranteed

A few left  
Low Price only

**\$2499**

**Powerful North Star BASIC Free  
Superb for Business & Science**

HORIZON STANDARD IS NOW HRZ-2-64K QUAD

Factory Assembled & Tested	List	Only
Horizon-2-64K-Quad .....	\$3599	\$2689
Horizon-1-64K-QHD 5 .....	\$5999	\$4559
Horizon RAM ASM. .... 32K = \$424 64K = \$594		
Big Sale on Multi-User Time-Sharing		.. call
English to Basic Translator .....		.. \$99
North Star Hard Disk 18 Mb .....	\$5375	.. \$4568
North Star Time Sharing Multi User		.. call
Zbasic 2 to 5 times faster! .....	\$350	.. call
Secretary Word Processor .....		.. \$99
Wordstar Word Processor .....		.. \$296
Floating Point Board .....	\$399	.. \$339
Oasis Multi-User Software .....	SAVE	.. call
CP/M for N* Extra features .....		.. \$230
Micro Mike Software .....	SAVE	.. call
Ecosoft Accounting MICROSTAT		.. \$265
Pascal-80 .....	\$600	.. \$515
Extra Precision Basic .....		.. \$50
Northwood .....	\$199	.. \$179
Mailmanager .....	\$299	.. \$224
Infomanager .....	\$399	.. \$349
General Ledger .....	\$499	.. \$429
Accounts Receivable .....	\$499	.. \$429
Accounts Payable .....	\$499	.. \$429
Inventory .....	\$499	.. \$429
Order Entry .....	\$499	.. \$429
PROPAC .....	\$1499	.. \$1274
DOS + Basic 5.2 .....		.. 27

## DECISION I



"The IBM-360 on the Z-80 & S-100 BUS!"

Sixteen Programs running simultaneously! Free CPM, Microsoft BASIC and WORDSTAR with Complete system!

	LIST	ONLY
DECISION 1 + 65K Static + 8" Disks .....	\$4375	3377
DECISION 1 + 65K Static + 2 - " Disks .....	4195	3149
DECISION 1 + 65K Static + 5" Disk + 5MB Hard Disk .....	5990	4784
DECISION 1 3 user 195K Static + 5" Disk + 5Mb Hard Disk + MICRONX	8035	6428
DECISION 1—Z-80 + 1/0 = Power .....	1725	1294

## MORROW 8" Disk

Discus 2D + CP/M 600K only \$834  
Discus 2 + 2 + CP/M 1.2 MEGA B \$1074  
Add Drives 2D = \$599 2 + 2 = \$795  
Discus 2D-dual + CP/M Only \$1384  
Free Microsoft BASIC from MORROW with Discus system or hard disk



M-26 MORROW Hard Disk  
26,000,000 Bytes!!  
List \$4495 .....

## InterSystems

Z-80A CPU 4 MHz  
64K Dynamic RAM  
Front Panel

VI/O-1 - with interrupts  
FDCII Disk Controller  
20 slot motherboard

**List \$3795 .....** **Only \$2839**

**Without front panel as above only \$2716**  
**Front Paneless Recommended for Business**

## Save on Memory and Programs

Systems Memory 64K A&T ..... \$459  
Systems Memory 64K Bank ..... \$555  
Microangelo ..... \$985

Corvus Hard Disk ..... SAVE  
SSM Video BRD VB3 kit ..... \$361  
Spectrum Color ASM ..... \$326

Cat Novation Modem ..... \$169  
Memory Merchant 16K ..... \$159

Which Computers are Best?—FREE.  
Insured Shipping at Low Rates. Call  
For Latest Prices, Details. We Beat  
Advertised Prices.

Factory Guarantees

Expert Advice

# AMERICAN



# COMPUTERS

919-889-4577

4167 Kivett Dr.

Jamestown N.C. 27282

919-883-1105

Circle 23 on inquiry card.

©CP/M is a registered trademark of Digital Research, Inc.

# EXPAND AND ENHANCE YOUR IBM PERSONAL COMPUTER

with the complete line of fully compatible multi-function adapter cards and peripherals by **Automated Business Machines, Inc.** From entry level configurations to full function office support for the sophisticated business user, **ABM** products offer exceptional flexibility and capability in expanding the potential of your IBM Personal Computer.

- **OMNI-BOARD™** **from \$165**  
 Featuring up to five functions on one board, the OMNI-board provides the capabilities of an expansion chassis on a single board. Configure the functions required now and expand to the maximum configuration when needed. Fully IBM compatible adapters provide for a parallel printer and up to two RS232 asynchronous communication ports. Add the game adapter option which is compatible with IBM software and connects to two standard Apple joysticks. The clock/calendar option with rechargeable battery backup maintains correct time and date even when the computer is switched off.

Printer only.....	<b>\$165</b>	Printer, game & clock.....	<b>\$295</b>
Printer & RS232.....	<b>\$265</b>	Clock & 2xRS232.....	<b>\$345</b>
Printer, clock & RS232.....	<b>\$275</b>	Printer, game, clock & RS232.....	<b>\$345</b>
Printer, clock & 2xRS232.....	<b>\$435</b>	Printer, game, clock & 2xRS232.....	<b>\$485</b>
- **MEMORY EXPANSION** **from \$445**  
 To complement the capabilities of the OMNI-board, this memory expansion provides parity protected memory for your IBM Personal Computer. 64KB increments allow for easy growth to 256KB.

MEM-64K.....	<b>\$445</b>	MEM-128K.....	<b>\$625</b>
MEM-192K.....	<b>\$805</b>	MEM-256K.....	<b>\$985</b>
- **CP/M-80® ADAPTER** **\$545**  
 The CP/M-80 adapter makes available for your IBM Personal Computer thousands of CP/M-80 programs developed for the Z80 and 8080 processors. Featuring a Z80 processor and 64K bytes onboard memory, this adapter comes complete with software necessary to implement CP/M-80 on your IBM Personal Computer.
- **TELEPHONE RECEPTIONIST ADAPTER** **\$995**  
 The telephone receptionist adapter connects directly into a modular phone jack and provides a fully featured 300/1200 baud modem with auto dial and auto answer. A voice synthesis unit and touch tone decoder provide interfaces for automatic telephone answering and remote data input.
- **BSR-X10™ ADAPTER** **\$215**  
 Convert your IBM Personal Computer into a security watchdog. The adapter allows the computer to control any electrical appliance in your home or office. Inputs are provided for monitoring of sensors for security and safety control.
- **COLOR TO MONOCHROME INTERFACE CABLE** **\$95**  
 Providing the flexibility to use the features of your IBM color graphics adapter with the quality of your IBM monochrome display, this interface cable allows you to upgrade to color display when required.
- **APPLE™ JOYSTICK INTERFACE** **\$29**  
 This interface module plugs into any standard IBM game adapter and provides connections for 2 Apple compatible joysticks.
- **PROTOTYPING CARD** **\$49**  
 Providing space for up to 96 integrated circuits, this full size prototyping card has power and ground busses and provision for mounting of a DB25 or DB37 connector.
- **OFFICE-WRITER™** **\$1195**  
 Offering letter quality output at matrix printer prices, this unit is a fully featured Adler-Royal 1010 electronic typewriter. It produces impeccable letter quality printing at 18 c.p.s. and connects to your IBM Personal Computer via an RS232 asynchronous communication port or parallel printer port.
- **5MB WINCHESTER DISK & ADAPTER** **\$2195**  
 Fitting conveniently inside the second floppy drive location of your IBM Personal Computer, this fast access disk comes complete with an adapter and all necessary software for integration into PC-DOS.



**OFFICE AUTOMATION  
THAT MAKES SENSE.**

**Automated Business  
Machines Incorporated**  
 29352 Avocet Lane  
 South Laguna, CA 92677  
 (714) 643-0439

All ABM, Inc. products come complete with a one year warranty and IBM compatible documentation.

Order By Mail or Call Today — (714) 643-0439

Name \_\_\_\_\_

Company \_\_\_\_\_

Address \_\_\_\_\_

City, State, Zip \_\_\_\_\_

Enclose Check, Money Order or Credit Card Number and Exp. Date.  
 California residents add 6% sales tax.

**AVAILABLE AT SELECTED COMPUTERLAND STORES**

Dealer Inquiries Invited.

CP/M is a registered Trademark of Digital Research, Inc.. IBM-PC is a registered Trademark of IBM Corp.

Circle 49 on inquiry card.

strated the code repeatedly in 1838. (The best-known demonstration took place in 1844, when Morse transmitted over a wire from Washington to Baltimore the message, "What hath God wrought?") For a time, 5 ceased to be a magic number in communications codes. Morse's code used combinations of from one to six dots and dashes—a dash lasting three times as long as a dot—to represent each of the characters and figures, with pauses indicating the end of one character or word and the beginning of the next. The Morse code soon became the standard in the United States. Europeans found Morse code wanting because it didn't include characters with diacritical marks. To correct this deficiency, the Europeans developed an international version of Morse code in 1851.

## Morse and Machine Decoding

Early in the twentieth century, interest developed in replacing human telegraph operators with machines. Morse code was unsuitable for machine decoding because of the problems caused by the varying lengths of the characters.

On the other side of the Atlantic, J. M. E. Baudot developed a code around 1880 that became one of the standards in international telegraph communications. Since Baudot's code used the same number of binary digits to represent each character, it was better suited to machine decoding. Unfortunately, the number of binary digits was only 5 (there's that number again). The 5-bit code could generate only 32 possible combinations, fewer than necessary to represent the 26 characters of the alphabet, the 10 decimal digits, and the punctuation marks.

Baudot used two shift-control characters—the letter shift and the figure shift—to permit the code to represent all the characters thought necessary. The shift codes do not represent printable characters but select one of two character sets, each composed of the 32 characters. Receipt of a letter-shift code causes all following codes to be interpreted as letters of the alphabet; receipt of a figure-shift code causes all the follow-



# Go For The Gold



## DOW JONES NEWS/RETRIEVAL®... The Standard Of Excellence In Electronic Information.

Every four years, athletes set their sights on the "gold." Every day, millions of people set their sights on another standard of excellence—information from Dow Jones, the world's leading provider of business and financial news.

Now, through **DOW JONES NEWS/RETRIEVAL**, the publishers of *The Wall Street Journal* offer owners of personal computers and terminals instant, electronic access to this same standard of information excellence. Reliable information you can use to plan, solve problems and make more informed personal money management decisions. News and services that will help educate your family and bring it into the "Information Age."

### The Best... From The Biggest

**DOW JONES NEWS/RETRIEVAL** gives you access to a wealth of exclusive information. Quickly. Easily. In the convenience of your home or office. It's the best in business and financial news and data... plus the best in consumer information, such as sports reports, weather forecasts, movie reviews and, coming soon, an encyclopedia service. Our customers appreciate the quality of Dow Jones information. That's why **DOW JONES NEWS/RETRIEVAL** is the nation's largest information retrieval service.

### Free Introductory Time

If you own a personal computer, or are about to buy one, ask your nearest computer dealer about **DOW JONES NEWS/RETRIEVAL** or call our toll free hotline for our free color booklet. We'll give you one hour of free introductory non-prime time after you become a customer.

Don't be confused. There are other retrieval services. But only **DOW JONES NEWS/RETRIEVAL** gives you news from *The Wall Street Journal* and *Barron's*, along with other news and information essential for business and investing. Step up to the standard of excellence in electronic information that's as good as gold. Subscribe to **DOW JONES NEWS/RETRIEVAL** today.

**CALL TOLL FREE 800-257-5114**

(In New Jersey call 609-452-1511)

**DOW JONES**  
**NEWS/RETRIEVAL**

DOW JONES NEWS/RETRIEVAL is a registered trademark of  
Dow Jones & Company, Inc.



Experts Voted



Software Product of the Year

InfoWorld  
1/18/82

**AWARDED**

Proofreads 40 pages/minute  
for spelling errors.

Compresses 20,000 word  
dictionary into only 53 K

**ANNOUNCING  
NEW PRODUCTS:**

For Canada, Europe, Australia,  
Asia, and other areas outside  
the U.S.A., Spellguard now has  
a specialized international  
dictionary, including British  
spelling, available at no extra  
cost. (Adds 9 K to dictionary.)

Spellguard now available for  
Apple with CP/M™ and  
IBM's PC Dos or CP/M 86.™

Handsome new packaging.

Spellguard is the fastest, most  
compressed, most accurate spelling  
checker. We guarantee reliability.  
Spellguard works with any CP/M word  
processor and with hundreds of machines.  
It's the only award winner!

Has your work been Spellguarded?

**PLACE**

**INNOVATIVE**  
software applications

The Plaza Building  
1150 Chestnut Lane  
Menlo Park, California 94025  
Telephone 415 326 0805

Excellent dealer opportunities!  
Give us a call today.

CP/M/Trademark Digital Research, Pacific Grove, CA

ing characters to be interpreted as numerals and punctuation marks. For example, following the letter shift, the sequence 10000 stood for "A"; following the figure shift, the same sequence meant "1."

After designating 2 of the 32 possible codes as shift codes in each character set, Baudot code was left with 30 codes for representing characters in each set. That was still not enough characters for efficient, reliable machine communication. Baudot's code makes all combinations of 5 bits meaningful, which leaves no bit for error checking. The loss of a bit could garble an entire message. All the telegraph companies could do to guard against errors was to retransmit all the figures in a message after the end of the message itself.

Another 5-bit code, the Murray code, came into use around 1900. Murray code differed from Baudot code only in some of the code assignments to characters. Murray code also used shift characters and lacked error checking. As with Baudot code, the proper interpretation of a message depended on characters previously received. Unless the receiving device knew which character set to use—letters or figures—there was a 50 percent chance of incorrect decoding. The main contribution of Murray code was incompatibility with Baudot code—the first input/output incompatibility problems.

Clearly, 5 bits were not enough. Modern communications required a code that could represent all printable characters and still leave room for error checking. The code had to permit decoding without reliance on correct reception of previous transmissions, and also had to permit decoding by machine. Perhaps most important of all, the new code needed to be expandable. Machine communications should not be trapped in still another dead-end system.

### The Two New Codes

By the time the need for this new code was felt, the technology capable of supporting more complex codes was available. Many manufacturers

were building equipment that could potentially use a new character code. Whenever the need arises for standardization, such standards can come into existence in two ways. A single manufacturer can simply invent a solution, expecting the rest of the industry to follow. This is what IBM did. It created the EBCDIC (Extended Binary Coded Decimal Interchange Code) character code, which is an 8-bit code allowing 256 characters to be represented. Since there aren't that many printable characters, several codes in EBCDIC aren't used.

No other manufacturer chose to follow IBM's lead. (Maybe no one could pronounce the name of the new code.)

### ASCII at Last

The other method of obtaining a standard is through compromise in a committee. Other manufacturers met and produced a national standard called ASCII (American Standard Code for Information Interchange). It's pronounced "ask-key."

ASCII is a 7-bit code, formally known as ANSI (American National Standards Institute) standard X3.4-1977. One hundred and twenty-eight characters are represented in ASCII, not all of them printable. Included in the character set are all the letters of the alphabet (both upper-case and lowercase), the 10 numerals, and punctuation marks. Table 4 shows the ASCII characters and their associated codes.

The nonprintable codes are *control codes*, so called because they control the operation of the receiving device. Carriage return and linefeed are control codes familiar to anyone who has used a typewriter. Other control codes include formfeed, bell, and horizontal and vertical tabs. These control codes were clearly set up for printing or display devices, although some manufacturers have pressed the control codes into service for all manner of special functions.

Finally, as in the 5-bit codes, some codes control how a receiving device will interpret subsequent codes. Two shift characters called *shift in* and *shift out* are used to shift between ASCII and character sets other than



See us at  
**COMDEX/SPRING '82**  
BOOTH 1462

# Childhood's End: The 68000



## ADDRESSING THE NEW FRONTIER... THE MICROCOMPUTER COMES OF AGE.

SAGE COMPUTER TECHNOLOGY IS NOW MANUFACTURING A 68000 BASED SINGLE-BOARD MICROCOMPUTER SYSTEM WHICH DELIVERS THE HIGHEST PERFORMANCE PER UNIT PRICE OF ANY COMPUTER IN HISTORY.

### THE SAGE II MICROCOMPUTER HAS THE FOLLOWING FEATURES:

- INTERRUPT DRIVEN, 8 MHZ 68000 MICROPROCESSOR
- 2 MILLION INSTRUCTIONS PER SECOND, NO WAIT STATES
- WILL ADDRESS 16 MEGABYTES WITH UP TO 1/2 MEGABYTE OF PARITY RAM ON BOARD
- UP TO 1.5 MEGABYTES OF 5-1/4 INCH FLOPPY DISK STORAGE
- FULLY SUPPORTED IEEE-488 INTERFACE
- TERMINAL AND MODEM RS-232C SERIAL PORTS
- CENTRONICS COMPATIBLE PARALLEL PRINTER PORT
- UCSD PASCAL, BASIC, FORTRAN AND ASSEMBLER AVAILABLE

\*TM-U OF CALIFORNIA

PRICES FOR THE SYSTEM START AT \$3600.  
FOR MORE INFORMATION CONTACT OUR MARKETING  
DEPARTMENT AT 702-322-6868

Circle 387 on Inquiry card

**SAGE**  
COMPUTER TECHNOLOGY

195 NORTH EDISON WAY, SUITE 14 • RENO, NEVADA 89502

		b <sub>7</sub> b <sub>6</sub> b <sub>5</sub>				0 0 0 0				1 1 1 1				Mnemonic and Meaning <sup>1</sup>	Mnemonic and Meaning <sup>1</sup>	
Bits		b <sub>4</sub>	b <sub>3</sub>	b <sub>2</sub>	b <sub>1</sub>	0	0	1	1	0	0	1	1			
		COLUMN				0	1	2	3	4	5	6	7			
		ROW				0	1	2	3	4	5	6	7			
		0	0	0	0	0	NUL	DLE	SP	0	@	P	`	p	NUL Null	DLE Data Link Escape (CC)
		0	0	0	1	1	SOH	DC1	!	1	A	Q	a	q	SOH Start of Heading (CC)	DC1 Device Control 1
		0	0	1	0	2	STX	DC2	"	2	B	R	b	r	STX Start of Text (CC)	DC2 Device Control 2
		0	0	1	1	3	ETX	DC3	#	3	C	S	c	s	ETX End of Text (CC)	DC3 Device Control 3
		0	1	0	0	4	EOT	DC4	\$	4	D	T	d	t	EOT End of Transmission (CC)	DC4 Device Control 4
		0	1	0	1	5	ENQ	NAK	%	5	E	U	e	u	ENQ Enquiry (CC)	NAK Negative Acknowledge (CC)
		0	1	1	0	6	ACK	SYN	&	6	F	V	f	v	ACK Acknowledge (CC)	SYN Synchronous Idle (CC)
		0	1	1	1	7	BEL	ETB	'	7	G	W	g	w	BEL Bell	ETB End of Transmission Block (CC)
		1	0	0	0	8	BS	CAN	(	8	H	X	h	x	BS Backspace (FE)	CAN Cancel
		1	0	0	1	9	HT	EM	)	9	I	Y	i	y	HT Horizontal Tabulation (FE)	EM End of Medium
		1	0	1	0	10	LF	SUB	*	:	J	Z	j	z	LF Linefeed (FE)	SUB Substitute
		1	0	1	1	11	VT	ESC	+	:	K	[	k	{	VT Vertical Tabulation (FE)	ESC Escape
		1	1	0	0	12	FF	FS	,	<	L	\	l		FF Formfeed (FE)	FS File Separator (IS)
		1	1	0	1	13	CR	GS	-	=	M	]	m	}	CR Carriage Return (FE)	GS Group Separator (IS)
		1	1	1	0	14	SO	RS	.	>	N	^	n	~	SO Shift Out	RS Record Separator (IS)
		1	1	1	1	15	SI	US	/	?	O	_	o	DEL	SI Shift In	US Unit Separator (IS)
																DEL Delete

**Table 4:** The table of ASCII (American Standard Code for Information Interchange) characters. Since ASCII is a 7-bit code, it has 128 characters (2<sup>7</sup>). Some of the characters are printable, but others are control characters. The table shows all the control characters but one (DEL) in the first two columns. DEL is the last character in the last column.

The head of each column gives the most significant 3 bits (in both binary and decimal) of the characters in the column. The left of each row shows the most significant 4 bits of the characters in the row.

To find the ASCII code for "E," for example, locate "E" in the table. The 3 bits at the head of that column (100) are the most significant 3 bits in the code for "E." Then, get the least significant 4 bits from the extreme left of the row that contains "E" (0101). The full code for "E" is 1000101.

those used in English. ANSI standards X3.41-1974 and X3.64-1979 expand the definition of the *escape* control code for even greater flexibility.

Some control codes delimit text, such as *start of text* and *end of text*. These codes are used primarily in block transmissions.

ASCII has been a very successful character code. Thousands of instruments and computer-related products use it for interfacing. Even IBM now offers equipment that understands ASCII.

Almost any hardware interface can handle ASCII transmissions. The exception is the BCD interface, designed to handle 4-bit BCD codes.

### Planning the Escape

The developers of ASCII tried to foresee as many different applications as possible. That is why they included

the various control codes. They recognized that technological advances could not be well predicted. Therefore, they gave themselves an escape clause.

As was mentioned above, one of the ASCII characters is the *escape* character. It designates that the codes that follow have special meaning.

The intent in creating the *escape sequence* was to extend the range of the character set by allowing selection from a range of available sets. Graphics characters, foreign-language character sets, and special applications sets have been developed. Escape-character sequences allow for a much richer variety of printable symbols than the simple shift in/shift out scheme of the 5-bit codes.

The now common video-display terminal has provided the escape sequence its widest application. The in-

clusion of microprocessors in terminal design has greatly augmented video-display capabilities. The serial-communications link to these terminals has not changed in years. Only one data channel to the host is available. Ordinarily, any characters received via this channel are displayed on the terminal screen. But the ASCII standard did not foresee capabilities for character and line deletion; display enhancements such as inverse video, underlining, and blinking; and even control of tape drives built into a terminal. The escape sequence allows manufacturers to add these system functions while remaining compatible with ASCII.

### Escape to Chaos

Manufacturers of video-display terminals are now using escape sequences to add increased perfor-



mance to their products. Unfortunately, little standardization of these sequences existed until the X3.64 standard came out in 1979. Without standardization, designers felt free to exercise their creativity.

For example, one major feature now found on most video-display terminals is absolute cursor positioning. The computer can send a command to the terminal that will place the cursor anywhere on the screen. This capability is important for many types of form-filling operations. There are about as many escape sequences to do this task as there are terminal manufacturers. The Digital Equipment Corporation (DEC) has several varieties, depending on the vintage of the terminal. The new DEC terminal, the VT100, is one of the few terminals available today that conforms to the X3.64-1979 standard.

How does an escape sequence such as cursor positioning work? The host computer starts by sending the escape character. This is followed by one or

more characters that indicate the type of escape sequence. Two or more characters then follow giving the desired x and y coordinates for the cursor. Some escape sequences self-terminate. When the receiver has obtained the right number of characters, it exits the escape-sequence mode and returns to normal mode.

Self-terminating escape sequences don't meet ANSI standards. The X3.41 and X3.64 standards are quite explicit about what kinds of characters can appear in escape sequences. All legal escape sequences have proper terminating characters. This allows for variable-length escape sequences.

Characters received in an escape sequence are not interpreted as printing characters but as control information. The escape character has the effect of making all character codes available for control of a device.

### Code Conversion

The vast majority of computer

equipment available today uses the ASCII character set. Unfortunately, some older equipment does not. Interfacing these older devices may require conversion of ASCII characters to the character codes the peripheral device would like to see. (We assume that the hardware-interfacing requirements have already been met.)

In addition, some modern devices have odd requirements that can only be met through code conversion. An example is a printer that automatically inserts a linefeed after receiving a carriage return. Unless the application calls for double-spaced printing, the printout will not be as desired because most computers send both a carriage return and linefeed to cause printing on a new line.

One solution to this problem is to have the computer convert all linefeeds to nonprinting characters, such as nulls. Nulls are supposed to be ignored by receiving devices. They serve as timewasters to help in synchronizing fast computers and slow

# DISCOUNT PRINTER RIBBONS

Brand New, Top Quality, Exact Replacement Ribbons & Cartridges. These Ribbons Produce Super Jet Black Impressions and Ultra Reliable Print Life. They Are Delivered to Your Door Promptly for Much Less Than Most Retail Stores

**★SPECIAL! BUY 10 and GET ONE FREE!**

**40% OFF!! OR MORE!**

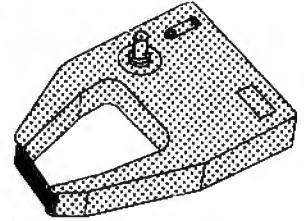

### TERMS:

MINIMUM PURCHASE - \$20  
PAYMENT BY: C.O.D. (UPS), CHECK, MASTER CARD, OR VISA CHARGE CARD.

VOLUME DISCOUNTS:

20 - 50 PACKS 10%  
51 - 100 PACKS 15%

\*UNDER \$20, ADD \$5 HANDLING.

\*\*APPROX. RETAIL. PRICE VARIES.

### ANCIE LABORATORIES

5200-J Philadelphia Way 301-345-6000 (Wash. D.C. Local)

Lanham, Maryland 20706 301-792-2060 (Balto. MD Local)

800-638-0987 (National)

YOUR PRINTER	PACK SIZE	RETAIL LIST**	YOUR WHOLESALE PRICE	SIZE	COMMENTS	CAT. ORDER#
ANADIX 9000 Series	1/pk	14.00 ea	14.00 (14.00 ea)	500	Nylon Jet Bk	C-777
CENTRONICS 700-703, 737, 779	3/pk	18.95/3 pk	11.95/3 pk (13.98 ea)	563" x 45"	Nylon Jet Bk	C-700
CENTRONICS 100, 101A, 102, 103, 300, 301, 306, 308, 330, 358, 398, 500, 501, 503, 508, 588, 620, 820.	3/pk	26.33/3 pk	17.55/3 pk (15.85 ea)	1" x 108"	Nylon Jet Bk	C-100
CENTRONICS 704-705	1/pk	16.95 ea	13.95/Giant Cart (13.95 ea)	5 16" x 210"	Giant Cart	C-7045
DEC 1/2 x 40YD	3/pk	17.77/3 pk	12.95/3 pk (14.32 ea)	1 2" x 120"	Double Spools	R-600
DEC 1/2 x 60YD	3/pk	20.12/3 pk	14.25/3 pk (14.75 ea)	1 2" x 180"	Double Spools	R-644
DIABLO HYTYPE II (M, S, BLK) HI YIELD. FITS 70 PRINTERS'	1/pk	9.31 ea	6.87 ea (6.87 ea)	5 16" x 300,000 plus imp	'High Yield'	C-511
EPSON MX70 80	1/pk	16.00 ea	16.00 ea (13.95 ea)	500 x 60	Nylon Jet Bk	C-522
IBM - "SILVER DOLLAR" Sys. 34, Sys. 32 MOLA, Series IMOL4974, 5256, 3287, 3770, 3771-3774, 4974, 5100, 5103, 5110, 5228, 5256, 5320MOLA	5/pk	5.80 ea	14.90/5 pk (12.98 ea)	9 16" x 30"	Nylon Jet Bk	R-300
IBM - HARMONICA 1/2" SERIES 1, MOD 4973/II, 3200, 3289, MOD 2.	3/pk	9.42 ea	20.85/3 pk (16.95 ea)	1 2" x 108	Nylon Jet Bk	C-350
NEC SPINWRITER	4/pk	23.40/3 cart	23.60/4 pk rtr reload (15.90 ea)	1 2" x 51"	Nylon/Ex Lng Life	R-400
QUME (FITS 80 PRINTER MODS)	3/pk	18.00/3 pk	13.95/3 pk (14.65 ea)	1 4" x 310"	Multistrike Film	C-525
RADIO SHACK DAISY WHEEL II	1/pk	24.95/3pk	8.25 (8.25 ea)	250"	Mylar: Multistrike	C-789
RADIO SHACK LPIII, LPIV	one/pk	13.95/cart	8.95/Reload rib* only (8.95 ea)	500" x 45"	Nylon Incl Instr	R-13
RADIO SHACK LPII, LPIV	3/pk	18.95/3 pk	11.95/3 pk (13.98 ea)	563" x 45"	Nylon Jet Bk	C-700
TELETYPE MOD 33, 28, 35, 37, 38, 88.	10/pk	2.40 ea	13.90/10 pk (11.39 ea)	1 2" x 36"	Nylon Jet Bk	R-450
WANG M/S 5541W, WC, 5581, WD, 5581W, 2281W	1/pk	6.85 ea	5.95 ea (5.95 ea)	5 16" x 393"	Multistrike Film	C-550

NAME \_\_\_\_\_  
ADDRESS \_\_\_\_\_  
CITY \_\_\_\_\_ STATE \_\_\_\_\_ ZIP \_\_\_\_\_

ANCIE Laboratories  
5200-J Philadelphia Way  
Lanham, Maryland 20706

301-345-6000 (Wash. D.C. Local)  
301-792-2060 (Balto. MD Local)  
800-638-0987 (National)

QTY	CAT.#	AMT.
_____	_____	_____
_____	_____	_____
_____	_____	_____
_____	_____	_____
TOTAL	_____	_____

Check Enclosed  
 C.O.D.  
 VISA  
 MASTER CHARGE  
ACCT. # \_\_\_\_\_  
EXP. DATE \_\_\_\_\_  
MIN. ORDER \$20  
PRICES SUBJECT TO CHANGE



**"DISCOUNT PRICING ON QUALITY PRODUCTS"**



**\$248**

## VIC 20



### HARDWARE

Vic Datasette	64
Vic Disk Drive	489
Vic Graphic Printer	329
Vic 8K Memory Expander	49
Vic 16K Memory Expander	139
Vic 24K Memory Expander	179
3 Slot Expansion Unit (Mini-Mother)	59
RS232C Terminal Interface	43
IEEE-488 Interface	84
Super Expander	49
Programmers Aid Card	44
VICMON	43
Pro Ref. Guide	14
Intro. to Basic Pro	18
Victerm	8
Prog. Charc. Set/Game Ed.	11
Joystick/Paddles	19
Reference Card	4
Vic Modem	89
Monitor Cables	12
PROM Simulator (Call for info)	199
80 Col. Card	CALL
Epson MX-70 (Configured for Vic)	CALL

**CALL FOR COMPLETE SELECTION!**

### SOFTWARE ON CARTRIDGE

Spiderman	36
Robot Blasters	30
Meteor Run	36
Sattelites & Meteors	36
Amok	29
Alien Blitz	29
Renaissance (Othello)	36
Alien	19
Cosmic Kamakazi	19
Vic Avengers	21
Super Slot	21
Super Alien	19
Super Lander	21
Draw Poker	20
Midnight Drive	21

### ON TAPE

Star Wars	11
Vic Term A	15
Vi Calc	11
Vi Check	18
Vi Cat	18
Amok	14
Alien Blitz	18
Sky Math	11
Space Division	11
Globber	18
B-1 Nuclear Bomber	12
Blastoids	14
Nuke War	13
Planet Miners	12
Lords of Karma	15
Vic Games (3 on one tape)	19
Household Finance Pace (4 programs on 2 cassettes)	26
Home Inventory (2 programs on 1 cassette)	12
Recreational/Educational Pack I (2 on 1)	12
Recreational/Educational Pack II (2 on 1)	12
Car Costs (2 on 1)	12

\*NEEDS 3K \*\*NEEDS 8K

**NEC PC-8001A 32K \$729**

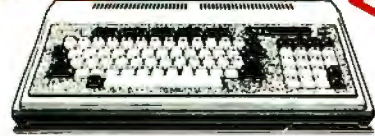

NEC I/O Unit 32K RAM	549
NEC Add on Dual Drive	729
The Wedge I/O Unit-W/32K	489
32K Mem. board for use with the Wedge	179
Wordstar for NEC	299
Super Calc for NEC	279
NEC Wordprocessing & Actcing Software	CALL

## commodore CBM 8032



### HARDWARE

4016 Pet	749
4032 Pet	959
Super Pet SP9000	1495
CBM 8032	1099
CBM 8096	1459
4022 Dot Matrix Printer	589
4040 Dual Disk Drives	939
8050 Dual Disk Drives (1 meg.)	1299
8250 Dual Disk Drives (2 meg.)	CALL
2031 Single Disk Drive	499
8300 P Letter Quality Printer	1699
IEEE to IEEE Cable	36
Pet to IEEE Cable	29
8023	729
8096 Mem Board for CBM	379
C2N Recorder	65
4010 Voice Synthesizer	289

### SOFTWARE

Software Encyclopedia	9
Word Pro 4 Plus	325
Wordcraft 80	289
Visicalc	149
BPI Gen. Ledger	329
OZZ Info System	299
Dow Jones Portfolio	114
Pascal	229
Legal Time Actcing	449
Create-A-Base	249
Silicone Valley	CALL
BPI Inventory Control	319
BPI Job Costing	319
BPI Pay Roll	319

## COMMODORE 64

**NOW SHIPPING \$479**

*The Commodore 64 is a compact unit (will fit into briefcase). Full size typewriter keyboard, high res. color, this computer is the major breakthrough you've been waiting for.*

- 64K Built in RAM • CP/M option
- Upper/lower case • Graphics characters
- TV interface • Music synthesizer
- 40 col. color display • "Smart" peripherals
- Cartridge game slot

**DISK DRIVES MODEMS PRINTERS SOFTWARE**

Computer Specialties' goal is to become the premier dealer of products made for your IBM PC. In keeping with that idea — we are now offering a free IBM Personal Computer Catalog, featuring hardware & software made for the IBM Personal Computer. Please call for details.



### ACCESSORIES

PC-mate™ Expansion Chassis (Incl. Adapters & Cables)	789
Time Master	85
Device Tender	159
Device Master	194
Speech Master	335
Winchester Disk Controller & Assembly	2595
128K Dynamic RAM	629
256K Dynamic RAM	1099
Scribe Tender	169
Scribe Master	335
IEEE 488 Interface	329
Lab Tender	335
Lab Master	859
Video Digitizer Board	289
Amdek Color II (RGB)	789
Electro Home RGB Color Monitor	CALL
Joysticks & Paddles	47
5 Meg. Winchester Disk Drive by Davong	1699
PROM Blaster Card by Apparat	129
Clock Calendar by Apparat	109
Combo Card by Apparat	239
(adds parallel Printer, RS232C Asynch & Clock Calendar Functions)	
Hardware Print Spooler Card (64K) by Apparat	339

### QUADRAM PRODUCTS

### MORE MEMORY

Plugs into any I/O expansion slot available in the IBM PC. Access time is 225NS permitting maximum utilization of CPU speed. On board DIP switches assign the address space for easy customer configuration.

64K by CI	469
128K by CI	579
192K by CI	629
256K by CI	689
256K by Seattle	CALL
256K Combo card by AST (includes, parallel port & 1 serial port)	1094

### SOFTWARE

Home Actcing Plus by Continental	129
Visicalc (Standard) by Visicorp	175
Visicalc (256 K Reg.) by Visicorp	199
Easy by Denver Software	594
Super Writer by Sorcim	289
Super Calc by Sorcim	219
Easy Speller by IUS	CALL
Easy Filer by IUS	CALL
Temple of Apsah	29
Zork I & Zork II by Infocom	29
Deadline by Infocom	39
Joystick by TG	47
Mathemagic by ISM	69

For a complete list of our current selection of Software, Languages, and utilities for your IBM personal computer... please call.

## ATARI 800 16K \$695

Atari 400 W/16K (Mem. Expanders Avail.)	319
410 Recorder	79
810 Disk Drive	449
825 80 Col Dot Matrix	649
850 Interface	159
Ramcrum	149
Ram Disk	499



# BASIS 108

The Alternative



- 6502 and Z80 Microprocessors
- 64K RAM, expandable to 128K
- RGB and Composite Video Output
- Selectable 80 or 40 column text display
- High Resolution Graphics: 6 colors, 280x192 or 280x160 with four lines of text
- 8 bit Parallel I/O • RS-232c Serial I/O
- Detached Keyboard: All standard keyboard functions, Upper/Lower case characters, Numeric keypad, Cursor block, and 15 Programmable special function keys
- Built-in mounting for two 5-1/4 inch floppy disk drives
- Six Apple compatible slots for plug-in peripherals • Game paddle I/O

## ACCESSORIES

Disk Drive W/Controller by Fourth (100% Compatible) .....	499
Disk Drive (100% Compatible) by Fourth .....	419
16K RAM Card (2 yr Warranty) .....	88
Videoterm (80 col. card) by Videx .....	259
Softswitch for Videoterm .....	29
Z-80 Card by Microsoft .....	269
A10 II by SSM .....	CALL
CCS Asynch #7710A or 7710D .....	129
CPS Multi Function Card .....	159
Joystick by TG .....	47
Micromodem II® by Hayes .....	295
Micro Sci Drives .....	CALL

## ALL 3 OF THESE SYSTEMS ARE 100% COMPATABLE WITH THE ACCESSORIES & SOFTWARE LISTED BELOW

 **Apple II PLUS 48K**  
FOURTH DISK DRIVE WITH CONTROLLER



**\$1758**

Chronograph® by Hayes .....	180
Keyboard Enhancer II by Videx .....	124
Microbuffer II by Practical Peripherals .....	CALL
32K RAM (Incl. Software) by Saturn .....	209
Lowercase for Apple .....	29
Numeric Keypad (23 Key) by Keyboard .....	119
Sup R Mod (TV Interface) .....	35
Music System W/Software by Mtn. Hardware .....	299
Expansion Chassis by Mtn. Hardware .....	559
The Clock by Mtn. Hardware .....	219
D-Cat Modem by Novation .....	169
Corvus Hard Disk .....	CALL
Corvus Mirror .....	CALL
A/D + D/A (no cable) by Mtn. .....	269
Supertalker SD200 by Mtn. .....	154
8" Disk Controller by SVA .....	199
The Grappler by Orange Micro .....	124
Versawriter Digitizer .....	209

**FREE SHIPPING**  
(with prepaid cash orders)

# FRANKLIN ACE 100



- Apple II software & hardware compatible
- 64K of RAM memory
- Upper and lower case
- Typewriter-style keyboard
- Twelve key numeric pad
- Alpha lock shift key
- VisiCalc friendly
- 50 watt power supply
- Built-in fan

## NEW!!!

RANA Systems Drives .....	CALL
Metacard by Metamorphic .....	895
Sooper Spooler (16K) .....	289
Microsoft Softcard Premium System .....	589
Signalman Modem .....	79
Supercolor Board by Electrohome .....	269
NTSC Interface by Electrohome .....	76
APP-L-CACHE 256K by SVA .....	995

## SOFTWARE

Bus. Pkgs by Continental .....	199 ea.
DB Master by Stoneware .....	169
Desktop Plan by Visicorp .....	189
Home Money Minder by Continental .....	CALL
Magic Window by Art-Sci .....	88
Peach Tree Accounting Pkgs .....	CALL
Personal Filing System .....	95
Screen Writer II (formerly Super Scribe II) .....	99
TASC by Microsoft .....	159
The Last One .....	449
Visifile .....	199
Visicalc .....	189
Visidex .....	189
Visischedule .....	239
Visitrend/Visiplot .....	199

## Entertainment

Alkemstone .....	34
Apple Panic .....	24
Castle Wolfenstein .....	24
Gorgon .....	35
Olympic Decathlon .....	24
Time Zone .....	29
Softporn .....	79
Complete Selection ... in Stock .....	CALL

## CP/M

Basic 80 .....	284
Basic Compiler .....	299
Calcstar .....	166
Mailmerge .....	79
Spellstar .....	159
T/Maker .....	229
Wordstar .....	239

**CALL! FREE CATALOGUE CALL!**

\*APPLE IS A REGISTERED TRADEMARK.

SEE AD PAGE 273

ORDER TOLL FREE! 1-800-854-2833

## PRINTERS in stock MAJOR BRANDS

CALL FOR BEST PRICE & FAST SERVICE

**EPSON**  
MX-70  
MX-80G  
MX-80 F/T  
MX-100

**SPECIAL THIS MONTH ONLY!**  
**LETTER QUALITY**

**ONLY \$1095**

**IDS PRISM — NOW SHIPPING!**

• QUME • NEC  
• ANADEX • C-ITOH  
**DIABLO**  
CALL FOR BROCHURE

**COMPUTER SPECIALTIES**

**FREE CATALOGUE CALL**

TO ORDER: Phone orders invited using Visa, Mastercard or bank wire transfers. Visa and MC service charge of 2%. Mail orders may send charge card number (include expiration date), cashiers check, money order, or personal check (allow 10 business days for personal or company checks to clear). Please add 3% (\$5.00 minimum) for UPS shipping, handling, and insurance. APO and FPO include 5% (\$7.00 minimum) for postage. Calif. residents add 6% sales tax. Please include phone number on all orders.

FOREIGN ORDERS include 1% handling—shipped air FREIGHT COLLECT only. Credit cards not accepted on foreign orders. All equipment is in factory cartons with manufacturer warranty. Opened products not returnable. Restocking fee for returned merchandise. Equipment subject to price change and availability. Retail prices differ from mail order prices. WE SHIP THE SAME DAY ON MOST ORDERS!

MAIL TO: 1251 BROADWAY EL CAJON, CA. 92021 (714) 579-0330

Circle 117 on Inquiry card.

peripheral devices. A null is ASCII character code 0.

As you can see, character codes are still a source of incompatibility in the world of I/O. If a computer has a *programming* language that is rich in I/O capability, however, a programmer can overcome character-code incompatibilities.

### Outputting Characters

This series is concerned with the interconnection of computers and peripheral devices. Such connections produce systems that process data and perform important tasks. During the development of a system, the programmer communicates with the machine through a programming language. This language could be at the machine level, though that practice is growing less common. The language may be at a high level; that is, a sophisticated programming language provided by the machine's manufacturer.

After the system software is

developed, people will have to use it. The computer must be able to interface with people in an effective manner; the people are not concerned with the software running the system. They just want results. Software must make information easy for people to use.

Many different kinds of information are now being used—prices, quantities, voltages, written documents, drawings, and innumerable other forms. Information is the most powerful tool people have. One of the reasons that computers have become such a major factor in current human endeavor is their information-processing power. Yet, for all this capability, computers can only store information in two forms: numbers and nonnumbers.

Prices, inventory quantities; or voltages are not recorded in a computer's memory. It only has numbers with which a program associates these values. My text-editor program doesn't have any pages; it only has character data that the software pro-

cesses to cause the printing of pages. The software of I/O tells the computer how to accept data from the outside world and how to provide internally stored data to the world in a form that people can understand.

We must first see how information is stored in the computer in order to understand the software of I/O. Numbers are usually stored in something called internal format. The author of the programming language for the computer decided the best way or ways to represent numbers inside the machine. In any internal representation, the 1s and 0s that make up a number are not easy for people to recognize or understand as a number. For example, the number 21 in 16-bit binary is 000000000010101. In addition, though we have many ways of writing numbers—such as \$2.69,  $6.02 \times 10^{23}$ , and 3.14159—the computer has only a limited number of numeric types.

The most common types are integer and floating point. Whatever type a number is stored in, the com-

## BUY A 212A-TYPE MODEM AND GET A \$212 REBATE.

Now, as an introductory offer, when you buy Cermetek's new fully-featured Bell 212A compatible modem, the CERMETEK 212A, you'll get a \$212 rebate.

Just consider the CERMETEK 212A's features:

- Integral Auto-Dialer
- 0-300 or 1200 BPS Operation
- Bell 212A Compatibility. Bell 103/113 compatibility or 0-300 BPS mode
- Auto-originate/Auto Answer/Auto-Speed sense
- User option menu
- Full Duplex operation
- Seven (7) diagnostic modes
- One year limited warranty



To get your CERMETEK 212A modem, contact:

A.C.T.  
Rocky Mountain  
2640 Youngfield  
Lakewood  
CO 80214  
(303) 233-4431

A.C.T.  
15800 Addison Rd.  
Addison TX 75001  
(214) 980-1888

P & L Associates  
11 Laura Lane  
P.O. Box 481  
East Setauket  
NY 11733  
(516) 221-7623

Offer expires September 30th, 1982. Limited to two modems per customer.



# "Only VR Data can offer you a Winchester Hard Disk Drive for your IBM Personal Computer..."



...with the same level of excellence and state-of-the-art technology you'd expect from IBM."

Warren Rosenkranz, President, VR Data

We are tremendously impressed with the IBM Personal Computer. When we set out to increase its capability with our exclusive,

totally compatible Winchester Hard Disk Drive and Memory Board, we dedicated ourselves to making the very finest products possible. Some very knowledgeable dealers and users say we've totally succeeded. See for yourself!!

#### OTHER QUALITY PRODUCTS FROM VR DATA

##### Winchester Hard Disks

6.3 Megabytes  
9.6 Megabytes  
19.0 Megabytes

2x 6.3 Megabytes  
2x 9.6 Megabytes  
2x 19.0 Megabytes

##### Memory Boards with Error Correction

64 Kbytes 192 Kbytes  
128 Kbytes

##### In The Queue

D-Con Direct connect  
internal modem

The Echo  
Winchester Backup

As with our Winchester Hard Disk Drive, all our designs are tested, re-tested and "burned in." We're so sure of our quality control that we offer an unconditional 120 day extended warranty covering full costs of parts and labor on all VR Data products.

Insist on the best.  
Ask for us by name.

777 Henderson Boulevard N-6 Folcroft, PA 19032 800-345-8102

MICROCOMPUTER EXCELLENCE SINCE 1972

puter should print the number in a format that makes sense to the user. Bank tellers will laugh if a payroll program prints checks that read 6.02E2 dollars, and wage earners will weep when that number is interpreted as \$6.02 instead of \$602.

Most high-level languages can make the computer input or output numeric values in the form desired. This capability is called formatting. It may come as a format statement in the language or as a format field within the statement that causes the computer to output information. In either case, the format specification describes exactly how the number is to be output or input—how characters are to be presented to the user.

We can use the above check-writing example to demonstrate formatted I/O. Suppose our program has the following statement in it:

```
210 PRINT Pay
```

That is a very simple program statement. The computer, being the simple

machine it is, will print the value of the variable Pay in whatever format the computer is set for at the time the statement is executed. If the machine is in fixed 2 format (two decimal places) and Pay = 602, we get the correct "602.00" printed. If the machine were in fixed 0 format, we would get "602," which is close. However, if the machine were in floating-point 9 format, we would get "6.020000000E02." This last printout is not the sort of thing I want to see on my paycheck.

What can we do about this PRINT statement to prevent unacceptable output? A first attempt might be to change the default format of the machine just before the PRINT statement:

```
200 FIXED 2
210 PRINT Pay
```

This approach is taken by programmers who don't know about or don't want to learn about formatting output. The disadvantage of this approach is that the state of the machine

is altered, and all subsequent printing will be done in the fixed 2 format unless another FIXED or FLOAT statement is executed. We are also missing the dollar sign that should precede the number on the printout. The program could be changed to:

```
200 FIXED 2
210 PRINT "$",Pay
```

Then we would get "\$ 602.00" on the printout. Clearly, the machine is just not understanding what we want. In most languages, the instrument for telling the computer exactly how the number is to be printed is the format field in a PRINT USING statement.

In many languages, changing the program to

```
210 PRINT USING
"A,000.00";"$",Pay
```

would result in a printout that reads "\$602.00," exactly what is desired.

Just as different computer languages have different statements for performing similar functions, format techniques vary widely from language to language. Even differing dialects of languages such as BASIC may vary as to how formatted I/O is performed. The best way to learn how to perform formatted I/O in a given language is to read the manual several times.

### Stringing Things Together

As mentioned earlier, not all data can be represented in numeric form. Text, such as this article, is best represented as a linear array of characters. Such arrays are almost always called strings. This data type is useful for storing letters, instructions, and even command sequences for some instruments.

Character codes are used to represent text data in a form that can be transferred from machine to machine. Each character is represented by 5 to 8 bits. As we have seen, ASCII, the most popular code, is a 7-bit code.

Eight bits is a convenient size to store data in most modern digital computers (there are exceptions). Strings are usually composed of 8-bit

## ADD A 5 MBYTE WINCHESTER TO YOUR COMPUTER ARSENAL FOR \$2995.00

### INTERFACES WITH:

- S-100 BUS (CP/M)
- Heath H89, H90 (CP/M, HDOS)
- Zenith Z89, Z90 (CP/M, HDOS)
- TRS 80 Model III (CP/M, TRS DOS)
- Xerox 820 (CP/M)
- IBM Personal Computer (CP/M 86, IBM DOS)



AMT's EZ8X5 is a complete, ready to plug in Winchester Hard Disk Subsystem. Featuring easy implementation, enhanced system interface cards, an extensive disk test package. The EZ-8X5 delivers a full 5, 10, or 20 megabytes. Dealer and Distributor inquiries are being accepted.

Route 30 West  
Greengate Professional Building  
Greensburg, PA. 15601 412/837-7255  
or call Toll Free 1-800/245-6908

... It's What's Inside That Counts.



SEIKOSHA  
GP-100A

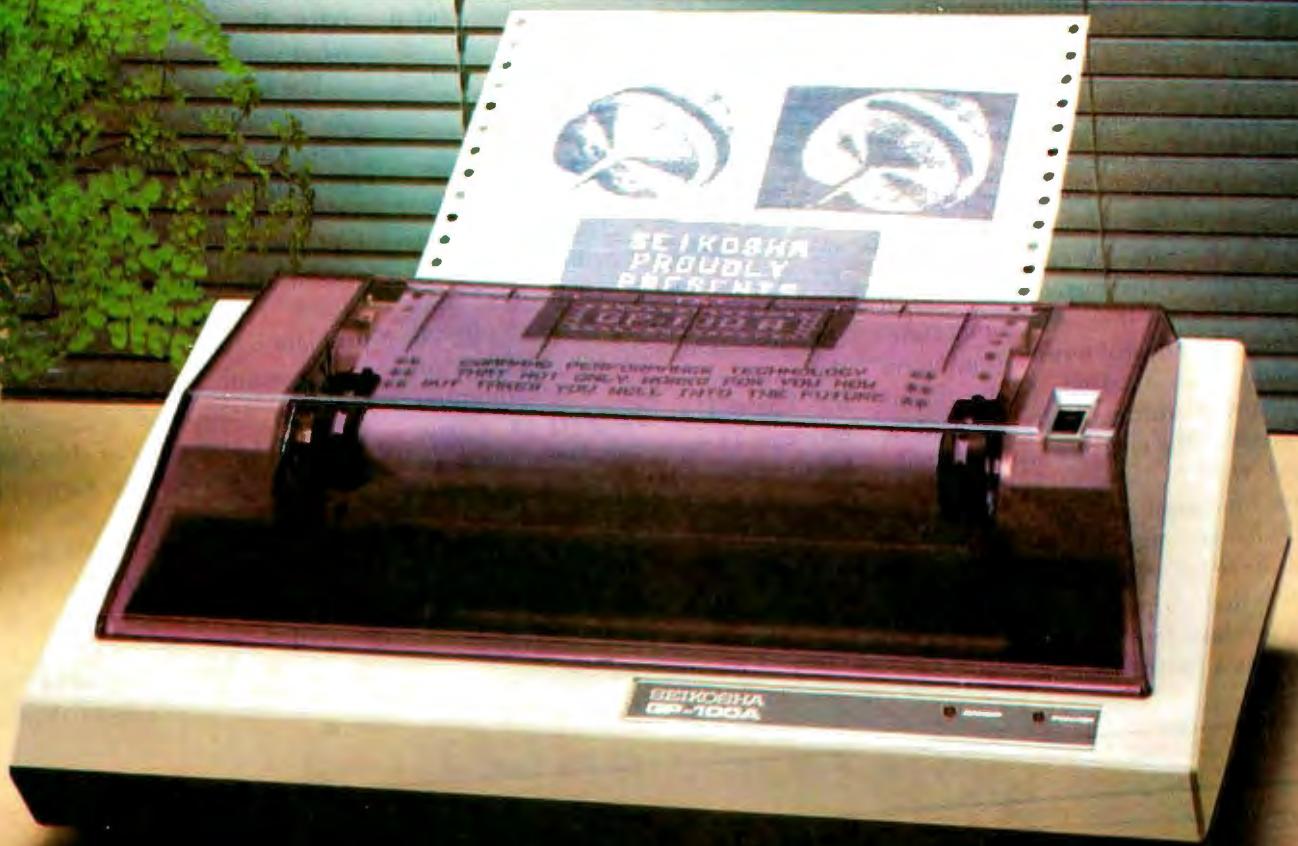

GP-100A: US\$389

## COMMAND PERFORMANCE.

Seikosh gives you all the best features—including economy and super-clear graphics.

Unlike some graphic printers, Seikosh's new GP-100A Uni-Hammer Graphic Printer puts full dot addressable graphic at your command. The GP-100A lets you repeat a column of data as many times as needed with just one command. Software control enables double-width character output, and the positioning is both character and dot addressable. Designed for simple operation, it ranks among the most cost-efficient graphic printers on the market. Command performance technology that not only works for you now, but takes you well into the future.

Other valuable features:

- Graphics, regular and double width character modes can be intermixed on the same line.
- Automatic printing. When the text exceeds the maximum line length, there is no loss of data due to overflow.
- Self-test printing is a standard feature.
- Centronics type parallel interface.
- Paper width is adjustable up to 10 inches.
- Optional Interface: RS232C, IEEE488, apple II, etc.

Graphic Printer  Series

Distributed by **AXIOM CORPORATION** 1014 Griswold Avenue San Fernando, Calif. 91340 Phone (213) 385-9521 TWX (810) 498-1748  
Manufactured by **SEIKOSHA SYSTEM EQUIPMENT DIV.** 4-1-1 Taihei Sumida-ku Tokyo Japan. Phone: 03-623-8111 Telex: 282-2820  
Circle 408 on inquiry card.

parcels of data. Since ASCII is only 7 bits, 1 bit of each string character is usually wasted.

Input and output of strings is much simpler than for numerics. The internal representation for strings is almost what the printout would look like. The exception to this statement is the terminator, which marks the end of a message.

Input of a string must stop at some point so that data can be processed. The terminating character tells the computer when it has reached the end of the message. A common default terminator is the linefeed character. It is so common that most input statements default to terminating upon receipt of a linefeed. Most output statements automatically append a linefeed at the end of a string output.

As with numeric I/O, everything runs fine until you don't want the defaults any more. Eventually, you will have to read data in from a device that outputs a carriage return as a message terminator. Or perhaps you have a printer that needs an ENQ

(Enquiry) character as a terminator instead of a linefeed. Eventually, a situation will arise where the defaults don't work.

What can you do? Use a format statement. If a device requires only a carriage return as a message terminator, the program might contain the following statement:

```
200 PRINT A$
```

This program will output the string A\$ and follow it with the carriage return and linefeed characters. Since the device to which you are outputting will terminate one message on the carriage return, it will interpret the linefeed as the start of a new message. In some languages, this may be suppressed by changing the program to:

```
200 PRINT USING  
    "#,B",A$,CHR$(13)
```

The "#,B" specifier tells the computer to refrain from adding any

embellishments to the string being output. The CHR\$(13) is a carriage return, which is the proper terminating character. Again, the formatting capabilities of the language have allowed you to specify exactly what you want the I/O to do.

The software of I/O is an extremely important topic in interfacing. Software is the interface between the programmer and the computer. By understanding how to control system I/O needs through explicit software statements, a programmer can turn a "dumb" computer into a flexible problem solver.

This month, we've seen some of the problems associated with character codes and also some of the software provisions needed to turn stored characters into acceptable printed output. Next month, we'll see how software can take advantage of buffers and interrupts to control input/output. We'll conclude by looking at problems associated with grounds and resulting signal degradation. ■

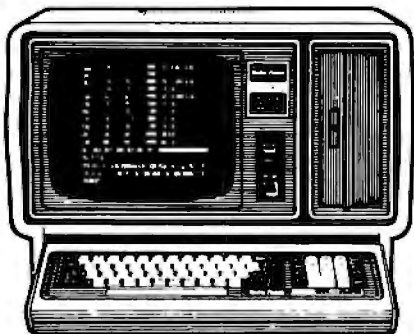

Model II  
26-4002

**\$3279<sup>00</sup>**

8 Megabyte

**Hard Disk**

(Primary)  
26-4150.

**\$3994<sup>00</sup>**

## DISCOUNT TRS-80<sup>®</sup> Computers

We have the Largest Inventory in the Central United States. Discount prices on all software and accessories for your TRS-80 computer needs.

BUY

DIRECT

Toll Free Order:

1-800-835-9056

Kansas Residents:

1-800-362-9091

- ★ No out of state Taxes
- ★ Immediate Shipment
- ★ Several Payment Methods
- ★ Direct Buying

**Jimscot, Inc.**

P.O. Box 607 - 1023 N. Kansas  
Liberal, Ks. 67901

**WRITE TODAY FOR YOUR  
FREE CATALOG!**

• TRS-80 is a Registered Trademark of Tandy Corporation



# Best prices anywhere. We beat 'em all!

## COMPUTERS

### INTERSYSTEMS



DPS 1, DPS 1A, DPS 2A.. Call for Prices

ALTOS List..... Less 20%

NorthStar  
HORIZON 2Q-64K .. \$2685  
ADVANTAGE..... Call

TeleVideo COMPUTER SYSTEMS..... CALL

### SUPERBRAIN



64 DD ..... *NEW LOW PRICE* .. \$1995  
64 QD ..... *NEW LOW PRICE* .. \$2395  
DSS-10 Meg. Hard Disk ..... \$2895

### Cromemco

CS-1 List, \$3995 ..... Our Price \$3195  
CS-2 List, \$4695 ..... Our Price \$3549  
CS-3 List \$7995 ..... Our Price \$5595  
Z 2H List, \$995 ..... Our Price \$7995

### ZENITH data systems



Z-89 List \$2895  
Our Price  
**\$2099**  
Z-90, \$2299

## TERMINALS

### TeleVideo



### TeleVideo

910C..... \$569  
912C..... \$659  
920C..... \$719  
925C..... \$719  
950C..... \$915

### INTERTEC

INTERTUBE..... \$725  
EMULATOR..... \$725

### OKIDATA

Microline 80 ..... \$329  
Microline 82A ..... \$469  
Microline 83A ..... \$739  
Microline 84 ..... Call

C.ITOH ..... Call for Prices

### SOROC

IQ-120 ..... \$629  
IQ-130 ..... \$585  
IQ-135 ..... \$719  
IQ-135 w/Graphics ..... \$789  
IQ-140 ..... \$995

### HAZELTINE

1420 ..... \$789  
1500 ..... \$845  
1510 ..... \$1029

ZENITH Z-19..... \$699

Prices apply to *prepaid orders only*, and reflect a cash discount. Charge card orders are slightly higher.

Most items in stock for immediate delivery in factory sealed cartons, with a full factory warranty. N.Y. State residents add appropriate sales tax. Prices do not include shipping. C.O.D. orders require 25% deposits. Prices subject to change and offers subject to withdrawal without notice.

## PRINTERS

### CENTRONICS



### CENTRONICS

730-1 Parallel..... \$349  
739-1 Parallel..... \$499  
739-3(RS232)..... \$599  
704-11 Parallel..... \$1569  
704-9 (RS232)..... \$1519

### Texas Instruments

TI-810 Basic..... \$1289  
TI-810 Full Option..... \$1549  
TI-820 RO Basic..... \$1545  
TI-820 KSR Basic..... \$1739

NEC 3510 (RS232)..... Call  
NEC 7710 (RS232), 7730 (Parallel)..... \$2295  
NEC 7720 (RS232)..... \$2795

QUME..... Call for Prices

DIABLO 630 RO..... \$2049

### Paper Tiger

Prism 80 w/o color ..... \$895  
Prism 132 w/color..... \$1495

### EPSON

MX 80..... \$441  
MX 80FT..... \$548  
MX 100..... \$745

## DISK SYSTEMS

### MORROW

Discus 2D..... \$835  
Dual Discus 2D..... \$1385  
Discus 2 + 2..... \$1069  
Dual Discus 2 + 2..... \$1855  
M5 5Meg. Hard Disk..... \$1949  
M 10 10 Meg. Hard Disk..... \$2995  
M 26 26 Meg. Hard Disk..... \$3349  
CORVUS 5Meg. Hard Disk..... \$2555  
CORVUS 10 Meg. Hard Disk..... \$3955  
CORVUS 20 Meg. Hard Disk..... \$4755

# COMPUTERS WHOLESALE

P.O. Box 144 Camillus, N.Y. 13031

## 315-472-2582

Circle 122 on inquiry card.

Prices subject to change without notice

# A General-Purpose I/O Board for the Color Computer

*Build this low-cost interface for less than \$25 and plug it into the ROM cartridge slot.*

---

William Barden Jr.  
28122 Orsola  
Mission Viejo, CA 92692

---

In previous articles in this series, I've gone to some extremes to implement input/output (I/O) ports by using the Color Computer's cassette input and output, joystick inputs, and RS-232C port. In this article, I'll show you the "right" way to connect discrete (on/off) lines to the outside world from the Color Computer. It's not that you can't use the other designs to control and monitor outside events—the previous implementations work fine—it's just that you can easily build a general-purpose I/O (GPIO) board that can plug into the Color Computer's ROM connector and provide 24 lines (bits) of I/O. Each of the 24 lines can be programmed for either input or output. The entire board costs less than \$25. With a few inexpensive components, you can use it to control sprinkling systems and coffeepots, and to monitor burglar alarms and door-

bells. You can even use an *interrupt* with the board to run a real-time, foreground task while also running a BASIC program or other task in the background.

To understand the design of the GPIO board, you must first know how the Color Computer handles read-only memory (ROM) and other input/output operations.

## Color Computer I/O Structure

Figure 1 shows a logic diagram of Color Computer I/O. In fact, a large portion of the I/O structure is defined by two chips—the 6809E microprocessor and the synchronous address multiplexer (SAM) chip.

The 6809E is closely related to the Motorola 6800 chip. If you want an in-depth understanding of both, I suggest getting the *Motorola Microprocessors Data Manual*, which contains specifications on both the 6800 and 6809E. I'll capsule some of the basic information here.

The 6809E is basically an 8-bit microprocessor with some 16-bit processing capability. It has 16 address lines, designated A15 (most signifi-

cant) through A0 (least significant). The address lines are used to define memory addresses for instruction fetches, access of operands, and reading and writing of data.

It also has eight data lines, designated D7 (most significant) through D0 (least significant). The data lines are used to transfer instruction bytes to the processor during instruction fetch and operand bytes during instruction execution. D7-D0 are also used to transfer I/O data. All data transfers are done one byte at a time.

The 6809E (the "E" designation specifies an external clock) uses two clock inputs, QIN and EIN. The SAM chip (described below) generates the E and Q clock inputs for the 6809E, using a pulse from a crystal oscillator.

The three interrupt inputs to the 6809E are \*IRQ, \*FIRQ, and \*NMI. The asterisk prefix indicates that these are "active low" signals that must go to 0 volts (V) for action.

\*IRQ is the primary interrupt input to the 6809E. It signals the 6809E that an interrupt has occurred. If the interrupts are enabled by software, the

---

## About the Author

*William Barden Jr. is the author of several books on microcomputers, including Z-80 Microcomputer Design Projects.*

---



# IBM PERSONAL COMPUTER USERS

## COMPLETE YOUR REFERENCE LIBRARY

Que On Systems

### IBM's PERSONAL COMPUTER

Que Corporation's new 300 page book, IBM's PERSONAL COMPUTER describes the hardware, peripherals and IBM's program library. Whether you are an IBM Personal Computer user or prospective buyer, you will discover the significance of IBM's new product to your personal or business applications.

...at computer stores and fine book stores \$14.95



and...

### PERSONAL COMPUTER AGE

*The Definitive Journal For The IBM Personal Computer User*

Keeps you updated monthly with the latest news and applications for your IBM Personal Computer. Featuring: Hardware and Software Reviews — New Product Announcements — Technical Articles — Problem Reporting — Vendor Directory — Classified Ads — Special Interest Columns.

\$18.00/YR.  
(12 issues)



**BOTH FOR ONLY \$22.95**

#### PERSONAL COMPUTER AGE

For Credit Card Orders, Dial Toll Free  
(800) 227-2634 ext. 936  
In California  
(800) 772-2666 ext. 936

- I Want Everything — PERSONAL COMPUTER AGE and IBM's PERSONAL COMPUTER for \$22.95
- NEW     RENEWAL
- Send the Book only for \$14.95
- Just enter my subscription to PERSONAL COMPUTER AGE for \$18.00
- Payment Enclosed

Charge my:     VISA     MASTER CHARGE

Card # \_\_\_\_\_

Expiration Date: \_\_\_\_\_

Authorized Signature \_\_\_\_\_

Name \_\_\_\_\_

Address \_\_\_\_\_

City \_\_\_\_\_

State \_\_\_\_\_ Zip \_\_\_\_\_

PERSONAL COMPUTER AGE P.O. BOX 70725 Pasadena, California 91107 Dept. B 1

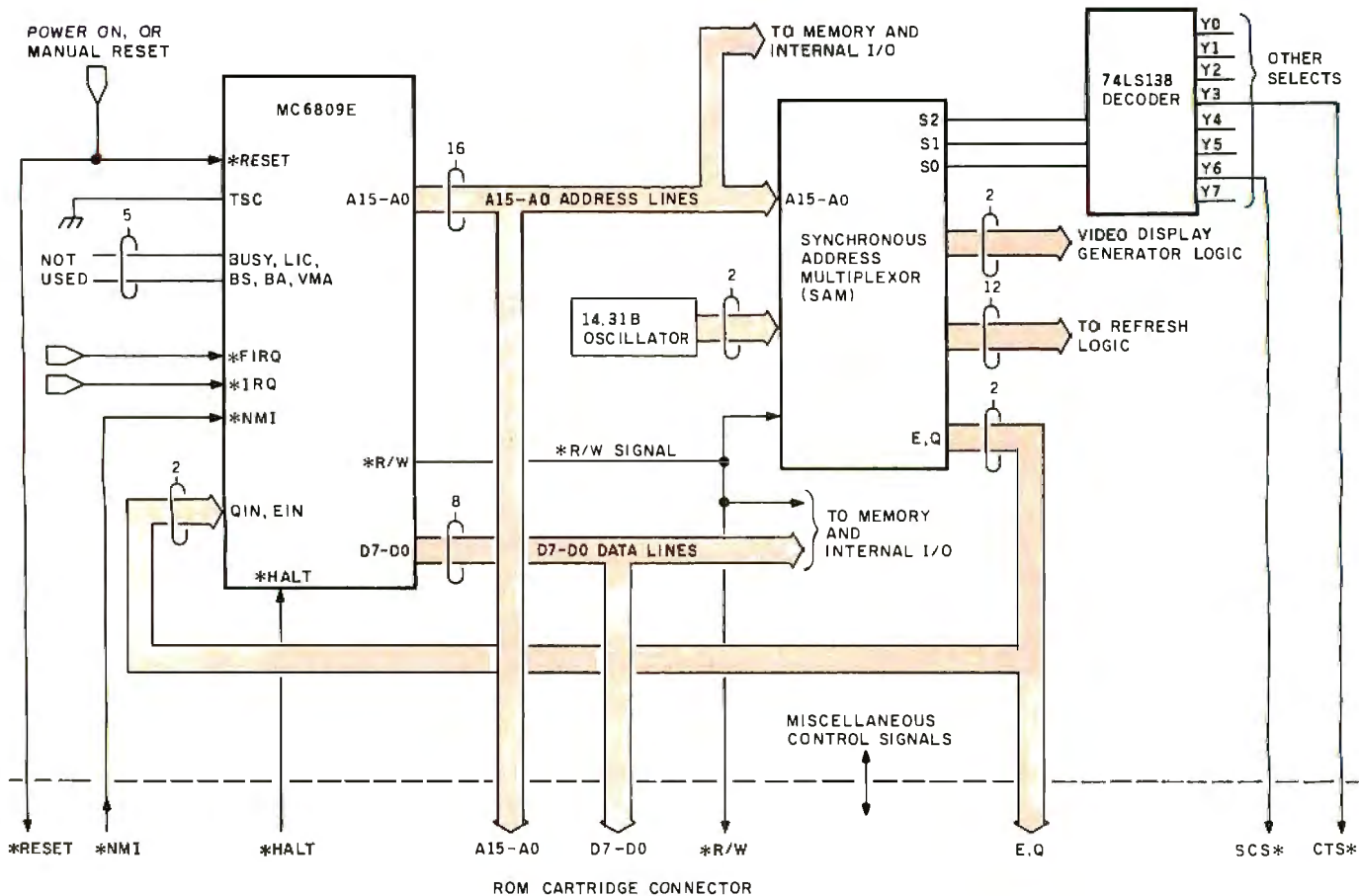

**Figure 1:** Color Computer input/output is controlled primarily by the 6809E microprocessor and the synchronous address multiplexer (SAM) integrated circuits. One set of SAM outputs defines the address selection for system RAM, ROM, and I/O devices.

6809E goes into a predefined interrupt processing routine at the location defined by the contents of a fixed memory location (BFF8-BFF9 hexadecimal in the Color Computer).

The \*FIRQ input is a "fast" interrupt that saves less of the "environment" (processor registers) when an FIRQ occurs.

\*NMI is a "nonmaskable" interrupt that cannot be disabled. It is generally used for major conditions that must always be detected, such as a real-time clock pulse or an impending power failure.

The \*HALT input halts the processor at the end of the current instruction. It is an orderly way to stop the processor and allow control of the program by an outside source. A typical application might be in single-instruction stepping.

The \*RESET input is used to initiate a start-up action, either at power-up or when the processor is

"hung up" due to improper programming or I/O protocol.

The \*R/W output signal tells the external memory or I/O devices whether a read (high, logic 1, or +5 V) or write (low, logic 0, or 0 V) is taking place.

The TSC, BUSY, LIC, BS, BA, and VMA pins are not used in the Color Computer configuration. Many of these signals relate to controlling the address and data bus lines for direct memory access—independent control of system memory for I/O action.

The lines from the processor discussed above constitute part of the system bus that is brought out to the ROM cartridge connector, a 40-pin edge connector on the Color Computer printed-circuit (PC) board.

### The SAM Chip

The 6809E works in conjunction with the synchronous address multi-

plexer (SAM) chip, an important chip in the Color Computer.

The SAM handles refresh of the 4116 dynamic memory in the Color Computer. This type of memory must be accessed periodically to retain the voltage charge and, hence, memory data. Since this refresh is done during times in which no processor memory addressing is taking place, there is no conflict in using the memory address lines.

Another major task of the SAM is to synchronize video-display updates and processor operation. The 6847 video display generator uses random-access read/write memory (RAM) data to update the video display, so it must know when valid data appears from the video-display portion of RAM. The SAM chip integrates the processor and video-display memory addressing.

The timing-signal generation of the SAM was discussed above.



# The World's First

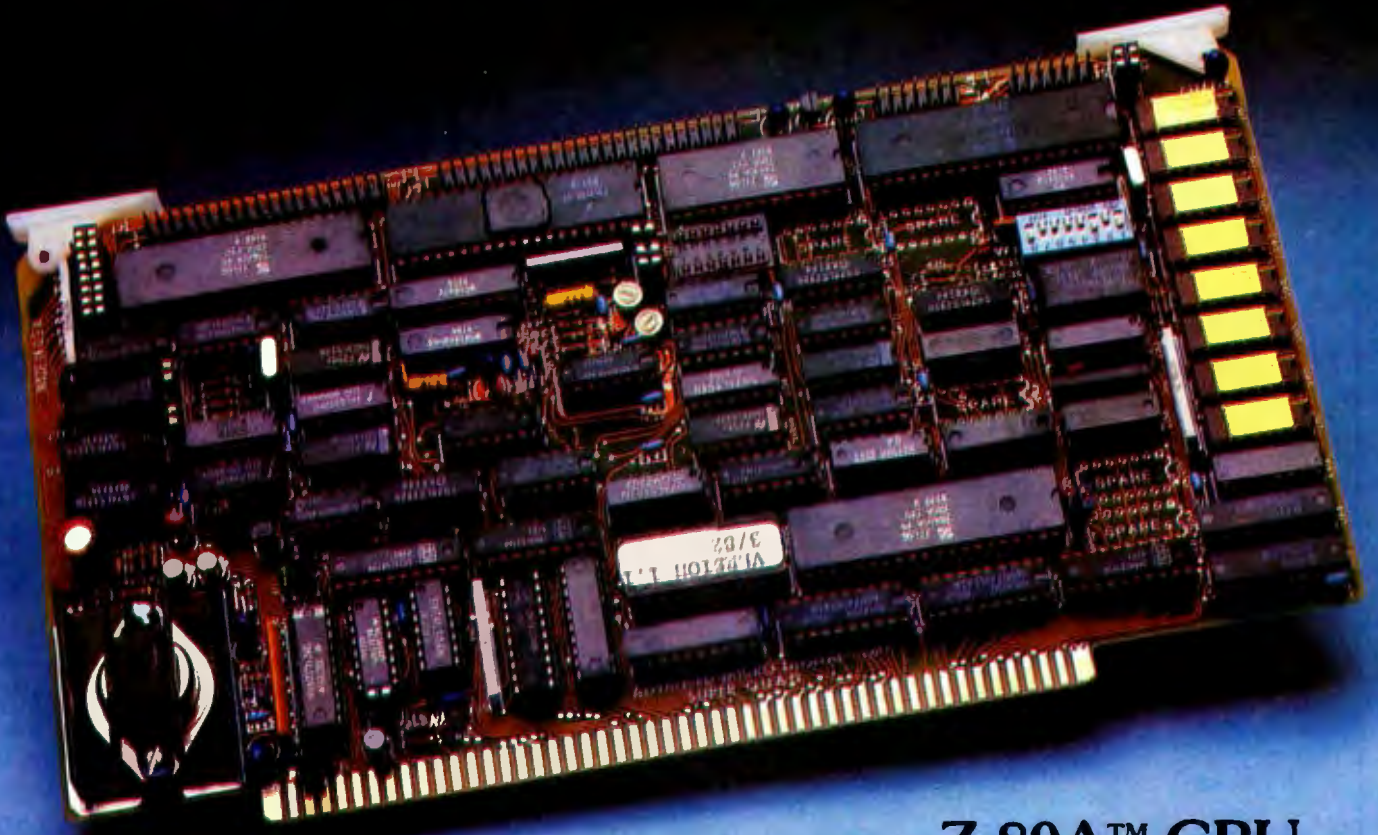

## Z-80A™ CPU, Floppy Disk Controller, 64K of Memory, Serial & Parallel I/O Ports . . . all on a SINGLE S-100 BOARD!

Don't Buy Another One of Those 3 Board Sets Till You See What One Can Do!

Advanced Micro Digital has been producing the SUPER QUAD for some time now and it's truly one of a kind. Just plug this board into any S-100 mother board and hook-up your disk drives to it. It files. Runs with CP/M, MP/M, and turbo-DOS. You can also plug in additional boards, I/O, hard disk controllers, etc. SUPER QUAD is a BUS master. The cost of this board is one third to one half of what you have been paying for the three board set. Just take a look at these features:

- IEEE S-100 Standard
- Z-80A CPU
- 64K of Bank Select Memory as well as extended addressing
- Double density floppy disk controller. Both 8 or 5¼" Disk Drives
- 2 serial & 2 parallel I/O ports (RS-232 and intelligent hard disk interface).
- 2K or 4K of monitor EPROM
- Runs with CP/M®, MP/M® and turbo-DOS™
- One year warranty.
- Free copy of bios disk.

Also introducing SUPER/SLAVE to run multi-processing operating systems such as turbo-DOS™. With 128/64K of memory, serial & parallel I/O, you can plug multiple of the slaves with the master and each user will have its own CPU and memory local.

NOTE: no custom logic used (no PAL'S) makes it easy for field service.



Now it's time to replace or throw away the old S-100 boards and plug the SUPER QUAD in. Save space, money and power.

Retail price is \$875.

For more information write or call: Sales Dept.



7201 Garden Grove Blvd. • Suite E • Garden Grove CA 92641 • (714) 891-4004 TELEX: 678401 tab irin

®Registered Trademark of Digital Research Corp.  
™Registered Trademark of Software 2000 Inc.

Circle 12 on Inquiry card.

© Copyright 1981 Advanced Micro Digital Corp

Type	Pin	Name	Source	Description
Power	1	-12 V	CC	
	2	+12 V	CC	
	9	+5 V	CC	
	33	GND	CC	
	34	GND	CC	
Data	10	D0	CC-6809E	Data Bus
	11	D1	CC-6809E	
	12	D2	CC-6809E	
	13	D3	CC-6809E	
	14	D4	CC-6809E	
	15	D5	CC-6809E	
	16	D6	CC-6809E	
Address	17	D7	CC-6809E	
	19	A0	CC-6809E	Address Bus
	20	A1	CC-6809E	
	21	A2	CC-6809E	
	22	A3	CC-6809E	
	23	A4	CC-6809E	
	24	A5	CC-6809E	
	25	A6	CC-6809E	
	26	A7	CC-6809E	
	27	A8	CC-6809E	
	28	A9	CC-6809E	
	29	A10	CC-6809E	
	30	A11	CC-6809E	
	31	A12	CC-6809E	
	37	A13	CC-6809E	
Clock	6	E	CC-SAM	
	7	Q	CC-SAM	
Select	32	CTS*	CC-74LS138	ROM or I/O Select
	36	SCS*	CC-74LS138	
	40	SLENB*	External	
Other	3	HALT*	External	Halts Processor
	4	NMI*	External	NMI Interrupt
	5	RESET*	CC	Power-on or Reset
	8	CART	External	Cartridge Sense
	18	R/W*	CC-6809E	Read/Write Signal
	35	SND	External	External Sound

CC = Color Computer  
External = Input to CC

Table 1: Signals available on the Color Computer ROM cartridge port.

The last function of the SAM is to decode and control the memory mapping of the system. Three signals, S2, S1, and S0, are output from the SAM into a 74LS138 decoder chip. Only one of the eight outputs (Y0-Y7) of the 74LS138 is active (low) at any time. The one chosen depends upon the states of S2, S1, and S0, which in turn depend upon the A15-A0 inputs.

If Y0 is active, RAM from address 0000-7FFF hexadecimal is being addressed. (Unless otherwise noted, all addresses are in hexadecimal form.) If Y1 or Y2 is active, ROM area 8000-9FFF or A000-BFFF is being ad-

ressed. If Y3 is active, cartridge ROM at C000 and up is being addressed (CTS\*). If Y4 is active, the PIA addresses at locations FF00-FF1F are being addressed. If Y5 is active, the PIA addresses at locations FF20-FF3F are being addressed. If Y6 is active, memory locations FF40-FF5F are being addressed. These locations are nonexistent in the Color Computer, but come out to a ROM cartridge pin (SCS\*) and can be used in external logic. Signal Y7 is not used.

### ROM Cartridge Signals

The ROM cartridge connector uses

40 pins with signals from the 6809E processor, SAM, power supplies, and some additional logic.

The ROM cartridge port is more than just a port that enables the Color Computer to execute a program in ROM or erasable programmable read-only memory (EPROM); it is a general-purpose port that enables interfacing RAM memory or I/O devices of many types.

Table 1 lists the ROM cartridge-port pins, signal names, source, and description.

Signals D7-D0 and A15-A0 are the data and address lines from the processor, respectively. These are essential in connecting memory or I/O devices to the system. Bringing out all 16 address lines allows any of the 65,536 addresses in the 6809E addressing space to be specified.

The \*RESET signal to the processor is also brought out on pin 5 of the ROM cartridge port. A power-on or manual reset can reset an external device with this signal, in addition to causing the processor reset.

The CART and \*HALT processor inputs are generated from external logic connected to the ROM cartridge port. The EIN and QIN clock outputs from the SAM are also sent to pins 6 and 7 of the ROM cartridge port. I'll soon explain how these signals work in the cartridge ROM.

The \*R/W signal from the processor is brought out on pin 18 of the connector. This signal is necessary to define whether a read or write should be done during I/O between an external device and the system.

The \*NMI signal to the processor is generated only by external logic. It can be used to cause a nonmaskable interrupt to the processor, but is not used in the standard ROM configuration.

The SCS\* signal is the select signal from the 74LS138 chip that indicates that an address in the range FF40-FF5F is being used. This spare address is not normally used in Radio Shack software, although I'll be using it in this design.

The SLENB\* signal is generated by logic connected to the ROM cartridge port. Bringing this input low (0 V)



# you have one apple... now get a whole bushel

of apple add-ons

from **Vista** COMPUTER  
COMPANY,  
INC.

Available through your  
local computer dealer.



## MODEL GB75© Typewriter Interface

Compatible to IBM Electronic 50, 60, 85 Typewriters Interface ■ Reads IBM keyboard in parallel with Apple keyboard ■ Supports the IBM code functions using an escape sequence ■ Types at about 13 characters per second ■ Prints from Integer or Applesoft programs ■ Supports the "Control Number N" parallel line length mode sequence ■ Has switch selectable upper/lower case I/O 60, 83, 78 continuous from feed length, 40+video, 80, 95, 132 character line lengths

Suggested price \$225.00

## IMECARD III©

Multi-function time utility for the APPLE III computer system. Contains the year of the century, the month, the date, the day of the week, the hour, the minute, the second. ■ A countdown timer with a range of one millisecond to 999 hours, 59 minutes, 59 seconds, 999 milliseconds ■ Selectable 12 or 24 hour time formats ■ Diagnostic error reporting ■ Fully compatible with the APPLE SOS operating system

Suggested price \$195.00

## MODEL 150 TYPE AHEAD BUFFER

■ Up to 40 character type ahead capability ■ Enter commands or data while your Apple is processing previous instructions ■ Compatible with all Apple computers, keyboards and software ■ No cuts — no jumpers — no software patches required ■ Includes complete instructions for quick and easy installation

Suggested price \$49.95

## A800© FLOPPY DISK CONTROLLER

■ High speed DMA transfer of data (1 micro-second/byte) ■ Documentation provided — includes theory of operation, schematics and diskettes ■ Uses all standard Apple DOS commands (OPEN, CATALOG, LOCK, DELETE, LOAD, etc.) except for INIT which has been improved and enhanced in a Vista format routine ■ Compatible with Apple DOS 3.3, Pascal 1.1 and CP/M 2.2 (with the Z80 soft card by Microsoft) ■ 2K x 8 PROM contains Autoboot functions and all eight-inch

floppy driver code allowing complete compatibility with Apple DOS 3.3

Suggested price \$595.00

## PROM DEVELOPMENT SYSTEM©

■ Menu driven program development monitor ■ Programs 2708, 2716, 2532, 2732 and 48016 EPROMS ■ Simulates PROM from RAM 4K ■ Data and address interface for operator location and control ■ Complete user documentation

Suggested price \$495.00

## VISION 80

■ Full upper and lower case character with 3 dot descenders ■ 9x10 dot matrix per line U.S. (9x11 Europe) ■ 128 ASCII character set ■ BASIC, FORTRAN and Pascal languages supported ■ Z80™ and CP/M™ compatible ■ Compatible with all standard Apple™ peripherals

**Vista** COMPUTER  
COMPANY,  
INC.

Circle 459 on Inquiry card.

©Copyright 1981 Vista Computer Company, Inc.  
\*Apple Computer Company, Inc.

■ Shift and lock for upper and lower case ■ Source switches between 40x24 and 80x24 software and hardware ■ Rated #1 video card by Softalk and Call Apple

Suggested price \$395.00

## VISION 40

Softscreen programmable character/generator card for the Apple II computer ■ Allows use of DOS tool kit upper/lower case character sets in Apple 40 column mode ■ Permits creation of new alpha/numeric and graphic characters under Amatrix ■ Ideal for non-English language applications ■ Compatible with most popular word processing software packages

Suggested price \$195.00

## VISION 20

■ Cost effective ■ Compatible with the latest Apple II ■ Complete easy to follow installation guide ■ 120 day warranty ■ Immediate delivery

Suggested price \$29.95

1317 E. Edinger  
Santa Ana, CA 92705  
(714) 953-0523

™Digital Research, Inc.  
©Designed by Burtronix

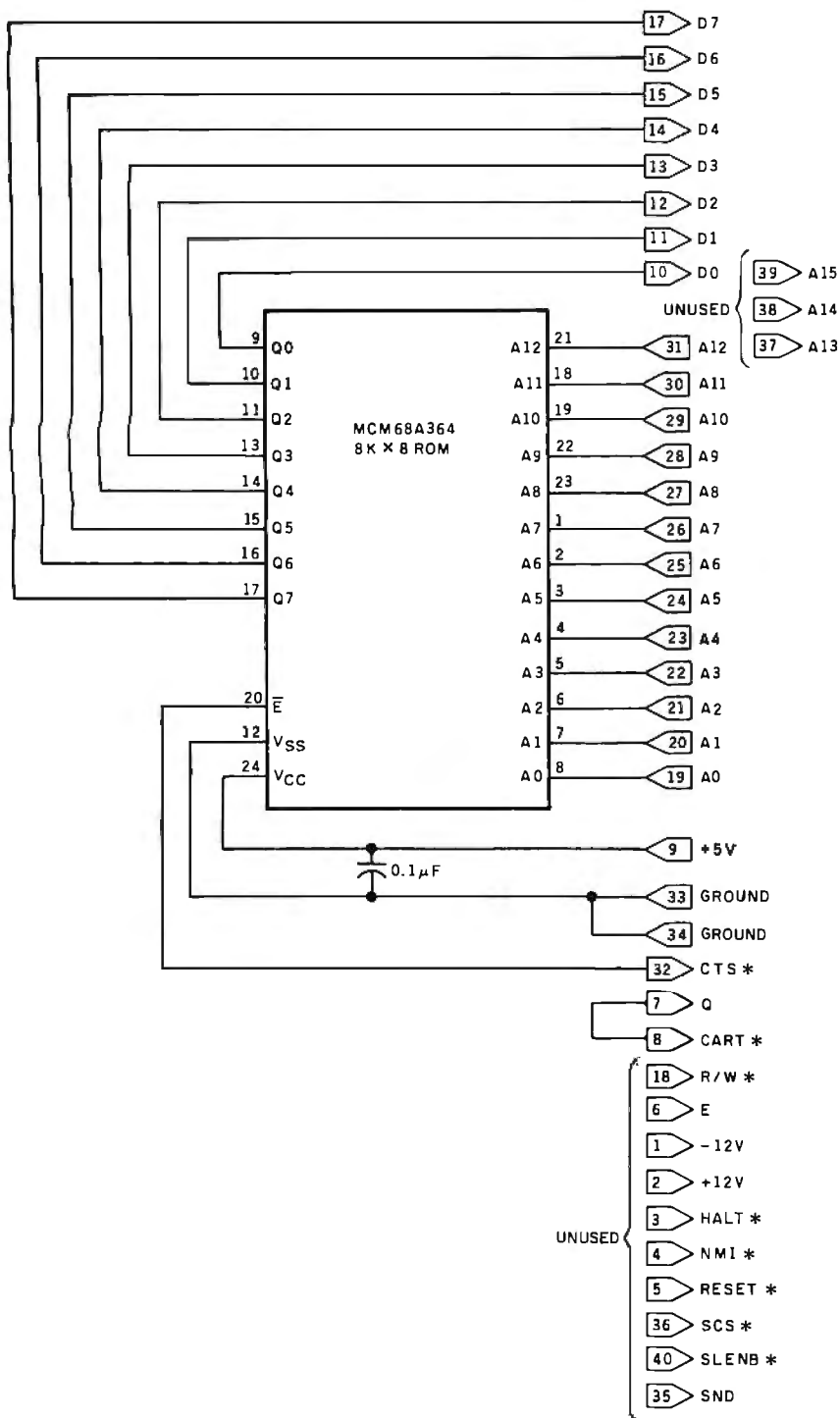

Figure 2: A typical ROM cartridge contains a program in up to 8K bytes of ROM. Minimal logic is required in addition to the ROM chip itself.

disables the address decoding by the 74LS138 (Y0-Y7 remain inactive). This signal enables the device connected to the cartridge port to "turn off" all internal devices. It is not normally used in Radio Shack software.

The SND input from logic connected to the ROM cartridge port enables an external sound to be

routed through the system to television audio.

### ROM Operation

A typical ROM plug-in cartridge is shown in figure 2. The data lines D7-D0 connect to the data lines of the ROM memory.

When any address in the range of

C000-DFFF is addressed by the processor, the CTS\* line goes active. The CTS\* signal from the 74LS138 address decoder goes to the ROM cartridge and enables the ROM. The actual ROM address for the ROM chips is defined by the state of address lines A12-A0. These 13 lines go to the address inputs of the ROM chips. The ROMs may be any size up to 8K bytes, requiring 13 address bits, which are supplied by the remainder of the C000-DFFF address.

No \*R/W signal is required in the ROM case, since by definition a ROM must always be a read device.

The ROM plug-in cartridge routes the Q signal from the SAM to the CART input. This causes an FIRQ interrupt that results in a hardware branch to the address found at FFF6-FFF7 (BFF6-BFF7 in the Color Computer). Normal Radio Shack software at this address contains an FIRQ interrupt processing routine that transfers control to the program found in the ROM.

### I/O Device Operation

I/O operation is similar to memory addressing as used in the ROM cartridge or in RAM addressing. I/O in the 6809E is memory mapped. This means that an input/output device is treated just as another memory location, rather than using separate I/O instructions.

Reading 8 bits of data from an I/O device is done by an "LDA ADDRESS" or similar instruction; "ADDRESS" may be a memory location or an I/O device. The programmer must know how the 65,536 memory addresses in the addressing space of the 6809E are mapped—which addresses are RAM, which are ROM, and which are I/O devices.

Writing is handled in similar fashion. An "STA ADDRESS" can store 8 bits of data either to a memory location or to an I/O device, depending on how the system is mapped.

PEEK and POKE instructions in BASIC operate in identical fashion to LDA and STA; the two commands can read or write data from either memory or I/O devices.



# Announcing the Printing Breakthrough of the Century: Smith-Corona® TP-1™ Text Printer



- Low Cost Daisy Wheel Printer

**\$845<sup>00</sup>**

- Microprocessor Electronics
- Serial or Parallel Interface
- Simple, Reliable Mechanism

**ACT NOW: Limited Supply, Low, Low Cost**

Smith Corona, one of the largest manufacturers of small printers in the world, gives a whole new perspective to printing with their electronic text printer—TP-1. The TP-1 is a microprocessor controlled, high quality daisy wheel printer. It produces perfectly formed, executive quality printouts at the speed of 120 words per minute. Typewriter quality printing at dot matrix prices.

Simple, durable and dependable, TP-1 may be used with word processing systems, microcomputers and most small business systems. Compact and attractively



Additional daisy print wheels . . . . \$4.95



Additional ribbons . . . . . \$2.95

styled, the TP-1 blends well with any setting.

Now, all your letters, documents forms and reports can have the crisp, professional look you demand—for business or personal use—at an affordable price. TP-1, the electronic text printer.

Don't delay. Order your TP-1 TODAY at the low price of \$845.

Micro Printer Marketing offers same day shipping, nationwide service and invites dealer inquiries. Catalogues available. No shipping charges on pre-paid orders.

**Micro™  
Printer  
Marketing**

**Call Micro-Printer Marketing**

CALL TOLL FREE **1-800-523-9859** MasterCard and Visa Accepted

In PA Call Collect 215 / 433-3366



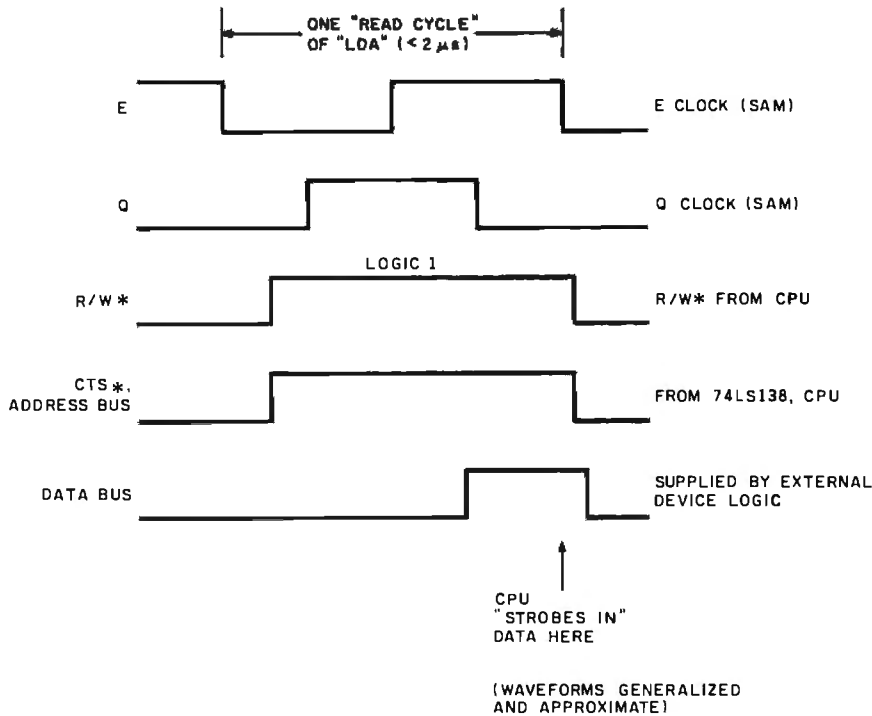

Figure 3: Generalized input for transfer of data from an external I/O device. Data is supplied by the I/O device after detection of the CTS\* and an R/W\* signal of 1.

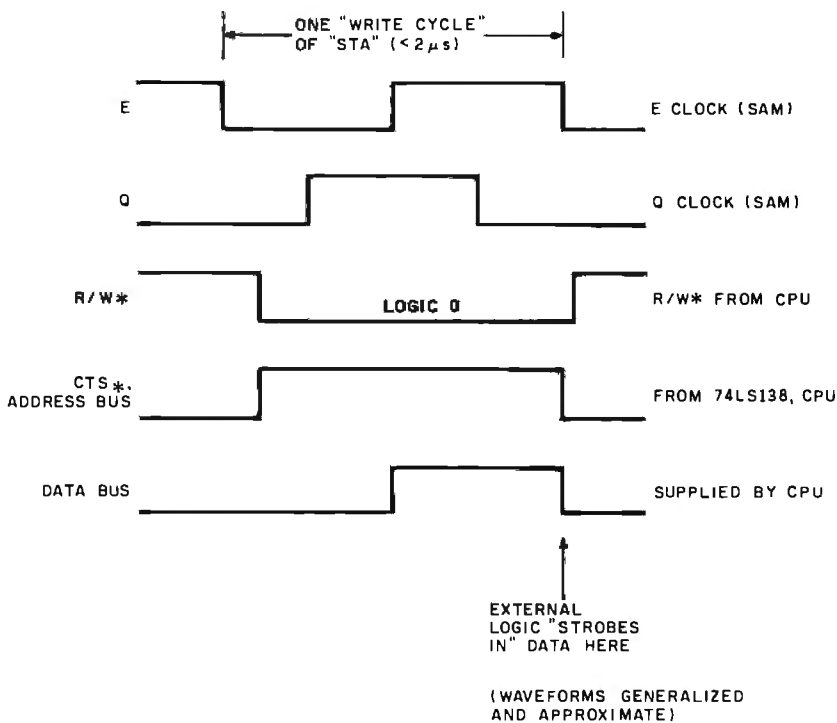

Figure 4: Generalized output for transfer of data to an external I/O device. Data is supplied to the I/O device along with CTS\* and an R/W\* signal of 0.

## General Input Operation

In general, reading from an external device plugged into the ROM cartridge connector would proceed as follows:

1. An LDA \$xxxx or PEEK &Hxxxx would be executed by the program, where xxxx is an address in the range C000-BFFF.
2. The CTS\* signal would become active and the address lines to the cartridge would contain the entire xxxx address.
3. The \*R/W line would, at a certain point, go to a logic 1, indicating a read.
4. The external I/O controller logic would detect the CTS\* and \*R/W, and deduce that a read instruction was being executed by the processor.
5. The controller logic would supply 8 bits of data on the data bus lines.
6. The processor logic would strobe in the data from the data bus.

In fact, this operation would occur very rapidly over a portion of one LDA instruction, as shown in figure 3.

Notice that the controller did not use the address lines. All it needed to know was that it was being addressed, and this was apparent by the CTS\* line (the controller's address is the address range C000-DFFF). Either the CTS\* or SCS\* signals could have been used as the controller's address. In fact, the SCS\* is probably better, since it defines a smaller range of addresses, more suitable for an I/O device. In this case, the controller's address would have been FF40-FF5F.

If the controller had to pass many different types of data, it might well decode all or a portion of the address lines A15-A0. It depends upon the application. A paper-tape reader, for example, might use address FF40 as the address for "reading the next byte of data from paper tape" and FF41 as the address for "reading the status of the paper tape (jammed, moving, etc.)." It depends upon the complexity of the I/O device.

## General Output Operation

In general, writing to an I/O device



# NEC PC-8000 SYSTEM



"The end of the compromise."

PC-8001A	CPU/32K	\$745
PC-8012A	I/O - 32K	\$490
PC-8023A	100 CPS Printer: Friction, Tractor, Graphics	\$485
PC-8031A	Dual Disk	\$745
PC-1201M(A)	12" Green	\$159
PC-1202DH(A)	13" RGB Color	\$830
PC-8091A	RGB Cable	\$19
PC-CPM	CP/M DOS FOR NEC	\$119
PC-GA	Gen. Accounting	\$245
PC-AR	Acct. Receivable	\$245
PC-INV	Inventory Control	\$245
PC-JC	Job Cost	\$245
PC-WP	Word Processor	\$350
PC-RM	3-D Report Mgr.	\$139
PC-32K	32K Card	\$155
PC-SER	RS-232 Card	\$199

## PRODUCTS FOR APPLE



AP-16	16K Ram Card	\$95
AP-128	128K Ram Floppy	\$700
AP-B1	Bison Drive W/3.3	\$475
AP-B2	Bison Drive Add-On	\$365
AP-K6	Konan 6MB Hard Disk	\$2265
AP-111	Konan 11 MB Hard Disk	\$2750
AP-K11	Konan 16MB Hard Disk	\$2970
AP-PAR	Parallel PrinterCard	\$72

## PRODUCTS FOR IBM

B-B2	Bison Drive-1 Side	\$275
B-B3	Bison Drive-2 Side	\$465
B-A64	AST 64K Card	\$375
B-A128	AST 128K Card	\$530
B-A192	AST 192K Card	\$710
B-A256	AST 256K Card	\$815
B-A2S	AST Dual Serial	\$235

20% Discount!  
- Entire Line.



## CS8000-14S/MTU

208K, 4 USER, Z80A  
5M Floppy  
40MB Winchester  
17MB Tape Cartridge Backup  
Nationwide Service  
L-40M List \$15,500 BISON .....\$12,400

# BISON

## SINGLE BOARD COMPUTER

- 64K
- 2 Serial
- 2 Parallel
- 5 1/8" Floppy Controller (Double Density)
- Z-80A (4MHZ)
- Hard Disk Expansion
- CP/M DOS

Just add drives, power supply, cables, and CRT terminal .....\$900

## VIDEO MONITORS

-AC1	Amdek Color I	\$310
-ACII	Amdek Color II - Apple	\$Call
-A300G	Amdek 300 Green	\$150
-Z12G	Zenith 12" Green	\$115
-J13	JCS 13" RGB	\$625
-J12G	JCS 12" Green	\$166

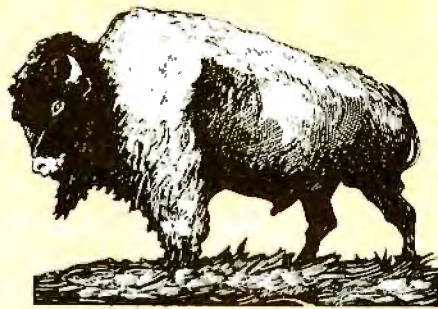

# BISON PRODUCTS

MAIL ORDERS:  
P.O. Box 9078-184  
Van Nuys, CA 91409

WILL CALLS:  
16709 Roscoe Boulevard  
Sepulveda, CA 91343  
(213) 891-5702

Please confirm price and availability  
by phone prior to ordering.



We accept VISA and Mastercard.



Shipping additional - \$3 minimum.  
Calif. residents add 6% sales tax.

Overseas orders and dealer inquiries accepted.

All merchandise is new and  
comes with factory guarantee.

## SIERRA DATA SCIENCES

### S-100 BOARDS Z-80 Master/Slave Single Board Computers

- Master:
- 4MHZ
  - 64K
  - Serial
  - 4 Parallel
  - 16K EPROM
  - 8" Floppy Disk Controller (Double Density)
  - Winchester Interface
- S-S4M .....\$690
- Slave: Without Disk Controllers
- S-S4S .....\$625
- Winchester Adapter: Uses Micropolis Drives
- S-SW .....\$145



## DISKETTES

F-D8SD	Dysan 8" SSDD, 10 PCS	\$45.00
F-W5SS	Wabash 5 1/4" SSSD, HUB	\$23.50
F-W8SD	Wabash 8" SSDD	\$33.00
F-W8DD	Wabash 8" DSDD	\$40.00

## PRINTERS

P-MX80	Epson MX100	\$405
P-MX80F/T	Epson MX-80 F/T	\$515
P-MX100	Epson MX-100	\$685
P-OK82	Okidata 82A	\$468
P-OK83	Okidata 84, Serial	\$1125
P-PC8023A	NEC PC-8023A	\$485
P-PRO	C. ITOH Prowriter, 120 CPS	\$485
P-PRO II	C. ITOH Prowriter II	\$Call
P-F10	C. ITOH 40 CPS Daisywheel	\$1395
AP-PAR	Parallel Int/Cable/Apple	\$72

Circle 62 on Inquiry card.

## MicroPro SOFTWARE

MP-WS8	Word Star, 8"	\$250
MP-WSA	Word Star, Apple	\$192
MP-MM8	Mail Merge, 8"	\$ 77
MP-MMA	Mail Merge, Apple	\$ 63
MP-SS8	Spell Star, 8"	\$127
MP-SSA	Spell Star, Apple	\$ 53
MP-DS8	Data Star, 8"	\$175
MP-SR8	Super Sort, 8"	\$127
MP-SRA	Super Sort, Apple	\$100
MP-SLII8	Super Sort II, 8"	\$105
MP-CS8	CalcStar, 8"	\$149

Many additional software packages are available at similar discounts.

## DISK DRIVES

D-S801R	Shugart 801R	\$390
D-QDT8	QumeDT-8	\$495
D-T81	Tandon Thinline 8", SS	\$390
D-T82	Tandon Thinline 8", DS	\$485

## SIGNALMAN MKI 300BPS MODEM

- RS-232 to Telephone Link, Full Duplex
  - Direct Connect, FCC Approved
  - 1 Year Warranty
  - Low Power Design
- M-S300 List .....\$115 BISON .....\$89

## AB DIGITAL DESIGN LABS

### 256K BYTE - 128K

### WORD DYNAMIC MEMORY

- 4MHZ with Extended DMA
  - IEEE696, Multi-Layer
  - 1 Year Warranty
- S-B810A List .....\$1245 BISON .....\$975

## STATIC MEMORY SYSTEMS 64K



- 24 Line Addressing
  - 200NS, Lower Power CMOS
  - Intermix RAM and EPROM
  - New Super Low Price
- S-ST64 List .....\$594 BISON .....\$440

## 8086 SUPER MICRO

- 8 MHZ 8086 S-100 SET
  - 128K 70NS Static RAM
  - DD Disk Controller
  - 22 Slot Mainframe
  - Cable for 2 1/2" Drives
  - MS-DOS (86-DOS)
  - Add Drives and Terminal!
- SC-SYS2 System 2 List..\$4185 BISON ...\$3450
- SC-2/3 8086 2 BRD Set w/DOS  
List .....\$795 BISON .....\$595

## QT S-100 & 8" Floppy Drive Mainframe



- +8V@25A/±16V@5A S-100 Power
- +5V@2.5A/-5V@.5A/ +24V@3A Drive Power
- Keyed Power Switch
- Shielded Motherboard
- Rugged Card Cage
- 9 1/2" x 17" x 21" (HxWxD)
- Strappable 110V or 220V AC



QT-MF6	6 Slot, 2-8" Drive	\$525
QT-MF8	8 Slot, 2-8" Drive	\$550
QT-MF12	12 Slot, 2-8" Drive	\$575

## QT S-100 & 5 1/4" Floppy Mainframe

- Similar to 8" Mainframe
  - Power for 5 1/4" Drives
  - 7" x 17" x 20" (HxWxD)
  - 7" x 17" x 20" (HxWxD)
- QT-5MF6 6 Slot, 2-5 1/4" Drive .....\$350
- QT-5MF8 8 Slot, 2-5 1/4" Drive .....\$375
- QT-5MF12 12 Slot, 2-5 1/4" Drive .....\$400



## DRIVE CABINETS

H-BT8	BISON 2 Dr, Vert, 8", Thinline	\$245
H-QT8	QT 1 Drive, 8" Vertical	\$215
H-QT8-2	QT 2 Dr, Horizontal, 8"	\$305

# Main/Frames Main/Frames from \$200

- 30 Models of Enclosures
- Assembled and tested
- Quasi-Coax Motherboards
- Power Supply
- Card cage and guides
- Fan, line, cord, fuse, power & reset switches



8" Floppy Main/Frame



8" Disc Enclosure



Phase/80 8" Floppy Mainframe



Phase/80 Desk + Mainframe

Write or call for our brochure which includes our application note:  
"Building Computers — A Recipe"

## INTEGRAND

8620 Roosevelt Ave. • Visalia, CA 93291  
209/733-9288

We accept BankAmericard/Visa and MasterCharge

plugged into the ROM cartridge port would proceed as follows:

1. An STA \$xxxx or POKE &Hxxx,v would be executed, where xxxx is the ROM cartridge-port address of C000-DFFF and v is the 8-bit value to be transferred.
2. The CTS\* signal would become active and the address lines to the cartridge would contain the entire xxxx address.
3. The \*R/W line would, at a certain point, go to a logic 0, indicating a write. The processor would supply the 8 bits of data on the data bus lines.
4. The external I/O controller logic would detect the CTS\* and \*R/W, and deduce that a write instruction was being executed by the processor.
5. The controller logic would strobe in the data from the data bus.

All of this would occur in the space of a single "STA" instruction, even if a BASIC POKE was involved (see figure 4). Again, additional address-line decoding might be required, and it would be convenient to use the SCS\* signal in place of the CTS\*.

### A General-Purpose I/O Board

Figure 5 shows the logic diagram of a general-purpose I/O (GPIO) board that plugs into the ROM cartridge connector. It operates in a similar fashion to the general input/output described above. The board is built around an Intel 8255 programmable peripheral interface (PPI). It uses three 74LS240 bus buffers to provide higher current-drive capability to 24 lines, 8 of which are inputs and 16 of which are outputs.

### The 8255 PPI

The 8255 is a general-purpose I/O device that operates in several modes. I've chosen the simplest mode for this application, the mode in which each of three sets of lines can be programmed to be inputs or outputs. In this case, I've arbitrarily made the "A" and "B" lines outputs, and the "C" lines inputs, although the sets could have been either inputs or out-

puts by simply outputting the proper control byte.

Many of the signals previously described are used in this design.

The addresses of the device are FF40, FF41, FF42, and FF43. The SCS\* signal enables the 8255 (CS is chip select), and address lines A1 and A0 choose the two lower address bits.

Since the 8255 requires a write signal of 0 (WR) and a read signal of 0 (RD), I've added some additional logic (74LS00) to provide the proper signal from the basic R/W\* signal.

The 8255 is cleared by a RESET signal of logic 1; another section of the 74LS00 changes the active low RESET\* from the 6809E to an active high signal.

The 24 lines go to three 74LS240 chips. These are octal buffers that provide up to 40 milliamps (mA) of "sink" current and invert the 8255 signal.

### Software for the GPIO Board

Programming the board is easy. First, the 8255 must be initialized to mode 0, the simplest I/O mode that it can use. This is done by outputting a value of decimal 137 to address FF43 hexadecimal (the 8255 control register), either by a BASIC POKE 65347,137 or by an assembly-language instruction. This initialization should be done on power-up or after every system reset.

To write to port A or B, do a POKE 65344,v or a POKE 65345,v, with v set to the 8-bit value for lines PX7-PX0. The value will be latched into the 8255 and remain on the outputs until overwritten by a new value. To set lines PB7, PB6, and PB0, for example, do a POKE 65345,193. The outputs of the 74LS240 will be inverted.

To read port C, do a PEEK (65346). The value will be returned as an 8-bit number, corresponding to lines PC7-PC0. The inputs from the 74LS240 are inverted.

### Using the GPIO Board

A small reed relay can be driven by a 74LS240 output. The maximum current required to pull in the relay cannot exceed 40 mA. Radio Shack relays (275-228) were used in the pro-



# SuperBrain II™



## Summa Cum Laude!

Just three years ago, Intertec stunned the microcomputer industry when its SuperBrain™ desktop computer graduated with honors . . . outperforming all the others by achieving the best price/performance ratio in its class. Today, that scholastic achievement remains unchallenged. At least until now. . .

Announcing SuperBrain II™ . . . our latest microcomputer marvel that's destined to be the "Most Likely to Succeed" in the Class of '82. With thousands of SuperBrains in use worldwide, it's no surprise that SuperBrain II users have given our new model the highest honors yet. Standard features include a powerful 64K of internal memory, a CP/M\* operating system, a 24 line × 80 column display on a 12-inch non-glare screen, a full-featured ASCII keypad with operator convenience keys, twin Z80 processors and dual RS-232 communications and printer ports. But SuperBrain II outsmarts its Class of '79 counterpart by

offering *leaner* pricing, *more* features and *better* overall system performance. New SuperBrain II features include a faster, enhanced disk operating system, a library of new visual attributes including reverse video, below-the-line descenders and impressive graphics capabilities and Microsoft† BASIC — all included at absolutely no extra cost!

SuperBrain II's internal circuitry has also been completely redesigned and is now computer tested to ensure optimum field reliability. Plus, there are four new SuperBrain II models from which to choose, offering disk storage capacities from 350K bytes to 10 megabytes! But, best of all, prices start as low as \$2,495, including software!

Of all the single-user microcomputers available today, our SuperBrain II is certainly in a class by itself. Not only does it outprice *and* outperform its competitive classmates, it's also backed by our comprehensive customer protection

programs — depot maintenance, extended warranties, a satisfaction guarantee and a factory sponsored users group. All in all, the SuperBrain II™ represents the most incredible microcomputer value we've ever seen (or probably ever will see) in a long, long time.

Contact your local dealer or call or write us at the address below for more information on our full line of single and multi-user microcomputers. Ask for our SuperBrain II "Buyers Guide" and find out why so many microcomputer buyers who insist on quality and value . . . insist on Intertec.

 **INTERTEC  
DATA  
SYSTEMS®**

2300 Broad River Rd. Columbia, SC 29210  
(803) 798-9100 TWX: 810-666-2115

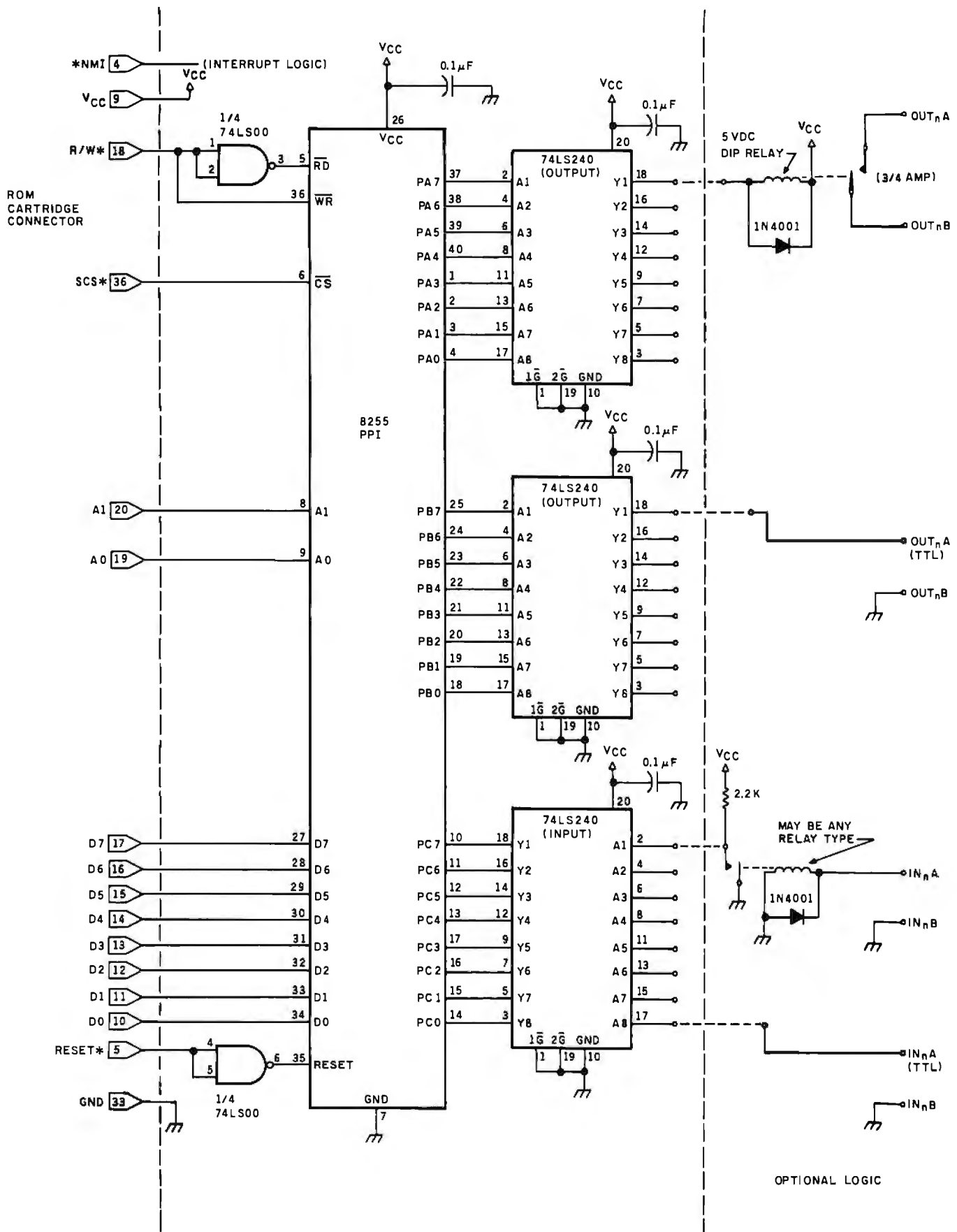

Figure 5: The general-purpose I/O board consists of a programmable peripheral interface (PPI) chip, 3 bus-driver chips, and minor logic conversion. The PPI provides 24 discrete lines that can be used to drive relays or other devices. In this configuration, 16 of the lines are outputs and 8 are inputs.



Take a bite  
out of the  
high cost  
of drives  
for the  
Apple™



Buy the SUPER DRIVE™ by Fourth Dimension

ORDER NOW — \$30 REBATE

- 1 year warranty
- 100% compatible
- 1/2 track
- Quiet, accurate tracking
- Controller card available



Just plug the Super Drive into an Apple and hear the quiet sound of dependable & accurate mechanics. Buy a Super Drive for only \$419 before Aug. 31, 1982 & get a \$30 rebate from Fourth Dimension. Quality & value is the bottom line.

Order Toll Free 1-800-854-2833

We accept VISA • MasterCard • Checks • Money Orders • COD • Calif. residents add sales tax

**COMPUTER SPECIALTIES**

1251 Broadway, El Cajon, CA 92021

Dealer Inquiry Invited • Apple II is the trademark of Apple Computer, Inc. • SUPER DRIVE is the trademark of Fourth Dimension.

Circle 118 on inquiry card.

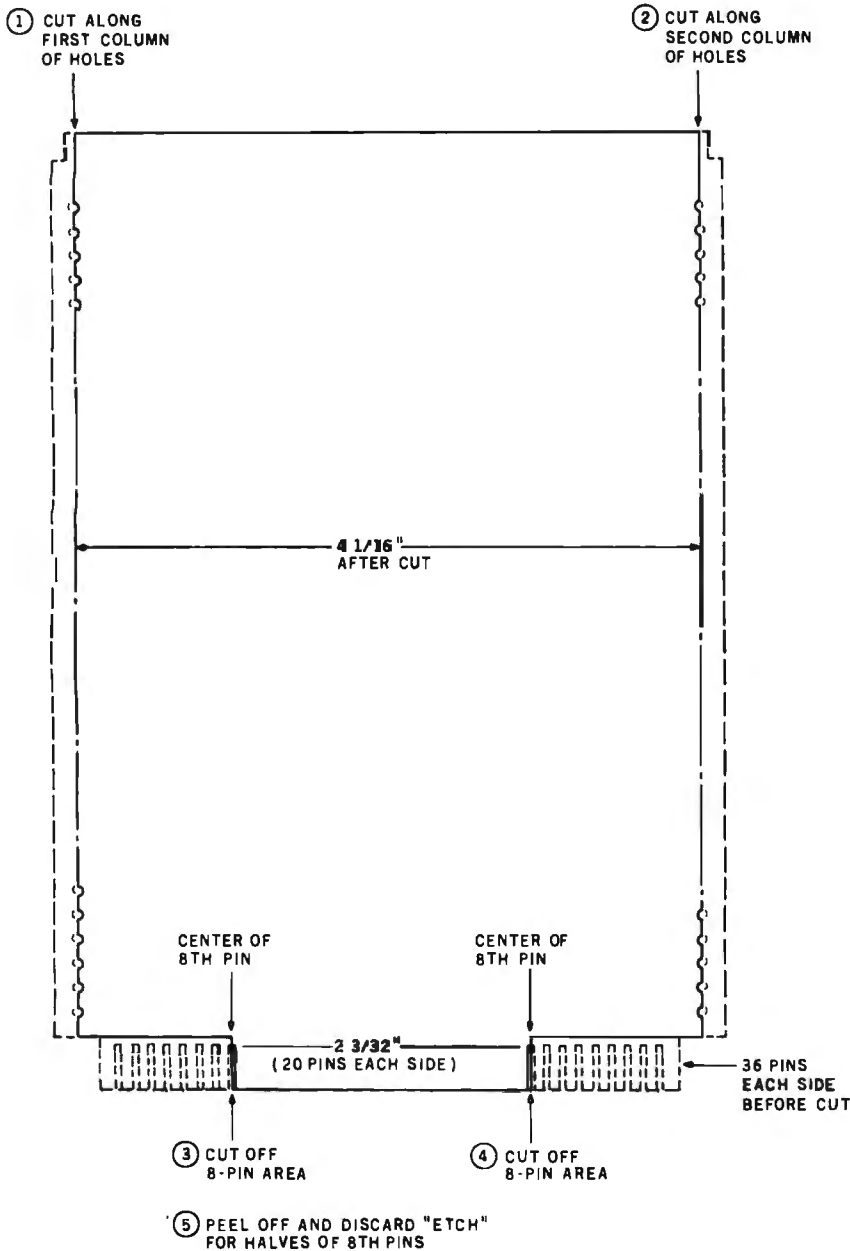

Figure 6: A Vector Electronics 3719-1 DIP plugboard can be cut to fit the 40-pin edge connector and cutout for the Color Computer ROM cartridge port.

tototype, drawing 22.5 mA. These relays will handle up to 3/4 ampere (A) on the contacts and can be used to drive a larger relay or small load at a local or remote location.

On the input side, the Radio Shack relay can be used in reverse. The contact closure pulls down a signal input from logic 1 to 0, as shown in figure 5. The control voltage can be 5 to 6 V DC from a remote location.

The output side can also drive any other transistor-transistor logic (TTL)

circuit, as long as the length of wire from the 74LS240 output to TTL input is kept shorter than three or four feet.

Devices such as optoisolators or solid-state relays can be driven by the outputs to control virtually any device.

### Construction of the GPIO Board

The board is constructed on a Vector Electronics 3719-1 DIP plugboard. This board is not available at Radio

From	To	Signal
CC-18	74LS00-1	R/W*
74LS00-1	74LS00-2	R/W*
74LS00-3	8255-5	<u>RD</u>
74LS00-1	8255-36	<u>WR</u>
CC-36	8255-6	SCS*/CS
CC-20	8255-8	A1
CC-19	8255-9	A0
CC-17	8255-27	D7
CC-16	-28	D6
CC-15	-29	D5
CC-14	-30	D4
CC-13	-31	D3
CC-12	-32	D2
CC-11	-33	D1
CC-10	-34	D0
CC-5	74LS00-4	RESET*
74LS00-4	74LS00-5	RESET*
74LS00-6	8255-35	RESET
CC-9	V <sub>cc</sub> Bus	V <sub>cc</sub>
CC-33	GND Bus	GND
8255-37	74LS240-2	PA7
-38	-4	6
-39	-6	5
-40	-8	4
-1	-11	3
-2	-13	2
-3	-15	1
-4	-17	0
8255-25	74LS240-2	PB7
-24	-4	6
-23	-6	5
-22	-8	4
-21	-11	3
-20	-13	2
-19	-15	1
-18	-17	0
8255-10	74LS240-18	PC7
-11	-16	6
-12	-14	5
-13	-12	4
-17	-9	3
-16	-7	2
-15	-5	1
-14	-3	0
To V <sub>cc</sub> Bus:		
74LS00-14		
8255-26		
74LS240-20 (3)		
To GND Bus:		
74LS00-7		
8255-7		
74LS240-1 (3)		
74LS240-19 (3)		
74LS240-10 (3)		
0.1-μF capacitors between:		
V <sub>cc</sub> and GND Buses		
V <sub>cc</sub> and GND Pins on 5 IC Sockets		
Table 2: General-purpose I/O board wire list.		

Shack stores, but is probably one of the most popular "prototype" boards around.

The Vector board comes with a 36-position edge connector, as shown in figure 6. Cut the board as shown in



# Peripherals

# Unlimited...

## FANTASTIC PRICES!

OUR FAST SERVICE, PRODUCT SELECTION AND OUR CUSTOMERS' SATISFACTION MAKE US #1.

### ZENITH

Z-89-48K	\$2299
Z-90-64K DO	\$2588
Z-19 Terminal	\$777
Z-121 Monitor 12"	\$149

### ATARI COMPUTERS

Atari 800 16K	\$688
Atari 400	\$318
Atari Interface Module	\$174
Atari 810 Single Disk	\$444
Atari 815 Dual Disk	TBA
Atari 830 Modem	\$166
Programmer	\$59
Entertainer	\$84
Star Raiders	\$34
16K Mem. Exp. for Atari	\$74
32K Mem. Exp. for Atari	\$114

### NEC PRINTERS

7710/30 Spinwriter R/O	\$2279
7720 Spinwriter KSR	\$2649
3510/30 Spinwriter R/O	\$1699
3500 Serial Spinwriter	\$1599

### NEC DOT MATRIX

PC-8023	\$474
---------	-------

Call for prices on ribbons, etc.

### MORE PRINTERS

Anadex 9500/9501	\$1295
Anadex DP-9000	\$1049
Okidata Microline 80A	\$339
Okidata Microline 82A	\$474
Okidata Microline 83A	\$724
Tractor (OKI 80 + 82 only)	\$60
Diablo 630	\$2044

### MONITORS

Sanyo 12" GRN Phosphor	\$266
Sanyo 12" Black + White	\$239
Amdek 12" 300 GRN Phosphor	\$164
Amdek 12" Color	\$344
NEC 12" GRN Phosphor	\$164
NEC 12" Color	\$344

### EPSON PRINTERS

MX-70	\$288
MX-80 w/Graphics	\$444
MX-80 FT (Friction + Tractor)	\$544
MX-100 (15" Carriage)	\$744

Call for prices on Ribbons, Cables and Interfaces

### NEC-PC 8000 Series Microcomputer

PC-8001A Computer w/32K	\$888
PC-8012A w/32K + Exp. Slots	\$588
PC-8031A Dual Mini Disk	\$888
PC-8032A Add-on Mini Disk	\$777

Call for Software Prices

# TOLL FREE

# 1-800-343-4114

### ORDERING INFORMATION

Our order lines are open 9AM to 6PM EST Monday thru Friday. Phone orders are welcome; same day shipment on orders placed before 10AM. Free use of Mastercard and VISA. Personal checks require 2 weeks clearance. Manufacturer's warranty included on all equipment. Prices subject to revision. C.O.D.'s accepted.

For service, quality and delivery call:

**PERIPHERALS UNLIMITED**  
**(617) 655-7400**

62 N. Main St. • Natick, MA 01760

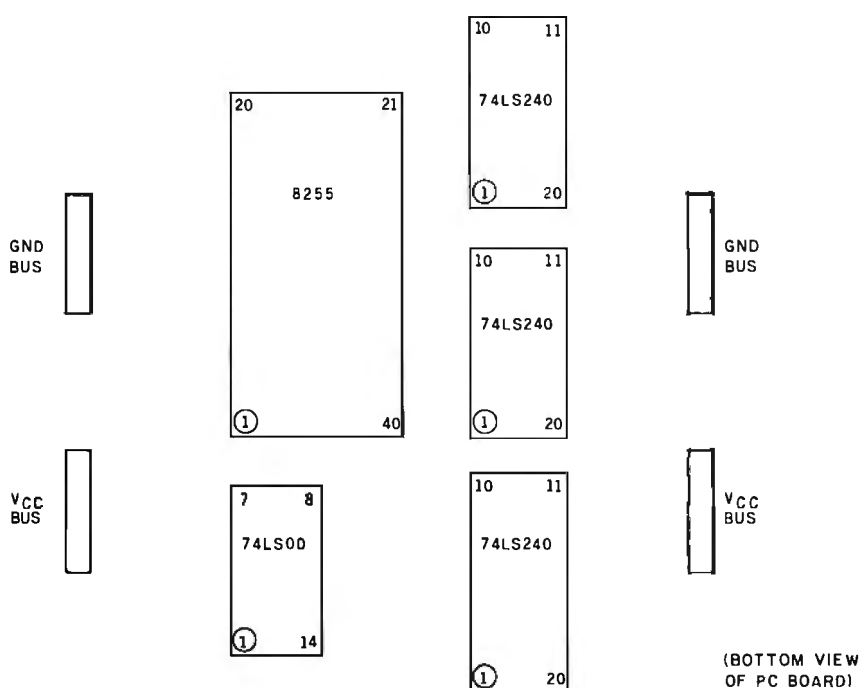
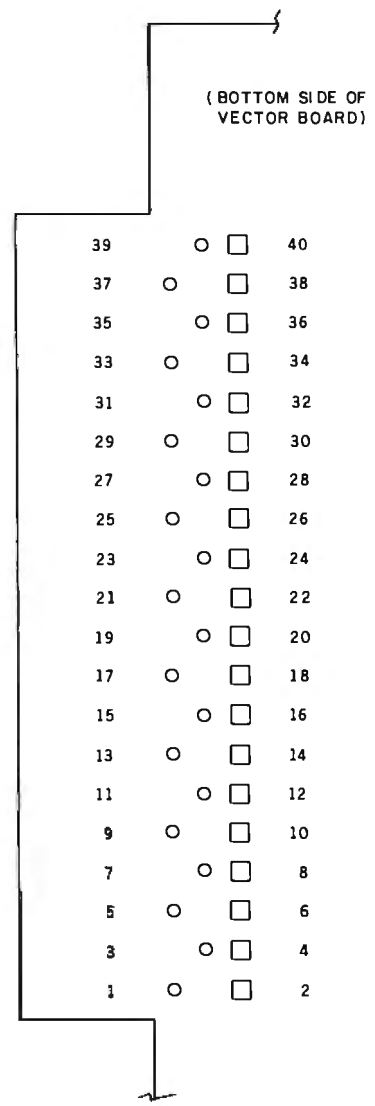
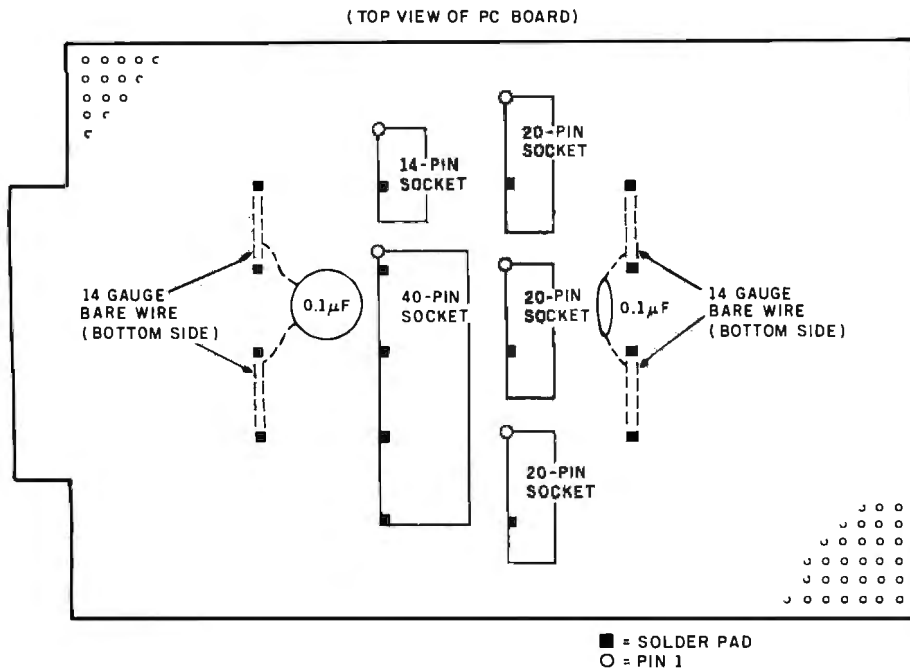

**Figure 8:** GPIO pin connections viewed from the bottom side.

buses, wire the board as shown in table 2. I used wire-wrap wire (30 AWG) for all logic connections and larger-gauge "hook-up" wire for power and bus connections. The wire-wrap wire can be soldered to the IC socket pins, or, if you wish, you can wire-wrap the pins. Edge-connector connections are soldered.

Add five additional 0.1- $\mu$ F disk capacitors between the  $V_{CC}$  and ground pins of each socket for noise immunity.

The pin-position numbering for the 40 pins of the edge connector is shown in figure 8. Pin numbering for the board and Color Computer connector is shown in figure 9.

**Figure 7:** GPIO board component mounting. Five IC sockets and two sets of buses constitute the major mechanical construction of the board.

the figure so that it will be able to fit into the ROM cartridge hole and connector.

Once the board is cut, mount five IC sockets (see figure 7). At least one pin of each socket should be soldered to a copper pad on the board. Wiring will provide additional mechanical support for the sockets.

Four buses are constructed out of 14-gauge bare wire, as shown in the figure. Enlarge the holes slightly to pass the wire and solder the ends to the solder pads on the top side of the board. Two 0.1-microfarad ( $\mu$ F) disk capacitors are mounted between each set of buses.

After mounting the IC sockets and



# IMAGINE IT..

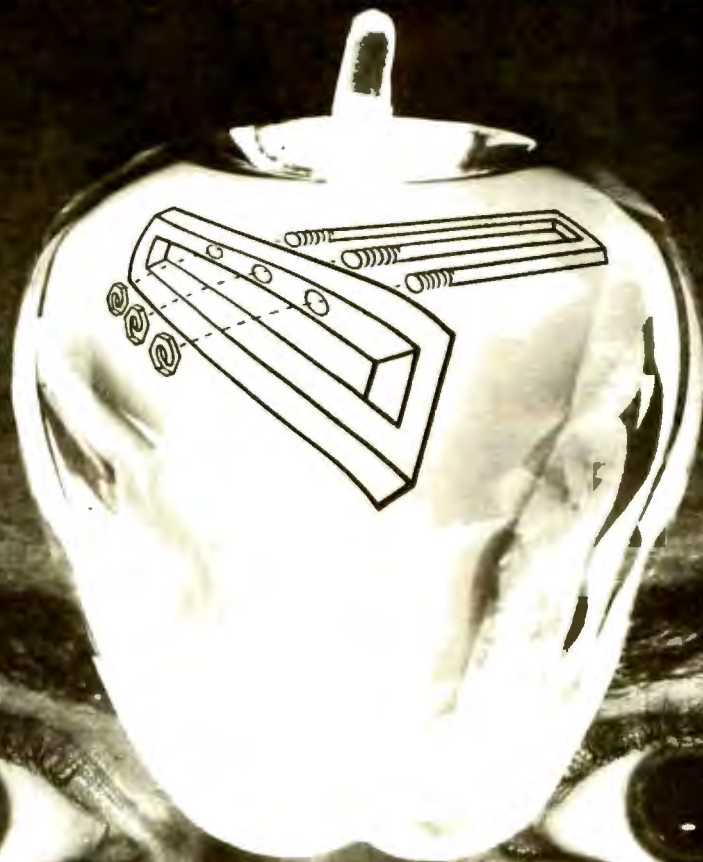

## CAPTURE IT

The Grappler™ is the most intelligent Apple interface available. Simple commands from the keyboard or user program, are all you need to dump screen graphics to your printer. The Grappler's exclusive EPROM chip makes high resolution graphics that easy. There are Grappler versions to accommodate the Adex, Epson Series,\* IDS Super Tigers, Centronics 739, C 8023, C. Itoh Pro-writer, Idata 82A,\* Malibu 200, and more graphic printers.

\*requires Graphics Upgrade.

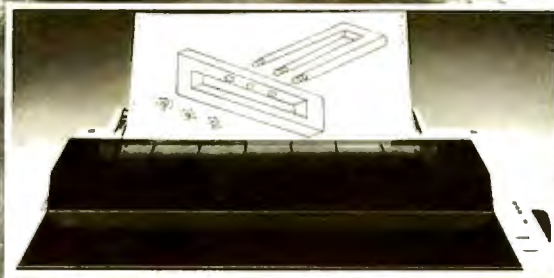

ACTUAL APPLE II PRINTER USING GRAPPLER™ AND EPSON 6300

With **The Grappler™**  
Printer Interface

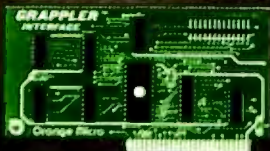

**Orange Micro**  
inc.

3150 E. La Palma, Suite G, Anaheim, CA 92806

**(714) 630-3620**

The Grappler's features include:

- Graphics Screen Dump
- Inverse Graphics
- Emphasized Graphics
- Double Size Picture
- 90° Rotation
- Center Graphics
- Chart Recorder Mode
- Block Graphics
- Bell Control
- Skip-over-Perf
- Left and Right Margins
- Variable Line Length
- Text Screen Dump.

The Grappler™ works with Pascal and CPM.

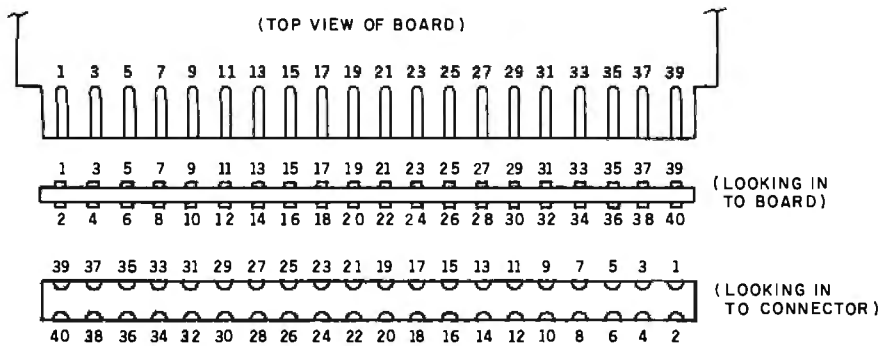

Figure 9: GPIO and Color Computer cartridge-connector pin designations.

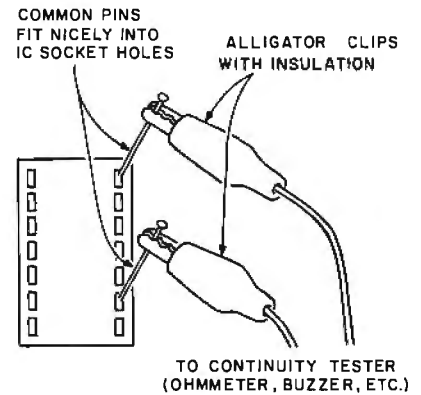

Figure 10: The GPIO may be conveniently "buzzed out" with a continuity tester or ohmmeter and two common pins that fit into IC socket holes.

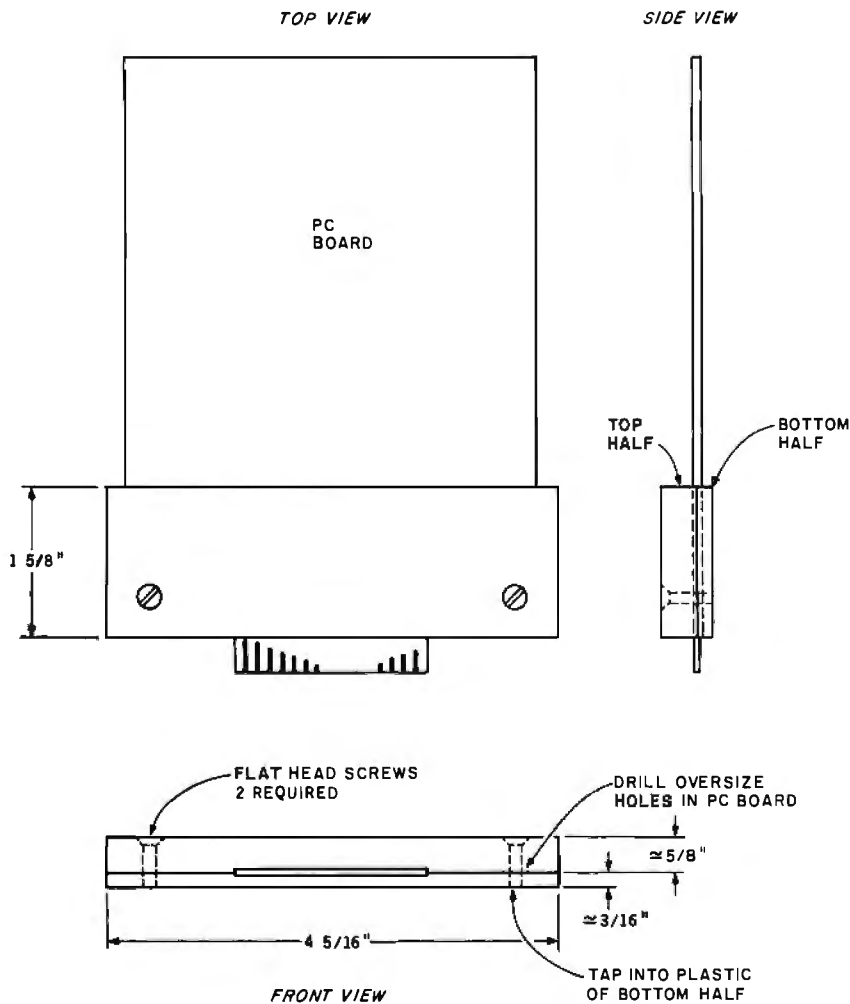

Figure 11: The GPIO protective cover is made from two cut-down plastic cassette-tape cases. The cover holds the GPIO board in place and acts as a guide in inserting the board.

After wiring, check all connections by "buzzing out" the sockets with a continuity tester. I use two common pins to get into the IC socket holes, as shown in figure 10.

Once the board connections have been checked out, you can add the protective cover. By a strange coin-

cidence, the Color Computer ROM cartridge hole is almost an exact match for a common cassette-tape case inserted widthwise. Two covers can be sacrificed to make a workable cover that will align the board properly in the ROM cartridge hole (see figure 11).

The plastic on the case is easy to work with, and I found that a sharp razor blade will cut through the plastic quite easily, albeit with a dozen passes. File off the cut edges for aesthetics. Add two screws to hold the cover in place.

### Testing the Board

Turn off the Color Computer and insert the board into the cartridge cut-out. The PC board should go in easily and the cover should clear the sides with no binding.

Enter the program shown in listing 1. The first part of this program prints the input lines and allows entry of output data. The second part toggles the output lines on and off at a slow rate. You can test the outputs by using a common light-emitting diode (LED) with a current-limiting resistor, as shown in figure 12. Inputs may be carefully grounded as shown in the figure; you should see the values change on the display as you vary the inputs.

The relay connections for both input and output are shown in figure 13.

### Using the Nonmaskable Interrupt

The NMI\* signal on pin 4 can be generated on the GPIO board quite easily by grounding pin 4. When this signal goes to ground (logic 0), it causes the following hardware actions to occur:



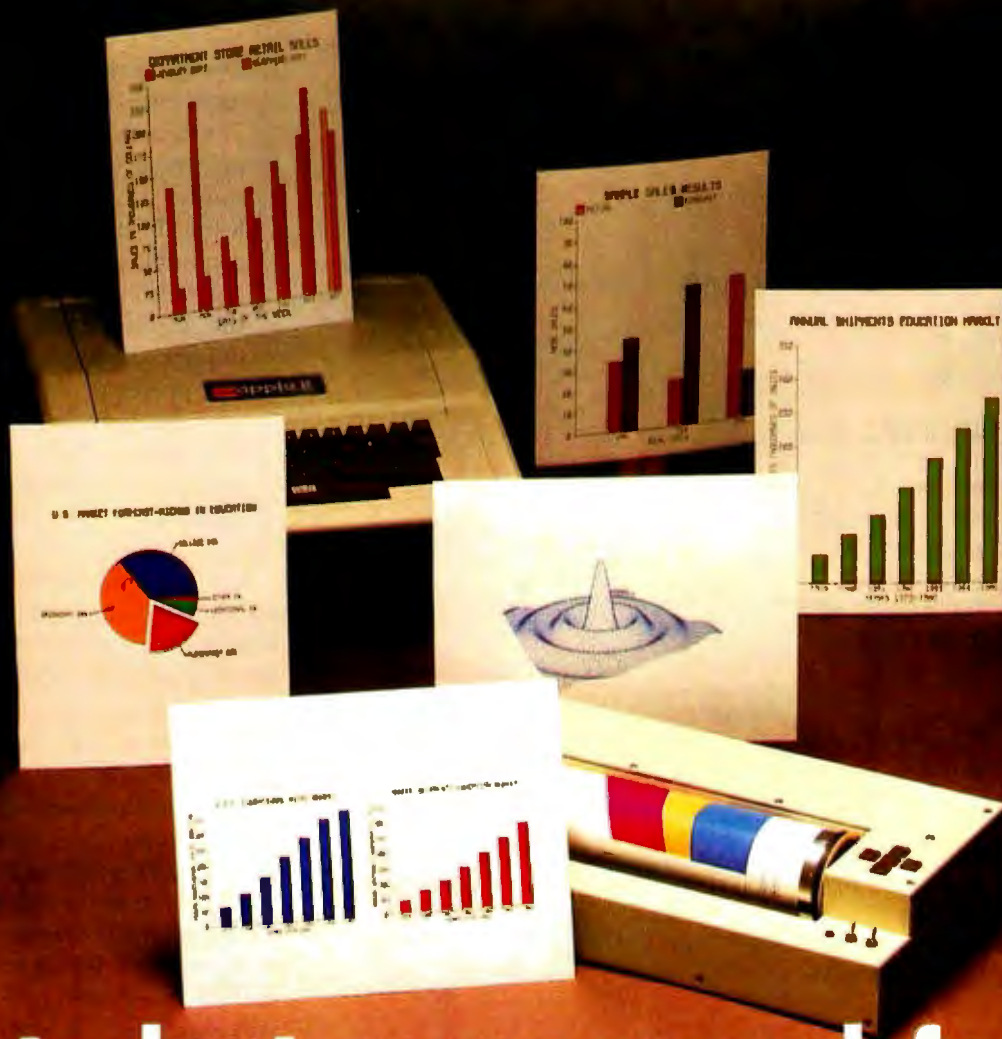

# How to chart your company's fortune without spending one

It's a fact. A single chart or graph can tell you instantly what it takes hours to interpret from printouts or other raw data.

Now, with the Strobe 100 Graphics Plotter and Software package, you can create superb hardcopy graphics directly from your computer. And you can do it for an investment of only \$995.

The Strobe System transforms complex data into dynamic, colorful visuals with a few simple commands from your computer. Charts and transparencies that once took hours to produce are plotted within minutes. Information can be presented as bar charts, pie charts, curves or isometrics in a variety of colors. And with a resolution of 500 points per inch, the Strobe 100 matches or surpasses the quality of plotters costing thousands of dollars more.



You can also save and modify your graphics through Strobe's menu-driven programs. A broad selection of software—including a VisiCalc<sup>®</sup>-compatible program—is now available.

When the Strobe Graphics System is interfaced to your computer, an 8-1/2 x 11 inch sheet of paper can speak anyone's language—visually. Visit your local dealer and learn how to start charting your fortunes today. Because a perspective on the present can also be your window on the future.



**Strobe Inc.**  
897-5A Independence Avenue  
Mountain View, CA 94043  
Telephone 415/969-5130

## The Strobe Graphics System

Seeing is believing

Circle 427 on inquiry card.

<sup>®</sup>VisiCalc is a trademark of VisiCorp.

Listing 1: This test driver for the GPIO board allows manual entry of output values or a slow-speed toggling of output lines.

```

100 ' TEST DRIVER FOR GENERAL-PURPOSE I/O
110 POKE 65347,137
120 POKE 65344,0
130 POKE 65345,0
140 PRINT PEEK(65346)
150 IF INKEY$="" THEN GOTO 140
160 INPUT A,B
170 POKE 65344,A
180 POKE 65345,B
190 GOTO 140
1000 POKE 65347,137
1010 POKE 65344,0
1020 POKE 65345,0
1030 FOR I=0 TO 1000:NEXT I
1040 POKE 65344,255
1050 POKE 65345,255
1060 FOR I=0 TO 1000:NEXT I
1070 GOTO 1010

```

Listing 2: This simple interrupt-handling program increments location 3FFF hexadecimal for each NMI interrupt received.

```

100 ' NMI INTERRUPT EXERCISER
110 POKE &H109,126:POKE &H10A,63:POKE &H10B,240
120 POKE &H3FF0,124:POKE &H3FF1,63:POKE &H3FF2,255
130 POKE &H3FF3,59
140 POKE &H3FFF,0
150 PRINT PEEK(&H3FFF)
160 GOTO 150

```

1. The processor completes the current instruction.
2. The processor saves the contents of the program counter in the stack.
3. If the "E" bit is currently set in the condition codes, all the processor registers are saved in the stack. If the "E" bit is not set, only the condition codes are saved in the stack.
4. The processor reads the NMI vector address from memory location FFFC-FFFD. It then transfers control to the address found at that location.

In the Color Computer, the NMI vector is actually at location BFFC-BFFD, which normally holds address 0109. Locations 0109, 010A, and 010B would normally contain a jump instruction to the machine-language NMI processing routine in RAM. The NMI processing routine would handle the NMI and then, as a last instruction, perform an "RTI," or return from interrupt, instruction. This would return processing to the interruption point, which could be in the BASIC interpreter or in a machine-language program in RAM.

I can't provide a complete course in reentrant interrupt processing, but I can give you a flavor of what is involved in using the NMI. The program in listing 2 shows a simple BASIC program that pokes a "JMP \$3FF0" instruction into locations 0109-01B and "INC \$3FFF" and "RTI" instructions into locations 3FF0-3FF3. This short NMI processing program will increment location 3FFF for every NMI.

To see the effects of the NMI, connect a short piece of wire from pin 4, with the opposite end loose. Key in the program after first protecting high RAM by a "CLEAR 200, &H3FEF". Run the BASIC program and ground the NMI pin by grounding the wire on the ground bus or ground pin.

You'll see the count in location 3FFF change rapidly. Each time it changes by one, an NMI interrupt has occurred, and the NMI interrupt processing routine at location 3FF0 has been entered. The count changes by more than one because the connec-

#### TESTING OUTPUTS

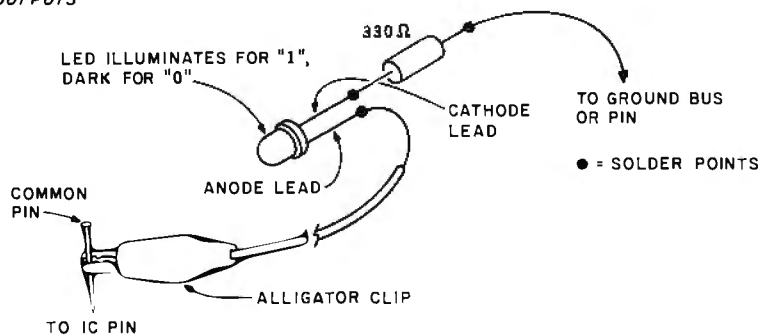

#### TESTING INPUTS

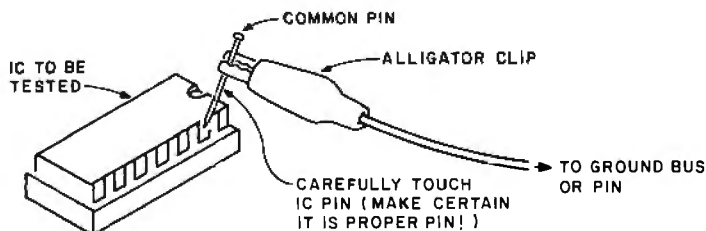

Figure 12: Outputs are tested by a common LED in series with a 330-ohm resistor. The LED should illuminate for a logic 1 output. Inputs are tested by grounding the input pins and observing the value read.



# LETTER-PERFECT PRINTER DOUBLES AS DATA CRUNCHER.



**Print two ways...correspondence quality and high speed data processing.  
Now priced under \$2000!**

The new T-1805 dual purpose serial printer uses a unique 40 x 18 matrix dot pattern for high quality correspondence printing; or, flip a switch, it uses a 7 x 9 matrix for high speed data processing printing. In the high speed mode, it generates reports at time-saving throughput rates reaching 200 lines per minute. In the reduced speed correspondence mode, its pivoting print head lays down overlapping dots to create a letter-perfect character that looks like it came from an office typewriter.

The T-1805 is the latest evolution in the popular and proven T-1000 series of serial printers. As such, the

T-1805 offers the same quality construction, high reliability, ease of operation and operator conveniences. Plus, for the benefit of the office crew, the T-1805 is exceptionally quiet. Its 53 dbA noise level ranks it as the quietest impact printer on the market.

There's much more to tell, so visit or call your Mannesmann Tally sales outlet today.

Mannesmann Tally, 8301 South 180th Street, Kent, WA 98031. Phone (206) 251-5524.

*Printers for the long run.*

**MANNESMANN**  
**TALLY** NCC HOUSTON  
JUNE 7-10  
BOOTH 6100



OUTPUT

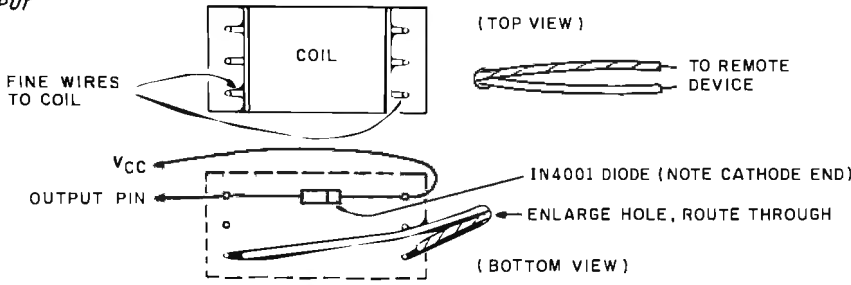

INPUT

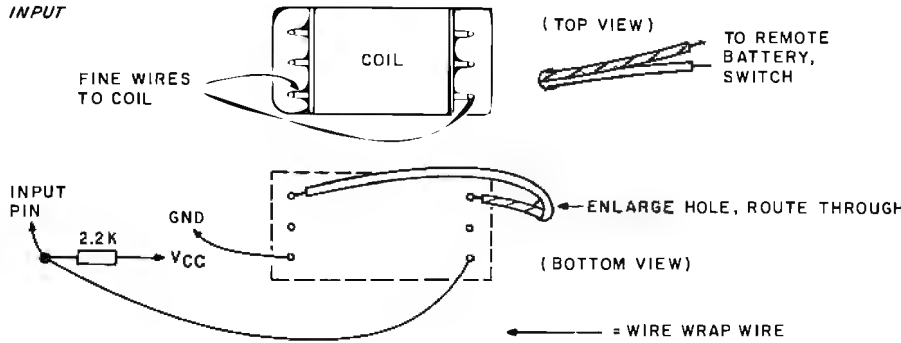

Figure 13: Radio Shack 275-228 reed relay can be used either for output driving or for current-driven inputs. Although the relays are inelegant, they do prevent problems with noise over long cable runs.

tion to ground has not been “de-bounced”—many momentary contacts have occurred in connecting the wire to ground, and each one has generated an NMI.

The NMI\* input can indeed be used for real-time processing by providing a single pulse from a logic 1 to a logic 0, and by a relevant NMI processing routine in assembly-language code. As the textbooks state, “This will be left up to the student as an exercise!” ■

References

1. Ahrens, Tim, Jack Browne, and Hunter Scales. “What’s Inside Radio Shack’s Color Computer?” BYTE, March 1981, p. 90.
2. Motorola Microprocessors Data Manual (available from Motorola Semiconductor Products Inc., POB 20924, Phoenix, AZ 85036).

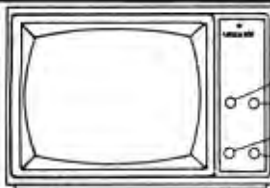

1. CONTRAST  
2. POWER-BRIGHT  
3. V-HOLD  
4. H-HOLD

**VIDEO 100**  
12" Black & White  
MONITOR  
**\$89.50**  
by AMDEK

Fourth Dimension Systems  
**FLOPPY DISK DRIVE FOR APPLE<sup>®</sup> COMP.**

The unit features a track zero micro-switch and read/write electronics DOS 3.2.1., DOS 3.3, PASCAL or CP/M.

**\$349.95**

**BROAD BAND MICROWAVE RECEIVER SYSTEM**  
1.8GHZ to 2.4 GHZ  
only **\$295.00**

RANGE: Line of sight to 250 miles.  
SCOPE: Will receive within the frequency band from satellites, primary microwave stations, and repeater microwave booster stations.  
CONTENTS: Packaged in 19"x19"x4 1/2" corrugated carton complete with:

- 24" Dish
- Feed-Horn Receiver
- Mounting Bracket
- Mounting Clamp
- Instructions
- 300 Ohm to 75 Ohm Adapter
- 750 Ohm to 300 Ohm Adapter
- 60 Feet Coax Cable with Connectors
- 3 Feet Coax Cable with Connectors

**DISKETTES**  
5 1/4" BULK "OEM" PACK  
FOR YOUR APPLE  
**\$149**  
Box of 100

**SUPER BUY!**  
16K RAM EXPANSION CARD  
For Your APPLE<sup>®</sup>  
LANGUAGE TRANSPARENT  
ALL NINE RAMS INSTALLED!  
**\$79.95**



**VISION-80<sup>®</sup> 80x24 Video Display Card** **\$269**

Vista Computer Company's new Vision-80 board is a sophisticated yet easy to use video display card for the Apple™ computer.

TERMS OF SALE: Cash, checks, credit cards, C.O.D. Calif. residents add 6% sales tax.

"HAVE YOU KISSED YOUR COMPUTER LATELY?"

Components Express, Inc.

1380 E. Edinger • Santa Ana, Calif. 92705 • 714/558-3972 TWX 910-595-1565



If you want to move up to **16 bits**  
but don't want to leave your data behind

If you want to move up to **multi-user**  
but don't want to lose size and speed

You want **MP/M™ 8-16.**

**G&G ENGINEERING** and CompuPro™ do it best!

**MP/M 8-16** gives you:

- Both 8 and 16 bit CP/M® program execution on the same sophisticated multi-user, multi-tasking system.
- Complete compatibility with CP/M 2.2,™ CP/M 86,™ MP/M 2,™ and MP/M 86™ software. You get it all!
- Large CP/M 2.2 program user area—61K! This is 6K more user space than you get on single user CP/M 2.2!
- Effortless transition from 8 to 16 bits. Conversion to 16 bit versions of current 8 bit software (e.g. CBASIC™ to CBASIC 86™) is totally transparent—your 8 bit data and source files are ready to run in the 16 bit world.

**MP/M 8-16** is a proprietary implementation of Digital Research's MP/M 86 operating system, configured for CompuPro by G&G Engineering. An extraordinary feature of **MP/M 8-16** is that it runs both 8 and 16 bit programs AT THE SAME TIME! This is not an emulation. **MP/M 8-16** uses CompuPro's 8085 CPU board to run CP/M 2.2 compatible programs on a high speed 8085 CPU and CP/M 86 compatible programs on a high speed 8088.

But G&G doesn't stop there. We've added enhancements that make **MP/M 8-16** exceptionally user friendly, including: user accounting with password protection, selective account access on individual terminals, single-user start-up for system maintenance, printing of a message-of-the-day file for user information, inter-terminal communication, user mail system and more.

**MP/M 8-16** systems start at \$8995, terminals not included.

G&G Engineering is an authorized CompuPro Systems Center.

The logo for G&G Engineering features a stylized 'G' and 'E' in a square frame on the left, followed by the text 'G&G ENGINEERING' in a bold, sans-serif font.

1922 Republic Avenue, San Leandro, CA 94577 (415) 895-0798

# Birth of a legend.



## Epson.

A whole new generation of Epson MX printers has just arrived. And while they share the family traits that made Epson famous — like unequalled reliability and ultra-fine printing — they've got a lot more of what it takes to be a legend.

For instance, they've got a few extra type styles. Sixty-six, to be exact, including italics, a handy subscript and superscript for scientific notation, and enough international symbols to print most Western languages.

What's more, on the new-generation MX-80, MX-80 F/T and MX-100, you get GRAFTRAX-Plus dot addressable graphics. Standard. So now you can have precision to rival plotters in a reliable Epson printer. Not to mention true backspace, software printer reset, and programmable form length, horizontal tab and right margin.

All in all, they've got the features that make them destined for stardom. But the best part is that beneath this software bonanza beats the



# Uh...three legends.

heart of an Epson. So you still get a bidirectional, logical seeking, disposable print head, crisp, clean, correspondence quality printing, and the kind of reliability that has made Epson the best-selling printers in the world.

All of which should come as no surprise, especially when you look at the family tree. After all, Epson *invented* digital printers almost seventeen years ago for the 1964 Tokyo Olympics. We were

the first to make printers as reliable as the family stereo. And we introduced the computer world to correspondence quality printing and disposable print heads. And now we've given birth to the finest printers for small computers on the market.

What's next? Wait and see. We're already expecting.

**EPSON**  
EPSON AMERICA, INC.

3415 Kashiwa Street • Torrance, CA 90505 • (213) 539-9140

FEATURE	ORIGINAL MX-80	GRAFTRAX-80*	ORIGINAL MX-100	MX-80 with GRAFTRAX-Plus	MX-80 F/T	MX-100
Bidirectional printing	X	X	X	X	X	X
Logical seeking function	X	X	X	X	X	X
Disposable print head	X	X	X	X	X	X
Speed: 80 CPS	X	X	X	X	X	X
Matrix: 9 x 9	X	X	X	X	X	X
Selectable paper feed			X		X	X
<b>PAPER HANDLING FUNCTIONS</b>						
Line spacing to r/216		X		X	X	X
Programmable form length	X	X	X	X	X	X
Programmable horizontal tabs	X	X	X	X	X	X
Skip over perforation			X	X	X	X
<b>PRINT MODES AND CHARACTER FONTS</b>						
96 ASCII characters	X	X	X	X	X	X
Italics character font		X		X	X	X
Special international symbols				X	X	X
Normal, Emphasized, Double-Strike and Double/Emphasized print modes	X	X	X	X	X	X
Subscript/Superscript print mode				X	X	X
Underline mode				X	X	X
10 CPI	X	X	X	X	X	X
5 CPI	X	X	X	X	X	X
17.16 CPI	X	X	X	X	X	X
8.58 CPI	X	X	X	X	X	X
<b>DOT GRAPHICS MODE</b>						
Line drawing graphics				X	X	X
Bit image 60 D.P.I.		X	X	X	X	X
Bit image 120 D.P.I.		X	X	X	X	X
<b>CONTROL FUNCTIONS</b>						
Software printer reset		X		X	X	X
Adjustable right margin			X	X	X	X
True back space		X		X	X	X
<b>INTERFACES</b>						
Standard — Centronics-style 8-bit parallel	X	X	X	X	X	X
Optional — RS-232C current loop w/2K buffer	X	X	X	X	X	X
RS-232C x-on/x-off w/2K buffer	X	X	X	X	X	X
IEEE-488	X	X	X	X	X	X

\*Tandy TRS-80 block graphics only available with GRAFTRAX 80.

ABCDEFGHIJKLMNOP abcdefghi jklmn ABCDEFGHIJKLMNOP abcdefghi jklmn @1234  
 ABCDEFGHIJKLMNOP abcdefghi jklmn ABCDEFGHIJKLMNOP abcdefghi jklmn @1234  
 ABCDEFGHIJKLMNOP abcdefghi jklmn ABCDEFGHIJKLMNOP abcdefghi jklmn @1234  
 ABCDEF abcdef ABCDEF abcdef @123456  
 ABCDEFGHIJKLMNOPQRSTUVWXYZ abcdefghi jklmnopqrstuvwxyz ABCDEFGHIJKLMNOPQRSTUVWXYZ abcdefghi jklmnopqrstuvwxyz @1234567  
 ABCDEF abcdef ABCDEF abcdef @123456  
 ABCDEFGHIJKLMNOP abcdefghi jklmn ABCDEFGHIJKLMNOP abcdefghi jklmn @1234  
 ABCDEFGHIJKLMNOPQRSTUVWXYZ abcdefghi jklmnopqrstuvwxyz ABCDEFGHIJKLMNOPQRSTUVWXYZ abcdefghi jklmnopqrstuvwxyz @1234567

# Terminal Madness, The Word, Grammatik, and Then Some

*The critic reviews some new computer terminals, word-processing software, BASIC compilers, and M-drive.*

---

Jerry Pournelle  
c/o BYTE Publications  
POB 372  
Hancock, NH 03449

---

As if we didn't have enough problems here at Chaos Manor, we had to buy a new terminal the other day.

We've had the Godbout 8085/88 running for a couple of months now. (Incidentally, I need a name for that machine; preferably one not too blasphemous.) We set it up with a Zenith Z-19 terminal, which works all right (except that all three that my consultant friend Tony Pietsch bought had a loosely soldered wire in the horizontal amplifier); but I don't like it. The dislike is purely personal: the keyboard is too close to the screen for me. I wear bifocal glasses, and I'm torn between moving my head forward and looking down, or moving back and not being able to see the letters at all.

So, what I wanted was a terminal

with detached keyboard. Preferably one with a video output on the back so that I could switch the output onto my big 15-inch Hitachi monitor that

---

**I may one day buy  
an IBM—but not until  
I get over the shock  
of that ruined  
keyboard.**

---

sits 29 inches from my head. I also required a really nifty keyboard, one that has a good feel and a Selectric key layout.

"DEC VT-100," said my engineering-genius friend Tony.

"Costs a little more but has everything you want. And DEC equipment is *reliable*. It's also *maintainable*. If I've got to work on it, I prefer DEC."

Only there's no store that sells VT-100s in Los Angeles County, which is weird, but there it is.

"Televideo 950," said Bill Godbout when I asked him. "We're converting to Televideo 950s everywhere, and our people really like them."

That, at least, I could look at, so off I went to Dick Dickenson's establishment, which seems to be named Compu-Plus this week. (It began as Computer Components, where my mad friend and I bought our old memo-wreck keyboards and some other surplus equipment; changed to Computer World; changed again to,





## **“We provide business programs as individual as your business needs.”**

“Allow me to introduce myself. I’m a Vector computer, dedicated to the advancement of society. And I’d like to tell you how a computer can help you manage your business more efficiently. Especially if that computer is a Vector, like me. Because we’re probably the most flexible and cost-effective computers you can find.

“Our programs are the key. Because they enable me to handle sales forecasting, budgeting, job costing and proposals, commissions, personalized mass mailings, charts and graphs. We Vectors can even talk to each other and to other bigger computers.

“Unique combinations of our individual programs can actually customize me to meet your specific requirements. Any combination of our software packages can be assembled right off the shelf, to help you realize your full potential as a salesman, merchant, stockbroker, clergyman, contractor, real estate or insurance agent or whatever your business.

“Choose from Memorite III for word processing and mail list management, Execuplan for financial planning and forecasting, Business Accounting, Data Management for filing and sorting information, Communications and a host of others. And, of course, all we Vectors come with the popular CP/M operating system.

“For more information and your local dealer, call us at (805)499-5831 or (800)235-3547. In California, call (800)322-3577. Or write to us at 500 North Ventu Park Road, Thousand Oaks, CA 91320.

“We’ll show you how we small information systems can mean big business for you!”

Circle 457 on Inquiry card.

**VECTOR**  
Vector Graphic, Inc.

### **COMPUTERS FOR THE ADVANCEMENT OF SOCIETY.**

Sold and supported by 400 dealers worldwide.  
Vector Products are approved on General Services Administration authorized ADP scheduled price list.

## Dan Mac Lean, RIP

I often start these columns with a quote from my mad friend. Alas, I'll never be able to do that again. Dan Mac Lean died of cancer in December. He'd known for a good year that he had about a year to live.

My mad friend never published much, but he had a great and beneficial effect on the microcomputer world. For one thing, any influence I may have is due to him; he talked me into getting my first machine, held my hand while I learned to use it, and encouraged me to do these columns.

More than that, he was insatiably curious. He examined everything in the microcomputer field: programs, hardware, and you name it. He'd used it or knew someone who had; and he had strong opinions.

I suppose he was sometimes wrong, although I can't think of an instance just now; but because he had strong opinions, with good reasons for holding them, he shook up a lot of prejudices. Winning an argument with Mac Lean was possible, but it was never easy; and whether you won or lost, after you discussed a matter with him, you understood it much better than you did when you began.

Mac Lean was an expert software thief: I don't suppose there was a single program in all the world that he hadn't

got, somehow. When George Tate first met him, he offered Mac Lean copies of any programs Ashton-Tate had on the grounds that, if he gave them to him, Mac Lean would feel some ethical obligation; and Mac Lean would certainly get them one way or another, anyway.

Understand, my mad friend didn't do anything unethical with his booty. He never sold anything and was reluctant to give programs away, except to people he knew wouldn't have bought them. But he did analyze programs and try to use them, and his views often got into this column. (At the direction of his widow, all of Mac Lean's disks except those containing his own writings have been reformatted; we'll never know precisely what he had on those disks, which is probably just as well.)

He also wrote letters. Lord Almighty, did he write letters. Some of them were hilarious. Some were very serious, and many of his suggestions were taken by major firms. He had a lot more influence than you see on the surface.

Mac Lean worked off and on for the U.S. government, as a consultant to private firms, and as a collector of general information. He helped hundreds of people, and we're all going to miss him. I certainly do.

and I kid you not, "The Place You Go To Buy Computers Incorporated"; and now has become Compu-Plus. My son Alex says that next week they'll be Xylophone Computers, but I don't believe that.)

Dickenson had a Televideo 950 set up there, and I played about with it and liked the feel of the keyboard. The screen was rock steady and easy to read. The character set looked good. He had them in stock, and my son Alex needed a terminal for his machine down in San Diego, so if I bought the 950 on the spot, Alex could take my Z-19 away with him.

But there was one other alternative to explore: buy an IBM Personal Computer and teach it to be a terminal. That would be an expensive solution, but just at the moment that's not a problem; so off we went

to Computerland, where IBM machines are set up and working.

After all, I've worn out three IBM Selectric typewriters. I know that keyboard and its feel and layout, and I love it. From Gregg Williams's review of the Personal Computer (see "A Closer Look at the IBM Personal Computer," January BYTE 1982, page 36), I could see I would like the graphics and letter set, and IBM sells complete technical manuals for the computer.

Meanwhile, Bill Godbout called to say he was sending me a new Godbout disk controller that would handle Qume DT-5 double-sided double-density 5¼-inch disks in IBM-compatible format. So there was everything going for getting an IBM.

Only IBM has ruined the keyboard! What ought to be its

strongest point, the thing IBM always excelled at, is its worst mistake.

What IBM did was to put extra keys between the space bar and the Shift key. Why, I don't know. The result is that when you think you've typed, say, a capital T, you get instead /t, which isn't useful at all.

There is also no line-feed key; instead IBM seems to have manipulated the Carriage Return key to give both carriage return and line feed when struck. Unfortunately, many programs won't be able to stand that. I suppose there's a way to filter that madness; but there's no help for the Shift key being mislocated, nor for the egregious amount of space between the home keys and the Return key.

I may one day buy an IBM—but not until I get over the shock of that ruined keyboard. I've never been so disappointed in my life.

So back to Dick Dickenson's place for a Televideo, which we took home with us. Installation was no problem. The documents are absolutely clear, the data-rate switches and other such stuff are on the back and clearly marked, and the stop-bit settings are simple enough to understand. Bill Godbout's 8085 BIOS (basic input/output system) is also clear, so I was able to set up the 950 in no time.

At first, the only thing I didn't like about the 950 was minor: the keyboard cable attaches in *back* of the terminal, so that the cord has to come around the side of the machine. It should attach in front.

So we set it up and turned it on, and it worked the first time, controlling the Godbout perfectly. I played about with it a bit, then I loaded Wordmaster.

Bloody.

"Why?" I wondered. So I experimented some more. And sure enough, any time I sent an escape character, the terminal went into a different mode, until eventually it got into a block mode where it didn't send anything to the computer at all.

I looked through the manual. Nothing on that problem. Try logic. The Televideo 950 uses the Escape key to send an escape character out, while Shift-Escape is used to tell the



# II for Apple II

## PLUS VERSAbox FOR EVERYBODY

### VERSAbox

The only intelligent SPOOLER/BUFFER with an optional REAL TIME CLOCK interface/display. For use with all Centronics parallel and RS 232C INPUT/OUTPUT interfaces.

VERSAbox's high speed input combined with up to 60K buffer (more with character compression) frees up your computer from the slow job of printing. Modems and other compatible devices can also be buffered. Multiple software-selectable outputs permit you to choose between two or more VERSAbox outputs or use them simultaneously. You can buffer multiple inputs simultaneously too.

Add the optional REAL TIME CLOCK to VERSAbox and you get a six digit LED numeric time display. Your computer can read the time via the RS 232C port. Another useful option is the SWITCHED 120V SOCKET that can turn external devices on and off by clock control.

VERSAbox is supplied in an attractive, compact 11" wide, 8" deep, 3" high cabinet. Interface cables are available from your dealer or Prometheus. **SPECIAL OFFER** for Apple II owners. Buy a VERSAbox this month and you will receive a free parallel interface and cable.

VERSAbox, standard model with Centronics parallel INPUT/OUTPUT only and 16K buffer **\$249.00**

VERSAbox, with both Centronics parallel and RS 232C INPUT/OUTPUT and 16K buffer **\$299.00**

REAL TIME CLOCK option with DISPLAY add **\$150.00**

SWITCHED 120V OUTLET option add **\$50.00**

Additional 16K BUFFER MEMORY KITS each add **\$50.00**

### I. VERSAcad

Four cards on one for Apple II: (1) Serial Input/Output Interface, (2) Parallel Output Interface, (3) Precision Clock Calendar, and (4) BSR Control. All on one card with TRUE SIMULTANEOUS OPERATION.

Before you buy Mountain Computer CPS or any other multifunction card, ask these questions:

Can I use CPM and Apple Pascal with NO disk modification?

Does it have interrupts?

Will I be able to read and set the year?

Does it have BSR control?

Can I use DB Master? Asca Express? VISIDex? Easy Writer? WORDSTAR? Z TERM PRO? VISITERM? other software packages?

If the answer is YES to all of the above, then you're talking about VERSAcad and ONLY VERSAcad. And, the list price has been reduced by \$50 to **\$199.00**.

**SPECIAL OFFER** Buy a VERSAcad and we'll sell you GRAFTRIX, a sophisticated screen dump graphics package, with \$25 off the regular list price of \$65 for only **\$40.00**.

### II. AUTO-DOC

An automatic diagnostics system for your Apple II computer. Get a complete check of your critical Apple hardware EVERY time you power up.

AUTO-DOC saves TIME, ENERGY, and MONEY by identifying problems in your Apple before they make themselves known by system failures. And, you don't have to remember to insert a disk. DOC automatically identifies system problems before you run your programs by doing extensive system diagnostics. If DOC finds a failure, it indicates the problem area and, in some cases, the specific chip or component that's responsible.

DOC includes a memory test, processor test, ROM test, and more. In addition, extensive disk based diagnostics are included for further testing and subsystem checks for many popular peripheral cards.

AUTO-DOC is simple and easy to install. And once installed, DOC will always be there working AUTOMATICALLY everytime you power up.

Can you afford to be without AUTO-DOC?

AUTO-DOC List Price **\$99.00**

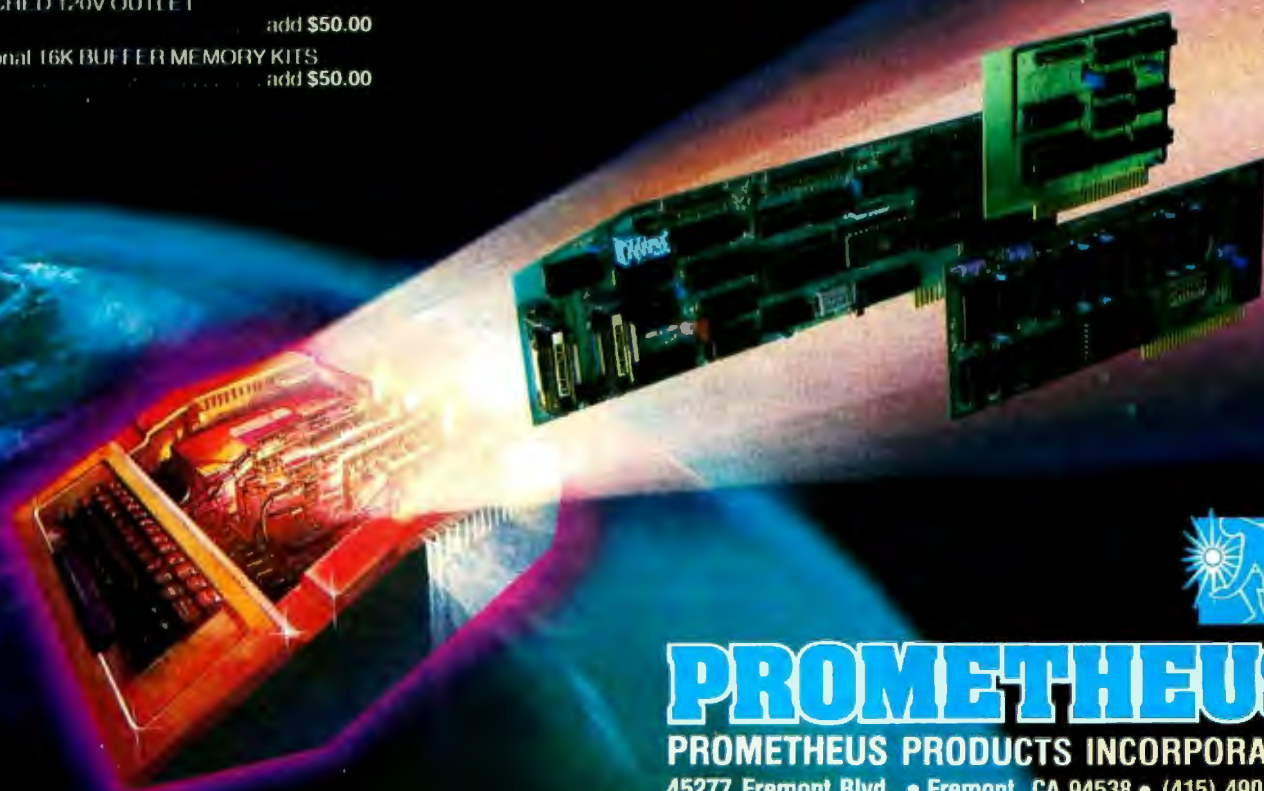

# PROMETHEUS

PROMETHEUS PRODUCTS INCORPORATED

45277 Fremont Blvd. • Fremont, CA 94538 • (415) 490-2370

Circle 503 on inquiry card.



# New CP/M software

**WordIndex II™ \$195**  
Automatic generation of subject index and tables of contents, figures, etc.

WordIndex commands placed in any document produced by WordStar™ automatically number chapters and § levels of sections; create tables of contents, figures, and tables, and a sorted subject index with page references.

**WordIndex II is loaded with new features:**

**Multiple files.** WordIndex II supports the WordStar™ .fi dot command.

**Free choice of page number format.**

**Multiple choice of layout of all tables.**

**No limit on size of subject index.**

**Automatic generation of headings and footings.**

**Alternating page offset for even and odd pages** simplifies printing procedures.

**SPECIAL OFFER** for owners of all previous versions of WordIndex: return your original WordIndex diskette directly to us and receive WordIndex II at a nominal cost of \$50.

**MicroPlot™ \$395**  
100% Tektronix Plot-10 TCS compatible graphic package.

Previously available on minis and mainframes only.

Supplied with the original Tektronix™ documentation, MicroPlot fully implements the entire Tektronix Terminal Control System on your 8080/280 based microcomputer at a fraction of the original cost.

This package enables you to run even mainframe-developed software for the Plot-10 TCS on your microcomputer using Tektronix compatible peripherals.

MicroPlot is supplied as Microsoft™ .REL files to be used with Fortran-80™.

**MenuMaster™ \$95**  
Stop messing around with CP/M commands. MenuMaster makes all your software menu-driven.

Simply create your own menus directly on-screen using any text editor. The menu dispenses of long and hard-to-remember CP/M™ commands. The user may simply select programs from the menu using simple commands of his own choice.

Order your copy today directly from us by phone, telex, or mail. Please send cashier's check or state Visa or Master Charge account no.

Detailed descriptions may be requested at no cost. Just circle reader service. Dealers may apply for free demo-versions of all programs.

**BORLAND Ltd.**

69, Upper Georges Street  
Dun Laoghaire

Dublin, Republic of Ireland

Phone 1802514. Telex 92188 GSOP  
ATTN. BORLAND

machine "This is a setup. Don't send out the next character, but execute it as an internal setup instruction." Unfortunately, this particular machine was broken; Shift-Escape worked fine, but Escape did both: that is, it sent out the escape character all right but also executed the next character as an instruction (and sent it out as well). The results were maddening.

So. Back to Compu-Plus. "Take it back," I told Dick. "I want a DEC VT-100."

"Sure you can have your money back," he said. "But I have a Televideo at home, and we've had that one out there as a demo for a year, and nobody ever had any problems with either of them."

It was Saturday, and Alex wanted to go back to San Diego, and he needed a terminal, and they had three more 950s in stock.

"Okay," I said. "I'll take a different one in exchange. Only this time we try it out here."

"Right," said Dick. "We'll plug it in right here where the demo is."

So we did. The first one didn't work: it couldn't set the proper data rate. The next one didn't work. It couldn't set something, I forget what. The third one didn't work. It didn't even turn on. And that was surely enough.

So I've got my money back, and I'm using the Z-19 just now, and I've ordered a DEC VT-100. You can conclude anything you want from my ordeal. One lesson for sure is that, although Dick Dickenson's price for a Televideo 950 is about \$150 above the discount houses, he was right there and ready to take care of it for me when I had a problem. It's worth dealing with established firms with a reputation for good service; or so say I.

## Words

I have here the biggest software bargain I know. It's called The Word, and it comes from Oasis Systems.

The Word is a spelling program; but it's also a lot more. It counts words for you. It makes files of words. It will make a list of each unique word in a text file and sort it alphabetically. It will also do a list of each word used and

the number of times you used it, sorted by frequency of use.

I've used The Word to find strange character names: that is, I'm working on *Janissaries Two* right now. That story takes place on a planet settled by successive waves of Celts, Minoans, Romans, and Franks, so that the character names tend to be a little strange. They have to be kept consistent with the culture in which they appear.

This is all right for major characters, but what if I'm writing along and need a minor character name? I grab one of my reference works (such as Robert Graves's *Greek Myths* or R. W. Munro's *Highland Clans and Tartans*) and find a suitable name in the index; and if I'm sensible, I make a note of that somewhere. But usually I don't make the note or can't find it, and I can't remember where this particular spear carrier appeared when I need to use him (her, it) again.

But with The Word, I can simply run the text through the spelling program, and the program makes a file of all the words it doesn't recognize. I can now examine that file, and, lo!, there will be my strange character name.

Then with the Find program I got from Barry Workman (Utility Disk One) I can go right into the text files and find that word in context. Saves no end of time.

The Word does much more; and it sells for under \$100, which is why I say it's the biggest bargain in word-handling software I know.

Incidentally, I'm still using Spellguard too. The Word, while excellent, isn't quite as convenient for the straight job of checking spelling, particularly at three in the morning when I don't want to think about options and toggles and command lines. I want a fully menu-driven program that just does what I ask it to without quibbles; and that's Spellguard. But for really sophisticated word work fully under user control, you just won't beat The Word. [Editor's Note: Oasis Systems has just announced *The Word Plus*. Priced at \$150, several features have been added including display of suspect words in context, the ability to use LOOKUP from within REVIEW, and the ability



# MORROW DESIGNS

5 1/4" DMA Hard Disk System M5 \$2,195  
M10 \$3,195

## Morrow DMA Controllers Supercharge Disk Systems.

**What EDN said:** "The (Disk Jockey™ DMA floppy-disk controller) offers two to three times the performance of comparable controllers" And that's for either 5 1/4" or 8" floppy-disk drives operating from an S-100 (IEEE-696) bus.

**How we do it?** With channel drive that's almost identical to IBM 370® channel controllers. The DJ/DMA uses 24-bit addressing. The host writes commands into memory. The DJ/DMA picks up commands from the host processor via memory on the system bus, and transfers data during DMA cycles. Channel commands may be located anywhere in the 24-bit address range. Upon completion of the command, the controller returns status. It may also generate an interrupt. Chained commands allow the controller to return status, or to execute a number of commands in succession. The controller board also contains logic which allows other IEEE-696 temporary bus masters to contend for memory cycles. That's the Morrow "channel concept." Fast and Simple.

**On-board Z-80A.\*** By managing both memory and disk transfers, the resident Z-80A allows reading or writing to almost any floppy-disk media. 8" or 5 1/4". Single or double density. Single or double-sided. And up to eight drives per controller board (no more than four of each type).

**System compatible.** Disk Jockey DMA sub-systems are compatible with all IEEE-696, S-100 systems (such as the Morrow Decision I™). And, with most S-100 like systems.

**Faster Winchester.** Hard disks put micros in the mini category. Now, Morrow's channel driven

DMA controller concept makes Winchester's lightning fast. Which Winchester? Industry standards—Seagate's 5 1/4" ST506/512, or 8" drives from Shugart/Quantum.

**DMA Transfer (Burst Mode).** The Morrow Direct Memory Access Hard Disk Controller (HDC/DMA) picks up commands from the host processor via memory on the system bus. Commands are accessed and data is transferred during DMA cycles. Commands and data transfers may occur anywhere in the 24-bit address range.

**Interrupts.** The controller can generate an interrupt at the end of each command and/or at the end of each command chain.

**Imbedded μP.** An on-board 8X300 supervises data transfers between the Winchester drive(s) and main memory. Microcode in this 7 MHz bipolar microprocessor implements the command structure of the controller.

**Expansion.** The HDC/DMA addresses one to four drives, one to 16 drive heads and an unlimited number of tracks. These capabilities allow system upgrades to additional platters and tracks as Winchester technology advances.

**S-100 sub-systems.** The HDC/DMA is compatible with all IEEE-696 systems and most existing S-100 systems—providing the bus clock is 2.5 MHz or faster.

**Fast answers.** Give us a call, or write us for more details on our new DMA controller boards and disk sub-systems.

**LOOK TO MORROW FOR ANSWERS.**

\*Z-80A is a trademark of Zilog, Inc.

Morrow HDC/DMA  
Direct Memory  
Access  
Hard Disk  
Controller

Disk Jockey  
DMA Floppy Disk  
Controller

**MORROW DESIGNS** 

5221 Central Avenue, Richmond, CA 94804  
(415) 524-2101, TWX: 910-382-8132, (Power Key-Richmond)

IBM/370 is a registered trademark of IBM Corp.  
Disk Jockey and Decision I are trademarks of Morrow Designs.

Circle 325 on inquiry card.



Photo 1: The critic at work at his California home. Photo by Frank Pournelle.

to have the software actually make the correction in your text file. Present owners of *The Word* will be able to upgrade to *Plus* for the difference in cost between the two packages. The original version of *The Word* will still be available for \$75. . . . M.H.]

### Pascal, Anyone?

My son Alex is a senior in computer science at the University of California, San Diego. Since they developed UCSD Pascal there, you will understand that he's become fairly proficient in it.

When we got the Godbout 8085/88 running here, Alex undertook to write some utilities for me, using Sorcim's Pascal-M on the new Godbout machine. Consequently, I had the fascinating experience of watching someone familiar with computers and Pascal, but unfamiliar with CP/M, trying to get programs running. So, as it happens, did Barry Workman, who happened to be over. (He's an assistant scoutmaster in the troop my younger boys belong to.)

There was no problem with Pascal itself. The Sorcim documentation is adequate for that, provided that you're fairly familiar with Pascal.

Hooking to CP/M was another story. Of course Pascal is notoriously deficient in input-output (I/O) to begin with, and it's not so hot in handling strings. But the Sorcim Pascal has a "feature" that sometimes makes things even worse. When Sorcim Pascal looks at a file using the "read line" Pascal command, it ignores line feeds.

A story goes with that. The American Standard Code for Information Interchange (ASCII), while nice enough to work with in many respects, has one defect: there's no new-line character. Instead, there are carriage return and line feed, two separate characters which together give you a new line. Many programs will insert a line feed when they see a carriage return. Others will not. All have to deal with this somehow. Sorcim Pascal-M solves the problem by ignoring line feeds altogether.

Now this is a good thing under certain circumstances because some text editors (for example, Wordmaster and Wordstar) put both carriage return and line feed into the text, while others (Electric Pencil, Magic Wand, and WRITE [Writer's Really Incredible Text Editor]) insert carriage returns only. (To make the confusion complete, Elec-

tric Pencil and WRITE mark the ends of paragraphs when you hit the Line Feed key; but the mark they actually insert in the text is not a line feed, but a carriage return!) In any event, what appear to be identical files can be different, depending on the editor that created them. What is the poor Pascal programmer to do? So the Sorcim solution is as good as any, except. . . .

Unfortunately, Sorcim has not provided a way to turn this feature off; so that if you want to make an exact copy of a file, you must go through massive contortions to test for whether or not there were line feeds in the original file.

Now the way I intended to learn Pascal was to go through the excellent book *Software Tools in Pascal* by Kernighan and Plauger (Addison-Wesley, 1981) and implement all their utilities as I came to them. Alas, one of the first utilities was a Copy utility, and what could I do about the line-feed and carriage-return problem? Worse, none of that is explained in either Kernighan and Plauger or the Pascal-M documentation. (The documentation tells you that the read-line utility ignores line feeds but doesn't tell you the consequences and the way to get around the problem if you want to see if there were line feeds.)

Eventually Alex managed a way around the problem, and after that he turned out programs in rapid fire order. He'll shortly have written a really good text formatter and printer that will do everything but wash the dishes; the basic program and most of its features work now.

He also got many of the programs from Kernighan and Plauger running and, for good measure, set up some of the demonstration programs for me from Peter Grogono's really excellent *Programming in Pascal* (Addison-Wesley, 1980) so that they work with CP/M. The result is that now I can use Kernighan and Plauger, and Grogono as tutorial guides to learning the Pascal language.

And the books are really good. I can learn more in a couple of hours of playing about with those books and getting the programs up than I can in a week of reading; and when I'm through, I often have useful utilities as well.

At this point enter Barry Workman.





## How to get hold of any information your company has...

There's a big gap between having information in your company and having it in your hands.

First you have to know where it is. Sometimes you don't.

Then you have to send for it (or go get it yourself). It might be in your secretary's office. It might be in your Hong Kong office. It might even be in your data processing department where you need a specialist to get it for you.

Now there is a better way.



## ...in seconds.

With Datapoint's Integrated Electronic Office™, you can find the letter, report, or data you want on the screen of your Datapoint workstation in seconds.

The Integrated Electronic Office (or IEO) includes complete data processing, word processing, electronic message, color graphics, intelligent printing, facsimile and telecommunications capabilities in one system. Two features make it a more productive way to get hold of information: One, it does the searching. Two, it gives any number of people access to the same information.

### It does the file searching

You don't need file numbers or special codes. Just type in something that occurs in the document you're looking for, like a name, a date, or a title. All documents containing that word or words are identified and listed on the screen. Select the one you need and the system will display the entire document.

Only Datapoint® systems have this unique search capability.

### Every workstation has every file

*All* your Datapoint workstations will have access to *all* your information, no matter where the information is physically located. (Except, of course, where you want security.) This gives your people the facts they need faster and eliminates the need to duplicate information in several locations.

The IEO is expandable, so you buy only what you need when you need it. You can start with one function like data processing and add, or begin with multiple functions. Every component is compatible with every other component so you won't have to scrap old equipment or programs when you add something. And there is no practical limit to the number of users you can add.

The Datapoint IEO isn't just a nifty idea for the office of the future, it's a working reality. Let us show it to you. Call (512) 699-7059. Or write for our free brochure: A Capsule Look at Datapoint. Datapoint Corporation, Corporate Communications, T41PM, 9725 Datapoint Drive, San Antonio, Texas 78284.

**D**  
**DATAPOINT**

---

SYSTEMS THAT WORK TOGETHER NOW

---

"That's worth something," he said. "There's lots of people who want to learn Pascal and get discouraged because they don't know where to start. You take those programs Alex did, his notes, your notes, and the two books, and you've got a complete guide to learning the language."

"Not me," said I. "I write books for a living, articles for fun, and programs for a hobby, and I'm damned if I'll get into the software publishing business."

"But I'm in the software publishing business," said Barry. "At least by default." (His normal business is consulting on new installations, but he's slowly built up the mail-order publishing end as a sideline.) "Let me put that out for you."

So, Workman offers a package deal on learning Pascal. The disk with Alex's programs (sources and notes) and my notes on what I thought I needed to know is \$50, and whether or not it's worth it depends entirely on how badly you want to learn Pascal and how much of a duffer you are when you begin work. I can truthfully say I wish I'd had the package when I started; it would have saved me a week and perhaps more. But it is not the Earth. You'll still need to work.

Understand that you will also need Grogono's *Programming in Pascal* and Kernighan and Plauger's *Software Tools in Pascal*. Each sells for about \$15.95 in book stores and computer

shops. Workman will send the two of them postpaid for \$20 each, so that his total package is \$90 if you want it all.

And understand that this is implemented for Sorcim's Pascal-M. Since Alex's programs are in Pascal, you will *not be able to run them* if you don't have the Sorcim compiler. (Alex has done exactly the same job on Digital Research's Pascal-MT+. See Items Reviewed, page 298.) Barry Workman has now put together a package that includes Pascal-M (or Pascal-MT+), Alex's programs and notes, my notes, and the two books.

Alex's evaluation of the two Pascals is that both are very good. If you're doing a lot of experimental programming, you'll want the Sorcim Pascal—which is also the best one to learn the language on. This is because Sorcim's Pascal-M compiles like lightning, much faster than UCSD Pascal or MT+ will compile. The error messages are very complete and informative. Thus you can do a lot of programming work in a short time.

Pascal-M's shortcoming is that it compiles to an intermediate code, and thus the programs written in Pascal-M tend to be slow. Not egregiously slow, but certainly slower than programs written in Pascal-MT+, which compiles to machine language. So if you're more interested in your programs running fast, you'll want Digital Research's MT+.

Me, I keep both and develop programs with the Sorcim package. Then when they're running I use MT+ to get them running fast; translation isn't all that difficult. But that's an expensive solution.

## The Great BASIC Compiler

### Debate

I recently received several letters imploring me to choose between Microsoft's BASCOM and Digital Research's CB-80. Both are, of course, BASIC compilers; the difference is that BASCOM compiles Microsoft's *interpretive* BASIC, while CB-80 compiles CBASIC, which is itself a pseudocompiled language.

Unfortunately, those were no easy letters to answer. As usual, the answer is "it depends."

First, let's establish something: of the two languages, CB-80 is unquestionably better if your criteria are ease of use and ability to write structured programs. CB-80 has "functions" that are indistinguishable in operation from Pascal procedures and calls by label (GOSUB DO-ONE is a perfectly legal statement). CB-80 has a whole host of features that Microsoft's BASIC simply doesn't support.

Why, then, don't I simply recommend CB-80 and be done with it?

It's a bit like Pascal-M vs. Pascal-MT+. Microsoft's BASCOM, used in conjunction with Microsoft's inter-

## MEMORY EXPANSION MODULE FOR IBM PERSONAL COMPUTER

- Directly expands memory to 256K Bytes. Replaces three 64K Byte cards. (larger configurations available)
- Each card aged at high temperature and voltage margined; less than 350 mA of +5v; one year warranty.
- Available at participating COMPUTERLAND stores; contact factory for further information.
- Intermedia Systems: 10 year old company; also produces CAD and Medical Graphic Display systems for Hewlett-Packard computers.

STAINLESS STEEL BRACKET

**\$579**  
EACH

CARD GUIDE INCLUDED

EXTENDED FOOT FOR VERTICAL STABILITY

FULL WIDTH CARD FOR HORIZONTAL STABILITY



**intermedia systems**

10601 S. De Anza Blvd. ■ Cupertino, CA 95014  
(408) 996-0900



# 36Mhz Z-80

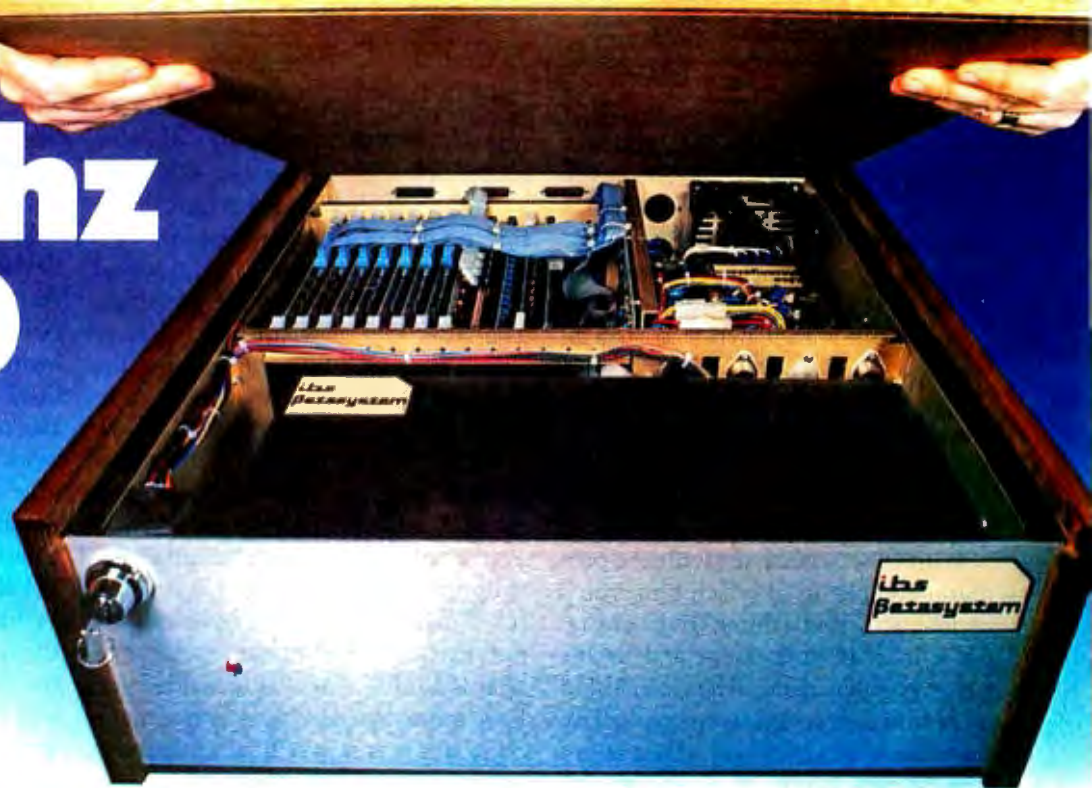

## Parallel multiprocessor power.

We've put nine 4 Mhz Z-80's working in parallel to give you this performance.

Here's the key: eight SLAVENET™ processors, each a complete S-100 computer that can handle two timeshared users, with 128K RAM plus parity, 2K EPROM, full interrupts, software bank boundary and two serial ports for synchronous and asynchronous protocol.



simultaneous and independent users. Our operating system includes such features as semaphores, concurrency, chaining and true word processing. And

we have an impressive library of applications software too.

backup. Get up to 100 Mbytes on a single videotape cartridge.

## Get the most computer bang for the buck.

That's because you can get started with a low-cost, single user system and grow from there. Just plug in boards to go from one to sixteen users. And we've made it easy to reconfigure our I/O system so you can interface a remarkable variety of peripherals and controllers without special programming.

## PASCAL & CP/M™

We have full compatibility with UCSD PASCAL II™ and CP/M™ through IBS PASCAL™ and TURBODOS™, which are fully interrupt driven, allowing up to 16

## Store up to 600 Mbytes on hard disk.

Hang on 5", 8" or 14" Winchester disk drives with from 5 Mbyte to 600 Mbyte storage. Or go with 5" or 8" floppies. With our system you can even use your video tape recorder for

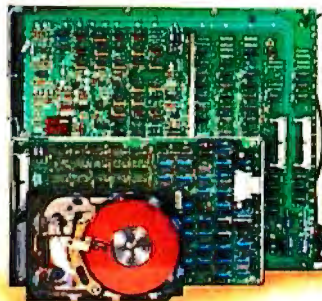

**INDEPENDENT BUSINESS SYSTEMS**

**(415) 443-3131**

5915 Graham Ct.

Livermore, CA 94550

**OUR DEALERS:** DOMESTIC • CEB3, Los Gatos, CA, (408) 559-0288 • Donald Coffman, Cupertino, CA (408) 253-2327 • ICE, Gaithersburg, MD, (301) 869-2896 • QUALI-TYPE, Livermore, CA, (415) 447-6121 • ERS, Brea, CA, (714) 524-2470 • Innovative Interfaces, Berkeley, CA, (415) 524-8416 • Khalsa Consultants, Cambridge, MA, (617) 235-3580 • Khalsa International, Herndon, VA, (703) 437-4177 • FOREIGN • Phillip Baksh, London, England, Tel: 44 1 7413707 • EEI, Sharjah, United Arab Emirates, Tel: 971 6 354 688 • JH Systems, Etobicoke, Ontario, Canada, Tel: (416) 621-0538 • ELIF, Inc., Montreal, Quebec, Tel: (514) 337-3214 • FDM, Madrid, Spain, Tel: 34 1 255 14 04 • Micro Service, Saint-Clement La Riviera, France, Tel: 33 67 84 31 88 • Servonic, Munich, Germany, Tel: 37 089 483253 • Terrace Computer Services, Terrace, British Columbia, Canada, Tel: (604) 635-7606 • Technisch Bureau Muller, Amsterdam, The Netherlands, Tel: 31 20 668110 • ICE, 6 Yousef Abbaf #808, Nasr, Cairo, Egypt • .....

pretive BASIC, isn't as fast or as convenient as CB-80; but you can get your program running much more easily because of the *interpretive* feature of the language. With Microsoft's BASIC you can write a complex program and run it (slowly) in the interpretive mode. You'll be able immediately to correct all the syntax errors and other trivia, after which you can check the program logic to see that the damned thing really does what you wanted it to do. Only then must you invest the time in actual compilation.

With CB-80, you must write the program; compile it, at which time you'll undoubtedly find a dozen trivial errors; put it back in your editor and fix the trivia; compile again, when you'll find more trivial errors that were masked by the first set of errors; etc. After about four to five iterations of the above, you'll finally be ready to check program logic, which may also drive you crazy because you can't jump around in the program at will the way you can in an interpretive language.

So, what do you want? As for me, I find I do the following: for a quick and dirty program, one I want to get running *right now*, I invariably use Microsoft's BASIC; if I'm going to use it very much, I then compile it with BASCOM.

For a program that will be part of my permanent inventory, meaning that it's complex and will need modifications over the years, and for which I'll want lots of comments and a rigid structure, I almost always start with CB-80. That's because CB-80 programs are inherently better structured than BASCOM programs.

Sometimes I'll use Microsoft's BASIC to get started, then translate to CB-80 later; but that's rare because CB-80 has so many nifty features that Microsoft's BASIC lacks.

But that's me. I discussed this with my mad friend not long before he died, and he said—not unsurprisingly—that the answer is “none of the above.” Mac Lean was enamored of Digital Research's PL-I/80, which is admittedly harder to learn than either of the above BASICs, but which he claimed was far more powerful than either.

And my son Alex, not surprisingly, argues that Pascal is much better; a sen-

timent shared by Carl Helmers, the former editorial director of this magazine.

And if all that's not enough, I can find no end of people to tell you that you must ignore *all* of the above and adopt the C programming language. The latter is a view for which I have surprisingly friendly sentiment; but the problem is that there is no good C compiler for microcomputer systems. Now true, Leor Zolman's BDS C (B.D. Software C, available from Lifeboat Associates, and worth the price even if you're only mildly curious about C) is a truly amazing product; but it isn't the full C language, and the omissions are not trivial. The Whitesmiths C compiler is a full C compiler (provided you have more than 60K bytes of free memory), but it is slower than molasses in January and has perhaps the worst error-reporting features of any language I've ever seen. You can spend *days* trying to get the simplest program running in Whitesmiths C.

And yet, the C language compiles to the tightest code of all the higher-level languages. It runs fast and is suitable for operating-system programming—something you certainly can't say for any of the other higher-level languages. If there were a really decent C for microcomputers I'd be inclined to support it; and I'm very much looking forward to the development of a good C for my Godbout 8088.

As of this writing, I've no definitive advice. If I could buy only one higher-level language, I suppose I'd get CB-80, an opinion which I suspect is causing my mad friend to revolve rapidly because he didn't care much for BASIC in any of its guises. The second one I'd buy would be BDS C, followed by BASCOM, and PL-I-80. But that's me, and I've different problems from many of you.

I wish I could be more definitive.

### Goodies

One reason you'll probably want the BDS C compiler is the BDS C User's Group. It puts out a truly amazing pile of useful software at practically no cost. You can purchase file comparators, Game of Life, graphics for the Z-19 terminal, Pong games, Rally games, and the like. If you like playing

with computers, you really ought to have BDS C and belong to the user group; if you get something you like only once a year, that's worth the cost.

I'm also pleased to say that WRITE, devised for Larry Niven and myself by Anton Pietsch, is now available from Ashton-Tate for *terminals* as well as for memory-mapped video. I'm using it on the Z-19 right now, and it has a mind-staggering pile of features that really work. George Tate tells me that by the time you read this it will have been announced and demonstrated at the West Coast Computer Faire.

WRITE will, in my judgment, blow Wordstar out of the market. I know that's a heavy statement, given the number of people using Wordstar; but I still think it's true. WRITE is a truly transparent editor. To use it, you just type. If you want to go back and insert and delete and in general mess about with your text, WRITE reformats the paragraphs automatically; there aren't any dangles poking out at the end as if your sentences had rigor mortis. WRITE lets you change disks while your text is in the machine, so that paranoids (like me) can make safety copies that are truly safe. (The worst power failure isn't going to go across the room to the bookcase to clobber my disk.)

And so forth. Obviously I'm prejudiced. Not that I get any profit from WRITE, because I don't; but the program was written to make Larry Niven and me happy. All I can say is, get a demonstration; if you're a creative writer, I can't believe you won't prefer WRITE to any other text editor you've seen. Meanwhile, Tony is also doing a programmer's version of WRITE that, he says, will more than compete with Wordmaster.

### Grammar, Anyone?

One real problem with artificial intelligence is that we can teach computers to spell, but we can't really teach them grammar. For all the rules that appear to be rigid, when you get right inside the grammar of English, there is far too much of the “you-know-what-I-mean” type of statement.

One valiant attempt to change this comes from the Aspen Software Company, which makes Proofreader and



# We speak the language of word processing. In plain English.

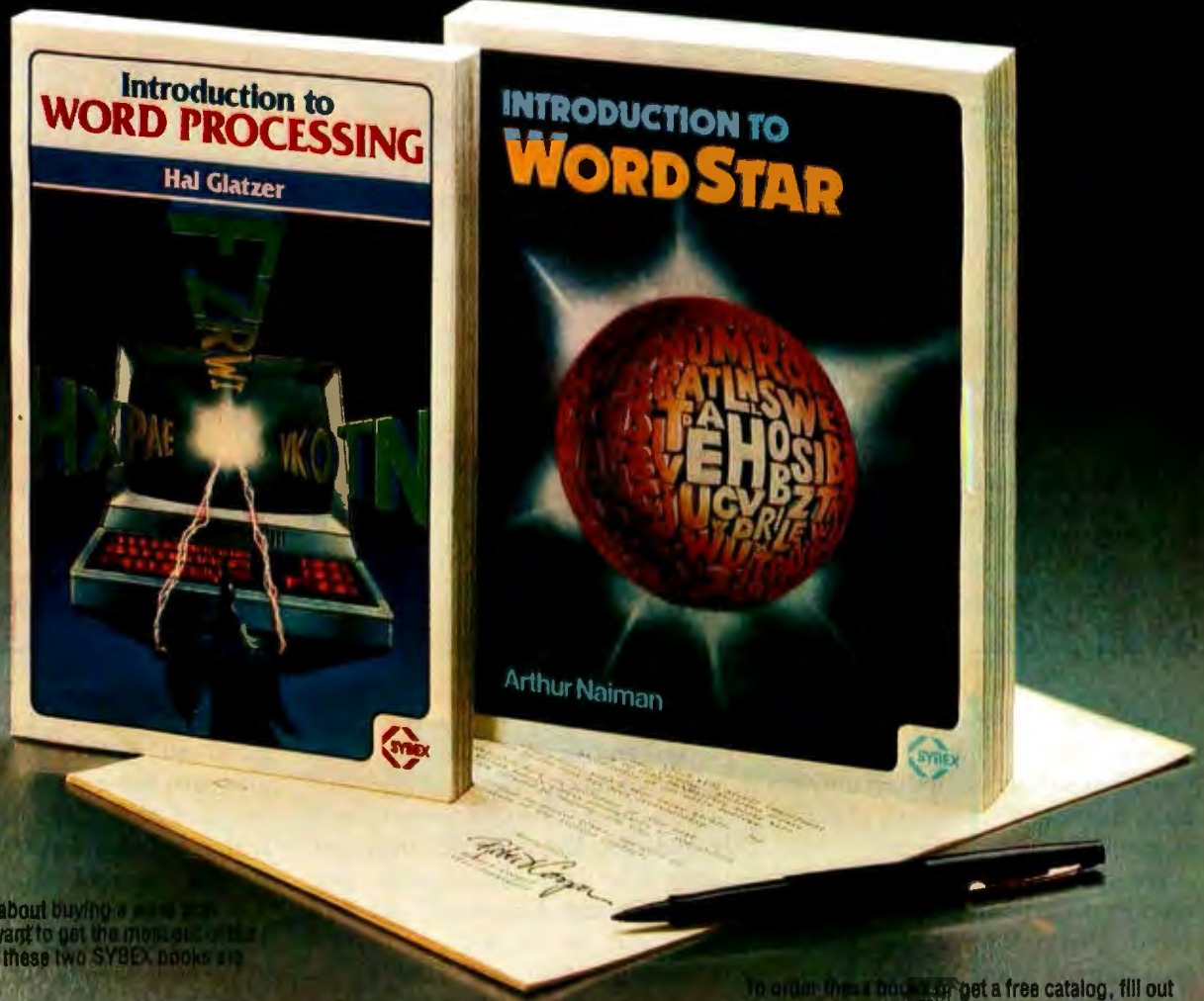

If you're thinking about buying a word processor, or if you want to get the most out of the system you have, these two SYBEX books are required reading!

**Introduction to Word Processing** by Hal Glatzer, \$12.95, contains over 200 pages of easy-to-understand information on what a word processor can do for you, how to evaluate what kind of system best fits your needs, and a step-by-step guide on how to use a word processor.

"This book . . . takes a tough, contemporary subject, crucial to every business reader, and renders it comprehensible." *Seattle Business Journal*

"For anyone wondering what a word processor is, . . . or even remotely considering buying one, this is a very important book." *The Atlanta Journal*

**Introduction to WordStar™** by Arthur Naiman, \$8.95. Learn how easy it is to use WordStar, today's most popular and powerful word processing program. Get off to a smooth start with this clear, complete reference manual which teaches you the program, step-by-step. You'll learn how

to: • edit copy • move and delete blocks of text • create and merge files • check copy for spelling accuracy • format on-screen • create special print effects • and more! Graphically designed for the convenience of the reader, *Introduction to WordStar™* is a finger-tip guide and indispensable reference for both beginners and experienced users.

When you look for information on business or personal computing, remember SYBEX. We have the most comprehensive library available, from introductory to business to hardware, programming and assembly language titles; all written by computer professionals. The thorough, readable approach of SYBEX books is well known and favored by both non-technical people and computer specialists. SYBEX is the name you should think of when you want computer literature.

To order these books or get a free catalog, fill out the coupon, or call **TOLL-FREE: 800/227-2346**. (within California) **415/848-8233**.

WordStar is a registered trademark of MicroPro Int'l.

Send me:  free catalog  
 Introduction to Word Processing \$12.95  
 Introduction to WordStar \$8.95

Add:  \$1.50/Book UPS  75¢/Book 4th Class  
 \$8.00/Book Overseas Mail

Charge my  VISA  MasterCard  American Express

Card # \_\_\_\_\_ Exp. date \_\_\_\_\_

Total Amount Enclosed \$ \_\_\_\_\_

Signature \_\_\_\_\_

NAME \_\_\_\_\_

ADDRESS \_\_\_\_\_

CITY \_\_\_\_\_ STATE \_\_\_\_\_ ZIP \_\_\_\_\_

**SYBEX** MAIL TO: SYBEX Inc.  
 2344 Sixth St., Dept. C-1  
 Berkeley, CA 94710

## Items Reviewed

### Ashton-Tate

9929 Jefferson  
Los Angeles, CA 90230

WRITE  
(Writers' Really Incredible Text Editor  
for terminals) \$395

### Aspen Software Company

POB 339  
Tijeras, NM 87059

Proofreader and Grammatik (combined)  
IBM Personal Computer \$250  
TRS-80 Model I or III \$139  
TRS-80 Model II \$179

### CompuPro/Godbout

Oakland Airport, CA 94614

M-Drive  
128K memory \$1590  
256K memory \$3100

### Digital Research

POB 579  
Pacific Grove, CA 93950

Pascal-MT+ 5.5 system \$350  
CB-80 1.1 \$500

### IBM

Information Systems Division  
Entry Systems Business  
POB 1328  
Boca Raton, FL 33432

IBM Personal Computer \$1600

### Lifeboat Associates

1651 Third Ave.  
New York, NY 10028

BDS C Compiler \$150

### Microsoft

400 108th Ave. NE  
Suite 200  
Bellevue, WA 98004

BASCOS BASIC Compiler  
CP/M and Apple \$395

### Oasis Systems

2765 Reynard Way  
San Diego, CA 92103

The Word \$75

### Osborne Computer Corporation

26500 Corporate Ave.  
Hayward, CA 94545

Osborne 1 \$1795

### Sorcim Corporation

405 Aldo Ave.  
Santa Clara, CA 95050

Pascal-M \$395

### Televideo Systems Inc.

1170 Morse Ave.  
Sunnyvale, CA 94086

Televideo 950 \$1195

### Whitesmiths Ltd.

POB 1132  
Ansonia Station  
New York, NY 10023

C compiler for CP/M \$750

### Workman & Associates

112 Marion Ave.  
Pasadena, CA 91106

Utility Disk One  
(including FIND) \$32.50  
Pascal Primer \$50

with Grogono's *Programming  
in Pascal* and Kernighan and  
Plauger's *Software Tools in Pascal* \$90

with both books and Sorcim's  
Pascal-M compiler \$350

with both books and Digital  
Research's Pascal-MT+  
compiler \$425

## Books Reviewed

*Software Tools in Pascal*  
by Brian W. Kernighan and P. J. Plauger,  
Reading, MA: Addison-Wesley Publishing  
Company, 1981. \$15.95

*Programming in Pascal* by  
Peter Grogono, Reading, MA: Addison-  
Wesley Publishing Company, 1980 \$15.95

Grammatik. Proofreader is another spelling program. It's not very good, compared to the best; it's certainly not up to Spellguard's standards of performance as far as convenience.

For one thing, the Aspen spelling checker doesn't know about dot commands: that is, whereas the best spelling programs know that a line beginning with a period is a command line and contains words to be ignored, Proofreader faithfully offers all my formatting commands as candidate misspelled words. It's also quite slow, even on the 8085 at 6 MHz.

What makes the Aspen program unique is Grammatik, which is an attempt to teach a computer elementary rules of grammar. Grammatik is an integral part of Proofreader and is invoked from within that program. It first makes a table of words by frequency (just as The Word does); the idea

here is to let you see if you've overworked any words. Then it looks for "grammatical errors."

Now, no program yet written actually understands English grammar; certainly none that work on 8-bit microcomputers can. Grammatik can look for strange errors, such as doubled words ("the the") and STicky SHift KEy (more than one letter capitalized in a word). It makes sure that the first letter of each sentence (defined as the word following a period; be wary of abbreviations) is capitalized. It can find misplaced or unbalanced quotation marks, and it can look at a table of trite and overworked phrases that are best avoided and indicate them on the screen. In other words, it's useful if your work has to do with words. I've been using it since it arrived with no regrets.

Proofreader is apparently available

without Grammatik; I wouldn't recommend getting Proofreader alone. There are much better spelling programs. I'm not sure that Grammatik will work without Proofreader, which compromises its value. So it goes.

## Integrity and High Speed

We now have four major computers: Ezekial, my five-year-old Cromemco Z-2 Z80; the Osborne; the Godbout 8085/88; and Alex's CCS (California Computer Systems) Z80. There's also Dr. Stefan Possony's CCS in Palo Alto, California, and we have a cousinly relationship with the L-5 Society, which has installed a Godbout.

Amazingly, we're happy with all of them. The Osborne, just at the moment, is in the shop; we got one of the really early ones made before they shook the bugs out of it. The dealer to whom Alex took it doesn't know that I



# First, the *IBM Personal Computer*, The Next Step . . .

## Tecmar



The **TECMAR** Expansion series is the first and only, complete line of expansion options available for the IBM Personal Computer.

Now totaling over twenty-five separate options, the **TECMAR** series gives you the broadest range of expansion available for your IBM Personal Computer.

**SYSTEM EXPANSION** with a complete Expansion Chassis providing six additional system slots, a separate power supply and styling that complements the IBM system.

**MEMORY EXPANSION** in 64K, 128K, 192K and 256K Byte increments of Dynamic RAM with parity, 32K Bytes of Static RAM, 32K Bytes of CMOS RAM with battery backup, or up to 128K Bytes of Read Only Memory.

**PRACTICAL EXPANSION** with two Serial ports and one Parallel port on a single board, or a Time of Day calendar with battery backup, a Voice Synthesizer with vocabulary in ROM and phoneme speech generation, even a BSR X10™ device controller for lights and appliances.

**DISK EXPANSION** through the addition of a five or ten megabyte Winchester disk. The disk options come enclosed in the **TECMAR** Expansion Chassis, providing additional expansion slots as well as Winchester disk storage. This approach assures you of unmatched system expandability for nearly any application.

**FUNCTIONAL EXPANSION** is also available with **TECMAR** Speed Disk™ and print Spooling Software that give new functionality to memory options.

**UNMATCHED EXPANSION** for the serious IBM Personal Computer user through these and the many other **TECMAR** Expansion products available through participating **COMPUTERLAND** stores, and other fine computer retailers nationwide.

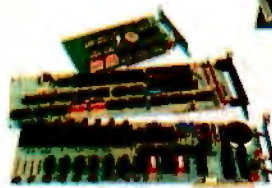
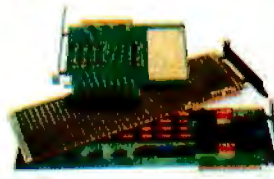
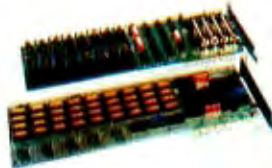

**LABORATORY/INDUSTRIAL EXPANSION** through an IEEE 488 interface, the Lab Tender with an 8 bit A/D and D/A, or the Lab Master for 12 bit A/D and D/A, a two axis Stepper Motor Controller, or the Parallel Digital-In/Digital-Out Base Board™, Video Digitization with Video VanGogh™.

**DEVELOPMENT EXPANSION** using an E+EEPROM programmer, Protozoa prototyping boards or a **TECMAR** Extender card.

**NEW PRODUCTS** are currently under development with many soon to be announced. At present shipping 26 unique IBM add-on products, we are still looking for needs to meet. If you have an need for a new product for the IBM Personal Computer, and would like to ask us about it, give a call on our Product Input Hotline at (216) 464-8317.

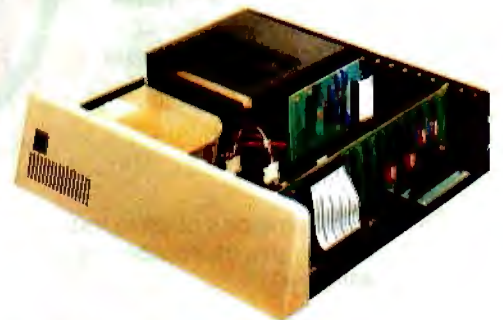

For IBM Personal Computer Expansion, TAKE THE NEXT STEP . . .

# Tecmar Inc.

PERSONAL COMPUTER PRODUCTS DIVISION  
23600 Mercantile Road, Cleveland, Ohio 44122  
Telephone: (216) 464-7410 Telex: 241735

got mine direct from Adam Osborne or that I'm going to write a review. As far as he's concerned he's got an early model, well past its warranty date, but with an early main board known to be defective. And he's having it fixed. There is, it seems, a directive from Osborne headquarters covering such cases. Consequently, they're installing completely new electronics, at no cost. And, I hasten to add, the Osborne you

can buy now comes already with the newly designed board.

So, where does this put Osborne? As one of those companies that uses its customers as its quality-control department? No. There is, after all, one company around with a prodigious reputation for delivering DOA equipment (that is, equipment dead on arrival) and doing nothing at all about the problems. It hasn't redesigned

anything, nor has it made contact with all its dealers to tell them how to handle the problems. It just goes on buying advertising.

Osborne, on the other hand, obviously wants to make his customers happy. He keeps sending software updates, for example; and when he finds a design defect in his early models, he eats the cost of updating them. So, sure, it would have been better if there hadn't been problems with the first three hundred machines delivered; but that was, after all, a fairly small number, and Lord knows Adam Osborne has worked prodigiously to rectify any early problems.

And until the flaw showed up, as mentioned above, the Osborne performed more than satisfactorily. We've amazed a lot of friends with it. And we've now got it talking to our other machines, so that we can put programs in it and get text out. I use it at all my meetings and conferences, and I've missed it the past few days that it was gone.

Then there's the Godbout 8085/88: built like a Mack truck and every bit as reliable; the only thing to report about its operations is that there's nothing to report.

We do have a new feature, though. We've just installed Bill Godbout's M-Drive, which is a way of fooling your computer programs into thinking that a lot of extra memory (in our case 512K) is a disk drive; and you can't believe how fast that runs. Compilations and assemblies are nearly instantaneous. Of course the data isn't saved that way; if the power goes off, you've lost it. But for compilations and the like, who cares? Compile once with M-Drive, and if it compiles without errors, save it on disk. If there are errors, you get the result instantly and can fix things.

I wouldn't recommend M-drive for people primarily concerned with text and creative writing because they'll mostly be concerned with preservation of their output. I, for instance, want to see a copy of my text disks in a box on the other side of the room before I'm completely satisfied. But for programmers with frequent test compilations and the like, the Godbout M-Drive is a real godsend. ■

# Multiperipherals For Your Multibus

## MULTIWAYS

Need large disk capacity for your Multibus system? Xylogics has what you need.

### Multi Disks

- CDC Hawk (10 MB)
- CDC cartridge modules (32-96 MB)
- CDC storage modules (80-300 MB)
- CDC Lark (8 MB/8 MB)
- BASF (24 MB)
- NEC (20-80 MB)

### Multi Interfaces

Choice of Xylogics **Peripheral Processors** for either storage module or Diablo 44B interface.

### Multi Benefits

- Bit-slice control technology
- Compatible with INTEL, NATIONAL 80/20, 86/12
- SMD configurations of up to four drives in any mix of storage capacities
- Fast delivery
- Low prices

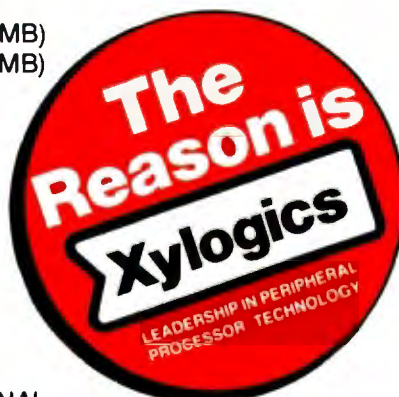

U.S. Headquarters: 144 Middlesex Tnpk., Burlington, MA 01803 Tel: (617) 272-8140 (TWX 710-332-0262)  
European Headquarters: 46-48 High St., Slough, Berks SL1 1ES U.K. Tel: (0753) 78921; Telex 847978



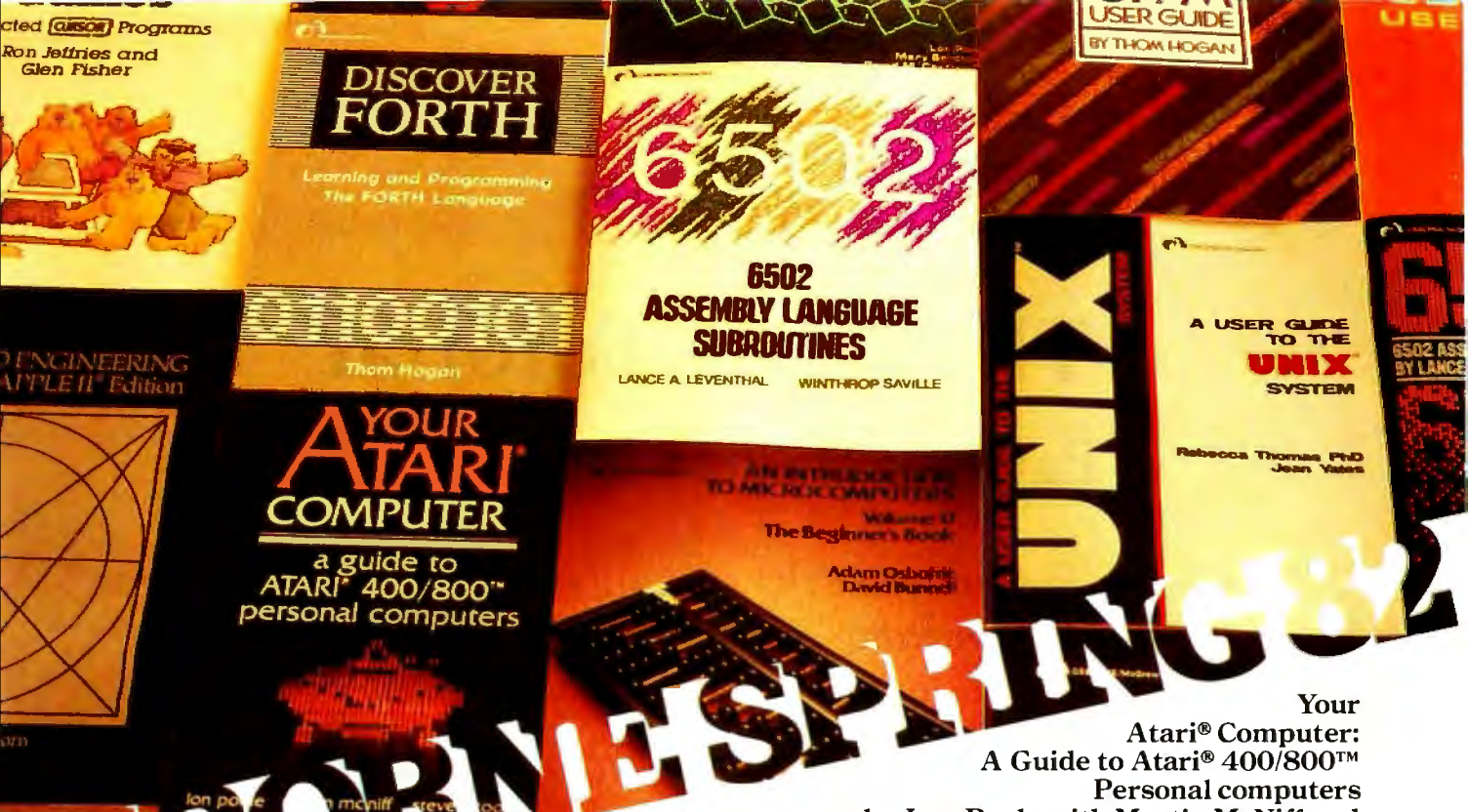

**An Introduction To Microcomputers: Volume 0—The Beginner's Book, Third Edition**  
by Adam Osborne and David Bunnell

One of our most popular titles, Volume 0 has been expanded and revised to include new sections on software and communications. Written for the complete novice, this book introduces the construction and operation of microcomputers. *Paper \$12.50*

**6502 Assembly Language Subroutines**  
by Lance Leventhal and Winthrop Saville

This book includes over 50 indispensable, ready-to-use subroutines. A boon to every 6502 programmer, it will save hours of programming time. Includes array, bit and string manipulation, sorting and searching operations, much more. *Paper \$12.99*

**Assembly Language Programming for the Apple II™**  
by Robert Mottola

This comprehensive, easy to understand introduction provides solid groundwork for getting started in assembly language programming on the Apple II. Many subroutines written in assembly language are provided, and most explanations are shown with equivalent examples in BASIC. *Paper \$12.95*

**Discover FORTH: Learning And Programming the FORTH Language**  
by Thom Hogan

Using a friendly approach, the author explains the history and uses of FORTH, as well as how to program to an intermediate level. Includes notes on logical extensions and alterations to the current standard FORTH syntax. *Paper \$14.95*

Now at your dealer, or write Osborne/McGraw-Hill, 630 Bancroft Way, Berkeley, CA 94710. Phone orders: CALL TOLL FREE 800-227-2895. In California call 415-548-2805. Canadian orders contact L.A. Varah (416) 561-9311, McGraw-Hill-Ryerson (416) 293-1911.

**Osborne/McGraw-Hill**

Atari® 400/800™ are trademarks of Atari, Inc. PET™ is a trademark of Commodore Business Machines, Inc. CURSOR™ is a trademark of The Code Works. Unix™ is a trademark of Bell Laboratories. Apple II® is a registered trademark of Apple Computer, Inc. VisiCalc® is a registered trademark of VisiCorp.

Circle 350 on inquiry card.

**Your Atari® Computer: A Guide to Atari® 400/800™ Personal computers**  
by Lon Poole with Martin McNiff and Steven Cook

*Your Atari® Computer* provides invaluable reference material for Atari® home computer users. This "how-to" guide written for the novice covers all the common external devices, including disk drives and printers. The reader can also learn to program in Atari® BASIC. *Paper \$16.95*

**Trade Secrets: How to Protect Your Ideas and Assets**  
by James Pooley

Attorney James Polley provides legal advice on a "hot" topic: who owns your ideas in today's business world. Employers can learn to tighten company security systems and protect their intellectual assets. Employees can become familiar with their rights to take "commercial" ideas to new jobs or start competing businesses without being sued. *Cloth \$19.95*

**A User Guide to the UNIX™ System**  
by Rebecca Thomas and Jean Yates

Designed to ease the novice through the difficult learning stages, this volume is also an excellent reference for those already familiar with the UNIX™ operating system. Computer-side tutorials teach forty basic commands plus there's a list of UNIX™ system resources, and a bibliography for further study. *Paper \$15.99*

**VisiCalc®: Home and Office Companion**  
by David M. Castlewitz and Lawrence Chisausky with Patricia Kronberg. Illustrated by L. D. Chukman

Contains 50 models that can be used immediately for personal and business applications. Provides models for loans and investments, advertising and sales, inventory control, personnel, household aids and more. Designed to accommodate most micros and every version of the VisiCalc® program. *Paper \$15.99*

# The Atari Tutorial

## Part 10: Human Engineering

*The interaction between the computer and its human user is easily the most important—and most often neglected—aspect of commercial software.*

---

Chris Crawford  
Atari Inc.  
1265 Borregas Ave.  
POB 427  
Sunnyvale, CA 94086

---

The Atari home computer is first and foremost a consumer computer, being designed to make it easy for people to use. Many of the hardware features protect the consumer from inadvertent errors. Because the average consumer is unfamiliar with the conventions and traditions of the computer world, software should reflect an equal concern for the consumer. If a program is understandable, it will be used correctly most of the time. Occasionally, a user will be careless and make mistakes. It is the programmer's responsibility to protect the user from as many mistakes as possible.

*Human engineering* refers to the interaction between the design of tools and the resulting ease of use by people. The current state of human engineering found in personal computer software is dismal. Many programs

being sold contain atrocious design decisions that reflect unawareness of human engineering. Although the worst offenders are written by amateur programmers, even software written at some of the largest firms shows occasional lapses in this respect.

---

### Can you imagine what Star Raiders would be like without animation?

---

Human engineering is an art, not a science. It demands great technical skill, but it also requires insight and sensitivity. As such, it is a highly subjective field devoid of absolutes. Since this article is the work of one hand, it betrays the subjectivity of its author. A full treatment of the many opinions on the subject would be both lengthy and confusing. I therefore chose the simpler and more pleasant task of presenting only my own point of view, giving appropriate lip service to the most serious objections. The result is contradictory enough to satisfy even the most academic of readers.

### The Computer as a Sentient Being

An instructive way of viewing the problem of human engineering is to cast the programmer as a sorcerer who conjures up an intelligent being, a *homunculus*, within the innards of the computer. This creature lacks physical embodiment but possesses intellectual traits—specifically, the ability to process and organize information. Although the user of the program enters into a relationship with this homunculus, these two sentient beings think differently. The human's thought patterns are associative, integrative, and diffuse; the program's thought processes are direct, analytical, and specific. These differences *are* complementary and productive because the homunculus does well what the human cannot. Unfortunately, these differences also create a communications barrier between the user and the homunculus. They have much to say to each other because they are so different, but because they are different they cannot communicate well.

The central aim of good programming should therefore be to provide better communications between the user and the homunculus. Sad to say,

---

*This article appears in slightly different form in De Re Atari, published by Atari Inc., and is reproduced with its express permission. De Re Atari is available from the Atari Program Exchange, 155 Moffett Park Dr., POB 427, Sunnyvale, CA 94086.*

---



# IT TAKES A HOT COMPUTER TO RUN NON-STOP IN A DEEP-FREEZE

**Smoke Signal's Chieftain™ computer series:**  
The kind of tough reliability you need today  
on your business team.

Chieftains are preferred by discerning buyers when extra performance has to be delivered under less-than-ideal operating conditions. The track record this computer has achieved in hundreds of demanding installations worldwide is proof that a Chieftain can meet any challenge your business environment has to offer.

**Select from a family of field-proven systems.**

**Chieftains range from floppies to this 5¼-inch Winchester hard disk system with 20-megabyte tape streamer option.**

It's available with the new OS-9 Level I and II, multi-user, UNIX comparable operating system for mainframe-like performance.



**6809-based Chieftains deliver six months of continuous operation at Arctic Circle**

*Two Chieftains accompanied an Adak research expedition during the frigid winter of 1981. The computers fulfilled a vital support role for an earthquake prediction study. In sub-zero temperatures, rain, snow, ice and wind-driven weeds and dust, the extraordinary Chieftains — supported by Smoke Signal's factory-based staff — proved they were up to the challenge.*



**All Chieftains are so cost-effective and advanced, they obsolete most other systems available today at any price.**

Whether you select an upward-compatible 5¼- or 8-inch floppy disk system, or 5¼- or 8-inch hard disk configurations of 4- to 60-megabyte capacity, you'll receive Chieftain's widely acclaimed quality — plus value that makes your dollar go a lot further. Smoke Signal's huge software array begins at comprehensive business programs, and expands into esoteric applications for rare and specialized tasks.

Here's a sampling of the latest additions to the Chieftain hard disk computer systems that are destined to change the way you think about data processing:

**THE CHIEFTAIN 95W4**

4-megabyte, 5¼-inch Winchester  
with a 360-k floppy disk drive

**THE CHIEFTAIN 98W15**

15-megabyte, 5¼-inch Winchester  
with a 1-megabyte 8-inch floppy  
disk drive

**THE CHIEFTAIN 95XW4**

4-megabyte, 5¼-inch Winchester  
with a 750-k octo-density floppy  
disk drive

**THE CHIEFTAIN 9W15T20**

15-megabyte, 5¼-inch Winchester  
with a 20-megabyte tape streamer

WRITE OR CALL TODAY FOR DETAILS ON THE TOTAL CHIEFTAIN SERIES . . . AND ON DEALERSHIP OPPORTUNITIES STILL AVAILABLE . . .

**Smoke Signal Broadcasting • 31336 Via Colinas, Westlake Village, CA 91362 • (213) 889-9340**



**SMOKE SIGNAL**  
Chieftain Computers

For dealers only, circle 414  
All other inquiries, circle 415

Name \_\_\_\_\_  
Title \_\_\_\_\_  
Company \_\_\_\_\_  
Address \_\_\_\_\_  
City \_\_\_\_\_  
State \_\_\_\_\_ Zip \_\_\_\_\_  
Telephone (     ) \_\_\_\_\_

many programmers expend the greater part of their efforts on expanding and improving the processing power of their programs. This only heightens the tragedy by increasing the intelligence of the homunculus while leaving him blind, deaf, and dumb.

Today's personal computers have sufficient computing power to meet many of the average consumer's needs. The primary limiting factor is no longer clock speed or resident memory; the primary limiting factor is now the thin pipeline connecting our now-intelligent homunculus with his human user. Each can process information rapidly and efficiently; only the narrow pipeline between them slows down the interaction.

### Human-Machine Communication

How can we widen the pipeline between the two thinkers? We must focus on the language with which they communicate. Like any language, a man-machine language is re-

stricted by the physical means of expression available to the speakers. Because the computer and the human are physically different, their modes of expression are physically different. This forces us to create a language that is not symmetric (as human languages are). Instead, a man-machine language will have two very different channels: an input channel and an output channel. Just as we study human language by first studying the sounds that the human vocal tract can generate, we begin by examining the physical components of the man-machine interface.

### Output (Computer to Human)

Two primary output channels go from the computer to the user. The first is the television screen; the second is the television speaker. Fortunately, these are flexible devices that permit a broad range of expression. For the purposes of this article, it is better to discuss these devices in terms of the human point of view. Of

the two devices (screen and speaker), the display screen is easily the more expressive and powerful device. The human eye is a more finely developed device for gathering information than the human ear. An electrical engineer might say that the eye has more "bandwidth" than the ear—that is, it can interpret a far more complex input stream. The eye can process three major forms of visual information: shapes, color, and animation.

### Shapes

Shapes are an ideal means for presenting information to the human eye. The human retina is especially adept at recognizing shapes. The most direct use of shapes is for the depiction of objects. If you want the program to tell the user about something, draw a picture of it. A picture is direct and immediately recognizable.

The second use of shapes is for symbols. Some concepts in the human lexicon defy direct depiction. Concepts like love, infinity, and direction cannot be shown with pictures. They must instead be conveyed with symbols, such as a heart, a horizontal figure 8, or an arrow. These are a few of the many symbols we all recognize and use. Sometimes you can create an ad hoc symbol for limited use in your program. Most people can adapt to such a symbol quite readily. Although symbols are a compact way to express an idea, they should not be used in place of pictures unless compactness is essential. A symbol is an indirect expression; a picture is a direct expression. The picture conveys the idea more directly and more forcefully.

The third and most common use of shapes is for text. A letter is an indirect symbol; we put letters together to form words. The language thereby produced is extremely rich in its expressive power. Truly it is said, "If you can't say it, you don't know it." This expressive power is gained at the price of extreme indirection. The word that expresses an idea has no sensory or emotional connection whatever with the idea itself. We are forced to carry out extensive mental

## ETHERNET and the S-100 Bus

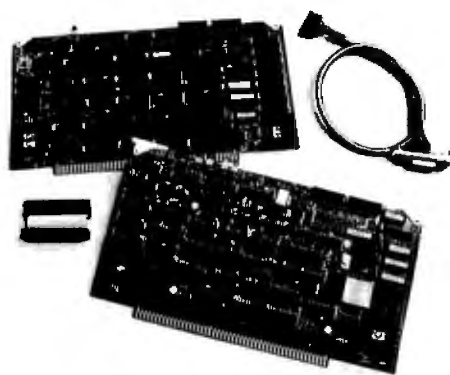

Now, it's possible for any S-100 Bus Microcomputer to plug into the high speed, 10 megabits per second ETHERNET local area network. The FILTABYTE S 2.0 plugs into any standard S-100/IEEE 696 bus and allows the user to collect, from the ETHERNET, up to 8 or 32, two thousand byte message packets, back-to-back.

- Available in either 16K or 64K dual ported memory
- Memory may be used for data or program storage if not used for buffering
- Polled or vectored interrupt modes available
- Controller's address inserted automatically
- 32 bit CRC
- Meets DEC, INTEL, and XEROX ETHERNET specifications version 1.0
- Connects to ETHERNET using any transceiver which conforms to the ETHERNET specification
- \$1,295 in OEM quantities

**Perex, Inc.** 1798 Technology Drive, San Jose, CA 95110  
(408) 280-7566, TELEX: 171-647, TWX: 910-338-7067



# ALPHANUMERIC or GRAPHIC?

If high resolution required, install  
BMC color/green monitor in your system.



BM-1401RGB



BM-12A

RGB Interface Board for  
Apple-II is available now.

**BM-12A**  
12" Green P4 Phosphor CRT  
Composite Video Signal  
60 Char X 24 Lines

**BM-1400CLU**  
13" Composite Video Signal  
40 Char X 25 Lines

**BM-1401RGB**  
13" RGB Separate Video Signal  
63 X 7 Dots, 40 Char X 25 Lines

**BM-1402RGB**  
13" RGB Separate Video Signal  
63 X 7 Dots, 80 Char X 25 Lines

Circle 85 on inquiry card.

## BMC USA, INC.

LOS ANGELES

20810 Manhattan Place Suite 112, Torrance, CA. 90501

Telex: 99054 BMC USA TRNC Phone: 213-920-9880, 9881

NEW YORK OFFICE

450 Barell Avenue, Carlstadt, N.J. 07072

Telex: 130221 BMC NY CARL Phone: 201-839-7076, 7281

gymnastics to decipher the word. Of course, we do it so often that we have become quite fluent at translating strings of letters into ideas. We do not notice the effort. The important point is that the indirection detracts from the immediacy and forcefulness of the communication.

One school of thought maintains that text is superior to graphics for communication purposes. The gist of the argument is that text encourages freer use of the reader's rich imagination, while graphic depiction of reality always falls short of our imaginative expectations. This argument fails to convince me because it seems to arbitrarily draw a line between the user's need for information and the ability to supply information through the use of imagination. If the user has an active imagination, why is the program needed at all? Why doesn't the user simply imagine the entire program? Conversely, if a small amount of information provided in the form of text is the seed for the user's imagination, would not

more information, provided in the form of graphics images, encourage even grander flights of imaginative fancy? An equal exercise of imagination with graphics should provide even greater results.

**The eye can process three major forms of visual information: shapes, color, and animation.**

A more compelling argument for text is that its indirection allows it to pack a considerable amount of information into a small space. The space constraints on any real communication make text's greater compactness valuable. Nevertheless, this does not make text superior to graphics; it simply makes text more economical. Graphics requires more space, time, memory, or money, but it also com-

municates better than text. To some extent, the choice between graphics and text is a matter of taste, and the taste of the buying public has never been in doubt. Compare the popularity of television with that of radio, or the popularity of movies with books. Graphics beats text easily.

**Color**

Color is another vehicle for conveying information. Since it is less powerful than shape, it normally plays a secondary role in visual presentations. Its most frequent use is to differentiate between otherwise indistinguishable shapes. It also plays an important role in providing cues to the user. Good color can salvage an otherwise ambiguous shape. For example, a tree represented as a character must fit inside an 8- by 8-pixel grid. The grid is too small to draw a recognizable tree. By coloring the tree green, however, the image becomes much easier to recognize. Color is also useful for attracting attention or signaling important

**PRODUCTS FOR YOUR RADIO SHACK**

# COLOR COMPUTER

**MICROTEXT COMMUNICATIONS VIA YOUR MODEM!**

**NEW!**

Now you can use your printer with your modem! Your computer can be an intelligent printing terminal. Talk to timeshare services or to other personal computers; print simultaneously through a second printer port; and re-display text stored in memory. Download text to Basic programs; dump to a cassette tape, or printer, or both. Microtext can be used with any printer or no printer at all. It features user-configurable duplex/parity for special applications, and can send any ASCII character. You'll find many uses for this general purpose module! Available in ROMPACK, ready-to-use, for **\$59.95**.

**SOFTWARE DEVELOPMENT SYSTEM**

The Micro Works Software Development System (SDS80C) is a complete 6809 editor, assembler and monitor package contained in one Color Computer program pack! Vastly superior to RAM-based assemblers/editors, the SDS80C is non-volatile, meaning that if your application program bombs, it can't destroy your editor/assembler. Plus it leaves almost all of 16K or 32K RAM free for your program. Since all three programs, editor, assembler and monitor are co-resident, we eliminate tedious program loading when going back and forth from editing to assembly and debugging!

The powerful screen-oriented Editor features finds, changes, moves, copies and much more. All keys have convenient auto repeat (typamatic), and since no line numbers are required, the full width of the screen may be used to generate well commented code.

The Assembler features all of the following: complete 6809 instruction set; complete 6800 set supported for cross-assembly; conditional assembly; local labels; assembly to cassette tape or to memory; listing to screen or printer; and mnemonic error codes instead of numbers.

The versatile ABUG monitor is a compact version of CBUG, tailored for debugging programs generated by the Assembler and Editor. It features examine/change of memory or registers, cassette load and save, breakpoints and more. **SDS80C Price: \$89.95**

**GAMES**

**Star Blaster** — Blast your way through an asteroid field in this action-packed Hi-Res graphics game! Available in ROMPACK; requires 16K. **Price: \$39.95**

**Pac Attack** — Try your hand at this challenging game by Computerware, with fantastic graphics, sound and action! Cassette requires 16K. **Price: \$24.95**

**Berserk** — Have fun zapping robots with this Hi-Res game by Mark Data Products. Cassette requires 16K. **Price: \$24.95**

**Adventure** — *Black Sanctum* and *Calixto Island* by Mark Data Products. Each cassette requires 16K. **Price: \$19.95 each.**

---

**ROMLESS PAK I** — is an empty program pack capable of holding two 2716 or 2732 EPROMs, allowing you up to 8K of program! The PC board inside comes with sockets installed, ready to go with the addition of your custom EPROMs. **Price: \$24.95**

**2-PASS DISASSEMBLER** — with documentation package. 16K; cassette. 80C Disassembler **Price: \$49.95**

**CBUG** — Machine language monitor. CBUG Cassette **Price: \$29.95**

**CBUG ON 2716 EPROM:** Can plug into Romless Pak I. CBUG ROM **Price: \$39.95**

**PARALLEL PRINTER INTERFACE** — serial to parallel converter allows use of all standard parallel printers. **PI80C Price: \$69.95**

**Assembly Language Programming**, by Lance Leventhal. **Price: \$16.95**

**MEMORY UPGRADE KITS:** 4-16K Kit **Price: \$39.95**. 16-32K (requires soldering experience) **Price: \$39.95**

**PARTS & SERVICES:** SAMs, 6809Es, RAMs, PIAs. Call for prices.

**THE MICRO WORKS**

**GOOD STUFF!**

**WE SHIP FROM STOCK!**

Master Charge/Visa and COD Accepted

**P.O. BOX 1110 DEL MAR, CA 92014 714-942-2400**



# SANYO MONITORS

**When you're ready to stop playing around.**

Maybe your home TV was OK as a display when all you were concerned with was blasting Klingons.

But if you spend more than a couple of hours in front of your TV screen, you'll start to pay the price in eyestrain. Maybe even headaches.

It's not worth it. Not when you can get a Sanyo data monitor that's specifically designed for long-term, day-in, day-out use.



Compare display quality of a typical home TV (left) with a Sanyo professional monitor (right).

Sanyo monitors have been the industry standard for as long as there's been a personal computer industry—in fact they're recommended by computer dealers and manufacturers alike. That's because when you buy a Sanyo, you're not just getting a stripped-down TV set. You're getting a truly professional display system.

Sanyo offers a complete selection of monitors for any application. You can choose from

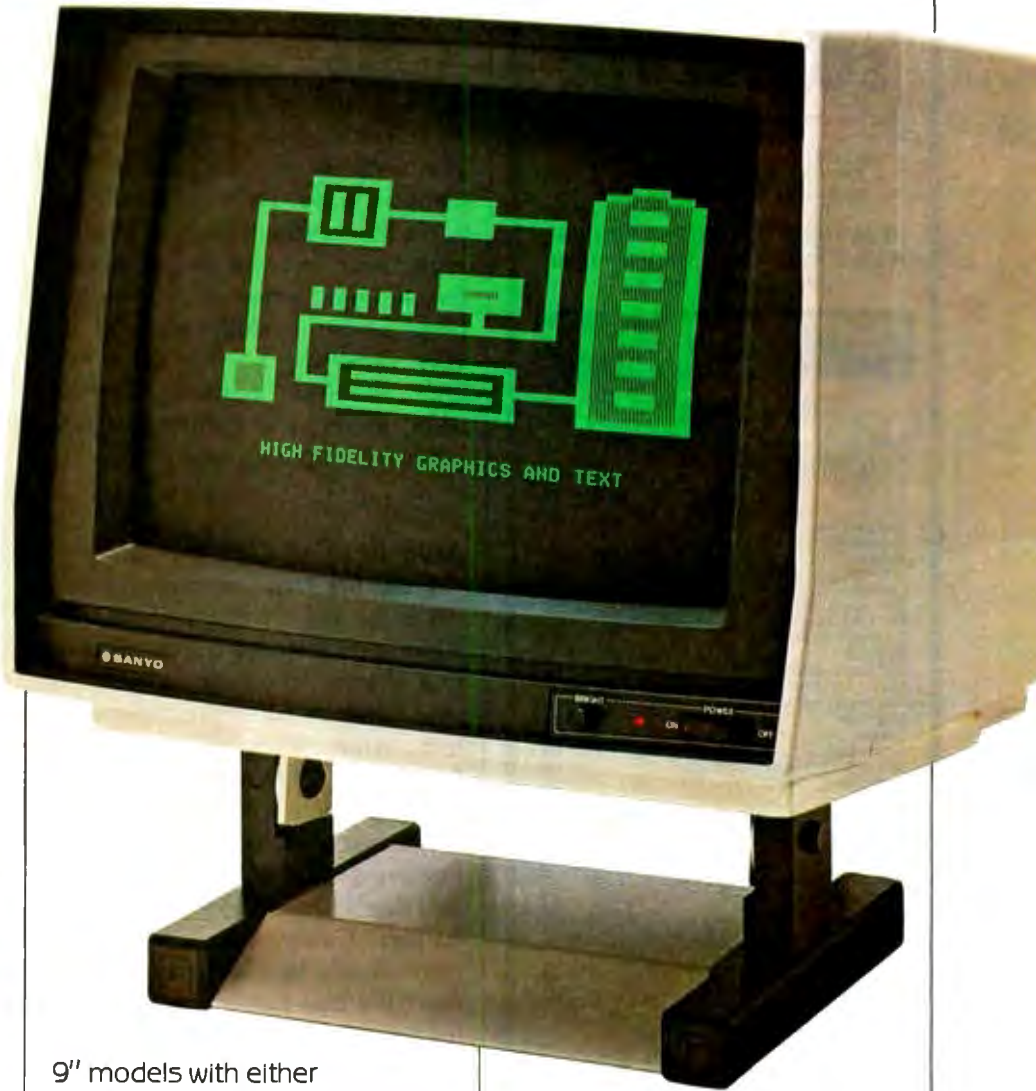

9" models with either white or easy-on-the-eyes green phosphors. Or a sleek new 12" model with a special anti-reflec-

tive screen (green or white), and an optional desk stand with adjustable tilt. If color graphics are your thing, check our 13" full-color models—one with TV-compatible video input, and a new ultra-high resolution RGB model for computers like the IBM, NEC and Apple III.

Visit your computer dealer and find out how much better things look on a real, professional monitor from Sanyo.

Anything less is just playing around.



Communications Products Division

Sanyo Electric Inc., 1200 W. Artesia Blvd., Compton, CA 90220 (213) 537-5830



# Oryx software

What does the Oryx, an African antelope, have in common with reliable service? They are both almost extinct. Oryx Software wants to bring trustworthy service back to life. We're here to stay!

**GUARANTEED LOWEST PRICES!**  
We will match any advertised price.  
Just show us the ad.

**ORDER TOLL FREE - Outside WI**  
**1-800-826-1589**

## SOFTWARE

<b>APPLE</b>	
Mailing List Program . . . . .	48.
Supertext II . . . . .	128.
C.O.R.P. I . . . . .	235.
Estimator . . . . .	295.
Magic Window . . . . .	79.
Vistrend/Plot . . . . .	199.
Vistern . . . . .	120.
Supercalc . . . . .	269.
Locksmith 4.0 . . . . .	99.
Tax Preparer '82 . . . . .	127.
Real Estate Analyzer . . . . .	127.
Creative Financing . . . . .	127.
DB Master . . . . .	174.
Micropro Wordstar . . . . .	248.
Context Connector . . . . .	180.
Easy Writer (Pro) . . . . .	195.
Easy Mailer . . . . .	160.
Datadex . . . . .	249.
Nevada Cobol . . . . .	129.
Visicalc 3.3 . . . . .	159.
Spellguard . . . . .	239.
PFS & Report . . . . .	80.
Systems plus Acct'g. Module . . . . .	425.
Electronic 1, 2, 3 . . . . .	39.
Wizardry . . . . .	42.
Apple Panic . . . . .	25.
Sublogic Flight Simulator . . . . .	28.
Micropainter . . . . .	34.
Zork II . . . . .	33.
Edu-ware . . . . .	35.
Raster Blaster . . . . .	25.
Intl. Grd. Prix . . . . .	26.
Graphic Software . . . . .	19.
Logic Simulator . . . . .	135.
<b>AND MANY MORE!</b>	
<b>CP/M</b>	
Word Processor I . . . . .	425.
Mail Management . . . . .	250.
Mailmerge . . . . .	90.
Spellstar . . . . .	169.
Supersort II . . . . .	159.
Microplan Basic . . . . .	419.
Micro Pro Wordstar . . . . .	297.
<b>AND MANY MORE!</b>	
<b>Others for</b>	
CBM, NEC, ATARI, IBM, ETC. . .	

Prices valid for stock on hand and subject to change without notice.

Write for our **FREE** catalog.

For **Peripherals**  
see our other ad, page 456

Please:  
• Wisconsin residents - add 4% sales tax  
• Add \$2.50 for shipping per software and small item. Call regarding others.

We Welcome:  
• Visa, Mastercharge - (Add 4%)  
• Checks (Allow 1-2 weeks for clearing)  
• CDD (Add \$1.50 per shipment)

**ORDER TOLL FREE - Outside WI**  
**1-800-826-1589**

For Technical info & in Wisconsin:

**715-848-2322**

**Oryx Software**

205 Scott St., Dept. BB  
P.O. Box 1961 • Wausau, WI 54401



material. Hot colors attract attention. Finally, use of color enhances the aesthetic appeal of any program. Colored images are more pleasing to look at than black-and-white images.

Hard-boiled programmers may question the relevance of aesthetic considerations to communications. The obvious attention to the design of highway advertising billboards and television commercials indicates the importance our culture attaches to the aesthetic aspect of communication. These carefully planned and very expensive ads are little more than exquisite aesthetic trappings (skin, glitter, and chrome) wrapped around a corporate logo.

### Animation

I use the term *animation* here to designate any change in the display. Animation includes colors or shapes that change, moving foreground objects, or a moving background pattern. Animation's primary value is for showing dynamic processes. Indeed, graphics animation is the only way to successfully present highly active events. The value of animation is best demonstrated by a game like Star Raiders. Can you imagine what the game would be like without animation? For that matter, can you imagine what it would be like in pure text?

The value of animation extends far beyond games. Animation allows the designer to show dynamic, changing events clearly. The ability to do animation is one of the major advantages that computers have over paper-and-ink as an information technology. Animation is very powerful in sensory terms. The human eye is organized to respond strongly to changes in the visual field. Animation attracts the eye's attention.

Finally, animation increases the energy level of the program, consequently increasing the user's emotional involvement. Many program failures are due to user failures, which in turn can be traced to user inattentiveness. If you want the user's attention, you've got to jump up and down.

### Sound

Graphics images must be looked at to have effect. Sound can reach a user's ears even when the user is not paying direct attention to the video display. Sound therefore has great value as an annunciator or warning cue. A wide variety of beeps, tones, and grunts can be used to signal feedback to the user. Correct actions can be answered with a pleasant bell tone. Warning conditions can be noted with a honk.

Sound has a second use: providing realistic sound effects. Quality sound effects greatly add to the impact of a program because the sound provides a second channel of information flow that is effective even when the user is overlooking the visual component of the program.

Sound is ill-suited for conveying straight factual information; most people do not have the aural acuity to distinguish fine tone differences. Sound is much more effective for conveying emotional states or responses. People associate many sounds with emotional states. A descending sequence of notes implies deteriorating circumstances. An explosive sound denotes destruction. A fanfare announces an important arrival. Certain note sequences from widely recognized popular songs are immediately associated with particular feelings. For example, in Energy Czar, a dirge indicates that the user's energy mismanagement has ruined America's energy situation; a fragment of "Happy Days Are Here Again" indicates success.

### Input (Human to Computer)

Three input devices are most commonly used with the Atari 400/800 home computer: the keyboard, paddles, and joystick.

The keyboard is easily the most powerful input device available to the designer, with more than 50 direct keystrokes immediately available. Use of the Control and Shift keys more than doubles the number of distinguishable entries possible. The Caps/Lowr and Atari keys extend the expressive range of the keyboard



# Our "Personal" Improvement Plan

## MICROBYTE Add-Ons for the IBM Personal Computer from ASAP

MICROBYTE lets your IBM Personal Computer become all that it can be with a wide variety of enhancements. We can stretch memory, increase computing ability, provide printer support, improve storage capacity and expand the overall capability of your system to reach limits you never thought possible.

With MICROBYTE and ASAP your Personal Computer has all the potential you need for a variety of applications: video games, educational use, home budget applications or business use.

All MICROBYTE add-ons are constructed of high quality components and feature gold contacts and clear solder mask. Built to MICROBYTE's rigid standards, each board is fully assembled and tested.

Choose the IBM add-ons you need for your applications. Then call ASAP today, and start your own "Personal" improvement plan.

- Expansion Chassis with 5-slot motherboard
- 256K RAM Board
- Winchester Disk Drive and Controller, 6 and 12 megabytes (specify)
- Expansion Chassis with one or two 5¼" floppy disk drives, either 48 TPI or 96 TPI, single-sided or double-sided, double-density
- 32K Serial Printer Buffer Board
- 32K Parallel Printer Buffer Board
- EPROM Board up to 32K



ASAP offers a 15-day buyer protection policy: full money-back guarantee if not totally satisfied.

Ordering information: name, address, phone; ship by: UPS or Mail. Shipping charge: add \$2.90 up to 1 lb. (UPS blue), U.S. Mail add \$1.50 (U.S. only) (\$25.00 minimum order). Terms: We accept cash, check, money orders, Visa and MasterCard (U.S. funds only). Tax: 6% Calif. res., COBs and terms available on approval (School PO's Accepted).

Toll free outside California: (800) 421-7701 inside California: (213) 595-6431 (714) 891-2663

ASAP Computer Products LTD., 116 Viceroy Road., D-12 Concord, Toronto, Ontario, Canada L4K 1A9  
(416) 738-0500 (800) 268-1996

Circle 37 on Inquiry card.

**asap**  
computer  
products, inc.

1198 E. Willow St., Signal Hill, CA 90806

even further. Thus, with a single keystroke, the user can designate one of 125 commands. A pair of keystrokes can address more than 15,000 selections. Obviously, this device is very expressive; it can easily handle the communications needs of any program. For this reason, the keyboard is the input device of choice among programmers.

While the strengths of the keyboard are undeniable, its weaknesses are seldom recognized. Its first weakness is that few people know how to use it well. Programmers use keyboards heavily in their daily work; consequently, they are fast typists. The average consumer, however, is not too comfortable with a keyboard, which can lead to many wrong keys being pressed. The very existence of all those keys, and the knowledge that one must press the correct key, is itself intimidating to many people.

A second weakness of the keyboard is its indirection. It is very difficult to attach direct meaning to a

keyboard because it has no obvious emotional or sensory significance. The new user has great difficulty relating to it. All work with the keyboard is symbolic, using buttons marked with symbols that are assigned meaning by the circumstances. The nested indirection of this can be most confusing to the beginner. Keyboards also suffer from their natural association with text displays; I have already discussed the weaknesses of text as a medium for information transfer.

Another property of the keyboard that the designer must keep in mind is its digital nature. The keyboard is digital both in selection and in time (i.e., keyboard input is divided into keystrokes, and only one keystroke can be entered at a time). This provides some protection against errors. Because keystroke reading over time is not continuous but digital, the keyboard is not well suited to real-time applications. Since humans are real-time creatures, this is a weakness. The designer must realize

that use of the keyboard will lengthen the distance from real-time interaction with the user.

## Paddles

Paddles are the only true analog input devices readily available for the system. As such, they suffer from the standard problem all analog input devices share: the requirement that the user make precise settings to get a result. Their angular resolution is poor, and thermal effects produce slightly fluctuating readings in even an untouched paddle.

The primary value of paddles is twofold. First, they are well suited for choosing values of a one-dimensional variable. People can readily absorb the idea that the paddle sweeps through all values and that pressing the trigger makes the selection known. Second, the user can sweep from one end of the spectrum to the other with a twist of the dial, which makes the entire spectrum of values immediately accessible.

An important factor in the use of paddles is the creation of a closed input/output loop. In most input processes, it is desirable to echo inputs to the screen so that the user can verify the input that was entered. This echoing process creates a closed input/output loop. Information travels from the user to the input device (paddles) to the computer, then back through the video display to the user. Because it is difficult for the user to verify the position to which the paddle has been set, it is essential that the program echo the paddle input.

Any set of inputs that can be meaningfully placed along a linear sequence can be addressed with a paddle. For example, menus can be addressed with a paddle. The sequence is from the top of the menu to the bottom. It is quite possible (but entirely unreasonable) to substitute a paddle for a keyboard. The paddle could sweep through the letters of the alphabet, with the current letter being addressed shown on the screen. Pressing the paddle trigger would then select the letter. While this scheme would not produce any typing speed records, it could be useful for

## multiuser WICAT system 150

The WICAT 150-WS set a new standard of price/performance with its powerful Motorola 68000 processor, large memory, hard disk, floppy disk, and complete system software.

Now there is a flexible efficient multiuser System 150. Memory and resources are assigned dynamically to each user as needed. Program code is shared to avoid multiple copies. Background processing can be initiated. All of the power of the top of the line WICAT System 100 is here.

Concurrent Corporation will be adding full network database and screen management software as well as applications soon. We can discuss your needs with you and help select the proper configuration. Please write or call

(513) 281-1270.



**Concurrent**™ Corporation  
1870 Madison Road Cincinnati, Ohio 45206



**\$9450**

- WICAT System 150-WS (single user)  
Motorola 68000, terminal, 10MB Winchester,  
960KB floppy, 256K memory, 1 parallel and 2 serial  
ports, system software ..... **\$9450**
- WICAT SYSTEM 150-3 (three user)  
Motorola 68000, terminal, 10MB Winchester,  
960KB floppy, 256K memory, memory manage-  
ment, 1 parallel and 2 serial ports, system  
software ..... **\$10850**
- WICAT SYSTEM 150-6 (six users)  
Motorola 68000, terminal, 10MB Winchester,  
960KB floppy, 512K memory, memory manage-  
ment, 5 serial and 1 parallel ports, system  
software ..... **\$12850**



# consumer computers

# NO RISK\* MAIL ORDER DISCOUNTS

Call for details

SPECIAL • SPECIAL OF THE MONTH • SPECIAL OF THE MONTH • SPECIAL

## 16K RAMBOARD

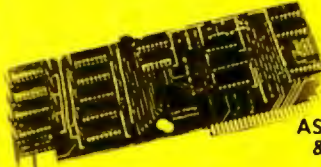

for Apple II Computers  
by ConComp

ASSEMBLED & TESTED **\$69**

RAMBOARD KIT \$50

SPECIAL • SPECIAL OF THE MONTH • SPECIAL OF THE MONTH • SPECIAL

At Consumer Computers we're experts in the business of selling computer products by mail. We have become one of the leaders not only because our prices are better, but because of the reputation we've worked hard to earn. Over the years we have learned what you, the customer, want and need from a mail order company. If we offer any merchandise that you're in the market for, you should seriously compare what we have to offer over the others. Here are just a few of the reasons.

Our helpful salespeople are prepared to meet any currently advertised price on anything we sell (call for details...it's Toll Free!). We pay shipping and insurance

charges on prepaid cash orders (with destinations in the continental US). We accept major credit cards for your convenience. If the product you receive is defective, even up to 30 days after you purchase it, we'll repair or replace it and pay for shipping back to you.

Consumer Computers carefully selects the hardware and software it offers to insure that quality is maintained in everything we sell. Our attention to quality is why we can stand behind our policy, because we stand behind our products.

You'll never regret becoming a member of our growing customer family. You have our word.

## NEC Microcomputer

The NEC PC-8001A has so many things that are options on other computers built right in that you may never have to buy another accessory! The quality that the NEC name has come to stand for has been built-in.

- 8001A Microcomputer (32K)
- iO unit with 32K ram
- The Wedge 32K Expansion mod
- NEC 8023A Printer
- Peachtree Business Software
- Report Manager
- Wordstar by Micropro
- 32K Memory Card
- Select Word Processor
- Supercalc
- BPI Accounting Software

CALL

FOR

BEST

PRICE

## Commodore

### NEW! Commodore 64

- 8032 Computer with 32K
- 4022 Dot Matrix Printer
- 4040 Dual Disk Drive (5")
- 8050J5" Dual Drive system
- 16K Pet
- 32K Pet
- SuperPet
- OZZ Information Wizard
- Viscicalc
- Dow Jones Portfolio Mgt

CALL FOR

BEST

PRICES

## ATARI

- Atari 800 (16K)
- Atari 400 w/16K
- 410 Program Recorder
- 810 Disk Drive
- 825 80 Col. 7x8 Dot matrix impact printer
- 824 80 Col. Quiet Thermal Printer
- 850 Interface Module
- Atari 16K Ram Module
- Axon Ramcrum 32K Module
- Caverns of Mars on Disk
- Microtek 16K Memory Board

CALL

FOR

BEST

PRICE

## XEROX. SAM

- 820 System with 5-1/4" drives
- 820 System with 8" drives
- Xerox 630 (RS-232) Printer
- Forms tractor for printer
- Xerox 8205 "x" CP/M 2.2
- Xerox 8208 CP/M 2.2
- Systems Plus software for Xerox

CALL

FOR

BEST

PRICE

CALL OR WRITE FOR FREE CATALOG

## APPLE II ACCESSORIES



Mountain Computer Inc.

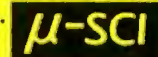

MICROSOFT



- 16K RamBoard by ConComp Industries
- Hayes Micromodem II
- Hayes Smartmodem
- Hayes Chronograph
- Novation Apple Cal
- Novation Cal Modem
- Novation Expansion Mod
- Novation Handset
- Novation BSR
- Videx Videoterm 80 Column card
- Videx Keyboard Enhancer (Rev 6)
- Videx Keyboard Enhancer (Rev 7)
- Videx Keyboard Enhancer II (Rev 7 & up)
- Videx Switchplate
- Videx Soft Video Switch
- Z-80 Softcard by Microsoft
- AppleSoft Compiler
- 16K RamCard by Microsoft
- Thunderclock clock/calendar card
- Thunderclock X-10 Inter/Scheduler
- Smartierm 80 col. card
- Corvus Winchester Disk Drives
- ALF 3 Voice Music Card
- ALF 9 Voice Music Card
- Alphasylatun keyboard system
- Lazer Lower Case +
- Lazer Keyboard Plus +
- 23 Key Numeric Keypad by Keyboard Co
- Joystick by Keyboard Co
- 6809 CPU Card (The Mill) by Stellation
- AIO Serial & Parallel Interface by SSM A&T
- Music System (16 voices)
- A/D + D/A Interface
- Expansion Chassis (8 slots)
- introlix-10 Controller card
- Clock/Calendar Card
- Supertalker SD-200
- Romplus + card
- Romwriter card
- Symtec Hi-Res Light Pen
- Sup-R-Fan
- Sup-R-Terminal
- SVA 2x4 Megabyte 8" Disk Controller

- 99 SVA 2 + 2 Single Den 8" Disk Controller
- 299 Versawriter Digitizer Tablet
- 115 Asynchronous Serial Interface card by CCS
- 229 Centronics Parallel Interface card by CCS
- 339 VisiCalc version 3.3
- 169 VisiFile (IKEWData base manager)
- 39 VisiTrend/VisiPlot
- 29 VisiDex
- 19 VisiTerm
- 249 Desktop Plan II
- 115 Easywriter Word Processor
- 99 Tax Preparer '82 version
- 129 Real Estate Analyzer
- 15 Creative Financing
- 29 Personal Filing System (PFS)
- 299 PFS Report
- 149 Peachtree Accounting Software
- 159 System P us Accounting Software
- 129 Wordstar by Micro Pro
- 49 DataStar by Micro Pro
- 299 Apple III Joystick
- CALL Microtek 16K RamBoard
- 199 Grappler Interface
- 149 Apple Cache 256K

- CALL
- Micro-Sci Disk Drives
- A2(Compatible with Apple) w/cont
- A2(Compatible with Apple) w/o cont
- 45 A40 with cont
- 319 A40 without cont
- 189 A70 with cont
- 299 A70 without cont
- 279 Micro Sci Controller card

- CALL
- Popular Games
- Typing Tutor
- Microsoft Adventure
- 135 Olympic Decathlon
- 149 Sargon II
- 210 Jawbreaker
- 45 Rasler Blaster
- 329 Gorgon
- 649 Fight Simulator

- 8K Ram Cartridge for VIC-20
- 3K Ram Cartridge for VIC-20
- Super Alien
- Jupiter Lander
- Draw Poker
- VIC Software 6 pack A
- VIC Software 6 pack B
- Datassette Cassette I/O Unit
- VIC IEEE 488 interface
- Vicomor Machine Lang Monitor
- VIC Super Expander
- VIC RS232C Terminal Interface
- VIC Printer
- 16K Memory Card by Microtek
- Victerm

- 550 Viccalc
- 534 Viccalc
- 524 VIC Portfolio Mgt
- 519 Vicheck
- 524 Voice Synthesizer CBM/PET
- 513 Pgm Chai SoftGame Graphics ED
- 539 Spiders of Mars
- 569 Outworld
- 579 Satellites and Meteorites
- 547 Alien Blitz
- 554 RS-232C Communicator Interface
- 539 18 In Communicator Cable M/M
- 36 In Communicator Cable M/M
- 599 3K RAM Expander for VIC-20 by UMI
- 516 8K RAM Expansion for VIC-20 by UMI

## VIC-20 \$249

## VIDEO MONITORS



- Amdek/Leadex Video 100 12" B&W
- Amdek/Leadex Video 100G 12" Green Phosphor
- Amdek (Hiachi) 13" Color w/audio output
- Amdek Color II
- NEC 12" Green Phosphor Display JB-1201M
- NEC 12" Lo-Res Color Display
- NEC 12" Hi-Res RGB Color Display
- Sanyo 9" B&W Display
- Sanyo 9" Green Display
- Sanyo 12" B&W Display
- Sanyo 12" Green Phosphor Display
- Sanyo 13" Color Display
- Zenith 12" Green Phosphor Display



## ACCESSORIES



- IBM Joysticks
- Easywriter II
- Viscicalc
- 256K Dynamic Ram Card
- Expansion Chassis
- Time Master
- Scribe Tender
- Scribe Master

## PRINTERS



- Anadex 9501 w/2K Buffer
- C. Itoh Starwriter F-10
- Epson MX-70
- Epson MX-80 & MX-80 FT
- Epson MX-100
- NEC Spinwriters (Latest models)
- Oxum Sprint Daisywheels (Latest models)
- Diablo 630 Daisywheel 40 CPS
- NEC 8032 Impact Dot Matrix
- Paper Tiger IDS-560G w/graphics
- New! Prism 80 by IDS w/color
- New! Prism 132 by IDS w/color
- Okidata B2A w/tractor
- Okidata B3A w/tractor
- Okidata B4A

## WE CARRY THE NEW COLOR PRISM PRINTERS

Ordering Information: Phone orders using VISA, MASTERCARD, AMERICAN EXPRESS, DINER'S CLUB, CARTE BLANCHE, bank wire transfer, cashier's or certified check, money order, or personal check (allow ten days to clear). Unless prepaid with cash, please add 5% for shipping, handling and insurance (minimum \$10). California residents add 6% sales tax. Foreign customers please add 10% for shipping. (Minimum \$500) OEM's, institutions and corporations please send for a written quotation. All equipment is subject to price change and availability without notice. All equipment is new and complete with manufacturer's warranty (usually 90 days). Showroom prices may differ from mail order prices.

Send Orders to:  
**consumer computers** Mail Order

8338 Center Drive  
La Mesa, CA 92041

COMING SOON!



FREE SHIPPING\*  
\*prepaid cash orders (continental US only)

In California and outside continental U.S. (714) 698-8088

ORDER TOLL FREE 800-854-6654

Telex 695000 Beta CCMO

children, and the concept can be applied to other selection problems.

## Joysticks

Joysticks are the simplest input devices available for the computer. Since they are very sturdy, they can be used in harsh environments. They contain only five switches (one for the red button on the joystick and one for each of the four principal directions of the compass). For this reason, their expressive power is frequently

underestimated. Joysticks, however, are surprisingly useful input devices. When used with a cursor, a joystick can address any point on the screen and can indicate a selection with the red button. With proper screen layout, the joystick can thus provide a wide variety of control functions. I have used a joystick to control a nuclear reactor (in the game Scram) and run a war game (in Eastern Front 1941).

The key to proper use of the joystick is the realization that the

critical variable is not the selection of a switch, but the duration of time for which the switch is pressed. By controlling how long the switch is pressed, the user determines how far the cursor moves. This normally requires a constant-velocity cursor, which introduces a difficult trade-off. If the cursor moves too fast, the user will have difficulty positioning it on the item of choice. If the cursor moves too slowly, the user will become impatient waiting for it to traverse long screen distances. One solution to this problem is an accelerating cursor. If the cursor starts moving slowly and accelerates if it remains in motion past a set length of time, the user can have both fine positioning and high speed.

The real value of the joystick is its high tactility. The joystick involves the user in inputs in a direct and sensory way. The tactility of the keyboard is not emotionally significant. A joystick makes sense—push up to go up, push down to go down. If the cursor reflects this on the screen, the entire input process makes much more sense to the user.

Joysticks do have their limitations. Although it is possible to press the joystick in a diagonal direction and get a correct reading of the direction, the directions are not distinct enough to allow diagonal entries as separate commands. Just as some words (e.g., "library," "February") are difficult to enunciate clearly, some diagonal orders are difficult to enter distinctly. Thus, diagonal values should be avoided unless they are used in the pure geometrical sense: up on the joystick means up, right means right, and diagonally means diagonally.

## Recap

We have discussed a number of features and devices that, taken together, constitute the elements of a language for interaction between the computer and the user. The features are:

- shapes
- color
- animation
- sound

## WHAT A BEAUTIFUL COMPUTER!



## BRIDGE computer system?

Yes, that's a familiar InterSystems computer. Starting from there we have taken the hassle out of getting a complete system up and running. In a BRIDGE system, the terminal, printer and software speak the same language. Then we integrated some unique BRIDGE software and hardware enhancements. Result—BRIDGE has configured a very good computer into a more versatile, high performance, truly integrated system.

Just consider . . .

### THE SOFTWARE

- BRIDGEMEM-DISC™ memory buffering runs CP/M 2.2 6-10 times faster.
- InterSystems Cache BIOS.
- BMATE™ screen oriented text editor/word processor, including drivers for popular terminals and printers.
- BRIDGE FORTRAN Development System—includes RATFOR preprocessor, symbolic debugger and scientific/math library.
- System diagnostic package. ● Regularly scheduled user seminars.

### THE HARDWARE

- New 6 MHz Z80 CPU with memory management system and 256KRAM memory.
- BRIDGE AUTOCHK™ automatic hardware/software check on startup.
- Disk Drive Options—two 8" (2.4M) or 5.25" (0.8M) Disks, or 8" or 5" Hard Disk.

Complete BRIDGE systems start as low as \$5900! No wonder they're saying—a BRIDGE computer system is beautiful.

Circle the reply number, today, for complete information.

Dealer inquiries invited.

 **BRIDGE™**  
Computer Company  
DIVISION OF SEA DATA CORPORATION  
ONE BRIDGE STREET  
NEWTON, MASS. 02158 U.S.A.  
PHONE: (617) 244-3203

MEM-DISK, BMATE and AUTOCHECK are trademarks of BRIDGE Computer Company, Division of Sea Data Corporation.



# Which personal computer can make you better at what you do best?

PERSONAL COMPUTER COMPARATIVE ANALYSIS

	IBM PC	Apple III	HP-87
MAXIMUM MEMORY	256 K	256 K	544 K
SOFTWARE SELECTIONS	VisiCalc® Data Communications Word Processing	VisiCalc® III Data Communications Word Processing Data Base Mgt. Business Graphics	VisiCalc® PLUS Data Communications Word Processing Data Base Mgt. Graphics Presentations Statistics (3 pkgs.) Financial Decisions Linear Programming Math AC Circuit Analysis Waveform Analysis CP/M® Library Series 80 Users' Library
EASE OF USE			
Programmable Soft Keys	10	0	14
Error Messages	73	38	107
Built-in Disc Operating System	No	No	Yes
Built-in Screen Graphics	No	Yes	Yes
RELIABILITY			
Self Diagnostics	Yes	No	Yes
Operating Temperature	61-90°F	No figures available	32-133°F

THE BIGGEST MEMORY I'VE EVER HEARD OF.

MY KIND OF SOFTWARE.

SURE LOOKS EASY.

For you, choosing a personal computer means making an intelligent decision. And isn't that what you do best?

The first step in your decision-making process is analysis. You look at all the numbers, and all the facts, before you leap. So you don't want a computer that's going to run short on memory. Not when you can have the HP-87 and a memory that expands to over half a million bytes.

Hewlett-Packard will make sure you don't run short on analytical software, either. For example, our VisiCalc® PLUS will let you turn up to 16,000 cells of data into bar graphs, pie charts or whatever you need to present your results graphically. And our CP/M® module gives you access to the expanding world of CP/M software.

We call it HP-Easy. Turn on the HP-87, and it's ready to go. The ROM-based operating system puts our built-in, enhanced BASIC to work for you. Instantly. The HP-87 has built-in commands and editing keys that eliminate complicated keystroke sequences. Whether you're generating a complex graph, writing a program or correcting errors.

And interfacing peripherals is as easy as putting a plug into a socket. That's the kind of craftsmanship that's putting all our Series 80 computers on the map. We're building power, friendliness and reliability into every one of them. From our portable partner, the HP-85, to the high-powered HP-87.

The most intelligent thing to do now? Get your hands on an HP-87. And then on the competition. You won't have any trouble making the right decision. Not if you want to get better and better at what you do best.

For the HP dealer nearest you, call TOLL FREE 800/547-3400 or in Oregon, Alaska and Hawaii call 503/758-1010. For additional product information, write Hewlett-Packard, Dept. 276L, Corvallis, OR 97330.



**Introducing the new HP-87.**  
**It's very good at what you do.**



**HEWLETT  
PACKARD**

612/02  
VisiCalc® is a registered trademark of VisiCorp—Personal Software. CP/M® is a registered trademark of Digital Research, Inc.

The devices are:

- keyboard
- paddles
- joystick

How do we assemble all these elements into an effective language? To do so, we must first determine the major traits we expect of a good language:

- completeness
- directness
- closure

### Completeness

The language must completely express all the ideas that need to be communicated between the computer and the user, but it need not express ideas internal to either thinker's thought processes. For example, the language used in Star Raiders must express all concepts related to the control of the vessel and the combat situation. It need not express the

player's anxiety or the flight-path intentions of the Zylon enemy ships. These concepts, while germane to the entire game function, need not be communicated between user and computer.

Completeness is an obvious function of any language, one that all programmers recognize intuitively. Problems with completeness most often arise when the programmer must add functions to the program, functions that cannot be supported by the language the programmer has created. This can be quite exasperating, for in many cases the additional functions are easily implemented in the program itself. The limiting factor is always the difficulty of adding new expressions to the language used between the human and the computer.

### Directness

Any new language is difficult to learn. Nobody has time to waste in learning an unnecessarily florid language. The language a program-

mer creates must be direct and to the point. It must rely as much as possible on communications conventions that the user already knows and must be emotionally direct and obvious. For example, a CTRL-X keystroke is obscure. What does it mean? Perhaps it means that something should be destroyed; X implies elimination or negation. Perhaps it implies that something should be examined, expunged, exhumed, or something similar. If none of these possibilities is indeed the case, the command is unacceptably indirect. Keyboards are notorious for creating this kind of problem.

### Closure

Closure is the aspect of communications design that causes the greatest problems. The concept is best explained with an analogy. The user is at point A and wishes to use the program to get to point B. A poorly designed program is like a tightrope stretched between points A and B. The user who knows exactly what to

# Olympic Sales Company

SERVING YOU SINCE 1947

CABLE: "OLYRAV" LSA  
Main Showroom & Offices:  
216 So. Oxford Ave.  
Los Angeles, CA 90004  
Telex: 67 34 77

WE HONOR VISA and MASTERCHARGE

ORDER DESKS  
open 6 days a week!  
7:00 am to 7:00 pm Mon thru Sat  
Order Desks: (213) 739-1130

TOLL-FREE (outside Calif.) 800-421-8045  
TOLL-FREE (within Calif.) 800-252-2153

Prices shown are for mail or phone orders; Walk-in slightly higher.

Goods subject to availability; OSC will meet or beat almost any advertised price as long as the competition has the goods on hand; not responsible for typographical errors; prices & specifications subject to change without notice; this ad supercedes all previous ads; min shipg & hndlg \$5.95; Send \$2 for 112-pg catalog!

## hp HEWLETT PACKARD

HP-87 32K Bytes standard \$1885.00

82907A	32K Mem. mod.	239.00
82908A	64K Mem. mod.	337.00
82909A	128K Mem. mod.	537.00

HP-85A Computer \$1985.00  
HP-125 Computer 1985.00  
HP-41C Prog. scientific 188.00  
HP-41CV Prog. scientific 248.00  
HP-41 Card reader 168.00  
HP-41 Printer 297.00  
HP-41 Optical wand 99.00  
82106A 41C Memory module 26.00  
82170A 41C Quad mem. mod. 84.00  
82160A HP-IL interface 109.00  
82161A Cassette drive 437.00  
82162A HP-IL printer 397.00  
HP-97 Prog. scien/printer 584.00  
HP-32E Scientific 55.00  
HP-33C Prog. scientific 74.00  
HP-34C Adv. prog. scientific 114.00  
HP-37E Business 74.00  
HP-38C Prog. financial 119.00  
HP-11C Prog. scientific 114.00  
HP-12C Prog. financial 127.00  
82905A Impact printer 619.00  
82901M 5 1/4" dual drive 1699.00  
9895A 8" dual drive 4499.00  
2631 B Impact printer 2999.00  
2601 A Letter qual. ptr. 2999.00

85-15001 Mass storage ROM 124.00  
85-15002 Plot/print ROM 124.00  
85-15003 I/O ROM 239.00  
85-15004 Matrix ROM 124.00  
85-15005 Adv. prog. ROM 124.00  
85-15007 Assembler ROM 239.00  
82903A 16K mem. module 169.00  
82937A HP-IB interface 328.00  
82939A Serial interface 338.00  
82940A GPIB interface 408.00  
82941 A BCD interface 408.00  
82949A Parallel ptr. int. 239.00  
HP-7470A Hi-speed color graphic plotter w/interface 1269.00

Your Cost \$229<sup>95</sup>  
Retail \$325.00

MATEL ELECTRONICS  
Intellivision  
Most animated TV game!  
Large selection of cartridges!

## Texas Instruments Home Computer

New TI-99/4A - 48K RAM  
100% TI parts w/Extended Basic  
or TI-LOGO Re: \$1300 Y/C: \$3689.95

TI-99/4A Only \$299<sup>95</sup>

16K 10" color monitor high res  
32K memory module  
Extended Basic  
Speech synthesizer  
Disk memory drive  
Telephone coupler (modem)  
Printer (solid state)  
TI-LOGO

RETAIL	Your Cost
374.95	339.95
399.95	314.95
100.00	75.00
149.95	129.95
499.95	394.95
224.95	189.95
399.95	319.95
250.00	99.95

## AMDEK Loedex

High Quality Monitors

Model	Description	Retail	Your Cost
100	12" B/W, 12 MHz	189.00	149.00
300-G	12" Green, 18 MHz	269.00	199.00
Color I	13" Color, NTSC comp. input, audio amp & spkr	499.00	359.00
Color II	13" Color, RGB input, hires graphics, spkr	1295.00	799.00

## SANYO MONITORS

High resolution, number one seller!

	Retail	Your Cost
15" Black & white	390.00	199.00
13" color (DM 6113) RGB, High Res	1195.00	989.00
13" color (new) high quality!	650.00	449.00
12" Green phosphorous	360.00	269.00
12" Black & white	340.00	249.00
9" Black & white (the best seller)	235.00	179.00
9" Green phosphorous	295.00	199.00

## commodore VIC-20

5K Personal Computer  
(Expands to 32K) Works with any TV!

Retail: \$300.00 Your SPECIAL Cost: \$259.95  
FREE with purch of VIC-20 one \$49.50 LCD Pen Watch!  
Commodore Datasette: Recorder  
for VIC-20 Your Cost: \$68.95 We carry all peripherals, software & access. for the VIC-20 (we will beat any price)!

## ATARI COMPUTERS IN STOCK

Model	Retail	Your Cost
800 16K	1080.00	689.95
800 48K	1280.00	789.95
800 160K		
(800-32K + 128 RAM disk)		1299.95
810 Disk drive		600.00 469.95
Atari VisiCalc		200.00 169.95
825 Impact Ptr		1000.00 779.95

SUPER SPECIAL - ATARI 400 (16K)  
Your Cost \$299.95  
Retail \$595.00  
400 Lang. card opt. \$49.95

FOR ATARI 400 & 800-  
GHOST HUNTER (similar to Pac-Man)  
Disk \$34.95 Cassette \$29.95

## ATARI

Atari's game cartridge  
Pac-man \$35<sup>95</sup>

## APPLE COMPUTERS

Graphics Tablet  
Second disk drives  
Disk with controller DOS3.3 VisiCalc/Apple II & III  
Pascal-Fortran-Cobol languages most available!

## EPSON PRINTERS

	Your Cost
MX70	\$299.95
MX80	429.95
MX80 with graftrax	499.95
MX80 FT	599.00
MX100	749.00
Graftrax chip	95.00

## AXLON HOTLINE Model 1

HAND-HELD Personal Communication TERMINAL with BUILT-IN Modem Y/C: \$399.95

## AXLON Memory Expansion for ATARI & APPLE

RAMCRAM Instant 32K boost for your Atari 400 or 800 software; can be used as add'l disk-function for function.  
Re: \$189.00 Y/C \$119.95

RAMDISK 128K for Atari 800-comp w/existing Atari 800 software; can be used as add'l disk-function for function.  
Retail \$699.00 Your Cost \$499.95

RAMDISK for APPLE 320K bytes of RAM (200K) mem. designed to function like 2 35 track floppy disk drives; comp. atile w/Apple DOS 3.3 & Apple Pascal 1.1  
Retail \$1395.00 Your Cost \$1095.00



# SIGGRAPH '82

Plan now to attend SIGGRAPH '82, The Ninth Annual Conference on Computer Graphics and Interactive Techniques, July 26-30 in Boston.

The premier national event in computer graphics. SIGGRAPH '82 is the only conference where you can get a well-focused and in-depth perspective on both the present and future directions of this challenging aspect of computer technology.

SIGGRAPH '82 is a complete technical conference covering every phase of computer graphics. The conference features:

- Exhibits by more than 140 companies displaying the latest graphics hardware, software, peripherals, and services
- 24 diversified courses including introductory tutorials and advanced seminars
- Technical sessions featuring the latest in research and innovative applications
- Detailed vendor forum presentations
- Computer-generated film and art shows

For registration information, call or write:  
SIGGRAPH '82  
Convention Services Department  
111 East Wacker Drive  
Chicago, Illinois 60601 U.S.A.  
312/644-6610



acm

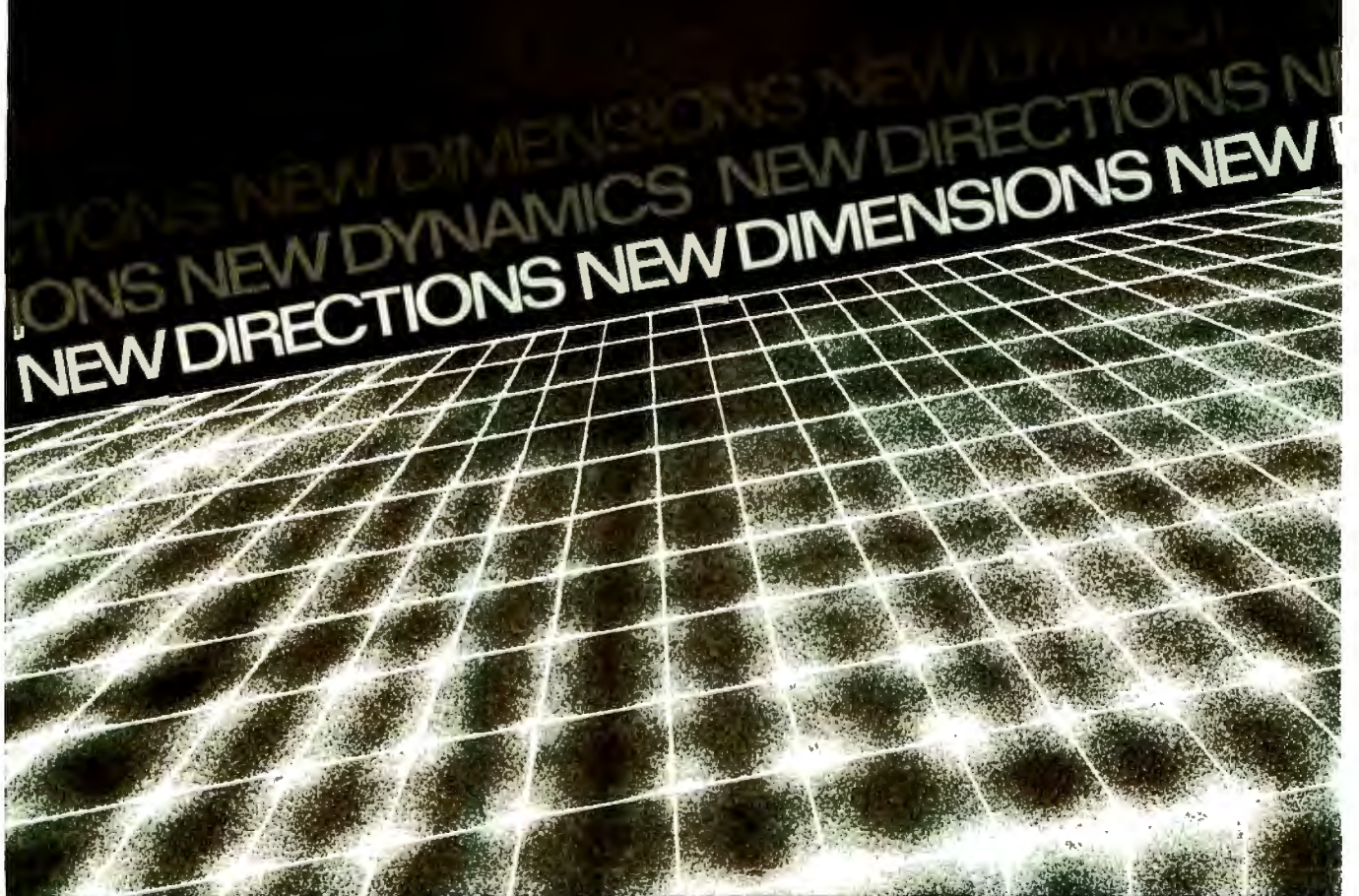

Sponsored by the Association for Computing Machinery Special Interest Group on Computer Graphics in cooperation with the IEEE Technical Committee on Computer Graphics, Eurographics, Harvard Graphics Week, and the Summer Institute of Media Arts.

do and performs perfectly will succeed. More likely, he or she will slip and fall. Some programs try to help by providing a manual or internal warnings that tell the user what to do and what not to do. These are analogous to signs along the tightrope advising "BE CAREFUL" and "DON'T FALL." I have seen several programs that place signs underneath the tightrope, so that the user can at least see why the fall is happening. A somewhat better class of programs provides masks against illegal entries, equivalent to guardrails alongside the tightrope. These do help, but they must be well constructed to ensure that the user does not thwart them. Some programs have nasty messages that bark at the errant user, warning against making certain entries. These are analogous to scowling monitors in school corridors, and they are useful only for making an adult feel like a child. The ideal program is like a tunnel bored through solid rock. There is but one path, the path

leading to success.

The essence of closure is the narrowing of options, the elimination of possibilities, and the placement of rock-solid walls around the user. Good design is not an accumulative process of piling lots of features onto a basic architecture; good design requires the programmer to strip away minor features, petty options, and general trivia.

---

**While the strengths of the keyboard are undeniable, its weaknesses are seldom recognized.**

---

This contention clashes with the values of many programmers, who crave complete freedom to exercise power over the computer. Their most common complaint against a program is that it somehow restricts their

options. Thus, deliberate advocacy of closure is met with shocked incredulity. Why would anyone be so foolish as to restrict the power of this wonderful tool?

The answer lies in the difference between the consumer and the programmer. The programmer's life is devoted to the computer; the consumer is a casual acquaintance at best. The programmer uses the computer so heavily that it is cost-effective to take the time to learn to use a more powerful tool. Since the consumer does not have such time to lavish on the machine, a simple, quick operation is required. The fine points that a programmer dotes on are not important to the user; nor are the bells and whistles cherished by programmers. As a programmer, you may not share or approve of the consumer's values. But if you want to maintain your livelihood, you had better cater to them.

Closure is obtained by creating inputs and outputs that do not admit illegal values. This is extremely difficult to do with a keyboard, for a keyboard always allows more entries than any real program would need. This provides an excellent argument against the use of the keyboard. A joystick is much better because you can do so little with it, making it easier to conceptually exclude bad inputs. The ideal is achieved when all necessary options are expressible with the joystick and no further options will fit. In this case, the user cannot make a bad entry because it doesn't exist. More important, as in the language Newspeak in George Orwell's *Nineteen Eighty-four*, the user cannot even conceive bad thoughts because no words (inputs) for them even exist.

Closure is much more than masking out bad inputs. Masking makes bad inputs conceivable and expressible, but not functional. For example, a keyboard might be used with the "M" key disabled because it is meaningless. The user can still see the key, can imagine pressing it, and can wonder what would happen if it was pressed—all wasted effort. The user can waste even more time by pressing

**RESCUER 1...  
all new  
Z80 versatility  
from Eltec.**

**Eltec's New Z80 Board provides  
CPU, EPROM, RAM, Serial and Parallel I/O  
with STD\* Bus and more...all on one board!**

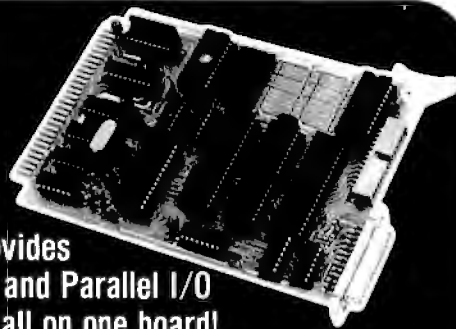

For the first time you can have the powerful Z80 CPU, up to 8K EPROM and 2K RAM plus the added capability of adding external memory. The New Eltec RESCUER 1 Board accepts four of the popular 2716 or two 2732. It provides RS232C interface with baud rates from 110 to 4800 (2 mhz version) or 110 to 9600 baud (4 mhz version). Interface is via the on-board RS 232 connector. Zilog parallel I/O chips provide two completely independent channels of I/O, accessed via 26-pin ribbon header on the board.

RESCUER 1 comes complete with Z80, one EPROM, one RAM, full capability described above. Operating system included provides minimum utilities such as display memory, enter memory, select baud rate, etc. 2 mhz version \$289.00; 4 mhz version, \$314.00. Use your Visa or Mastercard. Phone or write for details.

Only **\$289.**  
complete!



\*95% complete

**Electrotechnics  
Corporation**



P.O. Box 8122  
Shreveport, Louisiana 71108  
Ph. (318) 636-0563



# Express yourself past check-in lines on TWA.



With TWA's Round-Trip Check-In and Advance Seat Selection you can express yourself past check-in lines.



Express yourself straight to the gate and...



express yourself straight to your seat.

## It's easy with TWA's Airport Express.

Nothing gets you past check-in lines and through the airport faster than TWA's Airport Express.<sup>®</sup> And that's because with TWA's Round-Trip Check-In,<sup>®</sup> Connection Check-In<sup>SM</sup> and Advance Seat Selection you can get boarding passes and seat assignments for your outbound, connecting and return flights before you depart.

So on your trip home you can go straight to your seat on the plane. Instead of straight to the back of a check-in line.

Ask for TWA's Airport Express. And express yourself past check-in lines.

### Get 2 free First Class tickets to Europe

At TWA we believe in rewarding our frequent business flyers for making us their number one choice. In addition to

our current Frequent Flight Bonuses<sup>SM</sup> which begin at 10,000 miles, we've just added 2 new Frequent Flight Bonus levels. So now if you fly 75,000 miles in the U.S. on TWA during the course of our program, we'll give you 2 free First Class tickets to anywhere we fly in the U.S. And if you fly 95,000 miles anywhere we fly in the U.S., we'll give you 2 free First Class tickets to Europe. You can take advantage of both tickets yourself, or use them to treat a friend or colleague to a free trip. Airport Express and Frequent Flight Bonus. Two ways TWA is helping to make business travel a pleasure.

For complete details, and reservations, call your travel agent, corporate travel department or TWA.

You're going to like us



it and wondering why nothing happened. The waste is compounded by the programmer imagining the user doing all these wasteful things and putting in code to stop the symptoms without eliminating the disease. Why are these people wasting so much time over a button that doesn't do anything in the first place? A properly closed input structure avoids all these problems because it uses an input device that can express only the entries necessary to run the program—and nothing more. The user can't waste time dealing with something that isn't there, and the programmer can't waste time masking out bad inputs that can't be entered.

Closure provides an important feature for the beginning user: security. Imagine the naive user peering down at an army of deadly keys, each one laden with the potential for triggering World War III, or at least destroying the computer. A properly

closed program offers fewer choices and fewer lurking disasters. Less perceived opportunity for failure generates confidence that, in turn, generates more fluent use of the program.

---

**The designer must carefully weigh the capabilities of the machine and the needs of the user.**

---

Many advantages accrue to the programmer when closure is properly applied. Code is tighter and runs faster because there need be no input error checking. Program structure is simpler because there are fewer logical tests and branches. Less testing is needed because there are fewer input conditions to test.

The primary problem with closure is the design effort that must be expended to achieve good closure. The entire relationship between the user and the program must be carefully analyzed to determine the minimum vocabulary necessary for the two to communicate. Numerous schemes of communication must be examined and discarded before the true minimum scheme is found. In the process, many bells and whistles that the programmer wanted to add will be eliminated. An objective viewpoint will conclude that the bells and whistles are more clutter than chrome.

### Conclusions

The design of the language of communication between the user and the program will be the most difficult part of the design process in consumer software. The designer must carefully weigh the capabilities of the machine and the needs of the user. The information that flows between the two sentient beings must be precisely defined. The language is then designed to maximize the clarity (not the quantity) of information flowing to the user while minimizing the effort the user must expend to communicate with the computer. The language must utilize the machine's features and devices effectively while maintaining its own completeness, directness, and closure.

The result will be a program that eliminates mental distance between the user and the computer. The two thinking beings achieve a mental resonance, an intellectual communion. ■

# Music and Art Cross Paths at the Computer

**DIGITAL HARMONY**  
On the Complementarity of Music and Visual Art  
By John Whitney

BYTE Books is pleased to offer *Digital Harmony*, a major new work by John Whitney. *Digital Harmony* lays the foundation for the new field of audiovisual art made possible by microcomputers. Whitney, whose film art has been an influence on technological arts and cinematic special effects from *STAR WARS* to *2001: A SPACE ODYSSEY*, explores the special union of music and computer graphics. Colorful illustrations as well as the program listings that generated them are included. The descriptions are sufficient for any composer or computer experimenter to transform the small computer into an ideal instrument for creating compositions in aural and visual art.

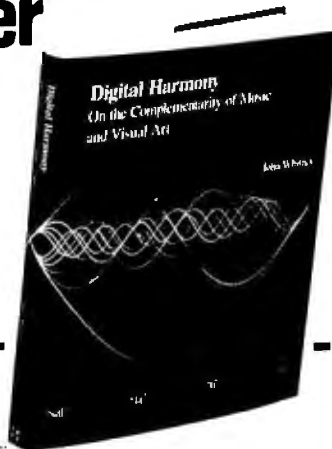

**BYTE BOOKS**

Please send me: \_\_\_\_\_ copies of DIGITAL HARMONY \$21.95

Add 75¢ per book to cover postage and handling.  
Please remit in U.S. funds or draw on a U.S. Bank.

Check enclosed in the amount of \$\_\_\_\_\_

Bill VISA     Bill MasterCard

Acct. No. \_\_\_\_\_ Expires \_\_\_\_\_

Name \_\_\_\_\_

Title \_\_\_\_\_

Company \_\_\_\_\_

Street \_\_\_\_\_

City \_\_\_\_\_ State/Prov. \_\_\_\_\_ Code \_\_\_\_\_

Call our toll-free Number **800-258-5420** 70 Main St. Peterborough, NH 03458

*The Atari Tutorial ends this month with Chris Crawford's essay on human engineering. We at BYTE have been proud to present it to you, and we want to thank Chris Crawford, Bob Fraser, Kathleen Pitta, and Lane Winner for making it possible.*

*In the past year, the Atari 400/800 computer has become one of the most popular microcomputers. We plan to continue coverage of the Atari in BYTE, and we are very interested in seeing Atari-related articles from you. . . .G. W.*





**WHEN AMERICAN BUSINESS HITS THE ROAD,  
AMERICAN BUSINESS MERGES AT HILTON.**

**HILTON**

**AMERICA'S BUSINESS ADDRESS™**







# Upward Migration

## Part 1: Translators

*Using translation programs to move CP/M-86 programs to CP/M and MS-DOS*

---

Roger Taylor and Phil Lemmons  
c/o BYTE Publications Inc.  
POB 372  
Hancock, NH 03449

---

In software migrations as in any other, the first thing you must know is where you are and where you are going. If a Californian decides to move to Australia, he can call an airline, ask for a ticket from San Francisco to Sydney, and the airline clerk will be happy to reserve a seat for him. If the Californian asks for a ticket from Los Angeles-or-San Francisco to Sydney, however, the airline clerk will find the request confusing. If the Californian asks for a ticket from Los Angeles-or-San Francisco to Sydney under Catholic rule, or a ticket from Los Angeles-or-San Francisco to Sydney under Protestant rule, the airline clerk will probably say, "You've already spent too much time in the hot tub, buddy. Stay in California. You're right where you belong."

In this little parable of modern

times, Los Angeles is the 8080, San Francisco is the Z80, Sydney is the 8086, Catholicism is CP/M-86, and Protestantism is MS-DOS. The

---

**XLT86 takes 8080  
source code and  
converts it into  
8086 source code  
in an intelligent  
manner using  
data-flow-analysis  
techniques.**

---

operating systems are represented by religions because they generate similar passions, controversies, true believers, and skeptics.

Is there really any need to explain

why Los Angeles stands for the 8080 and San Francisco for the Z80? Or that the airlines stand for the software houses that have written translation programs?

You've probably guessed who the guy is who's trying to buy the ticket. He's the experienced 8080 or Z80 programmer, and the hot tub symbolizes his strong preference for staying right where he is—on one familiar processor with one familiar operating system. What could be cozier?

The programmer may not have the urge for going, but he has to go to one unfamiliar processor and to both operating systems. And so do the rest of us.

We're lucky to have software from at least three companies to help us along. In this article, the first of two parts, we will review three CP/M-80-to-8086 translator programs. We'll

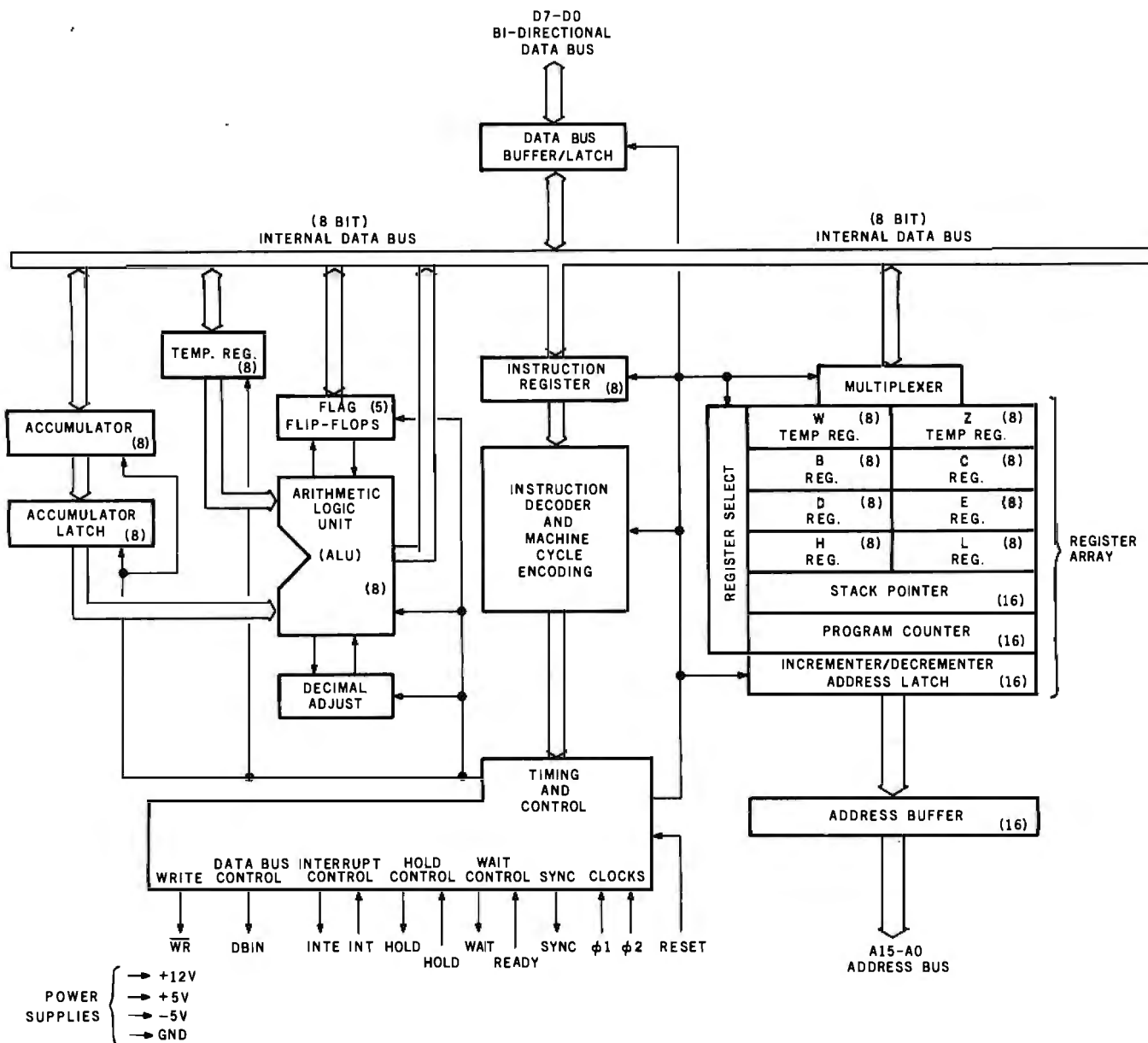

Figure 1: Architecture of the 8080 microprocessor showing the internal registers.

show the output that each of the three translators produced from the same original code. In addition, we'll make some observations about the differences in adapting the translated code to CP/M-86 and MS-DOS. Next month, we'll take a closer (although still not comprehensive) look at CP/M-86 and MS-DOS.

### Orientation to the 8086

The first thing we have to do is examine the differences between the familiar 8080 and Z80 microprocessors and the 8086. For reference, figure 1 shows the registers and architecture of the 8080; figure 2 shows

the registers and architecture of the Z80. We'll make few comments about these registers because they are familiar to you if you have 8080 or Z80 source code that you want to translate.

Figure 3 shows the registers and architecture of the 8086. Since the 8086 is less familiar, we'll take a brief look at it for orientation. (For further enlightenment, see *The 8086 Book*, Russell Rector and George Alexy, Osborne/McGraw-Hill, 1980, and *The 8086 Primer*, Stephen P. Morse, Hayden, 1980.) The 8086 is, of course, a 16-bit microprocessor. The 8088 is the same as the 8086 inter-

nally. Externally, however, they appear different due to the 8-bit bus of the 8088 and the 16-bit bus of the 8086. This means that programs that run on the 8088 will also run on the 8086 assuming that the memory resources and peripheral resources are the same. In general, statements in this article that apply to the 8086 apply to the 8088 as well.

The 8086 can access up to 1 megabyte of memory and as many as 65,000 input/output ports. The megabyte of memory is  $2^{20}$  8-bit bytes; any two consecutive bytes are a 16-bit word. Some 8086 instructions access bytes; others access words.





INTERTEC  
DATA  
SYSTEMS.

# WE'VE WON THE PRICE WARS

When it comes to Intertec microcomputer equipment we've won the battles over pricing, service, and support. And we fully expect to keep on winning.

## **The Battle Over SuperBrain™**

The micro with the best price/performance ratio in the industry just got better. When Intertec reduced its prices, we were ready. With machines in stock at the absolute lowest prices anywhere and 72-hour warehouse burn-in, we won the battle over SuperBrain with little opposition. It's just what you'd expect from Intertec's largest dealer in the Northeast.

## **The Strategy of the CompuStar™ Network**

Just the system for the dealer or OEM who wants to make it big in the business market. The expandability of the CompuStar network lets you answer your clients' needs today and tomorrow. And our low prices let you offer a package your customers can afford to buy and you can afford to sell.

Because we're experts in networking and support, Intertec has chosen us to distribute this incredible, expandable business system.

## **Our Foreign Wars**

No matter where the need for microcomputer equipment arises, TriStar is Circle 453 on inquiry card.

there. Our products, our prices, and our support sound good in any language. We welcome all international inquiries.

## **Our Infiltration Into the Government**

We've infiltrated the government on the local, state, and federal levels with the kinds of systems, support, and prices that governments require. To TriStar, there's no such thing as red tape; just special customers with special needs that we can easily satisfy.

## **The Secret to Our Success**

It's called SSDS—Single Source Dealer Support. With well over 10 years in the computer industry, we've got the knowledge, experience, products, support, and flexibility that dealers and OEMs look for.

We've got a full line of printers to meet any customer's requirements. We've got a library of software, from the most common to the most unusual. We've got a substantial inventory of spare parts and we offer 24-hour turn-around on replacement modules. And most importantly, we've got the ability to develop new support capabilities as quickly and as expertly as anyone in the industry.

## **If You Want to Sign Up**

Your commitment can be as large or as small as you want. You can buy one machine or 100. No matter, we'll give

## **With SuperBrains™ From \$1995**

you all the support you want on product knowledge, hardware service, marketing and sales support, and pricing. For instance, the leads we get from our national advertising are passed on to you. Our hardware service is fast and reliable. And our technical personnel are always available to help with software development, systems configuration, communications, and installation.

It's tough out there, but the rewards are great. And with the strong support TriStar can give you, chances are you'll win some wars of your own.

You and your customers are welcome to visit our facilities for a tour and free demonstration. For more information, call 609-424-4700 or 215-629-1289. To order, call toll free (800) 257-5217.

**See us at COMDEX/SPRING '82,  
Booth 1011.**

# TRISTAR

2 Keystone Avenue  
Cherry Hill, NJ 08003

SuperBrain and CompuStar are trademarks of  
Intertec Data Systems  
© 1982, TriStar

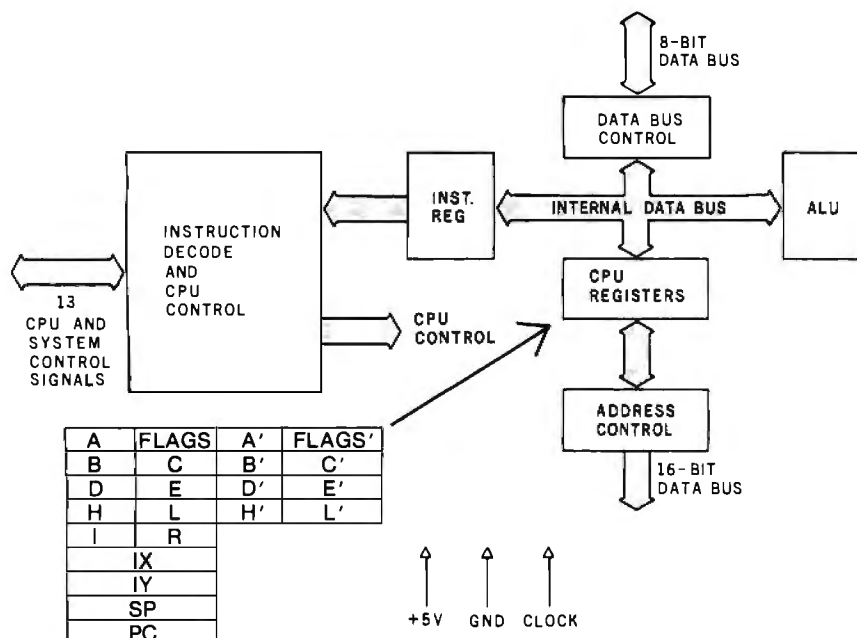

Figure 2: Architecture of the Z80 microprocessor showing the internal registers.

Sixteen bits are not enough to address a megabyte of memory. The 8086 manages to do so, however, by dividing the megabyte of memory into a number of segments of 64K bytes each. Each segment begins at an address that yields an even result when divided by 16.

All calculations of memory addresses in the 8086 involve four special registers called segment registers. The 8080 family has a 16-bit address bus that allows addressing of 65,536 bytes of memory. While the internal registers of the 8088/8086 family also have 16 bits, the external address bus has 20 bits. To get the 20-bit address, the 8086 extends a segment register with 4 low-order bits of 0, and adds the segment register to a 16-bit address from another register, as shown in figure 4.

Each segment register defines what is known as its own "current" segment. Each instruction specifies an offset into a segment. The segment registers, which *cannot* be used interchangeably, are as follows:

**CS**—The Code Segment register defines the 64K-byte current code segment. When an instruction is fetched, the contents of the program counter are added to the CS register contents to calculate the address of the instruction to be fetched.

**DS**—The Data Segment register defines the current data segment. With three exceptions, all data memory references are understood in relation to the DS register. (The exceptions are that the stack pointer is used to calculate stack addresses, any data memory addresses calculated using the BP register are taken in relation to the stack segment, and any string operations involving the destination are taken in relation to the extra segment. See SS and ES immediately below.)

**SS**—The Stack Segment register identifies the current stack segment. References to data memory that use the BP or SP register in calculating the address are understood in relation to the SS register. For example, the PUSH, POP, CALL, INT, and RET instructions use the SS register.

**ES**—The Extra Segment register plays

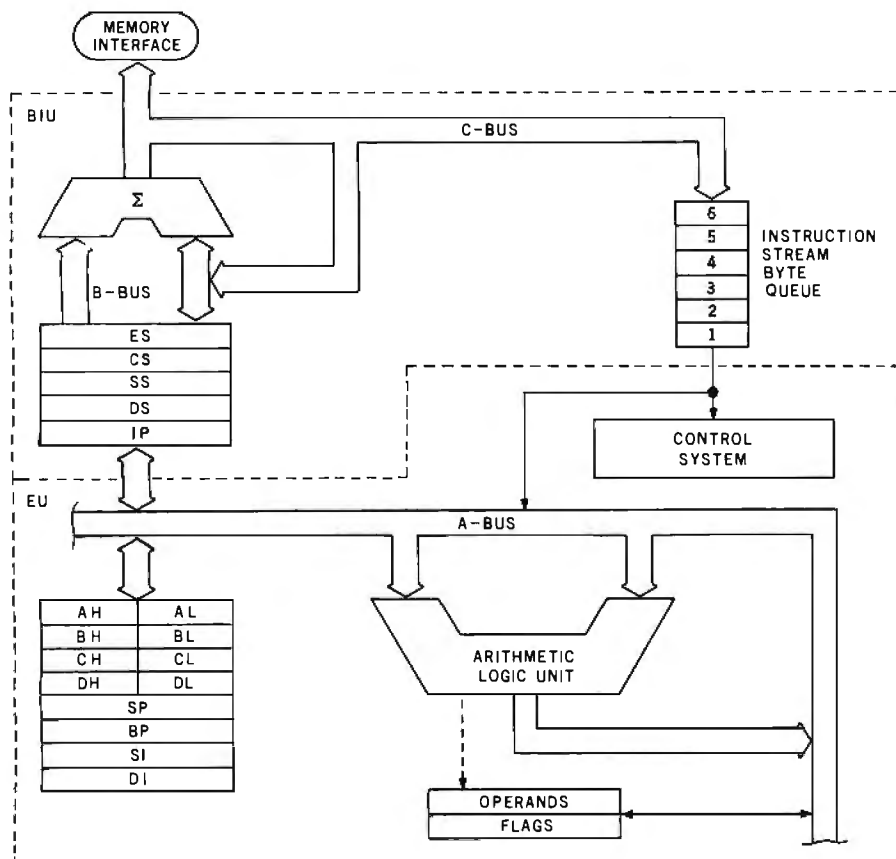

Figure 3: Architecture of the 8086/8088 microprocessor showing the internal registers.



# Take your pick of the litter.

When you're ready to let your computer out and introduce it to the rest of the world, one of the Cat family of Modems is the way to do it.

Take your pick. You can't go wrong. They're all purebreds—from Novation, the recognized world leader in personal communications.



## Cat Acoustic Modem

Fast, accurate, reliable originate/answer modem—with built-in diagnostics. Just add your computer and phone. Then dial up the world. \$189\*\*

## Super Mike

Replace your phone's carbon mike with Super Mike. No more carbon granule problems. Making things perfectly clear has never been so easy.

\$14.95\*\*

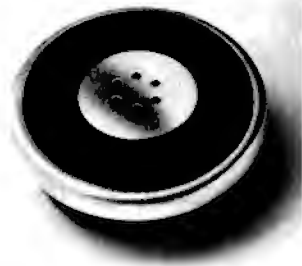

## Auto-Cat

Answers automatically and stores data in your computer until you're ready. The world's first LSI 103 modem. State-of-the-art, all digital, crystal controlled direct connect.

You're off the hook for under \$250\*\*



NEW

## Apple-Cat II™\*

Major breakthrough—the intelligent modem. Slips into your Apple. All auto functions, selectable baud rates, Serial RS-232 port, BSR X-10 controller\*\*\* easy-to-use self-prompting format. Other options available.

From \$389\*\* including software



## D-Cat

Get the performance and reliability of a direct connect modem (up to 20dB improvement) with the portability and price of an acoustic. Use it at home. Use it at work. Truly unique. So's the price. \$199\*\*

# Novation



Call for details: **(800) 423-5410**

In California (213) 996-5060

Available from Avnet Electronics, Hamilton Electro, Hamilton Avnet, Kierulff Electronics, Byte Shops, Computerland, and your local computer store.

Novation, Inc., 18664 Oxnard Street, Tarzana, California 91356

\*Apple is a registered trademark of Apple Computer Inc. Cat is a trademark of Novation, Inc. which does not make Apple computers.

\*\*Suggested retail price \*\*\*BSR is a trademark of BSR Corporation

Circle 339 on inquiry card.

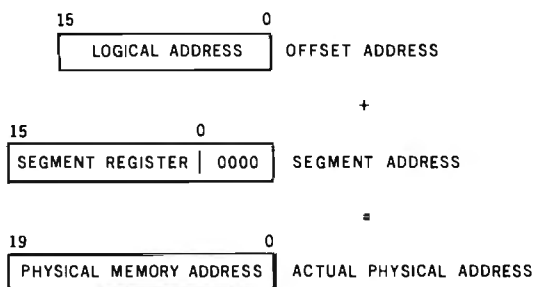

**Figure 4:** The 8086 extends a segment register with 4 low-order bits of 0. It then adds the segment to a 16-bit address from another register to achieve a 20-bit address.

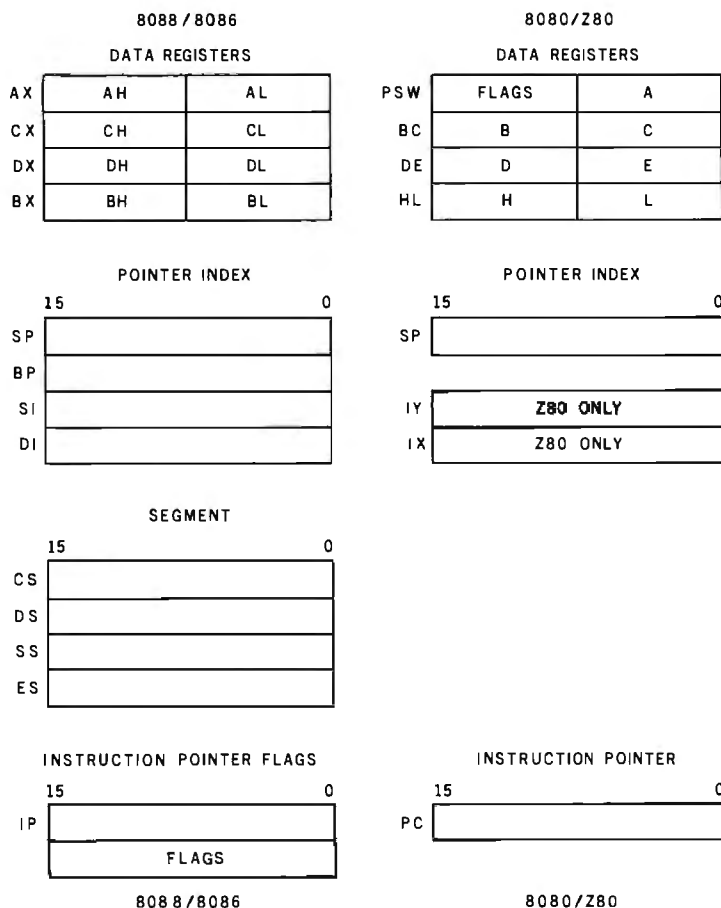

**Figure 5:** Register-usage mapping between the two processor families is shown. Note that the IX and IY registers of the Z80 do not exist for the 8080/8085. More registers are in the 8088/8086 than in either the 8080 or Z80. Observe that the 8088/8086 segment registers have no parallel in the 8080/Z80 family. The 8080 family has a 16-bit address bus that allows addressing of 65,536 bytes of memory. While the internal registers of the 8088/8086 family also have 16 bits, the external address bus has 20 bits, formed by extending a segment register with 4 low-order bits of 0, and adding it to a 16-bit address from another register.

a role in string operations. All destinations of string operations use the DI register in calculating addresses, and are taken relative to the ES register.

Besides the four segment registers, the 8086 has the following:

- Four general-purpose registers: AX, BX, CX, and DX. Each is addressable as a 16-bit register or as two 8-bit registers. When addressed as 8-bit registers, the pairs are called: AH, AL; BX, BL; CH, CL; and DH, DL. The general-purpose registers hold the intermediate results of operations.
- Four pointer and index registers; these locate data within a specified segment of memory. SP is the stack pointer, BP the base pointer, SI the source index, and DI the destination index.
- One program counter.
- One 16-bit flag register (program status word, or status register) containing nine flags.

Now that we've looked inside the 8086, we can take a look at how register usage in the 8080/Z80 processor family corresponds generally with that in the 8086. Figure 5 shows the sets of registers alongside each other so that you can see the general correspondence clearly. Note that the IX and IY registers of the Z80 do not exist for the 8080/8085. On the other hand, the alternate register set of the Z80 (not shown) as well as the I and R registers have no parallel in the 8086 register set; operations involving these will require special attention from the programmer after the conversion is done.

Clearly, the 8086 has more registers than either the 8080 or Z80. Since the 8086 also has a more powerful instruction set, translation should be possible with minor restrictions.

### Complications

Since all CP/M-80 programs had to exist in a 64K-byte region, there should be little trouble fitting a translated program into a 1-megabyte (1,048,576-byte) region. If you're translating from the Z80, however, things are complicated slightly





## S-100 Boards from S. C. Digital

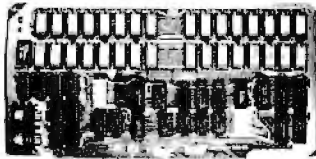

### 256K DYNAMIC RAM

features: **Model 256KE**  
 ● 16 or 24 bit address. ● 8/16 bit wide data ● Transparent refresh with unlimited OMA, immune to Wait States, halts, resets. ● Fast access time 180nsec from Smemr or Psync high, will run with Z80, Z8000 to 8mhz, 8080, 8085, 8086 to 8mhz without Wait States. ● Accepts 4116, 4164's.

### 64K DYNAMIC RAM 'Uniselect: 2'

features: **Model 64KUS**  
 ● 16 or 24 bit address. ● 8 bit data. ● Bank select by SW settable port, bits in two blocks. ● Two 32kb (128kb) addressing. ● Transparent refresh - same as M:256KE. ● Fast access time - 220nsec, will run with Z80, Z8000 to 4mhz, 8080, 8085, 8086, 8088 to 5mhz without Wait States. ● Can be configured to various multiusers OS's. ● Expandable to 256K8 using 4164's.

### 32K STATIC RAM 'Uniselect: 3'

features: **Model 32KUS**  
 ● Fully Static using 2k by 8 NMOS chips. ● 16 or 24 bit address. ● 8/16 bit wide data. ● Bank Select by port and bit in 32K block. ● Two 16K block addressing with window capability in 2k increments. ● EPROM can be mixed with RAM. ● Fast access - 250nsec from address valid - will run with Z80, Z8000 to 4mhz, 8080, 8085, 8088, 8086 or 68000 to 8mhz without Wait States. ● Provision for Battery Backup.

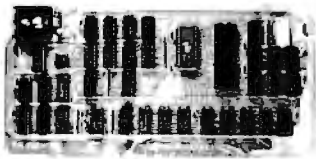

### Z80 CPU Board

features: **Model CPU1 Z80**  
 ● 2 or 4mhz clock. ● Jump on Reset. ● 8 levels of prioritized vectored interrupts.

### I/O, Memory Interface 'Interface: 1'

features: **Model 3SPC**  
 ● 3 serials using UART, RS-232C or 20ma current loop. ● 1 Parallel I/O with hand shakes. ● 4k Ram, 4k EPROM (not supplied). ● Built in Kansas City Audio Cassette interface. ● Baud rate generator from 19.2kbaud to 110 baud.

### 2K Z80 Monitor Program available for M:3SPC

features: many routines including breaker points, cassette record and play back . . . etc. Comes in 2 EPROMs and 1K RAM.

All boards conform to IEEE696/S100 specifications, fully socketed, screened legends, masks, Gold contacts. Guaranteed One Full year.

Model	Prices	with	
256KE	\$795	256KB	A&T
256KE-126	\$535	128KB	A&T
64KUS-64	\$395	64KB (4164's)	A&T
64KUS	\$395	64KB (4116's)	A&T
64KUS-16	\$295	16KB	A&T
32KUS	\$399	32KB	A&T
32KUS-16	\$269	16KB	A&T
32KUS-N	\$149	no memory	A&T
CPU1-Z80	\$219	with interrupt	A&T
CPU1-Z80-K	\$149	no interrupt	Kt
3SPC	\$229	with cassette	A&T
3SPC-KC	\$159	with cassette	Kt
2K Monitor	\$ 55	with 1K Ram	

Delivery is within 3 working days. MC, Visa or COD orders accepted. Illinois residents add 5 1/4% sales tax.

O.E.M. & DEALER PRICING AVAILABLE

## S. C. DIGITAL

P.O. Box 906, Aurora, Illinois 60507  
 Phone: (312) 897-7749

because its extensive instruction set has to be mapped to the 8086 instructions, as well as the 8080 registers.

The 8086 does, however, have a rich instruction set that covers all the bit instructions and most of the block instructions. The problems encountered in mapping instructions and registers can be formalized and solved by using a variety of software tools.

To convert a source file running under CP/M-80 so as to assemble it with an 8086 assembler requires either the use of a code translator or a considerable effort with a program editor. At least three commercial products come under the translator category:

- XLT86 from Digital Research Inc.
- TRANS86/ACT86 from Sorcim
- The Z80-to-8086 translator from Seattle Computer Products

Intel also has a translator, CON-VERT 86, but it is sold only as part of a large software package intended for its OEM customers and doesn't run under CP/M. In addition, some reports indicate that Microsoft may soon bring out a translator.

Two issues must be addressed when converting from a CP/M-80 source:

#### 1. Where is the source coming from?

Z80 instruction mnemonics?

- (a) Zilog
- (b) TDL (Technical Design Labs)
- (c) Intel (Digital Research with macros)
- (d) Sorcim/ACT-80

or

Straight 8080/8085 code with no macros?

#### 2. Where is the resultant code going?

CP/M-86 or MS-DOS?

The three translators under review do not always approach these issues in the same way. Furthermore, they all handle register mapping somewhat differently. We'll look at the

translators now one at a time. Then we'll see how they translated the same CP/M-80 listing. With the listing in hand, we'll see how each of the translators handled register mapping. Finally, we'll turn to the subject of how the two different 16-bit operating systems affect program translation.

### XLT86 from Digital Research

Digital Research's XLT86 takes standard 8080 source code in a format compatible with ASM, MAC, or RMAC assemblers and converts the 8080 source code to 8086 source code in a format compatible with ASM86 operating under either CP/M-80 or CP/M-86. Since XLT86 is written in PL/I-80, the translator can run either stand-alone under CP/M-80 or for cross development under VAX/VMS. It produces optimized 8086 code in a five-phase, multipass process, doing global data-flow analysis to determine optimal register usage.

Although macro definitions are not supported, conditional-assembly directives are. The *XLT86 User's Guide* suggests that if you want macro expansion, you can use a pass through MAC or RMAC to produce a PRN file that can be edited (removing the first few columns of generated hexadecimal code) to produce an expanded source file for input acceptable to XLT86. XLT86 does not recognize Z80 instructions. XLT86 passes repeat loops through to the 8086 source code.

XLT86 analyzes the source program in its entirety, determining the block structure and the register/flag usage. Working from this information, it translates the code to 8086 assembler code in an optimized way. The decision algorithm for each instruction type is given in a section of the manual to allow the user to see what happens in each situation.

Register mapping generally follows the correspondence shown in figure 4, with a loose relationship between the 8086 AX and the 8080 PSW; the exact relationship is determined from register usage at translate time.

Many run-time options are available to control the translation pro-



**NEW**  
**512KB W/RS232 PORT**

# YOU CAN'T KEEP A GOOD MEMORY DOWN

**EXCEPT IN PRICE  
AND AT CHRISLIN  
WE PROVE IT!**

We offer new super competitive memory prices for your LSI 11, Motorola, IBM PC, S100, and Multibus microprocessor based systems.



Our CI-S100 64KB single card is compatible with most S100 bus systems.

The CI-6800/2 expansion memory for EXORCISOR I and EXORCISOR II microprocessors has a capacity of 64KB on a single card, parity is standard.

Our new add-in expansion memory for IBM's Personal Computer has capacity up to 512KB on a single card with one RS232-C port and parity.

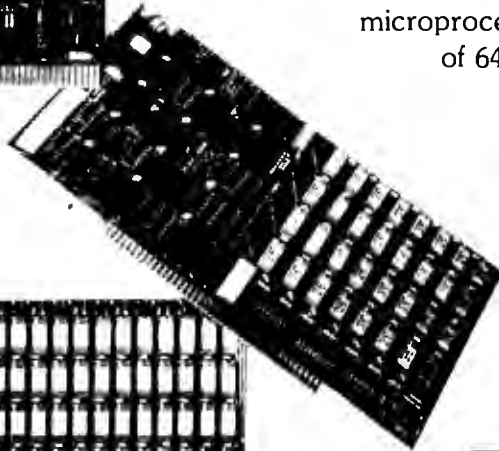

The CI-1123 add-in memory has capacity up to 256KB on a single board, parity is standard.

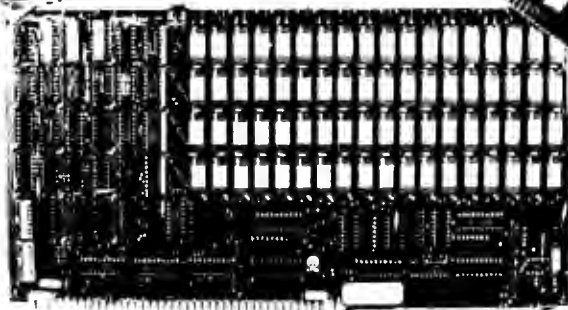

The CI-8086 is compatible with the Multibus 8 bit and 16 bit microprocessors. The memory has capacity up to 512KB on a single card, and parity is standard.



**DON'T ASK WHY WE CHARGE SO LITTLE, ASK WHY THEY CHARGE SO MUCH.**



**Chrislin Industries, Inc.**

31352 Via Colinas • Westlake Village, CA 91362 • 213-991-2254  
TWX 910-494-1253 (CHRISLIN WKVG)

Circle 90 on Inquiry card.

cess, both on the command line and embedded in the 8080 source text. The options control the disks that the work and output files are on, whether the block-analysis information is output to disk, whether code and data segments are to be intermixed or kept separate, and whether the condition flags are active on exiting from subroutines.

XLT86 is a sophisticated program that does a reasonable job of optimizing the translation of 8080 source code to 8086 source code. BDOS calls from CP/M-80 are mapped into BDOS calls that are compatible with CP/M-86.

XLT86 has special features for handling translation of conditional JMP and CALL instructions in 8080 source code. In the 8080 instructions, JMP and CALL instructions are capable of reaching any address within the 64K-byte region. The 8086 conditional JMP instructions can reach only 128 bytes on either side of the IP (Instruction Pointer) register. XLT86 examines the target of the con-

ditional JMP. If the target cannot be reached, XLT86 changes the sense of the conditional JMP and skips over a long JMP to the target address. Since there are no conditional CALL or RET instructions in the 8086, the sense of the condition is changed and a short conditional JMP is performed

---

## The 8086 can access up to 1 megabyte of memory and as many as 65,000 input/output ports.

---

to skip over an unconditional CALL or RET.

As noted earlier, the segment registers allow for separation of code and data regions. To reference data, you have to tell the 8086 whether data is in the code segment (CS) or the data segment (DS). For the Digital Research ASM86 assembler, the Offset directive handles this chore.

XLT86 examines an expression and determines the proper segment for the particular instruction.

XLT86 does have limits on the size of the 8080 source files that it can translate because the flow-analysis information must be in memory. In a 64K-byte CP/M system, the maximum source file that can be translated is approximately 6K bytes, depending on the structure of the program. Nothing is said in the manual about being able to deal with modular code using RMAC and external references. This implies that the entire source program must be converted at once, limiting the size of the program that can be translated by using XLT86 to 6K bytes.

In summary, if you're starting from 8080/8085 assembly code written for ASM or MAC and you want to go to CP/M-86, and if the source program does not exceed 6K bytes, XLT86 is the most useful translator. Code written for Z80s using MAC requires careful examination after the translation process to make sure that no

**For your students' first course in computing... pick the program that's first in delivering actual computer skills**

# COMPUTER POWER

Michael Moshell, Project Director

### A hands-on approach to computer literacy

Students do a lot more than *read* about computers. They also...

- become *capable beginning computer programmers* who can program the computer for business, personal, and school use
- strengthen their *problem-solving skills* and *attention spans*
- sharpen their *planning skills* by analyzing sub-tasks
- learn about *career opportunities* in the computer field

### Classroom-tested materials that are easy to use

The *student text* and *courseware* reduce computer anxiety by offering lively instruction featuring graphics and animation. And the *Teacher's Manual* offers thorough, step-by-step guidance to the new-to-the-computer teacher.

Text, 224 pp. (65773-4) \$7.50\*  
Teacher's Manual, 372 pp. incl. 7 disks (65774-2) \$385.00\*

To learn more, just fill out and mail the coupon. **Or dial toll-free: 800-223-4180. (From New York State, call collect: 212-997-2646.)**

**Computer Power**  
Gregg/McGraw-Hill  
1221 Avenue of the Americas  
New York, N.Y. 10020



Name \_\_\_\_\_  
 Title \_\_\_\_\_  
 Institution \_\_\_\_\_  
 Street Address \_\_\_\_\_  
 City \_\_\_\_\_  
 State \_\_\_\_\_ Zip \_\_\_\_\_  
 Best Time to Call \_\_\_\_\_  
 Area Code & Phone # \_\_\_\_\_

BYTE 6/82

**Note:** \*For better service, Gregg's educational courseware is available under a license agreement, rather than through sale.

To take full advantage of **Computer Power**, you need the following equipment:

APPLE II Plus micro-computer, equipped with a video monitor (color or black and white), UCSD APPLE Pascal-language card, and game paddles.

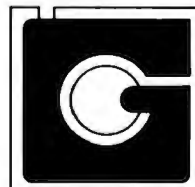

GREGG SOFTWARE





# Many are the doors that lead to the underground.

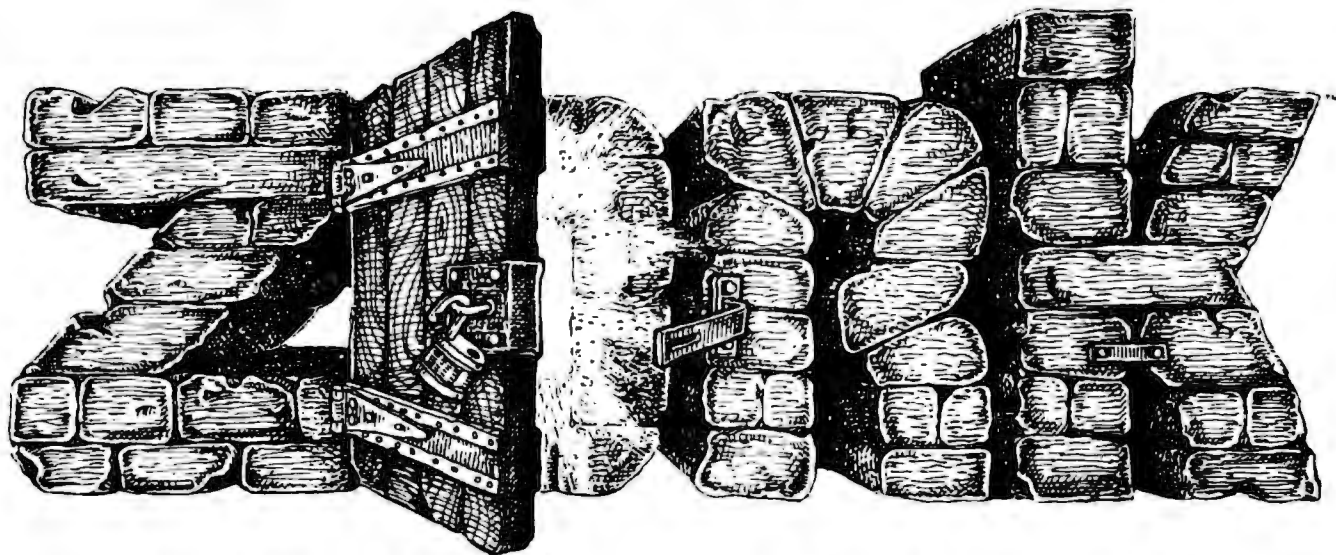

**The top prose adventure bestsellers, ZORK I and ZORK II.**

## Now available for

Apple® II, ATARI® 400/800, IBM Personal Computer,  
NEC PC-8000, CP/M®, and PDP™-11.

### **Few are they who come back alive.**

Your greatest challenges lie ahead—and below. ZORK I: The Great Underground Empire, and ZORK II: The Wizard of Frobozz will transcend any computer age adventure you've ever encountered.

Those who live to tell the tale of ZORK's mysteries speak of becoming immersed in a dimension where the extraordinary is commonplace, and the dangers are as real as any in human experience. It is said that once you have known the forbidden realm, you are changed—and that he who dares ZORK's depths twice will never be the same again.

Now your door to ZORK has opened to beckon you below. The journey begins where Infocom's new worlds of INTERLOGIC™ prose adventure—including the new mystery thriller DEADLINE™—await you, at fine computer stores everywhere.

### **Open your door to the underground—here's \$2 for openers!**

To get your \$2 ZORK rebate by mail, just send Infocom this coupon with your completed warranty card and sales slip from ZORK in their original form. No reproductions will be accepted. Limit 1 rebate for household, address or organization. Offer good only in U.S.A. Void where prohibited, taxed or otherwise restricted. Rebate request must be postmarked before midnight 7/31/82. Infocom is not responsible for lost, late or misdirected mail. Allow 4 to 6 weeks for delivery.

**Infocom, 55 Wheeler St., Cambridge, MA 02138  
OFFER EXPIRES JULY 31, 1982**

Apple is a registered trademark of Apple Computer, Inc. ATARI is a registered trademark of Atari, Inc. CP/M is a registered trademark of Digital Research, Inc. PDP is a trademark of Digital Equipment Corporation.

## **INFOCOM™**

55 Wheeler Street, Cambridge, MA 02138

flags were inadvertently changed. You have to expand macros before using XLT86 unless the number of invocations was small. In that event, expanding the macros by hand with an editor might be just as easy.

### Sorcim's TRANS86

TRANS86 is an 8080/ACT80-to-8086 translator. It takes 8080 or ACT80 source code as input and creates a file compatible with the input to ACT86, an 8086 assembler.

The output of TRANS86 is incompatible with any assembler other than ACT86. The ACT86 mnemonics are different enough so that, unless the programmer has a sophisticated text processor and the talent (or patience) to do a great deal of text manipulation, TRANS86 should be used only with ACT86.

Both TRANS86 and ACT86 run on either 8080 or Z80 processors under CP/M-80, MP/M, or CDOS with a minimum of 24K bytes of RAM (random-access read/write memory). TRANS86 consists of an executable file, an overlay file, and a translation table. The input assembly source code must be in a form acceptable to the standard CP/M-80 assemblers (ASM, MAC, or RMAC), or to ACT80, Sorcim's Assembly Code Translator for 8080/Z80 processors.

Translation occurs on an instruction-by-instruction basis with some optimization rules applied to conditional jumps. There appears to be no limit as to the size of the source file that can be translated. A file is produced on the same disk as the source file with the same name and an .ASN extension. If a file by that name already exists, the user is asked if the file should be deleted or if the program should be aborted.

TRANS86 flags the following Z80 instructions as errors:

ACT80 code	Zilog/Mostek equivalent code
Mov A,R	Ld A,R
Mov R,A	Ld R,A
Mov A,I	Ld A,I
Mov I,A	Ld I,A
In,C reg	In reg,(C)
Inir	Inir
Otir	Otir
Rld	Rld
Rrd	Rrd

TRANS86 supports macros in the ACT80 format. Although TRANS86 acts on macros in the MAC format, there is no guarantee that the macros will expand correctly. The user is cautioned to examine the result of a

macro expansion to determine if the sense of the macro has been maintained. Examples are given of some macros that work and some that do not. The *TRANS86 User's Reference Manual* includes a section that gives hints on how to hand-optimize the output of TRANS86; specifically, accumulator indirect loads through the DE and BC registers, 8080 conditional jumps, and Z80 block instructions.

Another section describes the differences between ACT80 and Z80 mnemonics. This information allows the programmer to manually convert assembly source code to a form acceptable to TRANS86. The ACT80 instruction set has some ASM-style instructions, some Z80-style instructions, and some instructions that are unique to the ACT80 assembler. If the source code is written in 8080 ASM mnemonics, TRANS86 will process it and output ACT86 assembler code. The 8080 instruction SPHL, however, was translated incorrectly in the current version of TRANS86.

Another section in the manual contains suggested constructions that can be manually entered to deal with Z80 op codes that are flagged as errors. Block input/output instructions and input/output through register C are described in detail.

## NEW FROM EXTENDED PROCESSING THE BURNER I/O FOR THE S-100 BUS

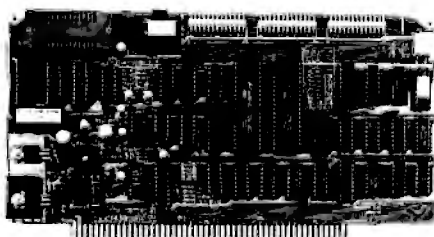

The BURNER I/O has a complete EPROM programmer, two serial ports, one parallel I/O port with handshaking and memory management.

Programmer features:

- Most EPROM types from 2704 thru 2764 and 2508, 2516 and TMS2716.
- CPM compatible software supplied in EPROM that can be easily written on a diskette.

- Programming socket is zero insertion force type.
- Programming voltages generated on board.
- Programmer is totally I/O mapped.

I/O features: (serial)

- 2 fully independent RS-232 serial ports.
- RS-232 data ready supported.
- Each serial port has independent baud rate generators that are software programmable from 50 to 19,200 baud.
- Serial ports may be polled and/or interrupt driven.

I/O features: (parallel)

- Independent 8 bit output, input and status flags.
- All I/O including flags are latched.
- In addition, there are 4 direct sense lines.

Memory management features:

- Controls the S-100 address lines from A16-A23.
- Uses output instruction to load the address. Normally 40H.

We are offering this board with all options, or just the portions that are needed may be purchased. Regardless of which version that is purchased, documentation for the entire board is supplied. All combinations are assembled and tested.

Option A: Complete board with programmer,

I/O and memory management. \$324.95

Option B: Programmer only. \$199.95

Option C: I/O only. (2S + P) \$199.95

Option D: Option B and C. \$299.95

Option E: Memory management only \$150.00

Memory management may be added to options B or C for \$25.00.

AVAILABLE FROM

**Microbyte Computer Systems**

2798 So. Bascom, San Jose, CA 95124

(408) 377-4685

DEALER INQUIRIES INVITED



# Smith-Corona introduces the only daisy wheel printer for under \$900.\*



You're putting together a desktop computer system for your office or home. And you want to add a letter quality printer so you can do word processing, too. But you don't want to spend a fortune.

Until now, you really had little choice but to settle for dot matrix printers. True, dot matrix doesn't produce letter-perfect printing, but daisy wheel printers just cost too much. That is, they did.

Now, Smith-Corona® offers a daisy wheel printer at such an incredibly low price, you can't afford *not* to get it. (The fact is, you won't find a daisy wheel printer *anywhere* at a price so low.)

The Smith-Corona TP-I™ printer operates with microprocessor controlled daisy wheel technology, and is available with either standard serial or parallel data interface. It is compatible with most microcomputers currently on the market. And, unlike many printers, it's made in America.

Best of all, the TP-I produces results identical to those of our very finest office typewriters—printing with real character. So it can be used to send out letters that have to look perfect. As well as financial statements, inventory reports, direct mail campaigns, manuscripts. Even a letter to your son in college!

Anything at all you need printed.

The basic TP-I will handle letter or legal sized paper. An option that will be available soon will enable it to handle either fanfold or single sheet paper.

The TP-I is easy-to-use—just turn the power on, load the paper, and away it goes. There are drop-in ribbon cassettes and a choice of easy-to-change, snap-on daisy print wheels for a variety of fonts.

So stop thinking you can't afford a daisy wheel printer. Because, thanks to Smith-Corona, a printer with real character is no longer expensive. **Smith-Corona**

Please send me more information on the Smith-Corona TP-I daisy wheel printer.

Name \_\_\_\_\_

Title \_\_\_\_\_

Company Name \_\_\_\_\_

Business Address \_\_\_\_\_

City \_\_\_\_\_ State \_\_\_\_\_ Zip \_\_\_\_\_

Mail Coupon to:

Dwight P. Newcomer, National Sales Manager—Office Products  
Smith-Corona

65 Locust Avenue  
New Canaan, Connecticut 06840

B6

\*Manufacturer's suggested retail is under \$900, but prices may vary.

## LIGHTNING FAST SAFE AND SOUND

Rapidly write programs and save your files with **Audio Light** utilities for CP/M:

### BACKFIELD

#### MPL—MENU PROGRAMMING LANGUAGE

Our Quality Software will improve your productivity.

#### THE BACKFIELD

Our backfield software saves and protects your hard disk data with these fine features:

- Backs up a hard disk to floppies
- Backs up selected files or all files
- Automatically selects files that have changed since last backup

The **BACKFIELD** consists of three programs:

**FULLBACK** backs up an entire disk to another set of disks file-by-file, optimizing the use of all available memory. It writes a special checksum directory file for later use by **QUARTERBACK**.

**HALFBACK** backs up a large file to multiple disks.

**QUARTERBACK** automatically determines which files have been changed since the last backup, and backs up these files only.

#### MPL—MENU PROGRAMMING LANGUAGE

MPL simplifies application programming by using menus to structure programs:

- Data is displayed as items in a menu
- Data is organized by connecting menus together
- Selecting an item in a menu may call an application module
- Message area at top of each menu for module communication
- Selection causes data to be placed in the message area
- Interfaces with other programming languages

MPL is a revolutionary new programming language for the system developer or end user to structure applications in a natural easy-to-use manner. The design of MPL allows application modules to be written in any compiled language supported by CP/M.

#### PRICE—ORDER INFORMATION

**THE BACKFIELD** \$150.00

**MENU PROGRAMMING LANGUAGE** \$175.00

Backfield available third quarter 1982

MPL requires a 24x80 CRT. All software is supplied on 8" single density diskette for CP/M 2.2.

Call (408) 395-0838, or send check to:

**AUDIO LIGHT, INC.**  
146 Town Terrace, Suite 4  
Los Gatos, CA 95030

\*California residents add 6% for sales tax

Dealer Inquiries Welcome

MPL is a trademark of Audio Light, Inc.  
CP/M is a trademark of Digital Research.



**Audio Light**

## Seattle Computer System

Seattle Computer Products' (SCP) translation system consists of two programs: a Z80 translator (called TRANS86 on the disk, though *not* the same as Sorcim's) and a compatible 8086 cross assembler (ASM86). Both programs run on Z80 processors under CP/M-80 with a minimum of 24K bytes of RAM. The programs do not run on 8080/8085 processors.

The translator accepts source files in Zilog/Mostek mnemonics and produces an 8086 assembler source file in a form acceptable to the SCP 8086 cross assembler. Since the 8086 source format required by the SCP 8086 cross assembler is different from any other 8086 assembler that we know of, you must use these two programs together. The translator places its output on the same disk as the Z80 source code and gives it an .A86 file extension.

The translation is on an instruction-by-instruction basis with no optimization. There appears to be no limit on the file size that may be translated. Not all Z80 instructions are translated, however. Those in the following list will produce an op code error:

Cpd	Ldi
Cpi	Otdr
Ind	Otir
Indr	Outd
Ini	Outi
Inir	Rld
Ldd	Rrd

These op codes are mostly in the block-manipulation set of instructions. Although programmers do use these instructions, they must be manually coded when converting to the 8086. The SCP translator does not support macros and permits use of the following pseudo-ops only:

Db
Dm
Ds
Dw
Equ
If/Endif
Org

If the Z80 index registers IX and IY are used, they are mapped into memory locations with the labels IX: and IY:. The programmer has to define these locations; otherwise, they will show up on the assembly listing as undefined labels. The Z80 alternate register set (BC',DE',HL') is treated the same way, as memory locations that the programmer must define.

Either the DI or SI register can be used as a temporary IX register by loading one of them from the location IX when required to do indexed instructions. The programmer has to take care of this substitution; the translator does not.

When using the DI register, you must always keep in mind that the only 8086 segment base that can be used with the DI register is the ES segment; the SI register, on the other hand, can reference all the segment bases, defaulting to the DS segment. If this 8086 source code is going to be run under CP/M-86, you have to be careful about using the ES segment register. The CP/M-86 documentation specifically states that ES is not saved through a BDOS call.

For the SCP Z80-to-8086 translator's register usage, see figure 6b.

## Translating the Test File

To determine how the three programs actually translate source text, we prepared a file acceptable as input to an assembler and containing all the op codes of the 8080 and Z80. Since the SCP translator could accept only Zilog/Mostek mnemonics, the test text was run through an 8080-to-Z80 filter program before the translation.

Listing 1 presents, side by side and line by line, the original 8080 code, the Sorcim TRANS86 translation, the Seattle translation, and the XLT86 translation. Here are reminders of some things to consider when you examine the translations:

- Because of the differences in the architectures of the 8086 and the 8080/Z80, some choices must be made when translating from one architecture to the other. Therefore, some difference in translation is to be expected.



# Explore the excellence of your ZX81 with a

MEMOPAK

MEMOPAK

MEMOPAK

MEMOPAK

MEMOPAK

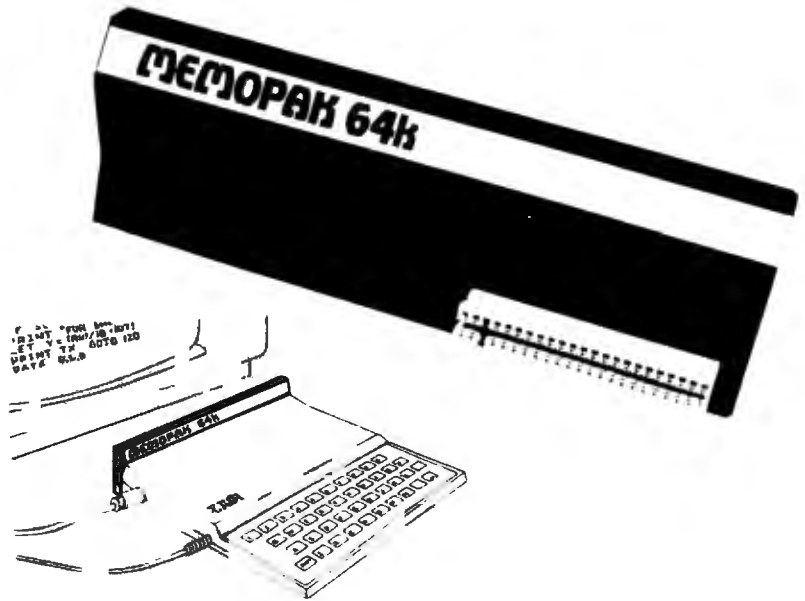

## MEMOPAK 64k memory extension for \$179.95

Give your diminishing memory more byte.

### MEMOPAK 64K RAM \$179.95

The Sinclair ZX81 has revolutionized home computing. The MEMOPAK 64K RAM extends the memory of ZX81 by a further 56K to a full 64K. It is neither switched nor paged and is Directly Addressable. The unit is user transparent and accepts such basic commands as 10 DIM A (9000). It plugs directly into the back of ZX81 and does not inhibit the use of the printer or other add-on units. There is no need for an additional power supply or leads.

#### Description of memory

0-8K . . . Sinclair ROM

8-16K . . . This section of memory switches in or out in 4K blocks to leave space for memory mapping, holds its contents during cassette loads, allows communication between programs, and can be used to run assembly language routines.

16-32K . . . This area can be used for basic programs and assembly language routines.

32-64K . . . 32K of RAM memory for basic variables and large arrays. With the MEMOPAK 64K extension the ZX81 is transformed into a powerful computer, suitable for business, leisure and educational use, at a fraction of the cost of comparable systems.

**MEMOTECH**

Memory Extension Specialists

Memotech Corporation  
7550 West Yale Ave., Suite 220  
Denver, Colorado 80227  
Ph.(303) 986-0016

### MEMOPAK 16K RAM \$79.95

With the addition of MEMOPAK 16K, your ZX81 will have a full 16K of Directly Addressable RAM. It is neither switched nor paged and enables you to execute longer and more sophisticated programs and to hold an extended data base.

The 16K and 64K Memopaks come in attractive, custom-designed and engineered cases which fit snugly on to the back of the ZX81 giving a firm connection.

#### Free service on your MEMOPAK

Within the first six months, should anything go wrong with your MEMOPAK, return it to us and we will repair or replace it free of charge.

### Try MEMOPAK with no obligation

You can use our MEMOPAK in your home without obligation. After 10 days if you are not completely satisfied, simply return it for a full refund.

#### Coming soon . . . .

A complete range of ZX81 plug-in peripherals:

MEMOTECH Hi-Res Graphics  
MEMOTECH Digitising Tablets  
RS232 interface  
Centronic Interface and  
Software Drivers

All these products are designed to fit "piggy-back" fashion on to each other and use the ZX81 power supply.

Further information forthcoming.

Memotech Corp. 7550 W. Yale Ave. Suite 220 Denver, Colo. 80227

Yes! I would like to try the Memopak. I understand that if I'm not complete satisfied, I can return it in 10 days for a full refund.

	Price +	Qty.	Amount
<input type="checkbox"/> Check	Memopak 64k RAM	\$ 179.95	
<input type="checkbox"/> Visa	Memopak 16k RAM	\$ 79.95	
<input type="checkbox"/> MC	Shipping and Handling	\$ 4.95	\$ 4.95
<b>Total</b>			

Act. No.  Exp.

+ U.S. Dollars

Name

Street

City  State  Zip

BYT06

# NEW FROM NETRONICS AUTO-PATCH HARD DISK

With plug-in multi-user ports  
Automatically Installs Itself Into  
Your Present CP/M® 2.2 Operating  
system & Floppy Disk Hardware.

It's Exclusive!

6 megabytes . . . \$2995.00    12 megabytes . . . \$3495.00



What's the big concern of S100 owners when they consider adding Hard Disks? They worry that it will be difficult to install, that it won't be compatible with their present software and hardware, and that it may cause down-time on their S100 system.

Worry no more — Netronics new AUTOPATCH Hard Disks Systems are here. AUTOPATCH installs in just one-two-three: (1) plug in the hard disk S100 card; (2) run three short programs supplied on disk; (3) disable the boot on your floppy controller and enable the boot on your hard disk controller (this step not required if you wish to continue to boot to your floppy drives).

And that's it: The AUTOPATCH feature automatically finds the end of your existing BIOS and then self-relocates and patches itself into the existing BIOS. A virgin copy of CCP and BIOS are loaded into memory, a customized SBOOT is added to the front of CCP and the whole memory image is written to the reserved tracks on your hard disk. You can add up to 4 hard disks to the controller supplied. The new BIOS will automatically rename any old devices as B: and C: and define the hard disk as drive A:. All with the lift of one finger!!! If your BIOS is large you may have to re-sysgen your system down 1 or 2 k. If this is necessary the AUTOPATCH program will prompt you to do so.

AUTOPATCH Hard Disk Systems are available in 6 and 12 megabyte models. Included in the system: 6 or 12 megabyte Hard Disk Drive . . . Controller for up to 4 Hard Disk drives . . . S100 Hard Disk card with provisions for adding 8 additional I/O ports to be used when adding a multi-user operating system . . . Power Supply . . . Deluxe Steel Cabinet . . . All necessary cables . . . AUTOPATCH Programs supplied on either 8" or 5 1/4" IBM formatted single density diskettes (specify style required) . . . Complete installation instructions . . . Fully wired and tested, ready to go.

## SPECIFICATIONS

Unformatted Recording Capacity: 6.4 or 11.6 MB . . .  
No. of tracks: 612 or 1380 . . . Data Transfer Rate: 3 ms  
. . . Bytes/sector format: 512 . . . Communication Port:  
DO (other ports available on special order) . . . Programs  
supplied on 5 1/4" or 8" single density IBM formatted  
diskettes (North Star CP/M® version available  
on special order)

## 10 DAY MONEY BACK OFFER

Continental U.S.A. Credit Card Buyers Outside Conn.

**CALL TOLL FREE 800-243-7428**

To Order From Connecticut Or For Tech. Assist.  
Call (203) 354-9375

**NETRONICS R&D LTD. Dept.**

333 Litchfield Road, New Milford, CT 06776

Please send the items checked below:

AUTOPATCH/6 Hard Disk System . . . \$2995.00

AUTOPATCH/12 Hard Disk System . . . \$3495.00

Additional 6-megabyte drive with power supply,  
cabinet, cables and necessary software . . . \$1995.00

Additional 12-megabyte drive with power supply,  
cabinet, cables and necessary software . . . \$2495.00

All plus \$15.00 P&I (postage & insurance). For Canadian  
orders, double the postage (\$30.00). Conn. res.  
add sales tax.

Total Enclosed \$ \_\_\_\_\_

Personal Check     Cashier's Check/M.O.

VISA     MasterCard (Bank No. \_\_\_\_\_)

Acct. No. \_\_\_\_\_ Exp. Date \_\_\_\_\_

Signature \_\_\_\_\_

Print Name \_\_\_\_\_

Address \_\_\_\_\_

City \_\_\_\_\_ State \_\_\_\_\_ Zip \_\_\_\_\_

(a)

	8080/8085	TRANS86	8086/8088 Seattle	XLT86
8-bit registers	A	AL	AL	AL
	B	CH	CH	CH
	C	CL	CL	CL
	D	DH	DH	DH
	E	DL	DL	DL
	H	BH	BH	BH
	L	BL	BL	BL
16-bit register pairs	PSW	AX(1)	AX	AX
	BC	CX	CX(2)	CX(2)
	DE	DX	DX(2)	DX(2)
	HL	BX	BX	BX
16-bit register pairs	SP	SP	SP	SP
	PC	IP	IP	IP

(1) TRANS86 does not preserve 8080 byte order on the stack.

(2) The Seattle translator uses SI on loads from memory and DI for stores to memory. TRANS86 and XLT86 do a register exchange between BX and the appropriate register to allow indirect addressing through BX, then a register exchange to fix up BX and the appropriate register.

(b)

	Z80	TRANS86	8086/8088 Seattle	XLT86
8-bit	R	(3)	(3)	(3)
	I	(3)	(3)	(3)
16-bit	IX	DI	(4)	(5)
	IY	SI	(4)	(5)
alternate registers set	BC'	(5)	(4)	(5)
	DE'	(5)	(4)	(5)
	HL'	(5)	(4)	(5)

(3) Since the 8086 does not have equivalent registers, none of the translators support these registers. However, they can be mapped to a memory location by the programmer.

(4) Seattle's TRANS86 handles these registers by generating memory references to storage locations defined by the programmer.

(5) Although these registers are not mapped by the translators, the programmer can define storage locations and deal with them through macro definitions.

**Figure 6: 8080/8085/Z80-to-8086/8088 register mapping. Figure 6a shows 8080/8085-to-8086 register mapping by the three translator programs. Figure 6b shows Z80-to-8086 register mapping by the three translator programs.**

● In general, when the 8080 does 16-bit arithmetic, only the carry bit is affected; this is definitely not so in the 8086.

● The Z80 and 8086 do string and block operations differently; the 8080 has no primitive block operations at all.

● As noted earlier, the segment registers in the 8086 allow addressing of up to 1 megabyte; no corresponding registers exist in either the 8080 or Z80.

● Registers used for indirect memory references in the 8080/Z80 are different from the corresponding mapped registers in the 8086.

● Conditional jumps in the 8080/Z80

can reach anywhere in its address space; conditional jumps in the 8086 can reach only 128 bytes on either side relative to the IP register.

● No conditional calls in the 8086 correspond to the conditional calls of the 8080/Z80.

Listing 1 makes it apparent that the three translators treat most instructions the same way, allowing for the differences in the target instruction set. The following comments highlight the differences found.

The only incorrect translation is TRANS86's rendering of the SPHL instruction. The transfer is in the wrong direction. The comment field of the instruction was wrong in the



# FOR ONLY \$129.95 Learn Computing From The Ground Up

Build a Computer kit that grows with you, and can expand to 64k RAM, Microsoft BASIC, Text Editor/Assembler, Word Processor, Floppy Disks and more.

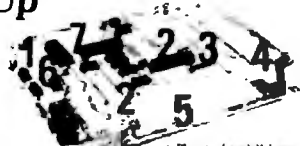

## EXPLORER/85

Here's the low cost way to learn the fundamentals of computing. The all-important basics you'll need more and more as you advance in computer skills. For just \$129.95 you get the advanced-design Explorer/85 motherboard, with all the features you need to learn how to write and use programs. And it can grow into a system that is a match for any personal computer on the market. Look at these features: 8005 Central Processing Unit, the microprocessor "heart" of the Explorer/85. (It can do millions who will buy and use the 8005/8085 this year alone). Four 8-bit buses—hit input/output ports from which you can input and output your programs, as well as control exterior switches, relays, lights, etc. • a cassette interface so you store and reload programs you've learned to write. • deluxe 2,000 byte operating system/monitor makes it easy to learn computing in several important ways. • It allows simpler, faster writing and entering of programs. • It permits accessing by you all parts of the system so you can check on the status of any point in the program. • It allows tracing each program step by step, with provision for displaying all the contents of the CPU (registers, flags, etc.) • and it does much more.

You get all this in the starting level (Level A) of the Explorer/85 for only \$129.95. Incredible! To use, just plug in your 8VDC power supply and terminal or keyboard/display — if you don't have them, see our special offers below.

Level A computer kit (Terminal Version) ... \$129.95 plus \$3 P&I\*  
Level A kit (Hex Keypad/Display Version) ... \$129.95 plus \$3 P&I\*

LEVEL B — This "building block" converts the motherboard into a two-slot 5100 bus (industry standard) computer. Now you can plug in any of the hundreds of 5100 cards available.  
Level B kit ... \$49.95 plus \$2 P&I\*  
5100 bus connectors (two required) ... \$4.85 each, postpaid.

LEVEL C — Add still more computing power, the "building block" mounts directly on the motherboard and expands the 5100 bus to six slots.  
Level C kit ... \$39.95 plus \$2 P&I\*  
5100 bus connectors (five required) ... \$4.85 each, postpaid.

LEVEL D — When you reach the point in learning that requires more memory, we'll offer two choices: either add 4k of a memory directly on the motherboard, or add 16k to 64k memory by means of a single 5100 card, our famous "JAWS".  
Level D kit (CHECK ONE):  
4k on-board ... \$49.95 plus \$2 P&I\*  
16k S100 "JAWS" ... \$149.95 plus \$2 P&I\*  
32k S100 "JAWS" ... \$249.95 plus \$2 P&I\*  
64k S100 "JAWS" ... \$299.95 plus \$2 P&I\*

LEVEL E — An important "building block," it activates the ROM/PROM space on the motherboard. Now just plug in our 8k Microsoft BASIC or your own custom programs.  
Level E kit ... \$5.95 plus \$2 P&I\*

Microsoft BASIC — It's the language that allows you to talk English to your computer! It is available three ways:  
8k cassette version of Microsoft BASIC (requires Level B and 32k of RAM minimum; we suggest a 16k S100 "JAWS" — see above) ... \$84.95 postpaid.  
8k ROM version of Microsoft BASIC (requires Level B & Level E and 4k RAM; just plug into your Level E sockets. We suggest either the 4k Level D RAM expansion or a 16k S100 "JAWS") ... \$89.95 plus \$2 P&I\*  
Disk version of Microsoft BASIC (requires Level B, 32k of RAM, floppy disk controller, 8" floppy disk drive) ... \$325 postpaid

TEXT EDITOR/ASSEMBLER — The editor/assembler is a software tool (a program) designed to simplify the task of writing programs. As your programs become longer and more complex, the assembler can save you many hours of programming time. This software includes an editor program that enters the programs you write, makes changes, and saves the programs on cassettes. The assembler performs the clerical task of translating symbolic code into the computer-readable object code. The editor/assembler program is available either in cassette or a ROM version.

Editor/Assembler (Cassette version; requires Level "B" and 8k (min) of RAM — we suggest 16k "JAWS" — see above) ... \$55.95 plus \$2 P&I\*  
Editor/Assembler (ROM version supplied on an S100 card; requires Level B and 4k RAM (min) — we suggest either Level D or 16k "JAWS") ... \$89.95 plus \$2 P&I\*

FLOPPY DISK — A remarkable "building block." Add our 8" floppy disk when you need faster operation, more convenient program storage, perhaps a business application, and access to the literally thousands of programs and program languages available today. You simply plug them into your Explorer/85 disk system — it accepts all IBM-formatted CP/M programs.  
8" Floppy Disk Drive ... \$299.95 plus \$12 P&I\*  
Floppy Controller Card ... \$199.95 plus \$2 P&I\*  
Disk Drive Cabinet & Power Supply ... \$69.95 plus \$3 P&I\*

Drive Cables (set up for two drives) ... \$25.00 plus \$3 P&I\*  
CP/M 2.2 Disk Operating System, includes Text Editor/Assembler, dynamic debugger, and other features that give your Explorer/85 access to thousands of existing CP/M-based programs ... \$150.00 postpaid.

NEED A POWER SUPPLY? Consider our AP-1. It can supply all the power you need for a fully expanded Explorer/85 (note: disk drives have their own power supply). Plus the AP-1 fits neatly into the attractive Explorer steel cabinet (see below).  
AP-1 Power Supply kit (8V @ 5 amp) in deluxe steel cabinet ... \$39.95 plus \$2 P&I\*

NEED A TERMINAL? We offer you choices: the least expensive one is our Hex Keypad/Display kit that displays the information on a calculator-type screen. The other choice is our ASCII Keyboard/Computer Terminal kit, that can be used with either

1. Plug in Netronics's Hex Keypad/Display
2. Add Level B to convert to 5100
3. Add 4k RAM
4. Plug in Level E hardware except Microsoft BASIC or ROM
5. Add two 5100 boards
6. Add your own custom circuits (prototyping area)
7. Connect terminal

a CRT monitor or a TV set (if you have an RF modulator)  
Hex Keypad/Display kit ... \$69.95 plus \$2 P&I\*

**FASTERM-64 TERMINAL KIT** — Featuring a 56 key ASCII Keyboard, 128 character set upper and lower case 75 ohm output, 8 baud rates, 140 to 19,200 (switch selectable) RS232C or 20MA output, 32 or 64 character by 16 line formats, complete with Deluxe Steel Cabinet and Power Supply ... \$199.95 plus \$3 P&I\*

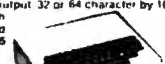

- RF Modulator kit (allows you to use your TV set as a monitor) ... \$8.95 postpaid
- 12" Video Monitor (10MHz bandwidth) ... \$139.95 plus \$5 P&I\*
- Deluxe Steel Cabinet for the Explorer/85 ... \$49.95 plus \$3 P&I\*
- Fan for cabinet ... \$15.00 plus \$1.50 P&I\*

### ORDER A SPECIAL-PRICE EXPLORER/85 PAK — THERE'S ONE FOR EVERY NEED.

**Beginner Pak** (Save \$26.00) — You get Level A (Terminal Version) with Monitor Source Listing (\$25 value) AP-1, 5-amp power supply, Intel 8085 User Manual (Reg. \$199.95) SPECIAL \$169.95 plus \$4 P&I\*

**Experimenter Pak** (Save \$53.00) — You get Level A (Hex Keypad/Display Version) with Hex Keypad/Display, Intel 8085 User Manual, Level A Hex Monitor Source Listing, and AP-1, 5-amp power supply (Reg. \$275.95) SPECIAL \$219.95 plus \$6 P&I\*

**Special Microsoft BASIC Pak** (Save \$103.00) — You get Levels A (Terminal Version), B, D (4k RAM), E, 8k Microsoft in ROM, Intel 8085 User Manual, Level A Monitor Source Listing, and AP-1, 5-amp power supply (Reg. \$439.70) SPECIAL \$329.95 plus \$7 P&I\*

**Add a Rom-Version Text Editor/Assembler** (Requires Levels B and D or S100 Memory) ... \$99.95 plus \$2 P&I\*

**Starter 8" Disk System** — Includes Level A, B floppy disk controller, one CDC 8" disk drive, two drive cable, two 5100 connectors; just add your own power supplies, cabinets and hardware. (Reg. \$165.00) SPECIAL \$99.95 plus \$13 P&I\*  
32k Starter System, \$1049.95 plus \$13 P&I\*  
48k Starter System, \$1095.95 plus \$13 P&I\*  
64k Starter System, \$1149.95 plus \$13 P&I\*

**Add to any of above Explorer steel cabinet, AP-1, 5-amp power supply, Level C with two S100 connectors, disk drive cabinet and power supply, two sub-D connectors for connecting your printer and terminal** (Reg. \$225.95) SPECIAL \$199.95 plus \$13 P&I\*

**Complete 64K System** — Wired & Tested ... \$1650.00 plus \$26 P&I\*  
Special! Complete Business Software Pak (Save \$625.00) — Includes CP/M 2.2 Microsoft BASIC, General Ledger, Accounts Receivable, Accounts Payable, Payroll Package ... (Reg. \$1325) SPECIAL \$699.95 postpaid

\*P&I stands for "postage & insurance." For Canadian orders, double this amount.

Continental Credit Card Buyers Outside Connecticut:

**TO ORDER**  
Call Toll Free:  
800-243-7428

To Order From Connecticut, or For Technical Assistance, Call (203) 354-9375

CP/M is a reg. trademark of Digital Research

★ (Clip and mail entire ad) ★

SEND ME THE ITEMS CHECKED ABOVE

Total Enclosed (Conn. Residents add sales tax) \$ \_\_\_\_\_  
Paid by:  
 Personal Check  Cashier's Check/Money Order  
 VISA  MASTER CARD (Bank No. \_\_\_\_\_)

Acct. No. \_\_\_\_\_ Exp. Date \_\_\_\_\_

Signature \_\_\_\_\_

Print Name \_\_\_\_\_

Address \_\_\_\_\_

City \_\_\_\_\_ State \_\_\_\_\_ Zip \_\_\_\_\_

**NETRONICS Research & Development Ltd.**  
333 Litchfield Road, New Milford, CT 06776

# ANNOUNCING TWO NEW TERMINALS

Smart • Fast • Graphics • Matching Modem and \$295 Printer



Netronics announces a state of the art breakthrough in terminals. Now at prices you can afford, you can go on-line with data-bank and computer phone-line services. It's all yours: "electronic newspapers," educational services, Dow-Jones stock reports, games, recipes, personal computing with any level language, program exchanges, electronic bulletin boards ... and more every day!!!

Netronics offers two new terminals, both feature a full 56 key/128 character typewriter-style keyboard, baud rates to 19.2 kilobaud, a rugged steel cabinet and power supply. The simplest one, FASTERM-64, is a 16 line by 64 or 32 character per line unit, with a serial printer port for making hard copy of all incoming data, and optional provisions for block and special character graphics. The "smart" version, SMARTERM-80, features either 24 line by 80 characters per line or 16 by 40 characters per line, it offers on-screen editing with page-at-a-line printing, 12,000 pixel graphics, line graphics, absolute cursor addressing, underlining, reverse video, one-half intensity and much more ... simply plug them into your computer or our phone modem and be on-line instantly. Use your TV set (RF modulator required) or our deluxe green-phosphor monitor pictured above. For hard copy just add our matched printer.

Price breakthrough!!! Own the FASTERM-64, a complete terminal kit, ready to plug in for just \$199.95 or order the SMARTERM-80 kit for just \$299.95, (both available wired and tested). Be on-line with the million-dollar computers and data services today ... we even supply the necessary subscription forms.

More good news: All the components in our terminals are available separately (see coupon), so you buy only what you need!!!

**FASTERM-64** ... DISPLAY FORMAT: 64 or 32 characters/line by 16 lines ... 96 displayable ASCII characters (upper & lower case) ... 8 baud rates: 150, 300, 600, 1200, 2400, 4800, 9600, 19,200 (switch sel.) ... LINE OUTPUT: RS232C or 20 ma current loop ... VIDEO OUTPUT: 1V P/P (EIA RS-170) ... CURSOR MODES: home & clear screen, erase to end of line, erase cursor line, cursor up & down, auto carriage return/line feed at end of line & auto scrolling ... 1, 1.5, 2 ... DATA BITS PER CHARACTER: 5, 6, 7 or 8 ... CHARACTER OUTPUT: 5 by 7 dot matrix in a 9 by 12 cell ... PRINTER OUTPUT: prints all incoming data ... 1K ON BOARD RAM ... 2K ON BOARD ROM ... CRYSTAL CONTROLLED ... COMPLETE WITH POWER SUPPLY ...  
**OPTIONAL GRAPHICS MODE**: includes 34 Greek & math characters plus 30 special graphics characters. ASCII ENCODED KEYBOARD: 56 key/128 characters.  
**SMARTERM-80** ... DISPLAY FORMAT: 80 characters by 24 lines or 40 characters by 16 lines 128 displayable ASCII characters (upper & lower case) 8 baud rates: 110, 300, 600, 1200, 2400, 4800, 9600, 19,200 ... LINE OUTPUT: RS232C or 20 ma current loop ... VIDEO OUTPUT: 1V P/P (EIA RS-170) ... EDITING FEATURES: insert/delete line, insert/delete character, forward/back tab ... LINE OR PAGE TRANSMIT ... PAGE PRINT FUNCTION ... CURSOR POSITIONING: up, down, right, left, plus absolute cursor positioning with read back ... VISUAL ATTRIBUTES: blink, reverse video, half intensity, & blank ... GRAPHICS: 12,000 pixel resolution block plus line graphics ... ON-SCREEN PARITY INDICATOR ... PARITY: off, even or odd ... STOP BITS: 110 baud 2, all others 1 ... CHAR. OUTPUT: 7 by 11 character in a 9 by 12 block ... PRINTER OUTPUT ... 60 OR 50 Hz VERTICAL REFRESH ... BLINKING BLOCK CURSOR ... CRYSTAL CONTROLLED 2K ON BOARD RAM ASCII ENCODED KEYBOARD: 56 key/128 character ... 4K ON BOARD ROM ... COMPLETE WITH POWER SUPPLY.

TELEPHONE MODEM 103 O/A ... FULL DUPLEX, FCC APPROVED DATA RATE: 300 baud ... INTERFACE: RS232C and TTY ... CONTROLS: talk/data switch (no need to connect and disconnect phone), originator/answer switch on rear panel ... NO POWER SUPPLY REQUIRED.  
**ASCII KEYBOARD ASCII-3** ... 56 KEY/128 CHARACTER ASCII ENCODED UPPER & LOWER CASE ... FULLY DEBOUNCED ... 2 KEY ROLL-OVER ... POS OR NEG LOGIC WITH POS STROBE ... REQUIRES +5 & +12V DC (SUPPLIED FROM VIDEO BOARD).  
**PRINTER COMET I** ... SERIAL I/O TO 9600 BAUD ... 80 CHARACTER COLUMN (132 COMPRESSED) ... 10" TRACTOR FEED ... UPPER/LOWER CASE ... INDUSTRY STANDARD RIBBONS ... 4 CHARACTER SIZES ... 9 BY 7 DOT MATRIX ... BI-DIRECTIONAL PRINTING



Continental U.S.A. Credit Card Buyers Outside Connecticut  
CALL TOLL FREE 800-243-7428

To Order From Connecticut Or For Tech. Assist. Call (203) 354-9375

**NETRONICS R&D LTD. Dept.**  
333 Litchfield Road, New Milford, CT 06776

Please send the items checked below:

- COMPLETE FASTERM-64 TERMINAL (includes FASTVID-64 video board ASCII-3 keyboard, steel cabinet and power supply) ... kit \$199.95 plus \$3 P&I ... wired & tested \$249.95 plus \$3 P&I ... graphics option add \$19.95 to each of above
- COMPLETE SMARTERM-80 TERMINAL (includes SMARTVID-80 video board, ASCII-3 keyboard, steel cabinet and power supply) ... kit \$299.95 plus \$3 P&I ... wired and tested \$369.95 plus \$3 P&I
- FASTVID-64 VIDEO BOARD (requires +5 & -12V DC) ... kit \$99.95 plus \$3 P&I ... graphics option add \$19.95 ... wired & tested \$129.95 plus \$3 P&I ... graphics option add \$19.95
- SMARTVID-80 VIDEO BOARD (requires +5 & -12V DC) ... kit \$199.95 plus \$3 P&I ... wired & tested \$249.95 plus \$3 P&I
- DELUXE STEEL TERMINAL CABINET ... \$19.95 plus \$3 P&I
- ASCII-3 KEYBOARD (requires +5 & -12VDC) ... kit \$69.95 plus \$3 P&I ... wired and tested \$89.95 plus \$3 P&I
- POWER SUPPLY (powers ASCII-3 keyboard & video boards) ... kit only \$19.95 plus \$2 P&I
- ZENITH VIDEO MONITOR (high resolution green phosphor) ... wired & tested \$149.95 plus \$6 P&I
- TELEPHONE MODEM MODEL 103 O/A ... wired & tested \$189.95 plus \$3 P&I
- DOT MATRIX PRINTER Comet I ... wired & tested \$299.95 plus \$10 P&I
- RF MODULATOR MOD RF-1 ... kit only \$8.95 plus \$1 P&I
- 3FT-25 LEAD MODEM/TERMINAL OR PRINTER/TERMINAL CONNECTOR CABLE ... \$14.95 ea plus \$2 P&I

For Canadian orders, double the postage. Conn. res. add sales tax.

Total Enclosed \$ \_\_\_\_\_  
 Personal Check  Cashier's Check/Money Order  
 VISA  Master Card (Bank No. \_\_\_\_\_)

Acct. No. \_\_\_\_\_ Exp. Date \_\_\_\_\_

Signature \_\_\_\_\_  
Print Name \_\_\_\_\_  
Address \_\_\_\_\_

City \_\_\_\_\_ State \_\_\_\_\_ Zip \_\_\_\_\_

# MTI stocks 'em all for faster delivery.

Ask about our "QED" discounts.  
VISA and MasterCard orders accepted.

	MTI Price
<b>VIDEO TERMINALS</b>	
VT100 DECscope .....	\$ 1595
VT18X Computing option .....	2395
VT101 DECscope .....	1215
VT131 DECscope .....	1785
VT132 DECscope .....	1995
ADM 3A (dumb terminal) .....	595
ADM 5 (dumb with visual attributes) .....	645
ADM 31 (two page buffer) .....	1095
ADM 21, 24, 32, 36, 42 .....	*
Hazeltine Esprit .....	645
Hazeltine Executive 80 Model 20 .....	1495
Hazeltine Executive 80 Model 30 .....	1715
1410 (Hazeltine dumb terminal) .....	575
1421 (Consul 580 & ADM 3A comp.) .....	595
1500 (dumb terminal) .....	825
1520 (buffered, printer port) .....	1105
<b>RETRO-GRAPHICS TERMINALS</b>	
VT100 with graphics pkg. ....	3250
VT125 (DEC graphics) .....	3280
ADM 3A with graphics pkg. ....	1795
ADM 5 with graphics pkg. ....	1845
<b>300 BAUD TELEPRINTERS</b>	
LA 34-AA DECwriter IV .....	1095
LA 36 DECwriter II .....	1095
Diablo 630 RO .....	2295
Diablo 630 KSR .....	2695
Diablo 1650 KSR .....	2635
TI 743 (portable) .....	1190
TI 745 (port/built-in coupler) .....	1485
TI 765 (port/bubble/b.i. coupler) .....	2595
<b>600 BAUD TELEPRINTERS</b>	
Epson MX-80 .....	645
TI 825 KSR impact .....	1570
TI 825 KSR pkg. ....	1795
<b>1200 BAUD TELEPRINTERS</b>	
Epson MX-100 .....	995
LA 120 RA (receive only) .....	2095
LA 120 AA DECwriter III .....	2295
TI 783 (portable) .....	1645
TI 785 (port/built-in coupler) .....	2270
TI 787 (port/internal modem) .....	2595
TI 810 RO impact .....	1545
TI 810 RO pkg. ....	1795
TI 820 RO impact .....	1850
TI 820 RO pkg. ....	2025
TI 820 KSR impact .....	2025
TI 820 KSR pkg. ....	2195
Lear Siegler 310 ballistic .....	1945
<b>2400 BAUD</b>	
Dataproducts M200 (2400 baud) .....	2910
<b>DATAPRODUCTS LINE PRINTERS</b>	
8300 (300 LPM band) .....	5455
8600 (600 LPM band) .....	6930
81000 (1000 LPM band) .....	11330
8P1500 (1500 LPM band) .....	19700
<b>ACOUSTIC COUPLERS</b>	
A/J A242-A (300 baud orig.) .....	242
A/J 247 (300 baud orig.) .....	315
Vadic VA 3413 (300/1200 orig.) .....	845
Vadic VA 3434 (1200 baud orig.) .....	845
<b>MODEMS</b>	
GDC 103A3 (300 baud Bell) .....	395
GDC 202S/T (1200 baud Bell) .....	565
VA 3212 (Bell 212A comp.) .....	825
VA 103 (300 baud modemphone) .....	235
VA 3451 (orig/ans triple modem) .....	885
VA 3455 (1200 baud orig/ans.) .....	770
VA 2450 (Bell 201 comp.) .....	725
<b>CASSETTE STORAGE SYSTEMS</b>	
Techtran 816 (store/forward) .....	735
Techtran B 17 (store/for/speed up) .....	915
Techtran 818 (editing) .....	1225
Techtran 822 (dual) .....	1640
<b>FLOPPY DISK SYSTEMS</b>	
Techtran 950 (store/forward) .....	1395
Techtran 951 (editing) .....	1995

\* Please call for quote.



Applications Specialists & Distributors  
Computer Terminals, Peripherals & Systems

New York:  
516/621-6200, 212/767-0677, 518/449-5959  
Outside N.Y.S.: 800/645-6530  
New Jersey: 201/227-5552  
Ohio: 216/464-6688

Listing 1: The original 8080 code, the Sorcim TRANS86 translation, the Seattle translation, and the XLT86 translation.

Original 8080 code	TRANS86	Seattle	XLT86
Stax B	Xchg BX,CX Sto AL,[BX] Xchg BX,CX	Mov DI,CX Stob	Mov SI,CX Mov [SI],AL
Inx B	Inc CX	Lahf Inc CX Sahf	Lahf Inc CX Sahf
Dad B	Add BX,CX	Lahf Add BX,CX Rcr SI Sahf Rcl SI	Lahf Add BX,CX Sahf
Ldax B	Xchg BX,CX Ld AL,[BX] Xchg BX,CX	Mov SI,CX Lodsb	Mov SI,CX Mov AL,[SI]
Stax D	Xchg BX,DX Sto AL,[BX] Xchg BX,DX	Mov DI,DX Stob	Mov SI,DX Mov [SI],AL
Ldax D	Xchg BX,DX Ld AL,[BX] Xchg BX,DX	Mov SI,DX Lodsb	Mov SI,DX Mov AL,[SI]
Dad H	Add BX,BX	Lahf Add BX,BX Rcr SI Sahf Rcl SI	SHL BX,1
Dec H	Dec BX	Lahf Dec BX Sahf	Dec BX
Inr M	Incb [BX]	Inc B,[BX]	Inc Byte Ptr 0[BX]
Mvi M,3	Stob #3,[BX]	Mov B,[BX],3	Mov Byte Ptr 0[BX],3
Dad SP	Add BX,SP	Lahf Add BX,SP	Add BX,SP
Dcx SP	Dec SP	Lahf Dec SP Sahf	Dec SP
Mov M,A	Sto AL,[BX]	Mov [BX],AL	Mov Byte Ptr 0[BX],AL
Rnz	Jz :G1 Ret :G1:	Jnz Ret	Jz L 1 Ret L 1:
Jnz Help	Jz :G2 Jmp Help :G2:	Jnz Help	Jz L 2 Jmp Help L 2:

Listing 1 continued on page 340





# NEECO



## Commodore Computer

VIC 20 Personal Computer	\$ 299.95
VIC 1515 Graphic Printer	\$ 395.00
CBM 4016	\$ 995.00
CBM 4032	\$1295.00
CBM 8032	\$1495.00
CBM SuperPet 9000	\$1995.00
CBM 8050 Dual Disk Drive	\$1795.00
CBM 4040 Dual Disk Drive	\$1295.00
CBM 2031 Single Disk Drive	\$ 695.00
CBM 4022 Tractor Printer	\$ 795.00
CBM 8010 IEEE Modem	\$ 279.00
CBM Datasette	\$ 74.95
CBM-IEEE Interface Cable	\$ 39.95
IEEE-IEEE Interface Cable	\$ 49.95



## Professional Software for CBM Computers

WordPro™ — a Family of CBM Word Processing Programs

WordPro 2 Plus	\$ 199.95
WordPro 3 Plus	\$ 295.00
WordPro 4 Plus	\$ 450.00
WordPro 5 Plus (for CBM 8096)	\$ 450.00
The Administrator (DataBase for CBM)	\$ 650.00
Power™ (Programmer's Utility ROM)	\$ 89.95
InfoPro™ (DataBase for CBM)	\$ 295.00



## Atari

Atari 400 16K	\$ 399.00
Atari 800 16K (incl. BASIC cartridge)	\$ 899.00
Atari 410 Recorder	\$ 99.95
Atari 810 Disk Drive	\$ 599.95
Atari 822 Thermal Printer	\$ 299.95

## Amdek Monitors

Video 100C	\$ 179.00
Video 300C	\$ 200.00
Color 1	\$ 449.00
Color 2	\$ 999.00

## CMD Mupet

MC-800A Mupet Controller (Multi-User Controller for CBM Computers)	\$ 995.00
CM-100 Channel Module	\$ 250.00
Printer Module	\$ 350.00

## Qume

Sprint 9/45	\$2495.00
Tractor Option	\$ 210.00

## Epson Printers

MX-70	\$ 299.95
MX-80 w/Graphtrax	\$ 645.00
MX-80 FT	\$ 745.00
MX-100 FT	\$ 945.00
INTERFACE CARDS	
8141 RS-232 Interface Board	\$ 75.00
8145 RS-232 Interface Board w/2K Buffer	\$ 149.00
8151 RS-232 Interface Board w/X/ON-X/OFF	\$ 170.00
8161 IEEE Interface Board	\$ 55.00
8131 Apple Interface Card	\$ 85.00
8232 Apple Interface Cable	\$ 35.00
8220 TRS-80 Cable	\$ 35.00

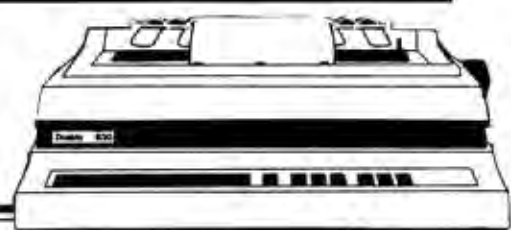

## Diablo 630 Printer

Diablo 630	\$2710.00
Tractor Option	\$ 350.00

## NEC Spinwriter Printer

NEC 7730	\$3085.00
NEC 7710	\$3085.00
NEC 7720	\$3610.00
NEC 3510	\$2290.00
NEC 3500RD	\$1895.00

Tractor Feed Options are available

\* WordPro, POWER, & InfoPro are registered trademarks of Professional Software Inc.

CALL FOR OUR 70 PAGE CATALOG FOR COMPLETE PRODUCT LINE AND PRICE LISTINGS

WE WILL MATCH SOME ADVERTISED PRICES ON CERTAIN PRODUCTS LISTED UNDER SIMILAR "IN STOCK" CONDITIONS.



# NEECO

679 Highland Ave.  
Needham, MA 02194

## (617) 449-1760

TELEX: 951021

MON-FRI 9:00 - 5:30 E.S.T.



MASTERCARD \* UISA

Listing 1 continued:

Cnz Help	Jz :G3 Call Help :G3:	Jz X000 Call Help X000:	Jz L 3 Call Help L 3:
Xthl	Mov BP,SP Xchg BX,[BP]	Pop SI Xchg SI,BX Push SI	Mov BP,SP Xchg BX,[BP]
Pop PSW	Pop AX Sahf	Pop AX Xchg AH,AL Sahf	Pop AX Xchg AL,AH Sahf
Push PSW	Lahf Push AX	Lahf Xchg AH,AL Push AX Xchg AH,AL	Lahf Xchg AL,AH Push AX Xchg AL,AH
Sphl	Mov BX,SP	Mov SP,BX	Mov SP,BX
(Z80 opcodes)			
Djnz Label	Dec CX Jnz Label	Dec CH Jnz Label	-----
Cpir	Xchg BX,DI Cld Repnz Scasb Xchg BX,DI	UP Mov DI,BX Repnz Scab Mov BX,DI	-----
Ldir	Xchg BX,SI Xchg DX,DI Cld Repnz Movsb Xchg BX,SI Xchg DX,DI	Up Mov SI,BX Mov DI,DX Rep Movb Mov DX,DI Mov BX,SI	-----
Push Ix	Push DI	Push [Ix]	-----
Pop Iy	Pop SI	Pop [Iy]	-----

translated text, also. We therefore suspect that the program has a minor bug with regard to this particular instruction.

Since this test program was nonsense as far as logical program flow is concerned, XLT86 was at a loss to determine the active registers, and sometimes chose simpler instructions than it would have in a real program. The results for XLT86 could be different in different situations.

The conditional jumps for TRANS86 and XLT86 can vary, depending on the distance of the target label from where the jump is.

The conditional return in Seattle's translator references a label called RET. This refers to any RET within 128 bytes on either side of the statement. This is one reason why Seattle's

translator should be used with ASM86; no other assembler will take advantage of this feature.

Note that TRANS86 and the Seattle translator treat the DJNZ instruction differently. TRANS86 uses a 16-bit register, CX, and the Seattle translator uses CH, an 8-bit register. A warning message comes out of the Seattle translator reminding the programmer that DJNZ does not affect the flags in the Z80 but that this sequence of instructions will affect the 8086 flags.

### Register Mapping

Figure 6 shows a detailed, side-by-side comparison of the differences in register mapping performed by the three translators. Figure 6a deals with the 8080/8085-to-8086 mapping;

figure 6b, with Z80-to-8086 mapping.

As the notes there state, TRANS86 does not preserve 8080 byte order on the stack.

The Seattle translator uses SI on loads from memory and DI for stores to memory.

TRANS86 and XLT86 do a register exchange between BX and the appropriate register to allow indirect addressing through BX, then a register exchange to fix up BX and the appropriate register.

Since the 8086 does not have some of the registers of the Z80, the translators can't support them. The programmer can, however, map those registers to a memory location.

TRANS86 generates memory references to storage locations supplied by the programmer to take care of the Z80's IX, IY, BC', DE', and HL' registers.

### Summing Up the Translators

A general view is that Sorcim's TRANS86 is a useful product if the original source is in 8080 or ACT80 form and the user has ACT86 as a target 8086 assembler. The register and flag usage appear to be a little looser than for the other two programs. This requires more knowledge and more involvement from the programmer to make sure that the sense of the translated code is maintained. No limitations exist as to the size of the source file and macros are supported if the input is in ACT80 format. Sorcim's TRANS86 is sold separately from ACT86, but they should be used together.

The Seattle Computer Products' Z80-to-8086 translator is a straightforward code translator that uses Zilog mnemonics and runs only on Z80-based processors. There appear to be no limitations as to the size of the source program that may be translated since the program translates one instruction at a time. Register and flag usage are very conservative, protecting the source architecture as much as possible and providing warnings when potential problems could arise. The converted program has more of a chance of working the first time than a less conservative translation would have.



# PERSYST ADD-IN MEMORY

*When Only The Very Best Will Do!*

You wanted the very best...that's why you waited for the IBM Personal Computer. Now you're ready to expand your memory capacity and again, you want the very best.

The best is here now. Introducing the PERSYST Memory Expansion Module (MEM).

Available in a variety of configurations from 64K to 256 KBytes on a single board, the PERSYST "MEM" has been designed with the same dedication to quality, performance and ease of use as your IBM Personal Computer. Each "MEM" undergoes extensive test and high-temperature burn-in to ensure quality, reliability and dependability.

Key features include:

- Competitively priced.
- Completely IBM compatible.
- Permits utilization of the 1 megabyte addressing capability.
- Can be placed in any expansion slot.
- Expandable up to 256K Bytes on one board.
- Parity generate and check.
- Completely tested and burned-in.
- No Wait States.
- One year warranty.

PERSYST also makes Single and Dual line Asynchronous Communication Controllers.

- Fully compatible with IBM's Asynchronous Communication Controller.
- All standard baud rates up to 19,200.
- Full modem signal support on both lines.
- Operates with IBM's Asynchronous Communications Software Support.
- Single board.
- Simple Installation.

Don't settle for less...insist on PERSYST. See the expanding line of PERSYST products at your local PERSYST dealer or contact: Don McDonald.

## PERSYST, INC.

22957 LA CADENA  
LAGUNA HILLS, CA. 92653  
(714) 859-8871



# CHOOSE...

## Choose an Apple Desk



A compact Bi-Level desk ideal for the Apple computer system. This 42" x 29 1/2" desk comes with a shelf to hold two Apple disk drives. The top shelf for your TV or monitor and manuals can also have an optional paper slot to accommodate a printer. It is shown here with the optional Corvis shelf which will hold one Corvis disk drive. The Corvis shelf is available on the 52" x 29 1/2" version of the Apple desk.

## Choose a Micro Desk



The Universal Micro desk accommodates the S-100 type microcomputers. The desk is available in four sizes: 17.75 inch, 19.06 inch, and 20.75 inch wide openings with 24 inch front-to-rear mounting space. The fourth size is a 20.75 inch wide opening with a 26.50 inch front-to-rear mounting space.

## Choose a Mini Rack



Mini racks and mini micro racks have standard venting, cable cut outs and adjustable RETMA rails. Choose a stand alone bay or a 48", 60", or 72" desk model in a variety of colors and wood tones. A custom rack is available for the Cromemco.

## Choose a Printer Stand



The Universal printer stand fits the:

Centronics 700's	Diablo 1600's & 2300's
Dec LA 34	T.I. 810 & 820
NEC Spinwriter	Okidata Slimline
Lear Siegler 300's	Anadex 9500's

Delivery in days on over 200 styles and colors in stock. Dealer inquiries invited.

### ELECTRONIC SYSTEMS FURNITURE COMPANY

17129 S. Kingsview Avenue  
Carson, California 90746  
Telephone: (213)538-9601

Once the program is working correctly, the programmer can reedit the 8086 source to trim out the unnecessary register saves and flag manipulations to speed up the code and make it smaller. If the source code is in Zilog mnemonics, or if a filter program is available to convert to Zilog mnemonics, we recommend the pair of programs from Seattle Computer Products. The Seattle translator and its ASM86 assembler should be used together for optimum benefit.

XLT86 from Digital Research is a program that takes 8080 source code and converts it into 8086 source code in an intelligent manner using data-flow-analysis techniques. It will produce better code than either of the other two translators if two conditions are met: (1) no Z80 instructions are used, and (2) the source code is not bigger than 6K bytes (assuming the CP/M system is a 64K-byte system). XLT86 should be used with ASM86 under either CP/M-80 or CP/M-86.

### MS-DOS versus CP/M-86

In the trade press and various advertisements, we see claims that conversion of CP/M-80 programs to MS-DOS (IBM PC-DOS, Lifeboat Associates' SB-86, Seattle Computer Products' 86-DOS) is as easy, or even easier, than from CP/M-80 to CP/M-86. In fact, some differences are seen in interfacing to the two 16-bit operating systems. With the assumption that the program had to operate in a 64K-byte region under CP/M-80, we will bypass memory-allocation questions. The remaining issues that have to be addressed are:

- How does a program gain access to operating system resources?
- How are file control blocks used to manipulate files?

Gaining access to the operating system under CP/M-80 requires placing the function code in the C register, placing the information address in the DE registers, and calling location 05 hexadecimal, the CP/M-80 entry point. If the system

call returns a value, it returns the value to the A register. A so-called warm boot under CP/M-80 is accessed by jumping to location 00 hexadecimal, which reads in the operating system and resets the disk system.

Now let's look at similar functions under CP/M-86 and MS-DOS.

### Gaining Access to CP/M-86

Gaining access to CP/M-86 requires placing the function code in the CL register, placing the byte parameter in the DL register or placing the word parameter in the DX register, placing the data segment in the DS register (the data segment is usually not changed for a converted program), and executing a software interrupt, INT #224. The result is returned in the AL register if it is a byte value; if the result is a word value, it is returned in both the AX and BX registers. Double-word values are returned with the offset in the BX registers and the segment in the ES register. Conversion of programs from CP/M-80 to CP/M-86, then, requires replacing the call to location 5 with the software interrupt INT #224.

Another necessary change involves the warm boot. Under CP/M-80, the warm boot may be accessed by a system call with a function code of 0 for a jump to location 0. CP/M-86, however, does not support the jump to location 0. As a result, you must change this program exit in the translated program if the program is to run correctly.

Provided that the call to location 5 is replaced with INT #224, that the warm boot change is made, and that the registers are mapped correctly, there should be little problem in getting the translated program to access the CP/M-86 system functions.

### Gaining Access to MS-DOS

Although MS-DOS has a "preferred" mechanism through a software interrupt, INT #33, for accessing the system, an additional mechanism is provided for "pre-existing" programs that is compatible with CP/M-80 calling conventions, at least for functions in the range of



# Ten reasons why your floppy disk should be a BASF FlexyDisk®.

More than four decades of experience in magnetic media – BASF invented magnetic recording tape, the forerunner of today's wide range of magnetic media, back in 1934, and was the first independent manufacturer of IBM-compatible floppy disks.

Tough Tyvek sleeve – no paper dust, no static electricity.

Special self-cleaning jacket and eraser help eliminate data errors and media wear and tear.

Packaging to suit your requirements – standard flip-top box, Cassette 10® storage case, or bulk pack.

Center hole diameter punched to more accurate standards than industry specifications, for top performance.

100% certification – every single disk is tested at thresholds 2-3 times higher than system requirements, to be 100% error-free.

Bi-axially oriented polyester substrate – for uniform and reliable performance year after year.

For the name of your nearest supplier, write BASF Systems, Crosby Drive, Bedford, MA 01730, or call 617-271-4030.

Cross-linked oxide coating – for low head wear and long trouble-free media life.

Total capability – one of two manufacturers in the world that makes both 8" and 5.25" models, has tape and disk experience, and manufactures floppy disk drives.

Double lubrication – lubricants both in the formula and on the disk surface, to minimize media wear due to head friction.

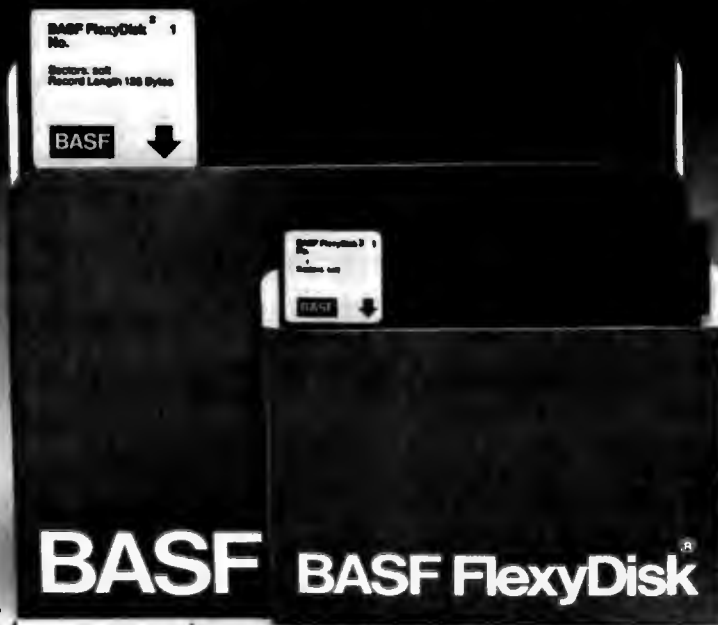

## BASF

Floppy Disks Mag Cards Cassettes Computer Tapes Disk Packs Computer Peripherals

Circle 53 on Inquiry card.

Visit BASF during NCC at the Astro Village Hotel.

0-36. As far as system calls within the allowed function range are concerned, the programmer doesn't have to do anything to translated programs to get them to run under MS-DOS other than to correctly map the registers.

MS-DOS also supports the warm boot function of CP/M-80. A jump to location 0 under MS-DOS executes a software interrupt, INT #32, which is functionally a program end and the normal way to exit from a program.

### Manipulating File Control Blocks

The file control block used in CP/M-80 consists of a 36-byte block, which describes the disk drive on which to find or create the file, the file name, and information relating to which record of the file is desired.

At least so far as normal file-access requests are concerned, both MS-DOS and CP/M-86 treat this block of information the same.

System-level information is quite different in the two cases, and pro-

grams that look at system bytes within the file control block need to be changed for MS-DOS to function correctly. The MS-DOS file control block has many more features, including the date the file was created

## The problems encountered in mapping instructions and registers can be formalized and solved by using a variety of software tools.

or last updated, the logical record size, and the file size. These system-information bytes are in areas within the file control block that application programs normally do not access. Nevertheless, converting programs to make use of MS-DOS file control blocks should take little effort.

### Conclusion

There is, in fact, little if any difference in the difficulty of translating sound CP/M-80 programs to CP/M-86 or MS-DOS. With CP/M-86, the programmer will have to make minor changes to gain access to the operating system. With MS-DOS, the programmer will have to make minor changes to handle the extra features of the MS-DOS file control blocks.

Next month, we will make further comparisons between MS-DOS and CP/M-86. We will include some benchmarks made with the Compu-pro 8085/8088 dual-processor S-100 system. We will report not only the results of running programs under both CP/M-86 and MS-DOS on the same 8088 in the same machine, but also the results of running the same programs under MS-DOS running Emulator-86 on the same 8088 in the same machine. Although that may sound more like a cat chasing its own tail than a test of operating systems, we will try to keep it all straight. ■

**Bare Bones APPLE II**  
w/o Keyboard  
w/o Pwr. Supply  
**\$450. 48k RAM**  
Microswitch: Power Supply: APPLE  
Keyboard / Pad: 5amp.: Reference Manl.  
\$95.00 : \$124.00 : \$18.00

**SPECIALS**  
B255 -- \$5.95  
8748-B -- \$31.00  
3341PC -- \$2.00  
MM5060 -- 35c  
MC6800 -- \$7.75  
MC6802 -- \$14.95  
MC6850 -- \$4.50  
MC6821 -- \$4.95

**82 I.C. MASTER \$59.95 GLOBAL LPK-1:**  
Logic Probe Kit - Complete nothing extra to buy. Min. pulse width 300nsec.  
**\$18.95**

**DISKETTE SALE!! 'WABASH'**  
5 1/4 8inch  
SS/SD \$25.00 \$25.00  
SS/DD 27.40 30.40  
DS/DD 32.40 37.40  
Box of 10 pcs  
**QTY. PRICE AVAIL**

**COMPUTERS ATARI 800™ COMPUTER SYSTEM**  
400w/16K \$350.00  
800w/16K \$899.00  
800 Computer w/48K  
BEST BUY \$825.00

**ATARI PERIPHERALS:**  
Printer 825 - 6500 Asteroids  
Disk Dr. 810 - 4850 Missile Com. -> 32.50  
Record 410 - 8200 Sup. Brk. Out  
Paddle (pr) 16.95 Assm. Edit. - 4900  
Joystick (pr) 16.95 Star Raiders - 4500  
32k RAM - 179.95 Basketball - 2800  
Basic Cart. - 4900 Chess - 3200

**\* MONITORS \***  
ZENITH 1 12in 15MHz 1. Green Phos Hi-Res. -> \$118.50  
J.C.S. 2 12in 18MHz 2 Green Phos Hi-Res. -> \$155.50  
AMDEK 3 12in 12MHz 3 Green Phos Hi-Res. -> \$165.50  
13in Color 3a 3a Lo-Res -> \$375.50

**CONCORD COMPUTER PRODUCTS**  
1971 SO STATE COLLEGE ANAHEIM, CALIF 92806  
(714) 937-0637  
10 MIN ORDR AT L.A. RES ADD 6.00  
10 48 1200 200 488 1000  
100 280 800 1000 LP CALL

**COMPONENTS**

74LS SERIES				7400 SERIES					
74LS00	24	74LS83	70	74LS165	85	7400	18	7454	19
74LS02	24	74LS86	38	74LS169	155	7402	18	7470	30
74LS03	24	74LS90	80	74LS170	155	7406	21	7474	30
74LS04	24	74LS91	85	74LS171	155	7409	23	7475	40
74LS05	24	74LS92	65	74LS175	85	7409	18	7476	30
74LS06	30	74LS93	60	74LS190	80	7411	22	7480	55
74LS08	28	74LS95	80	74LS191	90	7411	22	7481	100
74LS10	24	74LS107	38	74LS207	85	7412	26	7489	3.85
74LS12	33	74LS109	38	74LS240	95	7413	32	7490	40
74LS13	45	74LS112	40	74LS241	95	7414	35	7491	45
74LS14	89	74LS113	40	74LS244	85	7417	24	7492	45
74LS15	33	74LS114	45	74LS245	155	7417	24	7494	60
74LS16	33	74LS112	40	74LS248	100	7420	18	7495	50
74LS21	24	74LS123	85	74LS249	90	7422	25	7496	2.50
74LS26	30	74LS125	90	74LS251	120	7425	25	74107	25
74LS27	28	74LS126	85	74LS253	80	7427	25	74122	40
74LS28	32	74LS132	70	74LS257	80	7430	18	74125	40
74LS30	24	74LS136	50	74LS258	80	7432	25	74144	2.50
74LS32	32	74LS138	65	74LS259	125	7435	25	74145	50
74LS37	50	74LS139	65	74LS260	60	7440	18	74148	100
74LS38	32	74LS145	110	74LS271	80	7442	15	74154	1.00
74LS42	50	74LS151	70	74LS275	300	7443	30	74158	1.25
74LS48	70	74LS153	70	74LS279	50	7446	20	74160	80
74LS51	24	74LS157	70	74LS283	75	7445	60	74161	80
74LS55	35	74LS158	70	74LS373	90	7447	60	74166	80
74LS74	35	74LS161	85	74LS374	150	7448	60	74169	90
74LS75	48	74LS162	85	74LS377	140	7449	18	74181	1.00
74LS76	38	74LS163	85			7451	18	74393	1.00
74LS78	50	74LS164	85			7453	19		

**DYNAMIC RAMS**

4027	200	8/175ns	74500	35	74586	110
4116	200ns	1.75 8/1300	74502	38	74512	145
4164	200ns	9.50	74503	38	74532	110

**STATIC RAMS**

2111	2	85 8/2.50ns	74504	45	74538	95
2112	2	85 8/2.50ns	74505	65	74540	125
2114	2	85 4/14.00	74508	40	74558	125
2116	200ns	2.00 4/12.00	74510	55	74574	95
HM6116	200ns	11.50 4/12.00	74515	55	74581	95
			74520	55	74589	400
			74526	70	74592	2.75
			74530	35	74598	350
			74537	1.25	74624	30
			74551	60	74624	350
			74555	60	74624	350
			74574	55	74624	350
			74585	2.00	74624	350

**MISC**

8726	120					
8728	120					
8038	2.75	8212	1.95			
8080A	3.75	8218	1.80			
8155	4.50	1103A	95			
8255	10.50	UP0765	19.85			
MC1310	1.65	AY5-1013A	3.00			
MC1350	1.15	1489	38			
MC1358	1.50	MC6802	14.95			
MC1458	1.10	MC6821P	4.95			
LM350	1.10	MC6850P	4.50			
LM396	1.55					
LM385	.95					
LM741	.25					
LM1310	2.90					
LM1800	2.95					
LM1889	1.45					

**MORE MISC**

1702	4.25	8/3.95ns				
2708	2.95	8/2.65ns				
74522	5.00	8/4.50ns				
TMS2716	8.95	8/8.00ns				
2732 (5V)	10.50	8/9.25ns				
TMS2532	11.90	8/10.25ns				

**I.C. SOCKETS**

74	8	10/1.20				
10/5.30	14	10/1.40				
10/5.70	16	10/1.40				
10/7.20	18	10/1.60				
10/9.70	20	10/2.70				
10/12.70	22	10/2.70				
10/13.70	24	10/2.70				
10/14.70	28	10/3.00				
10/17.70	40	10/3.90				

**VOLTAGE REGULATORS**

7805	85					
7808	85					
7809	85					
7812	85					
7818	85					
7824	85					
7806	85					
7808	85					
7812	85					
7818	85					
7824	85					

**CPU'S**

Z80	8.50					
Z80A	6.00					
Z80A PIO	6.00					
8502	6.00					
8502A	12.00					
8085A	8.50					
MC6800	7.75					



# YOUR BEST FRIEND FOR FRIENDLY COMPUTING

## Commodore VIC-20 from ASAP

ASAP brings you the Commodore VIC-20, the friendly computer that costs little more than a video game. The VIC-20 plays great space games, but it can also improve learning skills, help with household budgets and much, much more.

The VIC-20 features color, sound, graphics, programmable function keys, built-in BASIC and expandable memory. The Friendly Computer connects to any TV or monitor. And ASAP gives you the VIC-20 complete with RF modulator, switchbox, cables and a self-teaching instruction book at a great low price.

ASAP also carries a full line VIC-20 peripherals and software, including:

### Part Number Description

- VIC1530 Commodore Datassette
- VIC1540 VIC1540 Single Disk Drive
- VIC1515 VIC Graphic Printer

### SPECIAL CARTRIDGES

- VIC1210 VIC 3K Memory Expander Cartridge
- VIC1110 VIC 8K Memory Expander Cartridge
- VIC1011A RS-232-C Terminal Interface
- VIC1112 VIC IEEE-488 Interface Cartridge

### APPLICATIONS SOFTWARE ON CARTRIDGE

- VIC1211A VIC-20 Super Expander — 3K RAM memory expansion, high resolution, graphics plotting, color, paint and sound commands. Graphic, text, multicolor and music modes. 1024 x 1024 dot screen plotting.
- VIC1212 Programmers Aid Cartridge — More than

20 new BASIC commands help new and experienced programmers renumber, trace and edit BASIC programs.

- VIC1213 VICMON Machine Language Monitor — Helps machine code programmers write fast, efficient 6502 assembly language programs.

### RECREATIONAL GAMES ON CARTRIDGE

- VIC1901 VIC Avengers
- VIC1904 Superslot
- VIC1906 VIC Super Alien
- VIC1907 Super Lander
- VIC1908 Draw Poker
- VIC1909 Midnight Drive

### COMPUTER PROGRAMS ON TAPE

- VT 106A Recreation Program Pack A
- VT 107A Home Calculation Program Pack A
- VT 164 Programmable Character Set/Gamegraphics Editor
- VT 232 VICTerm I — Terminal Emulator

### TEACH YOURSELF PROGRAMMING SERIES

- VL 101 Introduction to Computing
- VL 102 Introduction to BASIC Programming

### VIC-20 BOOKS AND MANUALS

- VM 101 Personal Computing on the VIC-20
- VM 110 VIC-20 Programmers Reference Guide

### ASAP Add-Ons for VIC-20

- 5 1/4" Floppy Disk Drive Subsystems, single or double-sided, single or double density
- 80 x 24 Video Card
- 27K Memory Board (static)
- Expansion Chassis with Motherboard

ALL PRICES SUBJECT TO CHANGE WITHOUT NOTICE. CALL FOR BEST PRICE.

ASAP offers a 15-day buyer protection policy: full money-back guarantee if not totally satisfied.

Ordering Information: name, address, phone; ship by: UPS or Mail. Shipping charge: add \$2.90 up to 1 lb. (UPS blue), U.S. Mail add \$1.50 (U.S. only) (\$25.00 minimum order).

Terms: We accept cash, check, money orders, Visa and Master Charge (U.S. funds only). Tax: 8% Calif. res., COD's and terms available on approval (School PO's Accepted).

Toll free outside California: (800) 421-7701  
Inside California: (213) 595-6431 (714) 891-2663

ASAP Computer Products, LTD., 116 Viceroy Rd.  
D-12 Concord, Toronto, Ontario, Canada  
L4K 1A9 (416) 738-0500 (800) 268-1996

**asap**  
computer  
products, inc.

1198 E. Willow St., Signal Hill, CA 90806

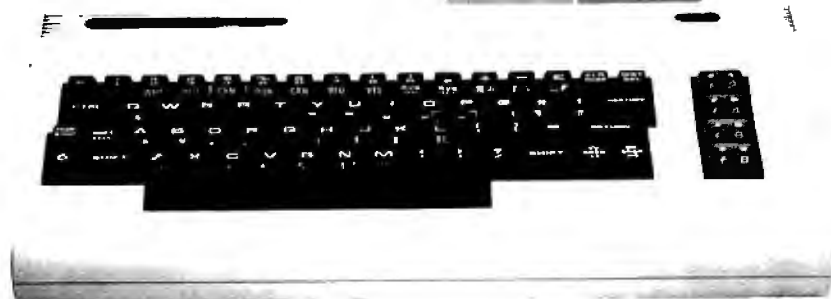

# WE'LL "DRIVE" YOU WILD



**with our variety of quality disk drives.**

Announcing the latest addition to ASAP's broad product line—disk drives from Mitsubishi. The Mitsubishi M2894-63 is a double-sided, double-density 8-inch drive featuring high-performance characteristics at a surprisingly low price. LSI microprocessor-based electronics provide sophisticated logic control functions, assuring signal and data integrity. And a unique Gimbal Head design assures a smoother drive for longer-wearing media.

Mitsubishi's 5¼" drives provide improved storage capacity over that of conventional drives. The M4853 features 96 tpi density; twice that of many others. And the M4854 provides the storage capacity of 8-inch drives.

**M2894-63** ..... Call for price  
**M4853** ..... Call for price  
**M4854** ..... Call for price

Additional drives from ASAP:  
**Data Trak™ 5** (ANSI 5¼" compatibility) ..... Call for price  
**Data Trak™ 8** (IBM compatibility) ..... Call for price  
**Shugart Model 801** (standard floppy) ..... \$390.00  
**Shugart Model 850** ..... \$600.00

ASAP also provides a full line of high reliability disk drive subsystems. For superior quality, high reliability disk drives, contact ASAP today.

Part No. — Description*	Price
<b>CAB5V</b> — Single cabinet for either Shugart or Qume 5¼" floppy disk drives (cabinet only) .....	\$ 75.00
<b>CAB5V/1Q</b> — Single cabinet with (1) Qume® DT-5 double-sided double-density 5¼" floppy disk drive installed .....	\$ 425.00
<b>CAB8H</b> — Dual cabinet for 8" floppy disk drives (horizontal mounting) .....	\$ 225.00

<b>CAB8V</b> — Cabinet for 8" floppy disk drives (vertical mounting) .....	\$ 250.00
<b>CAB8H/V+1S</b> — Dual cabinet with (1) Shugart SA801R 8" floppy disk drive installed (horizontal or vertical mounting) .....	\$ 635.00
<b>CAB8H/V+2S</b> — Dual cabinet with (2) Shugart SA801R's 8" floppy disk drives installed (horizontal or vertical mounting) .....	\$1050.00
<b>CAB8H+1M</b> — Dual cabinet with (1) Mitsubishi double-sided double-density 8" floppy disk drive installed .....	\$ 690.00
<b>CAB8H+2M</b> — Dual cabinet with (2) Mitsubishi double-sided double-density 8" floppy disk drives installed .....	\$1055.00
<b>CAB8H/V+1Q</b> — Dual cabinet with (1) Qume® DT-8 double-sided double-density drive installed (horizontal or vertical mounting) .....	\$ 750.00
<b>CAB8H/V+2Q</b> — Dual cabinet with (2) Qume® DT-8's double-sided double-density drives installed (horizontal or vertical mounting) .....	\$1200.00
<b>HDC8/1-HD</b> — Cabinet with (1) Priam 10 megabyte hard disk drive with Microbyte Controller .....	Call for price
<b>HDC8/1F+1HD</b> — Cabinet with (1) Qume® DT-8 double-sided, double-density drive, and (1) Priam 10 megabyte hard disk drive with Microbyte Controller .....	Call for price
<b>CAB8V/2F-9SMB</b> — Desk top cabinet for (2) 8" Shugart or Qume floppy disk drives, 9-slot motherboard, card cage, fan, dust filter, power supply, and all power and drive cables .....	Call for price

\*All cabinets come complete with power supply, fan and internal cables.



Terminals		
Manufacturer	Model #	Price
Ampex	Dialogue 80	\$ 875.00
ear Siegler	ADM-5	\$ 660.00
ear Siegler	ADM-3A	\$ 635.00
ear Siegler	ADM-3A-	\$ 1225.00
ear Siegler	ADM-31	\$ 1095.00
ear Siegler	ADM-32	\$ 1225.00
ear Siegler	ADM-42	\$ 1195.00
elevideo	TVI 910	\$ 625.00
elevideo	TVI 912C	\$ 725.00
elevideo	TVI 925	\$ 825.00
elevideo	TVI 950C	\$ 925.00

Components		
1116's (200 nS)/5290-3		
Apple TRS-80 Heath		
16-49	\$1 70 each	50-99 \$1 50 each
66-99	\$1 60 each	100 up \$1 30 each

1114 L-2/200 nS		
Low-Power 1K x 4 Static RAM		
16-49	\$2 80 each	50-99 \$2 60 each
7-49	\$2 70 each	100 up \$2 45 each

170B/450 nS		
1K x 8 EPROM		
	\$4 00 each	or 8/\$28 00

1716/5 Volt		
1K x 8 EPROM		
	\$4 95 each	

Regulators		
2015	\$ 70	\$ 80
4015	\$ 70	\$ 80
20112	\$ 80	\$ 90
40112	\$ 80	\$ 90

Connectors			
description	1-9	10-24	25 up
DB25P	\$2 00	\$1 90	\$1 75
DB25S	\$2 95	\$2 75	\$2 50
DB25C	\$ 95	\$ 85	\$ 75

100 Pin IMSAI  
Gold/S-100 Solderless Connectors  
250 each or 10/\$2 40 each

Capacitors  
@ 12 Volt Ceramic . . . . 8c each or 100/\$7 00

SIP Sockets — Low Profile Tin Soldertail				
description	1-9	10-49	50-99	100 up
4 pin tin st	\$ 15	\$ 13	\$ 12	\$ 11
8 pin tin st	\$ 16	\$ 14	\$ 13	\$ 12
8 pin tin sl	\$ 19	\$ 18	\$ 16	\$ 14
8 pin tin st	\$ 25	\$ 23	\$ 21	\$ 20
8 pin tin st	\$ 26	\$ 24	\$ 22	\$ 20
8 pin tin st	\$ 32	\$ 30	\$ 29	\$ 27
8 pin tin st	\$ 42	\$ 40	\$ 38	\$ 34

### SYSTEMS WITH SPICE from CALIFORNIA COMPUTER SYSTEMS

#### FOR S-100 USERS

2K Static RAM Board part Number 2032C	Price: \$595 00
6K Static RAM Board part Number 2116C	Price: \$300 00
4K Dynamic RAM Board part Number 2065C	Price: \$550 00
30A CPU Board part Number 2810A	Price: \$270 00
copy Disk Controller part Number 2422A	Price: \$370 00
PJM™ Version 2.2 Free With Purchase	
100 Mainframe part Number 2200A	Price: \$475 00
100 Motherboard part Number 2501A	Price: \$150 00
Port Serial I/O Interface part Number 2710A	Price: \$285 00
Serial, 2-Parallel I/O Board part Number 2719A	Price: \$280 00
Port Parallel I/O Board part Number 2720A	Price: \$195 00

#### OR APPLE II™ USERS

Asynchronous Serial Interface part Number 7712A	Price: \$149 00
Programmable Timer part Number 7440A	Price: \$ 95 00
Synchronous Serial Interface part Number 7710A	Price: \$139 00
Memory/Clock Module part Number 7424	Price: \$ 99 00
1/4 Digit BCD A-to-D Converter part Number 7470A	Price: \$ 95 00
2K ROM/PRGM Module part Number 7114A	Price: \$ 85 00
Parallel Interface part Number 7720A	Price: \$125 00
Arithmetic Processor part Number 7811A	Price: \$349 00
Centronics Printer Interface part Number 7728A	Price: \$125 00

**Printers**  
**Epson MX-80**  
80 Column Dot Matrix Printer  
Character set: full 96-character ASCII with descenders  
Graphics characters: 64 block characters  
Centronics-style 8-bit parallel interface  
standard: Apple, TRS-80, RS-232 interfaces optional.

### MX-80 FT/Friction Feed MX-100/132 Column

**Okidata Dot Matrix Printers**  
82A — 80 column printer w/tractor  
Throughput @ 80 characters per line: 76 lines per minute  
Print Speed: 120 CPS  
83A — 136 column printer w/tractor  
Throughput @ 136 characters per line: 76 lines per minute  
Print Speed: 120 CPS  
84A — 136 column printer w/tractor  
Throughput @ 136 characters per line: 114 lines per minute  
Print Speed: 200 CPS  
Centronics & RS-232C interfaces standard on models 82A & 83A. 2K serial buffer board (RS-232) optional on all models. 84A: Centronics 8-bit parallel interface optional; Hi-RES Graphics standard.

CALL FOR PRICE & DELIVERY

### Apple Parallel Interface: AEI-1 W/Cable \$69.95

- Standard Interface
- Compatible with Epson & Okidata Printers
- On-board Firmware (2708)
- Optional Cables: \$20.00
- AEC-2/Atari to Epson Printer
- TREC-2/TRS-80 to Epson/Okidata Printer
- RSC-1/RS-232 (male to male)

### Serial Interface SEI-1 \$55.00

- Asynchronous 300, 1200, 2400 or 9600 BPS
  - Compatible with Epson Printers
  - 75 to 9600 BPS
- Manufacturer/Model # Price  
Anactex-9501 W/2K buffer . . . . \$1295.00  
Diablo-630R0 . . . . \$2095.00  
C Itoh Pro/Writer II . . . . Call for price  
C Itoh F-10 Printmaster . . . . Call for price  
Texas Instruments-810 . . . . \$1650.00

### Modems

Manufacturer	Model #	Price
Novation	CAT	\$ 149.00
Novation	d-CAT	\$ 160.00
Novation	Auto-Cat	\$ 229.00
DC Hayes	Smart Modem	\$ 235.00
DC Hayes	Micro Modem II (Apple)	\$ 320.00
DC Hayes	Micro Modem 100	\$ 320.00
Lexicon	Lex-11	\$ 139.00
Livermore	LIV-Star 20M	\$ 149.00
UDS	UDS 103 LP (300 Bd)	\$ 185.00
UDS	UDS 202 LP (1200 Bd)	\$ 245.00

### Monitors

Manufacturer	Model #	Price
Amdek	100/12" B&W	\$ 110.00
Amdek	100-80	\$ 169.00
Amdek	100G/12" Grn.	\$ 120.00
Amdek	Color-1 13"	\$ 350.00
Sanyo	DM 5109CX/9" Grn.	\$ 175.00
Sanyo	DM 5012/12" B&W	\$ 270.00
Sanyo	DM 5112ex/12" Grn.	\$ 290.00
Sanyo	DM C6013/13" Color	\$ 450.00
Zenith	ZVM-121/12" Grn.	\$ 115.00

### ATARI COMPUTER PRODUCTS

#### ATARI 800 (16K) Personal Business Computer Features:

- Computer console
  - Atari BK basic
  - 57 full stroke alpha-numeric keyboard with four function keys
  - Operator's manual
  - RF modulator
  - Power supply
- Call for price

ATARI 400 . . . . \$349.00

#### Atari Optional Accessories

Model #	Description	Price
410	Program Recorder	\$ 80.00
810	Disk Drive System	\$ 455.00

822	40 Column Thermal Printer	\$ 299.00
820	40 Column Dot Matrix Printer	\$ 279.00
825	80 Column Dot Matrix Printer	\$ 625.00
830	Acoustic Modem	\$ 159.00
850	Interface Module	\$ 169.00
CX30-04	Paddle Controls	\$ 17.95
CX40-04	Joysticks (pair)	\$ 17.95

### INTRODUCING ASAP's Atari 800 16K RAM Module: \$55.00

1 year warranty parts & labor

### Software Atari

Basketball	\$ 27.00
Super Breakout	\$ 30.00
Chess	\$ 32.00
Video Ease!	\$ 25.00
3-D Tic Tac Toe	\$ 25.00
Star Raiders	\$ 36.00
Asteroids	\$ 32.00
Music Composer	\$ 42.00
Assembler/Editor	\$ 45.00
Teletink I	\$ 24.00
Space Invaders	\$ 30.00
Kingdom	\$ 12.95
Missile Command	\$ 32.00
Biorhythm	\$ 12.95
Graph II	\$ 17.95
Energy Czar	\$ 12.95
Mailing List	\$ 19.95
Touch Typing	\$ 19.95
Stock Charting	\$ 22.95
Stock Analysis	\$ 19.95
Bond Analysis	\$ 22.95
Word Processor	\$ 119.00
Personal Finance	\$ 64.95
Microsoft BASIC	\$ 75.00
Dasoft	
Atari Mailing List Disk	19.95
Atari Character Generator Disk	16.95
Text Wizard Disk	89.95
Micropainter Album 1 Disk	16.95
Micropainter Album 2 Disk	16.95
Le Stick Accessory	30.00
Innovative Design Software, Inc.	
Pool 1 5 HI-RES 48K	\$28.95
On-Line Systems	
HI-RES Adv #0 — Mission: Asteroid Disk	19.95
HI-RES Adv #2 — Wiz & Princess Disk	25.00
Radwork Disk	29.95
Jobbreaker Disk	25.00
Soltporn Adventure (X-rated) Disk	25.00
The Next Step Disk	29.95
Personal Software	
Visicalc Disk	169.00
Arcade Plus	
Ghost Hunter (Cassette)	\$ 25.00
Ghost Hunter (Disk)	\$ 30.00

### FOR HOME ENTERTAINMENT SYSTEMS

Activision	
Dragger Cartridge	18.50
Boxing Cartridge	18.50
Checkers Cartridge	18.50
Fishing Derby Cartridge	18.50
Skiing Cartridge	18.50
Bridge Cartridge	23.95
Tennis Cartridge	18.50
Laser Blast Cartridge	18.50
Freeway Cartridge	18.50
Kaboom! Cartridge	18.50
Stamper Cartridge	18.50
Ice Hockey Cartridge	23.95

All prices subject to change without notice. Call for best price.

ASAP offers a 15-day buyer protection policy: full money-back guarantee if not totally satisfied.  
Ordering Information: name, address, phone, ship by: UPS or Mail. Shipping charge: add \$2.90 up to 1 lb. for UPS blue; add \$1.50 for U.S. Mail (U.S. only) (\$25.00 minimum order). Call for larger shipments.

Terms: We accept cash, check, money orders, Visa & Master Charge (U.S. Funds only). Tax: 6% Calif. res. COD's and terms available on approval (school PO's accepted).

ASAP Computer Products LTD., 116 Viceroy Road, D-12 Concord, Ontario, Canada L4K 1A9 (416) 738-0500 (800) 268-1996



Stampede Cartridge	18.50
Ice Hockey Cartridge	23.95

### DISKETTES from ASAP

Verbatim 5 1/4" Diskettes			
Part #	Sector		Price
MD525-01	Soft	10/527 50	
MD525-10	Hard 10	10/527 50	
MD525-16	Hard 16	10/527 50	
8" Diskettes			
FD32-1000	Hard	10/535 00	
FD34-1000	Soft	10/535 00	

### Memorex 5 1/4" Diskettes

Part #	Side/Dens	Sector	Price
MEM 3481	1/Dbt	Soft	10/526.50
MEM 3483	1/Dbt	Hard 10	10/526.50
MEM 3485	1/Dbt	Hard 16	10/526.50
8" Diskettes			
MEM 3060	1/5gl	Soft	10/535 00
MEM 3101	2/5gl	Soft	10/545 00
MEM 3090	1/Dbt	Soft	10/545.00
MEM 3102	2/Dbt	Soft	10/555.00

### Scotch 3M 5 1/4" Diskettes

Part #	Side/Dens	Sector	Price
744-0	1/5gl	Soft	10/533 00
744-10	1/5gl	Hard 10	10/533 00
744-16	1/5gl	Hard 16	10/533 00
745-0	2/Dbt	Soft	10/549 00
745-10	2/Dbt	Hard 10	10/549 00
745-16	2/Dbt	Hard 16	10/549 00

### Maxell 5 1/4" Diskettes

Part #	Side/Dens	Sector	Price
MD1	1/5gl	Soft	10/532 00
MD20	2/Dbt	Soft	10/544 00
MH1	1/5gl	Hard 16	10/539 00
MH20	2/Dbt	Hard 16	10/550 00
8" Diskettes			
FD1-128	1/5gl	Soft	10/541 00
FH1-32	1/5gl	Soft 32	10/541 00
FD2-XD	2/Dbt	Soft	10/550 00

### Elephant Memory Systems

Part #	Side/Dens	Sector	Price
EMS 1	1/5gl	Soft	10/525 00
EMS 2	1/Dbt	Soft	10/527 50
EMS 3	1/Dbt	Hard 10	10/527 50
EMS 4	1/Dbt	Hard 16	10/527 50
EMS 5	2/Dbt	Soft	10/533 00
EMS 6	2/Dbt	Hard 10	10/533 00
EMS 7	2/Dbt	Hard 16	10/533 00

### Control Data 5 1/4" Diskettes

1241-00	1/5gl	Soft	10/525 00
1241-10	1/5gl	Hard 10	10/525 00
1241-16	1/5gl	Hard 16	10/525 00
1242-00	1/Dbt	Soft	10/530 00
1242-10	1/Dbt	Hard 10	10/530 00
1242-16	1/Dbt	Hard 16	10/530 00
1244-00	2/Dbt	Soft	10/540 00
1244-10	2/Dbt	Hard 10	10/540 00
1244-16	2/Dbt	Hard 16	10/540 00

### FOR HOME ENTERTAINMENT SYSTEMS

Part #	Side/Dens	Sector	Price
1221-60	1/5gl	Soft	10/538 00
1223-00	1/Dbt	Soft	10/543 00
1225-00	2/Dbt	Soft	10/548 00

FLEXCASE Disk Storage . . . . . Call for price

### SRW Media Storage Cases

Part #	Size	Price
SRW-5	5 1/4"	\$2 50 ea
SRW-8	8"	\$3 25 ea.

All prices subject to change without notice. Call for best price.

ASAP offers a 15-day buyer protection policy: full money-back guarantee if not totally satisfied.  
Ordering Information: name, address, phone, ship by: UPS or Mail. Shipping charge: add \$2.90 up to 1 lb. for UPS blue; add \$1.50 for U.S. Mail (U.S. only) (\$25.00 minimum order). Call for larger shipments.

## The Osborne 1

Mark Dahmke  
Consulting Editor

The Osborne 1 is Adam Osborne's solution to the problem of incompatibility among personal computers. Designed to use industry-standard software, it combines the best of several designs while compromising in only a few areas, such as color and graphics.

The Osborne 1 can best be classified as a business system because it was designed to run a word processor and have the standard printer and modem interfaces that would be most useful to a business person. If you are looking for a computer that you can play games on, the Osborne 1 is not for you. If you need a solid, well-supported, well-documented business system at a reasonable price, you should give it a great deal of consideration.

You really do get a lot for your money when you buy an Osborne 1. Just out of curiosity, I added up the manufacturers' suggested retail prices of all the software included with the system. The total came to about \$1530 (allowing for some variation in retail prices). If we subtract this amount from the retail price of the Osborne 1, the computer hardware itself would cost only \$265 — not bad for a Z80 with 64K bytes of memory, two 5¼-inch disk drives, printer and modem ports, and a built-in 5-inch video display. Of course the software is being distributed for much less than normal retail prices, but in a way you are getting a software package with a computer thrown in for (almost) free.

### Hardware

The Osborne 1 is approximately 9 inches high, 20.5 inches wide, and 13 inches deep. The case is weather-proof when closed and can fit under an airline seat. The power cord can be stored in the case with a plastic panel



Photo 1: *The Osborne 1 personal computer.*

with velcro strips, which also covers the power switch and the red circuit breaker. The unit operates at 120 volts (V) AC and 50 or 60 Hz (three-wire grounded plug) and draws about 37 watts (W). It can be set to operate at 230 V AC by changing an internal jumper. The unit is convection cooled, so there is no built-in fan.

A 69-key detachable keyboard with 12-key numeric keypad (all with sloping key tops) is standard. The software supports full key-rollover operation.

Two 5¼-inch floppy-disk drives mounted on either side of the display screen each provide 102,400 bytes of secondary storage.

The processor board uses the Z80A microprocessor operating at 4 MHz. Main memory consists of 60K bytes of user-programmable memory and 4K bytes of ROM (read-only memory), which are bank switched. Bank switching gives the maximum use of the address space to the user by allowing physically separate memory areas to occupy the same logical address space. Memory-access time is 250 nanoseconds.

### About the Author

Mark Dahmke is a Consulting Editor for *BYTE* and *Popular Computing*.



# TEST-FLY A \$20 MILLION JET ON AN APPLE? YES. WITH MICROSPEED.

At the Bethesda Naval Research Center, they've discovered the power of MicroSPEED. The Navy's engineers use this remarkable hardware/software combination to "fly" an advanced fighter aircraft *in real time*—even making vertical landings on a simulated carrier deck. A "crash" is merely another learning experience, and an opportunity to modify the research aircraft—inside the Apple—to improve tomorrow's combat planes.

Surprised that such a sophisticated task is possible on the Apple? So were the Navy's officials, and many others who have discovered...

**THE MICROSPEED DIFFERENCE** This extraordinary Language System exploits the real potential of the microcomputer for the first time. The difference between MicroSPEED and other programming languages is that with MicroSPEED, there is virtually *no limit* to what you can achieve. It may well be the ultimate language for the Apple II and III (and soon the IBM Personal Computer). MicroSPEED literally combines the performance of a *minicomputer* with an exhaustive set of user-friendly capabilities: hard-

ware math processing, fast hi-res graphics and text, turtle graphics, print formatting, two text editors, unlimited data types, and incredible FORTH extensibility—all at speeds up to 100 times faster than Basic.

**USER-FRIENDLY, EASY-TO-LEARN** Starting with simple commands that are comfortable even for non-programmers, MicroSPEED extends and builds, allowing you to create your own tailored application languages. The capability of your computer will grow exponentially, as you work in an active partnership with the machine, exploring and developing new problem-solving facilities—creating, correcting, refining your increasingly powerful system.

**DEMANDING JOBS AT LOW COST** Developed by a team of standout computer professionals, MicroSPEED has been put to the test in fields as diverse as medicine, the stock market, oceanography, and the arts. In even the most challenging applications, MicroSPEED users have been unanimous in their praise of the System and manual. Typical comments are:

**"Very high marks,"**

Thomas Tosch Phd., Tosch Information Management.

**"The more I use MicroSPEED, the more I love it,"**

James L. Hockenull, University of Washington.

**"Great!...A joy to use,"**

Henry Harris, Mission Designer, Cal Tech's Jet Propulsion Lab.

**"If you plan to use the Apple or IBM Personal Computer for *any* demanding task, then we built MicroSPEED for you,"**

Sam Cottrell, President of Applied Analytics.

MicroSPEED requires the Apple or IBM Personal Computer with single disk. MicroSPEED II includes 2 MHz math processor. MicroSPEED II+ includes 4 MHz math processor.

Applied Analytics Incorporated  
8910 Brookridge Drive  
Upper Marlboro, Maryland 20772 (301) 627-6650

I'm interested! My computer is: \_\_\_\_\_

Please send me:

\_\_\_\_\_ MicroSPEED II, \$495.00      \_\_\_\_\_ 160 Page Manual, \$15.00  
\_\_\_\_\_ MicroSPEED II+, \$645.00      \_\_\_\_\_ Detailed Information

Name: \_\_\_\_\_

Company: \_\_\_\_\_

Address: \_\_\_\_\_

City: \_\_\_\_\_ State: \_\_\_\_\_ Zip: \_\_\_\_\_ Phone No. ( ) \_\_\_\_\_

Use this coupon to order, or for more information.

**MicroSPEED**   
APPLE IS A TRADEMARK OF APPLE COMPUTER INC.



# MEGABYTER



## ZVX4 FOUR TIMES THE BYTE AMLYN COMPATIBLE

The ZVX4 MEGABYTER is for the APPLE II user who wants to DOUBLE file size, expand the capability of existing business software, and make other SERIOUS applications more viable.

Now you can have compatibility with IBM, INTEL, CP/M\*, Z80 Softcard\*, UCSD Pascal, and others.

Look what the MEGABYTER dual density 8" floppy disk controller, with its LSI circuitry and reliable industry standard IBM 3740 format, means to you:

### INCREASED STORAGE

- Increase online storage to 2 Mega bytes
- Double your maximum accounts and file size
- Add high capacity efficient hard disk backup
- Control up to 4 Shugart SA800/SA850 drives

### IMPROVED COMPATIBILITY

- Operate APPLE DOS 3.1/3.2/3.3, mini disks
- Preserve existing software investment
- Interchange data with other computers

### SIMPLIFIED OPERATION

- Reduce disk handling and I/O slot usage
- Gain automatic single/double density operation
- Change to double sided drives with one switch

Available at your Apple dealer. Call or write today!!



SORRENTO VALLEY ASSOCIATES  
11722 SORRENTO VALLEY ROAD  
SAN DIEGO, CA 92121-1084  
(714) 452-0101—TWX 910-335-2047

\* CP/M trademark of Digital Research, Inc.  
Z80 Softcard trademark of Microsoft, Inc.

## At a Glance

**Name**  
Osborne I

**Manufacturer**  
Osborne Computer Corporation  
26500 Corporate Ave.  
Hayward, CA 94545  
(415) 887-8080

**Hardware**  
Z80A microprocessor running at 4 MHz; 64K bytes of main memory; 4K-byte video display organized as 32 lines of 128 characters each; white on black display, 52 characters by 24 lines visible with scrolling screen to view remainder of display; built-in 5-inch video monitor; half- or full-intensity video with optional underlining; 96-character ASCII set with 32 graphics characters; dual 100K-byte, 5 1/4-inch disk drives; 69-key keyboard with numeric keypad and four-direction arrow keys; serial RS-232C interface with separate modem connector (modem adapter allows simultaneous use of modem and printer); and IEEE-488 interface

**Software**  
60K CP/M 2.2 (operating system), Wordstar with Mailmerge, Supercalc, CBASIC, MBASIC, XDIR (extended directory display), Help (system help file), FMT (disk formatter program), Copy (disk copy program), Setup (system configuration program), CP/M standard utilities (i.e., PIP, SYSGEN, MOVCPM, ASM, DDT, Dump, Load, Submit, and XSUB)

**Options**  
External video, battery adapter, double-density disk drives, 80-column display

**Price**  
\$1795

**Warranty**  
90-day limited

**Audience**  
Anyone who needs a complete business computer system or a portable computer at a reasonable price

A recent ad for the Osborne 1 shows a man carrying a briefcase and another carrying an Osborne 1. While I can see many reasons for carrying along a computer in my work, I doubt I would carry an Osborne 1 in the same way I would carry a briefcase. First, the Osborne 1 weighs about 24 pounds, which would tire out all but the most athletic of travelers. Second, though the Osborne 1 was designed to fit under an airline seat, I don't think I would want to put one there. In fact, some of the commuter flights I have taken won't allow anything that size to be carried on, and the thought of checking my computer as baggage makes me a bit nervous. Remember, inside that rugged-looking package is a small video monitor and two disk drives, all of which are vulnerable to sudden shocks. Cathode ray tubes have been known to implode from less stress than a two-foot drop onto concrete. Also, disk drives can be thrown out of alignment fairly easily. The Osborne 1 would be portable enough for many people, provided sufficient care is taken to avoid bouncing it around.

The Osborne 1 comes with two single-density disk



# 10 reasons why...the new Moore Computer Supplies Catalog is the only one you'll ever need!



1. Now, you can buy the best, top-quality computer and word processing supplies from Moore—serving business for 100 years.
2. Moore offers you a large selection of leading brand name supplies. High-performance products for today and tomorrow that have passed rigorous examination by our team of Product Specialists.
3. Low prices. Our skilled buyers are in touch with market trends, worldwide, and use Moore's buying power to bring you real savings.
4. All prices guaranteed to August 31, 1982, regardless of inflation.
5. We move fast. Our standard practice is to process and ship every order within 24 hours from one of Moore's four regional warehouses.
6. You save money and time. All products stocked in our own warehouses. No middlemen. No hassles. And, no delays.
7. Emergency overnight delivery when you need supplies NOW.
8. It's easy to order by mail. Or, call us toll-free any business day, 8 a.m.—5 p.m. (your time anywhere in the continental U.S.) for fastest delivery.
9. The *only toll-free technical assistance line* in the industry. Practical, professional help is always as close as your telephone. Another free service from Moore.
10. Moore guarantees your 100% satisfaction, no strings attached. Every product is backed by our no nonsense, unconditional written guarantee.

To get your free copy of The Moore Computer Supplies Catalog, call us toll-free, 800-323-6230\*, ext. 152, or fill in and mail the coupon below.



**Call toll-free TODAY! 800-323-6230, ext. 152**

\*In Illinois, call 312-459-0210, ext. 152

\*In Alaska and Hawaii, 800-323-4185, ext. 152.

Send for your  
**FREE** catalog  
today!

Complete and mail this coupon or call the toll-free number above.

Name \_\_\_\_\_  
 Title \_\_\_\_\_  
 Company \_\_\_\_\_  
 Address \_\_\_\_\_  
 City \_\_\_\_\_ State \_\_\_\_\_ Zip \_\_\_\_\_  
 Phone (\_\_\_\_) \_\_\_\_\_ ext. \_\_\_\_\_



Catalog Group  
**MOORE  
BUSINESS  
CENTER**

A Division of Moore Business Forms

Moore Computer Supplies Catalog  
Dept. 152  
P.O. Box 20  
Wheeling, IL 60090

© 1982 Moore Business Forms, Inc.

# DISCOUNT PRICES

ECT™  
 NorthStar™  
 OKIDATA  
 TeleVideo®  
 Zenith data systems  
 AND OTHERS

## WE'RE ON THE EAST COAST

### DUPRÉ ENTERPRISES, INC.

#### MICROCOMPUTER SALES DIVISION

SUITE 6 NELSON BLDG.  
 271 FORT LEE ROAD  
 LEONIA, NJ 07605

(201) 461-8086  
 9 AM-3 PM  
 MON.-FRI.

# LIFE ISN'T CHEAP.

# SHARE THE COST OF LIVING.

GIVE TO THE AMERICAN CANCER SOCIETY. 

THIS SPACE COVERED BY ADVERTISING SERVICE



**Photo 2:** The keyboard of the Osborne 1. The four arrow keys on the upper right next to the Return key can be configured for use with CP/M or Wordstar, but not both. Numeric keypad is at the far right.

drives, each capable of storing 102,400 bytes or characters of information on a single 5¼-inch floppy disk. A double-density option is also available, allowing the Osborne 1 to store as much as 204,800 bytes or characters per disk. According to the user's manual, data is physically stored on each disk as 40 tracks, each track divided into 10 sectors (soft-sectored). Each sector contains 256 bytes of data. This works out to 100K bytes, which matches the 102,400-bytes-per-disk figure mentioned in the manual. Tracks 0, 1, and 2 contain the CP/M 2.2 operating system. On track 2, sectors 3 through 6 hold the customized BIOS (basic input/output system), sectors 7

---

**While I can see many reasons for carrying along a computer in my work, I doubt I would carry an Osborne 1 in the same way I would carry a briefcase.**

---

and 8 hold the initial screen display (the Osborne logo), and sector 9 holds information such as the serial number and some system test procedures. Thus, about 92.5K bytes remain for user storage.

The video display of the Osborne 1 has some unique features and some problems. The "real" display window provides 32 lines of 128 characters per line. To accommodate the small video monitor (5 inches diagonally), however, only 24 lines of 52 characters each can be seen at any one time. The user may scroll the screen both horizontally and vertically to look at any 24-line by 52-character portion of the total display window. Scrolling is accomplished by holding down the control key while simultaneously using one of the four arrow keys. The display doesn't jump as one would expect but instead scrolls smoothly causing no eyestrain.



# PERSONAL COMPUTERS PERSONAL COMPUTERS PERSONAL COMPUTERS PERSONAL COMPUTERS

## EPSON MX-80



**\$439.00**

INTERFACES & CABLES  
IEEE \$55.00 RS-232 \$70.00  
APPLE INTERFACE & CABLE \$90.00  
TRS-80 CABLE \$35.00

Amdek Video-300 .....	199.00
Amdek Color-1 Monitor .....	359.00
Atari 400 16K .....	349.00
Atari 810 Disk Drive .....	449.00
Atari 850 Interface .....	169.00
Atari 830 MODEM .....	159.00
Atari 800 16K .....	749.00
Diablo 630 .....	2095.00
Epson MX-70 .....	329.00
Epson MX-80 FT .....	549.00
Epson MX-100 FT Printer .....	739.00
Hayes Micromodem II (Apple II) .....	299.00
Microtek 16K Ramboard for Atari 800 .....	79.00
Microtek 32K Ramboard for Atari 400 & 800 ..	149.00
M&R Sup-R-Terminal .....	279.00
Microsoft Soft Card (Z-80) .....	329.00
Microsoft Soft Card Premium System for Apple	649.00
Microsoft Ramcard 64K for IBM-P.C. ....	439.00
Microsoft Ramcard 16K for Apple .....	159.00
NEC 3510 Spinwriter .....	1795.00
NEC 3515 Spinwriter .....	1845.00
NEC 3530 Spinwriter .....	1795.00
NEC PC-8023 Printer .....	569.00
NEC JC1201 M(A) - Color 12" Monitor .....	359.00
NEC GREEN JB1201M - 12" Monitor .....	169.00
Okidata Microline-80 Matrix Printer .....	329.00
Okidata Microline-82A .....	499.00
Okidata Microline-83A .....	729.00
Televideo 910 .....	559.00
Televideo 912C .....	669.00
Televideo 920C .....	749.00
Televideo 925 .....	849.00
Televideo 950 .....	929.00

**CALL TOLL FREE!**

**800-343-0873**

Stock Shipments Same Day or Next  
No Surcharge for Credit Cards  
All Equipment Factory Fresh w/MFT Warranty  
Prices do not Reflect Shipping Charges  
Mass. Residents Please Add 5% Sales Tax

**PRICES ARE SUBJECT TO  
CHANGE WITHOUT NOTICE**

# OMEGA SALES COMPANY

430 PEARL STREET, STOUGHTON, MA 02072  
(617)344-6645

# THE ENCRYPTOR™

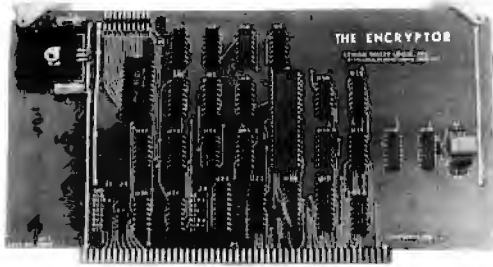

## DATA SECURITY

- \* HELPS PROTECT: 1) PAYROLL DATA
- 2) MODEM COMMUNICATIONS
- 3) SENSITIVE INFORMATION

- \* S-100 COMPUTERS, IEEE-696 DESIGN.
- \* CIPHERMASTER™ SOFTWARE FOR CP/M\* SYSTEMS AVAILABLE.
- \* NATIONAL BUREAU OF STANDARDS ENCRYPTION ALGORITHM.
- \* HIGH SPEED A.M.D. 9518 DATA CIPHERING PROCESSOR.
- \* 1.3 MEGABYTES PER SECOND THROUGHPUT.
- \* 3 ENCRYPTION/DECRYPTION FORMATS.
- \* OVER 72 QUADRILLION 56 BIT MASTER KEYS.
- \* PLUG SELECTABLE I/O PORT ADDRESSES AND INTERRUPTS.
- \* GOLD PLATED FINGERS, CARD EJECTORS AND SOLDER MASK.
- \* ASSEMBLED, BURNED-IN AND TESTED.
- \* 1 YEAR LIMITED WARRANTY.
- \* \$425 SINGLE QUANTITY.

\* DEALER AND O.E.M. INQUIRES INVITED.

### LEHIGH VALLEY LOGIC, INC.

2503 NORTH COURT - P. O. BOX 3216 - BETHLEHEM, PENNSYLVANIA 18017 - (215) 865-1222

\* PRICES AND SPECIFICATIONS SUBJECT TO CHANGE WITHOUT NOTICE.

\* CP/M IS A REGISTERED TRADE MARK OF DIGITAL RESEARCH, INC.

# UV EPROM ERASER



## \$49.95

- ERASES ALL UV ERASABLE EPROMS (2708, 2716, 2564, etc.)
- QUICK FIFTEEN MINUTES ERASE TIME
- ERASES OVER FIFTEEN EPROMS AT A TIME
- LAMP LIFE, 7700 HOURS
- INDUSTRIAL MODEL \$68.50.
- INDUSTRIAL MODEL WITH TIMER & SAFETY INTERLOCK SWITCH \$97.50. (Rugged steel enclosure with bottom drawer)

### THE BEST 6809 SINGLE BOARD COMPUTER AVAILABLE

- Floppy Controller
- Printer Port
- RS-232 Port
- SWTPC compatible
- Runs TSC Flex
- Full Documentation

PRICE: **\$389.00**

FOR THE SS-50 AND S-100 BUS

ASSEMBLED, TESTED, 48 HOUR BURN-IN, 90 DAY WARRANTY

2716 EPROMS 250 ns \$4.95 DIRECT FROM FACTORY

SS-50 6809 CPU CARD: 1MHZ \$149.00 2MHZ \$189.00

RS-232 INTELLIGENT EPROM PROGRAMMER... \$489.00  
Programs: 2716, 2516, 2532, 2732, 8748, 8749

ANTISTATIC FOAM 4" x 8" ..... \$3.95

WE ACCEPT VISA, MASTERCARD, C.O.D., CHECKS

PHONE ORDERS (305) 776-5870

TWX: 510-955-9496 • Engineering Hot-Line: (305) 974-0867

## LOGICAL DEVICES INC.

781 W. OAKLAND PARK BLVD. • FT. LAUDERDALE, FLORIDA 33311

ADD: \$3.00 SHIPPING, \$2.00 C.O.D. CHARGES



Photo 3: Front view of the Osborne 1. The 5-inch diagonal video display is seen at center, and the 5 1/4-inch disk drives are on either side of the display. Storage space for disks is provided below the two disk drives. RS-232C, IEEE-488, and modem cable connectors are in the lower left. An insulated ribbon cable connects the keyboard to the rest of the computer just below the video display. Brightness and contrast controls and external video connectors are found up front. The reset switch is also up front but is not likely to be pressed accidentally because of its location. The last connector is for the external battery pack.

Surprisingly, the size of the display doesn't cause eye-strain either. I asked a friend with bifocals to try it, and he claimed he wasn't bothered by staring at the small screen. This is interesting because if you stand 3 feet away from the screen, it is almost unreadable. But if you sit at the keyboard with the screen about 15 inches away, it is quite clear.

Characters on the display screen are formed in an 8 by 10 dot matrix. The character generator holds 128 character shapes, and a standard 96-character ASCII (American Standard Code for Information Interchange) set is provided, plus an additional 32-character graphics set. Unlike many personal computers, the character set cannot be changed by the user. The display does allow for underlining and half-intensity display of individual characters on the screen.

The keyboard of the Osborne 1 is detachable. In fact, there is no way it can be attached, except when the unit is closed up. After it is unlatched from the computer cabinet, all that connects it to the computer is a flat, insulated ribbon cable. Although the connector looks like it is ready to break off, it is quite solid.

Keyboard decoding is done on the main circuit card, so no complex circuitry is present in the keyboard housing itself. The hardware supports full key-rollover operation, meaning that no matter how fast you type, the computer can keep up with you. The only characters missing from the keyboard are [ ] ~ ` and DEL. However, these can be entered by depressing the control key simultaneously with . , / = and ? , respectively. These keys are not that important except, perhaps, for programming in certain high-level languages such as Pascal. Also, the backspace function is provided by the Left Arrow key. Since the ar-



# Tired Of Your GENERAL LEDGER?



- ★ THE ULTIMATE PERSONAL CHECK REGISTER
- ★ A PROFESSIONAL ACCOUNTING SYSTEM
- ★ A PERSONAL FINANCIAL MANAGER
- ★ A SMALL BUSINESS ACCOUNTING SYSTEM
- ★ A COMPLETE GENERAL LEDGER

FOR YOUR TRS-80 MODEL I, II III - COLOR COMPUTER • APPLE II • I.B.M. • XEROX • ATARI  
ALL MICROSOFT BASIC COMPUTERS

## HOW IT WORKS . . . .

**VERSALEDGER** is a complete accounting system that grows as you or your business grows. To start, your **VERSALEDGER** acts as a simple method of keeping track of your checkbook. Just enter your check number, date and to whom the check is made out to. As you or your business grows, you may add more details to your transactions . . . . account number, detailed account explanations, etc.

- **VERSALEDGER** can give you an instant cash balance at anytime. (IF YOU WANT IT TO)
- **VERSALEDGER** can be used as a small personal checkbook register. (IF YOU WANT IT TO)
- **VERSALEDGER** can be used to run your million dollar corporation. (IF YOU WANT IT TO)
- **VERSALEDGER** prints checks. (IF YOU WANT IT TO)
- **VERSALEDGER** stores all check information forever. (IF YOU WANT IT TO)
- **VERSALEDGER** can handle more than one checkbook. (IF YOU WANT IT TO)
- **VERSALEDGER** can be used to replace a general ledger. (IF YOU WANT IT TO)
- **VERSALEDGER HAS AN ALMOST UNLIMITED CAPACITY . . . .**  
 (300 checks per month on single density 5¼" disk drives such as the TRS-80 Model-I)  
 (500 checks per month on the Apple II)  
 (2400 checks per month on the TRS-80 Model III)  
 (6000 checks per month on the TRS-80 Model II)  
 (3000 checks per month on single density 8" CP/M)
- **VERSALEDGER** will soon have an add-on payroll package. (IF YOU NEED IT)

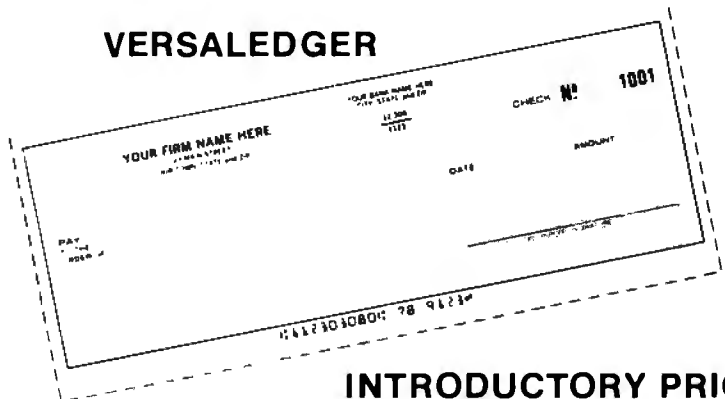

**INTRODUCTORY PRICE**  
**\$99.95**

— CAN BE USED WITH 1 or MORE DISK DRIVES —

**VERSALEDGER HAS BEEN CREATED  
WITH THE FIRST TIME COMPUTER USER IN MIND**

**COMPUTRONICS**  
NATIONAL ACCELERATOR SYSTEMS

50 N. PASCACK ROAD  
SPRING VALLEY, NEW YORK 10977

- ★ ADD \$3.00 FOR SHIPPING IN UPS AREAS
- ★ ADD \$4.00 FOR C.O.D. OR NON-UPS AREAS
- ★ ADD \$5.00 TO CANADA AND MEXICO
- ★ ADD PROPER POSTAGE OUTSIDE U.S., CANADA & MEXICO



**24 HOUR  
ORDER  
LINE**

**(914) 425-1535**



**NEW TOLL-FREE  
ORDER LINE**  
(OUTSIDE OF N.Y. STATE)

**(800) 431-2818**

\*\*\* ALL PRICES & SPECIFICATIONS SUBJECT TO CHANGE \*\*\*

# Heath®/Zenith News

**Buss: The Independent Newsletter of Heath Co. Computers publishes the news and information you need on Heath®/Zenith computers.** Each issue has the most complete coverage of new product announcements from independent vendors. Read about all the latest developments in hardware and software that will help you to maximize the value of your computer.

Buss is not affiliated with the Heath Co. or the Zenith Radio Corp. Each issue carries candid reports from Heath®/Zenith owners and offers you the opportunity to communicate your experiences to over 5,000 readers.

Start your subscription today with the latest issue or any available back issues (about 20 in stock). Buss is mailed to you first class (airmail overseas) about every three weeks. A full refund is guaranteed any time you're not satisfied.

	US & Canada	Overseas
24 issues	\$32	\$45
18 issues	\$26	\$35
12 issues	\$20	\$25

Payment must be in U.S. dollars payable on a U.S. bank, by international postal money order, or charged on VISA or MasterCard. Send your order right away to: Buss, 325-B Pennsylvania Ave. SE, Washington, DC 20003 or for faster response call Buss, 202/544-0900.

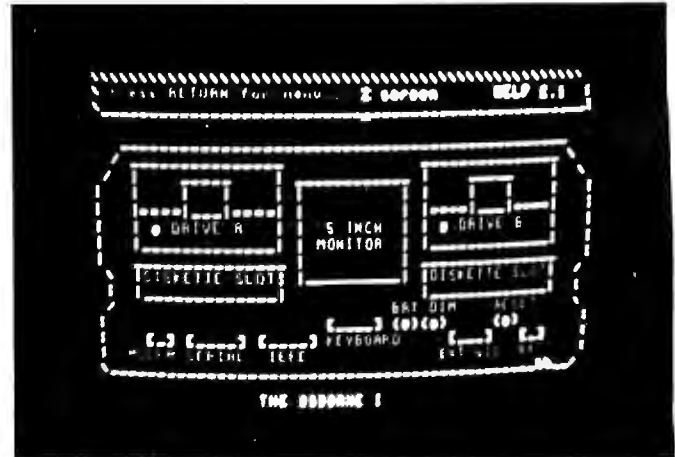

**Photo 4:** The Osborne 1 video display is arranged as 32 lines of 128 characters per line, but only 24 lines of 52 characters can actually be seen at one time with the built-in display. The four arrow keys (when used in conjunction with the control key) can be used to scroll horizontally and vertically.

row keys (cursor controls) cannot be set up for use in CP/M and Wordstar simultaneously, the user must choose one or the other configuration. If Osborne had simply defined the arrow keys to work in Wordstar (where they are much more useful), then a separate backspace key could have been assigned for CP/M. Considering how many products have been ruined by poor keyboard layouts, I find it difficult to understand why a few keys were left off an otherwise excellent design.

The Osborne 1 comes complete with an RS-232C connector and a separate modem connector. You need a separate interface box to use a standard modem when it is connected to the modem connector. It is important to note, however, that if you want to use a modem by itself, you can connect it directly to the RS-232C port and eliminate the need for the interface box. Therefore, the only limitation is that you can't use a modem and a serial printer at the same time without the interface box. Apparently, a single serial interface is used to talk to both the RS-232C port and the modem.

The IEEE-488 interface has two uses. First, as the name implies, you can use it as a full IEEE-488 port with handshaking, thus allowing the use of several interesting peripherals, such as a hard disk. It may also be used as a Centronics-compatible printer port, if you purchase a cable with a Centronics-type connector at one end.

## Software

The Osborne 1 comes with an impressive array of software. Included as standard are the CP/M operating system, Wordstar (with Mailmerge), Supercalc, CP/M 2.2, CBASIC, and MBASIC. Also included are several useful utility programs.

Wordstar, the popular word processor, is fully implemented on the Osborne. The only annoying feature is the scrolling of the 52-character display. If your text line becomes longer than 52 characters, the screen has to

## On March 2, 1981 the Genetic Time-Bomb started ticking.

The waiting begins for another potential victim of Huntington's Disease. And because the symptoms (the only way to diagnose HD) don't develop until midlife, the sons and daughters of HD carriers spend an agonizing lifetime wondering if and when this terrifying, fatal illness will strike.

And that's no way to live.

Give to the National Huntington's Disease Association. Help make this generation its last.

**HD** National Huntington's Disease Association  
128A East 74 Street New York, N.Y. 10021







# Are your operators making computer errors with their feet?

As they walk and move about, your operators build up a static charge.

Just by taking a couple steps across the floor in a well air-conditioned room, they can generate 5,000 volts or more.

Or, in the wintertime, 10,000 volts or more.

Static can also be generated just by sitting down in a chair.

And if the operator's next move is to touch one of your terminals, the result can be a blank screen, erratic data, spewing paper, or an altered memory.

Another result can be annoyed customers.



*3M Static Control Floor Mats create an island of protection.*

But, for less than the cost of a single service call, you can effectively control static at every terminal, every word processor and microprocessor-based unit.



*With 3M Static Control Mats, you keep static from coming between you and your customers.*

3M Static Control Floor Mats and Runners create inexpensive islands and pathways of protection around and between sensitive areas. Static charges drain harmlessly from operators and other personnel as they walk, stand or sit.

Available in a choice of colors, and in many sizes, 3M Static Control Mats are carefully engineered for performance, comfort, durability, ease of

cleaning and safety. For standing and sitting applications.

**Send the coupon for a free catalog and more information.**

Send coupon to: Data Recording Products Division/3M, 223-5N, 3M Center, St. Paul, MN 55144. Or, if you've already put up with static problems too long, call this toll-free number for the name of a distributor or dealer near you: 1-800-328-1300.



*Free catalog shows 3M's complete selection of mats and runners.*

3M: Please send free catalog and other information on Static Control Mats and Runners.

NAME \_\_\_\_\_

COMPANY \_\_\_\_\_

ADDRESS \_\_\_\_\_

CITY, STATE, ZIP \_\_\_\_\_

Mail to: Data Recording Products Division/3M,  
223-5N, 3M Center,  
St. Paul, MN 55144

**3M Hears You...**

# 3M

# Keep Magazines, Catalogs, Manuals, Journals NEAT & ORGANIZED End Clutter In Home, Office, Workshop With SHELF FILES



Eliminate the mess of loose magazines, catalogs and newspapers. Find what you want when you want it by using these handy shelf or desk top files. Attractive brown front panel. Adhesive ID labels included.

## 6 POPULAR SIZES AVAILABLE

From digest size to newspaper size! Popular letter and magazine size (9" x 11 1/2", 3 3/4" box width) - 8 for \$13.95. 25 for \$31.95 prepaid. Sturdy, heavy-duty fiberboard will last for years! Charge it! Call or mail coupon today.

**Professional Aids Co., Suite 163  
3685 Commercial Ave., Northbrook, IL 60062 • 312/291-0558**

Please rush postpaid Fiberboard Desk and Shelf Files as checked below:

How Many	Qty.	Size	Price	Total Price
	8	Letter Size	\$13.95	
	25	Letter Size	\$31.95	

Check for Free Catalog. I enclose \$\_\_\_\_\_ full payment. Shp postpaid.

Illinois Residents add 6% Sales Tax, please. Other sizes from digest to newspaper available.

Charge it to  VISA  MasterCard TOTAL: \_\_\_\_\_

Card No. \_\_\_\_\_ Exp. Date \_\_\_\_\_

Name \_\_\_\_\_

Address \_\_\_\_\_

City, State, Zip \_\_\_\_\_

# L I S P

## SPECIAL OFFER FOR JUNE: P-LISP: \$99.95

for the Apple II

**P-LISP** is a full LISP interpreter for the Apple II, which normally sells for \$199.95. We are offering a limited special opportunity for BYTE readers only, to purchase P-LISP for \$99.95 through July 15, 1982.

**P-LISP** contains HI-RESOLUTION graphics, FLOATING POINT math, full LISP functions, full support for Apple disk files (including sequential or random access, and writing Lisp functions or full workspaces to disk), PEEK, POKE, CALL, and a memory scheme to let you take advantage of ALL available memory, while letting you protect any pages (for hires shape tables or assembly language code).

**P-LISP** is supplied on diskette with a binder bound manual, a function editor, and several sample programs.

For those of you who do not fully understand **P-LISP**, we have available the **P-LISP Tutorial** for \$25.00. This expertly written text is bound in a handsome binder and is packaged to include a disk containing all the sample programs referenced in the text at no extra charge.



Applesoft in ROM or a language card is needed.

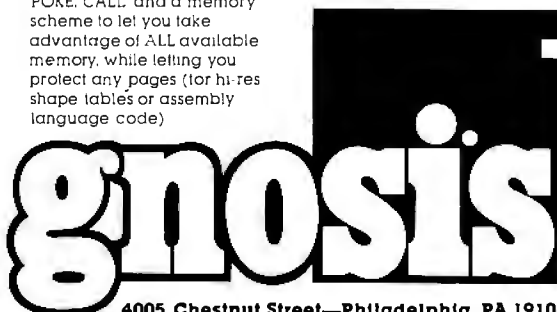

4005 Chestnut Street—Philadelphia, PA 19104  
Orders Only: 800-523-0725—Penna. Residents: 215-387-1500

Pennsylvania residents add 6% sales tax. Apple is a trademark of Apple Computer, Inc.



**Photo 5:** The power cord, on/off switch, and circuit breaker are located on the back of the unit covered by a plastic panel with velcro strips.

scroll horizontally. Also, you must run Setup (a utility program) and choose whether the four arrow keys on the keyboard are to work in Wordstar or in CP/M. Apparently, you can't have both. Otherwise, Wordstar operates just as it would on any other computer.

Supercalc may be the best buy on the system. Similar to Visicalc, Supercalc lets you set up electronic spread sheets for budgeting, balance sheets, or just about any columnar information.

## Supercalc may be the best buy on the system.

CBASIC and MBASIC are provided so you can test BASIC programs with interpretive MBASIC, then compile them with CBASIC to run faster. Both are fairly standard versions of BASIC.

### Utilities

Utilities provide the user with the basic tools necessary to manipulate the computer system and data. I found the utility called Setup, which comes with the Osborne 1, to be the most useful. It allows you to change certain characteristics of the system. For example, Osborne included a number of standard printer protocols in the BIOS. These allow the computer to communicate successfully with a variety of printers. You can choose between standard serial (no protocol), Qume (ETX, ACK), Diablo (XON, XOFF), Centronics, or PET IEEE-488. You can also change the serial-port data rate to 300 bits per second (1200 bps is the default). You may choose a different screen size—52 for a fixed screen, 128 for scrolling—or you can enter a width of your own choice, such as 80. The automatic horizontal scrolling mode can be enabled or disabled, and the four arrow keys can be set to work either in Wordstar or in CP/M.



# 1-UPMANSHIP.



We opened our doors with two basic goals:

To distribute as many software packages to as many dealers as possible.

And to make money doing so.

Our success on both counts is the result of hard work, a positive business attitude and a recognition that you, as a retailer, have a right to be treated fairly and honestly by your distributor.

## We're 1-up for three good reasons:

1. We always offer a wide selection of the latest and best microcomputer software packages available anywhere. (Why should you have to hunt for what you need?)
2. Our dealer discounts start with quantities of 1. (Remember all those times you just wanted one or two to see how they'd sell?)
3. We don't play The BackOrder Game. (If we can't ship your order within 48 hours we'll let you know, instead of hanging you out to dry.)

If there's anything else we can do for you, just let us know. Because we're 1-up and we intend to stay that way.

Software Distributors, 9929 Jefferson Blvd., Culver City, CA 90230. Telex 4990032 BVHL, ATT: SOFT

For our dealer info package, call (213) 559-9330.

## SOFTWARE DISTRIBUTORS

We won't leave you holding the bag.

Circle 416 on inquiry card.

# BYTE

## Back Issues For Sale

The following issues are available:

\$2.00 ea.	\$2.75 ea.	\$2.75 ea.	\$3.25 ea.	\$3.25 ea.
July 76	May 78	June 79	May 80	May 81
May 77	June 78	July 79	June 80	June 81
June 77	July 78	Aug. 79	July 80	July 81
July 77	\$2.75 ea.	Sept. 79	Aug. 80	Aug. 81
Aug. 77	Aug. 78	Oct. 79	Sept. 80	Sept. 81
\$2.75 ea.	Sept. 78	\$3.25 ea.	Oct. 80	Oct. 81
Sept. 77	Oct. 78	Nov. 79	Nov. 80	Nov. 81
Nov. 77	Dec. 78	Dec. 79	Dec. 80	Dec. 81
Dec. 77	Jan. 79	Jan. 80	Jan. 81	\$3.70 ea.
Feb. 78	Feb. 79	Feb. 80	Feb. 81	Feb. 82
Mar. 78	Apr. 79	Mar. 80	Mar. 81	Mar. 82
Apr. 78	May 79	Apr. 80	Apr. 81	Apr. 82
				May 82

The above prices include postage in the US. Please add \$.50 per copy for Canada and Mexico; and \$2.00 per copy to foreign countries (surface delivery).

Send requests with payment to:

### BYTE Magazine

70 Main St, Peterborough NH 03458

Attn: Back Issues

\* Payments from foreign countries must be made in US funds payable at a US bank.

\* Please allow 4 weeks for domestic delivery and 8 weeks for foreign delivery.

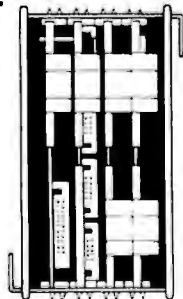

Photo 6: The Osborne 1 when closed up. The handle makes it easy to carry, but the sloping keyboard (which becomes the bottom) makes it sit at an angle. It has the feel of a lightweight sewing machine.

## DEC LSI-11 Components

Dependable service  
at discount prices

Domestic  
and Export



Mini  
Computer Suppliers, Inc.

25 Chatham Rd., Summit, N.J. 07901  
Since 1973

(201) 277-6150 Telex 13-6476

©Mini Computer Suppliers, Inc.  
1979

The keys on the numeric keypad can be programmed as function keys if you don't plan to use them to do numeric entry. The 0 through 9 keys can be redefined using Setup to any sequence of characters. For example, you could define the "0" key to be "XDIR", which would enter the extended directory display command (in CP/M).

When you make system changes with Setup, typing "X" when asked for the destination disk will return you to the CP/M level without saving the changes on disk. They will remain in effect only until you reset the system or power down. However, system changes can be stored permanently on one or more disks so the options are active the next time you boot the system with that disk.

FMT is a utility that will format a disk for use with the Osborne 1. Because the computer cannot use soft-sectored disks before they are formatted for a particular track/sector layout, you must run this program on all new disks.

The Copy utility allows you to make a complete copy of a disk for backup purposes, or just the data or user portion, or the system or CP/M portion. A separate pro-



# Apple\* en **CASTELLANO**

## Tercer Medio presenta su **sistema administrativo** **(T.M.A.) para Apple**

Diseñado de acuerdo con los principios contables aceptados en todos los países de habla hispana.

### **APLICACIONES COMERCIALES Y CIENTIFICAS**

- **CONTABILIDAD GENERAL**

Diario General  
Resumen del Diario  
Consulta parcial al Diario  
Mayor General  
Balance de Comprobación  
Balance General  
Ganancias y Pérdidas  
Catálogos de Cuentas  
Consultas por pantalla

- **CUENTAS POR COBRAR**

Catálogo de Cuentas  
Listado de Transacciones  
Antigüedad de Saldos  
Saldos por Vencer  
Relación de Cobranzas  
Relación de Pagos  
Estado de Cuentas  
Consultas varias por pantalla

- **INVENTARIO Y FACTURACION**
- **CONTROL DE BANCOS**
- **PERT/CPM**
- **CUENTAS A PAGAR**
- **CONTROL DE COSTO DE OBRAS**

### **VENTAJAS DEL SISTEMA T.M.A.**

- Son completamente conversacionales.
- El chequeo de la información es instantáneo.
- Los reportes impresos o por pantalla guardan los formatos generalmente aceptados.
- Están pensados para adaptarse a cualquier empresa.
- Toda la información está instantáneamente disponible
- Precisión Expandida.
- Números de hasta ± 999.999.999.99

Circle 141 on inquiry card.



**Tercer Medio**  
**Sistema de Información C.A.**

APARTADO DE CORREOS 62533  
CARACAS 1060 - A - VENEZUELA  
TELEX: 27.876 - CPB TH - VE.  
TELEFONOS: 283.60.88 - 284.74.68

\* Apple es marca registrada por APPLE COMPUTER INC.

gram called Backup will direct you through a backup procedure to save your files.

## Documentation

Many popular personal computers have such poor documentation, I am amazed the average user can make any sense of it. The Osborne 1 comes with one of the most impressive user's manuals I have seen. No doubt Adam's publishing background helped in this area. The manual begins by showing how to set up the computer and gives you a tour of all its connectors, the video display, the keyboard, and the disk drives. It then explains how to handle floppy disks and how to "boot" the CP/M operating system.

For many users, the lack of simple start-up instructions can be the first in a long series of frustrations. When the Osborne 1 is first turned on, the display tells you to insert a disk in drive A and press the Carriage Return key on the keyboard. Most other personal computer manufacturers assume the user understands this.

After CP/M is loaded from disk into memory, the display lists a menu of options such as "Just starting" and "Self portrait." Each of these menu entries gives the user a quick explanation of the hardware and software of the computer and how to use it. Even without the bound instruction manual, most users would be able to run the system after a few hours of experimenting.

Another advantage to the Osborne 1 is that all disks

that come with the system have a copy of CP/M on them. Each disk is a "master." You can insert any of the disks into drive A, and the system will boot properly. While this doesn't mean that you won't have to make backups, it does mean that some of the frustration is eliminated when you first use the system. Most companies give you just one copy of the disk operating system, expecting that you will make backup copies yourself. Of the disks provided with the Osborne 1, one is a CP/M system disk and another is a CP/M utilities disk. Also included are ready-to-go disks with Wordstar, Supercalc, MBASIC, and CBASIC on them.

## Conclusions

- The Osborne 1 definitely has a lot going for it. It has the best features of all the business computers, plus enough software to satisfy all but the most demanding of requirements.
- It is well designed with a rugged all-in-one enclosure, making it easy to move and set up.
- The major complaints have been the stark "military" look and the small video display (52 characters wide). Also, 5¼-inch disks hold only 100K bytes of data, just under half that of a single-density 8-inch disk.
- Apart from these limitations, the Osborne 1 comes closer to being the ideal business system for low-end applications. ■

### Give Your TRS-80\* a Tremendous Boost with RACET COMPUTES Software

RACET COMPUTES Utility Software makes the TRS faster, more efficient, and easier to use. Our programming aids improve your productivity. Our reputation is for products that are professional in design and work as advertised!!!

#### FIELD PROVEN HARD DISK DRIVES AND OPERATING SYSTEM

Now you can use RACET's Hard/Soft Disk Operating System (HSDS) with the ARM Winchester Disk Drive on the Model II. This cost effective combination provides 15 Megabytes per drive including ECC Error Correction Code and an advanced sequencer to further ensure data integrity. An incremental backup to floppy is provided so that only those sectors that were changed from the last backup are saved. A full monthly service contract is available at \$30 per month per drive.

The HSDS Software has more than One Year's FIELD Experience. The latest HSDS version adds several enhancements including maintenance of system files on the hard drive, files as large as the disk, the ability to segment the disk as logical drives, definable directory size, and many utilities including bulk copies between floppy and hard drives, multiple purge, Superzap, and Directory Catalog System. Full program compatibility with TRSDOS 2.0a is maintained. Mixed floppy and hard drive operation is supported.

HSDS is available for the Cameo, Cynthia Bull, Corvus, Data Peripherals, and Santa Clara Systems hard disk systems as well as the ARM Winchester Drive.

ARM 15 Megabyte Drive Subsystem \$3895. HSDS Software \$400.  
Cameo 5/5 Cartridge Drive \$5995. Cynthia Bull 10/10 Drive \$7995

#### NEW PRODUCT ★ Model II Fast Backup Utility ★ \$75

5 to 10 times faster backups!!! Full disk backup (including verify) 55 seconds!!! on two drive system — 2:15 on single drive system. In business, time is money, and one BACKUP is worth 1000 tears!!

#### NEW PRODUCT ★ INTEGRATED BUSINESS SYSTEM ★

ISAM File Structure — Multi-Company Capability. Modular structure. Each module includes complete user documentation which guides the user through installation and allows "practice" using a sample data base. When ready, the user simply names his data base and begins. The Integrated Business System program set includes General Ledger, Accounts Receivable, Accounts Payable, Payroll, Inventory, General Journal, Asset Management and more.

Business Programs \$250/module Mod III, \$300/module Mod II, \$795 for all four Mod III, \$995 for all four Mod II. General Ledger and Accounts Receivable available now. Accounts Payable and Payroll 1st Quarter 1982.



1330 N. GLASSELL, SUITE M, ORANGE, CA 92667

CIRCLE READER RESPONSE BELOW FOR FREE CATALOG

\*TRS-80 IS A REGISTERED TRADEMARK OF TANDY CORPORATION

CHECK, VISA, M/C, C.O.O., PURCHASE ORDER

TELEPHONE ORDERS ACCEPTED (714) 997-4950

### GET THE MOST FROM YOUR NEC PC-8001 WITH RACET COMPUTES SOFTWARE!!

RACET NECDOS \$175

RACET NECDOS does more for your PC-8001 than any other DDS. It's faster, more efficient and easier to use. It's loaded with extra features to let you stretch the limits of your system. This advanced operating system works with the ROM NBASIC to give full compatibility with color and other BASIC commands.

USER FRIENDLY — Emphasizes Integrity. No MOUNT or REMOVE commands!!! Excellent protection from improper diskette swapping. AGAIN, HELP, FINO and REF commands. File password protection.

ADVANCED DESIGN. RACET NECDOS utilizes the computer in the 8031 for most disk I/O functions minimizing memory utilization in the PC-8001. The Dynamic Transient Area (DTA) allows multiple transients to be scatter loaded and relocated in memory simultaneously. This unique capability optimizes use of valuable memory, yet provides an almost limitless growth potential.

ADVANCED FEATURES. All DOS functions and commands may be used directly in a BASIC program!!! Special RUN option allows merging of programs, retaining all variables in memory. Fixed block spanned records, AUTO and DO commands. Machine language loads and saves. MATPRINT and MATINPUT to disk. Complete directory. ALL supervisory calls documented and available to the machine language programmer. Superzap utility included.

#### CONVERT TRS-80\* PROGRAMS TO RACET NECDOS WITH 'PRDTRAN' \$99.95

COMPLETE utilities for file transfer and BASIC program conversion. Model III diskettes may be read directly. Model I and II via RS-232. Transfer BASIC programs, data files, or machine language files. NO support is provided for conversion of machine language files or PEEK's, POKE's, or USR's to function on PC-8001. Includes Mod I, Mod II and RACET NECDOS Datadisk with complete documentation on conversion requirements and syntax differences.

#### MULTI-KEY SORT 'MKS' \$60

SUPER FAST Machine Language In-Memory Sorts. Three-key sort on 500 elements in 4 Seconds!!! Simple one-line BASIC functions — SORTV and SORTC verbs. Mixed ascending and descending keys.

#### KFS-80 KEYED FILE SYSTEM \$150

Machine language BASIC ISAM utility provides keyed and sequential access to multiple files. Simple interface to BASIC. Binary tree keyed-file index system provides rapid access to records.

RACET COMPUTES software for the NEC is distributed by the Waybern Corporation and is available from your local NEC Dealer.

**Waybern Corporation**

13911 Enterprise Dr., Garden Grove, CA 92643  
(714) 554-4520 • (213) 222-7514

CIRCLE READER RESPONSE BELOW FOR FREE CATALOG

RACET COMPUTES





## Are you and your small copier giving each other breakdowns?

It's a vicious circle.

You get a small copier without realizing how many copies you'll be making.

You overwork the copier and it has a breakdown.

Then you can't get your work done and you feel like you're ready for a breakdown.

It's nobody's fault, certainly not the small copier's. It just wasn't built to handle big work loads.

Which brings us to the Minolta EP 530R. It can take on work loads that would overwhelm an ordinary small copier.

And it takes big-copier options. Like a sorter. A document feeder. And a counter to keep track of how many copies you've made.

It has a self-diagnostic system to catch small problems before they become big headaches.

**The EP 530R.  
The bigger small  
copier.**

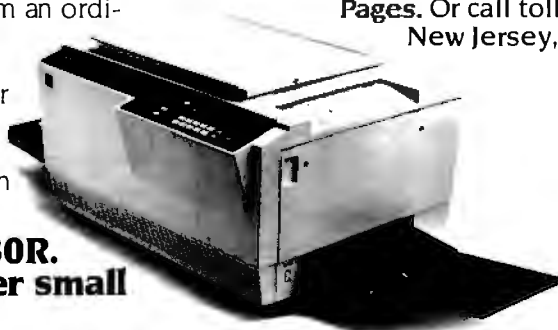

It makes copies up to 11 x 17". And it has Minolta's exclusive micro-toning system for crisp, clear copies. From edge to edge. It even makes reduced copies.

If you don't need copy reduction, you can get the EP 530R without the R. The Minolta EP 530.

So get the bigger small copier. And give yourself a break instead of a breakdown.

For the name of your nearest authorized Minolta dealer, look under our trademark in the Yellow Pages. Or call toll-free 800-526-5256. In New Jersey, 201-797-7808.



**MINOLTA**

Circle 322 on inquiry card.

## Applescope Stores Dual Traces

Gregory MacNicol  
211 Maple  
Santa Cruz, CA 95060

Imagine an easy-to-use digital-storage oscilloscope with a computer's high-resolution video display. The Applescope, selling for \$595, is just that and more. If you've ever used an oscilloscope and wanted to store the display, whether just to examine it for a few seconds or to

make a permanent record, you can already appreciate the Applescope's foremost virtue. Even if you want to show timing relationships, graph slow audio-spectrum sweeps, create Fourier transforms, or smooth data, the Applescope can help.

For those who have never used an oscilloscope, this tool will allow you to learn about digital-storage technology without great expense. Although the Applescope is geared toward the experienced amateur, the 48-page manual makes the unit easy to use.

### At a Glance

**Name**

Applescope

**Manufacturer**

R. C. Electronics Inc.  
7265 Toulumne St.  
Goleta, CA 93117  
(805) 968-6614

**Dimensions**

Two printed-circuit boards, 7.6 by 23 cm (3 by 12 inches) each

**Price**

\$595

**Hardware required**

Apple II computer with 24K bytes of memory and two free expansion-bus slots

**Power requirements**

+5 V at 420 mA; -5 V at 50 mA; +12 V at 80 mA; -12 V at 80 mA

**Features**

Single- or dual-trace storage oscilloscope, 1  $\mu$ s to 999.999999 seconds per division time scale, 25 mV to 8 V per division voltage scale ( $\pm$  11.1 V maximum input), 44 k $\Omega$  input impedance, up to 1020 samples pretrigger or posttrigger, 1024-byte memory buffer with DMA, 2K-byte software in EPROM

**Audience**

Any user of oscilloscopes, especially in the fields of education, medicine, and audio

**Warranty**

Covers parts and labor for 90 days from date of purchase

### Construction

The circuitry of the Applescope interface is simple when compared with typical digital-storage oscilloscopes on which the plethora of knobs tends to confuse the user. All functions of the device are activated through simple keyboard entries.

The Applescope consists of two printed-circuit boards (see photo 1) that separate the digital and analog circuitry to avoid noise problems. The quality of the boards is

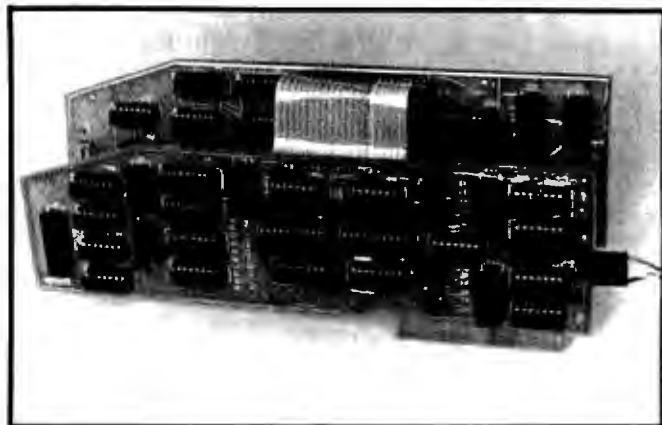

Photo 1: Applescope's two boards. Noise is reduced by separating the analog and digital circuitry. The boards are connected by a 20-conductor flexible cable.



# \$389.

Made by Seikosha, AXIOM's new GP-100 is the finest printer a little money can buy. It uses standard 8-1/2 x 11 paper and has AXIOM's fabulous graphics interfaces for Apple, TRS-80, Atari, PET, HP and more! See the GP-100 at your AXIOM dealer today!



## AXIOM

AXIOM CORPORATION

Seikosha is the leading company of the worldwide Seiko Group.

1014 Griswold Avenue, San Fernando, CA 91340 • Telephone: (213) 365-9521 • TWX: 910-496-1746

Circle 51 on inquiry card.

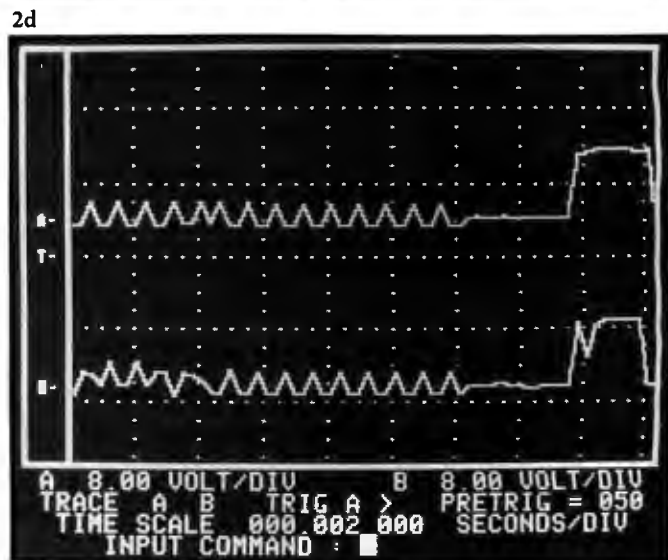
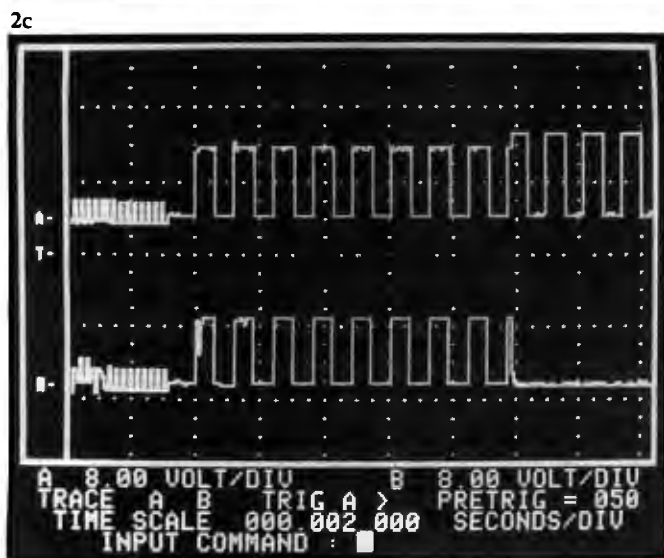
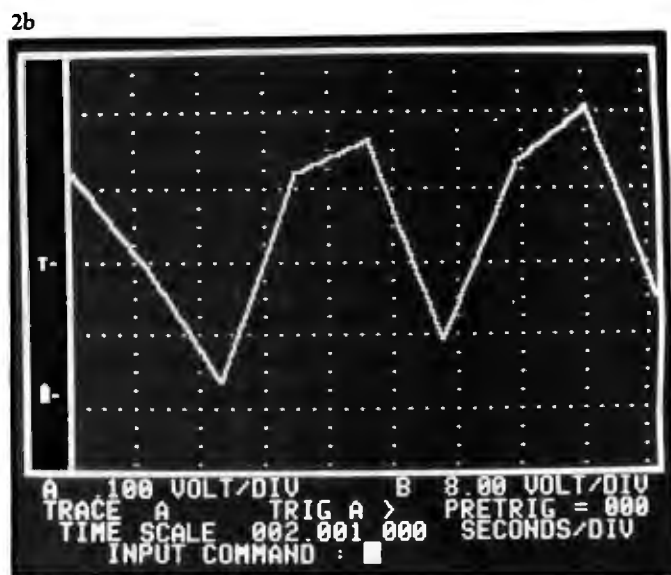
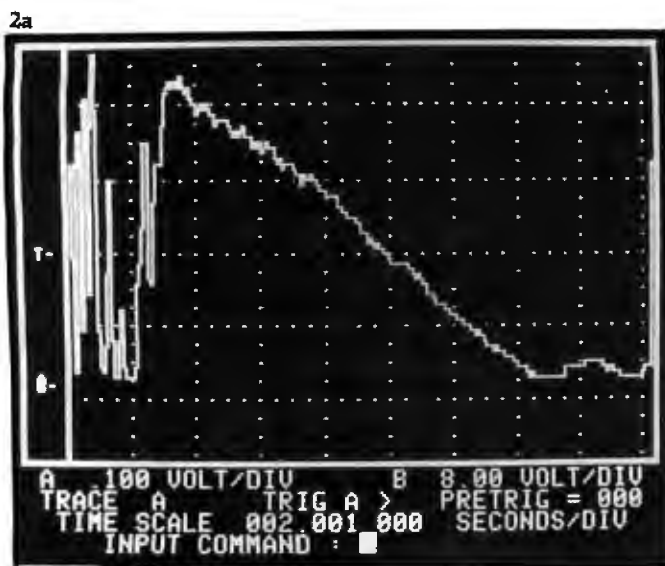

Photo 2: Images produced by Applescope. Photos 2a and 2b demonstrate the expansion function: 2b is the first segment of 2a, expanded along the horizontal axis 64 times (expansion by 256 is possible). Photos 2c and 2d show a combination of the pretrigger and expansion functions: 2d is the expansion of 2c, where the pretrigger parameter was set at 50 samples. Note the three-line status display at the bottom of the screen.

very clean and professional; all parts are labeled. All 45 integrated circuits are installed in sockets, allowing easy maintenance.

Both channel A and channel B inputs enter through a small 5-pin connector manufactured by Berg. Personally, I don't like this arrangement because probes made by most manufacturers use BNC connectors. (There is, however, a \$95 option that includes two standard probes and their mating BNC connector. This is a sensible addition to the unit that both makes it easier to use and reduces input-signal noise.)

### Operation

The installation procedure is easy; however, the manual provided does assume that you have prior knowledge of electronics. Setup requires that you go into the Apple II's monitor program, change the interrupt code, and execute the G (go) instruction specifying the

expansion-slot location of the Applescope's digital board. The manual does not help you to distinguish between the analog and the digital board.

All instructions to the software are entered through 22 keyboard codes. They control settings for the trigger, voltage scales, time scale, sweep mode, expansion factor, and pretrigger (see photo 2). Pretrigger is a feature that allows you to view a record of the trace that occurred *before or after* the trigger point. This is great for digital troubleshooting when you wonder what happened first; for instance, it might let you find a glitch, or voltage transient, that occurred several clock cycles before a problem became obvious.

### How It Works

If you were to try to design an Applescope, you would encounter two problems: size and power limitations. Laudable but invisible to the user, the ADC (analog-to-



# WELCOME A BOARD

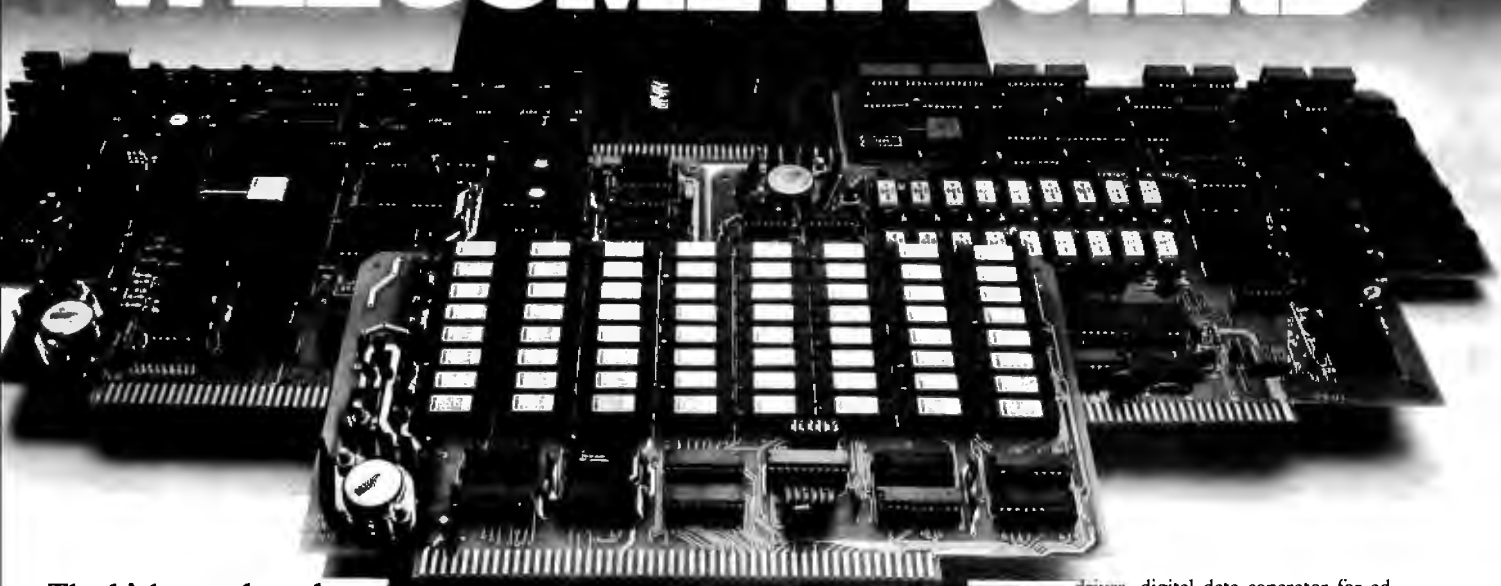

## The high speed, cool, reliable static ram without waitstates.

Our RAM67 static RAM offers low power for cool operation and high reliability. It is the first S100 memory of its size to offer battery back up. The RAM67 will run without waitstates with any present S100 bus CPU.

### Advanced features of the static RAM67:

- Low power CMOS RAM
- 100 ns access time
- No wait states with our 10 MHz *Lightning One*<sup>TM</sup>
- 8/16 bit operation
- Phantom disable
- Battery back up option

If you need high performance and high reliability at an affordable price, the RAM67 is the memory for you.

128K RAM .....\$1495.00  
Battery back-up option .....\$100.00

## The Lightning One

The *Lightning One* is the fastest S100 CPU board presently available. The 8086 processor with its two co-processors, the 8087 and 8089, provide exceptional data manipulation, numeric processing and I/O handling capability.

### The Lightning One features:

- 8086 or 8088 16 bit processor
- 4,5,8, or 10 MHz jumper selectable operation
- Optional 8087 and 8089 co-processors
- Onboard monitor with diagnostics
- 9 vectored interrupts expandable to 65

# RAM67.

When you need mini-computer performance at micro-computer prices, the *Lightning One* should be your choice. Benchmarks available. Prices start at .....\$395.00

## Other LDP Products

In addition to the RAM67 and *Lightning One*, Lomas Data Products offers the following fine products:

- HAZITALL System Support**  
2 serial ports, 2 parallel ports, clock/calendar, 9511 or 9512 math support (option), hard disk controller host interface ..... A & T, \$325.00
- LDP72 Floppy Disk Controller**  
Single or double density operation, single or double sided disks, controls both 8" and 5 1/4" floppy



For 16 bit computing on the S100 bus, come to the leader ...



## LOMAS DATA PRODUCTS, INC.

729 Farm Road, Marlboro, Massachusetts 01752 ☐ Telephone: 617-481-2822

Circle 269 on inquiry card.

drives, digital data separator for adjustment free reliable operation ..... A & T, \$274.95

### LDP128/256K Dynamic RAM

An advanced dynamic RAM with static like performance. An ideal choice for large memory configurations where cost is an important consideration. No DMA, or reset restrictions ..... A & T, 128K \$795.00, 256K \$1395.00

### LDP88 8088 CPU Board

Ideal for inexpensive systems requiring the processing power of a 16 bit instruction set. The LDP88 has up to 8K of on-board EPROM, 1K bytes of RAM, 1 serial RS232 port, 9 vectored interrupts, 5 MHz operation. Useable as a single board 8088 processor ..... A & T, \$349.95

## Software Available

- CP/M-86\***  
Full track buffered BIOS, memory disk support, double density format ..... \$300.00
- MP/M-86\***  
Full MP/M-86 implementation, hard disk and floppy disk support, plus memory drive. 1, 2 and 5 user configurations.
- MS-DOS\*\***  
The IBM Personal Computer operating system, includes macro assembler ..... \$250.00
- Other software:**  
BASIC86, BASCOM86, FORTRAN86, C, FORTH.

\*CP/M-86 & MP/M-86 trademark of Digital Research.  
\*\*MS-DOS trademark of Microsoft.  
Lightning One trademark of Lomas Data Products, Inc.

Dealer and O.E.M. inquiries invited.

# Go with McGraw-Hill's

**TAKE ANY 3 BOOKS  
FOR ONLY \$1<sup>00</sup> EACH  
when you join the  
COMPUTER PROFESSIONALS'  
BOOK CLUB (values up to \$75.00)**

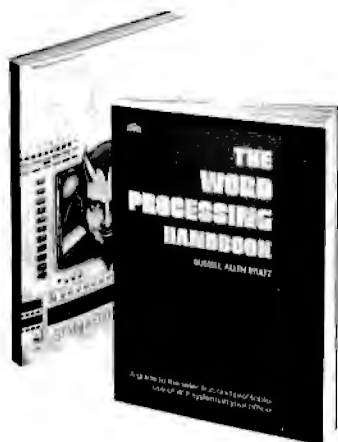

**THE PASCAL HANDBOOK.** By Jacques Tiberghien. 471 pp. A single reference manual that tames this unruly language. Every feature of Pascal is explained in a brilliantly organized format that covers the major Pascal dialects, including Jensen and Wirth's original definition, with the CDC implementation ... the proposed ISO Standard ... UCSD Pascal ... Pascal 1000 (HP1000) ... OMSI Pascal-1 ... and Pascal/Z.  
582365-98 \$35.00  
(Counts as 2 of your 3 books)



**MICROCOMPUTER INTERFACING.** By Bruce Artwick. 352 pp., 117 illus. In this up-to-date, complete design guide you'll find the detailed descriptions and explanations necessary to enable you to select, build, and interface microcomputer systems to virtually all applications. Advanced interface devices and methods are thoroughly examined and illustrated.  
789/4368 \$26.00  
(Counts as 2 of your 3 books)

**COMPUTER CAPACITY.** By Melvin J. Strauss. 288 pp., tables and charts. The key purpose of the book is to provide both senior management and DP practitioners with a methodology for identifying and quantifying issues of capacity and demand within the data center without becoming entrapped by language problems  
582317-9 \$24.95

**BUILD YOUR OWN 280 COMPUTER.** By Steve Garcia. 330 pp., diagrams, softbound. Written for people who don't need an introductory electronics handbook. Its admirably achieved objective is to present a practical, step-by-step analysis of digital computer architecture and the construction details for a complete and functional micro-computer.  
109/621 \$15.95

**MICROPROCESSORS/MICROCOMPUTERS/SYSTEM DESIGN.** By Texas Instruments Learning Center and the Engineering Staff of Texas Instruments, Inc. 634 pp., illus., outsized 7 1/4 x 10 1/4 format. The book takes you through the development of memory-to-memory architecture, shows you the components, and details programming methods and techniques.  
637/58X8 \$26.95  
(Counts as 2 of your 3 books)

**DATA STRUCTURES USING PASCAL.** By Aaron M. Tenenbaum and Moshe J. Augenstein. 544 pp., illus. With its emphasis on structured design and programming techniques, this definitive work takes you on a trailblazing journey through Pascal. Separate chapters are devoted to the stack, recursion, queues and lists, Pascal list processing, trees, graphs and their applications.  
582230-X \$23.95

**THE ADA PROGRAMMING LANGUAGE.** By I. C. Pyle. 293 pp., illus., softbound. Written primarily for practicing programmers of embedded computer systems, this book provides a full presentation of the power of Ada. It will also prove of great interest to other programmers as well as to managers of programming projects.  
582447-7 \$14.95

**AUTOMATIC DATA PROCESSING HANDBOOK.** Edited by The Diebold Group. 976 pp., 269 illus. Written by a staff of internationally recognized authorities on ADP, this comprehensive handbook explains systems, programming and the languages, communications processes, and the design and installation of today's computers.  
168/0758 \$49.95  
(Counts as 2 of your 3 books)

**MICROPROCESSOR APPLICATIONS HANDBOOK.** By David F. Stout. 472 pp., 284 illus. This BIG book on SMALL chips will help you make your systems timely, versatile and cost-effective. The 16 expert contributors provide in-depth treatments of both hardware and software so you can completely analyze, design, construct and program.  
617/9888 \$35.00  
(Counts as 2 of your 3 books)

**APPLE PASCAL: A Hands-On-Approach.** By Arthur Luehrmann & Herbert Peckham. 426 pp., spiral-bound. Finally, a how-to-use-PASCAL book for Apple computer users that makes a complex language as easy as (forgive us!) applesauce. Takes you from "total ignorance" all the way up to very impressive competence in the use of that rather complex language, PASCAL.  
491/712 \$14.95

**OPERATING SYSTEMS.** By Harold Lorin & Harvey M. Deitel. 378 pp., 56 illus. With the relationship of operating systems to both hardware and the systems software environment, this timely book offers stimulating insights and opinions on basic questions—what operating systems should be and what they should do.  
582354-3 \$19.95

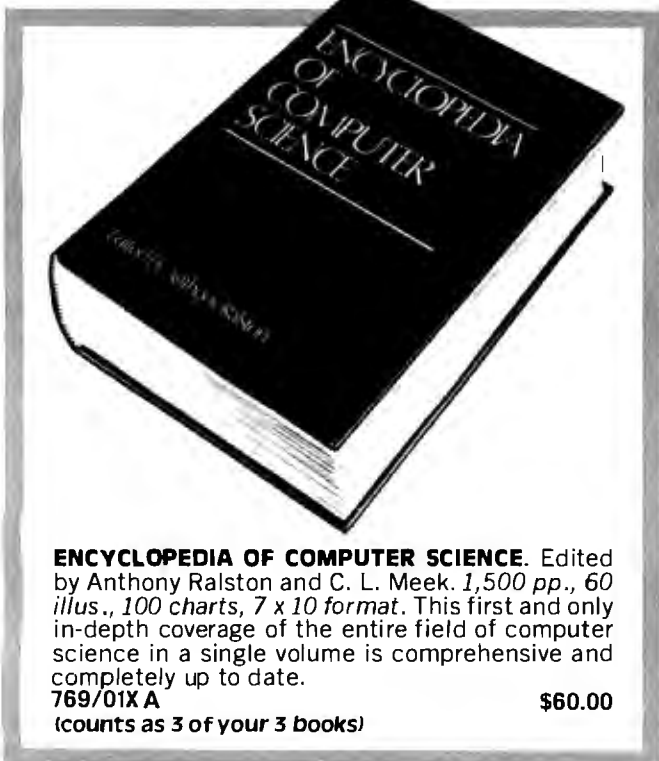

**ENCYCLOPEDIA OF COMPUTER SCIENCE.** Edited by Anthony Ralston and C. L. Meek. 1,500 pp., 60 illus., 100 charts, 7 x 10 format. This first and only in-depth coverage of the entire field of computer science in a single volume is comprehensive and completely up to date.  
769/01X A \$60.00  
(counts as 3 of your 3 books)



# EXPERIENCE!

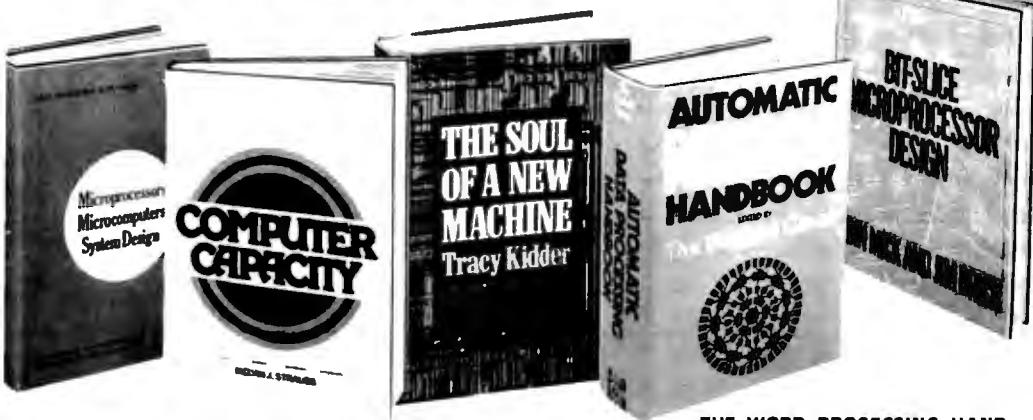

**THE DEVIL'S DP DICTIONARY.** By Stan Kelley-Bootle. 160 pp., softbound. This devilishly clever little book is guaranteed to fill anyone who has ever slaved over a hot terminal with savage delight. Some 500 computer words and terms are misdefined, from abacus to your program.

340/226 \$7.50

**SOFTWARE DEBUGGING FOR MICROCOMPUTERS.** By Robert C. Bruce. 351 pp., illus. Takes you through the fundamental methods for finding errors, glitches, and faults in programs ... goes on to techniques for tracking down and exterminating program bugs ... then combines these techniques into a complete debugging plan.

582075-7 \$18.95

**PERSONAL COMPUTING: Hardware and Software Basics.** Electronics Book Series. 224 pp., 175 illus., 8 1/2 x 11 format. Gives you comprehensive guidance to the present state of the art in personal computers—an overall survey of the technology and methods available to perform various tasks, facts about the work others are doing—and just how they are doing it.

191/514 \$24.50

**THE SOUL OF A NEW MACHINE.** By Tracy Kidder—PULITZER PRIZE WINNER—293 pp. You may have already lived what happens in this true story ... or you may never live what happens here. But if your life touches computers in any way, you'll finish this book in one stay-up-all-night reading.

582439-6 \$13.95

**Z80 USERS MANUAL.** By Joseph Carr. 326 pp., with diagrams, charts and tables. Takes you through every opportunity the ZAP can offer. It covers Z80 pin definitions, CPU control signals, support chips, interfacing peripherals, and much more. It also includes a 177-page Z80 instruction set so you can study the instructions on a one-by-one basis.

582336-5 \$18.95

**ELECTRONIC GAMES: Design, Programming, and Troubleshooting.** By W. H. Buchsbaum and R. Mauro. 335 pp., 338 illus. Information you need to design, program, and troubleshoot electronic games is right here in this widely popular hands-on guide.

087/2108 \$26.95

(Counts as 2 of your 3 books)

**THE WORD PROCESSING HANDBOOK.** By Russell A. Stultz. 237 pp., with tables and diagrams. This book gives you the basics—and the many extras—that you need to cope intelligently with the outsized choice of word processors on the market today. It provides a comprehensive understanding of what they do, and which one to select.

582463-9 \$17.95

**BIT-SLICE MICROPROCESSOR DESIGN.** By John Mick and Jim Brick. 398 pp. All in one place—the crucial information you've been needing about the 2900 family of bit-slice microprocessor components. This remarkable "first" designs right before your eyes not just one but two complete 16-bit machines!

417/814 \$24.00

Be sure to consider these important titles as well!

**6502 SOFTWARE DESIGN.** By L. J. Scanlon  
582138-9 \$12.95

**STRUCTURED PROGRAMMING: Theory and Practice.** By R. C. Linger, H. D. Mills, & B. J. Witt  
788/537 \$22.95

**THE BYTE BOOK OF PASCAL.** Edited by B. W. Liffick  
789/6738 \$25.00  
(Counts as 2 of your 3 books)

**COMPUTER PERIPHERALS FOR MINICOMPUTERS, MICROPROCESSORS AND PERSONAL COMPUTERS.** By L. C. Hohenstein  
294/518 \$19.50

**16-BIT MICROPROCESSOR ARCHITECTURE.** By T. Dolthoff  
582003-X \$24.95

**PRINCIPLES OF INTERACTIVE COMPUTER GRAPHICS.** By W. M. Newman & R. Sproull  
463/3878 \$28.95  
(Counts as 2 of your 3 books)

**THEORY & PRACTICE OF MICROPROCESSORS.** By K. G. Nichols & E. J. Zaluska  
582414-08 \$36.50  
(Counts as 2 of your 3 books)

**COBOL BOOK OF PRACTICE AND REFERENCE.** By R. L. Grauer  
582316-0 \$19.95

**THE SCIENCE OF PROGRAMMING.** By D. Gries  
582452-3 \$19.80

**SOFTWARE VERIFICATION AND VALIDATION.** By M. S. Deutch  
580501-5 \$21.95

\*If you join now for a trial period and agree to purchase three more books—at handsome discounts—during your first year of membership. (Publishers' prices shown)

## Why YOU should join now!

■ **BEST AND NEWEST BOOKS IN YOUR FIELD**—Books are selected from a wide range of publishers by expert editors and consultants to give you continuing access to the best and latest books in your field.

■ **BIG SAVINGS**—Build your library and save money too! Savings ranging up to 30% or more off publishers' list prices—usually 20% to 25%.

**BONUS BOOKS**—You will immediately begin to participate in our Bonus Book Plan that allows you savings of between 70%—80% off the publishers' prices of many professional and general interest books!

■ **CONVENIENCE**—12-14 times a year (about once every 3-4 weeks) you receive the Club Bulletin FREE. It fully describes the Main Selection and alternate selections. A dated Reply Card is included. If you want the Main Selection, you simply do nothing—it will be shipped automatically. If you want an alternate selection—or no book at all—you simply indicate it on the Reply Card and return it by the date specified. You will have at least 10 days to decide. If, because of late delivery of the Bulletin you receive a Main Selection you do not want, you may return it for credit at the Club's expense.

As a Club Member you agree only to the purchase of 3 books during your first year of membership. Membership may be discontinued, by either you or the Club at any time after you have purchased the 3 additional books.

### Other McGraw-Hill Book Clubs:

Accountants' and Controllers' Book Club • Architects' Book Club • Chemical Engineers' Book Club • Civil Engineers' Book Club • Electronics and Control Engineers' Book Club • Mechanical Engineers' Book Club

For more information, write to:

McGraw-Hill Book Clubs

1221 Avenue of the Americas, 26th fl., New York, NY 10020

### MAIL THIS COUPON TODAY

McGraw-Hill Book Clubs  
Computer Professionals' Book Club  
P.O. Box 582, Hightstown, New Jersey 08520

Please enroll me as a member and send me either the ENCYCLOPEDIA OF COMPUTER SCIENCE, billing me only \$3.00, or any three other books, billing me only \$1.00 each, plus local tax, shipping and handling. I agree to purchase a minimum of three additional books during my first year of membership as outlined under the Club plan described in this ad. A shipping and handling charge is added to all shipments.

Check here if you want ENCYCLOPEDIA OF COMPUTER SCIENCE (769/01X).

Check here if you prefer three other volumes, and indicate below by number the books you want. A few expensive books (noted in the description) count as more than one choice.

\_\_\_\_\_

Name \_\_\_\_\_

Address/Apt. \_\_\_\_\_

City/State/Zip \_\_\_\_\_

Corporate Affiliation \_\_\_\_\_

This order subject to acceptance by McGraw-Hill. All prices subject to change without notice. Offer good only to new members. Orders from outside the U.S. cannot be accepted.

P39558

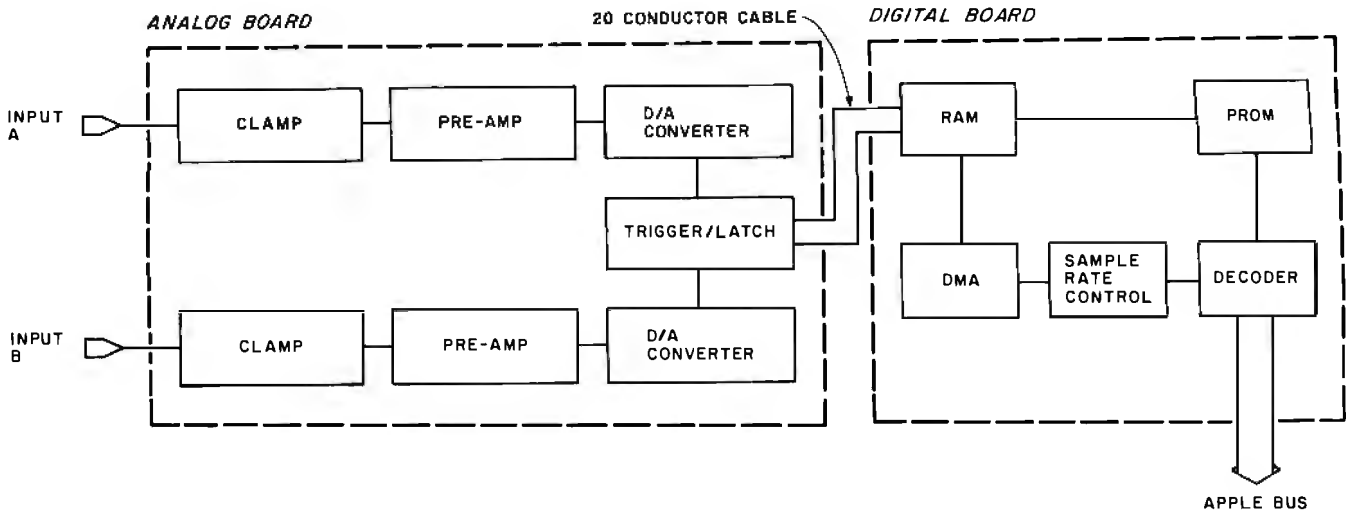

Figure 1: Block diagram of Applescope's circuitry. The interface occupies two slots on the Apple II's expansion bus; the amplifiers and conditioning circuits for analog input signals are kept separate from the digital electronics to reduce interaction and noise.

digital converter) has been carefully designed to work within the Apple II's interface requirements; otherwise, the power supply would sizzle from overuse.

The Applescope's major components are shown clearly in figure 1. All input signals are clamped to  $\pm 11.1$  volts (V); the two channels are individually amplified. The analog board digitizes the processed signals through two modified tracking ADCs; 1024 samples (512 in dual-trace mode) are obtained at 0.286 microseconds per sample.

The digital board has 1K bytes of memory on-board that temporarily stores the digitized data as it comes in. This board also has the triggering logic, DMA (direct memory access) support logic, and the PROM (programmable read-only memory) that contains the Applescope's operating software.

Data is eventually transferred over the Apple II's bus in two's-complement form and is read at locations 0C00 through 0FFF hexadecimal. This data is stored on disk in its raw form. Roughly 200 milliseconds later, this information is displayed on the video monitor as an oscilloscope trace with 280- by 160-pixel (picture element) resolution. The various parameters and settings chosen are displayed at the bottom of the screen as three lines of text.

Because uses of the Applescope might vary, the designers have provided places for extra capacitors and resistors on the analog board. The idea is that additional components might be necessary in some applications to alter the response of the clamping and amplifying circuits. These vacant locations are all labeled.

## THIN is IN!

State-of-the-art 8" disk drive subsystems give you a remarkable 2.4 MB in the space of a single-drive cabinet, 4.8 MB storage capacity in the space of a 2-drive cabinet. Perfect add-ons for IBM, Apple, Radio Shack and all 8" Shugart compatible computers.

Systems	Introductory Price	Retail
2-Drive	\$1695	\$1995
4-Drive	\$2995	\$3495
2-Drive Horizontal	\$1750	\$2050

write protect switch option = \$30/drive

**Columbia microSystems, Inc.**  
905 E. Broadway, Columbia, MO 65201  
(314) 875-8900

Circle 499 on Inquiry card.

**\* ADDS \***

**VIEWPOINT TERMINALS . \$495**

**DEC COMPATIBLE CRTS**

[VT-100] .....	\$995
[VT-100 AVO & PRINTER PORT] .....	\$1295
[VT-132] .....	\$1395
[VT-100 COLOR] .....	\$2295
[VT-132 COLOR] .....	\$2495

**DATA GENERAL COMPATIBLE**

[D100 & D200] .....	\$995
[D100 & D200 COLOR] .....	\$2295

**MODEMS**

300/1200 212A COMPATIBLE .....	\$699
--------------------------------	-------

.....

**ECONOMY PERIPHERALS INC.**  
**(404) 952-0213**

Circle 500 on Inquiry card.

## Votrax SC-01A SPEECH SYNTHESIZER

**\$70 Each**  
**(5 or more, \$55 each)**

**Order in Ones or Thousands**

The SC-01A Speech Synthesizer is a completely self-contained solid state device. This single chip phonetically synthesizes continuous speech of unlimited vocabulary.

The SC-01A contains 64 different phonemes which are accessed by a 6-bit code. Computer interfaces and text-to-speech algorithms also available for product development.

Votrax is a trademark of Federal Screw Works

**Call 1-800-645-3479, in N.Y. 1-516-374-6793**

**MICROMINT INC.**  
917 Midway  
Woodmere, N.Y. 11598

Call for quantity pricing.

Circle 501 on inquiry card.



The MICROMINT Z8 BASIC COMPUTER/CONTROLLER board represents a milestone in microcomputer performance. It is cheap enough to be programmed directly in a high level language, and efficient enough to be battery operated if required. The entire computer is 4" by 4½" and includes a tiny BASIC interpreter, 4K bytes of program memory, one RS-232 serial port and two parallel ports, plus a variety of other features. Using a powerful Z8 microcomputer chip and Z6132 4K X 8 RAM, the Z8 BASIC COMPUTER/CONTROLLER board is completely self-contained and optimized for use as a dedicated controller. The unit is assembled and tested and comes with over 200 pages of documentation.

**The price, in single quantity, a tiny \$195.\***

Optional power supply

(+ 5, + 12 and -12V) \$35.

Please include \$4 for shipping and handling.

\*Call Micromint for quantity pricing

#### Z8 MICROCOMPUTER

- On board tiny BASIC interpreter.
- Parallel and serial I/O ports.
- 6 interrupts.

#### RS-232 CONNECTOR

- Just attach a CRT terminal and immediately write control programs in BASIC.

#### 4K BYTES OF RAM

- Z6132 4K X 8 low power quasi-static RAM. EPROM pin compatible.

#### SWITCH SELECTABLE BAUD RATES

- 110-9600 BPS.

#### FULLY EXPANDABLE

- Data and address buses available for 124K memory and I/O expansion.
- 2 onboard parallel ports.
- 7.3728MHZ crystal for fast control operations.

#### JUMPER SELECTABLE MEMORY OPTIONS

- 4K RAM, 2716 or 2732 EPROM operation.

#### LOW POWER

- Consumes only 1½ WATTS at +5, +12 and -12V (optional power supply available).

To Order:

Call Toll Free

1-800-645-3479

For Information Call

1-516-374-6793

MICROMINT INC.

917 Midway

Woodmere, N.Y. 11598

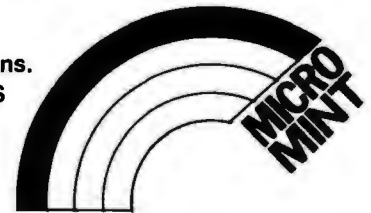

**Micromint will put both a computer development system and an OEM dedicated controller in the palm of your hand for only \$195.**

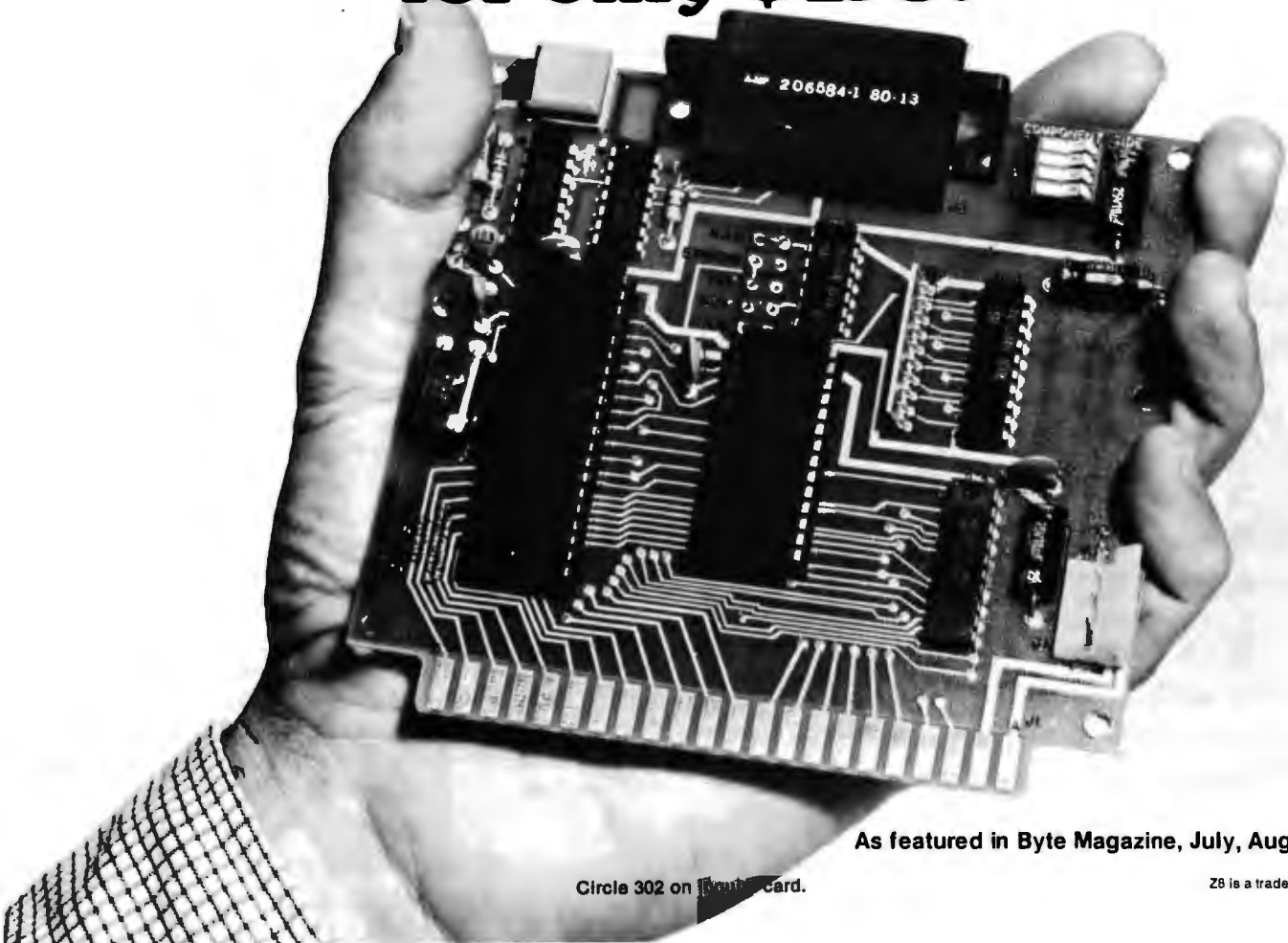

As featured in Byte Magazine, July, August, 1981.

Circle 302 on Reader Card.

Z8 is a trademark of Zilog Inc.

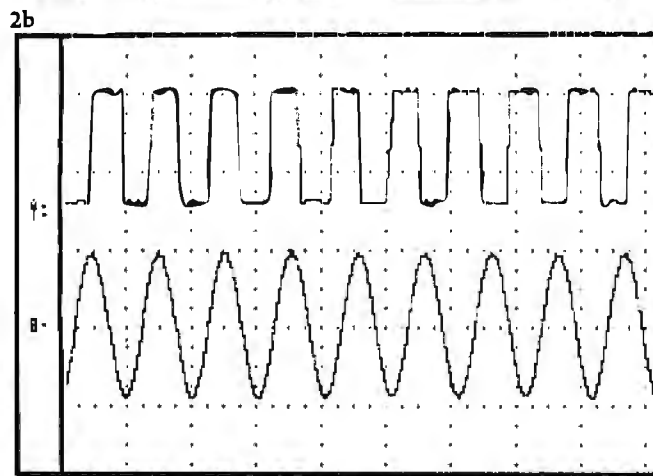
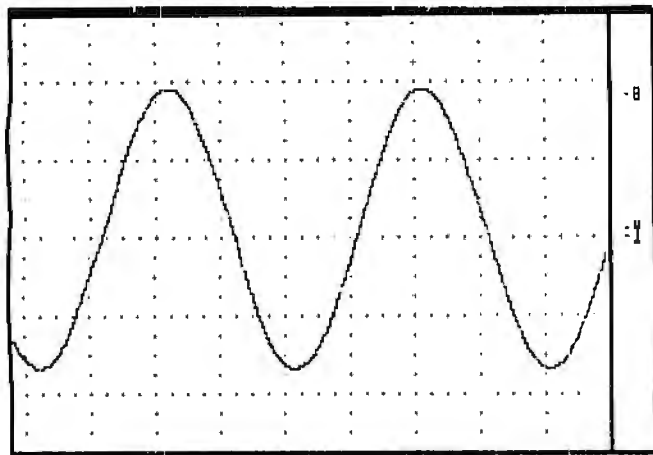

A 400 VOLT/DIV B 1.00 VOLT/DIV  
 TRACE A B TRIG B > PRETRIG=000  
 TIME SCALE 000.000 001 SECONDS/DIV  
 INPUT COMMAND

Figure 2: Hard copy is available from a printer. Figure 2a is a simple sine wave that shows Applescope's resolution. Figure 2b demonstrates that Applescope suffers from neither overshoot nor crosstalk.

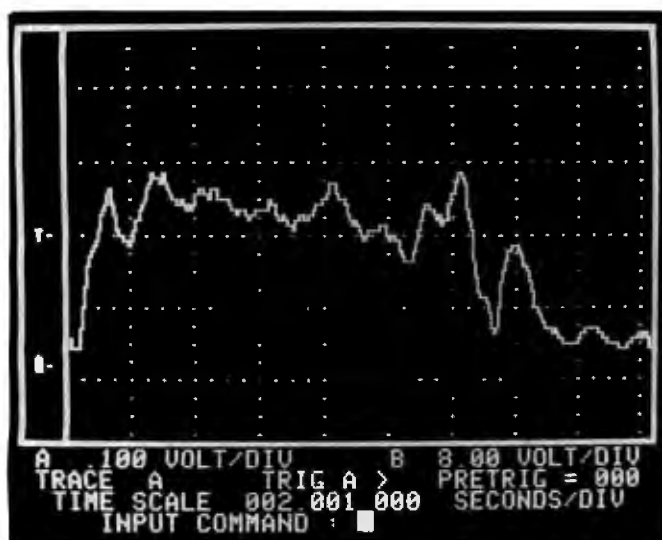

Photo 3: Typical audio-spectrum plot. Information collected during the input cycle is stored on disk and may be used or modified by other Apple programs.

## Software

Remarkably, the Applescope's software is all packed into 2K bytes of EPROM (erasable programmable read-only memory). The software contains all the commands and display directives that the average user needs. There is also a disk-based software package, available for \$49, that lets you do signal averaging, real-time display update, and exact voltage measurement. Provision is made for hard copy from a printer (see figure 2).

The Applescope's manufacturer, R. C. Electronics, has promised to provide customized software for specialized applications. Other companies are showing interest in this type of software. For example, W. H. Nail Company in Oroville, California, is providing physiologic-related software for educational use that includes biofeedback, heart-rate analysis, and histograms—all with hard-copy output. I can also see a need for a logarithmic package that displays signals with a decibel scale for audio work.

## Sound Applications

Because I'm involved with speaker design, I went about applying the Applescope to create a spectrum plot of speaker-system response. Setup was a snap: I wanted a 20-Hz-to-20-kHz near-field spectrum plot as might be seen on standard audio test equipment. Normally this would mean using a Polaroid camera to photograph an oscilloscope screen while an audio generator made a 70-second sweep of the spectrum. With the Applescope (see photo 3), I simply set the time scale at eight seconds per division and triggered it and the generator. The labeled result was displayed, printed out, and put in my notebook for reference. This was easier, faster, and less expensive than the Polaroid technique.

A product of this sort has tremendous potential. So far, a mix of current and future applications might include audio and speech analysis, physiologic recording, biofeedback applications, education, chart recording and documentation of analog data, and fast Fourier transform experiments.

## Conclusions

The Applescope acts like a digital-storage oscilloscope, storing information in memory and freezing the signal image on screen. It is very well designed and constructed. However, before you pull the plug on your trusty Tektronix, it is important to determine the Applescope's limitations. While it is excellent for digital signals slower than 3.5 MHz, the Applescope, like any tool, requires careful use. The images it produces can suffer from aliasing and Apple-bus noise—problems not encountered in an analog oscilloscope. (The display time is quicker with an analog oscilloscope too.) If you need fast response or work with high voltage, keep your analog oscilloscope around, but if you require graphic display of digital data or sophisticated storage of signal traces, the Applescope is the tool you need. ■





# FTL makes Applesoft faster!

FTL is the easy way to speed up your Applesoft programs. You can run all your Applesoft programs with *no* changes, and without 'compiling' them. Plus, FTL doesn't reduce your available memory. The key is ALF's AD8088 Processor Card, which adds a fast, 16-bit computer to your Apple. FTL, the Formula Transfer Link, sends Applesoft formulas (\*, /, ↑, LOG, EXP, COS, SIN, TAN, and ATN) to the card for fast processing. FTL runs programs that compilers won't, like programs with embedded assembly language. But FTL is compatible with most Applesoft compilers, so you can use TASC or Expediter II and FTL for even faster execution!

ALF's dependable Processor Card easily meets Apple's 2 watt power recommendation. The Apple's 6502 processor runs at full speed while the Processor Card runs programs from its on-board memories. Several AD8088's can be used simultaneously.

FTL is just one use for the powerful AD8088 Processor Card. There's a Multiple Event Timer (MET) for timing critical routines in your programs, with resolution to 50 μS for scientific applications. Coming soon are MS-DOS (the IBM Personal Computer's DOS), CP/M-86, and a fast 3-D high-res graphics card that connects through the AD8088's versatile expansion port.

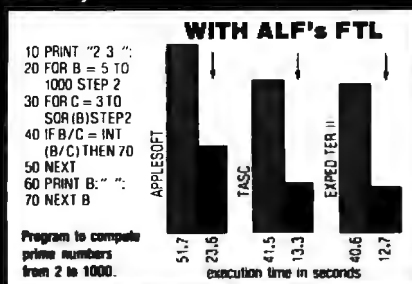

\$345 is the suggested price for the AD8088 Processor Card with FTL and MET. An Apple II with Language Card (or 16K RAM Card) and disk drive is required. See your local Apple dealer, or write for more information.

Trademarks: "Apple", Apple Computer, "TASC", "MS-DOS", Microsoft, "Expediter II", Einstein/Goodrow, "CP/M-86", Digital Research

# ALF

A L F Products Inc. 1448 Estes Denver, CO 80215 [303] 234-0871

# ATARI HOME COMPUTERS



**ATARI 800**  
 16K ... \$679  
 32K ... \$749  
 48K ... \$819

**ATARI 400**  
 16K ... \$329  
 32K ... \$478  
 48K ... \$555

410 Recorder	\$76.00
810 Disc Drive	\$449.00
822 Printer	\$269.00
825 Printer	\$629.00
830 Modem	\$159.00
820 Printer	\$269.00
850 Interface	\$169.00
New DOS 2 System	\$29.00
CX30 Paddle	\$18.00
CX40 Joy Stick	\$18.00
CX853 16K RAM	\$89.00
Microtek 16K RAM	\$69.00
Microtek 32K RAM	\$139.00
Ramdisk (128K)	\$449.00
Inteck 48K Board	\$249.00
One year extended warranty	\$70.00
481 Entertainer	\$83.00
482 Educator	\$130.00
483 Programmer	\$57.00
484 Communicator	\$344.00

## ATARI HOME COMPUTER PROGRAMS

<b>HOME OFFICE</b>	
CX404 ATARI Word Processor	\$119.00
CX8102 Calculator	\$29.00
CX412 Dow Jones Investment Evaluator	\$99.00
CX4109 Graph It. Joystick optional	\$17.00
CX4104 Mailing List	\$20.00
CX4115 Mortgage & Loan Analysis	\$13.00
CX4103 Statistics 1	\$20.00
CX8107 Stock Analysis	\$20.00
CXL4015 TeleLink 1	\$23.00
<b>HOME STUDY</b>	
CX4101 An Invitation to Programming 1	\$20.00
CX4106 An Invitation to Programming 2	\$23.00
CX4117 An Invitation to Programming 3	\$23.00
CX4107 Biorhythm	\$13.00
Conversational Languages (ea.)	\$46.00
CX4121 Energy Czar	\$13.00
CX4114 European Countries & Capitals	\$13.00
CX4108 Hangman. Joystick optional	\$13.00
CX4102 Kingdom	\$13.00
CXL4007 Music Composer	\$47.00
CX4123 Scram. uses joystick	\$20.00
CX4112 States & Capitals	\$13.00
CX4110 Touch Typing	\$20.00
<b>HOME ENTERTAINMENT</b>	
PAC MAN	\$35.00
CENTPEPE	\$35.00
CAVERNS OF MARS	\$32.00
CXL4013 Asteroids	\$35.00
CXL4004 Basketball	\$27.00
CX4105 Blackjack	\$13.00
CXL4009 Computer Chess	\$33.00
CXL4012 Missile Command	\$35.00
CXL4008 Space Invaders	\$35.00
CXL4011 Star Raiders	\$42.00
CXL4006 Super Breakout	\$33.00
CXL4010 3-D Tic-Tac-Toe	\$27.00
CXL4005 Video Easel	\$24.00
<b>PROGRAMMING LANGUAGES AND AIDS</b>	
CXL4003 Assembler Editor	\$47.00
CXL4002 ATARI BASIC	\$47.00
CX8126 ATARI Microsoft BASIC	\$70.00
CXL4018 PILOT	\$72.00
CX405 PILOT (Educational)	\$105.00

## ATARI PROGRAM EXCHANGE:

Eastern Front '41	\$25.50
Avalanche	\$15.50
Outlaw	\$15.50
747 Landing Simulation	\$15.50
Babel	\$15.50
Dog Daze	\$15.50
Downhill	\$15.50
Attack!	\$15.50
Blackjack-Casino	\$15.50
Reversi II	\$15.50
Domination	\$15.50
Solitaire	\$15.50
Disk Fixer	\$15.50
Supersort	\$15.50
Data Management	\$15.50
Chameleon	\$15.50
instedit	\$15.50
Insomnia	\$15.50
My First Alphabet	\$25.50
Mapware	\$18.00
Number Blast	\$11.50
Family Cash Flow	\$15.50
Weekly Planner	\$15.50
Bowler's Data Base	\$13.00
Banner Generator	\$11.50
<b>Crystal Software</b>	
Bermuda Fantasy	\$26.00
Beneath Pyramids	\$20.00
Galactic Quest	\$26.00
House of Usher	\$26.00
Forgotten Island	\$20.00
Haunted Palace	\$33.00
Compumax (Acct. Rec., Gen. Ledger, Inventory, Payroll, ea.)	\$110.00
<b>Synapse</b>	
File Manager 800	\$69.95
Dodge Racer	\$19.00
Chicken	\$24.00
Slime	\$24.00
Nautilus	\$24.00
Disk Manager	\$24.00
Fort Apocalypse	\$24.00
Assembler	\$39.00
Protector	\$24.00
<b>EXPY</b>	
Ricochet	\$14.50
Crush Crumble & Champ	\$24.00
Star Warrior	\$29.00
Rescue at Rigel	\$24.00
Datestones	\$16.00
Invasion Orion	\$18.50
Mission Asteroid	\$22.00
<b>OnLine</b>	
Jaw Breaker	\$27.00
MouskATTACK	\$31.00
The Next Step	\$34.00
Softporn	\$27.00
Wizard & Princess	\$29.00
<b>Arcade Plus</b>	
Ghost Hunter (cassette)	\$24.00
Ghost Hunter (disk)	\$30.00
<b>K-Byte</b>	
K-BYTE Crazy Shoot Out (ROM)	\$39.00
K-DOS	\$69.00
Visicalc	\$179.00
Letterperfect (Word Processor)	\$109.00
Data Soft Textwizzard	\$89.00

# Texas Instruments



**TI-99/4A \$299**

PHA2100 R F Modulator	\$29.00
PHP 1600 Telephone Coupler	\$179.00
PHP 1700 RS-232 Accessories Interface	\$179.00
PHP 1800 Disk Drive Controller	\$239.00
PHP 1850 Disk Memory Drive	\$389.00
PHP 2200 Memory Expansion & 32K RAM	\$319.00
PHP 1100 Wired Remote Controllers (Pair)	\$31.00
32K Expansion	\$329.00
PHP Printer Solid State	\$319.00
PHM 3006 Home Financial Decisions	\$26.00
PHM 3013 Personal Record Keeping	\$43.00
PHD 5001 Mailing List	\$60.00
PHD 5021 Checkbook Manager	\$18.00
PHM 3008 Video Chess	\$60.00
PHM 3010 Physical Fitness	\$26.00
PHM 3009 Football	\$26.00
PHM 3018 Video Games I	\$26.00
PHM 3024 Indoor Soccer	\$26.00
PHM 3025 Mind Challengers	\$22.00
PHM 3031 The Attack	\$35.00
PHM 3032 Blast	\$22.00
PHM 3033 Blackjack and Poker	\$22.00
PHM 3034 Hustle	\$22.00
PHM 3036 Zero Zap	\$18.00
PHM 3037 Hangman	\$18.00
PHM 3038 Connect Four	\$18.00
PHM 3039 Yahtzee	\$22.00
Tombstone City 21st Century	\$34.00
Munch Man	\$34.00
T I INVADERS	\$34.00
CAR WARS	\$34.00

## Printers

Centronics 739-1	\$519.00
Centronics 739-3	\$619.00
Diablo 630 Special	\$1799.00
<b>Epson</b>	
MX80 w/Graftrax	\$449.00
MX80FT	Call
MX100	Call
<b>NEC</b>	
8023	\$549.00
7730	Call
7720	Call
7710	Call
<b>Okidata</b>	
82A	\$499.00
83A	\$749.00
84	\$1129.00
<b>Citoh Starwriter</b>	
F10-40 CPS	\$1469.00
F10-55 CPS	Call
Prowriter	\$479.00
<b>Talley</b>	
8024-7	\$1399.00
8024-L	\$1629.00
MPC Apple Parallel Board & Cable	\$69.00
<b>IDS</b>	
Paper Tiger	SCall
Prism	SCall
2 Meter RS232-RS232	\$29.95

## Computer Covers

ATTRACTIVE DUST COVERS FOR YOUR COMPUTER AND DISK DRIVE.

Atari 400	\$6.99	Commodore VIC-20	\$6.99
Atari 800	\$6.99	Commodore 8032	\$14.99
Atari 810	\$6.99	Commodore 8050/4040	\$10.99
All Atari Covers are Beige.		All Commodore covers are Royal Blue.	

Most software for Atari 400/800 available on cassette or disk.

**computer mail order west**  
 CALL TOLL FREE **800-648-3311**

Franco  
 Habla  
 Espanol

IN NEVADA, CALL (702) 588-5654  
 P.O. BOX 6689, STATE LINE, NEVADA 89449



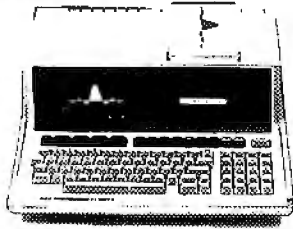

## HP-85 \$1899

80 Column Printer	\$799.00
HP-125	\$1999.00
HP-83	\$1699.00
HP-85 16K Memory Module	\$169.00
5 1/4" Dual Master Disc Drive	\$1769.00
HP-87	\$1769.00
Hard Disk w/Floppy	\$4349.00
Hard Disk	\$3440.00
"Sweet Lips" Plotter	\$1149.00
<b>HP-41CV Calculator</b>	<b>\$239.00</b>
41C	\$189.00
11C	\$104.00
12C	\$114.00
34C	\$114.00
38C	\$114.00
HP-41 Printer	\$340.00
<b>HPIL CALCULATOR PERIPHERALS</b>	
IL Modul	\$104.00
Digital Cassette	\$449.00
Printer/Plotter	\$419.00
Card Reader	\$164.00
Optical Wand	\$99.00

## NEC

8001-A	\$749.00
8031	\$749.00
8012	\$549.00
Accounts Receivable	\$295.00
Word Processing	\$395.00
General Accounting	\$295.00
Inventory Control	\$295.00
Job Cost	\$295.00

## Disks

Maxell	
MD I (box of 10)	\$36.00
MD II (box of 10)	\$46.00
MFD I (8")	\$44.00
MFD II (8" Double Density)	\$54.00
Syncom (box of 10)	\$29.00

## Apple

Call for availability and prices on all Apple computers and peripherals.

## Televideo

910	\$579.00
912C	\$699.00
920C	\$749.00
925C	\$749.00
950	\$939.00
802	\$Call

Call for computers



## BUSINESS MACHINES

### SOFTWARE

Word Pro 5 Plus	\$319.00
Word Pro 4 Plus	\$299.00
Word Pro 3 Plus	\$199.00
Commodore Tax Package	\$589.00
Visicalc	\$179.00
Medical Billing	\$449.00
The Source	\$89.00
OZZ Information System	\$289.00
Dow Jones Portfolio	\$129.00
Pascal	\$239.00
Legal Time Accounting	\$449.00
Word Craft 80	\$289.00
Power	\$79.00
Socket-2-Me	\$20.00
Jinsam	\$Call
MAGIS	\$Call
CPA	\$Call
Real Estate Package	\$799.00
The Manager	\$209.00
Softrom	\$129.00
BPI Inventory Control	\$319.00
BPI Job Costing	\$319.00
BPI Payroll	\$319.00
BPI General Ledger	\$329.00
Creative I SAM	\$79.00
Creative General Ledger	\$229.00
Creative Accounts Receivable	\$229.00
Creative Inventory	\$229.00



## CBM 8032 \$1039

4032	\$969.00
4016	\$769.00
8096 Upgrade Kit	\$399.00
Super Pet	\$1599.00
2031	\$529.00
8250 Doubled Sided Disk Drive	\$1699.00
5 Megabyte Hard Disk	\$2399.00
8050	\$1299.00
4040	\$969.00
8300 (Letter Quality)	\$1799.00
8023	\$769.00
4022	\$599.00
Pet to IEEE Cable	\$37.00
IEEE to IEEE Cable	\$46.00
Tractor Feed for 8300	\$240.00

## VIC 20 \$249

**COMPLETE**  
CALL FOR AVAILABILITY AND PRICE FOR NEW VIC-64

16K VIC Expansion	\$99.00
VIC 6 Pack Program	\$44.00
VIC 1530 Commodore Datasette	\$69.00
VIC 1540 Disk Drive	\$499.00
VIC 1515 VIC Graphic Printer	\$339.00
VIC 1210 3K Memory Expander	\$32.00
VIC 110 8K Memory Expander	\$53.00
VIC 1011 RS232C Terminal Interface	\$43.00
VIC 1112 VIC IEEE-488 Interface	\$86.00
VIC 1211 VIC 20 Super Expander	\$53.00
VT 232 VIC Term I Terminal Emulator	\$9.00
VIC 1212 Programmers Aid Cartridge	\$45.00
VIC 1213 VICMON Machine Language Monitor	\$45.00
VIC 1901 VIC AVENGERS	\$23.00
VIC 1904 SUPERSLOT	\$23.00
VIC 1906 SUPER ALIEN	\$23.00
VIC 1907 SUPER LANDER	\$23.00
VIC 1908 DRAW POKER	\$23.00
VIC 1909 MIDNIGHT DRIVE	\$23.00

### COMMODORE VIC-20



Terminal	\$13.00
Un Word	\$13.00
Grafix Menagerie	\$11.00
VIC PICS	\$15.00
Ticker Tape	\$13.00
Banner Headliner	\$13.00
RS 232	\$39.00
VT 106A Recreation Pack A	\$44.00
VT107A Home Calculation Pack A	\$44.00
VT 164 Programmable Character/Gamegraphics	\$12.00
Household Finance	\$27.00
VIC Games	\$19.00
VIC Home Inventory	\$13.00
VIC Rec/Ed II	\$13.00
VL101 Introduction to Computing	\$19.00
VL 102 Introduction to BASIC Programming	\$19.00
VM110 VIC 20 Programmers Reference Guide	\$15.00

In-stock items shipped same day you call. No risk, no deposit on C.O.D. orders. Pre-paid orders receive free shipping within the continental United States with no waiting period for certified checks or money orders. All prices shown are cash prices. Add 3% for Mastercard and Visa. NV and PA residents add sales tax. All items subject to availability and price change.

## Monitors

Amdex 12" B&W	\$129.00
12" Green	\$139.00
13" Color	\$349.00
NEC	
12" B&W	\$169.00
12" Color	\$339.00
T1 10" Color	\$349.00
Zenith ZVM 121 (Green)	\$119.00

## Modems

Livermore Star	\$119.00
Hayes	
Smart	\$239.00
Chronograph	\$199.00
Novation Auto	\$239.00
D Cat	\$169.00
Cat	\$159.00
Micromodem II	\$279.00
Micromodem 100	\$309.00

Nev. & Pa. residents add sales tax.

# computer mail order east

CALL TOLL FREE **800-233-8950**

INTERNATIONAL CALLS AND IN PA. CALL (717) 327-9575  
477 E. THIRD ST., WILLIAMSPORT, PA 17701

Patricio  
Habla  
Español

## NEWDOS/80 Version 2.0

Mahlon G. Kelly  
268 Turkey Ridge Rd.  
Charlottesville, VA 22901

NEWDOS/80 Version 2.0 is the latest in a line of DOSes (disk operating systems) produced by Apparat for the Radio Shack TRS-80. The series was started with NEWDOS 2.1 so as to overcome deficiencies in Radio Shack's original DOS, TRSDOS 2.1. Since then the process of evolution and change has resulted in what may be the most powerful operating system for any microcomputer.

A disk operating system determines the whole environment within which the user works. The DOS controls not only input and output from a disk, but also all of the operating commands, the configuration of the system (disk-drive types, data density, and so on), the data-file types, various extra features in BASIC, and new editing procedures. NEWDOS/80 Version 2.0 (hereafter called V2) enhances all of those features of a DOS and provides several important utility programs as well, such as Superzap, an excellent machine-language monitor for disk files and main memory, a new disassembler, and an enhanced editor/assembler.

A disk operating system is complex. In unaltered form,

V2 occupies nearly an entire 35-track disk—that's almost 90,000 bytes (although parts can be deleted to provide space on a single-drive system). The source code for the system is some 10,000 lines long. More than 800 combinations and permutations of commands, statements, and so on are possible. The user's manual is more than 260 pages long and it's lean; there's no redundancy or wordiness.

### Features

V2's features are comprised of three parts: commands, enhanced BASIC language features (including new file structures), and utility programs. Commands include things like DIR, COPY, and FORMAT; i.e., instructions that are issued directly from the keyboard to the operating system but do not invoke user programs. Among the BASIC enhancements are new statements and commands, new editing features, and new file structures. Several newly modified utility programs, such as Superzap, are provided along with a variety of other attractions. For example, simultaneously pressing the "jkl" keys sends the screen contents to the printer.

### Commands

The command set for V2 is summarized in table 1. Most of the commands used by TRSDOS are found there (with some exceptions like BACKUP, which is superseded by COPY). New commands have been added, and the format and function of other commands have been changed. There's not enough space to completely describe all of the commands and their differences so I'll concentrate on the most important ones; the others should be clear from table 1.

SYSTEM and PDRIVE are V2's most important commands. They provide the tremendous flexibility that is characteristic of V2. SYSTEM allows you to set up the operating environment, that is, it specifies whether an uppercase modification is installed, whether the cursor should blink, what the cursor should look like, and so on. Figure 1 shows the result of typing SYSTEM 0 with

### At a Glance

<b>Name</b> NEWDOS/80 Version 2.0	<b>Language</b> Z80 machine language
<b>Type</b> Disk operating system	<b>Computer</b> TRS-80 Model I or III with disk drives
<b>Manufacturer</b> Apparat Inc. 440 South Tamarac Parkway Denver, CO 80237 (303) 741-1778	<b>Documentation</b> More than 260 pages in three-ring binder
<b>Price</b> \$149	<b>Audience</b> Any TRS-80 user with a need for advanced DOS
<b>Format</b> 5 1/4-inch floppy disk	



# For serious business microcomputing, only one operating system exactly fits.

Whether you're in business and do microcomputing, or in computing and sell to business, you'll like OASIS.\* Not a hobby or scientific system warmed-over for business use, OASIS is the only operating system designed from the ground up for business.

## SERIOUS BUSINESS

### COMES IN ALL SIZES.

Whatever your business need, OASIS has the operating system to match: 8-bit or 16-, single-user or the multi-user system that professionals tell us makes micros run like minis. And that's even truer now with new OASIS-16.\*\* (OASIS exact business fit #1: choice.)

## ANY SYSTEM IS ONLY

### AS GOOD AS THE

## BUSINESS

### PROGRAMS IT RUNS.

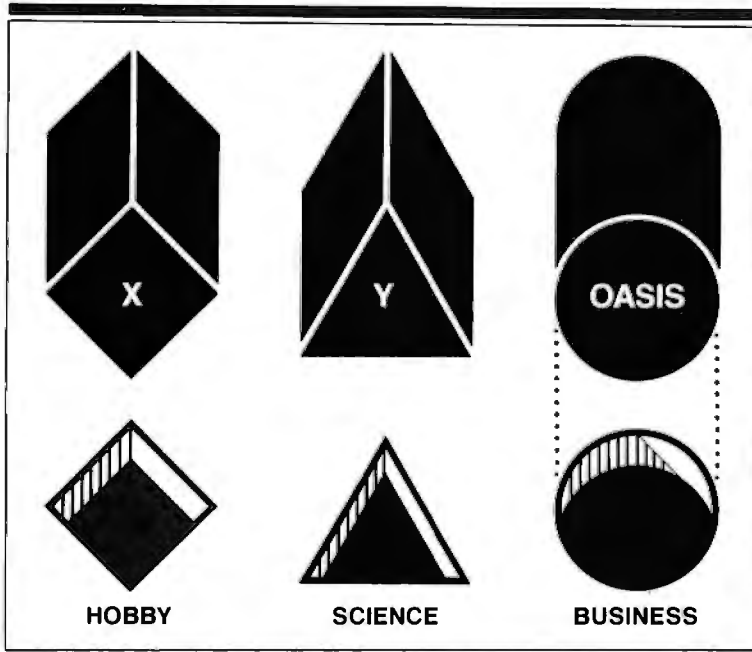

available, type 'HELP' and the command function title—OASIS displays the syntax and options available.

And it's all in your language—not computerese. (OASIS exact business fit #5: user-friendliness.)

## AND, AND, AND...

Some of the best, most extensive documentation in the industry; a packed Application Software Directory; multi-level training; direct telephone support; worldwide sales & service; options like CONTROL Relational Data Base Management System and MASTERPLAN Financial Modeling Package; OASIS has it all. (OASIS exact business fits #6 through #12.)

Now you know why there's no reason to struggle trying to put a square peg in a round hole. For serious business microcomputing,

The acid test for any business operating system is the application software available to run on it. There's plenty for OASIS—for nearly any job.

And it's top quality, too, because our integrated tools are top quality—and there are more of them. Like a high-level BASIC Interpreter/Compiler/Editor/Debugger; ISAM/Keyed/Direct/Sequential Files; a smart Print Spooler; Automatic Record Locking (OASIS exclusives!); plus COBOL & 'C' Languages. These tools are mandatory for high-quality business application program development—ask any developer. (OASIS exact business fit #2: high-quality application software.)

## PORTABILITY PROTECTS BUSINESS

### SOFTWARE INVESTMENTS.

OASIS is custom-fitted to manufacturers' hardware so application software developed to run on one OASIS equipped machine can also run on others—and is upwardly compatible from 8-bit OASIS Single-User to Multi-User, on up to OASIS-16. This kind of application software portability is exclusive with OASIS.

Device independence allows various printers and terminals to be used—with no modification to application

software: OASIS system software compensates for differences. (OASIS exact business fit #3: portability.)

## ACCURATE DATA & A SECURE SYSTEM REDUCE BUSINESS RISKS.

Data integrity—a challenge for any multi-user system—is insured by OASIS File & Automatic Record Locking. With it, normally all users can view a record at the same time. BUT, if the record is being updated by one user, other users are automatically denied access until the update is complete. That means data is always accurate and up-to-date. And it's still another OASIS exclusive.

For system security, there's OASIS Logon, Password & Privilege Level. User Accounting keeps track of who used the system, when. (OASIS exact business fit #4: data integrity/system security.)

## A FRIENDLY SYSTEM IS

### GOOD BUSINESS.

For user-friendliness, OASIS sets new standards. Example: the EXEC Job Control Language is so smart it walks users through their applications—and around the operating system.

With our 'HELP' feature, if you are unsure of the functions and options

there is one operating system that exactly fits: OASIS. Call or write us today for details.

\* For Z80.

\*\* For 8086, 68000, Z8000, LSI-11, & others.

# OASIS

STRICTLY BUSINESS

## PHASE ONE SYSTEMS, INC.

7700 Edgewater Drive, Suite 830  
Oakland, CA 94621-3051  
Telephone 415/562-8085 TWX 910-366-7139

I'm serious about my business—  
please send me:

- OASIS-16 Manual, \$75
- OASIS Manual, \$60
- Free Application Software Directory

and put me on your mailing list.  
(Add \$3 for shipping, California residents add sales tax.)

Name \_\_\_\_\_

St. (No Box #) \_\_\_\_\_

City \_\_\_\_\_ State \_\_\_\_\_ Zip \_\_\_\_\_

Check enclosed  UPS C.O.D.

VISA  Mastercharge

Card No. \_\_\_\_\_ Exp. date \_\_\_\_\_

Signature \_\_\_\_\_

NEWDOS/80 Version 2.0 Commands	Description	LC,(Y,N)	Enable or disable lowercase input (Model I).
		LCDVR	Load a lowercase drive routine (Model I).
APPEND,filespec1,filespec2	Append (attach) the text of filespec2 to the end of filespec1.	LIB	List the available commands.
ATTRIB,filespec,(options)	Change the protection status of filespec as specified by (options).	LIST,filespec,n1,n2	List on the screen the contents of filespec from line n1 to line n2.
AUTO,program/CMD	Executes the program with extension /CMD immediately on "booting" or powering up the system.	LOAD,filespec	Load a machine-language program with name filespec into memory.
BASIC2	Activate nondisk BASIC.	MDBORT	Exit the Mini-DOS to the operating system command level.
BLINK,(Y,N)	Enable or disable the flashing cursor.	MDCOPY,(options)	Perform a limited disk-data copy while in the Mini-DOS.
BOOT	Reboot the system.	MDRET	Return from Mini-DOS to execution of a program.
BREAK(Y,N)	Enable or disable the Break key.	PAUSE	During execution of a job-control-language task, pause and wait for the operator to press ENTER.
CHAIN,file/JCL	Execute a job-control-language instruction file.	PDRIVE,(options)	Specify the characteristics of the disk drives.
CHNON	Start or stop chaining during a job-control-language run.	PRINT,filespec	Same as LIST, but output goes to printer.
CLEAR	Clear user memory and some parameters.	PROT,(options)	Set the password and user protection for a disk.
CLOCK,(Y,N)	Continuously show the time in the upper right-hand corner of the screen.	PURGE,nn	List the files on drive h n and give the operator the option to delete or retain them.
CLS	Clear the screen.	R	Repeat the previously issued command.
COPY,(options)	Perform a wide variety of file-copying functions.	RENAME,filespec1,TO,filespec2	Change the name of a file from filespec1 to filespec2.
CREATE,filespec,(options)	Create a new file with specified characteristics.	ROUTE,(options)	Direct the output and input between devices (e.g., printer, keyboard, memory, RS-232C interface).
DATE,nn/nn/nn	Set or display the system date.	SETCOM,(options)	Set the status of the RS-232C interface (Model III).
DEBUG	Enter the debugging monitor; also accessed by simultaneously pressing "123."	STMT,(words)	Display a statement during execution of a job-control-language task.
dfg	When pressed simultaneously enters a limited version of DOS.	SYSTEM,(options)	Specify the characteristics of the operating system and the working environment.
DIR,(options)	Show a disk directory of files.	TIME,nn:nn:nn	Set or display the system time.
DO,file/JCL	See CHAIN.	VERIFY,(Y/N)	Require (or don't require) that everything written to disk from memory be checked.
DUMP,filespec,(options)	Dump memory to disk.	WRDIRP	Change the protection status of disk-directory sectors to enable cross-recognition of single-density disks between Models I and III.
ERROR,nn	Show the error message for error number n.		
FORMAT,nn,(options)	Format disk number nn using various options.		
FORMS,(options)	Set printer page length and width (Model III).		
FREE	Display free storage space on each disk drive.		
HIMEM,(number)	Set the top of user memory at (number) or HIMEM alone displays the top of user memory.		
jkl	When pressed simultaneously these keys will send screen contents to printer.		
KILL,filespec	Remove the specified file from disk.		

**Table 1:** NEWDOS/80 Version 2.0 commands. Many options give this system flexibility. The word filespec refers to a file name in the format name/ext:n, where ext is a three-letter extension and n is the drive number.

my configuration. Each pair of letters is followed by a Y or N that specifies whether an option should be used or not, or each pair is followed by a number that specifies options such as the number of drives in the system. The options are summarized in table 2. Notice the great flexibility this provides and the protection that may be given to files and programs.

PDRIVE is similar to SYSTEM, but it specifies the

characteristics of the system's drives. It allow great flexibility in intermixing different types of drives as well as for reading disks written on other drives. An example of PDRIVE 0 is shown in figure 2. Drive 0 is a 40-track double-density unit, while drives 1 and 2 are double-density double-sided 80-track units. In this configuration more than 1.5 megabytes of storage are available with three small floppy-disk drives.



# Distributed Microprocessing Local Area Network.



## Compare HiNet.™

The era of the local area network has arrived. What was once a quiet experiment has become today's computer phenomenon. And Digital Microsystems is proud to be among the few who recognized the network's potential long ago.

In fact, the HiNet Local Area Network is the first of its kind to be delivered. Just what you'd expect from Digital Microsystems—the first company to deliver microcomputer business systems, double density floppies, and Winchester hard disk systems.

Over 500 HiNet installations are already up and running in 16 countries. More are being added every month. Why? Because HiNet delivers power, flexibility and special features that network users demand.

For little more than the cost of a good typewriter HiNet gives a high performance microcomputer to each user—there's no central processor to overload. No big-computer backlogs either.

Compare HiNet's quality, reliability, design, and performance. Contact DMS today: 1840 Embarcadero, Oakland, CA 94606 (415) 532-3686. TWX: 910-366-7310 ... or DMS International in England & Europe: Extel House, East Harding St., London; EC4P-4HB 01-353-1081, Telex 23721.

**Digital**   
**Microsystems**

NOW WITH THOUSANDS OF INSTALLATIONS AROUND THE WORLD.

### **HINET IS COMPLETE HARDWARE AND SOFTWARE LOCAL AREA NETWORK TECHNOLOGY.**

HiNet builds 8 or 16 bit processors in single board or Multibus™ configurations with advanced memory management and data storage; high-speed local network data and telecommunications; real time processing redundancy and back-up capabilities; multi-level data security provisions; end-to-end diagnostics and automatic error correction routines; total CP/M® applications software compatibility; international support and comprehensive training. Specially dedicated stations: print spool, telex or voice store & forward, and graphics. For a catalog and complete specifications contact your local computer dealer or distributor.

Multibus is a trademark of Intel Corporation. CP/M is registered trademark of Digital Research.

Circle 158 on inquiry card.

SEE US AT NCC BOOTH #A749

SYSTEM Command Options	Description		
AA = yn	enable/disable passwords.	AU = yn	enable/disable repeat of input when key is held down
AB = yn	enable/disable a run-only mode	AV = nn	pause before repeat of key held down
AC = yn	enable/disable debounce for the Model I	AW = nn	number of disk-write and verify attempts allowed
AD = yn	enable/disable screen printing using command jkl	AX = nn	ASCII code of highest character allowed to printer
AE = yn	enable/disable DEBUG invocation with command 123	AY = yn	ask operator for date and time when power turned on?
AF = yn	enable/disable Mini-DOS invocation with command DFG	AZ = yn	ask operator for date and time after RESET?
AG = yn	enable/disable the Break key	BA = yn	allow system headers after reset?
AH = yn	not used	BB = yn	are clock interrupts at 50 or 60 microseconds (Model III)
AI = yn	enable/disable uppercase or lowercase (Model I)	BC = yn	can operator cancel or pause JCL chaining?
AJ = yn	enable/disable the keyboard intercept routine	BD = yn	can operator stop AUTO execution at reset?
AK = yn	not used	BE = yn	can the R command be used to repeat command?
AL = nn	specify the number of drives	BF = yn	enable/disable loading of lowercase driver at power-on (Model I)
AM = nn	the number of read attempts before an error is found	BG = yn	enable/disable shifted uppercase mode (Model I)
AN = nn	specifies which drive is searched for a directory on default	BH = yn	should the cursor blink?
AO = nn	default drive where a new file will be written	BI = nn	the ASCII value of the cursor character
AP = nn	highest unprotected memory address	BJ = nn	slow disk read/write when speed up modification is installed
AQ = yn	enable/disable the Clear key	BK = yn	enable/disable conversion between Model I and III single-density disks using WRDIRP or DIRCHECK
AR = yn	enable/disable COPY without password	BL	not used
AS = yn	change BASIC strings from lowercase to uppercase (Model I)	BM	not used
AT = yn	take single character JCL inputs from keyboard	BN = yn	use Model I (N) or Model III (Y) directory address protocol for Model I single density?

Table 2: SYSTEM command options. A yn indicates that a yes or no response is required; an nn requires a decimal number.

**USE YOUR PERSONAL COMPUTER!**

**Magic! FOR FUN AND PROFIT!**

**YOU CAN PLAY THE STOCK & BOND MARKETS WITH YOUR PERSONAL COMPUTER!** *New! One-of-a-kind 308 page illustrated Source Book can teach you how to use computers in the Investment Field. For Novice or Advanced Computer Hobbyists who want MORE from their machines and make money! Shows how to get started in Stock & Bond Markets PLUS how to use your computer as a data source for determining profitable stock selections, buy-sell decisions, market evaluations. Order #T1251 Delivered \$11.75*

\* SEND FOR "JUMBO" 94 PAGE "ALL SUBJECTS" CATALOG \$2. (REFUNDABLE WITH ORDER!) \*

**NEW! A TO Z BOOK OF COMPUTER GAMES! HOME 'N' OFFICE FUN-TO-MAKE PROJECTS!**  
*Tested, Ready-to-Run Programs with Adult & Kids Variations, Poker, Black Jack, Roulette, PLUS Gunners, Knights, Hot-Shot 'N' More! 308 Pages 73 Illust. Order T1026 Delivered \$9.75.*

**YOUR POCKET CALCULATOR NOW COMES ALIVE!**

HUNDREDS OF ADVANCED **NEW!** USES

STARTING TODAY!

**HANDBOOK JUST OFF THE PRESS!** 304 Pages, 275 Tables and Illust. Get NEW Horizons, Money Making Potentials, Time Saving, Problem Solving Answers to be found in those Marvelous Little Machines. Use with any Calculator! Order #T824 Delivered \$7.75.

**MONEY BACK GUARANTEE**

CHECK YOUR SELECTION ABOVE!

Check M.O.  VISA  MASTERCARD

# \_\_\_\_\_ Exp. \_\_\_\_\_

Name \_\_\_\_\_

Address \_\_\_\_\_

City \_\_\_\_\_ State \_\_\_\_\_ Zip \_\_\_\_\_

**CONSULTORS INT'L. BOX 6589 — BC DENVER, CO 80206**

PDRIVE parameters are summarized in table 3. Notice the flexibility. The parameters can be changed in the same way as the SYSTEM command's parameters and they can also be changed en bloc. In figure 2 the asterisks beside drives 0 through 2 indicate that they are actually physical drive units (the computer knows that because of the SYSTEM option AL specification). Drives 3 through 9 do not exist; those are dummy specifications. However, if you type PDRIVE 0,1=3,A, drive 1 will accept a disk written on a 35-track single-density drive (the dummy specification for drive 3). Parameter A tells the TRS-80 to make the change immediately; otherwise, you would have to reboot the system. Thus, the TRS-80 thinks that drive 1 is a 35-track single-density unit. Disks written on a Model III can be accessed in this way by a Model I and vice versa. Of course, you need a double-density modification (on a Model I) to read double-density disks, and to read 80-track disks you need 80-track drives. In other words, you can "retrogress"; you can access disks created on a less sophisticated system, but a 35-track drive cannot read 40- or 80-track disks. Another point is that 80-track drives skip a track when reading 40-track disks. Although it is possible to write 40-track disks using an 80-track drive, the result will not be reliably read by a 40-track drive. Therefore, it's not a good idea to convert all of your drives to 80-track units.

The meaning of most of the commands should be clear, from table 1, but some are quite complex. For example,



# Why wait?

## Announcing the mbp COBOL Compiler for CP /M86\*... available now.



Recently, 16-bit microcomputers have been the big news. And here's more news just as big: the mbp COBOL Compiler for 16-bit systems. Not a 'sometime-in-the-future' product, it's here now—we're already delivering.

For commercial and administrative applications, COBOL has long been recognized as the language. It's standardized and maintained like no other language—witness its popularity on mainframes for the last twenty years. Now, as 16-bit micros grow in popularity, so will COBOL. How can it miss? For business micro users, it opens up a whole range of benefits that previously only mainframe and mini users enjoyed. For application software developers, it's a completely new market—for dealers, too.

The mbp COBOL Compiler's fine features include: meets ANSI 74 Standard (low intermediate), certification applied for • real executable machine code—run-time efficient, memory efficient • use-proven reliability • user-friendly (example: over 500 error messages) • maximum portability protects software investments.

And it's available now for CP/M-86, iRMX-86\*, and ISIS\*; available soon for OASIS-16\* and MS-DOS\*.

Who is mbp? We're a worldwide company with more than twenty-five years of system software experience—more than twelve in custom COBOL Compiler installations for mainframes and minis. Now, this vast experience is also available to micro users. Take advantage of it—send the coupon or call today and start getting mainframe capabilities from your CP/M-86 micro. Why wait?

## mbp SOFTWARE AND SYSTEMS TECHNOLOGY INC.

7700 Edgewater Drive, Suite 626 B  
Oakland, California 94621  
Phone 415/632-1555

mbp COBOL is what I've been waiting for.  
Please send me today:

### Special introductory offer

- mbp COBOL for CP/M-86 at single copy special introductory price of **\$990.** (User's Manual included. Offer expires June 30, 1982 when retail price will become \$1400.)
- mbp COBOL User's Manual only, **\$95.**
- Complete mbp COBOL information.
- Please have a representative contact me with information about OEM and distributor arrangements.



Name \_\_\_\_\_

Title \_\_\_\_\_

Company \_\_\_\_\_

Street (no PO Box numbers) \_\_\_\_\_

City \_\_\_\_\_ State \_\_\_\_\_ Zip \_\_\_\_\_

- Check enclosed       VISA
  - UPS C.O.D.             Mastercharge
- (Add \$3 for shipping. California residents add sales tax.)

Card Number \_\_\_\_\_ Exp. date \_\_\_\_\_

Signature \_\_\_\_\_

Hardware required: 96K memory, hard disk, 8-inch floppy.  
\*CP/M-86 is a Digital Research trademark; iRMX-86 and ISIS are Intel TMs; OASIS-16 is a Phase One Systems, Inc. TM; MS-DOS is a Microsoft, Inc. TM.

See us at  
**COMDEX**  
Booth 1467

**mbp COBOL. Now.**

```
AA=N,AB=N,AC=Y,AD=Y,AE=Y,AF=Y,AG=N,AI=Y,AJ=Y,AL=3/3H,AM=10/AH,AN
=1/1H,AO=1/1H,AP=0/0H,AQ=Y,AR=N,AS=Y,AT=Y,AU=Y,AV=30/1EH,AW=2/2H
,AX=90/5AH,AY=Y,AZ=N,BA=N,BC=Y,BD=Y,BE=Y,BF=N,BG=N,BH=Y,BI=127/7
FH,BJ=1/1H,BK=Y,BM=N,BN=N
```

NEWDOS/80 READY

**Figure 1:** SYSTEM command display. This screen shows the result of entering the command SYSTEM 0.

```
PDRIVE 0
0* TI=CK,TD=E,TC=39,SPT=18,TSR=0,GPL=2,DDSL=17,DDGA=2
1* TI=CK,TD=G,TC=79,SPT=36,TSR=0,GPL=8,DDSL=35,DDGA=6
2* TI=CK,TD=G,TC=79,SPT=36,TSR=0,GPL=8,DDSL=35,DDGA=6
3 TI=AL,TD=A,TC=35,SPT=10,TSR=3,GPL=2,DDSL=17,DDGA=2
4 TI=CKL,TD=E,TC=39,SPT=18,TSR=3,GPL=2,DDSL=17,DDGA=2
5 TI=A,TD=A,TC=35,SPT=10,TSR=3,GPL=2,DDSL=17,DDGA=2
6 TI=CKL,TD=E,TC=39,SPT=18,TSR=3,GPL=2,DDSL=17,DDGA=2
7 TI=A,TD=C,TC=80,SPT=20,TSR=0,GPL=8,DDSL=20,DDGA=6
8 TI=A,TD=C,TC=80,SPT=20,TSR=0,GPL=4,DDSL=17,DDGA=6
9 TI=CK,TD=G,TC=79,SPT=36,TSR=0,GPL=8,DDSL=35,DDGA=6
```

NEWDOS/80 READY

**Figure 2:** PDRIVE command display. This screen shows the result of entering the command PDRIVE 0.

ATTRIB changes the protection "attributes" of a file. It has the form:

ATTRIB,filespec,(options)

The options are shown in table 4. In general, this command regulates who can access the file. I find that I have little use for this command, since all my files are open. However, I have written some teaching programs that I don't want students to see or modify. ATTRIB provides the needed security.

The CHAIN and DO commands both perform the same function. They execute a file of commands, instructions, or statements as if the instructions came from the keyboard. DO and CHAIN provide a powerful feature known as a JCL (job control language). With JCL, the computer will automatically execute a task without user input. The command file must have the suffix /JCL. The files can be written with the CHAINBLD program supplied with V2, or by using Scripsit, Electric Pencil, or other text editors.

A very simple job-control-language file, ENHBAS/JCL, is shown in listing 1. If the command AUTO DO ENHBAS or AUTO CHAIN ENHBAS has been entered beforehand, each time the system is booted the program ENHBAS/CMD, which calls an enhancement of disk BASIC, will be executed, a variety of byte values will be entered in memory, and the system will return to the DOS command level. Without prior use of the AUTO command, the same sequence will take place if you type DO ENHBAS or CHAIN ENHBAS. Some commands are used mostly from within a /JCL file: CHNON will stop the job so that input from the keyboard will be accepted; PAUSE will stop chaining, display a message, and wait for the operator to press ENTER; STMT will display a message to the screen. Otherwise, a /JCL file will use commands, statements, and so on that are recognized by

PDRIVE Command Options	Description
TI = LL	Types of drive interfaces and their specifications. A combination of letters may be used: <ul style="list-style-type: none"> <li>A) TRS-80 standard</li> <li>B) Omikron mapper interface (Model I)</li> <li>C) Percom doubler with TRS-80 interface (Model I)</li> <li>D) Apparat disk controller (Model III)</li> <li>E) LNW interface (Model I)</li> <li>H) head settle delay?</li> <li>I) lowest sector is 1; Model III TRSDOS specifications</li> <li>J) tracks start at 1; not normally used</li> <li>K) format of track 0 density opposite to the rest of disk. Needed for system disks when using double density on Model I or single density on Model III. Model I reads the BOOT data in track 0 in single density; Model III does the opposite.</li> <li>L) two step-pulses between tracks: lets 40-track disks be read on 80-track drives</li> <li>M) disks are from Model III TRSDOS</li> <li>F-G) reserved for future use</li> </ul>
TD = nn	specifies single- or double-density, single- or double-sided 5 1/4- or 8-inch drives
TC = nn	number of tracks on disk
SPT = nn	number of sectors per track
TSR = nn	rate of stepping between tracks
GPL = nn	granules per lump
DDSL = nn	specify location of directory
DDGA = nn	disk area allocated for directory

**Table 3:** PDRIVE command options. The LL indicates that a letter must be entered.

ATTRIB Command Options	Description
INV	makes the files invisible
VIS	makes invisible files visible
PROT = nn	specifies protection or access level of the file: <ul style="list-style-type: none"> <li>7) LOCK no access allowed</li> <li>6) EXEC execute only; no reading or changes</li> <li>5) READ read and execute; no editing or changes</li> <li>4) WRITE read, execute, or change; no name changes</li> <li>3) not used</li> <li>2) NAME read, execute, change, or rename, do not delete</li> <li>1) KILL complete access, including removal</li> <li>0) FULL total and complete access</li> </ul>
ACC = pwd	specify the password that allows access
UPD = pwd	specify the password for changing the file
ASE = yn	can the allocated file space be increased?
ASC = yn	can the allocated files space be decreased?
UDF = yn	mark the file as updated or not

**Table 4:** ATTRIB command options. The pwd indicates that a password is required.



# 16 Bit 8086 Multi-User Microcomputer System

**\$7595**  
**FOUR**  
**USER**  
**SYSTEM**

FOR **MP/M-86™**

**ONLY**  
**\$1899\***  
**PER**  
**USER**

THE  
**TEC 86M**



**1/2 MEGABYTE**  
**OF MEMORY**  
**TWO 8 INCH D.D.**  
**FLOPPY DISKS**

## STANDARD FEATURES

- 16 BIT 8086 CPU** - Processor performance is the most critical element in a Multi-User System. Speed, power and the increased throughput of our 16 Bit 8086 CPU are just a few of the reasons why our TEC 86M Multi-User Systems really perform.
- 1/2 MEGABYTE OF MEMORY** - The second most important factor which affects system performance is available user memory. Our 1/2 Megabyte, four user system gives each user well over 100K Bytes of memory, eliminating program size compromises which lead to poor Multi-User system performance.
- MP/M-86™ COMPATIBILITY** - The TEC 86M includes a ROM Boot for MP/M-86™ and is designed to provide optimal support for MP/M-86™. The MP/M-86™ Operating System is available separately from Tecmar for \$600. See Software Options listed below for important MP/M-86™ features.
- FULLY INTERRUPT DRIVEN** - The TEC 86M provides terminal and disk I/O interrupts to MP/M-86™, allowing for maximum system performance in Multi-User operation.
- TWO 8 INCH DOUBLE DENSITY FLOPPY DISK DRIVES** - The two Double Density floppy disks total 1.2 Megabytes of storage. Options include double sided floppy disk drives and Winchester drives.
- FOUR SERIAL USER PORTS** - Four serial user ports are provided. Each port can be independently set for speeds from 50 to 19200 Baud.
- MULTIPLE PARALLEL PORTS** - Parallel ports are provided for operating printers as well as other parallel devices.
- EASILY EXPANDABLE** - The modular design of the Tec 86 and Tec 86M assures you of continued system expandability. All options are easily field installable. Available options include: Memory 64K and 256K, additional users, double sided floppy disks, Winchester 31 Megabyte hard disk, terminals, and printers.
- ATTRACTIVE DESKTOP ENCLOSURE** - Tecmar Single and Multi-User systems come in your choice of an attractive desk top enclosure with wood grained side panels to blend nicely into your office surroundings, or an industrial quality cabinet for more hostile environments. Rack mount enclosures are available as options.
- ONE YEAR WARRANTY** - Tecmar Systems are fully assembled and thoroughly tested. All Tecmar Components carry a full One Year Warranty.

## SOFTWARE OPTIONS

- MP/M-86™** - Multi-User interrupt driven Operating System for the 16 Bit 8086 TEC 86M Microcomputer System. FILE PASSWORD PROTECTION - Access to user files can be restricted to require proper passwords prior to access. CONCURRENT FILE ACCESS - Files may be accessed by multiple users, each reading and/or writing the same file, with protection provided at both the file and the record level. FILE TIME AND DATE STAMPING - Files contain creation, and modification Times and Dates for ease and accuracy in determining the latest or most useful file versions. PRINT SPOOLER - Files may be submitted to the System Spool file for printing. This frees the user terminal to continue operation during the independent printing function.
- LANGUAGES** - BASIC-86™ FORTRAN-86™ PASCAL-86™ CBASIC/86™ CIS-COBOL™ PASCAL/M86™ FORTH  
\*NOT INCLUDING MP/M-86 and User Terminals.

## OTHER FINE S100 and APPLE PRODUCTS AVAILABLE, INCLUDING:

- ANALOG to DIGITAL CONVERTERS** (12, 14, 16 bit accuracy; 30, 40, 100, 125 KHz Conversion rates; 16 to 256 Channels; programmable gain; timer/counters). **DIGITAL to ANALOG CONVERTERS** (12 bit accuracy, 3 microsecond conversion rate). 8086 CPU Board, I/O Boards 64K/256K Memory Boards, Real-time Video Digitizer and Display. Complete Systems also available for Data Acquisition, Video Digitization, and General Purpose Applications.

REQUEST OUR CATALOG FOR COMPLETE LISTING, AND SPECIFICATIONS ON THE ENTIRE TECMAR PRODUCT LINE.

**TECMAR**  
INC. →

DEALER INQUIRIES INVITED

23600 Mercantile Rd. • Cleveland, OH 44122

**TECMAR, INC.**

**(216) 464-7410**

CP/M-86 and MP/M-86 are registered trademarks of Digital Research Inc. BASIC-86, FORTRAN-86 and PASCAL-86 are registered trademarks of Microsoft Inc. PASCAL/M86 is a registered trademark of SOCRIM. CBASIC/86 is a registered trademark of Compiler Systems Inc. CIS-COBOL is a registered trademark of Microfocus Inc. CANADA: Our Ontario Distributor is OCTANT COMPUTER SERVICES INC., 146 Front Street West, Suite 485, Toronto, Ontario M5J 2L7 (416) 598-1046

# Daisy Wheel Printer.

# \$ 695

## Smith-Corona® TP-1™



SAVE \$200.00

SUGGESTED RETAIL \$895.00

- Letter Quality Printing
  - Centronics Type Parallel Interface Connects To TRS-80 & Other Microcomputers
  - Serial Interface Available
  - Compatible With Most Microcomputers
  - Full Form Characters 10 or 12 Pitch
- \*Manufactured By A Name You Can Trust\*

**SCM** SMITH-CORONA

**MICRO MANAGEMENT SYSTEMS, INC.**

PARCEL DIVISION - DEPT. NO. 1 TP  
2803 THOMASVILLE ROAD  
CAIRO, GEORGIA 31728

**800-841-0856**

GA. & INFO 1-912-377-7120

**Listing 1:** A job-control-language file that first enters ENHBAS, specifies certain control parameters (the two POKES), defines the printer line width at 132, and exits BASIC to the disk operating system.

```
ENHBAS
POKE 16409,1
POKE 16419,127
CLM=132
CMD"S"
```

the system. For example, listing 1 could be followed with instructions to reenter BASIC, load a program, execute the program, make certain entries, and turn operation over to the user. This is useful for teaching programs where the student should not have to remember all of the details for initializing a program. In general, nearly anything that can be executed from the keyboard can be executed from a /JCL file.

COPY is V2's most complex command. It can be used to copy single files, several files from one disk to another, or everything on a disk. It also incorporates the function of formatting disks and it replaces the BACKUP function in TRSDOS and other systems. Additionally, COPY has a number of options that allow various types of drives to be used and allow copying on a single drive. It will be the first command you will use because it must be drawn on to produce copies of the source disk. COPY has six different formats. The simplest is:

COPY FILE1/FIL:1 TO FILE2/FIL:2

which will copy FILE1/FIL from drive 1 to FILE2/FIL on drive 2. An example of the general format for copying several files or a whole disk from one drive to another is:

COPY 1 TO 2,date,(options)

The date can be left out (the commas must remain), in which case the present date is put on the new disk. The option FMT will format the disk and produce a complete backup from drive 1 to drive 2; CBF will specify that the files be copied one by one; NFMT will not format the disk first. There are several other important options. For example, CFWD lets the user specify which files will be copied.

Disks from "foreign" systems can be copied, and, if you buy a Model III with the intention of transferring files from an old Model I system, the COPY command will do the job. If you have a more sophisticated system, say double-density double-sided drives and so on, your first use of COPY to backup the V2 disk could be difficult. Careful reading of the manual and use of the examples, however, will make it possible.

The command CREATE, new to V2, allows creation of



# YOUR COMPUTER HEADQUARTERS

apple®

## SUPER SPECIAL!

### THE NEW APPLE III

- Apple III plus 128K
- Apple III SOS package
- 12" High Resolution Green Monitor

\$2999<sup>00</sup>

## THE HOME ACCOUNTANT PACKAGE

- Apple II plus 48K
- Apple II Disc Drive w/ DOS 3.3
- 12" High Resolution Green Monitor
- The Home Accountant

\$1934<sup>00</sup>

## WORD PROCESSOR SYSTEM

- Apple II plus 48K
- Apple Disc Drive II w/DOS 3.3
- 12" High Resolution Monitor
- OKIDATA Microline 80 Printer
- Printer cable w/interface
- IUS Orig. Easywriter

\$2399<sup>00</sup>

## ACCESSORIES FOR APPLE

- Videx Videoterm - 80 Col. \$269<sup>00</sup>
- Videx Keyboard Enhancer II . . . \$119<sup>00</sup>
- DC Hayes Micromodem II \$289<sup>00</sup>
- Microsoft Z-80 CP/M Card \$289<sup>00</sup>
- Microsoft 16K Ram Card . . . \$159<sup>00</sup>
- Saturn 32K Ram Card . . . \$199<sup>00</sup>
- VC Expand for Saturn Card \$84<sup>00</sup>
- Mountain CPS Multifunction Card . . . \$179<sup>00</sup>
- Mountain Clock . . . \$239<sup>00</sup>
- Keyboard Company Numeric Keypad . . . \$135<sup>00</sup>
- Apple Pascal . . . \$209<sup>00</sup>
- Apple High Speed Serial Interface . . . \$158<sup>00</sup>
- Dan Paymar Lower Case Chip . . . \$39<sup>00</sup>
- System Saverpan with Line Search Suppression . . . \$74<sup>00</sup>
- Apple Graphics, Tablet \$649<sup>00</sup>
- Verawriter Graphic Tablet \$249<sup>00</sup>
- Special! Game Paddles . . . \$19<sup>00</sup>

## WORD PROCESSORS

- IUS - Pro Easywriter . . . \$149<sup>00</sup>
- IUS - Pro Easywriter . . . \$119<sup>00</sup>
- Orig. Easywriter . . . \$79<sup>00</sup>
- Apple Pie (W/P 40 Col.) . . . \$104<sup>00</sup>
- LJK Letter Perfect . . . \$129<sup>00</sup>
- Supertext II . . . \$129<sup>00</sup>
- Screenwriter (70 Col.) . . . \$104<sup>00</sup>
- Executive Secretary . . . \$199<sup>00</sup>
- Magic Window . . . \$84<sup>00</sup>

## PRACTICAL PERIPHERALS

- Micro Buffer II 16K . . . \$214<sup>00</sup>
- Micro Buffer II 32K . . . \$249<sup>00</sup>

Don't tie up your computer while your printer is printing!

## FOR EPSON ONLY

- Micro Buffer Parallel 16K \$135<sup>00</sup>
- Micro Buffer Serial 8K . . . \$135<sup>00</sup>

## SOFTWARE FOR APPLE

- Fortran 80 . . . \$154<sup>00</sup>
- A.L.D.S. . . . \$99<sup>00</sup>
- Basic Compiler . . . \$295<sup>00</sup>
- Tasc Compiler . . . \$149<sup>00</sup>
- Cobol - 80 . . . \$595<sup>00</sup>
- Context Connector . . . \$145<sup>00</sup>

## USA

- Apple World . . . \$49<sup>00</sup>
- 3D Super Graphics . . . \$33<sup>00</sup>

## SENSIBLE

- The Apple Spaller . . . \$59<sup>00</sup>
- Wordstar 3.0 . . . \$269<sup>00</sup>
- Spell Star . . . \$169<sup>00</sup>
- Mail Merge . . . \$94<sup>00</sup>
- Super Sort-1 . . . \$139<sup>00</sup>

## MICROLAB

- Data Factory . . . \$119<sup>00</sup>
- Invoice Factory . . . \$159<sup>00</sup>
- Tax Manager . . . \$119<sup>00</sup>

## HOWARD SOFTWARE

- Tax Preparer New 1982 . . . \$119<sup>00</sup>
- NEW! Real Estate Analyzer 2nd Addition . . . \$149<sup>00</sup>

## PERSONAL SOFTWARE

- Visicalc 3.3 . . . \$199<sup>00</sup>
- Visiplot . . . \$159<sup>00</sup>
- Visidex . . . \$149<sup>00</sup>
- Visitrend/Visiplot . . . \$239<sup>00</sup>
- Visitem . . . \$79<sup>00</sup>
- Visifile . . . \$199<sup>00</sup>
- Desktop Plan II . . . \$199<sup>00</sup>
- Desktop Plan III . . . \$253<sup>00</sup>

## THE SOURCE

- Telecommunication . . . \$89<sup>00</sup>

## AARDVARK

- Personal Tax Plan . . . \$104<sup>00</sup>
- Individual Tax Plan . . . \$199<sup>00</sup>

## SYSTEM PLUS

- Accounting Plus II . . . \$119<sup>00</sup>

## ASHTON TATE

- DBase II . . . \$524<sup>00</sup>

## HIGH TECHNOLOGY

- Info. Master . . . \$119<sup>00</sup>
- Store Manager . . . \$199<sup>00</sup>
- Data Master . . . \$79<sup>00</sup>
- Job Control System . . . \$595<sup>00</sup>
- Client Billing System . . . \$279<sup>00</sup>

## SOUTHEASTERN SOFTWARE

- Data Capture 4.0 40 Col. \$49<sup>00</sup>
- Data Capture 4.0 80 Videx. \$69<sup>00</sup>

## SOFTWARE PUBLISHING

- PFS New! . . . \$97<sup>00</sup>
- PFS Report New! . . . \$97<sup>00</sup>

## PHOENIX SOFTWARE

- Zoom Graphics . . . \$34<sup>00</sup>

## Master Diagnostic

(Formerly Brain Surgeon) \$42<sup>00</sup>

## STONEWARE

- DB Master Vers. 3 . . . \$179<sup>00</sup>
- Utility Pack I . . . \$89<sup>00</sup>
- Z-Term (CP/M) . . . \$99<sup>00</sup>
- ASC II Express 3.3 . . . \$65<sup>00</sup>
- Brodebound Payroll . . . \$299<sup>00</sup>

## GAME AND HOBBY

- Temple of Asphal . . . \$32<sup>00</sup>
- Hellfire Warrior . . . \$32<sup>00</sup>
- Rescue at Rigel . . . \$24<sup>00</sup>
- Crush, Crumple & Chomp . . . \$24<sup>00</sup>
- Jabber Talky . . . \$24<sup>00</sup>
- Major League Baseball . . . \$24<sup>00</sup>
- Alien Rain . . . \$21<sup>00</sup>
- Apple Panic . . . \$24<sup>00</sup>
- Snack Attack . . . \$24<sup>00</sup>
- Joy Breaker . . . \$24<sup>00</sup>
- Space Quarks . . . \$24<sup>00</sup>
- Genetic Drift . . . \$24<sup>00</sup>
- Red Alert . . . \$24<sup>00</sup>
- Ultima . . . \$32<sup>00</sup>
- Star Thief . . . \$24<sup>00</sup>
- Bug Attack . . . \$24<sup>00</sup>
- Sargon II . . . \$30<sup>00</sup>
- Pool 1.5 . . . \$30<sup>00</sup>
- Shuffle Board . . . \$24<sup>00</sup>
- Trick Shot . . . \$24<sup>00</sup>
- Dog Fight . . . \$24<sup>00</sup>
- Olympic Decathlon . . . \$32<sup>00</sup>
- Three Mile Island . . . \$24<sup>00</sup>
- ABM . . . \$24<sup>00</sup>
- Robot War . . . \$24<sup>00</sup>
- Castle Wolfenstein . . . \$32<sup>00</sup>
- Zork . . . \$32<sup>00</sup>
- Falcons . . . \$24<sup>00</sup>
- Beer Run . . . \$30<sup>00</sup>
- Raster Blaster . . . \$24<sup>00</sup>
- Space Eggs . . . \$32<sup>00</sup>
- Gorgon . . . \$30<sup>00</sup>
- Cops and Robbers . . . \$32<sup>00</sup>
- Tigers in the Snow . . . \$32<sup>00</sup>
- The Battle of Shiloh . . . \$32<sup>00</sup>
- The Shattered Alliance . . . \$48<sup>00</sup>
- Computer Baseball . . . \$32<sup>00</sup>
- Computer Quarterback . . . \$32<sup>00</sup>
- Sneakers . . . \$24<sup>00</sup>
- TG Joystick . . . \$48<sup>00</sup>
- TG Game Paddles . . . \$34<sup>00</sup>
- NEW! LOGO for Apple . . . \$149<sup>00</sup>

apple®

## THE COMMUNICATOR PACKAGE

- Apple II plus 48K
- Apple Disc Drive II w/controller DOS 3.3
- DC Hayes Micromodem II
- 12" Green Monitor
- Source Telecommunication

\$2255<sup>00</sup>

## BUSINESSMAN'S SPECIAL

- Apple II plus 48K
- Apple Disc Drive II w/interface DOS 3.3
- 12" High Resolution Green Monitor
- Visicalc 3.3 Software

\$2074<sup>00</sup>

## THE FAMILY SYSTEM NOW ONLY \$2099<sup>00</sup>

- Fits Apple & 2 Disc Drives
- Detachable Cover \$65<sup>95</sup>

Apple is a registered trademark of Apple Computer Inc.

VP-3501 Videotex Data Terminal  
Turn your home TV into a time-sharing videotex display.



Only \$359<sup>00</sup>

## \* SHARP MINI COMPUTERS \*

- PC-1500 LED POCKET COMPUTER  
Extended BASIC system capable of 2 dimens. arrays. Full graphic commands.  
Now Only \$249<sup>95</sup>
- PC-1211 POCKET COMPUTER  
Formidable computing power. Programmable with BASIC language. 24 digit LCD.  
Now Only \$139<sup>95</sup>

## CE-122 16-DIGIT MINI DOT PRINTER

- Print out program & program performance CASSETTE INTERFACE: Saves data or programs on cassette tape. Search saved data by file name. Now Only \$104<sup>95</sup>
- CE-150 Color Graphics Printer with Cassette Interface . . . \$214.95
- 4K and 8K Memory Expansion IN STOCK!

## PRINTERS

- GRAPPLER Graphic Inter/Cable . . . \$139.95
- OKIDATA 82A 120 CPS, Bidirectional, Friction and Tractor Feed, Serial & Parallel, 80/132 Columns . . . \$474.95
- OKIDATA 83A 120 CPS, Bidirectional, Friction & Tractor, 136 Col. Serial & Parallel, Takes 15" Paper . . . \$719.95
- Tractor Feed, (optional) . . . \$4.95
- OKIDATA OKIGRAPH™ Create illustrations, Graphs, Charts or whatever a CRT screen tells it to . . . \$69.95
- CENTRONICS 739-I Graphics, 100 CPS Monospaced Mode, Right Justification, Friction and Tractor . . . \$514.95
- XEROX Diablo 630 with word processing enhancement . . . \$2299.95
- Bi-directional Tractor (optional) . . . \$204.95
- NEW! C.I.TOH F10-40 Parallel, Daisy Wheel, Letter Quality Printer . . . \$1549.95
- C.I.TOH 8510 Pro Writer, 120 CPS, 136 Columns, Parallel, Bidirectional, F/T, High Resolution Graphics . . . \$509.95
- NEC 8023 Pro Writer, 100 CPS, 136 Col. Parallel, Bidirectional, Tractor and Friction, High Resolution Graphics . . . \$484.95
- ★ ★ EPSON ★ ★ ★
- MX-80 . . . \$449.95
- MX-80FT . . . \$549.95
- MX-100FT . . . \$719.95

## commodore

VIC 20 COMPUTER w/RF Modulator



## PRICED TOO LOW TO PRINT

- 8K Memory Expansion . . . \$3.95
- Phone Modem w/VIC by Bizcom . . . \$39.95
- DATA CORDER (II Cass. Prog.) . . . \$69.95
- Jupiter Landers (cart.) . . . \$24.95
- Super Alien (cart.) . . . \$24.95
- Midnight Driver (cart.) . . . \$24.95
- Household Finance (cass.) . . . \$29.95
- Car Cost (cass.) . . . \$13.95
- Loan Analyzer (cass.) . . . \$13.95
- Amok (cass.) . . . \$15.95
- Alien Blitz (cass.) . . . \$20.95
- VT 106A 6 Pk. Recreational Prog. . . \$49.95
- Super Expender . . . \$57.95
- Snackman . . . \$14.95

## QUANTAM DATA

- RS 232 Interface . . . \$47.95
- 24K Memory . . . \$179.95
- Amok . . . \$20.95
- Household Finance . . . \$29.95
- Home Inventory . . . \$13.95

## Texas Instruments



## TI 99/4A COMPUTER

- NEW LOW PRICE \$329<sup>95</sup>
- FREE! RF Modulator with purchase of TI 99/4A
- TI LOGO PHM 3040 . . . \$89<sup>95</sup>

Full line of hardware, software and accessories in stock!

## ATARI

- ATARI 800 w/16K . . . \$699<sup>95</sup>
- ATARI 400 . . . \$329<sup>00</sup>
- 810 Disc Drive . . . \$459<sup>95</sup>
- 850 Interface . . . \$179<sup>95</sup>
- 410 Programmable Recorder . . . \$79<sup>95</sup>
- Ax Lon 32K Ram . . . \$134<sup>95</sup>

POPULAR ATARI GAMES IN STOCK!

## hp HEWLETT PACKARD



## A Complete Computer System in One Small Package.

The HP-85A is a powerful BASIC language computer, complete with keyboard, CRT display, printer and disc drive all in one self contained 20 lb. unit.

Now Low Price \$1982<sup>00</sup>

- Special! HP-83 (Ltd. Qty.) . . . \$1295<sup>00</sup>
- New! HP-87A . . . Only \$1885<sup>00</sup>
- 32K and 64K Memory Expansion Modules for HP-87 In Stock!
- HP-125 Reg. \$2750 . . . Only \$1982<sup>00</sup>
- HP 82091 M 5 1/4" Disc Drive . . . \$1650<sup>00</sup>
- HP 82905 Serial Printer . . . \$595<sup>00</sup>

We carry the full line of TI and HP Programmable Calculators.

47st photo  
Cameras - Electronics - Audio - Video - Computers - Darkroom - Accessories  
67 West 47th Street, New York, N.Y. 10036  
115 West 45th Street, New York, N.Y. 10036  
MAIL ORDER ADDRESS: 36 E. 19th St. New York, N.Y. 10003

CORPORATE ACCOUNTS WELCOME (212) 260-4410  
TOLL FREE OUT-OF-STATE  
800-221-7774  
800-221-5858  
800-223-5661

Items on sale for limited time only, and are subject to limited availability. Not responsible for typographical errors. This ad supersedes all other ads prior to June '82. Prices effective as of April 23, 1982, and are subject to change without notice. All orders subject to verification and acceptance. Minimum shipping and handling \$4.95

**Listing 2: NEWDOS/80 Version 2.0 directory.** If the command `DIR S, I, A, P` is entered, the following information is provided: file name, number of full sectors, number of bytes in the last sector, the logical record length, number of logical records in the file, number of granules, and the number of extensions used.

```

DRIVE 0 NEWDOS80 08/04/81 35 TRKS 29 FDES 1 GRANS
      EOF LRL RECS GRANS EXTS SIUEC.....UAL
BOOT/SYS 5/000 256 5 1 1 SI.....UA6
SYS6/SYS 35/000 256 35 7 1 SIU.....UA7
SYS14/SYS 5/000 256 5 1 1 SIU.....UA7
BASIC/CMD 18/000 256 18 4 1 .IU.....U.6
DIR/SYS 10/000 256 10 2 1 SI.....UA5
SYS7/SYS 5/000 256 5 1 1 SIU.....UA7
SYS15/SYS 5/000 256 5 1 1 SIU.....UA7
NWD80V2/XLF 2/054 256 3 1 1 ..U.....0
SYS0/SYS 15/000 256 15 3 1 SIU.....UA7
SYS8/SYS 5/000 256 5 1 1 SIU.....UA7
SYS16/SYS 5/000 256 5 1 1 SIU.....UA7
CHAINST/JCL 1/050 256 2 1 1 ..U.....0
NWD80V2/ILF 2/002 256 3 1 1 ..U.....0
SYS1/SYS 5/000 256 5 1 1 SIU.....UA7
SYS9/SYS 5/000 256 5 1 1 SIU.....UA7
SYS17/SYS 5/000 256 5 1 1 SIU.....UA7
ASPOOL/MAS 10/000 256 10 2 1 ..U.....0
CHAINBLD/BAS 19/059 256 20 4 1 ..U.....0
SYS2/SYS 5/000 256 5 1 1 SIU.....UA7
SYS10/SYS 5/000 256 5 1 1 SIU.....UA7
SYS18/SYS 5/000 256 5 1 1 SIU.....UA7
LMOFFSET/CMD 10/000 256 10 2 1 ..U.....0
SYS3/SYS 5/000 256 5 1 1 SIU.....UA7
SYS11/SYS 5/000 256 5 1 1 SIU.....UA7
SYS19/SYS 5/000 256 5 1 1 SIU.....UA7
SYS4/SYS 5/000 256 5 1 1 SIU.....UA7
SYS12/SYS 5/000 256 5 1 1 SIU.....UA7
SYS20/SYS 5/000 256 5 1 1 SIU.....UA7
DISASSEM/CMD 25/000 256 25 5 1 ..U.....0
DIRCHECK/CMD 15/000 256 15 3 1 ..U.....0
EDTASM/CMD 35/000 256 35 7 1 ..U.....0
SYS5/SYS 5/000 256 5 1 1 SIU.....UA7
SYS13/SYS 5/000 256 5 1 1 SIU.....UA7
SYS21/SYS 5/000 256 5 1 1 SIU.....UA7
SUPERZAP/CMD 30/000 256 30 6 1 ..U.....0

```

an empty, blank file, but with specified attributes and length. Generally it has the form:

`CREATE,filespec,(options)`

where the options control the record count for the file, the record length, specify whether the file length can be automatically extended, and whether unused file length can be cleared. Sometimes a user program expects a file to exist already or requires pre-allocated file space; `CREATE` allows that possibility.

The `DEBUG` command enters the system's debugging and monitor utility. Suffice to say, the original TRSDOS `DEBUG` has been praised by reviewers as an excellent piece of software, and Apparatus's version is much better. One brief point, `DEBUG` can be entered from within a program by simultaneously typing "123."

`DIR`, available in all operating systems for the TRS-80, displays a directory of the files on a specified disk. For `V2`, it's been greatly enhanced. Listing 2 shows the directory for the `V2` source disk using the command:

`DIR 0,S,I,A,P`

where `0` is the drive number, `S` displays the system files, `I` specifies "invisible" files, `A` asks for various specifications on each file (without `A`, the listing would show only the names), and `P` sends the output to the printer. I could have added `U`, which would have shown only those files that had been updated, and `/CMD` (or some other extension), which would have displayed only those files with the specified extension. Listing 3 gives the following information: the file name, the number of full sectors in the file and the number of bytes in the last sector (e.g., 12/123), the logical record length used for the file, the number of logical records in the file, the number of granules (a granule is five sectors and is used to allocate file space), and the number of extensions used.

In listing 3, eight flags describe the file, as shown at the end of each file entry. These flags explain whether the file is a system (`S`) or invisible (`I`) file, if it's been updated (`U`), whether it can be allocated more space (`E` for no), whether space beyond the end of file can be cleared (`C` for no), whether it has an update password (`U`) or access password (`A`), and the protection level (`L`, specified as a number).

The `DUMP` command simply writes a memory block to disk with a specified file name, start and end address, and an entry address (if it is a program). New to `V2`, `DUMP` allows the load locations for machine-language code to be changed. One important feature is that problematic main memory contents can be dumped to disk and later examined and modified as if the code were in memory by using Superzap's `DMDB` (display memory dump block) feature.

`V2`'s `FORMAT` command is more powerful than similar commands in other TRS-80 operating systems. It allows many of the options of the `COPY` command and it

**Listing 3: A short program to demonstrate the generation of a cross-reference table using the command `REF$`.**

```

10 LPRINT "THIS IS A PROGRAM"
20 GOTO 2000
500 FOR I=1 TO 2
510 FOR J=1 TO 5
520 IJ=I*J
530 AS="SIN OF"
540 LPRINT AS;IJ; " = ";SIN(IJ)
550 NEXT J
560 NEXT I
570 RETURN
2000 LPRINT "TO DEMONSTRATE"
2010 LPRINT "EDITING ENHANCEMENTS"
2020 LPRINT "IN NEWDOS/80 VERSION 2.0": LPRINT " "
2030 GOSUB 500
2040 END

REF $
1 500 510
2 500
5 510
500 2030
2000 20
A 530/$ 540/$
I 500 520 560
IJ 520 540/2
J 510 520 550

RUN

THIS IS A PROGRAM
TO DEMONSTRATE
EDITING ENHANCEMENTS
IN NEWDOS/80 VERSION 2.0

SIN OF 1 = .841471
SIN OF 2 = .909298
SIN OF 3 = .14112
SIN OF 4 = -.756802
SIN OF 5 = -.958924
SIN OF 2 = .909298
SIN OF 4 = -.756802
SIN OF 6 = -.279416
SIN OF 8 = .989358
SIN OF 10 = -.544021

```



# Great Buy!

## On a great terminal.

The Hazeltine 1420 display terminal delivers all the features you need for today's conversational applications at a new low price. Just \$595 per terminal. A \$440 reduction from list price.

**Great warranty:** With the 1420, you get the industry's most comprehensive warranty. Free board replacement for two full years.

**Great performance:** You get a high quality, 1920-character display with upper and lower case, multiple

intensities and separate numeric key pad.

**Great value:** It's a lot of terminal for very little money. Your Hazeltine distributor has 1420 terminals in stock, for immediate delivery. Contact your local distributor today, or call Hazeltine toll free at **800-645-5300**.

At \$595, the 1420 is too good a bargain to pass up.

Hazeltine Corporation  
Computer Terminal Equipment  
Greenlawn, NY 11740 (516) 549-8800



Answers for the **80s**



## PARTICIPATING DISTRIBUTORS

**ADL ENTERPRISES**  
(201) 328-1300

**W.A. BROWN**  
(305) 425-5505

**CAMERON COMPUTERS, INC.**  
(716) 473-4590

**COMPUTER DATACOM, INC.**  
(714) 540-6327

**COMSEL CORPORATION**  
(703) 734-3880

**DANER HAYES, INC.**  
(617) 894-7290

**DATA SYSTEMS MARKETING**  
(714) 560-9222

**DAVID JAMISON CARLYLE CORPORATION**  
(213) 277-4562

**ELECTRONIC MARKETING SPECIALISTS**  
(714) 832-9920

**GENERAL MICRO COMPUTER**  
(219) 277-4972

**GRAHAM ELECTRONICS**  
(513) 772-1661

**HAMILTON AVNET ELECTRONICS**  
(213) 615-3900

**INLAND ASSOCIATES, INC.**  
(913) 764-7977

**LOONAM ASSOCIATES, INC.**  
(612) 831-1616

**LOWRY & ASSOCIATES, INC.**  
(313) 227-7067

**MARKETLINE SYSTEMS, INC.**  
(215) 947-6670

**MTI SALES CORPORATION**  
(516) 482-3500

**JOHN D. OWENS ASSOCIATES**  
(212) 448-6283

**PLS ASSOCIATES, INC.**  
(303) 773-1218

**SCHWEBER ELECTRONICS**  
(516) 334-7474

**TSC DATA TERMINALS**  
(201) 245-6333

**WESTWOOD ASSOCIATES, INC.**  
(201) 376-4242

**J.J. WILD, INC.**  
(617) 449-5600

# Reliable Business Software

DATASMITH software requires no previous computer experience, so it can be used effectively by your present office staff. The menu-driven systems feature extensive error detection and correction facilities, so they are "friendly" to the user.

- **GENERAL LEDGER.** Everything you need to keep the books. Features easy-to-use data entry and error correction, trial balance, fast post, and a variety of comprehensive reports. Automatic error detection keeps the books in balance. Writes checks and makes journal entries in one operation.
- **PAYROLL.** A very flexible system that adapts to a wide variety of needs. Features Federal, state, and local tax calculations, EI credit, and special pay and deduction amounts. Prints all necessary reports, paychecks, and W-2 forms.
- **DATA MANAGER.** A powerful generalized data management system that lets you define, enter, update, sort, select, and print reports from a database of your own design. Applicable to almost any job where records must be kept, this system can replace literally hundreds of programs.

Put your computer to work with these sophisticated systems now. Programs are available for 48K or larger two-disk systems in your choice of code for Microsoft BASIC-80® under CP/M®, IBM® Personal Computer BASIC, or Micropolis® BASIC.

## DATASMITH

Box 8036, Shawnee Mission, KS 66208, (913) 381-9118

lets you specify whether only certain tracks are to be formatted. Also, it will accept default values for the disk name, password, and date. For example:

FORMAT 1,,,Y

assigns to the disk the name NOTNAMED, the current date, and the password PASSWORD. Y tells the computer to format the disk even if data is already there.

The commands MDRET, MDBORT, and MDCOPY use a Mini-DOS that's entered by simultaneously pressing the "dfg" keys. If this is done while a program is executing (interrupts must be enabled), a subset of the system commands may be issued. You can return to the execution of the program by typing MDRET (Mini-DOS-Return) or exit to the command level by typing MDBORT (Mini-DOS-aBORT). For example, I wrote this article using Scripsit. While writing, I wanted to see the directory. I pressed "dfg" and saw the MINI-DOS READY prompt. I then typed DIR and saw the directory. I could have killed a file if I so wished. When I typed MDRET, I returned to the Scripsit program. If I wanted to exit the Scripsit program, I would have typed MDBORT. The Mini-DOS will not work with a few of the commands, such as FORMAT, but it works with most. The MDCOPY command allows a limited version of COPY from Mini-DOS.

The ROUTE command directs input and output between devices. It's best understood from some examples. In the following discussion, DO refers to video-display output, PR is printer output, RO is RS-232C output (on the Model III only), RI is RS-232C input (only on the Model III), and KB is keyboard input. Thus, ROUTE, PR,DO will "route" printer output to the screen. (This is useful if you don't have a printer and want to use programs that expect one.) ROUTE,PR,DO,PR will send output to both the screen and printer. On the Model III, ROUTE,KB,RI allows keyboard input from the RS-232C interface, while ROUTE,DO,RO would send screen output to the RS-232C. In addition, you can "route" to a machine-language routine in memory, but, unfortunately, you cannot "route" to a disk file. ROUTE,CLEAR clears everything back to the original state.

The last command, WRDIRP, is used for exchanging single-density disks between Model I and Model III machines. I'll describe it later in this article.

### BASIC Language Enhancements

V2 BASIC in the TRS-80 uses memory overlays; i.e., when certain functions are called from a program, the necessary code is read from disk and "overlaid" into memory. The disk drives may turn on even when there is no input or output, allowing V2 to expand BASIC without using extra memory.

V2's most important BASIC enhancement is the statement CMD"xxx" (also implemented in earlier versions of NEWDOS). The "xxx" option can be almost any system command. When this statement is encountered, the com-

PASS

## MOD II CP/M® IQ QUIZ

FAIL

### Does your TRS-80 Mod II:

Yes No

- give you access to hundreds of applications programs?
- give you a choice of a dozen or more languages?
- transfer files from TRSDOS to CPM?
- store 596 K bytes on a floppy disk?
- talk to a Cameo cartridge disk system?
- talk to a Corvus Winchester disk system?
- support XON/XOFF, ETX/ACK and clear-to-send serial printer protocols?
- talk to double sided floppy drives?
- run the best documented, best supported CP/M available?

If you answered no to any of these questions, raise your Mod II's IQ with

### P&T CP/M® 2

Contact us, and we'll send you details on how to expand your Mod II's horizons.



Price \$185 for standard P&T CP/M® 2; \$250 for P&T CP/M® 2 for Corvus or Cameo hard disk drives. (FOB Goleta)

### PICKLES & TROUT

P O BOX 1206. GOLETA. CA 93116. (805) 685-4641

CP/M is a registered trademark of Digital Research. TRS-80 is a trademark of Tandy Corp.



# The real energy crisis is the company that does nothing about it.

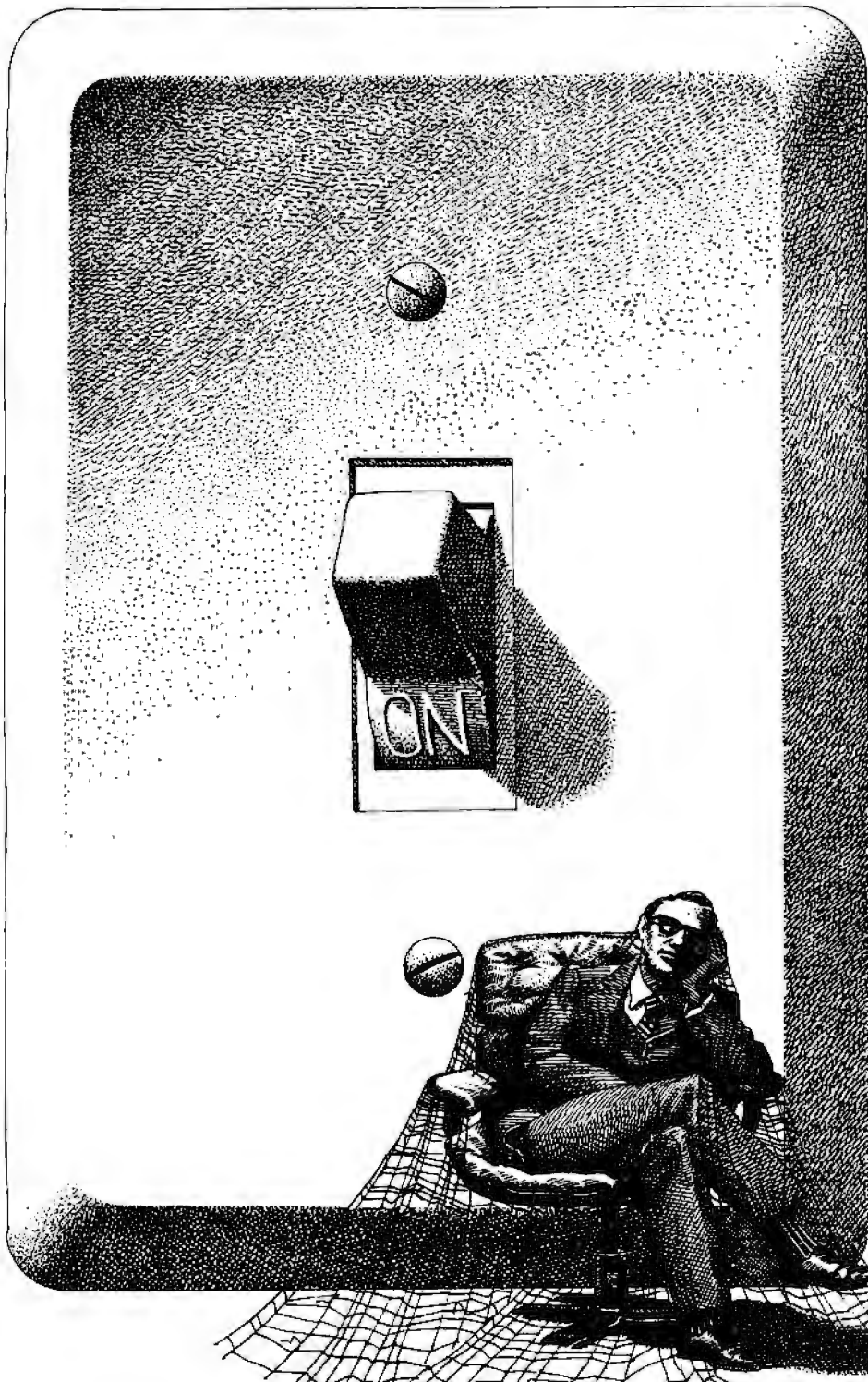

Back when the energy crisis was no more than a gleam in a speculator's eye, few of us gave much thought to lighting costs.

Today, few companies give more than a passing glance at their light bills —despite the fact that now there's plenty they can do about them.

Westinghouse saw that energy costs would skyrocket so we did something about them.

## **Saving electricity is as simple as switching light bulbs.**

We introduced the Econ-o-watt® lamp, the lower-watt fluorescent that saves up to 20% of your energy costs. For the Lockheed company, the savings came to \$323,948 a year in one plant alone.

And where the quality of the light is as important as energy savings, look to Westinghouse's revolutionary Ultralume™ fluorescents. Under Ultralume lamps, everything and everyone looks sharper, brighter and more colorful. Plus, there's a 30% increase in light over deluxe fluorescents. So you can reduce the number of fluorescents and save energy and enjoy better lighting.

To really maximize your energy savings, a total system replacement with Ceramalux-4™ lamps would be just the ticket. Ceramalux-4 lamps save up to 80% of the energy of incandescents. And they are the first high pressure sodium lamps to produce a light quality equal to or better than cool white fluorescents.

## **Call or write for your free copy of "Substitute for Savings!"**

If you're the do-something kind of executive, get up off your apathy right now and give us a call. Ask us for a copy of "Substitute for Savings." **Call toll-free: 800-631-1259.**

The brochure gives a non-jargon rundown on what you should know about lighting costs and what you can do about them.



**Westinghouse**

Lamp Divisions  
Bloomfield, New Jersey 07003

## MICROSTAT® - Release 3.0

### MICROSTAT® + baZic® = PERFORMANCE

The best just got better! MICROSTAT has been the leader in the statistics field for microcomputers since 1979, and the new release 3.0 outperforms and is noticeably faster than previous versions. Just a few of the features include:

#### GREATER ACCURACY

BCD with up to 14 digit precision;

#### PROGRAM ENHANCEMENTS

Missing data capabilities and many more;

#### FASTER EXECUTION

Calculation time greatly reduced;

#### DYNAMIC FILE ALLOCATION

Data can be inserted, added, or deleted;

#### SPECIAL PRICE:

For a limited time get MICROSTAT plus baZic complete with program disk and documentation for each for \$395.00, save \$50.00!

The MICROSTAT - baZic version requires: a Z80 CPU, CP/M™ and 48K of memory. Available formats: 8" SD disk or 5¼" North Star only. Check with your dealer for other formats. Also available for: Microsoft's Basic-80™, North Star DOS and IBM. For more information, call or write:

#### ECOSOFT INC.

P.O. Box 68602  
Indianapolis, IN 46268-0602  
(317) 255-6476



MICROSTAT is a registered trademark of ECOSOFT, INC.  
baZic is a registered trademark of MICROMIKES, INC.  
CP/M is a registered trademark of DIGITAL RESEARCH  
Basic-80 is a registered trademark of MICROSOFT

mand is executed and operation is returned to the BASIC program. If the program includes the line:

```
200 CMD"DIR"
```

a directory will appear on the screen and then execution will be returned to the program. CMD also calls functions that are unique to BASIC. It can be used either from within a program or from the keyboard. From within a program, it allows language enhancements using the forms CMD"F" and CMD"O." The first of these has the format:

```
ln CMD"F=function"
```

where ln is a line number and "function" determines what happens.

Briefly, the CMD functions, POPS, POPR, and POPN, allow a variety of options in exiting FOR . . . NEXT loops. For example, they permit exiting a loop before its limit is exceeded or stopping the loop "early," ignoring the NEXT statement. The SASZ option lets you change the memory area allocated to string variables without affecting or clearing the variables; i.e., it clears string space without really executing a CLEAR. When followed by a variety of variables, ERASE clears the specified variables to zero. KEEP does the opposite; it clears all variables except the specified ones. SWAP, followed by two variables, exchanges the values of the variables. SS executes a program step by step, which provides a much more sophisticated form of debugging. In operation, SS displays the current line number. With SS, the line number where single-stepping should be started can be specified, and single-stepping can be stopped by using the suffix N.

CMD"F",DELETE ln1-ln2 will delete the program code between line numbers ln1 and ln2, which lets you remove a subroutine from memory and bring in another subroutine from disk. For example:

```
1000 CMD"F",DELETE 25000-30000
1010 MERGE "NEWSUB/BAS"
```

would delete the specified lines and bring in a new subroutine named NEWSUB/BAS (which must be between lines 25000 and 30000). (Note that the MERGE function no longer requires that the new code be stored in ASCII format.) This is potentially very powerful; for example, a menu could be used to select different subroutines to be loaded at different times during execution of a program. In essence, a program can "call" a variety of subroutines from disk.

Another important enhancement provides a sorting feature by using the statement:

```
ln CMD"O",n,(array variable list)
```

where n is the number of elements in the array to be

## MULTI-PROGRAMMER SYSTEM-10

### Features:

- Dedicated keys and large display vocabulary for ease of use.
- I/O - 6 baud rates, 13 formats including Inteltec, Textronix and Motorola.
- EPROMs, E<sup>2</sup>PROMs and bipolars.
- Gang option - programs eight at once.
- Remote control option.

**\$1,295**

**PROGRAMS  
OVER 250  
DEVICE TYPES**



### FUNCTIONS:

DISPLAY DEVICE DATA	LOAD DATA	CRC - DEVICE/RAM
EDIT RAM DATA	COMPARE FIELDS	CRC - RAM
DEVICE PROGRAM	FILL MEMORY FIELD	I/O HOST PROMPT
TYPE SELECTION	BLOCK MOVE	DIAGNOSTICS
		and more . . .



COMPUTER SYSTEMS CORP

100 East Linton Blvd. Delray Beach, Fla. 33444 (305) 272-2051



# IF YOU BUY MICRO-COURIER™ BEFORE JULY 1, YOU GET A \$100 SUBSCRIPTION TO THE SOURCE<sup>SM</sup> FREE.

Micro-Courier is *the* electronic mail software for Apple™ computers. It lets you send anything in your Apple computer to any other Apple, in any other office, anywhere in the world. It's fast, 100% error-free, and inexpensive. You can send and receive charts, graphs, VisiCalc™ reports and entire programs.

Micro-Courier also takes you right to THE SOURCE.

You can access one of the largest data bases in the world, including news, travel service, commodity updates, educational programs, electronic games and more.

And if you act now, you can get a free \$100 subscription to THE SOURCE with your Micro-Courier package.

See your Apple dealer for complete details.



## MICROCOM

We make little computers talk big.

1400A Providence Highway  
Norwood, MA 02062

Apple is a trademark of Apple Computer Inc. VisiCalc is a trademark of VisiCorp., Inc. THE SOURCE is a servicemark of Source Telecomputing Corporation, a subsidiary of The Reader's Digest Association, Inc.

Circle 296 on inquiry card.

sorted. The specifications allow for ascending and descending sorts, sorting a limited part of an array, and tagging other arrays onto sorts. Both strings and numbers can be sorted. It's not possible to describe all of the possibilities here, but the function is powerful and fast.

### Changes in BASIC Invocation

Bringing up BASIC from the system mode is done by using the form:

BASIC *n,m,line*,

where line is any BASIC program line or statement, *n* sets the number of files to be made available, and specifying *m* will set the upper limit on available memory (*n,m*, and line are all optional). (BASIC may still be entered by typing the word BASIC alone.) The command can be followed by RUN or LIST with a program name, and the program will be run or listed. For example, entering the line:

BASIC 5,30000,CMD"DIR":RUN"TESTPROG/BAS"

would bring up BASIC, set up five files, protect memory from location 30000 on up, display the disk directory, and start to run the program TESTPROG/BAS.

The command BASIC \* is quite useful: it allows recovery of a program even after an accidental reset. If

the program is still in memory, the computer will reenter BASIC, list the program, and allow it to be executed. Of course, it will not work if something destroyed the program in memory. While BASIC is still enabled, RENEW performs a similar function by reinstating a program eliminated by the BASIC command NEW.

### Editing and Program Manipulation

The original Level II BASIC provided a good line-oriented editor. V2 doesn't change this, but it adds many useful features.

The REF\$ utility, for example, sends a cross-referenced list of all variables and integer numbers (mostly line numbers) to the printer (see listing 3). REF\* sends the list to the screen. REFA gives all line numbers where variable *A* appears, and REF200 displays all references to integer 200, including line number 200. REF"The" finds all strings containing the word "The," and REF=FOR locates all references to FOR (not as strings, but in statements) in the program.

The CMD"C" utility compresses and manipulates the text of a program. CMC"C" alone removes both comment lines and spaces. CMD"C",R removes remarks alone, and CMD"C",S deletes only spaces.

RENUM rennumbers a program in almost any configuration. Simply typing:

RENUM ,

**ORDER: 1-800-547-2492**

IN OREGON CALL

**SERVICE: 503-479-4150**

**ATARI** 400 (16K) \$325  
800 (16K) \$675

**EPSON I.D.S.**

MX-80 \$439 560G Printer \$10 49  
MX-80FT \$539 Prism 80 w/color \$1249  
MX-100 \$699 Prism 132 w/color \$1549

SMITH CORONA - Letter Quality Printer \$749  
SYNERGIZER - WORDSTAR, 80 Column, w/enhanced character set, Z-80 & 16K Card by ALS \$1049  
MAGNUM SYSTEM - OLIVETTI 121 Printer/Typewriter w/RS 232 or Parallel Interface \$1495

**TERMS:** SHIPPING: Add 3% of total transaction for UPS brown (ground) or 5% for UPS blue (air), Parcel Post, or any special arrangements.  
PAYMENT: Cashier's checks, certified checks, money orders, and bank wires honored immediately. Wire transfer funds to U.S. National Bank of Oregon, South Grants Pass Branch. Credit RCE, account number 501-981. Add 3% for Visa and Master Charge. Allow 20 days for personal checks to clear.  
REFUNDS: 10% restocking charge on all returns or exchanges. No refunds on opened software. Call first.  
GUARANTEE: All products with full manufacturer's warranty. Sanyo and Apple warranty available. We have full repair and service facilities for all electronic repairs with HP, Dynascan, Pioneer, Sanyo and Apple trained and certified technicians. For any technical service call them for instant advice or questions right on their benches at (503) 479-4150.  
REPAIRS: Out of warranty guarantee: Labor 30 days from date of your receipt, 90 days on parts. Call for details on quality guaranteed discount repair and reconditioning service.  
We have been repairing electronic equipment for 12 years and love it!

**SPECIAL ON APPLE REPAIRS - ALL PRICES PLUS PARTS**

APPLE II \$50 DRIVES \$40 PRINTERS \$100  
APPLE III \$100 SILENTYPE \$50 PERIPHERAL CARDS \$45

**"A Unique Combination of Quality Products, Competitive Prices, and Service"**

### APPLE HARDWARE

MICRO SCI DISK DRIVES  
(DIRECT APPLE REPLACEMENT)  
A-2 DISK DRIVE \$395  
A-70 \$489  
A-40 \$369  
CONTROLLER - 3.3 & 3.2 \$79  
CC5 7710A SERIAL INT \$139  
CC5 7710D SERIAL INT \$139  
VIDEX 80 COLUMN \$269  
VIDEX ENHANCER II \$139  
LOWER CASE ADAPTOR \$39  
16K RAM CARD \$149  
MICROSOFT OR MPC \$139  
ALS \$299  
Z-80 CARD (MICROSOFT) \$289  
HICKOMODEM (HAYES) \$229  
SMART MODEM (HAYES) \$229  
NOVATION MODEMS  
APPLE CAT \$309  
AUTO CAT \$209  
CAT \$139  
D CAT \$149  
HIZCOMP MODEM \$139  
MOUNTAIN CLOCK \$239  
MOUNTAIN MUSIC SYSTEM \$369  
MOUNTAIN A/D CONVERTER \$299  
MOUNTAIN INTROL/X-10 CARD \$169  
MOUNTAIN C.P.S. \$199  
KBD 23 KEYPAD \$139  
SUP-R-TERM (80 COLUMN) \$299  
SUP-R-MOD R.F. MODULATOR \$24  
JOYSTICK (T.G.) \$45  
12" B & W MONITOR (SANYO) \$145  
12" B & W MONITOR (SANYO) \$189  
12" GREEN MONITOR (SANYO) \$229  
12" GREEN MONITOR (ZENITH) \$119  
13" COLOR MONITOR (SANYO) \$385  
EPSON CABLE & INTERFACE \$79  
EPSON GRAFTRAX \$70  
POWERLINE PROTECTOR \$39

### ATARI HARDWARE

410 PROGRAM RECORDER \$85  
810 DISK DRIVE \$419  
820 PRINTER \$249  
822 PRINTER \$339  
825 PRINTER \$579  
830 MODEM \$149  
850 INTERFACE MODULE \$165  
853 16K MEMORY EXPANSION \$79

### SOFTWARE

VISICALC (ATARI) \$159  
BASIC (ATARI) \$49  
VISICALC \$179  
VIDEX \$179  
VISIPILOT \$145  
VISTERM \$75  
VISTREND/PLOT \$214  
VISIPAC \$499  
DESK TOP PLAN #2 \$179  
DESK TOP PLAN #3 \$214  
MICROLAB DATA FACTORY \$129  
DB MASTER (STONEWARE) \$179  
SUP-R-TEXT II \$108  
WORDSTAR \$349  
B.F.I. SOFTWARE (each) \$319  
STOCKFILE INVENTORY \$269  
ZDRK \$35  
SARGON CHESS \$29  
GALAXIAN \$22  
VERBATIM DISKS \$29  
MAXELL DISKS \$38  
THE SOURCE \$93

MINIMUM ORDER - \$100.00

MINIMUM SHIPPING CHARGES - \$4.00

PRICES SUBJECT TO CHANGE WITHOUT NOTICE

WRITE FOR CATALOG



**RALSTON-CLEARWATERS ELECTRONICS**

530 N.E. 'E' Street • Grants Pass, Ore. 97526  
ALL BRAND NAMES ARE REGISTERED TRADE MARKS



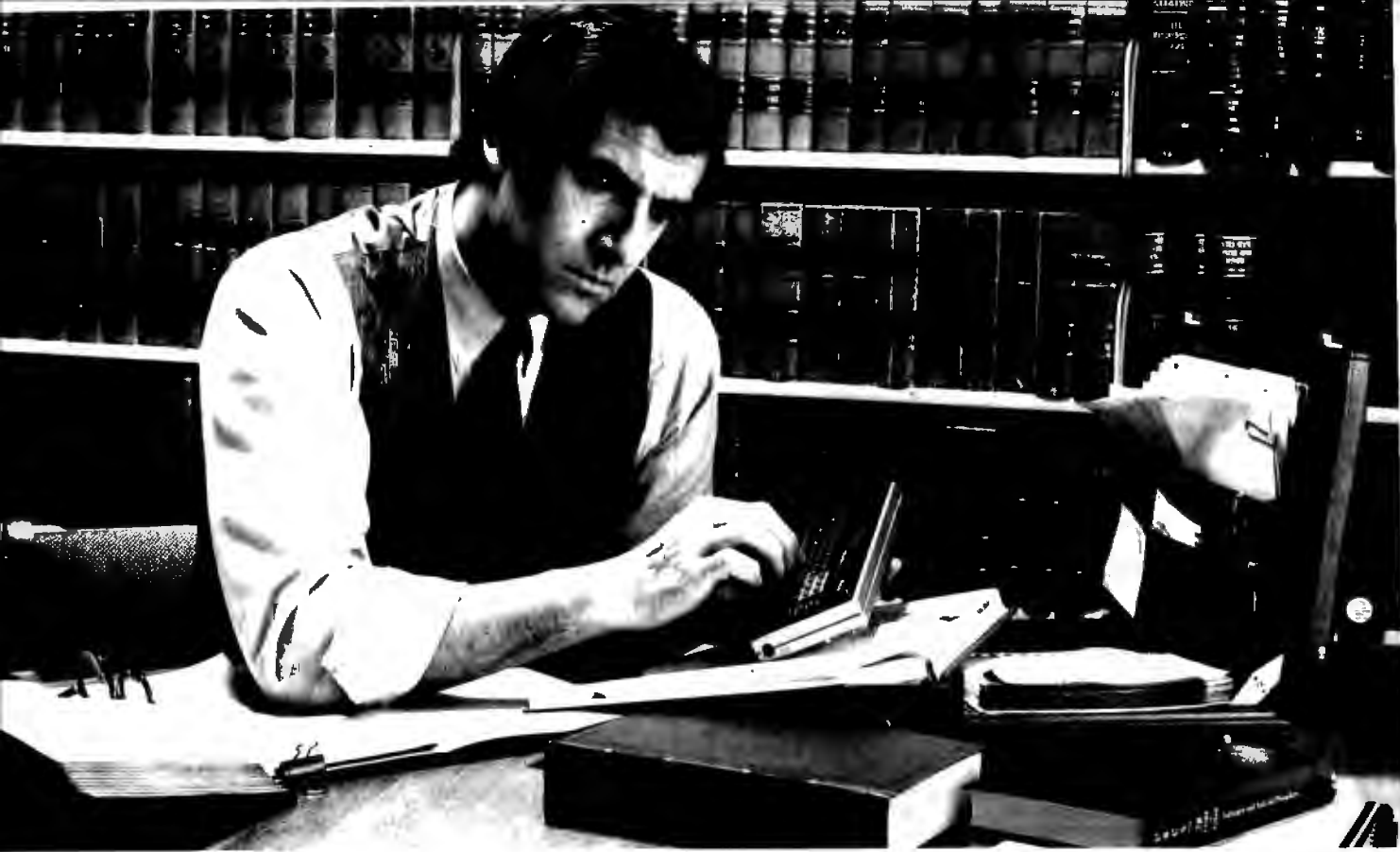

# THE QUASAR HHC TAKES COMPUTERS WHERE THEY'VE NEVER BEEN BEFORE.

## Make Every Minute Count.

The Quasar HHC puts computer power into a package you can hold in one hand. It can be your constant companion wherever you go.

You can create or update files, access a database, perform complex routines, or keep an itinerary up-to-date.

The HHC can transmit information directly to another computer through the HHC RS232C interface, or via

telephone through the HHC acoustic coupler. A handy Micro Printer provides hard copy records. The HHC and all seven of its peripherals fit in an attache case.

### Time Management Software

Software capsules tailor the HHC for specific applications. The Time Management capsule, for instance, is perfect for lawyers, accountants, agency executives, consultants—anyone who bills time to clients. With just four

keys, users can record time by client and by job type; view each day's results, including billed and unbilled time; and accumulate time by client and by job for the month, quarter, and year-to-date. All while performing other jobs. By increasing time-tracking efficiency, the HHC can usually increase billable time.

Some day, there may be other computers like the Quasar HHC. If you can't afford to wait, write on your letterhead to Quasar Group Director HHC for information, including how to become a dealer or distributor.



**Quasar**  
ONE GREAT IDEA AFTER ANOTHER...

**HHC**

**WARNING!**  
**Electric Power Pollution.**  
**Spikes & Lightning**  
**HAZARDOUS to**  
**MICROCOMPUTERS!!**

Patented ISOLATORS provide protection from ...

- Computer errors caused by power line interference
- Computer errors due to system equipment interaction
- Spike damage caused by copier/elevator/air conditioners
- Lightning caused damage

**MONEY BACK GUARANTEE!**

- ISOLATOR (ISO-1) 3 Isolated 3-prong sockets; Spike Suppression; useful for small offices, laboratories, classrooms. . . . . \$69.95
- ISOLATOR (ISO-2) 2 Isolated 3-prong socket banks; (6 sockets total); Spike Suppression; useful for multiple equipment installations. . . . . \$69.95
- SUPER ISOLATOR (ISO-3) similar to ISO-1 except double isolation & oversize Spike Suppression; widely used for severe electrical noise situations such as factories or large offices. . . . . \$104.95
- SUPER ISOLATOR (ISO-11) similar to ISO-2 except double isolated socket banks & Oversize Spike Suppression; for the larger system in severe situations. . . . . \$104.95
- MAGNUM ISOLATOR (ISO-17) 4 Quad Isolated Sockets; Multiple Spike Suppressors; For ULTRA-SENSITIVE Systems in extremely Harsh environments. . . . . \$181.95
- CIRCUIT BREAKER, any model (Add-CB) . . . . . Add \$9.00
- REMOTE SWITCH, any model (Add-RS) . . . . . Add \$16.00

AT YOUR DEALERS MasterCard, Visa, American Express  
 ORDER TOLL FREE 1-800-225-4876 (except AK, HI, PR & Canada)

**Electronic Specialists, Inc.**  
 171 South Main Street, Box 389, Natick, Mass 01760  
 (617) 655-1532

will renumber everything with increments of 10 between lines. Entering:

RENUM 30000,5,15365,18112

would renumber all lines between 15365 and 18112 with an increment of five; the new numbering would start with 30000. Thus, 15365 would become 30000, 15366 would be 30005, and so on. All branches are kept track of, and you can't mix up two parts of the program. The function RENUM U is slightly different: it produces a list of all references to undefined lines (i.e., GOTO 1000 would be shown as an error if line 1000 didn't exist).

The DI and DU functions are closely related to RENUM. Entering the command:

DI 1005,2010

will displace (DI) line 1005 to 2010.

DU 1005,2010

will duplicate (DU) 1005 at 2010—but 1005 will still be at its original location. Similarly, D 1005 will delete (D) line 1005, which is the only way it can be done. You can no longer accidentally remove line 50 by typing the number 50.

Additional enhancements provided include a variety of abbreviated, single-character functions that are a great aid when writing and editing programs. For example:

- "." lists the current program line
- ";" puts the current program line into the edit mode
- ";" or "shift up-arrow" lists the first program line
- "/" or "shift down-arrow" lists the last program line
- "up-arrow" displays the preceding line
- "down-arrow" displays the following line
- "+" scrolls one display page down
- ":" scrolls one display page up

The editing character must be the first and only entry on a line; backspacing is not allowed. However, pressing BREAK will reset things, permitting character entry. These functions allow rapid and simple program editing. I find myself editing programs on the screen that would have required a printed output with TRSDOS. (TRSDOS for the Model III, however, has many of these features.)

**File Types**

File types are the most confusing aspect of V2, although they are intuitively easy to grasp. The file structures and input/output procedures are similar to those normally found on much larger computers. The new files are powerful, but they're hard to describe, both in a review and in the documentation (Apparat devotes 80 pages to the file types).

Both the sequential and random files supported by TRSDOS and similar systems are maintained by V2, but V2's sequential and random files have new features. First,



**FLEX**  
 Color Computer  
 SWTPC  
 Smoke Signal  
 Gimix  
 Hazelwood

**Games**  
 Word Processing  
 Business Applications  
 BASIC  
 Programming Tools  
 System Software

**Software & Hardware**

**Off-the-Shelf & Custom Systems**

**COMPUTERWARE®**

Box 668  
 6809 Specialists Encinitas, CA 92024 • (714) 436-3512

Computerware is a trademark of Computerware.



# Announcing The Most Powerful, Flexible, Sophisticated, S-100 Bus, Board Level System Ever Available.

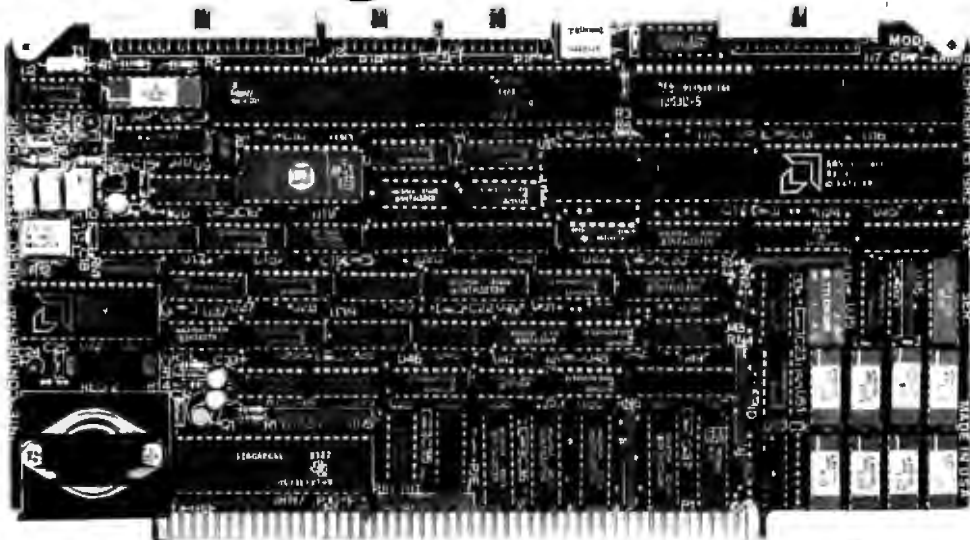

## CPZ-48000 From Intercontinental Micro Systems

### No bull, just a beefed up product

A lot of people have been claiming the title of best S-100 bus, board level micro. Some with only prototype or paper boards. Intercontinental Micro's CPZ-48000 is in production now, and we think it's the most powerful. Here's why:

- Z80A™ based system. Complies with IEEE 696.1/D2 S-100 BUS specifications.
- Single or Double Density Floppy Disk controller. Controls up to four 8" or 5 1/4" floppy disk drives in either DMA, Interrupt or Programmed I/O mode.
- 64 Kbytes of onboard Dynamic RAM with Memory Bank Selection of 4 Kbytes to 64 Kbytes under software control.
- Four Channel Direct Memory Access Controller.
- Two synchronous or asynchronous Serial I/O channels with one channel programmable in either DMA, Interrupt or Programmed I/O mode.
- Two Parallel I/O channels with one channel programmable in either DMA, Interrupt or Programmed I/O mode.
- Memory Management capable of addressing 16 Megabytes of system memory.

- Eight Vectored Priority Interrupts chained together with I/O Interrupts for use with Z80 Mode 2 Interrupts.
- Provisions for either a 2 Kbyte or 4 Kbyte onboard EPROM. (Monitor in a 2 Kbyte EPROM supplied with board.)
- CP/M™ and MP/M™ operating systems available, TurboDOS™ and CP/NET™ available soon.
- Turbo-Disk™ Implementation included.

### Flexibility

CPZ-48000 can be used in many applications, including:

- Single board, stand alone computer
- Network master. Handles IBM Bisync, HDLC and SDLC protocols
- Multiuser host
- Multiprocessor host

### We've Got Personality

Power and flexibility are great, but not enough. You've got to be able to interface with a variety of peripherals, and you get tired of nearly redesigning stock boards for your applications. Intercontinental Micro Systems' complete line of "Personality" boards combine to make the CPZ-48000 compatible with: Centronics, 8" floppy disks, 5 1/4" floppy disks,

full modem and RS232C interfaces. NEC, Diablo, Qume, Archive and RS422 high speed serial interfaces available soon.

### Not only a great product, but a great line of products

Intercontinental also manufactures a 256K, 16K increment, fully bank selectable memory board, compatible with Cromi x™ as well as other popular systems. Also, our hard disk controller controls both 5 1/4" and 8" units.

If you're looking for sophisticated S-100 bus board level computing for anything from process control to a multiuser host look to Intercontinental Micro. Call or write for further information and pricing. Dealer inquiries are welcome.

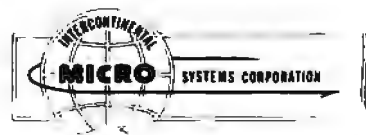

1733 South Douglass Road, Suite E  
Anaheim, California 92806  
(714) 978-9758 • Telex: 678401-TAB-IRIN

#### Listing 4: Superzap program menu.

```

APPARAT'S SUPERZAP/80. INPUT ONE OF THE FOLLOWING FUNCTIONS:
'DD' - OR NULL - DISPLAY DISK SECTOR
'DM' - DISPLAY MAIN MEMORY
'DFS' - DISPLAY FILE'S SECTOR
'DTS' - DISPLAY TRACK'S SECTOR
'DMDB' - DISPLAY MEMORY DUMP BLOCK
'VDS' - VERIFY DISK SECTORS
'ZDS' - ZERO DISK SECTORS
'CDS' - COPY DISK SECTORS
'CDD' - COPY DISK DATA
'DPWE' - DISPLAY PASSWORD ENCODE
'DNTH' - DISPLAY NAME/TYPE HASH CODE
'EXIT' - END SUPERZAP, EXIT TO DOS
PRINTER OUTPUT. APPEND ,P TO DD, DM, DFS, DTS OR DMDB

```

#### Listing 5: A directory sector as displayed by Superzap.

```

DRV 00 5F20 0000 0053 5953 3120 2020 2053 5953 .....SYS1.....SYS
0 10 5678 1234 0500 1000 FFFF FFFF FFFF FFFF V..4.....
OH 20 5F20 0000 0053 5953 3920 2020 2053 5953 .....SYS9.....SYS
30 5678 1234 0500 1320 FFFF FFFF FFFF FFFF V..4.....
DRS 40 5F20 0000 0053 5953 3137 2020 2053 5953 .....SYS17...SYS
175 50 5678 1234 0500 0A20 FFFF FFFF FFFF FFFF V..4.....
APH 60 1020 0062 0042 4153 5255 4E20 2043 4D44 ....BASRUN..CMD
70 9642 9642 3900 0804 1906 FFFF FFFF FFFF .B.B9.....
80 1020 0000 0041 5350 4F4F 4C20 204D 4153 ....ASPOOL..MAS
90 9642 9642 0A00 1C21 FFFF FFFF FFFF FFFF .B.B..1.....
A0 1020 003B 0043 4841 494E 424C 4442 4153 ...;CHAINBLDBAS
B0 9642 9642 1400 1D23 FFFF FFFF FFFF FFFF .B.B..#.....
FRS C0 0000 0000 0000 0000 0000 0000 0000 0000 .....
5 DD 0000 0000 0000 0000 0000 0000 0000 0000 .....
5H E0 0000 0000 0000 0000 0000 0000 0000 .....
P F0 0000 0000 0000 0000 0000 0000 0000 .....

```

a sequential file can be opened at its end with data being added at that point (Model III TRSDOS also does this). You would normally open a sequential file at the beginning with the statement:

```
OPEN"O",1,"FILE/FIL"
```

which would open the file at the beginning only. The statement:

```
OPEN"E",1,"FILE/FIL"
```

will now open it at the end.

A second new feature is that random files can have variable logical record lengths, or LRLs. (In TRSDOS for the Model I, the length is fixed at 256 bytes.) BASIC must be invoked by a statement such as BASIC 3V; the V indicates that the files will have variable LRLs. Entering the statement:

```
OPEN"R",1,"FILE/FIL",128
```

will produce an LRL of 128 bytes. This arrangement is easier than using the complex bookkeeping required with other systems and it saves space.

Additionally, V2 has two file types that are found in no other operating system: marked item files (with three subtypes) and fixed item files (with two subtypes). Marked item files are intended to be similar to sequential files, but they use less disk space and are easier to access. Also, some other limitations of sequential files are removed. Fixed item files are similar to random files, although the FIELD statement, LSET, RSET, and other buffer-formatting statements are not used. The PUT and GET statements define the sequence of storage and recall

of variables as well as the space allocated to each. Both file types can be used for random access.

#### Utility Programs

In addition to the various utilities that have already been described (e.g., REF and RENUM), V2 has several machine-language utility programs, including Superzap, DISASSEM, LMOFFSET, DIRCHECK, EDTASM, CHAINBLD, and ASPOOL.

The most useful is Superzap. The menu shown in listing 4 describes its functions. The display mode (using DD, DM, DFS, DTS, or DMDB) gives sectors and 256-byte blocks of memory as shown in listing 5. The location and other data are on the left, the hexadecimal-byte values are in the middle, and the ASCII equivalents of the hexadecimal values are on the right. If a hexadecimal-byte value lacks an ASCII equivalent, a period is shown.

Several editing functions are available while in Superzap's display mode. The most important of these is MOD, which allows modification of a byte within the displayed sector. Here's how it works: a cursor appears that can be moved around as you see fit; modifications are made by simply typing over byte values. Preceding and following sectors can also be displayed. When you type ENTER, the system asks if the modification should be written to disk. This is how Apparat's updates (zaps) are made on system programs. The modify option can be used to change file names and dates, to repair disk directories, and to change text files. Two other editing functions, F and L, are available. F is quite important: it searches a disk, file, or memory for a value up to four bytes. For example, entering the command F,2A,5C,33,AC would find those four hexadecimal bytes. Another function, SCOPY (DD and DTS modes only), allows the displayed sector to be copied to another sector on the disk.

DISASSEM/CMD is capable of disassembling object code from a tape, disk, or memory, displaying the Z80 mnemonics, providing a printed listing, and sending the generated source code to a new disk file. The source code may then be modified and reassembled using the EDTASM/CMD program. There are a variety of other options, and this is a very powerful disassembler.

LMOFFSET/CMD reads a machine-language program from tape or disk, displays the start, end, and entry locations, allows relocation of the program load address, optionally sets up the program so that it can be loaded from disk and executed under the nondisk BASIC Level II SYSTEM command, and dumps the code to tape or disk. I have found little need to offset program locations using this routine, but its ability to tell me the start and end locations is handy. Most important, however, is its ability to dump a machine-language program from disk to tape (new to V2); this is invaluable for transferring programs to systems without disk drives.

DIRCHECK/CMD performs a simple but essential function: it checks the disk directory. It also lists the directory, characteristics of the files, and gives messages



# We'd like your apple® to meet **The Executive Secretary™**

The professional  
 word processing system  
 for the Apple™ computer



### GENERAL

Editing, printing, form letters, mail-merge, and electronic mail all in one package at one price? ✓

User's manual designed for the user? ✓

User-controlled configuration of printers, slots, drives, and 40/80 column editing? ✓

### THE MANUAL

Complete index included? ✓

Organized as a set of lessons? ✓

Easel-bound for ease of use? ✓

### THE DOCUMENT PRINTER

Integrates files from DE MASTER's Utility Pack™, The Data Factory™, Visicalc™, Information Master™, and most DIF™ files. ✓

Accepts keyboard input at print time? ✓

Supports all major printers, including Centronics 737 and IBM ET-series? ✓

Has IF and related commands to allow conditional printing of information based on the contents of a database or on keyboard input? ✓

Prints page headers of arbitrary complexity? ✓

Prints page numbers wherever you want them? ✓

Automatically generates alphabetical index for words you specify? ✓

Supports file chaining and file nesting? ✓

Has multi-level outline indenting? ✓

Has left- and right-justified tab stops? ✓

Gives full control of all margins, dynamic text reformatting, centering, and justification? ✓

Supports Thunderclock™ and the CCS clockcard for automatic dating? ✓

## check this chart:

### INTEGRATED CARD FILE FEATURES

Allows multiple card files per disk? ✓

Allows user to define size and content of 'cards' in each file? ✓

Generates new subset card files based on search or sort criteria for an existing file? ✓

Incorporates one/multiple line report printer for card files? ✓

Allows totals and subtotals during report printing? ✓

### THE DOCUMENT EDITOR

Keeps up with professional typing speeds? ✓

User-defined phrase abbreviations? ✓

40 or 80 character edit modes user-selectable? ✓

Supports Smarterm™, Superterm™, Videoterm™ and Full View 80™. ✓

Uses real shift key? ✓

Supports file merge and unmerge? ✓

Global search and replace? ✓

Block operations: move, transfer, delete? ✓

Character/word/line: insert/replace/delete? ✓

Allows embedded commands to control special printer functions? ✓

### ELECTRONIC MAIL SYSTEM

Menu driven? ✓

Multiple document queuing? ✓

Fully automatic with Hayes modem? ✓

Published by:

Available at computer stores nationwide.  
 \$250 suggested retail.



4306 Upton Avenue South  
 Minneapolis, Minnesota 55410  
 Phone (612) 929-7104

Now available: The Executive Speller™. Allows on-the-fly corrections and specialized dictionaries. 25,000 word capacity. Suggested retail \$75.00.

relating to any problems. The error messages can be difficult to understand without careful reading of the documentation.

EDTASM/CMD is best understood by quoting the V2 user's manual:

*Thirty-five months ago Apparat converted the TRS-80's tape-oriented editor/assembler to:*

1. Read text from disk as well as cassette.
2. Write text and/or object to disk as well as cassette. . .
3. Allow scrolling to display up to 15 text lines.
4. Prevent the confusing printer output associated with DEFM. . .
5. List symbols in alphabetical order with reference list.
6. Accept and convert lowercase to upper[case].

The manual also states that EDTASM is a modification of Radio Shack's copyrighted product, so all users *must buy the original*. In addition, Apparat provides documentation for the enhancements only. If you want to use EDTASM, you must have the manual for Radio Shack's tape-based editor assembler.

CHAINBLD/BAS is a BASIC program that constructs or edits a job-control-language file (see above). The same file can be written more easily using Scripsit; however, with earlier versions of NEWDOS, you had to write a BASIC program to create the JCL file. The

CHAINBLD/BAS program is better than other versions that are on the market.

The ASPPOOL utility speeds program execution while output is being sent to a printer. Print-data is sent to a disk buffer and from there to the printer without delaying the program. Because disk output is much quicker than printer output, program execution continues when the printer would normally be active. ASPPOOL was written by a consultant (H.S. Gentry), not by the Apparat staff, and it's an excellent program. One reviewer has said that the value of the spooler equaled the price of NEWSDOS/80.

### Compatibility

The TRS-80 Models I and III have different ROMs, and no operating system can make them completely compatible. Yet, the ROMs are similar, and most programs will operate on both. The main problem is the transfer of software. TRSDOS for the Model III permits a limited transfer from the Model I's single-density disks, but not the reverse. V2 allows two-way transfers, and you can copy double-density disks created on either computer. If PDRIVE and SYSTEM are set correctly, either computer can read files and execute programs written by the other. With single-density disks, the WRDIRP command may have to be used, but that's simple. V2 seems to allow as much compatibility between the two computers as is possible.

V2 for the Model I is a different system than that for the Model III. If you have both a Model I and a Model III, you will need V2 on both computers to use the disks interchangeably.

### Documentation

The documentation for NEWDOS has been notoriously poor. The first versions were simply supplements to the TRSDOS documentation. NEWDOS/80 Version 2's documentation is much better. It consists of more than 260 pages of very detailed text with an index and a good table of contents, packaged in a three-ring binder. For the machine-language programmer, the documentation has a lot of technical detail. But the first-time user may have a problem. All the information you will need is in the documentation, but you need some understanding of operating systems to use it.

The text is not a tutorial for the newcomer, but Apparat has tried to include examples for the novice, and it has mostly succeeded. Although you may have to do some studying, everything is spelled out in regard to commands, BASIC enhancements, and so forth. The problem is that the documentation is written by experts for experts. For example, I doubt that anyone will be able to understand the file types without first understanding sequential and random files in TRSDOS. Reference is even made to the TRSDOS manual. If V2 is a stand-alone system, it seems odd to expect people to buy the TRSDOS manual. If you want to use the most important features of V2, you should have no problem with the documenta-

## TERMINALS FROM TRANSNET

PURCHASE PLAN • 12-24 MONTH FULL OWNERSHIP PLAN • 36 MONTH LEASE PLAN

DESCRIPTION	PURCHASE PRICE	PER MONTH		
		12 MOS	24 MOS	36 MOS
<b>DEC</b>				
LA36 DECwriter II	\$1,095	\$105	\$ 58	\$ 40
LA34 DECwriter IV	995	95	53	36
LA34 DECwriter IV Forms Ctrl.	1,095	105	58	40
LA120 DECwriter III KSR	2,295	220	122	83
LA120 DECwriter III RD	2,095	200	112	75
VT100 CRT DECscope	1,695	162	90	61
VT101 CRT DECscope	1,195	115	67	43
VT125 CRT Graphics	3,295	315	185	119
VT131 CRT DECscope	1,745	167	98	63
VT132 CRT DECscope	1,995	190	106	72
VT18KAC Personal Computer Option	2,395	230	128	86
<b>TEXAS INSTRUMENTS</b>				
T1745 Portable Terminal	1,595	153	85	58
T1765 Bubble Memory Terminal	2,595	249	138	93
T1 Insight 10 Terminal	695	67	37	25
T1785 Portable KSR, 120 CPS	2,395	230	128	86
T1787 Portable KSR, 120 CPS	2,845	273	152	102
T1810 RD Printer	1,695	162	90	61
T1820 KSR Printer	2,195	211	117	80
<b>LEAR SIEGLER</b>				
ADM3A CRT Terminal	595	57	34	22
ADM3 CRT Terminal	645	62	36	24
ADM32 CRT Terminal	1,165	112	65	42
ADM42 CRT Terminal	1,995	190	106	72
<b>DATAMEDIA</b>				
EXCEL 12 CRT Terminal	1,695	162	90	61
EXCEL 42 Smart Buffered CRT	995	96	54	36
COLORSCAN 10 Color CRT	3,195	307	171	116
<b>TELEVIDEO</b>				
925 CRT Terminal	850	82	46	31
950 CRT Terminal	1,075	103	57	39
<b>NEC SPINWRITER</b>				
Letter Quality, 7715 RD	2,895	278	154	104
Letter Quality, 7725 KSR	3,295	316	175	119
<b>GENERAL ELECTRIC</b>				
2030 KSR Printer 30 CPS	1,195	115	67	43
2120 KSR Printer 120 CPS	2,195	211	117	80
<b>HAZELTINE</b>				
Executive 80/20	1,345	127	75	49
Executive 80/30	1,695	162	90	61
<b>EPSON</b>				
MX-80 F/T Printer	745	71	42	27
MX-100 Printer	895	86	48	32
<b>TIMEPLEX</b>				
E0400 4 Channel Stat Mux	1,525	147	82	55
E0800 8 Channel Stat Mux	2,050	197	110	74

FULL OWNERSHIP AFTER 12 OR 24 MONTHS • 10% PURCHASE OPTION AFTER 36 MONTHS

MICROCOMPUTERS

APPLE • COMMODORE • HP85 • DEC LSI 11

ACCESSORIES AND PERIPHERAL EQUIPMENT

ACOUSTIC COUPLERS • MODEMS • THERMAL PAPER • RIBBONS • INTERFACE MODULES • 100PPY DISK UNITS

TRANSNET CORPORATION

1945 ROUTE 22 • UNION, N.J. 07083 • (201) 688-7800

TWX 710-985-5485      800-526-4965 OUTSIDE N.J.



# STOP SOFTWARE FAILURES

*Using a micro in a product sounds easy...  
One piece of software can make the difference  
between success and failure.*

What do you do when the software doesn't work? Over the years, we have seen many good products fail, either before or after they reached the market, because the microprocessor software did not do its job.

## WHAT WENT WRONG?

Many of the failures occurred because the people programming the micro did not know how to organize a large control program. Those responsible for the product implementation were wizards at hardware design and had easily coded small micro control programs before. But the programming techniques that worked for less than 2K bytes of code simply fell apart as the program grew beyond 4K bytes.

Unfortunately, the loops and tests and flags that work so well for a small program get out of control very rapidly as the program grows. Pretty soon, some of the things the program must do are not being done fast enough. The code gets too complicated, difficult to modify and unreliable. The result: another software failure!

Fortunately, these problems can be avoided by using a program manager. You can divide your complex control program into a number of separate, more manageable programs, called *tasks*, each designed to do one job. For example, a Keyboard Task might handle user input; a Printer Task might generate reports. Each task can be written and tested separately and then combined to form a reliable, finished system.

The program manager, called a *multitasking executive*, supervises the orderly execution of these tasks, assuring that the most important jobs always get done first. Tasks appear to be executing simultaneously. It's almost like having a separate CPU for each task!

That is why professional software designers are now turning to AMX as the starting point for their product and system designs. They know that AMX will shield them from the difficulties of managing the micro, freeing them to concentrate on their application.



AMX is our **multitasking executive** for the 8080, 8085, Z80 and 6809 processors. We're rather proud of it. We made AMX compact, very fast, and ROMable to meet our own application needs. Even though the AMX nucleus is less than 1400 bytes in size, it features multiple task priorities, intertask message passing with priority queuing, external event synchronization, and interval timing with 32-bit precision. Each feature is clearly explained in the AMX Reference Manual.

## RELIABILITY BUILT IN

We don't know anyone who can write an executive without errors, so we thoroughly tested AMX in real applications before ever offering it as a product. That is why not one system malfunction has ever been attributed to AMX. That kind of reliability just isn't an accident.

## HARDWARE INDEPENDENCE

AMX does not require a particular hardware configuration. Of course, it does need a microprocessor, but even there we offer you a choice. *You* control your environment. *You* pick the I/O method. *You* decide the most optimum interrupt service technique for your system. AMX will support your choice.

High level language interface modules are available separately to allow AMX to be used with most popular programming languages including PASCAL, C, PL/M and FORTRAN. Of course, you can also code in assembly language if required.

Users of the CP/M and FLEX Operating Systems can utilize our AMX interface modules to access information on diskette in real time.

## COMPLETE DOCUMENTATION

AMX can be judged by the quality of our documentation. The positive response from our users has exceeded our expectations. Our manuals are especially valuable to those just being introduced to real-time multitasking. More experienced users will appreciate the fact that we deliver AMX source on diskette to permit AMX to be moved to the software development system of your choice.

## HOW TO ORDER

A specification sheet and price list are available, free. Your check or money order for \$75 will purchase the AMX Reference Manual for immediate evaluation (specify 8080, 8085, Z80 or 6809 processor). Add \$25 for postage and handling outside USA and Canada. The standard AMX Multitasking Executive package, including source code, is available for \$800 after signing our liberal license agreement.

AMX is the choice of professionals the world over. Make it yours, today.



## KADAK Products Ltd.

1847 West Broadway Avenue  
Vancouver, B.C., Canada V6J 1Y5  
Telephone (604) 734-2796  
Telex 04-55670

tion that's supplied. But if you have no experience using a DOS, then you should expect to do a lot of studying. I hope that someone will write a V2 manual for the newcomer. Apparat has not done it.

### Conclusion

The TRS-80 is now served by more than nine operating systems. In my opinion, a satisfactory system must provide double-density operation, optimal compatibility between the Model I and the Model III, and flexibility in system configuration. At least two DOSes meet these criteria: LDOS and NEWDOS/80 Version 2.0. (See "LDOS—Disk Operating System for the TRS-80," by Tim Daneliuk, March 1982 BYTE, page 372.) They are both superior to any operating system I have used on any mini- or microcomputer. If they were designed for a less common machine, they would cost many thousands of dollars. In fact, if purchased separately, the cost of a few

of the utilities in NEWDOS/80 Version 2.0 would probably be more than the complete operating system.

I believe that NEWDOS/80 Version 2.0 is the most powerful operating system available for the TRS-80 Models I and III. As far as I know, it has all of the important features of other operating systems for TRS-80s. Some DOSes may have other options, such as the filtering procedures of LDOS, but those are made up for by such things as V2's BASIC enhancements, Superzap and other utilities, and by improved file types. Above all, V2's flexibility in supporting various system configurations and allowing compatibility between the Models I and III is outstanding.

Given my choice, I would rather own an Aston Martin than a Ferrari, but I recognize that the choice is subjective. The choice between NEWDOS/80 Version 2.0 and some of its competitors may be equally subjective, but it's one of the best operating systems ever designed. ■

**For The Best In Price, Selection and Delivery,**

**Call Now TOLL FREE  
800-368-3404**

**(In VA, Call Collect 703-237-8695)**

**AMPEX • INTERTEC • TEXAS INSTRUMENTS • GENERAL DATA  
COMM. • ANDERSON JACOBSON • C. ITOH • QUME • BEEHIVE •  
DATASOUTH • DIABLO • CENTRONICS • NEC • PRENTICE**

#### **SUPERBRAIN MICROS**

##### **INTERTEC:**

64K DD ..... **ONLY \$1975**  
64K QD ..... **ONLY \$2350**  
64K SD (96TPI) ... **ONLY \$2750**  
DDS-10 Meg  
(Hard Disk) ..... **ONLY \$3195**

##### **PRINTERS**

**DATASOUTH:** ..... Call  
**NEC:**  
7710 ..... \$2196  
7715 ..... Call for Special Price  
7730 ..... \$2196  
7720 ..... Call for Special Price  
7725 ..... Call for Special Price  
Std. Forms Tractor ..... \$ 200  
3510 ..... \$1690  
**DIABLO:** 630-R102 RO .. \$1995  
**QUME:**  
Sprint 5, 55RO ..... \$2339  
Sprint 5, 55KSR ..... Call  
Sprint 9, 45RO,  
  Limited Panel ..... \$1845  
  Full Panel ..... \$1969  
Std. Forms Tractor ..... \$ 199  
Bi-Dir. Forms Tractor ..... \$ 199

##### **CENTRONICS:**

739-1 (Parallel) ..... \$ 649  
739-3 (Serial) Call for Special Price

##### **TERMINALS**

##### **AMPEX:**

Dialogue 30 ..... \$ 775  
Dialogue 80 ..... \$ 939

##### **BEEHIVE: (SMART DISPLAY)**

DM5 ..... Call  
DM5A ..... Call  
DM310 (3101 Emulator) ..... Call

NOTE: IBM and Burroughs compatible terminals available. Please inquire.

##### **C. ITOH**

CIT 101 ..... \$1350

##### **TEXAS INSTRUMENTS:**

745 Standard ..... \$1390  
745 Std. (Reconditioned) ... Call  
810 Basic ..... \$1249  
810 Package ..... \$1439  
820 Package RO Package .. \$1610  
820 RSR Package ..... Call  
840 RO Basic ..... \$ 795  
840 RO Tractor Feed Pkg. .. \$1059

##### **COUPLERS**

STAR: 300 Baud ..... \$ 124

#### **Special! While They Last!**

##### **SOROC TERMINALS**

IQ 120	.....	<b>ONLY \$625</b>	<del>\$ 675</del>
IQ 130	.....	<b>ONLY \$525</b>	<del>\$ 575</del>
IQ 135	.....	<b>ONLY \$659</b>	<del>\$ 709</del>
IQ 140	.....	<b>ONLY \$989</b>	<del>\$1039</del>

##### **DISC DRIVES**

##### **QUME:**

Data Trak 5 ... \$325 or 2 for \$599  
Data Trak 8 .. \$549 or 2 for \$1049

##### **SOFTWARE**

BISYNC-80 RJE ..... \$ 769  
Wordstar ..... \$ 319  
Data Star ..... \$ 215  
Cobol ..... \$ 789  
Forms 2 (Cobol Gen.) .... \$ 179  
Mail Merge ..... \$ 99  
Spell Guard ..... \$ 229  
Plan 80 ..... \$ 249  
Super Calc ..... \$ 249  
Milestone ..... \$ 249

**In addition, we can make EIA RS232 or RS449 cables to your order, and supply you with ribbons, printer stands, print wheels, thumbles for all printers listed. And many, many more items. CALL NOW.**

All items shipped freight collect either motor freight or UPS unless otherwise specified. VISA and MasterCard welcomed; add 3% for credit card purchases. Virginia residents, add 4% Sales Tax. For fastest delivery, send certified check, money order or bank-wire transfer. Sorry, no C.O.D. orders. All equipment is in factory cartons with manufacturers' warranty. Prices subject to change without notice. Most items are in stock now.



**TERMINALS TERRIFIC**



Terminals Terrific, Incorporated, P.O. Box 216, Merrifield, VA 22116, 800-368-3404 (In VA, Call Collect 703-237-8695).



# EPSON

## PRINTERS & ACCESSORIES

If you buy your EPSON somewhere else you'll probably pay too much!

### Common Features of the MX80, MX80FT & MX100 Printers

- 80 characters per second
- Replaceable print head by user
- User programmable from BASIC
- Bi-directional logic seeking printhead
- 96 ASCII characters
- Programmable tabs (vert./horz.)
- Cartridge ribbons
- Self-test mode
- Tractor/pin feed paper flow
- Extreme reliability
- 12 type fonts under software control
- 9x9 & 9x18 matrix
- Programmable form feeds
- Compressed/expanded letters
- Parallel interface standard
- Double strike & emphasized modes

**MX80**....The Printer that started it all. All of the above features plus extreme ease of use. Complete TRS80 block graphics set as well as user selectable international symbols. Gives correspondence quality printing in several user selectable modes. Dip switch pins may be set for dedicated applications. Complete forms programmability from BASIC software.

**MX80FT**....All the features of the MX80 but with FRICTION feed as well for the use of single sheets of paper or roll paper. An exceptional buy for the user needing the single sheet capability. In the compressed mode 132 characters can be printed across the width of a page which means it can be used for any printouts that normally need a 15 inch wide printer.

**MX100**.... An exceptional printer with an extra quiet printhead and extra heavy duty construction for the intense use of a business environment. Does not have the TRS80 graphic blocks but comes standard with Bit-Image graphics which allow the user control of individual dots for designing specialized graphs, symbols, etc. A best buy for business use.

**MX70**....For the budget minded an excellent entry level printer. It has most all of the features mentioned above including Bit-Image graphics in place of the TRS80 graphic blocks set. The Printer is unidirectional only. Expandable text can be printed but not compressed. Only single density printings is supported on the MX70. An inexpensive heavy duty printer.

**BEST prices on Epson Printers**  
All Printers & accessories in STOCK now!!!

### EPSON ACCESSORIES, INTERFACES & CABLES

- GRAPHTRAX 80 option (bit-image/italics).....\$79
- CABLE Model I interface & Model III.....\$35
- \$25 if purchased with EPSON printer
- CABLE & INTERFACE to Model I keyboard.....\$85
- APPLE interface & cable.....\$89
- GRAPLER Apple hi resolution graphics.....\$Call
- IEEE interface & cable (CBM/Pet).....\$79
- ATARI cable (must have 850 interface).....\$35
- SERIAL RS232 2k buffered int. card.....\$149
- RS COLOR computer to Epson card/cable.....\$59

**EPSON PACK 2 - GRAFTRAX**  
version for MX80, 80FT & MX100. This package includes updated versions of modules in original Epson Pack. A screen oriented BIT IMAGE GRAPHICS generator utility is provided. Create your special characters, symbols, etc. directly on your monitor and then send to printer. Printout includes code to generate graphics and will save needed code as BASIC program line to disk. Then MERGE these into your BASIC program. Also demo programs showing use of Bit-Image graphics. Full documentation. **INTRO SPECIAL: \$24.95 with printer or GRAFTRAX. \$34.95 separately. \$7.50 for update of old Epson Pack**

RIBBONS AND CARTRIDGES IN STOCK NOW

**\$CALL 800-433-5184**

## PRINTERS

### MATRIX PRINTERS

- EPSON MX70 \$CALL
- EPSON MX80 \$CALL
- EPSON MX80 FT \$CALL
- EPSON MX100 FT \$CALL
- LINE PRINTER VII RS \$325
- NEC 8023A \$495
- C. ITOH 8510 \$495
- OKIDATA 82A \$499
- OKIDATA 82A w/tractor \$559
- OKIDATA 83A \$769
- LINE PRINTER VIII RS \$649
- CENTRONICS 739parallel \$599
- CENTRONICS 739 serial \$749
- OKIDATA 84 / 200cps \$1295
- LINE PRINTER VI RS \$988
- CENTRONICS 704 \$1559
- ANADEX 9500/01 2k buf. \$1295
- TEXAS INST. 810 Basic \$1595
- LINE PRINTER V RS \$1549
- Centronics 352 / 200 cps \$1795
- Centronics 353 / dual mode, 200cps data proc., 50cps super letter quality \$2495

### LINE PRINTERS

- CENTRONICS 6080/81 \$6399
- 600 lines per minute high speed band printer. For serious business applications.
- 6081 standard \$7676
- 6080 quietized cabinet \$6399

### LE TBR QUALITY

#### Daisy Wheel / Spinwriters

- C. ITOH F-10 / 40 cps \$1595
- DAISY WHEEL II RS \$1695
- NEC SPINWRITERS
- 3510 RS232 \$1795
- 3530 Centronics pa'el \$1795
- 7710 Read Only \$2375
- 7710 R/O w/tractor \$2575
- 7720 kybd w/tractor \$2750
- 7730 R/O parallel \$2375
- 7730 R/O par.w/tract. \$2575
- DIABLO 630 R/O \$2350
- DIABLO 630 keyboard \$2850
- QUME 9/35 R/O \$1850
- QUME 9/35 keyboard \$1950
- QUME 9/45 limited \$2295
- QUME 9/55 limited \$2395

Interfaces & cables available for most printers with any TRS80, Apple, Atari & most other computers. **\$\$\$CALL FOR PRICES!**

### HIGH RESOLUTION MONITOR

- NEC green monitor \$179
- NEC color monitor \$349

### ALTOS COMPUTERS \$CALL

# TEXAS COMPUTER SYSTEMS

Offers Lowest Prices on

# TRS-80



- ★ MODEL II 64k.....\$3248
- MODEL II 1 Drive Expansion...\$995
- MODEL II 2 Drive Expansion...\$1495
- MODEL II 3 Drive Expansion...\$1995
- Radio Shack HARD DISK.....\$3995
- TCS 1 Drive/single cabinet.....\$849
- TCS 1 Drive/triple cabinet.....\$949
- TCS 2 Drive/triple cabinet...\$1424
- TCS 3 Drive/triple cabinet...\$1899
- TCS uses original Shugart drives
- MODEL 16 1 Drive.....\$4499
- MODEL 16 2 Drive.....\$5199
- DT-1 DATA TERMINAL.....\$629

## CORVUS HARD DISKS

CALL FOR PRICES \$\$\$\$

Add 5, 10 or 20 megabytes of storage to your TRS80, Apple, Atari, Heath, Zenith, Intertec, IBM, S-100 and many others. One or several computers can share a hard disk. Get simultaneous access to data for multiple users. Available NOW at SUPER SAVINGS!

**DEALERS...You can buy CORVUS from us for less. Call & SAVE.**

## COLOR COMPUTERS

- Original mtg.warranty on these items: \$308
- 4K Level 1.....\$308
- 16K Level 1.....\$439
- 16K Extended Basic.....\$459
- 32K Extended Basic.....\$569
- Color Disk 0.....\$499
- Color Disk 1.....\$349
- TCS 180 day Limited warranty on TCS items:
- 16K Level 1.....\$369
- 16K Extended Basic.....\$439
- 32K Extended Basic.....\$499
- 32K Upgrade Kit (TCS).....\$79
- EPSON/COLOR Int.& cable.....\$59

## MODEL III SYSTEMS

- The following with Radio Shack Warranty:
- Model III 16k.....\$818
- Model III 32k.....\$918
- Model III 48k.....\$1018
- Model III 48k 2 Drives RS232.\$2049
- The following come with quality TCS memory and our own 180 day limited warranty. No warranty when customer opens computer or adds internal components.
- MODEL III 16k TCS.....\$788
- MODEL III 32k TCS.....\$818
- MODEL III 48k TCS.....\$848

## MODEL III DISK EXPANSION KITS

We use the highest quality fiberglass CONTROLLER BOARDS with double sided glass epoxy board and gold plated contacts in our TCS systems. The finest switching POWER SUPPLY available is also provided. The aluminum MOUNTING HARDWARE has slotted holes for easy installation of the drives and includes all the power and data cables necessary to install the controller, drives and power supply.

- Our DISK DRIVES are made by Tandon the same company that makes the drives used by Radio Shack. These drives are 40 track, double density, 5 millisecond stepping rate and are fully burned in for 48 hours. These drives have the same specifications as the drives used by Radio Shack. No soldering or modifications to existing circuitry is necessary. The following kits are available:
- KIT 1 Controller, Power Supply & Mounting Hardware.....\$379
- KIT 2 Controller, Power Supply, Hardware & 1 Disk Drive.....\$595
- KIT 3 Controller, Power Supply, Hardware & 2 Disk Drives.....\$819
- KIT 4 One Tandon Disk Drive (bare drive only).....\$219
- KIT 5 16k of High Quality TCS Memory chips.....\$49.95
- KIT 6 32k of High Quality TCS Memory chips.....\$79.95

## MODEL III 48k 2 DISK DRIVES ... \$1795

Above KIT fully assembled, with 48 hour burn-in test & 180 day TCS Limited Warranty!!!

## CUSTOM SOFTWARE FROM TCS

Completely Integrated BINARY SEARCH TREE programs now available. This series of programs fully implements the B-TREE structures including INSERTION, DELETION, EDITING & TRAVERSAL. No more sorting or long data file searches and yet files can be larger than memory. Duplicate keys are fully supported. Files can be retrieved in sorted order via B-TREE Traversal. Each of the programs come with fully commented source code so that you can use the modules in your own programming.

- B-TREE Library (organize your home library keyed by author).....\$39.95
- B-TREE Video (organize your video cassette library, prints labels, etc).....\$39.95
- B-TREE Mailing List (keyed by name or zip,label printing,etc).....\$49.95

For fast, efficient service. Heart of we can air freight from Dallas

## TEXAS COMPUTER SYSTEMS

P.O. Box 1327 Arlington, Texas 76004-1327

★ Toll Free Number 800 433-5184

Texas Residents 817 274-5625

Payment: Money order, cashiers or certified check. Prices above reflect 3% cash Discount. Call for Visa/MC card prices.

- Prices subject to change at any time
- No Tax out-of-state. Texans add 5%.
- Many items shipped FREE. Call for quote.

# Book Reviews

## Beneath the Apple DOS

Don Worth and Pieter Lechner  
Quality Software  
Reseda, CA, 1981  
166 pages,  
softcover, \$19.95

Reviewed by Rob Moore  
Warner Hill Rd.  
RFD #5  
Derry, NH 03038

*Beneath the Apple DOS*, by Don Worth and Pieter Lechner, is the first publication that truly explains the innermost workings of the Apple II's disk operating software.

Since the Apple Disk II first became available to the public, users have been trying to gain access to the inner DOS routines with varying degrees of success. With the exception of the low-level RWTS (read-write-track-sector) disk drive, Apple Computer Inc. has never published the source listing or any other information to help the user access the DOS internals.

The reasons for this are understandable. Many people have difficulty with assembly language and publication of the DOS information could result in a tremendous influx of phone calls to Apple from users with questions. Also, Apple's DOS represents a large development expense and the source listings are proprietary. They were never designed to be accessed internally by the casual user.

*Beneath the Apple DOS* removes most of the mystery. The book describes the operation of the Apple DOS from the file buffers at one end to the RWTS routines at the other. The book contains numerous diagrams, tables, and example listings of assembly-language programs

using DOS features that are normally inaccessible to the user. I did notice one significant error, but it doesn't affect the accuracy of the rest of the information.

Following the introduction and a short history of Apple DOS, the third chapter provides an excellent discussion of the Apple disk format. Even though much of this information has been previously published, it's presented in such a clear and organized fashion that it will be helpful even to disk "experts." After discussing tracks and sectors, the authors describe how data is actually written on the disk surface. Although the authors have an excellent grasp of the DOS software, their discussion of data bits and clock bits stored on the disk surface is almost entirely incorrect. (This was verified with Randy Wigginton, author of the DOS RWTS routine at Apple Computer Inc. For an explanation of the actual storage method see the accompanying "Apple Disk Storage" text box.) Once past the point where the authors describe the physical bit-storage method, the information is again correct (as far as I know) and very useful.

The balance of the book is excellent. The material is well organized and presented in a clear, understandable manner. In particular, Chapter Six—"Using DOS from Assembly Language"—provides all the details necessary to directly control the Apple disk, use the DOS RWTS routines, or access the disk with the DOS File Manager.

The information describing the File Manager routine has never before been published and will be invaluable to any programmer writing disk utilities or applications programs that require a special interface to DOS files. Using

## Apple Disk Storage

### FM Recording

*The disk-storage method described in Beneath the Apple DOS is called FM (or frequency-modulated) recording. This is the industry-standard single-density recording method and can typically store 80.6K bytes of memory on a standard 35-track 5¼-inch floppy disk.*

*On an FM-recorded disk, each bit of data is stored as a "clock" bit followed by the presence or absence of a "data" bit. The clock bits each define the beginning of a time "window" (or bit cell) in which a data bit may be present and are necessary to deal with the timing shifts caused by rotational speed variations.*

*While FM recording is reliable and easy to decode, it is relatively inefficient because two bits are written for each actual data bit stored. More efficient encoding*

*methods can increase the amount of usable data stored on each disk track.*

### GCR Recording

*The Apple Disk II achieves its 143K-byte storage capacity through a modified form of GCR (or group-coded recording). Rather than storing alternate clock and data bits, Apple's form of GCR assembles 6 data bits into an encoded 8-bit group and writes the group to the disk without interleaved clock bits. So, where FM recording would write 12 bits, the Apple actually writes 8 bits to gain a 50 percent increase in effective density.*

*Apple's GCR encoding rules are very well described in Beneath the Apple DOS. If all references to clock bits are disregarded, the information is correct and very useful.*

the File Manager, the programmer can easily create, open, access, and close DOS files with complete access to all of the file internals. For example, you may cue the File Manager to read or write any single byte or range of bytes within any file of any type. (The Apple FID and MUFFIN programs use the File Manager to accomplish their functions.)

The book also contains a complete list of all DOS entry points and key addresses along with descriptions of several ways to customize DOS. The authors provide five example programs to il-

lustrate direct control of the disk, use of the RWTS routines, and use of the File Manager.

For those interested, the authors briefly discuss disk-protection methods and bit copiers. The discussion is general, however, and does not describe specifically how to "break" protected disks or how to protect your own.

In conclusion, *Beneath the Apple DOS* is an excellent book. It's the only one of its type and should be part of every Apple assembly-language programmer's library. The authors deserve congratulations. ■



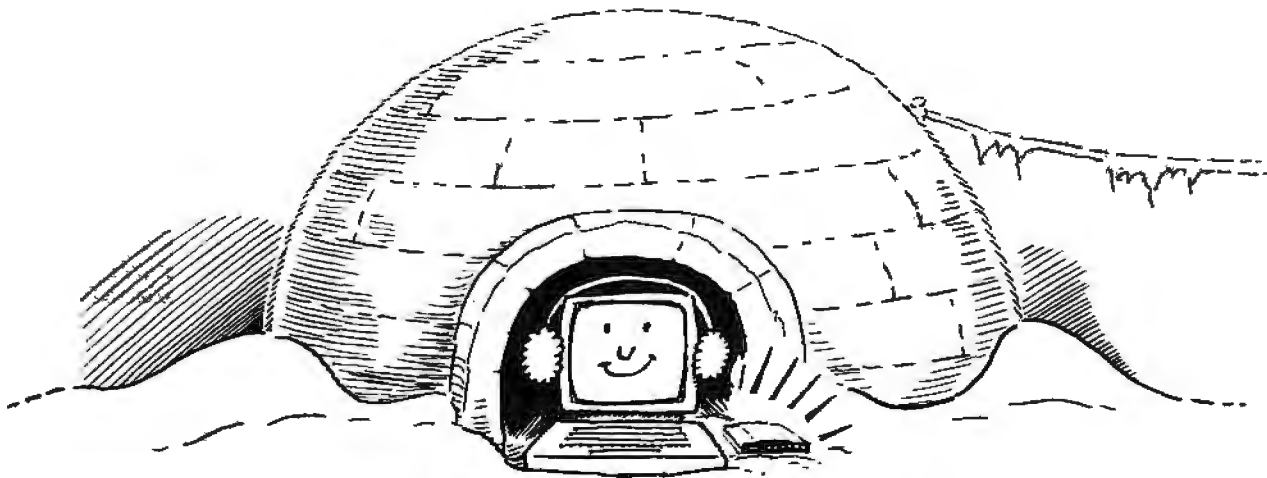

# NOW YOUR COMPUTER CAN MAKE PERSONAL-TO-PERSONAL PHONE CALLS.

## A Hayes modem makes it possible.

Your personal computer could be doing a lot more for you. It could be communicating over ordinary telephone lines with any location in North America... any time of the day or night. With the help of a Hayes modem (Smartmodem™, Micromodem II™ and Micromodem 100®), you can send and receive reports from your home or office, and exchange messages or programs with personal computer owners hundreds of miles away. You can even get the stock reports, today's *Washington Post*, airline schedules and movie reviews by subscribing to one of several information utilities. The possibilities seem endless. Modems are clearly the way of the future. And Hayes leads the way—today!

### Smartmodem is a smart buy.

When it comes to features and performance, Smartmodem tops the 300-baud modem market. With the Smartmodem, your IBM Personal Computer, TRS-80 Model II™, XEROX 820—or any computer

with RS-232C I/O—can communicate with all other computers using Bell 103-type modems. Smartmodem can answer calls, dial numbers, receive and transmit data, and disconnect... all automatically.

Many cheaper modems connect to a telephone receiver, which can cause distortions and transmission losses. Smartmodem plugs right into your telephone jack... no phone needed! And thanks to an internal speaker, you can actually listen to your connection being made. That way you'll know immediately if the line is busy or if you reached a wrong number.

No wonder Smartmodem is, well, a

smart modem. And it stacks neatly atop other Hayes peripherals, like the Hayes Stack Chronograph™ RS-232C calendar/clock.

**Micromodem II... exclusively for Apple II® owners.** The same quality and automatic features associated with Hayes Smartmodem are built right in the Hayes direct-connect Micromodem II. It's easy to see why more Apple II owners choose



**Hayes** Hayes Micromodem II than any other modem in the world.

Don't settle for anything less than Hayes... Smartmodem, Micromodem II and Micromodem 100 for S-100 bus computers. Available at computer stores nationwide.

## Put your personal computer on the line!

I'm ready to talk! Please send info on:

- Smartmodem       Micromodem 100  
 Micromodem II       Chronograph

Name \_\_\_\_\_

Address \_\_\_\_\_

City \_\_\_\_\_

State \_\_\_\_\_ Zip \_\_\_\_\_

MAIL TO: Hayes Microcomputer Products  
5835 Peachtree Corners East  
Norcross, Georgia 30092  
OR CALL: (404) 449-8791

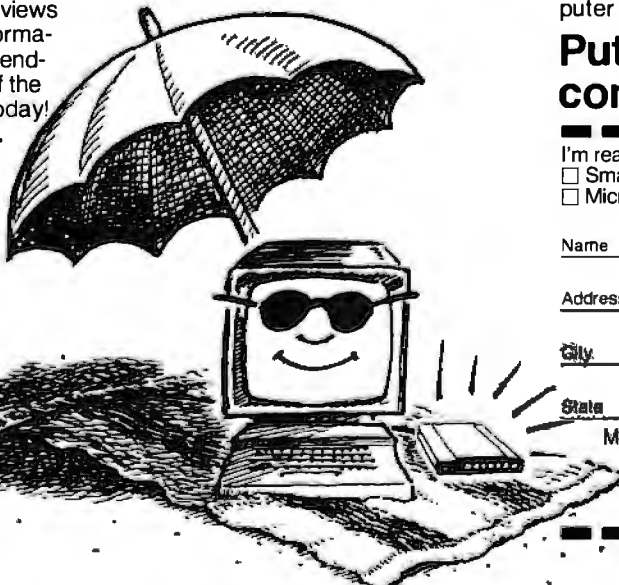

## Adapting "Harvesting the Sun's Energy" for the Commodore PET

---

Jerry Berry  
11558 East Wesley Ave.  
Aurora, CO 80014

---

My July 1981 BYTE with "Harvesting the Sun's Energy" by George Mobus (page 48) arrived just as I was completing the framework for mounting solar collectors at my home in Aurora, Colorado. I wasted no time in adapting his program, which helps determine the amount of solar energy received by a flatplate collector, to run on my PET, which uses the upgraded ROMs (read-only memories). Though the majority of the changes necessary were in the print routines, it was also necessary to replace the backslash with the PET colon for multiple statements on a single line.

The program in listing 1 directs the questions and

answers to the PET video display and then formats and directs the output to a printer (identified as device #4 on the PET IEEE-488 bus). Lines 140 to 250 perform this function and can be modified if a different output channel or device is desired. Lines 240 to 244 set up the format for the printer and assume that a formattable printer, such as the Commodore 2022, is available.

A run for my Aurora location is shown in listing 2. A comparison of this run with others at various tilt angles convinced me that 55 degrees was the best compromise between winter performance and overall yearly heat gain. ■

**Listing 1:** BASIC program adapted to run on the Commodore PET with the upgraded ROMs. It calculates the total energy falling on a flatplate collector for various combinations of tilt angle, azimuth (south = 0°), and location. This program is an adaptation of the one by George Mobus that appears in the July 1981 BYTE, page 50.

```
10 REM...COMPUTE AND PRINT DAILY SOLAR
30 REM...FLUX ON FLAT PLATE COLLECTOR
35 REM...FROM JULY 81 BYTE,G.E.MOBUS
40 RESTORE
50 CLOSE 1:CLOSE 2:CLOSE 3
60 PRINT"Q"
70 DIM I(11):F=PI/180
80 PRINT"TABLE OF BEAM RADIATION SOLAR ENERGY"
90 PRINT:PRINT
100 PRINT"ENTER DATA (DECIMAL VALUES) AS REQUESTED"
110 PRINT:INPUT "LATITUDE":L:L=L*F
120 PRINT:INPUT "TILT ANGLE":T:T=T*F
130 PRINT:INPUT "AZIMUTH ANGLE":A:A=A*F
140 OPEN 1.4
150 CMD 1
160 PRINT"Q";TAB(26);"TABLE OF SOLAR RADIATION"
170 PRINTTAB(24);"BTUS PER SQUARE FOOT PER HOUR"
171 PRINT
172 PRINTTAB(10);"LATITUDE:";L/F;"      TILT ANGLE:";T/F;"      AZIMUTH:";A/F
```



# THE FORTH SOURCE™

FORTH DISKS WITH DOCUMENTATION	PRICE	NEW	PRICE
fig-FORTH Model and Source Listing, with printed Installation Manual and Source Listing.		<input type="checkbox"/> "FORTH PROGRAMMING AIDS" by Curry Assoc. Decompiler, Subroutine Decompiler, Callfinder and Translator requires fig-FORTH nucleus. Specify CP/M, 8" or Apple 3.3, 5/4	150.00
<input type="checkbox"/> APPLE II 5 1/4	<input type="checkbox"/> 8080/Z80® 8		
<input type="checkbox"/> 8086/8088 8	<input type="checkbox"/> H89/Z89 5/4		
<input type="checkbox"/> APPLE II/III + by MicroMotion. Version 2. FORTH-79 Standard, editor, assembler, 200 pg manual, 5/4	65.00	<b>CROSS COMPILER DISKS</b>	
<input type="checkbox"/> APPLE II/III + COMBO 1 by MicroMotion. Version 2. All of the above plus floating point and HiRes Turtle graphics	100.00	<i>Allows extending, modifying and compiling for speed and memory savings, can also produce ROMable code.</i>	
<input type="checkbox"/> APPLE II by Kuntze. fig-FORTH editor, assembler, source listing and screens, 5/4	140.00	<b>Nautilus (NS), Talbot Microsystems (TM), Laboratory Microsystems (LM) and Inner Access (IA).</b>	
<input type="checkbox"/> ATARI® by Pink Noise Studio. fig-FORTH, editor, assembler, missile graphics, sound and handle drivers, 5/4	90.00	<input type="checkbox"/> CP/M (NS) 200.00	<input type="checkbox"/> IBM (LM)* 300.00
<input type="checkbox"/> CP/M by MicroMotion. Version 2.x. FORTH-79 Standard, editor, assembler. 200 pg manual, 8	90.00	<input type="checkbox"/> H89/Z89 (NS) 200.00	<input type="checkbox"/> 8086 (LM)* 300.00
<input type="checkbox"/> CP/M Combo 1 by MicroMotion. 2.x. All of the above plus floating point.	100.00	<input type="checkbox"/> TRS80/1 (NS) 200.00	<input type="checkbox"/> Z80 (LM)* 200.00
<input type="checkbox"/> CROMEMCO® by Inner Access fig-FORTH editor, assembler, 5/4 or 8	140.00	<input type="checkbox"/> Northstar (NS) 200.00	<input type="checkbox"/> CP/M (IA) 450.00
<input type="checkbox"/> H89/Z89 by Haydon. fig-FORTH Stand Alone, source, editor, assembler & tutorial on disk. 5/4	100.00	<input type="checkbox"/> 6809 (TM) 350.00	<input type="checkbox"/> Cromemco (IA) 450.00
<input type="checkbox"/> H89/Z89 by Haydon. fig-FORTH, CP/M®, source, editor, assembler, & tutorial on disk, 5/4	250.00		
<input type="checkbox"/> HP-85 by Lange. fig-FORTH, editor and assembler, 5/4	175.00		
<input type="checkbox"/> IBM® PC/FORTH by Laboratory Microsystems. fig-FORTH, editor and assembler. Manual, 5/4	90.00		
<input type="checkbox"/> IBM-Floating Point by Laboratory Microsystems. Requires PC/FORTH. Specify software or for AMD 9511, AMD 9512 or Intel 8087	100.00		
<input type="checkbox"/> IBM-Cross Compiler by Laboratory Microsystems. Requires PC/FORTH. (Nautilus Systems Model)	100.00		
<input type="checkbox"/> PET® by FSS. fig-FORTH editor and assembler, 5/4	300.00		
<input type="checkbox"/> PET® with floating point, strings, disk I/O	90.00		
<input type="checkbox"/> TRS-80/1 by Nautilus Systems. fig-FORTH, editor and assembler, 5/4	150.00		
<input type="checkbox"/> TRS-80/1 or III by Miller Microcomputer Services. MMSFORTH, FORTH-79 subset, editor, assembler, dbf-precision, arrays, utilities & applications. 210 pg. manual, 5/4	90.00		
<input type="checkbox"/> 6800 by Talbot Microsystems. fig-FORTH, editor, assembler, disk I/O, FLEX® 5/4 or 8	130.00		
<input type="checkbox"/> 6809 by Talbot Microsystems. fig-FORTH, editor, assembler, disk I/O, FLEX® 5/4; or 8	100.00		
<input type="checkbox"/> 6809 Enhanced 2nd screen editor, macroassembler, tutorial, tools and utilities, FLEX	100.00		
<input type="checkbox"/> Z80 by Laboratory Microsystems. Editor and assembler, CP/M, 8	250.00		
<input type="checkbox"/> Z80, floating point, requires Z80 above	50.00		
<input type="checkbox"/> Z80, AMD 9511 support, requires Z80 above	150.00		
<input type="checkbox"/> Z80 by Inner Access. Editor, assembler and manual, CP/M, 8	150.00		
<input type="checkbox"/> 8080 by Inner Access. Editor, assembler, and manual, CP/M, 8	100.00		
<input type="checkbox"/> 8086/88 by Laboratory Microsystems. Editor, assembler, CP/M-86®, 8	100.00		
<input type="checkbox"/> 8086/88 with floating point, CP/M-86	100.00		
<input type="checkbox"/> 8086/88 with AMD 9511 support CP/M-86	200.00		
	200.00		

ORDERS ONLY (415) 961-4103

DEALER & AUTHOR INQUIRIES INVITED

Ordering Information: Check, Money Order (payable to MOUNTAIN VIEW PRESS, INC.), VISA or MasterCard accepted. No COD's or unpaid PO's. California residents add 6 1/2 % sales tax. Shipping costs in US included in price. Foreign orders, pay in US funds on US bank, include for handling and shipping by Air: \$5.00 for each item under \$25.00, \$10.00 for each item between \$25.00 and \$99.00 and \$20.00 for each item over \$100.00. Minimum order \$10.00. All prices and products subject to change or withdrawal without notice. Single system and/or single user license agreement required on some products.

Specializing in the FORTH Language

## MOUNTAIN VIEW PRESS, INC.

PO BOX 4656

MOUNTAIN VIEW, CA 94040

(415) 961-4103

## System Notes

Listing 1 continued:

```
174 PRINT
180 PRINT:PRINTSPC(35);"SOLAR HOUR"
190 PRINTSPC(18);"MORNING";SPC(12);"NOON";SPC(10);"AFTERNOON"
200 PRINT"  MONTH";:FOR J=7 TO 12:PRINTSPC(2);J;:NEXT J
210 FOR J= 1TO 5:PRINTSPC(2);J;:NEXT J:PRINT"  TOTAL"
220 PRINTSPC(3):FOR I = 1 TO 70:PRINT"=";:NEXT I:PRINT"="
230 PRINT#1:CLOSE 1
240 OPEN 2,4,2
241 PRINT#2," 99 99999 999 999 9999 9999";
242 PRINT#2," 9999 999 999 999 999 999 99999"
244 CLOSE 2
250 OPEN 3,4,1
260 FOR Q=1 TO 12
270 READ N:H=75:P=0
280 FOR B = 1 TO 11
290 H1=H*F:GOSUB 350:I(B)=I:H=H-15:P=P+I(B)
300 NEXT B
310 PRINT#3,SPC(5);Q;:FOR Z=1 TO 11:PRINT#3,I(Z);:NEXT Z:PRINT#3,P
320 NEXT Q
330 PRINT#3:CLOSE 3
340 PRINT"END OF RUN":END
350 REM ...SUBROUTINE TO COMPUTE
360 REM...SOLAR INSOLATION PER HOUR
370 I=429*(1+(.034*COS(360*N/365*F)))
380 D=23.45*SIN(360*(284+N)/365*F):D=D*F
390 S=SIN(L)*SIN(D)+(COS(L)*COS(D)*COS(H1))
400 M=SQR(1229+(614*S)^2)-(614*S)
410 IF M>94.976 THEN E1=0:GOTO 430
420 E1=EXP(-.65*M)
430 E2=EXP(-.095*M)
440 I=I*.56*(E1+E2)
450 C=SIN(D)*(SIN(L)*COS(T)-(COS(L)*SIN(T)*COS(A)))
460 C=C+COS(D)*COS(H1)*(COS(L)*COS(T)+(SIN(L)*SIN(T)*COS(A)))
470 C=C+COS(D)*SIN(T)*SIN(A)*SIN(H1)
480 I=I*C:R=INT(I):Q=I-R
490 IF Q>.5 THEN I=R+1:GOTO 510
500 I=R
510 IF I<0 THEN I=0
520 RETURN
530 DATA21,52,80,111,141,172,202,233,264,294,325,355
READY.
```

Listing 2 is on page 408

## YOUR LAP: PERSONAL COMPUTER WORK STATION

Turn your favorite chair into a computer work station. The Northern Bytes Keyboard Lap Desk holds information to be entered right above the keyboard at an eye-pleasing angle. No neck craning. No sliding papers. No hands.

Works with all computers/keyboards up to six inches high. Easily holds an open magazine (enter programs from Byte!).

Made of light but sturdy, smokey-gray plexiglass in a flowing shape.

**\$32.95\***

Includes shipping. \*West of Mississippi, add \$2.00. Try our ten-day money-back offer. Send check or money order.

**NORTHERN BYTES**

Box 309, Spofford, NH 03462  
603/363-8908







## LASTING MEMORY™

The LASTING MEMORY™

uses byte-wide electrically

eraseable PROM's (E<sup>2</sup>PROM's) to bring ease of

firmware development and non-volatile memory to the S100

bus. An E<sup>2</sup>PROM programmer on this 32K (8 bit only) board gen-

erates all required timing and voltages. Single bytes can be erased and

written using normal memory write instructions. E<sup>2</sup>PROM's can be operated and

programmed in the same socket. All sockets also accomodate static RAM's and 2716 type

EPROM's. Prices for the LASTING MEMORY™ start at \$299 without memory IC's. Call or write for pricing on additional configurations.

For your general memory needs, remember THE LAST MEMORY™ 64 K static RAM/EPROM board for 8 bit S100 systems. Prices start at less than \$100.



**static memory systems inc.**

15 So. Van Buren Ave. Suite 209  
Freeport, Illinois 61032 (815) 235-8713  
9 A.M. to 4 P.M. Monday - Friday

MC, VISA accepted  
All prices net, FOB Freeport, IL  
OEM discounts available  
Dealer inquiries invited.

## System Notes

**Listing 2:** Sample output of the program in listing 1. By running the program for various values of tilt angle, I determined that 55 degrees provided the best compromise of winter performance and overall yearly heat gain.

### TABLE OF SOLAR RADIATION BTUS PER SQUARE FOOT PER HOUR

LATITUDE: 39.8      TILT ANGLE: 45      AZIMUTH: 0

MONTH	SOLAR HOUR											TOTAL
	7	8	MORNING			NOON		AFTERNOON			5	
			9	10	11	12	1	2	3	4		
1		66	143	207	249	264	249	207	143	66		1594
2	20	95	173	239	282	297	282	239	173	95	20	1915
3	41	116	194	259	301	316	301	259	194	116	41	2138
4	49	123	198	259	299	313	299	259	198	123	49	2169
5	49	120	190	247	284	297	284	247	190	120	49	2077
6	48	117	185	240	276	288	276	240	185	117	48	2020
7	49	119	189	245	282	295	282	245	189	119	49	2063
8	49	122	196	256	296	309	296	256	196	122	49	2147
9	41	115	192	256	298	312	298	256	192	115	41	2116
10	19	93	170	235	278	292	278	235	170	93	19	1882
11		64	140	204	246	261	246	204	140	64		1569
12		50	127	191	233	247	233	191	127	50		1449

A REFURBISHED DAISY WHEEL TERMINAL  
FOR PERSONAL COMPUTER USERS AND SMALL BUSINESSES.

# Now you can have letter-quality printing and professional features for just \$1,295\*

AJ daisy wheel printer terminals are renowned for exceptional performance, high reliability, and applications versatility. Now you can have all this for only \$1,295\* in our special limited offer.

- 30 cps *letter-quality* printing
- Changeable type faces
- Full ASCII keyboard with numeric pad
- High resolution X-Y plotting
- Complete electronic forms control
- 128-character buffer
- Asynchronous RS-232 interface
- Printwheel, ribbon cartridge, and cable included
- 30-day parts/labor warranty

And you can choose from a list of options including forms tractor, pin-feed platen, paper trays, side shelves, extra printwheels, APL keyboard and 2K buffer.

Call your nearest AJ regional office for details: San Jose, CA (408) 946-2900; Rosemont, IL (312) 671-7155; Hackensack, NJ (201) 488-2525. Or check the phone book for the number of your local AJ sales/service office.

\*Price excludes options and is subject to change without notice. Model shown includes certain options. Offer available only in the contiguous U.S.



**ANDERSON  
JACOBSON**



# BOY, IS THIS COSTING YOU.

It's really quite basic: time is money.

And BASIC takes a lot more time and costs a lot more money than it should every time you write a new business software package.

Especially when you could speed things up with dBASE II.

## **dBASE II is a complete applications development package.**

Users tell us they've cut the amount of code they write by up to 80% with dBASE II.

Because dBASE II is the high performance relational database management system for micros.

Database and file handling operations are done automatically, so you don't get involved with sets, lists, pointers, or even opening and closing of files.

Instead, you write your code in concepts.

And solve your customers' problems faster and for a lot less than with BASIC (or FORTRAN, COBOL or PL/I).

## **dBASE II uses English-like commands.**

dBASE II uses a structured language to put you in full control of your data handling operations.

It has screen handling facilities for setting up input and output forms.

It has a built-in query facility, including multi-key and sub-field searches, so you can DISPLAY some or all of the data for any conditions you want to apply.

You can UPDATE, MODIFY and REPLACE entire databases or individual characters.

CREATE new databases in minutes, or JOIN databases that already exist.

APPEND new data almost instantly, whether the file has 10 records or tens of thousands.

SORT the data on as many keys as you want. Or INDEX it instead, then FIND whatever you're looking for in seconds, even using floppies.

Organize months worth of data in minutes with the built-in REPORT. Or control every row and column on your CRT and your printer, to format input and output exactly the way you want it.

You can do automatic calculations on fields,



records and entire databases with a few keystrokes, with accuracy to 10 places.

Change your data or your entire database structure without re-entering all your data.

And after you're finished, you can protect all that elegant code with our run-time compiler.

## **Expand your clientbase with dBASE II.**

With dBASE II, you'll write programs a lot faster and a lot more efficiently. You'll be able to write more programs for more clients. Even take on the smaller jobs that were out of the economic question before. Those nice little foot-in-the-database assignments that grow into bigger and better bottom lines.

## **Your competitors know of this offer.**

The price of dBASE II is \$700 but you can try it free for 30 days.

Call for our Dealer Plan and OEM run-time package prices, then take us up on our money-back guarantee. Send us your check and we'll send you a copy of dBASE II that you can exercise on your CP/M<sup>®</sup> system any way you want for 30 days.

Then send dBASE II back and we'll return all of your money, no questions asked.

During that 30 days, you can find out exactly how much dBASE II can save you, and how much more it lets you do.

But it's only fair to warn you: business programmers don't go back to BASIC's.

Ashton-Tate, 9929 Jefferson, Los Angeles, CA 90230. (213) 204-5570.



# Ashton-Tate

©Ashton-Tate 1981

®CP/M is a registered trademark of Digital Research.

# T A F T

## Terminal Apple with File Transfer

*Low-cost telecommunication capability for the Apple II*

---

Tom Gabriele  
Cardigan Rd.  
Timonium, MD 21093

---

Has your Apple computer ever sat around alone and unused on a Saturday night? TAFT (Terminal Apple with File Transfer) is a short but useful program that turns an Apple II into a simple CRT terminal. With it, you can access the host computer at school or work and reach data in computer bulletin-board systems.

TAFT has two main functions. First, it handles the interchange of individual characters between a serial communications port, the keyboard, and the CRT display to make the Apple function as a simple terminal. Second, the program transfers the contents of text files (bidirectionally) between the Apple floppy-disk drives and the host computer disk storage.

Like any CRT terminal, your Apple can give commands to, and interchange data with, a host computer. The host computer could be located in the same building as the Apple or, with the aid of a modem (modulator/demodulator) and your telephone, it could be across the country. Rather than staying late at work to finish what you're doing on the host computer, you can have dinner with your family at home, use your Apple II to call the host computer, and finish your task later in the evening. The user load on the host computer during off hours is prob-

ably much lighter. Therefore, the host computer can give you more of its undivided attention and will exhibit faster response and throughput.

---

**TAFT ignores any input from its keyboard and communication line while it writes the contents of its receive buffer to disk.**

---

You should be able to use TAFT, without modification, as a terminal with *any* host computer. As written, however, TAFT will exchange disk files only with a DEC (Digital Equipment Corporation) VAX-11 time-sharing host computer running the standard VMS operating system. (VAX and VMS are trademarks of DEC.) But without access to a VAX-11, you can still use TAFT to exchange files with your host computer because only two of its Apple-soft statements (280 and 630) are "VAX-specific." The purpose and content of both statements are thoroughly described here, allowing you to easily modify TAFT to exchange files with other hosts.

TAFT communicates with its host computer using the RS-232 serial interface. The only hardware required by TAFT is a serial I/O (input/output) interface board. (An appropriate board is available from

Electronic Systems, POB 21638, San Jose, CA 95151, telephone (408) 448-0800.) This board provides the full-duplex (send and receive simultaneously) bipolar voltage input/output as specified by the RS-232 standard. It is available without parts as a "bare board"; with all parts as a kit; and assembled and tested. (I purchased the kit and had it assembled and working in one evening.)

The RS-232 serial interface is asynchronous, meaning that the serial sequence of bits for each character is synchronized independently—making a separate clock signal unnecessary. The data-in, data-out, and ground signals from this board may be connected directly to the host computer at one of its RS-232 ports. Alternately, the board can be attached to a modem for remote communication with the host computer.

TAFT has been extensively tested with the serial board speed set at 300 bps (bits per second), about 30 characters per second. The majority of readily available, inexpensive modems operate at this data rate and most are compatible with the Bell-103 standard. Although 30 characters per second may seem a little slow (and it is for large file transfers), it permits you to immediately monitor what the host computer is sending as it is sending it. Faster data rates flash the characters by on the screen too rapidly to be read. If the Apple is directly connected to the host computer, much faster data rates are practical.

Since the heart of the program's

---

### About the Author

*Tom Gabriele has been an electrical engineer for more than 15 years. He is interested in the application of microcomputers to music and chess.*

---



Shugart, Qume, Tandon, MPI, Siemens, Remex,  
Altos, Apple, Epson, NEC, Tally and more.

## Apple II Add-on Disk Drive\* (Runs 3.2 or 3.3 DOS)

**for only \$339.00**

### DISK DRIVES

Shugart	
SA 400	\$230
SA 450	\$285
SA 800/801	\$385
SA 850/851	\$535

Qume	
DT-8	\$479
DT-5	\$285

Tandon	
TM100-1	\$225
TM100-2	\$285
TM100-3	\$285
TM100-4	\$399
TM848-1	\$449
TM848-2	\$549

MPI	
92-M	\$389

Siemens	
FDD 200-8	\$525
FDD 100-8	\$370

Tandon Winchester	
TM 602-5MB	\$1040
TM 603-10MB	\$1199

Corvus	
5MB	\$2999
10MB	Call
20MB	for
Mirror Backup	price

### COMPUTERS

Altos	
8000-10	Call
8000-12	for
8000-14	price

### PRINTERS

Epson	
MX-80	\$469
MX 80 FT	\$569
MX 100	\$769

Tally	
MT1602	\$1399
MT1605	\$1399
MT1802	\$1699
MT1805	\$1699

NEC - Spinwriter	
Model 7710	\$2339
Model 7720	\$2690
Model 7730	\$2340
Model 7715	\$2599
Model 7725	\$3100
PC 8023	\$ 625

Data Products	
D50	\$1499

Prices are subject to change without notice.

Contact:

**P.D.S., inc.**  
PERSONAL COMPUTERS

2630 Walnut Avenue, Suite H, Tustin, CA 92680

**(714) 730-7207**

\*INCLUDES CABLE AND CABINET

character-handling portion is written in assembly language, it should be able to operate as a terminal and transfer files at speeds much higher than 300 bps. A problem could develop with high-speed file transmission from the Apple to the host if the Apple sends characters faster than the host can accept them. Some hosts will send a Control S character back to the terminal telling it to delay sending more characters. When the host can once again accept the transmission, it will send a Control Q, telling the terminal that it's okay to continue.

A problem may arise with rapid (greater than 300 bps) file transmission because TAFT ignores the host computer while it is sending the contents of a disk file. If when verifying the contents of a "high-speed" transfer you discover portions of the file missing, you may assume that the host lagged behind the Apple II. Should this occur, a simple solution is to insert a short delay (by means of a FOR . . . NEXT loop) after each line of characters is transmitted. Use the shortest delay that avoids any character loss for your host. This

problem should not arise at 300 bps operation, a data rate that should be acceptable to even the slowest host computer.

To handle high-speed file transfer from a host to the Apple, TAFT buffers (temporarily stores) the entire contents of the received file in main memory (RAM) as it is received. TAFT does not store early portions of the incoming file on disk while portions of the file are still being received. If it did store them, TAFT might lag behind high-speed transfers, losing some data as a consequence.

This design decision limits the largest file size transferable from the host computer to the Apple II. The file cannot be larger than the RAM buffer of a 48K-byte Apple II. The buffer begins at memory address 6144 (decimal) and ends at memory address 36864. Therefore, the largest file transferable to the Apple II is  $36864 - 6144$ , or 30,720 bytes (or characters), a large file by normal Apple standards. The size of a file sent from an Apple to a host is limited only by the Apple disk's capacity.

TAFT has three modes of operation: terminal mode, transmission mode (file transfer from Apple to host), and reception mode (file transfer from host to Apple).

### Terminal Mode

You will use TAFT most often in the terminal mode, where it begins operation. Terminal mode is used to sign the host on and off, to give the host any command, and to receive the host's response. The only reason to ever leave the terminal mode would be to transfer a disk file.

In the terminal mode, every character from the Apple keyboard is sent to the host immediately, except one: the Control T. When a Control T is keyed, TAFT exits from the terminal mode. The Control T was chosen to exit because this control character does not have a special function on most host computers, and "T" is a good mnemonic for file Transfer. (If your host computer supports Control T functions, you can choose another control character to exit the terminal



## The DS120 Terminal Controller makes your LA36 perform like a DECwriter® III.

The Datasouth DS120 gives your DECwriter® II the high speed printing and versatile performance features of the DECwriter® III at only a fraction of the cost. The DS120 is a plug compatible replacement for your LA36 logic board which can be installed in minutes. Standard features include:

- 165 cps bidirectional printing
- Horizontal & Vertical Tabs
- Page Length Selection
- 110-4800 baud operation
- 1000 character print buffer
- X-on, X-off protocol
- Self Test
- RS232 interface
- 20 mA Current Loop interface
- Top of Form
- Adjustable Margins
- Double wide characters
- Parity selection
- Optional APL character set

Over 5,000 DS120 units are now being used by customers ranging from the Fortune 500 to personal computing enthusiasts. In numerous installations, entire networks of terminals have been upgraded to take advantage of today's higher speed data communications services. LSI microprocessor electronics and strict quality control ensure dependable performance for years to come. When service is required, we will respond promptly and effectively. Best of all, we can deliver immediately through our nationwide network of distributors. Just give us a call for all the details.

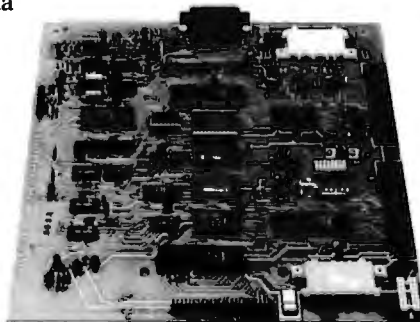

**datasouth computer corporation**

4740 Dwight Evans Road • Charlotte, North Carolina 28210 • 704/523-8500



# RM/COBOL™<sup>1</sup> MAKES IT ACROSS!

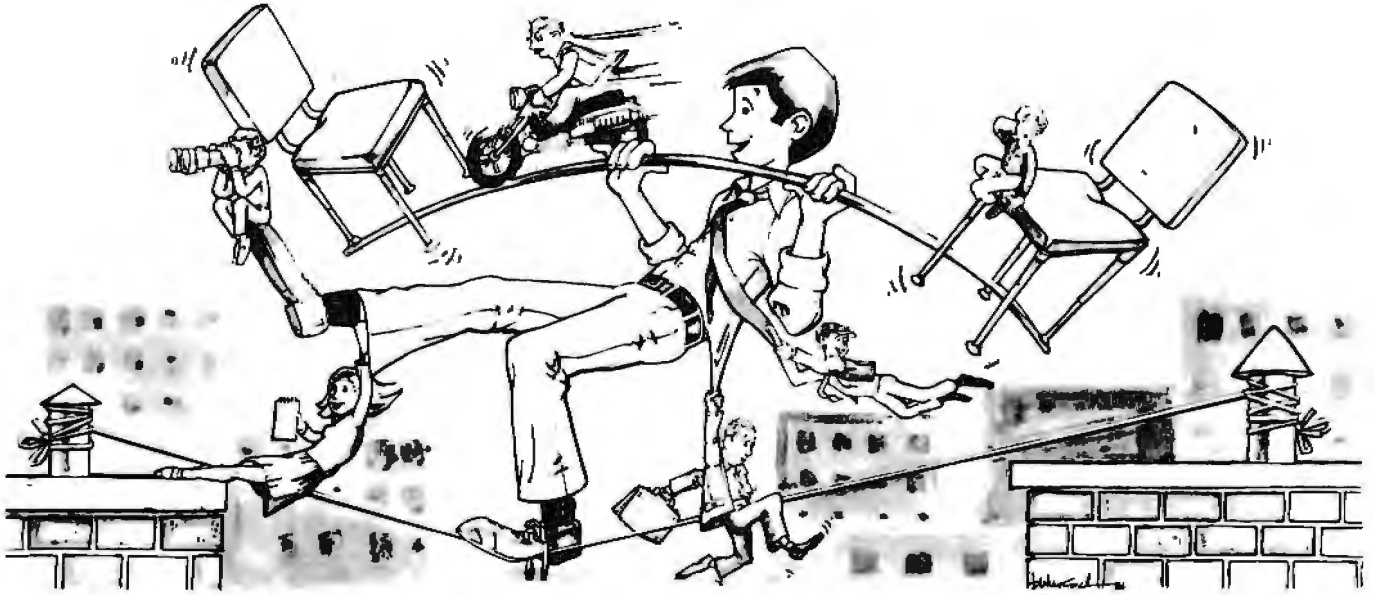

**...FROM ONE OPERATING SYSTEM TO ANOTHER!  
A VITAL WAY TO PROTECT YOUR SOFTWARE INVESTMENT FOR THE FUTURE!!**

The **RM/COBOL** language runs on more different Operating Systems and more

different-sized computers than any other similar language. For starters, it runs on NCR and TI minicomputers and, in the micro field, on the CP/M<sup>2</sup>, MP/M<sup>2</sup>, CP/M86<sup>2</sup>, MP/M-86<sup>2</sup>, TRSDOS<sup>3</sup>, OASIS<sup>4</sup>, MOASIS<sup>4</sup>, and UNIX<sup>5</sup>, (ONYX version) Operating Systems . . . to mention only a few.

Until now, serious business software of the scope and flexibility seen in the minicomputer world has not been available on micros. **RM/COBOL** now allows transfer of such software with a minimum of fuss.

We have participated in such a mini-to-micro transfer of a major set of general business software . . . using **RM/COBOL**, as the transfer mechanism, of course. Running on literally thousands of minicomputers, these refined, enhanced, and proven software packages cover A/R, A/P, G/L, P/R, Order Entry (with Invoicing and Inventory Control) as well as Sales Analysis. The Packages define a new level of achievement for features and flexibility in micro applications software and offer top quality at a reasonable price.

For immediate information, call 714/848-1922 for your complete product descriptions.

**Trademarks of:**

1-Ryan-McFarland Corp.; 2-Digital Research, Inc.; 3-Tandy Corp.; 4-Phase One Systems, Inc.; 5-Bell Telephone Laboratories, Inc.; 6-Cybernetics, Inc.

**RM/COBOL and CRT!™<sup>6</sup> from CYBERNETICS ARE GOING STEADY...**

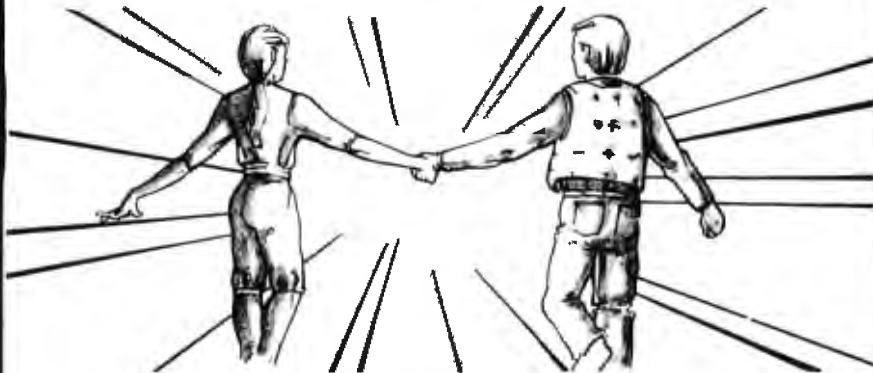

**...AND YOU'RE GONNA LOVE 'EM TOO!!**

Use your computer to program itself. **CRT!** (Cobol Reprogramming Tool!) from Cybernetics is a program generator for **RM/COBOL** that produces error-free **RM/COBOL** source programs for data input, file maintenance, and report printing programs.

A full feature interactive program generator, not a subset! Call Now! 714/848-1922.



8041 NEWMAN AVE., SUITE 208  
HUNTINGTON BEACH, CA 92647  
714/848-1922

mode. Listing 2, which is the assembly-language form of the data in lines 930-1030 of listing 1, explains how to modify TAFT to use whatever control character you choose.)

The Apple keyboard does not have three keys that are very useful in terminal-to-host communication: a delete key that removes the previous character, a horizontal-tab key, and an open-bracket key, "[". TAFT provides all three key functions by assigning these ASCII (American Standard Code for Information Interchange) values to other keys. When you press the *back-arrow* key, TAFT sends an ASCII Delete character. Press the *forward-arrow* key, and TAFT sends an ASCII Horizontal Tab character. And when you press a Control M, TAFT sends the ASCII "[" character. (The close-bracket character "]" is already available on the Apple keyboard as a shift M.)

Since an unmodified Apple can display only uppercase characters, all lowercase characters received from the host computer are automatically converted to uppercase prior to display. (If your Apple displays lowercase ASCII characters, you can defeat conversion by changing the "32" "0" in the middle of the data

statement in line 970.)

In summary, the terminal mode simply sends all keyed characters to the host and displays all characters coming from the host.

### Transmission Mode

After leaving the terminal mode (by keying Control T), you can enter the transmission mode by answering Y or YES to the first on-screen prompt, FROM APPLE TO HOST? TAFT then requests the name of the Apple source file to be transferred and the name this file will be given at the host computer. The Apple source file must be a text file.

TAFT displays each line of the file (delimited by a carriage-return character) after its transmission to the host. Any lowercase characters in the transferred file will appear as gibberish. The file transmission mode ends by displaying a brief end-of-transmission message, clearing the screen and returning to the terminal mode.

You can verify that the file was transmitted by commanding the host computer to transmit the contents of its new file back to the Apple. Since TAFT is now in the terminal mode, the received characters would be dis-

played on the Apple screen for direct verification. (Most host computers have a TYPE or similar command to do this.)

### Reception Mode

If you answer anything but Y or YES to the first prompt, the next question is whether you want to *receive* a host-resident file. If the reply is Y or YES, TAFT prompts you to input the name of the source file to be received from the host and the name by which the Apple will store the file. Any existing file with this name will be overwritten. The new Apple file will be a text file, so it can be an input file to any Apple program or sent to this or another host using the previously described TAFT file transmission mode. You can also specify whether incoming lowercase characters are to be converted to uppercase. After this final operator input, TAFT begins the file-transfer process. It sends a message to the host requesting transmission of the specified file contents. Each received character is immediately displayed to you.

Upon receiving an end-of-file character (Control Z) from the host, TAFT ignores any input from its keyboard and communication line while it writes the contents of its receive buffer to disk. This operation is performed in Applesoft, rather than machine language, so the disk-write operation requires patience. Upon completion of the Apple disk file, TAFT gives you an end-of-transmission message and automatically initiates a disk catalog so that you can immediately verify that the new file has been added. When you finish reviewing the catalog, press any key and TAFT will return to the terminal mode.

Use the following procedure to terminate TAFT operation: exit the terminal mode with a Control T, decline both transmit and receive file-transfer prompts, and respond Y or YES to the QUIT? prompt. Any other response to the QUIT? prompt will return TAFT to its terminal mode. It is important that you exit TAFT in this manner; otherwise only a small amount of memory (RAM) will be

· A\$ = operator responses and host commands to be sent to the host.
AF\$ = name of Apple disk file.
BOO = the DOS or Applesoft error number if one occurred. The value is PEEKed from location 222 (see page 114 on the Apple DOS 3.2 manual).
C\$ = utility storage for a single character and operator case-conversion decision.
C = numeric value of received character.
CA\$ = the Control A character.
CNV = operator case-conversion decision, 0 or 1.
CZ\$ = the Control Z character, indicating end-of-file to the host.
D\$ = the Control D character for accessing DOS functions from BASIC (see page 29 of the Apple DOS 3.2 manual).
HOTAP = calling address of the host-to-Apple file-transfer, machine-language program.
I = loop index.
L\$ = the line of characters currently being composed before being written to the new file or displayed.
LAST = address of the 1-byte output buffer for characters to be sent on the communication line.
OUTCHR = character-output machine-language, routine calling address.
PLACE = loop index used as the address to store machine-language code bytes.
PTR = memory address where the machine-language portion of the file-reception mode will store the address in the receive buffer of the last character received.
R\$ = the carriage-return character.
TERMA = calling address of the machine-language subroutine to implement the terminal mode; TERMinal Apple.
VF\$ = name of the host file being read or written.
X = the numeric value of a machine-language byte of code.

Table 1: The variable names and functions of TAFT.

Text continued on page 420



# TIM<sup>TM</sup> III

## The Non-Programming Approach to Data Base Management

### Data Base Management

Data management packages were created to save time and money in the development of software solutions to information problems. Many have been designed to accomplish just that, although most have only the programmer in mind. Sure they would save time in the long run, but what of the initial investment in time and effort required to learn the new language? What about the non-programmers in the world who would like an easy yet powerful applications generator? The solution is one of the most highly acclaimed software packages of our time, T.I.M. III.

### What is T.I.M.?

T.I.M. is **Total Information Management**. Programmers love it due to its original solutions to classic data management problems. Non-programmers adore it since they can use it to achieve the same results as with other more complicated programming-like packages.

### What Makes T.I.M. So Simple to Use?

We at Innovative Software, Inc. designed T.I.M. from day one with the end user in mind. Maybe he is a programmer who doesn't have time to learn a new language. Or perhaps a neophyte who fears coding pads and lines numbered by tens. We felt that a data management package should be able to be used by anyone from a systems analyst to a secretary. That's why T.I.M. takes a full *menu-driven* approach, uses multiple *HELP* screens, and has a manual that sets a new standard in documentation.

### The Manual

Many people believe that the manual is just as important as the software itself, a view that we at Innovative Software, Inc. tend to share. The manual for T.I.M. is divided into two sections, the Reference section and the Primer. The Reference section describes all of T.I.M.'s commands and subcommands. This is done in English, not in technical terms or in our own language. Even if you have

never seen a computer before in your life, you'll be able to read and understand our manual immediately. The second section is a primer which goes through several examples for you, again in plain English. These true-to-life examples take the beginner by the hand, and instructs him what to do and when. You will be able to see for yourself that T.I.M.'s only limitation is the imagination of the user.

### Features of T.I.M.

T.I.M. has all of the features one has come to expect from a data management package, as well as many new ones. For example, a *word processing* interface that allows you to merge information from a T.I.M. file with letters or other documents created by a word processor. Now you can automatically send personalized letters to hundreds or thousands—quickly and easily. T.I.M.'s *Select* command enables you to pull specific information from a file. For example, "All customers who live in a certain ZIP code, whose last name begins with the letter A to L, whose balance due is less than \$50.00." A sophisticated *report generator* and even a *list generator* are also included.

How powerful is T.I.M.? With a maximum record size of 2400 characters and the ability to keep up to forty fields sorted properly at all times, T.I.M. is powerful enough to handle just about any application. T.I.M. can handle over 32,000 records per file, and two files can be linked together for reports if your application requires a many-to-one relationship. T.I.M. also includes all of the same editing commands as your word processor, thus making data entry and editing a snap. You can also pull selected records from one file to place them into another. Files may be restructured to add or subtract fields and/or change field lengths or types. T.I.M. even has it's own utility for backing up hard disks onto floppies.

### Where to Find T.I.M.

T.I.M. is available from many fine computer dealers across the country. Or you may purchase from us direct by calling 913/383-1089.

Either way you will have the finest data management program available.



Available for CP/M,\* and IBM PC DOS.\*\*

CP/M version—\$695. IBM PC version—\$495.

Innovative Software, Inc.

9300 W. 110th Street, Suite 380  
Overland Park, Kansas 66210 USA  
913/383-1089

TIM is a Trademark of Innovative Software, Inc.  
\*CP/M and MP/M are Trademarks of Digital Research  
\*\*Trademarks of IBM

Listing 1: TAFT (Terminal Apple File Transfer) program written in Applesoft BASIC.

```

10 REM *****
20 REM **  T A F T          **
30 REM **  Terminal Apple   with **
40 REM **      File Transfer **
50 REM **  by Tom Gabriele   **
60 REM *****

70 HIMEM: 6143: REM  $17FF
80 PTR = 254: REM  $FE
90 D$ = CHR$ (4):R$ = CHR$ (13):CA$ = CHR$ (1):CZ$ = CHR$
(26)
100 OUTCHR = 36959: REM  $905C = OUTPUT ROUTINE CALLING
ADDRESS
110 LAST = 36973: REM  $906D = STORAGE ADDRESS FOR OUTPUT
CHARACTER
120 HOTAP = LAST + 1
130 TERMA = 36864: REM  $9000 = ALC STARTING ADDRESS
140 GOSUB 930
150 HOME : PRINT "ENTERING HOST TERMINAL MODE."
160 CALL TERMA: REM  TRANSFER TO ALC
170 INPUT "FROM APPLE TO HOST? (Y/N)";A$
180 IF LEFT$ (A$,1) = "Y" THEN 260
190 INPUT "FROM HOST TO APPLE? (Y/N)";A$
200 IF LEFT$ (A$,1) = "Y" THEN 570
210 INPUT "QUIT?";A$
220 IF LEFT$ (A$,1) < > "Y" THEN 150
230 HIMEM: 38400
240 PRINT : PRINT "GOOD-BYE!": PRINT
250 END
260 INPUT "APPLE SOURCE FILENAME?";AF$
270 INPUT "HOST DESTINATION FILENAME?";VF$
280 A$ = "CREATE " + VF$ + R$
290 FOR I = 1 TO LEN (A$)
300 POKE LAST, ASC ( MID$ (A$,I,1))
310 CALL OUTCHR
320 NEXT I
330 ONERR GOTO 520
340 PRINT D$;"OPEN ";AF$
350 PRINT D$;"READ ";AF$
360 L$ = ""
370 GET C$
380 POKE LAST, ASC (C$)
390 CALL OUTCHR
400 IF C$ = R$ THEN GOTO 430
410 L$ = L$ + C$
420 GOTO 370
430 PRINT R$;D$
440 PRINT CA$;L$
450 GOTO 350
460 REM  EOF DETECTED, FINISH TRANSFER
470 POKE LAST, ASC (CZ$)
480 CALL OUTCHR
490 GOSUB 920
500 FOR I = 1 TO 500: NEXT I
510 GOTO 150
520 BOO = PEEK (222)
530 PRINT D$;"CLOSE ";AF$
540 IF BOO = 5 THEN GOTO 470
550 PRINT "ERROR NUMBER ";BOO;" OCCURRED."
560 GOTO 470
570 REM  FILE TRANSFER FROM HOST TO APPLE
580 INPUT "HOST SOURCE FILENAME?";VF$

```

Listing 1 continued on page 418



# **POPULAR COMPUTING** is making computing more popular . . . and simple . . . and enjoyable! Month after month after month.

Here it is! A magazine that provides the computer news, how-to's, and feature articles necessary for you to keep abreast of how computers do, and will, affect your work and your play. Best of all, it's delivered in plain language, without technical razzmatazz and jargon.

POPULAR COMPUTING is so exciting, so important, so informative, that everyone will fully understand what's really happening. Every issue is enriched with dollar-saving product reviews, special news briefs, and feature articles by famous contributors (like Isaac Asimov).

POPULAR COMPUTING is a magazine that must be read to be truly relished. That's why we've mounted a . . .



## **SPECIAL INTRODUCTORY OFFER**

that enables you to try  
POPULAR COMPUTING  
at **NO RISK** whatsoever.

# **POPULAR COMPUTING**

P.O. Box 307  
Martinsville, NJ  
08836



SUPER SAVINGS FOR ME...I'm enclosing my check or credit card number to take advantage of this super introductory offer of 12 issues for only \$11.97 saving me \$3.03 on the basic rate of \$15.00—and saving me \$18.03 off the newsstand rate of \$30.00. If my 30-day review of your first issue doesn't 100% please me, I may cancel my subscription and you will promptly refund ALL my money or give me a FULL credit on my charge card marked below:

Mail Today to: **POPULAR COMPUTING** P.O. Box 307 Martinsville, NJ 08836

Bill me at \$12.97     Check Enclosed for \$11.97  
 Charge \$11.97 to:     Visa     Mastercard

Card No. \_\_\_\_\_

Signature \_\_\_\_\_ Expires \_\_\_\_\_

Name (Please Print) \_\_\_\_\_

Address \_\_\_\_\_

City \_\_\_\_\_ State \_\_\_\_\_ Zip \_\_\_\_\_

Please allow six to eight weeks for processing

7B6Z

Listing 1 continued:

```
590 INPUT "APPLE DESTINATION FILE?";AF$
600 CNV = 0
610 INPUT "UPPER CASE CONVERSION? (Y/N)";C$
620 IF LEFT$(C$,1) = "Y" THEN CNV = 1
630 A$ = "@TYPAPL " + VF$
640 FOR I = 1 TO LEN (A$)
650 POKE LAST, ASC ( MID$ (A$,I,1))
660 CALL OUTCHR
670 NEXT I
680 FOR I = 1 TO 1000: NEXT I: REM DELAY FOR ECHO OF COMMAND
IN 560 TO CLEAR.
690 POKE LAST,CNV
700 CALL HOTAP
710 UL = 256 * PEEK (PTR + 1) + PEEK (PTR)
720 ONERR GOTO 890
730 PRINT D$;"OPEN ";AF$
740 PRINT D$;"DELETE ";AF$
750 PRINT D$;"OPEN ";AF$
760 PRINT D$;"WRITE ";AF$
770 L$ = ""
780 FOR I = 6144 TO UL: REM STARTS AT HIMEM+1
790 C = PEEK (I)
800 IF C < > 13 THEN L$ = L$ + CHR$ (C): GOTO 820
810 PRINT L$:L$ = ""
820 NEXT I
830 PRINT D$;"CLOSE ";AF$
840 PRINT D$: GOSUB 920
850 PRINT D$;"CATALOG": PRINT D$
860 PRINT "PRESS ANY KEY TO CONTINUE."
870 GET C$
880 GOTO 150
890 BOO = PEEK (222)
900 PRINT "ERROR NUMBER ";BOO;" OCCURRED."
910 GOTO 830
920 PRINT : INVERSE : PRINT "END OF TRANSFER.": NORMAL : PRINT
: RETURN
930 DATA 173, 145, 192, 41, 128, 240, 17, 32, 56, 144, 173,
144, 192, 32, 63, 144
940 DATA 9, 128, 32, 240, 253, 32, 51, 144, 44, 0, 192, 16,
227, 173, 0, 192
950 DATA 44, 16, 192, 201, 148, 240, 55, 32, 74, 144, 141,
109, 144, 32, 95, 144
960 DATA 76, 0, 144, 169, 96, 76, 58, 144, 169, 160, 164, 36,
145, 40, 96, 201
970 DATA 97, 144, 6, 201, 123, 176, 2, 73, 32, 96, 201, 157,
208, 3, 169, 91
980 DATA 96, 201, 136, 208, 3, 169, 127, 96, 201, 149, 208,
2, 169, 9, 96, 173
990 DATA 145, 192, 41, 1, 240, 249, 173, 109, 144, 141, 146,
192, 96, 0, 169, 24
1000 DATA 133, 255, 160, 0, 132, 254, 174, 109, 144, 169, 13,
141, 109, 144, 32, 95
1010 DATA 144, 32, 164, 144, 32, 164, 144, 201, 26, 240, 22,
224, 0, 240, 3, 32
1020 DATA 63, 144, 145, 254, 9, 128, 32, 240, 253, 200, 208,
232, 230, 255, 76, 132
1030 DATA 144, 132, 254, 96, 173, 145, 192, 41, 128, 240,
249, 173, 144, 192, 96
1040 FOR PLACE = TERMA TO TERMA + 175 - 1
1050 READ X: POKE PLACE, X
1060 NEXT PLACE
1070 RETURN
1080 REM (C) 1981 by Tom Gabriele
```



# Computer Exchange

ALL MAIL: P.O. Box 1380, Jacksonville, OR 97530

DEALER INQUIRIES INVITED

WAREHOUSE AND OFFICES, BY APPOINTMENT AT 6791 APPLGATE ROAD.

Ad # 932B

## HARDWARE for Apple II/II+



## apple supply center

★ STAR INDICATES BEST BUYS

★ Apple II 48K or 64K Disk II W/or W/O controller	CALL	CALL
Apple II 128K	CALL	CALL
Apple III Profile 5 Meg H.D.	\$2950	16%
Apple Interface Cards	\$2499	30%
Silentype	CALL	50%
	CALL	30%

### Direct Substitute for Apple Drives

Micro-Sci A2 is a direct substitute for Apple II drives. It will run all Apple II software. Save \$350 on a dual A2 disk system.

Micro-Sci 5" Drives for Apple II	SAVE
A2 Drive, 5", 143K	\$ 395 18%
Controller Card for A2	\$ 95 15%
A70 Drive, 5", 286K	\$489 20%
A40 Drive, 5", 160K	\$369 18%
Controller Card for A70 or A40	\$ 79 21%

### MONITORS:

NEC	12" Color	\$359	24%
	12" Green	\$169	22%
SANYO	9" B&W	\$149	31%
	9" Green	\$159	31%
	12" B&W	\$219	30%
	12" Green	\$229	30%
	13" Color	\$399	28%
ZENITH	12" Green	\$119	20%

### DISKETTES, 5", box of 10:

Memorex	\$ 25	45%
Maxell	\$ 39	33%
Dysan	\$ 45	20%

### 80 COLUMN VIDEO CARDS:

Videx Videoterm	\$249	18%
M&R Sup R Term	\$295	22%
ALS: Smarterm	\$269	30%

### MISCELLANEOUS:

CCS: Serial Interface 7710A	\$139	22%
Other CCS Cards In Stock,	CALL	CALL
Hayes: Micromodem II	\$289	25%
Smartmodem	\$229	20%
ISC Videostick Paddle	\$ 35	23%

### Keyboard Company:

Joystick II	\$ 45	10%
Game Paddle	\$ 25	17%
Numeric Keypad	\$119	21%
M&R: RF Modulator	\$ 25	27%
Sup R FAN	\$ 39	25%

★ Microsoft: Z80 Softcard	\$279	33%
16K RAM Card	\$159	20%
Softcard Premium Pack	\$579	25%

Mountain:		
CPS Multifunction Card	\$209	13%
Clock/Calendar	\$195	30%

Novation Applecat Modem	\$329	16%
Orange Micro Grappler	\$129	21%
Dan Paymar LCA New rev.	\$ 34	33%

Saturn Systems: 32K RAM Card	\$189	24%
64K RAM Card	\$359	16%
128K RAM Card	\$509	15%

★ SSM AIO Serial/Para. Interface	\$159	20%
ALS: Smarterm 80 Col Card	\$269	30%
Z-Card (Z-80)	\$209	22%
Addram 16K Card	\$119	20%
Synergizer Package	\$549	27%

★ Videx Videoterm 80 col.	\$249	28%
Soft Video Switch	\$ 25	29%
Enhancer II	\$ 99	34%
Full Videx Line, Call	up to 35%	

PAPER:	Fan Fold, Call for sizes, thickness and prices	
--------	--	--

LETTER QUALITY PRINTERS:	SAVE	
Qume Sprint 9 45RO	\$2195	23%
Sprint 5 45RO	\$2395	20%

NEC 3510 RO Serial	\$1995	20%
TEC Transtar 140	\$1495	12%

Olympia (Typewriter/Printer)		
ES-100, 18CPS, with full cable and interface to Apple II	\$1295	24%

PRINTERS:		
Epson, See special Epson section at right		
Integral Data		

Prism 132, Color Printer w/Graphics	\$1695	16%
Prism 80, Color, ASF, W/Graphics	\$1395	19%
445 Tiger W/Graphics & 2K	\$ 695	23%
560 Tiger W/Graphics	\$1095	22%
Okidata Microline 82A	\$ 495	25%

ORDERING INFORMATION:		
Minimum order \$100. Cashiers Checks and Money Orders welcomed. Personal Checks allow 20 days to clear. Add 3% for shipping, insurance and handling. UPS is standard. Additional 7% for US Postal or APO. Additional 3% for VISA or MC. Include telephone #. No COD. Prices subject to change and type errors. Call to verify. Order desk hours are 8 to 6 PST, 10 to 3 Saturdays.		

## Apple Software: SAVE

★ 50% off Apple III Software	50%
The Controller	\$ 425 32%
Dow Jones News & Quotes	\$ 42 50%
How to!	\$ 25 50%
Microcourier	\$189 24%
Many others	CALL

Applied Software Technology	
Versa Form	\$289 26%
Artsci Magic Window	\$ 75 25%

Ashton-Tate CP/M dBase II for Apple II	\$495 30%
Beagle Bros. DOS Boss	\$ 18 25%

Broderbund Software:	
★ Payroll	\$269 30%
General Ledger	\$349 30%
Apple Panic	\$ 21 30%
Arcade Machine	\$ 32 30%
Red Alert	\$ 21 30%
Space Warrior	\$ 18 30%
Many Others In Stock	CALL

Budgeco Raster Blaster	\$ 22 27%
Cal. Pacific Ultima	\$ 30 25%
Cavalier Computer Bug Attack	\$ 23 23%

Central Point Software:	
★ Copy II Plus ver. 4	\$ 35 10%

Will copy most copy protected software for your backup in 45 seconds! NEW

Continental Software:	
Home Accountant	\$ 56 25%
Home Money Minder	\$ 26 25%

Data Most:	
Snack Attack	\$ 22 25%
Thief	\$ 22 25%

Denver Software:	
Financial Partner	\$185 25%
Epson MX 80 Graphics Dump	\$ 9 30%
Edu-Ware Compumath	\$ 29 25%

Fox & Geller:	
Quickscreen for dBaseII	\$129 13%
Quickcode for dBaseII	\$259 13%
Hayden: Sargon II (chess)	\$ 29 22%
Apple Pie (specify sup.)	\$ 99 25%

High Technology:	
★ Job Control System	\$ 469 40%

Howard Software:	
Tax Preparer 1982 ver.	\$115 25%
Real Estate Analyzer	\$149 25%
Creative Financing	\$149 25%

## SOFTWARE on disk for Apple II/II+

Infocom Zork II Info Unlimited	\$ 29 30%
Easywriter (PRO)	\$139 25%

Innovative:	
★ Apple Spellguard CP/M	\$150 50%
Insoft:	
Electric Duet NEW	\$ 26 20%
ALD System II or III	\$110 10%
TRANSFORTH II or III	\$110 10%
★ Insoft Accountant CP/M	\$355 66%
GrafORTH NEW!	\$ 69 25%

ISA Spellguard	\$219 25%
Lighting Software Mastertype	\$ 29 25%
LJK Letter Perfect	\$112 25%

Micro Lab:	
Dala Factory, ver. 5.0	\$ 249 20%
Invoice Factory	\$129 35%
Tax Manager	\$ 95 38%

Micro Pro All CP/M	
★ Word Star	\$239 36%
Mail Merger	\$ 79 36%
Spell Star	\$159 36%
Data Star	\$189 36%
Calc Star	\$189 36%
Super Sort	\$129 36%

Microsoft:	
A.L.D.S.	\$110 10%
BASIC Compiler	\$299 25%
Cobol80	\$559 25%
Fortran 80	\$149 25%
Olympic Decathlon	\$ 24 24%
TASC Compiler	\$159 22%
Typing Tutor II	\$ 19 30%

Muse:	
Super Text II	\$113 25%
Castle Wolfenstein	\$ 23 25%
Robot War	\$ 29 25%

Omega Microwave:	
Locksmith Rev 4.0	\$ 75 25%

On-Line:	
Expediter II	\$ 95 27%
Superscribe II	\$ 59 26%
Lisa 2.5	\$ 22 25%
Pegasus II	\$ 30 25%
Threshold	\$ 26 25%
Cranston Manor	\$ 15 25%
Mission Astroird	\$ 19 25%
Mystery House	\$ 22 25%
Softporn	\$ 22 25%
Ulysess	\$ 22 25%

Osborne/C.P. Soft. (Disk and Book)	
★ Some Common Basic Programs, 75 Business, Statistics and Math programs for the Apple II	\$ 49 50%

Peachtree Software All CP/M	
Magic Wand	\$ 250 37%
CL, AR, AP, PR or Inv	\$ 189 38%

Personal Software/VisiCorp:	
VisiCalc 3.3	\$ 189 25%
VisiDex	\$ 199 25%
VisiFile	\$ 199 25%
Desktop Plan II	\$ 199 25%
VisiPlot	\$ 159 20%
Desktop Plan III	\$ 199 35%
VisiSchedule	\$ 239 20%
VisiTrend and VisiPlot	\$ 239 20%
VisiTerm	\$ 79 20%
Zark	\$ 33 20%

Soft/Sys Inc.	
Executive Secretary-WP	\$ 189 25%

Softech Int'l:	
★ Stockfile	\$ 250 60%
Stockseller	\$ 423 30%

Software Publishing:	
PFS II or III	\$ 69 26%
Report II or III	\$ 69 26%
Sorcim Supercalc	\$ 219 25%

Southwestern Data:	
ASCII Express	\$ 59 25%

Stoneware:	
DB Master (new version)	\$179 22%
DB Utility	\$ 75 10%
Sub Logic Flight Simulator	\$ 28 20%
Tymac Super Pix	\$ 20 20%

**OTHER BRANDS IN STOCK:**  
Accent, Adventure International, Astar, Auto. Sim., Avalon, Avant-Garde, Beagle, CPU, Datasoft, Delta, Edu-Ware, Info Com, Lazer, LJK, Phoenix, Quality, Sensible, Sentient, Sirius, Strategic, Synergistic and United.

### CP/M Software 8" and 5"

All Ashton-Tate, Insoft, Micro Pro, and Peachtree CP/M software available for most 5" and 8" drives, and computers at similar discounts.

IBM® 3101-10 Terminal	CLOSEOUT SAVE	\$ 995 30%
-----------------------	---------------	------------

Commodore VIC-20 Home Computer	\$249 16%
--------------------------------	-----------

INTERTEC DATA SYSTEMS SUPERBRAIN 64K QD	While They Last	\$2595 36%
---	-----------------	------------

HP HEWLETT H/P 85A PACKARD	★ \$1,995
----------------------------	-----------

H/P 85 Microcomputer/Monitor/Printer	\$1995 27%
H/P 87 CP/M Microcomputer NEW!	\$1995 20%
H/P 125 CP/M Microcomputer NEW!	\$1995 27%
H/P 82901M 5" Dual Drives	\$1850 27%
H/P 7225B Professional Graphics Plotter	\$2060 25%
H/P 7470A Graphics Plotter	\$1249 19%
H/P 41C Calculator	\$ 185 25%
H/P 41CV Calculator 2.2K	\$ 245 25%
Full Accessories and Software Line	CALL

EPSON PRINTERS	SAVE
MX80	\$ 449 31%
MX80 FIT	\$555 25%
MX100 F/T w/graphics	\$ 729 27%
70, 80, 100 Apple Interface and Cable	\$ 85 15%
MX80 Friction feed adapter	\$ 59 22%
MX80 Graftrax Chip	\$ 79 20%

Corvus	
6 Meg Hard Disk	\$2250 38%
11 Meg Hard Disk	\$3950 25%
20 Meg Hard Disk	\$4775 25%
Apple Interface	\$ 179 40%
Other Interfaces, Omni-Nel, Constellation, Mirror, All In Stock	



800 16K	\$ 666 17%
400 16K	\$ 333 26%

Microtek 16K RAM	\$ 75 25%
Microtek 32K RAM	\$149 25%
410 Recorder	\$ 79 17%
810 Disk Drive	\$449 26%
850 Interface	\$169 25%

Other Hardware	20 to 30%
Full Line of Software	25%

Visicalc	\$159 21%
Pac Man Avail 5/82	\$ 34 25%
Communicator Kit	\$345 25%
Educator Kit	\$129 27%



NEC Microcomputer	SAVE
8001 32K Computer	\$ 750 25%
286K Total Dual Drive PC8031	\$ 750 25%
32K add-on and I/O Unit PC8012	\$ 495 24%
Ren Tec "The Wedge" 32K	\$ 495 17%
8023 Impact Printer F/T	\$ 595 25%
Impact Printer Cable	\$ 49 25%
3510 Letter Qual. Printer	\$1995 20%
NEC PC Software	CALL



ACE 100 Features	
• Apple II Software Compatible	ACE
• Apple II Hardware Compatible	100
• 64K of RAM	
• Built-in 12 Key Numeric Pad	
• Upper/Lower Case	
• 50 Watt Power Supply	
<b>\$1195</b>	

Note: The Ace 100 has all the features of the Apple II+ plus the last four features listed above, but no color.

NO SALES TAX Oregon Order Desk (503) 772-3803

TOLL FREE NATIONAL ORDER DESK (800)547-1289



Call for references. Apple is a registered trademark of Apple Computer, Inc.

Ad # 932B

available to the next program to be run. (Before terminating TAFT operation, you should remember to sign off or log off the host computer.)

### Understanding TAFT

Discussion of the program in listing 1 is divided into four parts:

- Initialization of constants and POKEing the machine-language code into high memory
- Terminal mode
- File transfer from Apple to host computer
- File transfer from host computer to Apple

The Applesoft BASIC statements used to implement each of these four parts are described next so you can master the programming techniques used and modify TAFT to your own needs (see listing 1).

### Initialization

Line 70 causes the TAFT program to be stored below memory location 6144. This insures that locations at and above that address are free to hold the machine-language code and the file-transfer receive buffer. Should the user make any significant additions to TAFT, it is necessary to increase the number of the memory address, in this case, 6143. For convenience, that number should always be one less than an even multiple of 256 (in this case,  $6143 = 24 \times 256 - 1$ ). If this number is changed, two other constants in lines 780 and 990 must also be changed. The lower limit of

the FOR . . . NEXT loop in line 780 must be the even multiple of 256; in this case, 6144. The last number in the data statement in line 990 must be the integer multiplier of 256; in this case, 24.

Line 80 defines the memory address where the machine-language portion of the file-reception section stores the address of the last character received. The address is held in the receive buffer for later use by its Applesoft portion. This 2-byte character address is stored in the two highest memory locations in page 0 of Apple memory, locations 254 and 255 (see table 1 for all TAFT variables).

Line 90 initializes control-character variables. CZ\$ contains a Control Z character, which is used as an end-of-file character. This is a very common convention. In the unlikely event that your host computer requires a different end-of-file character, simply change the "26" in this statement to the decimal equivalent of the alternate control character (once its most significant bit is set to zero).

Line 100 defines the address of the machine-language subroutine used to output a character on the serial communication line.

Line 110 defines the address of the character to be output by the machine-language subroutine located at OUTCHR. To send a character, TAFT simply POKES the character's ASCII code into location LAST and CALLS OUTCHR.

Line 120 defines the CALLing address of the host-to-Apple machine-language subroutine, HOTAP. This address is located immediately after the 1-byte character buffer LAST.

Line 130 defines the calling address of the terminal-mode machine-language subroutine TERMA. The machine-language code stored at (and above) this address contains references to its own location and is therefore said to be *nonrelocatable*. This means that the machine code cannot be moved in memory and that the values of TERMA, OUTCHR, LAST, and HOTAP defined in this line and previous lines cannot be changed without major modifications to lines 930 to 1030.

Line 140 calls the Applesoft subroutine to store machine-language code.

Lines 920-1030 contain the 175 decimal equivalents of machine-language code to be stored in sequential memory locations. To change the character to exit from the terminal mode, you must change the "148" in line 950. To determine the new value, turn to page 7 of your Apple II Reference Manual and consult the table listing all Apple keys and their associated ASCII codes. The "\$" before each two-character entry means that each code is given in hexadecimal notation, so a conversion from hexadecimal to decimal is required. For example, the Control T entry is "\$94". Take the more significant character, multiply it by 16, and add the less significant character to that product. In this example,  $9 \times 16 + 4 = 148$ . This is the origin of "148" in line 950. Those interested in 6502 assembly language can review the assembly-language listing of the program that produced these 175 values (see listing 2). The listing is thoroughly commented, so even if you have no assembly language experience, you should be able to follow what the machine-language portion of TAFT is doing. This program uses ROM-based subroutines at high addresses in Apple memory to do such things as display a character on the Apple screen. (A complete listing of the contents of this ROM-based monitor begins on page 155 of the Apple II Reference Manual.)

For TAFT to use it, the serial I/O board must be installed in slot 1 of the Apple. If the slot is already in use, five values must be changed in these data statements to permit installation of the serial board in another slot. Add 8 to the slot number that you wish to use and multiply that sum by 16. (In the case of slot 1, this final product is 144.) The new value must replace the 144 near the end of statement 1030 and the 144 in statement 930, between the 173 and the 192. Add 1 to the product computed above. This new value must replace 145 in statements 930 and 1030. Finally, add 2 to the product com-

Symbol Table			
SLOT	\$01	INPORT	\$C090
STATUS	\$C091	OUTPRT	\$C092
CH	\$24	BASL	\$28
PTRLOW	\$FE	PTRHI	\$FF
START	\$9000	DOWN	\$9018
UNFLSH	\$9038	INCONV	\$903F
MSBLAB	\$9010	FLASH	\$9033
ENDOUT	\$905E	OUTCON	\$904A
LAST	\$906D	OUTCHR	\$905F
FLDWN	\$903A	ENDINC	\$9049
DELETE	\$9051	TAB	\$9058
HOTAP	\$906E	INCHR	\$90A4
CLOOP	\$9084	ENDHST	\$90A1
		NOCONV	\$9092

**Table 2:** Symbol table for listing 2, showing subroutine labels and their assigned locations in memory.



Get Omni quality  
for as little as \$1.99...  
even if all you  
want is a  
10 pack.

Call toll-free for great savings on Omni's complete line of 5 1/4" premium disks. Each is certified error-free at a minimum of twice the error threshold of your system. Each is rated for more than 12 million passes without disk-related errors or significant wear. And each is precision fabricated to exceed all ANSI specifications with such standard features as reinforced hub rings and Tyvec sleeves. Get same day shipment and an unconditional, no hassle money-back guarantee.

## ARCHIVE

23 Alvarado Ave., Worcester, MA 01604  
(800) 343-0314; In Mass:  
(617) 756-2960



Call toll free  
(800) 343-0314  
In Mass: (617) 756-2960

Call if you're not sure which disk is compatible with your system. Call for prices on 96 tpi and special formats. We offer an unconditional money-back warranty. We're here to help.

Be sure to indicate system name and model # at right.

# of 10 Packs	5 1/4" Disks	Price Per 10 Pack	Total Price
_____	Single side/single density	\$19.90	\$ _____
_____	Single side/double density	\$23.90	\$ _____
_____	Double side/double density	\$39.90	\$ _____
_____	Flip/Floppy reversible Double side/double density	\$39.90	\$ _____
_____	Protective plastic library case (in lieu of soft storage box)	\$ 2.99	\$ _____
	Shipping and handling		\$ 1.50
	5% sales tax (Mass. only)		\$ _____
	<b>Total</b>		\$ _____

Check  
 COD

Master Card  
 VISA

Card # \_\_\_\_\_ Exp. \_\_\_\_\_

System and model # \_\_\_\_\_

Name \_\_\_\_\_

Address \_\_\_\_\_

Tel. \_\_\_\_\_

puted above. This new value must replace 146 in statement 990.

Lines 1040-1060 store the 175 machine-language bytes that were defined in lines 920-1030. Note that the lower limit of the FOR . . . NEXT loop begins POKEing bytes at the exact address defined in line 130.

### Terminal Mode

Most host computers automatically echo every character when operating in a full-duplex communication link. That is, each character the host receives from a terminal is returned to

that terminal to verify that it was received correctly. In the terminal mode, the echoed character is displayed so that you can monitor the development of any communication problems. This process happens so quickly that you don't realize the interchange has taken place. The TAFT terminal mode is written entirely in machine language to keep any delay, from key depression to character display, as short as possible.

Line 150 clears the screen and informs you that TAFT has entered the

terminal mode.

Line 160 transfers control to the machine-language terminal subroutine that was POKEd into memory.

Lines 170-180 determine if you want to transfer a file from the Apple to the host computer. If so, these lines transfer control to the transmission mode, Part 3 of TAFT. Line 170 executes upon return from the machine-language terminal subroutine. This return is caused by keying a Control T.

Lines 190-200 determine if you want to transfer a file from the host computer to the Apple. If so, they transfer control to the reception mode, Part 4 of TAFT.

Lines 210-220 determine if TAFT operation is to be terminated. If not, control reverts to the terminal mode in Part 1 of TAFT.

Line 230 resets the upper memory limit available to Applesoft (see pages 141-142 of the DOS manual).

Lines 240-250 politely terminate the program.

### Transmission Mode

Line 260 requests the name of the Apple disk file to be sent to the host and stores it as AF\$.

Line 270 requests the name for the new file to be created on the host disk and stores that name as VF\$.

Line 280 composes the host-compatible command to create a file on the host disk, with the name specified in VF\$. The command is stored as A\$. (This line will probably have to be changed to use TAFT with a host other than a VAX-11. Most hosts will have a simple command for creating a disk file and then accepting input from the terminal. In this case, the VAX command CREATE is followed by the specified file name and a carriage-return character. If your host computer does not use the term CREATE, then adapt line 280 to your own host system by using the appropriate host command as the first part of A\$.)

Lines 290-320 send the host command (composed in line 280) to the host computer. The FOR . . . NEXT loop successively stores each command character in the 1-byte charac-

Whitesmiths, Ltd.  
is now shipping Pascal Compilers  
for 10 (count 'em ten) different  
operating system families:

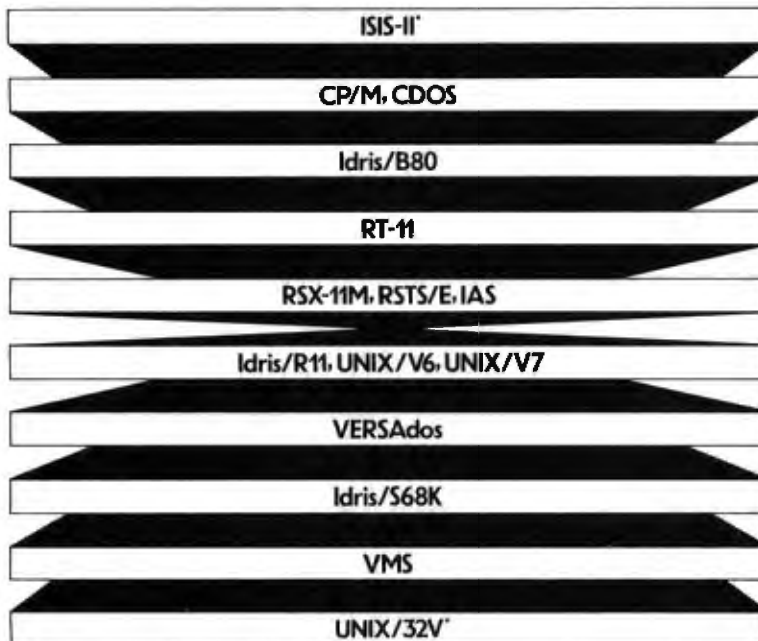

\*Available in source form only.

Idris is a trademark of Whitesmiths, Ltd. ■ UNIX is a trademark of Bell Laboratories ■ CP/M is a trademark of Digital Research ■ RSX-11M, RSTS/E, RT-11, LSI-11, VAX, and VMS are trademarks of Digital Equipment Corporation ■ VERSA dos is a trademark of Motorola Inc.

All implementations support the full ISO Pascal (Level 0). All pass the Tasmanian Validation Suite with flying colors.

You can partition your Pascal program into separately maintainable files. You can write library functions to add to the extensive set we give you. And you can mix in modules written in other languages, like assembler or C.

In fact, a C Compiler comes with every Pascal Compiler we sell. Prices start at \$950.00. Write or call.

Distributors: Australia, Fawcay Pty Ltd. P.O. B 224 Hurstville NSW 2220 570-6100  
Japan, Advance Data Controls Corp. Chiyoda-ku, Tokyo 03263-0383  
United Kingdom, Real Time Systems, Newcastle upon Tyne 0632 733131

Whitesmiths, Ltd.

Parkway Towers, 'B', 485 US Route 1 So., Iselin, New Jersey 08830 (201) 750-9000 Telex: 645592



# Condor database obsoletes compilers!

**Condor relational database management system makes your personal/business computer far simpler to use and much more useful to own... for less money... than other software.**

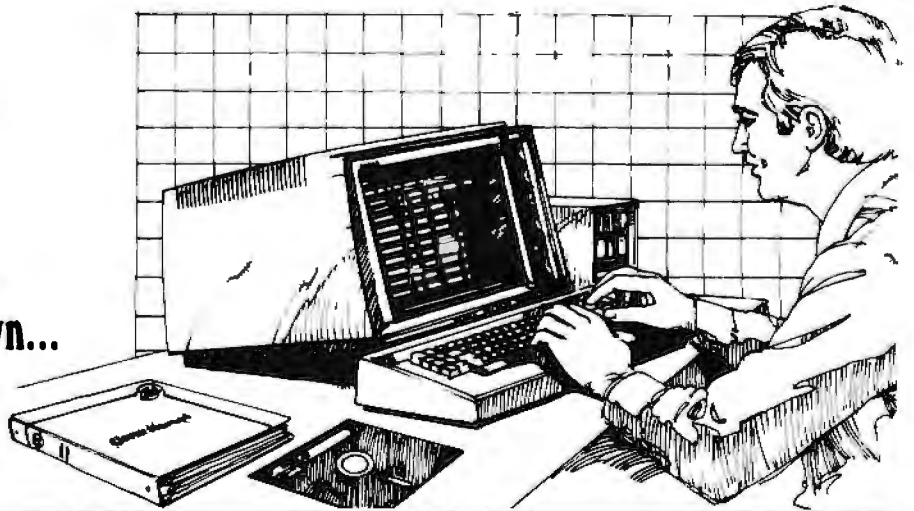

## Plain English, no computerese.

Condor relational database management is a complete development and operation system. It eliminates BASIC, PL/1, COBOL, FORTRAN, or other compilers in almost every case. It allows you to deal directly with your information without complex code words. In plain English, *it lets you manage your business instead of your data.*

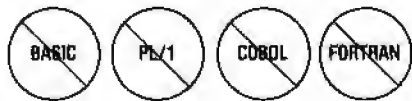

**Save 90%.** Because no complex programming is needed, Condor saves up to 90% of the cost of program writing and testing! You also eliminate costly and time-consuming programmer "talent searches."

## State-of-the-art relational format.

Condor makes traditional programming approaches using compilers *obsolete*. Features such as SORT, DEFINE, ENTER, POST AND REORG permit rapid database creation, access, control, monitoring and manipulation. For instance (by using the JOIN command), you can combine the information contained in two large file cabinets—such as "Purchases" and "Labor Cost"—

into a single file—in one operation. To do the same task, ordinary software usually requires substantial reprogramming.

## Easiest to learn and use.

Independent evaluators rate Condor more "user-friendly" than any other personal/business computer database system. After a brief study of the manual, you start building a database *within 15 or 20 minutes.*

In fact, *Condor has allowed many hundreds of first-time users to produce and process their own management reports.*



## Only \$295 for entry level.

Condor's three-level modular design provides *full upward compatibility*, up to the most powerful software of its kind in the industry. The entry level Condor I features database file development

and management; entry, update, and posting; inquiry and report writing capabilities; and complete operations aids.

And as information needs grow, you can easily upgrade by simply adding Condor II relational features for joining multiple database files, and Condor III for writing highly complex reports and for fast-query indexing.

Condor DBMS is the most complete system, with *almost limitless applications...* from handling General Ledger and Accounts Receivable to Credit Assessments and Contract Management.

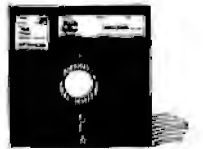

**Questions?** See Condor at your local software dealer, write to P.O. Box 8318, Ann Arbor, MI 48107, or call **(313) 769-3988.**

# condor

COMPUTER CORPORATION

P.O. Box 8318, Ann Arbor, MI 48107

**The Industry Standard... Selected by Major Dealers, Distributors and Manufacturers.**

Listing 2: The 6502 assembly-language portion of TAFT. This 175-byte listing corresponds to the data in lines 930 to 1030 (see listing 1).

```

*
* Assembly Language Portion
* of the Apple Terminal Program
* with Bidirectional File Transfer
*
* written by Thomas L. Gabriele
*
* 15 JUNE 1980
*

SLOT EQU 1 Serial board slot number.
INPORT EQU SLOT*10+$C080
STATUS EQU INPORT+1
OUTPRT EQU STATUS+1
CH EQU $24
BASL EQU $28
PTRLOW EQU $FE LS byte of address
PTRHI EQU $FF HS byte of address

ORG $9000 Beginning address

*
* Has a character come in ?
*
9000-AD91C0 START LDA STATUS Read status of slot.
9003-2980 AND #$80 Save only input buffer full bit.
9005-F011 BEQ DOWN IF BIT=0 Branch

*
* A character has been received.
*
9007-203890 JSR UNFLSH Remove cursor.
900A-AD90C0 LDA INPORT Read input port.
900D-203F90 JSR INCONV Call input conversion subroutine.
9010-0980 .MSBLAB ORA #$80 Set the MSB.
9012-20F0FD JSR $FDFO CALL COUT1, output.
9015-203390 JSR FLASH Put up cursor.

*
* Has a character been keyed ?
*
9018-2C00C0 DOWN BIT $C000 Go back & read again until ...
901B-10E3 BPL START the MSB is set.

*
* Process the keyed character.
*
901D-AD00C0 LDA $C000 Get the last character keyed.
9020-2C10C0 BIT $C010 Clear keyboard strobe.
9023-C994 CMP #$94 If CTRL T, return.
9025-F037 BEQ ENDOUT Branch to return to BASIC.
9027-204A90 JSR OUTCON Call the output conversion subroutine.

*
* Output the character.
*
902A-8D6D90 STA LAST Save the character to go out.
902D-205F90 JSR OUTCHR Call the output routine.
9030-4C0090 JMP START

```

Listing 2 continued on page 426



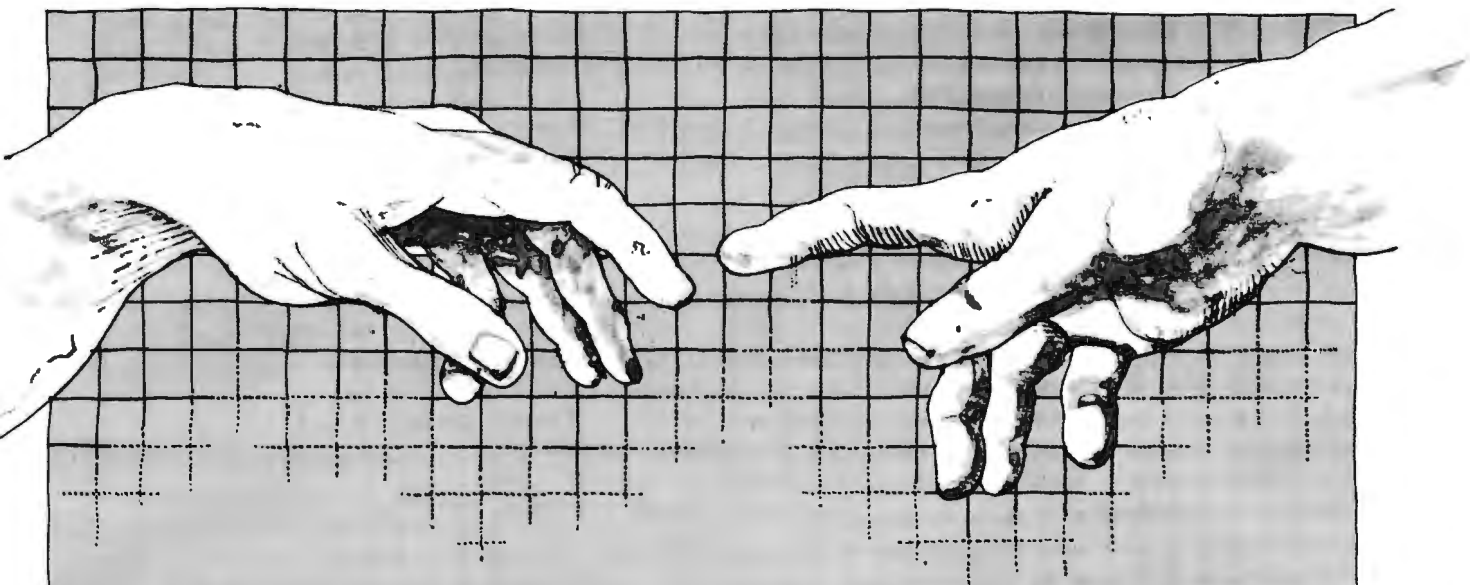

# DATAFLEX™

## SOFTWARE FOR CREATORS

Bring your CP/M\* software applications to life with DataFlex. From menus to multi-key ISAM, DataFlex has the features and power you need to create complete turn-key software applications in a RELATIONAL data base environment.

Compare...what else gives you: up to 125 data files with 4 indexes each, fast on-line multi-key ISAM file maintenance, a multi-file report generator, on-line multi-file transaction processing, an easy to use Query, even a "soft" menu to replace the CP/M command mode. All of this using DataFlex's configuration utilities, and NO PROGRAM CODE!

Is it easy to use? You can type in a screen format "image" of a file with your text editor. Then, DataFlex's AUTODEF utility will create the file definition from the screen image...in about five seconds!

DataFlex will handle your multi-user requirements too! It runs under Software 2000's TurboDos Network O/S with data protection to the field level. That means multiple users in the same record at the same time!

If the 16 bit world is your domain, an 8086 version of DataFlex

will be available second quarter '82. And, you can develop now on your 8080/Z-80 system, and transport completed applications to the 8086.

If you need applications now, Data Access has a Library of existing DataFlex applications developed by other creators. They're ready to go at prices that will get you going. The DataFlex Library has Order Entry/Inventory, Accounting, Pharmacy, and Legal Billing, with more being added all the time. For highly specialized requirements, DataFlex's PASCAL Library is available to application developers.

DataFlex can change the way you do business. And, at \$750 it's the best software value in the business. A demo package, which limits file sizes internally, is only \$100 including the manual.

Get the full system, or get the demo, but get your hands on DataFlex.

It's software for creators.

### DATAACCESS®

CORPORATION

4221 Ponce De Leon Blvd.,  
Coral Gables, FL 33146  
(305) 446-0669

"Dealer, Systems House and OEM inquiries invited."

\*CP/M is a registered trademark of Digital Research, Pacific Grove, CA.

```

*
* Manage the flashing cursor.
*
9033-A960  FLASH  LDA  $$60      Code = Flashing space.
9035-4C3A90      JMP  FLDWN
9038-A9A0  UNFLSH LDA  $$A0      Code = Normal space.
903A-A424  FLDWN  LDY  CH
903C-9128      STA  (BASL),Y
903E-60      RTS

*
* Received character conversion subroutine
*
903F-C961  INCONV CMP  $$61      Compare with a lower case "a".
9041-9006      BCC  ENDINC      Is it a lower case?
9043-C97B      CMP  $$7B      Compare with a lower case "z" + 1.
9045-B002      BCS  ENDINC      Is it lower case?
9047-4920      EOR  $$20      Convert to upper case.
9049-60      ENDINC RTS      End of input conversion routine.

*
* Output character conversion subroutine.
*
904A-C99D  OUTCON CMP  $$9D      Is it a CTRL M?
904C-D003      BNE  DELETE      If not, skip down and test for next character.
904E-A95B      LDA  $$5B      Open bracket character.
9050-60      RTS      Store the character.
9051-C988  DELETE CMP  $$88      Is it a back arrow character?
9053-D003      BNE  TAB      If not, skip down.
9055-A97F      LDA  $$7F      Delete character.
9057-60      RTS      Store the character.
9058-C995  TAB    CMP  $$95      Forward arrow?
905A-D002      BNE  ENDOUT      If not, skip down.
905C-A909      LDA  #9      Horizontal tab character.
905E-60      ENDOUT RTS      End of output conversion routine.

*
* Output character to serial board.
*
905F-AD91C0  OUTCHR LDA  STATUS      Read slot status.
9062-2901      AND  $$01      Save only output buffer empty bit.
9064-F0F9      BEQ  OUTCHR      Poll until buffer empty.
9066-AD6D90      LDA  LAST      Get the last character.
9069-8D92C0      STA  OUTPRT      Write output port.
906C-60      RTS      End of output routine.

906D-00      LAST  DFB  0      Storage for last character.

*
* Host to Apple file transfer coding.
*
* Initialize assembly lang variables.
*
906E-A918  HOTAP  LDA  $$18      Initialize the buffer pointer high byte.
9070-85FF      STA  PTRHI
9072-A000      LDY  #0      Reset index register.
9074-84FE      STY  PTRLOW      Initialize the buffer pointer low byte.
9076-AE6D90      LDX  LAST      Load the conversion flag.

*
* Send a carriage return character and discard the host echo.
*
9079-A90D      LDA  #13      Send carriage return character.
907B-8D6D90      STA  LAST

```



# INTRODUCING INFONE.<sup>™</sup> THE PORTABLE ELECTRONIC OFFICE.<sup>™</sup>

It's a 2½ lb. computer terminal and modem.

It's a telephone.

It's an electronic appointment book.

It's a message center.

It's an electronic mail station.

It's a data entry device.

It's a remote inquiry station.

It's a telephone directory and automatic dialer.

It's portable.

It's also battery operated.

And best of all, it's profitable.

## Infone<sup>™</sup>

The Portable Electronic Office.<sup>™</sup>

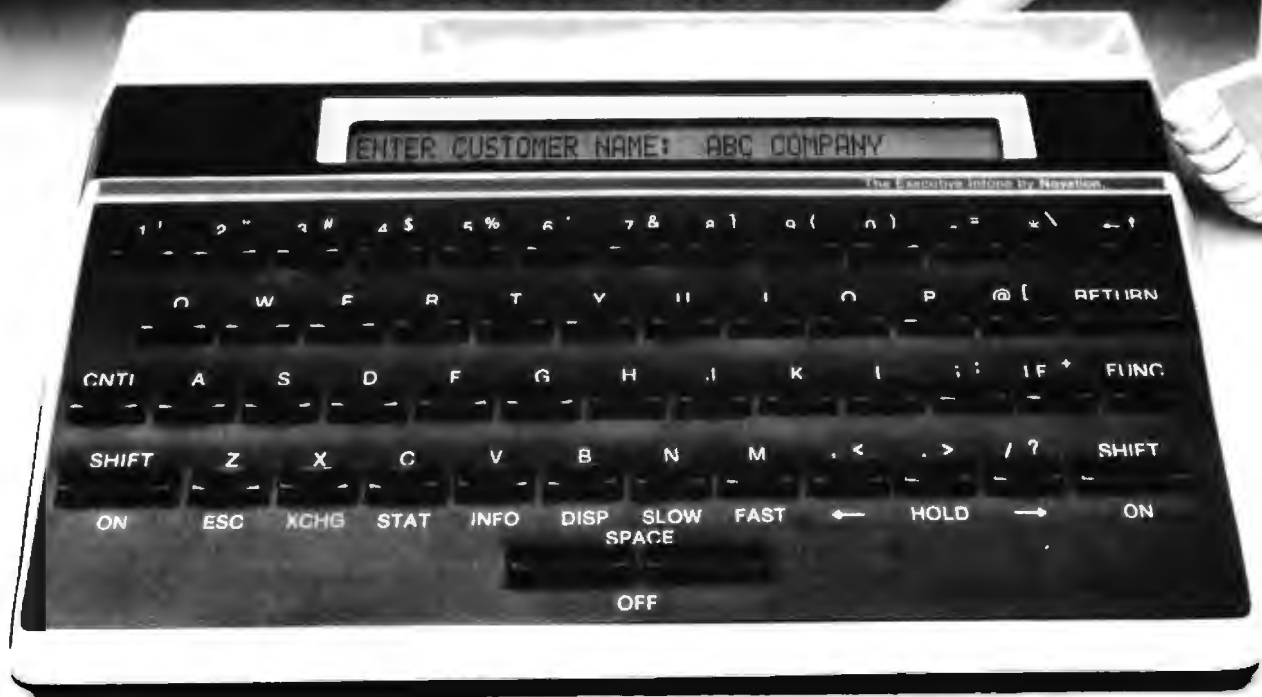

Novation, Inc., 18664 Oxnard Street, Tarzana, CA 91356, 800-423-5419.



Listing 2 continued:

```
907E-205F90      JSR OUTCHR
9081-20A490      JSR INCHR      Discard echo of carriage return character.

*
* Character acquisition loop
*
9084-20A490 CLOOP JSR INCHR      Get the next character.
9087-C91A     CMP #26       Is it a CONTROL Z?
9089-F016     BEQ ENDHST   If so, branch.
908B-E000     CPX #0       Case conversion flag set?
908D-F003     BEQ NOCONV   If not, bypass conversion subroutine call.
908F-203F90   JSR INCONV   Convert lower case.
9092-91FE     NOCONV STA (PTRLOW),Y Store the incoming character.
9094-0980     ORA #$80    Set the most significant bit.
9096-20F0FD   JSR $FDF0   CALL COUT1
9099-C8       INY       Point to next byte.
909A-D0EB     BNE CLOOP   Get next character.
909C-E6FF     INC PTRHI   Point to next page of memory.
909E-4C8490   JMP CLOOP

*
* End of transmission
*
90A1-84FE     ENDHST STY PTRLOW Save the file length.
90A3-60       RTS

*
* Input character subroutine.
*
90A4-AD91C0   INCHR  LDA STATUS
90A7-2980     AND #$80    Buffer full bit.
90A9-F0F9     BEQ INCHR   Loop if nothing.
90AB-AD90C0   LDA INPORT Get character.
90AE-60       RTS
```

ter buffer before calling the machine-language output routine.

Line 330 defines where control is to pass when the end of the Apple file is encountered or if any other error condition should occur.

Lines 340-350 prepare the specified Apple sequential text file to be read.

Line 360 initializes, with a null string, a string variable that will buffer (hold) characters sent until an entire line is accumulated. This line will be displayed on the Apple screen with a single PRINT command (see line 440).

Line 370 obtains the next character from the Apple source file.

Lines 380-390 send the ASCII code of that next character out the serial communication line.

Line 400 echoes the entire line to the display if the character just sent was a carriage return.

Lines 410-420 append that character to the string to be echoed and go back to get another character from

the source file if the last character was not a carriage return.

Lines 430-450 echo the line to the Apple II display and go back to redefine the disk file as the source of characters asked for by the GET in line 370.

Lines 460-480 send a Control Z character as the end-of-file indication to the host computer so it will close the new file and stand by for the next command. The use of a Control Z character for this purpose is a fairly common protocol. If, however, your host computer doesn't echo commands typed from the TAFT terminal mode after a transfer to the host is complete, then the host probably uses a different end-of-file character. (The host computer won't echo your terminal-mode commands because it doesn't know that the file transfer is completed and it is putting your terminal commands into that file as well.) If this occurs, find out what character (or sequence of characters)

should be used as the end-of-file marker, then modify these lines appropriately. If more than a single character is required, you can use a construct similar to the one contained in lines 290-320.

Line 490 calls the one-line subroutine that displays the TRANSFER COMPLETE message.

Line 500 delays a moment.

Line 510 transfers control back to the terminal mode.

Line 520 begins error-handling routine by saving the error code in variable BOO.

Line 530: whether the error was a normal detection of the end of the source file or an unwanted error condition, the source Apple file is closed immediately.

Line 540: if a normal end-of-source-file condition was detected, transfer control to the code that sends the end-of-file marker.

Lines 550-560: if it wasn't a "normal" error condition, you are in-



# BYTE'S Best Cellar List

BUILD YOUR OWN  
Z80 COMPUTER

Design Guidelines and  
Application Notes

Ciarcia's  
Circuit Cellar  
BY STEVE CIARCIA

Volume II  
Ciarcia's Circuit Cellar  
by Steve Ciarcia

**NEW**  
Ciarcia's Circuit Cellar

## Ciarcia's Circuit Cellar, Volumes I, II, & III by Steve Ciarcia

Collections of Steve Ciarcia's perennially popular columns from BYTE Magazine, these three volumes are sure to please home computer users and electronics hobbyists. **Volume I** includes power conversions, programming EPROMs, remote terminal interfacing, touch-input video display, and more. **Volume II**, focusing on projects which interface the personal computer with the home, features useful applications such as a computer-controlled home security system, computerized appliances, input-output expansion for the TRS-80, and even a computer-controlled wood stove. **Volume III** offers low-cost construction projects such as an ultrasonic rangefinder, handheld remote computer control, two speech synthesizers, and a remote-control motorized platform, to name just a few.

## Build Your Own Z80 Computer

This complete guide to building a working computer offers engineers, students, and hobbyists an exciting alternative to buying a computer. With clear instructions, Steve Ciarcia fully explains how to build a basic single-board micro-computer based on the Zilog Z80 microprocessor. The finished product features a 1 K-byte operating system, serial and parallel ports, hexadecimal display, audio cassette mass storage, and easy expansion to include a video terminal.



Please send

- Ciarcia's Circuit Cellar, Vol. I \$8.00
- Ciarcia's Circuit Cellar, Vol. II \$12.95
- Ciarcia's Circuit Cellar, Vol. III \$12.95
- Build Your Own Z80 Computer \$15.95

Call Toll-Free 800/258-5420

Name _____			Check Enclosed _____
Address _____			Bill Visa/ MasterCard # _____
City _____	State _____	Zip _____	Expiration Date _____



70 Main Street Peterborough, N.H. 03458

Please add .75 per book to cover shipping cost.

formed which error occurred before TAFT transfers to the end-of-file marker code.

### Reception Mode

Line 580 requests the name of the host source file to be sent to the Apple and stores it as VF\$.

Line 590 requests the name of the new Apple file to be created and stores that name as AF\$.

Lines 600-620 ask you if you want conversion of lowercase characters to uppercase and stores your decision in variable CNV.

Line 630 composes a command to the host computer to send the contents of the file (specified in VF\$) followed by a Control Z (end-of-file marker) and stores that command as A\$. This is the second and last TAFT statement that is VAX-11 host-specific. For a different host, this statement must be changed. If your host computer automatically sends an end-of-file character other than a Control Z, simply change the "26" in the data statement in line 1010 to the

decimal equivalent of the control character your host uses. TAFT will then look for this character as the end-of-file marker. Unlike the host command composed in line 280, this command is not terminated with a carriage-return character. The following explains why.

Lines 640-670 send the host command composed in line 630 to the host computer.

Line 680 waits for the echo of the command characters, sent by lines 640-670, to return from the host. You don't want to begin accumulating characters for the new file too quickly or you will find the host echo of the command characters at the beginning of that file. Since a carriage return has not yet been sent, the host will not perform the command (that is, send the file). Therefore, this delay will not cause us to miss any file contents.

Line 690 informs the machine-language subroutine whether the lower-to-uppercase conversion is to be performed (see lines 600-620).

Line 700 transfers control to the

machine-language subroutine, HOTAP, for file reception. After setting up the address pointers used to store incoming characters in the receive buffer, HOTAP sends the carriage-return character to the host computer to complete the command. Because HOTAP is a fast machine-language routine, it readily receives and stores characters as they come from the host.

One final subtlety is that after sending the return character, HOTAP ignores the first character coming from the host—the echo of that return character. All characters that follow will be saved in the receive buffer. This procedure is relatively time insensitive, and should work on any host. Finally, HOTAP stores the 2-byte address of the last character received at PTR and PTR+1, which is used in the next line.

Line 710 computes the address from the two binary bytes previously stored by HOTAP and re-stores this address in the Applesoft variable UL.

Line 720 defines where program

Computer Channel

**Best Price • Good Quality • Swift Delivery • Export**

	COMPUTER	PRINTER	SOFTWARE
	<p><b>*The Best Graphic Personal Computer*</b></p> <p>LNW 80 I Z80A, 65K, 480 x 19.2 . . . . . 1,395 w/CPM compatible . . . . . 1,795 125K, CPM compatible . . . . . 2,295 RGB interface . . . . . 125</p> <p><b>*Multuser Business/Engineer*</b></p> <p>CROMEMCO 26% off system &amp; software 15% off boards &amp; components</p> <p>OS1 5 1/4" floppy . . . . . 2,956 Z2H hard disk system . . . . . 7,396 CS3 64K, 8" . . . . . 5,916 CS1D2E 256K RAM, 68000 &amp; Z80 . . . . . 4,067 DYNABYTE 5200 64K, 1MB, Z80A . . . . . 3,300 5605 64K, 6MB hard d. . . . . 6,550 SWTPC /O9 128K (UNIFLEX) . . . . . 3,450 /O9 64K . . . . . 1,835 *6809* 68A BK . . . . . 799 1 MB RAM, NEW . . . . . call</p> <p><b>*Professional/Word Process*</b></p> <p>ZENITH Z90-80, 64K . . . . . 2,290 Z90-82, 64K, 1 disk . . . . . 2,490 Z89, 48K, 1 disk . . . . . 2,130 Z37 1.2MB Drives . . . . . 1,450</p> <p>NORTH STAR HORIZON, 2 quad drives, 64K . . . . . 3,200 ADVANTAGE, 2 quad drives, 64K . . . . . 3,100</p> <p><b>*16-bit CPU*</b></p> <p>WICAT S150 IT 1-user . . . . . 3,750 256K RAM, CRT *68000* S150 WS 1-user . . . . . 8,450 256K RAM, 10MB hard disk, 960KB floppy CRT, OS + 1 language S150-3 WS 3-users . . . . . 10,800 same as S150 WS S150-6 WS 6-users . . . . . 12,800 512K RAM same as S150 WS</p> <p>TERAK Graphics 300 x 400 . . . . . 900 8510A w/CRT . . . . . 8,000 320 x 240, DD *LSI/11 graphic* 8600 w/13" color . . . . . 17,000 monitor, 640 x 480 ALLOS ACS8600-10 500KB . . . . . 10,000 RAM, 10MB hard disk, *8086* 500KB floppy multiusers DEC PDP/11, VAX780, MINC . . . . . call ATARI . . . . . call</p>	<p>Integral Data System PRISM 80 150 cps, 80 col. . . . . 710 w/graphic 84 x 84 . . . . . 780 W/color &amp; graphic . . . . . 1,080 W/all options . . . . . 1,250</p> <p>PRISM 132 132 col. . . . . 999 w/graphics 84 x 84 . . . . . 1,070 w/color &amp; graphic . . . . . 1,370 w/all options . . . . . 1,562</p> <p>EPSON MX80 w/Graftrax . . . . . 450 MX80 F/T . . . . . 555 MX80 F/T Graftrax . . . . . 620 MX100 . . . . . 725 PC-8023A . . . . . 480 DP-9500 . . . . . 1,300</p> <p><b>*Letter Quality*</b></p> <p>DIABLO 630 . . . . . 2,095 C.I.TOH Starwriter F-10 . . . . . 1,495 OUME 9/35 R.O. . . . . 1,800 BROTHER HR-11 excellent . . . . . 1,050</p>	<p>database \$</p> <p>dBASE II Ashton-Tate . . . . . 575 CONCOR I . . . . . 250 " . . . . . 450 " . . . . . 850</p> <p>financial (AR, AP, Inventory etc.)</p> <p>Accounting Plus . . . . . 450 Peachtree . . . . . CALL</p> <p>other</p> <p>VISCALC . . . . . 150 MICROSOFT software . . . . . 330 FORTRAN 80 . . . . . 345 BASIC 80 . . . . . 285 BASIC Compiler . . . . . 310 SUPERCALC Sorcim . . . . . 250 Micro Pro WORDSTAR . . . . . 295 MAILMERG . . . . . 105 SUPER SORT I . . . . . 165 CP/M 2.2 Digital Research . . . . . 130</p> <p style="text-align: right;">Mailing Label w/sort. . . . . 200 For Accounting Plus All Software . . . . . CALL Custom-made software for local</p>
		<p><b>MONITOR</b></p> <p>ZENITH 12" green . . . . . 119 AMDEK COLOR II RGB 13" . . . . . 805 COLOR I 13" . . . . . 350 300 G 12" green . . . . . 179 SANYO 13" color . . . . . 445 13" RGB . . . . . 999 NEC 12" green . . . . . 170 12" color . . . . . 330 BMC 12" green . . . . . 165 12AU 12" green . . . . . 110</p>	<p><b>DIGITIZER/PLOTTER</b></p> <p>HOUSTON INSTRUMENT HI PAD DIGITIZER DT-11 11" x 11" . . . . . 725 DT-11A w/APPLE interface . . . . . 750 HI PLOT DMP-2 8 1/2" x 11" . . . . . 975 COM PLOT DP-11 4000 steps/sec. . . . . 4,000 8411A PRINTER/PLOTTER . . . . . 5,200</p>
		<p><b>TERMINAL</b></p> <p>ZENITH Z19 . . . . . 699 HAZELTINE ESPRIT . . . . . 640 BEEHIVE DM5 smart ter. . . . . 800 IBM 3101-10 . . . . . 1,195 3101-12 . . . . . 1,225 3101-20 . . . . . 1,400 SWTPC 8212 intelligent . . . . . 1,050 12" most beautiful terminal ever built!</p>	<p><b>CALL (212) 937-6363</b> <b>free consultation, catalogue</b></p> <p>Prices subject to change, American Express, Visa/Mastercard add 3% F.O.B. point of shipment. 20% restocking fee for returned merchandise. Personal checks take 3 weeks to clear. COD on certified check only. N.Y. residents add sales tax.</p> <p>CABLE: COMSYSTEC NEW YORK TELEX: 429418 CSTNY 21-55 44th Road L.I.C., NY 11101 *special</p>



# If it flies on aerospace software, Kearfott...and you... may well help create it.

As a company engaged in dozens of major projects that depend on software advances in flight, orbiting, command, communications or controls, we can offer you the opportunity to work in a DP complex that's as sophisticated as the ring laser gyroscope system we're developing for the Tomahawk-2 MRASM Cruise Missile. Or as advanced as our JTIDS communications terminal.

In engineering and scientific programming, your realtime software designs will operate airborne computers and support everything from aircraft navigation systems to inertial measurement units on the Space Shuttle... guidance controls for the Trident missile... ASW... scanning beam landing systems... and much, much more. Have a background in simulation, linear systems, firmware for SW validation, Kalman filtering or FORTRAN? Then find out about our firmware projects.

In MIS—the expanding sphere that helps give Kearfott's rarefied environment a very solid basis—you'll run the gamut. Accounting. Finance. Payroll. Inventory and manufacturing controls. All involve COBOL programming, CICS, MVS, IMS, and data base design and telecommunications.

At our Data Center, you'll be joining an elite software systems group that maintains IBM and Amdahl mainframe computers with supporting software that includes MVS/SE-2, SE/A, JES 2, IMS DB/DC, CICS, TSO, WYLBUR, ACF/VTAM, ACF/NCP, SAS, information systems. And more.

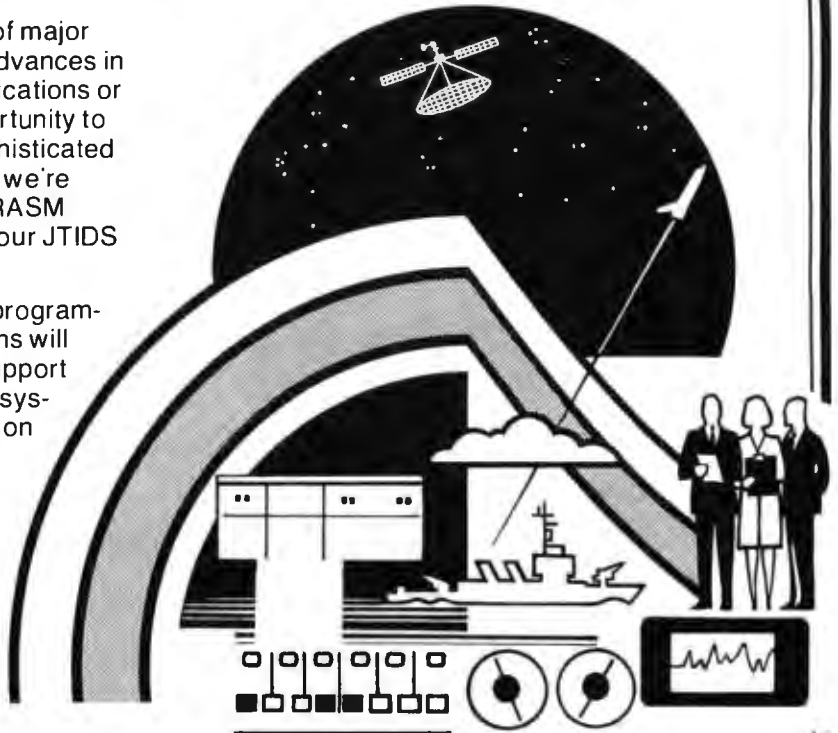

So whatever your software specialty may be, there's a career path for you at Kearfott. You'll need at least 3 years experience in a large-scale IBM environment or HP 2100 MUX. If you're looking to accelerate your career, please send your resume to: Carol Batte, Singer Company, Kearfott Division, 1150 McBride Avenue, Little Falls, NJ 07424.

## Kearfott

a division of The SINGER Company

An equal opportunity employer, m/f, who creates opportunities.

control is to pass if an error occurs *while storing* the new file on disk.

Lines 730-760 prepare the sequential text file to be written on the Apple disk, using the name you specified. Any other disk file with this name will be overwritten.

Line 770 initializes (to the null string) a string variable that will be used to write an entire line of text to the disk.

Lines 780 and 820 create a FOR...NEXT loop to process each character stored in the receive buffer, at addresses beginning at HIMEM+1 and going up to the address computed in line 710.

Line 790 gets the next character from the receive buffer.

Line 800: if this character is not a carriage return, then the line of text is incomplete. Therefore, this statement appends it to the string being composed and passes control to line 820, which returns for the next character.

Line 810: if the character was a carriage return, then the line of text is

complete. This statement writes it to the new disk file and reinitializes the composing string variable L\$ to the null string.

Line 830 closes the new Apple file.

Line 840 temporarily stops disk operations and gives you a prompt indicating the end of a valid transfer.

Lines 850-880 display a catalog of disk files (to show the new file just generated) and wait for you to press any key to re-enter the terminal mode.

Lines 890-910: in the event of an error, this section displays the error number before closing as much of the new file as was written to that point.

### Whys and Wherefores

As our society becomes increasingly computer-based, the home that can access the computer at the bank, store, or library will be the home that gets the best service. TAFT can be the first step toward ensuring that you have access to these new services.

Commercially, TAFT can form the basis for many profitable home activities. Although the processing power of host computers surpasses that of an Apple II, the smaller computer has the advantage of more cost-effective peripheral devices. In other words, although a large computer can process much data rapidly, the Apple II is better equipped to display the answers to people and to get their responses.

For example, the host computer may have a number of alternate solutions to a problem in bus routing, stock ordering, plant layout, or molecular structure. Using its graphic-display capability, the Apple II could present these solutions in a manner more easily understood than pages of printout. You could communicate your selection or "grading" of the host output back to the host computer for further processing or final output. Through its own processing and disk storage, an Apple II with terminal and file-transfer capability can make the most efficient use of a mainframe's computer time.

The most obvious commercial use of TAFT would be as a *data capture* station. Consider moving traditional keypunch operations to your home. The Apple would capture the data (i.e., make it machine readable) and communicate that data, using TAFT, to the customer's host computer. An Apple with a text editor becomes an off-line, key-to-disk system. Or the more exotic input devices of voice input or graphic tablet could be used to efficiently capture the data. Regardless of the exact functions, TAFT allows you to deliver the output data product directly to the client computer.

Some may find these ideas impractical—others do not. Alvin Toffler devotes a chapter of his recent book, *The Third Wave*, to the emerging trend of "electronic cottage industries" where workers "telecommute" with their employers. As usual, individual entrepreneurs will spearhead the initial exploration of these new modes of providing service. Perhaps TAFT can help you and your Apple II "catch the wave." ■

## 100 Watt Switching Power Supply

Introducing the A100 . . . the switching power supply that is a drop-in replacement for

The A100 is rated at 100 watts continuous power with outputs as follows:

output	
#1	+5v 7a max
2	+12v 4a max
3	-12v 1a max
4	-5v 1a max

All outputs are fully regulated.

The best news of all is that Apple Juice comes reasonably priced at 295.00 from AccuPower. Write today for a free data sheet and all the details.

Now there's a power supply specifically designed to add juice to your APPLE™

the power supply that came with your Apple II. Except for one big difference: the A100 provides you with THREE TIMES the power!

ACCUPOWER

2216 Lundy Avenue  
San Jose, CA 95131





# Ask BYTE

Conducted by Steve Clarcia

## Signals Got Crossed

Dear Steve,

I am currently using a Soroc IQ-120 terminal with a North Star system. What would it take to hook up a "slave display" (without a keyboard) to the Soroc so that I can monitor what's happening from a few yards away?

I've tried connecting a Motorola composite-video monitor to the Soroc's auxiliary port, and I have tried the same thing with an Amdek 100, with sorry results. I have tried connecting these monitors in parallel with the Send and Receive lines coming out of the computer (one at a

time, that is), and all I could get was a screenful of black-and-white lines. Obviously, something is not being translated correctly.

According to Soroc technicians, any composite video monitor should work when connected to the auxiliary port (of course, a CHR\$(27)

+CHR\$(64) must be included in the beginning part of the program being run to set up the IQ-120 so that the auxiliary port is on). Well, it doesn't work.

Can you tell me if this is due to a program error, or do I need additional hardware to modify the system, or is it simply impossible? Have I been wasting my time and money accumulating useless monitors?

N.B. Sadorian  
Montebello, CA

*The Soroc IQ-120 is designed to take an RS-232C serial-input signal and convert it to characters that are displayed on the screen. To do this, it takes the serial input, converts it to parallel, and stores it in memory. Then, using a character generator and shift register, it generates the bit stream that forms the characters on the screen. It's after this stage that a composite-video signal (made up of data and horizontal- and vertical-sweep information) is generated.*

*This signal is what is fed to the monitor portion of the terminal. To use a "slave" monitor, it would have to be connected after the shift register.*

*You are confusing the RS-232C data input with a composite-video signal. The auxiliary port is used to attach a printer or modem to the terminal and to provide serial digital data, not a composite-video analog signal.*

*Since you already have a monitor, get a video board that will take the RS-232C input and generate the composite-video output. (One such board is available from Standard Microsystems Corp., 35 Marcus Blvd., Hauppauge, NY 11788, 516 273-3100.) This board can be*

### ★ ★ ★ FEATURING 8 and 16 BIT S-100 SYSTEMS ★ ★ ★

WE OFFER A WIDE RANGE OF CRTs, PRINTERS, GRAPHICS EQUIPMENT, SOFTWARE FOR ALL SYSTEMS. EACH SYSTEM IS COMPLETELY TESTED, INTEGRATED AND READY FOR PLUG-IN OPERATION WHEN YOU RECEIVE IT. WE TAILOR & CONFIGURE SYSTEMS TO MEET YOUR BUDGET AND NEEDS. WE WELCOME YOUR REQUEST FOR TECHNICAL INFO BY PHONE OR LETTER.

**CROMEMCO:** New 68000 systems w/256K-512K memory.  
SYSTEM I: Low priced small system with 5MB hard disk ..... \$5,246.  
SYSTEM I: W/O hard disk ..... \$2,996. Cromix multi-user systems starting at \$4,713.  
High resolution color graphics hard disk system Model Z2HGS ..... \$10,875.

**NEW SX SYSTEMS FROM IMS** 2 yr. warranty on boards! SX systems w/8" or 5 1/4" drives, optional 10, 20 or 40MB Winchester, built-in tape back-up, multi-user capability (TURBODOS or MP/M). Z-80, S-100 bus. Integrated system with built-in monitor, detached keyboard, 5 1/4" drives. Over 150 configurations to match your specific needs and budget. On site service contracts for NY tri-state area.

**SEATTLE 8086 SYSTEMS** Featuring 86-DOS, the IBM PC Operating System.  
System I: 8MHz CPU set w/1 serial, 1 parallel I/O (additional I/O option) 64KB 16 bit Static RAM, Tarbell DD controller, TEI 22 slot mainframe w/constant voltage transformer ..... \$2,695 System II: with 128K Static RAM ..... \$3,550.  
Interfaced to dual Shugarts 801 ..... \$1,275. or dual QUME DT-8 ..... \$1,680.

**CALIFORNIA COMPUTER SYSTEMS 2210A** High quality, low price. Z80 CPU, 1 serial port, disk controller w/CP/M 2.2 64K RAM ..... \$1,750.  
Add our Max Box w/dual Shugarts or Qumes and IMS I/O w/2 serial, 1 parallel.

**LOMAS DATA 8086 SYSTEM:** Complete Lomas card set in TEI 12 slot mainframe, 86-DOS, dual Shugart 801s, Televideo 912, assembled & tested ..... \$4,599. Options: 8087 ..... add \$600; 8089 ..... add \$100.

**GODBOUT:** New CPU 86/87 includes Intel 80130 operating system firmware w/iRMX Kernel. Complete GODBOUT line at discount prices.

**MAX BOX DISK DRIVE SUBSYSTEM** mfg by John D. Owens Assoc. Dual drive cabinet w/regulated power supply, fan, complete internal cabling. Will hold Shugarts, Qumes, Tandons and/or 8" Winchester, horizontally mounted. Excellent design and engineering. 17 1/2 x 5 1/2 x 22. Attractive buff color.  
W/2 Shugart 801 ..... \$1,275 W/2 QUME DT-8 dble sided drives ..... \$1,680.

**GRAPHICS SYSTEM:** Advertising • Architects • Designers • Package includes powerful interactive graphics software + MicroAngelo Graphics Subsystem + M9900 16 bit, S-100 w/dual 8" floppies, + HIPAD Digitizer + Plotter ..... \$10,200.

**PER SCI:** Model 299B & 277 with or without cabinet & power supply.

**TURBODOS:** Spectacularly FAST CP/M Compatible Multi-user Operating System. Z80 Code interrupt driven. Up to 6X faster than CP/M; up to 35% increased disk capacity. Available for NorthStar, IMS, TRS-80 Model II, CCS & Tarbell controllers.

Prices subject to change without notice Write or call for free catalogue

## JOHN D. OWENS Associates, Inc.

12 Schubert Street, Staten Island, New York 10305  
212 448-6283 212 448-2913 212 448-6298



connected to the Soroc's auxiliary RS-232C port and the board output connected to the slave monitor. . . . Steve

### A Shifty Problem

Dear Steve,

I have a 48K-byte OSI (Ohio Scientific) C4P DMF computer that can produce lowercase characters. It serves my purposes very well, except for one annoying feature: the shift-lock on the keyboard.

From time to time, I use a typewriter as well as the computer, so the fact that the two machines have substantially different keyboard layouts is a great inconvenience. I produce all my correspondence on the computer using a word-processing program, which is much to my liking. But a problem arises when I try to program in BASIC: I cannot conveniently enter text that has lowercase characters, because the fingering is wrong.

I see no need for the two shift keys to be independent and dissimilar in function. The shift-lock should be an all-caps keys. It should only "unlock" the alphabetic keys. Has anyone attacked this problem? Do you know of any way I can get relief from this problem?

Carl M. King  
Sarasota, FL

*I do not know an easy solution to your uppercase/lowercase problem with the OSI C4P computer. The most practical solutions are:*

- Rewrite the keyboard routine. This is located in ROM (read-only memory) at location hexadecimal FD00. This would require installing a new PROM (programmable ROM).

- Use an auxiliary keyboard and attach it through the parallel-input port that normally reads the existing keyboard. This, too, will require a soft-

ware driver to function properly.

*I would vote for the second method as the lesser of the two evils. . . . Steve*

### One-Alarm Question

Dear Steve,

I have an application that requires a low-power audible alarm. What I need is the type of alarm that's found in an electronic watch or calculator,

but I don't want to destroy a watch to get one. Can you help me find a source for them?

Brian Gravenhorst  
Chicago, IL

*Here is a list of manufacturers that make miniature audible alarms. While none are designed to fit into a watch, they are quite small and consume little power. I hope this solves your problem. . . . Steve*

Star Micronics Inc.  
Suite 2308, Pan Am Building  
200 Park Ave.  
New York, NY 10166  
(212) 986-6770

Knowles Electronics Inc.  
3100 North Mannheim Rd.  
Franklin Park, IL 60131  
(312) 455-3600

Mallory Capacitor Company  
Mallory Components Group  
POB 372  
Indianapolis, IN 46206  
(317) 636-5353

## ★ ★ ★ SYSTEMS INTEGRATION SPECIALISTS ★ ★ ★

### HOUSTON INSTRUMENTS

PLOTTERS Standard & Intelligent models w/surface areas of 8 1/2" x 11" to 11" x 17". Front panel electronic controls.

DMP-2 . . . \$ 935. DMP-3 . . . \$1,195.  
DMP-4 . . . \$1,295. DMP-5 . . . \$1,455.  
DMP-6 . . . \$1,685. DMP-7 . . . \$1,865.

HAYES MICRO MODEM 100 . . . \$359.  
Smartmodem \$251. Chronograph \$224.

EPSON MX 80 . . . \$475.  
MX80 F/T . . . \$575. MX 100 . . . \$725.  
RS232 . . . \$ 70. 2K BUFFER . . . \$140.

3M SCOTCH® DISKETTES—Discounts

TELETYPE MODEL 45 Cluster controllers, terminals, printers. IBM 3270 compatible; Bisync or SNA/SDLC protocol. Up to 32 devices on one cluster at 9600 baud. Highly cost effective!

TEI MAINFRAMES, S-100  
MCS 112 . . . \$620. MCS 122 . . . \$745.  
RM 12 . . . \$655. RM 22 . . . \$790.  
OEM & Qty. discounts offered

TARBELL Z80 CPU . . . \$395.  
New I/O card 4S + 2P . . . \$347.  
Double Density Controller . . . \$435.

PMMIS-100 Modem . . . \$385.  
Compatible w/telex & Twx. 51 to 600 baud. On board pulse dialer.

NEW ITEMS AVAILABLE Summa-  
graphics Bit Pads • ALTOS systems •  
Microline printers • PIICEON

CORVUS HARD DISK SYSTEMS  
6.7MB . . . \$3,005. 11.3MB . . . \$4,655.  
20.5MB . . . \$5,595.  
For S-100 and most other systems.

TELETYPE  
Model 4320 AAK . . . \$1,140.  
Model 43ASR, 8 level, 1" tape . . . \$2,595.

MEMORY MERCHANT  
64KRAM . . . \$716.

BABY BLUE: Z-80B, 64K RAM substitutes for IBM memory card in IBM PC. Enables you to run Z80, CP/M software . . . \$600.  
w/Wordstar & Mail Merge totally configured for IBM keyboard . . . \$980.

TELEVIDEO 950 . . . \$980.  
3 pg. memory upgrade . . . \$150.

MICROANGELO GRAPHICS  
SUBSYSTEM W/LIGHT PEN . . . \$2,300.  
Without light pen . . . \$1,930.  
Graphics card alone . . . \$ 975.  
Screenware Pak II . . . \$ 350.

TEKEM Tektronix emulator . . . \$ 350.  
Color systems from 4 to 256 colors. Basic color system (4 colors) . . . \$2,330.

IDS PRISM COLOR PRINTER . . \$1,795.  
Enhanced 560 w/software selectable colors; high speed printing at 200cps.

KONAN SMC-100 hard disk controller. S-100, 2400MB control . . . \$1,469.  
Complete KONAN line available.

COMMUNICATIONS SOFTWARE  
Enables communications from a micro to a terminal or to another micro, mini or maxi computer. HAWKEYE GRAFIX Source Code . . \$500. Object Code . . \$75.

MICROSOFT COBOL-80 . . . \$560.  
BASIC-80 (interpreter) . . . \$270.  
BASIC COMPILER . . . \$305.  
FORTRAN-80 . . . \$380.  
X-MACRO-86 . . . \$275.  
muLISP/muSIMP . . . \$190.

MICROPRO Wordstar . . . \$290.

FORMULA ALL-IN-ONE data base + w/p + accounting software . . . \$595.

QUICKSCREEN . . . \$149.  
Create reports or forms on CRT.

dBASEII demo package . . . \$ 75.  
dBASE complete software . . . \$595.

WE EXPORT

Overseas Callers: TWX 710 588 2844  
Phone 212 448-6298 or Cable: OWENASSOC

JOHN D. OWENS Associates, Inc.

SEE OUR AD ON FACING PAGE

**The End of 8-Bit Epoch?**

Dear Steve,

I'm thinking of getting a microcomputer so that I can write and sell software. However, since IBM has introduced a 16-bit computer, and I had planned to buy an 8-bit Atari 800, I fear that Atari will follow IBM's lead and replace the 800 with a 16-bit computer after I make my purchase. Then I will own an outdated piece of junk. Do you know if Atari is about to convert to 16 bits?

Harry Sices  
Hanover, NH

*The future trend of computers will certainly include 16-bit and possibly 32-bit machines, but 8-bit machines will definitely not become "outdated pieces of junk." Look to the bright side of 8-bit machines:*

- they have been around for several years
- virtually every home computer is an 8-bit machine
- documentation and software abound for these machines

•at least a half million of them are in use

*I doubt that you will see 16-bit computers taking over in the near future, so don't fear buying an 8-bit machine. If your goal is to write and sell software, you will certainly have a larger market with the 8-bit machines. Atari even offers the part-time programmer an advantage, since it will help market good software written for its machine.*

*At this time, I am not aware of any effort by Atari to market a 16-bit machine, but I assume that Atari may eventually feel market pressures to do so. . . . Steve*

Computer-Controlled Security System for Your Home," Part 1, January 1979 BYTE, page 56; Part 2, February 1979 BYTE, page 162; Part 3, March 1979 BYTE, page 150.) What devices do you use?

I'm planning on installing two sensors about 10 feet apart mounted on split-rail fence posts. (That way I can sense the direction of movement.) I will have to run at least 250 feet of wire from the house to the sensors. The distance from the source to the sensor across the driveway is about 12 feet. Any ideas that you have would be greatly appreciated.

Charles Finn  
Fayetteville, GA

**Sensing Motions**

Dear Steve,

I'm interested in adding sensors to my driveway and connecting them to my security system. In the articles that you've written on security systems, you mentioned that you were using sensors in your driveway. (See "Build a

*I have tried a number of different sensors in my driveway, and I found that the most reliable is a microwave motion-detector combined with an ultrasonic beam that goes directly across the driveway.*

*I have a fairly long, U-shaped driveway. The ultrasonic transmitter (see*

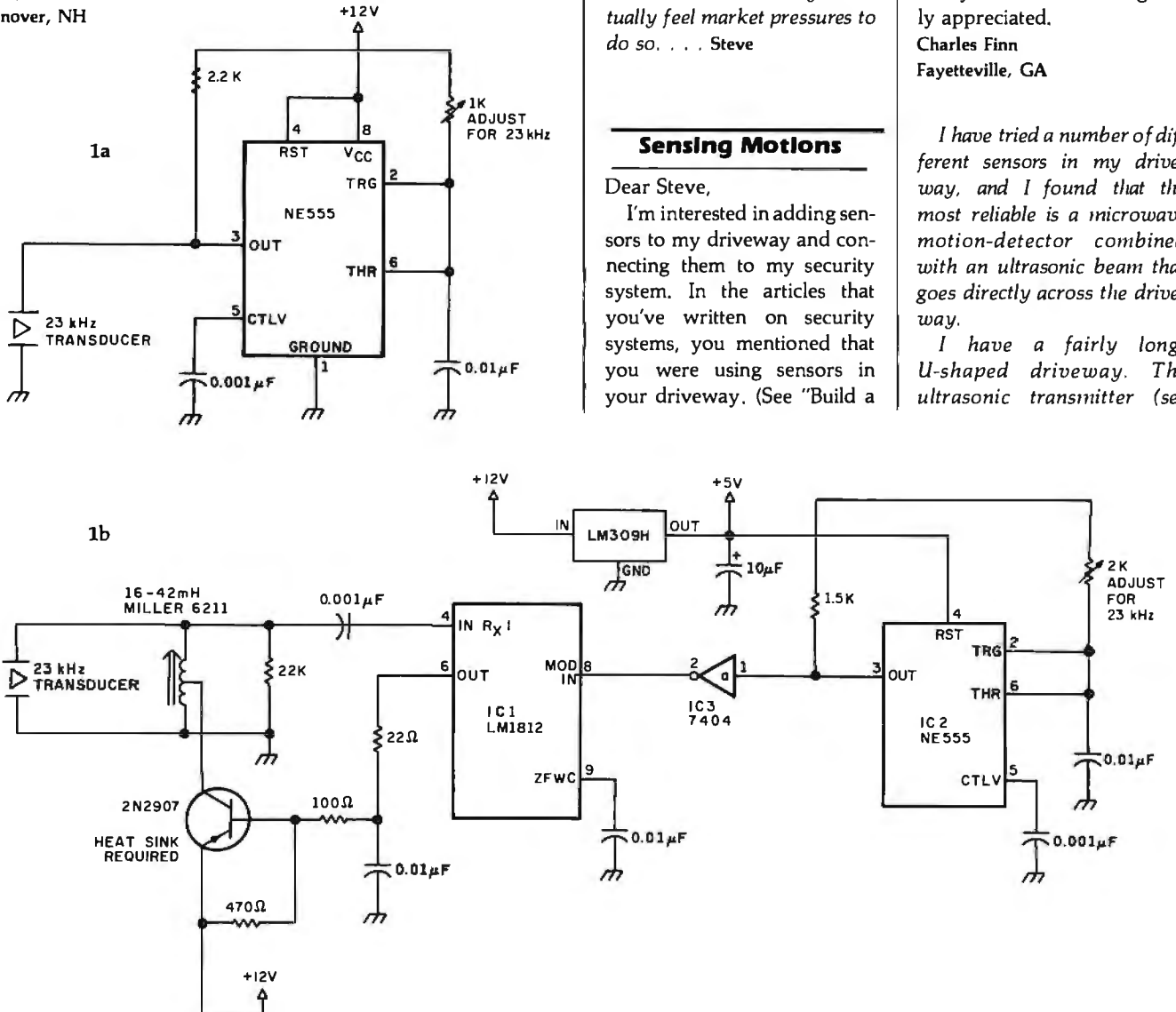

Figure 1: Ultrasonic transmitters.



# THE ANN ARBOR AMBASSADOR™ 300



*Why settle  
for an  
emulation  
when you can have  
an **AMBASSADOR 300**?*

	AAA 300	DEC*VT100*		AAA 300	DEC*VT100*
Display Lines	60	24	Send/Print Controls	12	0
Screen Size	15"	12"	Send/Print Modes	30	0
Cursor Controls	22	15	Operator Convenience Mode	24	10
Graphic Renditions	6	5	Programmable Keys	48	0
Tab Controls	12	4	Line Drawing	Yes	Yes
Erase/Edit Controls	25	4	Non-Volatile Setup	Yes	Yes
Form-Filing Controls	10	0	Non-Volatile Control String	Yes	No

The Ann Arbor Ambassador 300 supports most of your VT100\* software *without* asking you to give up other features you'll like. Its selectable 60-line display lets you see more of your program or report. And you still get all the capability of the standard Ambassador. Things like editing, formatting, printer output and programmable function keys.

**For more information, call Ann Arbor Terminals at (313) 663-8000.**

\*DEC and VT100 are trademarks of Digital Equipment Corporation.



6175 JACKSON ROAD • ANN ARBOR, MICHIGAN 48103 • TEL: 313-663-8000 • TWX 810-223-6033

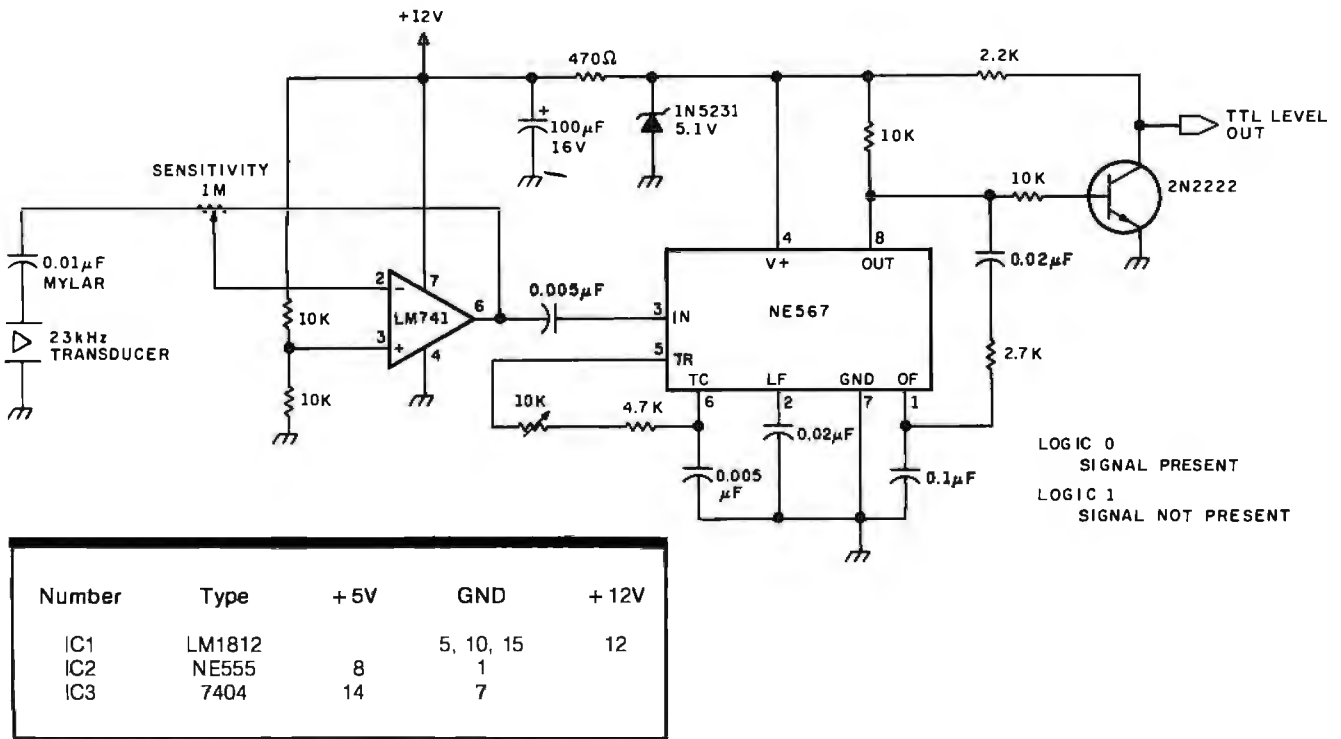

Figure 2: Ultrasonic receiver.

figure 1) projects a 12-foot beam across the driveway to an ultrasonic receiver (see figure 2, above). It has a usable range of about 20 feet. (These are the circuits from my articles.) The transmitter is built into a couple of small, sealed aluminum boxes and mounted across the road. Further down the driveway, where the space opens up, I have a microwave motion-detector. I used microwave because the standard infrared and ultrasonic motion-detectors have too many false alarms. While the microwave units cost much more (\$300 or so), their reliability makes up for the difference in price.

In your application, it sounds as though you can use an ultrasonic transmitter/receiver pair aimed across the driveway. When something passes through the beam, the connection is broken and the logic-level output of the

receiver changes. The 250 feet of wire you mentioned shouldn't inhibit operation. You may find it advisable to add a level-shifting transistor to the output of the receiver. This will give you a 0- to 12-volt signal, which will be easier to transmit 250 feet.

I'd be interested in hearing from you after it's set up. . . . Steve

### A One-Shot Solves All

Dear Steve,

In your article "Build an Intelligent EPROM Programmer" (October 1981 BYTE, page 36), why did you implement the 50-ms (millisecond) programming pulse in hardware instead of using a software loop?

George Kaplan  
Spring Valley, NY

I implemented the 50-ms programming pulse on my EPROM programmer in hardware rather than software for simplicity. It was easier for me to add the "one-shot" circuit than to set up a software timing loop (regular readers of the Circuit Cellar will notice a definite tendency toward hardware solutions). However, either method is perfectly satisfactory. If I had used a software timing loop, the

write pulse would have been tied to pin 18 through the 74LS04 and 7406 circuits in the same manner that pin 20 of the 2716 was tied (see figure 4b, October 1981 BYTE, page 43). If you take this route, be sure that a constant high level is not applied in the programming mode. The one-shot circuit gives built-in protection against this happening. . . . Steve ■

In "Ask BYTE," Steve Ciarcia answers questions on any area of microcomputing. The most representative questions received each month will be answered and published. Do you have a nagging problem? Send your inquiry to:

Ask BYTE  
c/o Steve Ciarcia  
POB 582  
Glastonbury CT 06033

If you are a subscriber to The Source, send your questions by electronic mail or chat with Steve (TCE317) directly. Due to the high volume of inquiries, personal replies cannot be given. Be sure to include "Ask BYTE" in the address.



## Got a computer?



### Get a Giltronix Selector Switch.

Eliminate unplugging and re-plugging your CPU's, peripherals, and modems. Eliminate expensive duplication of interconnection hardware. Connect three components to Giltronix Selector Switch #S8AB. Then select your connection with a simple turn of the dial. Only \$79 in OEM quantities. Monitoring options available. Full 5 year warranty on all Giltronix units.

**SWITCH TO GILTRONIX.**



970 San Antonio Ave., Palo Alto, CA 94303

Circle 202 on inquiry card.

## Get Greedy!



### Get your TRS-80 a Giltronix Switching Unit.

Maximize price/performance by connecting your TRS-80 and two peripherals to Giltronix Switching Unit #GTRS-2AB-AP2. Then select your connection with a single turn of the dial. Eliminate duplicate interconnection hardware. Eliminate wasted time spent unplugging and replugging components. Off-the-shelf availability with a wide selection of I/O configurations. Call for your FREE product catalog.

**SWITCH TO GILTRONIX.**



970 San Antonio Ave., Palo Alto, CA 94303

Circle 203 on inquiry card.

## Got to expand?

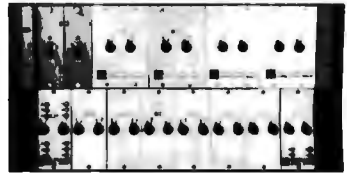

### Get a Giltronix Dual Switching System.

Expand and upgrade your 19" rack mounted dual switching system with a Giltronix Switching System #GDnS24. Superior design features: PCB technology for increased reliability... Vertically mounted connectors for easy access... Optional 3rd position and monitoring functions. For only \$139. Quantity discounts available. Dealer inquiries invited.

**SWITCH TO GILTRONIX.**



970 San Antonio Ave., Palo Alto, CA 94303

Circle 204 on inquiry card.

## RIBBONS at GREAT DISCOUNTS

Multistrike ribbons (black) for:

	New Ribbons	Reloaded Cartridges	Refill* Ribbon Pancakes
Qume (Ours)	\$3 ea.	\$2 ea.	\$1 ea.
Diablo (Univ.)	\$4 ea.	\$3 ea.	\$2 ea.
NEC (Orig.)	\$4 ea.	\$3 ea.	\$2 ea.
Wang (Ours)	\$4 ea.	\$3 ea.	\$2 ea.
Ricoh (Orig.)	\$6 ea.	\$4 ea.	\$3 ea.

(Cloth ribbons will be available shortly.)

\*Minimum order 3 pancakes with instructions. Add 25 percent for orders of less than 1 doz. We "trade" for RELOADABLE used cartridges. Write for price lists on diskettes, printwheels and other ribbons. Order our new 150 page book HOW TO RELOAD MULTI-STRIKE DAISY WHEEL WORD PROCESSING RIBBONS. \$49. This book puts you in business reloading ribbons at home.

**WILLIAM WALKER**

Word Processing Supplies  
306 West 46th St.  
New York, NY 10036

Circle 461 on inquiry card.

## \$73.80\* Single Board Computer



6800 MPU, serial I/O, parallel I/O, RAM, EROM, 44-pin 4 1/2" x 6 1/2" PCB

**EXPANSION MODULES**  
RAM, ROM, CMOS RAM/battery, analog I/O, serial I/O, parallel I/O, counter/timer, 486 GPIB, EROM programmer, power fail detect/power on reset



Wintek Corp  
4801 South Street  
Lafayette, IN 47904  
317-742-8428

Circle 472 on inquiry card.

## FORECASTING

**EASI/ARIMA** — The first and only microcomputer program to develop and run ARIMA (Box-Jenkins) models...all automatically. Designed for the stock or commodity trader. Create a database or read Compu Trac files directly. Requires no knowledge of statistics. Recommended by Chase Econometrics. \$300.

**TWG/ARIMA** — The statistician's version of EASI/ARIMA. Complete control and more options, such as seasonal models and Box-Cox transformations. \$300.

**ELF** is our general purpose statistical package. \$200.

All are for the Apple II\* with 48K of memory, Applesoft\* and DOS 3.3.

Visa and MasterCard accepted.  
Call or write:

*The Wickendon Group*  
3907 Lakota Road  
P.O. Box 10114  
Alexandria, VA 22310  
(703) 960-2587

\*Trademarks of Apple Computer, Inc.

Circle 471 on inquiry card.

## SUPER SALE

### EPROM

	1-7	8 up	50 up
2716	4.15	3.90	CALL
2732	9.70	8.85	CALL

### 16K RAM EXPANSION KIT

For TRS-80 Model III

Set of 8 pieces UPD416-2 (200nS)

Data furnished with purchase on request. **\$13.95**

### WRITE FOR FREE CATALOG

**SUNTRONICS CO., INC.**  
12621 CRENSHAW BOULEVARD  
HAWTHORNE, CALIFORNIA 90250  
LOCATED NEXT TO FORTVILLA INTERNATIONAL  
STORE HOURS: Mon-Fri 10:00-6:00pm-Sat 10:00am-5:00pm  
IN CALIFORNIA OUTSIDE CALIFORNIA TOLL FREE  
**(213) 644-1149 1-800-421-5775**

Mail Order—Minimum Order \$10. Send Money Order or Check to:  
P.O. BOX 1957—Dept B HAWTHORNE, CA 90250. Use your  
VISA or MasterCard (please include expiration date). Add \$2.00  
postage and handling to order. California residents add 6% sales tax.

## DMB 6400

## LOOK ALIKE

# \$399

One Year Full Warranty  
Delivery from stock

# Sonics systems

1500 NW. 62 Street  
Ft. Lauderdale FL.  
33309 Suite 409

305-776-7177

Circle 417 on inquiry card.

## SOFTWARE AUTHORS

Cash in on your creative energies. Join InfoSoft Computer Systems' SOFTWARE DEVELOPMENT PROGRAM. Get all of your R&D hardware at our distributor cost plus

## 20% Royalty!

We give you personalized service, offer a non-exclusive marketing agreement, plus other specialized services. We seek: high level language compilers, cross-assemblers, utilities, DMBS, new OS, educ. and business applications, and any other marketable program. We offer full development and documentation. Don't hesitate, contact us immediately.

Michael L. Dean, V.P. R&D  
**InfoSoft Computer Systems**

2699 Clayton Rd.  
Concord, CA 94519



(415) 680-0202

Single Source Solution

Circle 226 on inquiry card.

## News and Speculation about Personal Computers

Conducted by Sol Libes

**R**andom Rumors: Add the following items to the NCC (National Computer Conference) rumor list I gave in last month's BYTE LINES: Hitachi is expected to show a personal computer prototype with specifications very similar to the IBM machine. It will use the Intel 8088 processor and will also have three operating systems: MS-DOS, CP/M-86, and Pascal. It should be on the market before year-end. . . . Also expected at NCC is a scaled-down version of the Star workstation from Xerox, expected to sell for 50 percent less and to be called (what else?) the Starlet. Incidentally, although the Star was a hit at last year's NCC, I am not aware that any units have been shipped to customers. . . . Other anticipated new entries at NCC include a videodisc-to-micro-computer interface and a videodisc with a 250-mega-byte legal database from Xedex, New York, and a 120K-byte, 6809-based multi-user system, with a Unix-like operating system, from Gimix, Chicago, Illinois. . . . Also at NCC you can expect to see at least four manufacturers running Microsoft's Xenix multi-user DOS on their systems.

Look for Panasonic to shortly introduce a \$199 personal computer; a color version will sell for \$299. Later the firm expects to introduce voice I/O for the unit. Options will include memory expansion, disk drives, joysticks, and an 80-column printer. Software packages will include word processing and business applications under standard CP/M and Apple CP/M. . . . Several IBM look-alikes are expected on the market shortly.

### **R**andom News Bits:

Digital Research has confirmed what was previously rumored in this column, namely that it is working on a 68000 implementation of the CP/M disk operating system. Hitachi is expected to be the first to use it. . . . Vector Graphic has reported a 156 percent increase in income for the last quarter of 1981—\$1 million, up from \$395,000 the year before. Sales for the quarter were \$9.68 million. . . . Commodore reported that its net income rose 63 percent on a sales increase of 55 percent for the second half of 1981 (\$124 million). . . . Diablo reportedly will shortly begin making videodisplay terminals. . . . Cromemco, Mountain View, California, has disclosed that it is working on a 2-megabyte S-100-card memory, designed primarily for its new 68000 system. With just eight cards, the user can have 16 megabytes of directly addressable memory! . . . G & G Engineering, San Leandro, California, has introduced "IBM-ulator" for S-100 CP/M systems. Using an 8088 processor card, the IBM-ulator can read and write CP/M-compatible files from and to an IBM 5¼-inch disk. . . . Later this year Toshiba will introduce a dot-matrix printer with a 24-pin head mechanism capable of producing fully formed characters at 100 characters per second (cps) and draft-formed characters at 160 cps. . . . New England Digital Corporation, White River Junction, Vermont, and Hazelcom Industries Ltd., Toronto, Ontario, have announced machines with piano-like keyboards that transcribe

whatever music is played on them.

### **M**arketing Is the Name of the Game:

Computerland Corporation has disclosed that it is planning to set up franchised stores that will sell only software. The company's goal is to have 400 software stores open by 1984. . . . Sears is so delighted with the performance of its five computer stores that it will shortly open 45 more in 17 cities. The stores will be known as "Business System Centers" and will employ an expected 300 sales personnel. The Sears stores currently carry IBM, NEC (Nippon Electric Company), and Vector Graphic computer systems, TI (Texas Instruments) and HP (Hewlett-Packard) calculators, Exxon and Olivetti typewriters, Saxon copiers, and Wang word processors.

There is no doubt that success in the personal computing marketplace now is less a function of having a well-designed product than of having adequate distribution. I recently made a brief survey of all the computer stores in the 10 largest U.S. cities to determine system distribution. I checked Boston, Chicago, Dallas, Detroit, Houston, Los Angeles, New York, Philadelphia, San Francisco, and Washington, DC., and I discovered that in these cities a total of 165 computer stores were carrying 37 different makes of computers. Ranked in order, the 20 leading systems and the number of dealers for each system were: Apple, 120; Atari, 60; HP, 43; IBM, 38; Commodore, 37; Vector

Graphic, 35; Radio Shack Computer Centers, 34 (full-line stores not included); Cromemco, 30; TI, 21; North Star, 18; Dynabyte, 18; Data General, 16; DEC (Digital Equipment Corporation), 15; Zenith, 15; and Altos, 15.

Some interesting conclusions can be drawn. First, Apple is far and away the most popular with dealers, probably due to the large amount of advertising done by Apple that, in effect, pre-sells the system for the dealer. Second, most of the leading systems are made by large companies to whom computers are only a small part of the total business. Most of the companies that grew out of garages, so to speak, are now only a small part of the industry. Third, none of the Japanese suppliers has yet achieved acceptance from computer stores. I found only six dealers who carried the NEC system, and only one carried the Sharp system.

**I**ntegrated Circuits: Fujitsu has disclosed that it will shortly begin providing samples of a 64K-bit CMOS EPROM (erasable programmable read-only memory). . . . DEC will soon start supplying the integrated circuits used in its base-level PDP-11 machines. . . . Motorola is making final plans to introduce the MCM2816, an EEPROM (electrically erasable programmable read-only memory) that will be a pin-for-pin replacement for the popular 2716 EPROM. The company will follow this shortly with a 32K-bit version. The days of the ultraviolet





## “Our current recommendation for a big five accounting package is MBSI”

*Computer Dealer* magazine  
January, 1982

At last, full feature general business software for micro-computers.

Officially authorized derivations from the popular MCBA® mini-computer packages, these packages have been eased down to micros and made even more user friendly.

The mini versions of these packages are distributed by over 900 OEMs and dealers, and are in use at over 9,000 end user sites worldwide.

And already these micro versions themselves are in use by thousands of end users.

Written in RM/COBOL™, these packages run under CP/M®, OASIS™, UNIX®, COS-990® and other operating systems.

They run on dozens of brands of micro-computers, including properly configured models from Radio Shack II,

Apple III, Zenith, Hewlett Packard 125, Xerox 820, ALTOS, ONYX and many more.

Tens of man-years have gone into these packages, which comprise over 230 programs, 165,000 lines of structured source code, and 1,800 pages of user and technical documentation.

Our claim is simple:

**THIS IS THE BEST MICRO-COMPUTER GENERAL BUSINESS SOFTWARE AVAILABLE.**

*And we stand behind that with a moneyback guarantee.*

It's no accident that *Computer Dealer* magazine recently endorsed MBSI software.

So if you're a re-seller looking for first class micro-computer software, contact us today.

# mbsi

**Micro Business Software, Inc.**  
Dover Rd., Dept. BY2  
Chichester, NH 03263  
Phone: (603) 798-5700

EPROM eraser appear to be numbered. . . .

**I****BM News Items:** Software Techniques, Alexandria, Virginia, has published a report that provides engineering data on the custom integrated circuits and proprietary devices used in the IBM Personal Computer system. It includes schematics, parts lists, timing diagrams, etc., not provided by IBM in its documentation. The report costs \$5000. . . . Xedex Corporation, New York, has introduced a plug-in Z80 processor card with 64K bytes of memory (similar to the Microsoft Softcard for the Apple II) that allows an IBM Personal Computer to run CP/M-80 software. The price is \$600. Xedex hopes that IBM users will take advantage of this until there is a decent amount of software available for the IBM system. . . . IBM is expected to open soon a Personal Computer manufacturing plant in France. . . . Several Computerland stores are reportedly offering quantity discounts on the IBM Personal Computer. . . . Corvus Systems, San Jose, California, is rumored to be working on a networking system for the Personal Computer that should be available later this year. . . . Several C compilers for the Personal Computer are due for release this summer.

IBM has also introduced a robot, called the 7535 Manufacturing System, that can be programmed using an IBM Personal Computer system with a special version of IBM's new robotics language called AML (A Manufacturing Language). The robot is built in Japan and will cost \$28,500. The program costs \$5575. IBM is also test-marketing the RS-1 robotic system, which has an arm that can move in six directions and a two-fingered hand. The RS-1 is

presently being used to assemble IBM computers.

**A****pple Happenings:** Microsoft's Z80-based processor card for the Apple III will be marketed exclusively through Apple Computer Inc. Microsoft disclosed that 20 percent of all Apple IIs are using the company's Softcard with CP/M. . . . Franklin Computer Corporation, Pennsauken, New Jersey, has introduced a computer that is compatible with the Apple II. The machine will do everything the Apple II does except display color graphics (that would infringe on Apple patents). The Franklin computer, however, has extra keyboard functions, more memory, and sells for \$300 less than the Apple II. I suspect that Franklin should find several mail-order dealers very interested in selling its product. . . . Several imitations of the Apple II are reportedly being made in the Far East. Apple is investigating action against these copiers as the machine is protected by four or five patents.

**C****P/M News:** Digital Research reports that CP/M-80 has now been implemented on over 450 different computer systems. Can there be any doubt that CP/M is the standard for single-user 8-bit disk-operating systems? . . . Lifeboat Associates, New York, has released EM-86, a software module that will allow CP/M-86 software to run under the control of Microsoft's MS-DOS without any modifications. The module costs \$75. . . . Dasoft Design Systems, Aloha, Oregon, has introduced a design-automation system called Magic. Running under CP/M, it aids in the design of circuits, documentation, and printed-circuit generation. It

includes a design editor, device library, schematic generator, and more. It produces camera-ready artwork and is priced at \$729. . . . Virtual Microsystems, Berkeley, California, has introduced a CP/M-80 simulator for DEC PDP-11 and VAX-11 systems. Running as a task under RSTS, RSX, or Unix, it allows the reading and writing of standard 8-inch CP/M disks and the running of CP/M programs.

**M****S-DOS Versus CP/M:** When Microsoft wanted to implement many of its languages and applications packages on the Apple II, the company chose what it considered the easiest, fastest, and most economical way to do it: creation of a "hardware bridge"—a Z80 processor card for the Apple II that allows the running of CP/M-based versions of Microsoft's software.

There is no doubt that CP/M has become the most successful microcomputer DOS. It has the broadest support from language- and application-software suppliers and public-domain software (I challenge anyone to tell me, with any accuracy, how many software packages are currently available for CP/M-based systems). CP/M has been licensed, according to Digital Research, on over 450 different types of systems (this probably translates into over 450,000 actual machines).

Microsoft, with extensive experience in system software development, last year decided to introduce its own DOS, called MS-DOS, naturally (for Microsoft disk operating system). Actually MS-DOS was created a few years earlier by Seattle Computer Products for its 8086-based S-100 system when the company gave up waiting for Digital Research to introduce

CP/M-86. Microsoft acquired exclusive rights to the DOS, hired its author and invested a considerable effort in enhancing it.

The battle lines have now been drawn—picture CP/M as Goliath and MS-DOS as David. In just six short months, MS-DOS has gained a strong foothold in the single-user/single-task DOS marketplace. The greatest coup, of course, is the IBM Personal Computer: although IBM has announced three different operating systems for the Personal Computer, at this writing only one is available—MS-DOS. Microsoft has further announced that MS-DOS has already been implemented on 20 different machines and that 32 more (11 of which will be from Japan) should be announced by year-end. In other words, MS-DOS will have been implemented on over 50 machines by the end of 1982.

Microsoft took a close look at CP/M—its strengths and particularly its weaknesses—in developing MS-DOS. There is little doubt that the firm has created a DOS that is much more user-friendly, faster, with many more advantages, and fewer disadvantages than CP/M.

One of MS-DOS's biggest disadvantages appears to be the lack of a floppy-disk-format standard that allows users of different systems to exchange disks. One of CP/M's greatest advantages is that software vendors can supply CP/M software on 8-inch single-density soft-sectored disks and cover most of the CP/M marketplace (although the increasing popularity of 5¼-inch disks is becoming a problem). Microsoft is attempting to convince its MS-DOS original equipment manufacturers that a 5¼-inch disk format is important. With IBM's help the 5¼-inch format may become



# NNC HAS A NEW LOOK

We've given our Series 80 microcomputers a bold new look. Now you can have a computer that will enhance the appearance as well as improve the efficiency of your installation.

Our new die-cast front panel has improved the integrity and strength of the chassis, while adding protection for the reset switch. And, behind our pretty face you'll find a solidly-built, high performance computer that is ideal for stand alone as well as multi-user, multi-tasking applications.

The Model 80W shown below features an IEEE standard 4MHz Z80 CPU, 64KB of Dynamic RAM, 2 Serial and 3 Parallel ports, 10MB Winchester disk storage, 8" Floppy disk drive for file loading and backup, professionally prepared documentation, and has complete upgrade capability.

Here are several reasons why NNC should be your next computer:

**RELIABILITY**—standard proven components, quality parts, professional industrial design techniques and intensive quality control add up to outstanding reliability.

**FLEXIBILITY**—NNC computers have been designed to meet a wide variety of applications.

**COMPATIBILITY**—NNC utilizes CP/M\* and OASIS\* operating systems which provide access to extensive single and multi-user application packages.

**SERVICEABILITY**—NNC's modular design and use of standard, readily available, quality components improves maintainability and minimizes down time.

See the new look of NNC at your nearest computer dealer. He'll be glad to demonstrate the Series 80 and show you the total beauty of NNC computers.

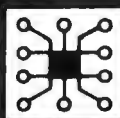

**NNC**  
ELECTRONICS

15631 Computer Lane, Huntington Beach, CA 92649  
Telephone: (714) 895-8000 TWX: 910 596 2360

CP/M is a trademark of Digital Research  
OASIS is a trademark of Phase One Systems



**NNC—The Difference Between Toys and Tools in Microcomputers**

Circle 490 on Inquiry card.

a standard. In other words, while machines may be able to read other formats, they should at least be able to read the standard format.

Microsoft has announced that this fall it will introduce Version 2.0 of MS-DOS; among the new features are a visual shell, more user friendliness, network interface (so the system can be used as a work station in a local network), improved utilities (print spooler, debug, etc.) and standard terminal interface including graphics using ANSI (American National Standards Institute) standard escape sequences. Microsoft has disclosed that it is working on MS-DOS enhancements (version 3?) that will include MS-DOS recoded in the C language for easy conversion to other microprocessors, a C compiler to be included with MS-DOS, file I/O transparency across networks, and diskless work stations. Microsoft has also revealed that it is working on language enhancements that will include support for the Intel 8087 floating-point math processor.

As an aside, Microsoft, a privately held company, disclosed that last year it grossed \$16 million and this year it expects to double that figure.

**More 32-Bit Micros:** Bell Laboratories and Hewlett-Packard have disclosed that they will shortly begin manufacturing 32-bit microprocessor integrated circuits. The Bell Labs version is called Bellmac-32A. It is a full 32-bit microprocessor; the data and address buses, internal and external, have 32 lines. All of the registers are 32 bits wide and all instructions operate directly on 32-bit data words. The device, which has close to 150,000 transistors, can directly address a gigabyte of memory. It has been

designed with the Unix operating system and the C language in mind.

The HP 32-bit device is a set of ICs that will be used in a new product to be introduced in about a year. The set includes the processor, memory controller, read/write and read-only memory, I/O processor, and clock generator. The processor is on a 1/4-inch-square chip that has three to eight times the circuit density of any current IC, according to HP, and contains 450,000 transistors.

**Motorola Adds to 68000 family:** Motorola has reached an agreement with six other semiconductor manufacturers whereby the companies involved will design new devices to add to the MC68000 family of microcomputers. The joint contributions of Motorola and the six members of the design group (Mostek, Signetics, Rockwell, Hitachi, Thompson CSF, and Philips) allow the addition of far more products to the 68000 product line than any company could do by itself. The new products announced are 8-bit-bus and 32-bit-bus versions of the 68000 microprocessor, a virtual-memory version of the 68000, and a floating-point mathematics processor. Some of the products will not be available until late 1983 or early 1984. The following is a brief look at the announced products.

The 68008 is a 48-pin version of the 68000 that has data and address buses compatible with conventional 8-bit microcomputers. Motorola obviously hopes it will find a market analogous to that of Intel's 8088, an 8-bit-bus variation of the 8086 microprocessor. The 68008 will address one megabyte of memory. Samples will be

available in the fourth quarter of 1982.

The 68020 is reported to be the beginning of a 32-bit family of microprocessors. It will have 32-bit-wide data and address paths and will come in several configurations, the largest of which will be a package with 100 pins. Because of mechanical problems with a device of this size, Motorola is discarding the dual-inline design of present ICs for a new package. The address space of this largest configuration will be 4 billion bytes of memory. The 68020 will have several interesting features, including a cache memory, a 16-MHz clock (allowing it to execute 1.5 million instructions per second), and an interface to auxiliary coprocessors. One interesting technical note: the chip, which is primarily conventional NMOS (negative-channel metal-oxide semiconductor), will have a small portion of grafted-on CMOS (complementary metal-oxide semiconductor) circuitry. According to Motorola, this will significantly reduce power consumption. Motorola is calling this new process HCMOS III or "merged MOS." Samples are promised for the fourth quarter of 1983.

The 68881 is a floating-point math coprocessor that is said to be the first of a line of coprocessors for use with the 68020 microprocessor and other members of the 68000 family. The unit will handle several degrees of precision, conform to the IEEE (Institute of Electrical and Electronics Engineers) floating-point standard, coprocess with the 68020 whenever possible, and do over 150,000 operations per second. It will also use the HCMOS III technology described above, and samples will be available by the fourth quarter of 1983. The 68452, a bus-arbitration

module, and the 68440 dual DMA (direct memory access) coprocessor will be introduced in late 1983 or early 1984.

The 68010 is a microprocessor, pin-compatible with the 68000, that will work with the existing 68451 Memory Management Unit (MMU) to create a microcomputer that implements virtual memory (i.e., the majority of the memory will actually reside on a disk and will be swapped in and out of random-access memory automatically).  
... G. W.

**Spreadsheets Proliferate:** Visicalc, introduced in late 1979, was the first spreadsheet program. Now about 24 such programs are on the market. Visicalc, without doubt, is the most successful, and to a great extent it has made the Apple II the success that it is.

But Visicalc has some limitations: restricted memory capacity; crude editing, text processing, and formatting; and lack of conditional statements. However, the most serious shortcoming has been the lack of a CP/M version.

Competing spreadsheet programs have capitalized on these limitations. Most run under CP/M. Some offer modeling-language extensions to allow manipulation of the work sheet itself (e.g., Microplan, Plannercalc). Some allow different spreadsheets to associate with one another by means of a sheet-linkage feature (e.g., Multiplan, Calcstar, Forecaster). One (NEC Report Manager) even allows a three-dimensional sheet. Many allow their spreadsheets to share data with other programs.

It is also interesting to note that some software suppliers now offer versions for mini-computers. One supplier (Digicalc) offers a spreadsheet



STOCK ORDERS SHIPPED IN **24 HOURS**

# ADDS VIEWPOINT \$499\* QTY. 1

TERMINAL

The Best Equipped Printer for the Money!

**MODEL 88G**  
B&G FEATURES

Graphics  
Friction Feed  
Adjustable Inlet Feed  
Postnet Interface  
gPIII Printer  
Data Buffer  
Carriage Spacing Font II + 7  
Print Speed  
Number of Counts  
Variable Forms Lettering

Standard  
Standard  
Standard  
Standard  
16 Stylized  
Standard  
100 CPS  
80/96/132  
Standard

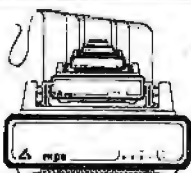

**mp**  
**\$649** QTY. 1

Interface cables for IBM-PC, Apple, Centronics, Alpha and PPT

## DISC DRIVES

<b>QUME:</b> DT-8...\$525.00* QTY. 1 <small>8" D5DD 18 TP</small>	<b>DT-5...</b> \$310.00* QTY. 1 <small>5 1/4" X5DD 18 TP</small>
<b>TANDON:</b> TM-100-2...\$335.00* QTY. 1 <small>7 1/2" HT 18 TP</small>	<b>TM-100-4...</b> \$425.00* QTY. 1 <small>5 1/4" D5DD 96 TP</small>
<b>TM-848-1...</b> \$475.00* QTY. 1 <small>10 1/2" 18 TP</small>	<b>TM-848-2...</b> \$550.00* QTY. 1 <small>8" 18 TP</small>
<b>TM-602...</b> \$995.00* QTY. 1 <small>5 1/4" 10MBYTE WINCHESTER</small>	<b>TM-603...</b> \$1175.00* QTY. 1 <small>5 1/4" 10MBYTE WINCHESTER</small>

## QUME LETTER QUALITY PRINTERS

**SPRINT 9/45 \$2245\*** QTY. 1

OTHER MODEL AND CONFIGURATIONS AVAILABLE

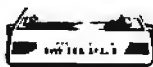

**(408) 438-5454**

4444 SCOTT'S VALLEY DR., SCOTT'S VALLEY, CA 95066

TERMS: Cashiers Check, VISA, M/C, COD

Shipping charges added to all orders

\* Quantity Discounts Available



# YOU'VE JUST FOUND THE MISSING LINK!



Computer Shopper is your link to individuals who buy, sell and trade computer equipment and software among themselves nationwide. No other magazine fills this void in the marketplace chain.

Thousands of cost-conscious computer enthusiasts save by shopping in Computer Shopper every month through hundreds of classified ads. And new equipment advertisers offer some of the lowest prices in the nation.

Computer Shopper's unbiased articles make for some unique reading among magazines and there's a "help" column to answer difficult problems you may have with interfacing, etc.

For a limited time you can subscribe to Computer Shopper with a six month trial for only \$6.

**6 month trial, \$6<sup>00</sup> Call Toll Free** **800-327-9920**

or send a check to:

**COMPUTER SHOPPER**

P.O. Box F301 • Titusville, FL 32780

305-269-3211

# TWO STEPS TO FREEDOM



Programmers! Unshackle yourself from chores and devote more time to creative work. Here are two powerful tools for faster, easier retrieval of data:

**\$200**  
with manual

## PFAS

The fastest, portable ISAM for UCSD p-System™ CP/M™ and Pascal MT+™

PFAS is a set of routines written in Pascal which allow programmers to access data records by a primary key and any number of secondary keys. A professional, easy-to-use program development tool which supports variable length records, multiple key access and unlimited number of records in a file. PFAS can find and read records in less than half a second on floppy disk systems. Truly machine independent - from Apple to Zenith, from HP125 to HP1000.

\* UCSD Pascal and UCSD p-System are trademarks of the Regents of the University of California.

\* CP/M and Pascal MT+ are trademarks of Digital Research, Inc.

**\$95**  
with manual

## PHOSFORM

Allows you to easily design, write and modify programs that use fill-in-the-form input. An editor and a set of portable input routines help you quickly create and custom design forms to fit your needs. Form headings and the order of information are easily changeable. The PHOSFORM editor will document the finished form. PHOSFORM and applications are portable and run on any terminal.

AVAILABLE FOR IBM PERSONAL COMPUTER

# GRYPHON SYSTEMS

1917A Edinburg Avenue  
Cardiff-by-the-Sea, CA 92007  
714-436-1455 • TLX 4990529

## Powerful Lab Graphics For Your Apple II +<sup>®</sup> Computer

**SCIENTIFIC PLOTTER**

**VIDICHART™**

**CURVE FITTER**

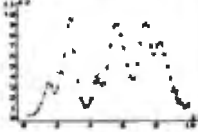
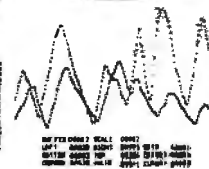
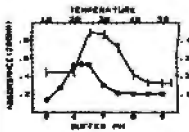

**SCIENTIFIC PLOTTER**

Draws professional-looking graphs of your data. EASIER, FASTER, NEATER and more ACCURATE than handplotting. You choose data format, length and position of axes, 20 symbols, error bars, labels anywhere in 4 orientations, etc. Includes 5 DEMOS on disk with 30-PAGE MANUAL.

**CURVE FITTER**

Selects the best curve to fit your data. SCALE, TRANSFORM, AVERAGE, SMOOTH, INTERPOLATE (3 types), LEAST SQUARES FIT (3 types), EVALUATE UNKNOWNNS from fitted curve. Includes 5 DEMOS on disk with 33-PAGE MANUAL.

**VIDICHART™**

NEW tools for lab data management. FAST plots of 4 data sets with SCROLLING in 4 directions, ZOOM scaling on X and Y axes, 2 types of graphic CURSORS and on-screen STATUS REPORT. PLOTS A/D INPUT while sampling. ADD, SUBTRACT, MULTIPLY, DIVIDE, INTEGRATE, DIFFERENTIATE, AVERAGE or NORMALIZE data sets with SIMPLE COMMANDS. Ideal for spectra, chromatograms, rate curves, etc. Includes SAMPLE DATA on disk with 28-PAGE MANUAL.

**SPECIAL!** All 3 programs on one disk, only \$120. Since each program uses the same data format on disk, data may be shared.

**BUY THESE PROGRAMS AT YOUR LOCAL DEALER OR ORDER DIRECT.** For more information, ask for FREE brochure or send \$5 for any manual (\$12 for all 3), deductible with purchase. Add \$1.50 shipping on all orders. For fastest service, call in your VISA or Master Card order.



**INTERACTIVE MICROWARE, INC.**  
P.O. Box 771, Dept. B State College, PA 16801  
CALL (814) 238-8294 for IMMEDIATE ACTION

® Trademark of Apple Computer, Inc.

## SWEET-TALKER, IT GIVES YOUR COMPUTER AN UNLIMITED VOCABULARY.

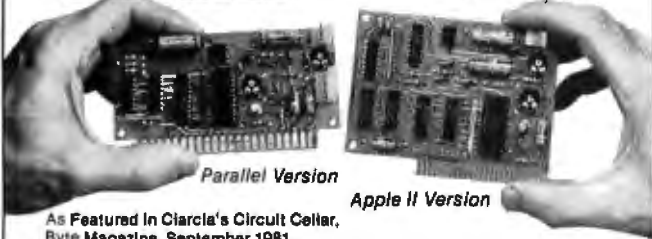

As Featured In *Circuit's Circuit Cellar, Byte Magazine, September 1981.*

The Sweet-Talker voice synthesizer allows you to add speech of unlimited vocabulary to your computer. Utilizing the Votrax SC-01A chip, you can output any message by programming individual phonemes. Comes in two versions; one plugs directly into your Apple II, the other connects to any computer with an 8-bit parallel printer port. +12 volts and +5 volts required for parallel board.

- Contains 64 different phonemes accessed by a 6-bit code. ST01 Sweet Talker Parallel Port Board A & T. . . . . \$139.00
- Automatic and manual inflection modes. ST02 Sweet Talker Apple II plug in board. . . . . \$149.00
- Parallel port driven or plug-in compatible with Apple II. ST06 Text-to-Speech algorithm on disk for Apple II. . . . . \$35.00
- Super text-to-speech algorithm on disk for Apple II. Makes Sweet-Talker equivalent to units 3 times the cost. SC01A Votrax Speech Synthesizer chip. . . . . \$70.00
- On board audio amplifier 5 or more. . . . . \$55.00 each
- Sample program on cassette with Apple II board. UPS01 Universal Power Supply. A & T. . . . . \$35.00
- Optional power supply for parallel board. Add \$2.00 for shipping & handling.

To Order: Call Toll Free 1-800-645-3479  
(In N.Y. State Call: 1-516-374-6793)  
For Information Call: 1-516-374-6793



**MICROMINT INC.**  
917 Midway  
Woodmere N.Y. 11598



## BYTE LINES

program for DEC VAX machines at only \$6,000.

### Color-Graphics Costs Drop:

Color-graphics-display terminals are being introduced at new low prices, some under \$1000. This is expected to bring color graphics into the business marketplace. In fact, in a few more years, color may become standard. Leading the way now is Intelligent Systems Corporation (ISC), Norcross, Georgia, which is shipping a color-video terminal priced at \$995 for single units. Televideo and Applied Digital Data Systems Inc. are expected to introduce competing units by year-end. The ISC unit can display eight foreground and eight background colors on a 13-inch video screen. It includes function keys and firmware for drawing vectors, bar graphs, and point plots. (Incidentally, Megatek Corporation, San Diego, California, has announced a three-dimensional color-graphics terminal: prices start at \$50,000.)

Color-printer prices are dropping quickly too. Integral Data Systems has a color impact printer for under \$2000 that produces eight colors using a four-band ribbon. Integrex Ltd., England, has developed a color printer based on the Epson MX-80 that it sells for \$1995.

A host of companies are producing color pen plotters. The lowest in cost is currently the Radio Shack 6-pen plotter at \$1995.

The Japanese have not yet entered this market, although they are known to be developing color printers. When they do enter, substantial price reductions can be expected.

**Floppy-Disk News:** Last year 568,000 double-sided

5¼-inch disk drives were made. This year the figure should double to 1.1 million drives. Also, track densities are increasing. The 96-tpi (track per inch) density will soon dominate the market. The result is that companies such as Micropolis have announced 5¼-inch drives with 2-megabyte storage capacities. Delivery of these drives has been slowed pending the availability of improved disks. Better materials are necessary because uneven disk coating and thermal and hygroscopic distortion of the disk surface increase errors.

Several companies have announced they will soon start production of 1.6-inch-high 5¼-inch drives. Thus two drives will fit into the space previously occupied by one drive. Half-high 8-inch drives are already available.

Sony's 3½-inch disk drive is being used in Sony's word-processing system. However, because it is available from only a single source, other manufacturers have been leery of designing it into their products. Sony has announced that it will soon introduce a dual-sided version of the drive.

### Finally, 68000 Software:

I receive many letters from readers of this column regarding the availability of 68000-system software and low-cost hardware. The following, I think, answers most of the questions raised.

It should be noted that Intel introduced its 8086 16-bit microprocessor in 1977—almost five years ago. The first systems using the 8086 became available the following year. However, it was not until 1980-81 that the first DOS development software became available. And it is only now, in 1982—five years later—that applications soft-



# Overcome CP/M Limitations

## TurboDOS

The Professional CP/M-Compatible Operating System

- **CP/M Compatible** Virtually any CP/M (ver. 2.x) program will run under TurboDOS without modification. Fully media compatible with standard CP/M-format diskettes.
- **Spectacular Performance** Programs run 3-10 times faster than TRSDOS or CP/M. Benchmark results to 20 times faster with some applications, as tested by an independent firm.
- **Double-Sided Drive Support** Provides 1.25 MBytes of Storage per 8" double-sided/density disk. Intermix combinations of single or double sided drives on line.
- **Expanded Directories** Store more files and information per disk.
- **Automatic Density/Side Recognition** Detects changes in disk format automatically. Change disks at any time without compromising data or "BDOS/Read-Only" errors.
- **Fast Disk Backup** Copy an 8" SS/DD diskette (610K) in less than 80 seconds.

Copy a double sided/density diskette (1.25 MBytes) in under 1 min. 45 sec.

- **Hard Disk Drive Support** Supports large hard disks in excess of 1,000 MBytes without partitioning.
- **Advanced Utilities** Complete set of disk utilities, system date and time functions, communications channel interface, and more included.
- **Enhanced Automatic Print Spooling** Run multiple printers simultaneously. Supports multiple queues and printers on spooling versions, standard.
- **Advanced Mainframe-like Features** Includes read-after-write validation of all disk update operations, type-ahead buffers, incremental disk backup utility, password/log-on security, system date and time functions, accepts string of multiple commands, and many other capabilities not available under CP/M or TRSDOS. Multi-user networking versions also available.

Versions for TRS-80 Mod II & Xerox 820.  
Print spooling option \$50 additional.  
Adaptable to any Z80-based computer.

**Only \$249**

Manual \$25 refundable with purchase.



**DATA-RX, INC.**

686 Lighthouse Ave., Monterey, Ca 93940

**(408) 375-2775**

TURBODOS is the registered trademark of Software 2000  
CP/M, MP/M, and CP/NET are registered trademarks of Digital Research Dealer/OEM Inquiries Invited.

# BDOS ERROR ON B:BAD SECTOR



Before disk errors ruin your work again order BADLIM.

- BADLIM assures the reliability of your CP/M computer.
- You can use your disks 10 times longer without losing your data AND your time.
- BADLIM checks thoroughly your disk marking all the blocks which have defective sectors. The operating system will know that those sectors should be skipped.
- BADLIM is the only program that gives protection for soft and hard errors.
- The first time BADLIM will list which files in your disk are on bad sectors, so you can take action to correct it.
- But thereafter the bad areas in your disk will be automatically by-passed.
- For CP/M 1.4 single density and for CP/M 2.xx of any format and density. It is a must for Winchester as the media cannot be replaced.

BADLIM cost only \$73. Whatever the reason you have to use a computer you need BADLIM. Contact your dealer or call us today:

BLAT R&D Corp., 8016 188th. St SW, Edmonds WA 98020. Phone: [206] 771-1408

DEALER INQUIRIES INVITED. **BADLIM**

# Marymas INDUSTRIES, INC.

In Texas Orders  
Questions & Answers  
1-713-392-0747

21969 Katy Freeway  
Katy (Houston) Texas 77450

To Order  
1-800-231-3680  
800-231-3681

## SAVE BIG DOLLARS ON ALL TRS-80<sup>®</sup> HARDWARE & SOFTWARE

TRS-80<sup>®</sup> BY RADIO SHACK. Brand new in cartons delivered. Save state sales tax. Texas residents add only 5% sales tax. Open Mon.-Fri. 9-6, Sat. 9-5. We pay freight and insurance. Come by and see us. Call us for a reference in or near your city. Ref: Farmers State Bank, Brookshire, Texas.

### WE OFFER ON REQUEST

- Federal Express (Overnight Delivery)
- Houston Intercontinental Airport Delivery (Same Day)
- U.P.S. BLUE (Every Day)
- References from people who have bought computers from us probably in your city

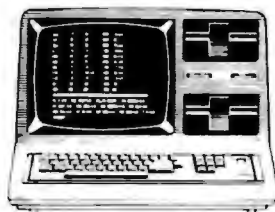

In stock TRS-80 Model II and III

No Tax on Out of Texas Shipments!

**Save 10% 15%**

**OR MORE**

Reserve Your Model 16 Today

Telex 77-4132 (Fleks Hou)

### WE ALWAYS OFFER

- NO extra charge for Master Card or Visa.
- We use Direct Freight Lines. No long waits.
- We always pay the freight and insurance
- Toll free order number
- Our capability to go to the giant TRS-80<sup>®</sup> Computer warehouse 5 hours away, in Ft. Worth, Texas, to keep you in stock.

**JOE McMANUS**

\* TRS-80 is a Registered Trademark of Tandy Corp

**ED McMANUS**



ware packages are beginning to appear.

The 68000 was introduced by Motorola in 1980, and the first 68000 system became available last year. The disk operating systems are only now becoming available, and languages should start becoming available early next year. Therefore, I do not expect to see any significant amount of 68000 applications software becoming available until 1984.

I doubt that the 68000 will have much of an impact on the single-user/single-task personal computer market. Its great strengths will be in the multi-user/multi-tasking market competing against traditional minicomputers. Keep in mind that Microsoft's 68000 DOS (Xenix) requires 50K bytes of 16-bit-wide user memory, as compared to 8086 DOS (MS-DOS), a

single-user/single-tasking DOS that occupies only about 5K bytes of memory. I am not currently aware of any companies developing low-cost 68000-based personal computer systems. I would appreciate hearing from anyone who knows of one.

**Large Direct-view LCD:** Kyles Inc. of Mountain View, California, a subsidiary of 3M Company, has developed a new type of alphanumeric liquid-crystal display (LCD) called the TAD (thermally addressed dye) display that has been incorporated into what is possibly the largest direct-view panel LCD ever made: a 6- by 7-inch, 288- by 357-pixel flat display screen. Each pixel is 15 hundredths of an inch square, and in alphanumeric use 24 lines of 50 characters each can be

displayed. The TAD display could make possible a new generation of portable computer terminals.

The TAD technology uses a so-called guest molecule of dichroic dye attached to host molecules of liquid crystal; the two types of molecules have a similar physical structure. In the normal nematic molecular orientation, the dye is invisible. When the liquid-crystal molecules are reoriented in the display, the dye molecules are also re-oriented, causing the dye to become visible.

For the liquid-crystal molecules to be changed in orientation, they must first be heated; in the display one row of pixels is heated at a time by an electric heating current passed through heating elements in the panel. The heating places molecules into random orientations, allowing

the dye to show up. Then, while all the molecules in the row are cooling down, the pixels that are to be restored to the blank state (i.e., dye not visible) are addressed along the appropriate column by pulses of current.

A unique property of the TAD display is the permanence of its images. Because the pixels must be heated for their states to change, they do not revert to blankness when not in use. You can unplug a TAD display from its control circuitry and keep it in a drawer for a year—and when you take it out, it will still show the image it contained when it was unplugged.

The TAD display is driven by a control module containing a Z80A microprocessor, 4K bytes of read/write memory, 16K bytes of read-only memory, and various other components; the control

**\$495.**

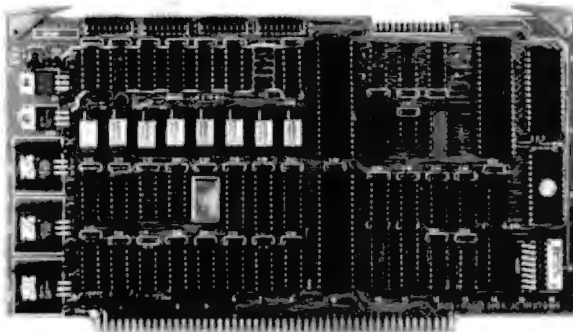

**SBC can be redundant!!**

- Z80A 4MHz, 64K RAM, 2K ROM
- 2 serial, 2 parallel, 4 timer ports
- Bi-directional inter-processor channel
- Multi-processor architecture capability
- Redundant processor manipulation capability
- Matching double-density disc controller with SASI and PRIAM interface
- Application note for system configurations

**JC SYSTEMS** (415) 657-4215  
1075 Hiawatha Ct. Fremont, CA 94538

**MAIL ORDER DISCOUNTS**



**SOFTWARE & ACCESSORIES**

VISIGALC .....	169
VISITREND/VIPILOT .....	215
VISIFILE .....	210
DESKTOP PLAN II .....	159
BPI BUSINESS SOFTWARE .....	335
CONTINENTAL BUS. SOFTWARE .....	245
SUPERSCRIBE II .....	110
SUPERTEXT II .....	105
EASYWRITER .....	219
WORDSTAR (CP/M) .....	299
REAL ESTATE ANALYZER .....	120
TAX PREPARER .....	85
CREATIVE FINANCING .....	120
HAYES MICROMODEM II .....	289
MICROSOFT Z-80 SOFTCARD .....	299
MICROSOFT 16K RAM CARD .....	169
VIDEX 80 COLUMN CARD .....	289

**Epson PRINTERS**

EPSON MX-70 .....	350
EPSON MX-80 .....	450
EPSON MX-80FT .....	550
EPSON MX-100 .....	730
QUME SPRINT 5/45 .....	2499

**MONITORS**

AMDEX LOW-RES 13" COLOR I .....	369
AMDEX HI-RES 13" COLOR II .....	850
SANYO 9" 58W .....	185
ZENITH 12" GREEN .....	125
NEC 12" GREEN .....	189
NEC 12" LOW-RES COLOR .....	365
NEC 12" HI-RES RGB COLOR .....	875

**ATARI 800 & 400**

ATARI 800 (16K) .....	675
ATARI 400 (16K) .....	335
810 DISK DRIVE .....	439
16K RAM MEMORY MODULE .....	89
850 INTERFACE MODULE .....	165
830 ACOUSTIC MODEM .....	159
ATARI WORD PROCESSOR .....	125

**XEROX 820 "SAM"**

SYSTEM I (5 1/2" DRIVES) .....	2395
SYSTEM II (8" DRIVES) .....	2995
XEROX 630 PRINTER .....	2325
WORD PROCESSING (WORDSTAR) .....	425
CP/M OPERATING SYSTEM .....	175

**NEC PC-8000**

PC-8001A SYSTEM W/32K .....	750
PC-8012A I/O & EXPANSION .....	525
PC-8031A DUAL DRIVES .....	750
PC-8023A MATRIX PRINTER .....	550
TRACTOR/FRICTION .....	145
PC-8033A I/O PORT FOR DISK DRIVES .....	145
THE WEDGE—DISK, RS232 & .....	515
GAME I/O W/32K .....	515

**DISKETTES**

BASE 5 1/4" DISKETTES (10) .....	25
BASE 8" DISKETTES (10) .....	29

TO ORDER: Please send cashier's check, money order or personal check (allow 10 business days to clear): VISA and Master Card credit card service add 3%. Shipping, handling and insurance in U.S. add 3% (minimum \$5). California residents add 6% sales tax. Foreign orders add 10% for shipping. Equipment is subject to price change and availability. All equipment carries factory warranty. TELEX: 697120 DATAMAX-SDG

**COMPUTER HORIZON**

16766 Bernardo Center Drive, Suite 110B, San Diego, CA 92128  
(714) 565-7092 (800) 854-1941



**S-100 USERS**

**INTERFACE 9-TRACK TAPE DRIVES**

With the DTI - DMA Tape-Unit Interface

- Transfers data via DMA up to 200K bytes per second
- Allows full control over all tape-drive functions



**SPEED NUMBER-CRUNCHING SOFTWARE 5-10 X's AND MORE**

With the FMP - Fast Math Processor

- Kit or assembled
- 32-bit floating point operations for arith., trig., exponential, etc. functions
- Or 64-bit floating point operations for arithmetic functions



Both the DTI and FMP meet the IEEE S-100 standard. Software is available.

For further information contact:

A MEMBER OF THE SPC GROUP



**SPC TECHNOLOGIES, INC.**

P.O. Box 248, Arlington, VA 22210  
(703) 841-3632



**NOW WITH TMS 9918A**

SINGLE BOARD COLOR VIDEO AND SOUND GENERATOR KIT \$350\*  
COLOR VIDEO KIT ..... \$320\*  
\*STANDARD KIT INCLUDES TMS 9918, ADD \$25 FOR TMS 9918A.

**COLOR VIDEO PROCESSOR**

- Text, Graphics, Animation • 16 Colors • 256 x 192 Resolution • NTSC Composite Video Output • Uses TMS 9918
- Includes I/O Mapped 16K Video Memory • 3D Simulation with 32 Video Sprites • 2 Byte X-Y Positioning • Real Time Clock • 8 Level Interrupt Selection • Inexpensive RF Modulator allows easy connection to any color TV • Video over Video and Extended Graphics II Mode with TMS 9918A •

**PROGRAMMABLE SOUND GENERATOR**

- Music, Sound Effects, Tone Signaling, Ultrasonics • 27 Hz to 111 KHz Range • 3 Programmable Analog Channels with Separate Frequency, Volume and White Noise Control • 10 Selectable Envelope Wave Shapes under Software Control • Two 8-Bit Programmable I/O Ports for use as External Keyboard/Display Interface • Power Amplifier for driving External Speaker •

Texas residents add 5% sales tax. Prices include complete documentation with programming examples. PC board is solder-masked with gold contacts. Add \$100 for assembled and tested units. Send \$14.50 for 120 page manual, refundable with order. Compatible with Z80, 8085 and 8080 at 2 or 4 MHz on S-100 bus.

**EDA ELECTRONIC DESIGN ASSOCIATES**  
P.O. Box 94055 Houston, Texas 77018 (713) 999-2255

SAVE \$\$

**DISCOUNT PRICES**

SAVE \$\$

**apple computer**



APPLE COMPUTER SYSTEMS SOLD ONLY IN STORE. CALL FOR PRICES.

**RAM MEMORY**  
FOR TRS-80, APPLE II  
16K SET 4116's (200 NS) 24.95

**General Information:**  
We carry a large selection of hardware and software by other companies. Send for our catalog.  
We are an authorized repair center for APPLE, ATARI, NORTH STAR, AND EPSON.

**ATARI**



- |                      |        |
|----------------------|--------|
| 400 16K              | 349.00 |
| 800 16K              | 699.00 |
| 410 Recorder         | 89.00  |
| 810 Disk             | 449.00 |
| 822 Printer          | 359.00 |
| 825 Printer          | 779.00 |
| 830 Modem            | 159.00 |
| 850 Interface Module | 179.00 |
| CX853 RAM            | 89.00  |
| CX70 Light Pen       | 64.00  |
| CX30 Paddle          | 18.00  |
| CX40 Joystick        | 18.00  |

**VERBATIM DISKETTES**  
Box of 10 5 1/4" 29.50  
Box of 10 8" 39.50

**NorthStar**

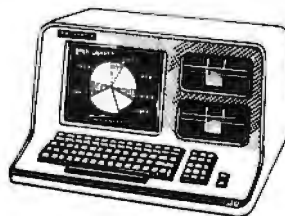

ADV-2Q-64K 3150.00  
ADV-1Q-64K-HD-5 5195.00



HRZ-2Q-64K 2795.00  
HRZ-1Q-64K-HD-5 4695.00  
HRZ-1Q-64K-HD-18 6295.00  
5 MB HARD DISK 2350.00  
18 MB HARD DISK 4195.00

**PRINTERS**

- |                   |         |
|-------------------|---------|
| <b>EPSON</b>      |         |
| MX-70             | 299.00  |
| MX-80             | 469.00  |
| MX-80 F/T         | 569.00  |
| GRAFTRAX          | 90.00   |
| INTERFACE (APPLE) | 75.00   |
| CABLE (APPLE)     | 22.50   |
| <b>IDS</b>        |         |
| 560G              | 1450.00 |
| PRISM             | 1795.00 |
| <b>NEC</b>        |         |
| 3510 35CPS        | 1995.00 |
| 7710 55CPA        | 2650.00 |
| 8023A             | 599.00  |
| <b>OKIDATA</b>    |         |
| MICROLINE 80      | 389.00  |
| MICROLINE 82A     | 549.00  |
| MICROLINE 83A     | 849.00  |
| MICROLINE 84      | 1245.00 |
| <b>C.I.T.O.H.</b> |         |
| STARWRITER 25CPS  | 1595.00 |
| STARWRITER 45CPS  | 2195.00 |
| FORMS TRACTOR     | 275.00  |

PRICES SUBJECT TO CHANGE WITHOUT NOTICE. MARYLAND RESIDENTS ADD 5% SALES TAX

**FREDERICK COMPUTER PRODUCTS, INC.**

**TO ORDER CALL:**  
**(301) 694-8884**

**Store Hours:**

MON. THRU THURS. 9:30 AM-9:00 PM  
FRI. AND SAT. 9:30 AM-5:00 PM

5726 INDUSTRY LANE

FREDERICK, MD. 21701

# AIM for Control

For process control or industrial development systems, put Rockwell's AIM 65 to work for you. Use off-the-shelf AIM-Mate Series and STD BUS expansion products to configure the system you need.

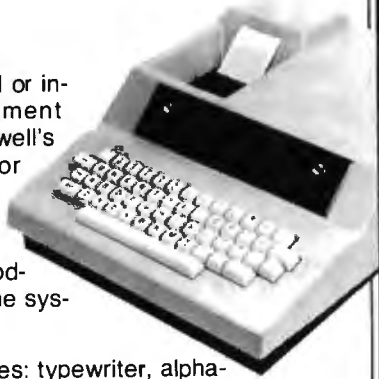

The AIM 65 includes: typewriter, alphanumeric LED display, and fast thermal printer.

Plug-in options include: memory (to 48K), ROM languages, parity protection, video display, floppy disk storage, STD BUS expansion cage, TTL and real world interfaces, and complete system software.

Call or write for complete AIM-Mate Series information.

**FORETHOUGHT  
PRODUCTS**

87070 Dukhobar Road, Eugene, Oregon 97402 (503) 485-8575

# TELEPHONE VOICE RESPONSE

The V100 interactive voice synthesizer

with telephone interface is an Apple II® or IBM Personal Computer® compatible, low-cost, solution to remote data base access arrangements.

**\$395.00**  
V100-A

- Direct telephone connection, auto-dial/answer
- Touch-tone® generation and detection
- Includes 1000 word, LPC allophone vocabulary
- Software for sentence/library construction
- Expandable with 300 (\$150) or 1300 (\$495) high quality LPC words

For a demonstration call toll free (800) 538-7002  
In California call (408) 942-1595

**VYNET CORPORATION**  
2405 Qume Dr., San Jose, CA 95131  
(408) 942-1037



## BYTE LINES

module keeps track of the temperature of the pixel rows to keep the display operating within the most efficient range while using a minimal amount of energy.

The inventor of the TAD technology, Dr. Sun Lu, described his research in a paper delivered in May at a conference of the Society for Information Display. . . . **R. S. S.**

### V

**ideo Games Battle In Court:**

Pac-man has replaced Space Invaders in computer-game popularity. In fact, Pac-man has generated nearly \$1 billion in arcade sales. Atari is now selling Pac-man cartridges for its home units and expects sales to top that of the arcade version. Warner Communications, Atari's parent company, expects that Pac-man will gross more money than its *Star Wars* film. But there are problems. Magnavox is marketing a game called K.C. Munchkin that Atari claims is "a knock-off of Pac-man." Atari took Magnavox to court and succeeded in enjoining the latter from marketing the game on the basis of copyright infringement; however, a second ruling stayed the first ruling until a full trial could be held.

Pac-man was licensed from Namco of Japan by Bally Manufacturing Corporation,

which also licensed the arcade version of Space Invaders (Atari sells the home cartridge version). Bally is now shipping Ms. Pac-man games to arcades, and this is expected in cartridge version also.

**Apology Due:** In my February 1982 BYTE LINES column I reported on Condesin, a small research and development company using a new technology to develop a 4-megabit nonvolatile memory. I reported the company as being in Cupertino, California. I have been informed that the company has moved to Texas. As yet I have not been able to locate its new address.

**Quote of the Month:** "There are eight different ways to insert a disk into a drive. . . only one of which is interesting." Eddie Currie, Vice President Lifeboat Associates

**MAIL:** I receive a large number of letters each month as a result of this column. If you write to me and wish a response, please include a self-addressed, stamped envelope.

**Sol Libes**  
**POB 1192**  
**Mountainside, NJ 07092**

## BYTE's Bits

### Graphics Printing System

If you are interested in the Graphics Printing System mentioned in the January and February 1982 BYTEs (see pages 443 and 222, respectively), please note that Progressive Software has gone into bankruptcy and will no longer sell or support the program. However, Crow Ridge Associates is selling and sup-

porting the program. It should be noted that the system must be used with the Apple serial interface card with the P8A PROM (programmable read-only memory). It costs \$109.95. Contact Crow Ridge Associates Inc., POB 90, New Scotland, NY 12127, (518) 765-3620. ■



### MODEM HEADQUARTERS

Connect any computer or terminal to the phone lines!

**1200 Baud — 120 Characters per Second**  
**Penril 300/1200** ..... \$739  
 Bell 212A identical. Full duplex, RS232. 1200 and 300 Baud. Originate/auto-answer. Phone connection via RJ11C standard phone jack. One year warranty. Self-test. Fits under phone.

**300/1200 Auto-Dialer** ..... \$225  
 Allows any computer to automatically dial out through the Penril 300/1200.

**300 Baud — 30 Characters per Second**  
**Phone Link Acoustic Modem** ..... \$129  
 Originate and Answer. Half/Full duplex. RS232. Operates with any standard telephone. Indicators for On, Carrier, Self-test, Send Data, Receive Data. One year warranty.

**Micro-link** ..... \$179  
 Originate/Auto-Answer, Half/Full duplex. RS232. Phone connection via RJ11C standard phone jack. Indicators for On, Carrier Detect, Self-test, Send Data, Receive Data. Two year warranty. Fits under phone.

**ADDS Viewpoint CRT** ..... \$529

**GE2120 Printing Terminal** ..... \$1,799  
 150 CPS. 300/1200 Baud.

**GE2030 Printing Terminal** ..... \$999  
 60 CPS. 300/1200 Baud.

*All equipment is in stock. Your satisfaction guaranteed. Any product may be returned for full credit. Write or call for full product information.*



**U.S. ROBOTICS INC.**  
 203 N. WABASH  
 SUITE 1718  
 CHICAGO, ILL 60601  
 (312) 346-5650



# Buckeye

## DESK TOP ENCLOSURES

ASK ABOUT OUR NEW BRACKET MOUNTING SYSTEM FOR DWC CASES

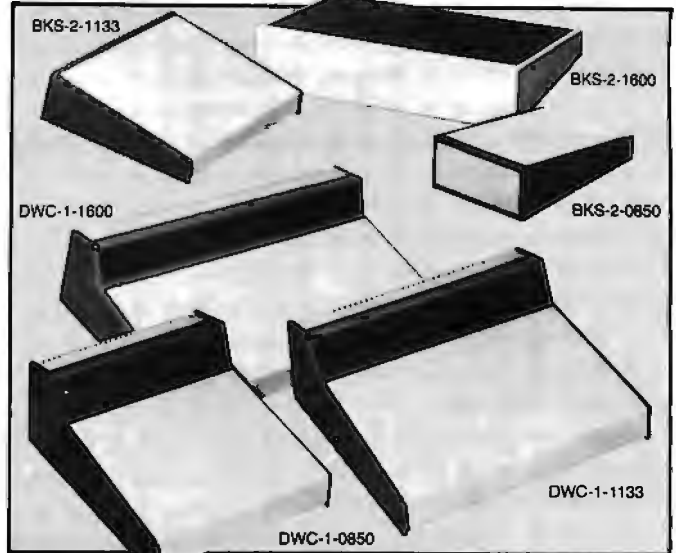

DWC-1-0850	\$54.70	BKS-2-0850	\$41.50
DWC-1-1133	60.60	BKS-2-1133	44.80
DWC-1-1600	68.80	BKS-2-1600	48.30

Send check for case in width desired.  
 Call or write for detailed literature

**The Buckeye Stamping Co.**  
 555 Marion Rd., Columbus, OH 43207 614/445-8433

## YOU'VE NEVER SEEN DISCOUNTS LIKE THESE!

**CROMEMCO**

**SYSTEM ONE \$2999**  
**SYSTEM 1H 5395**

**SYSTEM THREE \$5999**

**7-20**

**SYSTEM TWO \$3995**  
**SYSTEM Z2H 7495**

**VIDEO TERMINAL 3102 \$2099**

**NEW CROMEMCO PRODUCTS**

8 and 16 BIT DUAL PROCESSORS

CSID2E(256K RAM)	\$4299
CSID5E(512K RAM)	4999
CSIHD2E(256K, 5 Meg. H.D.)	5999
CS3D5E(512K RAM)	7299
CS3HD40E(5 Meg. H.D., 4 Meg. RAM)	20995

**MAXELL DISKETTES Boxes of 10**

MD 1	\$39.95	FD 1	\$42.95
MD 2	49.95	FD 2	57.95

### MORE SPECIALS

ATARI 800	\$ 699	EPSON MX80	\$ 499
TI 810 Printer	1349	EPSON MX80 FT	599
QANTEX Printer	1049	EPSON MX100	759
ADDS Viewpoint	599	SOROC IQ130	699
ADDS Regent 25	879	DEC LA34	949

CALL FOR INFORMATION ON NORTHSTAR, HAZELTINE, INTEGRAL DATA SYSTEMS, LEAR-SIEGLER, MORROW DESIGNS, QUME, OKIDATA, TELEVIDEO, DIGITAL MICRO SYSTEMS, CALIFORNIA COMPUTER SYSTEMS

All prices are CASH. American Express, Visa, Master Card, add 5%.  
 Prices subject to change without notice

**DATA DISCOUNT CENTER**  
 P.O. BOX 233, Greenvale, New York 11548

**PHONE ORDERS CALL 516-869-8537**

# Maintenance Alternatives for Personal Computers

*Repair service options to consider before you buy a computer and preventive maintenance steps to perform once you've made the purchase.*

---

Lewis A. Whitaker  
18360 Oxnard St.  
Tarzana, CA 91356

---

Whether you have already chosen your personal computer or are in the process of making that important decision, there is something you must consider that is as important as bits, bytes, bauds, and software—maintenance. Suppose you sat down to work at your system and found that the video terminal wouldn't light, the printer wouldn't print, or the computer just wouldn't compute. Where would you turn for help? Ideally you should determine the options for repairing your system before buying

---

#### About the Author

*Lew Whitaker has spent 20 years in sales and marketing, primarily with companies in the magnetic media field. He was the Western Regional Manager for the Computron (BASF) magnetic tape company and has worked for Data Devices, KYBE Corporation, and Innovative Computer Products. He has had a number of articles published in the Journal of Data Management, Interface Age, and Digital Design.*

---

it. However, even if you have purchased a computer already, you do have options for obtaining service.

A recent incident taught me the importance of planning maintenance

---

**You can take steps to maintain the components of your computer before a failure occurs.**

---

alternatives before disaster strikes. A friend, who had purchased a personal computer through a mail-order catalog, saw his printer stop in the midst of printing a long document. He called me frantically to ask where he could go to have someone fix his machine quickly. Not having an immediate answer, I looked in the Yellow Pages under "computer main-

tenance." That heading referred me to "computer store," where I found listings for twelve businesses. At this point, I decided that it might be interesting to call each company myself. I called them and the results were surprising, to say the least. Three were no longer in business, four specialized in computer games and video equipment, four were more interested in selling new computers and didn't service my friend's type of equipment anyway, and only one store said it would take a look at the machine if I brought it in. I wondered whether the results of my little survey were typical. If it proved difficult to get quick and efficient service in computer-conscious West Los Angeles, what could the personal computer user in more remote areas expect?

It was not many years ago that all data-processing or scientific computer installations had on-site field



# DYMARC

INDUSTRIES, INC.



## LINE VOLTAGE TRANSIENT SUPPRESSORS

Features Parallel Operation 5000 Amps/Second

### Clipstrip™ AND Clipper™

#### PROTECTS:

- Computers
- Micro-Computer Systems
- Word Processors
- Cash Registers
- Power Supplies

#### PROTECTS AGAINST:

- High Energy Voltage Transients
- On-Off Switching
- Lightning Induced Transients
- Inrush of On/Off Power

# DYMARC

INDUSTRIES, INC.

DEALER INQUIRIES INVITED

7133 Rutherford Rd. Baltimore, Md. 21207  
(301) 298-3130



# SAVE



## BUY DIRECT™ TRS-80'S Full Line

WE PAY SHIPPING in the 48 continental states on prepaid orders of \$100.00 or more.

NO TAXES are collected on out-of-state shipments. WE ACCEPT Visa, MasterCard and American Express, or you can save additional money by paying cash.

TOLL FREE ORDER NUMBER 800/531-7466

# Pan American Electronics

1117 Conway • Dept. B  
Mission, Texas 78572  
Phone 512/581-2766  
Telex Number 767339

FORT WORTH BRANCH  
2912 N. Main  
Ft. Worth, Texas 76106  
Phone 817/625-6333  
Telex Number 794836

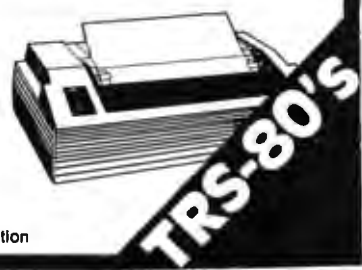

™ — Trademark of Tandy Corporation

### CUSTOM PRODUCTS

DESIGN • LAYOUT  
MANUFACTURING

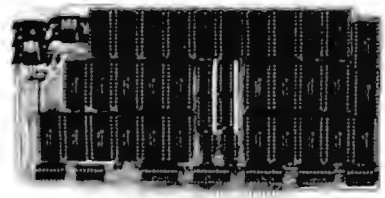

64K STATIC RAM  
FULLY STATIC MEMORY

SPECIALIZING IN  
QUALITY  
MICRO COMPUTER  
HARDWARE

# ECT™

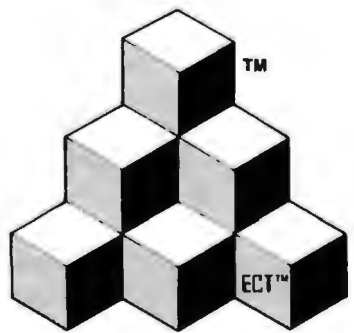

### BUILDING BLOCKS FOR MICROCOMPUTER SYSTEMS, DEDICATED CONTROLLERS AND TEST EQUIPMENT

CARD CAGES, POWER SUPPLIES  
MAINFRAMES, CPU'S, MEMORY  
I/O, OEM VARIATIONS

### S-100 PRODUCTS



TT-10  
TABLE TOP  
MAINFRAMES

### MULTIBUS® PRODUCTS

MULTIBUS IS A TRADEMARK OF INTEL CORP.

# ELECTRONIC CONTROL TECHNOLOGY, INC.

763 Ramsey Ave., Hillside, NJ 07205 (201) 686-8080

# SUPERBRAIN™

**PRICE  
BREAKTHROUGH**

**SUPERBRAIN II** . . . . . \$1895  
350K Disk—64 RAM

**SUPERBRAIN QD** . . . . . \$2275  
700K Disk—64K RAM

**NEW SUPERBRAIN SD** . . . . . \$2655  
1.5 MB Disk—64K RAM

**NEW DAZY CHAINER** List \$495 \$350  
(Includes All Hardware and Software)

**NEW STARGRAPH** List \$3890 \$ Call  
Includes 350K Disk—64K RAM.

Emulates Tektronix™4010 Graphics Terminal, Supports SAS-Graph and all Tektronix Plot 10 Software. (Larger Configurations Available)

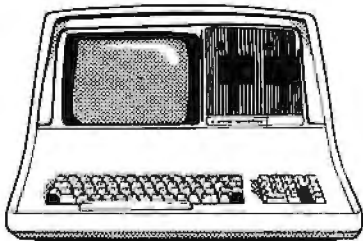

**90 DAY  
MONEY BACK  
GUARANTEE\***

**120 DAY  
EXTENDED WARRANTY\*\***

Ordering Information: Money Orders, Cashier Checks or Bank Wires Welcome. Personal or Company Checks, allow 15 days to clear. Surface Freight Standard FOB Origin. Include your telephone number. No COD's, Please. Prices are subject to change without notice. Order desk hours are 9 to 5 CST.

**CALL OR WRITE  
(214) 931-9069**

**WESTSTAR Micro**

16990 Dallas Parkway • Suite 151  
Dallas, Texas 75248

\* Refunds are Prorated.  
\*\* Extended Warranty offered by WestStar.

SuperBrain is a Registered Trademark of Intertec Data Systems.

Dazy Chainer is a Registered Trademark of Gemini Computer, Inc.

StarGraph is a Registered Trademark of Tektronix.

engineers with proper training and enough spare parts to solve whatever problem might arise within a system. Service contracts for computer systems were mandatory and were written as part of the system purchase or lease. The development of solid-state chips has not only accelerated the trend toward smaller and less expensive computer systems but has also greatly improved reliability. There is still a huge segment of the market that addresses large-scale computer systems, which require on-site or on-call field engineers. As the computer system shrinks in size and cost and as the reliability of all components increases, however, there is a need for practical alternatives for computer maintenance. It does not make sense for the Apple or PET user to retain a full-time field engineer. But where should the user go if he wanted to obtain the services of a qualified engineer to perform on-site maintenance? Are there local places where he can bring his machine for service? Must he send his machine back to the factory for even the simplest repairs? Is there anything that the average nontechnical person can do at home to keep costs down and efficiency up? What are the alternatives from which a personal computer user can choose before the first component failure ruins his love affair with his computer?

## Where to Go for Help

**Computer stores:** Many computers are sold through computer stores. In addition to the best-known manufacturers, a number of smaller companies sell their computers through these same stores. The questions that the buyer should ask the seller are the same as if the product under consideration were an automobile or a kitchen appliance: Does the seller offer a maintenance contract? What is the length of the warranty? What does the warranty include? Is the repair site local or are repairs made at a distant facility? Does the seller do the work or does he farm it out to a third party? Does the service provider offer loaner units?

Investigation has shown that there is no such thing as an industry-wide,

standard service policy for small computers. My initial disappointing experience in searching for a service company prompted me to make a wider investigation throughout the Los Angeles area. I found that most computer stores offered maintenance of the computers that they sold, but most were also reluctant to discuss turnaround time for repairs. Often they were not even able or willing to quote their hourly service rates. Radio Shack was the only store that had a printed parts and labor price sheet available to the customer. Certain manufacturers, such as Radio Shack and Apple, offer extensions of their warranty, which guarantee that a user can bring his system in for repair anytime during the covered period. However, while Radio Shack service policies are uniform from store to store, the same cannot be said for Apple service policies. I discussed service of Apple computers with several retail outlets. While some were vague at best about turnaround and uncertain about hourly rates, other Apple retail outlets welcomed inquiries into their service policies, offered quick turnaround for most problems, and not only stated rates for service but estimated the time each type of problem would require.

The price of an annual service contract varies from company to company, but it appears that about \$2000 is average for an extended warranty contract for a complete personal computer system. Whether you wish to spend the money to purchase a maintenance contract is obviously a personal decision. It is an expensive undertaking to be sure, but a computer sitting idle is both expensive and sad.

**Manufacturers:** I asked three manufacturers about their factory-direct service policies. Digital Microsystems, Vector Graphic, and Intertec all had similar policies. They preferred the user to go to a local service outlet, but each offered to service the unit at the factory if the customer wished, whether the unit was under warranty or not. The objections to having a machine returned to the factory are simple: time and trouble. Seldom does anyone have the time to







**GUARANTEED LOWEST PRICES!**  
We will match any advertised price.  
Just show us the ad.

**ORDER TOLL FREE - Outside WI**  
**1-800-826-1589**

**ACCESSORIES**

Mountain Expansion Chassis	625.
CPS Multifunction	199.
100,000 Day Clock	375.
Mountain Clock	252.
A/D + D/A	299.
CCS 12K ROM/PROM Board	99.
CCS A/D Converter Board	99.
CCS Serial Asynch. Board	139.
CCS Calendar/Clock Board	99.
MDTRAX Type-n-Talk	375.
ABT Pascal Tools I or II	75.
Scitronic Remote Controller	249.
Apple Speed Controller	69.
Applescope (your Apple as an Oscilloscope)	595.
Scope Driver	49.
Videx Enhancer II	149.
K&D Enhancer	115.
Videx Character Sets	29.
Echo Speech Synthesizer	225.
Upper/Lower Character	39.
ALS Smarterm	379.
ALS 2-Card	269.
SSM A10 s/p interface + cable	195.
Percom Doubler II	167.

**PRINTERS**

Epson MX 80 W/Graph Trax	495.
MX 80 F/T	615.
MX 100	CALL
NEC 8023A	515.
Okidata 82A	535
83A	785.
84	CALL

**MONITORS**

Amdtek 300 Hi Res Green	198.
Color II Hi Res	CALL
NEC JB 1201M, 12" Hi Res Green	215.
JC 1201 M, 12" Lo Res Color	349.
Sanyo 12" Hi Res Green	275.
13" Color w/Sound	CALL
KAGA Green-Inset	172.

**MODEMS**

Hayes Smartmodem	225.
Chronograph	198.
Micromodem	295.

**DISK DRIVES**

CALL

**... AND MANY MORE!**

Prices valid for stock on hand  
and subject to change without notice.

For Software  
see our other ad, page 308

- Please:
- Wisconsin residents - add 4% sales tax
  - Add \$2.50 for shipping per software and small item. Call regarding others.

- We Welcome:
- Visa, Mastercharge - (Add 4%)
  - Checks (Allow 1-2 weeks for clearing)
  - C00 (Add \$1.50 per shipment)

**ORDER TOLL FREE - Outside WI**  
**1-800-826-1589**

For Technical Info & in Wisconsin:

**715-848-2322**

**Oryx Software**

205 Scott St., Dept. BB

P.O. Box 1961 • Wausau, WI 54401



pack a bulky machine and ship it back to a factory. No one I know keeps the original cartons long, and that helps make long distance shipping complicated. In addition, few owners can afford to be without their machines for the time required. For practical reasons, therefore, factory maintenance should be considered a last resort. But it is comforting to know that a last resort is there if you should ever need it.

**Third Party Maintenance:** In addition to computer manufacturers and the retail outlets that promise to service what they sell, there is a network of independent service organizations. These companies, such as TRW, Dow Jones, and Sorbus, will write a contract on peripherals. Service organizations work under license to manufacturers and are often the only authorized repair service for a product. Large, nationwide organizations do have their advantages. You can move from Los Angeles to New York and still be assured of finding maintenance. They also perform service on site. The disadvantage of contracting with this type of organization is that you pay for the overhead; rates are high.

A different type of service organization is now emerging: the small, local service company willing to service more than one type of machine, either on site or on a carry-in basis. These companies will offer both an extended warranty contract or a one-time charge for time and materials. Rates quoted for this type of service were \$35 to \$60 per hour, with a two-hour minimum for on-site service. Remember, however, that there is more to service than cheap rates. The least expensive service contract may not prove least expensive in the long run.

**How to Help Yourself**

As stated above, early selection of a reliable repair service is strongly recommended. However, you can take steps to maintain the components of your computer before a failure occurs. The following are some simple and effective steps that a personal computer owner can take to care for his or her equipment.

**Central processor:** This is the "brain" of the computer and fortunately one of its most reliable parts. Because the average personal computer system draws power in the range of 3 to 5 amps, you should not overload the same circuit with other appliances. Overloading a circuit could result in power surges that could blow a fuse or cause unpredictable problems. A typical indication that a fuse has blown is that absolutely nothing happens when the power switch is turned on. If a fuse does blow, replace it with the size recommended by the manufacturer. If the fuse continues to blow, you must call the previously selected service company. Another problem that can affect the operation of the central processor is static electricity. Static electricity, that annoying and shocking "zzzap" so common indoors in winter, can cause data loss or even component failure. An antistatic mat or an antistatic spray is an excellent investment to prevent such failures.

**Floppy-disk drive:** This peripheral device is the one most likely to fail outright or marginally, causing disruption of processing or actual loss of data. Fortunately, the disk drive is also the peripheral that can benefit most from careful maintenance. Often, the problem is with the floppy disk itself. You should use only top-quality, fully tested, "certified" disks. However, even use of the best disks cannot guarantee that problems will not occur. Magnetic disks require careful handling. The slightest bit of dust or oil between the recording head and the disk surface can cause improper contact. This can prevent data from being written on the disk and can interfere with reading data too. The following rules for floppy-disk care are industry standard. You would be wise to follow them carefully.

1. Do not put fingers, pencils, or other objects through the head-access slot in the vinyl jacket.
2. Keep disks away from large motors or other magnetic fields.
3. Do not bend, fold, or wrinkle the disk's vinyl jacket.
4. Do not write on the vinyl jacket.



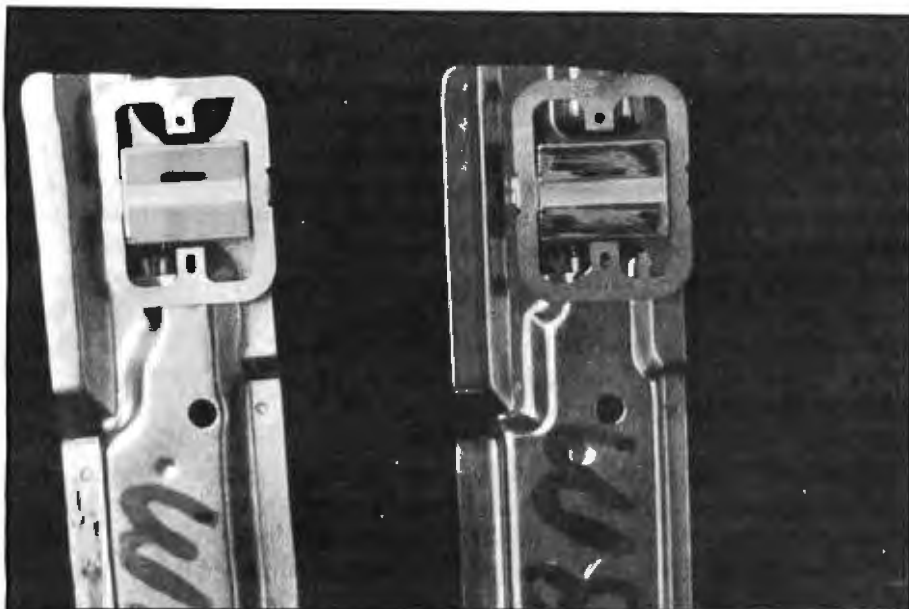

Photo 1: Contaminants on the read/write head of a floppy-disk drive.

5. Write on a label *before* affixing it to the jacket.
6. Keep the disk in its envelope when the disk is not in use.
7. Keep the disk and envelope in a protected storage area.
8. Keep disks in an area with a temperature range of 50° to 110°F.
9. Avoid blowing cigarette smoke on the disks.

Caring for the disks is only part of the problem. Equally important is proper care of the recording head. During operation, the read/write head rides on the surface of the disk. When a ceramic head is in constant contact with a rapidly rotating magnetic disk, there is the continual potential for head contamination. Contamination, in the sense used here, means that oxide from the disk is loosened in minute particles and smears onto the surface of the recording head. With oxide particles covering the recording surface of the head (see photo 1) magnetic signals can neither be recorded nor read. Until quite recently, the only way to rid a disk head of contamination was to have a qualified engineer dismantle a drive and manually clean the head surface by gently and carefully scrubbing it with a cotton swab soaked in alcohol. This procedure was both time consuming and potentially dangerous to the drives. A number of head cleaning devices are now

available to the user who wants to do the cleaning himself. (For a list of manufacturers, see table 1.) These head cleaning kits, which are available for both 8- and 5¼-inch drives, are of three types:

- **Dry cleaners** consist of a package of one, two, or three disks per box. The disk is a piece of standard Mylar substrate with a nonabrasive polyester material bonded to it. It is sealed inside a standard vinyl jacket. Examples of this type of cleaner are Compu-Clean and BASF—both European imports.

- **Wet/dry cleaners** typically consist of two cleaning disks and one bottle of cleaning solution. The cleaning disk is a slightly porous, flexible piece of nonwoven, nonabrasive polyester. It is sealed inside a modified jacket. One side of the jacket has a wide cutout, and the other side, a removable tab. (For single-sided drives, the tab stays in place; for dual-sided, the tab is removed.) The user applies cleaning solution to a third of the disk through the cutout. The disk is placed in the drive as is a normal magnetic disk. The heads are accessed and the disk is left in place for 15 to 20 seconds. While in operation, the disk rotates and cleans by means of a wet/dry, wet/dry action on the heads. Examples of this type of cleaner are 3M and Innovative Computer Products.

## ANNOUNCING

# FORTHWRITE

## AN OUTSTANDING WORD PROCESSOR FOR YOUR TRS-80 MODEL I OR III OR IBM PERSONAL COMPUTER!

If you need to type any of the following sorts of documents: business or personal letters, form letters, proposals and estimates, term papers and theses, newspaper and magazine articles, books, stage scripts — then FORTHWRITE is the tool you want. Designed for easy and effective use by computer novices, unusual power and flexibility for the advanced user's most complex tasks, all with instant response time.

FORTHWRITE combines the power of MMSFORTH with the best features of SCRIPSIT (trademark of Tandy Corp.) and WORDSTAR (trademark of MicroPro). Learning becomes easy thanks to on-line Help screens, excellent keyboard mnemonics and screen prompts, a good manual and sample documents. "Include" feature permits internal chaining of documents, text blocks (and address files), custom keyboard entries, etc. Outdenting, multiple-line odd and even headers and footers, screen windowing to 255 columns, MORE

Standard serial and parallel printer drivers with in-line printer control codes are provided, plus TRUE PROPORTIONAL drivers with tabbing for the NEC Spinwriter and TRS-80 Daisy Wheel II printers, subscript, superscript and boldprint on the above and Epson/IBM printers, a printer spooler and MUCH more.

Print capacity is limited only by disk space (multiple documents can be chained at printout and up to 8 disk drives can provide contiguous data space); while editing takes advantage of the exceptional speed of in-memory operation. A print-to disk option permits examination of formatted output without hardcopy.

FORTHWRITE V1.0 (requires MMSFORTH V2.0/2.1, 2 drives & 48 K RAM) **\$175.00\***

# mmsFORTH

## THE PROFESSIONAL FORTH SYSTEM FOR TRS-80 AND IBM PC

(Thousands of systems in use)

MMSFORTH Disk System V2.0 (requires 1 drive, 32 K RAM);  
For Radio Shack TRS-80 Model I or III . . . **\$129.95\***  
For IBM Personal Computer (80-col. screen) . . . **\$249.95\***

## AND MMS GIVES IT PROFESSIONAL SUPPORT

Source code provided  
MMSFORTH Newsletter  
Many demo programs aboard  
MMSFORTH User Groups  
Inexpensive upgrades to latest version  
Programming staff can provide advice, modifications and custom programs, to fit YOUR needs.

### OTHER MMSFORTH PRODUCTS:

The DATAHANDLER database management sys. . . **\$59.95\***  
FORTH.COM communications program . . . **\$39.95\***  
MMSFORTH UTILITIES Diskette . . . **\$39.95\***  
MMSFORTH GAMES Diskette . . . **\$39.95\***  
MMSFORTH GENERAL LEDGER . . . **\$350.00\***  
TRADESHOW Commodities Exchange  
smart terminal . . . **\$995.00\***

### FORTH BOOKS AVAILABLE

MMSFORTH USERS MANUAL - without Appendices, for non-owners . . . **\$17.50\***  
STARTING FORTH - best companion to our manual . . . **\$15.95\***  
THREADED INTERPRETIVE LANGUAGES - advanced, excellent analysis of MMSFORTH-like language . . . **\$18.95\***  
PROGRAM DESIGN & CONSTRUCTION - intro. to structured programming, good for Forth . . . **\$13.95\***  
FORTH .79 STANDARD MANUAL - official reference to 79-STANDARD word set, etc . . . **\$13.95\***  
FORTH SPECIAL ISSUE, BYTE Magazine (Aug. 1980) - we stock this collector's item for Forth users and beginners . . . **\$4.00\***

\* - ORDERING INFORMATION: Software prices include manuals and require signing of a non-transferable single system, single-user license. Describe your Hardware. Add \$2.00 S/H plus \$3.00 per MMSFORTH and \$1.00 per additional book; Mass. orders add 5% tax. Foreign orders add 20% UPS COD, VISA & M/C accepted; no unpaid purchase orders, please.

Send SASE for free MMSFORTH information  
Good dealers sought

Get MMSFORTH products from your  
computer dealer or

**MILLER MICROCOMPUTER SERVICES (B6)**

61 Lake Shore Road, Natick, MA 01760  
(617) 653-6136

# CP/M DATA ENTRY "RADAR"

RADAR is a high speed data entry system that will run on any CP/M system providing a "3741" style key-to-disk environment. RADAR is ideal for replacing KEYPUNCH machines and older, slower key-to-disk systems like the 3741's and 42's.

## Features:

- Verify Mode
- Check Digit Processor
- Auto Dup/Manual Dup
- 16 Accumulators
- Parameter Driven (No Programming)
- "Virtual" File Access
- Add or Delete Records
- Record Retrieval By Number Or Content
- Full Editing Capability
- Operator Prompts
- Extremely Fast (Written In Assembly Language)

In addition to "heavy-duty" data entry, RADAR is also the ideal "front-end" for many applications programs, providing acquisition and retrieval of keyed data with a degree of reliability simply not possible with any other technique. RADAR can cut programming time by more than 30%, simply because there is no longer any need to write the "input" portion of a program, just let RADAR handle it!

Write or call for free brochure. The RADAR manual is also available separately for \$25.00.



**SOUTHERN  
COMPUTER  
SYSTEMS,  
Inc.**  
P.O. Box 3373A  
Birmingham, AL 35255  
Phone: 205-933-1659

•Wet cleaners use a nonabrasive material totally saturated with an alcohol-based cleaning solvent. A recent entry from Verbatim Corporation uses this concept. It consists of a nonabrasive, polyester disk which has been presaturated with a solution and sealed in a foil pouch. To use, the saturated disk is removed from the pouch, placed in a specially provided disk jacket, and then inserted in the drive. After allowing the disk to rotate under the head for 30 seconds, the jacket is removed from the drive and the used cleaning disk discarded.

**Hard-disk drives** (cartridge or Winchester): While floppy-disk drives have heads that actually touch the disk surface, hard-disk drives have heads that "fly" on a thin cushion of air—in some cases as thin as 20 microinches. Even more than with a floppy-disk drive, it is important that the surface stay perfectly clean. When a hard disk is rotating at more than 2000 revolutions per minute with a head only 20 microinches above the

surface, a bit of dust or contamination can destroy not only the delicate recording head but the surface as well (see figure 1). Cleaning the disk cartridge surface (removable single platter cartridges, not Winchesters) is generally recommended three to four times per year, depending on the operating environment. Firms in major cities across the country perform cleaning and testing services as required. Examples of companies that perform this type of service are Scopus, Randomex, and PMI. If you have a large enough library of disk cartridges to warrant your own in-house cleaning equipment, cleaners or cleaner/inspection devices are available from Burroughs Corporation, NCR, DEC, Randomex, Data Devices, and Innovative Computer Products. Other than performing a periodic disk cleaning and keeping the area where disks are stored and operated free from dust, there is little more a user of hard-disk equipment can do. If a removable disk is at all

### THE EFFECT OF DIRT ON A MAGNETIC DISK

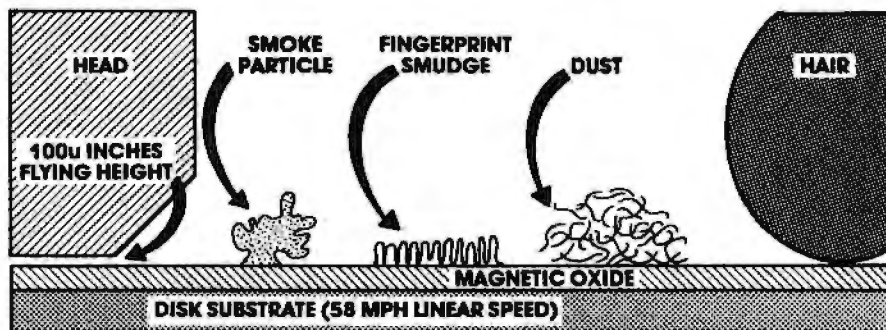

Figure 1: Hazards for hard disks: the smoke particle, the fingerprint smudge, and dust. Because only a minute cushion of air holds the read/write head above the disk surface, contaminants dwarfed by a human hair pose serious problems.

Company	Address
Data Recording Products Division	3M Center St. Paul, MN 55144
Computer Resources Corporation	4650 W. 160th St. Cleveland, OH 44135
Verbatim Corporation	323 Soquel Way Sunnyvale, CA 94086
Innovative Computer Products	18360 Oxnard St. Tarzana, CA 91356
BASF Systems Corporation	Crosby Dr Bedford, MA 01730

Table 1: Some manufacturers of cleaning kits for the read/write heads of floppy-disk drives.



suspect (e.g., if it has been roughly handled, dropped, or left in an environmentally harsh area), have the disk tested *before* attempting to load it on the system. Replacement of disk-drive heads is costly.

**Printers:** Because a printer is an electromechanical device, it can often be the source of annoying maintenance problems. The computer printer is much like a typewriter. It functions well until a buildup of paper particles and household dust interferes with operation. The printer then requires an expensive, professional cleaning. Other than having a maintenance contract, all a user can do is keep the print mechanism free from accumulated ink and paper dust. Commercial cleaning kits are available for wiping contamination from the print elements. These kits are sold by companies such as Texwipe, Innovative Computer Products, and a number of nationwide catalog distribution companies such as INMAC and Visible Computer. Clean typing elements will give sharp, clear print. You should have a plastic cover to protect the printer when it is not in use.

**Conclusions**

Although personal computers today are more compact and much more reliable than computers of 20 years ago, they are still a complex combination of electronic and mechanical components. Preventing problems is the best maintenance most personal computer owners can perform. Cleaning kits are available for disk drives, printers, and video screens. Mats and sprays are available to prevent static electricity. Plastic covers are available to protect computers and peripherals from dust. Keeping your computer free of contamination and trouble is by far the least expensive of the maintenance methods available to personal computer users.

When preventive maintenance is not enough and you need professional help, be sure that you have thoroughly researched the available service options. The decision you make will affect not only your pocketbook but also your mental health. ■

# FREE

## DISCOUNT & BONUS COUPONS

for  
PRINTERS, DISK DRIVES, DISKETTES, SOFTWARE, BOOKS  
and MORE!

just circle 258 on your

Reader Service Card and mail it today.

just good business!

or write to: **FREE COUPONS**  
P.O. Box 32010  
Cleveland, Ohio 44132

**joint  
marketing  
services**  
(216) 289-1100



**Carbonless checks, invoices and statements**

- ★ Standard formats...plus Custom Design Service!
- ★ Small quantities (as low as 500)...plus money-saving prices!
- ★ Super-fast service (shipped 5 days after receipt of order!)

SEND COUPON...OR CALL TOLL-FREE: 1-800-328-9697.

To: Delmart Company, Division of Deluxe Check Printers, Inc., 530 N. Wheeler St., P.O. Box 43495, St. Paul, MN 55164-0495

**YES**, please send free color catalog!

Name \_\_\_\_\_ Title \_\_\_\_\_

Firm \_\_\_\_\_

Street \_\_\_\_\_ Phone (\_\_\_\_) \_\_\_\_\_

City \_\_\_\_\_ State \_\_\_\_\_ Zip \_\_\_\_\_

B6

## Text-Handling Routines in Extended BASIC

---

Roger Greenhalgh  
4905 Old Mill Place  
Raleigh, NC 27612

---

As home computers have grown in popularity, their uses have developed in four general categories: games, problem solving, financial analysis, and word and file processing. Most users eventually want some sort of text-handling capability.

Many good text handlers already exist, but for those who would like to compile their own, I'll describe a group of BASIC subroutines designed to work together (see listing 1). You can use them complete as listed, in part, or as instructions for generating your own.

These subroutines operate by means of an *interactive* method. Text is entered, then commands are entered for actions on the text. Most commands issue prompts that augment the indication of what is wanted. Many commands, for example, prompt for the range of line numbers of the text to be operated upon. (This method contrasts with that of embedding commands into the text as it's entered. The interactive

mode was chosen so that fewer symbols and less structure need to be remembered.)

Table 1 lists brief descriptions of each subroutine (a more in-depth description of each follows); BASIC statement numbers are included in parentheses. Inevitably, the specific characteristics of my personal-computer system show through. These are pointed out where deemed significant.

### Subroutine Descriptions

**LN: line number (170).** The system assigns and maintains line numbers sequentially for each line of text. LN holds the number for the next line to be entered. The LN command lets you set LN to any number. Existing text at LN and higher numbers will be overwritten as additional text is entered. (In my system, the date is extracted from the operating system and placed in line 1.)

**LL: line length (210).** LL determines the line length desired for text justification. It's initialized at 65 but can be changed at any time. Of course, input text can exceed this number. It's used only for text justification.

**N: next text entry (230, 500 through 580).** In response to N, the symbol \* (asterisk) is displayed at position LL to visually indicate the line length. Then the prompt GOTO is issued. If your response is 0, the line of text entered will be placed at LN. All text lines entered subsequently will be placed at LN+1, LN+2, etc. When the text entered for a line is the word *exit*, the system reverts to the command prompt. If your response to GOTO is a specific line number, the text entered will be put into that line, replacing any existing text. The system then reverts to the command prompt.

**SH: shift text (180, 700 through 770).** SH results in the prompt FROM, TO, INTO. All lines of text



indicated by the range FROM, TO are shifted into a new area, beginning with line number INTO. Shifting can take place both up and down the page without concern about overwriting. Text is erased from the old area. For example, if lines FROM 5, TO 10 are shifted INTO 4, then line 5 goes into line 4, line 6 into line 5, etc. If they are shifted INTO 12, then line 10 goes into line 17, line 9 into line 16, etc.

Shifting is invoked by the system when justification causes paragraph overflow.

The instructions at line 700 determine the direction of shifting. Lines 710 through 740 cause shifting down the page. Line 730 adjusts the value of LN to indicate the new line number for the bottom of the page. Lines 750 through 770 cause shifting up the page. Here the value of LN is not

Command	Action	Prompt
LN	line number	SET LN =
LL	line length (initialized at 65)	LL = XX SET LL =
N	next text entry	GOTO XX SPECIFIC LINE. 0 FOR NEXT LINE AFTER TEXT AND CONTINUE. 'EXIT' TO COMMAND.
SH	shift text	FROM, TO, INTO.
CO	copy text	FROM, TO, INTO.
T	tab setup	TABS T1 T2 T3 ?
TP	table position setup	P1,P2,P3,P4,P5 ?
E	ends	

All following request range of lines FROM, TO.

D	display text	
TAB	tab text	
J	justify text	
COL	columnize data	
P	print text	
C	center text	
I	indent text	
F	find	INDENT X SPACES. 'FIND' WORD CONVERT TO UPPER? Y-YES. WHICH LINE? OF HOW MANY LINES?
R	replace	'FIND' WORD CONVERT TO UPPER? Y-YES. REPLACE WITH CONVERT TO UPPER? Y-YES.
SO	sort records	WHICH LINE?, OF HOW MANY LINES?, SORT WORD FROM LEFT?
CA	caption text	'PRINTS LINE WITH LINE NUMBER' CAPTION? CONVERT TO UPPER? Y-YES.
U	uppercase conversion	
S	save file	ENTER FILE NAME.
G	get file	ENTER FILE NAME. O, ANY-PLACE AT LINES SPECIFIED IN SAVE. N, ANY-PLACE AT LINES STARTING WITH N.

Notes: [ yields uppercase for next letter. Tab or columnize to next position. On 'CRASH' GOTO 150, continue. The date is loaded into line 1.

Table 1: A simple, quick-reference chart showing capabilities of the text-handling routines.

# We Beat All Prices!

**hp HEWLETT PACKARD**  
**HP-85**  
 OR  
**HP-125**  
CP M' based.  
**\$1979**  
 Your Choice 

## NEW HP-87...\$1889

5 1/4" DUAL MASTER DISK DRIVE... CALL  
 HP-7470 PLOTTER... \$1245  
 5 MEG. WINCHESTER HARD DISK... \$3599  
 5 MEG. WIN. W/5 1/4" DD SD FLOPPY... \$4399

APPLE II PLUS, 48K... CALL  
 APPLE III... CALL  
 TI 99/4... \$364  
 COMMODORE VIC-20... \$255  
 NEC PC-8001A, 32K... \$989  
 XEROX 820 5 1/4" DISK DRIVES... \$2489  
 XEROX 820 8" DISK DRIVES... \$3095

**TI CALCULATORS**  
 TI-55 II... \$36  
 TIP-BUSINESS ANALYSIS II... \$36  
 TIP-58C... \$79  
 TIP-59... \$169  
 TIP-P-100C... \$149

**HP-41CV**  
 w/Five times more memory  
 Built In List \$325  
**\$237**  
 NOW IN STOCK  **\$189**  
 HP-41C list. \$250

HP-41CV PRINTER... \$289  
 HP-41CV OPTICAL WAND... \$99  
 HP-41CV CARD READER... \$168  
 HP-821060A HP-IL MODULE... \$99  
 HP-82161A DIGITAL CASSETTE DRIVE... \$419  
 HP-82162A IL PRINTER... \$375  
 HP-41C/CV EXT. FUNC. MEM. MOD... \$62.75  
 HP-41C/CV EXTENDED MEM. MOD... \$62.75  
 HP-11C... \$107.95  
 HP-12C... \$119.95  
 HP-33C... \$74.95  
 HP-34C... \$117.95

## ATARI® 800 \$689

 **ATARI**  
 NEW LOW PRICE

## ATARI 400 \$339

ATARI 830 ACOUSTIC MODEM... \$145  
 ATARI 825 80 COL. IMPACT PRINT... \$565  
 ATARI 410 PROG. RECORDER... \$79  
 ATARI 810 DISK DRIVE... \$419

**Personal Computer systems** (315)478-6800  
 All prices are subject to change without notice.  
 P.O. Box 1073  
 Syracuse, N.Y. 13201

## System Notes

altered because the area shifted may not be from the bottom of the page.

**CO: copy text** (190, 1400). All text in the range indicated in response to the prompt FROM, TO is copied into the area starting with the line number INTO. Text is not erased from the old area. Copying allows various text-editing experiments without losing the original input. Protection against overwriting on down-page copying is not provided.

**T: tab setup** (220). Three tab positions are provided in this routine. The prompt TABS displays existing values. Three inputs are required in response to the prompt. Tabs not needed can be set far to the right. If more tabs are needed, they can be entered for a second pass through the text.

**TP: table position setup** (240 through 270). When printing tabular data, it's desirable to line up the units positions of all entries in a column. This routine defines units positions

for five columns. The prompt displays the present values and requires five inputs; those not needed can be set far to the right.

**Note:** all the following commands prompt by line numbers for the range of the text to be operated on; the prompt is FROM, TO. If the response is entered as 0,0, all lines from 1 to LN are used. If XX,0 or XX,XX is entered, only the single line XX is used. If XX,YY is entered, lines XX to YY are used.

**E: end** (200). Simply stops program execution and exits to the immediate mode of the BASIC interpreter.

**D: display text** (320, 600). All lines in the range are displayed with line numbers.

**TAB: tab text** (330, 800 through 820, 1800 through 1930). This routine causes text to be tabbed out to the positions indicated by TP. The routine searches lines in the range specified for the embedded symbol ] (right bracket). When the right

bracket is found, enough spaces are inserted into the text so that the next character after ] will be placed in the column indicated by the next higher TP position.

Line 800 tests to determine whether or not any of the TP positions is other than zero. Line 1820 searches for the position of any ], and line 1830 ends the processing of that line if none is found. Lines 1840 through 1860 determine the column of the next-higher TP position. Lines 1900 through 1910 generate the proper number of spaces, and line 1920 inserts them into the string.

**J: justify text** (340, 900 through 1100, 1600 through 1790). The justification routine handles in turn each line of text in the range specified. If a line is too long (i.e., exceeds LL), words are stripped off the right end. These overflow words are added to the beginning of the next line.

For a line shorter than LL, spaces are added to fill the line out to LL.

## Computer Based PROM Programming

Interface your S-100 Bus Computer with our PPS-100 MULTI-PROM Programmer.

- Disk storage of data/ no master PROMS required
- Clear English commands
- Programs up to 8 EPROMS simultaneously - each with different data
- \$1500



**FRYE  
ELECTRONICS,  
INC.®**

9826 SW TIGARD ST.  
TIGARD, OR. 97223  
(503-620-2722)



## EPISODE™ THE VERSATILE COMPUTER

## JUST ADD PERIPHERALS

EPISODE is a CP/M® computer with 1.6 M byte of disk storage on dual 5¼ floppies. Its compact design provides a wide range of standalone or network applications including data base sharing.

EPISODE gives you total flexibility. You can add your own CRT and Printer, whatever brand and price range you choose. All the logic including the 64K RAM memory is contained on a single 6" x 8" circuit board ensuring maximum reliability.

EPISODE includes a unique software system called SUPERVYZ™ - a menu based software control system that allows the user to integrate application programs.

Dealer inquiries invited, foreign and domestic.

**EPIC**  
EPIC SYSTEMS

Epic Computer Corporation  
7542 Trade Street  
San Diego, CA 92121  
Tel: 714-695-3560

\*Supervyz is a trademark of Epic Computer Corporation. CP/M is a trademark of Digital Research.



Listing 1: Text-handling routines. This program is written in Extended BASIC. The routines may be used as they appear by simply running the program or they may be incorporated into user programs as necessary.

```

00100 DIM I$(255):N=1:DIM P(5)
00110 FOR A=1 TO 9
00120 I$(1)=I$(1)+CHR$(PEEK(8382+A))
00130 NEXT A
00140 L=65
00150 C$="":C1=0:C2=0:C3=0
00160 LINE INPUT "COMMAND ";C$
00170 IF C$="LN" THEN PRINT "N=";N+1:INPUT "SET LN= ";N:N=N+1:GOTO 150
00180 IF C$="SH" THEN INPUT "FROM.TO.INTO ";A1,A2,C3:GOSUB 700:GOTO 150
00190 IF C$="CO" THEN INPUT "FROM.TO.INTO ";A1,A2,C3:GOTO 1400
00200 IF C$="E" THEN END
00210 IF C$="LL" THEN PRINT "LL=";L:INPUT "SET LL= ";L:GOTO 150
00220 IF C$="T" THEN PRINT "TABS ";T1,T2,T3:INPUT T1,T2,T3:GOTO 150
00230 IF C$="N" THEN PRINT TAB(L)*";":GOTO 500
00240 IF C$(">")TP" GOTO 200
00250 PRINT "TABLE POSITIONS ";P(5);"; ";P(4);"; ";P(3);"; ";P(2);"; ";P(1)
00260 INPUT P(5),P(4),P(3),P(2),P(1)
00270 GOTO 150
00280 INPUT "FROM.TO ";C1,C2
00290 IF C1=0 THEN A1=1:A2=N:GOTO 320
00300 IF C2=0 THEN A1=C1:A2=C1:GOTO 320
00310 A1=C1:A2=C2
00320 IF C$="D" GOTO 600
00330 IF C$="TAB" GOTO 800
00340 IF C$="J" GOTO 900
00350 IF C$="P" GOTO 1200
00360 IF C$="I" THEN INPUT "INDENT X SPACES ";C3:S$="":GOTO 1300
00370 IF C$="CR" GOTO 2800
00380 IF C$="U" GOTO 2900
00390 IF C$="COL" GOTO 2000
00400 IF C$="F" GOTO 2500
00410 IF C$="C" GOTO 1500
00420 IF C$="R" GOTO 2600
00430 IF C$="S" GOTO 3200
00440 IF C$="G" GOTO 3300
00450 IF C$="SO" GOTO 2200
00460 GOTO 150
00500 INPUT "GOTO ";C1
00510 IF C1(">") GOTO 570
00520 PRINT "INPUT"
00530 N=N+1
00540 LINE INPUT I$(N)
00550 IF I$(N)="EXIT" THEN I$(N)="":N=N-1:GOTO 150
00560 GOTO 500
00570 LINE INPUT "INPUT";I$(C1)
00580 GOTO 150
00600 FOR A=A1 TO A2:PRINT A;" ";I$(A):NEXT A:GOTO 150
00630 IF C3=A1 GOTO 750
00710 FOR A=A1 TO A2
00720 I$(C3+A2-A)=I$(A2+A1-A):I$(A2+A1-A)=" "
00730 NEXT A:IF N=C3+A2-A1 THEN N=C3+A2-A1
00740 RETURN
00750 FOR A=A1 TO A2
00760 I$(C3+A-A1)=I$(A):I$(A)=" "
00770 NEXT A:RETURN
00800 IF T1 AND T2 AND T3=0 THEN GOTO 150
00810 FOR F=A1 TO A2:S$=I$(F):GOSUB 1800
00820 I$(F)=S$:PRINT F;" ";I$(F):NEXT F:GOTO 150
00900 S3$="":S5=0
00910 FOR F=A1 TO A2
00920 S2$=LEFT$(I$(F+1),1):S5=0
00930 IF S2$=" " OR S2$=" " THEN S5=1
00940 S$=I$(F):GOSUB 1600:I$(F)=S$
00950 PRINT F;" ";I$(F)
00960 IF S5=1 AND S3$(">") GOTO 1040
00970 NEXT F
00980 A4=A2:N1=N:S5=1
00990 IF S3$=" " GOTO 150
01000 A4=A4+1:N1=N+1
01010 A1=A4:C3=A4+1:A2=N1-1
01020 GOSUB 700:S$="":GOSUB 1600:I$(A4)=S$
01030 PRINT A4;" ";I$(A4):GOTO 930
01040 N1=N:S5=1:A4=F:A5=A2
01050 IF S3$=" " THEN A1=F+1:A2=A5:GOTO 930
01060 A4=A4+1:N1=N+1
01070 A1=A4:C3=A4+1:A2=N1-1
01080 GOSUB 700:A5=A5+1
01090 S$="":GOSUB 1600:I$(A4)=S$
    
```

Listing 1 continued on page 464

**JUNE SPECIAL SALE ON PREPAID ORDERS**  
 (CHARGE CARDS, C.O.D. OR P.O.'S NOT AVAILABLE)  
 MUST MENTION AD FOR SPECIAL PRICES  
**WAMECO CRT-1 INTRODUCTION (AT LAST)**  
 16 x 80 OR 24 x 80 VIDEO BOARD 1/0 MAPPED  
 SIMULATES INTELLIGENT TERMINAL  
 PCBD..... \$36.95. KIT..... \$239.95  
 A & T..... \$299.95



**CALIFORNIA COMPUTER SYSTEMS**

<b>\$100</b>		
2032 32K STATIC RAM A & T	200 NSEC	\$629.00
2065 64K DYNAMIC RAM A & T.		\$548.95
2200 S-100 MAIN FRAM A & T		\$379.95
2422 FLOPPY DISC WITH CP/M 2.2"		\$329.95
2810A Z80 CPU A & T		\$249.95
2710A 4 SERIAL 1/0 A & T		\$291.95
2718A 2 SERIAL, 2 PARALLEL A & T		\$305.95
2720A 4 PARALLEL A & T		\$214.95
PROTO BOARDS WW		\$39.95
<b>APPLE PRODUCTS</b>		
7114A 12K ROM/PROM		\$68.50
7424A CALENDAR/CLOCK		\$106.95
7440A PROGRAMMABLE TIMER.		\$98.50
7470A A TO O CONVERTER		\$105.95
7490A GPIB (IE 488) INTERFACE		\$265.95
7710A ASYNC SERIAL		\$125.95
7712A SYNC SERIAL.		\$153.95
7720A PARALLEL STANDARD		\$98.95
7720B PARALLEL CENTRONICS		\$98.95
7811B ARITHMETIC PROCESSOR W/DISC		\$342.95
7811C ARITHMETIC PROCESSOR W/ROM		\$342.95
7500A WW BOARD.		\$22.95
7510A SOLOERTAIL BOARD		\$23.95



**MICROCOMPUTER PRODUCTS**

<b>\$100 PRODUCTS</b>		
CB-2 280 PROCESSOR BOARD.		
KIT	\$198.95. A & T	\$269.95
VBIC 64 x 16 VIDEO. PCBD		\$32.95
KIT	\$153.95. A & T	\$199.95
VB3 80 CHARACTER VIDEO 4MHZ		
KIT	\$345.95. A & T	\$425.95
104 2 PARALLEL, 2 SERIAL. PCBD		\$32.95
KIT	\$155.95. A & T	\$194.95
PB-1 2708, 2716 PROGRAMMER BOARD		
KIT	\$135.95. A & T	\$185.95

<b>APPLE PRODUCTS</b>		
A10 SERIAL/PARALLEL INTERFACE		
A & T.....		\$155.95
A810 SERIAL 1/0		
A & T.....		\$97.95
AP10 PARALLEL IO W/O CABLES		
A & T.....		\$87.95



**WAMECO INC.**

**BOARDS WITH MIKOS PARTS**

MEM-3 32K STATIC RAM. PCBD		\$36.95
KIT LESS RAM	\$95.95. A & T	\$135.95
CPU-2 Z80 PROCESSOR. PCBD		\$32.95
KIT LESS ROM	\$109.95. A & T	\$149.95
EPM-2 16K/32K EPROM. PCBD		\$32.95
KIT LESS ROM	\$65.95. A & T	\$99.95
FPB-1 FRONT PANEL. PCBD		\$48.50
KIT	\$144.95. A & T	\$184.95
QMB-12 13 SLOT MOTHER BOARD. PCBD.		\$39.95
KIT	\$95.95. A & T	\$135.95



MONDAY-FRIDAY, 8:00 TO 12:00, 1:00 TO 5:30  
 THURSDAYS, 8:00 TO 9:00 P.M.

(415) 728-9121

P.O. BOX 955 • EL GRANADA, CA 94018

PLEASE SEND FOR IC XISTOR AND COMPUTER PARTS LIST  
 VISA or MASTERCHARGE Send account number, interbank number  
 expiration date and sign your order. Approx postage will be added  
 Orders with check or money order will be sent post paid in U.S. If you are  
 not a regular customer, please use charge, cashiers check or postal  
 money order. Otherwise there will be a two-week delay for checks to  
 clear. Calif. residents add 6% tax. Money back 30-day guarantee. We  
 cannot accept returned IC's that have been soldered to. Prices subject to  
 change without notice. \$20.00 minimum order. \$2.00 service charge on  
 orders less than \$20.00.



**Smith-Corona TP-1  
Daisy  
Wheel  
Printer**



**\$659<sup>00</sup> DELIVERED**

- 120 words per minute
- Parallel or RS-232C interfacing (specify)
- 10 or 12 characters per inch (specify)
- Full letter quality print
- 13" carriage with 10.5" print line
- Friction feed handles 4-part forms

**Okidata Printers**

MICROLINE 82A .....	<b>\$469<sup>00</sup></b>
MICROLINE 83A .....	<b>\$729<sup>00</sup></b>
MICROLINE 84 (Parallel) .....	<b>\$1059<sup>00</sup></b>
MICROLINE 84 (RS-232C) .....	<b>\$1194<sup>00</sup></b>

**NEC Printers**

NEC PC-8023A-C .....	<b>\$499<sup>00</sup></b>
----------------------	---------------------------

**IDS Printers**

IDS PRISM 132 (4-color) .....	<b>\$1699<sup>00</sup></b>
IDS PRISM 80 .....	<b>\$989<sup>00</sup></b>

**Epson Printers**

MX-80 w/GRAFTRAX .....	<b>\$474<sup>00</sup></b>
MX-80/F-T .....	<b>\$569<sup>00</sup></b>
MX-80/F-T w/GRAFTRAX .....	<b>\$619<sup>00</sup></b>
MX-100 .....	<b>\$729<sup>00</sup></b>

**Centronics Printers**

CENTRONICS 739 (Parallel) .....	<b>\$539<sup>00</sup></b>
CENTRONICS 739 (RS-232-C) .....	<b>\$644<sup>00</sup></b>

**C.Itoh Printers**

C.ITOH PRO WRITER (parallel & RS-232C) w/3K buffer, 120 cps .....	<b>\$639<sup>00</sup></b>
C.ITOH F-10 STAR WRITER Daisy Wheel (parallel or RS-232C) 40cps ...	<b>\$1489<sup>00</sup></b>

Cables and interfaces available for the APPLE, ATARI, CBM/PET, IBM, OSBORNE, and TRS-80.

**Orders & Information:  
CALL (603)-673-8857**

Orders Only: CALL (800)-343-0796

We accept CODs—No surcharge for credit cards  
No charge for UPS shipping—Stock shipments  
next day—All equipment shipped factory  
fresh with the manufacturer's warranty

Prices subject to change

HIGH TECHNOLOGY AT AFFORDABLE PRICES

**THE BOTTOM  
LINE**

12 Johnson Street, Milford NH 03055-0423

**System Notes**

Listing 1 continued:

```

01100 GOTO 1050
01200 OPEN "AT:" FOR WRITE AS FILE #1
01210 FOR A=A1 TO A2:PRINT #1,I$(A):NEXT A
01220 CLOSE #1:GOTO 150
01300 FOR A=1 TO C3:S4=S4+" ":NEXT A
01310 FOR A=A1 TO A2:I$(A)=S4+I$(A)
01320 PRINT A;" ";I$(A):NEXT A:GOTO 150
01400 FOR A=A1 TO A2:I$(C3+A-A1)=I$(A):NEXT A:GOTO 150
01500 FOR A=A1 TO A2
01510 B=LEN(I$(A))
01520 D=INT((L-B)/2)
01530 FOR F=1 TO D
01540 I$(A)=" "+I$(A)
01550 NEXT F
01560 NEXT A
01570 GOTO 600
01600 S4=S4+S4:S3$="" :S1$=""
01610 B=LEN(S4)
01620 IF B<L-10 OR B=L THEN RETURN
01630 IF B>L GOTO 1730
01640 C=L-B:P=1
01650 IF C=0 THEN RETURN
01660 A=MATCH(S4,S1$,P)
01670 IF A=P THEN P=P+1:GOTO 1660
01680 IF A=B OR A=0 THEN P=1:S1$=S1$+" ":GOTO 1660
01690 IF A<L-20 AND RND(1)>.7 THEN P=A+1:GOTO 1660
01700 S2$=LEFT$(S4,A)+" "+RIGHT$(S4,B-A)
01710 C=C-1:P=A+2:B=B+1:S4=S2$
01720 GOTO 1650
01730 A=1
01740 S1$=MID$(S4,L+2-A,1)
01750 IF S1$<>" " THEN A=A+1:GOTO 1740
01760 S3$=RIGHT$(S4,B-L+2+A)
01770 IF S5=0 THEN S3$=S3$+" "
01780 S4=LEFT$(S4,L+1-A)
01790 GOTO 1610
01800 T5=0
01810 S2$="" :T4=LEN(S4)
01820 A=MATCH(S4,"J",1)
01830 IF A=0 THEN RETURN
01840 IF A<T1 THEN T5=T1:GOTO 1800
01850 IF A<T2 THEN T5=T2:GOTO 1800
01860 IF A<T3 THEN T5=T3:GOTO 1800
01870 GOTO 1920
01880 IF A=T5 GOTO 1920
01900 FOR T6=A TO T5-1
01910 S2$=S2$+" ":NEXT T6
01920 S3$=LEFT$(S4,A-1)+S2$+RIGHT$(S4,T4-A)
01930 S4=S3$:GOTO 1610
02000 FOR A=A1 TO A2
02010 B=1:S2$=""
02020 P=MATCH(I$(A),"J",B)
02030 IF P=0 GOTO 2100
02040 FOR M=1 TO 5
02050 IF P<T(M) THEN B=T(M):GOTO 2070
02060 NEXT M
02070 FOR G=1 TO T(M)-P+1:S2$=S2$+" ":NEXT G
02080 S1$=LEFT$(I$(A),T(M-1))+S2$+MID$(I$(A),T(M-1)+1,P-T(M-1)-1)+RIGHT$(I$(A),P+1)
02090 I$(A)=S1$:GOTO 2020
02100 PRINT A;" ";I$(A):NEXT A:GOTO 150
02200 INPUT "WHICH LINE?,OF HOW MANY LINES?,SORT WORD FROM LEFT? "J1:L2:W
02210 FOR A=A1+L1-1 TO A2+L1-1 STEP L2
02220 W1=0:S1=0:C=1:S=0:S1$="" :S2$=""
02230 S1$=MID$(I$(A),C,1):C=C+1
02240 IF S1$=" " THEN S1=0:GOTO 2300
02250 IF S1$=" " GOTO 2300
02260 S=1
02270 IF S1=0 THEN W1=W1+1:S1=1
02280 IF W1<W GOTO 2230
02290 S2$=S2$+S1$:GOTO 2230
02300 IF S=0 GOTO 2230
02310 IF W1<W GOTO 2230
02320 S4$(A)=S2$
02330 NEXT A
02340 A3=A2+L2-1
02350 S=0:A2=A2-L2
02360 FOR J=A1+L1-1 TO A2+L1-1 STEP L2
02370 IF S4$(J)<S4$(J+L2) GOTO 2450
02380 S1$=S4$(J):S4$(J)=S4$(J+L2)
02390 S4$(J+L2)=S1$
    
```

Listing 1 continued:

```

02400 FOR A=J-L1+1 TO J-L1+L2
02410 S1=I$(A):I$(A)=I$(A+L2)
02420 I$(A+L2)=S1$
02430 NEXT A
02440 S=1
02450 NEXT J
02460 IF S=1 GOTO 2350
02470 A2=A3:GOTO 600
02500 LINE INPUT "FIND WORD ";F$
02510 LINE INPUT "CONVERT TO UPPER? Y=YES ";U$
02520 IF U$="Y" THEN S$=F$:GOSUB 3000:F$=S$
02530 INPUT "WHICH LINE?, OF HOW MANY LINES? ";L1:L2
02540 FOR A=A1+L1-1 TO A2+L1-1 STEP L2
02550 IF MATCH(I$(A),F$,1)<>0 THEN PRINT A: " ";I$(A)
02560 NEXT A
02570 GOTO 150
02600 LINE INPUT "FIND WORD ";F$
02610 LINE INPUT "CONVERT TO UPPER? Y=YES ";U$
02620 IF U$="Y" THEN S$=F$:GOSUB 3000:W$=S$
02630 D=LEN(W$)
02640 LINE INPUT "REPLACE WITH ";X$
02650 LINE INPUT "CONVERT TO UPPER? Y=YES ";U$
02660 IF U$="Y" THEN S$=X$:GOSUB 3000:W$=S$
02670 FOR A=A1 TO A2
02680 E=LEN(I$(A))
02690 J=MATCH(I$(A),W$,1):IF J=0 THEN NEXT A:GOTO 150
02700 S$=LEFT$(I$(A),J-1)+X$+RIGHT$(I$(A),E-J+1)
02710 I$(A)=S$:PRINT A: " ";I$(A)
02720 GOTO 2600
02800 T7=0:IF T1 OR T2 OR T3<>0 THEN T7=1
02810 FOR J=A1 TO A2
02820 PRINT J: " ";I$(J):LINE INPUT "CAPTION? ";F$
02830 LINE INPUT "CONVERT TO UPPER? Y=YES ";U$
02840 IF U$="Y" THEN S$=F$:GOSUB 3000:F$=S$
02850 D=LEN(F$):E=LEN(I$(J))
02860 I$(J)=F$+RIGHT$(I$(J),E-D)
02870 PRINT J: " ";I$(J):NEXT J:GOTO 150
02900 FOR F=A1 TO A2:S$=I$(F):GOSUB 3000
02910 I$(F)=S$:PRINT F: " ";I$(F):NEXT F:GOTO 150
03000 A=1:C=LEN(S$)-1
03010 B=MATCH(S$,"I",A)
03020 IF B=0 THEN RETURN
03030 S$=LEFT$(S$,B-1)+CHR$(ASC(CHR$(S$,B+1,1))+32)+RIGHT$(S$,C-B)
03040 A=B+1:C=C-1:GOTO 3010
03200 LINE INPUT "ENTER FILE NAME ";C$
03210 OPEN C$ FOR WRITE AS FILE #1
03220 PRINT #1,A1:PRINT #1,A2
03230 FOR A=A1 TO A2:PRINT #1,I$(A):NEXT A
03240 CLOSE #1:GOTO 150
03300 LINE INPUT "ENTER FILE NAME ";C$
03310 OPEN C$ FOR READ AS FILE #1
03320 INPUT #1,A3:INPUT #1,A4
03330 A2=A1+A4-A3
03340 IF A1=0 THEN A1=A3:A2=A4
03350 N=MAX(N,A2)
03360 FOR A=A1 TO A2:LINE INPUT #1,I$(A):NEXT A
03370 CLOSE #1:GOTO 150

```

Spaces are added randomly with an algorithm that favors the left side of the line. If a line is shorter than LL by more than 10 positions, it is assumed to be the last line of a paragraph and is not justified.

A blank line or a space at the beginning of a line is assumed to mark a new paragraph. Beginning spaces are preserved (not added to by the justification). If a line overflow occurs at the end of a paragraph or at the end of the range, the shifting routine is called to shift the following text down page.

Lines 900 through 970 handle each line and test for the end of the

paragraph. Lines 980 through 1030 handle range overflow. Lines 1040 through 1100 handle paragraph overflow. Lines 1600 through 1640 add previous overflow to the current line and find line length. Lines 1650 through 1720 insert spaces to pad out the line to LL. Lines 1730 through 1790 strip off line overflow at a word boundary.

COL: columnize data (390, 2000 through 2100). The columnize-data routine allows handling of tabular data while maintaining the data's lined-up units positions. The column positions desired for the low-order digits are specified by the user with

# What's Better Than Basic?

## BASIC B+™ IS!

Delphic Systems has merged its Z80 BASIC with FairCom's MICRO B+™ to produce BASIC B+™, the first all purpose interpreter featuring a B-TREE file structure implemented using NEW commands. No more messy CALLS or difficult assembly language interfacing! Instead, use the following BASIC B+™ functions to manage an index without ever reorganizing the file:

BOPEN	BCLOSE	NEWB
KILLB	FINDB	GETB
NEXB	PREVB	STATS

In addition, BASIC B+™ was written using Z80 code in order to minimize size and enhance speed performance.

### Features & Requirements

- Search a 10,000 entry index in one second
- No index reorganization needed
- Uses fast and compact Z80 code
- CP/M® Versions 1.4 or 2.2
- 12 Digit precision
- Program Chaining
- Read only file protection
- Sequential and random files

## BASIC B+™

with documentation

**\$325.00**

**Delphic Systems**

2260 Compton Avenue

St. Louis, MO 63104

314/773-6753

Coming Next  
INVENTORY B+™

VISA

MasterCard

MICRO B+™ is a Trademark of FairCom

## System Notes

the TP command. Of course, this routine can be used with text as well as data.

The routine searches each line from left to right, looking for the symbol ]. The column containing this symbol is compared with TP columns, and the TP with the next-higher column number is selected. The substring that ends one column to the left of the ] is moved to the right so that it will end in the selected TP column. The length of this substring spans from the next-lower TP column plus one to the column holding the symbol ], minus one. Spaces are inserted to fill between the substring and the lower TP. The number of spaces equals the column number of the selected TP minus the column number of the symbol ], plus one.

No program precautions are made for data that exceed the distance between adjacent TP columns. Where a table entry is to be passed, use successive ] symbols.

**P: print text** (350, 1200 through 1220). This routine prints the text in the range specified on the output printer. Because it is assumed the output represents the final document, line numbers are omitted.

**C: center text** (410, 1500 through 1570). In some circumstances, it's desirable to center report and paragraph headings. The lines in the range are operated upon, and centering is performed relative to LL. The length of the line is compared with LL, and enough spaces are added to the left to obtain centering.

**I: indent text** (360, 1300 through 1320). All lines in the range are indented the number of spaces indicated by the user. A string of spaces is added to the beginning of each line. This routine can be implemented after text has been entered and justified in preparation for adding a numbering scheme using the caption routine.

**F: find** (400, 2500 through 2570). Find prompts the user for a *find word*

that is used as a search argument. This argument can be a word, phrase, or part of a word. It can be converted to uppercase.

All lines in the range that contain the search argument are displayed with line numbers. If records of more than one line are involved, the search can be limited to a specific line in each record. In such a case, the range is specified as covering the area from the first line in the first record to the first line in the last record. The routine prompts for which line of how many lines. The search is done by detecting the first match, if any, in a line. Lines 2500 through 2530 prompt for the necessary input. Line 2550 determines whether or not a match occurs and, if so, prints the line.

**R: replace** (420, 2600 through 2720). The replace routine operates in much the same manner as the find routine. A search string and a replace string are entered; either can be con-

THEY SAY IT ALL... WE DO IT ALL!



**THE C PROGRAMMING LANGUAGE**  
KERNIGHAN & RITCHIE



**C86™ C COMPILER**

ANNOUNCING  
THE C86™ C COMPILER  
—THE COMPILER THAT SPEAKS  
THE LANGUAGE OF THE FUTURE!

Kernighan and Ritchie's book, *The C Programming Language*, is the key source for C. Just as fundamental is the C86™ C Compiler.

The C86™ C Compiler is especially designed for the IBM® Personal, IBM® Display Writer, CP/M-66® and MS-DOS®

For further information on the C programming language and the C86™ C Compiler, please contact:



**Computer Innovations, Inc.**  
75 Pine Street  
Lincroft, New Jersey 07738  
Telephone: (201) 530-0995

IBM is a trademark of International Business Machines, Inc. CP/M-66 is a trademark of Digital Research. IBM and MS-DOS are registered trademarks of International Business Machines, Inc.

## REPAIR PCB'S ANYWHERE.

### With the NEW Pace Micro!

Perform power desoldering and soldering anywhere. Depot. Service center. Mobile van. On-site. Anywhere! Operates on AC or 12 VDC.

Write or call today for a FREE brochure.



See us at the NCC Show, Booth #3433

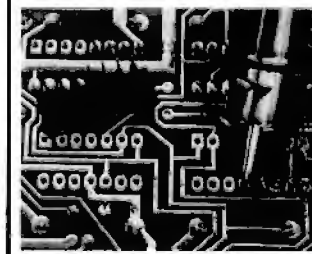

# PAGE

Micro Portable

Systems for PCB Repair Anywhere™

9893 Brewers Court  
Laurel, Md. 20707, U.S.A.  
(301) 490-9860.  
Telex 87446.

© 1981, Pace, Inc.



verted to uppercase, and the two strings need not be of the same length. Searching is not terminated when the first match is made, allowing multiple matches and replacements in the same line. Since this is the main editing routine and single-line operation is the norm, record-handling capability has not been included.

**F:** Lines 2600 through 2660 prompt for the find word and the replace word and call uppercase conversion if indicated. Lines 2670 through 2720 search for a match and, where found, insert the replacement. Line 2690 tests for no match and advances to the next line.

**SO:** sort records (450, 2200 through 2470). This routine allows sorting of complete records. A restriction: the sort word must be in the same position in all records, determined by counting words from the left of lines. Assume records have the form:

```
First-name Last-name
Street
City State Zip
```

To sort on Last-name, in response to the prompt WHICH LINE?, of HOW MANY LINES?, SORT WORD FROM LEFT?, the input would be 1, 3, 2. The range specified covers the area from the first line of the first record to the first line of the last record. To sort one-line records, the input is 1, 1, X.

The routine copies the key sort-word from each record and creates a file of these words. Then a *bubble sort* is used to sort this new file. As each transposition is made in this file during the bubble sort, the lines of the corresponding records are also transposed. Lines 2100 through 2330 copy the key words into the sort file. Line 2210 assures selection of the proper line in each record. Lines 2340 through 2470 contain the bubble sort and handle record transpositions.

**CA:** caption text (370, 2800 through 2910). The CA command replaces the leftmost characters in a line with a caption string. A different

caption can be used with each line in the range specified. The length of the string replaced equals the length of the caption.

This feature has two possible uses. First, text can be justified, then indented. With CA a numbering scheme can be inserted into the left margin. Second, data can be put into columns and item identifiers can later be entered.

**U:** uppercase conversion (380, 2900 through 3040). Some systems (at least mine) handle only uppercase in the display, while the printer will handle both uppercase and lowercase. To generate uppercase, the symbol [ (left bracket) is used in front of each character to be capitalized. Thus, input text displayed as [text appears on the printer as Text. The subroutine searches each line of text for the symbol [. When one is found, a fixed amount is added to the next character for the code conversion.

**S:** save file (430, 3200 through 3240). Save file permits storage of the text in a file. The BASIC commands are specific to my system, which uses a disk. Length of the record is determined by the line numbers entered as FROM, TO. The routine prompts for the file name, which must be used to obtain the file again.

**G:** get file (440, 3300 through 3370). This is the companion command to Save file. The file with the name specified is returned. The range is used to determine where on the page the file is to be placed. For the range 0,X (where X is any number), the entire file is placed at the same lines used in the SAVE command. If the range is N,X, the entire file is brought in, starting at line number N.

### Short and Sweet

These subroutines are intended to help those of you who want to build text handling into your own programs. The program as listed will run on some systems with Extended BASIC and work for manually manipulating text. The interactive scheme is, perhaps, the most important point, as it should help to make your programs user-friendly. ■

## F2P/F2

New 8" FD subsystems for CROMEMCO\* and other general systems

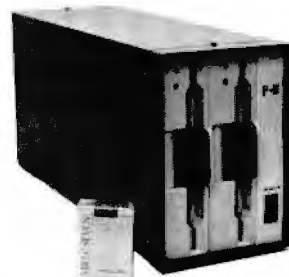

### GENERAL SPECIFICATIONS

● DRIVE: Ultra-compact NEC FD1165×2(8"double-sided dual-density, direct drive motor), fully compatible with Shugart SA850R

● ENCLOSURE: 160W×230H×500D(mm), power supply and noise filter included

● PRICES:

☆F2P (signal compatible with Persei299).....\$2,580.00 (including FSC-1250)

☆FSC-1250 (I/F for 16FDIC & Shugart type drives (no modification required of CDOS).....\$550.00

☆F2 (pin compatible with Shugart drives).....\$1,990.00

## SBC-488

Single-board computer conforming to IEEE-488 specifications

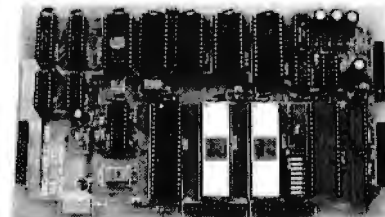

### GENERAL SPECIFICATIONS

● CPU: Z80 ● MEMORY: 2716/2732/6116 ● I/O: 6 parallel ports (8255×2), 1 RS-232C port (8251×1), 75-19,200 bauds ● STANDARD: IEEE-488 1975/1978 (TMS9914) ● EXT. BUSS: 8 data lines, 4 address decode outputs, 12 control lines.

● DIMENSIONS: 210mm×120mm ● POWER: 0.8A at +5V ● PRICE: \$488.00

## GPIB-100

S-100 multifunction board meeting IEEE-488 specifications.

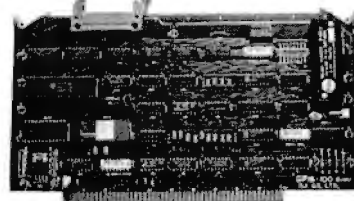

### GENERAL SPECIFICATIONS

● GPIB: IEEE-488, 1975/1978(TMS9914) ● TIMER: 100/μs to 18 hours(8253) ● INTERRUPT: Universal interrupt controller (AM9519) ● CLOCK: Real time, battery-backup (MSM5832) ● BUSS: IEEE S-100 ● SOFTWARE: All necessary handler programs included on 8"diskette ● PRICE: \$550.00

\*CROMEMCO is a trade mark of Cromemco Inc.

ALL PRICES ARE FOB TOKYO AND SUBJECT TO CHANGE WITHOUT NOTICE (Dealer inquiries invited)

International Systems & Automation

## ISA co.,Ltd.

HEIAN BLDG. 2-6-16 OKUBO  
SHINJUKU-KU, TOKYO 160  
JAPAN PHONE: 03-232-8570  
TELEX: 2324496 ISATOK,  
CABLE: ISAHEIAN

# Omni Aviation Navigation System

*Simulate aircraft instrument navigation using  
simple trigonometry.*

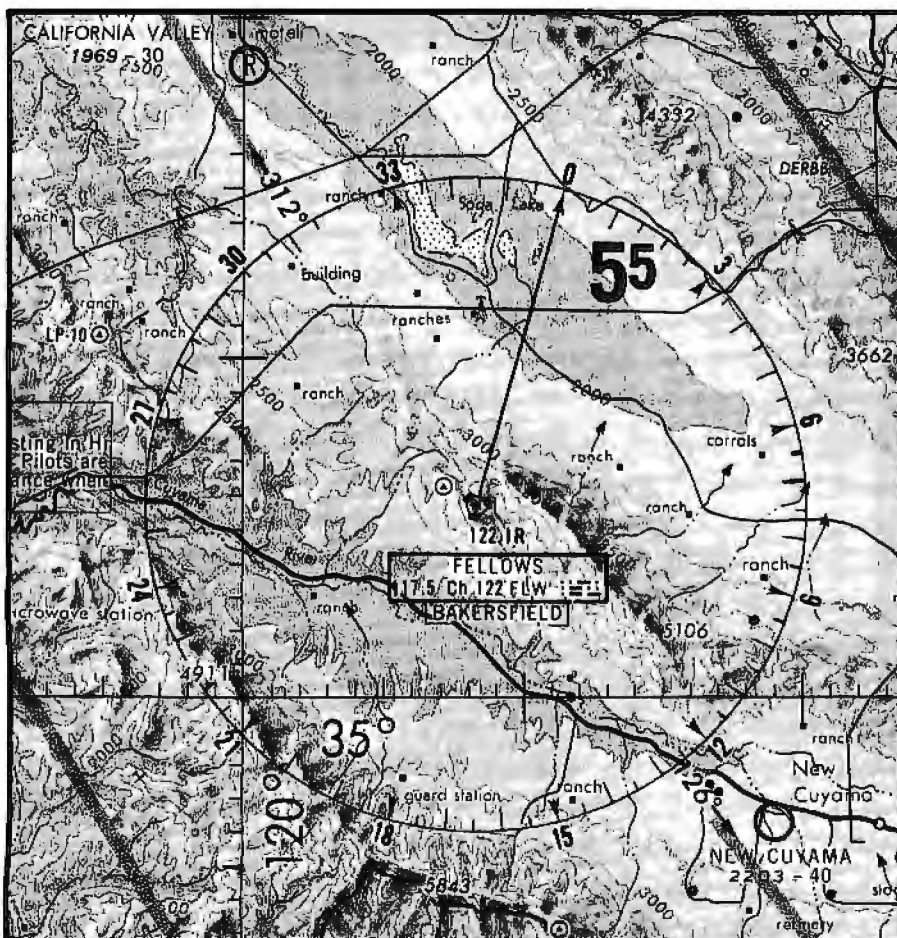

Richard Campbell  
10184 Herb Rd.  
Windsor, CA 95492

Computer simulation is a practical and, in many cases, an economical method for training people to respond to situations they have never actually experienced. Rising fuel costs in recent years have forced airlines to make more frequent use of simulation in pilot training and testing. The cost of training a pilot in an empty Boeing 747, for example, is astronomical. Training by simulation not only cuts that cost, it also allows the pilot to practice emergencies that could pose grave dangers if practiced in a real aircraft. Simulation also is gaining popularity in general aviation, especially for aircraft instrument training.

For beginning pilots, one of the most time-consuming and difficult aspects of flying is navigation using

*Photo 1: Typical VOR as represented on an aircraft navigation map. The information block contains the station's frequency and the three-letter code it broadcasts.*

the very high frequency Omni-directional range system, commonly known as VOR or Omni. This article presents a program for simulating Omni on a nonspecialized computer system.

More than 800 Omni stations in the United States make up the Federal Airways Network, with many more stations worldwide. Aircraft navigation charts indicate Omni stations with a compass rose accompanied by a station-identification block (see photo 1). The station-identification block gives the frequency of the station, along with the three-letter identification code the station transmits.

The station also transmits an infinite number of *radials*. But because of the resolution of the aircraft navigation receiver, we can pretend there are only 360 radials—one for each degree of a circle, radiating from the center of the station like spokes from a wheel. The station's 0° radial points to the north, the 90° radial points east, the 180° south, and the 270° west. If you know what radial you are on, you can draw an LOP (line of position) along that radial and through the center of the station on a map. With two Omni stations, you can draw two LOPs. The intersection of these two lines is the position of the aircraft (see figure 1). You can fly toward a station by choosing a course that is the reciprocal of the radial you are on or away from the station by making your course match the radial (see figure 2). If this sounds confusing, imagine trying to keep it all straight while learning to fly the airplane at the same time.

The Omni station works by modulating its radio output with two 30-Hz (cycles per second) sine waves. One is called the reference wave, the other the variable wave. The radial of your position is determined by the phase angle between the two waves. At the 0° radial, the waves are in phase; at the 90° radial, they are 90 degrees out of phase; and so on around the circle.

To illustrate this concept, let's build an imaginary station that operates like a real one. Picture the station as a box topped with a wheel that rotates clockwise in a horizontal plane. In the center of the wheel is a

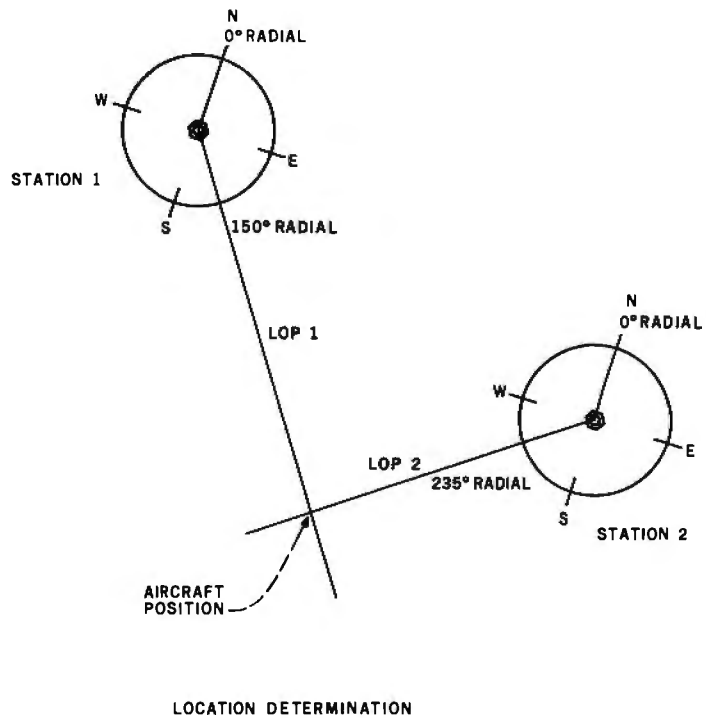

Figure 1: An aircraft's position may be determined using two VOR or Omni navigation stations. By drawing the respective radials, the pilot can plot the current location as the intersection of two lines on a map.

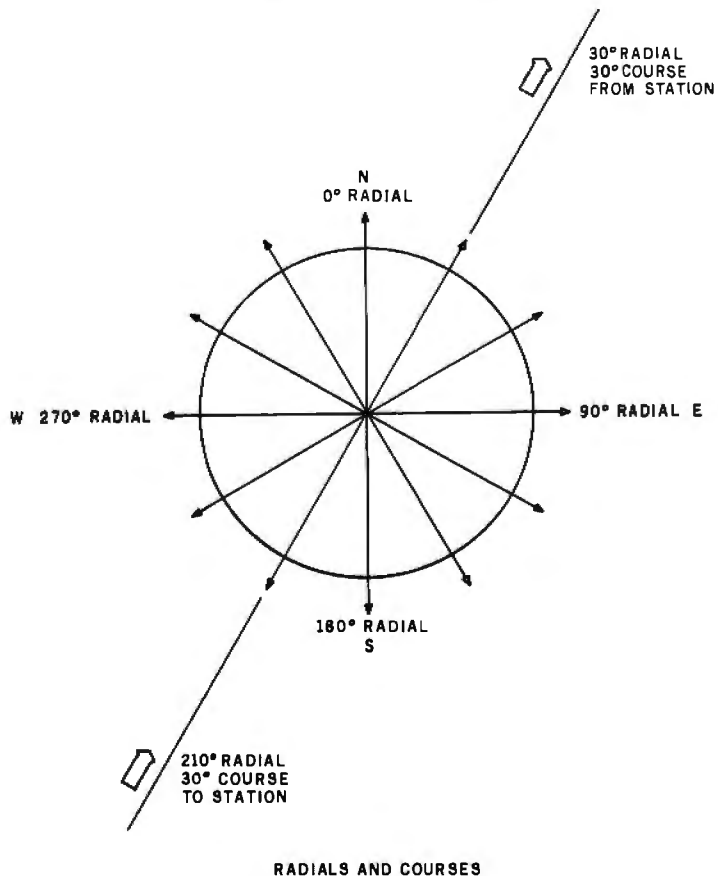
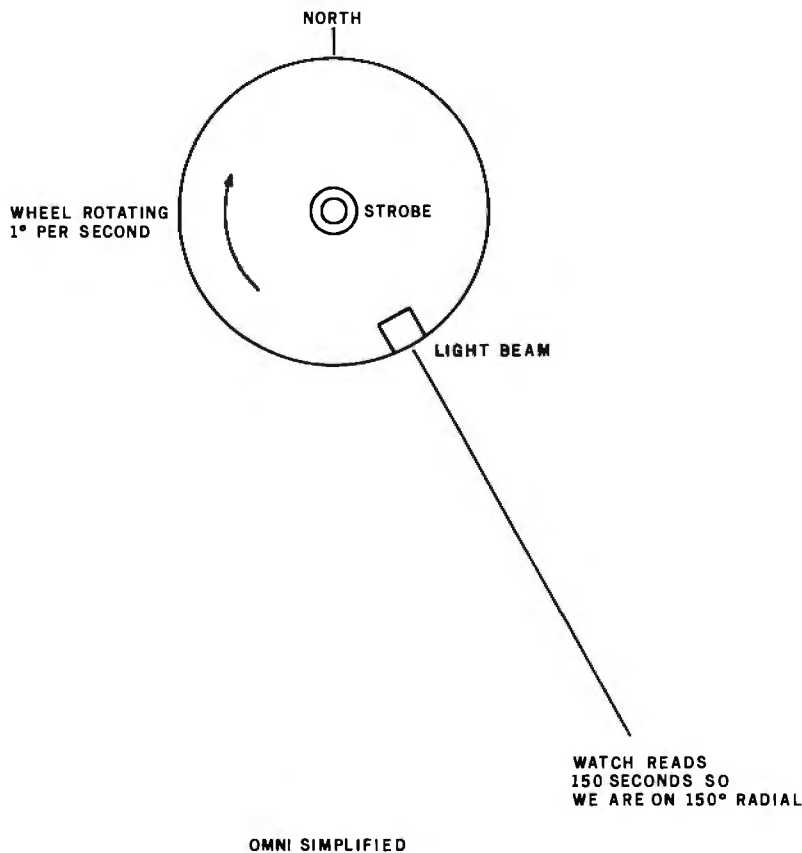

Figure 2: Standard layout for the radials as broadcast by a VOR station. Note that an aircraft traveling along the line is on a course 180° opposite the value of the radial when it is heading to the station.





**Figure 3:** This simplified model diagrams the function of the VOR aircraft navigation receiver. In this model, the wheel rotates clockwise one degree per second, and a strobe light flashes when the radial beam is at 0°. The current radial is found by counting the number of seconds between the flash of the strobe and the sighting of the radial light beam.

strobe light. A lamp shining outward with a highly directional beam is mounted on the edge of the wheel. The wheel rotates at one degree per second, and the strobe blinks when the lamp on the wheel is pointing due north. To determine what radial you are on, start your stopwatch when you see the strobe flash, and stop it when you see the light on the wheel. The number of seconds on your watch is the radial where you are located (see figure 3).

Instead of a stopwatch, the pilot of an airplane uses a navigation receiver with a VOR indicator (see figure 4). Assume that you, the pilot, wish to fly directly to the station. You turn the OBS (Omni Bearing Selector), causing the *course card* to rotate. The card rotates until the CDI (Course Deviation Indicator) centers. Next you examine the *To/From* flag. If it says "From", the plane's position is on the radial shown under the fiducial marker—a course taking it directly away from the station.

Because you want to go *toward* the station, you must keep turning the card until the needle again centers (a 180° rotation) and the flag reads "To". If the flag read "To" the first time the needle centered, you would have left the OBS alone. The course shown under the fiducial marker is the direction in which you must turn the airplane to go to the station. It's also the reciprocal of the radial of your position. As previously stated, you fly to the station by flying the reciprocal of the radial (because radials point out from the station).

Once the radial is determined, you point the airplane in the direction displayed and follow the needle (CDI) to the station. If the needle drifts left, turn left until it centers. In other words, if the needle points left, the plane is to the right of its intended course and vice versa. The 5° and 10° dots tell how far off course you are. This relationship holds true as long as the course under the fiducial marker is roughly the same as the aircraft heading. The needle shows aircraft location with regard to the selected course, but it shows nothing about the aircraft heading. It's up to the

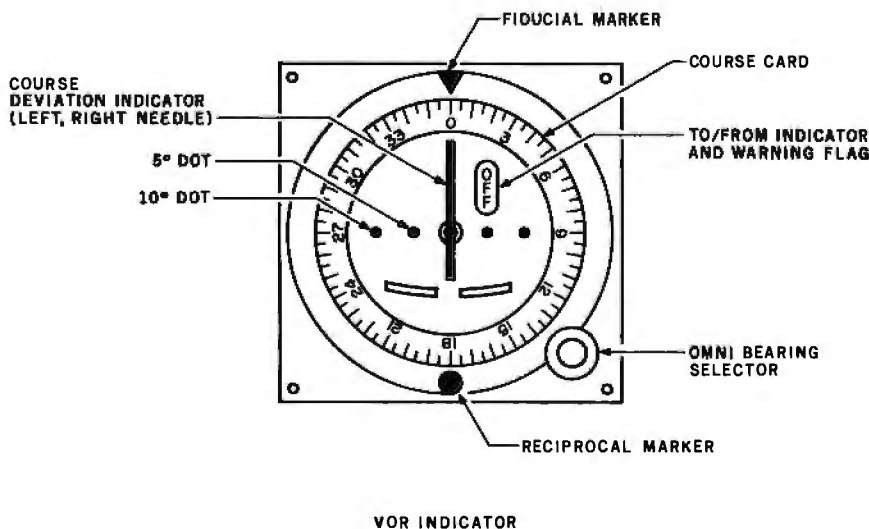

**Figure 4:** Layout of a typical VOR indicator. The course card is rotated via the Omni Bearing Selector until the Course Deviation Indicator is centered. The value indicated by the fiducial marker is the aircraft's direction relative to the Omni station.

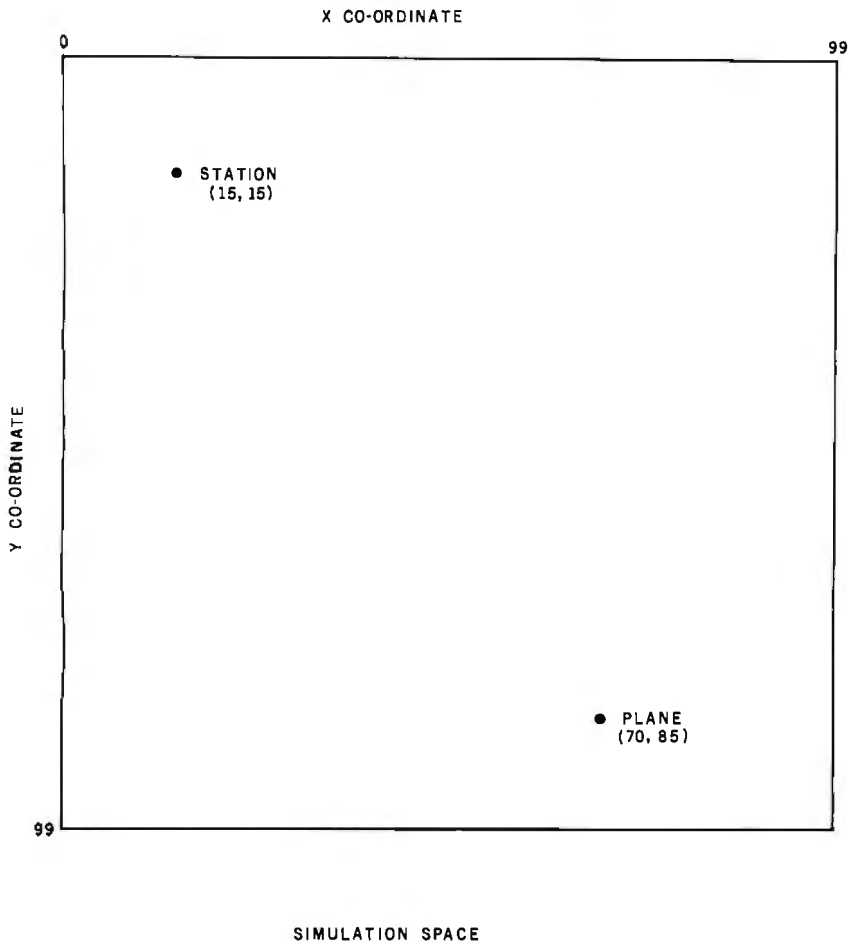

**Figure 5:** Possible computer display of the relative locations of a target aircraft and an Omni station for a simulation of actual operation. Note that the coordinate origin is at the top left of the simulation space.

pilot to control the aircraft so that the VOR indicator readings make sense.

Assuming you hold your course straight to the station, sooner or later you will fly directly over it, into an area called the "Cone of Confusion." The To/From flag gets highly agitated, settling down to a "From" reading once the plane passes the station. You are now on the actual radial shown on the indicator. As long as you follow the needle, you will fly directly away from the station.

As you may have gathered by now, it's no easy task to learn to use this system while also flying an airplane. The program given in listing 1 simulates the Omni system, allowing you to learn and practice without using fuel in the calm privacy of your computer area.

### How It Works

The small world in which our simu-

lated flying takes place is a 100-point by 100-point square (see figure 5). The y scale is inverted from normal (with the origin at the top left of the space), as in an Apple II. One point is chosen as the location of the Omni station, another as the airplane's current position. When provided with the course set on the VOR indicator, the program computes the radial, To/From flag, and CDI display.

The program starts with remarks, then jumps past a group of subroutines to the main routine. The subroutines are at the front to speed up operation of the program. The main routine consists only of a sequence of subroutine calls.

Subroutine 1 first requests both the coordinates of the station and the aircraft location. In both cases, it needs the x coordinate first, followed by the y coordinate. Subroutine 2 inputs the numbers, making sure the number in-

## SOURCE CODE for 3270 BISYNC COMMUNICATIONS

Trying to interface your microsystem with a host computer and are frustrated because you just don't have enough time to develop your software and you want to quickly start utilizing the power of the host?

Data Retrieval Corporation of America will share with you the benefits of a major research and development communications project.

**The 3270 communications source code package includes:**

Source Code (written in 8080 Assembler) for an Intel iSBC 544 Intelligent Communication Controller.

- Port 1 communicates with a host computer, emulating an IBM 327X control unit.
- Port 2 communicates with an IBM 327X control unit, emulating a host computer.
- Port 3 is not used.
- Port 4 communicates with an IBM 3101 terminal, emulating an IBM 3278 terminal.

Source code (written in PLM/86, running under the iRMX 86 operating system) for a job that communicates with the iSBC 544.

Ideal for a system like the new Intel 86/330, also a saver for anyone planning on developing their own 3270 bysync communication.

Source Code supplied on 8" single density diskettes or printout ...\$500

DATA RETRIEVAL CORPORATION OF AMERICA  
5600 W. Brown Deer Rd. • Milwaukee, WI 53223  
414-355-5900

**Listing 1:** Program that emulates the operation of the Omni Aviation Navigation System. Using a Cartesian-coordinate space to calculate the relative positions of two specified points in that space (an aircraft and a VOR station), the program determines the radial of the first point relative to the second. Note that the variable O is used for user input of the Omni Bearing Selector setting.

```
10 REM THIS IS A PROGRAM TO EMULATE AN OMNI NAVIGATION SYSTEM
20 REM
30 REM OMNI1 01/17/80
40 REM
50 GO TO 1430
60 REM *** SUBROUTINE 1 ***
70 REM GET CO-ORDINATES OF OMNI STATION
80 PRINT "INPUT X CO-ORDINATE OF STATION";
90 GOSUB 660
100 XO=N
110 PRINT "INPUT Y CO-ORDINATE OF STATION";
120 GOSUB 660
130 YO=99-N
140 PRINT "INPUT X CO-ORDINATE OF AIRCRAFT";
150 GOSUB 660
160 X1=N
170 PRINT "INPUT Y CO-ORDINATE OF AIRCRAFT";
180 GOSUB 660
190 Y1=99-N
200 REM REDUCE ORIGIN TO 0 AND DETERMINE QUADRANT
210 X2=X1-X0
```

## HOW DO YOU KEEP TRACK OF YOUR SPECIAL PEOPLE?

(customers, suppliers, members, employees, associates, etc.)

## EASY - WITH NAMOR™

The new full feature mail/telephone list program.

- ★ 100% menu driven
- ★ Generates, deletes, merges lists
- ★ Searches, sorts, modifies entries
- ★ Prints 1" label or special list format
- ★ Fast entry lookup, easy update

**Introductory Offer, \$100 (\$150 after Sept. 30, 1982)**

SYSTEM REQUIREMENTS: CP/M®, 56K, terminal with addressable cursor & 80 char. x 24 line screen, single or dual disk, 8" IBM or 5¼" North Star.

CP/M is a registered trademark of Digital Research. NAMOR is a trademark of SHAPE, Inc.

DETAILED INFORMATION AVAILABLE



**SHAPE, INCORPORATED**  
P. O. BOX 29882  
SAN ANTONIO, TEXAS 78229

### How to buy a screen editor for your IBM Personal Computer:

1. Find one of CompuView's full-page ads for VEDIT.
2. See if VEDIT can:
  - Simultaneously edit multiple files.
  - Split the screen into as many as 4 windows—horizontally, vertically or both.
  - Scroll each window up-and-down and side-to-side.
  - Move and copy text within and between windows.
  - Globally search or replace using regular expression pattern matching.
  - Give you online help when you need it, at the touch of a button.
- (EDIX, the world's finest microcomputer text editor, can do all of this and more!)
3. Send \$195 to us (instead of to them).
4. We'll send EDIX to you.

EDIX requires an IBM Personal Computer with 64K and one floppy. Call or write for our detailed brochure.



**Emerging Technology Consultants, Inc.**  
Box 154 Louisville, CO 80027  
(303) 447-9495

EDIX is a trademark of Emerging Technology Consultants, Inc.



Listing 1 continued:

```

220 Y2=Y1-Y0
230 REM CHECK FOR SPECIAL ZERO CASE
240 IF X2<>0 THEN 290
250 IF Y2>0 THEN R=0
260 IF Y2<0 THEN R=180
270 IF Y2=0 THEN R=0
280 GO TO 630
290 IF Y2<>0 THEN 340
300 IF X2>0 THEN R=90
310 IF X2<0 THEN R=270
320 IF X2=0 THEN R=0
330 GO TO 630
340 REM FIGURE QUADRANT
350 IF X2>0 THEN 430
360 IF Y2>0 THEN 400
370 REM BOTH X & Y NEGATIVE
380 Q=3
390 GO TO 490
400 REM X NEG, Y POS
410 Q=2
420 GO TO 490
430 IF Y2>0 THEN 470
440 REM X POS, Y NEG
450 Q=4
460 GO TO 490
470 REM X POS, Y POS
480 Q=1
490 REM COMPUTE PRIMARY ANGLE USING ABSOLUTE X&Y
500 REM ANGLE=ARCTAN OF OPPOSITE/ADJACENT
510 REM CONVERT TO DEGREES RADJANS*180/PI
520 P=ATN((ABS(Y2)/ABS(X2)))*180/PI
530 ON Q GO TO 540,570,590,610
540 REM COMPUTE RADIAL
550 R=90-P
560 GO TO 630
570 R=270+P
580 GO TO 630
590 R=270-P
600 GO TO 630
610 R=90+P
620 GO TO 630
630 PRINT " THE RADIAL WE ARE ON IS";
640 PRINT R
650 RETURN
660 REM *** SUBROUTINE 2 ***
670 INPUT N
680 IF N>99 THEN 670
690 IF N<0 THEN 670
700 RETURN
710 REM *** SUBROUTINE 3 ***
720 REM GET OBS SETTING
730 PRINT "INPUT THE OBS SETTING"
740 INPUT O
750 IF O<0 THEN 730
760 IF O>360 THEN 730
770 RETURN
780 REM *** SUBROUTINE 4 ***
790 REM REDUCE RADIAL R TO STANDARD CIRCLE(OBS=0)
800 R=R-O
810 IF R<0 THEN R=R+360
820 REM SET TO/FROM FLAG F
830 REM 1=OFF, 2=TO, 3=FROM
840 IF X2<>0 THEN 890
    
```

Listing 1 continued on page 474



**AMERICAN** Small  
Business  
**COMPUTERS**  
118 S. MILL ST. PRYOR, OK. 74761

ALL PRICES ARE CASH DISCOUNTED  
3% C.O.D. AND CHARGE ORDERS  
ARE 3% MORE. DEALER INQUIRIES  
INVITED.

**DON'T PAY MORE !!!**

**TRS-80 MODEL III**

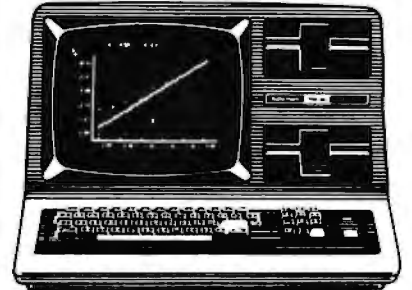

16K.....	\$825
48K.....	\$849
48K 1-DRIVE.....	\$1499
48K 2-DRIVE.....	\$1749

**TRS-80  
DISK DRIVES**

MODEL I  
TEAC or TANDON.....\$250

MODEL III  
DRIVE 0.....\$595  
DRIVE 1.....\$239  
DRIVE 2, 3.....\$250

COLOR COMPUTER  
DRIVE 0.....\$499  
DRIVE 1, 2, 3.....\$250

**EPSON PRINTERS**

ALMOST EVERYONE WHO CALLS ABOUT EPSON PRICES BUYS A PRINTER. THERE ARE TWO REASONS FOR THIS: 1. WE USUALLY HAVE THE LOWEST PRICE IN THE COUNTRY. 2. WE ALMOST ALWAYS HAVE THE PRINTER THEY NEED IN STOCK. SO...CALL US TODAY!

**AW...WHAT THE HECK**

RAM Memory Chips for the TRS-80 Apple

It is the policy of American Business Computers to offer merchandise at the lowest price possible. Several months back, we began selling RAM Memory Chips for the TRS-80 for \$45.00 per set. Someone else sold chips for \$44.00. We sold them for \$37.95. So we say "AW...WHAT THE HECK!" Let's see the other guys beat this price.

These chips are brand new "4116's". These 200 nano-second chips are fully compatible with all TRS-80 products. Instructions for insertion are included, however, the dip mounts required for converting a 4K Model I to a 16K Model I are not included at this low price.

\$16.95	PER
	16K
	SET

COLOR COMPUTERS	
4K LEVEL I.....	\$318
16K LEVEL I.....	\$335
16K EXT. BASIC.....	\$435
32K EXT. BASIC.....	\$520
MODEL II.....	\$3287
MODEL 16 1-DRIVE.....	\$4495
MODEL 16 2-DRIVE.....	\$5218

OKIDATA MICROLINE 80.....	\$399
82A.....	\$489
83A.....	\$719
84.....	\$1250
C. ITOH F10-40.....	\$1450
C. ITOH F10-55.....	\$1750
C. ITOH PROWRITER.....	\$499

PACKET MAN FOR  
COLOR COMPUTER.....\$24.95

**918-825-4844**

You can  
count on—

# MICRO Express

## apple computer

Hayes Micromodem II.....	\$ 289
Z80 Card.....	\$ 259
16K RAM Card.....	\$ 99
ThunderClock.....	\$ 105
Videx 80 Col. Card.....	\$ 265
Station II.....	\$ 105
LOBO Drive.....	\$ 389

## SOFTWARE

Visicalc.....	\$ 199
Visifile.....	\$ 215
Visidex.....	\$ 199
Visiplot.....	\$ 175
Visitrend.....	\$ 245
Desktop Plan II.....	\$ 199
BPI Accounting.....	\$ 299
Wordstar.....	\$ 269
DB Master.....	\$ 159
Easywriter.....	\$ 129
Datadex.....	\$ 135

## ATARI

Atari 800, 16K.....	\$ 679
Atari 400, 16K.....	\$ 329
Other Atari products.....	CALL

## NEC

PC-8001 A Computer.....	\$ 799
PC-8012 A I/O.....	\$ 495
PC-8031 A Disk Drives.....	\$ 799

## • MONITORS •

Zenith, Green.....	\$ 115
NEC, Green.....	\$ 175
NEC, Color.....	\$ 349
AMDEK, RGB Color.....	\$ 750

## • PRINTERS •

MX 80.....	\$ 450
MX 100.....	\$ 750
NEC 8023.....	\$ 525
Diablo 630.....	\$2299

## • CORVUS •

5 MB Hard Disk.....	\$2595
10 MB Hard Disk.....	\$4845
20 MB Hard Disk.....	\$5245

## TCS ACCOUNTING

### SOFTWARE

GL, AR, AP, Payroll 8", CP/M.....	\$69EA
ALL 4.....	\$ 235
Inventory, 8" CP/M.....	\$ 199

## TOP QUALITY

## ATHANA DISKETTES

5" SS/SD.....	\$2.15
5" SS/DD.....	\$2.30
5" DS/DD.....	\$ 2.99
5" DS/SD.....	\$ 2.50
8" SS/SD.....	\$ 3.19
8" SS/DD.....	\$ 3.30
8" DS/DD.....	\$ 3.30

Hard pack & bulk available. 100% Guaranteed!

Dealer Inquiries Invited

Price includes 3% cash, prepaid discount. Money Orders or Cashier Checks. Personal checks allow 3 weeks to clear. We accept VISA & Master Charge. NO COD. Prices subject to change. Add 3% shipping. Min \$3.00. Large items shipped freight collect. Calif. residents add 6% sales tax. FREE DELIVERY ON PREPAID ORDERS.

MAIL ORDER  
SALES

# MICRO Express

P.O. Box 21418  
San Jose, CA 95151-1418

408-274-1217

Listing 1 continued:

```

850 IF Y2<>0 THEN 890
860 F=1
870 REM FLAG IS OFF DIRECTLY OVER STATION
880 RETURN
890 IF R<>90 THEN 920
900 F=1
910 RETURN
920 IF R<>270 THEN 950
930 F=1
940 RETURN
950 IF R<>0 THEN 980
960 F=3
970 RETURN
980 IF R<>180 THEN 1010
990 F=2
1000 RETURN
1010 IF R<90 THEN 1050
1020 IF R>270 THEN 1050
1030 F=2
1040 RETURN
1050 F=3
1060 RETURN
1070 REM *** SUBROUTINE 5 ***
1080 REM FIGURE LEFT/RIGHT NEEDLE N
1090 REM ON A SCALE OF 0 TO 10
1100 REM WITH 0=LEFT, 5=CENTER, 10=RIGHT
1110 IF R<>0 THEN 1140
1120 N=5
1130 RETURN
1140 IF R<>180 THEN 1170
1150 N=5
1160 RETURN
1170 IF R>180 THEN 1260
1180 REM PROCESS LEFT NEEDLE
1190 IF R>90 THEN 1230
1200 IF R>10 THEN R=10
1210 N=(10-R)/2
1220 RETURN
1230 IF R<170 THEN R=170
1240 N=5-((180-R)/2)
1250 RETURN
1260 IF R<350 THEN 1290
1270 N=((360-R)/2)+5
1280 RETURN
1290 IF R>190 THEN R=190
1300 N=((R-180)/2)+5
1310 RETURN
1320 REM *** SUBROUTINE 6 ***
1330 ON F GO TO 1340,1360,1380
1340 PRINT "OFF"
1350 GO TO 1390
1360 PRINT "TO"
1370 GO TO 1390
1380 PRINT "FROM"
1390 PRINT "!!!!!!0!!!!!!"
1400 PRINT TAB(N); "*"
1410 RETURN
1420 REM *** MAIN PROGRAM ***
1430 GOSUB 60
1440 GOSUB 710
1450 GOSUB 780
1460 GOSUB 1070
1470 GOSUB 1320

```

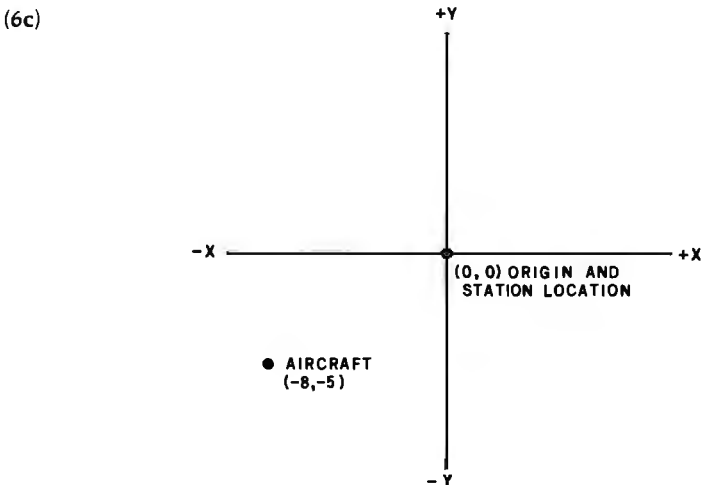
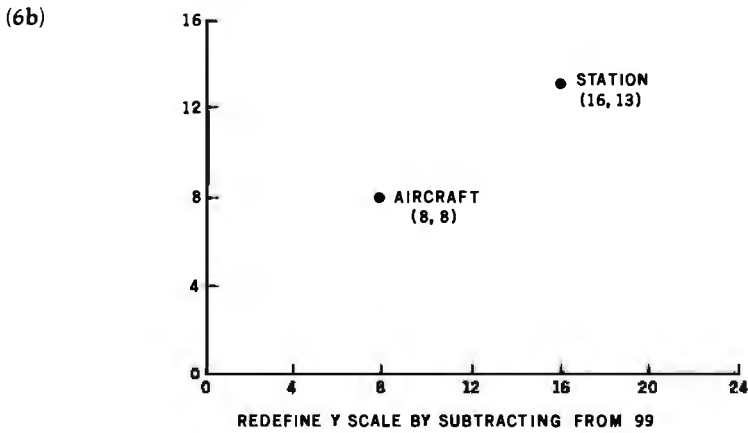
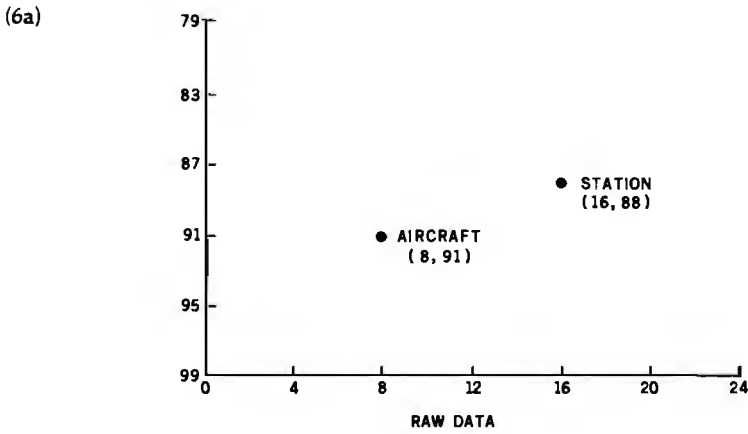

CONVERT TO CARTESIAN CO-ORDINATES BY SUBTRACTING STATION CO-ORDINATES FROM AIRCRAFT'S

Figure 6: Procedure followed by the program in listing 1 to transform the coordinate information into a form from which the actual radial may be calculated. 6a gives the raw data as displayed on a computer screen. In 6b the y coordinates have been converted to a normal scale by subtracting their values from 99. Finally, the space is converted to a standard Cartesian space with the VOR station at the origin by subtracting the station coordinates from the aircraft's position.

# INDUCTIVE COUPLED MODEM

Eliminates noise, vibration problems. Originate/Answer. Bell 103. Cassette port saves data.



**\$129.95** Money back if not delighted

**MFJ-1230 INDUCTIVE COUPLED MODEM.** eliminates room noise, vibration caused by acoustic coupling. Gives more reliable data transfer. Used like acoustic modem. 0-300 Baud. Bell 103 compatible. Originate/answer. Half/full duplex. RS-232. TTL. CMOS compatible. Use any computer. Cassette tape ports save data. 110 VAC or 9 V batteries. Crystal controlled. Carrier detect, power LEDs. 9x1 1/2x4". **MFJ-1231, \$39.95.** Optional cable, software for Apple II, II Plus. Plugs into game port. No serial board needed.

**\$99.95** **MFJ-1108 AC POWER CENTER.** Adds convenience, prevents data loss, head bounce, equipment damage. Relay latches power off during power



transients. Multi filters isolate equipment, eliminate interaction, noise, hash. Varistors suppress spikes. 3 isolated, switched socket pairs. One unswitched for clock, etc. Lighted power, reset switch. Pop-out fuse. 3 wire, 6 ft. cord. 15 A/125 V, 1875 watts. Aluminum case. Black. 18x2 3/4 x2 in. **MFJ-1107, \$79.95.** Like 1108 less relay. 8 sockets. 2 unswitched. Other models available.



It's like having an extra port **\$79.95**

**MFJ-1240 RS-232 TRANSFER SWITCH.** Switches computer between 2 peripherals (printer, terminal, modem, etc.). Like having extra port. Push button switches 10 lines (pins 2,3,4,5,6,8,11,15,17,20). Change plug or cable to substitute other lines. Push button reverses transmit-receive lines. LEDs monitor pins 2,3,4,5,6,8,20. PC board eliminates wiring, crosstalk, line interference. 3 RS-232 25 pin connectors. 7x2x6 in.

Order from MFJ and try it. If not delighted, return within 30 days for refund (less shipping). One year unconditional guarantee.

Order yours today. Call toll free 800-647-1800. Charge VISA, MC. Or mail check, money order. Add \$4.00 each for shipping and handling.

**CALL TOLL FREE ... 800-647-1800**

Call 601 323-5869 for technical information, or der/repair status. Also call 601 323 5869 outside continental USA and in Mississippi.

**MFJ ENTERPRISES, INCORPORATED**

921 Louisville Road, Starkville, MS 39759



# Verbatim flexible disks

Call Free (800) 235-4137 for prices and information. Dealer inquiries invited. C.O.D. and charge cards accepted.

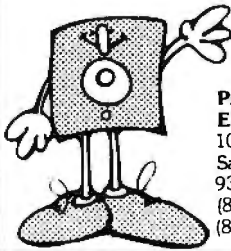

VISA

**PACIFIC EXCHANGES**  
100 Foothill Blvd.  
San Luis Obispo, CA  
93401. In Cal. call  
(800) 592-5935 or  
(805) 543-1037.

Circle 353 on Inquiry card.

## PROFESSIONAL COMPUTER CASSETTES

TRS-80\* - APPLE - COMMODORE-ATARI  
Instant Play Sliding Lock Out Doors



**Micro-comp Cassettes**  
Maxell Computer tape Head Cleaner to keep your recorder at peak performance  
CERTIFIED AT 1600 FCI ONE YEAR WARRANTY  
List price Micro-comp starting at \$3.95-Head Cleaner \$3.95

**SPECIAL INTRODUCTORY OFFER!**

MICRO-COMP MODEL	UNIT PRICE	10 PACK
C-10 (50 feet)	\$2.95 <input type="checkbox"/>	\$20.00 <input type="checkbox"/>
C-20 (TRS-80*) (100 feet)	3.15 <input type="checkbox"/>	22.00 <input type="checkbox"/>
C-30 (150 feet)	3.35 <input type="checkbox"/>	24.00 <input type="checkbox"/>
C-60 (300 feet)	3.55 <input type="checkbox"/>	26.00 <input type="checkbox"/>
Head Cleaner	2.95 <input type="checkbox"/>	20.00 <input type="checkbox"/>

\*TRS-80-trademark of the Tandy Corp.  
 CHECK  MASTER CHARGE  VISA

Minimum order for credit cards \$10.00

Card Account No. \_\_\_\_\_ Expiration Date \_\_\_\_\_

Name \_\_\_\_\_

Address \_\_\_\_\_

City \_\_\_\_\_ State \_\_\_\_\_ Zip \_\_\_\_\_

Mail to P.O. Box 806, Shelton, CT 06484 (203) 735-6477

Dealer's Inquiries Welcomed

Circle 279 on Inquiry card.

YOU'VE JUST  
FOUND



## THE MISSING LINK!

Computer Shopper is your link to individuals who buy, sell and trade computer equipment and software among themselves nationwide. No other magazine fills this void in the marketplace chain.

Thousands of cost-conscious computer enthusiasts use Computer Shopper every month through hundreds of classified ads. And new equipment advertisers offer some of the lowest prices in the nation.

Subscribe to Computer Shopper with a **6 month trial for only \$6.** MasterCard or VISA call **TOLL FREE 800-327-9920**

**COMPUTER SHOPPER**  
P.O. Box F307 • Titusville, FL 32780  
305-269-3211

Circle 116 on inquiry card.

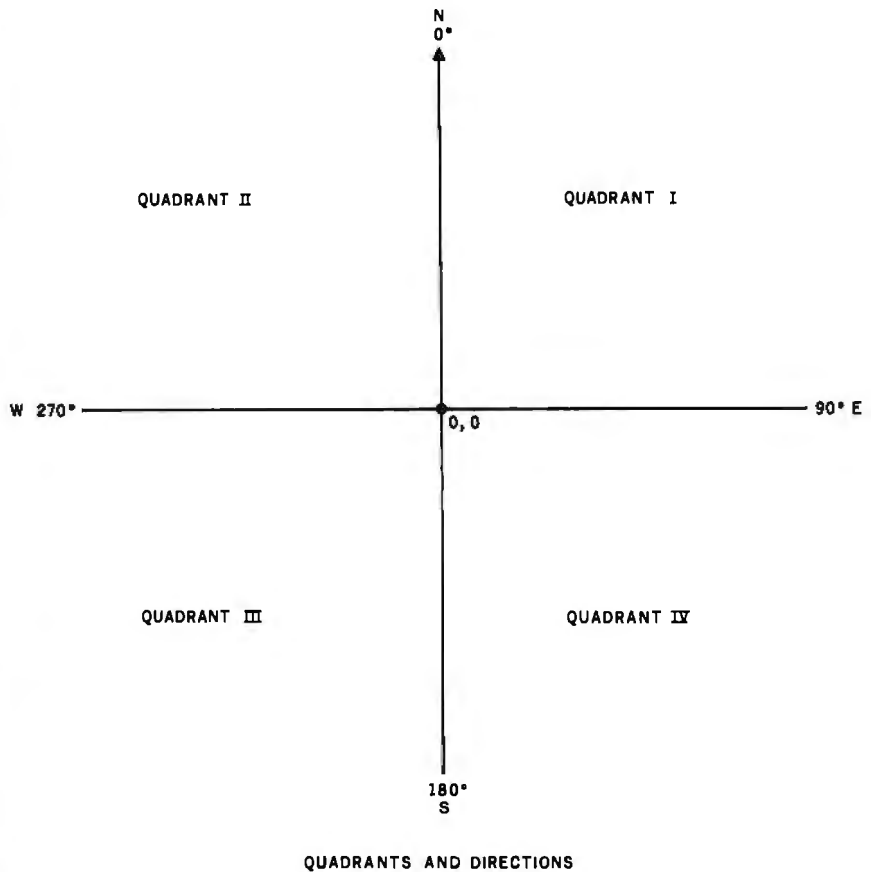

Figure 7: Standard Cartesian coordinate space as used with the Omni system.

put is not less than 0 or greater than 99. The program will simply request another number if an out-of-range response is given. Since the  $y$  coordinate is upside-down compared to a normal system, the  $y$  input is subtracted from 99 to compensate. Next, subtract the station's  $x$  coordinate ( $X_0$ ) from the airplane's  $x$  ( $X_1$ ) and the station's  $y$  ( $Y_1$ ). This operation adjusts the whole coordinate system to a standard four-quadrant Cartesian plane, with the station at the origin (figure 6). Notice that the relationship between the airplane and the station does not change during the transformations. Only the labels of the points' positions change.  $X_2$  and  $Y_2$  now define the aircraft location.

A Cartesian coordinate system is divided into four quadrants. In this program, the dividing lines between the quadrants are considered the four cardinal compass points (see figure 7). To determine which radial you are on, you must know the quadrant of your location. Before finding the quadrant, however, you must test for the special case of being on one of the

cardinal lines. You can accomplish this by testing for  $x$  or  $y$  equal to 0. If  $x$  is 0 and  $y$  is positive, you are on the  $0^\circ$  radial. If  $x$  is 0 and  $y$  is negative, you are on the  $180^\circ$  radial; if  $y$  is 0 and  $x$  is positive, the  $90^\circ$  radial; and if  $y$  is 0 and  $x$  is negative, the  $270^\circ$  radial. If both are 0, you are directly over the station. If you are indeed on a cardinal radial, you can print which radial it is and exit subroutine 1.

If you are not on a cardinal radial, use the following test to determine your quadrant ( $Q$ ). Both  $x$  and  $y$  positive means quadrant 1;  $x$  and  $y$  both negative means quadrant 3,  $x$  positive and  $y$  negative means quadrant 4; and  $x$  negative,  $y$  positive means quadrant 2. After this test,  $Q$  equals 1, 2, 3, or 4, and this number is used to perform an  $n$ -way branch to compute the final radial. The next step toward your radial is finding the primary angle using the absolute values of  $x$  and  $y$  (now labeled  $X_2$ ,  $Y_2$ ). This primary angle, labeled  $P$ , is computed with the formula:

$$P = \frac{\arctan(\text{opposite side})}{\text{adjacent side}}$$

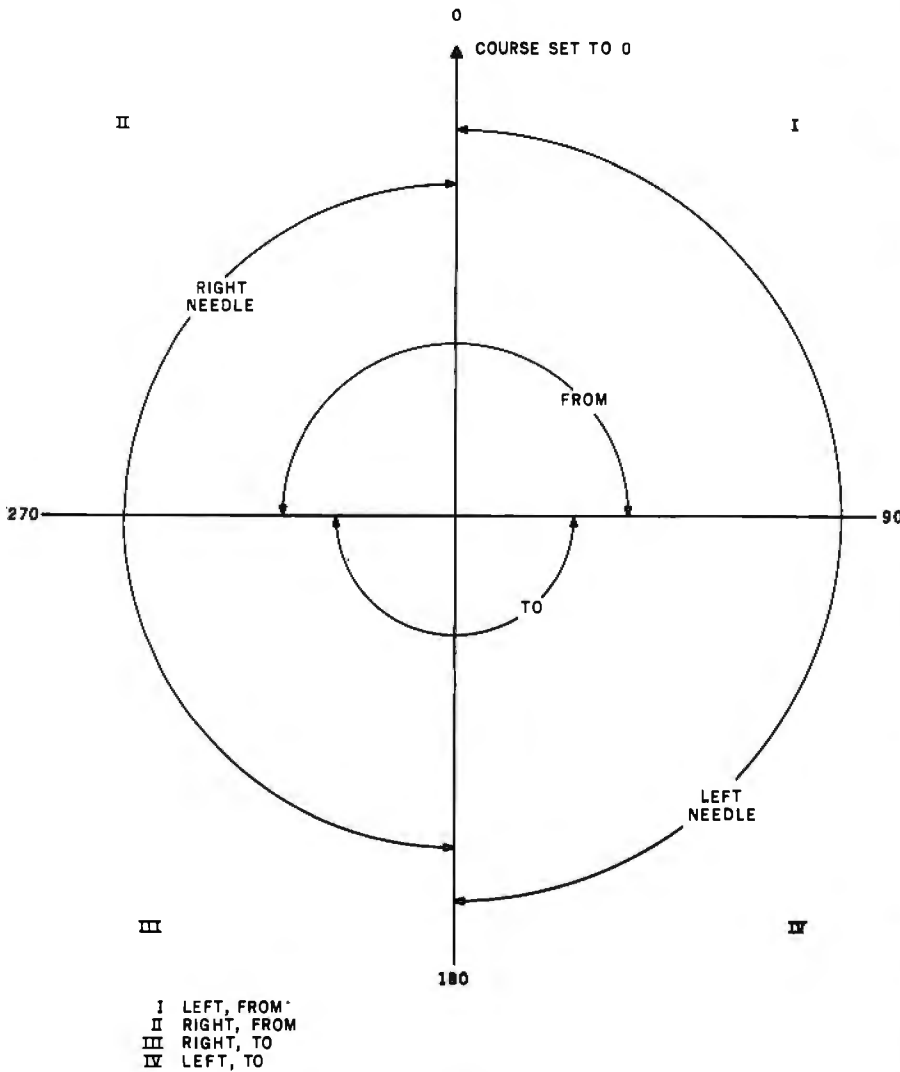

CDI AND TO/FROM DETERMINATION USING STANDARD CIRCLE

**Figure 8:** Cartesian representation of the interaction of the Course Deviation Indicator and the To/From Indicator used to determine the heading of an aircraft relative to a given VOR radial, in this case 0.

Because my computer, a Digital Equipment Corporation PDP-11/45, thinks in radians, I convert to degrees by multiplying by 180 and dividing by  $\pi$ . The final BASIC equation looks like this:

$$P = \text{ATN}(\text{ABS}(Y2)/\text{ABS}(X2))) \times 180/\text{PI}$$

With the primary angle computed, we can do our branch on Q and find the final radial (R). If Q is 1, R equals  $90 - P$ . If Q is 2, R equals  $270 + P$ . For a Q of 3, R is  $270 - P$ , and for a Q of 4, R equals  $90 + P$ . The last step of subroutine 1 is to print out the radial computed.

Now that the program knows the

radial of the airplane's location, you can compare that to the selected course, generate the CDI position, and compute the To/From flag reading. Subroutine 3 gets the ball rolling by requesting the OBS setting (O), which must be between 0 and 360 if you don't want the program to reprompt for input.

The CDI and To/From displays would be easier to understand if they were based on a standard circle with the OBS set to 0 (see figure 8). Subroutine 4 adjusts the current radial to standard form by rotating R the same number of degrees needed to set the OBS to 0. If R goes negative, it's added to 360 to keep the value positive. The To/From flag (F) can now be set to 1 for Off, 2 for To, or 3



# GOTCHA COVERED

If you're looking for computer terminal desks and work stations, CF&A has "gotcha covered". Not with just a desk or two, but with a full line of modular, integrated computer furniture. From our 24" x 26" Classic Series terminal stand to our 72" x 32" DR Series console with left or right-mounted twin RETMA enclosures...and everything in between. Like Microshelves, Datashelves, Apple or IBM desks, printer stands, media stands, turntables, returns, drawers, doors, color selections...the list goes on and on. You also get durable construction, competitive prices, quick delivery, and friendly service. Call or write for more information. We're the straight shooters. We're Computer Furniture and Accessories. We've "gotcha covered".

## CF&A

**Computer Furniture and Accessories, Inc.**  
515 West 132nd Street  
Gardena, CA 90248  
(213) 327-7710

for From. X2 and Y2 are checked to see if they both equal 0. If so, the plane is directly over the station, and the flag is set to Off. If they don't equal 0, you compute To or From. According to the standard circle, a radial from 271 to 89 is a From, while a radial from 91 to 269 is a To. Radials of 90 and 270 both rate an Off, since the plane is directly abeam the station. Subroutine 4 follows these rules and returns with F set appropriately.

Your last major task is to determine a needle value (N) to figure out the position of the CDI. A needle value of 0 is full left, 5 is center, and 10 is full right. Using a tab statement, the needle position will control the position of an asterisk which will appear under a scale marked at 2° intervals. The positions correspond to CDI needle position on a real VOR indicator.

Subroutine 5 does the chore of deciding the value of N. First it checks for a radial of 0° or 180°, either of which would center the needle and set

N equal to 5. Next, the subroutine decides if it's a left or right needle by seeing in which half of the standard circle the radial falls. Once this is checked, you must look for a difference of more than 10° between the radial and the 0°-to-180° line. If the difference exceeds 10°, the needle makes a full-scale deflection, setting N to either 0 or 10, depending on direction. With N computed, subroutine 6 prints the proper To/From flag value and the course deviation indication. This marks the end of the program.

### Modifications

This program lends itself very well to a computer with a graphic display, such as the Apple II. The high-resolution graphics mode can be used to show the simulation space, and you could write a routine using the game paddles to position the airplane in the space. One paddle button would mark the station location, and the other could cause the OBS setting to automatically increment. The

To/From flag and CDI could also be animated with graphics, and the program could run continuously. As the airplane moves around the station, the VOR indicator would give the same indications it would provide under actual flying conditions. You could also add another station for practicing such navigation problems as identifying airway intersections.

### Conclusion

Would-be pilots can familiarize themselves with the basics of VOR operation by running this simulation of the Omni navigation system. You can make the program more realistic by adding a second VOR station as suggested. Although this simulator provides invaluable experience for pilot trainees, it can become an entertaining and informative game for nonpilots with the addition of improved graphics and an operational theme. Simulation is an exciting computer application that combines the serious, the technical, and the enjoyable. ■

## In Less Than 3 Minutes

Your IBM Model 50, 60, or 75  
Electronic Typewriter  
can be an RS232C PRINTER or TERMINAL



CALIFORNIA MICRO COMPUTER Models 5060 and 5061 can be installed easily and require NO modifications to the typewriter.

For additional information contact:

CALIFORNIA MICRO COMPUTER  
9323 Warbler Ave., Fountain Valley, CA.  
92708 (714) 968-0890

## SUPERBRAIN™ 5 MB Plus (K System Five)

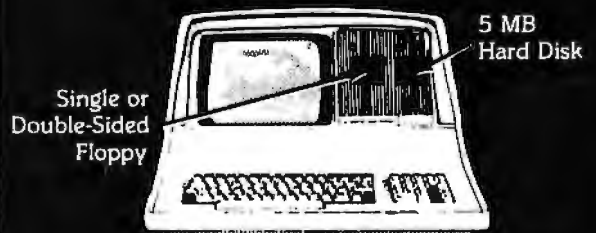

Now available INTERTEC'S amazing SUPERBRAIN with a built-in 5MB Hard Disk Storage. The K SYSTEM FIVE looks and operates like a normal SUPERBRAIN but with the advantage of 5 MB of hard disk storage and hard disk speed that are immediately available to the operator.

Kramer Systems International, Inc. has successfully installed COMPUSTAR™ and SUPERBRAIN™ Systems worldwide.

Dealer and International inquiries invited.  
Available on the GSA schedule.



Kramer Systems International, Inc.  
8403 Dixon Avenue  
Silver Spring, Maryland 20910  
(301) 585-7480

Call today for additional information



# Clubs and Newsletters

## Independent Group for the IBM Computer

IPCO is an independent group representing IBM Personal Computer users and owners. Its goal is to open communications between owners and users, and the *IPCO Info* newsletter is one means of attaining this goal. *IPCO Info* contains evaluations of hardware and software, articles with programming hints, and information requested by its readers. The group plans to establish a software exchange of owner-developed software. For more information, contact IPCO Inc., POB 10426, Pittsburgh, PA 15234.

## Hobbyists Meet In Denver

The Denver Amateur Computer Society (DACS) meets on the third Wednesday of each month at the Educational Plaza, 7350 North Broadway, North Denver, Colorado. Meeting time is 7 p.m. Meetings are made up of workshops or tutorial sessions, business, and formal presentations or demonstrations. The club produces a newsletter, *Interupt*, which is packed with notes from special-interest groups, news of other clubs' activities, and tutorials. Annual dues are \$12. This broad-interest group can be contacted at POB 1235, Englewood, CO 80150.

## ACS

The Atlanta Computer Society's (ACS's) monthly publication, *The ACS Newsletter*, is filled with tips on better programming, news of club activities, and product

reviews. The ACS members have established a number of active special-interest groups, including ones for 8080/Z80, 6800 series, Apple, and Atari microcomputers as well as a robotics group. Other club interests are maintaining a program library and a CBBS (computerized bulletin-board system), which can be contacted by calling (404) 394-4220. Contact the ACS, POB 888771, Atlanta, GA 30356.

## IBM Group Forming

A users group for the IBM Personal Computer is being formed in the Anaheim area. For details, contact Bob Martynec, 2633 East La Palma, Apt. 8, Anaheim, CA 92806, (714) 776-9376.

## Atari Group In Orange County

The Atari Computer Association of Orange County meets on the third Tuesday of each month at the Allstate Savings and Loan in Westminster, California. The group produces a newsletter that has summaries of club meetings, tips on better Atari programming, and book reviews. For details, contact the Atari Computer Association of Orange County, Suite 150, 141 Westminster Mall, Westminster, CA 92683.

## Public-Domain Pascal Software

The Pascal/Z Users Group is a nonprofit organization that maintains a large body

of public-domain software. Most of the software is geared toward the Pascal user, but some software is available in source and COM files and Z80 assembly language. In single-sided single-density IBM soft-sectored format, the disks cost \$10, postage paid. Your purchase includes a commitment to reply by return mail. A list of available software can be obtained by sending the club a large, self-addressed envelope with two stamps. The group also produces the bimonthly *Pascal/Z Users Group Newsletter*, which is available for \$9 a year. The newsletter has information on Pascal-related products, industry news, and letters from readers. Contact the Pascal/Z Users Group, 7962 Center Parkway, Sacramento, CA 95823. ■



## I See a Byte Future

for the **NEC PC-8000 Series** with the **REN TEC WEDGE**

- ★ Emulates all features of the NEC PC-8012A I/O Unit
- ★ 32K RAM card included, expandable to 64K RAM = 96K of RAM
- ★ Two Atari™-type joystick ports
- ★ Attaches easily to the bottom of the PC-8000
  - ★ NEC PC-8001A S/I/O channel brought out to a DB 25 connector
  - ★ Built-in 3-voice synthesizer
  - ★ NEC PC-8012A bus structure is implemented

### REN TEC Peripherals for PC-8000

32K Memory Board . . . . . \$199

RS-232-C Interface Card . . . . . \$159

RGB to Composite Video/RF . . . \$149

(40 column only)

Speech Synthesizer . . . . . \$295

★ The REN TEC WEDGE . . . . \$595.

## plus: Olympia Letter-Quality Printer with REN TEC ES INTERFACE

FOR MOST MICROCOMPUTERS

- ★ Converts Olympia typewriter to letter-quality printer
- ★ Easy installation using existing ES100/101/105 cables
- ★ Accepts RS-232-C serial, Centronics parallel, and IEEE-488
- ★ Selectable auto. line feed

**\$295:**

\*Commodore slightly higher

Authorized Distributor for:  
NEC, Olympia, Sanyo, Eagle, Sharp, Konan

DEALER INQUIRIES WELCOME

## RENAISSANCE TECHNOLOGY CORPORATION

1070 A SHARY CIRCLE, CONCORD, CA 94518 • (415) 930-7707

# Books Received

*Apple BASIC: Data File Programming, A Self-Teaching Guide*, Leroy Finkel and Jerald R. Brown. New York: John Wiley & Sons, 1982; 303 pages, 15.5 by 23 cm, softcover, ISBN 0-471-09157-X, \$12.95.

*Applied Multidimensional Systems Theory*, N. K. Bose. New York: Van Nostrand Reinhold, 1982; 411 pages, 14.6 by 22.3 cm, hardcover, ISBN 0-442-27214-6, \$29.50.

*Business Data Processing*, 2nd edition, Barbara J. Burian and Stuart S. Fink. Englewood Cliffs, NJ: Prentice-Hall, 1982; 494 pages, 17.5 by 23.5 cm, hardcover, ISBN 0-13-094045-3, \$18.95.

*Computer Capacity, A Production Control Approach*, Melvin J. Strauss. New York: Van Nostrand Reinhold, 1981; 265 pages, 17.5 by 25.5 cm, hardcover, ISBN 0-442-26243-4, \$24.95.

*Computer Choices, Beware of Conspicuous Computing*, H. Dominic Covvey and Neil Harding McAlister. Reading, MA: Addison-Wesley, 1982; 225 pages, 14.6 by 22.3 cm, softcover, ISBN 0-201-10113-0, \$8.95.

*Digital Principles and Applications*, 3rd edition, Albert P. Malvino and Donald P. Leach. New York: Gregg/McGraw-Hill, 1981; 490 pages, 14.6 by 22.3 cm, hardcover, ISBN 0-07-039875-5, \$24.10.

*Interfacing Microcomputers to the Real World*, Murray Sargent III and Richard L. Shoemaker. Reading, MA: Addison-Wesley, 1981; 288 pages, 15.5 by 23 cm, softcover, ISBN 0-201-06879-6, \$14.95.

*Introduction to Microcomputer-Based Digital Systems*, James W. Gault and Russell L. Pimmel. New York: McGraw-Hill, 1982; 429 pages, 15.5 by 23 cm, hardcover, ISBN 0-07-023047-1, \$26.95.

*Local Networks*, W. R. Franta. Lexington, MA: Lexington Books, 1981; 481 pages, 15.5 by 22.5 cm, hardcover, ISBN 0-669-03779-6, \$39.95.

*Management by Multiple Objectives, A Modern Management Approach*, Sang M. Lee. Princeton, NJ: Petrocelli Books, 1981; 225 pages, 14.6 by 22.3 cm, hardcover, ISBN 0-89433-083-7, \$17.50.

*Microprocessor Applications Handbook*, David F. Stout. New York: McGraw-Hill, 1981; 464 pages, 15 by 23 cm, hardcover, ISBN 0-07-061798-8, \$35.

*Microprocessors for Measurement and Control*, David M. Auslander and Paul Sagues. Berkeley, CA: Osborne/McGraw-Hill, 1981; 310 pages, 18.3 by 23 cm, softcover, ISBN 0-931988-57-8, \$15.99.

*Microprogramming, Concepts and Techniques*, Ben E. Cline. Princeton, NJ: Petrocelli Books, 1981; 169 pages, 14.6 by 22.3 cm, hardcover, ISBN 0-89433-133-7, \$20.

*The Micro Revolution, Living with Computers*, Peter Laurie. New York: Universe Books, 1981; 225 pages, 13 by 20.5 cm, softcover, ISBN 0-87663-560-5, \$7.95.

*Pascal Program Development with Ten Instruction Pascal Subsets (Tips) and Standard Pascal*, Michael Kennedy and Martin B. Solomon. Englewood Cliffs, NJ: Prentice-Hall, 1982; 532 pages, 16.5 by 22.5 cm, softcover, ISBN 0-13-652735-3, \$17.95.

*PET/IBM BASIC*, Richard Haskell. Englewood Cliffs, NJ: Prentice-Hall, 1982; 154 pages, 20.6 by 27.3 cm, softcover, ISBN 0-13-661751-4, \$12.95.

*PET Games and Recreations*, Mac Oglesby, Len Lindsay, and Dorothy Kunkin. Reston, VA: Reston

Publishing, 1981; 245 pages, 14.6 by 22.3 cm, softcover, ISBN 0-8359-5529-X, \$9.95.

*Problem-Solving on the TRS-80 Pocket Computer, A Self-Teaching Guide*, Don Inman and Jim Conlan. New York: John Wiley & Sons, 1982; 255 pages, 18.3 by 23 cm, softcover, ISBN 0-471-09270-3, \$8.95.

*Programming Language Translation*, R. E. Berry. New York: Halsted Press, 1981; 175 pages, 14.6 by 22.3 cm, hardcover, ISBN 0-470-27305-4, \$41.95.

*Queuing Theory: A Problem-Solving Approach*, Leonard Gorney. Princeton, NJ: Petrocelli Books, 1981; 184 pages, 15 by 23 cm, hardcover, ISBN 0-89433-128-0, \$20.

*Real Time Programming-Neglected Topics*, Caxton C. Foster. Reading, MA: Addison-Wesley, 1981; 190 pages, 23 by 15.5 cm, softcover, ISBN 0-201-01937-X, \$9.95.

*Software Manual for the Elementary Functions*, William J. Cody Jr. and William Waite. Englewood Cliffs, NJ: Prentice-Hall, 1980; 269 pages, 15 by 23 cm, hardcover, ISBN 0-13-822064-6, \$17.95.

*Software Engineering Economics*, Barry W. Boehm. Englewood Cliffs, NJ: Prentice-Hall, 1981; 767 pages, 23.5 by 17.5 cm, hardcover, ISBN 0-13-822122-7, \$32.50.

*Structured BASIC Programming for Business*, 2nd edition, V. Thomas Dock. St. Paul, MN: West Publishing, 1982; 131 pages, 18 by 24 cm, softcover, ISBN 0-314-63167-4, \$11.95.

*Understanding Microprocessors*, B. S. Walker. New York: Halsted Press, 1982; 110 pages, 14.6 by 22.3 cm, softcover, ISBN 0-470-27286-4, \$12.95.

*The TRS-80 Means Business*, Ted G. Lewis. New

York: John Wiley & Sons, 1982; 194 pages, 15.5 by 23 cm, softcover, ISBN 0-471-08239-2, \$12.95.

*Understanding Computer Systems*, Harold W. Lawson Jr. Rockville, MD: Computer Science Press, 1981; 164 pages, 15.5 by 23 cm, softcover, ISBN 0-914894-31-5, \$9.95.

*Using Programmable Calculators for Business*, C. Louis Hohenstein. New York: John Wiley & Sons, 1982; 296 pages, 15.5 by 23 cm, softcover, ISBN 0-471-08551-0, \$10.95. ■

This is a list of books received at BYTE Publications during this past month. Although the list is not meant to be exhaustive, its purpose is to acquaint BYTE readers with recently published titles in computer science and related fields. We regret that we cannot review or comment on all the books we receive; instead, this list is meant to be a monthly acknowledgment of these books and the publishers who sent them.

## BYTE's Bugs

### Tree Searching Yields Bugs

In Gregg Williams's article, "Tree Searching" (see the September 1981 BYTE, page 76), he stated, "... it is clear that the shortest route is ADDB, with a distance (cost) of thirteen." My calculations arrive at ADCB as the shortest route with a cost of twelve.

Michael L. Steiner, M.D.  
Suite 100  
3044 Sunset Ave.,  
Rocky Mount, NC 27801 ■

# 1 Infinity

# 2 Einstein Universe

# 3 Nesting Tree

## Three in a series of t-shirts by Scott Kim

What happens when you mix computer graphics, letters and illusion?

Inversions.

Wear one and your next encounter may be the one that goes beyond words.

More than 60 original inver-

sions can be seen in the new book, **Inversions: A Catalog of Calligraphic Cartwheels** by Scott Kim. **Inversions** is available through your local bookstore or by calling Byte Books' toll-free number, 800/258-5420.

*"Scott Kim's Inversions... is one of the most astonishing and delightful books ever printed... Over the years Kim has developed the magical ability to take just about any word or short phrase and letter it in such a way that it exhibits some kind of striking geometrical symmetry."*

— **Martin Gardner**,  
Scientific American

### Infinity:

- white on black
- black on white

### Einstein Universe:

- black/violet on gray\*
- black/lt. blue on white

### Nesting Tree:

- reds/oranges on tan
- greens on navy



\*All shirts are 100% cotton except gray, which is 50% cotton, 50% polyester.

### 1 Infinity

- black on white  
\_\_xs\_\_s\_\_m\_\_l\_\_xl
- white on black  
\_\_xs\_\_s\_\_m\_\_l\_\_xl

### 2 Einstein Universe

- black/violet on gray  
\_\_xs\_\_s\_\_m\_\_l\_\_xl
- black/lt. blue on white  
\_\_xs\_\_s\_\_m\_\_l\_\_xl

### 3 Nesting Tree

- reds/oranges on tan  
\_\_xs\_\_s\_\_m\_\_l\_\_xl
- greens on navy  
\_\_xs\_\_s\_\_m\_\_l\_\_xl

name \_\_\_\_\_

address \_\_\_\_\_

city \_\_\_\_\_

state \_\_\_\_\_

zip \_\_\_\_\_

**All t-shirts \$8.75 each.**

Total number shirts x \$8.75

Calif. residents add  
6½% sales tax

Postage (\$1 per shirt)

Total enclosed \_\_\_\_\_

Check or money order only.  
Sorry, no C.O.D.

Dealer inquiries invited.

**LOOK TWICE™** Dept. B-6, P.O. Box 50697 Palo Alto, CA 94303



# Event Queue

## June 1982

June

**Cooperative Education Program**, various sites throughout the U.S. This series of more than 100 data-processing courses is presented by Q. E. D. Information Sciences Inc. Course topics include systems development, structured methodologies, database, telecommunications, management, and human relations. These two-to five-day courses are tailored for analysts, designers, programmers, managers, and other users. For additional details, contact the Manager of Education Programs, Q. E. D. Information Sciences Inc., Q. E. D. Plaza, POB 181, Wellesley, MA 02181, (800) 343-4848; in Massachusetts, (617) 237-5656.

June

**Courses and Seminars from Sira Institute**, various sites throughout England. Sira Institute is sponsoring seminars on a wide variety of subjects, ranging from microprocessor familiarization to design and development of microprocessor-based equipment. For details, contact Conferences & Courses Unit, Sira Institute Ltd., South Hill, Chislehurst, Kent BR7 5EH, England.

June

**Datamation Institute Seminars on Information Management**, various sites throughout the U.S. Databases and communications, systems performance, data-processing management, word processing, office automation, computer graphics, and topics of general interest are among the areas to be covered by these two-day seminars. Fees range from \$495 to \$595. For schedules of times and places, contact Karen Smolens, the Cen-

ter for Management Research, Datamation Institute Seminar Coordination Office, 850 Boylston St., Chestnut Hill, MA 02167, (617) 738-5020.

June

**Education and Training Seminars**, various sites throughout the U.S. and Europe. Among the seminar topics offered by STSC Inc. and APL+Plus International are "Nested Arrays," "Intermediate APL," and "Advanced APL Programming Techniques." For complete details on these and other seminars, contact the Seminar Administrator, STSC Inc., 11 Clearbrook Rd., Elmsford, NY 10523, (914) 347-5560. In Europe, contact APL+Plus International, Tour Neptune, Cedex N°20, 92086 Paris La Défense, France, Tel: 773.79.64.

June

**Intensive Two-day Seminars for Professional Development**, various sites throughout New England. Among the seminars to be offered by Worcester Polytechnic Institute are "Fundamentals of Data Processing," "Distributed Systems: The Architecture and Utilization of this Revolutionary Technology," and "Microprocessors: Hardware, Software, and Applications." Registration fees range from \$445 for a two-day program to \$990 for a seven-day executive institute. For complete details, contact Ms. Ginny Bazarian, Office of Continuing Education, Worcester Polytechnic Institute, Worcester, MA 01609, (617) 793-5517.

June

**Knowledge Engineering in the 1980s**, Chicago, IL. Expert Systems are computer programs that reason in tasks that require considerable human

expertise, such as locating computer malfunctions, monitoring intensive care patients, analyzing noisy signal data, and diagnosing medical problems. This one-day executive briefing provides an introduction to the potential benefits and costs of Expert Systems. For further information, contact Dina Barr, Teknowledge, 151 University Ave., Palo Alto, CA 94301, (415) 326-6827.

June

**The Master Method of Selling Small-Business Systems**, Westlake Village, CA. This one-day seminar is designed for mini- and microcomputer manufacturers and software vendors who sell small-business systems. The seminar fee is \$150. For details, contact Seminar Information, M. W. L. Inc., 32038 Watergate Court, Westlake Village, CA 91361, (213) 889-2607.

June

**National Computer Graphics Association Seminar Program**, various sites throughout the U.S. Topics include "Successful Business Graphics," "Business Graphics for Financial Analysis and Decision Making," and "Applications of Computer Graphics to Transportation Problems." Seminar fees are \$395 for association members and \$425 for nonmembers. For complete details, contact Eloise Wenker, NCGA Seminar, 2033 M St. NW, #300, Washington, DC 20036, (202) 466-4102.

June

**One- and Two-day Professional Development Seminars**, various sites in the greater Boston area. Among the courses being offered by Boston University are "Business Writing for Results," Im-

proving Customer Service," and "Assertive Management." Registration fees range from \$295 for a one-day program to \$445 for a two-day program. These seminars can be conducted within your company. For details, contact Ms. Joan Merrick, Center for Management Research, 850 Boylston St., Chestnut Hill, MA 02167, (617) 738-5020. For information on the in-company seminars, contact Ms. Elaine Dee at the same address.

June

**Productivity '82**, various sites throughout the U.S. and Canada. This two-day show features hands-on demonstrations of Hewlett-Packard's newest computer and application solutions ranging from personal and small-business computers to the top-of-the-line computer systems for office computing, distributed data processing, and factory automation. Sixteen different seminars are held each day on such topics as using personal computers, choosing financial and applications software, and preparing easy-to-read graphics. Additional information can be obtained from local Hewlett-Packard sales offices or from Rudanne Clark, Hewlett-Packard, 3000 Hanover St., Palo Alto, CA 94304, (415) 857-7247.

June

**Sensors & Systems '82**, various sites throughout the central and western regions of the U.S. This series of three-day conferences will cover all aspects of sensor technology from temperature sensors through to displacement, velocity, acceleration, magnetic field, and moisture. Other topics to be covered include signal conditioning, digital interfaces, and system interfaces. Contact Network Exhibitions, 785 Harriet Ave.,

Campbell, CA 95008, (408) 370-1661.

*June-July*

**Courses from Integrated Computer Systems**, various sites throughout the U.S. Among the courses being offered are "Microprocessor Software, Hardware, and Interfacing," "Hands-on Microprocessor Troubleshooting," "Speech Synthesis and Recognition," and "Digital Image Processing and Analysis." Complete course listings including dates, locations, course outlines, and fees are available from Integrated Computer Systems, 3304 Pico Blvd., POB 5339, Santa Monica, CA 90405, (800) 421-8166; in California, (800) 352-8251.

*June-July*

**Meetings, Seminars, and Programs from the Electronic Industries Association (EIA)**, various sites throughout the U.S. Among the events planned are the Government/Industry Executive Roundtable '82 and a symposium on "Telecommunications: Trends and Directions." Contact EIA, 2001 Eye St. NW, Washington, DC 20006, (202) 457-4981.

*June-July*

**Technical Classes from Zilog**, Campbell, CA. Zilog is offering a series of one- to five-day technical classes at its California-based training facility. Topics range from "Microprocessors: A General Introduction" to "Zeus/System 8000 User." Contact Zilog, Training and Education Dept., 1315 Dell Ave., Campbell, CA 95008, (408) 446-4666.

*June-July*

**New York University SEHNAP Summer Sessions**, New York University, New York, NY. Among the courses being offered by the School of

Education, Health, Nursing, and Arts Professions (SEHNAP) are "Computer Graphics for Instruction," "Microcomputer Technology I," and "New Technology for Interactive and Individualized Instruction." These graduate-level courses are designed for teachers, administrators, and other professionals. For more information, contact NYU-SEHNAP Summer Sessions, 60 Press Building, New York University, New York, NY 10003, (212) 598-2772.

*June-August*

**Database Concepts and Design**, various sites throughout the U.S. Sponsored by the American Management Associations (AMA), this five-day seminar is designed for data-processing managers, system designers, and other personnel involved in database activities. Topics include an overview of the database environment; evaluating and measuring performance, costs, and results; determining organizational needs and the systems and software to meet them; and implementing, integrating, and supporting the database within company plans and budget. Highlighting this seminar is a comprehensive review of database products. Individual fees are \$850 for AMA members and \$975 for nonmembers. Team discounts are available. Contact AMA, 135 West 50th St., New York, NY 10020, (212) 586-8100. To register by phone, call (212) 246-0800.

*June-August*

**Engineering Summer Conferences**, Chrysler Center for Continuing Engineering Education, North Campus, University of Michigan, Ann Arbor, MI. Among the conferences being offered are "Interactive Design with Computers," "Applied Numerical Methods," and "Robotics:

Concepts, Theory, and Applications." For complete details, contact Engineering Summer Conferences, 200 Chrysler Center, North Campus, University of Michigan, Ann Arbor, MI 48109, (313) 764-8490.

*June 9-11*

**The International Conference on Consumer Electronics (ICCE)**, Arlington Park Hilton, Arlington Heights, IL. The technical program will include papers and panel discussions on such topics as personal computing, computer-aided design techniques, home information systems, and videotex, teletext, videodisc, video-cassette recorders, and cameras. Exhibits will be featured. This conference is sponsored by the Consumer Electronics Group of the IEEE (Institute of Electrical and Electronics Engineers). Contact the IEEE, 445 Hoes Lane, Piscataway, NJ 08854.

*June 11-13*

**South Florida Microcomputer Conference and Exhibition**, Broward Community College, North Campus, Fort Lauderdale, FL. This show will feature low-cost seminars, a trade show, and a used-computer flea market. The focus will be on the use of computers in small businesses, education, science and engineering, and word processing, as well as on hobbyist and consumer concerns. For details, contact Tom Blayney, Emergent Inc., 9466 Saddlebrook Dr., Boca Raton, FL 33434, (305) 483-5248.

*June 13-16*

**The Fifteenth Annual Conference of the Association of Small Computer Users in Education**, Chatham College, Pittsburgh, PA. This conference will include papers and demonstrations on the educational and administrative uses

of computers. Other topics include robotics, Pascal programming, computer literacy, and the use of packaged software in computer courses. For more information, contact Jan Carver, Computer Center, Chatham College, Pittsburgh, PA 15232, (412) 441-8200.

*June 13-16*

**The 1982 American Society for Information Science (ASIS) Mid-Year Meeting**, University of Tennessee, Knoxville, TN. The theme for this conference is "Information—The Critical Difference." Among the topics to be explored are linking information to the user, information as a commodity, quality assurance in information, and attributing value to information. Speakers, panel sessions, and technical sessions sponsored by special-interest groups will highlight this conference. For more details, contact ASIS, 1010 Sixteenth St. NW, Washington, DC 20036, (202) 659-3644.

*June 13-17*

**NCGA '82, The Third Annual Conference and Exhibition of the National Computer Graphics Association (NCGA)**, Anaheim Convention Center, Anaheim, CA. This conference will feature more than 20 tutorials and 60 technical sessions. Computer graphics products will be exhibited. Presentations from business, government, and academic graphics experts will be featured. Contact the NCGA, Suite 330, 2033 M St. NW, Washington, DC 20036, (202) 466-5895.

*June 14-16*

**The Fifteenth Power Modulator Symposium**, Hyatt Regency Baltimore, Baltimore, MD. This symposium will focus on the technology, devices, and systems associated with rep-rated power

## JUNE SPECIALS

	LIST PRICE	OUR SPECIAL CASH PRICE
Shugart SA400 Double Density bare drive	350.00	199.00
IMC cabinet no P/S for 1 5/8" drive	39.00	29.00
for 2 5/8" drives	69.00	58.00
Mullen Extender Board w/probe kit - TB-4	59.00	47.00
Tarbell Double Density Disk Controller A&T	495.00	396.00
S-100's own 16K EPROM Board-holds 2716,2732, 2764 A&T	169.00	143.00
S-100 (Tarbell) cassette interface kit	125.00	106.00
Godbout Spectrum-graphics board A & T	399.00	279.00
Central Data Ram Card w/64K A & T	665.00	310.00

Subject to Available Quantities • Prices Quoted Include Cash Discounts. Shipping & Insurance Extra.

We carry all major lines such as Seattle, Cromemco, Ithaca Intersystems, North Star, Morrow Designs CCS, ECT, TEI, Godbout, SSM, Tarbell For a special cash price, telephone us.



## Model 953A EPROM PROGRAMMER

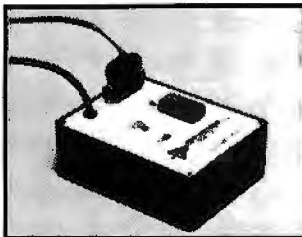

- Programs 2508, 2758, 2516, 2716, 2532 and 2732 five volt EPROMS.
- Complete - no personality modules to buy.
- Intelligent - microprocessor based, programs and verifies any or all bytes.
- RS-232 serial interface - use with computer or terminal.
- Verify erasure command - verifies that EPROM is erased.
- Extended diagnostics - error output distinguishes between a bad EPROM and one which needs erasing.
- May be used for extremely reliable data or program storage.
- All power on programming socket under processor control. LED warning light indicates when power is applied.
- Complete with Textool zero insertion force socket.
- High performance/cost ratio.
- Standard DB-25 I/O connector.

PRICE \$289



## Event Queue

modulators, including switches, auxiliary devices, energy storage, radio-frequency systems, and low-frequency generators. For details, contact Leonard Klein, Palisades Institute for Research Studies Inc., 201 Varick St., New York, NY 10014, (212) 620-3377.

June 14-16

**The Nineteenth Design Automation Conference**, Caesars Palace, Las Vegas, NV. This conference will focus on the computer-aided design of digital systems. Topics of interest include analog circuits, architectural and mechanical design and analysis, design verification, simulation, physical design and layout, documentation, testing, and databases. Other conference features include workshops and commercial exhibits. For further information, contact Bryan Preas, VR Information Systems, 5818 Balcones Dr., Austin, TX 78731.

June 15-17

**The 1982 IEEE MTT-S International Microwave Symposium**, Hyatt Regency Hotel, Dallas, TX. The theme of this symposium is "Thirty Years of Microwaves." Papers and tutorials on a wide range of topics, including computer-aided design and measurement techniques, microwave field and network theory, as well as satellite communications/microwave systems, will be presented. Contact J. R. Griffin, Texas Instruments Inc., Mail Stop 3432, POB 405, Lewisville, TX 75067, (214) 462-5693.

June 15-17

**The Office Automation Show/Conference**, Barbican Centre, London, England. For details on this show and conference, contact Clapp & Poliak International, 7315

Wisconsin Ave., Washington, DC 20014, (301) 657-3090.

June 15-18

**Electromagnetic Compatibility Workshop**, Washington, DC. For details on this course, contact Don White Consultants Inc., State Route 625, POB D, Gainesville, VA 22065, (703) 347-0030.

June 16-18

**The Twentieth Annual Meeting of the Association for Computational Linguistics**, University of Toronto, Toronto, Ontario, Canada. This meeting features papers on syntax, computational semantics, discourse analysis and speech acts, machine translation, as well as the mathematical and theoretical foundations of computational linguistics. For additional information, contact Don Walker, Artificial Intelligence Center, SRI International, Menlo Park, CA 94025, (415) 859-3071.

June 20-25

**DP Training Managers' Workshop**, Chicago, IL. This workshop is intended for individuals with less than 18 months' experience in coordinating data-processing training programs. Participants will learn to establish in-house education programs that will meet management objectives and ensure a high return on their organization's investment in training. The registration fee is \$850. Contact Linda Hubacek, Deltak Inc., 1220 Kensington Rd., Oak Brook, IL 60521, (312) 920-0700.

June 22-24

**Electromagnetic Interference Control and Noise Mitigation in Power and Telephone Systems**, Washington, DC. For details on this course, contact Don White Consultants Inc., State Route 625, POB D,



Gainesville, VA 22065, (703) 347-0030.

June 23-26

**Productivity 82**, Seattle University, Seattle, WA. This conference is sponsored by the Association for Computing Machinery (ACM) and the Canadian Information Processing Society (CIPS). Productivity 82 is designed to emphasize the use of computers to improve productivity in industry and in the office, as well as to improve productivity in the programming of computers. Papers and panel discussions will be featured. For more information, contact Productivity 82-ACM/CIPS, 10636 Main St. #276, Bellevue, WA 98004.

June 28-30

**COMDEX/Spring '82**, Atlantic City Convention Hall, Atlantic City, NJ. For details on this conference and exhibition, contact the Interface Group, 160 Speen St., POB 927, Framingham, MA 01701, (800) 225-4620; in Massachusetts, (617) 879-4502.

June 28-30

**National Educational Computing Conference (NECC-82)**, Radisson-Muehlebach Hotel, Kansas City, MO. This conference features papers, sessions, panel discussions, and exhibits of educational computing products. Among the topics to be addressed are "Computer Use in the Physical Sciences," "Computer Education for Teachers," and "Computer Science, Engineering, and Information Systems Education." For more information, contact E. Michael Staman, NECC-82 General Chairman, Computer Services, 305 Jesse Hall, University of Missouri-Columbia, Columbia, MO 65211.

## July 1982

July 6-9

**Peripheral Array Processors for Signal Processing and Simulation**, University of California, Los Angeles, CA. The fee for this course is \$795. For further details, contact Marc Rosenberg, University Extension, 6266 Boelter Hall, University of California-Los Angeles, Los Angeles, CA 90024, (213) 825-1047.

July 11-15

**The International Manufacturing Systems Conference '82**, Convention Center, Buffalo, NY. The conference theme is "The Technology of Productivity." More than 100 experts will conduct seminars on a wide variety of topics. Exhibits, vendor presentations, and plant tours are planned. Contact Roy Combs, International Manufacturing Systems Conference, 186 North Water St., Rochester, NY 14604, (716) 232-3950.

July 11-25

**The Twelfth Annual Summer Institute for Media Arts**, Endicott College, Beverly, MA. A wide variety of seminars and workshops will be offered, including computer animation, video production, and computer graphics. For more information, contact the Summer Institute for Media Arts, POB 83, Lincoln Center, MA 01773, (617) 259-0068.

July 13-14

**Controlling Electromagnetic Interference**, Hyatt Hotel at LA Airport, Los Angeles, CA. This seminar is sponsored by *Electronics* magazine, a McGraw-Hill publication, and is designed for electronics industry professionals who must

make technical or cost decisions based on an understanding of electromagnetic interference. Topics of discussion include intersystem problems, designing against environmental noise, how to determine the best frequency for a given application, and the structure and use of intrasystem electromagnetic compatibility models. The fee is \$595; in-plant programs can be arranged. Contact Ms. Barbara Bancroft, McGraw-Hill Seminar Center, Room 3112, 305 Madison Ave., New York, NY 10017, (212) 687-0243.

July 14-17

**Data Dictionaries**, Marina City Club, Los Angeles, CA. The fee for this course is \$750. For details, contact the Continuing Education Institute, Suite 1000, 10889 Wilshire Blvd., Los Angeles, CA 90024, (213) 824-9545.

July 18-22

**The Fourth General Assembly of the World Future Society**, Sheraton Washington Hotel, Washington, DC. The conference theme is "Communications and the Future." All areas of the communications field from telecommunications to interpersonal communication will be covered. The impact of new technologies on society will be explored. Contact the World Future Society, 4916 St. Elmo Ave., Bethesda, MD 20014, (301) 656-8274.

July 19-21

**Summer Computer Simulation Conference (SCSC)**, Marriott City Center Hotel, Denver, CO. The SCSC covers all aspects of computer simulation methodology and applications. Technical sessions and presentations on mathematical methods, model design, simulation languages,

and validation techniques will be featured. Information is available from Harvey Marks or Philicia Marks, Transaction Technology Inc., 7648 Capistrano Ave., Canoga Park, CA 91304, (213) 346-5376.

July 21-23

**The Computer: Extension of the Human Mind**, Eugene Hilton Hotel, Eugene, OR. This conference is sponsored by the University of Oregon College of Education. Workshops, speakers, and presentations on the use of computers in education will be held. Topics of interest include preparing teachers to teach with computers, the ethical and social issues associated with computers, and how computers assist learning. The conference fee is \$95; students enrolled in the university's summer session can register for \$55 and earn a single credit hour. For additional information, contact Judy Ohmer, College of Education, University of Oregon, Eugene, OR 97403, (503) 686-3405.

July 26-30

**SIGGRAPH '82: The Ninth Annual Conference on Computer Graphics and Interactive Techniques**, Boston, MA. This conference is sponsored by the Association for Computing Machinery's Special Interest Group on Computer Graphics (ACM SIGGRAPH). More than 140 exhibitors will display the latest in computer-graphics hardware, software, and services. A series of courses and technical sessions on a variety of topics, including device-independent graphics software, low-cost graphics, business graphics, solid modeling, and computer-aided design, will be offered. Other features include a multimedia computer-graphics art

## Event Queue

show and computer-generated films. For information, contact SIGGRAPH '82, Convention Services Dept., 111 East Wacker Dr., Chicago, IL 60601, (312) 644-6610.

July 27-30

**Database Systems: Comparison, Design, Applications, and Trends**, Marina Del Rey Hotel, Marina Del Rey, CA. For more information on this course, contact the Continuing Education Institute, Suite 1000, 10889 Wilshire Blvd., Los Angeles, CA 90024, (213) 824-9545.

### August 1982

August 15-19

**The Second International Computer Engineering Conference and Exhibition**, Sheraton Harbor Island Hotel, San Diego, CA. This conference is

sponsored by the Computer Engineering Division of the American Society of Mechanical Engineers (ASME). More than 50 exhibitors will display computer-engineering products, information, and services. The conference will feature technical sessions on more than 60 topics ranging from interactive graphics, personal computing by means of programmable calculators, computer-aided design and manufacturing, and robots. For complete details, contact the ASME, 345 East 47th St., New York, NY 10017, (212) 644-7100.

August 16-20

**The National Conference on Artificial Intelligence**, Carnegie-Mellon University and the University of Pittsburgh, Pittsburgh, PA. Among the topics to be addressed are expert systems,

robotics, computational vision, programmable automation, game playing, and knowledge representation. Other features include an exhibition program and a two-day tutorial program providing a nontechnical look at key areas of artificial-intelligence research. Complete conference details are available from the American Association for Artificial Intelligence, 445 Burgess Dr., Menlo Park, CA 94025, (415) 328-3123.

August 17-20

**Electromagnetic Compatibility Design and Measurement**

for **Control of Electromagnetic Interference**, Toronto, Ontario, Canada. For details on this course, contact Don White Consultants Inc., State Route 625, POB D, Gainesville, VA 22065, (703) 347-0030.

August 24-26

**Electromagnetic Compatibility Design of Printed-Circuit Boards and Electronic Modules**, Los Angeles, CA. For details on this course, contact Don White Consultants Inc., State Route 625, POB D, Gainesville, VA 22065, (703) 347-0030. ■

In order to gain optimal coverage of your organization's computer conferences, seminars, workshops, courses, etc, notice should reach our office at least three months in advance of the date of the event. Entries should be sent to: Event Queue, BYTE Publications, POB 372, Hancock NH 03449. Each month we publish the current contents of the queue for the month of the cover date and the two following calendar months. Thus a given event may appear as many as three times in this section if it is sent to us far enough in advance.

Great for Dealer  
Demonstrations

# CUBIE MOVIE

...Puts the fun into solving your Rubik cube

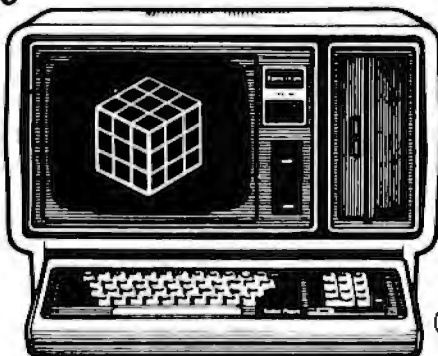

TRS-80 is a trademark of Tandy Corporation which is not associated with this product.

TM

No matter what combination your Rubik cube has, the Cubie Movie can solve it.

### HOW IT WORKS

- Solve Rubik's cube by typing the colours of your scrambled Rubik cube into your TRS-80 (requires 32K RAM).
- A Rubik cube will appear on the screen and will begin moving the sections to solve your Rubik cube.
- By following the cube on the screen, you will actually solve your Rubik cube. By hitting the space bar on your terminal you can stop and start the program to go at your own speed.

### TO ORDER

Send \$20 by cheque, Visa, or Mastercard to Five Stones Software, P.O. Box 1369, Station B, Ottawa, Ontario. K1P 5R4. Ontario residents add 7% provincial tax. All Canadian residents add 9% federal tax. The program is distributed on Model I, Level II cassette tape.

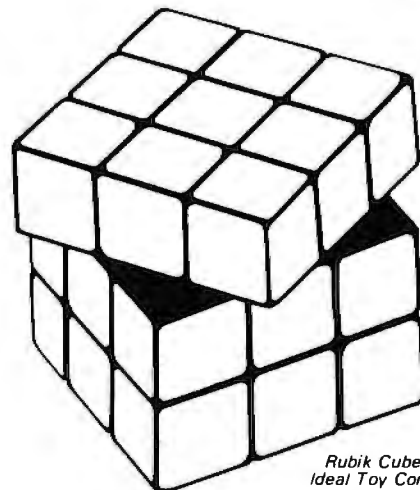

TM

Rubik Cube is a trademark of Ideal Toy Corporation which is not associated with this product.

# Software Received

## Apple

**Apple Spice**, a set of assembly-language routines to supplement Applesoft for the Apple II Plus. Floppy disk, \$29.95. Adventure International, 507 East St., POB 3435, Longwood, FL 32750.

**Borg**, an arcade-type game for the Apple II Plus. Floppy disk, \$29.95. Sirius Software Inc., 10364 Rockingham Dr., Sacramento, CA 95827.

**Eliminator**, an arcade-type game for the Apple II. Floppy disk, \$29.95. Adventure International (see address above).

**Executive Briefing System**, a system to develop and present visual information for the Apple II. Floppy disk, \$199. Professional Software Technology, 180 Franklin St., Cambridge, MA 02139.

**Foosball**, an arcade-type game for the Apple II. Floppy disk, \$29.95. Sirius Software Inc. (see address above).

**Key Perfect**, a program to verify keyboard program entry from a printed listing for the Apple II. Floppy disk, \$29.95. Micro-Sparc Inc., POB 325, Lincoln, MA 01773.

**P-LISP**, a LISP interpreter for the Apple II. Floppy disk, \$199.95. Gnosis, 4005 Chestnut St., Philadelphia, PA 19104.

**Rubik's Cube Unlocked**, solves Rubik's Cube puzzle for the Apple II. Floppy disk, \$24.95. Double-Gold Software, 13126 Anza Dr., Saratoga, CA 95070.

**Saga #1 Adventureland**, an adventure-type game with graphics for the Apple II Plus. Floppy disk, \$19.95. Adventure International (see address above).

**Track Attack**, an arcade-type game for the Apple II. Floppy disk, \$29.95. Broderbund Software, 1938 Fourth St., San Rafael, CA 94901.

**Twirps**, an arcade-type

game for the Apple II Plus. Floppy disk, \$29.95. Sirius Software Inc. (see address above).

**VC-Manager**, a Visicalc-file manipulator for the Apple II Plus. Floppy disk, \$65. Micro Decision Systems, POB 1392, Pittsburgh, PA 15219.

## CP/M

**C/80 Version 2.0**, a compiler for the C programming language for CP/M (Z80). 8-inch floppy disk, \$49.95. The Software Toolworks, 14478 Glorietta Dr., Sherman Oaks, CA 91423.

**Microshell 1.1**, an operating system with Unix-like features for CP/M (Z80). Floppy disk, \$150. New Generation Systems Inc., 2153 Golf Course Dr., Reston, VA 22091.

**Catalog**, a disk-cataloging system for CP/M (Z80). 8-inch floppy disk, \$75. SRX Systems, 2812 Westberry Dr., San Jose, CA 95132.

**FloBASIC 1.1**, a preprocessor that helps produce structured programs in BASIC for CP/M (Z80). 8-inch floppy disk, \$90. Terrasoft, 25 Bryan Rd., Rowayton, CT 06853.

## Texas Instruments

**Mission Impossible**, an adventure-type game for the TI-99/4. Floppy disk, \$29.95. Texas Instruments Inc., 13500 North Central Expressway, POB 225012, Dallas, TX 75265.

**Strange Odyssey**, an adventure-type game for the TI-99/4. Floppy disk, \$29.95. Texas Instruments Inc. (see address above).

**TI Invaders**, an arcade-type game for the TI-99/4. Command module (ROM cartridge), \$39.95. Texas Instruments Inc. (see address above).

**Voodoo Castle**, an adven-

ture-type game for the TI-99/4. Floppy disk, \$29.95. Texas Instruments Inc. (see address above).

## TRS-80

**AW Rats!**, an arcade-type game for the TRS-80 Models I and III. Cassette, \$14.95. Creative Thaumaturgy, POB 107, Forest Park Branch, Dayton, OH 45405.

**Crunch**, an arcade-type game for the TRS-80 Models I and III. Cassette, \$14.95. Creative Thaumaturgy (see address above).

**Earthquake San Francisco 1906**, an adventure-type game for the TRS-80 Models I and III. Floppy disk, \$20.95. Adventure International, 507 East St., POB 3435, Longwood, FL 32750.

**Electric Pencil 2.0**, newest version of the word processor for the TRS-80 Models I and III. Floppy disk, \$89.95. IJG Inc., 1260 West Foothill Blvd., Upland, CA 91786.

**Lion's Head Adventure**, an adventure-type game for the TRS-80 Models I and III. Cassette, \$14.95. Creative Thaumaturgy (see address above).

**Sfinks 3.0**, a chess-playing program for the TRS-80 Models I and III. Cassette and floppy disk, \$39.95. William A. Fink, POB 5912, Light-house Point, FL 33074.

**Space Invader**, an arcade-type game for the TRS-80 Models I and III. Cassette, \$14.95. Creative Thaumaturgy (see address above).

(see address above).

**Super Color Writer 1.0**, a word processor for the TRS-80 Color Computer. Cassette, \$49.95. Nelson Software Systems, POB 19096, Minneapolis, MN 55419.

**Trashman**, an arcade-type game for the TRS-80 Models I and III. Cassette, \$14.95. Creative Thaumaturgy (see address above).

## ZX80

**ZX80 1K Disassembler**, a disassembler and memory test for the 4K-ROM ZX80 and the Microace. Cassette, \$9.95. Lamo-Lem Laboratories, POB 2382, La Jolla, CA 92038.

**ZX81 1K Disassembler**, a disassembler and memory test for the 8K-ROM ZX81 and the Microace. Cassette, \$9.95. Lamo-Lem Laboratories (see address above).

## Other Computers

**AC Circuit Analysis**, analyzes complex electronic circuits for transfer function or impedance for the Atari 800. Floppy disk, \$39.95. L. W. James and Associates, 1525 East County Road 58, Fort Collins, CO 80524.

**Ezlabel**, a mailing-list and label-printing program for the IBM Personal Computer. Floppy disk, \$39.95. Systems, 3050 Spring St., West Bloomfield, MI 48033. ■

This is a list of software packages that have been received by BYTE Publications during the past month. The list is correct to the best of our knowledge, but it is not meant to be a full description of the product or the forms in which the product is available. In particular, some packages may be sold for several machines or in both cassette and floppy-disk format; the product listed here is the version received by BYTE Publications.

This is an all-inclusive list that makes no comment on the quality or usefulness of the software listed. We regret that we cannot review every software package we receive. Instead, this list is meant to be a monthly acknowledgment of these packages and the companies that sent them. All software received is considered to be on loan to BYTE and is returned to the manufacturer after a set period of time. Companies sending software packages should be sure to include the list price of the packages and (where appropriate) the alternate forms in which they are available.



## Micro-Decision Support System/Finance (DSS/F)

---

Robert Moskowitz  
22200 Tioga Place  
Canoga Park, CA 91304

---

Micro-Decision Support System/Finance (DSS/F) is the first of what may be a new generation of super-software packages: programs with immense capabilities and multiple automatic functions shoehorned into a microcomputer.

Rusty Luhring of Ferox Microsystems Inc. of Arlington, Virginia, wrote DSS/F. Luhring is a computer veteran with professional experience on mainframe systems. Before he began to develop DSS/F, he worked for a prominent time-sharing company where he was responsible for the technical support of large users with complex financial-modeling needs.

He bought an Apple II microcomputer about two and a half years ago and learned Pascal. Overcoming some microcomputer limitations, Luhring created a *very sophisticated* software package that runs more like commercial programs on large computers than just another version of Visicalc.

### Operation

In its current version, DSS/F requires the Apple Pascal system, two or three floppy-disk drives, and a dual-purpose hardware key that comes with the package. Once you have the Pascal prompt on screen and the key plugged into the game-paddle socket, you are ready to execute but not yet ready to produce useful results.

DSS/F builds and reports on a financial model from a series of separate files. By convention, the files carry a common root name and various suffixes to indicate their contents. (The disk name needed to call a file can be set up as a default value to save keystrokes.) MODEL.LOG might be the name of a file that defines the rows, columns, labels, and formulas that make up the model. This file tells the computer how to compute and compare

### At a Glance

**Name**

Micro-DSS/Finance

**Type**

Financial-modeling software

**Manufacturer**

Ferox Microsystems Inc.  
1701 North Ft. Meyer Drive  
Suite 611  
Arlington, VA 22209  
(703) 841-0800

**Publisher**

Addison-Wesley Publishing Company  
Business and Professional Division  
Jacob Way  
Reading, MA 01867

**Price**

\$1499; extended service policy: \$275 a year

**Format**

5¼-inch floppy disk

**Language Used**

Pascal

**Computer Needed**

Apple II with 48K bytes of memory; two or three disk drives; Pascal language system; 80 or 132 column printer

**Documentation**

100-page introduction and tutorial manual; 200-page reference manual, both wire bound

**Audience**

Financial managers, executives, and other business people interested in desktop computerized financial modeling or in providing such capabilities to specialists unfamiliar with computer operating procedures

all the values in the model so as to generate valid, meaningful results. You construct this logic file with the DSS/F Editor program, and you must compile it before you can use it the first time. If you make any changes to this file, you must compile the new version before you can rerun your model.

Following the name example above, the file MODEL.DATA contains the raw input data on which the MODEL.LOG file will operate. One way to use the DSS/F system is to enter all your data via the Editor, save it as a regular MODEL.DATA file, then go through the steps to run the model. Unfortunately, this tends to limit your spontaneity and cut down on the interaction between you and the DSS/F model. To minimize this limitation, enter data from the keyboard during the model run. Special *temporary data* commands allow you to change old values in mid-run and very quickly see the modified results. This approach saves a great deal of time and trouble and allows for "sensitivity analysis," or repeated runs of the model with only minor adjustments to find an optimum set of results.

If you run a DSS/F model without any MODEL.DATA file in memory, you would generate a null set of results. But you are then free to use the various commands to enter temporary data, manipulate it, and even save the computed results in a special disk file. DSS/F lets you retrieve and modify these files as easily as the regular MODEL.DATA files. When used in this manner, the system is much more interactive than virtually any time-sharing system.

Additional files that make up a complete model package include a MODEL.REP file that specifies the full-scale reporting format you will use and a MODEL.WS file that contains the derived information needed to print a work sheet. These work sheets are automatically keyed to the rows and columns of the model you are constructing. *More on these and other file types later.*

## So Many Numbers

Each of the files you need is constructed with the DSS/F Editor. The Editor assigns line numbers to the file as you go, but you must key into the line a row number that corresponds to the position of that line of logic or data in the model. The Editor-supplied line numbers are needed for line-oriented editing commands, such as Insert, Delete, Fix, and so forth. You can safely let the computer take care of these. But the computer does not give you much help with the row numbers, and they are the glue that holds the model together and makes it work.

Earlier versions of DSS/F were limited to a matrix size of 1919 data cells, or intersections of rows and columns. Your matrix could be 19 by 100 elements, 5 by 380, and so on. You could fill all available cells quite easily. (But the consolidation features made it possible to combine the results of separate models, and so work around this memory limitation.) The latest update of DSS/F, however, includes a virtual-storage routine that supports up to 32,000 data cells in a single financial model—a vast expansion in capacity.

## DSS/F and Market Positioning

*DSS/F is an unusual package in several ways. First and most obvious, its \$1500 price tag for a single disk of programming is very steep by personal computer standards. Second, and less obvious, it is published by Addison-Wesley Publishing Company. Addison-Wesley is well established as a publisher of business-oriented materials in print. Taking a flyer on Apple II software seems quite a leap for such a company.*

*The venture makes more sense if you turn the picture around and look at it from the point of view of mainframe time-sharing users. The organizations employing these people may already spend up to \$30,000 a year or more for computerized financial modeling. From their perspective, the DSS/F system is dirt cheap, even if you include the cost of the Apple II, disk drives, and the Pascal language system.*

*From this perspective, DSS/F is highly interactive too; you can get it running and do several iterations of a model in less than an hour right on your desk, whereas with a mainframe-supported modeling system you may need weeks simply to establish a model that works and do the first iteration.*

*As you look at the DSS/F package in this way, you begin to see the importance of the emphasis on user support, the orientation of the system toward paper-and-pencil preparation for computer runs, and the capabilities for automated operation by novices. All of these are marked similarities to, or advantages over, traditional time-sharing systems.*

*Program author Rusty Luhring readily admits much of this. "It is not as interactive as Visicalc," he recently confided, "but it is a whole lot more interactive than the mainframe systems our customers are used to. And while it does require a measure of familiarity with computers and programming to operate, it 'thinks' much more like a financial manager does than most of the time-sharing systems I have worked with."*

*All this adds up to a new critter in the Apple barnyard. If DSS/F proves itself over the long term—and as of now there is no reason to believe it won't—it may signal the approach of a new wave of software/hardware super-systems that vastly increase the basic Apple II's capabilities and, at the same time, command a vastly increased price.*

In operation, DSS/F is very much oriented to row and column numbers. You must keep them straight and be able to refer to them accurately if you want to get anywhere with your model. You can enter the rows of data in any order you wish: the computer builds the same model regardless. As long as the logic specified and the data for it to use carry the correct row numbers, the results will be what you want.

One initially confusing feature is the convention that says all data values must be entered as decimal numbers (1.0, 2.3, 1000000.0, etc.), while any integers (1, 2, 3, etc.) are automatically interpreted as row numbers. (I wish that "R" could be used to specify row numbers, so I wouldn't have to reprogram my brain to match the computer's numerical understanding.)

Another confusing element is the sheer volume of similar numbers: row numbers, line numbers, coded instruction numbers, disk-drive numbers, and data values

can blur together and leave room for an embarrassing sequence of silly mistakes. For example, if you insert a value where you need a code number, or a row number where you need a line number or a value, the model will twist itself out of shape, confounding your results but not always flashing an error message.

You can juggle all these numbers successfully in your head only for some of the simpler models. Almost as soon as you try to model a real financial situation, such as a home purchase or the break-even analysis on a new product line, you find yourself swamped in digits. You need a pencil and plenty of paper to dig yourself out. I found frequent printouts extremely helpful too. With a printout of the logic in front of me, for example, I could locate much more quickly the line or row number I wanted to access. Without hard copies of your files, you'll spend a lot of time listing groups of logic or data statements on the screen and trying to remember long series of numbers to key in somewhere else.

### Start with the Logic

To start a new model under DSS/F, you must construct a MODEL.LOG file that defines and structures the model. You have no model, and you cannot see any calculated results until you have the correct logic compiled (which may cause up to a five-minute delay each time you do it) and operating on temporary data (or a bona fide MODEL.DATA file). This means that in practice, DSS/F is too slow and cumbersome for simple models and spontaneous "what if" games. It's like outfitting yourself for a weekend in the wilderness—you don't go to all that trouble every time you want to take a walk in the park.

In fact, a quick way to give yourself a headache is to approach a financial-modeling problem by trying to give DSS/F some figures, manipulate them, give it some more data, change a few values, manipulate them slightly differently, and progress in this manner until you have an adequate working model. You cannot easily feel your way along. DSS/F requires more discipline, planning, and preparation. It trades off some simplicity of operation and interactivity for sophistication and flexibility on the high-end applications.

To use DSS/F properly, you will want to do a lot of paper-and-pencil work before you reach for the keyboard. As with the time-sharing systems you may be familiar with, you must have a firm grasp of what you are doing and where you are in the modeling process in order to make good use of your microcomputer's vast new capabilities.

But once you have a plan for the model you want to construct or once you have a basic financial model debugged and operating, it is very simple with DSS/F to get the model running and test a series of different values.

### Real Power

The real power of DSS/F lies in its ability to handle complexity and in its graphics and reporting capabilities. Here is a brief rundown on some of the features that

### Enhancements

*Ferox Microsystems plans to announce several enhancements to DSS/F soon. Some of these will eliminate problem areas identified in this review. Enhancements will include:*

- a menu-creation capability that will allow users with no computer knowledge to access the full power of DSS/F by simply selecting from a customized menu (no commands or file names required)
- the ability to refer to rows by variable names as well as row numbers, making it easier to create and modify logic files and avoid confusion between row and column numbers
- "goal seeking" or "backward iteration" will allow the user to reverse the calculation, entering a desired outcome (say, a particular target profit) and DSS/F will calculate the input values required to create that outcome

*Ferox also plans to announce database-manager, statistical, and communications packages, along with a pen-plotter graphics package—all with DSS/F interfaces. All Ferox software runs on the Apple II, Apple III, TRS-80 Model II, and IBM Personal Computer.*

make the DSS/F system flexible, powerful, and useful for large-scale modeling applications.

**Automated work sheets:** Once you have the logic file debugged and compiled, you can use the Report function to scan the logic and generate a MODEL.WS file. Printing this file generates a neatly formatted data-collection work sheet. The work sheet emerges from the printer with titles, labels, and appropriate spaces for all the data needed by the logic. If your model uses the built-in Loan, Depreciation, or Tax-Loss Carry-Forward functions, the computer even adds appropriate prompts for needed data to the work sheet without being asked!

In practice, you can generate these work sheets for others in your company to fill in, others who may have no understanding of computer modeling and no idea that a computer will later crunch their numbers. This feature saves you time, can increase the accuracy of data used, and even makes keying in the data easier because the work sheet is set up and labeled to fit the MODEL.DATA file structure your model needs.

**JOB files:** These are like Apple II Exec files. They offer a way to preprogram control of the computer and have it step itself through repetitive or complicated processing sequences. The JOB files are created in the Editor mode and saved under the MODEL.JOB name convention before the JOB mode is entered.

To run the computer in this mode, at the Command prompt, you enter JOB. The computer asks for the file containing the commands. When you give the proper file name, the computer goes off and does its business without you. In the JOB mode, DSS/F is fully capable of loading files, processing data, and printing the results while you do something else. You may appreciate this feature if you want to automate a frequent sequence of modeling commands so you can start the computer, leave the room, and pick up the finished printout later.



**GEN files:** This type of file controls the computer to prompt for data, insert that data where needed in the model being run, and generate customized reports as needed. GEN files are extremely valuable in conjunction with the data-gathering work sheets and the JOB files if you want to set up the system to give novices access to DSS/F's most advanced modeling capabilities without giving them the extensive training and computer-familiarization experiences they might need to work the system on their own.

While it takes a lot of work, you can use the GEN system to create a totally user-friendly self-controlled financial-modeling system. GEN files contain commands, prompt lines, and up to 20 variables. Available GEN commands include Ask (for input), Get (a file), Write (a file), Job (execute a JOB file), When (test for a condition), and Add and Subtract.

Using the GEN mode and its When commands, for example, you can cause DSS/F to display a menu of numbered choices on the screen, accept keyboard input in response, and then follow a complicated procedure that prompts for financial data from the work sheet, processes it, and produces a printed Report—all automatically. In addition, you can set up other GEN files to prompt the user for specific data to be manipulated within a model as it runs.

**Consolidating:** A set of commands within the DSS/F system allows you to extract portions of data sets and add them to or subtract them from other portions of other data sets. From several sets of data, you can extract a single row (line item), a single column (time period), or multiple rows and columns. What's more, you can engage a previously created GEN file that prompts for specifications and does the consolidation for you. This makes monthly reporting of sales by product, for example, or projected profit by division a very simple matter. You can create separate models for each of the basic subdivisions within your organization, and then consolidate performance or projections as needed. With the updated virtual-memory capacity, you can build one giant model and simply extract the portions of it you want for any specific report.

While it may take some time and planning to do this consolidation or extraction the first time, you can put the required commands into GEN or JOB files and execute the sequence again later with only a few keystrokes. By putting in the proper on-screen prompts, you can arrange DSS/F to do even the most complicated work for the most naive user.

**Built-in functions:** DSS/F has a large repertoire of pre-programmed functions it can execute on cue. Briefly, for a given cash-flow stream: NPV computes the net present value, MULTINPV does this for several discount rates, NPVPERPET does it as if the stream were perpetual, IRR gives the internal rate of return for the stream, and PAYBACK computes the number of periods needed to recover the initial investment.

DEPR calculates the depreciation on a given investment item according to five parameters you provide in

code, including life, depreciation method, residual value, half- or full-first-year depreciation, and optimal year switch-over options.

Various LOAN functions let DSS/F automatically calculate interest, principal, remaining balance, and periodic payment for a loan according to four parameters you provide in code, including interest rate, number of payments, and starting month.

Tax Loss Carry Forward automatically carries forward into each year of your model any losses applicable from prior years.

A LOOKUP function allows you to specify a table, such as a tax table, and then refer to it in your modeling computations. You set up a table by putting values in columns 1 and 2 which define an interval for each row. Then in another row you list the rows that make up the table.

The LOOKUP function will go to the table, find the appropriate interval into which a search value fits, and then pull out whatever result value is found in the requested column of that row. For example "4 LOOKUP 8 for 10" will do the following: take the value in row 4 (column by column), look it up in the table specified in row 8, find the proper row of that table, and pull out the value in column 10 of that row. The result will be returned, column by column, to the row where the LOOKUP command was placed.

A variety of logical operators and LOOP functions allow more sophisticated manipulation of specific data. If some formulas contain circular references, you can cause DSS/F to solve the model repeatedly until it finds the answer to these "simultaneous equations."

### Very Fancy Reporting

While DSS/F may have good points and bad points relative to other microcomputer financial-modeling programs, it is clearly on top when it comes to reporting.

Specific formatting commands tell the computer what values to print, in what order, and where on the page. The computer easily handles pagination, form length, brackets for negative numbers, decimal conventions, and other niceties, as well as providing extensive options for titles and headings, columns, underlining, mixing text and data, and more. It even has a special command to turn the matrix sideways, converting rows to columns and columns to rows.

DSS/F can also be set up to prompt for information as it prints and then to include the keyboard response in subsequent printing.

Specifications for formal reporting must be established using the Editor and saved in a special MODEL.REP file. This can take time. To get a quick response, you can obtain results without a MODEL.REP file. You simply specify the rows and columns you want to see, and DSS/F displays them on the screen (the QD command) or the printer (the PRINT command).

Another output mode is DATAVIEW. This subsystem of DSS/F actually processes data and logic together in real time and displays the results. But it is an interactive mode, and allows you to give various commands to cause

selected rows and columns of calculated results to appear. In this mode, the TD command allows you to enter temporary data from the keyboard and have it processed without constructing a MODEL.DATA file and without interrupting the model run.

If you like a set of results, you can save the calculated results to the disk for later retrieval. In the DATAVIEW mode, DSS/F accepts many disk-access, data-entry, and data-manipulation commands.

One nice feature is the ability to set up incremental changes in values, say a 10 percent increase, that is handled automatically by the computer. This saves key-strokes because the computer will accept an initial value and a change factor and use them to fill in an entire series of data values.

## Graphics

Once you have your calculated results, DSS/F offers extensive graphics options for displaying them. By ending the modeling session and running the DSS graphics program, you can turn data files or the data currently in memory into pie charts, bar charts, or line graphs quite easily. The computer will calculate the ranges automatically or accept your input and automatically print monthly labels. Color graphics are also no problem.

As with DSS/F reports, its graphs give great freedom for titling, labeling, and highlighting various parts of the finished graphic. You can use a previously saved graph-specification file or wing it as you go. The system provides for such capabilities as stacking up to eight sets of values into a single bar chart.

The hardware key in your game-paddle socket resembles and functions as a slide-projector remote control. It can be used to call up a series of previously constructed graphic images onto the monitor screen, almost exactly as if they were actual slides. It's uncanny to see this feature operate, and it's potentially useful for cutting the time and trouble of actually preparing slides from computer graphics output. Once you change the disk name to TRAY and save your previously prepared graphics images as SLIDE1, SLIDE2, . . . SLIDE17, the rest is as easy as pushing a button.

## Error Handling

DSS/F's error messages, like all its command prompts, are in English (that is to say, they avoid the common problem of being vague or cryptic). I found the error-trapping and error-handling routines quite good and very friendly. For example, illegal commands are met with the response: "Don't recognize that one. Try again." DSS/F does have some confusing elements not totally accounted for. If you try to run a GEN file with the wrong command, for example, the system responds with a lot of garbage. This can happen more often than you think, because it is very difficult for a person to keep accurate track of all the files involved in a DSS/F model package.

Similarly, it was very common for me to confuse line numbers and row numbers. In both editing the files and running the models, I got confusing and wrong results.

And I got unwanted results when I failed to include the needed decimal point in a data value or included one in a row number (where it is never needed). I suppose that experience with the system would eliminate many of these human errors, but these quirks make learning the system more difficult than it should be.

## Documentation

I found the 300 or so pages of instructions, reference materials, tutorials, and miscellaneous command lists an extremely valuable and accurate package. Other than a few typographical errors, the package is well written, accurate, and informative.

More to the point, Luhning and *his associates* are very strong on user support. Satisfied users of the package say that Luhning has nursed them through both silly and complicated problems without a murmur of discontent or any effort to point the finger of blame. For the price of this software, which places it in a different market position from most software for the Apple II, you would expect such treatment. It's good that the user can feel confident of getting it.

## Conclusions

- DSS/F is a sophisticated and comprehensive financial-management tool that can be a valuable aid to people who have a frequent need for complicated financial planning, modeling, or investment comparisons. All who used it expressed admiration for its sophistication and flexibility.
- Its graphics capabilities are excellent; it handles much of the work automatically and turns data files into visuals very efficiently.
- DSS/F is capable of automatic operation, on-screen prompting, and real-time presentation of its results in both numeric and graphics form. This makes it a flexible tool for processing as well as displaying financial-modeling data.
- The program does not live up to all the claims Addison-Wesley makes for it, though. Contrary to what Addison-Wesley says, the program requires the user to be quite familiar with standard computer operations and procedures and to think in computer—not only financial—terms.
- DSS/F trades quicker familiarization, speedier modeling, and a greater degree of user interaction for enhanced reporting, graphics, calculating, and automated capabilities. It does not compete with cheaper, simpler, and easier modeling programs. Instead, it adds a new high end to the existing levels of Apple II computer capabilities.
- For most financial-planning situations suitable for a microcomputer, using DSS/F is something like using an elephant gun to kill a rabbit. It will do the job, but with a measure of overkill. In practice, the hefty price tag will probably limit the number of small-computer users who will turn to DSS/F. For those who can afford it, though, DSS/F is certainly a very powerful financial-modeling tool. ■

## Conditionals in LISP

*Use the COND primitive as a decision-making function.*

---

M.S. Howard  
83½ Partition St.  
Saugerties, NY 12477

---

LISP is a programming language invented to implement list processing, which is a suitably vague term that denotes all the useful things you can do that involve building lists of objects and other lists, and taking them apart. For example, useful things include translating a high-level language into machine-executable code, book-keeping, and algebra.

The most useful aspect of a programming language is that it allows programs to be written that mimic problems and situations in the real world. This requires that a program be able to perform actions (make decisions) which are conditioned on the current state of the world (the environment and current data). The ability to make decisions is accomplished in most languages, such as FORTRAN and Pascal, by using the IF statement. Special classes of conditional action are built in to support iteration, with termination depending on a maximum number of counts (DO loops, FOR . . . NEXT loops, etc.) or on some logical predicate's operation on the current environment and data (REPEAT . . . UNTIL . . . , etc). LISP achieves all this using the COND primitive. This article discusses the application of this primitive to emulate the less general constructs of other languages. This is done to explain the syntax and to demonstrate the generality of the COND primitive. (For an overview of the LISP language see the August 1979 BYTE.)

### Syntax of COND

It's necessary to know a little about LISP in order to

discuss the syntax of COND. LISP is a language that essentially takes a function in a Polish notation form and evaluates it. The general syntax is:

(function arg 1 . . . arg N)

Please note that I haven't specified anything about the nature of the function, how it is defined, what the arguments are, how many there may be, or even if N must be a known fixed number. LISP doesn't need that information. Basically, you can have almost any type of function that you can define on any type of data structure that you can represent by using tree structures of objects and numbers. The arguments must be definable, e.g., objects with names, numbers, or some function applied to some arguments. If an argument is in a functional form, the system will evaluate it, etc. (If this sounds interesting, read a book on LISP, then go find a computer and play with it for a while.) The language system usually knows an initial set of functions which you don't have to build yourself. These are called primitives.

COND, a LISP primitive, takes a variable number of arguments. The arguments are of the form:

(predicate e1 . . . eN)

The predicate is a legal expression which is evaluated. If its value is not NIL (a special LISP list which is analogous



# FILL THE GAPS

## IN YOUR SYSTEMS' PERFORMANCE

### INTELLIGENT DATA BUFFER

Applications for:

- Printers, Terminals and Data Communications

### AUTO SWITCHER

- Remote Selection of Common Port to One of 4 Destinations

### UTILITY INTERFACE

- Sales Aid
- Instruction Aid
- Demonstration Aid

## REITH WALCOTT

ENGINEERING INCORPORATED

15074 N.E. 40th St. • Redmond, WA 98052

Order (206) 882-2225

Dealer Inquiries Welcome

# START YOUR OWN COMPUTER CO.

**HOW TO START YOUR OWN SYSTEMS HOUSE** \$36.  
7th edition, November 1981

Written by the founder of a successful systems house, this fact-filled 220-page manual covers virtually all aspects of starting and operating a small systems company. It is abundant with useful, real-life samples: contracts, proposals, agreements and a complete business plan are included in full, and may be used immediately by the reader. Proven, field-tested solutions to the many problems facing small turnkey vendors are presented.

**HOW TO BECOME A SUCCESSFUL COMPUTER CONSULTANT** \$28.  
by Leslie Nelson, 4th revised edition, December 1981

Independent consultants are becoming a vitally important factor in the micro-computer field, filling the gap between the computer vendors and commercial/industrial users. The rewards of the consultant can be high: freedom, more satisfying work and doubled or tripled income. This manual provides comprehensive background information and step-by-step directions for those interested to explore this lucrative field.

**FREE-LANCE SOFTWARE MARKETING** \$30.  
by B.J. Korites, 3rd edition, June 1980

Writing and selling computer programs as an independent is a business where • you can get started quickly, with little capital investment • you can do it full time or part time • the potential profits are almost limitless. This best-seller by Dr. Korites explains how to do it.

**HOW TO START YOUR OWN WORD PROCESSING SERVICE** \$39.50  
by Leslie Nelson, May 1982

Turn a small investment into a steady, money making business that adds \$10,000, \$50,000 or \$100,000 to your income. Detailed start-up, marketing and operations plans are included.

Send check, money order, VISA, Master Charge or American Express # and exp. date. Publisher pays 4th class shipping. Add \$1.00 per book for UPS shipping (USA only). NJ residents add 5% sales tax. For faster shipment on credit card orders call (201) 783-6940.

**ESSEX PUBLISHING CO.** Dept. 2  
285 Bloomfield Avenue • Caldwell, N.J. 07006

## Technical Forum

to 0 or the empty set), then each of the expressions e1 through eN is evaluated. The value of the entire COND expression is taken as the value of the last expression evaluated, i.e., the value of eN. In other words, COND is about as general a CASE statement as has been invented.

### Simulations

Let's see how COND corresponds to the more common types of conditionals. First we will try to simulate the IF . . . THEN . . . ELSE . . . statement:

```
(COND
  ((predicate of the IF) (the THEN clause))
  ( T [this is not NIL] (the ELSE clause)))
```

The first predicate is the only one we care about, so the second predicate is designed to make sure that the ELSE clause is performed when the IF clause is false. So far, COND appears to have no advantage over IF . . . THEN . . . ELSE . . . , but this is not the case (COND is more general).

Now let's try the CASE OF var DO . . . statement:

```
(COND
  ((EQUAL var case1) e11 . . . e1N)
  ((EQUAL var case2) e21 . . . e2N)
  .
  .
  ((EQUAL var caseM) eM1 . . . eMN))
```

Here COND signals the evaluator to test if var is EQUAL to case1, case2, etc., and to do the appropriate things under those conditions.

### More Syntax

To perform other conditionals mentioned at the beginning of this article we need to use recursion. Most programmers consider recursion a nasty word because it is not structured. The fact is that recursive structures, which have been around for a long time, are not all that hard to deal with. Everyone who has taken high school algebra is familiar with proof by induction. This is a fundamental recursive technique and pervades mathematics. The principal problem with recursive programs up to now has been the need for a lot of memory and the slow speed of execution. The memory-size problem was caused by the expense of high-speed memory and the fear that if the program isn't bound by the memory requirements at compile time, it may not fit in the machine. The fact is that high-speed memory is getting cheaper than birdseed, and very few legitimate problems ever really eat up the whole machine.

The second problem is execution speed. I am on shaky ground here, but I am told that the LISP at MIT does number crunching (which LISP is not supposed to do

well) as speedily as the DEC FORTRAN compiler (using the same computer) working on similar (or maybe the same) problems. This doesn't mean that LISP is necessarily great for number crunching, but it does mean that an interpreted language which encourages recursive programming at every turn need not be all that slow.

**Recursion**

Now that I have tackled a few prejudices, let's examine what recursion is. Basically, recursive programming is a means of setting down a procedure for writing a program at execution time, as opposed to iteration or standard programming, which is writing a program at compile time. Does this mean that we are writing *self-modifying code*? Not at all. In fact, we are avoiding any nontemporary modification of the state of the computer. The code which we write is not modified. It allows the language interpreter to construct a sequence of routine calls which will solve a given problem at execution time. It just so happens that the sequence of routine calls is problem-dependent and so varies from execution to execution. The state of the system *after* the program has been executed need not be different from what it was prior to execution, and none of the original instructions need be modified. How many times have you messed up a program by mod-

ifying a globally defined variable down in some BASIC or Pascal subroutine, and not known what happened when your program blew up? Recursive programming exterminates a lot of those types of bugs before they hatch.

Now that we have recursion, we need to be able to establish function definitions. A language must allow the programmer to associate a name with a function and so invoke a desired function at will. The mechanism used by LISP is the primitive LAMBDA. The syntax of LAMBDA is:

(LAMBDA list-of-variables things-to-do)

The list-of-variables is a LISP-type list of the dummy variables which are used in the function definition. For example, these are the variables you normally see in algebra when you write:

$$f(x,y,z)$$

The things-to-do are the instructions for applying the function. In order to use the function you usually need to name it. This is done in a variety of ways, depending on the particular LISP system you are working on. The University of Wisconsin allows two forms:

# POWER-LINE FILTERS

These filters protect any sensitive electronic equipment from power line transient damage and radio frequency interference. Both models offer surge suppression for power line "spikes". RF interference is suppressed using both inductive and capacitive components. Ideal for computers, test equipment, or TV.

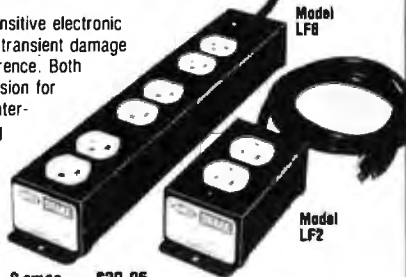

LF2—A duplex outlet, 120V, 8 amps ... \$39.95  
 LF6—Three separately filtered duplex outlets, 120V, total fused capacity 15 amps, powerswitch and indicator lamp . . . . . \$69.95

Add \$2.50 shipping and handling per order. Send check with order and provide street address for UPS shipment. Ohio residents add Sales Tax. Charge card buyers may call toll-free:



**1-800-543-5612**

In Ohio, or for information, call: 1-513-866-2421



## R. L. DRAKE COMPANY

540 Richard Street, Miamisburg, Ohio 45342

INSTITUTIONAL AND DEALER INQUIRIES INVITED

## HHC 6502 IN YOUR POCKET QUASAR HAND HELD COMPUTERS\* NOW AVAILABLE!

See BYTE January 1981, p. 34 - 45 for a System Description

HHC* Main Unit with 4K Internal RAM	HK2600TE	\$595
16K External RAM Memory Module	PC940TE	\$450
8K External RAM Memory Module	PC942TE	\$325
Acoustic Modem Module	PC920TE	\$275
RS232C Serial Interface Module	PC905TE	\$250
Video (B & W or Color) Adaptor Module	PC930TE	\$295
Micro Printer, 16 Character Thermal	PC910TE	\$225
Plotter Module, 3 Color, 5.5" Paper	PC9XXTE	\$450
Multiple Module Adaptor, 6 Port	PC900TE	\$150
AC Adaptor/Recharger, 1.2 Amp	KT593TE	\$ 55
Custom Attache Case, 21" x 14" x 4"	KT657TE	\$170
Single Module 12" Extender Cable	PC901TE	\$ 85
Microsoft BASIC Capsule	LK302TEB	\$ 77
SNAP (FORTH) Language Capsule	LK300TES	\$240
FLEX Data-Base Manager Capsule	LK3XXTEB	\$160
Telecomputing II Capsule for Modem	LK316TET	\$ 42
RS232C Interface Control Capsule	LK317TER	\$ 38

Other software capsules are also available including sales order entry, personal finance, word processor, inventory control, scientific calculator, IEEE488 interface, stock, audit, broker, time management, bid estimator, field service log, PASCAL, and 6502 assembler.

\*HHC is a trademark of Friends Amis, Inc.

Computer Applications, Inc. (303) 696-1864  
 4334 East 17th Avenue, Denver, CO 80220

(SETQ name (LAMBDA etc.))  
(CSETQ name (LAMBDA etc.))

The difference between the two functions has to do with the way the interpreter retrieves information from memory, and as such is beyond the scope of this article. Just remember that it is possible to name a function.

**Recursion in Use**

Now that recursion is out of the way, let's simulate a WHILE . . . DO . . . statement:

```
(SETQ f
(LAMBDA args
(COND
  ((WHILE clause) things-to-do (f modified-args))
  (T termination-conditions))))
```

This function works by first checking the WHILE clause to see if it is time to quit. If it is, the function does whatever is necessary upon termination time. If it is not time to quit, the function continues, then calls itself to check the WHILE clause, etc.

Now let's simulate a REPEAT . . . UNTIL . . . statement:

```
(SETQ f
(LAMBDA args
  tasks-to-be-REPEATED
(COND
  ((termination (i.e. The UNTIL) clause)
  termination-things)
  (T (f modified-args))))
```

This listing is similar to the WHILE . . . DO . . . statement above. This is because the two forms are essentially the same. The only difference is when the termination clause is tested. The WHILE . . . DO . . . and REPEAT . . . UNTIL . . . forms do not allow for combined forms such as:

```
(SETQ f
(LAMBDA args
  things-to-be-repeated upon every application
(COND
  ((termination clause) termination things)
  (T things-to-do if termination clause is false
  (f modified-args))))
```

This is a simple combination of the two forms.

**Conclusion**

The usual application of COND in a LISP program is a combination of all the above forms. This is tough on beginning LISP programmers, principally because they generally come from restricted programming environments. They attempt to jam LISP constructs into forms they are familiar with. This doesn't work, because LISP primitives are usually either more general than anything they have (e.g., COND) or more primitive than what they are familiar with (e.g., LAMBDA). They usually don't have much trouble with SETQ because this equates to '=' or whatever assignment primitive their languages use. But they have an awful time with SET. This feature of LISP, which always associates both a value and a label with an object, opens up all sorts of interesting areas, such as the difference between a function which returns a value and one which has "side effects." ■

**PRICE BREAK**  
**EPSON**  
**MX-80**  
**CARTRIDGE RIBBONS**  
**\$9.95** ■ EA.  
**\$107.46 per dozen**  
**Minimum Order 3 Ribbons**  
**Price Includes Shipping**  
**We accept Mastercard and Visa**  
**CHECK-MATE™**  
P.O. BOX 103, RANDOLPH, MA 02368  
Call Toll Free - 1-800-343-7706  
In Massachusetts - 617-963-7694

Circle 87 on inquiry card.

**Verbatim®**  
**Floppy Discs**  
**SAVE 40%** Write for our complete list.  
**5 1/4"** Specify soft, 10 or 16 sector Price/10  
MD525 1 side/dbl dens . . . . . \$27.30  
MD550 2 sides/dbl dens . . . . . 44.20  
MD577 1 side/77 track . . . . . 32.50  
MD557 2 sides/77 track . . . . . 44.20  
**8"** Critically Certified Soft sector  
FD34-9000 1 side/sgl dens . . . . . 33.80  
FD34-8000 1 side/dbl dens . . . . . 39.00  
FD34-4001 2 side/dbl dens . . . . . 46.20  
**CHECKS - VISA - MC - C.O.D.**  
**(313) 777-7780 ADD \$2 SHIPPING**  
**LYBEN COMPUTER SYSTEMS**  
27204 Harper Ave.  
St. Clair Shores, MI 48081

Circle 270 on inquiry card.

■ **Hey** ■  
**CANADIANS!**  
**New and Refurbished Equipment**  
8" Disc Drives . . . . . \$400.00  
Letter Quality Printers  
Qume & Diablo . . . . . \$1600.00  
Oscilloscopes  
Dual Trace, 15Mhz. . . . . \$900.00  
Computer Systems, CP/M  
with 2 8" disc drives, CRT  
84K, letter quality printer, . . . . . \$7500.00  
All Sales Final  
Ontario Residents add PST  
All items warranty 90 days, parts & labour  
All prices in Canadian Funds  
**TSA PROFORMA INC.**  
154 Fulton Ave.  
Toronto, Ontario  
M4K 1Y3  
(416) 922-1139 425-9058

Circle 454 on inquiry card.



## Listing the Disk Directory in CP/M-based Pascal

---

Daniel S. Hunt  
822 Green Valley  
Newbury Park, CA 91320

---

You'll often want to obtain a listing of the disk-file directory while operating directly from within an application program. It saves time and simplifies operation.

Because not all CP/M-based languages offer a built-in directory-search-and-list function, you have to create your own. The "getdir" program described here (see listing 1) is a directory-search-and-list program written in Pascal/MT. It will run alone, or you can modify it to run as a subroutine in a host program. Its output is much the same as that of the DIR command in CP/M. Identical results can be obtained in PL/I-80, FORTRAN, and CBASIC by using the algorithms of "getdir" to write assembly-language equivalents where needed. Descriptions of the Search First and Search Next function calls to the CP/M operating system are described in the *CP/M 2.0 and 2.2 Interface Guide*.

The core routine of "getdir" is procedure "gdir". Through procedure "search" it calls CP/M to obtain a directory locator code, which points to the file name most recently placed in the input buffer. "Search" uses CP/M Search First (17) and Search Next (18) functions, which are placed in register C. Register DE holds the pointer to a 12-byte FCB (file control block). This FCB is represented as "title", an array indexed from 0 to 11. Byte 0 in the array indicates the disk number, converted after user input from an ASCII "a" or "b" to a binary 1 or 2. The next eight positions are the file name, followed by the three positions of the extension. They are filled here with question marks to indicate to CP/M that any name found is to be listed.

When "search" returns the directory code, it is multiplied by 32 and added to hexadecimal address 80 (128 decimal), the base of CP/M's file I/O (input/output) buffer. The result, assigned to "dirptr", is the address immediately preceding the 11-character string that will hold a valid file name from the directory. Now that you

have control of the string, you can print it, transfer it to storage for later use, or remove names that you don't need displayed.

Procedure "printname" moves the newly found FCB at "dirptr" to a working string called "prntitle", where it is converted to readable form with spacing and colons. The variable "nmctr" limits the output of each line to four names so that the directory will be correctly displayed on a 64-column screen (see listing 2 on page 501).

Procedure "list", which calls "gdir", performs several vital functions. It is kept separate from "gdir" because you may want to modify one or more of its functions. "List" asks you which disk unit is to be searched and resets the CP/M system in preparation for listing the directory. Reset is mandatory; otherwise CP/M gets lost and throws garbage into the I/O buffer.

In Pascal/MT, an extension to the standard language allows an external procedure, with the absolute address of "bdos", to perform the reset function. If your compiler does not offer such an extension, "setdisk" may be replaced with the following assembly-language equivalent:

```
mvi    c,resetf    ;resetf equ 13
call   bdos        ;entry point at 0005
```

In CBASIC this function is performed by the built-in statement INITIALIZE, which must be used before calling an assembly-language version of "getdir".

The third function of "list" is the assignment of a string to the variable "title". This determines whether all names or only specific names are returned in register A by the Search First and Search Next calls. If "title" is chr(0) + "?????????", then everything on the default disk would be returned. If "title" is chr(2) + "???????DAT", then only those file names on disk B with the extension DAT would be returned. ■

## Programming Quickie

---

Listing 1: The "getdir" program, written in Pascal/MT, version 3.2, will search a CP/M disk and provide you with a listing of the disk directory from within an application program.

```
program getdir;

(*      Directory Search and Print...      *)
(*      By Daniel S. Hunt, April 3, 1981   *)
(*      Pascal/MT 3.2, CP/M 2.2, Sol-20    *)

type filename = packed array[0..11] of char;

procedure external[5] setdisk(func : integer);

function ucase(inchar : char) : char;
begin {convert lower to upper case}
  if (inchar >= 'a') and (inchar <= 'z') then
    ucase := chr( ord(inchar) & $5f)
  else ucase := inchar;
end;

procedure gdir(var title : filename);
const
  eodir = 255; {CP/M end of directory}
var
  prntitle : filename;
  ch : char;
  i : integer;
  dirptr : integer;
  func : integer;
  nmctr : integer;
  dircode : integer;

  procedure search(var title:filename;
                  var dircode : integer;
                  func : integer);
  const
    bdos = $0005;
  var
    fcb : integer;
    rega : integer;
  begin
    fcb := $5c;           {fcb address}
    move(title,fcb^,12);  {12 = fcb length}
    inline(
```

Listing 1 continued:

```
    "lhld / fcb /
    "xchg /           {fcb address to regs.DE}
    "lhld / func /
    "mov    c,l /     {search function to C}
    "call  / bdos /   {returns directory code}
    "mov   l,a /
    "mvi  h / $00 /
    "shld / rega);
    dircode := rega;  {reg.A passed back via dircode}
end; {search}
```

```
procedure printname;
begin
    move(dirptr^,prntitle,12);
    if nmctr = 1 then {only at start of line do we...}
        begin          {...precede name with unit name}
            {by translating back to uppercase letter.}
            ch := title[0];
            ch := chr(ord(ch) + ord('@'));
            write(ch);
        end;
    write(' : ');
    for i := 1 to 8 do {chars[1..8] of filename}
        write(prntitle[i]);
    write(' ');
    for i := 9 to 11 do {3-character extension}
        write(prntitle[i]);
    if nmctr = 4 then
        begin {on end of line, return, reset counter}
            writeln;
            nmctr := 0;
        end
end; {printname}
```

```
begin {gdir}
    nmctr := 0;
    func := 17; {cpm search first}
    search(title,dircode,func);
    func := 18; {cpm search next}
    while dircode <> eodir do
    begin
        nmctr := nmctr + 1;
        {calculate index, print and search for next}
```

Listing 1 continued on page 500



## Programming Quickie

Listing 1 continued:

```
        dirptr := 128 + (dircode * 32);
        printname;
        search(title,dircode,func);
    end
end; {gdir}

procedure list;
var
    title : filenamestype;
    ch     : char;
    func   : integer;
begin
    title := '?????????????'; {bytes 1..11 all wild cards}
    write('LIST DISK DIRECTORY: Unit A or B? ');
    read(ch);
    {translate disk name to binary}
    ch := ucase(ch);
    ch := chr(ord(ch) - ord('@'));

    title[0] := ch; {byte 0 is disk unit number}

    {re-set cp/m, default dma buffer to 80 hex}
    func := 13; {mvi c,resetf}
    setdisk(func); {call bdos}
    writeln;
    gdir(title);
    writeln;
end;

begin (*main*)
    repeat list until false;
end.
```

### If you won't read these 7 signals of cancer...

You probably have  
the 8th.

American Cancer Society

1. Change in bowel or bladder habits.
2. A sore that does not heal.
3. Unusual bleeding or discharge.
4. Thickening or lump in breast or elsewhere.
5. Indigestion or difficulty in swallowing.
6. Obvious change in wart or mole.

7. Nagging cough or hoarseness.

8. A fear of cancer that can prevent you from detecting cancer at an early stage. A stage when it is highly curable. Everyone's afraid of cancer, but don't let it scare you to death.

Listing 2: Sample output from "getdir" showing both the A and B disk directories.

getdir

LIST DISK DIRECTORY: Unit A or B? a

A : STAT	COM : EDIT	COM : SYSF	COM : PIP	COM
A : AUTO	COM : SETBIT	COM : GNTOKEN	LIB : DRAW	SRC
A : PAS	COM : PROMOLIB	SRC : PASCAL/B	RTP : PIERRORS	TXT
A : P2ERRORS	TXT : GDIR	DOC : GDIR	BAK : GDIR	LIB
A : CRTLONG	LIB : TRAILMIN	LIB : P2/BCD	OVL : SOLIO	LIB
A : VIEW	COM : LTEST	SRC : LTEST	COM : LTEST	BAK
A : ITEST	BAK : ITEST	COM : ITEST	SRC : TTYLONG	BAK
A : TTYLONG	LIB : GETDIR	SRC : GETDIR	BAK : GETDIR	COM

LIST DISK DIRECTORY: Unit A or B? b

B : QUMESTAR	COM : PIP	COM : STAT	COM : RND/IO	SRC
B : WRITEHEX	LIB : P2/FLT	OVL : STDLIB	SRC : GNB	LIB
B : PASCAL/F	RTP : FLTCOMP	COM : WNB	LIB : NEWDB	SRC
B : GNR	LIB : CATALOGX	SRC : PARSTEXT	SRC : SID	COM
B : CRTLONG	LIB : GDIR	LIB : PIERRORS	TXT : DCONV	LIB
B : GNSTR	LIB : DUMPSUBS	SRC : SETBIT	SRC : DISKMAP	LIB
B : DEMOIO	SRC : P2ERRORS	TXT : PARSEFRAC	LIB : PARSERS	SRC
B : SCONV	LIB : CLONGTRM	LIB : PARSEIO	LIB : WSMSGS	COM
B : SOLIO	LIB : WNSTR	LIB : TTYLTRM	LIB : RDCONSF	LIB
B : UTILMISC	LIB : CALC	SRC : PRINTAT	SRC : FNAMPARS	LIB
B : CHAROPS	LIB : HEXC	LIB : TTYLONG	LIB : READHEX	LIB
B : TTEST	SRC : SETMEM	LIB : READSTR	LIB : GETSYM	LIB

LIST DISK DIRECTORY: Unit A or B?

SLUDER HAS HIGH PERFORMANCE 6MHz to 10MHz SYSTEMS FOR EVERYONE

WE ARE A AUTHORIZED CompuPro<sup>tm</sup> System Center and Authorized DEALER For Lomas Data Products, Seattle Computer, and Morrow Designs. ALL SYSTEMS SHIPPED READY TO BOOT & RUN. Our Budget Line is in an Integrand Cabinet with 10 slot MB w/drives

LUXURY LINE SHOWN CENTER

Godbout CSC 10MHz 8086,

RAM 16, Disk 1, I/O I

CP/M 86<sup>tm</sup> Qume DT8's

& C.V.T on drs \$4395.

CSC CPU Z,64K,(2)8" 3895.

CSC 85/88,64K,(2)8" 3995.

Lomas Systems with C.V.T

10MHz 8086,128K, 3995.

MPM86<sup>tm</sup> 86,256K,DRS 4795.

Seattle Sys I,DrS 4145.

Seattle Sys II,DRS 4745.

Prism 80 w/options 949.

CP/M86 & MPM86 are trademarks of Digital Research ALL Prices Subject to Change

SLUDER P.O. BOX 951 Westminster, CA 92683-0951 (714) 895-1746



BUDGET LINE NOT SHOWN

6MHz CPU Z,64K,(2)8" \$2695.

6MHz 85/88,64K,(2)8" 2695.

8MHz 8086, 64K,(2)8" 3095.

Above are Godbout Systems

Lomas Data Products Below

10MHz 8086,128K,(2)8" 2995.

MPM86,8086,256K,(2)8" 3695.

Morrow Decision I Basic 1295.

Decision I System 3150.

Godbout Disk II 596.

Godbout 8086 A&T CPU 521.

C.Itoh F10 par. 40cps 1395.

# What's New?

## PUBLICATIONS

### Microcomputer Business Guide

Your Fortune in the Microcomputer Business, a two-volume series, serves as a complete reference guide for anyone wanting to break into the microcomputer industry. The first volume surveys the market, shows you how to select the right product or service and get necessary capital, and details the steps to follow when establishing a business. The second volume deals with the problems and decisions that must be faced when business starts rolling.

Each volume of *Your Fortune in the Microcomputer Business* costs \$20. For further details, contact Wildfire Publishing Co., 326 Toro Canyon Rd., Carpinteria, CA 93013, (805) 684-1489.

Circle 550 on inquiry card.

### TRS-80 Interfacing Guide

The TRS-80 M1/M3 Interfacing Guide describes the APIO-80 all-purpose I/O interface for the TRS-80 Models I and III. The guide offers information on how to control AC circuits with relays or triacs; how to control moisture, light, and voltage sensors; and how to control analog I/O. Also described are basic software techniques such as controlling individual bits and creating programmable waveforms. Additionally, the guide has in-

formation on interfacing a TRS-80 to a telephone for remote applications. The guide is available for \$2.50 from Syntex Electronic Innovations, Department 86, POB 4034, Lancaster, PA 17604.

Circle 551 on inquiry card.

### Computer Science Catalog

The 1982 edition of the North-Holland Computer Science Catalog has information on 130 books and 25 journals covering all branches of information processing. The catalog is available free of charge from Han van Eybergen, North-Holland Publishing Co., POB 103, 1000 AC, Amsterdam, the Netherlands.

Circle 552 on inquiry card.

### Wordstar 3.0 Literature

A 16-page brochure that describes the 3.0 Wordstar word-processing program is available from Micropro International. The brochure illustrates the standard operating capabilities of the program and its new features, which include horizontal-scroll and column-move capabilities and easy-to-understand menus. Descriptions of the Spellstar and Mail Merge programs are provided. For your copy, contact Micropro International Corp., Literature Department, 1299 Fourth St., San Rafael, CA 94901, (415) 457-8990.

Circle 553 on inquiry card.

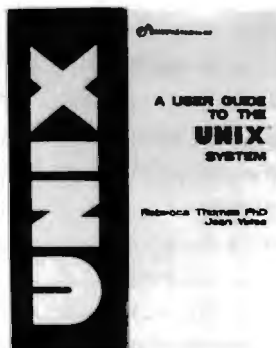

### Guide to Unix

*A User Guide to the Unix System* by Jean Yates and Rebecca Thomas is an introduction to the structure, software, and capabilities of this popular operat-

ing system. Written with the beginner in mind, this book explains how to log on to the system, enter the shell, handle files, send mail, and create directories. Other features include an introduction to Unix's sophisticated utility programs and information about Unix system software, related products, university facilities, user groups, and newsletters.

The book is available in paperback for \$15.99 from Osborne/McGraw-Hill, 630 Bancroft Way, Berkeley, CA 94710, (415) 548-2805.

Circle 554 on inquiry card.

### Management by Multiple Objectives

*Management by Multiple Objectives (MBMO)* is both a procedure and the title of a new book by Sang M. Lee. MBMO is an approach to integrating management systems and modern management technology to achieve many objectives. MBMO addresses a major shortcoming of management by objectives: how to reconcile mutually exclusive objectives to best meet the

goals of the entire organization.

*Management by Multiple Objectives* provides a basic understanding of MBMO concepts and techniques as well as the resources required to design and carry out an effective MBMO system. It is available for \$17.50 from Van Nostrand Reinhold Co., 135 West 50th St., New York, NY 10020, (212) 265-8700.

Circle 555 on inquiry card.

### Games for PETs

Playmasters Mac Oglesby, Len Lindsay, and Dorothy B. Kunin have designed a collection of computer games and recreations for computer-game enthusiasts of all ages. *PET Games and Recreations* has games that test your ability to plot winning strategies, that cast you in the role of a detec-

tive, and even games that help develop counting and language skills.

In hardcover, *PET Games and Recreations* costs \$14.95. The softcover price is \$9.95. For details, contact the Reston Publishing Co., 11480 Sunset Hills Rd., Reston, VA 22090, (800) 336-0338; in Virginia, (703) 437-8900.

Circle 556 on inquiry card.



# What's New?



## Introduction to Microprocessors

**From Chips to Systems: An Introduction to Microprocessors**, by Rodnay Zaks, is written for owners and users of personal and business computers. Containing more than 320 illustrations, the book explains what a microprocessor is, what it does, and how it performs its tasks.

**From Chips to Systems: An Introduction to Microprocessors** is available in softcover for \$14.95 from Sybex, 2344 Sixth St., Berkeley, CA 94710, (415) 848-8233.

Circle 557 on inquiry card.

## Programming the Apple

**Programming the Apple** by John Campbell and Lance Zimmerman contains enough information to keep even the best programmer occupied for a long time, yet beginners can also benefit from it. The book has more than 330 illustrations that help readers understand Apple program development and testing, graphics, and operating systems. A glossary and a bibliography are provided.

**Programming the Apple** costs \$24.95. Contact Mesa Research Inc., Route 1, Box 1456A, Waco, TX 76710, (817) 848-5272. Circle 558 on inquiry card.

## Computer Simulation of Cryptography

**Computer Simulation of Classical Substitution Cryptographic Systems** by Rudolph F. Lauer is packed with BASIC programs that let users simulate virtually any classical substitution cipher system. A number of cryptanalytic programs that assist readers in solving problems are given in each chapter. Other features include information on and a comprehensive list of U.S. cryptographic patents, a treatise on cryptanalysis, background information on various systems, discussions on cryptographic problems, and problems to be solved.

**Computer Simulation of Classical Substitution Cryptographic Systems** is available in softcover for \$24.80 from Aegean Park Press, POB 2837, Laguna Hills, CA 92653, (714) 586-8811.

Circle 559 on inquiry card.

## SYSTEMS

### Super/Net

The Super/Net, a single-board S-100 computer system, runs under the CP/M or MP/M operating systems. The board consists of a 64K-byte bank-select dy-

namic RAM (random-access read/write memory), a Z80A processor, a 2K-byte 2716 monitor EPROM (erasable programmable read-only memory), 5¼- and 8-inch floppy-disk controller, two serial and two parallel ports, and a Z80A counter/timer circuit for real-time interrupts.

The Super/Net meets IEEE-696 S-100 bus specifications and has a suggested retail price of \$1125. Contact Advanced Micro Digital Corp., Suite E, 7201 Garden Grove Blvd., Garden Grove, CA 92641, (714) 891-4004.

Circle 560 on inquiry card.

## Multuser System Supports Work Stations

The 5032 Multishare is a multuser, multitasking system that can support up to five work stations. The 5032 features a 32-mega-byte 8-inch Winchester hard-disk drive, a 6-MHz Z80B processor, and an expanded 128K-byte RAM (random-access read/write memory) that provides 56K bytes per terminal. Additionally, the 5032 has an extended version of the CP/M operating system and the ability to support a serial and a parallel printer simultaneously. Standard software includes Microsoft BASIC, the Scope editor, and ZSM assembler.

Available options include a four-track 15-megabyte cartridge-tape unit for system backup. The basic 5032 Multishare System, comprised of a video console, keyboard,

chassis with independent power supply, the Winchester drive, and a floppy-disk drive, costs \$13,995. Additional terminals cost \$1995 apiece; the backup tape drive costs \$3695. Contact Vector Graphic Inc., 500 North Ventu Park Rd., Thousand Oaks, CA 91320, (805) 499-5831.

Circle 561 on inquiry card.



## Business Computer

The basic Victor 9000 business computer has 128K bytes of memory, internally expandable to 256K or 521K bytes. Standard features of this 16-bit machine include disk-storage capacity of 1.2 megabytes, detachable keyboard with a user-defined function key, a 10-key numeric keypad, and a tilt-and-swivel video monitor with dual-format operation. In the normal format, the monitor can approximate a typewritten page of 80 characters by 25 lines. In the expanded mode, under program control, the character generator can display 132 characters by 50 lines. The screen can simultaneously display high-resolution graphics, bar charts, pie charts, diagrams, and schematics. It's

# What's New?

capable of addressing up to 800 horizontal dots by 400 vertical dots.

The Victor 9000 is available for \$4995. Contact Victor Business Products, 3900 North Rockwell St., Chicago, IL 60618, (312) 539-8200.

Circle 562 on inquiry card.

## Eagle Comes with Software

The Eagle II small-business computer is supplied with its own software. Users merely select the suitable software package to use the Eagle for word processing or accounting applications. In the accounting mode, a single entry simultaneously places information into the appropriate accounts: general ledger, accounts receivable and payable, inventory control, payroll, sales or purchase order, and so forth. The Eagle's double-entry accounting system automatically checks for errors.

In the word-processing mode, the Eagle displays information onscreen for editing, rearranging, storage, or output to a printer. Operating instructions can be accessed by a help key.

The Eagle II is CP/M-compatible, and its mass storage is expandable to more than 10 megabytes. It features both a standard typewriter keyboard and a numeric keypad. The Eagle II is available for \$4995 from Transnational Computer Corp., 1545 Old Bayshore Highway, Burlingame, CA 94010, (415) 692-7525.

Circle 563 on inquiry card.



## 6502-based Desktop System

The MTU-130 is a 6502-based desktop computer that can address more than 64K bytes of RAM (random-access read/write memory) without explicit bank-switching commands. The MTU-130 has a 256K-byte address space, 480 by 256 high-resolution graphics, up to 4 megabytes of storage on floppy disk, 80K bytes of RAM (random-access read/write memory), and antipiracy hardware that allows software vendors to protect their work. The system's 96-key keyboard features a full numeric keypad, cursor keys, and 10 programmable function keys. Other features include a one-watt audio amplifier, a 5- by 3-inch speaker, slots for four expansion boards, rear connectors for RS-232C and two parallel I/O ports, and switched AC outlets. The MTU-130's 80-character by 25-line display features a full-screen editor.

System software includes an advanced disk operating system called CODOS, which has Unix-style files, device-independent I/O, and, according to the manufacturer, the ability

to locate and load a 32K-byte file in less than 3 seconds. Microsoft BASIC is provided and has been enhanced to allow programs to specify "libraries" of additional commands. Standard libraries include graphics and operating-system interface commands. Also provided is a four-voice music package that uses the system's 8-bit analog-to-digital converter.

The MTU-130 is available from Micro Technology Unlimited, 2806 Hillsborough St., POB 12106, Raleigh, NC 27605, (919) 833-1458.

Circle 564 on inquiry card.

## Cromemco Unveils Desktop Computer

Cromemco's System One desktop computer is designed for single- and multiuser applications. The basic System One comes with Cromemco's Z80A-based central processing unit, 64K bytes of RAM (random-access read/write memory), a printer interface, and dual quad-capacity 5¼-inch floppy-disk drives that can provide up to 780K bytes of storage.

Standard features include diagnostics that provide a quick test to see that the memory, controller, and disk drives are operating properly. Software support includes the Writemaster word-processing program, the Slidemaster graphics package, and a database-management system. Available software includes Structured BASIC, FORTRAN, COBOL, C, RATFOR, and LISP.

The Model CS-1 System One, with a choice of operating systems including Cromix, is available from Cromemco dealers for \$3995. Contact Cromemco Inc., 280 Bernardo Ave., Mountain View, CA 94043, (415) 964-7400.

Circle 565 on inquiry card.

## JBE 1 Single-board Computer

The 6502-based JBE 1 is a single-board microcomputer with room enough for 16K bytes of EPROM (erasable programmable read-only memory), 4K bytes of RAM (random-access read/write memory), eight parallel ports, and a serial port. All address and data lines, power supply, RDY (ready), interrupts, and DMA (direct memory access) are brought off the board to a 50-pin edge connector.

Three JBE 1 versions are available: a fully populated board, a partially populated board, and a bare board. Documentation includes a 6502 programming manual and complete documentation for a 6522

# What's New?

VIA [versatile interface adapter], interfacing with an AD/DA [analog-to-digital/digital-to-analog] converter, solid-state switch, EPROM programmer, and a parallel-input speech synthesizer.

Available options include a monitor and tiny BASIC. The fully populated JBE 1 costs \$349.95, the partially populated version is \$249.95, and the bare board costs \$89.95. The EPROM with Tiny BASIC is available for \$19.95; the EPROM with monitor costs \$19.95. Information is available from John Bell Engineering Inc., POB 338, Redwood City, CA 94064, (415) 367-1137.

Circle 566 on inquiry card.

## New Computer from Hewlett-Packard

The HP-87 microcomputer features an 80-column by 24- or 16-line high-resolution video display with 16K bytes of dedicated RAM [random-access read/write memory]. Standard features include 48K bytes of enhanced HP [Hewlett-Packard] BASIC in ROM [read-only memory] and 32K bytes of RAM, expandable to 544K. All RAM is automatically configured into a single block when the HP-87 is switched on. Additionally, all memory can be used for program execution and data storage. Other system highlights include CP/M and HP-85 compatibility and a built-in interface, the HP-1B, which can communicate with a wide variety of

Hewlett-Packard peripherals.

Among the options available for the HP-87 are Visicalc Plus, a serial RS-232C interface, a Centronics-type parallel printer, and add-on RAM modules of 32K, 64K, and 128K bytes. Software available for the HP-87 includes Hewlett-Packard CP/M software, Micropro's database management programs, and the Wordstar word-processing system.

The HP-87 is available at local Hewlett-Packard dealers for \$2495 to \$7995, depending upon optional equipment. For the location of your nearest Hewlett-Packard dealer, call (800) 547-3400. In Alaska, Hawaii, and Oregon, call (503) 758-1010.

Circle 567 on inquiry card.

## S-100 Computers

Tecmar's new series of S-100 microcomputers are based on the 16-bit 8086 microprocessor. The Tec-86 includes the 8086 with vectored interrupts; 64K bytes of dynamic RAM [random-access read/write memory] or 32K bytes of static RAM, expandable to 1 megabyte; two serial RS-232C ports; three 8-bit parallel ports; EPROM [erasable programmable read-only memory] boot for the CP/M-86 operating system; double-density floppy-disk controller; dual 8-inch Shugart Associates' floppy-disk drives; and power supplies. The Tec-86W has all these features

plus a 31-megabyte Winchester hard-disk drive and 256K bytes of RAM.

Systems software includes CP/M-86, Microsoft BASIC-86, and Pascal/M86. The Tec-86 costs \$3990; the Tec-86W costs \$9990. For details, contact Tecmar Inc., 23600 Mercantile Rd., Cleveland, OH 44122, (216) 464-7410.

Circle 568 on inquiry card.

## SOFTWARE

### Unix Features for CP/M

Microshell is a user-friendly interface program that brings the power of the Unix operating system to any 8080-, 8085-, or Z80-based CP/M 2.2 system. Compatibility with CP/M programs is retained, but the user can enter multiple commands on a line, send normal output to a file rather than to the screen, and take input from a file instead of the keyboard. Microshell performs automatic disk-drive searches, eliminating the need for disk-drive prefixes to file names. Other features include direct execution of commands from a file without using the submit facility, user-defined prompt with drive or user number, user-customized search path to accommodate floppy- or hard-disk configurations, and an expanded submit facility. The Unix pipe facility is carried out using temporary files.

Microshell is available on 5¼- or 8-inch disks, including manual, for \$150. For

further details, contact New Generation Systems Inc., 2153 Golf Course Dr., Reston, VA 22091, (703) 476-9143.

Circle 569 on inquiry card.

## Disk Catalog System

Catalog, a master disk-cataloging system for CP/M-based 8080/Z80 computers, builds and maintains a compressed master database that's packed with information pertinent to each file. File displays include file name, file type, file size, and disk numbers with file- and user-entered notes. Among its other features are disk-content displays with the date of last entry and space used, and a quick summary of all disks including disk number and date last entered into database.

Catalog operates on CP/M versions 1.4, 2.0, and 2.2, and requires two disk drives and 24K bytes of memory. Catalog is available for \$75, plus \$2 shipping and handling, from SRX Systems, 2812 Westberry Dr., San Jose, CA 95132, (408) 926-9411. Circle 570 on inquiry card.

## BASIC Language Extension

BLX [BASIC Language Extension] is a structured programming tool that makes readable BASIC-80 or CBASIC programs possible. BLX provides an assortment of structures for program flow control, consist-



# What's New?

tently formatted listings to highlight program structure, automatic indentation of structures, remark positioning, and subroutine separation. It produces two outputs: a "pure" BASIC file and a formatted listing file.

Designed to be used with 44K-byte CP/M operating systems, BLX costs \$95, including documentation. The documentation alone costs \$20; the BLX translator with documentation is available for \$65. For further details, contact Quelo, 843 Northwest 54th, Seattle, WA 98107, (206) 784-8018.  
Circle 571 on inquiry card.

## 6809 Pascal Compiler

Omegasoft's native-code Pascal compiler runs under the MDOS, XDOS, Flex, DOS69, or OS-9 operating systems. The single-pass compiler rapidly translates Pascal into optimized 6809 assembly-language code. It permits long integers that allow representation of dollar amounts without the speed penalties of double-precision real or BCD (binary-coded decimal) implementations. Full dynamic-variable allocation is provided by means of the NEW, DISPOSE, MARK, and RELEASE procedures. Random-access files are supported. Other features include a symbolic debugger, run-time library with source code, and utilities to assist in creating a chain file for automatically linking a user's program with the run-time library.

The native-code Pascal compiler requires a 48K-byte system. Options include a relocatable assembler and linker. The compiler is supplied with a language reference handbook and a configuration manual detailing operating-system-dependent features. The suggested price is \$425. The assembler and linker cost \$75. Contact Omegasoft Industrial Products Group, POB 70265, Sunnyvale, CA 94086.

## Project Management System

The Visischedule program lets you create on-screen schedules of projects and tasks that incorporate all pertinent data, including costs, manpower, resource leveling, and scheduling constraints. Immediate response is given to your "What if?" schedule changes, complete with effects on subsequent events. Visischedule can chart and print out start and stop dates, slack time, holidays, and deadlines for as many as 160 projects. Visischedule can generate computer reports providing critical-path information, cost estimates, deadlines, and prerequisites of all or some of the project tasks.

Visischedule requires an Apple II or II Plus with a minimum of 48K bytes of memory and two disk drives. It's available for \$300 from Visicorp, 2895 Zanker Rd., San Jose, CA 95134, (408) 946-9000.  
Circle 572 on inquiry card.

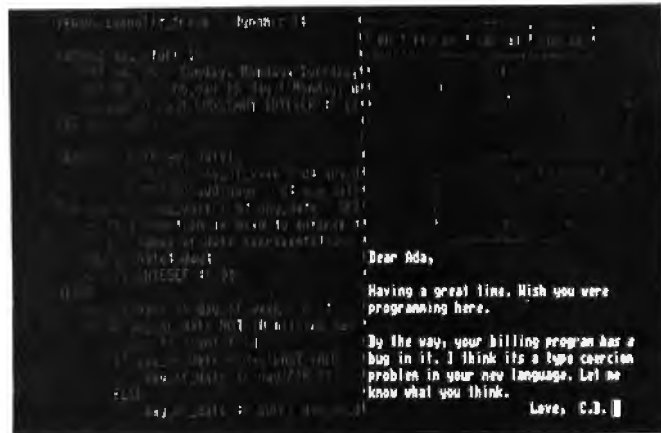

## Electric Blackboard

The Electric Blackboard is a multiwindow full-screen text editor that runs on any Z80-based microcomputer running under the CP/M operating system. The Blackboard lets you divide your display screen into vertical and horizontal windows as narrow as one column or as thin as a line. Text is edited directly in each window, and results are seen immediately. Windows can be created or deleted as needed. The Blackboard lets you load, save, erase, move text, replace strings, and perform other functions when you want and in any window, independently of the other windows. Other features include automatic horizontal and vertical scrolling, keystroke saving, large- and wide-file editing, automatic memory management, a picture cursor that lets you set the direction that the cursor will move after a character is typed, the ability to display two or more separate pieces of text, and easy rendering of diagrams, flowcharts, and graphs.

The Electric Blackboard, including a learning guide, a reference manual, and a quick-reference card, costs less than \$200 and is available from Santa Cruz Software Services, 1711 Quail Hollow Rd., Ben Lomond, CA 95005, (408) 336-2170.  
Circle 573 on inquiry card.

## Smart Security Analysis

The SMART (Securities Market Analysis, Reporting, and Transaction) system is designed for institutional money managers and sophisticated investors. SMART gives the Apple II Plus the ability to retrieve, store, graph, and analyze securities and economic data. A portfolio module provides capabilities for maintaining and reporting data and transactions for securities portfolios. SMART lets you automatically access data from one or more remote databases over telephone lines and prepare graphic displays in a variety of formats. Analytic tools include moving averages, exponential smoothing,

# What's New?

momentum, trend lines, and user-defined formulas.

SMART, which is available for \$1950, requires a 48K-byte Apple II Plus, two disk drives, a micromodem, a monitor, and a printer. For more information, contact Software Resources Inc., Suite 310, 186 Alewife Brook Parkway, Cambridge, MA 02138, (617) 497-5900.

Circle 574 on inquiry card.

## SMC BASIC on Fortune 32:16

Fortune System's 32:16 microcomputer is now available with SMC BASIC, a business-oriented interpreter with keyed-access capabilities, dynamic-memory management, and fast execution. SMC BASIC allows the IDOL database-management system and other business-applications software to be run on the 68000-based Fortune 32:16. For further details, contact SMC Systems and Technology Inc., Proprietary Systems Division, POB 6800, Bridgewater, NJ 08807, (201) 685-9000. Circle 575 on inquiry card.

## Farm and Ranch Management Programs

American Small Business Computers' Farm and Ranch Management programs are designed for the Radio Shack TRS-80 Models I, II, and III. Developed at the Oklahoma State University's Agriculture division, program titles include Beef Projection, Feed

Lot, Government Program, Feed Formulator, and Pasture Projection. Program prices range from \$15 to \$100. Contact American Small Business Computers, 118 South Mill St., Pryor, OK 74361, (918) 825-4844. Circle 576 on inquiry card.

## Color Adventures

Your Apple II can be the setting for Scott Adams's series of high-resolution-graphics Adventures. The graphics are compressed and drawn using more than 100 colors. In addition, the programs support the Votrax Type 'N Talk voice synthesizer. Adventureland, the first adventure in the series, is available for \$29.95 from Adventure International, Department G, POB 3435, Longwood, FL 32750, (800) 327-7172; in Florida, (305) 862-6917.

Circle 577 on inquiry card.

## CP/M Users Compat

Compat, a disk-utility program that provides CP/M users with complete access to IBM System 3740 formatted disks, offers total file-compatibility between CP/M and IBM 3740 disks. With Compat, IBM data can be read into and can be processed by a CP/M system, and vice versa. Additionally, IBM 3740 disks can be created on a CP/M system. Compat costs \$99.95 and is available from Starr Computer Systems Inc., 6126 Melissa Ln., Omaha, NE 68152, (402) 571-1722.

Circle 578 on inquiry card.

## PERIPHERALS



## Portable Terminal with Printer

The Execuport 4120 is a multiprocessor-based portable terminal system with a thermal printer. The 4120 can produce high-resolution characters up to 233 characters per line, complete with fully formed lowercase descenders, at speeds of up to 120 cps (characters per second). Two character fonts are available: 9 by 11, which can print both standard

and high-resolution copy at 10 characters per inch, and 5 by 7, which produces a 16 $\frac{3}{4}$ -characters-per-inch compressed print. System operating modes can be changed through keyboard instructions.

The 4120 is offered with a choice of modems and modem combinations that operate at 300 bps (bits per second) and 1200 bps. Through its RS-232C port, the 4120 can communicate at data rates up to 9600 bps. Provisions are available for as much as 56K-byte RAM (random-access read/write memory). For further details, contact Computer Transceiver Systems Inc., East 66 Midland Ave., POB 15, Paramus, NJ 07652, (201) 261-6800.

Circle 579 on inquiry card.

## Small-System Network Capability

Radio Shack's Network 3 Controller can link 16 non-disk TRS-80 Model IIIs to a master Model III disk computer. With the Network 3 in command, each work station can simultaneously run a disk-based program while functioning as if it were an independent, disk-equipped unit, complete with disk load and store commands. The Network 3 lets each work station select any program from a menu of programs on the host computer and employ a printer (optional) attached to itself or to the host computer. Print requests to the host com-

puter are automatically queued.

The TRS-80 Network 3 Controller requires a TRS-80 Model III with a minimum of 32K bytes of RAM (random-access read/write memory), one disk drive, and an RS-232C interface for its host. Individual work stations require a TRS-80 Model III with a minimum of 16K bytes of memory, Model III BASIC, and an RS-232C interface. The Network 3 Controller is available for \$599 at Radio Shack stores, Computer Centers, and participating dealers. Circle 580 on inquiry card.

# What's New?

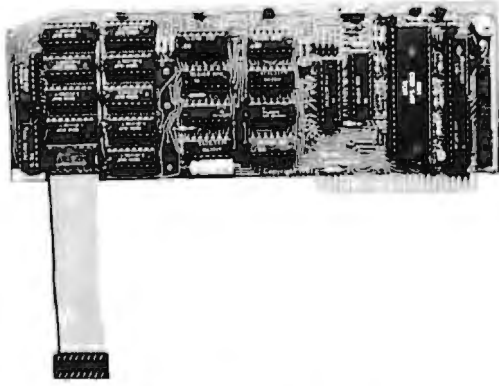

## Add Versatility to Your Apple

The Synergy-Card is a 16K-byte RAM (random-access read/write memory) card capable of adding a parallel printer port (Centronics standard), a serial RS-232C port, two interval timers, a real-time clock/calendar, and a BSR X-10 interface to an Apple II. It can save up to five Apple slots while reducing power consumption. Serial data rates are software-selectable from 50 to 9600 bits per second.

Options for the Synergy-Card include two programmable-interval timers that allow the Apple to do multiprogramming by producing regular interrupts so

that programs can be run on a priority basis. An optional clock/calendar, supplied with batteries, is capable of automatically storing file creation time and date plus displaying day of week, month, year, hour, minute, second, and millisecond. The BSR X-10 interface option lets the Apple control any plug-in electrical device.

The Synergy-Card costs \$195, including a user's manual. The options range in price from \$20 to \$59. Contact Spies Laboratories, POB 336, Lawndale, CA 90260, (213) 644-0056. Circle 581 on inquiry card.

## Logic Analyzer

The Kanel A2-1 logic-analyzer card can analyze TTL-compatible MOS (metal-oxide semiconductor) and TTL circuits. Designed for the Apple II, the card has 32 data input probes and 16 data output probes that are connected to the card by three ribbon cables. Software-supplied displays enter signals as columns of 1s and 0s. Additionally, from one to 16 inputs can be used for a trigger pattern.

The A2-1 is supplied with sample routines in BASIC, Pascal, and assembly language that can help you write custom programs for programmed stimulus-and-response interaction with circuits to be tested. The A2-1 logical analyzer costs \$400 and is available from the Kanel Corp., Department A, 1025 Reynolds Rd. B202, Johnson City, NY 13790. Circle 582 on inquiry card.

## Letter-Quality Printers

Southern Systems introduces two letter-quality daisy-wheel printers. The Model 3500 operates at 33 cps (characters per second), and the Model 7700 operates at 55 cps. Both feature parallel or serial interfacing (synchronous or asynchronous), automatic proportional spacing, and ribbon cartridges. The printers' forms-handling options include bidirectional tractor feed, cut-sheet guide with automatic loading, single-bin cut-sheet feeder, and a dual-bin adapter. Word-processing options include proportional-space printing, half-linefeed, negative half-linefeed, automatic bold printing, shadow printing, and underscore.

For complete details on these printers, contact Southern Systems Inc., 2841 Cypress Creek Rd., Fort Lauderdale, FL 33309, (305) 979-1000. Circle 583 on inquiry card.

## Family of Printers

The IPS-5000-C is the featured member of Dataroyal's new line of intelligent printers. The 5000-C is a 165-character-per-second impact dot-matrix printer with increased programmable memory, graphics abilities, international character sets (optional), and a variety of user-selectable print styles. Standard features include a 500-character FIFO (first-in/first-out) buffer, X-ON/X-OFF protocols, paper and forms-handling widths from 3 to 15 inches, and

the ability to print originals plus five copies. The 5000-C has both a parallel Centronics-type interface and an RS-232C interface, which operates at data rates from 110 to 9600 bits per second. Mean time between failures is 1500 hours at 100-percent duty cycle and paper density.

Members of the IPS-5000 family range in price from \$1100 to \$1695; quantity discounts are available. For further details, contact Dataroyal Inc., 235 Main Dunstable Rd., Nashua, NH 03060, (603) 883-4157. Circle 584 on inquiry card.

## New Televideo Products

Televideo Systems has added four new items to its product line. The first, the Intelligent I, is a smart video-display terminal. It features 64K bytes of RAM (random-access read/write memory), which gives it local-processing capabilities. The Intelligent I has a suggested retail price of \$1695. The second product, the Model 970 video-display terminal, is an extension of the company's Model 950 smart terminal. It has expanded memory and additional operating and printing functions.

The final two products are mass-storage devices for the TS806 computer, a multiuser system with 64K bytes of RAM, a 10-megabyte 5¼-inch Winchester disk drive, and a 500K-byte floppy-disk storage unit. The TS806C is a tape-cartridge unit that provides 17.2 megabytes of backup



# What's New?

tape-storage capacity. The TS806H gives the TS806 computer an additional 10-megabyte, 5¼-inch Winchester disk drive. The TS806C has a suggested retail price of \$3995. The TS806H costs \$3600. For complete details on these and other products, contact Televideo Systems Inc., 1170 Morse Ave., Sunnyvale, CA 94086, (408) 745-7760.

Circle 585 on inquiry card.

## Video-Cassette Recorder Control Board

The AM-610 is a VCR (video cassette recorder) controller board that uses a standard VCR and video-cassette tapes for data backup and transfer of user-selected files. The AM-610 provides file-oriented backup and a directory, so users can selectively record or retrieve random and sequential files. A single video tape can back up as much as 100 megabytes of data, depending on the tape's length, the mixture of random and sequential files, and the amount of recording redundancy desired. When used with an Alpha Micro time-of-day clock and a programmable VCR, the AM-610 can provide automatic backup capabilities.

For complete details, contact Alpha Micro, 17881 Sky Park North, POB 18347, Irvine, CA 92713, (714) 957-1404. Circle 586 on inquiry card.

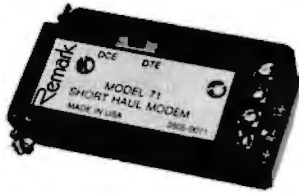

## Local-Network Component

The Model 71 is a short-haul modem that serves as a local-network component for any RS-232C device. It can operate at distances of 2 to 10 miles, at speeds of up to 9600 bps, full-duplex, using two twisted cable pairs, or simplex, using a single twisted pair. Designed for asynchronous operation, the network must provide DC continuity and be of the nonload type. The Model 71 draws its power from the host device.

In single units, the Model 71 costs \$87; quantity discounts are available. For details, contact Remark Datacom Inc., 4 Sycamore Dr., Woodbury, NY 11797, (516) 367-3806. Circle 587 on inquiry card.

## MISCELLANEOUS

### Manifest System Streamlines Shipping

The Parcel Manifest System is designed to streamline small package shipping. The system performs shipping functions such as weighing the parcel, calculating shipping charges, and selecting the least costly carrier; prints manifests; and compiles daily, monthly, and yearly shipping

reports. The system consists of a Z80-based micro-computer, a line printer, an electronic scale that sends data directly through an RS-232C interface, and software. The standard unit is equipped to handle both UPS (United Parcel Service) and U.S. Postal Service carriers and is designed to manage 3000 parcels in an eight-hour period. Modules for other carriers are available.

The Parcel Manifest System costs \$8995. For complete details, contact Tandata Corp., Suite Six, 3336 East 32nd St., Tulsa, OK 74135, (918) 747-2071. Circle 588 on inquiry card.



## Power-Line Monitor

The Inmac Power-Line Monitor can save you the expense of unnecessary repair calls by helping you determine whether a system shutdown is due to a faulty system or a power problem. The device keeps track of the power fed to computers and other sensitive equipment using 120 volts AC. It can pinpoint six different types of problems: power failure, low- or high-line voltage, voltage spikes

or dropouts, and high-frequency noise. Line problems are indicated by LEDs (light-emitting diodes) and by a user-selectable alarm.

The Inmac Power-Line Monitor costs \$295; quantity discounts are available. For details, contact Inmac Corp., Department 23, 2465 Augustine Dr., Santa Clara, CA 95051, (408) 727-1970.

Circle 589 on inquiry card.

## CP/M 2.2 for TRS-80 Model III

The CP/M 2.2 operating system is now available for the TRS-80 Model III, thanks to Parasitic Engineering. Shuffleboard III uses a memory-mapping technique that lets the TRS-80 use standard CP/M. It comes with 16K bytes of RAM (random-access read/write memory); 2K bytes of ROM (read-only memory) expandable to 8K bytes; and Maxi-Disk CP/M 2.2, which supports single- or double-density 5¼-inch disk drives and enhances the keyboard and screen. With the Maxi-Disk, the keyboard can generate all 128 ASCII (American Standard Code for Information Interchange) and all CP/M control characters. Additionally, the screen can handle both nondestructive cursor movements and direct cursor addressing.

Shuffleboard III plugs directly into two sockets within the TRS-80; soldering and cut traces are not required. Shuffleboard III costs \$495, including manuals and installation instructions. For more information, contact Parasitic

# What's New?

Engineering Inc., 1101 Ninth Ave., Oakland, CA 94606, (415) 839-2636. Circle 590 on inquiry card.



## Miniature Microprocessor Crystals

Statek has unrivaled a series of 1-MHz to 1.25-MHz quartz crystals that are 48 times smaller than the industry-standard HC-33 crystal package. Designed primarily for microprocessor-clock circuits, the crystals occupy only 10 percent of the board space required by conventional crystals. A 1-MHz version, the CX-11, is available with leads in a low-profile, hermetically-sealed ceramic package for use in printed-circuit board construction. Another version is leadless and can be used for direct surface mounting on printed-circuit boards or hybrid circuits.

In ten-unit lots, the crystals cost \$11.39 each. For details, contact Statek Corp., 512 North Main St., Orange, CA 92668, (714) 639-7810. Circle 591 on inquiry card.

## Computer Camps

The following is a list of computer camps and where to send for further information.

**Champlain College Computer Camp**, Room #4A, Box 670, 163 South Willard St., Burlington, VT 05402, (802) 658-0800.

**Computer Camp**, Registrar, J. Hamilton Welch Academy, 3049 McGregor Blvd., Fort Meyers, FL 33901, (813) 334-6044.

**Computer Camp Inc.**, Suite G, 1235 Coast Village Rd., Santa Barbara, CA 93103, (800) 235-6965; in California, (805) 969-7871.

**Family Computer Camp**, Conference and Information Center, Clarkson College, Potsdam, NY 13676, (315) 268-6647.

**Lake Forest Computer Camp**, Lake Forest College, Sheridan and College Roads, Lake Forest, IL 60045, (312) 234-3100.

**National Computer Camp**, POB 624, Orange, CT 06477, (203) 795-3049 or (203) 795-9495.

**Tar Heel Career Camps Inc.**, POB 2328, Chapel Hill, NC 27514, (919) 967-6996.

**Virginia Tech Computer Camp**, Carisa Blaylock, College of Education, 300 War Memorial Gym, Virginia Tech, Blacksburg, VA 24061, (703) 961-5587.

## High-Speed UARTs

The COM 8018 and the COM 1863 are high-speed UARTs (universal asynchronous receivers/transmitters) that operate at data rates of up to 62.5

kbps (thousand bits per second) at a 1-MHz clock rate. The COM 8018 has a high-accuracy mode in which the master transmitter and receiver clocks are 32 times faster than the data, rather than the standard UART speed of 16 times. This allows a higher-distortion margin in the receiver-data sampling, which, in turn, improves the data accuracy in noisy environments. When its high-accuracy mode is disabled, the COM 8018 is pin-compatible with industry-standard UARTs. The COM 1863 has the same features as the 8018, with two exceptions: it does not have pull-up resistors or the high-accuracy mode.

Both devices are available in ceramic and plastic 40-pin DIPs (dual inline packages). In 100-unit lots, they cost \$4.20 (plastic) and \$13 (ceramic) each. Contact Standard Microsystems Corp., 35 Marcus Blvd., Hauppauge, NY 11788, (516) 273-3100. Circle 592 on inquiry card.

## Microcomputer Reference Cards

Foldable, shirt-pocket-sized microcomputer-system reference cards are available from Nanos Systems. Each card has a complete summary of the system as well as its reference manuals. The cards are printed on heavy-stock paper stretch-wrapped in plastic for protection. Cards are available for a wide assortment of systems, including TRS-80 Model 1

BASIC and assembler, PET BASIC, Heath H-8/89 BASIC, Sinclair ZX80/81, and Atari BASIC and assembler. Card prices range from \$2.95 to \$5.95; quantity discounts are available. For further details, contact Nanos Systems Corp., POB 24344, Speedway, IN 46224, (317) 244-4078. Circle 593 on inquiry card.

## Where Do New Products Items Come From?

The information printed in the new products pages of BYTE is obtained from "new product" or "press release" copy sent by the promoters of new products. If in our judgment the information might be of interest to the personal computing experimenters and homebrewers who read BYTE, we print it in some form. We openly solicit releases and photos from manufacturers and suppliers to this marketplace. The information is printed more or less as a first-in first-out queue, subject to occasional priority modifications. While we would not knowingly print untrue or inaccurate data, or data from unreliable companies, our capacity to evaluate the products and companies appearing in the "What's New?" feature is necessarily limited. We therefore cannot be responsible for product quality or company performance.

## BYTE's Bugs

### New Address Correct Price

The new address for the Datasouth Computer Corporation is POB 240947, Charlotte, NC 28224. Also, the DS180 printer, mentioned in the March 1982 BYTE (see page 483), costs \$1595. We apologize for this error. ■

# SUNNY LOW LOW COST POWER SUPPLIES (LINEAR & SWITCHING) FOR S-100, DISK DRIVES

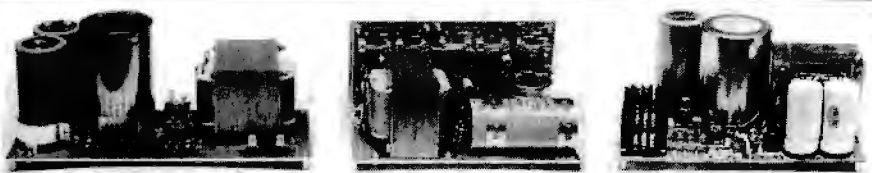

**KIT 1, 2 & 3** For S-100

**R3** For Three 8" or 5 1/4" Disk Drives

**S3** 2 in 1 Unit for S-100 and two 8" or 5 1/4" Disk Drives. It fits most Disk System Mainframes.

## S-100 POWER SUPPLY KITS

(OPEN FRAME WITH BASE PLATE, 3 HRS. ASSY. TIME)

ITEM	USED FOR	@ + 8 Vdc	@ - 9 Vdc	@ + 16 Vdc	@ - 16 Vdc	@ + 28 Vdc	SIZE W x D x H	PRICE
KIT 1	15 CARDS SOURCE	15A		2.5A	2.5A		12" x 5" x 4 7/8"	54.95
KIT 2	SYSTEM SOURCE	25A		3A	3A		12" x 5" x 4 7/8"	61.95
KIT 3	DISK SYSTEM	15A	1A	2A	2A	4A	14" x 6" x 4 7/8"	69.95

## DISK DRIVE POWER SUPPLY "R3" REGULATED, OPEN FRAME, ASSY. & TESTED ..... 69.95

SPECS: +5V @ 6A OVP, -5V @ 1A +24V @ 6A, SHORTS PROTECT. 2 SIZES AVAIL., 1) 9" (W) x 6 1/4" (D) x 4 7/8" (H), 2) 9" (W) x 4 7/8" (D) x 5 1/4" (H)  
OPTION: 1) REPLACE +24V BY +12V, 2) FOR SIZE 1 ONLY, ADD + 12V @ 1A, AT AN ADDITIONAL \$12.00.  
IDEAL FOR THREE 8" or 5 1/4" FLOPPY DISK DRIVES, SUCH AS SHUGART 801/851, SIEMANS FDD 100-8/200-8 OR 100-5 ETC.

## \* DISK SYSTEM PWR SUPPLY "S3" OPEN FRAME, ASSY. & TESTED. COMPACT SIZE: 10"(W) x 6"(D) x 5"(H) 102.95

REGULATED OUTPUTS FOR DISK DRIVES: +5V @ 5A, -5V @ 1A, +24V @ 5A (OR +12V @ 5A).  
UNREGULATED OUTPUTS FOR S-100: +8V @ 14A, ± 16V @ 3A.  
A COMPLETE UNIT FOR DISK SYSTEM WITH THE MAINFRAME CONTAINING 12 SLOTS & TWO FUSES PROTECT REG. OUTPUTS.  
WITH OVP CIRCUIT FOR +5V.

## POWER TRANSFORMERS (WITH MOUNTING BRACKETS)

ITEM	PRIMARY	SECONDARY #1	SECONDARY #2	SECONDARY #3	SIZE W x D x H	PRICE
T1	110/120	2 x 8 Vac, 15A	28 Vac, CT, 2.5A		3 3/4" x 3 3/8" x 3 1/2"	22.95
T2	110/120	2 x 8 Vac, 25A	28 Vac, CT, 3.5A		3 3/4" x 4 3/8" x 3 1/2"	28.95
T3	110/120	2 x 8 Vac, 15A	28 Vac, CT, 2.5A	48 Vac, CT, 2A	3 3/4" x 4 3/8" x 3 1/2"	30.95
T4	110/120	2 x 8 Vac, 6A	28 Vac, CT, 1.5A	48 Vac, CT, 3A	3 3/4" x 3 3/8" x 3 1/2"	23.95
T5	110/120	2 x 8 Vac, 6A	28 Vac, CT, 2A		3" x 3" x 2 1/2"	15.95

SHIPPING FOR EACH POWER SUPPLY: \$5.50 in Calif.; \$8.00 in other states; \$18.00 in Canada.

For each Transformer \$5.00 in all states; \$12.00 in Canada. Calif. residents add 6% sales tax.

## ATTENTION O.E.M.'S

**YOUR SPECIAL NEEDS OR DESIGNS OF TRANSFORMER, LINEAR & SWITCHING PWR SUPPLY WILL BE MADE TO ORDER AT SUNNY LOW LOW COST & FASTEST DELIVERY.**

MAILING ADDRESS:  
P.O. BOX 4296  
TORRANCE, CA 90510  
TELEX: 182558

**SUNNY INTERNATIONAL**  
(TRANSFORMERS MANUFACTURER)  
(213) 328-2425 MON-SAT 9-6

SHIPPING ADDRESS:  
22129 1/2 S. VERMONT AVE  
TORRANCE, CA 90502

## A Message to our Subscribers

From time to time we make the BYTE subscriber list available to other companies who wish to send our subscribers promotional material about their products. We take great care to screen these companies, choosing only those who are reputable, and whose products, services, or information we feel would be of interest to you. Direct mail is an efficient medium for presenting the latest personal computer goods and services to our subscribers.

information of interest to them in the mail. Used are our subscribers' names and addresses only (no other information we may have is ever given).

While we believe the distribution of this information is of benefit to our subscribers, we firmly respect the wishes of any subscriber who does not want to receive such promotional literature. Should you wish to restrict the use of your name, simply send your request to BYTE Publications Inc, Attn: Circulation Department, 70 Main St, Peterborough NH 03458. Thank you.

Many BYTE subscribers appreciate this controlled use of our mailing list, and look forward to finding

TANTALUM CAPACITORS	LINEAR CIRCUITS	CRYSTALS	
100UF 35V 1.00 100UF 50V 1.00 100UF 63V 1.00 100UF 75V 1.00 100UF 100V 1.00 100UF 150V 1.00 100UF 200V 1.00 100UF 250V 1.00 100UF 300V 1.00 100UF 350V 1.00 100UF 400V 1.00 100UF 450V 1.00 100UF 500V 1.00 100UF 550V 1.00 100UF 600V 1.00 100UF 650V 1.00 100UF 700V 1.00 100UF 750V 1.00 100UF 800V 1.00 100UF 850V 1.00 100UF 900V 1.00 100UF 950V 1.00 100UF 1000V 1.00	LM201 - 75 LM301 - 75 LM311 - 75 LM312 - 75 LM313 - 75 LM314 - 75 LM315 - 75 LM316 - 75 LM317 - 75 LM318 - 75 LM319 - 75 LM320 - 75 LM321 - 75 LM322 - 75 LM323 - 75 LM324 - 75 LM325 - 75 LM326 - 75 LM327 - 75 LM328 - 75 LM329 - 75 LM330 - 75 LM331 - 75 LM332 - 75 LM333 - 75 LM334 - 75 LM335 - 75 LM336 - 75 LM337 - 75 LM338 - 75 LM339 - 75 LM340 - 75 LM341 - 75 LM342 - 75 LM343 - 75 LM344 - 75 LM345 - 75 LM346 - 75 LM347 - 75 LM348 - 75 LM349 - 75 LM350 - 75 LM351 - 75 LM352 - 75 LM353 - 75 LM354 - 75 LM355 - 75 LM356 - 75 LM357 - 75 LM358 - 75 LM359 - 75 LM360 - 75 LM361 - 75 LM362 - 75 LM363 - 75 LM364 - 75 LM365 - 75 LM366 - 75 LM367 - 75 LM368 - 75 LM369 - 75 LM370 - 75 LM371 - 75 LM372 - 75 LM373 - 75 LM374 - 75 LM375 - 75 LM376 - 75 LM377 - 75 LM378 - 75 LM379 - 75 LM380 - 75 LM381 - 75 LM382 - 75 LM383 - 75 LM384 - 75 LM385 - 75 LM386 - 75 LM387 - 75 LM388 - 75 LM389 - 75 LM390 - 75 LM391 - 75 LM392 - 75 LM393 - 75 LM394 - 75 LM395 - 75 LM396 - 75 LM397 - 75 LM398 - 75 LM399 - 75 LM400 - 75	2.000 18.432 20.000 3.000 5.000 6.000 8.000 3.579 5.000 10.000 4.000 6.144 18.000 \$4.25 ea. \$3.50 ea.	
16PIN HEADERS	RS232 CONNECTORS	INTERFACE & DRIVERS	
16PIN HEADERS 40 16PIN HEADERS 75 16PIN HEADERS 110 16PIN HEADERS 150 16PIN HEADERS 200 16PIN HEADERS 250 16PIN HEADERS 300 16PIN HEADERS 350 16PIN HEADERS 400 16PIN HEADERS 450 16PIN HEADERS 500 16PIN HEADERS 550 16PIN HEADERS 600 16PIN HEADERS 650 16PIN HEADERS 700 16PIN HEADERS 750 16PIN HEADERS 800 16PIN HEADERS 850 16PIN HEADERS 900 16PIN HEADERS 950 16PIN HEADERS 1000	DB 25P Male \$2.75 DB 25P Female 3.25 HOODS 1.50	FD179 34.95 1468 80 1469 1.10 8130 2.50 8834 2.50 8837 2.00 8838 2.50 8839 2.50 8840 2.50 8841 2.50 8842 2.50 8843 2.50 8844 2.50 8845 2.50 8846 2.50 8847 2.50 8848 2.50 8849 2.50 8850 2.50 8851 2.50 8852 2.50 8853 2.50 8854 2.50 8855 2.50 8856 2.50 8857 2.50 8858 2.50 8859 2.50 8860 2.50 8861 2.50 8862 2.50 8863 2.50 8864 2.50 8865 2.50 8866 2.50 8867 2.50 8868 2.50 8869 2.50 8870 2.50 8871 2.50 8872 2.50 8873 2.50 8874 2.50 8875 2.50 8876 2.50 8877 2.50 8878 2.50 8879 2.50 8880 2.50 8881 2.50 8882 2.50 8883 2.50 8884 2.50 8885 2.50 8886 2.50 8887 2.50 8888 2.50 8889 2.50 8890 2.50 8891 2.50 8892 2.50 8893 2.50 8894 2.50 8895 2.50 8896 2.50 8897 2.50 8898 2.50 8899 2.50 8900 2.50	74LS00 - 75 74LS01 - 75 74LS02 - 75 74LS03 - 75 74LS04 - 75 74LS05 - 75 74LS06 - 75 74LS07 - 75 74LS08 - 75 74LS09 - 75 74LS10 - 75 74LS11 - 75 74LS12 - 75 74LS13 - 75 74LS14 - 75 74LS15 - 75 74LS16 - 75 74LS17 - 75 74LS18 - 75 74LS19 - 75 74LS20 - 75 74LS21 - 75 74LS22 - 75 74LS23 - 75 74LS24 - 75 74LS25 - 75 74LS26 - 75 74LS27 - 75 74LS28 - 75 74LS29 - 75 74LS30 - 75 74LS31 - 75 74LS32 - 75 74LS33 - 75 74LS34 - 75 74LS35 - 75 74LS36 - 75 74LS37 - 75 74LS38 - 75 74LS39 - 75 74LS40 - 75 74LS41 - 75 74LS42 - 75 74LS43 - 75 74LS44 - 75 74LS45 - 75 74LS46 - 75 74LS47 - 75 74LS48 - 75 74LS49 - 75 74LS50 - 75 74LS51 - 75 74LS52 - 75 74LS53 - 75 74LS54 - 75 74LS55 - 75 74LS56 - 75 74LS57 - 75 74LS58 - 75 74LS59 - 75 74LS60 - 75 74LS61 - 75 74LS62 - 75 74LS63 - 75 74LS64 - 75 74LS65 - 75 74LS66 - 75 74LS67 - 75 74LS68 - 75 74LS69 - 75 74LS70 - 75 74LS71 - 75 74LS72 - 75 74LS73 - 75 74LS74 - 75 74LS75 - 75 74LS76 - 75 74LS77 - 75 74LS78 - 75 74LS79 - 75 74LS80 - 75 74LS81 - 75 74LS82 - 75 74LS83 - 75 74LS84 - 75 74LS85 - 75 74LS86 - 75 74LS87 - 75 74LS88 - 75 74LS89 - 75 74LS90 - 75 74LS91 - 75 74LS92 - 75 74LS93 - 75 74LS94 - 75 74LS95 - 75 74LS96 - 75 74LS97 - 75 74LS98 - 75 74LS99 - 75 74LS00 - 75
UART's	CPUs & SUPPORT CHIPS	74LS SERIES	
AYS-1013 - 3.75 TR1602B - 3.95 DT1482B - 3.25 M1686A - 8.95 COM2017 - 3.75	8080A 1.75 8085A 1.75 AMD2001 - 4.95 6802 - 2.00 6803 - 2.00 6804 - 2.00 6805 - 2.00 6806 - 2.00 6807 - 2.00 6808 - 2.00 6809 - 2.00 6810 - 2.00 6811 - 2.00 6812 - 2.00 6813 - 2.00 6814 - 2.00 6815 - 2.00 6816 - 2.00 6817 - 2.00 6818 - 2.00 6819 - 2.00 6820 - 2.00 6821 - 2.00 6822 - 2.00 6823 - 2.00 6824 - 2.00 6825 - 2.00 6826 - 2.00 6827 - 2.00 6828 - 2.00 6829 - 2.00 6830 - 2.00 6831 - 2.00 6832 - 2.00 6833 - 2.00 6834 - 2.00 6835 - 2.00 6836 - 2.00 6837 - 2.00 6838 - 2.00 6839 - 2.00 6840 - 2.00 6841 - 2.00 6842 - 2.00 6843 - 2.00 6844 - 2.00 6845 - 2.00 6846 - 2.00 6847 - 2.00 6848 - 2.00 6849 - 2.00 6850 - 2.00 6851 - 2.00 6852 - 2.00 6853 - 2.00 6854 - 2.00 6855 - 2.00 6856 - 2.00 6857 - 2.00 6858 - 2.00 6859 - 2.00 6860 - 2.00 6861 - 2.00 6862 - 2.00 6863 - 2.00 6864 - 2.00 6865 - 2.00 6866 - 2.00 6867 - 2.00 6868 - 2.00 6869 - 2.00 6870 - 2.00 6871 - 2.00 6872 - 2.00 6873 - 2.00 6874 - 2.00 6875 - 2.00 6876 - 2.00 6877 - 2.00 6878 - 2.00 6879 - 2.00 6880 - 2.00 6881 - 2.00 6882 - 2.00 6883 - 2.00 6884 - 2.00 6885 - 2.00 6886 - 2.00 6887 - 2.00 6888 - 2.00 6889 - 2.00 6890 - 2.00 6891 - 2.00 6892 - 2.00 6893 - 2.00 6894 - 2.00 6895 - 2.00 6896 - 2.00 6897 - 2.00 6898 - 2.00 6899 - 2.00 6900 - 2.00	74LS00 - 75 74LS01 - 75 74LS02 - 75 74LS03 - 75 74LS04 - 75 74LS05 - 75 74LS06 - 75 74LS07 - 75 74LS08 - 75 74LS09 - 75 74LS10 - 75 74LS11 - 75 74LS12 - 75 74LS13 - 75 74LS14 - 75 74LS15 - 75 74LS16 - 75 74LS17 - 75 74LS18 - 75 74LS19 - 75 74LS20 - 75 74LS21 - 75 74LS22 - 75 74LS23 - 75 74LS24 - 75 74LS25 - 75 74LS26 - 75 74LS27 - 75 74LS28 - 75 74LS29 - 75 74LS30 - 75 74LS31 - 75 74LS32 - 75 74LS33 - 75 74LS34 - 75 74LS35 - 75 74LS36 - 75 74LS37 - 75 74LS38 - 75 74LS39 - 75 74LS40 - 75 74LS41 - 75 74LS42 - 75 74LS43 - 75 74LS44 - 75 74LS45 - 75 74LS46 - 75 74LS47 - 75 74LS48 - 75 74LS49 - 75 74LS50 - 75 74LS51 - 75 74LS52 - 75 74LS53 - 75 74LS54 - 75 74LS55 - 75 74LS56 - 75 74LS57 - 75 74LS58 - 75 74LS59 - 75 74LS60 - 75 74LS61 - 75 74LS62 - 75 74LS63 - 75 74LS64 - 75 74LS65 - 75 74LS66 - 75 74LS67 - 75 74LS68 - 75 74LS69 - 75 74LS70 - 75 74LS71 - 75 74LS72 - 75 74LS73 - 75 74LS74 - 75 74LS75 - 75 74LS76 - 75 74LS77 - 75 74LS78 - 75 74LS79 - 75 74LS80 - 75 74LS81 - 75 74LS82 - 75 74LS83 - 75 74LS84 - 75 74LS85 - 75 74LS86 - 75 74LS87 - 75 74LS88 - 75 74LS89 - 75 74LS90 - 75 74LS91 - 75 74LS92 - 75 74LS93 - 75 74LS94 - 75 74LS95 - 75 74LS96 - 75 74LS97 - 75 74LS98 - 75 74LS99 - 75 74LS00 - 75	
C/MOS	RAM's	ROM's	
4001 - 25 4002 - 25 4003 - 25 4004 - 25 4005 - 25 4006 - 25 4007 - 25 4008 - 25 4009 - 25 4010 - 25 4011 - 25 4012 - 25 4013 - 25 4014 - 25 4015 - 25 4016 - 25 4017 - 25 4018 - 25 4019 - 25 4020 - 25 4021 - 25 4022 - 25 4023 - 25 4024 - 25 4025 - 25 4026 - 25 4027 - 25 4028 - 25 4029 - 25 4030 - 25 4031 - 25 4032 - 25 4033 - 25 4034 - 25 4035 - 25 4036 - 25 4037 - 25 4038 - 25 4039 - 25 4040 - 25 4041 - 25 4042 - 25 4043 - 25 4044 - 25 4045 - 25 4046 - 25 4047 - 25 4048 - 25 4049 - 25 4050 - 25 4051 - 25 4052 - 25 4053 - 25 4054 - 25 4055 - 25 4056 - 25 4057 - 25 4058 - 25 4059 - 25 4060 - 25 4061 - 25 4062 - 25 4063 - 25 4064 - 25 4065 - 25 4066 - 25 4067 - 25 4068 - 25 4069 - 25 4070 - 25 4071 - 25 4072 - 25 4073 - 25 4074 - 25 4075 - 25 4076 - 25 4077 - 25 4078 - 25 4079 - 25 4080 - 25 4081 - 25 4082 - 25 4083 - 25 4084 - 25 4085 - 25 4086 - 25 4087 - 25 4088 - 25 4089 - 25 4090 - 25 4091 - 25 4092 - 25 4093 - 25 4094 - 25 4095 - 25 4096 - 25 4097 - 25 4098 - 25 4099 - 25 4100 - 25	2101 - 1.95 2102 - 1.95 2103 - 1.95 2104 - 1.95 2105 - 1.95 2106 - 1.95 2107 - 1.95 2108 - 1.95 2109 - 1.95 2110 - 1.95 2111 - 1.95 2112 - 1.95 2113 - 1.95 2114 - 1.95 2115 - 1.95 2116 - 1.95 2117 - 1.95 2118 - 1.95 2119 - 1.95 2120 - 1.95 2121 - 1.95 2122 - 1.95 2123 - 1.95 2124 - 1.95 2125 - 1.95 2126 - 1.95 2127 - 1.95 2128 - 1.95 2129 - 1.95 2130 - 1.95 2131 - 1.95 2132 - 1.95 2133 - 1.95 2134 - 1.95 2135 - 1.95 2136 - 1.95 2137 - 1.95 2138 - 1.95 2139 - 1.95 2140 - 1.95 2141 - 1.95 2142 - 1.95 2143 - 1.95 2144 - 1.95 2145 - 1.95 2146 - 1.95 2147 - 1.95 2148 - 1.95 2149 - 1.95 2150 - 1.95 2151 - 1.95 2152 - 1.95 2153 - 1.95 2154 - 1.95 2155 - 1.95 2156 - 1.95 2157 - 1.95 2158 - 1.95 2159 - 1.95 2160 - 1.95 2161 - 1.95 2162 - 1.95 2163 - 1.95 2164 - 1.95 2165 - 1.95 2166 - 1.95 2167 - 1.95 2168 - 1.95 2169 - 1.95 2170 - 1.95 2171 - 1.95 2172 - 1.95 2173 - 1.95 2174 - 1.95 2175 - 1.95 2176 - 1.95 2177 - 1.95 2178 - 1.95 2179 - 1.95 2180 - 1.95 2181 - 1.95 2182 - 1.95 2183 - 1.95 2184 - 1.95 2185 - 1.95 2186 - 1.95 2187 - 1.95 2188 - 1.95 2189 - 1.95 2190 - 1.95 2191 - 1.95 2192 - 1.95 2193 - 1.95 2194 - 1.95 2195 - 1.95 2196 - 1.95 2197 - 1.95 2198 - 1.95 2199 - 1.95 2200 - 1.95	2704.25 - 39.95 8264 (4164-2) 64K RAM \$ 8.95 TMS927NL CONTROLLER \$9.95 8275 CRT CONTROLLER - 16.95 4116-2 - 1.85 2114L \$1.65 FD1791 B - 28.95 2732-32K ROM - 11.95 GOOD THRU JUN. 1982	
POSTAGE RATES	TERMS: FOB CAMBRIDGE, MASS. SEND CHECK OR MONEY ORDER. MINIMUM TELEPHONE C.O.D. PURCHASE ORDER OR CHARGE \$20.00. MINIMUM MAIL ORDER \$5.00.	SEND \$25 FOR OUR CATALOG. RECTIFIERS: 145 HAMPSHIRE ST., CAMBRIDGE, MASS. 02138	

**SOLID STATE SALES** TEL: (617) 547-7053  
P.O. BOX 74B TOLL FREE 1-800-343-5230  
SOMERIDGE, MASS. 02143 FOR ORDERS ONLY



**Build and Enhance**  
your Apple<sup>®</sup> software library at affordable prices. For the FIRST time — PACKED disks with 60 outstanding programs. Your Apple<sup>®</sup> needs programs! At last you have an opportunity to use your Apple<sup>®</sup> to its fullest capacity!

**PROGRAMS \$1-EACH**

**APPLEWARE INC.** offers on each disk an extensive variety of programs including:

Business	• Printer	• Graphics
Games	• Text	• Music
Utilities	• Data Base	• Finance
Science	• Engineering	• and many others with 3.3 DOS for easy demuffling.

First 3 disks available at \$59.95 each  
Order all 3 for a free bonus disk.  
Call now toll free: 1-800-327-8664  
Fla. Residents: 305-584-7004  
Please add \$3 for postage & handling.

6400 Hayes St.  
Hollywood, FL 33024

\*TM Apple is a registered trademark of Apple Computer Co.

Circle 30 on inquiry card.

**MEMOREX FLEXIBLE DISCS**

**WE WILL NOT BE UNDER-SOLD!** Call Free (800)235-4137 for prices and information. Dealer inquiries invited and C.O.D.'s accepted.



**VISA**

**PACIFIC EXCHANGES**  
100 Foothill Blvd  
San Luis Obispo, CA 93401  
In Cal. call (800)592-5935 or (805)543-1037

Circle 353 on Inquiry card.

**Save \$ on Computer Books!**

We offer a 10% discount on computer books from Addison-Wesley, Wiley, Sybex, and Murach. Fast, reliable service and low shipping charges for mail orders. Write for FREE catalog (or stop in to see us in lower Manhattan).

**DOWNTOWN BOOK BAZAAR, Dept. B**  
172 Fulton St. (near World Trade Ctr.)  
New York, N.Y. 10007

Circle 162 on inquiry card.

**RAM: 64K-200ns(128 refresh) — 8/\$69**

**Color R.F. Modulator Kit: — \$9.95**

**14A S-100 Power Supply Kit—\$29.95**  
(for line cord and circuit breaker, add \$8.95)  
47-63 Hz, 95-250 VAC with RFI filter included. ±16V @2A

Enclosed versions now available for: NEC, IBM, Apple III (your choice). Call for Data.

**New! RGB Displays**  
Now Higher-Resolution!

- High Contrast Black-Stripe Tube
- Ultra Stable Convergence
- 90 Day Warranty
- 15.7 KHz Microangelo
- CAT-100, IBM

**13" — \$359<sup>00</sup>**  
525 x 420 lines, 32 lbs

**19" — \$389<sup>00</sup>**  
525 x 620 lines, 48 lbs.  
(Displays 80 characters on IBM)

Active 12" Cable to IBM with "intensity" input—\$75.00

Add shipping, and insurance. We are philosophically against VISA & M.C. (for 5% who wouldn't be?)

**Dealin' Electronics**  
735 Loma Verde, Palo Alto, CA 94303 • 415-493-5930

Dealerships Available

Circle 152 on inquiry card.

**OMEGA**

**The Last Disassembler You Will Ever Need!**

Mnemonics Externally Defined

Zilog, Intel, PASM Supplied  
ASCII/HEX Preconditioner  
Can Externally Def. Equates  
Optional Address Listing  
ASM/PASM/M80 Compatible

DB statements forcible over user specified range

\$150. complete/\$25. manual only for further information contact

**COMPUTER TOOLBOX, INC.**  
1325 East Main St.  
Waterbury, Ct. 06705  
Phone (203) 754-4197

Circle 119 on Inquiry card.

**NOW! 176K TOTAL RAM**



For the '89

- 3 MP/M II<sup>®</sup> Compatible Banks
- "Invisible Disk" CP/M<sup>®</sup> Software Included

Only **\$595.00**

**MAGNOLIA MICROSYSTEMS**

2264 - 15th AVE. W • SEATTLE, WA 98119  
[206] 285-7266 [800] 426-2841

CP/M<sup>®</sup> & MP/M II<sup>®</sup> are registered trademarks of Digital Research, Pacific Grove, CA.

Circle 280 on Inquiry card.

**daisy\*typer<sup>®</sup>**



**LETTER QUALITY PRINTERS**

Olivetti PRAXIS Electronic Daisywheel Model 30/35 Typewriter-Printer

non-ASCII interface versions from \$649  
Buffered Centronics version  
Buffered RS-232 Terminals

Brand new units with 90 day warranty and case. We supply ribbons and printwheels.

Dealer Inquiry Welcome

**SYSTEMED CORPORATION**

P.O. Box 18, Mountain City, Tennessee 37683  
Phone (615) 727-8600

Circle 434 on Inquiry card.

**Beech Enterprises**  
6109 South I Street  
Tacoma, Washington 98408  
(206) 472-1094

**Printers — Epson, Okidata, Nec, Anadex, Others**

Epson MX-70	..... 315.00
Epson MX-80	..... 445.00
Epson MX-100	..... 745.00
Anadex DP9500, DP9501	..... 1265.00
IDS 560	..... 1104.00

**Boards — Microsoft, Vidax**

Z80 Softcard by Microsoft	.... 287.00
16K Ramcard by Microsoft	.... 146.75

**Computer systems — Altos, Televideo, NEC**

NEC — 64K Ram, 2 Disk, 7 Expansion Slots CRT	..... 2379.00
--	---------------

**Other Products & Software Available. \$ Call**

Hard Disk, Visicalc, Modems, Monitors, Furniture

**Terms:** Certified checks, personal checks, money orders. Allow 2 weeks for personal checks to clear. Equipment is subject to price change and availability.

Circle 59 on Inquiry card.

**LABELS**

**299**  
perM

15/16" x 3 1/2" white pressure sensitive  
1 up - pin feed

**PRICE INCLUDES SHIPPING**  
Packed 5M per box - Min. order 1 box - \$14.95  
Check with order - Mass Residents add 6% Sales Tax



**CHECK-MATE<sup>™</sup>**  
P.O. Box 103, Randolph, MA 02368  
Telephone: 617-963-7694  
CALL TOLL FREE 1-800-343-7706

Circle 87 on Inquiry card.

# NO RISK \* MAIL ORDER DISCOUNTS

## Apple Cards and Hardware

16K RamBoard by ConComp Industries	69
Hayes Micromodem II	299
Novation Apple-Cat	349
Vindex Videoterm 80 Column card	249
Vindex Keyboard Enhancer II	129
Z-80 SoftCard by Microsoft	299
16K RamCard by Microsoft	159
Thunderclock Plus clock/calendar card	129
Smarterm 80 Column card	299
Corvus Winchester Hard Disk Drives	CALL
ALF 9 Voice Music Card	199
ALF 9 Voice Music Card	149
Lazer Lower Case Plus +	55
Razer Keyboard Plus +	99
23 Key Numeric Keyboard by Keyboard Co.	120
Joystick II by Keyboard Co.	120
6809 CPU Card (The Mill) by Stellation	319
AIO Serial & Parallel Interface by SSMA&T	189
Music System (16 voices)	299
A/D + D/A Interface	279
Expansion Chassis (8 slots)	599
Introl X-10 Controller Card	149
Clock/Calendar Card	225
CPK Multi-Function Card	175
Super Talker SD-200	159
RomPlus + Card	135
Romwriter Card	149
Symtec Hi-Res Light Pen	210
Sup-R-Fan ventilation system for Apple II	45
SVA ZVX4 Megabyte 8" Disk Controller	645
Apple II Joystick	55
SVA Z + 2 Single Den. 8" Disk Controller	345
Microtek 16K RamBoard	129
Versawriter Digitizer Tablet	229
Asynchronous Serial interface card by CCS	139
Centronics Parallel interface card by CCS	119
We carry all California Computer System Cards CALL	
* We stock many more items for the Apple II.	
Please call or write for current price list.	

## Software for the Apple

VisiCalc version 3.3	189
VisiFile (NEW data base manager)	189
VisiTrend/VisiPlot	229
VisiDex	189
VisiTerm	189
Desktop Plan II	169
DB Master	189
Wordsar (Apple 80-col version) by MicroPro	239
Easywriter Word Processor (80 col)	159
Tax Preparer '82 version	129
Real Estate Analyzer	129
Creative Financing	139
Personal Filing System (PFS)	79
Peachtree Accounting Software	CALL
Systems Plus Actng Software	CALL

## VIC-20 \$249

8K Ram Cartridge for VIC-20	550
3K Ram Cartridge for VIC-20	534
Datassette Cassette I/O Unit	369
VIC IEEE -488 interface	574
VIC SuperExpander	359
RS-232 Communicator Interface	540
16K Memory Card by Microtek	399
Single Disk Drive	CALL
VIC Modem	CALL
VIC Printer	CALL

## Video Monitors

Amdek/Leedex Video 100 12" B&W	129
Amdek/Leedex Video 100 G 12" Green Phosphor	149
Amdek(Hitachi) 13" Color w/audio output	389
AmdekColor II	769
NEC 12" Green Phosphor Display JB-1201M	CALL
NEC 12" Lo-Res Color Display	CALL
NEC 12" Hi-Res RGB Color Display	CALL
Sanyo 9" B&W Display	185
Sanyo 9" Green Display	199
Sanyo 12" B&W Display	269
Sanyo 12" Green Phosphor Display	285
Sanyo 13" Color Display	449
Zenith 12" Green Phosphor Display	139

## Printers

Anadex 9501 w/2K Buffer	1349
C. Itoh Starwriter F-10	1595
Epson MX-70	CALL
Epson MX-80 & MX-80 FT	CALL
Epson MX-100	CALL
NEC Spinwriters (Latest models)	CALL
Qume Sprint! Daisywheels (Latest models)	CALL
Diablo 630 Daisywheel 40 CPS	CALL
NEC 8032 Impact Dot Matrix	629
Paper Tiger IDS-560C w/graphics	1095
New! Prism 80 by IDS w/color	579
New! Prism 132 by IDS w/color	1649
Okidata B2A w/fractor	469
Okidata B3A w/fractor	725
Okidata B4A	CALL

## 16K RAMBOARD by ConComp for Apple II Computers



**A&T \$69**  
RAMBOARD KIT 50

## NEC

The NEC PC-8001A has all these features and much more. Expandability you want, expandability you get. Through the use of the PC-8012A A/O unit, total system RAM can be extended to 160K. The PC-8031 Dual Disk Drive puts 286K of floppy disk storage at your command.

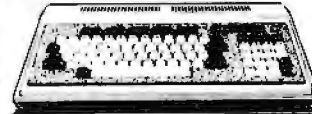

8001A Microcomputer (32K)	CALL
Dual Disk Drive	CALL
I/O unit with 32K ram	CALL
The Wedge 32K Expansion mod	FOR
NEC 8023A Printer	BEST
Peachtree Business Software	BEST
Reprint Manager	PRICE
Wordstar by Micropro	PRICE
32K Memory Card	PRICE

## XEROX. SAM

820 System with 5-1/4" drives	CALL
820 System with 8" drives	FOR
Xerox 630 (RS-232) Printer	BEST
Form II tractor for printer	BEST
Xerox 820 5-1/4" CPJM 2.2	PRICE
Xerox 820 8" CPJM 2.2	PRICE
Systems Plus software for Xerox	PRICE

## Commodore

## NEW! Commodore 64

8032 Computer with 32K	CALL FOR
4022 Dot Matrix Printer	BEST
4040 Dual Disk Drive (5")	BEST
8050 (5") Dual Drive System	PRICES
16K Pet	PRICES
32K Pet	PRICES
SuperPet	PRICES
OZZ Information Wizard	PRICES
Wiscatic	PRICES

## ATARI

Atari 800 (16K)	CALL
Atari 400 w/16K	349
410 Program Recorder	85
810 Disk Drive	459
825 80 col. 7x8 Dot matrix impact printer	595
822 40 col. Quiet Thermal Printer	245
850 Interface Module	169
Atari 16K Ram Module	69
Axion Ramcrum 32K Module	199
Caverns of Mars on Disk	32
Microtek 16K Memory Board	89

## IBM ACCESSORIES

IBM Joysticks	CALL
Easywriter II	CALL
Vi scale	FOR
256K Dynamic Ram Card	FOR
Expansion Chassis	BEST
Time Master	BEST
Scribe Tender	PRICE
SC/PC Master	PRICE
We Carry More IBM Accessories. Please Call.	

Ordering information: Phone orders using VISA MASTERCARD, AMERICAN EXPRESS, DINER'S CLUB, CARTE BLANCHE, bank wire transfer, cashier's or certified check, money order, or personal check (allow ten days to clear). Unless prepaid with cash, please add 5% for shipping, handling and insurance (minimum \$300). California residents add 6% sales tax. Foreign customers please add 10% for shipping, (minimum \$500). OEM's, Institutions and corporation please send for a written quotation. All equipment is subject to price change and availability without notice. All equipment is new and complete with manufacturer's warranty (usually 90 days). Showroom prices may differ from mail order prices.

Send Orders To:



8338 Center Drive  
La Mesa, CA 92041

In California and outside continental U.S. **(714) 698-8088**

**ORDER TOLL FREE 800-854-6654**

**FREE SHIPPING \***

\* Call for details

## FLOPPY DISK DRIVES

**SPECIAL!!!!!! QUME DATATRAK 8**  
Virtually the industry standard. High quality/reliability. Full featured, double sided, double density.

Tandon TM 848..... \$545

\$525 quantity 1, \$499 quantity 2 up.

## TANDON DOUBLE SIDED, DOUBLE DENSITY MINIS

TM100-2 . . . . 48 TPI (500 KBYTES) . . . . . \$325

Compatible with Northstar, Cromemco, TRS-80

TM100-4 . . . . 96 TPI (1000 KBYTES) . . . . . \$425

Compatible with Zenith, Heath, etc.

## TANDON 5 1/4" HARD DISKS

TM 602 (5MB) . . . . . \$1195

TM 603 (10MB) . . . . . \$1295

## CONTROLLERS

Tarbell single density kit	\$195
Tarbell single density A & T	\$310
Tarbell double density A & T	\$425
CCS 2422 w/CPM 2.2	\$350
Godbout Disk 1	\$450
MDA MXV-21 LSI-11 controller (RX-01, RX-02 compatible)	\$1050



## MISCELLANEOUS

2 Disk drive enclosure	\$ 95	Cable Kits	2 drives	\$ 35
(fits Siemens, Shugart, Qume)			3 drives	\$ 40
CP-206 power supply	\$110		4 drives	\$ 45
(powers two floppies)		Diskettes ss	\$39/10 - ds	\$59/10
Mini-Enclosure with power supply				
1 drive	\$ 85			
2 drives	\$120			

## Electrolabs

POB 1608, Palo Alto, CA 94302 (415) 965-7040

Terms of sale: cash or checks, MC/ VISA. Min. order \$25. CA residents add 6% tax. Prices subject to change without notice. All goods subject to prior sale.

# Like-new products

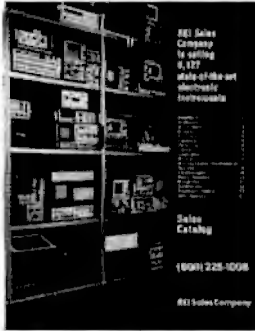

For free catalog,  
phone toll-free (800) 225-1008  
In Massachusetts (617) 938-0900  
**GENSTAR REI SALES COMPANY**  
19527 Business Center Dr., Northridge, CA 91324

Circle 201 on Inquiry card.

## BASF Flexy-Disks®

**SAVE 40%** Write for our complete list.

**5 1/4" Specify soft,** Price/10  
10 or 16 sector  
1 side/single density . . . . . \$26.70  
1 side/double density . . . . . \$31.90  
2 sides/double density . . . . . \$37.10

**8" Specify soft**  
or 32 sector  
1 side/single density . . . . . \$26.70  
1 side/double density . . . . . \$31.90  
2 sides/double density . . . . . \$41.60

CHECKS - VISA - MC - C.O.D.  
(313) 777-7780 ADD \$2 SHIPPING

**LYBEN COMPUTER SYSTEMS**  
27204 Harper Ave.  
St. Clair Shores, MI 48081

Circle 271 on inquiry card.

p-System\* + CPR =  
Word Processing

## CPR The Vital Link

CPR is an advanced text formatter offering fast, flexible word processing for the UCSD p-System.  
CPR functions include pagination, underlining, proportional spacing and a lot more.  
CPR is available now on 8" diskettes for p-System versions II and IV including 175 page users' manual . . . \$199.00.  
Users' manual alone . . . \$30.00

\*UCSD p-System is a trademark of the Regents of the University of California

**Chapin** SOFTWARE FOR SYSTEMS AND APPLICATIONS  
ASSOCIATES

11568 Sorrento Valley Rd. San Diego, CA 92121  
Suite 11 (714) 452-9340

Circle 86 on Inquiry card.

## PC/FORTH

Complete FORTH program development systems for the IBM® Personal Computer. Packages include interpreter/compiler with virtual memory management, line editor, custom screen editor, assembler, decompiler, utilities, file and record access modules, and many demonstration programs. 100 page user manual . . . \$100.00

Floating point arithmetic extensions and cross compiler available at additional cost.

Ready to run under PC-DOS or CP/M-86® Standalone version available soon. 64 kbytes RAM and two disk drives recommended. (IBM is a registered trademark of International Business Machines Corp. CP/M is a registered trademark of Digital Research, Inc.)

**Laboratory Microsystems**  
4147 Beethoven Street  
Los Angeles, CA 90066  
(213) 306-7412

Circle 259 on inquiry card.

## ANALOG ↔ DIGITAL DIGITAL ↔ ANALOG

CONVERSION MODULES

### SOFTWARE GAIN CONTROL

High accuracy - programmable gain instrumentation amplifier - custom board test 5-100 (1 to 15 kHz) conversion time - mizable high and low inputs - gain from 1 to 1024 (2 bit) sample and hold amplifier  
High accuracy differential 16-channel sample and hold amplifier  
High accuracy programmable gain instrumentation amplifier - gain mizable high and low inputs - gain from 1 to 1024 (2 bit) sample and hold amplifier  
8-channel differential 18-bit sample and hold amplifier  
High accuracy programmable gain instrumentation amplifier - gain mizable high and low inputs - gain from 1 to 1024 (2 bit) sample and hold amplifier

For additional details about the AD-100-4 and other fine California Data Corporation 100% Individually tested, high reliability products, circle the reader service card number below or for faster response write or call us.

**CALIFORNIA DATA CORPORATION**  
3475 Old Conejo Road, Suite C-10  
Newbury Park, CA 91320

(805) 498-3651

Circle 81 on inquiry card.

## CHIPS & DALE

THE INFLATION FIGHTERS!

4116 300ns 8/\$11.00  
4116 250ns 8/\$12.00  
4116 200ns 8/\$13.00  
4116 150ns 8/\$16.00  
2114L 300ns 8/\$16.25  
2114L 200ns 8/\$17.00  
\*4164 150ns \$7.90  
\*6116 150ns \$8.00

Z80A CPU \$5.50 ea.  
8251A \$4.75 ea.  
2716-1 (5V)350ns 8/\$7.00 ea. \$7.50 ea.  
2716 (5V)450ns 8/\$3.75 ea. \$4.15 ea.  
\*2732 (5V)450ns 8/\$7.25 ea. \$9.00 ea.  
2532 (5V)450ns 8/\$9.75 ea. \$10.00 ea.

Allow up to 3 wks. for personal checks to clear. Please include phone number. Prices subject to change without notice.  
Add \$3.50 Shipping & Handling  
Wash. residents add 6.6% Sales Tax

CHIPS & DALE Master Charge  
P.O. Box 31607 Seattle, Wash. Zip 98103 VISA accepted.  
1-206-524-9126

Circle 89 on Inquiry card.

**IEEE-488 TO TRS-80\* INTERFACE**  
Everything needed to add powerful BASIC GPIB-488 controller capability to TRS-80 Model 1 or 3, Level 2 or DOS with a minimum of 16K.

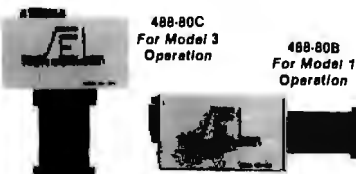

Model 488-80B or 488-80C Price: \$375.  
+ shipping, insurance & tax

WHEN ORDERING SPECIFY DISK OR TAPE  
**SCIENTIFIC ENGINEERING LABORATORIES**

11 Neil Drive • Old Bethpage, NY 11804  
Telephone: (516) 694-3370

\*Trademark of Tandy Corp.  
There is no affiliation between Scientific Engineering Laboratories and Tandy Corp. or Radio Shack.

Circle 400 on Inquiry card.



400 16K ..... \$319.00  
400 YOURS TO 32K or 48K ..... CALL  
800 (16K) ..... \$69.00  
410 RECORDER ..... \$84.00  
810 DISK DRIVE ..... \$449.00  
850 INTERFACE ..... \$169.00  
830 MODEM ..... \$149.00  
825 PRINTER ..... \$75.00  
481 ENTERTAINER KIT ..... \$85.00  
482 EDUCATOR KIT ..... \$125.00  
483 PROGRAMMER'S KIT ..... \$60.00  
484 COMMUNICATOR KIT ..... \$09.00

Prices subject to change without notice.  
Shipping extra. No tax out of state.  
Ca. residents add appropriate taxes.

WE ARE AN AUTHORIZED ATARI SALES AND SERVICE CENTER



**COMPUTERTIME, INC.**

P.O. Box 216  
Kentfield, CA 94944  
CALL TOLL-FREE 800-227-2520  
In California 800-772-4064

Circle 123 on Inquiry card.



"ELF" Interface  
Converts Your  
Typewriter Into Printer



- Finest print quality
- Easy installation
- Fits IBM Selectric® and Electronic Typewriters
- Models for all popular computers
- Call or write for more information, today!

- We export to all countries -  
**IPEX** INTERNATIONAL INC.  
5115 Douglas Fir Rd.  
Calabasas, CA 91302 U.S.A.  
Tel: (213) 710-1444 TLX/TWX: 910 494 2100

Circle 238 on Inquiry card.



# Why use their flexible discs:

Athana, BASF, Control Data, Dysan, IBM, Maxell, Nashua, Scotch, Shugart, Syncom, 3M, Verbatim or Wabash

when you could be using

# MEMOREX

high quality error free discs?

Product Description	Part #	CE quant. 100 price per disc (\$)
8" SSSD IBM Compatible (128 B/S, 26 Sectors)	3062	2.09
8" SSSD Shugart Compatible, 32 Hard Sector	3015	2.09
8" SSDD IBM Compatible (128 B/S, 26 Sectors)	3090	2.74
8" DSDD Soft Sector (Unformatted)	3102	3.14
8" DSDD Soft Sector (128 B/S, 26 Sectors)	3115	3.34
8" DSDD Soft Sector (1024 B/S, 8 Sectors)	3104	3.34
8" DSDD Burroughs B-80 Comp., 32 Hard Sector	3092	3.34
5 1/4" SSSD Soft Sector (Unformatted)	3401	1.94
5 1/4" SSDD Soft Sector w/Hub Ring	3481	2.34
5 1/4" SSDD 10 Hard Sector w/Hub Ring	3483	2.34
5 1/4" SSDD 16 Hard Sector w/Hub Ring	3485	2.34
5 1/4" DSDD Soft Sector w/Hub Ring	3491	3.09
5 1/4" DSDD 10 Hard Sector w/Hub Ring	3493	3.09
5 1/4" DSDD 16 Hard Sector w/Hub Ring	3495	3.09

SSSD = Single Sided Single Density; SSDD = Single Sided Double Density  
DSDD = Double Sided Double Density

## Memorex Flexible Discs...The Ultimate in Memory Excellence

**Quality**  
Memorex means quality products that you can depend on. Quality control at Memorex means starting with the best materials available. Continual surveillance throughout the entire manufacturing process. The benefit of Memorex's years of experience in magnetic media production, resulting, for instance, in proprietary coating formulations. The most sophisticated testing procedures you'll find anywhere in the business.

**100 Percent Error Free**  
Each and every Memorex Flexible Disc is certified to be 100 percent error free. Each track of each flexible disc is tested, individually, to Memorex's stringent standards of excellence. They test signal amplitude, resolution, low-pass modulation, overwrite, missing pulse error and extra pulse error. They are torque-tested, and competitively tested on drives available from almost every major drive manufacturer in the industry including drives that Memorex manufactures. Rigid quality audits are built into every step of the manufacturing process and stringent testing result in a standard of excellence that assures you, our customer, of a quality product designed for increased data reliability and consistent top performance.

**Customer-Oriented Packaging**  
Memorex's commitment to excellent does not stop with a quality product. They are proud of their flexible discs and they package them with pride. Both their packaging and their labeling have been designed with your ease of identification and use in mind. The desktop box containing ten discs is convenient for filing and storage. Both box labels and jacket labels provide full information on compatibility, density, sectoring, and record length. Envelopes with multi-language care and handling instructions and color-coded removable labels are included. A write-protect feature is available to provide data security.

**Full One Year Warranty — Your Assurance of Quality**  
Memorex Flexible Discs will be replaced free of charge by Memorex if they are found to be defective in materials or workmanship within one year of the date of purchase. Other than replacement, Memorex will not be responsible for any damages or losses (including consequential damages) caused by the use of Memorex Flexible Discs.

### Quantity Discounts Available

Memorex Flexible Discs are packed 10 discs to a carton and 10 cartons to a case. Please order only in increments of 100 units for quantity 100 pricing. We are also willing to accommodate your smaller orders. Quantities less than 100 units are available in increments of 10 units at a 10% surcharge. **Quantity discounts** are also available. Order 500 or more discs at the same time and deduct 1%; 1,000 or more saves you 2%; 2,000 or more saves you 3%; 5,000 or more saves you 4%; 10,000 or more saves you 5%; 25,000 or more saves you 6%; 50,000 or more saves you 7% and 100,000 or more discs earns you an 8% discount of our super low quantity 100 price. Almost all Memorex Flexible Discs are immediately available from CE. Our warehouse facilities are equipped to help us get you the quality product you need, when you need it. If you need further assistance to find the flexible disc that's right for you, call the Memorex compatibility hotline. Dial 800-538-8080 and ask for the *flexible disc hotline* extension 0997. In California dial 800-672-3525 extension 0997. Outside the U.S.A. dial 408-987-0997.

### Buy with Confidence

To get the fastest delivery from CE of your Memorex Flexible Discs, send or phone your order directly to our Computer Products Division. Be sure to calculate your price using the CE prices in this ad. Michigan residents please add 4% sales tax. Written purchase orders are accepted from approved government agencies and most well rated firms at a 30% surcharge for net 30 billing. All sales are subject to availability, acceptance and verification. All sales are final. Prices, terms and specifications are subject to change without notice. Out of stock items will be placed on back order automatically unless CE is instructed differently. Minimum order \$50.00. International orders are invited with a \$20.00 surcharge for special handling in addition to shipping charges. All shipments are F.O.B. Ann Arbor, Michigan. No COD's please. Non-certified and foreign checks require bank clearance.

Mail orders to: Communications Electronics, Box 1002, Ann Arbor, Michigan 48106 U.S.A. Add \$8.00 per case or partial case of 100 8-inch discs or \$6.00 per case or partial case of 100 5 1/4-inch mini-discs for U.P.S. ground shipping and handling in the continental U.S.A. If you have a Master Card or Visa card, you may call anytime and place a credit card order. Order toll-free in the U.S. Call anytime 800-521-4414. If you are outside the U.S. or in Michigan, dial 313-994-4444. Order your high quality, error free Memorex discs today.

Copyright © 1982 Communications Electronics™

## High Quality Error Free



Order Toll-Free!  
**(800) 521-4414**  
In Michigan (313) 994-4444

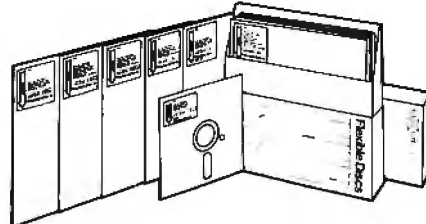

For Data Reliability—Memorex Flexible Discs

**COMMUNICATIONS ELECTRONICS™**

**Computer Products Division**

854 Phoenix □ Box 1002 □ Ann Arbor, Michigan 48106 U.S.A.  
Call TOLL-FREE (800) 521-4414 or outside U.S.A. (313) 994-4444

## ZENITH/Heath Users

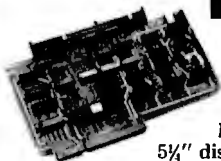

Double Your  
5 1/4" disk storage  
capacity without adding a drive.

Get twice as much from your H88 or H89 microcomputer. Our FDC-880H floppy disk controller, in conjunction with your 5 1/4" drives, for example, expands memory capacity from 256 bytes to 512 bytes per sector.

And it handles single and double-sided, single and double-density, 8" and 5 1/4" drives — simultaneously.

Call 714/275-1272 today or write for details.



C.D.R. Systems Inc.

Controlled Data Recording Systems, Inc.  
7667 Vickers St., San Diego, CA 92111

Circle 83 on inquiry card.

## CROSS REF. PROGRAM

for  
MBASIC & BASCOM  
Source Files  
M80 and CP/M's ASM

MXREF will list all program variables, functions, key words, strings, constants and line number references in alphabetical order. 1000 variable names allowed. Requires an 8080 or Z80 running CP/M ver. 1.4 or later and at least 48K RAM. Price \$96.00. Manual only \$15.00. Add \$5.00 COD. MXREF available in CP/M format on 5" NorthStar or 8" single or double density soft sector.

COMPUTER TOOLBOX INC.

1325 East Main St.  
Waterbury, CT. 06705  
(203) 754-4197

Circle 102 on inquiry card.

## FEEL TRAPPED BETWEEN CAPACITY AND COST?

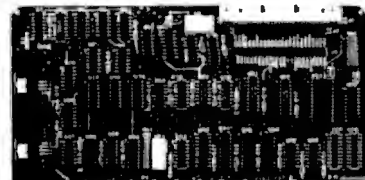

Processor Interface introduces the Cartridge Disk Controller for the S-100 bus. Configurable for 12 sector 2315 and 5440 type disk drives (1.25 - 10 Mbytes per drive) Complete with CPM\* CBIOS, disk formatter diagnostics and technical manual low cost \$595.00

Manual only \$25.00  
The performance  
you need at  
a cost you can  
afford



Processor Interfaces, Inc. P.O. Box 154A Elm Grove, WI 53122  
414-785-1245

Circle 373 on inquiry card.

## 5 1/4" Floppy Disk Drives

(single side-single or double density)

TANDON Model TM 100-1 } \$219.95 ea.  
CDC Model 9409 }  
2 or more — \$214.95 ea.\*

IBM personal computer direct plug in.  
Zenith monitor ZVM-121 12" green phosphor \$119.95 ea.\*  
Floppy Drive Power Connector Kit \$28.00\*

CALL NOW - TOLL FREE

800-824-7888 all states except CA.  
800-852-7777 for CA residents.  
Ask for Operator #99.

MC/VISA or C.O.D. with certified check or money order. Kansas residents add 3% sales tax.

\*Plus shipping.  
For info call: 316-683-9225  
316-685-9445



923 Longfellow Street  
Wichita, KS 67207

Circle 199 on inquiry card.

## \$GOLD DISKS CP/M® Compatible Z-80 Software

Z-80 DISASSEMBLER  
An easy to use \$175  
program to create  
source (.ASM) files  
from executable  
(.COM) files

EZ-TEXT WORDPROCESSOR  
EZ-TEXT will format \$75  
your text file the  
way you want it

5-8" SD/DD PPD  
Bower-Stewart  
& Associates

POST OFFICE BOX 1389  
HAWTHORNE, CALIFORNIA 90250

213-532-1237  
Trademark Digital Research

Circle 69 on inquiry card.

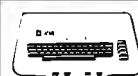

Entertainer Kit . . . 88.00	Atari 800 16K . . . 710.00
Programmer Kit . . . 56.00	Atari 400 16K . . . 359.00
Communicator Kit . . . 320.00	Atari 410 Cassette 80.00
Microsoft Basic . . . 72.00	Atari 810 Disk . . . 480.00

ALL ATARI SOFTWARE 20% OFF  
Plus Loads of 3rd Party Software!  
VOTRAX TYPE\*NTALK: 340.00  
ALSO EPSON & CENTRONICS PRINTERS  
ZENITH & TELEVIDEO TERMINALS

BBI Mail Order is a company made up of computer professionals. We are able to provide low prices as well as technical support. Give us a call and find out why we consider the Atari the best home computer on the market today. You won't be disappointed.



BBI Mail Order

Specializing in Atari Home Computers  
P.O. Box 365  
Newton Highlands, MA 02161  
(617) 964-3080

Circle 58 on inquiry card.

## RS-232 PROBLEMS?



LET THE RS-232 TESTER HELP YOU SOLVE YOUR COMPUTER INTERFACE PROBLEMS. DESIGNED TO CONNECT IN SERIES WITH ANY RS-232 INTERFACE, IT DISPLAYS THE STATUS OF SEVEN OF THE MOST IMPORTANT LINES: TRANSMIT DATA, RECEIVE DATA, REQUEST TO SEND, CLEAR TO SEND, DATA SET READY, CARRIER DETECT, AND DATA TERMINAL READY. THE RS-232 TESTER REQUIRES NO POWER AND MAY BE LEFT IN THE LINE PERMANENTLY.

\$39.95 POST PAID  
B & B ELECTRONICS  
BOX 475/MENDOTA, IL 61342

Circle 52 on inquiry card.

## SCR SUPER-BUYS

\$10.00 MIN. ORDER HANDLING/SHIPPING \$2.50  
UPS ANYWHERE IN CONTINENTAL U.S.

1982 BUYERS GUIDE  
NOT JUST ANOTHER  
CATALOGUE BUT A  
BUYERS GUIDE  
"OF THE FUTURE" FREE

1. UHF-VHF CONVERSION KIT. Complete with PC board, all required components, jumper wire, cabinet with speaker, and comprehensive brochure incl. schematic, board layout, mounting and hook-up diagrams, parts list, and assembly and set-up instructions. All parts are industrial prime quality. \$119.95 ea.

2. NEWZENITHZVM-121 HIGH-LEGIBILITY CRT MONITOR. Features 12" green phosphor CRT, with 15 Mhz Bandwidth, 40 or 80 character widths are operator switch-selectable. Fully compatible with 80-column Apple cards, etc. \$117.95 ea.

OUTSIDE CAL. 800-854-8660  
INSIDE CAL (714) 527-2554

SCR ELECTRONICS INC.

VISIT OUR NEW SUPER CENTER  
5303 Lincoln Ave., Cypress, CA 90630

Pay by CHECK M.O., VISA, M/C

Circle 404 on inquiry card.

## YOU CAN PAY MORE BUT YOU CAN'T GET MORE!



Model III 16K  
\$839  
Model III 48K  
2 disc & RS232C  
\$2059

Color Computer 4K  
\$310  
w/16K Ext. Basic  
\$459  
w/32K Ext. Basic  
\$525

BUY DIRECT. These are just a few of our great offers which include Printers, Modems, Computers, Peripherals, Disc Drives, Software and more. call TOLL FREE 1-800-343-8124

We have the lowest possible fully warranted prices and a full complement of Radio Shack Software.

computer plus  
Write for your free catalog.

245A Great Road  
Littleton, MA 01460  
617-486-3193

Circle 114 on inquiry card.

# INCREDIBLE? BELIEVE IT!

## Washington Computer Services

an affiliate of **WASHINGTON ELECTRIC COMPANY** est. 1912

CUSTOM COMPUTER ROOM WIRING SINCE 1960

97 Spring Street, New York, New York 10012

TO ORDER: CALL OUR TOLL-FREE NUMBER: (800) 221-5416 In N.Y. State and for technical information: (212) 226-2121

HOURS: 9 AM-5:30 PM (EST) Monday-Friday TELEX: 12-5606 CABLE: WASHCOMP NYK

### PRINTERS



150 cps bidirectional - 9x9 dot matrix, quietized case, 136 col, vertical form control and many other functions  
**NOW \$950**  
The best price/performance ratio available.

RS-232 serial to 19,200 baud x-on, x-off add \$25  
Teletype 40, 300 LPM-typewriter quality, RS-232 interface. This quality printer is available in many configurations including forms access, quietized case, etc.

- Teletype 43 from \$995
- Teletype AP-200, 340 cps dot matrix (similar to Data Prod. M-200) \$2799
- NEC Spinwriter-55 cps, bidirectional, letter quality R.O. 7710 \$2560 KSR 7720 \$2799
- DIABLO 630-40 cps, bidirectional, daisy wheel, plot/graph \$2349
- QUME Sprint 9/35 cps, daisy wheel \$1944
- C. ITOH Starwriter, 40 cps, daisy wheel, F10 \$1550
- EPSON MX-80, 100, 80 cps, 9x9 dot matrix \$CALL
- ANADEx 9500/9501, up to 200 cps, high resolution dot \$1325
- OKIDATA Microline 82A, bidirectional, friction/pin feed \$525
- Microline 83A, bidirectional, 120 cps, uses 15" paper \$799
- T1-810, 150 cps, Basic \$1449
- Package-Compressed print, vertical form control \$1630
- MANNESMANN MT 1705 200 cps, 7x9, 132 col \$CALL
- TALLY MT 1805 200 cps, 7x9 + NLQ 40x18 matrix \$CALL
- CENTRONICS \$CALL
- 739 100 cps, nx9 dot matrix, Full Graphics \$567
- 122 120 cps, International set, Full Graphics \$899

- DECLA-34 \$1085
- IDS PRISM, 132 col., color \$1785

### TERMINALS PMMI MODEM

- AMPEX DIALOGUE 30, 80, 81 \$359
- TELEVIDEO 910 C (multi-terminal) \$CALL
- 925C \$610
- 950C \$795
- 950C \$950
- SOROC IQ 120 \$729
- HAZELTINE ESPRIT \$669
- DEC VT-100 \$1575
- WYSE WY-100 (ALTOS 1) \$CALL

Similar savings for our HAZELTINE and LEAR SIEGLER lines

### SOFTWARE

- |                   |        |                     |        |
|-------------------|--------|---------------------|--------|
| MBASIC-80         | \$275  | WORDSTAR            | \$300  |
| MBASIC COMPILER   | \$285  | MAILMERGE           | \$110  |
| FORTRAN-80        | \$349  | DATASTAR            | \$230  |
| COBOL-80          | \$574  | DBASE II            | \$525  |
| PL/1-80           | \$425  | CONOOR III          | \$716  |
| PASCAL MT+ V5.5   | \$398  | MILESTONE           | \$235  |
| WHITESMITH'S C    | \$660  | SUPERCALC           | \$221  |
| BSTAM, BSTMS      | \$200  | FMS-80              | \$649  |
| CB-80             | \$420  | SELECTOR V          | \$396  |
| PEARL (LEVEL 3)   | \$549  | SPELLGUARD          | \$236  |
| LIFEBOAT SOFTWARE | \$CALL | SUPERSOFT           | \$CALL |
| PEACHTREE         | \$CALL | AMERICAN BUS. SYST. | \$CALL |
| GRAHAM-DORIAN     | \$CALL | ACCOUNTING PLUS     | \$CALL |
| STRUCTURED SYST.  | \$CALL | TURBODOS (MULTI)    | \$500  |
| VANDATA/OSBORNE   | \$500  | TURBODOS (1 USER)   | \$220  |

### 8" DISK DRIVE SALE

- 8" SHUGART SA801R \$450 8" SHUGART SA851R \$669 2 for \$1289
- QUME DATATRACK 8 \$589 2 for \$1110
- Enclosure, power supply for 2 8" drives A & T \$350
- MORROW DISCUS 2D + CP/M®, MICROSOFT BASIC, CONT. \$950

### HARD DISK SPECIALS

- CORVUS 5MB, 10MB, 20MB Constellation Multiplexer and Mirror Backup \$4495
- MORROW 26MB + controller + CP/M 2.2®, M basic \$3821
- controller, CDC Hawk Drive (5 fix, 5 rem) \$7995 \$6795
- controller, Western Dynex (5 fix, 5 rem) \$5995 \$5099
- Winchester 5 1/4 drives complete with case, cable, software, S-100 controller. Adapter avail. for use with any Z-80 system. Cartridge drive controllers avail.

- 5MB APPLE S-100 Z-89 \$2898
- 10MB XEROX ALTOS OEM discounts available! R.S. MOD. II \$3398

IRDS & KORAN 5 1/4", 8" and 14" Winchester/tape subsystems avail.

### FULLY CONFIGURED BUSINESS SYSTEMS

The following are some examples of the fully assembled and tested business and scientific computer systems which we offer.

- IMS INTERNATIONAL 8000 SX, multi-user, multi-processor, turbo DOS \$CALL
- CPM 2.2. FULL 2 YEAR WARRANTY!
- DATA SEATTLE 68000 16 bit multi-user UNIX V.7 \$CALL
- A SEATTLE COMPUTER 8086 16 bit, 128K RAM, Syst. #2 \$3499

**Systems Group** Call us for best prices on these high quality 2nd generation boards and systems.

**California Computer Systems** These high quality, reliable products have made CCS defacto industry standard for S-100 products  
Assembled and tested:

- 2200 H.D. Mainframe \$517 2810AZ-80 CPU, serial port \$316
- 2065C64K dynamic RAM \$409 2422A Floppy Cont, CP/M 2.2 \$427
- CCS 2210A w/floppy controller, 1 serial port \$2116
- CCS 300-1A w/1.2 MB floppy drives, 2 serial, 2 parallel ports \$CALL

### DIGIAC Fine Computers

We offer generous discounts on the Compupro line of fast, quality 8 and 16 bit boards

### NorthStar ADVANTAGE & HORIZON

- NEC Low prices on PC-8000 series \$CALL
- DELTA S-450D 10 User, Multi-Processor, 40 MB hard 17 MB tape \$CALL
- ALTOS single and multi-user systems \$CALL

### MORROW Decision 1, CP/M Microsoft Basic, UNIX

- 820 Desktop computer-64K, 2 floppys. (CP/M avail.) \$CALL
- XEROX. List \$2995

Similar savings on the full lines of CCS, SSM, NNC, MORROW, DELTA, NORTHSTAR, ITHACA INTERSYSTEMS, GODBOUT, NEC, TELEVIDEO, IMS ZENITH, ADOS, DEC, DATA GEN., ATARI, OYNABYTE, TECMAR, DUAL

### LOOK HERE! AMPEX

Call us for ALL your software needs Dialogue 80" Systems Houses, Educational Institutions, & Government Agencies Given Special Consideration



ALL OF OUR PERIPHERALS CAN BE CONFIGURED FOR RADIO SHACK® MODEL II

## DEALER and INTERNATIONAL INQUIRIES WELCOME

For fast delivery, send certified check, money order or call to arrange direct bank wire transfer. Personal or company checks require two to three weeks to clear. All prices are mail order only. Prices subject to change without notice; call for latest prices. Prices include 3% cash discount. N.Y. residents add sales tax. Qantex is a trademark of North Atlantic Industries, Inc. Radio Shack® is a trademark of the Tandy Corp. CP/M® is a trademark of Digital Research. All sales subject to our standard sale conditions (available on request).



# Compuchange

Such A Deal!

Have You Ever Considered  
USED EQUIPMENT?

Want To Save Lots?  
We Carry All Brands of  
Used Minis and Micros\*  
(DEC - DG - APPLE - TRS-80, ETC.)

Call or Write for FREE List of Bargains:  
Compuchange  
Box 4151  
Anaheim, Ca. 92803  
(714) 535-1990

\*No Cost or Obligation  
To List with Us!!  
Call for More Info!

Circle 102 on Inquiry card.

## AUDEX-1 the EAR & MOUTH for AIM-65



- Recognition and Response in One Unit
- Built-in Amplifier and Speaker
- Dynamic Microphone Included
- You can make your own vocabulary
- Good-Speech Quality
- Up to 98% Recognition Accuracy
- Easy-to-follow Users Manual
- In a 3 1/2" x 5 1/4" x 1 1/4" Box
- Assembled and Fully Tested

**\$169.00 ea.** plus shipping and handling charge: U.S. \$3.50 Overseas, 10%

NJ Residents, add 5% sales tax.

—VISA, Mastercharge Welcome—

**AUDEC CORPORATION (Dept. L1)**  
728 Larch Avenue  
Teaneck, NJ 07666 (201) 692-7228

Circle 45 on Inquiry card.



# Scotch

DISKETTES

**SAVE 40%** Write for our complete list.

**5 1/4"** Specify soft, Price/10  
10 or 16 sector  
#744 1 side/sgl dens. . . . . \$28.70  
#744D 1 side/dbl dens. . . . . 31.20  
#745 2 sides/dbl dens. . . . . 38.40

**8"** Specify soft  
or 32 sector  
#740 1 side/sgl dens. . . . . 27.30  
#741 1 side/dbl dens. . . . . 35.80  
#743 2 sides/dbl dens. . . . . 43.60

CHECKS — VISA — MC — C.O.D.  
(313) 777-7780 ADD \$2 SHIPPING

LYBEN COMPUTER SYSTEMS  
27204 Harper Ave.  
St. Clair Shores, MI 48081

Authorized Distributor  
Information Processing Products



Circle 272 on Inquiry card.

## S-100 VOICE

The ARTICULATOR board allows you to record, store, and play-back any vocabulary on your S-100 computer. Input speech is digitized by the ARTICULATOR and send to the computer via an on-board port for storage at 1K to 2K bytes/sec. This data is then sent back from the computer to the ARTICULATOR for very high quality playback. On-board VOX switching minimizes memory storage requirements.

PRICE — \$350 A&T  
AVAILABLE NOW

Quintrex, Inc.  
4461 Indian Creek Parkway  
PO Box 7384  
Overland Park, KS 66207

Circle 382 on Inquiry card.

## HY-TYPE 1 & 11 • QUME

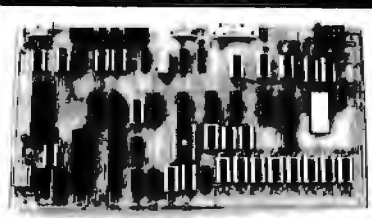

### INTELLIGENT PRINTER INTERFACE

16,000 BYTE BUFFER / STAND ALONE

PARALLEL / SERIAL INPUT (BAUD RATES - 50 to 19,200)

OPTIONS INCLUDE: GRAPHICS • REVERSE PRINT • BOLD PRINT  
UNDER-SCORE • REPRINT OF BUFFER  
ADJUSTMENT OF LINES PER-INCH  
CHARACTERS PER-INCH SELECTION  
DOUBLE LINE

CUSTOM OPTIONS ALSO AVAILABLE

A & T FROM \$450.00 BARE BOARD \$125.00

MASTER CARD & VISA ACCEPTED

**WARN ELECTRONICS, LTD.**

PO BOX 526 KNIGHTDALE, NC 27545 (919) 266-9411

Circle 463 on Inquiry card.

## WANT HELP?

### COBOL PROGRAMMER'S AIDE (CPA)

Provides extensive assistance in **CODING, DEBUGGING, MAINTAINING and DOCUMENTING** your Cobol programs - Improve your efficiency and productivity - **EASY TO USE - MENU DRIVEN - A PRACTICAL SET OF TOOLS - An INVALUABLE AIDE.**

CPA features:

- SOURCE ANALYZER & CROSS REFERENCE
- SOURCE EDITOR & REFORMATTER
- SOURCE OVERVIEWER
- DOCUMENTATION PRINTER
- PARAMETER FETCHER SUB-PROGRAM
- COMPREHENSIVE MANUAL and more

Available for CP/M\*, COOS<sup>2</sup> or CRDMIX<sup>2</sup> users utilizing COBOL-80<sup>1</sup> or Cromemco Cobol.

Satisfaction guaranteed or full refund!

For Program Samples and information call or write:

**Automated Programming Methods, Inc.**  
2212 Dupont Dr.,  
(714) 851-8686 Irvine, CA 92715

Trademarks <sup>1</sup>MicroSoft, <sup>2</sup>Digital Research, <sup>3</sup>Cromemco

Circle 48 on Inquiry card.

## NEW! M-68000 SINGLE BOARD COMPUTER

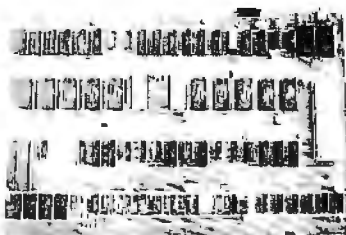

### FEATURES:

16 bit Motorola 68000 CPU operating @ 10MHz, 20Kbytes of on-board exclusive RAM, 16K bytes of on-board EPROM space, 7 levels of prioritized auto-structured interrupts, 2 memory expansion buses (up to 256K), 2 serial communication ports (RS-232C), 16-bit bidirectional parallel port, 6800 peripheral and control bus, 5.12-bit counter/timer with vectored interrupts, on-board real time clock, software compatible with Motorola MEX68000 board.

### PRICE:

Bare board with documentation . . . . . \$99.95  
MEX68000 compatible monitor or 2764 EPROMs . . . . . \$128.00  
168000 CPU & memory map PROM . . . . . \$115.00  
Shipping and handling (Euroserv) . . . . . \$3.00  
(Foreign) . . . . . \$15.00

**EMS** Educational  
Microcomputer  
Systems  
P.O. BOX 3635 BRYNE, CA 92716-3635

714-553-0133

Circle 171 on inquiry card.

## Convert your TRS-80 into a DEVELOPMENT SYSTEM

Z-80 In-Circuit  
emulation and  
EPROM/EEPROM  
programming in  
a single compact  
unit.

Debug stand-alone  
systems with  
program in  
TRS-80 RAM,  
then copy working program into PROM.

Only \$329 including personality module  
for 2716, 2516, 2758, 2508, 2532, 2816,  
2808, 48016.

**ORION INSTRUMENTS**  
172 Otis Ave, Woodside, CA 94062  
(415) 851-1172



Circle 346 on Inquiry card.

## TYPESETTING from your own COMPUTER

Type your manuscripts, catalogs, or other text into your word processing computer.

Send it to us on a diskette or via a modem transmission and we'll send you camera ready film copy.

Computer typesetting provides high quality, easy to read copy at a fraction of the cost of conventional typesetting.

Call or write for instructional brochure that includes typeset selections, formatting instructions, and examples.

## Dream Electronics

131 N.W. 2nd St. 1-503-7524833  
Corvallis, Oregon 97330

Circle 164 on Inquiry card.

# ARE YOU OUT OF CONTROL?

## OUR 6502 BASED MICROCOMPUTER HAS EVERYTHING UNDER CONTROL.

### THE COMPUTER "SLIM"

- 6502 MICROPROCESSOR
  - 2K BYTES RAM
  - 2K OR 4K EPROM
  - FOUR 8 BIT I/O PORTS
  - POWER ON RESET
  - CRYSTAL CLOCK
  - BUFFERED SYM-AIM BUS
- PRICE 81-260A \$199.95 ASSM.  
81-260K \$149.95 KIT  
81-260B \$ 39.95 BARE BOARD

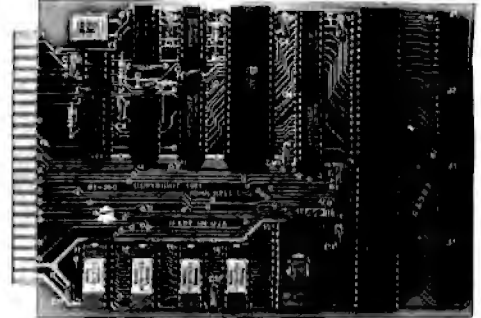

THE COMPUTER "SLIM"

### THE PERIPHERALS

#### RAM EPROM MEMORY

- 32K BYTES OF RAM OR EPROM
- PRICE 81-330A \$ 99.95 ASSM. W/O MEMORY  
81-330B \$ 49.95 BARE BOARD

#### 6 SLOT MOTHER BOARD

- .750" BOARD SPACING 44 PIN BUS
- PRICE 81-320A \$ 99.95 ASSEMBLED  
81-320B \$ 49.95 BARE BOARD

#### 24 HOUR REAL TIME CLOCK

- FOUR DIGIT LED DISPLAY
  - ON BOARD POWER SUPPLY
- PRICE 81-350A \$149.95 ASSEMBLED  
81-350B \$ 49.95 BARE BOARD

#### ANALOG I/O INTERFACE

- 16 ANALOG INPUT CHANNELS
  - 2 ANALOG OUTPUT CHANNELS
- PRICE 81-292A \$199.95 ASSEMBLED  
81-292B \$ 49.95 BARE BOARD

#### 12 PORT PARALLEL I/O BOARD

- 12 8 BIT I/O PORTS — 6 6522S
- PRICE 82-036A \$169.95 ASSEMBLED  
82-036B \$ 49.95 BARE BOARD

MONITOR + TINY BASIC 2532 \$39.95

ALL BOARDS ARE 4.5 X 6.5 WITH GOLD EDGE CONNECTORS SOLDER MASK BOTH SIDES

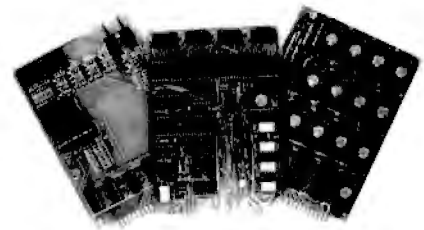

19" RACK MOUNTING

CALL 415 592-8411 FOR MORE INFORMATION.

OUR SALES PEOPLE WILL BE GLAD TO DEMONSTRATE OUR PRODUCTS AT YOUR COMPANY. OEM PRICING AVAILABLE.

 **JOHN BELL ENGINEERING, INC.**

ALL PRODUCTS ARE AVAILABLE FROM JOHN BELL ENGINEERING, INC. • 1014 CENTER ST., SAN CARLOS, CA 94070  
ADD SALES TAX IN CALIFORNIA • ADD 5% SHIPPING & HANDLING 3% FOR ORDERS OVER \$100

SEND FOR CATALOG

(415) 592-8411

10% OUTSIDE U.S.A.

WILL CALL HOURS: 9am - 4pm

MC

VISA

**YOU CAN SAVE \$\$\$**

5 1/4" DISKETTES (Soft or Hard Sector) Box of 10  
 Single Side/Double Density ..... \$25.25  
 Double Side/Double Density ..... \$31.25

**Altos • North Star • Zenith Data Systems**

**RIBBONS FOR:**  
 Anadex DP 9500/9501 ..... \$14.00  
 Centronics 700 Series  
 Zip Pack (Package of 3) ..... \$ 8.25  
 Cartridge ..... \$ 8.50  
 D.E.C. LA-34 (Box of 6) ..... \$30.00  
 Diablo 630 (Box of 6) ..... \$25.95  
 Epson MX 70-80 ..... \$12.95  
 NEC Spinwriter (Box of 6) ..... \$24.00  
 Okidata Microline 80 (Pkg of 3) ..... \$ 8.90  
 Qume (Boxes of 6)  
 (Black) ..... \$19.00  
 (Red, Green, Blue or Brown) ..... \$16.00  
 Texas Instruments 810 (Bx of 6) ..... \$19.00

Plus many others - Call for more information

CHECK - MASTER CARD - VISA Accepted  
 Add \$3.00 for Shipping & Handling:  
 Illinois Residents Add 6% Tax

**ILLINOIS COMPUTER PRODUCTS CO.**  
 P.O. Box 112  
 Mt. Prospect, IL 60056 (312) 228-5590

Circle 221 on inquiry card.

**Dysan CORPORATION**

Solve your disc problems, buy 100% surface tested Dysan diskettes. All orders shipped from stock, within 24 hours. Call toll FREE (800) 235-4137 for prices and information. Visa and Master Card accepted.

**PACIFIC EXCHANGES**  
 100 Foothill Blvd.  
 San Luis Obispo, CA 93401 (In Cal. call (805) 543-1037.)



Circle 353 on inquiry card.

LOOK TO THE FUTURE ...

**EPROM-32**

The only EPROM programmer you need!

- IEEE-696 (S-100) EPROM programmer for single supply (+5V) EPROMs.
- Programs current 1K through 16K (byte) EPROMs plus future 32K EPROMs.
- EPROM can be verified through a port or located in memory space for verification and use.
- Personality Modules adapt board to different EPROM types: PM-1-2508, 2758, PM-3-2732, 2732A, PM-6-68764, 2516, 2716, PM-4-2564, PM-7-2528, PM-2-2532, PM-5-2764, PM-8-27128
- Single zero-insertion-pressure socket accommodates both 24-pin and 28-pin EPROM packages.
- On-board OC-to-OC converter with adjustable regulator for programming voltage.
- Double-sided PC board with solder masks, silkscreen and gold-plated contact fingers.
- 8080/280 control software includes commands for programming, verification, disk I/O and editing.
- Comprehensive user's manual contains source listing of control software.

**MicroDynamics Corporation**  
 P.O. Box 17577  
 Memphis, TN 38117  
 (901)-755-0619

**\$269.95**  
 (assembled & tested)

Price includes EPROM-32, documentation and two Personality Modules (specify). Additional Modules - \$7.95. Control software on 8 inch single density CP/M-compatible diskette - \$9.95.

MasterCard & Visa TN residents add 6% sales tax.

Circle 310 on inquiry card.

TIRED OF CHANGING CABLES AND TURNING KNOBS?



**ASCII SWITCH**

- Computer Controlled or Manual
- Command Code User Selectable
- Select one of two Peripherals
- Select one of two Computers
- Asynchronous to 19200 Baud
- No External Power Needed

Call or write

**ADVANCED SYSTEMS CONCEPTS, INC.**  
 P.O. BOX Q, ALTADENA, CA. 91001  
 (213) 684-5461 or 794-2308

Circle 13 on inquiry card.

Get more out of your Apple with the MICRO on the Apple Series

Vols. 1, 2, & 3 \$24.95 ea.  
 + \$2.00 shipping each volume

Each book includes more than 30 programs — all on DISKETTE

Machine Language Aids  
 I/O Enhancements  
 Runtime Utilities  
 Graphics & Games  
 Hardware & Reference Information

To order toll free:  
 1-800-227-1617 ext. 564  
 In CA 1-800-772-3545 ext. 564

**MICRO INK, Inc.**  
 P.O. Box 6502  
 Chelmsford, MA 01824

Circle 486 on inquiry card.

**AUTO-DIAL/AUTO-ANSWER**

**MODEM FOR**  
~~\$249.95~~  
 \$199.00



The MICROCONNECTION™ con dial and answer the telephone, run printers, decode busses, transcribe transmissions, answer/originote and direct-connect to the telephone system. Lots of terminal and host software too. For more information write or phone:

**the micropipheral corporation**  
 2643 A - 151st Pl. N.E.  
 Redmond, WA 98052  
 (206) 881-7544

\*RS232 MICROCONNECTION™



Circle 313 on inquiry card.

Beautiful Plots with **PLOTPAK™**

PLOTPAK is a complete plotting library that runs under FORTRAN-80 and includes drivers for the following screens and plotters:

- MicroAngelo MA 512
- ADM + Retrographics
- TEK 4010 compatible terminals
- Houston Instruments DMP-4
- HP plotters 7225B and 7470
- Radio Shack Printer/Plotter

PLOTPAK (.REL file): ..... \$275.  
 PLOTPAK source code plus two drivers: ..... \$365.

**BRIDGE Computer Company**  
 DIVISION OF Sea Data Corporation  
 One Bridge Street, Newton, MA 02158  
 TEL. (617) 244-8190 TLX: 951107

Circle 71 on inquiry card.

Expansion Memory



for  
**The IBM Personal Computer**

- Parity generation & checking
- Fully assembled, quality tested
- One year warranty

PART. NO.	UNIT	PRICE
AIM-256-01B	64KB	\$349.
AIM-256-02B	128KB	\$499.
AIM-256-03B	192KB	\$639.
AIM-256-04B	256KB	\$769.
AIM-256-00B	Bare board, Bracket & Schematic	\$ 99.
AIM-256-09B	64KB EXP. KIT	\$149.

ADD \$4.00 FOR SHIPPING AND HANDLING

**APSTEK, INC.**  
 P.O. Box 5306  
 Richardson, TX 75080  
 (Texas residents add applicable sales tax)  
 VISA, M/C 24hr. order line  
 (817) 571-7171

Dealer inquiries invited

Circle 33 on inquiry card.

**LOGICAL ANALYSIS HARVARD/BAS VERSION 2.2**

WRITTEN IN BASIC for any BASIC SYSTEM WITH INSTR AND LEFT SIDE MID\$ FUNCTIONS. WILL REDUCE ANY BINARY STATE, MULTIVARIABLE EQUATION TO ITS MINIMUM FORM. "DOES FOR LOGIC WHAT THE CALCULATOR DID FOR ARITHMETIC."

SOURCE LISTING ..... \$5.00

**SCIENTIFIC TECHNIQUES**  
 P.O. Box 8453  
 GREENSBORO, N.C. 27419

Circle 401 on inquiry card.



# INTELLIGENT VIDEO I/O FOR S-100 BUS

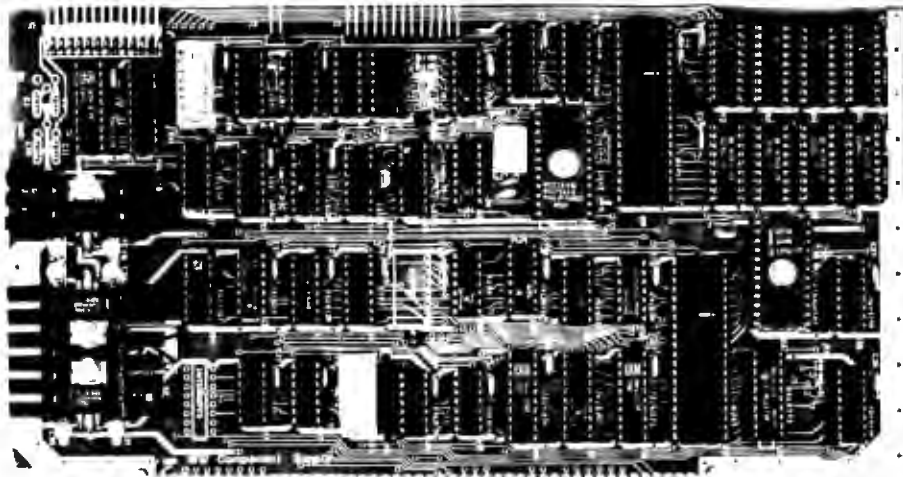

## VIO-X

The VIO-X Video I/O Interface for the S-100 bus provides features equal to most intelligent terminals both efficiently and economically. It allows the use of standard keyboards and CRT monitors in conjunction with existing hardware and software. It will operate with no additional overhead in S-100 systems regardless of processor or system speed.

Through the use of the Intel 8275 CRT controller with an onboard 8085 processor and 4k memory, the VIO-X interface operates independently of the host system and communicates via two ports, thus eliminating the need for host memory space. The screen display rate is effectively 80,000 baud.

The VIO-X1 provides an 80 character by 25 line format (24 lines plus status line) using a 5 x 7 character set in a 7 x 10 dot matrix to display the full upper and lower case ASCII alphanumeric 96 printable character set (including true descenders) with 32 special characters for escape and control characters. An optional 2732 character generator is available which allows an alternate 7 x 10 contiguous graphics character set.

The VIO-X2 also offers an 80 character by 25 line format but uses a 7 x 7 character set in a 9 x 10 dot matrix allowing high-resolution characters to be used. This model also includes expanded firmware for block mode editing and light pen location. Contiguous graphics characters are not supported.

Both models support a full set of control characters and escape sequences, including controls for video attributes, cursor location and positioning, cursor toggle, and scroll speed. An onboard Real Time Clock (RTC) is displayed in the status line and may be read or set from the host system. A checksum test is performed on power-up on the firmware EPROM.

Video attributes provided by the 8275 in the VIO-X include:

- FLASH CHARACTER
- INVERSE CHARACTER
- UNDERLINE CHARACTER or
- ALT. CHARACTER SET
- DIM CHARACTER

The above functions may be toggled together or separately.

The board may be addressed at any port pair in the IEEE 696 (S-100) host system. Status and data ports may be swapped if necessary. Inputs are provided for parallel keyboard and for light pen as well as an output for audio signalling. The interrupt structure is completely compatible with Digital Research's MP/M.

Additional features include:

- HIGH SPEED OPERATION
- PORT MAPPED IEEE S-100 INTERFACE
- FORWARD/REVERSE SCROLL or
- PROTECTED SCREEN FIELDS
- CONVERSATIONAL or BLOCK MODE (opt)
- INTERRUPT OPERATION
- CUSTOM CHARACTER SET
- CONTROL CHARACTERS
- ESCAPE CHARACTER COMMANDS
- INTELLIGENT TERMINAL EMULATION
- TWO PAGE SCREEN MEMORY

VIO-X1 - 80 x 25 5x7 A & T **\$295.00**

Conversational Mode  
VIO-X2 - 80 x 25 7 x 7 A & T **\$345.00**  
Conversational & Block Modes

For European enquiries and sales contact:

**Fulcrum** (Europe) England  
Phone 061 828763

Circle 474 on inquiry card.



**FULCRUM**  
COMPUTER PRODUCTS

Distributed by  
**WW COMPONENT SUPPLY INC.** 1771 JUNCTION AVENUE • SAN JOSE, CA 95112 • (408) 295-7171

# 64K STATIC RAM BOARD FOR S-100 BUS \$470

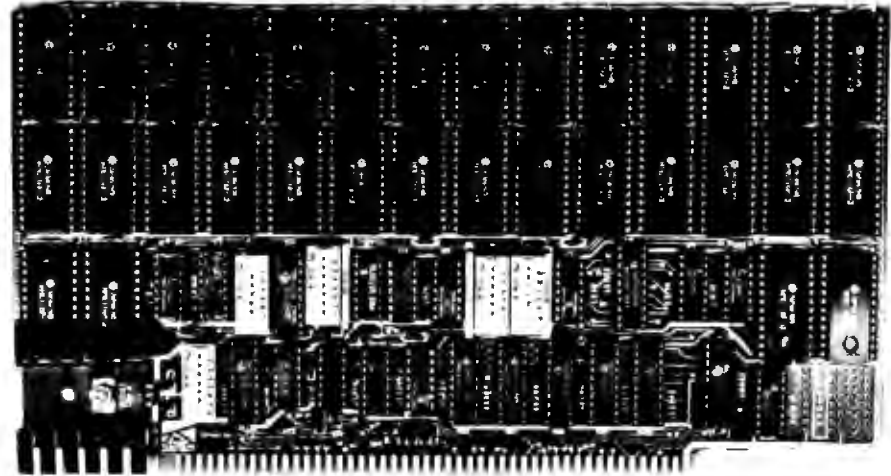

## FEATURES

- Conforms to IEEE 696 standard.
- 8 or 16 bit data transfers.
- 24 bit addressing.
- Bank select in 32K-32K or 48K-16K.
- Banks selectable/deselectable on DMA.
- Responds to phantom pin 67 or 16.
- 2K x 8 static rams with 2716 pin out.
- Power consumption is typically 600 ma.
- Banks on or off on power up.
- Bank addressable to any of 256 possible ports.
- 8MHz with 150ns parts standard, faster speeds available on request.
- Available partially loaded as a 32K board.
- Multiple bank residence.

# OMNIRAM

## OMNIRAM INTRODUCTION:

The Fulcrum Computer Products OMNIRAM for the IEEE 696 (S100) bus provides 64 kilobytes of fast static random access memory. Provision is made for 8 or 16 bit transfers, extended 24 bit addressing, and for control via the bus phantom line. In addition, a number of features are included to make the OMNIRAM compatible with systems designed before the IEEE 696 standard was developed. These include bank selection and provision for operation with IMSAI-type front panels. When the bank select option is activated, the board is divided into two parts which can reside in separate banks. The division of the board may be into two 32K sections or into one 16K section and one 48K section. 2K blocks may be disabled in the upper 16K, or 4K blocks in the upper 32K, of memory. Provision is made for DMA override of bank select if needed. The board is also compatible with IEEE 696 or IMSAI-type extended addressing.

Omniram 64 United States & Canada Prices Only

With Hitachi 6116	64K	32K
150ns. Rams	\$470	\$325
120ns. Rams	\$550	\$395
Board Without Ram	\$200	
With Toshiba 2016 Rams	64K	32K
Typical current draw 800mill	\$425	\$275



**FULCRUM**  
COMPUTER PRODUCTS

Distributed by:  
**WW COMPONENT SUPPLY INC.** 1771 JUNCTION AVENUE • SAN JOSE, CA 95112 • (408) 295-7171  
For European enquiries and sales contact: **Fulcrum** (Europe) England, Phone 061 828763

**CROMEMCO  
CROMIX USERS**

**ADDING MEMORY? BUY THE MEMORY  
MERCHANT S-100 64K STATIC RAM AND SAVE  
3 WAYS:**

**SAVE UP TO \$400 OVER COMPETING 64K  
DYNAMIC RAM CARDS**

**SAVE POWER WITH THIS COOL RUNNING  
DESIGN**

**SAVE YOUR STOMACH BY ELIMINATING  
DYNAMIC RAM BIT ERRORS THAT  
CAUSE SYSTEM CRASHES.**

WE OFFER AN UNPRECEDENTED 18 MONTH  
LIMITED WARRANTY ON THIS FIELD-PROVEN  
CROMEMCO COMPATIBLE RAM.

**64 K RAM MODEL MM65KLB5 \$759**

TO ORDER, SEND CHECK, MONEY ORDER, VISA  
OR MASTERCARD WITH YOUR ORDER OR

**CALL (512) 837-7696**

**MICROSYSTEMS ASSOCIATES**

4309 EVEREST LANE, AUSTIN, TX 78759

Cromemco and Cromix are trademarks of Cromemco, Inc.  
Memory Merchant is a trademark of Memory Merchant, Inc.

Circle 315 on inquiry card.

**NEC PC-8000 Computer System**

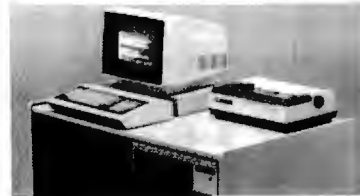

- \*PC-8001A Keyboard ..... **\$809.88**
- \*PC-8012A I/O Unit ..... **\$534.88**
- \*PC-8023A-C Printer ..... **\$499.88**
- \*PC-8031A Disk Drives ..... **\$809.88**
- PC-8032A Add-on Drives ..... **\$709.88**
- PC-8041A Monitor ..... **\$184.88**
- NC-8500 Wedge ..... **\$514.88**

\*Additional 5% discount for complete system purchase  
**HIGH TECHNOLOGY AT AFFORDABLE PRICES**

**THE BOTTOM  
LINE**

Orders & Information  
(603)-673-8857

Orders Only  
(800)-343-0726

12 Johnson Street, Milford NH 03055

Circle 66 on inquiry card.

**Make a  
Living at  
"21"**

**A Blackjack Program  
unique in its ability to  
teach card counting  
strategies.**

The program will effectively teach card counting strategies with  
more precision and speed than previously possible. Five proven  
strategies are taught, each with increasing complexity. Twelve  
user-alterable rules enable learning strategies specific to any  
casino in the world. Incorrect player actions are signaled and  
remembered for subsequent use. Other learning aids are also  
included, and of course normal casino-style blackjack can be  
played at any time. Send for brochure.

CP/M with cursor addressable screen.  
**kanadu engineering**

1653 minorca • costa mesa, ca 92626

CP/M is a trademark of Digital Research.

Circle 475 on Inquiry card.

**ELIZA IS HERE!**

AT LAST! A FULL IMPLEMENTATION of the original ELIZA  
program is now available to run on your microcomputer!

Created at MIT in 1966, ELIZA has become the world's most  
celebrated artificial intelligence demonstration program. ELIZA is  
a non-detractive psychotherapist who analyzes each statement as  
you type it in and then responds with her own comment or question  
— and her remarks are often startlingly appropriate!

Designed to run on a large mainframe, ELIZA has hitherto been  
unavailable to personal computer users except in greatly stripped  
down versions lacking the sophistication which made the original  
program so fascinating.

Now, our new microcomputer version possessing the FULL power  
and range of expression of the original is being offered at the  
introductory price of only \$25. And if you want to find out how she  
does it (or teach her to do more) we will include the complete  
Source Program for only \$20 additional!

Order your copy of ELIZA today and you'll never again wonder how  
to respond when you hear someone say "Okay, let's see what the  
computer of yours can actually do!"

**ELIZA IS AVAILABLE IN THE FOLLOWING DISK FORMATS:**

- 1 Standard 8 inch single density for all CP/M based computers  
\$25 for ELIZA.COM — add \$20 for Microsoft BASIC-80 Source
- 2 5 1/4 inch CP/M for Apple II equipped with Z-80 SoftCard  
\$25 for ELIZA.COM — add \$20 for Microsoft BASIC-80 Source
- 3 5 1/4 inch for 48K Apple II with Applesoft ROM and DOS 3.3  
\$25 for Protected File — add \$20 for Applesoft Source
- 4 5 1/4 inch for 64K IBM Personal Computer  
\$25 for Protected File — add \$20 for BASIC Source

**ARTIFICIAL INTELLIGENCE RESEARCH GROUP**

821 NORTH LA JOLLA AVENUE  
LOS ANGELES, CALIFORNIA 90046  
(213) 656-7368 (213) 654-2214  
MC, VISA and CHECKS ACCEPTED



Circle 36 on Inquiry card.

**TECH  
ELECTRONICS**

PO Box 508, Back Bay Annex  
Boston, MA 02117

- 2114, 150ns. .... **\$2.63**
- 2708 ..... **3.44**
- 2716 ..... **5.46**
- 4116, 150ns. .... **1.94**
- 4116, 200ns. .... **1.86**
- 4164 ..... **8.00**
- 6116, P-3. .... **9.64**
- 8086 ..... **24.00**

Call For Our Pricebook

**WE'VE GOT IT ALL  
(617) 876-5258**

Circle 440 on inquiry card.

**Wow! IBM PC**

**SOFTWARE**

- PCGAMES I — An anthology of 5 games BLACKJACK  
GOLLUM'S TUNNEL, MORTAR, MARS LANDER and  
KISMET 64K 1 disk drive \$ 20
- PCIFORMAT — An interactive screen formatter designed  
specifically for the PC Supported by Pascal Fortran and  
Basic (external subroutines) \$ 98

**HARDWARE** (Personal Systems Technology INC.)  
— 1 Year Warranty —

- 64K Expandable (256K) Ram Board \$209
- 128K Expandable (256K) Ram Board \$450
- 256K Ram Board \$750
- 65K Expansion Kit for Ram Board \$175
- Dual-Line Asynch Controller Board (50-19.2K Baud) \$159

**LITERATURE**

- Discount Buyer's Guide to the IBM PC \$ 3

Cal Residents Add 6% Sales Tax. MCVISA accepted  
Hardware/Software include \$3.50 shipping & handling

**Micro Express**

**(714) 859-7575** 3857 Birch St., Ste. 109  
Newport Beach, CA 92660

Circle 298 on Inquiry card.

**MCP COMPUTER PRODUCTS**

S-100 BOARDS

- MCPISCC - 6 Z80B 2-4-6 Mhz \$350
- W12 serial, 3 parallel, ram & Eeprom \$320
- MCPIFDC dual density disk cont. \$250
- W1793, 1681, 2143 \$490
- MCPVDB 80X24 video display \$CALL
- controller. Uses 6845
- MCP 64 KS static ram 150 ns 64K \$CALL
- H61162016
- MCP 8086 CPU/I/O Board set
- Suite 104-444
- 6892 El Carmino Real
- Carlsbad, CA 92008

Ph. 714-438-3270

Master Card & Visa

Circle 286 on Inquiry card.

**Design Line  
Micro Work  
Stations**



RETAIL  
PRICE  
\$185

- A complete range of work stations designed  
specifically to house all micro-computers.
- Delivered heavily packed, in self-assembly  
form needing only a Phillips screwdriver and  
a few minutes of your time to assemble.
- Manufactured from 1" all wood particle board  
surfaced with hard-wearing melamine veneer,  
in either Oak or Walnut.
- Dealer and Distribution prices on request.
- For more information on our full range of work  
stations write or call 301-223-8900.

**ATLANTIC CABINET CORPORATION**  
P. O. Box 100, Williamsport, Maryland 21795

Circle 44 on inquiry card.

**NEW PRODUCTS**

**CRT-1**

**INTELLIGENT VIDEO BOARD 4K  
X 8 DISPLAY RAM, 4K X 4 AT-  
TRIBUTE RAM KEYBOARD INTER-  
FACE. LITE PEN INTERFACE.**

**PCBD. ... \$38.95, KIT. ... \$259.95**

**MEM-4 65K X 8 RAM/ROM USES  
TMS 4016 RAM OR 2716 ROMS  
EXTENDED ADDRESSING BANK  
SELECTABLE ON UPPER 16K.**

**PCBD. .... \$38.95**

**KIT LESS MEMORY. .... \$99.95**

**A & T LESS MEMORY .... \$135.95**

**WAMECO INC.**

P.O. BOX 877 EL GRANADA CA 94018  
(415) 728-9114

Circle 462 on Inquiry card.

### SPECIALS on INTEGRATED CIRCUITS

6502	7.45	10/6.95	50/6.55	100/6.15
6502A/6512A	8.40	10/7.95	50/7.35	100/6.90
6520 PIA	5.15	10/4.90	50/4.45	100/4.15
6522 VIA	6.45	10/6.10	50/5.75	100/5.45
6532	7.90	10/7.40	50/7.00	100/6.60
2114-L200	2.45	25/2.30	100/2.15	
2114-L300	2.25	25/2.10	100/2.00	
2716 EPROM	5.50	5/5.15	10/4.80	
2532 EPROM	9.90	5/9.45	10/8.90	
6116 Hitachi 2Kx8 CMOS RAM	9.90	5/9.45	10/8.90	
4116-200 ns RAM			8 for 15	
Zero Insertion Force 24 pin Socket			2.00	
S-100 Wire Wrap Socket			2.40	

**A P Products 15% OFF**  
**A P Hobby-Blox 15% OFF**

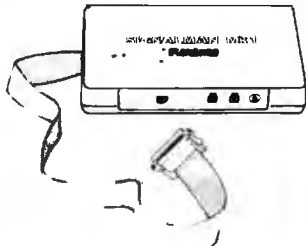

### MODEM SPECIAL \$99

**SIGNALMAN Mk1** from Anchor Automation  
 DIRECT CONNECT Modem with RS232 Cable and Connector included Fully compatible with all Bell 103 modems. 0 to 300 bps. full duplex, frequency shift keyed modulation, automatic ANSW/ORIG selection, direct connect, audible tone carrier detect indicator, self-contained battery powered.

**PET/CBM Version (Mk1P) \$169**

For Commodore Computers, the Signalman Mk1P includes connector, cable, and machine language software

**COMPACT INTELLIGENT TERMINAL PACKAGE \$115**

Combines intelligent RS232 port hardware from cgrs Microtech with EHS Intelligent Terminal software to allow you to connect any RS232 Modem to PET/CBM

**RS232 MODEM - STAR SALE \$128**  
**IEEE 488 MODEM - STAR SALE \$199**

**We carry Apple II+ from Bell & Howell**

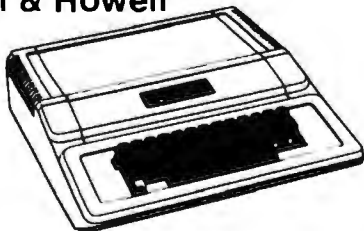

**16K RAM Card for Apple 95**

**CASH MANAGEMENT SYSTEM \$45**

Easy to use. Keeps track of cash disbursements, cash receipts, cash transfers, expenses for up to 50 categories.

**FORTH for PET by Cargile/Riley \$50**

Full FIG model with all 79 Standard Extensions.

**Metacompiler for FORTH for independent object code 30**

**KMMM PASCAL for PET/CBM \$85**

Includes translator for true machine language object code.

**EARL for PET/CBM 65**

Editor, Assembler, Relocator, Linkeditor.

**SuperGraphics - BASIC Language Extensions 40**

Fast Machine Language Graphics routines for PET/CBM.

## commodore



### CBM-PET SPECIALS

	list	SALE
8023 Printer - 136 col. 150cps bi-directional	(995)	775
8300 Daisy Wheel - 40 cps bi-directional	(2250)	1750
8032 80 x 25 CRT, business keyboard	(1495)	1100
Super Pet	(1995)	1600
8096 Board (extra 64K RAM for 8032)	(500)	400
8050 Dual Disk Drive - 1 megabyte	(1795)	1345
8250 Dual Disk Drive - 2 megabyte	(2195)	1760
CBM IEEE Modem	(395)	199
4016 full size graphics keyboard	(995)	795
4032 full size graphics keyboard	(1295)	999
4040 Dual Disk Drive - 330,000 bytes	(1295)	999
2031 Single Disk Drive - 165,000 bytes	(695)	550
4022 Tractor Feed Printer	(795)	630
C2N External Cassette Deck	(75)	65
Used CBM/PET Computers		CALL

**WE WILL MATCH ANY ADVERTISED PRICE**

**\*\*\* EDUCATIONAL DISCOUNTS \*\*\***

Buy 2 PET/CBM Computers, receive 1 FREE

### PETSCAN I \$345 base price.

Allows you to connect up to 20 CBM/PET Computers to shared disk drives and printers. Completely transparent to the user. Perfect for schools or multiple word processing configurations. Base configuration supports 3 computers.

VIC 20	259	VIC Superslot	24
VIC 1515 Printer	335	VIC Super Alien	24
VIC 3K RAM	36	VIC Maze in 3-D	12
VIC 8K RAM	54	VIC Cosmic Debris	9
VIC 16K RAM	112	VIC Amok (UMI)	17
VIC 1540 Disk Drive	500	VIC Snakman	13
VIC Invaders	24	VIC Rubik's Cube	13
VIC Jupiter Lander	24	VIC Night Rider	11

TNW 1000 Serial Interface	110
TNW 488/103 with DAA	450
Compute's First Book of PET /CBM	11
WordPro 3 Plus - 32K CBM, disk, printer	195
WordPro 4 Plus - 8032, disk, printer	300
VISICALC for PET, ATARI, or APPLE	190
<b>SM-KIT - PET ROM Utilities</b>	<b>40</b>
Programmers Toolkit - PET ROM Utilities	35
PET Spacemaker II ROM Switch	36
2 Meter PET to IEEE or IEEE to IEEE Cable	40
Dust Cover for PET	8
IEEE-Parallel Printer Interface for PET	110
IEEE-RS232 Printer Interface for PET	120
The Pet Revealed	12
Library of PET Subroutines	12

### 4 PART HARMONY MUSIC SYSTEM for PET

The Visible Music Monitor, by Frank Levinson, allows you to easily enter, display, edit, and play 4 part harmony music. Includes whole notes thru 64ths (with dotted and triplets), tempo change, key signature, transpose, etc. The KL-4M unit includes D to A converter and amplifier ready to hook to your speaker.

**KL-4M Music Board with VMM Program \$60**

## DISK SPECIALS



SCOTCH (3M) 5" 10/2 45 50/2 35 100/2 30  
 SCOTCH (3M) 8" 10/2 60 50/2 45 100/2 40

### WE STOCK VERBATIM DISKS

Try the new Verbatim Head Cleaner Kits

BASF 5" or 8" 10/2.00 20/1 95 100/1 85  
 Wabash 5" 10/2.00 20/1.95 100/1.85  
 Wabash 8" 10/2.00 20/1 95 100/1 85

### WE STOCK MAXELL DISKS

Diskette Storage Pages 10 for 3.95  
 Disk Library Cases 8" - 2.85 5" - 2.15  
 Disk Hub Rings 8" - 50 @ 7.50 5" - 50 @ 6.00

### CASSETTES - AGFA PE-611 PREMIUM

High output, low noise, 5 screw housings.

C-10 10/56 50/50 100/48  
 C-30 10/73 50/68 100/66  
 All other lengths available. Write for price list.

## SPECIALS

<b>EPSON MX-80 Printer</b>	
<b>EPSON MX-80 F/T Printer</b>	
<b>EPSON MX-70 Printer</b>	
<b>EPSON MX-100 Printer</b>	
Centronics 739 Printer with dot graphics	575
<b>STARWRITER Daisy Wheel Printer F10</b>	<b>1445</b>
Zenith ZVM-i21 Green Phosphor Monitor	119
DC Hayes Smartmodem	230
Watanabe Intelligent Plotter 1195 6-Pen	1445
BMC BM12A Green Phosphor Monitor	100
BMC BM1400BLUC 13" Color Monitor	285
BMC RGB 13" Color Monitor	329

### ALL BOOK AND SOFTWARE PRICES DISCOUNTED

### Synertek Systems

<b>SYM-1 Microcomputer</b>	<b>SALE 199</b>
SYM BAS-1 BASIC or RAE 1/2 Assembler	85
KTM-2/80 Synertek Video and Keyboard	349
KTM-3/80 Synertek Tubeless Terminal	385

## ZENITH data systems

Z90-80 64 K	2170
Z90-82 64K, 1 double dens. drive	2395
Z89-0 48K	1950
Z89-1 48K, 1 drive	2150
Z67 10 Megabyte + Floppy Drive	4495
Z37 1.3 Megabyte Dual Floppy	1495
Z25 High Speed Printer	1195
Z19 Video Terminal (VT-52 compatible)	670
ZVM-121 Green Phosphor Monitor	119
All Zenith Software discounted	



## ATARI SPECIALS

800 Computer	675	Microsoft BASIC	72
400 - 16K	330	<b>MISSILE COMMAND</b>	<b>32</b>
810 Disk Drive	440	<b>ASTERIODS</b>	<b>32</b>
825 Printer	629	<b>STAR RAIDERS</b>	<b>37</b>
850 Interface	170	Space Invaders	32
Inside Atari DOS	18	Music Composer	45
Paddle Pair	19	Chess	30
Joystick Pair	19	Super Breakout	30
16K RAM	69	<b>PAC-MAN</b>	<b>36</b>
32K RAM	99	<b>CENTPEDE</b>	<b>36</b>
Pilot	68	First Book of Atari	11

Write for prices on other Atari items.

### WRITE FOR CATALOG

Add \$1.25 per order for shipping. We pay balance of UPS surface charges on all prepaid orders. Prices listed are on cash discount basis. Regular prices slightly higher. Prices subject to change.

252 Bethlehem Pike  
 Colmar, PA 18915 215-822-7727

## A B Computers



# MICROANGELO Software

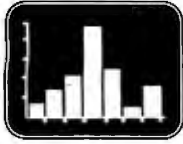

## GRAPH-PAK

Fortran compatible interactive plotting package based on CALCOMP standards. Output is to MicroAngelo or to pen plotter.....\$270.00 (CP/M and Microsoft Fortran-80 required.)

## SPRINT

Hardcopy program for MicroAngelo. Output is to I.D.S. or EPSON graphics printers. CP/M compatible.....\$125.00

Laboratory Computer Systems, Inc.  
139 Main Street, Cambridge, MA 02142  
(617) 547-4738

\* Trademark of SCION Corp

Circle 291 on Inquiry card.

## \$100 Intelligent Color Graphics

- 8085 6K Prom 8K Ram 6847
- SubLogic Graphics software in onboard Prom
- 32 Graphics commands including shaded polygons, circles, boxes, lines, rays
- Horizontal and vertical text
- 256h x 192v Hi Resolution
- 128h x 192v 4 color

\$395

California Computer Graphics  
25 Avenida Dr.  
Berkeley CA 94708  
(415) 540-5698

Circle 82 on Inquiry card.

## T.H.E. SMART TERMINAL<sup>®</sup>



Software that turns your Atari 400 or 800 into a real smart terminal. Send and receive data from all popular data services. Works with cassette or disk for upload/download. 16K min. Available at Atari Dealers Worldwide or directly from Binary. VISA/MC/AMEX/COD/CHECK. Cassette \$47.95 Disk \$49.95 add \$2.50 P & H U.S., \$5.00 overseas.

## BINARY<sup>TM</sup>

Computer Software  
3237 Woodward Ave.  
Berkley, MI 48072  
(313) 548-0533

BINARY CORPORATION

Circle 61 on Inquiry card.

## UNLEASH YOUR ATARI! USE ANY STD. PARALLEL OR SERIAL PRINTER

### CM-1000 — \$289

- EIA std. ser. port that really works
- 8 bit parallel port (use with 825 ptr.)
- Software selectable port addressing
- Configurable char. translation
- Bi-direct. communications

### ADD 80 CHARACTER VIDEO CM-1000/V — \$489.00

- Includes CM-1000 above
- Adds full page width process. Incl. other funct.
- 128 char. Software modifiable char. set, incl. U & LC

### CM-1000 & 1000/V INCLUDE

- Configuration program
- No physical changes to computer
- And much, much more!

### Compu-Mate CORP.

6305 Arizona Ave., Los Angeles,  
CA 90045 • (213) 991-7098

Circle 104 on Inquiry card.



## maxell

### Floppy Disks

SAVE 40% Write for your complete list.

5 1/4" Specify soft, 16 or 18 sector Price/10

MD1 or MH1 SS/DD .....	\$33
MD2 or MH2 DS/DD .....	47
MD1-DDM SS/QD/96 TP1 .....	43
MD2-DDM DS/QD/96 TP1 .....	53

8" Specify soft or 32 sector

FD1 or FH1 SS/DD .....	43
FD2 or FH2 DS/DD .....	53

CHECKS — VISA — MC — C.O.D.  
(313) 777-7780 ADD \$2 SHIPPING

LYBEN COMPUTER SYSTEMS  
27204 Harper Ave.  
St. Clair Shores, MI 48081

Circle 273 on Inquiry card.

## MICROPROCESSOR CRYSTALS

1,000, 1.8432, 2,000, 3,2768 MHz	3.00 each
3,5795, 4,000, 4,1934, 4,9152, 5,000, 5,0688, 6,000, 6,144, 6,400, 7,3728, 8,000, 10,000, 14,31818, 18,000, 19,6608	2.00 each
20,000, 22,1184, 32,000 MHz	2.00 each

## TUNING FORK CRYSTALS (3mm x 8mm Miniature)

32 768 KHz	1.00 each
30 - 40KHz	Inquire

## 60Hz CRYSTAL TIME BASE

Assembled	5.00 each
Kit	4.00 each

## We also carry BECKMAN PRODUCTS, please inquire:

D/A, A/D Converters, Resistor Networks, Trimming Potentiometers, Precision Potentiometers, Displays, Digital Multimeters.

## GET ACQUAINTED OFFER:

BECKMAN DMM TECH 300	110.00 each
BECKMAN DMM TECH 310	135.00 each
BECKMAN DMM TECH 330	165.00 each

Add sales tax in California. Postage: 5% of total order (\$1.00 minimum). Insurance: \$1.50

## SIGMATEK INTERNATIONAL CORPORATION

327 Clarkin Ct., Walnut Creek, CA 94598  
P.O. Box 5007, Concord, CA 94520

Circle 411 on Inquiry card.

## APPLE TREE GENEALOGY SYSTEM for your APPLE II+ Computer



- Professional-level Family Recordkeeping System
- 1000 Names (variable-length)
- Hierarchical Data-Structure
- Easy to Use
- Fast Memory-Resident Scroll
- Unique Label Control Matrix
- 100 User-Definable Fields
- The Linkage Analyzer™
- Customize Your Own Reports
- Automatic Proofreader Report
- Self-teaching Tutorial
- Backed by 4 Years Gen. Computing
- Apple II+ IIk 005 3.3 (1 or 2 Drives)



J.Fiske Software Systems, Inc.  
One University Place  
New York, N.Y. 10003

\$69.95 NYC/NYS Add Tax



Apple™ - Apple Computer

Apple Tree™/The Linkage Analyzer™ - JFSS

Circle 245 on Inquiry card.

## NEW! S-100 BUS COMPATIBLE

SINGLE BOARD COMPUTER WITH VIDEO OUTPUT

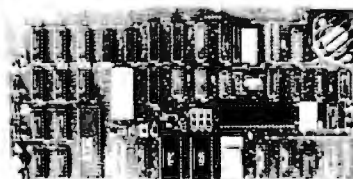

USES:  
This card can function as a stand alone single board computer or as S-100 intelligent video interface card

FEATURES:  
4 8042 Z80A\*, up to 64K of EPROM, 16 2048B RAM, and 8042 HI input/output BIT control (2048B BIT) smart input bus with address, control video output 400000, video distribution, device video, window, blanking, graphic capabilities

PRICE:  
Base board with documentation ..... \$49.95  
Monitor and video terminal software on EPROMS ..... \$49.00  
Source listings (with Monitor purchase) ..... \$15.00  
Hard to find Parts Kit (cassette and base kit PROMS) ..... \$19.00  
\*Patented by Intel Corp. © 1982 Intel Corp. All rights reserved.

EMS  
P.O. Box 6615 Irvine CA 92714-0615  
714-553-0133

Circle 172 on Inquiry card.

## Your FORTH 995

Questions Answered 995<sup>PPD</sup>  
30 minute audio cassette and 8-page booklet tell what FORTH is, how it works and gives pros & cons of using FORTH for all kinds of applications.

## Learn FORTH 5795

Fundamentals for 5795<sup>PPD</sup>  
Two floppy diskettes with interactive tutorial designed to teach FORTH fundamentals quickly, easily and inexpensively. Requires CP/M operating system. CP/M is a trademark of Digital Research.

## FORTH Workshops now being scheduled nationwide

For orders or information contact:

Laxen & Harris, Inc.  
24301 Southland Dr., #216  
Hayward, CA 94545  
(415) 887-2894

\*Post Paid. We accept VISA, Mastercard & Checks.

Circle 260 on Inquiry card.



# FULL LINE ALL PARTS & COMPUTER PRODUCTS

P.O. Box 4430x  
Santa Clara, CA 95054  
Will calls: 2322 Walsh Ave.  
(408) 988-1640

Same day shipment. First line parts only. Factory tested. Guaranteed money back. Quality IC's and other components at factory prices.

## INTEGRATED CIRCUITS

Phone orders only (800) 538-8196

74007L	16	LM317T	165	CD4017	1.05	8126	1.69	LM87PFD	1.95	08SS	1.95
74009	19	LM309	3.75	CD4018	.94	8129	1.95	AY5-1013	3.95	DA15P	2.10
74021	19	LM309	1.35	CD4019	.95	8129	.90	3341	6.95	DA35P	3.95
74029	22	LM3200-5	3.75	CD4020	.95	8138	.99			Complete Set	9.50
74031	19	LM3200-12	1.35	CD4021	.95						
74101	19	LM3200-15	1.35	CD4022	1.10						
74141	55	LM3200-8	.85	CD4023	.28	2101.1	1.95	1020R	4.50	Staple with Kit	28.95
74149	19	LM3201-12	.85	CD4024	.75	2102-1	.85	2532	17.50	Auto Clk Kit	17.95
74201	19	LM3201-15	.85	CD4025	.21	2102A-1	1.25	2708	2.95	1000 per type	1.05
74301	40	LM3201-5	1.35	CD4026	1.65	2104A-4	4.35	2716.5 Voh	5.30	10 per type	.05
74341	49	LM323A-5	4.95	CD4027	.85	2107F-1	2.75	2716.5 Voh	18.50	1000 per type	0.15
74471	49	LM324N	5.95	CD4028	.80	2111-1	2.95	2728	7.49	350 per type	0.02
74474	49	LM324N	1.35	CD4029	.30	2114	2.24	8748	39.95	250 per type	0.085
74479	35	LM340K-5	1.35	CD4030	.45	2115-1	2.95	8748	28.00	5 per type	8.95
74481	49	LM340K-8	1.35	CD4031	.85	2116-1	2.95	8748	28.00	1/4 watt 5% per type	0.5
74501	85	LM340K-24	1.35	CD4032	.75	2116-2	2.95	8748	28.00		
74509	85	LM340K-12	1.35	CD4033	.85	2116-200s	2.95	8748	28.00		
74521	85	LM340T-5	1.35	CD4034	.85	2116-200s	2.95	8748	28.00		
74529	85	LM340T-15	1.35	CD4035	.85	2116-200s	2.95	8748	28.00		
74530	1.00	LM340T-8	.75	CD4036	.45	2116-200s	2.95	8748	28.00		
74536	80	LM340T-24	1.35	CD4037	.85	2116-200s	2.95	8748	28.00		
74539	1.20	LM350	5.50	CD4038	.35	2116-200s	2.95	8748	28.00		
74540	1.15	LM350	2.25	CD4039	.35	2116-200s	2.95	8748	28.00		
74544	1.25	LM350N	5.50	CD4040	.35	2116-200s	2.95	8748	28.00		
74571	55	LM381	1.50	CD4041	.35	2116-200s	2.95	8748	28.00		
74574	80	LM382	1.50	CD4042	.35	2116-200s	2.95	8748	28.00		
74579	85	LM390N	5.00	CD4043	.35	2116-200s	2.95	8748	28.00		
74581	85	LM390N	1.50	CD4044	.35	2116-200s	2.95	8748	28.00		
74583	85	LM390N	1.50	CD4045	.35	2116-200s	2.95	8748	28.00		
74584	85	LM390N	1.50	CD4046	.35	2116-200s	2.95	8748	28.00		
74585	85	LM390N	1.50	CD4047	.35	2116-200s	2.95	8748	28.00		
74586	85	LM390N	1.50	CD4048	.35	2116-200s	2.95	8748	28.00		
74587	85	LM390N	1.50	CD4049	.35	2116-200s	2.95	8748	28.00		
74588	85	LM390N	1.50	CD4050	.35	2116-200s	2.95	8748	28.00		
74589	85	LM390N	1.50	CD4051	.35	2116-200s	2.95	8748	28.00		
74590	85	LM390N	1.50	CD4052	.35	2116-200s	2.95	8748	28.00		
74591	85	LM390N	1.50	CD4053	.35	2116-200s	2.95	8748	28.00		
74592	85	LM390N	1.50	CD4054	.35	2116-200s	2.95	8748	28.00		
74593	85	LM390N	1.50	CD4055	.35	2116-200s	2.95	8748	28.00		
74594	85	LM390N	1.50	CD4056	.35	2116-200s	2.95	8748	28.00		
74595	85	LM390N	1.50	CD4057	.35	2116-200s	2.95	8748	28.00		
74596	85	LM390N	1.50	CD4058	.35	2116-200s	2.95	8748	28.00		
74597	85	LM390N	1.50	CD4059	.35	2116-200s	2.95	8748	28.00		
74598	85	LM390N	1.50	CD4060	.35	2116-200s	2.95	8748	28.00		
74599	85	LM390N	1.50	CD4061	.35	2116-200s	2.95	8748	28.00		
74600	85	LM390N	1.50	CD4062	.35	2116-200s	2.95	8748	28.00		
74601	85	LM390N	1.50	CD4063	.35	2116-200s	2.95	8748	28.00		
74602	85	LM390N	1.50	CD4064	.35	2116-200s	2.95	8748	28.00		
74603	85	LM390N	1.50	CD4065	.35	2116-200s	2.95	8748	28.00		
74604	85	LM390N	1.50	CD4066	.35	2116-200s	2.95	8748	28.00		
74605	85	LM390N	1.50	CD4067	.35	2116-200s	2.95	8748	28.00		
74606	85	LM390N	1.50	CD4068	.35	2116-200s	2.95	8748	28.00		
74607	85	LM390N	1.50	CD4069	.35	2116-200s	2.95	8748	28.00		
74608	85	LM390N	1.50	CD4070	.35	2116-200s	2.95	8748	28.00		
74609	85	LM390N	1.50	CD4071	.35	2116-200s	2.95	8748	28.00		
74610	85	LM390N	1.50	CD4072	.35	2116-200s	2.95	8748	28.00		
74611	85	LM390N	1.50	CD4073	.35	2116-200s	2.95	8748	28.00		
74612	85	LM390N	1.50	CD4074	.35	2116-200s	2.95	8748	28.00		
74613	85	LM390N	1.50	CD4075	.35	2116-200s	2.95	8748	28.00		
74614	85	LM390N	1.50	CD4076	.35	2116-200s	2.95	8748	28.00		
74615	85	LM390N	1.50	CD4077	.35	2116-200s	2.95	8748	28.00		
74616	85	LM390N	1.50	CD4078	.35	2116-200s	2.95	8748	28.00		
74617	85	LM390N	1.50	CD4079	.35	2116-200s	2.95	8748	28.00		
74618	85	LM390N	1.50	CD4080	.35	2116-200s	2.95	8748	28.00		
74619	85	LM390N	1.50	CD4081	.35	2116-200s	2.95	8748	28.00		
74620	85	LM390N	1.50	CD4082	.35	2116-200s	2.95	8748	28.00		
74621	85	LM390N	1.50	CD4083	.35	2116-200s	2.95	8748	28.00		
74622	85	LM390N	1.50	CD4084	.35	2116-200s	2.95	8748	28.00		
74623	85	LM390N	1.50	CD4085	.35	2116-200s	2.95	8748	28.00		
74624	85	LM390N	1.50	CD4086	.35	2116-200s	2.95	8748	28.00		
74625	85	LM390N	1.50	CD4087	.35	2116-200s	2.95	8748	28.00		
74626	85	LM390N	1.50	CD4088	.35	2116-200s	2.95	8748	28.00		
74627	85	LM390N	1.50	CD4089	.35	2116-200s	2.95	8748	28.00		
74628	85	LM390N	1.50	CD4090	.35	2116-200s	2.95	8748	28.00		
74629	85	LM390N	1.50	CD4091	.35	2116-200s	2.95	8748	28.00		
74630	85	LM390N	1.50	CD4092	.35	2116-200s	2.95	8748	28.00		
74631	85	LM390N	1.50	CD4093	.35	2116-200s	2.95	8748	28.00		
74632	85	LM390N	1.50	CD4094	.35	2116-200s	2.95	8748	28.00		
74633	85	LM390N	1.50	CD4095	.35	2116-200s	2.95	8748	28.00		
74634	85	LM390N	1.50	CD4096	.35	2116-200s	2.95	8748	28.00		
74635	85	LM390N	1.50	CD4097	.35	2116-200s	2.95	8748	28.00		
74636	85	LM390N	1.50	CD4098	.35	2116-200s	2.95	8748	28.00		
74637	85	LM390N	1.50	CD4099	.35	2116-200s	2.95	8748	28.00		
74638	85	LM390N	1.50	CD4100	.35	2116-200s	2.95	8748	28.00		
74639	85	LM390N	1.50	CD4101	.35	2116-200s	2.95	8748	28.00		
74640	85	LM390N	1.50	CD4102	.35	2116-200s	2.95	8748	28.00		
74641	85	LM390N	1.50	CD4103	.35	2116-200s	2.95	8748	28.00		
74642	85	LM390N	1.50	CD4104	.35	2116-200s	2.95	8748	28.00		
74643	85	LM390N	1.50	CD4105	.35	2116-200s	2.95	8748	28.00		
74644	85	LM390N	1.50	CD4106	.35	2116-200s	2.95	8748	28.00		
74645	85	LM390N	1.50	CD4107	.35	2116-200s	2.95	8748	28.00		
74646	85	LM390N	1.50	CD4108	.35	2116-200s	2.95	8748	28.00		
74647	85	LM390N	1.50	CD4109	.35	2116-200s	2.95	8748	28.00		
74648	85	LM390N	1.50	CD4110	.35	2116-200s	2.95	8748	28.00		
74649	85	LM390N	1.50	CD4111	.35	2116-200s	2.95	8748	28.00		
74650	85	LM390N	1.50	CD4112	.35	2116-200s	2.95	8748	28.00		
74651	85	LM390N	1.50	CD4113	.35	2116-200s	2.95	8748	28.00		
74652	85	LM390N	1.50	CD4114	.35	2116-200s	2.95	8748	28.00		
74653	85	LM390N	1.50	CD4115	.35	2116-200s	2.95	8748	28.00		
74654	85	LM390N	1.50	CD4116	.35	2116-200s	2.95	8748	28.00		
74655	85	LM390N	1.50	CD4117	.35	2116-200s	2.95	8748	28.00		
74656	85	LM390N	1.50	CD4118	.35	2116-200s	2.95	8748	28.00		
74657	85	LM390N	1.50	CD4119	.35	2116-200s	2.95	8748	28.00		
74658	85	LM390N	1.50	CD4120	.35	2116-200s	2.95	8748	28.00		
74659	85	LM390N	1.50	CD4121	.35	2116-200s	2.95	8748	28.00		
74660	85	LM390N	1.50	CD4122	.35	2116-200s	2.95	8748	28.00		
74661	85	LM390N	1.50	CD4123	.35	2116-200s	2.95	8748	28.00		
74662	85	LM390N	1.50	CD4124	.35	2116-200s	2.95	8748	28.00		
74663	85	LM390N	1.50	CD4125	.35	2116-200s	2.95	8748	28.00		
74664	85	LM390N	1.50	CD4126	.35	2116-200s	2.95	8748	28.00		
74665	85	LM390N	1.50	CD4127	.35	2116-200s	2.95	8748			

# ATARI®

VIC-20 \$249	<b>800 (16K) 649</b>
	400 (16 K) 319
	410 Recorder 74
	810 Disk Drive 439
	822 Printer (THERMAL) 269
	825 Printer(80COLUMNS) 589
	830 Modem 149
	850 Interface 164
853 Memory(16K) 79	

**ATARI SOFTWARE**

4002 BASIC CARTRIDGE 45	483 THE PROGRAMMER 52
4003 ASSEMBLER EDIT 45	484 THE COMMUNICATOR 299
4006 SUPER BREAKOUT 35	404 WORD PROCESSOR 110
4007 MUSIC COMPOSER 45	405 PILOT (EDUC) 99
4008 SPACE RAIDERS 33	406 PROGRAMMING 2 21
4009 COMPUTER CHESS 35	417 PROGRAMMING 3 21
4011 STAR RAIDERS 37	8126 MICROSOFT BASIC 66
4012 MISSILE COMMAND 33	8121 MACRO ASSEMBLER 66
4013 ASTEROIDS 33	813 CAVERS OF MARS 29

**CALL OR WRITE FOR FREE CATALOG**

## COSMIC COMPUTERS

UNLIMITED

228 N. PROSPECTORS RD.  
DIAMOND BAR, CA.  
91765

SHIPPING EXTRA \$2 MINIMUM  
PRICES SUBJECT TO CHANGE  
CALIF. RESIDENTS ADD TAX

OPEN 7 Days (714) 861-1265  
8am - 9pm

Circle 134 on inquiry card.

**SAVE 25% ON YOUR**

## IBM® PERSONAL COMPUTER

IF YOU ARE BUYING OR UPGRADING WE CAN SAVE YOU A BUNDLE

- \*DISK DRIVE 1st OR 2nd ..... \$239
- \*16K MEMORY KIT ..... \$25
- \*NEC 8023 & CABLE ..... \$529
- \*64K MEM CARD W/RS232 PORT ..... \$450

PLUS A LOT MORE INCLUDING:  
\*EPSON, OKIDATA & LETTER QUALITY PRINTERS  
\*MODEMS, COLOR MONITORS, 3M DISKETTES  
\*KEYBOARD & MONITOR EXTENSION CORDS

\*\*SPECIAL: 10 3M DISKETTES—\$25 WITH EACH PURCHASE OF A DISK DRIVE

VOLUME DISCOUNTS AVAILABLE  
800-521-0521 IN MICH: 313-429-2678

## AEGIS SYSTEMS

P.O. BOX 401  
202 W. BENNETT ST.  
SALINE, MI 48176

Circle 14 on inquiry card.

# 80,000 WORDS!

WORD GRINDER IS AN ASCII DICTIONARY OF OVER 80,000 ENGLISH WORDS WHICH IS COMPATIBLE WITH THE POPULAR PROOF READERS SUCH AS SPELLSTAR, SPELLGUARD, AND ANY OTHER PROOFER WHICH ALLOWS THE COMBINING OF ASCII FILES INTO ITS DICTIONARY. WORD GRINDER REQUIRES 3/4 MEGA-BYTE OF STORAGE AND IS AVAILABLE ON 1 FILE ON EACH OF 4 CP/M DISKS. ALSO AVAILABLE ON ANSI TAPE, TRS-80, RT-11, OR APPLE DISKS. PRICES START AT \$125.00 FOR CP/M. ORDERS: DIGITAL WORD SYSTEMS DEPT. B, 22713 VENTURA BL. STE. F, WOODLAND HILLS CA. 91364. VISA/M.C. PHONE: 213-992-0514

SPELLSTAR IS A TRADEMARK OF MICROPRO INTERNATIONAL CORP. OF SAN RAFAEL, CALIF. U.S.A.  
SPELLGUARD IS A TRADEMARK OF ISA. TRS-80 IS A TRADEMARK OF TANDY CORP. CP/M IS A TRADEMARK OF DIGITAL RESEARCH.

Circle 165 on inquiry card.

"Shirtsleeves Productivity"

## SYSTEMS DOCUMENTATION, INC.

Writing and preparation of:

### USER MANUALS, SYSTEM/PROGRAM MANUALS, OPERATION GUIDES/RUN BOOKS, AND OTHER RELATED TRAINING MATERIALS AND DOCUMENTATION



222 Bridge Plaza South  
Fort Lee, NJ 07024  
(201) 592-8745 (212) 724-5055

Circle 495 on inquiry card.

## Maxell Floppy Disks

The Mini-Disks with maximum quality.



Dealer inquiries invited. C.O.D.'s accepted. Call FREE (800) 235-4137.



**PACIFIC EXCHANGES**  
100 Foothill Blvd., San Luis  
San Luis Obispo, CA 93401.  
In Cal call (800) 592-5935 or (805) 543-1037.

Circle 353 on inquiry card.

### Breakthrough BASIC For Mod II's

**SAVE TIME & EFFORT WITH Basic IDEAS™**

If you're like most people who write BASIC programs on their TRS-80® Mod II's, occasions arise when you must change the logic of a program written weeks, if not months, ago. Quite often, that logic has been obscured by time, and it's difficult to retrace your steps. Since BASIC is so difficult to read, your program logic can be obscured by the language itself.

**Program modifications are a SNAP with Basic IDEAS™.**

- Meaningful Variable Names.** Virtually unlimited length lets you write descriptive names. No more cryptic 2-character symbols.
- User-Defined Labels.** Nondescript line numbers are no longer an integral part of your logic. You can use meaningful labels in your GOTO's and GOSUB's.
- Nested IF/THEN/ELSE/ENDIF.** Up to 16 levels, span multiple lines, simplify logic & aid readability.

Basic IDEAS™ also comes with a Full Screen Editor, and it's EASY TO LEARN because it is NOT a totally new programming language. It is a package of improvements to EXISTING Mod II BASIC making BASIC easier to read and, therefore, easier to modify.

And there's more! So send for our FREE brochure for complete details and actual examples of Basic IDEAS™. Complete system, fully documented, only \$299.

**Computer IDEAS Corporation**  
4229 Hall St. • Dallas, Texas 75219

\*Registered Trademarks of Tandy Corporation

Circle 111 on inquiry card.

# ATARI®

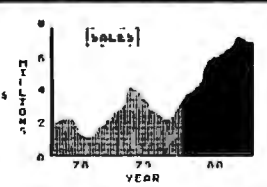

MACROTRONICS SCREEN PRINT

PRESS [F1] TO PRINT SCREEN DISPLAY

### GRAPHICS HARDCOPY

Dumps anything on screen of ATARI 400/800 to printer. All graphics and text modes. Players/Missiles/scaling/grey scale/GTIA/more! Works with EPSON, Centronics 739, IDS and Trendcom.

\*ATARI is a registered trademark of ATARI Computer Inc.

See Jan 82 COMPUTE! for review  
(209) 667-2888/634-8888



**MACROTRONICS, Inc.**  
1125 N. Golden State Blvd.  
Tullock, California 95380

Circle 278 on inquiry card.

A GREAT TEAM. YOU AND HP'S SERIES 80.



**NOW INSTOCK!**

- 85A Personal Computer
- 83A Personal Computer
- HP87 Computing System
- 125 Large Screen 64K
- 7470A Graphic Plotter
- All HP Peripherals
- 15% OFF HP Calculator

**MEC SYSTEMS**  
New England's Largest!  
HP DEALER

## MULTI-BUSINESS

### COMPUTER SYSTEMS, INC.

TEL. 203-342-2747 28 MARLBOROUGH ST.  
TWX. 710-428-6345 PORTLAND, CT. 06480

Circle 331 on inquiry card.

## CROMEMCO OWNERS DOUBLE DENSITY FOR THE 4FDC!!!

The FDCX4 Double Retrofit Board from JVB Electronics installs on your 4FDC single density disk controller board in seconds and doubles your disk storage... If you have a single density Cromemco system you'll want an FDCX4.

Some features of the FDCX4 are:

- Analog Phase-Locked Data Separator. The separator is used in all modes—Double and Single density, 8" and 5" drives.
- Write Precompensation. Allows reliable Double Density operation with ParSci ZTI and Shugartype® drives.
- Software compatibility with CDDS, CROMIX, and CP/M.
- Reads, Writes, and Formats double density, single density, 5" and 8" disks. Disables and sizes may be mixed.
- Installs in Seconds! Just unplug two chips from the 4FDC and plug the FDCX4 into the two vacated sockets. One solder joint completes installation for use with 8" drives. No soldering at all is required if the FDCX4 will be used exclusively with 5" drives. No traces are cut on the 4FDC. The 4FDC can be restored to its original state by just unplugging the FDCX4 and plugging back in the previously removed chips.
- No Risk! 15 Day Trial Period.

Price is \$229.96 including shipping in continental USA. C.O.D. charges extra. Calif. residents include 6% sales tax. Write, call, or circle the reader service card for further information. Dealer inquiries invited.

**JVB ELECTRONICS**  
1601 Fulton Ave. Suite 1  
Sacramento, CA 95825  
(916) 483-0709 (10AM-3PM Pacific)

CDDS and CROMIX are trademarks of Cromemco  
CP/M is a trademark of Digital Research

Circle 252 on inquiry card.



# Do Kay Computer Products, Inc.

3250 KELLER STREET, #9 • SANTA CLARA, CA 95050

### EPROMS

1702	(1ns)	3.00
2708	(45ns)	2.99
2716	(5v 450ns)	4.75
2716-1	(5v 350ns)	8.50
2532	(5v 450ns)	8.95
2732	(5v 450ns)	8.95
2764	(5v 450ns)	Call

### STATIC RAMS

2101	(450ns)	1.85
21L02	(250ns LP)	1.55
2111	(450ns)	2.49
2114	(450ns)	1.95
2114L-3	(300ns LP)	2.25
2114L-2	(200ns LP)	2.30
TMM2016	(200ns)	9.00
TMM2016	(150ns)	11.00
HM6116	(200ns)	Call
HM6116	(150ns)	Call
HM6116	(120ns)	Call

### DYNAMIC RAMS

4027	(250ns)	2.00
4116	(200ns)	1.75
4116	(150ns)	1.85
4164	(200ns)	Call

LP = Low Power

### 8000

8035	16.00	8239	4.75
8039	19.00	8243	4.75
8080A	3.90	8250	14.90
8085A	8.50	8251	4.50
8088	39.00	8253	8.75
8155	11.00	8253-5	9.75
8156	11.00	8255	4.50
8185	29.00	8255-5	5.20
8741	39.00	8257	8.50
8748	29.00	8259	6.85
8755	44.00	8272	39.00
8202	44.00	8275	29.00
8205	3.45	8279	9.25
8212	1.80	8279-5	10.25
8214	3.75	8282	6.50
8216	1.75	8283	6.50
8224	2.45	8284	5.50
8226	1.80	8286	6.50
8228	4.50	8287	6.50
8237	19.00	8288	25.00
8238	4.75	8289	49.00

### VOLTAGE REGULATORS

7805T	.75	7905T	.85
7812T	.75	7912T	.85
7815T	.75	7915T	.85
7824T	.85	7924T	.85
7805K	1.39	7905K	1.49
7812K	1.39	7912K	1.49
7815K	1.39		

### LEDS

Jumbo Red	10/1.00
Jumbo Green	6/1.00
Jumbo Yellow	6/1.00

### CONNECTORS

RS 232	Male	3.00
RS 232	Female	3.50
RS 232	Hood	1.20

### 6500

6502	6.90
6502A	9.45
6504	6.90
6505	7.65
6507	9.90
6520	4.35
6522	9.90
6532	13.95
6551	11.75

### Z80

Z80 A CPU	5.90
Z80 A PIO	5.90
Z80 A CTC	7.00

Call for Complete List

### MICROPROCESSOR REAL-TIME CLOCK MSM 5832

7.25

### 6800

6800	5.65	6828	14.90	6860	10.90
6802	8.65	6834	16.90	6862	11.90
6808	8.45	6840	7.95	6875	6.90
6809	24.00	6843	41.95	6880	1.80
6809E	29.00	6845	16.90		
6810	3.50	6847	15.90	68B00	10.00
6820	3.50	6850	3.50	68B21	12.00
6821	3.50	6852	3.50	68B50	12.00

### CRYSTALS

32.768 KHZ	3.75	5.185	3.90
1.0 MHZ	4.50	5.7143	3.90
1.8432	4.50	6.5536	3.90
2.0	3.90	8.0	3.00
2.097152	3.90	10.0	3.00
2.4576	3.90	14.31818	3.90
3.2768	3.90	18.0	3.00
3.579545	3.00	18.432	3.00
4.0	3.00	20.0	3.00
5.0	3.00	22.1184	3.00
5.0688	3.90	32.0	3.90

### UPGRADE YOUR APPLE OR TRS-80 4116 200ns 8/14.00

### 74LS00 SERIES

74LS00	.24	74LS123	.95	74LS253	.80
74LS01	.24	74LS124	2.90	74LS257	.80
74LS02	.24	74LS125	.95	74LS258	.80
74LS03	.24	74LS126	.79	74LS259	2.80
74LS04	.24	74LS132	.75	74LS260	.60
74LS05	.24	74LS136	.49	74LS266	.49
74LS08	.24	74LS137	.95	74LS273	1.60
74LS11	.24	74LS138	.75	74LS275	3.25
74LS12	.30	74LS139	.75	74LS279	.49
74LS13	.40	74LS145	1.10	74LS280	1.95
74LS14	.40	74LS147	2.20	74LS283	.95
74LS15	.89	74LS148	1.20	74LS290	1.20
74LS15	.30	74LS151	.75	74LS293	1.79
74LS20	.24	74LS153	.75	74LS295	.99
74LS21	.30	74LS154	1.75	74LS298	.99
74LS22	.24	74LS155	.89	74LS324	1.75
74LS26	.30	74LS156	.89	74LS352	1.49
74LS27	.24	74LS157	.75	74LS353	1.49
74LS28	.30	74LS158	.75	74LS363	1.49
74LS30	.24	74LS160	.95	74LS364	1.95
74LS32	.36	74LS161	.95	74LS365	.89
74LS33	.55	74LS162	.95	74LS366	.89
74LS37	.55	74LS163	.95	74LS367	.69
74LS38	.35	74LS164	.95	74LS368	.69
74LS40	.30	74LS165	.95	74LS373	.99
74LS42	.49	74LS166	1.95	74LS374	1.69
74LS47	.75	74LS168	1.69	74LS377	1.40
74LS48	.75	74LS169	1.69	74LS378	1.15
74LS49	.75	74LS170	1.69	74LS379	1.35
74LS51	.30	74LS173	.75	74LS385	1.89
74LS54	.35	74LS174	.89	74LS386	.59
74LS55	.35	74LS175	.89	74LS390	1.79
74LS63	1.20	74LS181	1.99	74LS393	1.79
74LS73	.39	74LS189	9.50	74LS395	1.59
74LS74	.44	74LS190	.89	74LS399	1.59
74LS75	.49	74LS191	.89	74LS424	2.89
74LS76	.39	74LS192	.89	74LS447	.75
74LS78	.49	74LS193	.89	74LS490	1.89
74LS83	.75	74LS194	.89	74LS668	1.65
74LS85	.95	74LS195	.89	74LS669	1.85
74LS86	.39	74LS196	.79	74LS670	2.10
74LS90	.65	74LS197	.79	74LS674	9.50
74LS91	.79	74LS221	1.10	74LS682	2.99
74LS92	.65	74LS240	.95	74LS683	2.39
74LS93	.59	74LS241	.95	74LS684	2.39
74LS95	.79	74LS242	1.79	74LS685	2.39
74LS96	.39	74LS243	1.79	74LS688	2.39
74LS107	.39	74LS244	.95	74LS689	2.39
74LS109	.39	74LS245	1.89		
74LS112	.39	74LS247	.79	81LS95	1.65
74LS113	.39	74LS248	1.20	81LS96	1.65
74LS114	.49	74LS249	.89	81LS97	1.65
74LS122	.45	74LS251	1.25	81LS98	1.65

### MISC.

### Disc Controller

1771	20.95
1791	34.95
1793	34.95
1797	49.95

### Uarts

AY3-1014	5.85
AY5-1013	3.90
AY5-2376	12.00
TR 1602	4.25

### Interface

8T26	1.65
8T28	1.95
8T95	.95
8T96	.95
8T97	.95
8T98	.95
DM8131	2.90
DS8836	1.25

### LINEAR

LM301	.32	LM741	.29
LM308	.75	LM747	.75
LM309K	1.25	LM748	.49
LM311	.64	LM1310	2.45
LM317T	1.65	MC1330	1.69
LM317K	1.70	MC1350	1.25
LM318	1.49	MC1358	1.69
LM323K	3.75	LM1414	1.49
LM324	.59	LM1458	.55
LM337K	3.90	LM1488	.95
LM339	.79	LM1489	.95
LM377	2.25	LM1800	2.45
LM380	1.25	LM1889	2.45
LM386	1.00	LM3900	.59
LM555	.38	LM3909	.95
LM556	.65	LM3914	3.70
LM565	.95	LM3915	3.70
LM566	1.45	LM3916	3.70
LM567	.99	75451	.35
LM723	.49	75452	.35
LM733	.95	75453	.35

# (800) 538-8800

### DIP SWITCHES

4 Position	.85
5 Position	.90
6 Position	.90
7 Position	.90
8 Position	.95

### IC Sockets

ST	W/W
8 PIN	.10 .49
14 PIN	.12 .50
16 PIN	.15 .57
18 PIN	.20 .85
20 PIN	.25 .99
22 PIN	.25 1.30
24 PIN	.25 1.40
28 PIN	.35 1.50
40 PIN	.40 1.80

ST = Solderfall  
W/W = Wirewrap

### CMOS

4000	.25	4071	.30
4001	.30	4072	.30
4002	.30	4073	.30
4006	.90	4075	.30
4007	.25	4076	.90
4008	.90	4078	.30
4009	.45	4081	.30
4010	.45	4082	.30
4011	.30	4085	.90
4012	.30	4086	.90
4013	.45	4093	.90
4014	.90	4098	2.49
4015	.90	4099	1.90
4016	.45	4502	.90
4017	1.15	4503	.60
4018	.90	4508	1.90
4019	.45	4510	.90
4020	.90	4511	.90
4021	.90	4512	.90
4022	1.10	4514	1.20
4023	.35	4515	2.20
4024	.75	4516	1.50
4025	.35	4518	1.20
4026	1.60	4519	1.20
4027	.60	4520	1.20
4028	.75	4522	1.20
4029	.90	4526	1.20
4030	.45	4527	1.90
4034	2.90	4528	1.20
4035	.85	4531	.90
4040	.90	4532	1.90
4041	1.20	4538	1.90
4042	.75	4539	1.90
4043	.75	4543	2.70
4044	.75	4555	.90
4046	.90	4556	.90
4047	.90	4581	1.90
4049	.50	4582	1.90
4050	.50	4584	.90
4015	.90	4585	.90
4053	.90		
4060	1.39	80C07	.90
4066	.75	80C95	.90
4068	.39	80C96	.90
4069	.30	80C97	.90
4070	.35	80C98	1.15

**Do Kay Computer Products, Inc.**  
3250 Keller Street, #9  
Santa Clara, CA 95050  
(800) 538-8800  
Calif. Residents (408) 988-0697



**TERMS:** For shipping include \$2.00 for UPS Ground. \$3.00 for UPS Blue Label Air. \$10.00 minimum order. Bay Area residents add 6% Sales Tax. California residents add 6% Sales Tax. We reserve the right to limit quantities and substitute manufacturer. Prices subject to change without notice. Send SASE for complete list.

**NOT 5 MEGABYTES BUT 10!!!  
10 MB Winchester Disk System  
S-100 \$1995 APPLE II**

If you desire the speed, capacity, and reliability of Winchester technology, the ASC W10 is the system for you.  
10 MB hard disk drive  
Smart controller  
S-100 or Apple II computer interface  
Enclosure  
Power supply  
All cabling  
CP/M Auto-configuration utility

CP/M 2.2 if required is available. Special discounts on all Micropro software products (originators of Wordstar\*). For additional information circle the reader service number below. Quantity discounts available.

**ASC**

Associates P.O. Box 815  
Lexington Park, MD 20653  
(301) 863-8784

CP/M is a registered trademark of Digital Research. Apple is a trademark of Apple Computers. \*Trademark of Micropro International

Circle 41 on inquiry card.

8 1/2" x 11" credit-card-type plastic MICRO CHARTS are fact-packed microprocessor summary cards that save you time and effort with instant access to the data you need.

**\$5.95**



Thousands of delighted users have made the switch from black & white, folded-up, paper summaries to colorful, ready-to-use, lifetime MICRO CHARTS. You get clear info on: full instruction set, disassembly, ASCII, base conversion, effect on flags, inequalities versus jumps, interrupt structure, pinout, cycle times, diagrams, notes, and much more. Two sided comprehensive MICRO CHARTS are ideal for professionals, hobbyists, and students alike. Countless readers and compliments confirm the benefit of these inexpensive, improved programming, debugging, and learning aids. Order today and you will be delighted. We guarantee it. Unless you are 100% pleased in 14 days, a prompt full refund will be made. To order, simply send name, address, and just \$5.95 per card plus \$1 total postage to: Micro Logic Corp., POB 174, Dept. Z, Hackensack, NJ 07602. Specify titles and quantity: Z80, 6502, 8080 & 8085, 8048 FAMILY, BASIC ALGORITHMS. (Dealer inquiries welcome).

**E-PAK**

**CAN YOU IMAGINE DOUBLING THE SPACE ON YOUR DISK?**

E-PAK is a software utility which compresses data by 40% to 80% of its original size. Available for TRS-80, Apple II and 8" disk CP/M systems (IBM single density). Specify one of the above on your order. Allow 4-6 weeks for delivery. Send check or money order for \$29.95 to:

Rolin Associates (201) 870-0244  
6 Orchard Road  
West Long Branch, N.J. 07764

Note: N.J. Residents add 5% sales tax. \$31.45.

**INTERNATIONAL SOFTWARE DIRECTORY**

**GIVES FULL DETAILS OF OVER 10,000 PROGRAMS**

**VOL. 1 MICROS • VOL. 2 MINIS**

The primary reference source on computer software. Comprehensive, easy-to-use, and fully up-to-date, it's essential for anyone concerned with computers — owners, users, and buyers. A total solution to all the problems of locating software.

Please send  copies of Vol 1 (micros) \$39\*\* + 2\*\* post.  
 copies of Vol 2 (minis) \$69\*\* + 2\*\* post.

Name \_\_\_\_\_ Address \_\_\_\_\_

Check enclosed. Credit cards accepted. (State which)

Acc. No. \_\_\_\_\_

Exp Date \_\_\_\_\_

Imprint Software  
1520 Sth College, Fort Collins  
CO 80524. Tel 303 482 5574



Circle 222 on inquiry card.

**STRUCTURAL engineering**

analysis of plane frames & trusses

microSTRAN

will run on any CP/M computer including APPLE II & TRS-80 II

- Large capacity
- High performance
- Easy to use

**\$350**

(Manual only \$30)

Write to:

Richard T. Collins  
Engineering Systems Consultant  
C/- Post Office Pymble, NSW 2073  
AUSTRALIA

Telephone: +612 449 5554

Circle 94 on inquiry card.

**FREE CATALOG OF NEW SOFTWARE AND HARDWARE FOR THE IBM PC\***

Describes all compatible hardware — memory boards & chips, clock calendars, cables, hard disks, modems, disk drives, color printers, plotters, daisy wheel printers, color monitors, battery backup, light pens, digitizers, Baby Blue cards, etc.

Includes all available software — word-processing, database management, mailing list, medical, dental, games, courseware, order entry, languages, operating systems, etc.

Provides price comparisons and discounts on every item.

Circle reader service number for your free copy. Call for more information or to get your products listed.

**STAR WARE**  
Everything for the IBM\*

1629 K St. NW, #551, Washington, D.C. 20006  
(202) 337-5300

\*TM of International Business Machines Corp.

Circle 424 on inquiry card.

**THE SBC 8671**

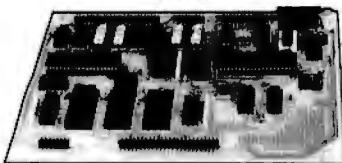

**Z8 CONTROL**

**FEATURES:** Zilog Z8671 microprocessor with on chip basic interpreter: 12K of on board user memory with choice of ROM, RAM, or PROM, selectable in 4K increments: RS 232 and 20 MA current loop serial I/O: 110 to 9600 baud: 8255 peripheral interface with choice of TTL, R-Pack, or Open Collector I/O buffers: 48 parallel I/O lines total: Pin compatibility with industry standard OPTO I/O modules: Two 8 bit counter/timers with 6 bit prescalers: 6 vectored interrupts: Module bus for full expansion: All chips socketed: Industrial grade construction.

Price (1-9) \$295.00

LEHMANN & ASSOCIATES  
P.O. Box 566, Maumee, Ohio 43537  
(419) 891-0687

Circle 497 on inquiry card.

**5 Meg Hard Disk \$600.00**

Introductory Offer — expand to Winchester Technology at 1/2 price.

Shugart SA1002 8" Hard Disk Drive. Optional controllers for IBM, S-100, STD BUS and others available.

Call Dave Starr at:

**COMPUTER DYNAMICS, INC.**

[803] 877-7471

105 S. Main St. Greer, S.C. 29615

Circle 107 on inquiry card.

**A LOGIC ANALYZER YOU CAN AFFORD!**



CHECK THESE FEATURES:

- INTERFACES TO DUAL CHANNEL SCOPE OR MICROCOMPUTER SYSTEM
- 10 MHz CAPTURE RATE
- STORES 16 WORDS 16-BITS WIDE
- I/OX, COMPARE WORD BIT SELECTION
- CRYSTAL CONTROLLED INTERNAL CLOCK
- TIME DOMAIN DISPLAY
- DATA DOMAIN STATE TABLE DISPLAY IN BINARY, OCTAL AND HEX\*
- VECTOR GRAPHIC DATA PICTURE DISPLAY\*\*
- EASY TO USE
- SIMPLE OPERATION

THE OWL MODEL R 1160 COMES COMPLETE WITH LOGIC PROBE CUPS, OPERATING MANUAL, SOFTWARE AND INTERFACE TO THE APPLE II MICROCOMPUTER

FOR ONLY \$950.

CALL TODAY FOR FULL INFORMATION

**Star**

1080 Linda Vista Avenue, Mountain View, CA 94043  
(415) 969-5111

\* Interface hardware & software for Apple II available. \*\* IBM PC application are under development — consult factory. Apple II, IBM PC and AT are trademarks of Apple Computer Inc. Intel Corp & Commodore respectively.

Circle 398 on inquiry card.

# WE WILL NOT BE UNDERSOLD

## SOFTWARE

<b>Micropro</b>	
Wordstar	\$319
Mailmerge	\$109
Wordstar/Mailmerge	\$419
Customization Notes	\$489
<b>Microsoft</b>	
Basic 80	\$289
Basic Compiler	\$329
Fortran 80	\$349
Cobol 80	\$579
<b>Data Base</b>	
FMS 80	\$649
dBASE II	\$595
<b>Miscellaneous</b>	
<b>Computer Station</b>	
Graphics Dump	<b>\$39.95</b>
Supercalc	\$269

## APPLE SOFTWARE

<b>Micropro</b>	
Wordstar	\$269
MailMerge	\$99
Wordstar/MailMerge	\$349
Spellstar	\$129
<b>VisiCorp</b>	
VisiCalc	\$229
VisiTerm	\$139
VisiDex	\$229
VisiPlot	\$185
VisiFile	\$229
VisiTrend/Plot	\$275
<b>Miscellaneous</b>	
Micro Courier	\$219
Screenwriter	\$129
<b>Entertainment</b>	
Wizard and Princess	\$29
Mystery House	\$24
Raster Blaster	\$26
Space Eggs	\$26
Sargon II	\$29
Twerps	\$28
Borg	\$28
Castle Wolfenstein	\$27
Beer Run	\$28
Epoch	\$32
Sneakers	\$27
Midnight Magic	\$32
Wizardry	\$45
Time Zone	\$79

## APPLE ACCESSORIES

Z-80 Card by Microsoft	\$299
16K Card by Microsoft	\$159
32K Card by Saturn. Increase your memory for VisiCalc	\$199
Keyboard Enhancer II by Videx	\$125

For fast delivery, send certified checks, money money orders, or call to arrange direct bank wire transfers. Personal or company checks require one to three weeks to clear. All prices are mail order only and are subject to change without notice. Call for shipping charges.

Videoterm by Videx	\$249
TG Game Paddles	\$49
TG Joystick	\$49
Keyboard Co. Numeric Keypad	<b>\$139</b>
Keyboard Co. Joystick	\$49
Sup-R-Mod	\$25
ALF 9 Voice Board	\$159

**Station II by Trace Systems. Secure and protect your Apple II. \$119**

## Apple Interface Cards by CCS

Parallel #7720	\$119
Centronics #7728	\$115
Serial Asynch #7710	\$139
Serial Synch #7712	\$149

## DISK DRIVES

<b>CCI 100</b> for the TRS-80 Model 1 5 1/4" 40 track		<b>\$299</b>
<b>CCI 189</b> for the Zenith Z-89 5 1/4" 40 track		<b>\$389</b>
<b>Corvus 5M with Mirror</b>		<b>\$3089</b>
<b>Corvus 10M with Mirror</b>		<b>\$4489</b>
<b>Corvus 20M with Mirror</b>		<b>\$5429</b>
<b>Corvus Interfaces</b>		<b>Call</b>

## DISKETTES - BOX OF 10

Maxell 5 1/4" single-side	\$40
Maxell 5 1/4" double side	\$54
Maxell 8" single side	\$45
Maxell 8" double side	\$59
Verbatim 5 1/4"	\$26.95
Verbatim 8"	\$36
Verbatim Datalife Head Cleaner	\$10
BASF 5 1/4"	\$26.95
BASF 8"	\$36

## RAM

16K Ram Kit	\$19
200 nano seconds 4116 chips for TRS-80; Apple II	
Two kits	\$37
Jumpers	\$2.50

## COMPUTERS

Zenith Z-89 48K	<b>Call</b>
Zenith Z-90 64K	<b>Call</b>
<b>CALL FOR PRICES ON THE COMPLETE ZENITH LINE OF COMPUTERS AND ACCESSORIES.</b>	

**Dealer (National/International) Inquiries Invited.  
Send for FREE catalogue**

<b>California Computer Systems</b>	
Mainframe 2200a	\$359
Z-80CPU 2810a	\$239
64K RAM 2065c	\$569
Floppy Controller 2422a	\$339
Integrated 2200 System	\$1999

## CASIO

Pocket Computer FX702	\$185
Calculator Game Watch CA90	\$49.95
Joggers Watch J100	\$49.95
Analogue/Digital Watch AX210	\$59.95
Scientific Calculator FX8100	\$49.95

## PRINTERS

NEC 7710 Serial	\$2395
NEC 7720 KRS	\$2595
NEC 7730 Parallel	\$2395
NEC 3510 Serial	\$1795
NEC 3515	\$1850
NEC 3530 Parallel	\$1795
<b>NEC 8023 Dot Matrix Printer</b>	<b>\$565</b>

## OLIVETTI DY 211 LETTER QUALITY DAISY WHEEL PRINTER

Parallel Only	<b>\$1395</b>
Universal	<b>\$1595</b>

<b>Epson MX-80</b>	<b>Call</b>
<b>Epson MX-80FT</b>	<b>Call</b>
<b>Epson MX-100</b>	<b>Call</b>

PaperTiger 560	Call
IDS Prism 80	Call
IDS Prism 132	Call
Okidata Microline 80	Call
Okidata Microline 82A	Call
Okidata Microline 83A 120cps	Call
Okidata Microline 84 200cps	Call
Centronics 739	\$739
Data South 180 cps	Call

## MONITORS

Leedex 12" B & W	\$109
Leedex 13" Color	\$329
Sanyo 9" B & W	\$149
Sanyo 9" Green Screen	\$189
Sanyo 12" Green Screen	\$249
Sanyo 12" B & W	\$239
Sanyo 13" Color	\$449
Zenith 13" Color	\$349

★ ★ ★ Special of the Month ★ ★ ★  
Zenith 12" Green Screen  
**\$119**

## TELECOMMUNICATIONS

Prentice Star Modem 1-yr. guar.	\$125
Novation Cat	\$139
Novation D-Cat	\$149
Novation Auto-Cat	\$199
Novation Apple Cat II	\$299
Hayes Smart Modem™	\$249
Hayes Micro-Modem II	\$295
Hayes Chronograph™	\$225

# The CPU Shop

TO ORDER CALL TOLL FREE 1-800-343-6522

420-438 Rutherford Ave., Dept. B06M, Charlestown, Massachusetts 02129



Hours: 9 AM - 9 PM (EST) Mon.-Fri. (Sat. till 7)  
Technical information call 617/242-3361

TWX- 710-348-1796

Massachusetts Residents call 617/242-3361  
Massachusetts Residents add 5% Sales Tax

Circle 136 on inquiry card.

BYTE June 1982 529



# SUPERBRAIN USERS!

## SUPERLETTER is for you!

It's the exciting bi-monthly packed with technical tips, feature articles, display and classified ads plus hardware and software reviews written just for the SuperBrain and CompuStar user.

Now in our second year, we offer:

- Substantial DISCOUNTS on popular nationally-advertised CP/M software.
- A full line of hard-to-find enhanced PROMS, BIOS's and GRAPHICS packages.
- A direct link to thousands of Intertec computer users around the world.

Subscriptions: \$20 in USA  
\$35 foreign

(Back-issues available at \$3.50)

To order, call or write:

**SUPERLETTER**

P. O. Box 3121  
Beverly Hills, CA 90212  
(213) 277-2410

Circle 7 on inquiry card.

# C compilers and Cross compilers

Available for:

PDP-11 RT-11/RSX-11  
6809 SDOS/FLEX  
8080 CP/M  
8085 CP/M  
Z80 CP/M  
8086 CP/M86  
8088 MSDOS CP/M86  
OTHERS PENDING

The full C language, as described in "The C Programming Language" by Kernighan and Ritchie.

UNIX version 7 compatible.  
Starting at \$200.00

UNIX is a trademark of Bell Labs. RT11/RSX11 are trademarks of Digital Equipment Corp. SDOS is a trademark of Software Dynamics. CP/M is a trademark of Digital Research. FLEX is a trademark of Technical Systems Consultants

**TELECON SYSTEMS**  
90 E. Gish Road, Suite 25  
San Jose, California 95112  
408-275-1659

Circle 169 on inquiry card.



# STARTJOB

SEE AN ALARM FOR YOUR COMPUTER  
AND SLEEP WHILE IT WORKS FOR YOU!

22:00:00

STARTJOB VERS 1.1  
These Jobs Will Start At  
22:00:00

Receive B:  
Transmit C:Test.txt  
Crun2 Update  
Submit Payroll

Starting Delayed Jobs

FOR ART 5-188 IN APPLE SORTING CP/M

STARTJOB AND G. Y. CALHOUN FILES ..... \$145.00  
PROGRAM SOFTWARE ONLY ..... \$ 75.00  
SOURCE CODE FOR STARTJOB PROGRAM ..... \$ 88.00  
MISSION RESOURCES PLACES AND 1/2" 3.5" 5.25" 8" DISKETS  
WRITE FOR OUR FREE CATALOG OF 5-100 & APPLE PRODUCTS \*

## SYSTEM SOLUTIONS

P.O. BOX 57  
280 N. GARDEN, R.D. 6114  
PACIFIC PALMS AND VISTA CALI  
1846 624-3865



APPLE is a registered trademark of Apple Computer, Inc.  
CP/M is a registered trademark of Digital Research, Inc.

Circle 433 on inquiry card.

**NEW!**

## MEGARAM

IBM COMPATIBLE MEMORY BOARD

\*Approved Trakmap IBM

**FEATURES:**  
On Board Memory Expansion from 64K to 1M Byte  
Memory Write Protect Command  
Program Controlled Banking Capabilities in 128K or 512K Blocks  
Memory Error Detection  
Flexible Memory Boundary Selection  
On Board Two MDOS Supported Asynchronous RS-232-C Ports  
Price Starts at \$494.00

**MBI** Microcomputer  
Business  
International  
P.O. BOX 16115, IRVINE, CA 92713  
(714) 553-0133 (714) 727-0202

Circle 173 on inquiry card.

## PLOTTING SOFTWARE

Calcomp compatible, for  
EPSON and HILOT with  
CPM, FORTRAN, and BASIC

PLOTWARE-z 6" ssd .....399  
Manuals only .....35  
PLOTWARE-z samples .....6  
\* Refundable on order

E N E R C O M P  
P. O. BOX 28014  
Lakewood, Colo.  
80228  
303-988-1848

PROG.

U.S. FUNDS ONLY

OPTIONAL:  
Map, Chart, Sorting  
Software in  
Character, Terminal  
Emulation

PLOTWARE-z draw this ad

Circle 184 on inquiry card.

## IS YOUR NorthStar OUT OF SORTS?

**INCREASE YOUR BASIC'S  
SORTING POWER OVER 1800%!**

N\*SORT is easy to use and will perform sorts on one and two dimensional or string arrays using optional sort keys. For example, to alphabetize AS:

10 AS = "ZYXWVUTS" \ REM Define String  
20 SRT AS,LEN(AS),1 \ REM Sort AS

N\*SORT interfaces to any release 4 or later North Star Basic and can be yours for **ONLY \$89** plus \$1.50 shipping  
Calif. Res add 6% tax  
Send check VISA or M/C  
Complete Brochure Available

**SZ Software Systems**

1269 Rubio Vista Road, Altadena, Calif. 91001  
(213) 791-3202

Circle 438 on inquiry card.

**LEO ELECTRONICS, INC.**  
8921 S. Sepulveda #208  
Los Angeles, CA 90045  
(213) 641-3101 (800) 421-2418

**WHY PAY MORE? SAVE MONEY!  
LOWEST PRICES ON PARTS!**

EPROMS		REGULATORS	
2708	2.80	7805	.75
2716	4.00	7812	.75
2716-1(350ns)	6.50	7815	.75
TMS 2716	6.00	7905	.85
2732	10.00	7912	.85
2532	12.00	7915	.85

RAMS		MICROPROCESSORS	
4116(200ns)	8/13.00	Z-80A-CPU	5.50
4116(150ns)	8/16.00	8080A	2.25
2114(200ns)	8/18.00	8085A	7.00

**TERMS:** Check, Visa, Mastercard. Call for C.O.D.  
U.S. Funds only. California Residents add 6% Sales Tax  
**SHIPPING:** Add \$2.00 for Ground \$5.00 for Air.  
**ALL MAJOR MANUFACTURERS  
ALL PARTS 100% GUARANTEED**

Circle 263 on inquiry card.

## FLOPPY DISKS

NEW Shugart SA400L.....	\$233.00
NEW Shugart SA450.....	325.00
NEW Shugart SAB01R.....	389.00
NEW Shugart SAB51R.....	520.00

Dual 8" enclosure, wired power, rack mount sides, remote AC power control..... 649.00  
Enclosure, 8" desk top, bare, unwired 75.00  
ENCLOSURE DUAL MINI WITH POWER, DESK TOP..... 90.00  
FO206 power supply..... 95.00

### DISKETTES

1 year warranty, 10 per plastic library case.  
8" ..single side-single density 28.40  
8" ..single side-double density 39.90  
8" ..double sided-double density 45.70  
5 1/4" REINFORCED HUB 10/PLASTIC LIBRARY CASE SOFT SECTORED, 10 OR 16 HOLES  
single side-single density 29.70  
single side-double density 36.10  
double sided-double density 43.90

### TRACTOR FEED PAPER

9 1/2 x 11 blank, 3700 sheets, perf 27.22  
8 1/2 x 11 blue bar, 3700 sheets 24.72

OTHER TYPES OF MEDIA AVAILABLE ...  
CALL FOR PRICE

**Mi METAVAN, INC.**  
1805 East Dyer Road, Suite 307  
Santa Ana, CA 92705  
(714) 540-2427

Circle 292 on inquiry card.

## SOFTWARE/HARDWARE PROFESSIONALS CONSIDER CALIFORNIA

Program Manager/Communication Analysis..... to 50K  
VLSI/BiPolar Design..... to 38K  
CAD/CAM Design Automation..... to 45K  
Analog Test Engineer..... to 38K  
Naval Communications/Software Design..... to 40K  
Microprocessor Hardware/Software Design..... to 35K  
(714) 565-4331 PLEASE SEND RESUME

**WESTBROOKE SEARCH, INC.**  
9320 Chesapeake Drive, Suite 202  
San Diego, California 92123

Circle 467 on inquiry card.

# Orange County ● Sunnyvale San Diego ● Los Angeles San Fernando Valley ● Dallas

## 8" Disk Drives on Sale !!!



- Shugart SA801R single-sided double-density**  
MSF-10801R .. \$394.95 ea 2 for \$389.95 ea
- Shugart SA851R double-sided double-density**  
MSF-10851R .. \$554.95 ea 2 for \$529.95 ea
- Tandon TM848-1 snl-sided dbl-den thin-line**  
MSF-558481 .. \$424.95 ea 2 for \$394.95 ea
- Tandon TM848-2 dbl-sided dbl-den thin-line**  
MSF-558482 .. \$574.95 ea 2 for \$549.95 ea
- Qume DT-8 double-sided double-density**  
MSF-750080 .. \$524.95 ea 2 for \$498.95 ea
- Siemens FDD 100-8 snl-sided dbl-density**  
MSF-201120 .. \$384.95 ea 2 for \$349.95 ea

## 5 1/4" Disk Drives on Sale !!!

- Tandon TM100-1 snl-sided dbl-density 48 TPI**  
MSM-551001 .. \$248.95 ea 2 for \$219.95 ea
- Shugart SA400L snl-sided dbl-density 40 track**  
MSM-104000 .. \$234.95 ea 2 for \$224.95 ea
- Tandon TM100-2 dbl-sided dbl-density 48 TPI**  
MSM-551002 .. \$324.95 ea 2 for \$298.95 ea
- Shugart SA450 dbl-sided dbl-density 35 track**  
MSM-104500 .. \$349.95 ea 2 for \$329.95 ea
- Tandon TM100-3 snl-sided dbl-density 96 TPI**  
MSM-551003 .. \$324.95 ea 2 for \$298.95 ea
- Tandon TM100-4 dbl-sided dbl-density 96 TPI**  
MSM-551004 .. \$448.95 ea 2 for \$419.95 ea
- MPI B-51 snl-sided dbl-density 40 track**  
MSM-155100 .. \$234.95 ea 2 for \$224.95 ea
- MPI B-52 dbl-sided dbl-density 40 track**  
MSM-155200 .. \$344.95 ea 2 for \$334.95 ea
- MPI B-91 snl-sided dbl-density 77 track**  
MSM-155300 .. \$369.95 ea 2 for \$359.95 ea
- MPI B-92 dbl-sided dbl-density 77 track**  
MSM-155400 .. \$469.95 ea 2 for \$459.95 ea
- 5 1/4" Cabinets with Power Supply**  
END-000216 Single cab w/pwr sup .. \$69.95  
END-000226 Dual cab w/pwr sup ... \$94.95

## Dual Disk Sub-Systems



### Dual 8" Sub-Assembly without Drives

- END-000420 Bare Cabinet ..... \$59.95  
END-000421 Sub-Assembly Kit ..... \$225.00  
END-000431 Sub-Assembly A & T ... \$359.95
- 8" Single-Sided, Double-Density Sub-Systems**  
END-000423 Kit w/2 SA-801Rs ..... \$999.95  
END-000424 A & T w/2 SA-801Rs .. \$1195.00
- 8" Double-Sided, Double-Density Sub-Systems**  
END-000426 Kit w/2 DT-8s ..... \$1224.95  
END-000427 A & T w/2 DT-8s ..... \$1424.95  
END-000436 Kit w/2 SA-851Rs ..... \$1274.00  
END-000437 A & T w/2 SA-851Rs ... \$1475.00

Circle 246 on Inquiry card.

## Okidata Graphics ROMs Available



- Microline 82A** 80/132 column, 120 CPS, 9 x 9 dot matrix, friction feed, pin feed, adjustable tractor feed (optional), handles 4 part forms up to 9.5" wide, rear & bottom feed, paper tear bar, 100% duty cycle/200,000,000 character print head, bi-directional/logic seeking, both serial & parallel interfaces included, front panel switch & program control of 10 different form lengths, uses inexpensive spool type ribbons, double width & condensed characters, true lower case descenders & graphics  
PRM-43082 Friction & pin feed .... \$499.95
- Microline 83A** 132/232 column, 120 CPS, handles forms up to 15" wide, removable tractor, plus all the features of the 82A.  
PRM-43083 with FREE tractor .... \$744.95
- Microline 84** 132/232 column, 200 CPS, full dot graphics built in, handles forms upto 15" wide, plus all the features of the 83A.  
PRM-43084 with FREE tractor ... \$1149.95

- PRA-27081 Apple card ..... \$39.95  
PRA-27082 Apple cable ..... \$19.95  
PRA-27087 TRS-80 cable ..... \$24.95  
PRA-43081 2K hi spd serial card .. \$169.95  
PRA-43082 Graphics ROMs 82A .... \$79.95  
PRA-43083 Graphics ROMs 83A .... \$79.95  
PRA-43088 Tractor option 82A ..... \$39.95  
PRA-43080 Extra ribbons pkg. of 2 ... \$9.95

## Letter Quality Printer for Under \$1000.00 !!!

Uses standard daisy wheels and ribbon cartridges, 16 CPS bi-directional printing, semi-automatic paper load (single sheet or fanfold), 10/12/15 pitch, up to 16" paper, built-in noise suppression cover.  
PRD-11001 Centronics parallel ..... \$959.95  
PRD-11002 RS-232C model ..... \$999.95

## C. Itoh Starwriter F-10 Letter Quality Printer

New inexpensive 40 CPS daisy wheel printer. Full 15 inch carriage for both letter processing and business report production. Uses standard Diablo ribbons and wheels. Both parallel and serial interfaces included. Small, light-weight, and handsome.  
PRD-22010 Starwriter F-10 ..... \$1795.00

## Modems on Sale !!!

- SIGNALMAN - Anchor**  
Direct-connect automatic answer/originate selection, 300 Baud full duplex, Bell 103, includes RS-232 cable  
IOM-5600A Signalman ..... \$98.50
- SMARTMODEM - Hayes**  
Sophisticated direct-connect auto-answer/autodial modem, touch-tone or pulse dialing, RS-232C interface, programmable  
IOM-5400A Smartmodem ..... \$249.95  
IOM-1500A Hayes Chronograph .... \$219.95  
IOM-2010A Micromodem II ..... \$329.95  
IOM-1100A Micromodem 100 ..... \$375.00
- Apple-CAT - Novation**  
Software selectable 1200 or 300 Baud, direct connect, auto-answer/auto-dialse dialing, auxiliary 3-wire RS-232C serial port for printer  
IOM-5232A Save \$50.00 ..... \$325.00

## New Epson Printers with GRAFTRAX-plus

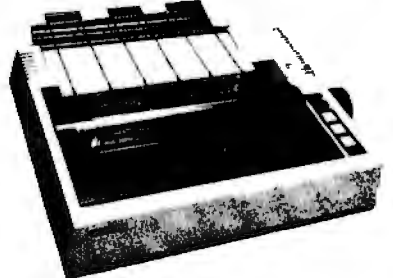

Epson has improved and upgraded their best selling line of printers to include their new GRAFTRAX-plus graphics package. Features now include; 9 x 9 matrix, bi-directional/logic seeking, line spacing to n/216, programmable forms length and horizontal tabs, skip over perf, italics fonts, international symbols, superscript/subscript, normal, emphasized, double-strike, and double-emphasized print, underlining, line drawing graphics, 60/120 DPI bit image, software reset, adjustable right margin, and true back space. Jade will also continue to offer the original style Epsoms at reduced prices.

- MX-80 with GRAFTRAX-plus** 80 column, 80 CPS, adjustable pin feed  
PRM-28080 MX-80 w/grftrx-plus .. \$479.95  
PRM-27080 Original MX-80 ..... \$424.95
- MX-80FT with GRAFTRAX-plus** same as MX-80 with friction feed added.  
PRM-28082 MX-80FT w/grftrx-plus \$559.95  
PRM-27082 Original MX-80FT .... \$529.95
- MX-100 with GRAFTRAX-plus** 132 column, correspondence quality, up to 15" paper, friction feed & adjustable pin feed, 9 x 9 dot matrix, 80 CPS.  
PRM-28100 MX-100 w/grftrx-plus .. \$754.95  
PRM-27100 Original MX-100 ..... \$724.95
- PRA-27084 Serial interface ..... \$54.95  
PRA-27088 Serial intf & 2K buffer .. \$144.95  
PRA-27081 Apple card ..... \$39.95  
PRA-27082 Apple cable ..... \$19.95  
PRA-27086 IEEE 488 card ..... \$52.95  
PRA-27087 TRS-80 cable ..... \$24.95  
PRA-27085 GRAFTRAX-plus ..... \$69.95  
PRA-27090 Extra print head ..... \$44.95  
PRA-27083 MX-80 ribbon cart. .... \$13.95  
PRA-27101 MX-100 ribbon only ..... \$9.95

**Printer Pal - paper holder & printer stand**  
PRA-99080 for MX-80, FT, 82A, NEC \$24.95  
PRA-99100 for MX-100, 83A, 84 ..... \$29.95

## Place Orders Toll Free

Continental U.S. Inside California  
800-421-5500 800-262-1710  
For Technical Inquiries or Customer Service call:  
213-973-7707

## JADE Computer Products

4901 W. Rosecrans, Hawthorne, Ca 90250

TERMS of SALE: Cash, checks, credit cards, or Purchase Orders from qualified firms and institutions. Minimum Order \$15.00. California residents add 6% tax. Minimum shipping & handling charge \$3.00. Pricing & availability subject to change

# JADE

Computer Products

3313 South Bristol St.  
Santa Ana 714-549-7108

**PLACE ORDERS  
TOLL FREE.**

# JADE

Computer Products

1291 West El Camino Real  
Sunnyvale 415-965-7980

Continental U.S. - 800-421-5500

Inside California - 800-262-1710

Los Angeles Area - 213-973-7707

# JADE

Computer Products

4344 Convoy Street  
San Diego 714-268-4661

## SD Systems ExpandoRAM III

64K to 256K expandable RAM board

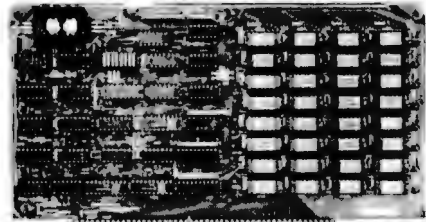

SD Systems has duplicated the famous reliability of their ExpandoRAM I and II boards in the new ExpandoRAM III, a board capable of containing 256K of high-speed RAM. Utilizing the new 64K x 1 dynamic RAM chips, you can configure a memory of 64K, 128K, 192K, or 256K, all on one S-100 board. Memory address decoding is done by a programmed bipolar ROM so that the memory map may be dip-switch configured to work with either COSMOS/MPM-type systems or with OASIS-type systems.

Extensive application notes concerning how to operate the ExpandoRAM III with Cromemco, Intersystems, and other popular 4 MHz Z-80 systems are contained in the manual.

MEM-65064A 64K A & T	\$475.00
MEM-65128A 128K A & T	\$575.00
MEM-65192A 192K A & T	\$675.00
MEM-65256A 256K A & T	\$775.00

## Our Finest Diskettes

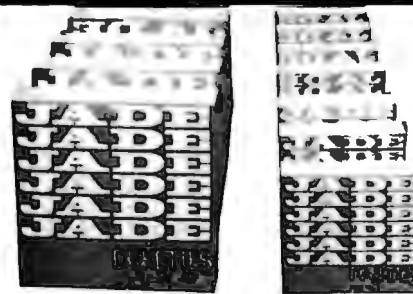

We proudly put our name on these high quality diskettes - guaranteed to satisfy you or your money back.

### 5 1/4" Diskettes, Box of Ten

MMD-5110103 SS, SD, 01S	\$29.00
MMD-5111003 SS, SD, 10S	\$29.00
MMD-5111603 SS, SD, 16S	\$29.00
MMD-5120103 SS, DD, 01S	\$31.00
MMD-5121003 SS, DD, 010	\$31.00
MMD-5121603 SS, DD, 16S	\$31.00

### 8" Diskettes, Box of Ten

MMD-8110103 SS, SD, 01S	\$31.00
MMD-8120103 SS, DD, 01S	\$39.00
MMD-8220103 DS, DD, 01S	\$48.00

## Bargain Diskettes on Sale

MMD-5110105 5 1/4" SS DD 01S	\$19.95
MMD-5220105 5 1/4" DS DD 01S	\$32.95
MMD-8110105 8" SS SD 01S	\$21.95
MMD-8120105 8" SS DD 01S	\$32.95
MMD-8220105 8" DS DD 01S	\$35.95

## 16K MEMORY UPGRADE

Add 16K of RAM to your TRS-80, Apple, or Exidy in just minutes. We've sold thousands of these 16K RAM upgrades which include the appropriate memory chips (as specified by the manufacturer), all necessary jumper blocks, fool-proof instructions, and our 1 year guarantee.

MEX-16100K TRS-80 kit	\$25.00
MEX-16101K Apple kit	\$25.00
MEX-16102K Exidy kit	\$25.00

## 16K RAM CARD - for Apple II

Expand your Apple to 64K. 1 year warranty.

MEX-16700A Save \$125.00 !!!	\$74.95
------------------------------	---------

## Z-80\* CARD for APPLE

Two computers in one. Z-80 & 6502, more than doubles the power & potential of your Apple, includes Z-80\* CPU card, CP/M 2.2, & BASIC-80

CPX-30800A A & T	\$299.95
------------------	----------

## 8" DISK CONTROLLER

New from Vista Computer, single or double sided, single or double density, compatible with DOS 3.2/3.3, Pascal, & CPM 2.2. Shugart & Quam compatible

IOD-2700A A & T	\$499.95
-----------------	----------

## 2 MEGABYTES for Apple II

Complete package includes: Two 8" double-density disk drives, Vista double-density 8" disk controller, cabinet, power supply, & cables, DOS 3.2/3.3, CP/M 2.2, & Pascal compatible.

1 MegaByte Package (Kit)	\$1495.00
1 MegaByte Package (A & T)	\$1695.00
2 MegaByte Package (Kit)	\$1795.00
2 MegaByte Package (A & T)	\$1995.95

## Apple-CAT - Novation

Software selectable 1200 or 300 baud, direct connect, auto-answer/auto-dial, auxiliary 3-wire RS232C serial port for printer.

IOB-5232A Save \$50.00!!!	\$334.95
---------------------------	----------

## DISK DRIVES - Micro Sci

Inexpensive disk drives for your Apple

A2 Direct replacement for Apple Disk II, works with Apple II controller as first or second drive.

MSM-123101 Micro Sci A2	\$399.95
MSM-123101C A2 with contrlr	\$479.95

A40 40 track drive for Apple II. Improved storage capacity and speed over Apple Brand drives - requires Micro Sci controller.

IOD-2340A Micro Sci A40	\$399.95
-------------------------	----------

A70 70 track drive for Apple II. Twice the storage capacity and three times faster than Apple Brand drives - requires Micro Sci controller

IOD-2370A Micro Sci A70	\$499.95
-------------------------	----------

Micro Sci Controller Disk controller for up to two Micro Sci A40 or A70 disk drives, DOS 3.2, 3.3, Pascal, and Z-80 SoftCard compatible, includes utility disk and 40 70 track patch.

IOD-2300A Micro Sci controller	\$95.00
--------------------------------	---------

## VISION 80 - Vista Computer

80 column x 24 line video card for Apple II, 128 ASC/II characters, upper and lower case, 9 x 10 dot matrix with 3 dot descenders, standard data media terminal control codes, CP/M Pascal & Fortran compatible, 50 60 Hz

IOV-2400A Vista Vision 80	\$375.00
---------------------------	----------

## Joystick - T G Products

A better joystick for your Apple II

SYA-1512A A & T	\$49.95
-----------------	---------

## CPS MULTICARD - Mtn. Computer

Three cards in one! Real time clock calendar, serial interface, & parallel interface - all on one card.

IOX-2300A A & T	\$179.95
-----------------	----------

## Commodore VIC-20 Computer

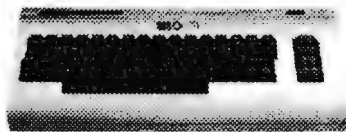

Complete personal computer with 5K RAM, fullcolor, 67 key keyboard, 4 dual special-function keys, serial ports, cassette port, composite video output (connects to standard color TV set), BASIC language, & expansion port.

COM-VIC20 VIC-20	\$279.95
------------------	----------

## Z-80 STARTER KIT - SD Systems

Complete Z-80 microcomputer with RAM, ROM, I/O keyboard, display, bludge area, manual, & workbook

CPS-30100K KIT	\$299.95
CPS-30100A A & T	\$469.95

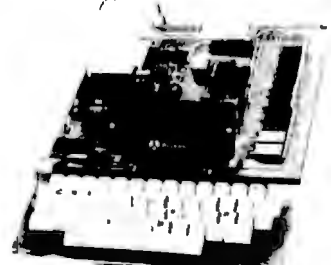

## AIM-65 - Rockwell

6502 computer with alphanumeric display, printer, & keyboard, and complete instructional manuals

CPK-50165A 1K AIM-65	\$424.95
CPK-50465A 4K AIM-65	\$474.95
SFK-74600008E 8K BASIC ROM	\$64.95
SFK-64600004E 4K Assembler ROM	\$43.95
PSX-030A Power Supply	\$64.95
ENX-000002 Enclosure	\$54.95
SFK-74600020E PL-65 ROM	\$84.95
SFK-74600010E Forth ROM	\$64.95
SFK-74600030E Instant Pascal	\$99.95

## Special Packages

4K AIM-65, 8K BASIC, power supply & enclosure	
Special Package Price	\$649.95

## Video Monitors

### HI-RES 12" GREEN - Zenith

15 MHz bandwidth, 700 lines inch, P31 green phosphor, switchable 40 or 80 columns, small, light-weight & portable.

VDM-201201 List price \$150.00	\$129.95
--------------------------------	----------

### 12" GREEN SCREEN - NEC

20 MHz, P31 phosphor video monitor with audio, exceptionally high resolution - A fantastic monitor at a very reasonable price

VDM-651200 Special Sale Price	\$199.95
-------------------------------	----------

### 12" COLOR MONITOR - NEC

Hi-res monitor with audio & sculptured case

VDC-651212 Color Monitor	\$479.95
--------------------------	----------

NEC-1202D RGB color monitor	\$1045.00
-----------------------------	-----------

## Leedex / Amdek

Reasonably priced video monitors

VDC-801310 13" Color I	\$379.95
VDC-801320 Color II	\$895.00
IOV-2300A DVM board for Apple	\$199.95

Prices may be slightly higher at our retail locations. Please call the store nearest you for local price and availability.



# JADE

Computer Products

13440 South Hawthorne Blvd.  
Hawthorne 213-973-7330

**PLACE ORDERS  
TOLL FREE.**

# JADE

Computer Products

21800-Ventura Blvd  
Woodland Hills 213-716-6120

**Continental U.S. - 800-421-5500  
Inside California - 800-262-1710  
Los Angeles Area - 213-973-7707**

# JADE

Computer Products

4950 Beltline Road  
Dallas 214-458-2782

## SBC-200 - SD Systems

4 MHz Z80A CPU with serial & parallel I/O, 1K RAM, 8K ROM space, monitor PROM included.  
CPC-30200A A & T ..... \$399.95

## THE BIG Z\* - Jade

2 or 4 MHz switchable Z-80\* CPU with serial I/O, accommodates 2708, 2716, or 2732 EPROM, baud rates from 75 to 9600  
CPU-30201K Kit ..... \$139.95  
CPU-30201A A & T ..... \$189.95  
CPU-30200B Bare board ..... \$35.00

## 2810 Z-80\* CPU - Cal Comp Sys

2.1MHz Z-80A\* CPU with RS-232C serial I/O port and on-board MOSS 2.2 monitor PROM, front panel compatible.  
CPU-30400A A & T ..... \$269.95

## CB-2 Z-80 CPU - S.S.M.

2 or 4 MHz Z-80 CPU board with provision for up to 8K of ROM or 4K of RAM on board, extended addressing, IEEE S-100, front panel compatible.  
CPU-30300K Kit ..... \$239.95  
CPU-30300A A & T ..... \$299.95

## 16K STATIC RAM - Mem Merchant

4 MHz 16K static RAM board, IEEE S-100, bank selectable, Phantom capability, addressable in 4K blocks, "disable-able" in 1K segments, extended addressing, low power  
MEM-16171A A & T ..... \$154.95

## 32K STATIC RAM - Jade

2 or 4 MHz expandable static RAM board uses 2114L's  
MEM-16151K 16K 4 MHz kit ..... \$169.95  
MEM-32151K 32K 4 MHz kit ..... \$299.95  
Assembled & tested ..... add \$50.00

## MEMORY BANK - Jade

4 MHz, S-100, bank selectable, expandable from 16K to 64K  
MEM-99730B Bare Board ..... \$49.95  
MEM-99730K Kit no RAM ..... \$199.95  
MEM-32731K 32K Kit ..... \$239.95  
MEM-64733K 64K Kit ..... \$279.95  
Assembled & Tested ..... add \$50.00

## 64K RAM - Calif Computer Sys

4 MHz bank port / bank byte selectable, extended addressing, 16K bank selectable, PHANTOM line allow memory overlay, 8080 / Z-80 / front panel compatible.  
MEM-64565A A & T ..... \$389.95

## 64K STATIC RAM - Mem Merchant

64K static S-100 RAM card, 4-16K banks, up to 8MHz  
MEM-64400A A & T ..... \$594.95

## 64K STATIC RAM - SSM

IEEE 696/S-100 standard, up to 6MHz/8 Bit, 12MHz/16 Bit, 24 Bit extended addressing, disable-able in 2K increments  
MEM-64300A A & T ..... \$749.95

## 64K STATIC - Lab Standard

Absolute IEEE 696 S-100 compliance, 8 or 16 Bit data paths, 16-bit request acknowledge properly implemented, supports DMA at 3MHz, switchable bank select system for use with Cromemco & Alpha Micro  
MEM-64900A A & T ..... \$699.95

## EPROM Erasers

Ultra-violet EPROM erasers

XME-3100A With out timer ..... \$69.50  
XME-3101 With timer ..... \$94.50  
XME-3200 Economy Model ..... \$39.95

## VERSAFLOPPY II - SD SYSTEMS

Double density disk controller for any combination of 5 1/4" or 8" single or double sided disk drives, analog phase-locked loop data separator, vectored interrupt, CP/M 2.2 & OASIS compatible, control diagnostic software PROM included  
IOD-1160A A & T ..... \$359.95  
SFC-55009047F CP/M 2.2 for VF II ..... \$99.95

## DOUBLE-D - Jade

Double density controller with the inside track, on-board Z-80A\* printer port, IEEE S-100, can function on an interrupt driven buss  
IOD-1200K Kit ..... \$299.95  
IOD-1200A A & T ..... \$375.00  
IOD-1200B Bare board ..... \$59.95

## DOUBLE DENSITY - Cal Comp Sys

5 1/4" and 8" disk controller, single or double density, with on-board boot loader ROM, and free CP/M 2.2\* and manual set.  
IOD-1300A A & T ..... \$374.95

## MPC-4 - SD Systems

Intelligent 4-port serial I/O card, on-board Z80A, 2K RAM, 4K PROM area, on-board firmware, fully buffered, vectored interrupts, four CTC channels, add to SD Board set for powerful multi-user system  
IOI-1504A A & T w/software ..... \$495.00

## I/O-4 - S.S.M.

2 serial I/O ports plus 2 parallel I/O ports  
IOI-1010K Kit ..... \$179.95  
IOI-1010A A & T ..... \$249.95  
IOI-1010B Bare board ..... \$35.00

## I/O-5 - SSM Microcomputer

Two serial & 3 parallel I/O ports, 110-19.2K Baud  
IOI-1015A A & T ..... \$279.95

## I/O-8 - SSM Microcomputer

Eight software programmable serial I/O ports, 110-19.2K Baud, ideal for multi-user systems  
IOI-1018A A & T ..... \$449.95

## PROM-100 - SD Systems

2708, 2716, 2732 EPROM programmer w/software  
MEM-99520K Kit ..... \$189.95  
MEM-99520A A & T ..... \$249.95

## PB-1 - S.S.M.

2708, 2716 EPROM board with built-in programmer  
MEM-99510K Kit ..... \$154.95  
MEM-99510A A & T ..... \$219.95

## EPROM BOARD - Jade

16K or 32K uses 2708's or 2716's, 1K boundary  
MEM-16230K Kit ..... \$79.95  
MEM-16230A A & T ..... \$119.95

## ISO-BUS - Jade

Silent, simple, and on sale - a better motherboard  
6 Slot (5 1/4" x 8 1/2")  
MBS-061B Bare board ..... \$19.95  
MBS-061K Kit ..... \$39.95  
MBS-061A A & T ..... \$49.95  
12 Slot (9 1/4" x 8 1/2")  
MBS-121B Bare board ..... \$29.95  
MBS-121K Kit ..... \$69.95  
MBS-121A A & T ..... \$89.95  
18 Slot (14 1/4" x 8 1/2")  
MBS-181B Bare board ..... \$49.95  
MBS-181K Kit ..... \$99.95  
MBS-181A A & T ..... \$139.95

## Single User System

SBC-200, 64K ExpandoRAM II, Versafloppy II, CP/M 2.2

**\$1095.00**

4 MHz Z-80A CPU, 64K RAM, serial I/O port, parallel I/O port, double-density disk controller, CP/M 2.2 disk and manuals, system monitor, control and diagnostic software.

Board set with 256K of RAM .... \$1295.00

-All boards are assembled and tested-

## The Bus Probe



So your computer is down. And you don't have an oscilloscope. And you don't have a front panel... You're not alone - most computers have their occasional bad days. But without diagnostic equipment such as an oscilloscope (expensive!) or a front panel (expensive!), it can be very difficult to pinpoint the problem. Even if you have an extender board with a superfast logic probe, you can't see more than one signal at a time. You're stuck, right?

Not anymore; Jade is proud to offer our cost-effective solution to the problems mentioned above: **THE BUS PROBE**.

Whether you're a hobbyist with a cantankerous kluge or a field technician with an anxious computer owner breathing down your neck, you'll find THE BUS PROBE speeds your repair time remarkably. Just plug in THE BUS PROBE and you'll be able to see all the IEEE S-100 signals in action. THE BUS PROBE allows you to see inputs, outputs, memory reads and writes, instruction fetches, DMA channels, vectored interrupts, 8 or 16 bit wide data transfers, plus the three bus supply voltages.

TSX-200B Bare board ..... \$59.95

TSX-200K Kit ..... \$119.95

TSX-200A A&T ..... \$149.95

## ISOBAR - GSC

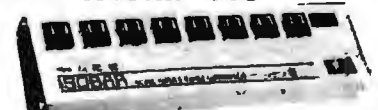

Isolates & protects your valuable equipment from high voltage spikes & AC line noise, inductive isolated ground, 15 amp circuit breaker, U.L. listed

EME-115103 3 socket ..... \$39.50

EME-115105 4 socket ..... \$49.50

EME-115100 8 socket ..... \$54.50

EME-115110 9 socket rackmount .... \$74.50

Prices may be slightly higher at our retail locations. Please call the store nearest you for local price and availability.

# WE HAVE IT!

System One

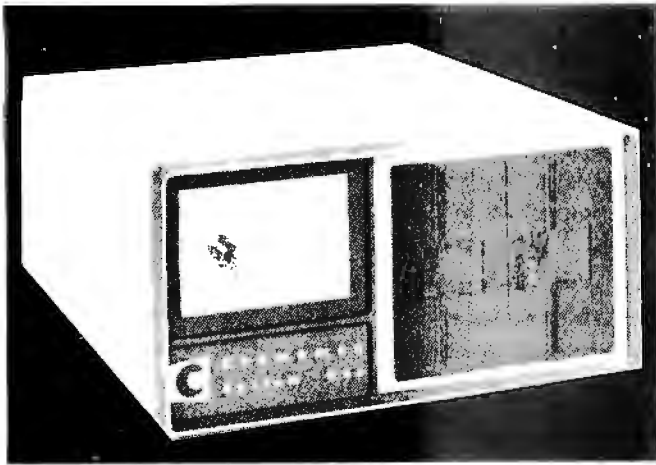

TOMORROW'S COMPUTERS NOW!

from  
**Cromemco**  
 64K-Z80A

System One

—\$3349—

System Two  
 with dual sided mini floppys.

—\$3749—

Multi-User and Hard Disk versions available.

CROMIX®, or MP/M® or OASIS® Systems now available from MiniMicroMart running CROMIX (or MP/M or OASIS) on a CDC Phoenix (96MB-16 removeable—80 fixed) hard disk.

## COMPUTER SYSTEMS

- CS-1 Computer System NEW**  
 (similar to CS-2 but only 8 slots), List \$3995 **\$3349**
- CS-1H, w/5mg Hard Disk NEW**  
 List \$6995 **\$5895**
- CS-3, features 4MHz CPU w/64K of RAM,**  
 Dual-sided PerSci 8" floppy disk drives (RS232C Interface),  
 List \$7995 **\$5895**
- HD-5, 5mg add-on Winchester Hard Disk, NEW**  
(fits inside CS 2 or CS 3)  
 List \$3495 **\$2949**
- HDD-11, 11 Megabyte Hard Disk System,**  
 List \$6995 **\$5945**
- HDD-22, 22 Megabyte Hard Disk System,**  
 List \$11,995 **\$10,195**

## TERMINALS & PRINTERS

- CRT Terminal 3102, (80 characters/line, 24 line display),**  
 List \$2295 **\$1949**
- Letter Quality Printer 3355A,**  
 (55 characters/second, 15" platen, tractor-feed,  
 List \$3495 **\$2969**

**NEW LOW PRICE ON  
 64K MEMORY BOARD**

List \$995, ..... our price **\$599**

Check with us on new low prices  
 for Multi-User CROMIX® Systems.

## CROMEMCO BOARDS

- |   |       |
|---|-------|
| SCC Single Card Comp. List \$494        | \$419 |
| ZPU Z-80 CPU 2/4MHz. List \$395         | \$335 |
| 16KZ Dyn. RAM Mem. List \$495           | \$419 |
| 48KTP 2 Port 48K Mem. List \$1495       | Call  |
| 64KZ Dyn. RAM Mem. List \$1195          | \$819 |
| 16FDC Disk Cont., DD. List \$595        | \$499 |
| 8K Bytesvr II Prom. Prog. List \$295    | \$249 |
| 32K Bytesvr. PromCard(2716s) List \$345 | \$295 |
| TU-ART I/O Interface. List \$345        | \$275 |
| D 7A Digital/Analog Inter. List \$295   | \$249 |
| 8PIO 8 Port Par. Inter. List \$295      | \$249 |
| 4PIO 4 Port Par. Inter. List \$395      | \$335 |
| QDRT 4Ch. Syn/Asyn Inter. List \$595    | \$499 |
| IOP Int. I/O Processor. List \$695      | \$589 |
| PRI Printer Inter. Card. List \$245     | \$209 |
| 16KPR 16K PromMem. Card. List \$245     | \$209 |
| CGI TV Dazzler. List \$395              | \$335 |
| SDI Hi-Res Col. Graphics. List \$795    | \$675 |

- EXC 2 Extender Board. List \$65 **\$38**  
 WWB 2 Wire Wrap Board. List \$65 **\$38**

## CROMEMCO SOFTWARE

(specify 8" or 5 1/4")

- |   |       |
|---|-------|
| CROMIX Multi-User. List \$595           | \$279 |
| FDA Macro Assembler. List \$295         | \$249 |
| FDB 16K Extended BASIC. List \$195      | \$165 |
| FDC COBOL Compiler. List \$595          | \$299 |
| FDF Fortran IV Compiler. List \$295     | \$179 |
| FDR RATFOR incl. Fortran IV. List \$395 | \$335 |
| STB 32K Struc. BASIC. List \$295        | \$165 |
| SGS Sup. Dazzler Graphics. List \$595   | \$299 |
| DBM DataBs. Mgt. (w/report) List \$295  | \$249 |
| WPS Word Proc. Sys. List \$295          | \$249 |
| TSS Trace Sys. Simulator. List \$195    | \$95  |
| WRMR Writemaster Wrtd. Pro. List \$595  | \$499 |
| SLMR Slidemaster. List \$595            | \$499 |
| SPMR Spellmaster. List \$295            | \$249 |
| FOMR Fontmaster. List \$595             | \$499 |

## CS-0 Computer System

w/SCC & MCB-216, List \$1295 **\$1099**

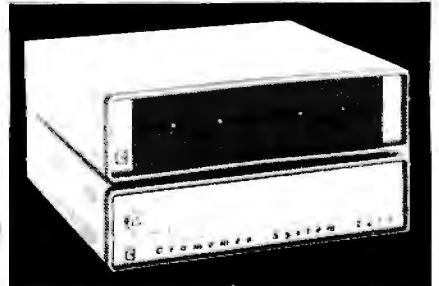

## CS-0/D Computer System

280 SCC CPU, 64KZ, 16FDC,  
 List \$2995 **\$2545**  
 DDF Dual Double-Sided 5" Drives for CS-0  
 List \$1295.....\$1,099

All prices, F.O.B. shipping point, subject to change. All offers subject to withdrawal without notice. Advertised prices reflect a 2% cash discount. (order prepaid prior to shipment). C.O.D.'s and credit card orders are 2% higher.

# MiniMicroMart, Inc.

943 W. Genesee St. BOX 2992K Syracuse, N.Y. 13204 (315) 422-4467 TWX-710-542-0431

Circle 321 on inquiry card.

# Super Specials on **SUPERBRAINS**<sup>®</sup>

**SUPERBRAIN<sup>®</sup> DD, \$1994**

Through July 7, 1982 **SD, \$2369**

**SD, \$2799**



INTERTEC has introduced a new model, the SD (super density) with dual double sided 80 track drives—**TWICE THE CAPACITY OF THE QD**—. The SD SUPERBRAIN is available from Mini MicroMart for \$2799

SUPERBRAINS come with CP/M; with the addition of an appropriate printer, and the necessary software you can have a complete data processing and /or word processing system.

You can take advantage of our MicroPro word processing software special. WordStar for only \$269;

We will include MailMerge with WordStar for \$358 or for only \$489 you get the full package— WordStar, MailMerge and SpellStar

## **MiniMicroMart stocks the full INTERTEC line.**

MICROSOFT 80 is only \$279 and a complete accounting package—GL, A/R, A/P, and payroll are available to run in MICROSOFT BASIC for only \$269

You can add capacity to your SUPERBRAIN by adding their 10 megabyte DSS Hard Disk. We offer it for only \$2995. We include the adapter cable to the SUPERBRAIN (if requested) at no extra charge.



If you need a distributed processing system, INTERTEC has lowered prices on their full series of COMPUSTARS— the VPU 10, the VPU 20 the VPU 30 and the VPU 40. Virtually any number of these can be daisy chained to share one of their hard disks, or they can be utilized as a stand alone computer, just like a SUPERBRAIN.

—CALL US FOR PRICING—

SUPERBRAINS and COMPUSTARS come with two built in serial ports, so you can support two printers or a printer and a modem. Among the printers suitable for the SUPERBRAIN are: Centronics 730-3, the 739-3, the 704-9 the TI 810s or 820s, or Okidata 82s, 83s or 84s (serial version) the IDS PRISM series is also suitable. If you choose to use an Epson, you will also have to buy one of their serial interface boards. If you want a letter quality printer there is the NEC 3510 or 7710, the Diablo 630 or the Qume Sprint 9/45.

All prices, F.O.B. shipping point, subject to change. All offers subject to withdrawal without notice. Advertised prices reflect a 2% cash discount (order prepaid prior to shipment). C.O.D.'s and credits cards are 2% higher.

# **MiniMicroMart, Inc.**

943 W. Genesee St. P.O. Box 3002 Syracuse, N.Y. 13220 (315) 422-4467 TWX 710-542-0431



**7400 SERIES**

7400	.19	74136	.50
7401	.19	74141	.65
7402	.19	74142	2.85
7403	.19	74143	2.95
7404	.19	74145	.60
7405	.25	74147	1.75
7406	.29	74148	1.20
7407	.29	74150	1.35
7408	.24	74151	.65
7409	.19	74152	.65
7410	.19	74153	.55
7411	.25	74154	1.40
7412	.30	74155	.75
7413	.35	74156	.65
7414	.55	74157	.55
7416	.25	74159	1.65
7417	.25	74160	.85
7420	.19	74161	.70
7421	.35	74162	.85
7422	.29	74163	.85
7423	.29	74164	.85
7425	.29	74165	.85
7426	.29	74166	1.00
7427	.29	74167	2.95
7428	.45	74170	1.65
7430	.19	74172	5.95
7432	.29	74173	.75
7433	.45	74174	.89
7437	.29	74175	.89
7438	.29	74176	.89
7440	.19	74177	.75
7442	.49	74178	1.15
7443	.65	74179	1.75
7444	.69	74180	.75
7445	.69	74181	2.25
7446	.59	74182	.75
7447	.69	74184	2.00
7448	.69	74185	2.00
7450	.19	74186	18.50
7451	.23	74190	1.15
7453	.23	74191	1.15
7454	.23	74192	.79
7460	.23	74193	.79
7470	.35	74194	.85
7472	.29	74195	.85
7473	.34	74196	.79
7474	.35	74197	.75
7475	.49	74198	1.35
7476	.35	74199	1.35
7480	.59	74221	1.35
7481	1.10	74246	1.38
7482	.95	74247	1.25
7483	.50	74248	1.85
7485	.65	74249	1.95
7486	.35	74251	.75
7489	4.95	74259	2.25
7490	.35	74265	1.35
7491	.40	74273	1.95
7492	.50	74276	1.25
7493	.49	74278	.75
7494	.65	74283	2.00
7495	.55	74284	3.75
7496	.70	74285	3.75
7497	2.75	74290	.85
74100	1.00	74293	.75
74107	.30	74298	.85
74109	.45	74351	2.25
74110	.45	74365	.65
74111	.55	74368	.65
74116	1.55	74367	.65
74120	1.20	74368	.65
74121	.29	74376	2.20
74122	.45	74390	1.75
74123	.55	74393	1.35
74125	.45	74425	3.15
74126	.45	74426	.85
74128	.55	74490	2.55
74132	.45		

**CMOS**

74C00	.35	4019	.45
74C02	.35	4020	.95
74C04	.35	4021	.95
74C08	.35	4022	1.15
74C10	.35	4023	.35
74C14	1.50	4024	.75
74C20	.35	4025	.35
74C30	.35	4026	1.65
74C32	.50	4027	.85
74C42	1.75	4028	.80
74C48	1.20	4029	.95
74C73	.65	4030	.45
74C74	.85	4034	2.95
74C76	.80	4035	.85
74C83	1.95	4040	.95
74C85	1.95	4041	1.25
74C86	.95	4042	.75
74C89	4.50	4043	.85
74C90	1.75	4044	.85
74C93	1.75	4046	.95
74C95	1.75	4047	.95
74C107	1.00	4049	.55
74C150	5.75	4050	.55
74C151	2.25	4051	.95
74C154	3.25	4053	.95
74C157	1.75	4060	1.45
74C160	2.00	4066	.75
74C161	2.00	4068	.40
74C162	2.00	4069	.35
74C163	2.00	4070	.35
74C164	2.00	4071	.30
74C185	2.00	4072	.30
74C173	2.00	4073	.30
74C174	2.25	4075	.30
74C175	2.25	4078	.95
74C192	2.25	4078	.30
74C193	2.25	4081	.30
74C195	2.25	4082	.30
74C200	5.75	4085	.95
74C221	2.25	4086	.95
74C373	2.75	4093	.95
74C374	2.75	4098	2.49
74C901	.80	4099	1.95
74C902	.85	14409	12.95
74C903	.85	14410	12.95
74C905	10.95	14411	11.95
74C906	.95	14412	12.95
74C907	1.00	14419	4.95
74C908	2.00	4502	.95
74C909	2.75	4503	.65
74C910	9.95	4508	1.95
74C911	10.00	4510	.95
74C912	10.00	4511	.95
74C914	1.95	4512	.95
74C915	2.00	4514	1.25
74C918	2.75	4515	2.25
74C920	17.95	4516	1.55
74C921	15.95	4518	1.25
74C922	5.59	4519	1.25
74C923	5.95	4520	1.25
74C925	6.75	4522	1.25
74C926	7.95	4526	1.25
74C927	7.95	4527	1.95
74C928	7.95	4528	1.25
74C929	19.95	4531	.95
74C930	19.95	4532	1.95
4000	.35	4538	1.95
4001	.35	4539	1.95
4002	.25	4543	2.70
4006	.95	4555	.95
4007	.29	4556	.95
4008	.95	4581	1.95
4009	.45	4582	1.95
4010	.45	4584	.95
4011	.35	4584	.95
4012	.25	4702	12.95
4013	.45	4724	1.50
4014	.95	80C07	.95
4015	.95	80C95	.85
4016	.45	80C96	.95
4017	1.15	80C97	.95
4018	.95	80C98	1.20

**74S00 SERIES**

74S00	.44	74S85	2.39	74S163	3.75	74S280	2.90
74S02	.48	74S86	1.44	74S168	4.65	74S287	4.75
74S03	.48	74S112	1.59	74S169	5.44	74S288	4.45
74S04	.79	74S113	1.98	74S174	1.09	74S289	6.95
74S05	.79	74S114	1.50	74S175	1.09	74S301	6.95
74S08	.48	74S124	2.77	74S181	4.47	74S373	3.45
74S09	.98	74S132	1.24	74S182	2.95	74S374	3.45
74S10	.69	74S133	.98	74S188	3.95	74S381	7.95
74S11	.88	74S134	.69	74S189	14.95	74S387	5.75
74S15	.70	74S135	1.48	74S194	2.95	74S412	2.90
74S20	.68	74S138	1.08	74S195	1.89	74S471	9.95
74S22	.98	74S139	1.25	74S196	4.90	74S472	16.85
74S30	.48	74S140	1.45	74S197	4.25	74S474	17.85
74S32	.98	74S241	3.75	74S201	14.95	74S482	15.60
74S37	1.87	74S244	3.98	74S225	8.95	74S570	7.85
74S38	1.68	74S251	1.90	74S240	3.98	74S571	7.85
74S40	.44	74S253	7.45	74S257	1.39		
74S51	.78	74S157	1.19	74S258	1.49		
74S64	.79	74S158	1.45	74S260	1.83		
74S65	1.25	74S161	2.85	74S274	19.95		
74S74	.69	74S162	3.70	74S275	19.95		

**EPSON PRINTERS**

MX-80 ~~479.00~~  
 MX-80/FT ~~579.00~~  
 MX-100 ~~775.00~~

CALL FOR THE LOWEST PRICES

**16K APPLE\* RAM CARD**

- ★ Upgrade your 48K Apple\* II to full 64K.
- ★ Fully software and hardware compatible with Apple language card and microsoft Z80 card.
- ★ Eliminates the need for Applesoft or Integer Basic ROM card when used in conjunction with DOS 3.3
- ★ Allows you to run Apple Fortran or Pascal.
- ★ Available as bare board kit, or completed and tested board.

BARE BOARD ..... \$ 40.00  
 KIT ..... 89.95  
**ASSEMBLED & TESTED ..... 109.95**

\* Apple is a trademark of APPLE COMPUTER INC.

**LED DISPLAYS**

1.28	HP 5082-7760	.8"	CC	14 Pin 3"
.99	MAN 72	.3"	CA	14 Pin 3"
.99	MAN 74	.3"	CC	14 Pin 3"
.75	FND-357 (359)	.375"	CC	10 Pin 2"
.99	FND-500 (503)	.5"	CC	10 Pin 8"
.99	FND-507 (510)	.5"	CA	10 Pin 8"

**LED LAMPS**

		1-99	100-up
Jumbo Red		.10	.09
Jumbo Green		.18	.15
Jumbo Yellow		.18	.15



**JDR MICRODEVICES, INC.**

1224 S. Bascom Avenue  
 San Jose, CA 95128  
 800-538-5000 • 800-662-6279 (CA)  
 (408) 995-5430 • Telex 171-110

Circle 249 on inquiry card.

HOURS: Mon. - Fri., 9 to 5; Sat. 11 to 3

**VISIT OUR RETAIL STORE!**

TERMS: For shipping include \$2.00 for UPS Ground, \$3.00 for UPS Blue Label Air. \$10.00 minimum order. Bay Area residents add 6 1/2 % sales tax. California residents add 6% sales tax. We reserve the right to limit quantities and substitute manufacturer. Prices subject to change without notice. Send SASE for complete list.



**STATIC RAMS**

			Each	100 pcs
2101	256 x 4	(450ns)	1.95	1.85
5101	256 x 4	(cmos) (450ns)	4.95	3.95
2102-1	1024 x 1	(450ns)	.89	.85
2102L-2	1024 x 1	(LP) (250ns)	1.69	1.55
2102L-4	1024 x 1	(LP) (450ns)	1.29	1.15
2111	256 x 4	(450ns)	2.99	2.49
2112	256 x 4	(450ns)	2.99	2.79
2114	1024 x 4	(450ns)	8/16.95	1.95
2114L-2	1024 x 4	(LP) (200ns)	8/19.95	2.35
2114L-3	1024 x 4	(LP) (300ns)	8/18.95	2.25
2114L-4	1024 x 4	(LP) (450ns)	8/17.95	2.10
2147	4096 x 1	(55ns)	9.95	call
TMS4044-4	4096 x 1	(450ns)	3.49	3.25
TMS4044-3	4096 x 1	(300ns)	3.99	3.75
TMS40L44-2	4096 x 1	(LP) (200ns)	4.49	4.25
MK4118	1024 x 8	(250ns)	9.95	call
TMM2016	2048 x 8	(150ns)	call	call
HM6116-4	2048 x 8	(cmos) (200ns)	call	call
HM6116-3	2048 x 8	(cmos) (150ns)	call	call
HM6116-2	2048 x 8	(cmos) (120ns)	call	call
HM6116LP-4	2048 x 8	(LP) (cmos) (200ns)	call	call
HM6116LP-3	2048 x 8	(LP) (cmos) (150ns)	call	call
HM6116LP-2	2048 x 8	(LP) (cmos) (120ns)	call	call
Z-6132	4096 x 8	(Qstat) (300ns)	34.95	call

LP = Low Power Qstat = Quasi-Static

**DYNAMIC RAMS**

			Each	100 pcs
TMS4027	4096 x 1	(250ns)	2.50	2.00
MK4108	8192 x 1	(200ns)	1.95	call
MM5298	8192 x 1	(250ns)	1.85	call
4116-120	16384 x 1	(120ns)	8/29.95	call
4116-150	16384 x 1	(150ns)	8/18.95	1.95
4116-200	16384 x 1	(200ns)	8/13.95	call
4116-250	16384 x 1	(250ns)	8/13.90	call
4116-300	16384 x 1	(300ns)	8/13.80	call
2118	16384 x 1	(5v) (150ns)	4.95	call
MK4816	2048 x 8	(5v) (300ns)	24.95	call
4164*200	65536 x 1	(5v) (200ns)	call	call
4164-150	65536 x 1	(5v) (150ns)	call	call

**EPROMS**

			Each	100 pcs
1702	256 x 8	(1us)	4.95	4.50
2708	1024 x 8	(450ns)	3.75	3.50
2758	1024 x 8	(5v) (450ns)	9.95	8.95
TMS2516	2048 x 8	(5v) (450ns)	6.95	5.95
2716	2048 x 8	(5v) (450ns)	4.95	3.95
2716-1	2048 x 8	(5v) (350ns)	9.00	8.50
TMS2716	2048 x 8	(450ns)	9.95	8.95
TMS2532	4096 x 8	(5v) (450ns)	9.95	7.95
2732	4096 x 8	(5v) (450ns)	9.95	7.95
2732A-2	4096 x 8	(5v) (200ns)	call	call
2764	8192 x 8	(5v) (450ns)	call	call
TMS2564	8192 x 8	(5v) (450ns)	call	call

5v = Single 5 Volt Supply

**EPROM ERASERS**

	Timer	Capacity Chip	Intensity (uW/CM <sup>2</sup> )	
PE-14		6	5,200	83.00
PE-14T	X	6	5,200	119.00
PE-24T	X	9	6,700	175.00
PL-265T	X	20	6,700	255.00
PR-125T	X	16	15,000	349.00
PR-320T	X	32	15,000	595.00

**JUNE SPECIALS**

**2K x 8 STATIC**

TMM-2016 (200NS)

**8/6<sup>95</sup>** EA.

HM6116 (200NS)

**8/7<sup>95</sup>** EA.

**64K DYNAMIC**

4164 (200NS)

**8/8<sup>95</sup>** EA.

**16K DYNAMIC**

4116 (200NS)

**8/13<sup>95</sup>** EA.

**16K EPROMS**

2716 (450NS)

**8/3<sup>95</sup>** ea.

**32K EPROMS**

2532 or 2732 (450NS)

**8/7<sup>95</sup>** EA.

PRICES GOOD FOR THE MONTH OF JUNE ONLY  
PLEASE MENTION JUNE SPECIALS WHEN ORDERING

**PROMS**

Order by National Part No.	Function	TI	SIG	MMI	Harris	
74S188	32x8 OC	18SA030	82S23	6330-1	7602	2.95
74S287	256x4 TS	14S10	82S129	6301-1	7811	3.25
74S288	32x8 TS	18S030	82S123	6331-1	7603	2.75
74S387	256x4 OC	14SA10	82S126	6300-1	7610	2.95
74S471	256x8 TS	18S22		6309-1		10.95
74S472	512x8 TS	18S42	82S147	6349-1	7649	10.95
74S473	512x8 OC	18SA42	82S146	6348	7648	10.95
74S474	512x8 TS	18S48	82S141	6341	7641	12.95
74S475	512x8 TS	18SA46	82S140	6340	7640	12.95
74S478	1Kx8 TS	28S86				19.95
74S570	512x4 OC	27S12	82S130	6305	7620	5.95
74S571	512x4 TS	27S13	82S131	6306-1	7621	5.95
74S572	1Kx4 OC	24SA41	82S136	6352-1	7642	9.95
74S573	1Kx4 TS	24SA1	82S137	6353-1	7643	9.95
87S180	1Kx8 OC	28SA86	82S180	6380-1	7680	19.25
87S181	1Kx8 TS	28S86	82S181	6381-1	7681	19.25
87S184	2Kx4 OC	24SA81	82S184		7684	17.20
87S185	2Kx4 TS	24SB1	82S185		7685	19.95
87S190	2Kx4 OC	28SA166	82S190		76160	39.95
87S191	2Kx8 TS	28S166	82S191		76161	39.95

**74LS00 SERIES**

74LS00	.25	74LS169	1.75
74LS01	.25	74LS170	1.75
74LS02	.25	74LS173	.80
74LS03	.25	74LS174	.95
74LS04	.25	74LS175	.95
74LS05	.25	74LS181	2.15
74LS08	.35	74LS189	9.95
74LS09	.35	74LS190	1.00
74LS10	.25	74LS191	1.00
74LS11	.35	74LS192	.85
74LS12	.35	74LS193	.95
74LS13	.45	74LS194	1.00
74LS14	1.00	74LS195	.95
74LS15	.35	74LS196	.85
74LS20	.35	74LS197	.85
74LS21	.25	74LS221	1.20
74LS22	.25	74LS240	1.29
74LS26	.35	74LS241	1.29
74LS27	.35	74LS242	1.85
74LS28	.35	74LS243	1.85
74LS30	.25	74LS244	1.29
74LS32	.35	74LS245	1.90
74LS33	.55	74LS247	1.75
74LS37	.55	74LS248	1.25
74LS38	.35	74LS249	.95
74LS40	.35	74LS251	1.30
74LS42	.55	74LS253	.85
74LS47	.75	74LS257	.85
74LS48	.75	74LS258	.85
74LS49	.75	74LS259	2.85
74LS51	.25	74LS260	.65
74LS54	.35	74LS266	.55
74LS55	.35	74LS273	1.65
74LS63	1.25	74LS275	3.35
74LS73	.40	74LS279	.55
74LS74	.45	74LS280	1.98
74LS75	.50	74LS283	1.00
74LS76	.40	74LS290	1.25
74LS78	.50	74LS293	1.85
74LS83	.75	74LS295	1.05
74LS85	1.15	74LS298	1.20
74LS86	.40	74LS324	1.75
74LS90	.65	74LS352	1.55
74LS91	.89	74LS353	1.55
74LS92	.70	74LS363	1.35
74LS93	.65	74LS364	1.95
74LS95	.85	74LS365	.95
74LS96	.95	74LS366	.95
74LS107	.40	74LS367	.70
74LS109	.40	74LS368	.70
74LS112	.45	74LS373	1.75
74LS113	.45	74LS374	1.75
74LS114	.50	74LS377	1.45
74LS122	.45	74LS378	1.18
74LS123	.95	74LS379	1.35
74LS124	2.99	74LS385	1.90
74LS125	.95	74LS386	.65
74LS126	.85	74LS390	1.90
74LS132	.75	74LS393	1.90
74LS136	.55	74LS395	1.65
74LS137	.99	74LS399	1.70
74LS138	.75	74LS424	2.95
74LS139	.75	74LS447	.37
74LS145	1.20	74LS490	1.95
74LS147	2.49	74LS624	3.99
74LS148	1.35	74LS668	1.69
74LS151	.75	74LS669	1.89
74LS153	.75	74LS670	2.20
74LS154	2.35	74LS674	9.65
74LS155	1.15	74LS682	3.20
74LS156	.95	74LS683	2.30
74LS157	.75	74LS684	2.40
74LS158	.75	74LS685	2.40
74LS160	.90	74LS688	2.40
74LS161	.95	74LS689	2.40
74LS162	.95	74LS783	24.95
74LS163	.95	81LS95	1.69
74LS164	.95	81LS96	1.69
74LS165	.95	81LS97	1.69
74LS166	2.40	81LS98	1.69
74LS168	1.75		

**TRANSISTORS**

PN2222	10/1.00	100/ 8.99
2N2222	.25	50/10.99
2N2907	.25	50/10.99
2N3055	.79	10/ 6.99
2N3904	10/1.00	100/ 8.99
2N3906	10/1.00	100/ 8.99
1N4148 (1N914)		25/ 1.00
1N4004		10/ 1.00

**JDR MICRODEVICES, INC.**

1224 S. Bascom Avenue  
San Jose, CA 95128

800-538-5000 • 800-662-6279 (CA)  
(408) 995-5430 • Telex 171-110

HOURS: Mon. - Fri., 9 to 5; Sat. 11 to 3

**VISIT OUR RETAIL STORE!**

TERMS: For shipping include \$2.00 for UPS Ground \$3.00 for UPS Blue Label Air. \$10.00 minimum order. Bay Area residents add 6 1/2% sales tax. California residents add 6% sales tax. We reserve the right to limit quantities and substitute manufacturer. Prices subject to change without notice. Send SASE for complete list.





Z-80	
2.5 Mhz	
Z80-CPU	6.00
Z80-CTC	5.95
Z80-DART	15.25
Z80-DMA	17.50
Z80-PIO	6.00
Z80-SIO/O	18.50
Z80-SIO/1	18.50
Z80-SIO/2	18.50
Z80-SIO/9	16.95
4.0 Mhz	
Z80-A-CPU	6.00
Z80-CTC	8.65
Z80A-DART	18.75
Z80A-DMA	27.50
Z80A-PIO	6.00
Z80A-SIO/O	22.50
Z80A-SIO/1, O	22.50
Z80A-SIO½2	22.50
Z80A-SIO/9	19.95
6.0 Mhz	
Z80B-CPU	17.95
Z80B-CTC	15.50
Z80B-PIO	15.50
ZILOG	
Z8132	34.95
Z8	39.95

8200	
8202	34.95
8205	3.50
8212	1.85
8214	3.85
8216	1.80
8224	2.50
8226	1.80
8228	4.90
8237	19.95
8238	4.95
8243	4.45
8250	14.95
8251	4.75
8253	9.25
8253-5	9.85
8255	4.75
8255-5	5.25
8257	8.50
8257-5	8.95
8259	6.90
8259-5	7.50
8272	39.95
8275	29.95
8279	9.50
8279-5	10.00
8282	6.65
8283	6.65
8284	5.70
8286	6.65
8287	6.50
8288	25.00
8289	49.95

8000 SERIES	
8035	7.25
8039	7.95
INS8060	17.95
INS8073	29.95
8080	3.95
8085	7.95
8085A-2	11.95
8088	59.95
8087	Call
8088	39.95
8089	89.95
8155	7.95
8156	8.95
8185	29.95
8185-2	39.95
8741	39.95
8748	29.95
8755	32.00

6800	
68000	call
6800	4.95
6802	10.95
6808	13.90
6809E	19.95
6809	19.95
6810	2.95
6820	4.95
6821	4.95
6828	14.95
6840	12.95
6843	34.95
6844	25.95
6845	16.95
6847	12.25
6850	3.45
6852	5.75
6880	10.95
6882	11.85
6875	6.95
6880	2.95
6883	24.95
68047	24.95
68488	19.95
68800	10.95
68802	22.25
68809E	29.95
68809	29.95
68810	7.85
68821	12.85
68845	35.95
68850	12.95

6500 SERIES	
1 MHZ	
6502	6.95
6504	6.95
6505	8.85
6507	9.95
6520	4.35
6522	8.75
6532	11.25
6545	22.50
6551	11.85
2 MHZ	
6502A	9.95
6522A	11.70
6532A	12.40
6546A	28.50
6551A	12.95
3 MHZ	
6502B	14.95

DISC CONTROLLERS	
1171	24.95
1791	36.95
1793	44.95
1795	54.95
1797	54.95
8843	42.95
8272	39.95
UPD765	39.95
1691	18.95
2143	18.95
INTERFACE	
8T26	1.69
8T28	2.49
8T95	.99
8T96	.99
8T97	.99
8T98	.99
DM8131	2.95
DP8304	2.29
MISC	
3341	4.95
76477	3.95
AY3-8910	12.95
MC3340	1.49
95H90	7.99
11C90	13.95
8202A	34.95
3242	7.95
MC3480	9.00
MC4024	3.95
MC4044	4.50
3205	3.50

9000 SERIES	
9316	1.00
9334	2.50
9368	3.95
9401	9.95
9601	.75
9602	1.50
96902	1.95
DATA ACQUISITION	
ADC0800	5.55
ADC0804	4.95
ADC0809	5.25
ADC0817	10.85
DAC0800	4.95
DAC0808	4.95
DAC1020	6.25
DAC1022	5.95
MC1408L8	4.95

CRYSTALS	
32.768 khz	3.95
1.0 mhz	4.95
1.8432	4.95
2.0	3.95
2.097152	3.95
2.4576	3.95
3.2768	3.95
3.579535	3.95
4.0	3.95
5.0	3.95
5.0688	3.95
5.185	3.95
5.7143	3.95
5.9904	3.95
6.0	3.95
6.144	3.95
6.5536	3.95
8.0	3.95
10.0	3.95
14.31818	3.95
15.0	3.95
16.0	3.95
18.0	3.95
18.432	3.95
20.0	3.95
22.1184	3.95
32.0	3.95

BIT-RATE GENERATORS	
14411	9.95
BR1941	9.95
4702	12.95
COM5016	16.95
MM5307	10.95
UARTS	
AY3-1014	6.95
AY5-1013	3.95
PT1472	9.95
TR1602	3.95
2350	9.95
TMS8011	5.95
IM6402	7.95
IM6403	8.95
INS8250	14.95
KEYBOARD CHIPS	
AY5-2376	11.95
AY5-3600	11.85
74C922	5.25
74C923	5.50

IC SOCKETS	
1-99 100	
8 pin ST	.13 .11
14 pin ST	.15 .12
16 pin ST	.17 .13
18 pin ST	.20 .18
20 pin ST	.29 .27
22 pin ST	.30 .27
24 pin ST	.30 .27
28 pin ST	.40 .32
40 pin ST	.49 .39
ST = SOLDER TAIL	
14 pin WW	.69 .52
16 pin WW	.69 .58
18 pin WW	.99 .90
20 pin WW	1.09 .98
22 pin WW	1.39 1.28
24 pin WW	1.49 1.35
28 pin WW	1.69 1.49
40 pin WW	1.99 1.80
WW = WIREWRAP	

CONNECTORS	
RS232 MALE	3.25
RS232 FEMALE	3.75
RS232 HOOD	1.25
S-100 ST	3.95
S-100 WW	4.95
DIP SWITCHES	
4 POSITION	.85
5 POSITION	.90
6 POSITION	.90
7 POSITION	.95
8 POSITION	.95

ORDER TOLL FREE  
**800-538-5000**  
**800-662-6279**  
 CALIFORNIA RESIDENTS

INTERSIL	
ICL7103	9.50
ICL7106	9.95
ICL7107	12.95
ICL8038	3.95
ICM7107A	5.59
ICM7208	15.95

LINEAR			
LM301	.34	LM350K	5.60
LM301H	.79	LM350T	4.60
LM307	.45	LM358	.98
LM308	.98	LM359	1.79
LM308H	1.15	LM376	3.75
LM309H	1.95	LM377	2.29
LM309K	1.49	LM378	2.50
LM310	1.75	LM379	4.50
LM311	.64	LM380	1.29
LM311H	.89	LM380B	1.19
LM312H	1.75	LM381	1.60
LM317K	3.95	LM382	1.60
LM317	1.95	LM383	1.95
LM318	1.49	LM384	1.95
LM318H	1.59	LM386	1.50
LM319H	1.25	LM387	1.40
LM319	1.25	LM389	1.35
LM320 (see 7900)	1.30	LM390	1.95
LM322	1.65	LM392	.69
LM323K	4.95	LM394H	3.60
LM324	.59	LM399H	5.00
LM329	.69	NE531	3.75
LM331	3.95	NE536	6.00
LM334	1.30	NE555	.39
LM335	1.40	NE556	.69
LM336	1.75	NE558	1.50
LM337K	3.95	NE561	19.95
LM337T	2.95	NE562	6.00
LM338K	6.95	NE564	3.95
LM339	.99	LM565	.99
LM340 (see 7800)	1.20	LM566	1.49
LM348	1.20	LM567	1.29
NE570	4.75	NE571	3.95
NE582	2.75	LM703	.89
LM709	.59	LM710	.75
LM711	.79	LM723	.49
LM723H	.55	LM723H	.55
LM733	.98	LM741N-8	.35
LM741N-14	.35	LM741H-14	.40
LM741H	.40	LM747	.79
LM748	.59	LM748	.59
LM1014	2.75	LM1303	1.95
LM1303	1.19	LM1304	1.19
LM1305	1.49	LM1305	1.49
LM1307	.85	LM1310	2.90
LM1310	2.90	MC1330	1.89
MC1349	1.89	MC1350	1.29
MC1350	1.29	MC1358	1.79
LM1414	1.59	LM1458	.69
LM1458	.69	LM1488	.99
LM1488	.99	LM1489	.99
LM1496	.85	LM1496	.85
LM1558H	3.10	LM1558H	3.10
LM1800	2.99	LM1812	8.25
LM1815	5.20	LM1818	2.90
LM1820	3.50	LM1830	3.50
LM1871	5.49	LM1871	5.49
LM1877	3.25	LM1889	2.45
LM1899	2.15	LM1896	1.75
LM2877	2.05	LM2877	2.05
LM2878	2.25	LM2900	.85
LM2900	.85	LM2901	1.00
LM3900	.59	LM3905	1.25
LM3905	1.25	LM3909	.98
LM3911	2.25	LM3911	2.25
LM3914	3.95	LM3915	3.95
LM3915	3.95	LM3916	3.95
MC4024	3.95	MC4024	3.95
MC4044	4.50	RC4136	1.25
RC4151	3.95	RC4151	3.95
LM4250	1.75	LM4500	3.25
LM4500	3.25	LM13080	1.29
LM13600	1.49	LM13600	1.49
LM13700	1.49	LM13700	1.49
TL071	.79	TL071	.79
TL072	1.19	TL072	1.19
TL074	2.19	TL074	2.19
TL081	.79	TL081	.79
TL082	1.19	TL082	1.19
TL083	1.19	TL083	1.19
TL084	2.19	TL084	2.19
LF347	2.19	LF347	2.19
LF351	.60	LF351	.60
LF353	1.00	LF353	1.00
LF355	1.10	LF355	1.10
LF356	1.10	LF356	1.10
LF357	1.40	LF357	1.40
TI			
TL494	4.20	TL494	4.20
TL496	1.65	TL496	1.65
TL497	3.25	TL497	3.25
75107	1.49	75107	1.49
75110	1.95	75110	1.95
75188	1.25	75188	1.25
75189	1.25	75189	1.25
75450	.59	75450	.59
75451	.39	75451	.39
75452	.39	75452	.39
75453	.39	75453	.39
75454	.39	75454	.39
75491	.79	75491	.79
75492	.79	75492	.79
75493	.89	75493	.89
75494	.89	75494	.89

BI FET	
XR 2206	3.75
XR 2207	3.85
XR 2208	3.90
XR 2211	5.25
XR 2240	3.25
EXAR	
CA 3010	.99
CA 3013	2.00
CA 3023	2.75
CA 3035	2.49
CA 3039	1.29
CA 3046	1.25
CA 3053	1.45
CA 3059	2.90
CA 3060	2.90
CA 3065	1.75
CA 3080	1.10
CA 3081	1.85
CA 3082	1.65
CA 3083	1.65
CA 30d6	.60
CA 3089	2.99
CA 3906	3.49
CA 3130	1.30
CA 3140	1.30
CA 3146	1.85
CA 3160	1.19
CA 3401	.59
CA 3600	3.45

CLOCK CIRCUITS	
MM5314	4.95
MM5369	3.95
MM5375	4.96
MM58167	8.85
MM58174	11.95
MSM5832	8.95

FUNCTION GENERATORS	
MC4024	Dual VCO 3.95
LM568	



# MICRO SALES

15381 CHEMICAL LANE ★ HUNTINGTON BEACH, CA 92649

★ (714) 891-2677 ★

## ★ SPECIALS OF THE MONTH ★



**ONLY \$25.00**

WOW! LOOK!  
Brand new fully encoded ASC keyboards. Guaranteed to work. With all documentation, SUPER DEAL! 40 pin dual .100 cable. +5V @ .500MA



**ONLY \$55.00**

Perfect for 8" or 5" drive power. Comes with Shugart type connectors but 5" type can be put on. These are overstock from our Horizontal Cabinet shown below.  
+5V @ 4A ● +24V or +12V @ 3A ● -12V @ 1A

## BREAK THE COST BARRIER!

NOW IS YOUR CHANCE TO GET THAT COMPUTER LOOK AT THESE FEATURES!

- 4MHZ Z-80 CPU with 2 Programmable Serial and 3 Parallel Ports
- 64K Dynamic Ram w/Extended Addressing to 1MB
- Floppy Disk Controller with WD1795. Runs 8" or 5" Floppys Error Free
- 30 Amp Power Supply with S-100 MOD 12 Slot Mother with Regulated Floppy Supplies as Shown Below
- Tan and Charcoal Sturdy Steel Cabinet with Space for 2 Floppy Drives at Left (8" or 5")

\$1750 Retail

**ONLY \$1350.00**

SOME MECHANICAL ASSEMBLY REQUIRED IN STOCK FOR IMMEDIATE SHIPMENT

CP/M\* \$150  
MP/M\* \$350  
DISC ACCES. \$50

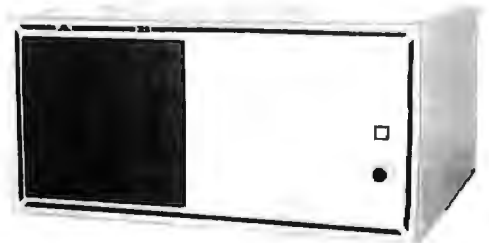

(Less Drives, Cables Pick-up Price)  
\*CP/M & MP/M are Trademarks of Digital Research

## ★ DUAL DRIVE SUBSYSTEMS ★



HORIZONTAL VERTICAL MINI

- Power Supply for 2 801/851 DT8 etc.
- 50 Pin Ribbon Cable, 36"
- AC Cord, Fuse, Internal Wiring and Connectors

Assembled and Tested	\$ 245.00
w/2 Empty 5"	\$ 87.00
w/2 Empty 8"	\$ 95.00
w/2 801R Shugart	\$1045.00
w/2 851R Shugart	\$1395.00
w/2 QUME DT-8	\$1295.00
w/2 MPI B-51	\$ 675.00
w/2 MPI B-52	\$ 830.00
w/2 MPI B91	\$ 850.00
w/2 MPI B92	\$ 995.00

## ★ XOR ★

### S-100 MOD KIT \$199.00 BY XOR

For test or hobby applications complete S-100 12 Slot Sub-System power for up to 4 Floppy Disk Drives. (6 connectors supplied.)

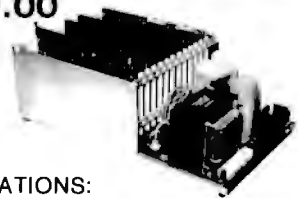

SPECIFICATIONS:	
UNREGULATED	REGULATED
• 12 Slots S-100	+5 at 5 Amps
• +8VDC at 30Amps	+24 at 4 Amps
• ±16VDC at 6 Amps	-5 at 1 Amp

XOR-CPU	Z-80 4MHZ, Prom 2 Serial 3 Par	\$255
XOR-DSK	WD-1795 MINI and 8"	\$275
XOR-64K	Bank SW Memory up to 1 Meg	\$389
XOR-32K	Static Ram (Kit)	\$199
XOR-MPM	IO MPM Interface Card	\$335
XOR-DTC	Hard Disk and DTC Tape	\$225
XOR-SMS	Hard Disk Controller	\$750
XOR-SER	4 Channel Serial Board	\$195

## ★ NEW PRODUCT ★



**XOR DELIVERS IBM-PC HARD DISK & TAPE BACKUP!**  
12 megabyte high performance 5 1/4" Hard Disk with internal 6 meg cassette backup tape. Outstanding product makes IBM-PC really useful for business or program development. Kit includes Hard Disk Drive, Interface Card w/2 serial IO ports, Power Supply and mounting hardware. **\$3250.00**

## ★ IBM AND APPLE ★

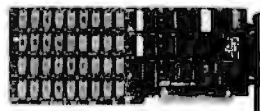

APPLE - 16K Ram Expansion Card, works with Microsoft Basic	\$99.50
APPLE - Z-80 CPU Direct replacement for Z-80 Sftcard	\$149.50
IBM-PC Ram Expansion Card with 64K (256K available)	\$475.00

# California Computer Systems



- 2810 CPU Only — \$255.00
- 2422 Dsk Cont Only — \$330.00
- 2065C 64K Only — \$510.00
- 2200A Mainframe Only — \$450.00
- CCS Apple Boards Call for prices
- CCS 2200 System Tested and Assembled Only — \$1,695.00

★ SPECIAL ★ SPECIAL ★ SPECIAL ★

## CCS SYSTEM 2410

### \*FEATURES\*

- \* DMA Disk Controller
  - \* 2-Real Time Clocks
  - \* 2-Serial/1-Parrell Port
  - \* Hardware Vectored Interrupts
  - \* Supports C/PM, M/PM, OASIS
  - \*\*\*Comes with C/PM\*\*\*
- only-\$2200.00



CB2-CPU .....	\$295.00
MB10A-16K .....	\$295.00
MB64-64K .....	\$845.00
I/O5-2SER 3PAR .....	\$329.00
I/O8-8SER .....	\$550.00
Apple	
A-I/O II .....	\$225.00
A-S/I/O .....	\$149.00

### COMMUNICATIONS PACKAGES

TRACEND I .....	\$89.00
TRACEND II .....	\$149.00

**commodore**  
computer systems  
CALL FOR PRICES



SYSTEMS 200, 300, 400  
CALL FOR PRICES



**data systems**

CALL FOR PRICES



**Cromemco**  
INCORPORATED

CALL FOR PRICES



**TeleVideo**  
SYSTEMS

CALL FOR PRICES



# MICRO SALES

11 EDISON DRIVE ★ NEW LENOX ★ ILLINOIS 60451  
CALL TOLL FREE: 1-800-435-9357 ★ MONDAY thru SATURDAY  
(ILLINOIS RESIDENTS CALL: 815-485-4002) ★ 8:00 a.m. to 6:30 p.m.

TERMS: Prepayment — C.O.D. up to \$100.00 — M/C Visa  
\$5.00 Processing and Handling added to each order PLUS  
Shipping Charges. Please allow personal check to clear before shipment.  
15% Restocking Charge for Non-Defective, Returned Merchandise.

## FEATURES! TERMINAL

- Feather Touch Capacitance Keyboard
- 60 Key Standard ASCII PLUS + Hex Keypad PLUS + 8 Special Function Keys PLUS + 20 Screen Editing Keys
- SOROC Type Screen Attribute Set
- Half Intensity

## S-100-8

INCLUDING CP/M 2.2®  
AND WORDSTAR®

WITH: 8" SS/DD Drives Only \$2850.00  
5 1/2" SS/DD Drives Only \$2700.00

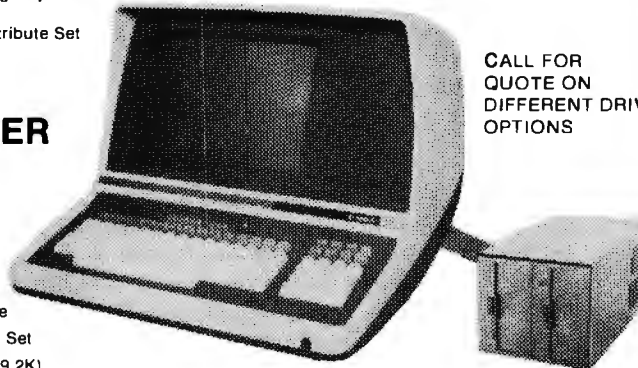

CALL FOR QUOTE ON DIFFERENT DRIVE OPTIONS

## COMPUTER

- 8 Slot S-100
- 64K Dynamic Ram
- 4MHZ Z-80
- Double Density Disk Controller
- Programmable Baud Rate
- Programmable Keyboard Set
- Serial Printer Port (150-19.2K)

WORDSTAR is a TM of Micropro Inc. — CP/M 2.2 is a TM of Digital Research Inc.

## MONITORS

ZENITH VIDEO MONITOR—	
ZVM .....	\$145.00
AMDEK MONITORS—	
AMDEK Color 1 .....	\$399.00
AMDEK Video 300 .....	\$229.00
w/Green Screen	

## DISK DRIVES

• Shugart 801's —	\$395.00
• Shugart 851's —	\$575.00
• Qume DT-8's —	\$540.00
• Shugart 400's —	\$255.00
• Tandom 5 1/4 —	\$255.00

## TERMINALS

• Adds Regent 20 —	\$570.00
• Televideo 910 —	\$575.00
• Televideo 912C —	\$665.00
• Televideo 925C —	\$740.00
• Televideo 950 —	\$950.00
• Ampex Dialog 80—	\$895.00
• Zenith Z19 —	\$745.00

## PRINTERS

• C-ITOH PROWRITER .....	\$625.00
• C-ITOH Comet I 9 x 7 Dot Matrix .....	\$450.00
• C-ITOH Comet II 132 Column Printer 9 x7 Dot Matrix .....	\$810.00
• MPI-88G .....	\$725.00
• EPSON MX 80 .....	CALL
• EPSON MX 100 .....	CALL
• Anadex 9501 .....	\$1,235.00
Graphic Printer	
• OKIDATA 82A .....	\$465.00
• Microline 80 .....	\$329.00

WE HAVE NEC SPINWRITERS  
CALL FOR PRICES

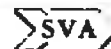

- Apple 8" Disk Controller Card
- ZVX4 Dual Density, Single & Double Sided - Auto Boot .....
- Disk 2 + 2 Single Density Single or Dual Sided .....



# CALIFORNIA DIGITAL

Post Office Box 3097 B • Torrance, California 90503

## California Digital STATIC • 64



RELIABILITY OF STATIC ... PRICE OF DYNAMIC

Sixteen Bit Memory

# \$595

February Price \$850  
30% Price Reduction

Utilizing the new Hitachi 6167/2187 ram chips, the Static 64 is the most current technology available in \$-100 memory products. 24 bit extended addressing, 8 or 16 bit data paths along with 16 bit register and acknowledge make this unique board completely compatible with the IEEE 696 S-100 bus standard.

The Static 64 has been engineered to allow each 16K segment of memory to be bank selectively supporting multiuser systems. Other selectable features allow the board to fully integrate with all current bank selection schemes including Cromemco and Alpha-Micro. Operates with all 16 bit computers including Seattle Computers, Zenith and Lotus. Designed for DMA operations at clock frequencies in excess of 10 Mhz. Standby power consumption less than one Amp.

To add to the total integrity of the product, each board is subjected to extensive high temperature burn-in and test procedures. CA1-8400



## ZENITH \$119

### GREEN PHOSPHOR MONITOR

The new Zenith 7VM-121 monitor features a P-31 green phosphor tube along with 15 MHz bandwidth.

Switch selectable for 40 and 80 character per line screen formats.

Accepts composite video and is fully compatible with 80 column Apple cards. VDM-121 20 lbs.

**EPSON MX80**  
**\$450**

**NEC PC-8023A**  
**\$535**

Epson MX801 T fraction/yr \$565.00  
Epson MX100 1/2 column 70.00  
Matrix HD option 70.00  
Appl. I/O cable (8131) 129.00  
Serial interface (8141) 79.00  
Serial Inter. - 5K buf. (8151) 145.00  
Cable for TRS-80 35.00  
MC-16 HD interface (8161) 65.00  
Replacement head 35.00  
Replacement Ribbon 14.00  
Paper 3100 sheets 9 1/2" 35.00

Dot-matrix, bi-directional, logic-seeking, friction or tractor feed, impact printer. Complete graphics, upper and lower case ASCII, Greek, mathematics along with the ability to print dot graphic screen images directly onto paper.

Proportional spacing and 132 column compressed print make this low cost machine the best value in today's printer market.

**PRINTRONIX P-300 \$450**

**P-600 \$6150**

## PRINTERS

Epson MX80	PREACX80	\$475	NEC/Sellum 1	PRN5510ps	2895
Epson MX80FT	PREMX80F	595	NEC/Sm 16K	PRN5510px	2785
Epson MX100	PREMX100		TEC/Starwrit.	PRV300	1395
Anadex 9500	PR A9500	1295	Okidata 80	PRO80	419
Anadex 9301	PR A9301	1295	Okidata 82	PRO82	619
Anacom 150	PR A150	1075	Okidata 83	PRO83	805
IDS Paper Ter.	PRG480G	1095	Teletype 43K	PTT 4320K	1095
IDS Tiger 560	PRG560G	1350	Texas Ins. 810	PRT810B	1450
Diablo 830	PRD830	2150	Tex. Ins 810C	PRT810C	1705
Diablo 1850	PRD1850	2850	Centronics 730	PRC730P	520
Diablo 1840	PRD1840	2495	Centronics 737	PRC737P	805
Dataouth 180	PRD180	1350	Centronics 738	PRC738P	795
Printronix 300	PRP300	4500	Centrx 704-9	PRC704-9	
Printronix 800	PRP800	8150	Centrx 704-11	PRC704-11	

## SYSTEMS

**HEWLETT PACKARD HP 85 COMPUTER**  
**BELOW OUR COST \$2295**

**Apple 48K Memory \$1150**

**IBM 3101 Display Terminal**  
**IBM Direct Price \$1395**  
**California Digital discount price \$1295**

**AMPEX DIALOGUE 80 REDUCED PRICE \$795**

## VIDEO TERMINALS

ADDS Viewpoint	VDT-RVP	595
ADDS Regent 25 numeric cluster	VDT-R25	850
ADDS Regent 30 25th status line	VDT-R30	950
ADDS Regent 40 limited graphics	VDT-R40	1195
ADDS Regent 60 Block mode	VDT-R60	1495
AmpeX Dialogue 80 two page, detach	VDT-D80	
Digital Equipment VT-100	VDT-V100	1595
Digital Equipment VT-132	VDT-V132	1895
IBM 3101-10 character mode green	VDT-3101	1195
IBM 3101-20 block mode	VDT-3102	1395
Visual 200	VDT-V200	995
Televideo 910C (new)	VDT-T910	595
Televideo 912C	VDT-T912	665
Televideo 920C	VDT-T920	745
Televideo 950C detachable keybd.	VDT-T950	985
Zenith Z-19	VDT-Z-19	

## VIDEO MONITORS

BMC KG-12C 20MHz	
P31 green phosphor	\$169
NEC gm. 1201	189
Zenith gm ZVM121	119
BMC color composit	339
Zenith color 13"	395
NEC RGB 1202DH	895

**EPROM ERASER Ultra Violet Products \$65**

All merchandise sold by California Digital is premium grade. Shipping: First five pounds \$2.00; each additional add \$.40. Foreign orders 10% shipping. Excess will be refunded. California residents add 8% sales tax. C.O.D. is discouraged. Open accounts extended to state supported educational institutions and companies with a "Strong Dan & Bradstreet." Warehouse: 15608 Inglewood Blvd. Visitors by appointment.

## ACCESSORIES FOR THE APPLE COMPUTER

CALIFORNIA COMPUTER SYSTEMS	
Arithmetic processor 7811 D/C	\$319
Asynchronous serial interface 7710	129
Centronics interface card 7728	95
12K PROM Module 7711	69
Calendar/Clock, Bat. back-up 7421	99
Parallel interface 7720	99
Programmable Timer 7740A	99
Analog/Digital converter 7470A	99
MICROSOFT PRODUCTS	
Apple to Z-80 CPU card	378
B. C. HAYES PRODUCTS	
Micromodem for Apple	319
COMPUTER STOP PRODUCTS	
Double Vision 40 Column Video	250
INTERACTIVE STRUCTURES	
16 Channel A/D card AIO/2	275

## S-100 BOARDS

CPU BOARDS	
Calif. Computer 2810A Z-80	
DMA, 431K, 810C-C7210	\$250
Goldbout Z-80 24 bit, 431K	
810C-475-80	239
Goldbout 8085/8080 dual 16 bit processor	375
810C-C80	
Measurement Systems Z-10	
4 serial 2 parallel real time clock, 8 vector	395
810C-C1280	
Sil Systems 810C-200 Z-80	
I/O ports	385
810C-S10C2	
Teltek 810C-1 single board CPU & floppy disk controller plus I/O	695

FLOPPY DISK CONTROLLER	
Calif. Computer 2820A with 2.25" CP/M	
810C-C212	329
Goldbout "Disk One" features die	
NEC 785 controller, DMA arbitration	395
810-C31	
Measurement Systems 785 chip, single & double density, error recovery	410
810-C41	
SD Systems Verano floppy II	
2 double density 810-V15	119
Turbid I/O	131
810-V152	
Moreno Design Disk Jockey II	165
810-D31	
Moreno Design Disk Jockey II double density	146

INTERFACE BOARDS	
Calif. Computer 2718 I/O	
2 serial/2 par 1 810C-C2718	
Moreno Designs Switchboard	
2 serial/4 par 810C-M50	319
Moreno Designs 4810board	
2 serial/3P. 810C-D310H	275
Goldbout Interface One	
2 serial/2 par 1 810C-G81	
Goldbout Interface Two	
1 serial/2 par 1 810C-G82	

MEMORY BOARDS	
Calif. Computer 2085A1 61K dynamic memory 810C-C2085	
Calif. Computer 2086 16K static memory	359
810C-C2016	
Calif. Computer 2087 48K static memory	1025
810C-C2087	
Goldbout Ram 17 84K static memory 16 bit	1025
810C-C17	
SD Systems Lancaster II 16K dynamic	205
810C-EX10	
64K dynamic	375
810C-EX10-64	
Measurement Systems 2010-640 for Alpha Micro	688
810C-S10G400	

**Rotron Muffin Fan \$14.77**

115 VAC. 7 Watts WR2A1  
Factory fresh Muffin fans  
NOT pull-outs. EMF-4M

TOLL FREE ORDER LINE  
**(800) 421-5041**  
TECHNICAL & CALIFORNIA  
**213 679-9001**  
TWX 910 325-6212

# CALIFORNIA Digital

Post Office Box 3097 B • Torrance, California 90503

## DISKETTES

FREE PLASTIC LIBRARY CASE INCLUDED WITH THE PURCHASE OF EVERY BOX OF DISKETTES

**\$24.95**

Produce outstanding performance from one of the most important parameters of computer disks, high reliability in every use. Memory of 40 tracks, 16 sectors, 5 platters. 100% guaranteed. 100% return. 100% satisfaction. 100% reliability. 100% quality. 100% service. 100% support. 100% success. 100% peace of mind. 100% happiness. 100% health. 100% wealth. 100% power. 100% love. 100% life. 100% everything.

Ten boxes \$22.75 One hundred boxes \$21.50

**5 1/4" DISKETTES WITH LIBRARY CASE**  
**\$26.50**

Your Choice  
**SCOTCH MEMOREX VERBATIM**

	Soft Sector	10 Sector	16 Sector	
SCOTCH	744-0	744-10	744-16	\$26.50
MEMOREX	3401	3403	3405	26.50
VERBATIM	525-01	525-10	NA	26.50
DYSAN	104/1	107/1	NA	39.50
Single Side Double Density				
DYSAN	104/1D	107/1D	NA	45.00
Double Side Double Density				
SCOTCH	745-0	745-10	745-16	42.50
DYSAN	104/2D	107/2D	NA	49.50
DYSAN 96	204/2D	NA	NA	59.50

**EIGHT INCH DISKETTES**

Single Side Single Density		Single Side Double Density		
SCOTCH	740-0	29.50	SCOTCH 741-0	39.00
MEMOREX	3060	29.50	MEMOREX 3090	35.00
DYSAN	3740/1	39.50	DYSAN 3740/D	57.50
Thirty Two Sector				
SCOTCH	740-32	29.50	SCOTCH 743-0	47.50
MEMOREX	3114	39.50	DYSAN 3740/20	65.00

**PLEASE PHONE FOR VOLUME PRICING.**

**BSR SYSTEM X-10**

The new BSR timer runs your home just like clockwork. Turns on lamps and appliances while you're away from home. Completely compatible with your existing System X-10 devices.

BSR Timer eight channel \$85.00  
Master control console 39.95  
Ultrasonic Controller 11.95

Appliance Module 500 W. \$13.95  
Lamp Module 300 Watts 13.95  
NEW full control wall switch 14.50

**WINCHESTER SUBSYSTEM**

**\$1250**

Includes seven megabyte Winchester hard disk, dual channel and power supply. Popy floppy drive \$195.00 additional.



## MEMORY

<b>64K DYNAMIC</b> <b>\$9.95</b> 4164 100-	<b>16K STATIC</b> <b>\$13.95</b> 2167 70ns.
<b>16K DYNAMIC</b> <b>\$2.10</b> 4116 100-1.85	<b>2716 EPROM</b> <b>\$4.95</b> 100-4.50 1K-4.00



## 2732 EPROM SALE \$7.95

**STATIC**

	2K	32+	100+	1K+
21102 1K	1.19	1.09	1.05	.99
2114 300ns.	2.95	2.75	2.50	1.99
4044-4 450ns.	4.50	4.19	4.00	3.75
4044-2 250ns.	4.95	4.65	4.50	4.25
6116 15K 24 pin	7.95	7.50	6.75	5.45
2167/6167 20 pin	11.95	10.75	9.65	9.25

**EPROM**

2708 450ns.	3.95	3.50	3.25	3.00
2716 5V.	4.95	4.00	3.75	3.30
2716 tri-volt	8.50	7.95	7.35	7.25
2732 Intel/Pitac.	7.95	7.50	7.00	3.65
2532 Texas Inst	12.95	11.50	10.00	9.50
2704 64K Eprom	29.95	27.00	25.00	23.50



**direct connect MODEM** Your Choice **\$169**

Direct connect modems eliminate loss of information due to the carbon compression associated with acoustic modems. Choose either of these two great units.

The Universal Data System 1021P is a high selectable between answer and originate modes. Fully Bell 103 compatible. Directly connects to the 2-wire modular telephone line. 100% pass rate from the telephone line. Comes to locate modem in proximity to A.C. power receptacle. MO11-1021P 2 tones.

Navigation "D" Cat connects to most of the new "Bell" modular modems. Used for multiple line office telephones. Requires external A.C. power. MOD-DCAT 2 L.B.

## SWITCHES

DIP SWITCHES		POGGLE		100+
100-1	.75	1001 on/off	1.19	.99
100-2	.89	1003 on/off/on	1.39	1.10
100-3	.89	1007 on/off	1.39	1.10
100-4	1.05	1008 on/off	1.39	1.19
100-5	1.19	1009 on/off	1.39	1.19

## CONNECTORS

**GOLD EDGE CONNECTORS**

S-100 .135" center	each	101
Immal solder .250" row	\$2.95	\$2.50
Immal wire wrap 1/11	3.65	3.50
Sullins Heflet. -550"	1.90	4.00
Sullins III-Intel. W/W	5.35	4.00
Sullins/Altair. 140"	1.85	4.50
.158" Centers (standard)		
22/48 Male Keytel	2.50	2.15
36/72 Digital Group S/T	5.95	5.50
36/72 Digital Group W/W	6.60	6.15
42/86 Motorola 6800 S/T	6.60	6.15
42/86 Motorola 6800 W/W	7.00	6.65

**INTEGRATED CIRCUIT SOCKETS**

	Low Profile	Wire Wrap
each 100	each 100	
8 pin \$10 \$0.98	\$1.46	\$1.31
14 pin -10 -0.99	.89	.81
16 pin -12 -1.10	.90	.85
18 pin -15 -1.13	.88	.81
24 pin -26 -1.24	.94	.87
40 pin -42 -1.30	1.23	1.17

**CENTRONICS**

57-3036D	7.95	6.75	5.75
----------	------	------	------

**RUBBER CABLE CONNECTORS**

17/24 3" dia	4.88	4.35	3.88
20/48 1/8"-50	5.85	5.00	4.70
22/40 1" dia	3.99	3.15	4.20



**NEW OLIVETTI 801 \$295**  
Eight Inch Disk Drive

		ONE	TWO	TEN
★ OLIVETTI 801	single	\$319	309	295
★ OLIVETTI 802/851	double	425	419	410
SHUGART 801/R	single	395	385	375
SHUGART 851/R	double	525	495	475
QUME DATA TRACK 8	double	525	495	475

\* The 8" Olivetti drives are approx. 1/2" wider than the Shugarts.

## Five Inch Disk Drives

OLIVETTI 501/400	single	199	185	175
OLIVETTI 502/451	double	235	225	215

Upon request, all drives are supplied with power connectors and one manual per order.  
230 volt 50Hz. B' add \$50.00 per drive.

**\$995 Eight inch Subsystem**

Two Olivetti 801 disk drives with power supply, 4" exhaust fan complete in dual enclosure with all necessary power cables. Documentation included. 50 Lbs. CAL-2801

Signal cable add \$35.00 WCA-650D  
Same as above but with:  
Shugart 801R MSD2801 \$1195 Olivetti 802 CAL2802 \$1250  
Shugart 851R MSD2851 1450 Qume DT8 MSD80T 1450

## SPECIAL \$895

**Seagate Compatible 7.5 MEGABYTE Winchester Hard Disk Drive**

We have priced this so low that the manufacturer has asked not to use their brand name in our advertising. Industry standard Seagate plug compatible. Fits into the same space as a 5 1/4" floppy disk drive. CAL-561/2

## S-100 MOTHER BOARD \$35

**IMSAI 18 Slot CAL-M18**

The Quiet Bomb from California Digital is quality engineered. No short cuts. Hand built to produce this mother board. Active termination circuitry prevents noise and electrical interference from other lines upon glass.

All merchandise sold by California Digital is premium grade. Shipping: First five pounds \$2.00; each additional add \$4.00 Foreign orders 10% shipping. Excess will be refunded. California residents add 6% sales tax. COD's discouraged. Open accounts extended to state supported educational institutions and companies with a "Strong Dun & Bradstreet." Warehouse: 15608 Inglewood Blvd. Visitors by appointment.

**TOLL FREE ORDER LINE (800) 421-5041**  
**TECHNICAL & CALIFORNIA (213) 679-9001**  
TWX 910 325-6212

# PALOMAR TAKES THE RISK

...Join the thousands of satisfied customers who buy from  
fast response, expert technical help, and



**NEC-8023 A**

High-resolution dot graphics. Proportional spacing. Correspondent quality printing. Bidirectional tractor and friction feed. 80, 136 col. Greek and math symbols. 100 cps matrix printer.

List \$780 Parallel ..... \$599

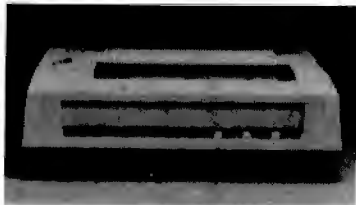

**C. ITOH**

Pro/Writer offers 8 character sizes, 5 different alphabets, and high proportional spacing. bidirectional, vert. and horiz. tabs, resolution graphics. nx9 matrix, 100 cps 136 col. max. Friction and tractor feed.

8510 Parallel ..... \$549  
8510 Serial ..... CALL

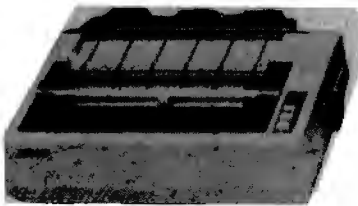

## EPSON—COMPLETE STOCK!

Features disposable print heads. Graphtrax. All models except MX-70 print text in two directions. MX-80F/T and MX 100 have both friction and tractor feed. Unparalleled dot placement accuracy.

MX-70 (80 col.) ..... CALL  
MX-80 (80 col.) ..... CALL  
MX-80F/T (80 col.) ..... CALL  
MX-100 (136 col.) ..... CALL  
Interface Cards ..... CALL  
Cables ..... CALL

## VIDEO TERMINALS, MONITORS

Ampex Dialog 80 ..... \$995  
Ampex Dialog 30 ..... \$795  
Televideo 920C ..... \$845  
Televideo 950 ..... \$995  
SOROC IQ 120 ..... \$699  
Zenith 12" Green ..... \$119  
NEC 12" Green ..... \$169  
Amdex 12" B/W (Leedex) ..... \$99  
Amdex 13" Color Lo-Res ..... \$439



## LOW, LOW PRICE ON NOVELL!

Heavy duty, 150 CPS, bidirectional, tractor feed. 9x9 dot matrix. 6 or 8 lines per inch. 10, 13.6 or 16.5 CPI. EIA RS-232C or parallel interface.

IMAGE 800 ..... \$995



## MPI 88G/99G MATRIX

High resolution dot-addressable graphics for Apple. Enhanced "correspondence quality" printing. Tractor and friction feed. Serial and Parallel Input. 100 cps Bi-directional printing.

88 G (132 col.) List \$749 ..... \$549  
99 G (132 col.) List \$849 ..... \$599  
Apple parallel I/O Card/Cable/Disk ... \$110  
with Graphics Prom (Ap-Pak) ..... \$145  
IEEE I/O Card ..... \$55  
Single Sheet Feeder ..... \$25  
QT Cover ..... \$30

## OKIDATA

(UP TO 200 CPS!)

Microline 82A—80/132 col., 120 CPS. 9x9 dot matrix. friction, pin feed or tractor feed (removeable) rear and bottom feed. Includes bi-directional/logic seeking, serial and parallel interfaces. Double width and condensed characters, true lower case descenders and graphics.

82A ..... \$545

Microline 83A—132/232 col., 120 CPS, handles forms up to 15 in. wide, plus all the features of the 82A.

83A ..... \$775

Microline 84SP—132/232 col., 200 CPS, with full dot graphics built-in. Takes forms up to 15 in. wide, plus all the features of the 83A.

84SP ..... \$1250

## MODEMS

UDS-103 LP, direct ..... \$175  
'03 JLP Auto Answer ..... \$209  
202 LP 1200 BAUD ..... \$259  
NOVATION-CAT, acoustic ..... \$145  
D-CAT, direct ..... \$155  
Auto Cat ..... \$219  
Apple Cat ..... \$329  
HAYES-S100 Micromodem ..... \$349  
Apple Micromodem ..... \$299  
Smart Modem ..... \$245



**ADLER**

17.5 CPI, 10, 12, 15 and proportional spacing, line correcting memory, inter-changeable p wheels.

SE1010 List \$1295 ..... SAVE \$300  
Interface Card ..... ADD \$30

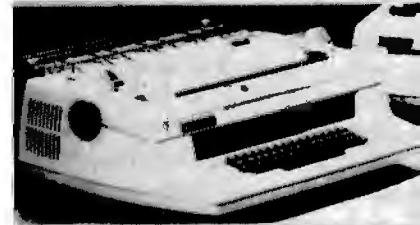

## NEC SPINWRITERS

7710/7730 RO w/tractor ..... \$250  
7720 KSR w/tractor ..... \$295  
3510/3530 RO ..... \$175  
Bidirectional tractor ..... \$200  
Push tractor ..... \$300

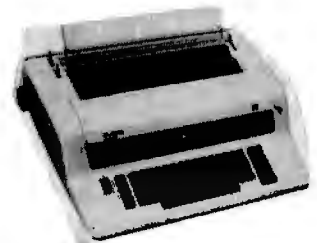

## OLYMPIA

Letter quality, Daisy wheel printer typewriter interfaces to Apple, Atari, NEC, TRS80 & RS232 Serial ports.

ES 100KRO Computer printer  
List \$1690 ..... SAVE \$300

ES 100 Typewriter only List \$1195 SAVE \$200

Interface Card Only ..... \$200

(specify serial or parallel)

I/O Cable (specify serial or parallel) ..... \$50

Apple Serial Card ..... \$100

## MODEMS

BIZCOMP Super low introductory price. \$50 over other modems! Apple—direct connect game port. No serial card needed. Save \$100 more.

Atari—direct connect via interface module and telelink cartridge. Commodore the only modem available. Each pkg. comes with connectors and phone T-adapt.

Apple Comm Pkg ..... \$100

VIC Comm Pkg ..... \$100

Atari Comm Pkg ..... \$100



# OUT OF MAIL ORDER BUYING!

Buy with confidence and know you'll receive the same **guaranteed satisfaction — at UNBEATABLE PRICES!**

## APPLE SOFTWARE

BUSINESS	
Financial Partner	\$191.99
Fiscal Tutor	\$97.99
Easy Writer	\$137.99
Easy Writer 40 col.	\$78.99
Word Star (Req. Softcard)	\$241.99
Super Sort (Req. Softcard)	\$129.99
Mail Merger (Req. Softcard)	\$80.99
Meta Star (Req. Softcard)	\$192.99
Bell Star (Req. Softcard)	\$129.99
Alc Star (Req. Softcard)	\$129.99
Per Tex II	\$117.99
Electronic Address Book	\$38.99
Form Letter Module	78.99
Spiffles	\$229.99
Desktop Plan III	\$275.99
Desktop Plan II	\$229.99
Plotplot	\$185.99
Plottrend/Visiplot	\$275.99
Plotindex	\$229.99
Plotterm	\$89.99
Plotical 3.3	\$229.99
Plotatory	\$198.99
Perispell (Req. Softcard)	\$435.99
Word Processor (Req. Softcard)	\$255.99

## PERSONAL/HOME

Spelling Tutor	\$19.99
Elementary Math	\$31.99
Personal Filing System	\$74.99
Personal Report System	\$74.99
Algebra I	\$31.99
Compu-Math: Arithmetic Skill	\$39.99
Compu-Math: Fractions	\$31.99
Compu-Math: Decimals	\$31.99
Compu-Spells: (Req. Data Disk)	\$23.99

## MISC

AppleSoft Compiler	\$145.99
Basic Compiler	\$27.99
Apple-Doc	\$41.99
Apple-B. Master	\$189.99
Apple-B. Utility Pack	\$81.99

## GAMES

Star Blaster	\$24.99
Traffic Controller	\$9.99
Temple of Apshai	\$31.95
Testones of Ryn	\$15.99
Arctoc's Tower	\$15.99
Rescue at Rigel	\$23.99
Bl Fire Warrior	\$31.99
War Warrior	\$31.99
Crash, Crumble and Chomp	\$23.99
Per Reaches of Apshai	\$15.99
Keys to Acheron	\$15.99
Back Attack	\$23.99
Prisoner	\$23.99
Bank I	\$31.99
Bank II	\$31.99
Robot Wars	\$31.99
Tree Mile Island	\$31.99
3.M.	\$19.99
Castle Wolfenstein	\$23.99
Wizard and Princes	\$25.99
Missile Defense	\$23.99
Antston Manor	\$27.99
Hyper Destroyer	\$23.99
Hyper Strike	\$31.99
Antstoms Five	\$23.99
Race Eggs	\$23.99



## APPLE ACCESSORIES

### MICROSOFT

Z80 Softcard	\$298.99
16K RAMcard	\$158.99

### CCS

Parallel Card	\$118.99
ASYNC Serial Card	\$148.99
Clock Calendar Card	\$98.99
IEEE Card	\$248.99
A-D Card	\$98.99

### MOUNTAIN COMPUTERS

ROM Plus	\$129.99
Keyboard Filter ROM	\$48.99
CPS Multifunction Card	\$178.99
Supertalker	\$229.99

### PAYMAR

L/C Adapter-New	\$34.99
L/C Adapter-Old	\$44.99

### VIDEX

Video Terminal	\$298.99
----------------	----------

### ADVANCE BUSINESS TECH

13 Key pad for Apple (New KBD)	\$110.99
13 Key pad for Apple (Old KBD)	\$110.99
BAR Code Reader	\$189.99

### DANA

Cooling Fan	\$39.99
-------------	---------

### LAZER

Lower Case Adapter	\$55.99
--------------------	---------

### T.G. PROD.

Game Paddles	\$31.99
Joy Stick	\$46.99
Select A Port	\$46.99
Wizard-80 (80 col.)	\$278.99

## RS232 CABLES

4 wire male-male 10 ft.	\$19.99
9 wire male-male 10 ft.	\$21.99
4 wire male-female 10 ft.	\$19.99
9 wire male-female 10 ft.	\$21.99
RS232 Switch Box (Use 2 terminals or printers from one output port)	\$109.99

## FAN FOLD PAPER

(Prices F.O.B. S.P.)

9 1/2 x 11-20# Bond White (2700 ct.)	\$30.10
14 7/8 x 11-20# Bond White (2400 ct.)	\$37.10
14 7/8 x 11-20# Bond 1/2" Green Bar (2400 ct.)	\$37.10

## RIBBONS

NEC	\$77/Doz.
Qume	\$45/Doz.
Diablo	\$66/Doz.
Anadex	\$135/6 ea.
Tritel	\$95/Doz.
TI/DEC/TTY	\$45/Doz.
Epson	\$13.95/ea.
MPI/Axiom/Base 2	\$13.95/ea.

## MAGNETIC MEDIA

Premium Quality At Bargain Prices  
100% Certified with hub rings, box of 10  
Economy Diskettes

5 1/4" SSSD Soft, 10 or 16 sector	\$25.00
SSSD Soft, 10 or 16 sector	\$28.50
DSDD Soft, 10 or 16 sector	\$36.00

### Quality Diskettes

5 1/4" SSD, Soft 10 or 16 sector	\$27.00
SSDD, Soft 10 or 16 sector	\$32.00
DSDD, Soft 10 or 16 sector	\$38.50
8" SSSD, Soft or 32 hard sector	\$28.50
DSDD, Soft or 32 hard sector	\$45.50

CALL for prices on name brand diskettes:

VERBATIM DYSAN 3M SCOTCH  
MEMOREX WABASH MAXELL

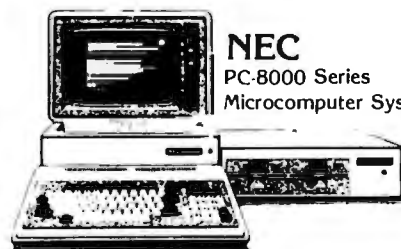

## NEC

PC-8000 Series  
Microcomputer System

- z-80A CPU 4 MHz
- 5 user programmable function keys
- 82 Keys with numeric keypad
- 160 x 100 resolution
- 80 character screen

PC-8001A Microcomputer w/32K RAM	\$899
PC-8012A I/O Unit w/32K RAM	
Expansion slots	\$599
PC-8031A Dual Mini-Disk Drive Unit	\$899
PC-8032A Add-On Dual Mini Disk Drive Unit	\$799

## ATARI SOFTWARE

Adventure # 1,2,3, (D)	\$31.99
Adventure #4,5,6, (D)	\$31.99
Adventure #7,8,9 (D)	\$31.99
Adventure #10,11,12 (D)	\$31.99
Adventure 1-12 (D)	\$79.99
Atari Mailing List (D)	\$19.99
Text Wizard (D)	\$79.99
Compu-Math/Fractions (D)	\$31.99
Compu-Math/Decimals (D)	\$31.99
Compu-Math/Fractions (C)	\$23.99
Compu-Math/Decimals (C)	\$23.99
Letter Perfect (D)	\$119.99
Mail Merge/Utility (D)	23.99

TO PLACE YOUR ORDER CALL:

TELEPHONE  
(714)744-7314

TELEX  
or write to: 697120

# PALOMAR

Computer Products

910-105 W. San Marcos Blvd., Dept. JB,  
San Marcos, CA 92069

TERMS OF SALE: Cash, check, money order, bank wire transfer, credit card or purchase orders from qualified firms and institutions. Please include telephone number with order and expiration date on credit card orders. California residents add 6% sales tax. Advertised prices are for prepaid orders F.O.B. shipping point. Add 3% for shipping in U.S. Pricing and availability subject to change without notice.



# ADVANCED COMPUTER PRODUCTS

SEND \$2.00 for 104 PAGE CATALOG

## 16K Apple™ Ramcard

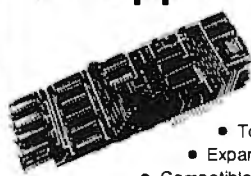

LIST 195  
ACP  
\$74.95

- Full 1 year warranty
- Top quality — gold fingers
- Expand Apple II 48K to 64K
- Compatible with Z-80 Softcard™
- Allows system to run with CP/M™, PASCAL, DOS 3.3, COBOL, Visicalc, etc.
- Supplied with extra 16K RAM & has (2) LED's

## 32K STATIC RAM



2 or 4 MHz Expandable Uses 2114's  
16K 4 MHz MR \$159.95  
16K 4 MHz A&T \$199.95  
32K 4 MHz KII \$269.95  
32K 4 MHz A&T \$339.00  
BARE BOARD \$39.35  
Bare Bd w/all parts less mem 99.95

## Astec RF Modulator



for COLOR & B/W  
P/N 1082 Channel 3 or 4 \$6.95  
P/N 4151 UHF Channel 33 8.95

## BARE BOARDS

- S-100 Sound Board \$34.95
- 8080A CPU 34.95
- 32K Static RAM (2114) 34.95
- 8K EPROM (2708) 24.95
- 2708/2716 EPROM 34.95
- ACP Proto Board 22.95
- Vector 880C Proto 22.20
- Vector 880C 11 slot MB 29.95
- ACP Extender with connector 18.95
- 13 Slot Mother Board (W/MC) 32.95
- 9 Slot Mother Board (W/MC) 29.95
- 8 Slot Mother Board (Expandable) 34.95
- Floppy PCB (8 S-UGART) 39.95
- S100(A75-8910) Sound Board 34.95
- Apple Sound Board 24.95

## MOSTEK 4K RAMS

200,000 pieces in stock — priced to move  
Same as MK4027 except 1ms refresh, MK4015 4Kx1 RAM

29¢ ea.

## PMI "Super Beta" LOW POWER AMPLIFIER

INTERNALLY COMPENSATED P/N OP12GJ  
list \$8.65  
ACP \$1.95  
Vofset = 1.0 mV  
Ibias = 5.0mA  
Gain = 40V/mV  
(quantity limited)

## UV "EPROM" ERASER

Model UVS-11E \$79.95  
Holds 4 EPROM's at a time  
Model S-52T \$325.00

## 4K STATIC RAM SELL-OFF

10/\$9.90  
Same as TMS4044 but designed specifically for Z-80 based systems. This is a full-spec 4Kx1 RAM, 450nS. Order P/N Zillog6104-4 while supply lasts.

## 16K Memory Expansion Kits for Apple/TRS-80

8'pchs. 4116 15K \$12.95  
200/250's  
Specially computer CALL FOR VOLUME PRICING

## "D" SUB CONNECTORS

Unreal price, DB37 male, DB25 female. Gold PC mount with mounting holes. Mtg. AMP. Specify 25 or 37 pins  
DB37 \$2.50 DB25 \$1.95

## Zilog Z8 CPU

with TINY BASIC  
Debug prog. \$49.95  
Plus 6132 companion quasi-static RAM 29.95

## "BLINKER" LED's

Respond to sound. Complete, ready to wear. (2"x2")  
Sold at Nerman Marcus for \$9.95 ACP \$49.95  
red, yellow, green LED's

## Stepper Motor

NEW USED IN DATA PRODUCTS PRINTER \$19.95 ea.  
DB25P (RS232) 3.25  
DB25FS Female 3.75  
Hood 1.25  
Set with Hood, Sale 7.50  
22/44 S/T, KIM 2.95  
43/86 S/T, WOT 8.50  
50/100 S-100 Connector W/W 4.95  
50/100 S-100 Connector S/T 3.95

## 12 VOLT BUZZER/HORN

2" DIAMETER ALL METAL 2/\$1.99

## GE D43C3

PNP power HFE = 40-120 VCEO = 30 I<sub>C</sub> = 3A  
6,000 pcs available 69¢ ea.

## CONNECTORS

DB25P (RS232) 3.25  
DB25FS Female 3.75  
Hood 1.25  
Set with Hood, Sale 7.50  
22/44 S/T, KIM 2.95  
43/86 S/T, WOT 8.50  
50/100 S-100 Connector W/W 4.95  
50/100 S-100 Connector S/T 3.95

## Full ASCII Encoded Keyboards

RG1128-Character, 58-Key Typewriter Format for Alphanumeric Entry  
VP-606 Async serial output. Reg. \$99.00  
ACP SALE ... \$69.95

## MICROPROCESSORS

Z8001 \$90.00	8008-1 \$1.95	6802P 14.95
Z8002 65.00	2801 9.90	8035 11.95
Z80 9.95	2901A 14.95	8039 12.95
Z80A 11.95	3903L 49.95	8073A 31.95
F-8 (3850) 16.95	6502 9.95	6755 49.95
2850 18.95	6502A 16.95	6748 -19.95
6802 9.75	IM6100 29.95	6850 30.00
6808A 11.75	8050 11.75	8086 49.95
6085 14.95	68008 19.95	68000 129.95

## RAMS

6116/2016 \$7.95	2147 \$5.99	5280 \$1.99
8264-64K 85.00	4111 5.99	5298 1.49
4116-2 1.99	414 4.89	6506 4.50
4118-2 0/12.95	1101 9.99	6518 6.79
2101 3.99	1103 9.99	6561 3.79
2102 7.99	4027 4.89	6804 3.99
2110-2 1.49	4044 3.99	6805 7.99
2110A-4 1.29	4050 4.89	9130 8.99
2111 3.49	4060 4.89	9140 8.99
2112 3.49	4086 3.99	93415 6.99
2114 1.99	4115 1.49	93425 6.99
2114-2 3.25	4200 7.95	
2114-4 2.29	4402 1.99	
2125 6.99	5280 4.60	

## SUPPORT

8155 59.95	8259 58.95	68047 \$22.95
8156 9.95	8275 19.95	88488 19.95
8202 2.69	6810 4.75	5500 22.95
8212 2.75	6820 6.50	6522 9.95
8214 4.95	6821 6.50	6530-X 24.85
8216 2.75	6828 10.50	6532 17.95
8224 2.95	6834 16.95	6551 19.55
8225 2.69	6845 22.95	6552 17.95
8228 3.95	6847 27.95	Z80A CPU 6.50
8243 9.50	6850 5.25	Z80-CTC 9.50
8250 14.95	6862 10.95	Z80-DMA 19.95
8251 6.50	6865 10.95	Z80-DMA 27.95
8253 11.95	6862 10.95	Z80-DMA 27.95
8255 4.50	6870 5.25	Z80-SIO 24.95
8257 9.50	6880 2.49	Z80-SIO 29.95

## MOS PROMS

2764 (8Kx8) TS 569.85	27F04(450nS) \$5.75
2712 (4Kx4) TS 12.95	2708 (650nS) 5.25
2716 (4Kx8) SV 17.29	2704 4.75
2764 TS 7.95	NM5125/203AC 14.50
2756 5V, 450nS 3.95	MMS204C 9.95

## HI-TECH

2513-001 5V Upper 3550	04C08 5995
2513-005 5V Lower 1045	04C08 995
2513-003 5V Lower 145	6038 Function Generator 4.80
MC466710 A/D Converter 1295	MC4024VDC 2.95
MC466720 D/A Converter 1395	MS4666VDC 1.95
ICM2655 5V Regulator 12.95	88286 Function Generator 5.25
1771-018 3.3V Memory 2495	TR6082P15V 12V 1.95
1781 Dual Fldrop 2995	AY1510 13V 12V 1.95
1791-01 Dual Fldrop 3695	AY1510-1 (AV12 15-AV) 6.95
1793-02 Dual Fldrop 4495	AY1510-1A (863 SV) 7.95
1793-03 0.5 Poppy 4495	IM-602 1.65
1793-04 0.5 Poppy 4495	IM-603 1.65
1813 Data Separator 1695	MS250 9.95
2613 Conv. Generator 1895	16718 Astrot 24.85
8700 8 bit Binary 1350	MC214 11.95
8701 10 bit Binary 2200	47.00 14.95
8702 8 bit 15 1350	WDR-11 9.95
94K 16 bit Parity Conv 75	04A016 18.95
8732A's Dept DC 1995	MS250 9.95
1408.6 bit 1.35	AY5-326 13.75
1408.8 bit 1.95	AY5-326 13.75
DAC1 D to A 3.95	MS5140AC 8.95

## SOCKETS

LOW PROFILE SOCKETS (TIN)

8 pin LP .16	.15	.14
14 pin LP .20	.19	.18
16 pin LP .22	.24	.20
18 pin LP .29	.28	.27
20 pin LP .34	.32	.30
22 pin LP .39	.37	.36
24 pin LP .45	.44	.43
40 pin LP .60	.59	.58

## 3L WIREWRAP SOCKETS (GOLD)

8 pin WW .55	.54	.49
10 pin WW (Tin) .65	.63	.58
14 pin WW .75	.75	.67
16 pin WW .80	.77	.70
18 pin WW .95	.90	.81
20 pin WW 1.18	1.08	.99
22 pin WW 1.45	1.35	1.23
24 pin WW 1.35	1.26	1.14
28 pin WW 1.60	1.50	1.38
40 pin WW 2.20	2.09	1.89

## LINEAR

Z8H05K \$5.95	LM1414N \$1.90
78M05 1.49	LM1458CN 49
78M06 1.49	MC1488N 99
LM1034H 2.95	MC1492N 1.35
LM300H .95	LM1498N 89
LM301CN .35	LM1556N 1.50
LM304H 1.89	LM1820N .95
LM305H 1.89	LM1850N .95
LM305H 3.25	LM1899N 3.10
LM307CN 1.49	LM1911N 1.35
LM308CN .95	LM2900N .95
LM309CN 1.49	LM2910N 2.50
LM310K 1.25	LM2917N 2.95
LM311D/CN .99	CA3031T 2.19
LM312H 1.75	CA3031T 1.98
LM317 1.70	CA3031T 3.49
LM318CN 1.49	CA3032T 2.95
LM319H/H 1.25	CA3035T 2.75
LM320C-XX* 1.35	CA3039T 1.29
LM320T-XX* 1.39	CA3046N 1.29
LM322C-XX* 1.25	LM3052N 1.49
LM323K 4.95	CA3059N 3.19
LM324N .95	CA3060N 3.19
LM327K 6.95	CA3062N 4.95
LM333K 5.95	LM3065N 1.49
LM339N .95	CA3080T 1.69
LM340-XX* 1.75	LM3081N 1.29
LM340T-XX* 1.25	CA3082N 1.89
LM340H-XX* 1.25	CA3083N 1.55
LM344H 1.95	CA3086N .80
LM348N 1.20	CA3098N 2.99
LM350K 5.60	CA3099N 3.49
LM350CN 1.99	CA3099N 3.49
LM358N 1.49	CA3130T 1.30
LM372N 1.95	CA3140T 1.19
LM378N 2.75	CA3146N 2.49
LM377N 3.75	CA3160T 1.19
LM380CN 1.95	CA3190N 1.95
LM381N 1.79	CA3190N 1.95
LM382T 1.25	MC3423N 1.49
LM386N 1.25	MC3460N 3.95
LM387N 1.40	SG3524N 3.95
LM390N 3.29	CA3800N 3.29
LM392N 3.75	LM3900N 1.95
NE555N .99	NE555N 1.19
NE556N .98	LM3909N .98
NE561T 19.95	LM3914N 3.75
NE656H/H 1.25	LM3915N 3.95
NE656N 1.75	LM3916N 3.75
NE659N 1.50	RC415N 2.95
LM702H 1.99	RC4151N 3.10
LM709N/H .79	RC4194TK 4.95
LM710N/H .26	RC4195TK 5.40
LM711N/H .39	ULN2001 1.25
LM715N .98	ULN2003 1.59
LM723H/H 1.50	SN75450N .59
LM738N .95	SN75451N .35
LM739N 1.15	SN75452N .49
LM741 CN/H .33	SN75453N .49
LM741CN-14 .19	SN75454N .49
LM747N 1.95	SN75455N .35
LM748N/H .39	SN75492N .89
LM760CN 2.95	SN75493N .89
LM1310N 1.90	SN75494N .89
MC1300 1.95	TL494CN 4.20
MC1350 1.75	TL496CP 1.65
MC1358 1.75	

## 7400

7400 S .19	7475 S .39	74161 S .88
7401 22	7476 34	74162 89
7402 22	7479 4.60	74163 87
7403 22	7480 .34	74164 87
7404 22	7482 .95	74165 87
7405 23	7483 .55	74166 1.20
7406 35	7485 .65	74167 1.95
7407 35	7486 .35	74170 1.69
7408 26	7488 1.75	74171 4.79
7409 39	7490 .39	74172 .70
7410 22	7491 .57	74174 .89
7411 29	7492 .45	74175 .85
7412 29	7493 .45	74176 .75
7413 39	7494 .69	74177 1.75
7414 53	7495 .69	74179 3.49
7415 29	7496 .69	74180 7.75
7417 29	7497 .90	74181 1.75
7418 22	74100 2.90	74182 1.75
7421 35	74107 .32	74184 2.25
7422 29	74109 .37	74185 2.25
7423 29	74116 1.95	74186 9.95
7425 29	74121 .29	74189 3.90
7426 29	74122 .39	74190 1.15
7427 25	74123 .59	74191 1.15
7429 45	74125 .39	74192 .85
7430 23	74126 .44	74193 .85
7432 29	74132 .69	74194 3.04
7437 25	74132 .69	74195 .89
7438 29	74136 .75	74196 .85
7439 29	74139 .95	74197 .85
7440 19	74141 .79	74198 1.39
7441 79	74142 2.95	74199 3.39
7442 57	74143 1.95	74200 3.90
7443 95	74144 2.95	74251 .95
7444 95	74145 .62	74273 1.09
7445 76	74147 1.95	74276 1.89
7446 79	74148 1.20	74279 1.75
7447 65	74150 1.08	74283 1.40
7448 79	74151 .87	



# IBM and APPLE COMPATIBLE BOARDS!

## STB-80™ APPLE VIDEO BOARD

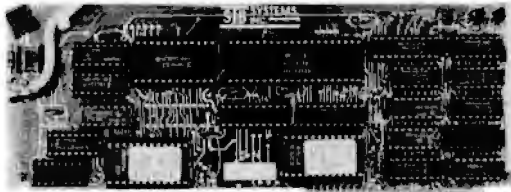

**\$259**  
ASSEMBLED  
& TESTED

### FEATURES:

- ★ 24 x 80 Display
- ★ Direct Keyboard Entry for Lower Case and Special Characters
- ★ Line Graphics
- ★ Software Screen Switch to Standard Apple
- ★ Emulates all Basic Screen Formatting Commands
- ★ Compatible with PASCAL & CP/M
- ★ Software Controllable Inverse Video by Character & Screen

### SOFTWARE

#### #1 DOS TOOL KIT PATCH DISKETTE

This patches the APPLE EDITOR & ASSEMBLER for use with the STB-80.  
**\$24.95**

#### #2 APPLE WRITER PATCH DISKETTE

This patches the APPLE WRITER WORD PROCESSOR package for use with the STB-80.  
**\$24.95**

*New*

## APPLE MEMORY EXPANSION BOARDS

### STB-16™ 16K BOARD

- ★ Assembled & Tested
- ★ Increases 48K to 64K
- ★ Compatible with PASCAL, CP/M DOS 3.3, PILOT, COBOL, FORTRAN, VISICALC, INT. BASIC, APPLE SOFT BASIC, etc.
- ★ Easy to Install. Plug in and Go. No Cables. No chips to Remove.
- ★ Expandable to 64K

**\$139**

16K A & T  
(64K UPGRADE FOR STB-16 IS \$189)

### STB-64™ 64K BOARD

**\$299**  
64K A & T

*New*

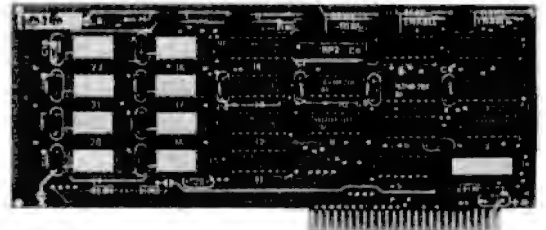

- ★ Assembled and Tested
- ★ Uses 64K RAMS
- ★ Four STB-16's on one Card
- ★ Software Bank Selectable
- ★ Compatible with 16K RAM Card Software
- ★ DOS 3.3 Support Disk FREE with Purchase

### STB-128™ 128K APPLE BOARD

#### MULTI-PURPOSE MEMORY BOARD & DISK EMULATOR

- ★ 128K of Expansion Memory
- ★ Includes DOS 3.3 Support Disk
- ★ Eight STB-16's on one Card
- ★ Processor Port for Direct Access Control
- ★ Uses 64K RAMS

**\$549**

128K A & T

COMING SOON: VISICALC EXPANSION SOFTWARE

### STB DOS 3.3 SUPPORT PROGRAM DISK

- ★ Disk Emulator (1 STB-128 or STB-64 Req)
- ★ Disk "Cache" (1 STB-128 or STB-64 Req)
- ★ Fast Basic Loader
- ★ Memory Tester
- ★ DOS Relocater (Free 8K for Basic)
- ★ Picture Flipper/Saver

**\$29.95**

(FREE with STB-64 or STB-128)

*New*

## IBM PC MEMORY EXPANSION BOARDS

*New*

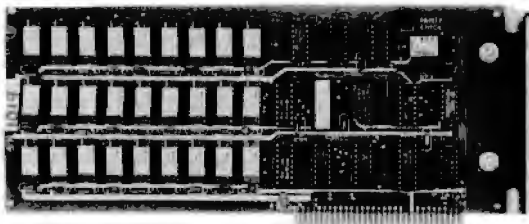

PUT UP TO 256K ON LINE  
IN YOUR IBM P.C.!

64K — \$399 (STB-I64)

128K — \$649 (STB-I128)

192K — \$799 (STB-I192)

ALL ASSEMBLED & TESTED

EXPANSION KIT TO GO FROM 64K  
TO 192K IS \$450

- ★ Expand Your IBM to 256K Using Only one Slot.
- ★ Available in 64, 128, or 192K Sizes
- ★ Easy to Install. Use in Any of the 5 Expansion Slots
- ★ Mounting Bracket. Included for Secure, Reliable Operation
- ★ Parity — All Three Models Support Parity Error Testing
- ★ One Year Limited Warranty on all Boards

IBM PC TM OF IBM CORP. APPLE AND APPLEWRITER TM OF APPLE COMPUTERS. CP/M TM OF DIGITAL RESEARCH. VISICALC TM OF VISICORP.

DIGITAL RESEARCH COMPUTERS IS PROUD TO BE ANNOUNCED AS THE NATIONAL MAIL ORDER OUTLET FOR THE FINE LINE OF S.T.B. "SIMPLY THE BEST" BOARDS.

**Digital Research Computers**  
(OF TEXAS)

P.O. BOX 401565 • GARLAND, TEXAS 75040 • (214) 271-3538

TERMS: Add \$2.00 postage. We pay balance. Orders under \$15 add 75¢ handling. No C.O.D. We accept Visa and MasterCard. Tex. Res. add 5% Tax. Foreign orders (except Canada) add 20% P & H. Orders over \$50, add 85¢ for insurance.

**NEW LOWER PRICES**

**"THE BIG BOARD"**  
 OEM - INDUSTRIAL - BUSINESS - SCIENTIFIC  
**SINGLE BOARD COMPUTER KIT!**  
**Z-80 CPU! 64K RAM!**

**NEW!**

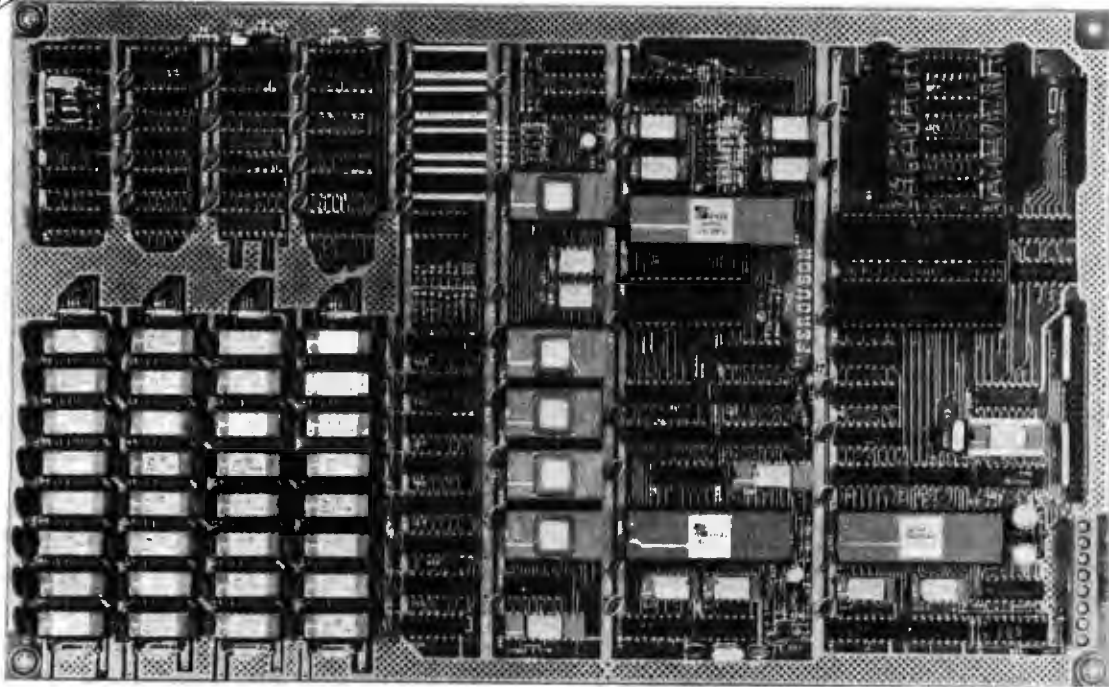

**PARTIALLY ASSEMBLED KITS**  
 For All Sockets Installed  
 And Soldered Add \$50.

**WANT MORE INFO?**  
 Full Documentation and  
 Schematics — \$5.

**THE BIG BOARD PROJECT:** Three years in the works, and maybe too good to be true. A tribute to hard headed, no compromise, high performance, American engineering! The Big Board gives you all the most needed computing features on one board at a very reasonable cost. The Big Board was designed from scratch to run the latest version of CP/M\*. Just imagine all the off-the-shelf software that can be run on the Big Board without any modifications needed! Take a Big Board, add a couple of 8 inch disc drives, power supply, an enclosure, C.R.T., and you have a total Business System for about 1/3 the cost you might expect to pay.

**\$399<sup>00</sup>\*\*** (64K KIT BASIC I/O)

SIZE: 8 1/2 x 13 1/4 IN.  
 SAME AS AN 8 IN. DRIVE.  
 REQUIRES: -5V @ 3 AMPS  
 - - 12V @ .5 AMPS.

**FULLY SOCKETED!**

**FEATURES: (Remember, all this on one board!)**

**64K RAM**

Uses industry standard 4116 RAM'S. All 64K is available to the user, our VIDEO and EPROM sections do not make holes in system RAM. Also, very special care was taken in the RAM array PC layout to eliminate potential noise and glitches.

**Z-80 CPU**

Running at 2.5 MHZ. Handles all 4116 RAM refresh and supports Mode 2 INTERRUPTS. Fully buffered and runs 8080 software.

**SERIAL I/O (OPTIONAL)**

Full 2 channels using the Z80 SIO and the SMC 8116 Baud Rate Generator. FULL RS232! For synchronous or asynchronous communication. In synchronous mode, the clocks can be transmitted or received by a modem. Both channels can be set up for either data-communication or data-terminals. Supports mode 2 Int. Price for all parts and connectors: \$49

**BASIC I/O**

Consists of a separate parallel port (Z80 PIO) for use with an ASCII encoded keyboard for input. Output would be on the 80 x 24 Video Display.

**BLANK PC BOARD — \$149**

The blank Big Board PC Board comes complete with full documentation (including schematics), the character ROM, the PFM 3.3 MONITOR ROM, and a diskette with the source of our BIOS, BOOT, and PFM 3.3 MONITOR.

**24 x 80 CHARACTER VIDEO**

With a crisp, flicker-free display that looks extremely sharp even on small monitors. Hardware scroll and full cursor control. Composite video or split video and sync. Character set is supplied on a 2716 style ROM, making customized fonts easy. Sync pulses can be any desired length or polarity. Video may be inverted or true. 5 x 7 Matrix - Upper & Lower Case

**FLOPPY DISC CONTROLLER**

Uses WD1771 controller chip with a TTL Data Separator for enhanced reliability. IBM 3740 compatible. Supports up to four 8 inch disc drives. Directly compatible with standard Shugart drives such as the SA800 or SA801. Drives can be configured for remote AC off-on. Runs CP/M\* 2.2.

**TWO PORT PARALLEL I/O (OPTIONAL)**

Uses Z-80 PIO. Full 16 bits, fully buffered, bi-directional. User selectable hand shake polarity. Set of all parts and connectors for parallel I/O: \$19.95

**REAL TIME CLOCK (OPTIONAL)**

Uses Z-80 CTC. Can be configured as a Counter on Real Time Clock. Set of all parts: \$9.95

**CP/M\* 2.2 FOR BIG BOARD**

The popular CP/M\* D.O.S. to run on Big Board is available for \$159.00.

**PRICE CUT!**

**PFM 3.3 2K SYSTEM MONITOR**

The real power of the Big Board lies in its PFM 3.3 on board monitor. PFM commands include: Dump Memory, Boot CP/M\*, Copy, Examine, Fill Memory, Test Memory, Go To, Read and Write I/O Ports, Disc Read (Drive, Track, Sector), and Search. PFM occupies one of the four 2716 EPROM locations provided. Z-80 is a Trademark of Zilog.

**Digital Research Computers**  
 (OF TEXAS)  
 P.O. BOX 401565 • GARLAND, TEXAS 75040 • (214) 271-3538

**TERMS:** Shipments will be made approximately 3 to 6 weeks after we receive your order, VISA, MC, cash accepted. We will accept COD's (for the Big Board only) with a \$75 deposit. Balance UPS COD. Add \$4.00 shipping.  
 USA AND CANADA ONLY

### UTIC MINI STEREO AM/FM RECEIVER WITH HEADPHONES

For Joggers, Cyclists, Skaters & Sports Events!

**FEATURES:** Lightweight headphones. Left/right balance control. Full fidelity stereo sound. Additional black soft carrying case & shoulder strap. Belt clip (hands free). Operates on 3 AA cell batteries (not incl.). Compact size: 3 1/2" x 4 1/2" x 1". Wt. 6 oz.

**Model 2830** List Price \$89.95 ..... **\$34.95**

### SPEAKERS



**Parts A0201** 1 2.8  
2 1/4" Round - 8 Ohm  
25 Watt (4 Leads)  
Size: 2 1/4" x 3/4"

**Parts SF-25016** 1 3.2  
2 1/2" Square - 16 Ohm  
25 Watt (4 mount. holes)  
Large Ceramic Magnet  
Size: 2 1/2" x 2 1/4" x 3/4"

### National Semiconductor RAM SALE

**STATIC RAMS**

MM2114N-24K (200NS) ..... \$2.49 each  
(8 EACH \$19.95) (100 EACH \$195.95)

MM2114N-2L 4K (200NS) Low Power ..... \$2.95 each  
(8 EACH \$19.95) (100 EACH \$223.00)

MM2147N 4K (70NS) ..... \$4.95 each  
(8 EACH \$34.95) (100 EACH \$419.95)

MM6116P-4 16K (200NS) ..... \$14.95 each  
(8 EACH \$99.95) (100 EACH \$1050.00)

**DYNAMIC RAMS**

MM4164N-20 64K (200NS) ..... \$14.95 each  
(8 EACH \$99.95) (100 EACH \$1195.00)

MM5200N-2 16K (150NS) 4116 ..... \$2.95 each  
(8 EACH \$19.95) (100 EACH \$223.00)

MM6200N-4 16K (250NS) 4116 ..... \$1.95 each  
(8 EACH \$14.95) (100 EACH \$173.00)

### EPROM Erasing Lamp



• Erases 2708, 2716, 7020A, 8203U, 8204Q, etc.

• Erases up to 4 chips within 20 minutes.

• Maintains constant exposure distance of one inch.

• Special conductive foam liner eliminates static build-up.

• Built-in safety lock to prevent UV exposure.

• Compact - only 7-5/8" x 2-7/8" x 2"

• Complete with holding tray for 4 chips.

UVS-11E1 Replacement Bulb ..... \$16.95

**UVS-11E ..... \$79.95**

### JOYSTICKS



JS-5K 5K Linear Taper Pots ..... \$5.25

JS-100K 100K Linear Taper Pots ..... \$4.95

JVC-40 40K (2) Video Controller in case ..... \$4.95

### MUFFIN® FAN

7 1/2" dependent, low cost, largest selling fan for commercial cooling applications.

• 100% fresh air delivery.

• 4.6B" sq. x 1.50" depth. Weight: 1.07z.

• acoustical rating as low as NC-3B

• more than 10 yrs. cont. duty at 10°C

• Impedance protected

• for ambient to 70°C

• UL low watt recognized & CSA approved

115V, 50/60Hz, 14 Watts, 105cfm

Ultronically cleaned & tested.

**MU2A1 ..... \$9.95 ea.**

### JE215 Adjustable Dual Power Supply

**General Description:** The JE215 is a Dual Power Supply with independent adjustable positive and negative output voltages. A separate adjustment for each of the supplies provides the user unlimited applications for IC current voltage requirements. The supply can also be used as a general all-purpose variable power supply.

**FEATURES:**

- Adjustable regulated power supplies, pos. and neg. 1.2VDC to 150VDC.
- Power Output (each supply): 5VDC @ 500mA, 10VDC @ 750mA, 12VDC @ 500mA, and 15VDC @ 175mA.
- Two, 3-terminal adj. IC regulators with thermal overload protection.
- Heat sink regulator cooling.
- LED "on" Indicator
- Printed Board Construction
- 120VAC Input
- Size: 3-1/2" w x 5-1/16" L x 2 1/4" H

**JE215 Adj. Dual Power Supply Kit (as shown) ..... \$24.95**  
(Picture not shown but similar in construction to above)

JE200 Reg. Power Supply Kit (5VDC, 1 amp) ..... \$14.95

JE205 Adapter Bld. (to JE200) ±5, ±9 & ±12V. \$12.95

JE210 Var. Pwr. Sply. Kit, ±5VDC, to 1.5amp. \$19.95

### MICROPROCESSOR COMPONENTS

8080A/8080A SUPPORT DEVICES

INS600A	CPU	4.95
OPR212	8-Bit Input/Output	3.25
OPR213	8-Bit Interrupt Control	3.25
OPR216	Bi-Directional Bus Driver	3.49
OPR220	Clock Generator/Driver	3.88
OPR226	Bus Driver	4.45
OPR228	System Controller/Bus Driver	4.95
OPR232	System Controller	5.95
INS2424	I/O Expander for All Series	9.95
INS2526	Arithmetic Core Element	16.75
OPR251	Prog. Interval I/O (USART)	6.95
OPR252	Prog. Interval I/O	4.95
OPR255	Prog. Interval I/O (PPI)	5.95
OPR257	Prog. DMA Control	5.95
OPR259	Prog. Interval Control	5.95
OPR273	Prog. CRT Controller	25.95
OPR279	Prog. Keyboard/Display Interface	9.95
OPR303	System Timing Element	6.95
OPR324	8-Bit Bi-Directional Receiver	3.25
OPR325	8-Bit Bi-Directional Receiver	3.25
OPR308	8-Bit Bi-Directional Receiver	3.95
OPR310	Octal Latched Peripheral Driver	5.25
OPR311	Octal Latched Peripheral Driver	5.25

8080/8080 SUPPORT DEVICES

MC8000	MPU with Clock and RAM	14.95
MC8002C	128x8 Static RAM	4.95
MC8003	Peripheral Inter. Adapt. (MC8001)	7.49
MC8008	Priority Interrupt Controller	17.25
MC8009	1024x8 PROM (MC8009A)	14.95
MC8009L	Asynch. Serial Comm. Adapter	11.95
MC8009S	Synchronous Serial Data Adapter	6.95
MC8009T	6400x8 DRAM (128x8)	19.95
MC8009U	256x8x8 Nonvolatile	11.95
MC8009V	Quad 3-State Bus Trans. (MC873)	2.25

MICROPROCESSOR CHIPS

280 (780C)	CPU (MK8000) (2MHz)	11.95
280A (780C1)	CPU (MK8000-1) (4MHz)	11.95
CDP1802	CPU	15.95
2850	CPU	15.95
ICM2016ADC	CPU-4-Bit Slice (Com. Temp. Grade)	11.95
MC8502	MPU w/Clock (16K Static Memory)	11.95
INS5031N-4	MPU-8-Bit (6MHz)	1.95
INS5031N-6	MPU-8-Bit (12MHz)	1.95
INS5031N-8	MPU-8-Bit (18MHz)	1.95
INS5031N-10	MPU-8-Bit (24MHz)	1.95
INS5031N-12	MPU-8-Bit (30MHz)	1.95
INS5031N-15	MPU-8-Bit (37.5MHz)	1.95
INS5031N-20	MPU-8-Bit (48MHz)	1.95
INS5031N-25	MPU-8-Bit (60MHz)	1.95
INS5031N-30	MPU-8-Bit (75MHz)	1.95
INS5031N-35	MPU-8-Bit (90MHz)	1.95
INS5031N-40	MPU-8-Bit (108MHz)	1.95
INS5031N-45	MPU-8-Bit (135MHz)	1.95
INS5031N-50	MPU-8-Bit (157.5MHz)	1.95
INS5031N-55	MPU-8-Bit (180MHz)	1.95
INS5031N-60	MPU-8-Bit (202.5MHz)	1.95
INS5031N-65	MPU-8-Bit (225MHz)	1.95
INS5031N-70	MPU-8-Bit (247.5MHz)	1.95
INS5031N-75	MPU-8-Bit (270MHz)	1.95
INS5031N-80	MPU-8-Bit (292.5MHz)	1.95
INS5031N-85	MPU-8-Bit (315MHz)	1.95
INS5031N-90	MPU-8-Bit (337.5MHz)	1.95
INS5031N-95	MPU-8-Bit (360MHz)	1.95
INS5031N-100	MPU-8-Bit (382.5MHz)	1.95
INS5031N-105	MPU-8-Bit (405MHz)	1.95
INS5031N-110	MPU-8-Bit (427.5MHz)	1.95
INS5031N-115	MPU-8-Bit (450MHz)	1.95
INS5031N-120	MPU-8-Bit (472.5MHz)	1.95
INS5031N-125	MPU-8-Bit (495MHz)	1.95
INS5031N-130	MPU-8-Bit (517.5MHz)	1.95
INS5031N-135	MPU-8-Bit (540MHz)	1.95
INS5031N-140	MPU-8-Bit (562.5MHz)	1.95
INS5031N-145	MPU-8-Bit (585MHz)	1.95
INS5031N-150	MPU-8-Bit (607.5MHz)	1.95
INS5031N-155	MPU-8-Bit (630MHz)	1.95
INS5031N-160	MPU-8-Bit (652.5MHz)	1.95
INS5031N-165	MPU-8-Bit (675MHz)	1.95
INS5031N-170	MPU-8-Bit (697.5MHz)	1.95
INS5031N-175	MPU-8-Bit (720MHz)	1.95
INS5031N-180	MPU-8-Bit (742.5MHz)	1.95
INS5031N-185	MPU-8-Bit (765MHz)	1.95
INS5031N-190	MPU-8-Bit (787.5MHz)	1.95
INS5031N-195	MPU-8-Bit (810MHz)	1.95
INS5031N-200	MPU-8-Bit (832.5MHz)	1.95
INS5031N-205	MPU-8-Bit (855MHz)	1.95
INS5031N-210	MPU-8-Bit (877.5MHz)	1.95
INS5031N-215	MPU-8-Bit (900MHz)	1.95
INS5031N-220	MPU-8-Bit (922.5MHz)	1.95
INS5031N-225	MPU-8-Bit (945MHz)	1.95
INS5031N-230	MPU-8-Bit (967.5MHz)	1.95
INS5031N-235	MPU-8-Bit (990MHz)	1.95
INS5031N-240	MPU-8-Bit (1012.5MHz)	1.95
INS5031N-245	MPU-8-Bit (1035MHz)	1.95
INS5031N-250	MPU-8-Bit (1057.5MHz)	1.95
INS5031N-255	MPU-8-Bit (1080MHz)	1.95
INS5031N-260	MPU-8-Bit (1102.5MHz)	1.95
INS5031N-265	MPU-8-Bit (1125MHz)	1.95
INS5031N-270	MPU-8-Bit (1147.5MHz)	1.95
INS5031N-275	MPU-8-Bit (1170MHz)	1.95
INS5031N-280	MPU-8-Bit (1192.5MHz)	1.95
INS5031N-285	MPU-8-Bit (1215MHz)	1.95
INS5031N-290	MPU-8-Bit (1237.5MHz)	1.95
INS5031N-295	MPU-8-Bit (1260MHz)	1.95
INS5031N-300	MPU-8-Bit (1282.5MHz)	1.95
INS5031N-305	MPU-8-Bit (1305MHz)	1.95
INS5031N-310	MPU-8-Bit (1327.5MHz)	1.95
INS5031N-315	MPU-8-Bit (1350MHz)	1.95
INS5031N-320	MPU-8-Bit (1372.5MHz)	1.95
INS5031N-325	MPU-8-Bit (1395MHz)	1.95
INS5031N-330	MPU-8-Bit (1417.5MHz)	1.95
INS5031N-335	MPU-8-Bit (1440MHz)	1.95
INS5031N-340	MPU-8-Bit (1462.5MHz)	1.95
INS5031N-345	MPU-8-Bit (1485MHz)	1.95
INS5031N-350	MPU-8-Bit (1507.5MHz)	1.95
INS5031N-355	MPU-8-Bit (1530MHz)	1.95
INS5031N-360	MPU-8-Bit (1552.5MHz)	1.95
INS5031N-365	MPU-8-Bit (1575MHz)	1.95
INS5031N-370	MPU-8-Bit (1597.5MHz)	1.95
INS5031N-375	MPU-8-Bit (1620MHz)	1.95
INS5031N-380	MPU-8-Bit (1642.5MHz)	1.95
INS5031N-385	MPU-8-Bit (1665MHz)	1.95
INS5031N-390	MPU-8-Bit (1687.5MHz)	1.95
INS5031N-395	MPU-8-Bit (1710MHz)	1.95
INS5031N-400	MPU-8-Bit (1732.5MHz)	1.95
INS5031N-405	MPU-8-Bit (1755MHz)	1.95
INS5031N-410	MPU-8-Bit (1777.5MHz)	1.95
INS5031N-415	MPU-8-Bit (1800MHz)	1.95
INS5031N-420	MPU-8-Bit (1822.5MHz)	1.95
INS5031N-425	MPU-8-Bit (1845MHz)	1.95
INS5031N-430	MPU-8-Bit (1867.5MHz)	1.95
INS5031N-435	MPU-8-Bit (1890MHz)	1.95
INS5031N-440	MPU-8-Bit (1912.5MHz)	1.95
INS5031N-445	MPU-8-Bit (1935MHz)	1.95
INS5031N-450	MPU-8-Bit (1957.5MHz)	1.95
INS5031N-455	MPU-8-Bit (1980MHz)	1.95
INS5031N-460	MPU-8-Bit (2002.5MHz)	1.95
INS5031N-465	MPU-8-Bit (2025MHz)	1.95
INS5031N-470	MPU-8-Bit (2047.5MHz)	1.95
INS5031N-475	MPU-8-Bit (2070MHz)	1.95
INS5031N-480	MPU-8-Bit (2092.5MHz)	1.95
INS5031N-485	MPU-8-Bit (2115MHz)	1.95
INS5031N-490	MPU-8-Bit (2137.5MHz)	1.95
INS5031N-495	MPU-8-Bit (2160MHz)	1.95
INS5031N-500	MPU-8-Bit (2182.5MHz)	1.95
INS5031N-505	MPU-8-Bit (2205MHz)	1.95
INS5031N-510	MPU-8-Bit (2227.5MHz)	1.95
INS5031N-515	MPU-8-Bit (2250MHz)	1.95
INS5031N-520	MPU-8-Bit (2272.5MHz)	1.95
INS5031N-525	MPU-8-Bit (2295MHz)	1.95
INS5031N-530	MPU-8-Bit (2317.5MHz)	1.95
INS5031N-535	MPU-8-Bit (2340MHz)	1.95
INS5031N-540	MPU-8-Bit (2362.5MHz)	1.95
INS5031N-545	MPU-8-Bit (2385MHz)	1.95
INS5031N-550	MPU-8-Bit (2407.5MHz)	1.95
INS5031N-555	MPU-8-Bit (2430MHz)	1.95
INS5031N-560	MPU-8-Bit (2452.5MHz)	1.95
INS5031N-565	MPU-8-Bit (2475MHz)	1.95
INS5031N-570	MPU-8-Bit (2497.5MHz)	1.95
INS5031N-575	MPU-8-Bit (2520MHz)	1.95
INS5031N-580	MPU-8-Bit (2542.5MHz)	1.95
INS5031N-585	MPU-8-Bit (2565MHz)	1.95
INS5031N-590	MPU-8-Bit (2587.5MHz)	1.95
INS5031N-595	MPU-8-Bit (2610MHz)	1.95
INS5031N-600	MPU-8-Bit (2632.5MHz)	1.95
INS5031N-605	MPU-8-Bit (2655MHz)	1.95
INS5031N-610	MPU-8-Bit (2677.5MHz)	1.95
INS5031N-615	MPU-8-Bit (2700MHz)	1.95
INS5031N-620	MPU-8-Bit (2722.5MHz)	1.95
INS5031N-625	MPU-8-Bit (2745MHz)	1.95
INS5031N-630	MPU-8-Bit (2767.5MHz)	1.95
INS5031N-635	MPU-8-Bit (2790MHz)	1.95
INS5031N-640	MPU-8-Bit (2812.5MHz)	1.95
INS5031N-645	MPU-8-Bit (2835MHz)	1.95
INS5031N-650	MPU-8-Bit (2857.5MHz)	1.95
INS5031N-655	MPU-8-Bit (2880MHz)	1.95
INS5031N-660	MPU-8-Bit (2902.5MHz)	1.95
INS5031N-665	MPU-8-Bit (2925MHz)	1.95
INS5031N-670	MPU-8-Bit (2947.5MHz)	1.95
INS5031N-675	MPU-8-Bit (2970MHz)	1.95
INS5031N-680	MPU-8-Bit (2992.5MHz)	1.95
INS5031N-685	MPU-8-Bit (3015MHz)	1.95
INS5031N-690	MPU-8-Bit (3037.5MHz)	1.95
INS5031N-695	MPU-8-Bit (3060MHz)	1.95
INS5031N-700	MPU-8-Bit (3082.5MHz)	1.95
INS5031N-705	MPU-8-Bit (3105MHz)	1.95
INS5031N-710	MPU-8-Bit (3127.5MHz)	1.95
INS5031N-715	MPU-8-Bit (3150MHz)	1.95
INS5031N-720	MPU-8-Bit (3172.5MHz)	1.95
INS5031N-725	MPU-8-Bit (3195MHz)	1.95
INS5031N-730	MPU-8-Bit (3217.5MHz)	1.95
INS5031N-735	MPU-8-Bit (3240MHz)	1.95
INS5031N-740	MPU-8-Bit (3262.5MHz)	1.95
INS5031N-745	MPU-8-Bit (3285MHz)	1.95
INS5031N-750	MPU-8-Bit (3307.5MHz)	1.95
INS5031N-755	MPU-8-Bit (3330MHz)	1.95
INS5031N-760	MPU-8-Bit (3352.5MHz)	1.95
INS5031N-765	MPU-8-Bit (3375MHz)	1.95
INS5031N-770	MPU-8-Bit (3397.5MHz)	1.95
INS5031N-775	MPU-8-Bit (3420MHz)	1.95
INS5031N-780	MPU-8-Bit (3442.5MHz)	1.95
INS5031N-785	MPU-8-Bit (3465MHz)	1.95
INS5031N-790	MPU-8-Bit (3487.5MHz)	1.95
INS5031N-795	MPU-8-Bit (3510MHz)	1.95
INS5031N-800	MPU-8-Bit (3532.5MHz)	1.95
INS5031N-805	MPU-8-Bit (3555MHz)	1.95
INS5031N-810	MPU-8-Bit (3577.5MHz)	1.95
INS5031N-815	MPU-8-Bit (3600MHz)	1.95
INS5031N-820	MPU-8-Bit (3622.5MHz)	1.95
INS5031N-825	MPU-8-Bit (3645MHz)	1.95
INS5031N-830	MPU-8-Bit (3667.5MHz)	1.95
INS5031N-835	MPU-8-Bit (3690MHz)	1.95
INS5031N-840	MPU-8-Bit (3712.5MHz)	1.95
INS5031N-845	MPU-8-Bit (3735MHz)	1.95
INS5031N-850	MPU-8-Bit (3757.5MHz)	1.95
INS5031N-855	MPU-8-Bit (3780MHz)	1.95
INS5031N-860	MPU-8-Bit (3802.5MHz)	1.95
INS5031N-865	MPU-8-Bit (3825MHz)	1.95
INS5031N-870	MPU-8-Bit (3847.5MHz)	1.95
INS5031N-875	MPU-8-Bit (3870MHz)	1.95
INS5031N-880	MPU-8-Bit (3892.5MHz)	1.95
INS5031N-885	MPU-8-Bit (3915MHz)	1.95
INS5031N-890	MPU-8-Bit (3937.5MHz)	1.95
INS5031N-895	MPU-8-Bit (3960MHz)	1.95
INS5031N-900	MPU-8-Bit (3982.5MHz)	1.95
INS5031N-905	MPU-8-Bit (4005MHz)	1.95
INS5031N-910	MPU-8-Bit (4027.5MHz)	1.95
INS5031N-915	MPU-8-Bit (4050MHz)	1.95
INS5031N-920	MPU-8-Bit (4072.5MHz)	1.95
INS5031N-925	MPU-8-Bit (4095MHz)	1.95
INS5031N-930	MPU-8-Bit (4117.5MHz)	1.95
INS5031N-935	MPU-8-Bit (4140MHz)	





1  
ONE

**CompuPro**



**NEW! CPU BOARDS**  
**CO-PROCESSOR 8086/8087 (816)**  
16 bit 8 or 10 MHz 8086 CPU with sockets for 8087 and 80130

Part No.	Description	List Price	Our Price
BFGBT168A	A&T 8MHz 8086 only	\$695.00	\$ 825.00
BFGBT188C	CSC 10MHz 8086 only	\$850.00	\$765.00
BFGBT188A87	A&T with 8087 option	\$1295.00	\$1225.00
BFGBT188C87	CSC with 8087 option*	\$1550.00	\$1458.00

\*8087 requires slower clock speeds

**DUAL PROCESSOR 8085-8088**

6 or 8 MHz Provides true 16 Bit Power with a standard 8 bit S-100 bus

BFGBT1612A	A&T 6MHz	\$425.00	\$399.00
BFGBT1612C	CSC 6/8 MHz	\$525.00	\$498.00

**CPU-Z Z80 CPU**

2/4 MHz Z80 CPU 24 Bit Addressing

BFGBT160A	A&T	\$295.00	\$269.00
BFGBT160C	CSC 3-8 MHz	\$395.00	\$375.00

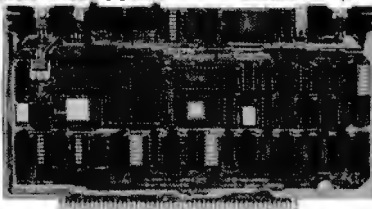

**I/O BOARDS**

**SYSTEM SUPPORT 1 MULTIFUNCTION BOARD**  
Serial port (software prog. baud), 4K EPROM or RAM provision, 15 levels of interrupt, real time clock, optional math processor

Part No.	Description	List Price	Our Price
BFGBT182A	Assembled & Tested	\$399.00	\$360.00
BFGBT182C	CSC	\$495.00	\$480.00
BFGBT8231	Math Chip		\$195.00
BFGBT8232	Math Chip		\$195.00
BFGBT182AM1	A&T with B231 Math Chip	\$855.00	\$855.00
BFGBT182CM1	CSC w/B231 Math Chip	\$855.00	\$855.00
BFGBT182AM2	A&T w/B232 Math Chip	\$855.00	\$855.00
BFGBT182CM2	CSC w/B232 Math Chip	\$855.00	\$855.00

**MPX CHANNEL BOARD**

I/O Multiplexer, using 8085A-2 CPU on board with 4K RAM

BFGBT188A4	Assembled & Tested	\$495.00	\$445.00
BFGBT188C4	CSC	\$595.00	\$535.00

With 16K RAM

BFGBT188A18	Assembled & Tested	\$649.00	\$595.00
BFGBT188C18	CSC	\$749.00	\$675.00

**INTERFACER 1**

Two Serial I/O

BFGBT133A	Assembled & Tested	\$249.00	\$219.00
BFGBT133C	CSC	\$324.00	\$298.00

**INTERFACER 2**

Three parallel, one serial I/O board

BFGBT150A	Assembled & Tested	\$249.00	\$219.00
BFGBT150C	CSC	\$324.00	\$298.00

**INTERFACER 3**

Eight channel multi-use serial I/O board

BFGBT1748A	Assembled & Tested	\$699.00	\$629.00
BFGBT1748C	CSC 200 hr. 8 Port	\$849.00	\$750.00
BFGBT1745A	Assembled & Tested	\$599.00	\$559.00
BFGBT1745C	CSC 200hr. 5 port	\$699.00	\$629.00

**NEW!**

**INTERFACER 4**

Three Serial, 1 Parallel, 1 Centronics Parallel

BFGBT187A	Assembled & Tested	\$350.00	\$315.00
BFGBT187C	CSC	\$450.00	\$415.00

**SPECTRUM COLOR GRAPHICS**

Color Graphics board with Parallel I/O

BFGBT144A	Assembled & Tested	\$399.00	\$348.00
BFGBT144C	CSC	\$449.00	\$398.00
BFGBT20	Sublogic Universal Graphics Interpreter Software		\$35.00

**S-100 MOTHERBOARDS**

Active termination, 6-12-20 Slot

BFGBT153A	A&T 6 slot, 2 lbs.	\$140.00	\$128.00
BFGBT153C	CSC 6 slot, 2 lbs.	\$190.00	\$175.00
BFGBT154A	A&T 12 slot, 3 lbs.	\$175.00	\$155.00
BFGBT154C	CSC 12 slot, 3 lbs.	\$240.00	\$220.00
BFGBT155A	A&T 20 slot, 4 lbs.	\$265.00	\$235.00
BFGBT155C	CSC 20 slot, 4 lbs.	\$340.00	\$310.00

**ACTIVE TERMINATOR**

Allows older S-100 motherboards to run faster and quieter

BFGBT108A	Assembled & Tested		\$59.50
-----------	--------------------	--	---------

**CompuPro**

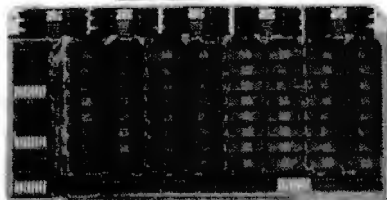

**STATIC MEMORY BOARDS**

**RAM 20 - 32K STATIC RAM**

RAM 20 10 MHz, 4K byte block disable, bank select or 24 bit addressing available 8, 16, 24 or 32K

Part No.	Description	List Price	Our Price
BFGBT164AA6	8K A&T	\$210.00	\$190.00
BFGBT164AC6	8K CSC	\$280.00	\$260.00
BFGBT164AA16	16K A&T	\$285.00	\$260.00
BFGBT164AC16	16K CSC	\$355.00	\$325.00
BFGBT164AA24	24K A&T	\$355.00	\$325.00
BFGBT164AC24	24K CSC	\$425.00	\$385.00
BFGBT164AA32	32K A&T	\$425.00	\$385.00
BFGBT164AC32	32K CSC	\$495.00	\$450.00

**CMOS STATIC RAM**

For a complete analysis of the advantages of CMOS memory, see the "Product Description" on page 416 of the January issue of BYTE

**RAM 17 - 64K CMOS STATIC RAM**

RAM 17, 10 MHz, 2 Watt, DMA Compatible 24 Bit Addressing

BFGBT175A84	64K A&T	\$599.00	\$550.00
BFGBT175C84	64K CSC	\$750.00	\$699.00

**RAM 16 - 32K x 16 BIT CMOS STATIC RAM**

8 and/or 16 Bit

Ⓜ RAM 16 10 MHz, 32K x 16 or 64K x 8

IEEE/696 16 Bit 2 Watt, 24 Bit Addressing

BFGBT180A	64K A&T	\$650.00	\$599.00
BFGBT180C	64K CSC	\$750.00	\$699.00

**NEW! RAM 21 - 128K STATIC RAM**

Ⓜ RAM 21 12MHz, 128K x 8 or 64K x 16

IEEE/696 B or 16 Bit 1.2 Amps, 24 Bit Addressing

BFGBT190A	128K A&T	\$1695.00	\$1610.00
BFGBT190C	128K CSC	\$1895.00	\$1795.00

**M-DRIVE SOLID STATE DISK DRIVE, 3500% FASTER!**

Not Really, But the Next Best Thing for CompuPro 8085/88 Users. Call for Detail on M-Drive.

M-Drive requires a 6MHz CPU 8085/88 dual processor, Disk 1 DMA disk controller and System Support 1 Multifunction Board

BFGBTMO126K	128K of A&T memory & M-Drive Software	\$1198.00
BFGBTMO126KC	128K of CSC memory & M-Drive Software	\$1308.00
BFGBTMO256KA	256K of A&T memory & M-Drive Software	\$2395.00
BFGBTMO256KC	256K of CSC memory & M-Drive Software	\$2795.00



**DISK CONTROLLERS**

**DISK 1 FLOPPY CONTROLLER**

Fast DMA, Soft Sector, Controls 8" or 5 1/4" Single or Double Density. OUR BEST!

BFGBT171A	A&T	\$495.00	\$450.00
BFGBT171C	CSC	\$595.00	\$555.00
BFGBTCPM00*	CP/M 2.2 for Z80/8085 with manuals & BIOS 8" S/D disk	\$175.00	
BFGBTCPM08	CP/M for 8086 with manuals & BIOS 8" S/D disk	\$300.00	
BFGBTOAS0S	Oasis 8 bit single user 8" S/D disk	\$500.00	
BFGBTOAS0M	Oasis 8 bit multiuser, 8" S/D disk	\$650.00	

**NEW! DISK 2/SELECTOR CHANNEL HARD DISK CONTROLLER**

Fast DMA 2 board set. Controls 4 Shugart 4000 series or Fujitsu 2300 type drives

BFGBT177A	Assembled & Tested	\$795.00	\$760.00
BFGBT177C	CSC	\$895.00	\$860.00



**S-100 MAINFRAME**

110V 60Hz CVT Mainframe uses famous 20 slot COMPUPRO Motherboard. 55 lbs.

BFGBTENC20M	20 Slot Rack Mount	\$895.00	\$825.00
BFGBTENC20K	20 Slot Desk Top	\$825.00	\$780.00

**MORROW DESIGNS**

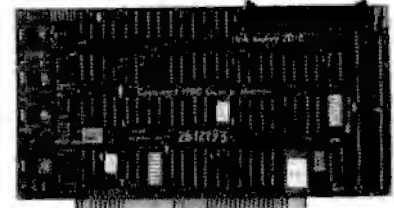

**FLOPPY DISK CONTROLLERS & SUBSYSTEMS**

**DISK JOCKEY 2B FLOPPY CONTROLLER**  
Memory mapped controller handles 4 8" drives, single or double density

Part No.	Description	List Price	Our Price
BFMDSJ2208	A&T w/CP/M™ 2.2	\$399.00	\$375.00

**DISCUS 2D & DISCUS 2+2 SUBSYSTEMS**

Each subsystem includes DJ/2B controller 8" double density drives with cabinet, power supply, CP/M™ 2.2 and Microsoft Basic

<b>SINGLE SIDED - DISCUS 2D</b>			
BFMDSF1218	1 Drive 30 lbs.	\$1095.00	\$ 950.00
BFMDSF1228	2 Drive 48 lbs.	\$1875.00	\$1875.00

<b>DOUBLE SIDED - DISCUS 2+2</b>			
BFMDSF812	1 Drive 30 lbs.	\$1395.00	\$1250.00
BFMDSF822	2 Drive 48 lbs.	\$2495.00	\$2200.00

**DISK JOCKEY/DMA FLOPPY CONTROLLER**

DMA Controller supports 4 soft-sectored 8" drives and 4 10 sector 5 1/4" drives simultaneously. On board Z80A

BFMDSOJ0MA	A&T w/CP/M™ 2.2	\$495.00	\$450.00
------------	-----------------	----------	----------

**DISK JOCKEY DMA SUBSYSTEMS**

Each subsystem includes DJ/DMA controller, 8" double-density drives or 5 1/4" 48 TPI drives, cabinet, power supply, CP/M™ 2.2 and Microsoft BASIC

<b>SINGLE SIDED DISCUS 2D/DMA</b>			
BFMDSF811	1 Drive 30 lbs.	\$1195.00	\$1050.00
BFMDSF821	2 Drive 48 lbs.	\$1975.00	\$1775.00

<b>DOUBLE SIDED DISCUS 2+2/DMA</b>			
BFMDSF812	1 Drive 30 lbs.	\$1495.00	\$1325.00
BFMDSF822	2 Drive 48 lbs.	\$2575.00	\$2295.00

**DOUBLE SIDED - DISCUS MINI-FLOPPY/DMA**

BFMDSF5124	1 Drive 17 lbs.	\$ 995.00	\$895.00
BFMDSF5224	2 Drive 32 lbs.	\$1695.00	\$1525.00



**NEW!**

**S-100 5-26 MB**

**HARD DISK SUBSYSTEMS**

**5 - 10 Mb DMA SUBSYSTEMS**

Each subsystem includes DMA Hard Disk Controller, Seagate ST506 5 Mb or ST412 10 Mb 5 1/4" Hard Disk, Cabinet, power supply, CP/M™ 2.2 and Microsoft BASIC.

BFMDSOMAM*	Software supplied on 8" IBM 3740 disk with blank I/O and INST ALL program	\$450.00
BFMDSOMAM*26	Software configured for Morrow DJ/2B controller and Multi I/O as console	\$175.00
BFMDSOMAM*0MA	Software configured for Morrow DJ/DMA controller and Multi I/O as console	\$175.00
BFMDSOMAM*NS	Software supplied on 5 1/4" 10 sector North Star disk with blank I/O and INST ALL Program	\$175.00

Replace \* in above part numbers with 5 for 5Mb Subsystems or 10 for 10Mb Subsystems.

DISCUSM5 - 5Mb Subsystems	\$2195.00	\$1875.00
DISCUSM10 - 10Mb Subsystems	\$3195.00	\$2875.00

(order by part numbers listed above)

**DISCUS HDC 20-26 Mb SUBSYSTEMS**

Each subsystem includes HDCA3 I/O mapped controller, Shugart SA4008 14" 26Mb or Fujitsu 2308 8" 20Mb Hard Disk, cabinet, power supply, CP/M™ 2.2 and Microsoft BASIC.

BFMDSHDC20	Discus M20 A&T	\$4795.00	\$3995.00
BFMDSHDC26	Discus M26 A&T	\$4495.00	\$3895.00

**I/O BOARDS**

**MULTI I/O**

BFMDSM83200	Three Serial, Two Parallel Assembled & Tested	\$359.00	\$329.00
-------------	---	----------	----------

**SWITCHBOARD**

Two serial I/O, four parallel I/O, one status port, one strobe port

BFMDS82411		\$299.00	\$269.00
------------	--	----------	----------

**ADVANCED MICRO DIGITAL CORPORATION**



**SUPERQUAD - ADVANCED MICRO DIGITAL AT LAST, A FULL S-100 SYSTEM ON A SINGLE BOARD!**

- IEEE S-100 Bus Compatible • Z80A CPU @ 4MHz • Floppy Disk Controller, Single & Double Density (Supports up to 4 disk drives 5 1/4" or 8") • 64Kb Memory, 16K Bank Selectable • S-100 Extended Address A16-23 • 2 Serial and 2 Parallel I/O Ports • 2K or 4K of Shadow EPROM • Real Time Interrupt Clock • One Year Warranty • Runs with CP/M, MP/M, CP/NET • All of These Features on a Single Standard Size S-100 Board.

Part No.	Description	List Price	Our Price
BFMADSOCl	A&T w/Asynch RS232C ports	\$875.00	\$795.00
DFMADP5I	1 Asynch adapter board required for each serial port used	\$ 30.00	

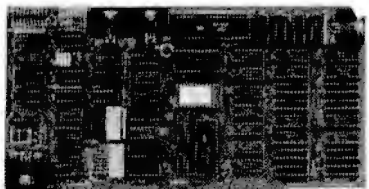

**VIDEO AND I/O**

**VB 3 - HIGH RESOLUTION VIDEO**

- 80 x 25 or 50 character video display Memory Mapped, Parallel Keyboard port
- DFSSMVB3A24 80 x 24 A&T \$499.00 \$440.00
- DFSSMVB3UP 80 x 50 Line Upgrade \$ 38.00

**VB 2 - I/O MAPPED 64 x 16 DISPLAY**

- I/O Mapped Video Board, with Parallel Keyboard port 64 x 16
- BFSSMVB24A Assembled & Tested \$269.00 \$228.00

**VB1B MEMORY MAPPED 64 x 16 DISPLAY**

- Memory Mapped Video Board 64 x 16 character display or 64 x 16 graphics display
- BFSSMVB1A Assembled & Tested \$242.00 \$220.00

**I/O 4**

- Two serial I/O, two parallel I/O
- BFSSMIO4A Assembled & Tested \$290.00 \$260.00

**NEW! I/O 5**

- 2 Serial, 3 parallel Including 1 Centronics
- DFSSMIO5I Assembled & Tested \$329.00 \$308.00

**NEW! I/O 8**

- 8 Port Serial I/O with Timer
- DFSSMIO8A Assembled & Tested \$550.00 \$495.00

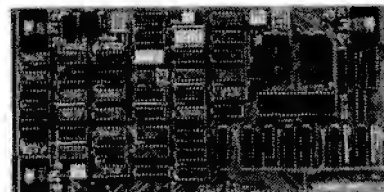

**CPU, RAM & PROM**

**CB2 Z80 CPU**

- 2/4 MHz will accept 2716, or 2732, or RAM
- DFSSMCB2A Assembled & Tested \$299.00 \$275.00
- DFSSMZ80M SSM Z80 Monitor \$ 68.00

**MB10A 16/8K 8/16 BIT STATIC RAM**

- 16K byte/8K word, 24 bit extended, addressing, "M write," Phantom disable, addressable in 4K blocks
- DFSSMMB10A Assembled & Tested \$299.00 \$275.00

**MB8A 1K/16K EPROM BOARD**

- 1K/16K 2708 EPROM board, disable in 1K increments
- DFSSMMB8AA Assembled & Tested \$179.00 \$158.00

**PBI PROM PROGRAMMER**

- Programs 2708 or 2716's, operates as a 4K/8K EPROM BOARD AS WELL
- BFSSMPIOA Assembled & Tested \$265.00 \$220.00

**California Computer Systems**

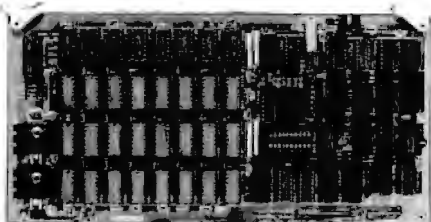

**CPU BOARDS**

2/4 MHz Z80A CPU with RS232C Serial I/O Port complete with Monitor PROM for 2422 Disk Controller

Part No.	Description	List Price	Our Price
BFCSS2810A	Assembled & Tested		\$300.00

**2820 Z80 DMA CPU**

4MHz Z80 with 2 RS232C Serial Ports, Centronics Parallel Port, separate data and status ports and DMA Daisy Chain Capability

BFCSS2820	Assembled & Tested		\$585.00
-----------	--------------------	--	----------

**I/O BOARDS**

**2830 - 6 PORT SERIAL**

Six Asynchronous RS232C Ports using three Z-80 DARTS. Programmable baud rates.

DFCCS2830	Assembled & Tested		\$550.00
-----------	--------------------	--	----------

**2710 4 PORT SERIAL**

4 Full handshaking RS232C ports and optional 2K ROM

BFCSS271001	Assembled & Tested		\$325.00
-------------	--------------------	--	----------

**2719 2 SERIAL & 2 PARALLEL**

2 RS232C ports, 2 8 bit parallel ports & optional 2K ROM

DFCCS271901	Assembled & Tested		\$360.00
-------------	--------------------	--	----------

**2720 4 PORT PARALLEL**

4 8 bit parallel ports and optional 2K ROM

BFCSS272001	Assembled & Tested		\$275.00
-------------	--------------------	--	----------

**2422 FLOPPY DISK CONTROLLER**

I/O Mapped, controls 8", single or 5 1/4" double density A&T with CPM™ 2.2 B" S.D.

BFCSS2422A	Assembled & Tested		\$425.00
------------	--------------------	--	----------

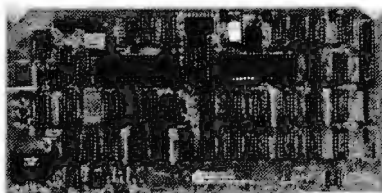

**MEMORY BOARDS**

**2065 64K DYNAMIC MEMORY BOARD**

64K 4MHz, Z80 or 8080 compatible, bank select for memory expansion to 512K, DMA compatible.

BFCSS2065	Assembled & Tested	\$375.00	\$350.00
-----------	--------------------	----------	----------

**2066 BANK SWITCH DYNAMIC MEMORY**

64K Memory with bank and block select switching functions for Cromemco Cromix™ & Alpha Microsystems

BFCSS2066	Assembled & Tested	\$450.00	\$425.00
-----------	--------------------	----------	----------

**2116 16K STATIC RAM**

16K 4MHz using 2 114 RAMs. Maybe divided into 4K blocks Cromemco & Alpha Microsystems compatible

BFCSS21163	Assembled & Tested		\$295.00
------------	--------------------	--	----------

**2032 32K STATIC RAM**

32K 4MHz using 2 114s. Divided into 4 8K blocks. Bank-port/bank-byte scheme compatible with Cromemco and Alpha Microsystems.

BFCSS2032	Assembled & Tested		\$500.00
-----------	--------------------	--	----------

**S-100 MAINFRAME**

12-slot motherboard with removable termination card

BFCSS220001	Office Cream	35 lbs.	\$575.00
BFCSS220002	Blue	35 lbs.	\$575.00

**SEND \$1.00 TODAY FOR THE NEW, FULL COLOR SPRING 1982 ENGINEERING SELECTION GUIDE!**



**PRIORITY ONE ELECTRONICS**

9161B DEERING AVE. • CHATSWORTH, CA 91311

**ORDER TOLL FREE (800) 423-5922 CA, AK, HI CALL (213) 709-5464**

Terms, U.S. VISA, MC, BAC, Check, Money Order, U.S. Funds Only. CA residents add 6% Sales Tax. MINIMUM PREPAID ORDER \$15.00. Include MINIMUM SHIPPING & HANDLING of \$3.00 for the first 3 lbs., plus 25¢ for each additional pound. Orders over 50 lbs., sent freight collect. Just in case, please include your phone number. Prices subject to change without notice. We will do our best to meet any prices throughout June, 1982. Credit Card orders will be charged appropriate freight. If you haven't received your Spring '82 Engineering Selection Guide by May 10th, send \$1.00 for your copy. Sale prices are for prepaid orders only.

**DMA**



**1 ONE**

**CPU BOARDS**

**CPU/68000 - 8MHz 68000 CPU**

16 bit 68000 CPU with on board ROM containing MACSBUG Monitor or Motorola 68541 Memory Management Unit (MMU).

Part No.	Description	List Price	Our Price
BFOULCPUB8000	A&T with Monitor	\$1195.00	\$1075.00
DFBULCPUB8000M	A&T with MMU	\$1495.00	\$1385.00

**MEMORY BOARDS**

**DMEM256KP-256K DYNAMIC MEMORY MODULE**

256Kb with byte parity error detection for 8 or 16 bit computers

DFOULDMEM256	256K A&T	\$1495.00	\$1385.00
--------------	----------	-----------	-----------

**CMEM NONVOLATILE CMOS MEMORY**

Nonvolatile CMOS memory with 3-10 year battery backup on board.

DFOULCMEM8	8K A&T	\$695.00	\$628.00
DFOULCMEM16	16K A&T	\$795.00	\$725.00
DFOULCMEM32	32K A&T	\$995.00	\$940.00

**2716/2732 EPROM BOARD**

**WITH 16 BIT DATA PATHS**

Designed to hold 32Kb of 2716 type or 64Kb of 2732 type EPROMs, or ROMs for read only use with 16 bit CPU systems.

BFOULEPROM32	2716 EPROM Board A&T	\$295.00	\$280.00
BFOULEPROM64	2732 EPROM Board A&T	\$295.00	\$280.00

**REAL TIME & DATA ACQUISITION**

**AIM 12-12 BIT A/D CONVERTER**

A/D input module with 12 bit accuracy, 32 input channels and optional instrumentation amplifier

BFOULAIM12	A&T with Instrumentation Amp.	\$745.00	
BFOULAIM12B	A&T without instrumentation Amp.	\$680.00	

**AOM 12-12 BIT D/A CONVERTER**

D/A output module, 4 channels, 12 bit accuracy. Optional VIC420 industrial output module (4-20Ma), 4 channels, used in conjunction with AOM12.

BFOULADM12	Assembled & Tested	\$675.00	\$640.00
BFOULVIC420	Assembled & Tested	\$675.00	\$640.00

**CLK24-NONVOLATILE CLOCK/CALENDAR**

Day, date, hours, minutes, seconds, and 3-5 year battery backup on board. Read or write directly from I/O port. Jumperable for 64Hz UNIX® or real time applications.

BFOULCLK24C	A&T w/64Hz Interrupt	\$300.00	\$285.00
-------------	----------------------	----------	----------

**SOFTWARE**

**DIGITAL RESEARCH**

DFDIRCPM	CP/M 2.2 Control Program/ Microcomputers	\$150.00
DFDIRMAC	MAC Macro Assembler	\$ 80.00
BFDIRRMAC	RMAC Relocating MAC	\$200.00
BFDIRSID	SID Symbolic Instruction Debugger	\$100.00
BFDIRTEX	TEX Text Formatter	\$100.00
BFDIRDES	DESPOOL Background Print Utility	\$ 50.00
BFDIRC800	CBASIC Programming Language	\$150.00
BFDIRC866	CBASIC-86 Programming Language	\$325.00

**MICROPRO INTERNATIONAL**

BFMDSWSTR	Wordstar Version 3.0	\$300.00
DFMDSMLMRG	Mail Merge	\$100.00
DFMDSPPSTR	Spell Star	\$150.00
DFMDSALSTR	Calc Star	\$200.00
BFMDSDATSTR	Data Star	\$200.00
BFMDSUPSET	Supersort	\$150.00

**SORCIM**

BFSORSCAL	SUPERCALC a Superior Electronic Worksheet	\$295.00
DFSORACTI	ACT I 8080/Z80 Assembler	\$175.00
DFSORACTII	ACT II 8086/8088 Assembler	\$175.00
BFSORTNNS	TRANS 8086/8088 Translator	\$125.00
BFSORPMD	PASCAL/M REL4 8080/8085/Z-80	\$395.00
BFSORPMB6	PASCAL/M 8086	\$495.00

**MICROSOFT**

BFMDSBAS80	BASIC-80 Version 5.X Extended Disk Basic	\$300.00
DFMCPDASC	BASIC Compiler Version 5.X	\$395.00
BFMDSMFT	FORTRAN-80	\$500.00





## HOW CLEAN IS YOUR POWER?



The Sola Micro/Mini Computer Ultra Isolated Regulator provides instantaneous voltage regulation, and ultra isolation from both transverse and common mode noise for any type of load. It also suppresses transients, protects against overloads and serves as a portable dedicated line. It is the ultimate in AC line conditioning equipment.

The Sola "Micro/Mini" is particularly applicable in systems involving mini or micro computers, POS equipment, microprocessors, or data terminals — where noise and transients cause errors, or low voltage and short term disruptions can result in loss of memory. The output waveshape is sinusoidal and contains less than 3% harmonic distortion, making it ideal for any electronic load.

Common mode noise rejection exceeds 120 dB for the regulator, while transverse noise rejection is better than 60 dB — true ultra isolation. Brownout protection is a real bonus feature. Input line voltage variations as great as ±15% are instantaneously regulated to a maximum output deviation of ±3%. And, the output will remain within NEMA voltage specifications for input voltages as low as 65% of nominal.

Especially designed for office type environments, the Sola "Micro/Mini" is truly portable and has a low sound level of 43 dB.

- Instantaneous regulation
- Regulator common mode noise rejection of 120 dB
- Regulator transverse mode noise rejection of 60 dB
- Completely portable — no installation costs
- Matches Micro/Mini computer packaging
- Complete isolation from power line - less than 3pFd
- Quiet operation — below normal office levels
- Operating range from -20°C to +50°C
- No loss of output for line loss up to 3 msec
- Line cord
- On-off switch
- Dual output receptacles

### MINICOMPUTER REGULATORS

#### PORTABLE 120VAC 60 Hz SINGLE PHASE

Part No.	Maximum Output VA Rating	Dimensions L x W x O (Approx.)	Approx. Shipping Weight	List	Our
BFLAS313070	70	12 x 6 x 8	10 lbs.	\$186.85	\$159.00
BFLAS313114	140	12 x 6 x 8	18	\$244.90	\$208.40
BFLAS313126	250	14 x 8 x 8	31	\$291.00	\$248.05
BFLAS313150	500	17 x 9 x 9	47	\$404.20	\$344.00
BFLAS313175	750	17 x 9 x 9	60	\$515.60	\$438.80
BFLAS313210	1000	17 x 9 x 9	75	\$597.20	\$508.25
BFLAS313220	2000*	17 x 11 x 11	108	\$1015.60	\$864.35

Output voltage is 120VAC ±3% for an input voltage of 95-130VAC \*Unit has 30 Amp twist receptacle.

Also available are Hard Wired and 50Hz Models.

#### MINI UPS

A mini UPS goes one step further than a minicomputer regulator. It provides the same voltage, noise and brownout protection plus maintains power to keep equipment running smoothly during a blackout. When a power failure occurs, the internal maintenance free battery continues powering the inverter without the use of any switching devices. This provides uninterrupted, conditioned AC power to the critical load.

A true UPS always between the AC line and critical load providing complete protection from brownouts and blackouts as well as line noise and transients. Output waveshape is sinusoidal with less than 3% single harmonic and 5% total harmonic distortion. Regulated output is ±3% when operating from either AC line or battery. Handles load surges and fault clearing providing 125% overload for 10 minutes, 150% overload for 10 cycles and 200% in short circuit with 2 automatic restrikes before shutdown. Maintenance-free battery automatically recharges upon return of AC line. Oper. Temp. 0°C to 40°C. Especially designed for small, sensitive electronic equipment such as minicomputers, data terminals, P.O.S. systems. Inplut voltage, 115VAC.

#### PORTABLE 120VAC 60Hz UNINTERRUPTIBLE POWER SYSTEMS

Part No.	Maximum Output VA Rating	Dimensions L x W x O (Approx.)	Approx. Shipping Weight	List	Our
BFLA260050400300	400/10Min	12x19x11	85	\$1544.00	\$1314.00
BFLA260050400301	400/20Min	12x19x11	95	\$1574.00	\$1339.00
BFLA260050750300	750/10Min	12x19x11	125	\$1674.00	\$1425.00

Also available are 220V 50Hz models of the above.

Call for all SOLA products not listed.



### WHY SETTLE FOR LESS?

DYSAN DISKETTES have long been regarded as the standard that all others attempt to duplicate. Today, Dysan still manufactures the ultimate in flexible recording media for 5 1/4" and 8" flexible disk drives. Both the 5 1/4" and 8" diskettes are certified to be 100% error free over the entire recording surface providing you with the best insurance from data error.

#### 5 1/4" DISKETTES 35/40 TRACK CERTIFIED

Part No.	Sectors	Density	Sides/Heads	Box of 10	PRICE
BFOSN1041	Soft	Single	1/1		\$45.00
BFOSN1041D	Soft	Double	1/1		\$50.00
BFOSN1051D	16 Hard	Double	1/1		\$50.00
BFOSN1071D	10 Hard	Double	1/1		\$50.00
BFOSN1042D	Soft	Double	2/2		\$60.00

#### 77/80 TRACK

BFOSN2052D	16 Hard	Double	2/2		\$80.00
------------	---------	--------	-----	--	---------

#### 8" DISKETTES

BFOSN37401	Soft	Single	1/1		\$55.00
BFOSN37401D	Soft	Double	1/1		\$65.00
BFOSN37402D	Soft	Double	2/2		\$85.00



### FCC CLASS 2 APPROVED DATA DISPLAY MONITORS

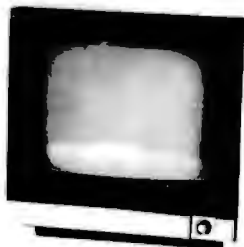

Part No.	Description	List Price	SALE
BFSYOVM4500	9" B&W P4, 10MHz (15 lbs.)	\$215.00	\$189.00
BFSYOVM4509CX	9" Green, P31, 10MHz (15 lbs.)	\$200.00	\$180.00
BFSYD0M8012C	12" B&W P4, 18MHz (24 lbs.)	\$250.00	\$225.00
BFSYD0M812CS	12" Green, P31, 18MHz (24 lbs.)	\$260.00	\$235.00
BFSYOVMC6013	13" Color, 16 x 64 (35 lbs.)	\$470.00	\$425.00
BFSYD0M6113*	13" RGB Color (35 lbs.)	\$995.00	\$885.00

\*As used with IBM P.C.

### Vista APPLE II® PERIPHERALS



#### ABDO DOUBLE DENSITY 8" DISK CONTROLLER

- High Speed DMA Transfer of Data (1 Microsecond/Byte)
  - Uses All Standard Apple DOS Commands (OPEN CATALOG, LOCK, DELETE, LOAD, etc.) Except for INIT Which Has Been Improved and Enhanced in a Vista Format Routine
  - Compatible with Apple DDS 3.2/3.3, Pascal 1.1 and CPM 2.2 (With the Z80 Sift Card by Microsoft)
  - Interfaces to All Shugart/ANSI Standard Eight-Inch Floppy Disk Drives
  - 2Kx8 PROM Contains Autoboot Functions and All 8" Floppy Driver Code Allowing Complete Memory Usage Map Compatibility w/Apple DDS 3.2/3.3
- |           |   |          |          |
|-----------|---|----------|----------|
| BFVISA800 | Controller and disk                                 | \$595.00 | \$499.00 |
| BFVISO180 | Vision 80 80 x 24 Display Card                      | \$395.00 | \$349.00 |
| BFVSD104  | Vision 40 - 40 Column, upper/lower case enhancement | \$195.00 | \$175.00 |



110V 60Hz CVT Mainframes, the best money can buy!  
12 Slot ±8V 17±16V @2A  
22 Slot ±8V @ 30A± 16V @ 4A

PART NO.	DESCRIPTION	LIST PRICE		OUR PRICE	
		1-9	10-24	1-9	10-24
BFEIMCS112	12 Slot Desk	\$755.00	\$660.00	\$627.00	
BFEIMCS122	22 Slot Desk	\$910.00	\$798.00	\$776.00	
BFEIRM12	12 Slot Rackmount	\$800.00	\$715.00	\$681.00	
BFEIRM22	22 Slot Rackmount	\$965.00	\$860.00	\$825.00	

Shipping Weight: On 12 Slot Mainframes: 45 lbs.

On 22 Slot Mainframes: 55 lbs.

#### S-100 MAINFRAME WITH 12 SLOT MOTHERBOARD AND CUTOUPS FOR 3 - 5 1/4" FLOPPY DISK DRIVES

+8V @ 17A ±16V @ 2A +12V @ 1.2A Internal Power Cable

BFEITF12	12 Slot desk	\$745.00	\$670.00	\$638.00
BFEIRF12	12 Slot Rackmount	\$855.00	\$765.00	\$732.00

Shipping Weight: On 12 Slot Desk: 40 lbs.

On 12 Slot Rackmount: 45 lbs.

#### DUAL 8" DISK DRIVE CHASSIS

For two Shugart 801R or two Qume DT-8 size drives with internal power cables provided +24V @ 1.5A +5V @ 1.0A -5V @ .25A

BFEIOF00	Desk Top	\$565.00	\$520.00	\$480.00
BFEIRF00	Rackmount	\$725.00	\$650.00	\$630.00

Shipping Weight: On Desk Top: 40 lbs.

On Rackmount: 45 lbs.

PRIORITY ONE ELECTRONICS is a master distributor for TEI. Dealers & OEM's call for quantity pricing.

## PRENTICE



### THE STAR OUR MOST POPULAR MODEM

#### We've Sold Thousands!

- 0 to 300 baud • Bell 103 and 113 • Exclusive triple seal acoustic chamber • Self Test, ±0.3% frequency stability, crystal controlled • Receiver Sensitivity of -50dB on, -53dB off • FSK Modulation • RS232 Compatible • Switches: Originate/Off/Answer, Full Duplex/Test-Half Duplex • Indicators: Transmit Data, Receive Data, Carrier Ready, Test

Part No.	Description	List Price	SALE
BFPNRSTAR	RS232, TTI, 20Ma Current Loop	\$199.00	\$128.00



### SMARTMODEM

- Auto Answer, Auto Dial, Full or Half-Duplex, LoopBack™ Serial binary, and asynchronous data formats with 7 or 8 data bits; 1 or 2 stopbits; odd, even or no parity • 0-300 baud • RS232C interface • Z8 Microprocessor with 2Kb control program • 40 character command buffer • Size: 1.5" x 5.5" x 9.6"
- |            |                                     |          |          |
|------------|-------------------------------------|----------|----------|
| BFOCH0200P | Smartmodem (Sh. Wt. 6 lbs.)         | \$279.00 | \$249.00 |
| BFOCH0300P | Chronograph (Sh. Wt. 3 lbs.)        | \$249.00 | \$219.00 |
| BFOCH0100P | Micromodem I 100 (Sh. Wt. 4 lbs.)   | \$399.00 | \$369.00 |
| BFOCH2901D | CP/M™ 8" Terminal Program for above |          | \$5.00   |
| BFOCH0000P | Micromodem II                       | \$379.00 | \$329.00 |
| BFOCH2401D | Datacom (PASCAL patch) for above    |          | \$5.00   |

FUJITSU

& NEC

## LETTER QUALITY SELLUM PRINTERS FROM



**Interfaces:** • RS232C and Current Loop • Centronics type parallel interface • IEEE488 All are DIP switch selectable.  
**Personality Protocols:** • NEC5510 • DIABLO630 • QUME Sprint9 • IBM Personal Computer • ATARI (Centronics 737).  
**Special Features:** • Z80 CPU • 12K ROM • Standard 16K Buffer • Optional 48K Buffer • 50 - 19.2K baud • Micro-coded alarm differentiates error conditions with pulse combinations • Intelligent bi-directional printing with logic seeking • Complete word processing features • Self test • Auto reprint • Auto clear error • Proportional spacing • Supports Automatic justification • Complete Vector plotting routines • Sheet feeder mode allows easy interface to most mechanical sheet feeders • 6 month warranty • Quiet - 60db • Front panel forms control • Universal power supply 115/220V 50/60 Hz.

### 80 CPS USING THE FUJITSU SP830

Part No.	Description	List Price	Our Price
BFSLMF88	Intelligent Printer	\$3495.00	\$2895.00

#### OPTIONS

BFSLMF88VFT	Vertical forms tractor	\$200.00
BFSLMF8848K*	48K RAM buffer	\$400.00

Call for pricing on sheet feed options

### 55 CPS USING THE NEC 7700

BFSLMN77	Intelligent Printer	\$3295.00	\$2895.00
----------	---------------------	-----------	-----------

#### OPTIONS

BFSLMN77VFT	Vertical Forms Tractor	\$ 230.00
BFSLMN77B0FT	Bidirectional Forms Tractor	\$ 400.00
BFSLMN77CSF	NEC Cut Sheet Feeder	\$1595.00
BFSLMN77CSF2	Twin Cut Sheet Feeder	\$2150.00
BFSLMN7748K*	48K RAM Buffer	\$ 400.00

\*Must be ordered with the printer

#### INTERFACE CABLES

BFCPAM572	Centronics IBM/NEC Cable	\$80.00
BFCSC8251	RS232C Serial Cable	\$60.00

Call for other cables not listed

## Para Dynamics

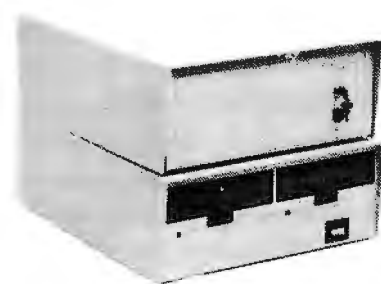

### 18 SLOT S-100 MAINFRAME

CVT Power Supply, forced air cooling; security lock 120 or 220V AC at 50 or 60Hz+8V@20A, ±16@3.5  
 BFPON20180 Desk Top \$799.00 \$699.00  
 BFPON2018R Rack Mount \$849.00 \$749.00

### 8 SLOT S-100 MAINFRAME WITH CUTOUPS FOR 2 5 1/4" DISK DRIVES

+5@5A, -5@500MA, +8@15A, +12@6A, +16@2, -16@2  
 BFPON25080 Desk Top \$899.00 \$799.00  
 BFPON2508R Rack Mount \$949.00 \$839.00

#### DISK DRIVE FACILITY

Accommodates two 8" floppy drives, of Shugart, Qume, or similar design and dimensions. 110 or 220V AC at 50 or 60Hz CVT power.

BFPON22000	Desk Top	\$659.00	\$579.00
BFPON2200R	Rack Mount	\$679.00	\$595.00

OKIDATA



- BI-DIRECTIONAL-120 CPS • Parallel and Serial I/O
- 9x9 Matrix (Alphanumeric) • 100 Thru 1200 Baud
- 6x9 or 12 matrix for graphics • Self Test
- 5.8, 3, 10, 16 Characters p/Inch • Out of paper switch
- 6 or 8 Lines per Inch • Friction or Tractor Feed
- 80 CPL@10 CPI for 82A • 3" to 14" Top of form
- 132 CPL@10 CPI for 83A & (Switch Selectable) 84
- 10 Different Character Sets

The above printers come complete with friction and tractor feed. Front panel selection of 10 different form lengths. Front or bottom paper loading for up to 4 part forms and tear bar. All three printers have a parallel interface as standard. The 82A and 83A also include a 1200 baud serial interface as standard.

Part No.	Description	List Price	SALE
BFOKIDAT82AT	80 column printer w/tractor (25 lbs.)	\$539.00	
BFOKBFRAPH02	High resolution graphics ROM 60x66	\$ 75.00	
BFOKIDAT83AT	132 column printer w/tractor (35 lbs.)	\$750.00	
BFOKIGRAPH03	High resolution graphics ROM 60x66	\$ 75.00	
BFOKISER2KBF	9600 Baud 2K serial buffer interface	\$149.00	
BFOKIDAT84AP	132 col. printer parallel interface with graphics (35 lbs.)	\$1095.00	

BFOKIDAT84AS	132 Col. printer 9600 baud serial 2K interface with graphics (35 lbs.)	\$1250.00
--------------	--	-----------

BFMB5APLINTWC\* Apple Parallel Interface w/cable (1 lb.) \$ 75.00

\*Sold only with printers

## EPSON

BFEFPMX80	80 col./CPS tractor feed (17 lbs.)	\$450.00
BFEFPMX80FT	with Tractor/Friction feed (20 lbs.)	\$550.00
BFEFPMX100	132 col./80CPS (30 lbs.)	\$725.00

Tractor/Friction Feed

BFMB5APLINTWC\* Apple parallel interface with cable \$ 75.00

BFMB5E1\* Serial interface for EPSON Printers \$ 59.00

\*Sold only with printers

## ADDS

Applied Digital Data Systems Inc.

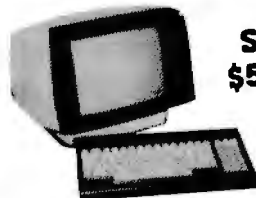

SALE!  
\$525.00

#### VIEWPOINT - ADDS

Detachable keyboard, RS232 interface and auxiliary port, 80 x 24 display, tiltable screen.

BFA00VWPR	Sh. weight: 30 lbs.	\$699.00	\$525.00
-----------	---------------------	----------	----------

#### DISK CABINETS

##### V-100 - VISTA

- Desk or rack mountable • Internal power and data cables
- Drives pull out for easy service and maintenance

BFFVISY100	Disk Drive Cabinet (43 lbs)	\$495.00	\$449.00
------------	-----------------------------	----------	----------

##### SINGLE 8" - Q.T.

Single 8" cabinet with power supply (22 lbs.) \$249.00 \$225.00

BFTQC00CB		\$249.00	\$225.00
-----------	--	----------	----------

##### DUAL 8" - Q.T.

Dual 8" cabinet with power supply (24 lbs.) \$395.00 \$349.00

BFTQC00CB		\$395.00	\$349.00
-----------	--	----------	----------

##### 5" CABINETS - VISTA

Single 5" with P.S. \$ 85.00

BFFVIS9001		\$ 85.00
------------	--	----------

Dual 5" with P.S. \$110.00

BFFVIS9002		\$110.00
------------	--	----------

Overseas Customers Send \$4.00 U.S. Currency or 22 International Reply Coupons to Receive Our New Catalog by Airmail



Tandon

Tandon TM-800 Thinline is exactly half the size of conventional 8" floppy disk drives.

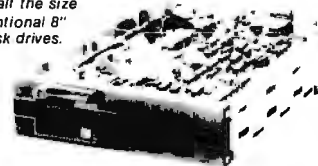

1 ONE

Exactly one-half the height of any other model. Proprietary, high-resolution, read-write heads patented by Tandon. D.C. only operation - no A.C. required. Industry standard interface.

Three millisecond track-to-track access time (9 lbs.)  
 BFTNOTM8401 Single Sided \$425.00 2 or more \$395.00  
 BFTNOTM8402 Double Sided \$575.00 2 or more \$550.00  
 BFTNOTM8M Manual - not included with drive \$ 19.00

#### TANDON 5 1/4" DRIVES

BFTNOTM1001 Single Sided, 250KB (5 lbs.) \$249.00 ea

2 or More \$220.00

BFTNOTM1002 Double Sided, 500KB \$325.00 ea.

2 or More \$299.00

BFTNOTM1003 Single Sided, 500KB \$325.00 ea.

2 or More \$299.00

BFTNOTM1004 Double Sided, 1000KB \$449.00 ea.

2 or More \$420.00

BFTNOTM5M manual, not included with drive \$ 10.00

\*As used in the IBM P.C.

## MITSUBISHI ELECTRIC



Better Than QUME!  
Better Than SHUGART!

8", Double-sided, double-density, interchangeable with QUME & Shugart  
 BFMITM289463 Sh. Weight 16 lbs. \$550.00  
 BFMITM289463M Manual \$ 10.00  
 2 or More \$525.00 each

#### Shugart 801R

Single sided, double density - most popular 8" drive  
 BFSHUB01R \$425.00 ea. or 2 or more (16 lbs) for \$395.00 ea.  
 BFSHUSAB01RM Manual for 801R drives \$ 10.00

## INTERNATIONAL INSTRUMENTATION, INC.



#### UNIVERSAL DISK ENCLOSURES

- Accepts any combination of 8" drives (QUME/Shugart 801R type or 1/2 size Tandon type) • Also accepts hard disks
- Positive pressure • Optional Disk environment monitor shows supply voltage and internal cabinet temperature
- Internal power and data cables provided.

UNIVERSAL DRIVE CABINET complete with power supply, fan and filter, and all internal cables for attachment of two 8" floppy drives.

BFIUDE004 Dual Drive Cabinet (Sh. Wt. 40 lbs) \$495.00 \$450.00

BFIUDE004EM w/Environmental Monitor installed \$584.95 \$535.00

BFIUDE004AUG Dual Drive cabinet with Aug-mentation power supply module to increase 5V supply from 6 amps to 9 amps for use with two hard disks or 4 Tandon drives. Also includes Disk Environment Monitor (45 lbs.) \$733.00 \$650.00

BFIUDE004AUG Dual Drive cabinet with Aug-mentation power supply module to increase 5V supply from 6 amps to 9 amps for use with two hard disks or 4 Tandon drives. Also includes Disk Environment Monitor (45 lbs.) \$ 89.95

BFIUDE004AUG Dual Drive cabinet with Aug-mentation power supply module to increase 5V supply from 6 amps to 9 amps for use with two hard disks or 4 Tandon drives. Also includes Disk Environment Monitor (45 lbs.) \$ 89.95

BFIUDE004AUG Dual Drive cabinet with Aug-mentation power supply module to increase 5V supply from 6 amps to 9 amps for use with two hard disks or 4 Tandon drives. Also includes Disk Environment Monitor (45 lbs.) \$ 89.95

BFIUDE004AUG Dual Drive cabinet with Aug-mentation power supply module to increase 5V supply from 6 amps to 9 amps for use with two hard disks or 4 Tandon drives. Also includes Disk Environment Monitor (45 lbs.) \$ 89.95

BFIUDE004AUG Dual Drive cabinet with Aug-mentation power supply module to increase 5V supply from 6 amps to 9 amps for use with two hard disks or 4 Tandon drives. Also includes Disk Environment Monitor (45 lbs.) \$ 89.95

BFIUDE004AUG Dual Drive cabinet with Aug-mentation power supply module to increase 5V supply from 6 amps to 9 amps for use with two hard disks or 4 Tandon drives. Also includes Disk Environment Monitor (45 lbs.) \$ 89.95

BFIUDE004AUG Dual Drive cabinet with Aug-mentation power supply module to increase 5V supply from 6 amps to 9 amps for use with two hard disks or 4 Tandon drives. Also includes Disk Environment Monitor (45 lbs.) \$ 89.95

BFIUDE004AUG Dual Drive cabinet with Aug-mentation power supply module to increase 5V supply from 6 amps to 9 amps for use with two hard disks or 4 Tandon drives. Also includes Disk Environment Monitor (45 lbs.) \$ 89.95

BFIUDE004AUG Dual Drive cabinet with Aug-mentation power supply module to increase 5V supply from 6 amps to 9 amps for use with two hard disks or 4 Tandon drives. Also includes Disk Environment Monitor (45 lbs.) \$ 89.95

BFIUDE004AUG Dual Drive cabinet with Aug-mentation power supply module to increase 5V supply from 6 amps to 9 amps for use with two hard disks or 4 Tandon drives. Also includes Disk Environment Monitor (45 lbs.) \$ 89.95

BFIUDE004AUG Dual Drive cabinet with Aug-mentation power supply module to increase 5V supply from 6 amps to 9 amps for use with two hard disks or 4 Tandon drives. Also includes Disk Environment Monitor (45 lbs.) \$ 89.95

BFIUDE004AUG Dual Drive cabinet with Aug-mentation power supply module to increase 5V supply from 6 amps to 9 amps for use with two hard disks or 4 Tandon drives. Also includes Disk Environment Monitor (45 lbs.) \$ 89.95

BFIUDE004AUG Dual Drive cabinet with Aug-mentation power supply module to increase 5V supply from 6 amps to 9 amps for use with two hard disks or 4 Tandon drives. Also includes Disk Environment Monitor (45 lbs.) \$ 89.95

BFIUDE004AUG Dual Drive cabinet with Aug-mentation power supply module to increase 5V supply from 6 amps to 9 amps for use with two hard disks or 4 Tandon drives. Also includes Disk Environment Monitor (45 lbs.) \$ 89.95

BFIUDE004AUG Dual Drive cabinet with Aug-mentation power supply module to increase 5V supply from 6 amps to 9 amps for use with two hard disks or 4 Tandon drives. Also includes Disk Environment Monitor (45 lbs.) \$ 89.95

BFIUDE004AUG Dual Drive cabinet with Aug-mentation power supply module to increase 5V supply from 6 amps to 9 amps for use with two hard disks or 4 Tandon drives. Also includes Disk Environment Monitor (45 lbs.) \$ 89.95

BFIUDE004AUG Dual Drive cabinet with Aug-mentation power supply module to increase 5V supply from 6 amps to 9 amps for use with two hard disks or 4 Tandon drives. Also includes Disk Environment Monitor (45 lbs.) \$ 89.95

BFIUDE004AUG Dual Drive cabinet with Aug-mentation power supply module to increase 5V supply from 6 amps to 9 amps for use with two hard disks or 4 Tandon drives. Also includes Disk Environment Monitor (45 lbs.) \$ 89.95

BFIUDE004AUG Dual Drive cabinet with Aug-mentation power supply module to increase 5V supply from 6 amps to 9 amps for use with two hard disks or 4 Tandon drives. Also includes Disk Environment Monitor (45 lbs.) \$ 89.95

BFIUDE004AUG Dual Drive cabinet with Aug-mentation power supply module to increase 5V supply from 6 amps to 9 amps for use with two hard disks or 4 Tandon drives. Also includes Disk Environment Monitor (45 lbs.) \$ 89.95

BFIUDE004AUG Dual Drive cabinet with Aug-mentation power supply module to increase 5V supply from 6 amps to 9 amps for use with two hard disks or 4 Tandon drives. Also includes Disk Environment Monitor (45 lbs.) \$ 89.95

BFIUDE004AUG Dual Drive cabinet with Aug-mentation power supply module to increase 5V supply from 6 amps to 9 amps for use with two hard disks or 4 Tandon drives. Also includes Disk Environment Monitor (45 lbs.) \$ 89.95

BFIUDE004AUG Dual Drive cabinet with Aug-mentation power supply module to increase 5V supply from 6 amps to 9 amps for use with two hard disks or 4 Tandon drives. Also includes Disk Environment Monitor (45 lbs.) \$ 89.95

BFIUDE004AUG Dual Drive cabinet with Aug-mentation power supply module to increase 5V supply from 6 amps to 9 amps for use with two hard disks or 4 Tandon drives. Also includes Disk Environment Monitor (45 lbs.) \$ 89.95

PRIORITY ONE ELECTRONICS

9161B DEERING AVE • CHATSWORTH, CA 91311

ORDER TOLL FREE (800) 423-5922 - CA, AK, HI CALL (213) 709-5464

Terms: U.S. VISA, MC, BAC, Check, Money Order, U.S. Funds Only. CA residents add 6%. Sales Tax. MINIMUM PREPAID ORDER \$15.00. include MINIMUM SHIPPING & HANDLING of \$3.00 for the first 3 lbs., plus 25¢ for each additional pound. Orders over 50 lbs. sent freight collect. Just in case, please include your phone number. Prices subject to change without notice. We will do our best to maintain prices through July, 1982. Credit Card orders will be charged appropriate freight. If you haven't received your Spring '82 Engineering Selection Guide, send \$1.00 for your copy today! Sale prices are for prepaid orders only.

## 1 FLUKE



### NEW 4 1/2 DIGIT HANDHELDS!

The FLUKE 8060A and 8062A offer the most powerful combination of capabilities ever in a handheld DMM, including these:

- 4 1/2 digit resolution
- 100KHz True RMA (8060A)
- Relative Reference
- Self diagnostics
- 10  $\mu$  V, 10mA, 10M sensitivity
- 30KHz True RMS (8062A)
- Constant current diode test
- Basic DC accuracy of 0.04% (8060A); 0.05% (8062A)

The 8060A also offers dBm, relative dB, frequency measurements to 200KHz, Auto ranging megohms to 300k  $\Omega$ , and conductance (2000 nS).

**BFFLU8060A** with safety designed test leads **\$349.00**  
**BFFLU8062A** with safety designed test leads **\$279.00**

### 3 1/2 DIGIT HANDHELDS: THE WORLD STANDARD

11 functions:

- dc voltage
- ac voltage
- dc current
- ac current
- resistance
- diode test
- conductance
- high-speed continuity beeper
- temperature (via K-type thermocouple)
- peak hold on voltage and current functions
- 0.1% basic dc accuracy (8024B & 8020B)
- 0.25% basic dc accuracy (8021B & 8022B)
- visual logic level detection
- continuity indicators

Extensive overload 3 1/2-digit resolution protection with 600V double-fused current input. Safety-designed test leads. Two-year parts and Two-year labor warranty. Calibration Cycle.

**BFFLU8024B** (All 11 functions) **\$239.00**  
**BFFLU8020B** (First 8 functions) **\$189.00**  
**BFFLU8021B** (First 7 functions) **\$149.00**  
**BFFLU8022B** (First 6 functions) **\$139.00**

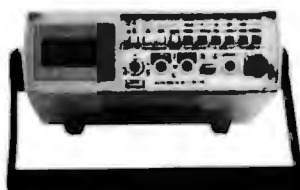

### 8010A/8012A. Measurement versatility on the bench

- 7 functions
- dc voltage
  - ac voltage
  - dc current
  - ac current
  - resistance
  - diode test
  - conductance

10 amp current range (8010A)  
 2  $\Omega$  and 20  $\Omega$  resistance ranges (8012A)  
 True RMS ac measurements  
 3 1/2-digit resolution  
 0.1% basic dc accuracy  
 Holds voltage, resistance and conductance readings via 80T-H Touch Hold Probe  
 Extensive overload protection with 600V double-fused current input

### The 8050A. 4 1/2 digits of unique function and features above 7 features, plus:

- 16 selectable reference impedances
- 4 1/2-digit resolution
- dBm (measuring ac and dc voltage)
- Relative reference/offset
- 0.03% basic dc accuracy

**BFFLU8050A** 4 1/2 digit True RMS Bench DMM **\$389.00**  
**BFFLU8050A01** with Ni-Cad battery option **\$410.00**  
**BFFLU8010A** 10 amp True RMS Bench DMM **\$259.00**  
**BFFLU8010A01** 8010A with Ni-Cad battery option **\$289.00**  
**BFFLU8012A** Low-Ohms TrueRMS bench DMM **\$339.00**  
**BFFLU8012A01** 8012A with Ni-Cad Battery Option **\$379.00**

The shipping weight on bench DMM is 5 lbs.; 5 lbs. with Ni-Cad Battery Option

## HITACHI

Hitachi Denshi, Ltd.



### Buy with confidence from the nation's largest HITACHI distributor

Single and dual trace, 15 thru 100 MHz. All high sensitivity Hitachi oscilloscopes are built to demanding Hitachi quality standards and are backed by a 2-year warranty. They're able to measure signals as low as 1mV/division (with X5 vertical magnifier). It's a specification you won't find on any other 15 or 30 MHz scopes. Plus: Z-axis modulation, trace rotation, front panel X-Y operation for all scope models, and X10 sweep magnification. And 30 thru 100 MHz oscilloscopes offer internal signal delay lines. For ease of operation, functionally related controls are grouped into three blocks on the color coded front panel. Now here's the clincher: For what you'd expect to pay more, you actually pay less. Check our scopes before you decide. All scopes complete with probes.

### NEW! FIELD SERVICE PORTABLES

**BFHITV209** 20MHz Dual Trace w/2 hour Battery Backup List Price: \$995.00 **Our Price: \$859.00**  
**BFHITV509** 50MHz Dual Trace w/Calibrated Variable Delay List Price: \$1895.00 **Our Price: \$1749.00**

- 20 MHz. Dual Trace
- 3.5" Rectangular CRT with Internal Graticule
- Battery Operated
- Only 4.3" High by 8.5" Wide
- 1 mV Sensitivity (to 5 MHz)
- 50MHz. Dual Trace
- Calibrated Delayed Sweep
- 3 1/2" 12KV CRT w/external graticule
- Lightweight - 11 lbs.
- Operates on Battery Pack (optional)
- 1 mV Sensitivity (to 10 MHz)

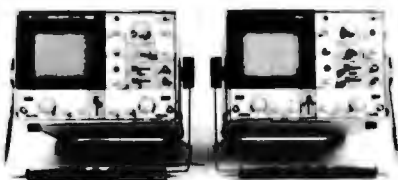

**BFHIT-V352** 35MHz Dual Trace WITH DELAY List Price: \$1150.00 **Our Price: \$ 859.00**  
**BFHIT-V202** 20MHz Dual Trace List Price: \$850.00 **Our Price: \$695.00**

Economically priced dual trace oscilloscope  
 Square CRT with internal graticule (Illuminated scale)  
 High-accuracy voltage axis & time axis set at #3% (certified at 10° to 35°C)  
 High-sensitivity 1mV/div. Low drift  
 2 Year Warranty

Dynamic range 8 div.  
 TV sync separator circuit  
 Built-in signal delay line (V-352)  
 X-Y operation  
 Sweep-time magnifier (10 times)  
 Trace rotation system  
 Fine adjusting, click-positioning function

### 50MHz & 100MHz

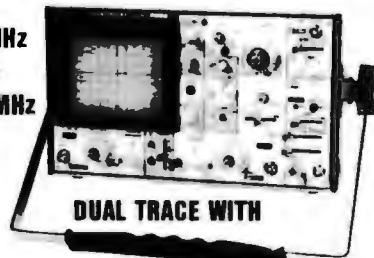

### DUAL TRACE WITH CALIBRATED TIME DELAY

**BFHITV550B** 50MHz with 3rd Trace Trigger View List Price: \$1745.00 **SALE \$1495.00**  
**BFHITV1050** 100MHz with 3rd & 4th Trace Trigger View List Price: \$2390.00 **SALE \$1995.00**

- Large, Bright 8 x 10cm screen
- High sensitivity 1mV/div (10MHz)
- 5 ns/div Sweep Rate
- 3rd channel display (Trigger View)
- Variable trigger hold-off
- Full TV Triggering
- Single Sweep
- Automatic Focus Correction
- Large, bright 8 x 10 cm screen
- Quad Trace Operation (Ch1, Ch2, A Trigger and B Trigger)
- High sensitivity 500  $\mu$  V/div (5MHz)
- High-accuracy  $\pm$ 2% (+10 to +35°C)
- Alternate Timebase Operation
- 20MHz Bandwidth Limiter
- Full TV Triggering

**BFHITV302B DUAL TRACE 30MHz w/delay** List Price: \$995.00 **Our Price: \$795.00**  
**BFHITV152B DUAL TRACE 15MHz (no delay)** List Price: \$735.00 **Our Price: \$595.00**

## KEITHLEY

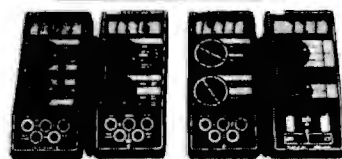

### Handheld DMMs For Every Application and Budget

- dc voltage
- ac voltage
- dc current
- ac current
- Resistance
- Diode Test
- Easy-to-use Rotary Switches
- Large 0.6" LCD displays
- 3/4 or 4 1/2 digit accuracy
- Overload protection
- Externally accessible battery & fuse
- Rugged 0.1" ABS Plastic Case
- Shock-Mounted PC Board

**BFKTH130**  $\pm$ 0.5% DCV accuracy, 10M  $\Omega$  input impedance auto polarity and current measurement through 10A **\$124.00**  
**BFKTH131** Same as BFKTH130 except 0.25% accuracy and enhanced band with on top ACV ranges **\$139.00**  
**BFKTH128** See/hear display includes both over/under threshold indicator arrows, audible tone that operates on all ranges & functions, and adjustable threshold **\$139.00**  
**BFKTH135** 4 1/2 digit, 0.05% accuracy **\$239.00**  
**BFKTH871** Thermocouple (TC) based thermometer **\$199.00**  
**BFKTH1304** Soft Carrying Case & Stand (handhelds) **\$ 10.00**  
**BFKTH1306** Deluxe Carrying Case (handhelds) **\$ 25.00**



### Bench DMMs: Solid Price/Performance Values

**BFKTH189** 0.25% DCV 3 1/2 digit LCD display **\$189.00**  
**BFKTH176** 0.05% DCV 4 1/2 digit LCD display 20kHz bandwidth on lower ranges **\$269.00**  
**BFKTH179A** 0.04% DCV 4 1/2 digit LED display 20A capacitance TRMS ACV **\$359.00**  
**BFKTH1792** BCD Output Option for BFKTH179A **\$189.00**  
**BFKTH1793** IEEE interface for BFKTH179A **\$325.00**

## GLOBAL



### GLOBAL SPECIALTIES LOGIC PROBES SPECIFICATIONS

MODEL	LP1	LP2	LP3
Response	50 ns. 80 ns. single-shot event, 10MHz pulse train	300 ns. 1.5 MHz pulse train	6 ns typical tested at 10 ns. 70MHz pulse train
Pulse Mode	High Speed Trainor Single Event		

Part No.	Description	List Price	Our Price
BFSCLP1	Standard 10MHz w/Memory	\$50.00	\$45.00
BFSCLP2	Economy 1.5MHz	\$32.00	\$30.00
BFSCLP3	High-Speed 50MHz w/Memory	\$77.00	\$69.00
BFSCLP4	100MHz + ECL Logic Probe	\$150.00	\$138.00
BFSCOP1	High-speed digital pulser, 100 PPS or single-shot	\$83.00	\$76.00

### 16 AND 40 CHANNEL LOGIC MONITORS

LM1 chips over any DIP IC up to 16 pins. Each of its 16 contacts connects to a single bit level detector that drives a high intensity, numbered LED indicator activated when the applied voltage exceeds a fixed 2 V threshold. Logic "1" turns LED on; logic "0" keeps LED off.

**BFSCLM1** **\$79.00** **\$72.00**  
 1 M 4 with instantly and clearly display the logic states of any digital IC of up to 40 pins or any of up to 40 independent circuit points when used with its standard supplied connector cable terminated with a 40-pin IC test clip  
**BFSCLM4** **\$199.00** **\$189.00**

### LOGICAL ANALYSIS KITS

**BFSCLT01** 1P1, D1 & 1 M1 unimolded case **\$240.00** **\$220.00**  
**BFSCLT02** 1P3, D1 & 1 M1 unimolded case **\$270.00** **\$245.00**





# Unclassified Ads

**FOR SALE:** Apple II with 16 K memory, Pixe-Verter, program tapes, and manuals. \$1000. Also have five issues of Creative Computing magazine for 1977 (July-August issue missing), six issues 1978, 12 issues 1979, and 12 issues 1980. \$2 each. Also have issues 9-12 of BYTE for 1979 and all 12 issues for 1980. \$2 each. Dale Arndt, 2900 McCann Rd. Apt. 415, Longview, TX 75604. (214) 758-1479.

**FOR SALE:** Two MITS 8800B computers, 64 K. Two MITS disk drives, cassette I/O, serial I/O, parallel I/O. BASIC, FORTRAN, COBOL, Pascal. \$3000. Steve Mastrianni, 2952 Main St., Coventry, CT 06238. (203) 742-6727.

**ATTENTION:** Schools that own Apple IIs with a disk: Are you tired of not having enough money for equipment? I am full of ideas and methods on how to make money using your Apple. Send a SASE for free information. Greg Lindahl, 10 Arbutus Trail, Greenville, SC 29607.

**FOR SALE:** TRS-80 voice synthesizer, cable, manual, and demonstration tape. Four months old. \$150 or best offer. Randy Rosier, 714 Brown St., Iowa City, IA 52240. (319) 338-5097.

**FOR SALE:** E & L MMD-1 microprocessor trainer in excellent working condition. Based on 8080A chip. Bug books 5 and 6. \$150. Jerry Fidel, 1365 West 7th St., Brooklyn, NY 11024. (212) 331-0028.

**SELL OR SWAP:** DEC PDP-8/L with 4 K core and TTY interface. PCB-L paper-tape reader/punch with interface cards and cable. No software or manuals for either at the moment. Will pass along if I get them. Datalog MC8800 ultra-high-speed printer (optical), horizontal synchronization needs adjustment, complete user/maintenance manual with schematics. I will consider offers of DEC equipment, accessories, software, or money, or any combination of these. Duane Berry, RR 1, Box 105, Kempner, TX 76539. (827) 547-5536.

**FOR SALE:** Hazeltine 1400: \$400. Hayes 80-103A (same as MM100, but requires DAA): \$200. AJ 841 Selectric (serial): \$600. Industrial Micro 8 K dynamic RAM: \$50. Or best offers. All very low usage and in excellent condition. Neil Weither, (212) 757-6300.

**FOR SALE:** Centronics P-1 printer in perfect condition. Rarely used. Four rolls of paper included. Paid \$430, asking \$200 or best offer. Philip E. Baffy, MD., 4758 Kinglet, Houston, TX 77035. (713) 729-6290.

**FOR SALE:** OSI Challenger IP with 16 K RW memory, 610 expander board, single minifloppy-disk drive, and Sylvania 9-inch monitor. Complete set of manuals and miscellaneous articles. \$850 or best offer. Randy Raymond, 102 Maple Grove Way, Columbia, MO 65201. (314) 874-1711

**FOR SALE:** Two single-board computers. Fairchild F8 with 1 K static RAM, four parallel I/O ports, one serial I/O port, 20 mA/TTY interface. Fair-bug in ROM with documentation, card edge connector, schematic, and programming manual \$60. Also, 1802 Super ELF with 2 K static RAM, monitor program in PROM, fully assembled with manual, schematic, and 13 issues of the 1802 newsletter. \$75. Both for \$110. Gordon Burnham, POB 14192B, Orlando, FL 32807.

**WANTED:** California Computer Systems S-100 boards. Need used disk-controller board (#2422), I/O (2718 or 2710), 64 K (2065), and Z80 (2810) in usable condition at a reasonable price. Also need a Shugart 800/801R disk drive. Ed Schneider, 8025 Coates Hwy., Manistee, MI 49660. (616) 723-7859

**FOR SALE:** BYTE issue #1 through September 1978. Interlink Age and Computer Decisions; 1975 through 1978 issues \$100. Alan Mattai, POB 2819, Mission Viejo, CA 92690. (714) 837-7540.

**FOR SALE:** KSR43 Teletype. Like new. Tractor feed, 12-inch carriage, uppercase/lowercase, dot-matrix printer, transmits and receives full ASCII set, interfaces using TTL levels, serial input/output, and standard keyboard with many extra characters and control key. Easily interfaced to TRS-80, SwTPC 6800-09, and others. Included: 1/4 box of white unlined fan-fold paper, extra ribbon cartridge, interfacing ribbon cable with connector, technical reference, and owner's manuals. \$700 F. Lunk, 16-06 Francis Lewis Blvd., Whitestone, NY 11357. (212) 746-0946.

**UNCLASSIFIED POLICY:** Readers who are soliciting or giving advice, or who have equipment to buy, sell or swap should send in a clearly typed notice to that effect. To be considered for publication, an advertisement must be clearly noncommercial, typed double spaced on plain white paper, contain 75 words or less, and include complete name and address information.

These notices are free of charge and will be printed one time only on a space available basis. Notices can be accepted from individuals or bona fide computer users clubs only. We can engage in no correspondence on these and your confirmation of placement is appearance in an issue of BYTE.

Please note that it may take three or four months for an ad to appear in the magazine.

## BOMB BYTE's Ongoing Monitor Box

Article #	Page	Article	Author(s)
1	48	The Videodisc Interfacing Primer	Daynes
2	60	Build an Interactive-Videodisc Controller	Ciarcia
3	78	Videodiscs in Education	Bejar
4	108	Interactive Training in Cardiopulmonary Resuscitation	Hon
5	142	Videodiscs and Optical Data Storage	Moberg, Laefsky
6	162	Armored Patrol	Callamaras
7	170	The Eliminator: Mayhem in Space	Pike
8	176	Galactic Chase	Wszola
9	182	On the Way to Standard BASIC	Kurtz
10	220	App-L-ISP	Bonar, Levitan, Lesser
11	235	Tawala's Last Redoubt	Leibson
12	242	The Input/Output Primer, Part 5: Character Codes	Barden
13	260	A General Purpose I/O Board for the Color Computer	Pournelle
14	286	User's Column: Terminal Madness, The Word, Grammatik, and Then Some	Crawford
15	302	The Atari Tutorial, Part 10: Human Engineering	Taylor, Lemmons
16	321	Upward Migration, Part 1: Translators	Dahmke
17	348	The Osborne 1	MacNicol
18	364	Applescope Stores Dual Traces	Kelly
19	376	NEW/DOS/80 Version 2.0	Gabriele
20	410	TAFT: Terminal Apple with File Transfer	Whitaker
21	452	Maintenance Alternatives for Personal Computers	Campbell
22	468	Omni Aviation Navigation System	Moskowitz
23	488	Micro-Decision Support System/Finance (DSSIF)	

### We Interrupt This BOMB . . .

For the second month in a row, Steve Leibson has captured first place. And this time it's no tie—he has it all to himself. For “The Input/Output Primer, Part 2: Interrupts and Direct Memory Access,” Steve will be awarded the \$100 purse. Second place goes to Ed Umlor for his review, “Integral Data Systems’ Prism Printer.” Ed will receive \$50. Despite threats of bodily harm (and worse), we’re forced to award third place to Steve Ciarcia for his article “Use Voiceprints to Analyze Speech.” Well after all, Steve, you can’t be first every month.

# Reader Service

Inquiry No.	Page No.	Inquiry No.	Page No.	Inquiry No.	Page No.	Inquiry No.	Page No.
1	47th STREET PHOTO 385	94	COLLINS ENG.SYS.CONSLT. 528	176	ELECTRONIC CONTROL 453	284	LIFEBOAT ASSOC. 327
2	A.M. ELECTRONICS 32	95	COLONIAL DATA SERV. 14	177	ELECTRONIC DESIGN ASSO. 449	286	LNW RESEARCH 75
3	A.M.T. 256	96	COLONIAL DATA SERV. 181	178	ELECTRONIC SPLISTS 394	287	LOGICAL DEVICES 354
4	A.S.T. RESEARCH 234	97	COLUMBIA DATA PROD. 215	179	ELECTRONIC SYS.FURN 342	288	LOGO COMP.SYS. 191
5	AB COMPUTERS 523	499	COLUMBIA MICRO SYS 370	180	ELECTROTECHNICS CORP. 316	289	LOMAS DATA PRODUCTS 367
6	ABM PRODUCTS 22	98	COMMODORE BUSN.MACH. 79	181	ELLIS COMPUTING 8	270	LYBEN COMP.SYS. 496
8	ACCUPOWER 432	99	COMMUNICATIONS ELECTR. 515	182	EMERGING TECH.CONSLT. 472	271	LYBEN COMP.SYS. 514
9	ACTION COMPUTER 183	101	COMPONENTS EXPRESS 282	183	EMPIRICAL RESRCH GRP. 90	272	LYBEN COMP.SYS. 516
10	ADV.COMP.PROD. 546, 547	102	COMPCHANGE 518	184	ENERCOMP 530	273	LYBEN COMP.SYS. 524
11	ADV.DIGITAL PROD. 239	103	COMPULINK CORP. 94	185	EPIC COMP.CORP. 213	275	MACROTECH INT'L. 194
12	ADV.MICRO DIGITAL CORP. 283	104	COMPUMATE 524	186	EPIC COMP.CORP. 462	276	MACROTECH INT'L. 194
13	ADV.SYS.CONCEPTS 520	*	COMPUPRO/GODBOUT 119	187	EPSON AMERICA 284, 285	277	MACROTECH INT'L. 194
14	AGSIS SYSTEMS 528	105	COMPUSERVE 188	188	ESSEX PUBLISHING 494	278	MACROTRONICS 526
*	ALF PRODUCTS, INC. 373	494	COMPUTER APPLICATIONS 495	189	EXPOTEK 96	279	MAGNETIC INFORMATION 476
15	ALLENBACH IND. 154	106	COMPUTER CHANNEL 430	*	FIVE STONES SFTWR 466	280	MAGNOLIA MICROSYS. 512
16	ALPHA BYTE COMP.PROD. 38, 39	107	COMPUTER DYNAMICS 526	190	FORETHOUGHT PRODUCTS 450	281	MANNESMANN TALLY 281
17	ALPHA SOFTWARE 145	106	COMPUTER EXCHANGE 419	191	FOURTH DIMENSION 137	282	MARYMAC INDUSTRIES 447
18	ALPHA SOFTWARE 147	109	COMPUTER FURN.& ACCS. 477	192	FRANKLIN COMP.CORP. 200, 201	283	MASTER COMPUTING INC. 190
19	ALSPA COMP.SYS. 101	110	COMPUTER HORIZON 448	258	FREE COUPONS 459	284	MAXELL DATA PRODUCTS 15
20	ALTS COMP.SYS. 158, 157	111	COMPUTER IDEAS CORP. 526	193	FREDERICK COMP.PROD. 449	285	MAXTEK 455
21	AMDEK CORP. 209	112	COMPUTER INNOVATIONS 466	194	FRIENDS SOFTWARE 222	173	MBI 530
22	AMER.SMALL BUSN.COMP 473	113	COMPUTER MAIL ORDER 374, 375	195	FRYE ELECTR. 462	*	MBP SFTF.&SYS.TECH. 361
23	AMER.SQUARE COMP. 244, 245	114	COMPUTER PLUS 516	198	FYI INC. 171	286	MCGRAW-HILL, GREGG DIV. 330
24	ANCIE LABS 251	*	COMPUTER PROFESSIONAL 368, 369	197	G R ELECTRONICS 208	287	MCP COMPUTER PROD. 522
25	ANDERSON JACOBSON 34	115	COMPUTER SHOPPER 445	198	G & G ENGINEERING 283	287	MEDIA DISTRIBUTING 445
28	ANDERSON JACOBSON 406	118	COMPUTER SHOPPER 476	199	G-H COMPUTER SYS. 516	*	MEDIAMIX 126
469	ANN ARBOR TERMINALS 437	117	COMPUTER SPLCTIES. 252, 253	200	GENERAL SOFTWARE INC. 164	288	MEMOREX MEDIA PROD. 155
27	ANSWER CORP. 132	118	COMPUTER SPLCTIES. 273	201	GENSTAR REI SALES CO. 514	289	MEMORY MERCHANT 113
28	APPARAT INC 83	119	COMPUTER TOOLBOX, INC. 512	202	GILTRONIX, INC. 439	290	MEMOTECH 335
30	APPLEWARE, INC. 512	120	COMPUTER TOOLBOX, INC. 516	203	GILTRONIX, INC. 439	292	METAVAN INC. 530
31	APPLIED ANALYTICS 349	*	COMPUTER WRHSE. 205	204	GILTRONIX, INC. 439	293	MFJ ENTERPRISES INC 475
32	APPLIED SOFTWARE TECH 229	122	COMPUTERS WHOLESALE 259	205	GNOSIS 356	294	MICRO AGE COMP.STORE 167
33	APTEK INC. 520	123	COMPUTERTIME INC. 514	344	GRAPPLER, THE 277	295	MICRO BUSINESS WORLD 163
34	ARBA 80	124	COMPUTERWARE 394	206	GREAT PLAINS SOFTWARE 225	295	MICRO BUSN.SFTW. INC. 441
35	ARCHIVE 421	125	COMPUTERWORLD INT'L. 203	470	GRYPHON SYS 445	298	MICROCOM 391
36	ARTIFICIAL INT'L. RESRCH 522	127	COMPUVIEW PROD. INC. 66, 67	207	H&E COMPUTRONICS 355	297	MICRO DEVELOPMENTS 186
37	ASAP COMP.PROD. INC. 309	128	CONCORD COMP.PROD. 344	208	HAYES MICROCOMP.PROD. 69	298	MICRO EXPRESS 522
38	ASAP COMP.PROD. INC. 345	228	CONDOR COMP.CORP. 423	209	HAYES MICROCOMP.PROD. 403	*	MICRO EXPRESS CO. 474
39	ASAP COMP.PROD. INC. 348	129	CONCURRENT CORP. 310	491	HAZELTINE 367	300	MICRO FOCUS 199
40	ASAP COMP.PROD. INC. 347	128	CONSULTORS INT'L 380	210	HEATH COMPANY 125	*	MICRO LOGIC 528
41	ASC ASSOCIATES 528	130	CONSUMER COMP. 311	211	HERTZ CORP. THE 455	488	MICRO MAGAZINE 520
42	ASHTON-TATE 409	131	CONSUMER COMP. 513	212	HEWLETT-PACKARD 135	301	MICRO MANAGEMENT SYS. 168
*	ASPEN SFTW.CO. 28	132	CONTEXT MANGMNT.SYS. 23	213	HEWLETT-PACKARD 216, 217	354	MICRO MANAGEMENT SYS. 384
43	ATARI 140, 141	*	CONTROL C SOFTWARE 210	214	HEWLETT-PACKARD 216, 217	302	MICRO MINT 371
44	ATLANTIC CABINET CORP. 522	133	CORONA DATA SYS. 43	215	HEWLETT-PACKARD 216, 217	501	MICRO MINT 370
45	AUDEC CORP. 516	134	COSMIC COMP.UNLTD. 528	216	HEWLETT-PACKARD 216, 217	502	MICRO MINT 448
*	AUDIO-LIGHT INC. 334	135	COVER CRAFT 214	217	HEWLETT-PACKARD 216, 217	303	MICRO PRINTER MKTG 267
48	AUTOMATED PRGRM METHODS 516	136	CPU SHOP, THE 529	218	HEWLETT-PACKARD 313	304	MICRO PRO INT'L. 83
49	AUTOMATED BUS. MACHINE 246	137	CROMEMCO CII, 1	219	HIGH TECH.SFTW.PROD. 131	305	MICRO SCI 143
48	AVOCET 156	138	CROMEMCO 2	*	HILTON HOTEL CORP. 319	308	MICRO WORKS, THE 306
51	AXIOM CORP 365	139	CUSTOM COMP.SYS. 195	220	I.B.C. 33	307	MICRO SPOT ELECTR. 16
52	B&B ELECTR. 516	*	CYBERNETICS INC 413	221	ILLINOIS COMP.PROD. 520	308	MICROBYTE/EXT.PROCSS. 332
53	BASF SYSTEMS 343	140	D & W DIGITAL 240	222	IMPRINT SOFTWARE 528	309	MICROCOMP.BUSN.IND. 37
*	BASIC BOOKS 210	142	DATA ACCESS CORP 425	223	IMS INTERNATIONAL 139	310	MICRODYNAMICS 520
54	BASIS, INC. 241	*	DATA DISCOUNT CTR 451	*	INDEPENDENT BUS.SYS. INC. 295	311	MICROHOUSE 12, 13
55	BAUSCH & LOMB INSTR.SYS. 81	487	DATA ED 44	225	INDIGO TECHNOLOGY 18	312	MICROMAIL 180
56	BAUSCH & LOMB INSTR.SYS. 81	143	DATA ROYAL INC. 233	*	INFOCOM, INC. 331	313	MICROPERIPH.CORP. THE 520
57	BAY TECHNICAL ASSOC. 464	496	DATA RETRIEVAL CORP. 471	228	INFOSOF COMP.SYS. 439	314	MICROSTUF INC. 121
58	BBI MAIL ORDER 518	*	DATA SOURCE SYS.CORP. 202	227	INNOVATIVE SFTW.APPL. 246	315	MICROSYSTEMS ASSOC. 522
59	BEECH ENTERPRISES 512	144	DATA-RX INC. 447	488	INNOVATIVE SFTW. 415	316	MICROTECH EXPORTS 212
*	BELL, JOHN ENGR. 519	145	DATA-TYPE INC. 35	229	INTEGRAL DATA SYS. 73	317	MIKOS 463
61	BINARY CORP. 524	146	DATAFACE 180	230	INTEGRAND 270	318	MILLER MICROCOMP.SERV. 457
62	BISON PRODUCTS 268	147	DATAPoint CORP. 293	231	INTEL CORP 98, 99	319	MINI COMP.SUPPLIERS 380
63	BIT 3 COMP.CORP. 150	148	DATASMITH 388	232	INTERACTIVE MICROWRE. 446	320	MINI MICRO MART 196, 197
64	BLAT RESRCH & DEVELP. 447	149	DATASOUTH COMP.CORP. 231	233	INTERACTIVE STRUCT. 10	321	MINI MICRO MART 534, 535
65	BMC INTL 305	150	DATASOUTH COMP.CORP. 412	234	INTERCONTN.MICROSYS. 395	322	MINOLTA CORP. 363
493	BORLAND LTD. 290	151	DAY STAR TECHNOLOGY 117	235	INTERMEDIA SYSTEMS 294	324	MOORE BUSN. FORMS 351
66	BOTTOM LINE, THE 522	152	DEALIN' ELECTR. 512	236	INTERTEC DATA SYS. 17	274	MORROW DESIGNS 193
66	BOTTOM LINE, THE 464	492	DELMAPI-DELUX CHK.PRINTRS. 459	75	INTERTEC DATA SYS. 271	325	MORROW DESIGNS 291
69	BOWER-STEWART 516	153	DELPHIC SYSTEMS 465	238	IPEX INT'L. 514	326	MOUNTAIN COMPUTER 19
70	BRIDGE COMPUTER 312	154	DELTA PRODUCTS 42	239	ISA CO.LTD. 467	327	MOUNTAIN VIEW PRESS 405
71	BRIDGE COMPUTER 520	155	DENNISON KYBE CORP. 115	240	ISE 71	328	MPC PERIPHERALS 111
72	BUCKEYE STAMPING CO. 451	156	DIGITAL EQUIP. CORP 46, 47	241	ISE 223	329	MPI 161
407	BYCS 358	157	DIGITAL MARKETING 8	242	ISOTEC, INC. 130	330	MTI, SYSTEMS CORP. 338
73	BYAD CORP. 165	158	DIGITAL MICROSYSTEMS 379	243	ITHACA INTERSYSTEMS 9	331	MULTI BUSN.COMP. INC. 528
*	BYTE BOOKS 318	159	DIGITAL RESEARCH 88, 87	244	J.C.SYSTEMS 448	332	NEBS 178
237	BYTE BOOKS 320	*	DIGITAL RESRCH COMP. 548, 549	245	J.FISKE SFTW.SYS. 524	333	NEC HOME ELECTR.USA 103
76	BYTE BOOKS 429	165	DIGITAL WORD SYS 528	246	JADE COMP.PROD. 531	334	NEECO 338
77	BYTE BOOKS 461	180	DISCOUNT SOFTWARE 152	247	JADE COMP.PROD. 532, 533	*	NETRONICS 336, 337
*	BYTE BACK ISSUES 360	181	DOKAY COMP.PROD. INC. 527	248	JAMECO ELECTR. 550, 551	335	NETWORK CONSULTING CORP 82
*	BYTE SUBSCRIBER 511	*	DOW JONES 247	249	JDR MICRODEVICES 536, 537	338	NEW GENERATION SYS. 204
79	BYTEK COMP. SYS. 390	182	DOWNTOWN BOOK BAZAAR 512	250	JDR MICRODEVICES 536, 539	*	N.N.C. ELECTRONICS 443
80	BYTEWRITER 198	183	DRAKE, R.L. CO. 495	251	JIMS COT. INC. 256	337	NORTH STAR COMPUTERS 100
61	CALIF DATA CORP 514	184	DREAM ELECTRONICS 516	252	JVB ELECTRONICS 526	338	NORTHERN BYTES 406
62	CALIF. DIGITAL 542, 543	186	DUAL SYS.CONTROL CORP. 211	253	KADAK PRODUCTS 399	339	NOVATION 325
*	CALIF.COMP.GRAPHICS 524	187	DUPRE ENTERPR. 352	254	KERN PUBLISHING 236	340	NOVATION 427
*	CALIF.MICRO COMP. 476	188	DYMARC IND. 453	255	KERN PUBLISHING 237	*	OASIS SYSTEMS 116
63	CDR SYSTEMS 516	93	DYNAMIC CONTROL SYS 92	257	KRAMER SYS INT'L. 478	341	OLYMPIC SALES 314
64	CENTENNIAL SOFTWARE 208	500	ECONOMY PERIPHERALS 370	291	LABORATORY COMP.SYS. 524	342	OMEGA SALES 353
85	CERMETEK 254	170	ECOSOF 380	259	LABORATORY MICROSYS. 514	343	OMEGA MICRO 192
86	CHAPIN ASSOCIATES 514	171	EDUCATIONAL MICROCOMP. 516	260	LAXEN & HARRIS INC. 524	345	OREGON INSTRUMENTS 109
67	CHECK-MATE 496, 512	172	EDUCATIONAL MICROCOMP. 524	281	LEADING EDGE PROD. CIII	348	ORX SOFTWARE 518
88	CHECKS-TO-GO 218	174	ELECTROHOME 159	282	LEHIGH VALLEY LOGIC INC. 354	349	ORX SOFTWARE 308
69	CHIPS & DALE 514	175	ELECTROLABS 513	497	LEHMAN & ASSOC. 528	348	ORX SOFTWARE 456
90	CHRISLIN INDUSTRIES 329			283	LEO ELECTRONICS 530	*	OSBORNE COMPUTERS 31

To get further information on the products advertising in BYTE, fill out the reader service card with your name and address. Then circle the appropriate numbers for the advertisers you select from the list. Add an 1B-cent stamp to the card, then drop it in the mail. Not only do you gain information, but our advertisers are encouraged to use the marketplace provided by BYTE. This helps us bring you a bigger BYTE. The index is provided as an additional service by the publisher, who assumes no liability for errors or omissions. \*Correspond directly with company.



## Reader Service

Inquiry No.	Page No.	Inquiry No.	Page No.	Inquiry No.	Page No.	Inquiry No.	Page No.
362	PERIPHERALS UNLTD. 275	393	RENAISSANCE TECHN. 479	423	STANDARD SFTW.CORP. 114	453	TRISTAR DATA SYS. 323
496	PERSONAL COMP AGE 261	*	ROLIN ASSOCIATES 528	424	STARWARE * 528	454	TSA PROFORMA 496
363	PERSONAL COMP.SYS. 461	394	RUPERT NEVE INC. 97	425	STATIC MEMORY SYS 407	*	TSC 227
364	PERSONAL SYS.TECHN. 341	395	S C DIGITAL 328	427	STROBE 279	455	U.S. MICRO SALES 540, 541
385	PHASE ONE SYS.INC. 377	*	S-100 INC 484	428	SUBLOGIC 228	456	U.S. ROBOTICS 451
366	PHONE I,INC. 188	398	S.P.C.TECH.INC. 449	429	SUNNY INT'L 511	457	VECTOR GRAPHICS 287
367	PICKLES & TROUT 388	397	SAGE COMP. TECH. 249	*	SUNTRONICS 439	458	VIDEX 21
*	POPULAR COMPUTING 417	398	SAGE ENTERPRISES INC. 528	7	SUPERLETTER 530	*	VISICORP INC. 85
368	PRACTICAL PERIPH. 24, 25	399	SANYO COMMUNICATIONS 307	430	SUPERSOFT 128, 129	459	VISTA COMPUTER CO 265
369	PRINTACOLOR 102	400	SCIENTIFIC ENG. 514	431	SYBEX 297	*	VR DATA 255
370	PRIORITY ONE 552, 553	401	SCIENTIFIC TECHNIQUES 520	432	SYNCOM 40	460	VYNET CORP. 450
371	PRIORITY ONE 554, 555	402	SCION CORP 5	495	SYS. DOCUMENTS 526	481	WALKER,WILLIAM 439
372	PRIORITY ONE 556, 557	403	SCITRONICS 243	433	SYSTEM SOLUTIONS 530	462	WAMECO 522
373	PROCESSOR INTERFACES INC. 516	*	SCM CORP. 333	434	SYSTEMED 512	463	WARN ELECTRONICS 518
374	PROF.AIDS 356	* SCOTTS DALE SYSTEMS 219	404	435	SYSTEMS GROUP, THE 29	464	WASHINGTON COMP.SERV. 517
375	PROFESSIONAL DATA SYS. 411	SCR ELECTR. 518	405	436	SYSTEMS GROUP, THE 29	485	WESPER MICRO SYSTEMS 226
376	PROGRAMMERS SOFT.EX. 16	406	SEATTLE COMP PRODS 179	437	SYSTEMS PLUS INC. 221	466	WESTSTAR MICRO 454
503	PROMETHEUS PROD. 289	406	SEIKO-SHA CORP. 257	438	SZ SOFTWARE SYSTEMS 530	487	WESTBROOK SEARCH INC. 530
*	PROMPT DOC.CO. 207	408	SHAPE INC. 472	439	TARBELL ELECTR. 127	468	WESTINGHOUSE/LIGHT.DIV. 389
377	PURCHASING AGENT,THE 144	409	SIERRA DATA SCIENCES 41	440	TECH ELECTRONICS 522	469	WESTWARE 20
378	QANTEX DIV. 91	410	SIGGRAPH '82 315	441	TECMAR INC 299	*	WHITESMITHS LTD 422
504	QUASAR CO. 393	411	SIGMA TEK 524	442	TECMAR INC 383	*	WICAT SYSTEMS 177
379	QUASAR DATA PROD.INC. 149	*	SINCLAIR RESEARCH 184, 185	443	TEKTRONIX INC. 105	471	WINCHENDON GRP.,THE 439
380	QUACES 187	412	SINGER CO. 431	169	TELECON SYSTEMS 530	472	WINTEX CORP. 439
381	QUEST ELECTR. 525	413	SLUDER 501	445	TELETEK 89	473	WINTERHALTER & ASSOC. 455
382	QUINTREX, INC. 518	414	SMOKE SIGNAL BRDCSTG 303	446	TELEVIDEO INC 188, 169	474	WW COMPONENT SUPPLY 521
383	QUME CORP. 95	415	SMOKE SIGNAL BRDCSTG 303	141	TERCER MEDIO 361	475	XANADU ENGINEERING 522
384	R.R. SOFTWARE 208	*	SOF/SYS.INC. 397	447	TERMINALS TERRIFIC 400	476	XAVAX CORP. 146
385	RACET COMPUTES 382	416	SOFTWARE DISTR. 359	448	TEXAS COMP.SYS. 401	*	XEDEX CORP. 172, 173
507	RACET COMPUTES 382	*	SOLID STATE SALES 511	449	THREE M COMPANY 175	477	XY LOGICS INC 300
386	RADIO SHACK CIV	417	SONICS MICRO SYS. 439	450	THREE M STATIC CONTROL 357	478	ZOBEX 189
387	RANA SYSTEMS 27	419	SORRENTO VALLEY ASSOC 350	*	TINNEY,RBT.GRAPHICS 433		
388	RCA 30	420	SOUTHERN COMP.SYS. 458	*	TRANS WORLD AIRLINES 317		
389	RCE 392	421	SSM MICRO COMP PROD 11	451	TRANSNET CORP. 398		
390	RED BARON COMP.PROD. 106, 107	*	STACKWORKS 230	452	TRAXX COMP.CORP. 151		
391	REITH,WALCOTT ENG. 494						
392	REMOTE EVOLUTIONARY COMP. 36						

\*Correspond directly with compan

### National Advertising Sales Representatives:

#### Northeast (617) 444-3946

ME, NH, VT, MA, CT, RI, DE, MD,  
VA, W/V, OK, TX, Upstate NY,  
Eastern Canada

#### Hajar Associates

280 Hillside Ave.  
Needham Heights, MA 02194

#### Mid Atlantic (201) 741-7744

NY, NYC, NJ, PA

#### Hajar Associates

321 Broad St.  
Red Bank, NJ 07701

#### Southeast (305) 628-3525

NC, SC, GA, FL, AL, MS, TN, KY

#### Hajar Associates

Diplomat Bldg.  
5400 Diplomat Circle  
Suite 272  
Orlando, FL 32810

#### Midwest (312) 966-0160

MN, WI, MI, IA, IL, IN, OH,  
MO, NE, KS, ND, SD, AR

#### Hajar Associates

5225 Old Orchard Rd.  
Suite 50  
Skokie, IL 60076

#### Northwest (415) 964-0706

AK, HI, WA, OR, ID, MT, WY,  
Northern California, Nevada Except  
Las Vegas, Western Canada

#### Hajar Associates

1000 Elwell Ct.  
Suite 124  
Palo Alto, CA 94303

#### Southwest (714) 540-3554

UT, CO, AZ, NM, Las Vegas,  
Southern California

#### Hajar Associates

3303 Harbor Blvd.  
Suite H-4A  
Costa Mesa, CA 92626

### European Advertising Sales Representatives:

Mr. Simon Smith  
McGraw-Hill Publishing Co.  
34 Dover St.  
London W1X 3RA  
England 1-493-1451

Mr. Andrew Karnig  
Andrew Karnig & Associates  
Kungsholmsgatan 10  
112 27 Stockholm, Sweden  
08/51-68-70

Mr. Hans Csokor  
Publimedia  
Reisnerstrasse 61  
A-1037 Vienna, Austria

Mr. Fritz Krusebecker  
McGraw-Hill Publishing Co.  
Lieblgstrasse 27C  
D-6000 Frankfurt/Main 1  
West Germany  
72-01-81

Mr. Michael Sales  
McGraw-Hill Publishing Co.  
17 rue Georges Bizet  
F 75116 Paris  
France  
720-33-42

Mr. Ello Gonzaga  
McGraw-Hill Publishing Co.  
Via Bracchini 1  
20123 Milan, Italy  
88-90-617

Mrs. Gurit Gepner  
McGraw-Hill Publishing Co.  
115 Yosephthal St.  
Bat Yam, Israel  
866-561

# SAVE 6 INCHES, 10 POUNDS, AND \$800.



On the new, slicked-up, trimmed-down Starwriter F-10.

It's C. Itoh's latest generation of letter-quality printers.

It cranks out flawless copy at 40 cps; and its full 15" carriage lets it double in brass for both letter processing and business applications. You can plug it into almost any micro on the market (serial or parallel) simply by plugging it in. And then make it keep on trucking with inexpensive, easily available Diablo com-

patible daisy wheels and ribbons.

In its serial mode, it can **print** just about anything (including boldface, underlines, subscripts and superscripts), and snap the carriage back to start the next line in less than a second. In its line mode, it prints in both directions, for even faster throughput.

(While making about as much noise as a cat walking on Kleenex.)

It's a nice, portable 30 pounds—about 10 pounds

lighter than the Starwriters before it. And it stands exactly as tall (or precisely as small) as a dollar bill.

**Speaking** of which:

**Incredibly**, the Starwriter F-10 sells for about the same preposterously low price as its predecessors. Which is to say, about \$800 less than a lot of other printers that don't even come close to measuring up. Or even better...

Measuring down.

*Distributed Exclusively by Leading Edge Products, Inc., 225 Turnpike Street, Canton, Massachusetts 02021. Call: toll-free 1-800-343-6833; or in Massachusetts call collect (617) 828-8150. Telex 951-624.*

**LEADING  
EDGE.**

Circle 261 on inquiry card.



# Radio Shack's TRS-80® is Your Best Choice in a First Computer

Why? Because you can start with our \$999 Model III and easily—and economically—expand into a powerful, professional system!



- Add Up to 4 Double-Density Disk Drives—2 Internally
- Go from 16K to 48K Memory
- Add RS-232-C Interface
- Or Get It All with Our \$2495 Model III Desktop Computer

A Radio Shack Model III is a versatile, self-contained computer that can grow with you. Whether you're a beginner or a pro, there's one that fits your budget and intended use. And features you'd expect to pay extra for are standard on Model III.

The built-in "extras". Our \$999 system includes: a 65-key keyboard with 12-key data pad, a 12" high-resolution monitor, and a parallel printer interface.

You get much more, including 16K memory, powerful Model III BASIC language, 500 and 1500 baud cassette operation, 16 lines of 64 or 32 upper and lower case characters, repeating keys, special graphics characters, program editor and real time clock.

Model III is ready for a wide range of professional and personal uses. Choose from our large library of user-proven programs or develop your own applications in easy-to-learn BASIC. Just add a cassette recorder to store and run programs and data. Cat. No. 26-1062. **\$999**

Choose our professional Model III Desktop Computer for more sophisticated applications. You get the same basic features as the smaller model, but with 48K internal memory, two built-in double-density mini disk drives for 368K of program and data storage and a built-in RS-232 Serial Interface to communicate with other computers using an optional telephone coupler, like our new Modem II (right). Our powerful disk operating system (TRSDOS) is included along with an expanded Disk BASIC language. And we have optional programming languages to meet specific needs—choose from COBOL, Assembler, Compiler BASIC and FORTRAN. And of course the smallest Model III can be upgraded to this top of the Model III line. **\$2495** Cat. No. 26-1066.

Get a "hands-on" demonstration of the TRS-80 Model III today at more than 240 Radio Shack Computer Centers and 6200 Radio Shack stores and participating dealers nationwide. Ask about our service and leasing plans, too.

## NEW! Direct-Connect Modem II Automatically Dials and Answers Phone



Connects Directly to Phone Line And Any RS-232-Equipped TRS-80

Now your TRS-80 can access and transfer data by telephone. Program the Modem II to dial and answer, receive and transmit, even hang-up. 300 baud. FCC registered. Cat. No. 26-1173. **\$249**

**Radio Shack®**  
The biggest name in little computers™  
A DIVISION OF TANDY CORPORATION

Send me a free TRS-80 catalog.

Mail To: Radio Shack  
Dept. 82-A-130  
1300 One Tandy Center  
Fort Worth, TX 76102

NAME \_\_\_\_\_  
COMPANY \_\_\_\_\_  
ADDRESS \_\_\_\_\_  
CITY \_\_\_\_\_  
STATE \_\_\_\_\_ ZIP \_\_\_\_\_

Retail prices may vary at individual stores and dealers.